

1. PRODUCT INFORMATON

Technical information	
Frequency Range	902-928MHz
Test Frequencies	902MHz, 915MHz, 928MHz,
Antenna Type	Whip Antenna
Dimensions	200mm
Impedance	50 Ω
Maximum test values	Gain: 3.5dBi; Efficiency:73.26%; VSWR:<2.0
Model	BDE-ANT868-20RP
Applicant	Guangzhou BDE Technology Inc.
Address	B2-403, Chuangyi Building, 162 Science Avenue, Huangpu District, Guangzhou 510663, China

2. PRODUCT PICTURE



3. TEST SUMMARY LIST

NO.	Test item	Remark
1	VSWR	--
2	Gain and efficiency	--
3	Radiation pattern	--

4. TEST SETUP

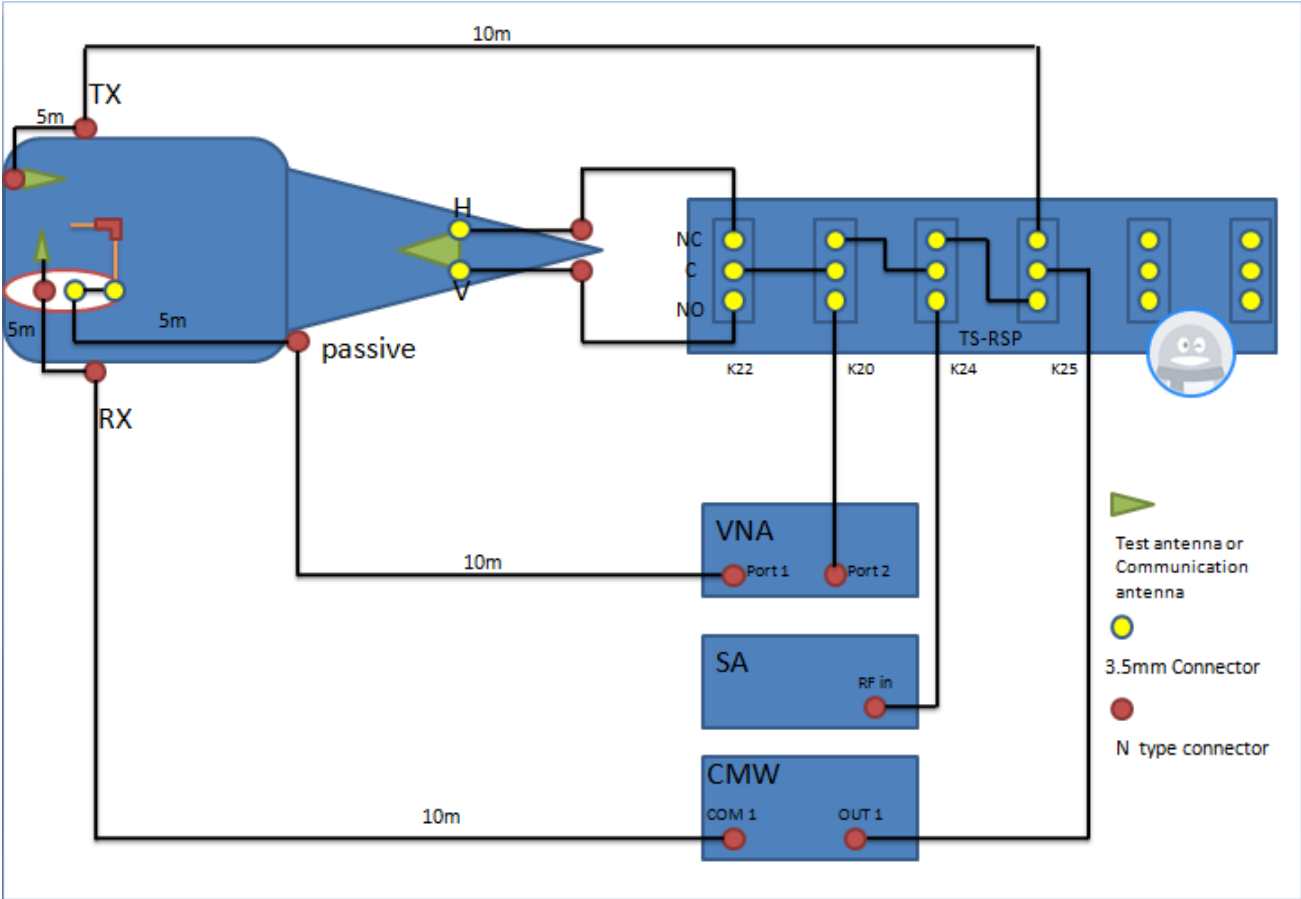
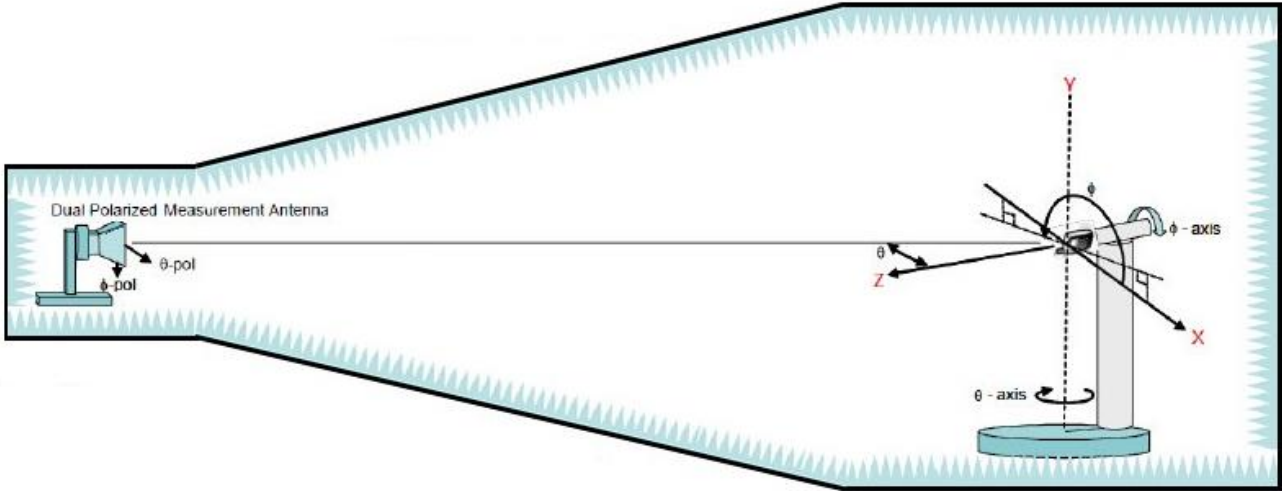

5.GAIN AND EFFICIENCY

Frequency(MHz)	Efficiency(dB)	Efficiency(%)	Gain(dBi)
902	-5.6985	54.99	2.68
915	-8.1221	73.26	3.50
928	-12.339	69.02	2.97

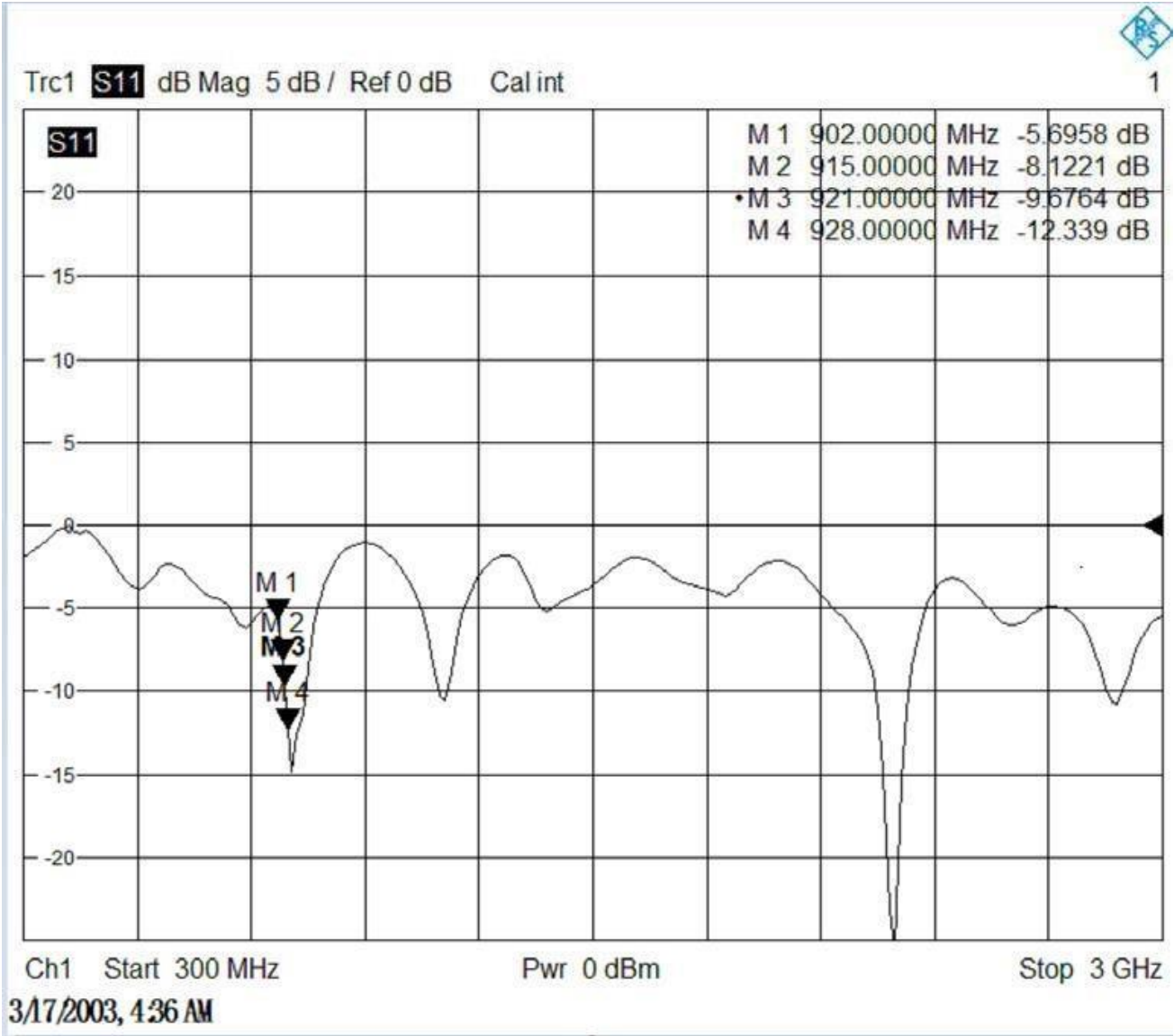

5.3. RADIATION PATTERN

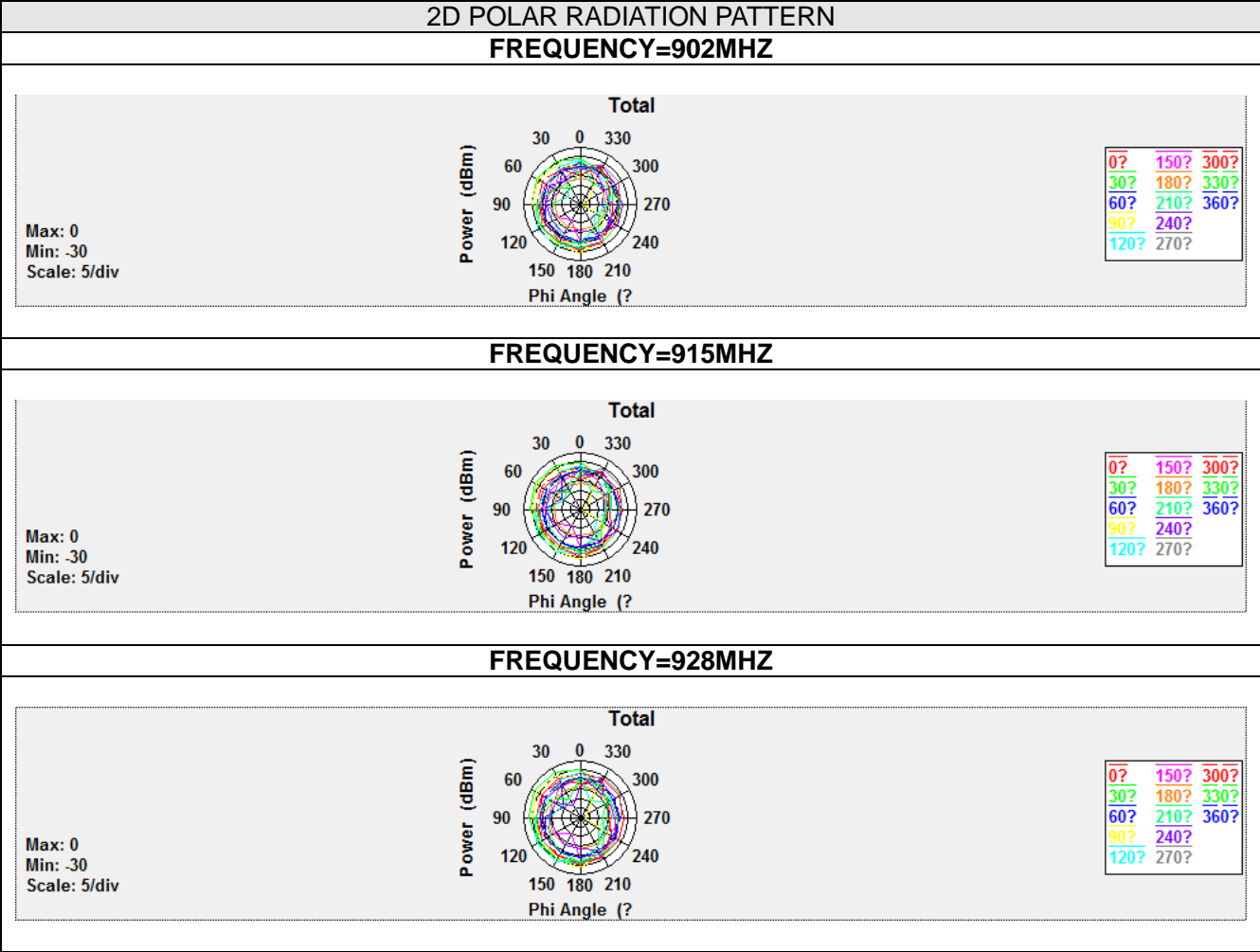

3D RADIATION PATTERN
FREQUENCY=902MHZ

Total

Azimuth = 0.0
Elevation = 0.0
Roll = 0.0

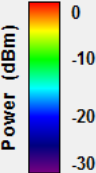
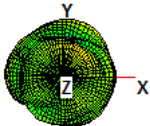

FREQUENCY=915MHZ

Total

Azimuth = 0.0
Elevation = 0.0
Roll = 0.0

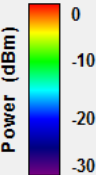
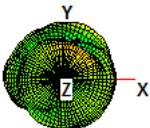

FREQUENCY=920MHZ

Total

Azimuth = 0.0
Elevation = 0.0
Roll = 0.0

