

# ELECTROMAGNETIC EMISSIONS COMPLIANCE REPORT

## INTENTIONAL RADIATOR CERTIFICATION TO FCC PART 15 SUBPART C AND RSS 247 REQUIREMENT

OF

**Product Name:** Blood Pressure Monitor  
**Brand Name:** Braun  
**Model No.:** BUA7200  
**Model Difference:** N/A  
**FCC ID:** 2ABRGBUA7200  
**IC:** 11714A-BUA7200  
**Report No.:** E2/2017/70029  
**Issue Date:** Aug. 17, 2017  
**FCC Rule Part:** §15.247, Cat: DTS  
**IC Rule:** RSS-247 issue 2 Feb. 2017  
**Prepared for:** Kaz USA, Inc (Helen of Troy, Home and Health)  
 400 Donald Lynch BLVD, suite 300, Marlborough, MA 01752  
**Prepared by:** SGS Taiwan Ltd.  
 Electronics & Communication Laboratory  
 No.2, Keji 1st Rd., Guishan District, Taoyuan City, Taiwan 333

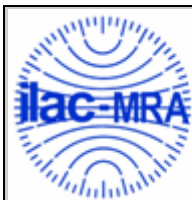

**Note:** This report shall not be reproduced except in full, without the written approval of SGS Taiwan Ltd. This document may be altered or revised by SGS Taiwan Ltd. personnel only, and shall be noted in the revision section of the document.

Unless otherwise stated the results shown in this test report refer only to the sample(s) tested and such sample(s) are retained for 90 days only.

除非另有說明，此報告結果僅對測試之樣品負責，同時此樣品僅保留90天。本報告未經本公司書面許可，不可部份複製。

This document is issued by the Company subject to its General Conditions of Service printed overleaf, available on request or accessible at [www.sgs.com/terms\\_and\\_conditions.htm](http://www.sgs.com/terms_and_conditions.htm) and, for electronic format documents, subject to Terms and Conditions for Electronic Documents at [www.sgs.com/terms\\_e-document.htm](http://www.sgs.com/terms_e-document.htm). Attention is drawn to the limitation of liability, indemnification and jurisdiction issues defined therein. Any holder of this document is advised that information contained hereon reflects the Company's findings at the time of its intervention only and within the limits of Client's instructions, if any. The Company's sole responsibility is to its Client and this document does not exonerate parties to a transaction from exercising all their rights and obligations under the transaction documents. This document cannot be reproduced except in full, without prior written approval of the Company. Any unauthorized alteration, forgery or falsification of the content or appearance of this document is unlawful and offenders may be prosecuted to the fullest extent of the law.

SGS Taiwan Ltd.

No.134,WuKungRoad,NewTaipeiIndustrialPark,WukuDistrict,NewTaipeiCity,Taiwan24803/新北市五股區新北產業園區五工路 134 號

台灣檢驗科技股份有限公司

t (886-2) 2299-3279

f (886-2) 2298-0488

www.tw.sgs.com

Member of SGS Group

## VERIFICATION OF COMPLIANCE

**Applicant:** Kaz USA, Inc (Helen of Troy, Home and Health)  
 400 Donald Lynch BLVD, suite 300, Marlborough, MA 01752

**Product Name:** Blood Pressure Monitor

**Brand Name:** Braun

**Model No.:** BUA7200

**Model Difference:** N/A

**FCC ID:** 2ABRGBUA7200

**IC:** 11714A-BUA7200

**Report Number:** E2/2017/70029

**Date of test:** Jul. 31, 2017(Conducted), Aug. 04, 2017(Radiated)

**Date of EUT Received:** Jul. 05, 2017

### We hereby certify that:

The above equipment was tested by SGS Taiwan Ltd. Electronics & Communication Laboratory The test data, data evaluation, test procedures, and equipment configurations shown in this report were made in accordance with the procedures given in ANSI C63.10:2013 and the energy emitted by the sample EUT tested as described in this report is in compliance with conducted and radiated emission limits.

The test results of this report relate only to the tested sample identified in this report.

**Test By:**  **Date** Aug. 17, 2017

**Vito Pei/ Engineer**

**Prepared By:**  **Date** Aug. 17, 2017

**Stefanie Yu/ Clerk**

**Approved By:**  **Date** Aug. 17, 2017

**Jim Chang / Asst. Manager**

Unless otherwise stated the results shown in this test report refer only to the sample(s) tested and such sample(s) are retained for 90 days only.

除非另有說明，此報告結果僅對測試之樣品負責，同時此樣品僅保留90天。本報告未經本公司書面許可，不可部份複製。

This document is issued by the Company subject to its General Conditions of Service printed overleaf, available on request or accessible at [www.sgs.com/terms\\_and\\_conditions.htm](http://www.sgs.com/terms_and_conditions.htm) and, for electronic format documents, subject to Terms and Conditions for Electronic Documents at [www.sgs.com/terms\\_e-document.htm](http://www.sgs.com/terms_e-document.htm). Attention is drawn to the limitation of liability, indemnification and jurisdiction issues defined therein. Any holder of this document is advised that information contained hereon reflects the Company's findings at the time of its intervention only and within the limits of Client's instructions, if any. The Company's sole responsibility is to its Client and this document does not exonerate parties to a transaction from exercising all their rights and obligations under the transaction documents. This document cannot be reproduced except in full, without prior written approval of the Company. Any unauthorized alteration, forgery or falsification of the content or appearance of this document is unlawful and offenders may be prosecuted to the fullest extent of the law.

## Revision History

Report Number	Revision	Description	Issue Date
E2/2017/70029	Rev.00	Initial creation of document	Aug. 17, 2017

Unless otherwise stated the results shown in this test report refer only to the sample(s) tested and such sample(s) are retained for 90 days only.

除非另有說明，此報告結果僅對測試之樣品負責，同時此樣品僅保留90天。本報告未經本公司書面許可，不可部份複製。

This document is issued by the Company subject to its General Conditions of Service printed overleaf, available on request or accessible at [www.sgs.com/terms\\_and\\_conditions.htm](http://www.sgs.com/terms_and_conditions.htm) and, for electronic format documents, subject to Terms and Conditions for Electronic Documents at [www.sgs.com/terms\\_e-document.htm](http://www.sgs.com/terms_e-document.htm). Attention is drawn to the limitation of liability, indemnification and jurisdiction issues defined therein. Any holder of this document is advised that information contained hereon reflects the Company's findings at the time of its intervention only and within the limits of Client's instructions, if any. The Company's sole responsibility is to its Client and this document does not exonerate parties to a transaction from exercising all their rights and obligations under the transaction documents. This document cannot be reproduced except in full, without prior written approval of the Company. Any unauthorized alteration, forgery or falsification of the content or appearance of this document is unlawful and offenders may be prosecuted to the fullest extent of the law.

SGS Taiwan Ltd.

No.134,WuKungRoad,NewTaipeiIndustrialPark,WukuDistrict,NewTaipeiCity,Taiwan24803/新北市五股區新北產業園區五工路 134 號

台灣檢驗科技股份有限公司

t (886-2) 2299-3279

f (886-2) 2298-0488

[www.tw.sgs.com](http://www.tw.sgs.com)

Member of SGS Group

## Table of Contents

1	GENERAL INFORMATION .....	5
2	SYSTEM TEST CONFIGURATION .....	7
3	SUMMARY OF TEST RESULTS .....	9
4	DESCRIPTION OF TEST MODES.....	9
5	MEASUREMENT UNCERTAINTY .....	11
6	CONDUCTED EMISSION TEST.....	12
7	PEAK OUTPUT POWER MEASUREMENT .....	14
8	6dB & 99% BANDWIDTH MEASUREMENT.....	17
9	CONDUCTED BAND EDGES AND SPURIOUS EMISSION MEASUREMENT .....	20
10	RADIATED BANDEDGE AND SPURIOUS EMISSION MEASUREMENT.....	28
11	PEAK POWER SPECTRAL DENSITY .....	49
12	ANTENNA REQUIREMENT.....	52
	PHOTOGRAPHS OF EUT .....	52

Unless otherwise stated the results shown in this test report refer only to the sample(s) tested and such sample(s) are retained for 90 days only.

除非另有說明，此報告結果僅對測試之樣品負責，同時此樣品僅保留90天。本報告未經本公司書面許可，不可部份複製。

This document is issued by the Company subject to its General Conditions of Service printed overleaf, available on request or accessible at [www.sgs.com/terms\\_and\\_conditions.htm](http://www.sgs.com/terms_and_conditions.htm) and, for electronic format documents, subject to Terms and Conditions for Electronic Documents at [www.sgs.com/terms\\_e-document.htm](http://www.sgs.com/terms_e-document.htm). Attention is drawn to the limitation of liability, indemnification and jurisdiction issues defined therein. Any holder of this document is advised that information contained hereon reflects the Company's findings at the time of its intervention only and within the limits of Client's instructions, if any. The Company's sole responsibility is to its Client and this document does not exonerate parties to a transaction from exercising all their rights and obligations under the transaction documents. This document cannot be reproduced except in full, without prior written approval of the Company. Any unauthorized alteration, forgery or falsification of the content or appearance of this document is unlawful and offenders may be prosecuted to the fullest extent of the law.

SGS Taiwan Ltd.

No.134,WuKungRoad,NewTaipeiIndustrialPark,WukuDistrict,NewTaipeiCity,Taiwan24803/新北市五股區新北產業園區五工路 134 號

台灣檢驗科技股份有限公司

t (886-2) 2299-3279

f (886-2) 2298-0488

[www.tw.sgs.com](http://www.tw.sgs.com)

Member of SGS Group

# 1 GENERAL INFORMATION

## 1.1 Product Description

General:

Product Name:	Blood Pressure Monitor
Brand Name:	Braun
Model No.:	BUA7200
Model Difference:	N/A
Product SW/HW version:	N/A/ N/A
Radio SW/HW version:	N/A/ N/A
Test SW Version:	N/A
RF power setting in TEST SW:	N/A
Power Supply:	3Vdc from AA battery

Bluetooth Low Energy:

Frequency Range:	2402 – 2480MHz
Bluetooth Version:	Bluetooth V4.0
Channel number:	40 channels
Modulation type:	GFSK
Transmit Power:	-0.81 dBm
Antenna Designation:	Internal Antenna, Gain: 0.84dBi

Unless otherwise stated the results shown in this test report refer only to the sample(s) tested and such sample(s) are retained for 90 days only.

除非另有說明，此報告結果僅對測試之樣品負責，同時此樣品僅保留90天。本報告未經本公司書面許可，不可部份複製。

This document is issued by the Company subject to its General Conditions of Service printed overleaf, available on request or accessible at [www.sgs.com/terms\\_and\\_conditions.htm](http://www.sgs.com/terms_and_conditions.htm) and, for electronic format documents, subject to Terms and Conditions for Electronic Documents at [www.sgs.com/terms\\_e-document.htm](http://www.sgs.com/terms_e-document.htm). Attention is drawn to the limitation of liability, indemnification and jurisdiction issues defined therein. Any holder of this document is advised that information contained hereon reflects the Company's findings at the time of its intervention only and within the limits of Client's instructions, if any. The Company's sole responsibility is to its Client and this document does not exonerate parties to a transaction from exercising all their rights and obligations under the transaction documents. This document cannot be reproduced except in full, without prior written approval of the Company. Any unauthorized alteration, forgery or falsification of the content or appearance of this document is unlawful and offenders may be prosecuted to the fullest extent of the law.

SGS Taiwan Ltd.

No.134,WuKungRoad,NewTaipeiIndustrialPark,WukuDistrict,NewTaipeiCity,Taiwan24803/新北市五股區新北產業園區五工路 134 號

台灣檢驗科技股份有限公司

t (886-2) 2299-3279

f (886-2) 2298-0488

www.tw.sgs.com

Member of SGS Group

## 1.2 Test Methodology of Applied Standards

FCC Part 15, Subpart C §15.247

FCC KDB 558074 D01 DTS Meas. Guidance v04

RSS-247 issue 2 Feb. 2017

Canada RSS-Gen issue 4: 2014

ANSI C63.10:2013

**Note:** All test items have been performed and record as per the above standards.

## 1.3 Test Facility

SGS Taiwan Ltd. Electronics & Communication Laboratory No.2, Keji 1st Rd.,  
Guishan District, Taoyuan City, Taiwan 333 (TAF code 0513)

FCC Registration Numbers are: 735305 / TW0002

Canada Registration Number: 4620A-5

## 1.4 Special Accessories

There are no special accessories used while test was conducted.

## 1.5 Equipment Modifications

There was no modification incorporated into the EUT.

Unless otherwise stated the results shown in this test report refer only to the sample(s) tested and such sample(s) are retained for 90 days only.

除非另有說明，此報告結果僅對測試之樣品負責，同時此樣品僅保留90天。本報告未經本公司書面許可，不可部份複製。

This document is issued by the Company subject to its General Conditions of Service printed overleaf, available on request or accessible at [www.sgs.com/terms\\_and\\_conditions.htm](http://www.sgs.com/terms_and_conditions.htm) and, for electronic format documents, subject to Terms and Conditions for Electronic Documents at [www.sgs.com/terms\\_e-document.htm](http://www.sgs.com/terms_e-document.htm). Attention is drawn to the limitation of liability, indemnification and jurisdiction issues defined therein. Any holder of this document is advised that information contained hereon reflects the Company's findings at the time of its intervention only and within the limits of Client's instructions, if any. The Company's sole responsibility is to its Client and this document does not exonerate parties to a transaction from exercising all their rights and obligations under the transaction documents. This document cannot be reproduced except in full, without prior written approval of the Company. Any unauthorized alteration, forgery or falsification of the content or appearance of this document is unlawful and offenders may be prosecuted to the fullest extent of the law.

SGS Taiwan Ltd.

No.134,WuKungRoad,NewTaipeiIndustrialPark,WukuDistrict,NewTaipeiCity,Taiwan24803/新北市五股區新北產業園區五工路 134 號

台灣檢驗科技股份有限公司

t (886-2) 2299-3279

f (886-2) 2298-0488

[www.tw.sgs.com](http://www.tw.sgs.com)

Member of SGS Group

## 2 SYSTEM TEST CONFIGURATION

### 2.1 EUT Configuration

The EUT configuration for testing is installed on RF field strength measurement to meet the Commissions requirement and operating in a manner which intends to maximize its emission characteristics in a continuous normal application.

### 2.2 EUT Exercise

An engineering test mode (software/firmware) that applicant provided was utilized to manipulate the EUT into transmit, selection of the test channel, and modulation scheme.

### 2.3 Test Procedure

#### 2.3.1 Conducted Emissions

The EUT is a placed on as turn table which is 0.8 m above ground plan. Conducted emissions from the EUT measured in the frequency range between 0.15 MHz and 30MHz,. The CISPR Quasi-Peak and Average detector mode is employed according to §15.207. The two LISNs provide 50 ohm/ 50uH of coupling impedance for the measuring instrument. Both lines of the power mains connected to the EUT were checked for maximum conducted interference.

#### 2.3.2 Radiated Emissions

The EUT is a placed on as turn table. For emissions testing at or below 1 GHz, the table height shall be 0.8 m above the reference ground plan. For emission measurements above 1 GHz, the table height shall be 1.5 m. The turn table shall rotate 360 degrees to determine the position of maximum emission level. EUT is set 3m away from the receiving antenna which varied from 1m to 4m to find out the highest emission. And also, each emission was to be maximized by changing the polarization of receiving antenna both horizontal and vertical. In order to find out the max. emission, the relative positions of this transmitter (EUT) was rotated through three orthogonal axes and measurement procedures for electric field radiated emissions above 1 GHz the EUT measurement is to be made “while keeping the antenna in the ‘cone of radiation’ from that area and pointed at the area both in azimuth and elevation, with polarization oriented for maximum response.” is still within the 3dB illumination BW of the measurement antenna.

### 2.4 Measurement Results Explanation Example

#### For all conducted test items:

The offset level is set in the spectrum analyzer to compensate the RF cable loss and attenuation factor between EUT conducted port and spectrum analyzer. With the offset compensation, the spectrum analyzer reading level is exactly EUT RF output level.

**Note:** The spectrum analyzer offset is =1.4dB.

Unless otherwise stated the results shown in this test report refer only to the sample(s) tested and such sample(s) are retained for 90 days only.

除非另有說明，此報告結果僅對測試之樣品負責，同時此樣品僅保留90天。本報告未經本公司書面許可，不可部份複製。

This document is issued by the Company subject to its General Conditions of Service printed overleaf, available on request or accessible at [www.sgs.com/terms\\_and\\_conditions.htm](http://www.sgs.com/terms_and_conditions.htm) and, for electronic format documents, subject to Terms and Conditions for Electronic Documents at [www.sgs.com/terms\\_e-document.htm](http://www.sgs.com/terms_e-document.htm). Attention is drawn to the limitation of liability, indemnification and jurisdiction issues defined therein. Any holder of this document is advised that information contained hereon reflects the Company's findings at the time of its intervention only and within the limits of Client's instructions, if any. The Company's sole responsibility is to its Client and this document does not exonerate parties to a transaction from exercising all their rights and obligations under the transaction documents. This document cannot be reproduced except in full, without prior written approval of the Company. Any unauthorized alteration, forgery or falsification of the content or appearance of this document is unlawful and offenders may be prosecuted to the fullest extent of the law.

## 2.5 Configuration of Tested System

**Fig. 2-1 Radiated Emission Conducted (Antenna Port) Configuration**



**Fig 2-2 Conducted (AC power line) Configuration**

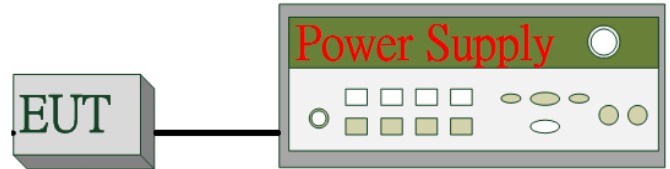

**Table 2-1 Equipment Used in Tested System**

Item	Equipment	Mfr/Brand	Model/Type No.	Series No.	Data Cable	Power Cord
1	Bluetooth Test Software	N/A	N/A	N/A	N/A	N/A
2	DC Power Supply	Agilent	E3640A	MY53140006	N/A	N/A

Unless otherwise stated the results shown in this test report refer only to the sample(s) tested and such sample(s) are retained for 90 days only.

除非另有說明，此報告結果僅對測試之樣品負責，同時此樣品僅保留90天。本報告未經本公司書面許可，不可部份複製。

This document is issued by the Company subject to its General Conditions of Service printed overleaf, available on request or accessible at [www.sgs.com/terms\\_and\\_conditions.htm](http://www.sgs.com/terms_and_conditions.htm) and, for electronic format documents, subject to Terms and Conditions for Electronic Documents at [www.sgs.com/terms\\_e-document.htm](http://www.sgs.com/terms_e-document.htm). Attention is drawn to the limitation of liability, indemnification and jurisdiction issues defined therein. Any holder of this document is advised that information contained hereon reflects the Company's findings at the time of its intervention only and within the limits of Client's instructions, if any. The Company's sole responsibility is to its Client and this document does not exonerate parties to a transaction from exercising all their rights and obligations under the transaction documents. This document cannot be reproduced except in full, without prior written approval of the Company. Any unauthorized alteration, forgery or falsification of the content or appearance of this document is unlawful and offenders may be prosecuted to the fullest extent of the law.

SGS Taiwan Ltd.

No.134,WuKungRoad,NewTaipeiIndustrialPark,WukuDistrict,NewTaipeiCity,Taiwan24803/新北市五股區新北產業園區五工路 134 號

台灣檢驗科技股份有限公司

t (886-2) 2299-3279

f (886-2) 2298-0488

[www.tw.sgs.com](http://www.tw.sgs.com)

Member of SGS Group



### 3 SUMMARY OF TEST RESULTS

FCC Rules	IC Rules	Description Of Test	Result
§15.207(a)	RSS-Gen §8.8	AC Power Line Conducted Emission	N/A
§15.247(b) (3)	RSS-247 §5.4(4)	Peak Output Power	Compliant
§15.247(a)(2)	RSS-247 §5.2 (1) RSS-Gen §6.6	6dB & 99% Bandwidth	Compliant
§15.247(d)	RSS-247 §5.5	Conducted Band Edge and Spurious Emission	Compliant
§15.247(d)	RSS-247 §5.5	Radiated Band Edge and Spurious Emission	Compliant
§15.247(e)	RSS-247 §5.2(2)	Peak Power Density	Compliant
§15.203 §15.247(b)	RSS- Gen §8.3	Antenna Requirement	Compliant

### 4 DESCRIPTION OF TEST MODES

#### 4.1 Operated in 2400 ~ 2483.5MHz Band

40 channels are provided for Bluetooth LE

CHANNEL	FREQUENCY	CHANNEL	FREQUENCY	CHANNEL	FREQUENCY
0	2402 MHz	14	2430 MHz	28	2458 MHz
1	2404 MHz	15	2432 MHz	29	2460 MHz
2	2406 MHz	16	2434 MHz	30	2462 MHz
3	2408 MHz	17	2436 MHz	31	2464 MHz
4	2410 MHz	18	2438 MHz	32	2466 MHz
5	2412 MHz	19	2440 MHz	33	2468 MHz
6	2414 MHz	20	2442 MHz	34	2470 MHz
7	2416MHz	21	2444 MHz	35	2472 MHz
8	2418 MHz	22	2446 MHz	36	2474 MHz
9	2420 MHz	23	2448 MHz	37	2476 MHz
10	2422 MHz	24	2450 MHz	38	2478 MHz
11	2424 MHz	25	2452 MHz	39	2480 MHz
12	2426 MHz	26	2454 MHz		
13	2428 MHz	27	2456 MHz		

Unless otherwise stated the results shown in this test report refer only to the sample(s) tested and such sample(s) are retained for 90 days only.

除非另有說明，此報告結果僅對測試之樣品負責，同時此樣品僅保留90天。本報告未經本公司書面許可，不可部份複製。

This document is issued by the Company subject to its General Conditions of Service printed overleaf, available on request or accessible at [www.sgs.com/terms\\_and\\_conditions.htm](http://www.sgs.com/terms_and_conditions.htm) and, for electronic format documents, subject to Terms and Conditions for Electronic Documents at [www.sgs.com/terms\\_e-document.htm](http://www.sgs.com/terms_e-document.htm). Attention is drawn to the limitation of liability, indemnification and jurisdiction issues defined therein. Any holder of this document is advised that information contained hereon reflects the Company's findings at the time of its intervention only and within the limits of Client's instructions, if any. The Company's sole responsibility is to its Client and this document does not exonerate parties to a transaction from exercising all their rights and obligations under the transaction documents. This document cannot be reproduced except in full, without prior written approval of the Company. Any unauthorized alteration, forgery or falsification of the content or appearance of this document is unlawful and offenders may be prosecuted to the fullest extent of the law.

#### 4.2 The Worst Test Modes and Channel Details

1. The EUT has been tested under operating condition.
2. Test program used to control the EUT for staying in continuous transmitting and receiving mode is programmed.

#### RADIATED EMISSION TEST:

RADIATED EMISSION TEST (BELOW 1 GHz)				
MODE	AVAILABLE CHANNEL	TESTED CHANNEL	MODULATION	DATA RATE (Mbps)
Bluetooth LE	0 to 39	0,20,39	GFSK	1
RADIATED EMISSION TEST (ABOVE 1 GHz)				
MODE	AVAILABLE CHANNEL	TESTED CHANNEL	MODULATION	DATA RATE (Mbps)
Bluetooth LE	0 to 39	0,20,39	GFSK	1

#### Note:

The field strength of radiation emission was measured as EUT stand-up position (H mode) and lie down position (E1, E2 mode) for Bluetooth LE Transmitter for channel Low, Mid and High, the worst case H position was reported.

#### ANTENNA PORT CONDUCTED MEASUREMENT:

CONDUCTED TEST				
MODE	AVAILABLE CHANNEL	TESTED CHANNEL	MODULATION	DATA RATE (Mbps)
Bluetooth LE	0 to 39	0,20,39	GFSK	1

Unless otherwise stated the results shown in this test report refer only to the sample(s) tested and such sample(s) are retained for 90 days only.

除非另有說明，此報告結果僅對測試之樣品負責，同時此樣品僅保留90天。本報告未經本公司書面許可，不可部份複製。

This document is issued by the Company subject to its General Conditions of Service printed overleaf, available on request or accessible at [www.sgs.com/terms\\_and\\_conditions.htm](http://www.sgs.com/terms_and_conditions.htm) and, for electronic format documents, subject to Terms and Conditions for Electronic Documents at [www.sgs.com/terms\\_e-document.htm](http://www.sgs.com/terms_e-document.htm). Attention is drawn to the limitation of liability, indemnification and jurisdiction issues defined therein. Any holder of this document is advised that information contained hereon reflects the Company's findings at the time of its intervention only and within the limits of Client's instructions, if any. The Company's sole responsibility is to its Client and this document does not exonerate parties to a transaction from exercising all their rights and obligations under the transaction documents. This document cannot be reproduced except in full, without prior written approval of the Company. Any unauthorized alteration, forgery or falsification of the content or appearance of this document is unlawful and offenders may be prosecuted to the fullest extent of the law.

SGS Taiwan Ltd.

No.134,WuKungRoad,NewTaipeiIndustrialPark,WukuDistrict,NewTaipeiCity,Taiwan24803/新北市五股區新北產業園區五工路134號

台灣檢驗科技股份有限公司

t (886-2) 2299-3279

f (886-2) 2298-0488

www.tw.sgs.com

Member of SGS Group

## 5 MEASUREMENT UNCERTAINTY

Test Items	Uncertainty
AC Power Line Conducted Emission	+/- 2.586 dB
Peak Output Power	+/- 0.84 dB
6dB Bandwidth	+/- 51.33 Hz
100 KHz Bandwidth Of Frequency Band Edges	+/- 0.84 dB
Peak Power Density	+/- 1.3 dB
Temperature	+/- 0.65 °C
Humidity	+/- 4.6 %
DC / AC Power Source	DC= +/- 0.13%, AC= +/- 0.2%

Radiated Spurious Emission:

Measurement uncertainty (Polarization : <b>Vertical</b> )	9kHz – 30MHz: +/- 2.87 dB
	30MHz - 180MHz: +/- 3.37dB
	180MHz -417MHz: +/- 3.19dB
	0.417GHz-1GHz: +/- 3.19dB
	1GHz - 18GHz: +/- 4.04dB
	18GHz - 40GHz: +/- 4.04dB

Measurement uncertainty (Polarization : <b>Horizontal</b> )	9kHz – 30MHz: +/- 2.87 dB
	30MHz - 167MHz: +/- 4.22dB
	167MHz -500MHz: +/- 3.44dB
	0.5GHz-1GHz: +/- 3.39dB
	1GHz - 18GHz: +/- 4.08dB
	18GHz - 40GHz: +/- 4.08dB

This uncertainty represents an expanded uncertainty expressed at approximately the 95% confidence level using a coverage factor of k=2.

Unless otherwise stated the results shown in this test report refer only to the sample(s) tested and such sample(s) are retained for 90 days only.

除非另有說明，此報告結果僅對測試之樣品負責，同時此樣品僅保留90天。本報告未經本公司書面許可，不可部份複製。

This document is issued by the Company subject to its General Conditions of Service printed overleaf, available on request or accessible at [www.sgs.com/terms\\_and\\_conditions.htm](http://www.sgs.com/terms_and_conditions.htm) and, for electronic format documents, subject to Terms and Conditions for Electronic Documents at [www.sgs.com/terms\\_e-document.htm](http://www.sgs.com/terms_e-document.htm). Attention is drawn to the limitation of liability, indemnification and jurisdiction issues defined therein. Any holder of this document is advised that information contained hereon reflects the Company's findings at the time of its intervention only and within the limits of Client's instructions, if any. The Company's sole responsibility is to its Client and this document does not exonerate parties to a transaction from exercising all their rights and obligations under the transaction documents. This document cannot be reproduced except in full, without prior written approval of the Company. Any unauthorized alteration, forgery or falsification of the content or appearance of this document is unlawful and offenders may be prosecuted to the fullest extent of the law.

SGS Taiwan Ltd.

No.134,WuKungRoad,NewTaipeiIndustrialPark,WukuDistrict,NewTaipeiCity,Taiwan24803/新北市五股區新北產業園區五工路 134 號

台灣檢驗科技股份有限公司

t (886-2) 2299-3279

f (886-2) 2298-0488

www.tw.sgs.com

Member of SGS Group

## 6 CONDUCTED EMISSION TEST

### 6.1 Standard Applicable:

Frequency range within 150kHz to 30MHz shall not exceed the Limit table as below.

Frequency range MHz	Limits dB(uV)	
	Quasi-peak	Average
0.15 to 0.50	66 to 56	56 to 46
0.50 to 5	56	46
5 to 30	60	50

Note

- 1.The lower limit shall apply at the transition frequencies
- 2.The limit decreases linearly with the logarithm of the frequency in the range 0.15 MHz to 0.50 MHz.

### 6.2 Measurement Equipment Used:

Conducted Emission Test Site					
EQUIPMENT TYPE	MFR	MODEL NUMBER	SERIAL NUMBER	LAST CAL.	CAL DUE.
EMI Test Receiver	R&S	ESCI 7	100950	12/12/2016	12/11/2017
Coaxial Cables	N/A	N30N30-1042-150cm	N/A	08/30/2016	08/29/2017
LISN	Schwarzbeck	NSLK 8127	8127-648	06/18/2017	06/17/2018
Test Software	Farad	EZ-EMC	Ver. SGS-03A2	N.C.R.	N.C.R.

### 6.3 EUT Setup:

1. The conducted emission tests were performed in the test site, using the setup in accordance with the ANSI C63.10:2013.
2. The AC/DC Power adaptor of EUT was plug-in LISN. The EUT was placed flushed with the rear of the table.
3. The LISN was connected with 120Vac/60Hz power source.

Unless otherwise stated the results shown in this test report refer only to the sample(s) tested and such sample(s) are retained for 90 days only.

除非另有說明，此報告結果僅對測試之樣品負責，同時此樣品僅保留90天。本報告未經本公司書面許可，不可部份複製。

This document is issued by the Company subject to its General Conditions of Service printed overleaf, available on request or accessible at [www.sgs.com/terms\\_and\\_conditions.htm](http://www.sgs.com/terms_and_conditions.htm) and, for electronic format documents, subject to Terms and Conditions for Electronic Documents at [www.sgs.com/terms\\_e-document.htm](http://www.sgs.com/terms_e-document.htm). Attention is drawn to the limitation of liability, indemnification and jurisdiction issues defined therein. Any holder of this document is advised that information contained hereon reflects the Company's findings at the time of its intervention only and within the limits of Client's instructions, if any. The Company's sole responsibility is to its Client and this document does not exonerate parties to a transaction from exercising all their rights and obligations under the transaction documents. This document cannot be reproduced except in full, without prior written approval of the Company. Any unauthorized alteration, forgery or falsification of the content or appearance of this document is unlawful and offenders may be prosecuted to the fullest extent of the law.

SGS Taiwan Ltd.

台灣檢驗科技股份有限公司

No.134,WuKungRoad,NewTaipeiIndustrialPark,WukuDistrict,NewTaipeiCity,Taiwan24803/新北市五股區新北產業園區五工路 134 號

t (886-2) 2299-3279

f (886-2) 2298-0488

www.tw.sgs.com

Member of SGS Group

#### 6.4 Test SET-UP (Block Diagram of Configuration)

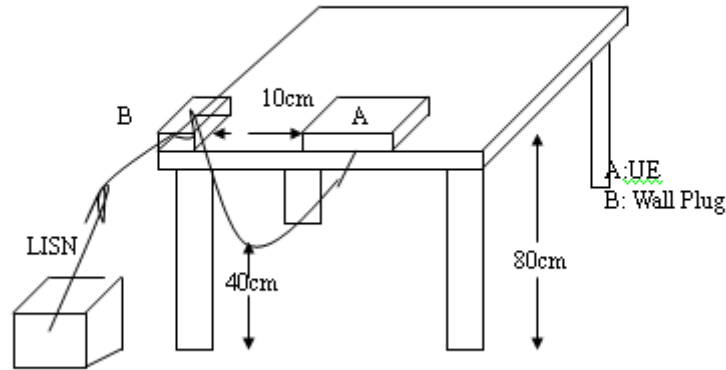

#### 6.5 Measurement Procedure:

1. The EUT was placed on a table which is 0.8m above ground plan.
2. Maximum procedure was performed on the six highest emissions to ensure EUT compliance.
3. Repeat above procedures until all phases of power being supplied by given UE are completed

#### 6.6 Measurement Result:

N/A, the device is powered from 3Vdc from AA battery.

Unless otherwise stated the results shown in this test report refer only to the sample(s) tested and such sample(s) are retained for 90 days only.

除非另有說明，此報告結果僅對測試之樣品負責，同時此樣品僅保留90天。本報告未經本公司書面許可，不可部份複製。

This document is issued by the Company subject to its General Conditions of Service printed overleaf, available on request or accessible at [www.sgs.com/terms\\_and\\_conditions.htm](http://www.sgs.com/terms_and_conditions.htm) and, for electronic format documents, subject to Terms and Conditions for Electronic Documents at [www.sgs.com/terms\\_e-document.htm](http://www.sgs.com/terms_e-document.htm). Attention is drawn to the limitation of liability, indemnification and jurisdiction issues defined therein. Any holder of this document is advised that information contained hereon reflects the Company's findings at the time of its intervention only and within the limits of Client's instructions, if any. The Company's sole responsibility is to its Client and this document does not exonerate parties to a transaction from exercising all their rights and obligations under the transaction documents. This document cannot be reproduced except in full, without prior written approval of the Company. Any unauthorized alteration, forgery or falsification of the content or appearance of this document is unlawful and offenders may be prosecuted to the fullest extent of the law.

SGS Taiwan Ltd.

No.134,WuKungRoad,NewTaipeiIndustrialPark,WukuDistrict,NewTaipeiCity,Taiwan24803/新北市五股區新北產業園區五工路 134 號

台灣檢驗科技股份有限公司

t (886-2) 2299-3279

f (886-2) 2298-0488

[www.tw.sgs.com](http://www.tw.sgs.com)

Member of SGS Group

## 7 PEAK OUTPUT POWER MEASUREMENT

### 7.1 Standard Applicable:

For systems using digital modulation in the 2400-2483.5 MHz bands, the limit for peak output power is 1Watt and the e.i.r.p. shall not exceed 4 W.

If the transmitting antenna of directional gain greater than 6dBi are used the peak output power from the intentional radiator shall be reduced below the above stated value by the amount in dB that the directional gain of the Antenna exceeds 6dBi.

In case of point-to-point operation, the limit has to be reduced by 1dB for every 3dB that the directional gain of Antenna exceeds 6dBi.

### 7.2 Measurement Equipment Used:

Conducted Emission Test Site					
EQUIPMENT TYPE	MFR	MODEL NUMBER	SERIAL NUMBER	LAST CAL.	CAL DUE.
Spectrum Analyzer	KEYSIGHT	N9010A	MY51440113	06/20/2017	06/19/2018
Power Meter	Anritsu	ML2496A	1326001	06/23/2017	06/22/2018
Power Sensor	Anritsu	MA2411B	1315048	06/23/2017	06/22/2018
Power Sensor	Anritsu	MA2411B	1315049	06/23/2017	06/22/2018
Coaxial Cable 30cm	WOKEN	00100A1F1A195 C	RF01	12/12/2016	12/11/2017
DC Block	PASTERNAK	PE8210	RF29	12/12/2016	12/11/2017
Splitter	RF-LAMBAD	RFLT2W1G18G	RF35	12/12/2016	12/11/2017
Attenuator	WOKEN	218FS-10	RF23	12/12/2016	12/11/2017
DC Power Supply	Agilent	E3640A	MY53140006	05/02/2017	05/01/2018

### 7.3 Test Set-up:

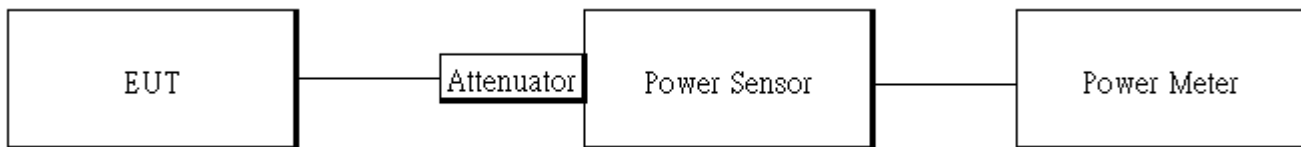

Unless otherwise stated the results shown in this test report refer only to the sample(s) tested and such sample(s) are retained for 90 days only.

除非另有說明，此報告結果僅對測試之樣品負責，同時此樣品僅保留90天。本報告未經本公司書面許可，不可部份複製。

This document is issued by the Company subject to its General Conditions of Service printed overleaf, available on request or accessible at [www.sgs.com/terms\\_and\\_conditions.htm](http://www.sgs.com/terms_and_conditions.htm) and, for electronic format documents, subject to Terms and Conditions for Electronic Documents at [www.sgs.com/terms\\_e-document.htm](http://www.sgs.com/terms_e-document.htm). Attention is drawn to the limitation of liability, indemnification and jurisdiction issues defined therein. Any holder of this document is advised that information contained hereon reflects the Company's findings at the time of its intervention only and within the limits of Client's instructions, if any. The Company's sole responsibility is to its Client and this document does not exonerate parties to a transaction from exercising all their rights and obligations under the transaction documents. This document cannot be reproduced except in full, without prior written approval of the Company. Any unauthorized alteration, forgery or falsification of the content or appearance of this document is unlawful and offenders may be prosecuted to the fullest extent of the law.

SGS Taiwan Ltd.

No.134,WuKungRoad,NewTaipeiIndustrialPark,WukuDistrict,NewTaipeiCity,Taiwan24803/新北市五股區新北產業園區五工路 134 號

台灣檢驗科技股份有限公司

t (886-2) 2299-3279

f (886-2) 2298-0488

www.tw.sgs.com

Member of SGS Group

**7.4 Measurement Procedure:**

1. Place the EUT on the table and set it in transmitting mode.
2. The testing follows the Measurement Procedure of FCC KDB 558074 D01 DTS Meas. Guidance .
3. Remove the antenna from the EUT and then connect a low loss RF cable from the antenna port to the power meter.

**Power Meter:**

It is used as the auxiliary test equipment to conduct the output power measurement.

4. Record the max. Reading as observed from Power Meter.
5. Repeat above procedures until all test default channel measured was complete.

**Duty Factor:**

	Duty Cycle (%)	Duty Factor (dB)
BLE	100.00	0.00

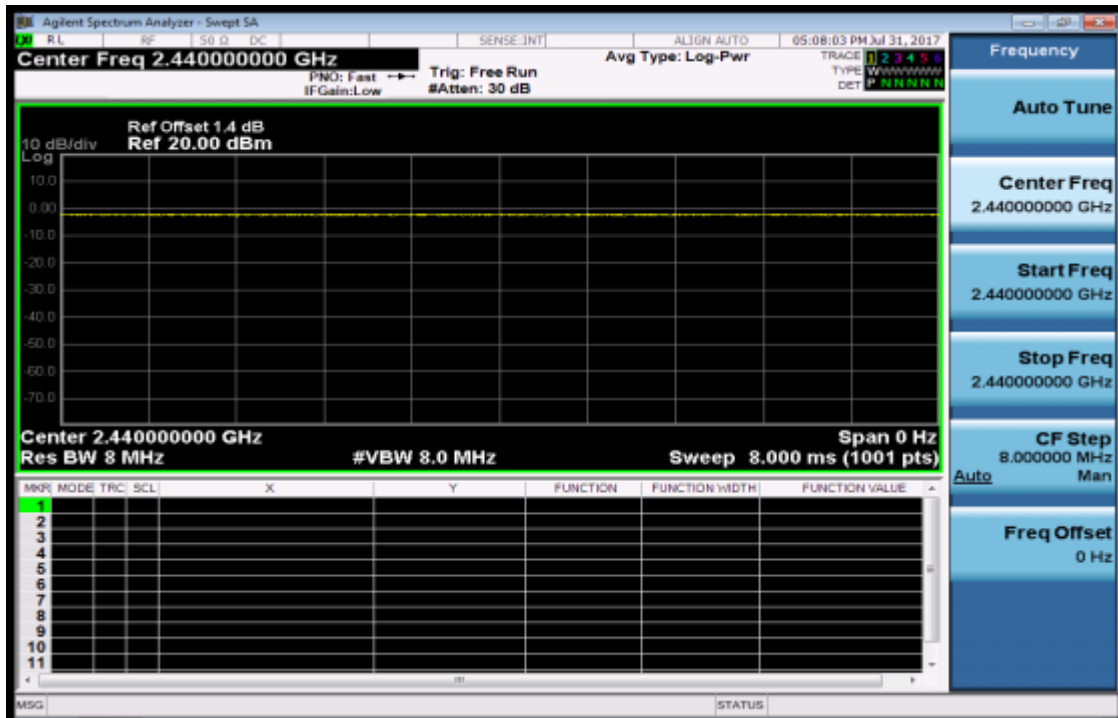

Duty Cycle Factor:  $10 \cdot \log(1/(100/100))=0$

Unless otherwise stated the results shown in this test report refer only to the sample(s) tested and such sample(s) are retained for 90 days only.

除非另有說明，此報告結果僅對測試之樣品負責，同時此樣品僅保留90天。本報告未經本公司書面許可，不可部份複製。

This document is issued by the Company subject to its General Conditions of Service printed overleaf, available on request or accessible at [www.sgs.com/terms\\_and\\_conditions.htm](http://www.sgs.com/terms_and_conditions.htm) and, for electronic format documents, subject to Terms and Conditions for Electronic Documents at [www.sgs.com/terms\\_e-document.htm](http://www.sgs.com/terms_e-document.htm). Attention is drawn to the limitation of liability, indemnification and jurisdiction issues defined therein. Any holder of this document is advised that information contained hereon reflects the Company's findings at the time of its intervention only and within the limits of Client's instructions, if any. The Company's sole responsibility is to its Client and this document does not exonerate parties to a transaction from exercising all their rights and obligations under the transaction documents. This document cannot be reproduced except in full, without prior written approval of the Company. Any unauthorized alteration, forgery or falsification of the content or appearance of this document is unlawful and offenders may be prosecuted to the fullest extent of the law.

SGS Taiwan Ltd.

No.134,WuKungRoad,NewTaipeiIndustrialPark,WukuDistrict,NewTaipeiCity,Taiwan24803/新北市五股區新北產業園區五工路 134 號

台灣檢驗科技股份有限公司

t (886-2) 2299-3279

f (886-2) 2298-0488

www.tw.sgs.com

Member of SGS Group

## 7.5 Measurement Result:

### BLE mode:

CH	Frequency (MHz)	Peak Power Output (dBm)	Required Limit
0	2402	-0.81	1 Watt = 30 dBm
19	2440	-0.93	1 Watt = 30 dBm
39	2480	-0.95	1 Watt = 30 dBm

### BLE mode:

CH	Frequency (MHz)	Max. Avg. Output include tune up tolerance Power (dBm)	Required Limit
0	2402	-1.87	1 Watt = 30 dBm
19	2440	-2.03	1 Watt = 30 dBm
39	2480	-2.50	1 Watt = 30 dBm

\*Note: Measured by power meter, cable loss as 1.4 dB that offsets on the power meter

\*Note: Measured by power meter, as Duty cycle factor that offsets on the power meter in Peak.

\*Note: Max. Output include tune up tolerance Power is average power

### EIRP

CH	Frequency (MHz)	Max. Avg. Output include tune up tolerance Power (dBm)	Antenna Gain (dBi)	EIRP (dBm)	Limit
0	2402	-1.87	0.84	-1.03	4W= 36 dBm
19	2440	-2.03	0.84	-1.19	4W= 36 dBm
39	2480	-2.50	0.84	-1.66	4W= 36 dBm

\* **Note:** EIRP = Average Power + Gain

Unless otherwise stated the results shown in this test report refer only to the sample(s) tested and such sample(s) are retained for 90 days only.

除非另有說明，此報告結果僅對測試之樣品負責，同時此樣品僅保留90天。本報告未經本公司書面許可，不可部份複製。

This document is issued by the Company subject to its General Conditions of Service printed overleaf, available on request or accessible at [www.sgs.com/terms\\_and\\_conditions.htm](http://www.sgs.com/terms_and_conditions.htm) and, for electronic format documents, subject to Terms and Conditions for Electronic Documents at [www.sgs.com/terms\\_e-document.htm](http://www.sgs.com/terms_e-document.htm). Attention is drawn to the limitation of liability, indemnification and jurisdiction issues defined therein. Any holder of this document is advised that information contained hereon reflects the Company's findings at the time of its intervention only and within the limits of Client's instructions, if any. The Company's sole responsibility is to its Client and this document does not exonerate parties to a transaction from exercising all their rights and obligations under the transaction documents. This document cannot be reproduced except in full, without prior written approval of the Company. Any unauthorized alteration, forgery or falsification of the content or appearance of this document is unlawful and offenders may be prosecuted to the fullest extent of the law.

SGS Taiwan Ltd.

No.134,WuKungRoad,NewTaipeiIndustrialPark,WukuDistrict,NewTaipeiCity,Taiwan24803/新北市五股區新北產業園區五工路134號

台灣檢驗科技股份有限公司

t (886-2) 2299-3279

f (886-2) 2298-0488

www.tw.sgs.com

Member of SGS Group



## 8 6DB & 99% BANDWIDTH MEASUREMENT

### 8.1 Standard Applicable

The minimum 6 dB bandwidth shall be at least 500 kHz .

### 8.2 Measurement Equipment Used

Conducted Emission Test Site					
EQUIPMENT TYPE	MFR	MODEL NUMBER	SERIAL NUMBER	LAST CAL.	CAL DUE.
Spectrum Analyzer	KEYSIGHT	N9010A	MY51440113	06/20/2017	06/19/2018
Coaxial Cable 30cm	WOKEN	00100A1F1A195C	RF01	12/12/2016	12/11/2017
DC Block	PASTERNAK	PE8210	RF29	12/12/2016	12/11/2017
Attenuator	WOKEN	218FS-10	RF23	12/12/2016	12/11/2017

### 8.3 Test Set-up:

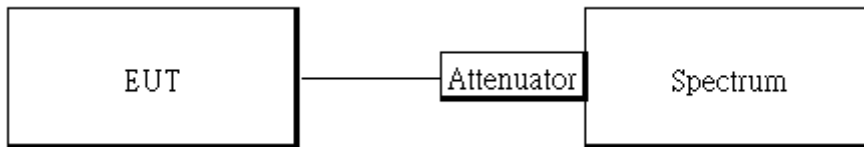

### 8.4 Measurement Procedure:

1. Place the EUT on the table and set it in transmitting mode.
2. The testing follows the Measurement Procedure of FCC KDB 558074 D01 DTS Meas. Guidance .
3. Remove the antenna from the EUT and then connect a low loss RF cable from the antenna port to the spectrum analyzer.
4. Set the spectrum analyzer as RBW=100 kHz, VBW= 3\*RBW, Span = 5MHz, Detector=Peak, Sweep=auto.
5. Mark the peak frequency and -6dB (upper and lower) frequency.
6. Turn on the 99% bandwidth function, max reading.
7. Repeat above procedures until all test default channel is completed

Unless otherwise stated the results shown in this test report refer only to the sample(s) tested and such sample(s) are retained for 90 days only.

除非另有說明，此報告結果僅對測試之樣品負責，同時此樣品僅保留90天。本報告未經本公司書面許可，不可部份複製。

This document is issued by the Company subject to its General Conditions of Service printed overleaf, available on request or accessible at [www.sgs.com/terms\\_and\\_conditions.htm](http://www.sgs.com/terms_and_conditions.htm) and, for electronic format documents, subject to Terms and Conditions for Electronic Documents at [www.sgs.com/terms\\_e-document.htm](http://www.sgs.com/terms_e-document.htm). Attention is drawn to the limitation of liability, indemnification and jurisdiction issues defined therein. Any holder of this document is advised that information contained hereon reflects the Company's findings at the time of its intervention only and within the limits of Client's instructions, if any. The Company's sole responsibility is to its Client and this document does not exonerate parties to a transaction from exercising all their rights and obligations under the transaction documents. This document cannot be reproduced except in full, without prior written approval of the Company. Any unauthorized alteration, forgery or falsification of the content or appearance of this document is unlawful and offenders may be prosecuted to the fullest extent of the law.

SGS Taiwan Ltd.

No.134,WuKungRoad,NewTaipeiIndustrialPark,WukuDistrict,NewTaipeiCity,Taiwan24803/新北市五股區新北產業園區五工路 134 號

台灣檢驗科技股份有限公司

t (886-2) 2299-3279

f (886-2) 2298-0488

www.tw.sgs.com

Member of SGS Group

8.5 Measurement Result:

BLE mode

Frequency (MHz)	6dB BW (MHz)	BW (MHz)	Result
2402	0.714	> 0.5	PASS
2440	0.683	> 0.5	PASS
2480	0.667	> 0.5	PASS

BLE mode

Frequency (MHz)	99%Bandwidth (MHz)
2402	1.0822
2440	1.0546
2480	1.0584

Note: Refer to next page for plots.

Unless otherwise stated the results shown in this test report refer only to the sample(s) tested and such sample(s) are retained for 90 days only.

除非另有說明，此報告結果僅對測試之樣品負責，同時此樣品僅保留90天。本報告未經本公司書面許可，不可部份複製。

This document is issued by the Company subject to its General Conditions of Service printed overleaf, available on request or accessible at [www.sgs.com/terms\\_and\\_conditions.htm](http://www.sgs.com/terms_and_conditions.htm) and, for electronic format documents, subject to Terms and Conditions for Electronic Documents at [www.sgs.com/terms\\_e-document.htm](http://www.sgs.com/terms_e-document.htm). Attention is drawn to the limitation of liability, indemnification and jurisdiction issues defined therein. Any holder of this document is advised that information contained hereon reflects the Company's findings at the time of its intervention only and within the limits of Client's instructions, if any. The Company's sole responsibility is to its Client and this document does not exonerate parties to a transaction from exercising all their rights and obligations under the transaction documents. This document cannot be reproduced except in full, without prior written approval of the Company. Any unauthorized alteration, forgery or falsification of the content or appearance of this document is unlawful and offenders may be prosecuted to the fullest extent of the law.

SGS Taiwan Ltd.

No.134,WuKungRoad,NewTaipeiIndustrialPark,WukuDistrict,NewTaipeiCity,Taiwan24803/新北市五股區新北產業園區五工路 134 號

台灣檢驗科技股份有限公司

t (886-2) 2299-3279

f (886-2) 2298-0488

[www.tw.sgs.com](http://www.tw.sgs.com)

Member of SGS Group

### 6dB Band Width Test Data CH-Low

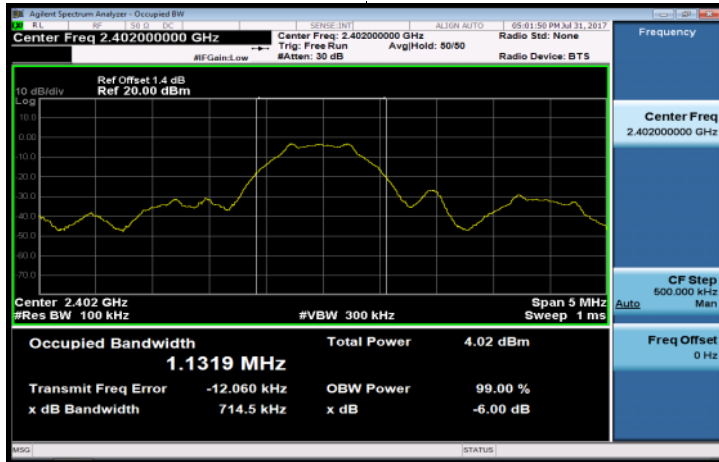

### 99% Band Width Test Data CH-Low

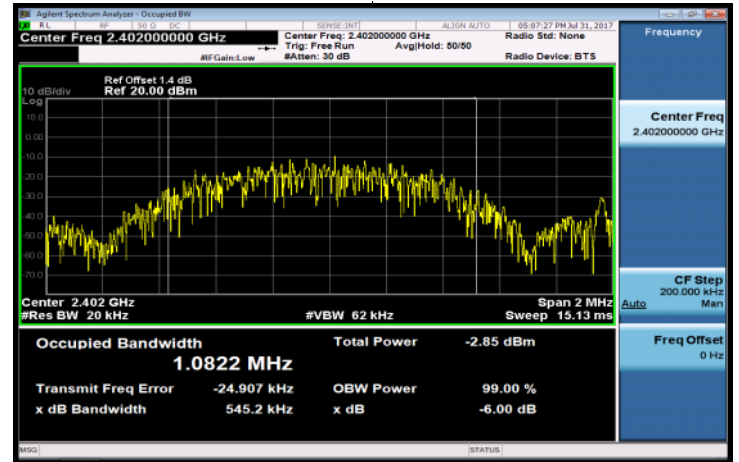

### 6dB Band Width Test Data CH-Mid

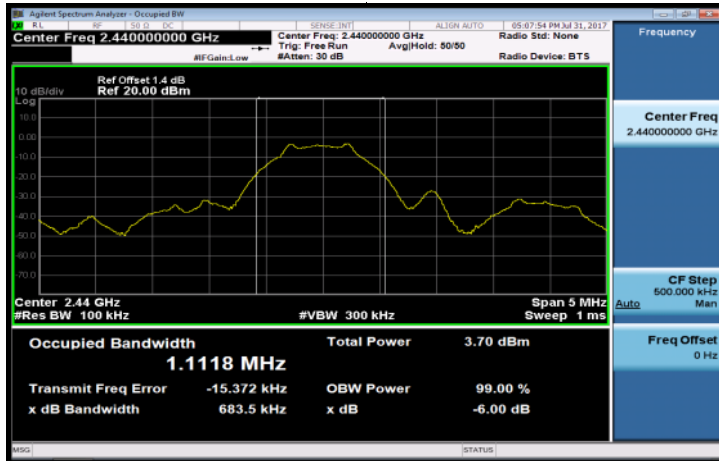

### 99% Band Width Test Data CH-Mid

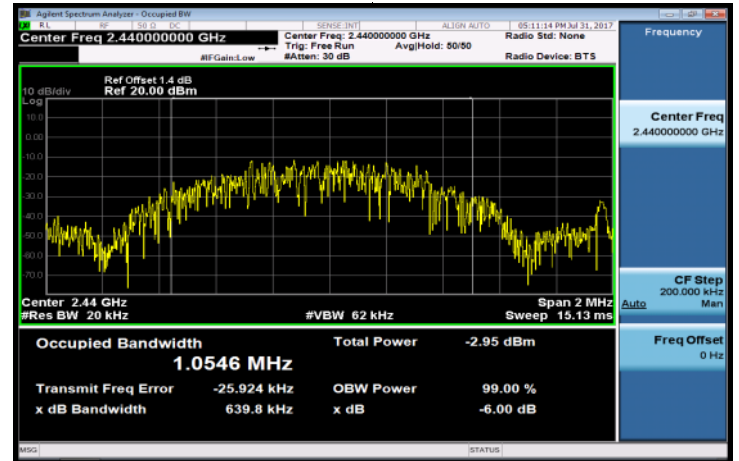

### 6dB Band Width Test Data CH-High

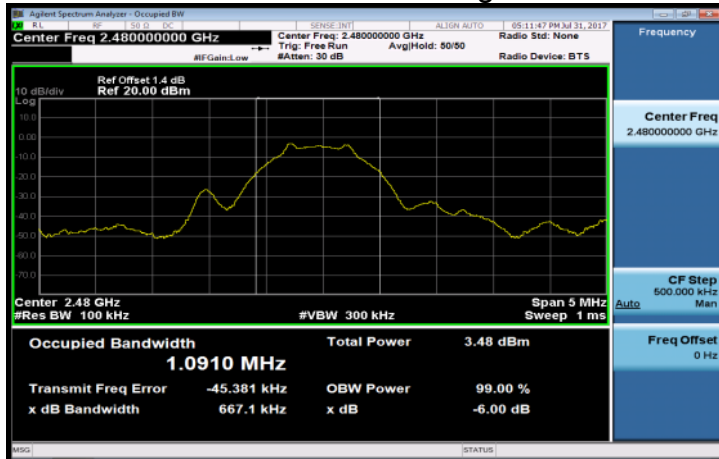

### 99% Band Width Test Data CH-High

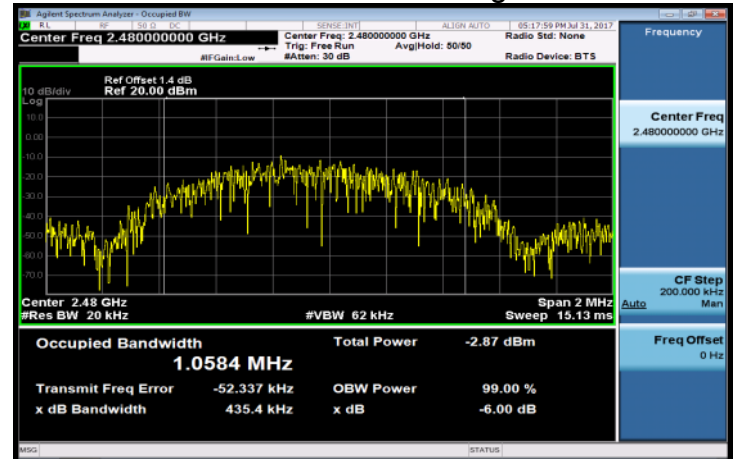

Unless otherwise stated the results shown in this test report refer only to the sample(s) tested and such sample(s) are retained for 90 days only.

除非另有說明，此報告結果僅對測試之樣品負責，同時此樣品僅保留90天。本報告未經本公司書面許可，不可部份複製。

This document is issued by the Company subject to its General Conditions of Service printed overleaf, available on request or accessible at [www.sgs.com/terms\\_and\\_conditions.htm](http://www.sgs.com/terms_and_conditions.htm), and for electronic format documents, subject to Terms and Conditions for Electronic Documents at [www.sgs.com/terms\\_e-document.htm](http://www.sgs.com/terms_e-document.htm). Attention is drawn to the limitation of liability, indemnification and jurisdiction issues defined therein. Any holder of this document is advised that information contained hereon reflects the Company's findings at the time of its intervention only and within the limits of Client's instructions, if any. The Company's sole responsibility is to its Client and this document does not exonerate parties to a transaction from exercising all their rights and obligations under the transaction documents. This document cannot be reproduced except in full, without prior written approval of the Company. Any unauthorized alteration, forgery or falsification of the content or appearance of this document is unlawful and offenders may be prosecuted to the fullest extent of the law.

## 9 CONDUCTED BAND EDGES AND SPURIOUS EMISSION MEASUREMENT

### 9.1 Standard Applicable

As per KDB 558074 D01 11.1 a)

If the maximum peak conducted output power procedure was used to demonstrate compliance as described in 9.1, then the peak output power measured in any 100 kHz bandwidth outside of the authorized frequency band shall be attenuated by at least 20 dB relative to the maximum in-band peak PSD level in 100 kHz (i.e., 20 dBc)

In any 100 kHz bandwidth outside the frequency band in which the spread spectrum or digitally modulated intentional radiator is operating, the radio frequency power that is produced by the intentional radiator shall be at least 20 dB below that in the 100 kHz bandwidth within the band that contains the highest level of the desired power, based on either an RF conducted or a radiated measurement, provided the transmitter demonstrates compliance with the peak conducted power limits. In addition, radiated emissions which fall in the restricted bands, as defined in §15.205(a), must also comply with the radiated emission limits specified in §15.209(a) & RSS-Gen §8.10 Table 6.

### 9.2 Measurement Equipment Used:

Conducted Emission Test Site					
EQUIPMENT TYPE	MFR	MODEL NUMBER	SERIAL NUMBER	LAST CAL.	CAL DUE.
Spectrum Analyzer	KEYSIGHT	N9010A	MY51440113	06/20/2017	06/19/2018
Coaxial Cable 30cm	WOKEN	00100A1F1A1 95C	RF01	12/12/2016	12/11/2017
DC Block	PASTERNAK	PE8210	RF29	12/12/2016	12/11/2017
Attenuator	WOKEN	218FS-10	RF23	12/12/2016	12/11/2017

### 9.3 Test SET-UP:

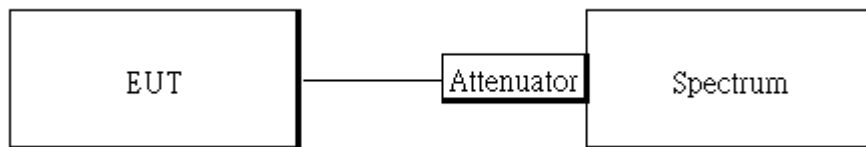

Unless otherwise stated the results shown in this test report refer only to the sample(s) tested and such sample(s) are retained for 90 days only.

除非另有說明，此報告結果僅對測試之樣品負責，同時此樣品僅保留90天。本報告未經本公司書面許可，不可部份複製。

This document is issued by the Company subject to its General Conditions of Service printed overleaf, available on request or accessible at [www.sgs.com/terms\\_and\\_conditions.htm](http://www.sgs.com/terms_and_conditions.htm) and, for electronic format documents, subject to Terms and Conditions for Electronic Documents at [www.sgs.com/terms\\_e-document.htm](http://www.sgs.com/terms_e-document.htm). Attention is drawn to the limitation of liability, indemnification and jurisdiction issues defined therein. Any holder of this document is advised that information contained hereon reflects the Company's findings at the time of its intervention only and within the limits of Client's instructions, if any. The Company's sole responsibility is to its Client and this document does not exonerate parties to a transaction from exercising all their rights and obligations under the transaction documents. This document cannot be reproduced except in full, without prior written approval of the Company. Any unauthorized alteration, forgery or falsification of the content or appearance of this document is unlawful and offenders may be prosecuted to the fullest extent of the law.

SGS Taiwan Ltd.

No. 134, WuKungRoad, NewTaipeiIndustrialPark, WukuDistrict, NewTaipeiCity, Taiwan24803/新北市五股區新北產業園區五工路 134 號

台灣檢驗科技股份有限公司

t (886-2) 2299-3279

f (886-2) 2298-0488

[www.tw.sgs.com](http://www.tw.sgs.com)

Member of SGS Group

## 9.4 Measurement Procedure

### Conducted Band Edge Limit

1. Set analyzer center frequency to DTS channel center frequency.
2. The testing follows the Measurement Procedure of FCC KDB 558074 D01 DTS Meas. Guidance .
3. Set the span to 1.5 times the DTS channel bandwidth.
4. Set the RBW = 100kHz & VBW = 300 kHz.
5. Detector = peak.
6. Sweep time = auto couple.
7. Trace mode = max hold.
8. Allow trace to fully stabilize.

Use the peak marker function to determine the maximum amplitude level.

### Conducted Band Edge:

1. To connect Antenna Port of EUT to Spectrum.
2. The testing follows the Measurement Procedure of FCC KDB 558074 D01 DTS Meas. Guidance .
3. Remove the antenna from the EUT and then connect a low loss RF cable from the antenna port to the spectrum analyzer.
4. Set start to edge frequency, and stop frequency of spectrum analyzer so as to encompass the spectrum to be examined.
5. Set the spectrum analyzer as RBW=100 kHz, VBW=300 kHz, Detector = Peak, Sweep = auto
6. Mark the highest reading of the emission as the reference level measurement.
7. Set DL as the limit = reading on marker 1 – 20dBm
8. Marker on frequency, 2.3999GHz and 2.4836GHz, and examine shall 100 kHz immediately outside the authorized (2400~2483.5) be attenuated by 20dB at least relative to the maximum emission of power.
9. Repeat above procedures until all default test channel (low, middle, and high) was complete.

Unless otherwise stated the results shown in this test report refer only to the sample(s) tested and such sample(s) are retained for 90 days only.

除非另有說明，此報告結果僅對測試之樣品負責，同時此樣品僅保留90天。本報告未經本公司書面許可，不可部份複製。

This document is issued by the Company subject to its General Conditions of Service printed overleaf, available on request or accessible at [www.sgs.com/terms\\_and\\_conditions.htm](http://www.sgs.com/terms_and_conditions.htm) and, for electronic format documents, subject to Terms and Conditions for Electronic Documents at [www.sgs.com/terms\\_e-document.htm](http://www.sgs.com/terms_e-document.htm). Attention is drawn to the limitation of liability, indemnification and jurisdiction issues defined therein. Any holder of this document is advised that information contained hereon reflects the Company's findings at the time of its intervention only and within the limits of Client's instructions, if any. The Company's sole responsibility is to its Client and this document does not exonerate parties to a transaction from exercising all their rights and obligations under the transaction documents. This document cannot be reproduced except in full, without prior written approval of the Company. Any unauthorized alteration, forgery or falsification of the content or appearance of this document is unlawful and offenders may be prosecuted to the fullest extent of the law.

### Conducted Spurious Emission:

1. To connect Antenna Port of EUT to Spectrum.
2. The testing follows the Measurement Procedure of FCC KDB 558074 D01 DTS Meas. Guidance .
3. Set RBW = 100 kHz & VBW=300 kHz, Detector =Peak, Sweep = Auto
4. Allow trace to fully stabilize.
5. Use the peak marker function to determine the maximum power level in any 100 kHz band segment within the fundamental EBW.
6. Repeat above procedures until all default test channel measured were complete.

### 9.5 Measurement Result

#### Band Edge Limit

Frequency (MHz)	RF Power Density (dBm)	Bandedge Limit = PSD - 20dB (dBm)
2402	-2.59	-22.59
2480	-3.40	-23.40

*NOTE: cable loss as 1.4dB that offsets in the spectrum*

*NOTE: Refer to next page for plots.*

Unless otherwise stated the results shown in this test report refer only to the sample(s) tested and such sample(s) are retained for 90 days only.

除非另有說明，此報告結果僅對測試之樣品負責，同時此樣品僅保留90天。本報告未經本公司書面許可，不可部份複製。

This document is issued by the Company subject to its General Conditions of Service printed overleaf, available on request or accessible at [www.sgs.com/terms\\_and\\_conditions.htm](http://www.sgs.com/terms_and_conditions.htm) and, for electronic format documents, subject to Terms and Conditions for Electronic Documents at [www.sgs.com/terms\\_e-document.htm](http://www.sgs.com/terms_e-document.htm). Attention is drawn to the limitation of liability, indemnification and jurisdiction issues defined therein. Any holder of this document is advised that information contained hereon reflects the Company's findings at the time of its intervention only and within the limits of Client's instructions, if any. The Company's sole responsibility is to its Client and this document does not exonerate parties to a transaction from exercising all their rights and obligations under the transaction documents. This document cannot be reproduced except in full, without prior written approval of the Company. Any unauthorized alteration, forgery or falsification of the content or appearance of this document is unlawful and offenders may be prosecuted to the fullest extent of the law.

SGS Taiwan Ltd.

No.134,WuKungRoad,NewTaipeiIndustrialPark,WukuDistrict,NewTaipeiCity,Taiwan24803/新北市五股區新北產業園區五工路 134 號

台灣檢驗科技股份有限公司

t (886-2) 2299-3279

f (886-2) 2298-0488

[www.tw.sgs.com](http://www.tw.sgs.com)

Member of SGS Group

### Power Spectral Density for Bandedge Limit (CH-Low)



### Power Spectral Density for Bandedge Limit (CH-High)



Unless otherwise stated the results shown in this test report refer only to the sample(s) tested and such sample(s) are retained for 90 days only.

除非另有說明，此報告結果僅對測試之樣品負責，同時此樣品僅保留90天。本報告未經本公司書面許可，不可部份複製。

This document is issued by the Company subject to its General Conditions of Service printed overleaf, available on request or accessible at [www.sgs.com/terms\\_and\\_conditions.htm](http://www.sgs.com/terms_and_conditions.htm) and, for electronic format documents, subject to Terms and Conditions for Electronic Documents at [www.sgs.com/terms\\_e-document.htm](http://www.sgs.com/terms_e-document.htm). Attention is drawn to the limitation of liability, indemnification and jurisdiction issues defined therein. Any holder of this document is advised that information contained hereon reflects the Company's findings at the time of its intervention only and within the limits of Client's instructions, if any. The Company's sole responsibility is to its Client and this document does not exonerate parties to a transaction from exercising all their rights and obligations under the transaction documents. This document cannot be reproduced except in full, without prior written approval of the Company. Any unauthorized alteration, forgery or falsification of the content or appearance of this document is unlawful and offenders may be prosecuted to the fullest extent of the law.

SGS Taiwan Ltd.

No. 134, WuKungRoad, NewTaipeiIndustrialPark, WukuDistrict, New Taipei City, Taiwan 24803/新北市五股區新北產業園區五工路 134 號

台灣檢驗科技股份有限公司

t (886-2) 2299-3279

f (886-2) 2298-0488

www.tw.sgs.com

Member of SGS Group

### Band Edges Test Data CH-Low



### Band Edges Test Data CH-High

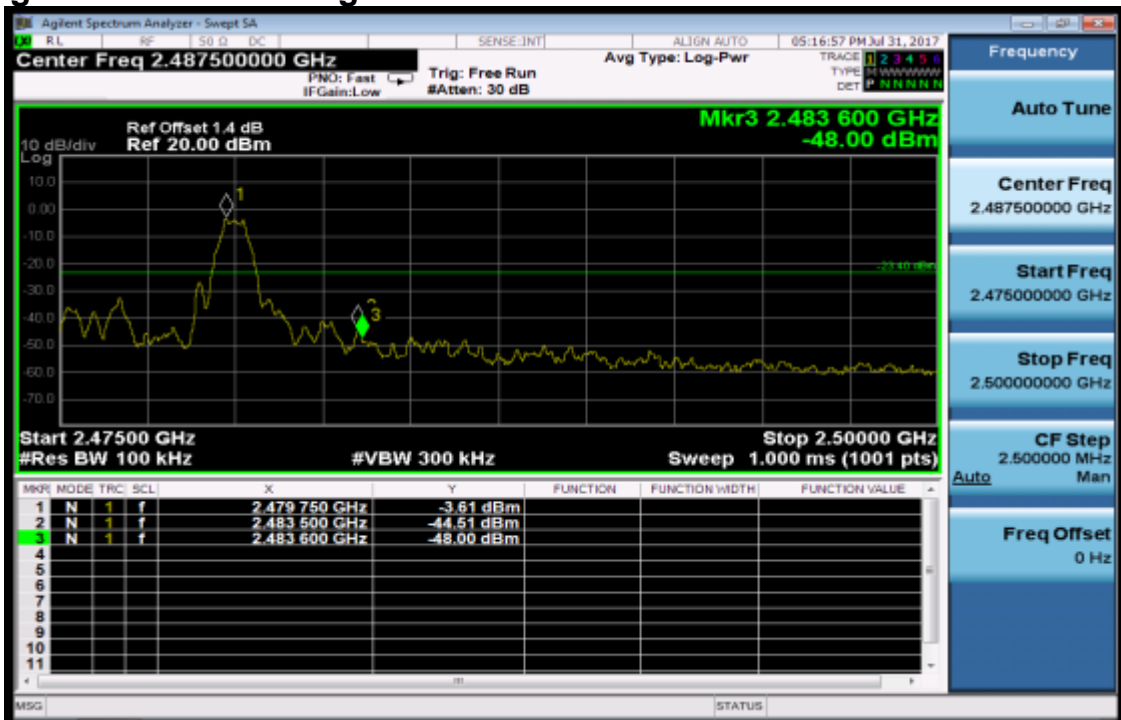

Unless otherwise stated the results shown in this test report refer only to the sample(s) tested and such sample(s) are retained for 90 days only.

除非另有說明，此報告結果僅對測試之樣品負責，同時此樣品僅保留90天。本報告未經本公司書面許可，不可部份複製。

This document is issued by the Company subject to its General Conditions of Service printed overleaf, available on request or accessible at [www.sgs.com/terms\\_and\\_conditions.htm](http://www.sgs.com/terms_and_conditions.htm) and, for electronic format documents, subject to Terms and Conditions for Electronic Documents at [www.sgs.com/terms\\_e-document.htm](http://www.sgs.com/terms_e-document.htm). Attention is drawn to the limitation of liability, indemnification and jurisdiction issues defined therein. Any holder of this document is advised that information contained hereon reflects the Company's findings at the time of its intervention only and within the limits of Client's instructions, if any. The Company's sole responsibility is to its Client and this document does not exonerate parties to a transaction from exercising all their rights and obligations under the transaction documents. This document cannot be reproduced except in full, without prior written approval of the Company. Any unauthorized alteration, forgery or falsification of the content or appearance of this document is unlawful and offenders may be prosecuted to the fullest extent of the law.

SGS Taiwan Ltd.

No. 134, WuKung Road, New Taipei Industrial Park, Wuku District, New Taipei City, Taiwan 24803/新北市五股區新北產業園區五工路 134 號

台灣檢驗科技股份有限公司

t (886-2) 2299-3279

f (886-2) 2298-0488

www.tw.sgs.com

Member of SGS Group



### Conducted Spurious Emission Measurement Result CH-Low 30MHz – 3GHz

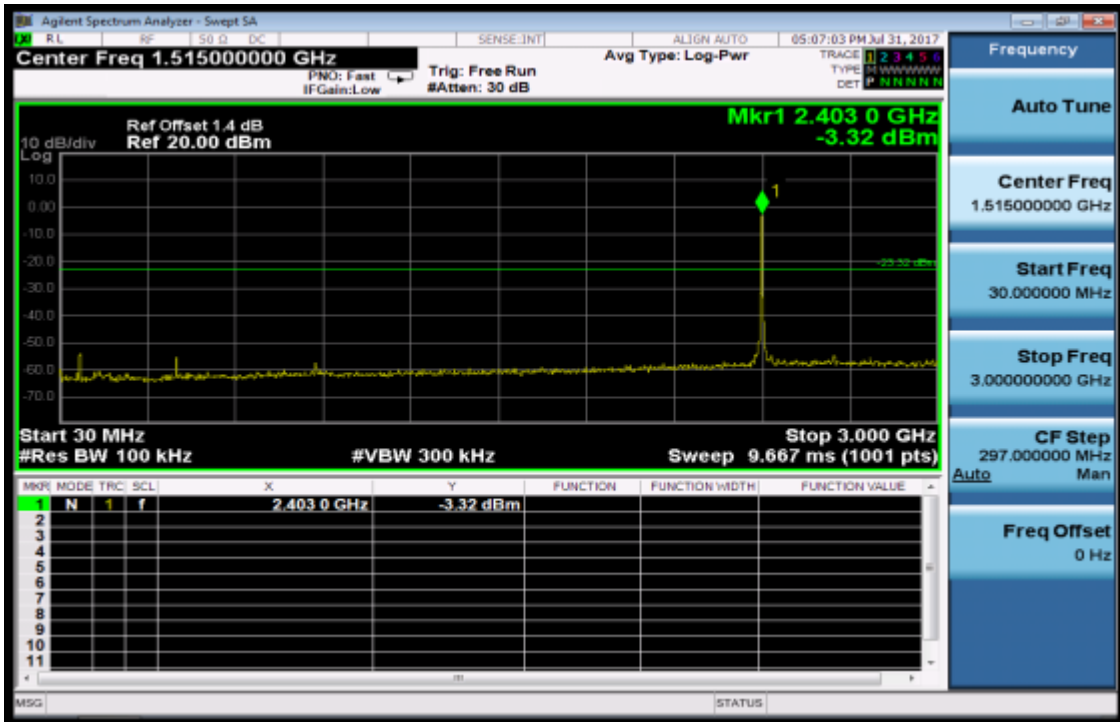

### CH-Low 3GHz – 26.5GHz

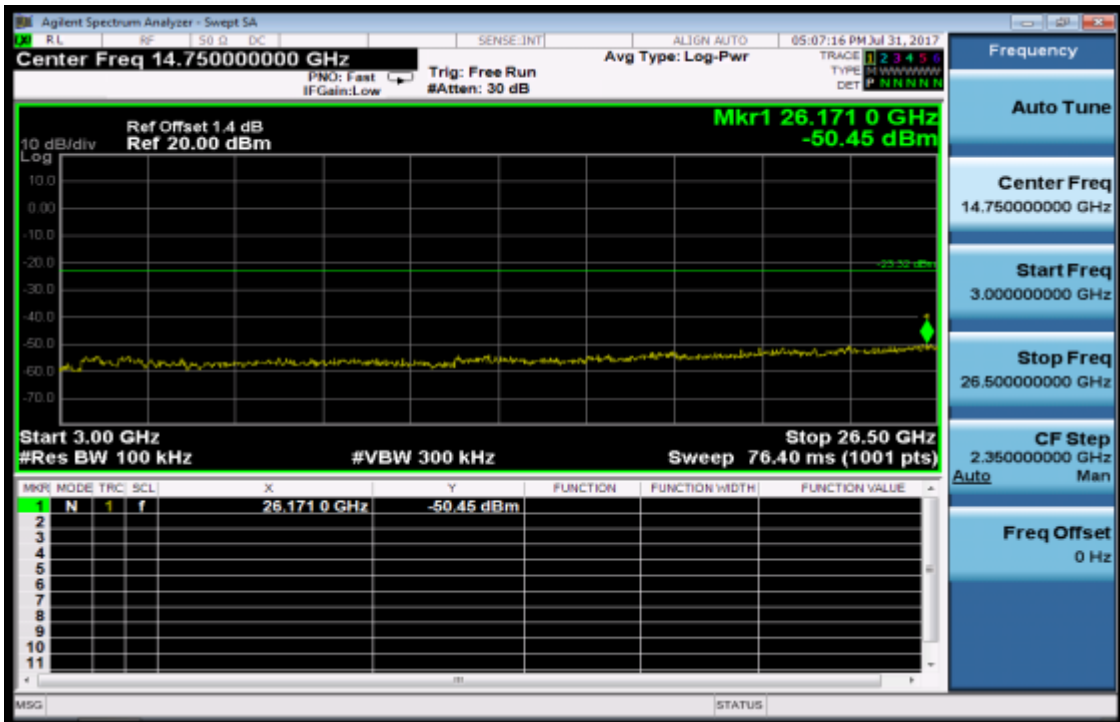

Unless otherwise stated the results shown in this test report refer only to the sample(s) tested and such sample(s) are retained for 90 days only.

除非另有說明，此報告結果僅對測試之樣品負責，同時此樣品僅保留90天。本報告未經本公司書面許可，不可部份複製。

This document is issued by the Company subject to its General Conditions of Service printed overleaf, available on request or accessible at [www.sgs.com/terms\\_and\\_conditions.htm](http://www.sgs.com/terms_and_conditions.htm) and, for electronic format documents, subject to Terms and Conditions for Electronic Documents at [www.sgs.com/terms\\_e-document.htm](http://www.sgs.com/terms_e-document.htm). Attention is drawn to the limitation of liability, indemnification and jurisdiction issues defined therein. Any holder of this document is advised that information contained hereon reflects the Company's findings at the time of its intervention only and within the limits of Client's instructions, if any. The Company's sole responsibility is to its Client and this document does not exonerate parties to a transaction from exercising all their rights and obligations under the transaction documents. This document cannot be reproduced except in full, without prior written approval of the Company. Any unauthorized alteration, forgery or falsification of the content or appearance of this document is unlawful and offenders may be prosecuted to the fullest extent of the law.

### CH-Mid 30MHz – 3GHz

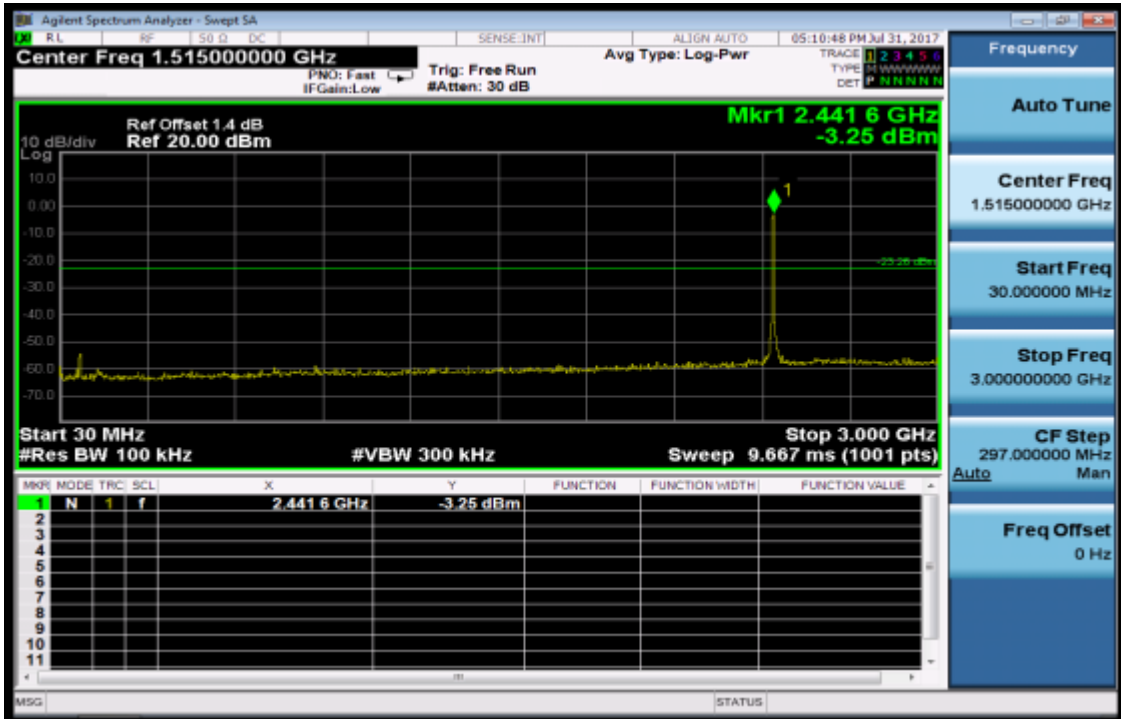

### CH-Mid 3GHz – 26.5GHz

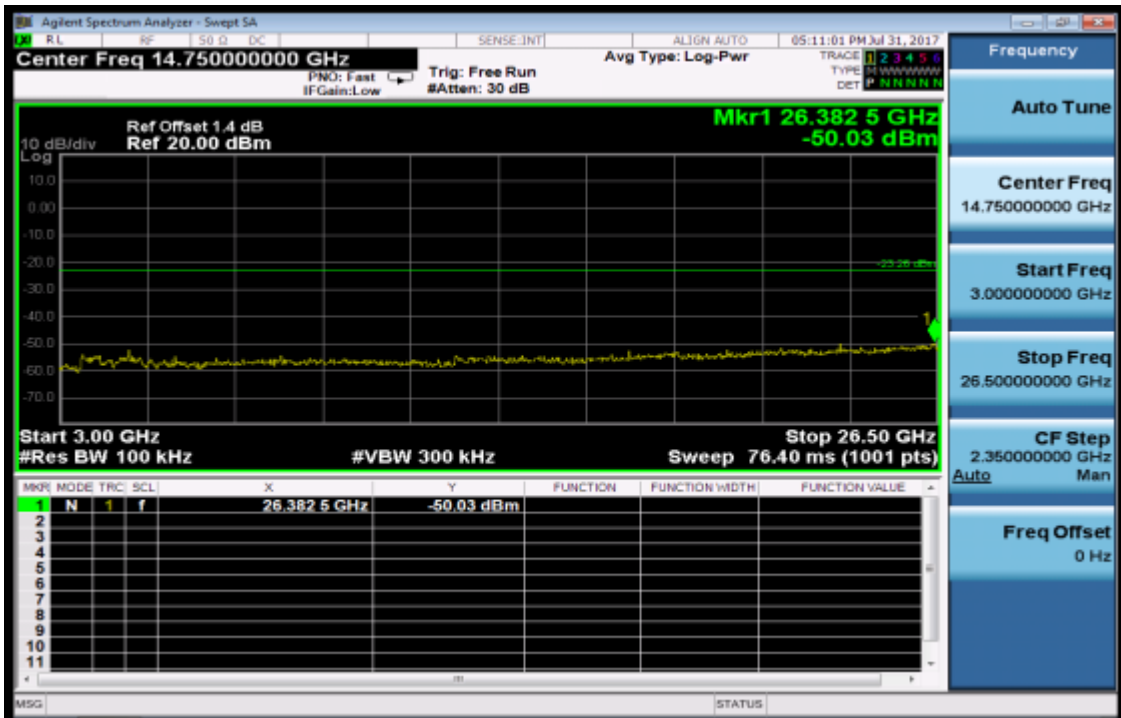

Unless otherwise stated the results shown in this test report refer only to the sample(s) tested and such sample(s) are retained for 90 days only.

除非另有說明，此報告結果僅對測試之樣品負責，同時此樣品僅保留90天。本報告未經本公司書面許可，不可部份複製。

This document is issued by the Company subject to its General Conditions of Service printed overleaf, available on request or accessible at [www.sgs.com/terms\\_and\\_conditions.htm](http://www.sgs.com/terms_and_conditions.htm) and, for electronic format documents, subject to Terms and Conditions for Electronic Documents at [www.sgs.com/terms\\_e-document.htm](http://www.sgs.com/terms_e-document.htm). Attention is drawn to the limitation of liability, indemnification and jurisdiction issues defined therein. Any holder of this document is advised that information contained hereon reflects the Company's findings at the time of its intervention only and within the limits of Client's instructions, if any. The Company's sole responsibility is to its Client and this document does not exonerate parties to a transaction from exercising all their rights and obligations under the transaction documents. This document cannot be reproduced except in full, without prior written approval of the Company. Any unauthorized alteration, forgery or falsification of the content or appearance of this document is unlawful and offenders may be prosecuted to the fullest extent of the law.

SGS Taiwan Ltd.

No. 134, WuKungRoad, NewTaipeiIndustrialPark, WukuDistrict, New TaipeiCity, Taiwan24803/新北市五股區新北產業園區五工路 134 號

台灣檢驗科技股份有限公司

t (886-2) 2299-3279

f (886-2) 2298-0488

www.tw.sgs.com

Member of SGS Group

### CH-High 30MHz – 3GHz

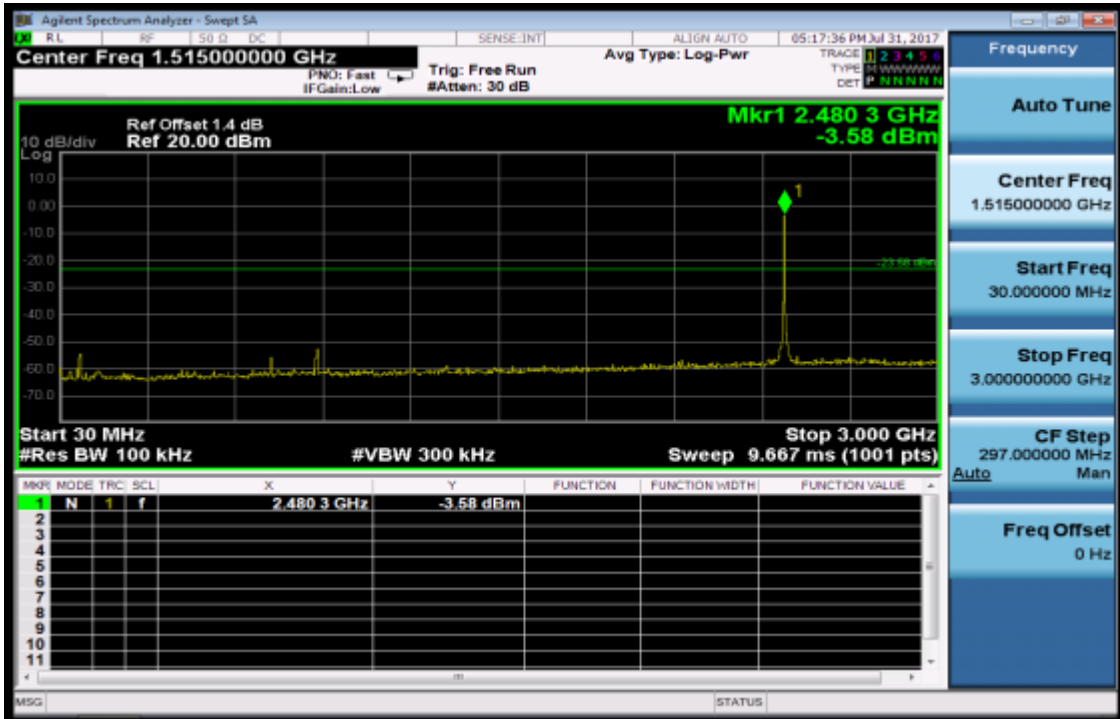

### CH- High 3GHz – 26.5GHz

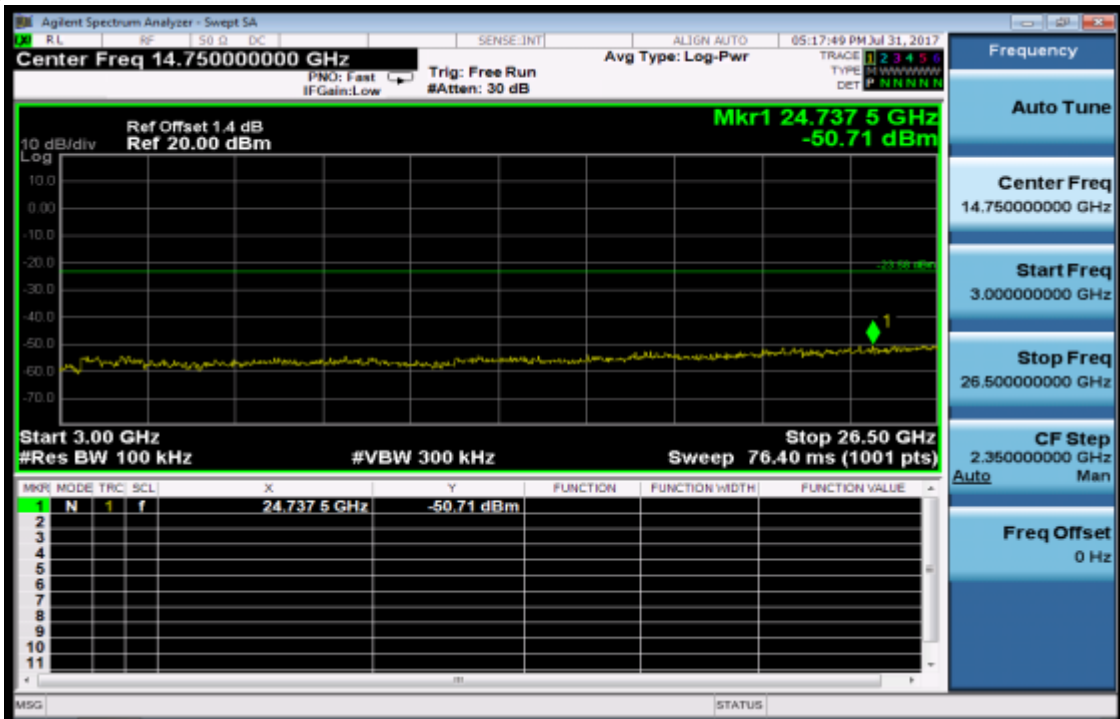

Unless otherwise stated the results shown in this test report refer only to the sample(s) tested and such sample(s) are retained for 90 days only.

除非另有說明，此報告結果僅對測試之樣品負責，同時此樣品僅保留90天。本報告未經本公司書面許可，不可部份複製。

This document is issued by the Company subject to its General Conditions of Service printed overleaf, available on request or accessible at [www.sgs.com/terms\\_and\\_conditions.htm](http://www.sgs.com/terms_and_conditions.htm) and, for electronic format documents, subject to Terms and Conditions for Electronic Documents at [www.sgs.com/terms\\_e-document.htm](http://www.sgs.com/terms_e-document.htm). Attention is drawn to the limitation of liability, indemnification and jurisdiction issues defined therein. Any holder of this document is advised that information contained hereon reflects the Company's findings at the time of its intervention only and within the limits of Client's instructions, if any. The Company's sole responsibility is to its Client and this document does not exonerate parties to a transaction from exercising all their rights and obligations under the transaction documents. This document cannot be reproduced except in full, without prior written approval of the Company. Any unauthorized alteration, forgery or falsification of the content or appearance of this document is unlawful and offenders may be prosecuted to the fullest extent of the law.

SGS Taiwan Ltd.

No. 134, WuKungRoad, NewTaipeiIndustrialPark, WukuDistrict, New TaipeiCity, Taiwan24803/新北市五股區新北產業園區五工路 134 號

台灣檢驗科技股份有限公司

t (886-2) 2299-3279

f (886-2) 2298-0488

www.tw.sgs.com

Member of SGS Group

## 10 RADIATED BANDEDGE AND SPURIOUS EMISSION MEASUREMENT

### 10.1 Standard Applicable

In any 100 kHz bandwidth outside the frequency band in which the spread spectrum or digitally modulated intentional radiator is operating, the radio frequency power that is produced by the intentional radiator shall be at least 20 dB below that in the 100 kHz bandwidth within the band that contains the highest level of the desired power, based on either an RF conducted or a radiated measurement, provided the transmitter demonstrates compliance with the peak conducted power limits. In addition, radiated emissions which fall in the restricted bands must also comply with the §15.209 & RSS-Gen §8.10 Table 6 limit as below.

And according to §15.33(a) (1) & RSS-Gen §8.9 Table 4 & 5, for an intentional radiator operates below 10GHz, the frequency range of measurements: to the tenth harmonic of the highest fundamental frequency or to 40GHz, whichever is lower.

Frequency (MHz)	Field strength (microvolts/meter)	Distance (meters)
0.009-0.490	2400/F(kHz)	300
0.490-1.705	24000/F(kHz)	30
1.705-30	30	30
30-88	100	3
88-216	150	3
216-960	200	3
Above 960	500	3

**Note:**

1. The lower limit shall apply at the transition frequencies.
2. Emission level (dB $\mu$ V/m) = 20 log Emission level (dB $\mu$ V/m)

Unless otherwise stated the results shown in this test report refer only to the sample(s) tested and such sample(s) are retained for 90 days only.

除非另有說明，此報告結果僅對測試之樣品負責，同時此樣品僅保留90天。本報告未經本公司書面許可，不可部份複製。

This document is issued by the Company subject to its General Conditions of Service printed overleaf, available on request or accessible at [www.sgs.com/terms\\_and\\_conditions.htm](http://www.sgs.com/terms_and_conditions.htm) and, for electronic format documents, subject to Terms and Conditions for Electronic Documents at [www.sgs.com/terms\\_e-document.htm](http://www.sgs.com/terms_e-document.htm). Attention is drawn to the limitation of liability, indemnification and jurisdiction issues defined therein. Any holder of this document is advised that information contained hereon reflects the Company's findings at the time of its intervention only and within the limits of Client's instructions, if any. The Company's sole responsibility is to its Client and this document does not exonerate parties to a transaction from exercising all their rights and obligations under the transaction documents. This document cannot be reproduced except in full, without prior written approval of the Company. Any unauthorized alteration, forgery or falsification of the content or appearance of this document is unlawful and offenders may be prosecuted to the fullest extent of the law.

SGS Taiwan Ltd.

台灣檢驗科技股份有限公司

No.134,WuKungRoad,NewTaipeiIndustrialPark,WukuDistrict,NewTaipeiCity,Taiwan24803/新北市五股區新北產業園區五工路 134 號

t (886-2) 2299-3279

f (886-2) 2298-0488

www.tw.sgs.com

Member of SGS Group

## 10.2 Measurement Equipment Used

966 Chamber					
EQUIPMENT TYPE	MFR	MODEL NUMBER	SERIAL NUMBER	LAST CAL.	CAL DUE.
EMI Test Receiver	R&S	ESU 40	100363	04/18/2017	04/17/2018
Loop Antenna	ETS-Lindgren	6502	00143303	12/23/2016	12/22/2017
Broadband Antenna	TESEQ	CBL 6112D	35240	11/03/2016	11/02/2017
Horn Antenna	ETS-Lindgren	3117	00143272	12/15/2016	12/16/2017
Horn Antenna	SCHWAZBECK	BBHA9170	185	08/01/2017	07/31/2018
Pre Amplifier	EMC Instruments	EMC330	980096	12/12/2016	12/11/2017
Pre Amplifier	EMC Instruments	EMC0011830	980199	12/12/2016	12/11/2017
Pre Amplifier	R&S	SCU-18	10204	12/12/2016	12/11/2017
Pre Amplifier	R&S	SCU-26	100780	12/12/2016	12/11/2017
Coaxial Cable	Huber+Suhner	RG 214/U	966Rx 9K-30M	12/12/2016	12/11/2017
Coaxial Cable	Huber+Suhner	RG 214/U SUCOFLEX 104	966Rx 30M-3G	12/12/2016	12/11/2017
Coaxial Cable	Huber+Suhner	SUCOFLEX 104	966Rx 1G-18G	12/12/2016	12/11/2017
Coaxial Cable	Huber+Suhner	mini 141-12 SUCOFLEX 104	966Rx 18G-40G	12/12/2016	12/11/2017
Coaxial Cable	Huber+Suhner	SUCOFLEX 104	966Tx 30M-18G	12/12/2016	12/11/2017
Coaxial Cable	Huber+Suhner	SUCOFLEX 102	966Tx 18G-40G	12/12/2016	12/11/2017
Attenuator	WOKEN	218FS-10	RF27	12/12/2016	12/11/2017
Site NSA	SGS	966 Chamber C	SAC-C	03/02/2017	03/01/2018
Site VSWR	SGS	966 Chamber C	SAC-C	03/02/2017	03/01/2018
DC Power Supply	HOLA	DP-3003	D7070035	05/04/2017	05/03/2018
Controller	MF	MF-7802	N/A	N.C.R.	N.C.R.
Antenna Master	MF	N/A	N/A	N.C.R.	N.C.R.
Turn Table	MF	N/A	N/A	N.C.R.	N.C.R.
Test Software	World-Pallas	Dr. E	V 3.0 Lite	N.C.R.	N.C.R.

Unless otherwise stated the results shown in this test report refer only to the sample(s) tested and such sample(s) are retained for 90 days only.

除非另有說明，此報告結果僅對測試之樣品負責，同時此樣品僅保留90天。本報告未經本公司書面許可，不可部份複製。

This document is issued by the Company subject to its General Conditions of Service printed overleaf, available on request or accessible at [www.sgs.com/terms\\_and\\_conditions.htm](http://www.sgs.com/terms_and_conditions.htm) and, for electronic format documents, subject to Terms and Conditions for Electronic Documents at [www.sgs.com/terms\\_e-document.htm](http://www.sgs.com/terms_e-document.htm). Attention is drawn to the limitation of liability, indemnification and jurisdiction issues defined therein. Any holder of this document is advised that information contained hereon reflects the Company's findings at the time of its intervention only and within the limits of Client's instructions, if any. The Company's sole responsibility is to its Client and this document does not exonerate parties to a transaction from exercising all their rights and obligations under the transaction documents. This document cannot be reproduced except in full, without prior written approval of the Company. Any unauthorized alteration, forgery or falsification of the content or appearance of this document is unlawful and offenders may be prosecuted to the fullest extent of the law.

SGS Taiwan Ltd.

No. 134, WuKungRoad, NewTaipeiIndustrialPark, WukuDistrict, NewTaipeiCity, Taiwan24803/新北市五股區新北產業園區五工路 134 號

台灣檢驗科技股份有限公司

t (886-2) 2299-3279

f (886-2) 2298-0488

www.tw.sgs.com

Member of SGS Group

### 10.3 Test SET-UP

(A) Radiated Emission Test Set-UP Frequency Below 30MHz.

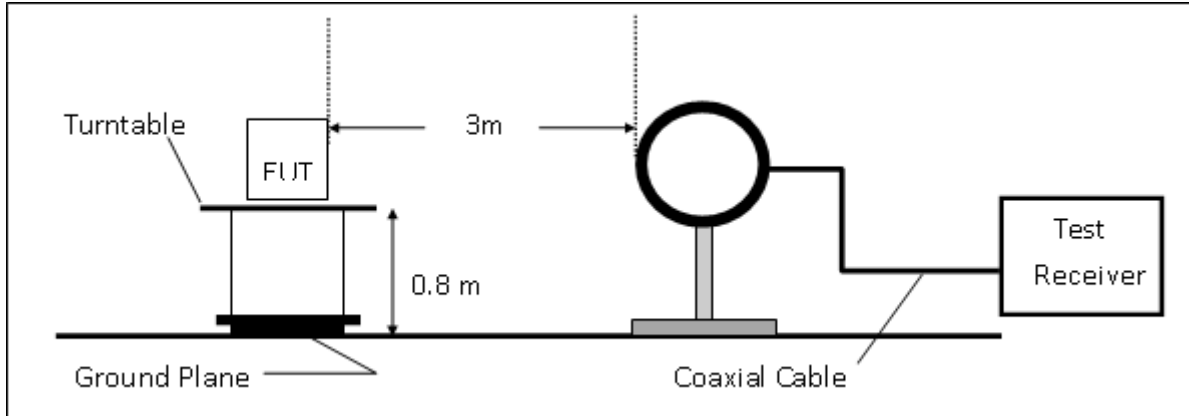

(B) Radiated Emission Test Set-UP, Frequency form 30MHz to 1000MHz

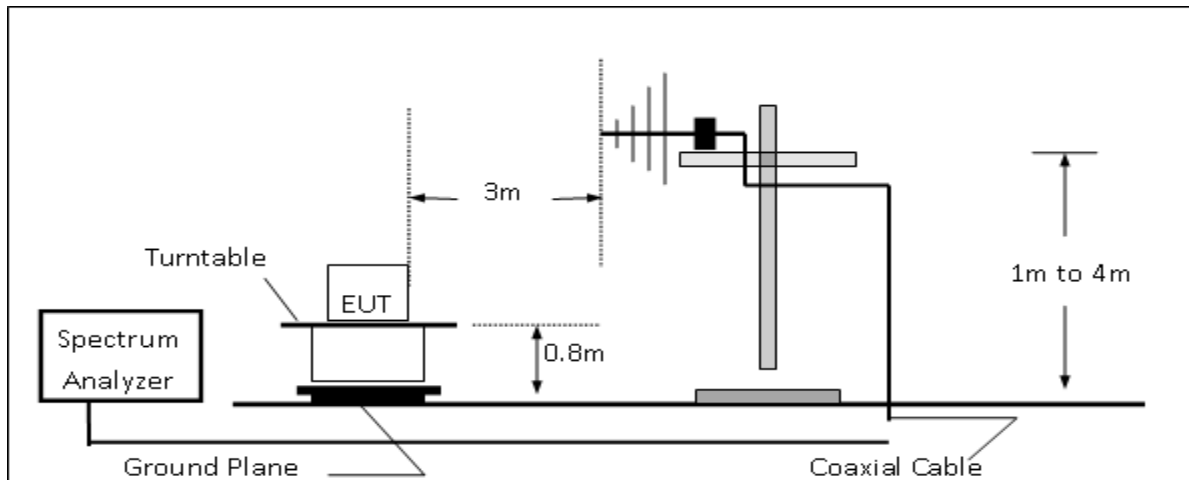

(C) Radiated Emission Test Set-UP Frequency Over 1 GHz

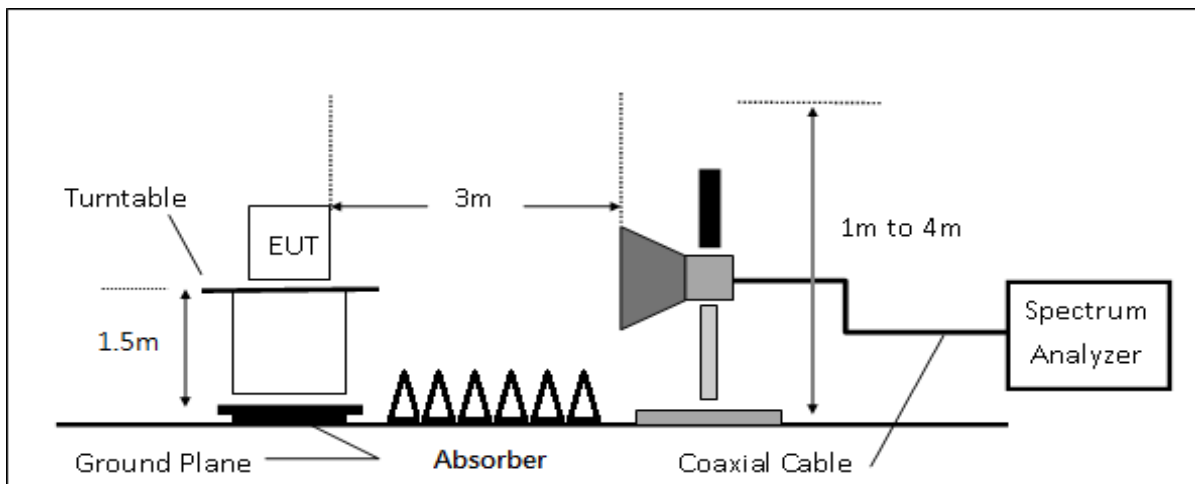

Unless otherwise stated the results shown in this test report refer only to the sample(s) tested and such sample(s) are retained for 90 days only.

除非另有說明，此報告結果僅對測試之樣品負責，同時此樣品僅保留90天。本報告未經本公司書面許可，不可部份複製。

This document is issued by the Company subject to its General Conditions of Service printed overleaf, available on request or accessible at [www.sgs.com/terms\\_and\\_conditions.htm](http://www.sgs.com/terms_and_conditions.htm) and, for electronic format documents, subject to Terms and Conditions for Electronic Documents at [www.sgs.com/terms\\_e-document.htm](http://www.sgs.com/terms_e-document.htm). Attention is drawn to the limitation of liability, indemnification and jurisdiction issues defined therein. Any holder of this document is advised that information contained hereon reflects the Company's findings at the time of its intervention only and within the limits of Client's instructions, if any. The Company's sole responsibility is to its Client and this document does not exonerate parties to a transaction from exercising all their rights and obligations under the transaction documents. This document cannot be reproduced except in full, without prior written approval of the Company. Any unauthorized alteration, forgery or falsification of the content or appearance of this document is unlawful and offenders may be prosecuted to the fullest extent of the law.

#### 10.4 Measurement Procedure

1. The testing follows the Measurement Procedure of FCC KDB 558074 D01 DTS Meas. Guidance .
2. The EUT was placed on a turn table with 0.8m for frequency< 1GHz and 0.8m for frequency> 1GHz above ground plan.
3. The turn table shall rotate 360 degrees to determine the position of maximum emission level.
4. EUT is set 3m away from the receiving antenna which varied from 1m to 4m to find out the highest emissions.
5. Set the spectrum analyzer as RBW=120 kHz and VBW=300 kHz for Peak Detector (PK) and Quasi-peak (QP) at frequency below 1 GHz.
6. Set the spectrum analyzer as RBW=1 MHz, VBW=3 MHz for Peak Detector at frequency above 1 GHz.
7. Set the spectrum analyzer as RBW=1 MHz, VBW=10 Hz (Duty cycle > 98%) or VBW ≥ 1/T (Duty cycle < 98%) for Average Detector at frequency above 1 GHz.
8. When measurement procedures for electric field radiated emissions above 1 GHz the EUT measurement is to be made “while keeping the antenna in the ‘cone of radiation’ from that area and pointed at the area both in azimuth and elevation, with polarization oriented for maximum response.” is still within the 3dB illumination BW of the measurement antenna.
9. Maximum procedure was performed on the six highest emissions to ensure EUT compliance.
10. And also, each emission was to be maximized by changing the polarization of receiving antenna both horizontal and vertical. On spectrum, change spectrum mode in linear display mode, and reduce VBW = 10Hz if average reading is measured.
11. Repeat above procedures until all default test channel measured were complete.

Unless otherwise stated the results shown in this test report refer only to the sample(s) tested and such sample(s) are retained for 90 days only.

除非另有說明，此報告結果僅對測試之樣品負責，同時此樣品僅保留90天。本報告未經本公司書面許可，不可部份複製。

This document is issued by the Company subject to its General Conditions of Service printed overleaf, available on request or accessible at [www.sgs.com/terms\\_and\\_conditions.htm](http://www.sgs.com/terms_and_conditions.htm) and, for electronic format documents, subject to Terms and Conditions for Electronic Documents at [www.sgs.com/terms\\_e-document.htm](http://www.sgs.com/terms_e-document.htm). Attention is drawn to the limitation of liability, indemnification and jurisdiction issues defined therein. Any holder of this document is advised that information contained hereon reflects the Company's findings at the time of its intervention only and within the limits of Client's instructions, if any. The Company's sole responsibility is to its Client and this document does not exonerate parties to a transaction from exercising all their rights and obligations under the transaction documents. This document cannot be reproduced except in full, without prior written approval of the Company. Any unauthorized alteration, forgery or falsification of the content or appearance of this document is unlawful and offenders may be prosecuted to the fullest extent of the law.

SGS Taiwan Ltd.

台灣檢驗科技股份有限公司

No.134,WuKungRoad,NewTaipeiIndustrialPark,WukuDistrict,NewTaipeiCity,Taiwan24803/新北市五股區新北產業園區五工路 134 號

t (886-2) 2299-3279

f (886-2) 2298-0488

www.tw.sgs.com

Member of SGS Group

## 10.5 Field Strength Calculation

The field strength is calculated by adding the Antenna Factor and Cable Factor and subtracting the Amplifier Gain and Duty Cycle Correction Factor (if any) from the measured reading. The basic equation with a sample calculation is as follows:

$$FS = RA + AF + CL - AG$$

Where FS = Field Strength	CL = Cable Attenuation Factor (Cable Loss)
RA = Reading Amplitude	AG = Amplifier Gain
AF = Antenna Factor	

Actual FS(dBμV/m) = SPA. Reading level(dBμV) + Factor(dB)

Factor(dB) = Antenna Factor(dBμV/m) + Cable Loss(dB) – Pre\_Amplifier Gain(dB)

### Note :

“F” : denotes Fundamental Frequency. ; “H” : denotes Harmonic Frequency.

“E” : denotes Band Edge Frequency. ; “S” : denotes Spurious Frequency.

## 10.6 Test Results of Radiated Spurious Emissions form 9 kHz to 30 MHz

The low frequency, which started from 9 kHz to 30MHz, was pre-scanned and the result which was 20dB lower than the limit per 15.31(o) was not reported.

## 10.7 Measurement Result:

Note: Refer to next page spectrum analyzer data chart and tabular data sheets.

Unless otherwise stated the results shown in this test report refer only to the sample(s) tested and such sample(s) are retained for 90 days only.

除非另有說明，此報告結果僅對測試之樣品負責，同時此樣品僅保留90天。本報告未經本公司書面許可，不可部份複製。

This document is issued by the Company subject to its General Conditions of Service printed overleaf, available on request or accessible at [www.sgs.com/terms\\_and\\_conditions.htm](http://www.sgs.com/terms_and_conditions.htm) and, for electronic format documents, subject to Terms and Conditions for Electronic Documents at [www.sgs.com/terms\\_e-document.htm](http://www.sgs.com/terms_e-document.htm). Attention is drawn to the limitation of liability, indemnification and jurisdiction issues defined therein. Any holder of this document is advised that information contained hereon reflects the Company's findings at the time of its intervention only and within the limits of Client's instructions, if any. The Company's sole responsibility is to its Client and this document does not exonerate parties to a transaction from exercising all their rights and obligations under the transaction documents. This document cannot be reproduced except in full, without prior written approval of the Company. Any unauthorized alteration, forgery or falsification of the content or appearance of this document is unlawful and offenders may be prosecuted to the fullest extent of the law.

SGS Taiwan Ltd.

No.134,WuKungRoad,NewTaipeiIndustrialPark,WukuDistrict,NewTaipeiCity,Taiwan24803/新北市五股區新北產業園區五工路 134 號

台灣檢驗科技股份有限公司

t (886-2) 2299-3279

f (886-2) 2298-0488

www.tw.sgs.com

Member of SGS Group



### Radiated Band Edge Measurement Result (BLE mode)

Operation Mode :	BLE	Test Date :	2017/8/4
Fundamental Frequency :	2402 MHz	Temp. / Humi. :	22.7deg_C/57RH
Operation Band :	BE CH Low	Test Engineer :	Ashton
EUT Pol. :	H	Measurement Antenna Pol. :	Vertical

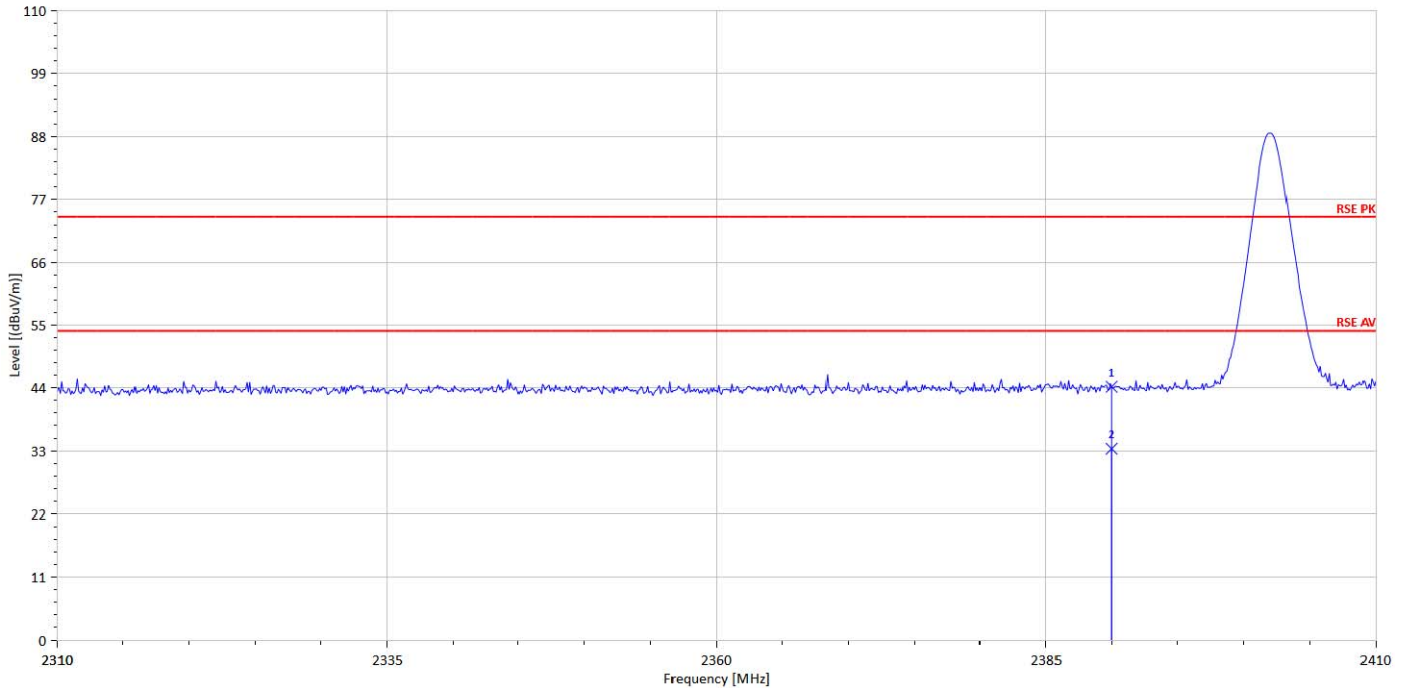

Freq.	Note	Detector Mode	Spectrum Reading Level	Factor	Actual FS	Limit @3m	Margin
MHz	F/H/E/S	PK/QP/AV	dB $\mu$ V	dB	dB $\mu$ V/m	dB $\mu$ V/m	dB
2390.00	E	Peak	43.29	0.92	44.21	74	-29.79
2390.00	E	Average	32.43	0.92	33.35	54	-20.65

Unless otherwise stated the results shown in this test report refer only to the sample(s) tested and such sample(s) are retained for 90 days only.

除非另有說明，此報告結果僅對測試之樣品負責，同時此樣品僅保留90天。本報告未經本公司書面許可，不可部份複製。

This document is issued by the Company subject to its General Conditions of Service printed overleaf, available on request or accessible at [www.sgs.com/terms\\_and\\_conditions.htm](http://www.sgs.com/terms_and_conditions.htm) and, for electronic format documents, subject to Terms and Conditions for Electronic Documents at [www.sgs.com/terms\\_e-document.htm](http://www.sgs.com/terms_e-document.htm). Attention is drawn to the limitation of liability, indemnification and jurisdiction issues defined therein. Any holder of this document is advised that information contained hereon reflects the Company's findings at the time of its intervention only and within the limits of Client's instructions, if any. The Company's sole responsibility is to its Client and this document does not exonerate parties to a transaction from exercising all their rights and obligations under the transaction documents. This document cannot be reproduced except in full, without prior written approval of the Company. Any unauthorized alteration, forgery or falsification of the content or appearance of this document is unlawful and offenders may be prosecuted to the fullest extent of the law.

Operation Mode :	BLE	Test Date :	2017/8/4
Fundamental Frequency :	2402 MHz	Temp. / Humi. :	22.7deg_C/57RH
Operation Band :	BE CH Low	Test Engineer :	Ashton
EUT Pol. :	H	Measurement Antenna Pol. :	Horizontal

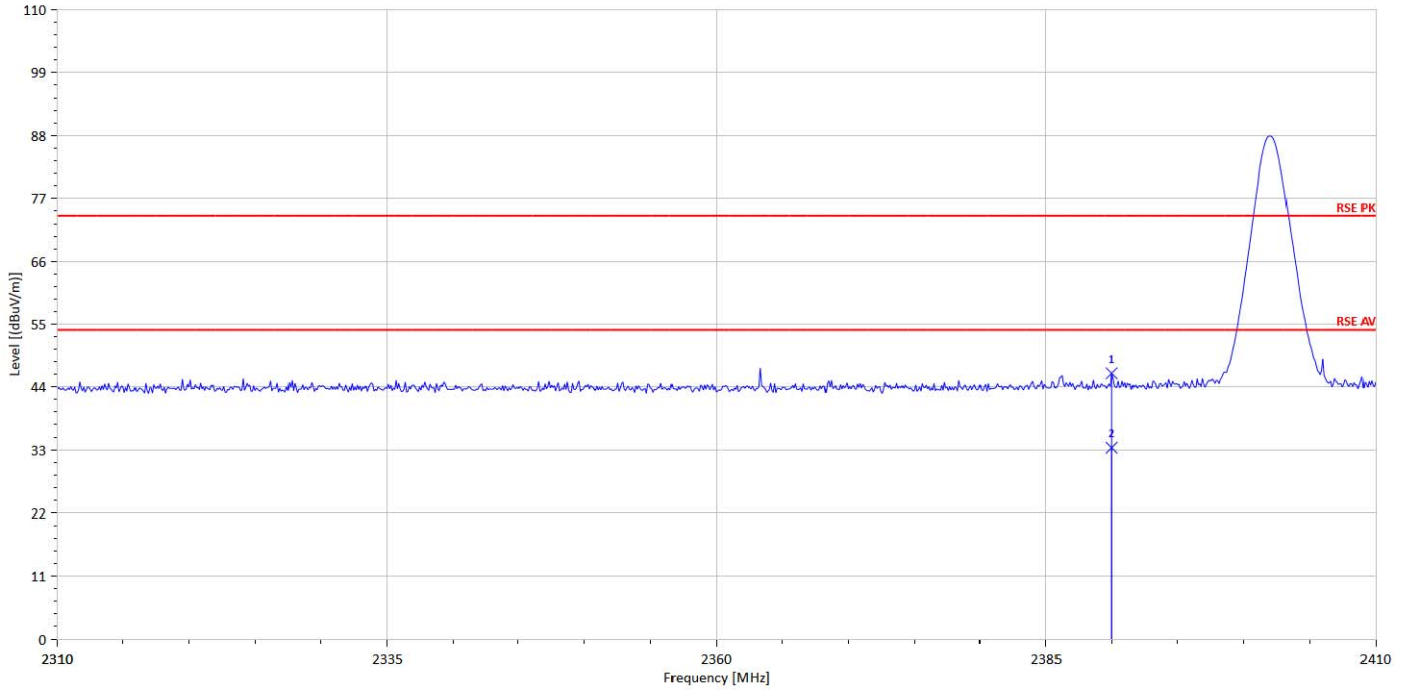

Freq. MHz	Note F/H/E/S	Detector Mode PK/QP/AV	Spectrum Reading Level dBµV	Factor dB	Actual FS dBµV/m	Limit @3m dBµV/m	Margin dB
2390.00	E	Peak	45.48	0.92	46.40	74	-27.60
2390.00	E	Average	32.43	0.92	33.35	54	-20.65

Unless otherwise stated the results shown in this test report refer only to the sample(s) tested and such sample(s) are retained for 90 days only.

除非另有說明，此報告結果僅對測試之樣品負責，同時此樣品僅保留90天。本報告未經本公司書面許可，不可部份複製。

This document is issued by the Company subject to its General Conditions of Service printed overleaf, available on request or accessible at [www.sgs.com/terms\\_and\\_conditions.htm](http://www.sgs.com/terms_and_conditions.htm) and, for electronic format documents, subject to Terms and Conditions for Electronic Documents at [www.sgs.com/terms\\_e-document.htm](http://www.sgs.com/terms_e-document.htm). Attention is drawn to the limitation of liability, indemnification and jurisdiction issues defined therein. Any holder of this document is advised that information contained hereon reflects the Company's findings at the time of its intervention only and within the limits of Client's instructions, if any. The Company's sole responsibility is to its Client and this document does not exonerate parties to a transaction from exercising all their rights and obligations under the transaction documents. This document cannot be reproduced except in full, without prior written approval of the Company. Any unauthorized alteration, forgery or falsification of the content or appearance of this document is unlawful and offenders may be prosecuted to the fullest extent of the law.

SGS Taiwan Ltd.

No.134,WuKungRoad,NewTaipeiIndustrialPark,WukuDistrict,NewTaipeiCity,Taiwan24803/新北市五股區新北產業園區五工路 134 號

台灣檢驗科技股份有限公司

t (886-2) 2299-3279

f (886-2) 2298-0488

www.tw.sgs.com

Member of SGS Group

Operation Mode : BLE                      Test Date : 2017/8/4  
 Fundamental Frequency : 2480 MHz      Temp. / Humi. : 22.7 deg\_C/57RH  
 Operation Band : BE CH High      Test Engineer : Ashton  
 EUT Pol. : H                              Measurement Antenna Pol. : Vertical

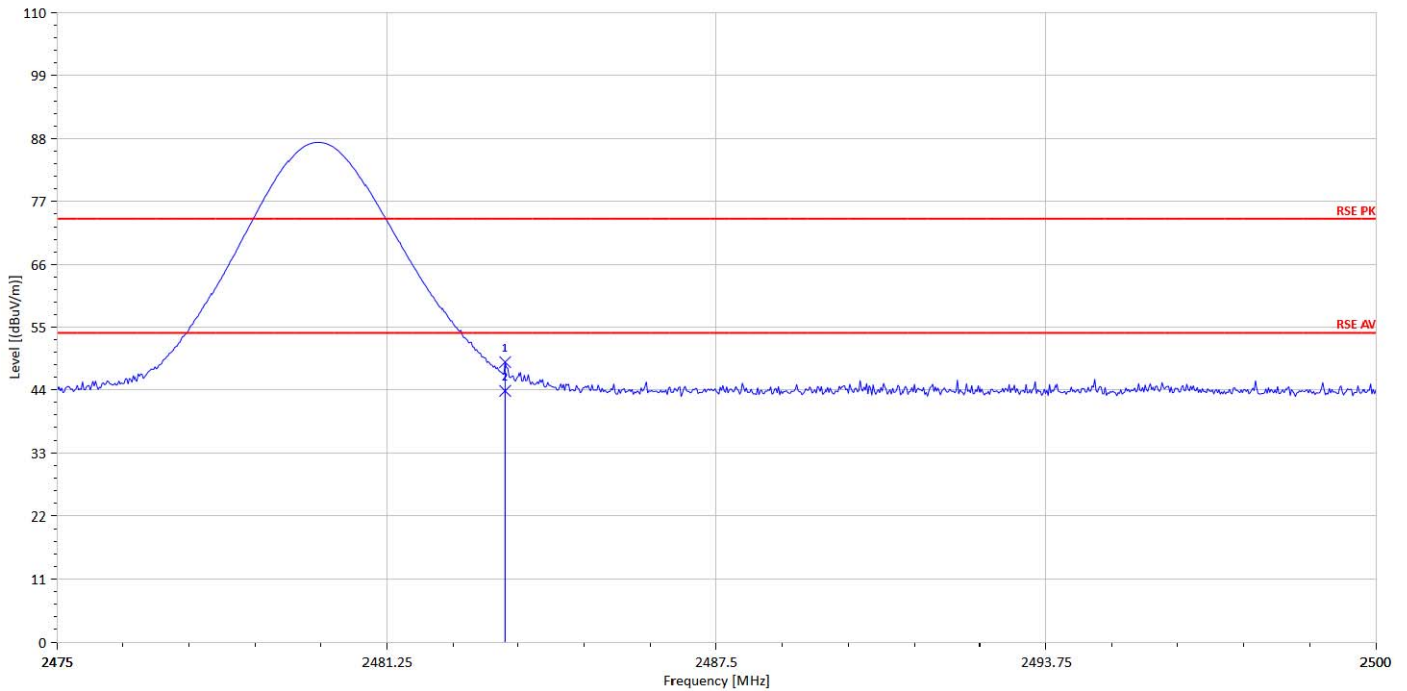

Freq. MHz	Note F/H/E/S	Detector Mode PK/QP/AV	Spectrum Reading Level dBµV	Factor dB	Actual FS dBµV/m	Limit @3m dBµV/m	Margin dB
2483.50	E	Peak	47.72	1.16	48.88	74	-25.12
2483.50	E	Average	42.68	1.16	43.84	54	-10.16

Unless otherwise stated the results shown in this test report refer only to the sample(s) tested and such sample(s) are retained for 90 days only.

除非另有說明，此報告結果僅對測試之樣品負責，同時此樣品僅保留90天。本報告未經本公司書面許可，不可部份複製。

This document is issued by the Company subject to its General Conditions of Service printed overleaf, available on request or accessible at [www.sgs.com/terms\\_and\\_conditions.htm](http://www.sgs.com/terms_and_conditions.htm) and, for electronic format documents, subject to Terms and Conditions for Electronic Documents at [www.sgs.com/terms\\_e-document.htm](http://www.sgs.com/terms_e-document.htm). Attention is drawn to the limitation of liability, indemnification and jurisdiction issues defined therein. Any holder of this document is advised that information contained hereon reflects the Company's findings at the time of its intervention only and within the limits of Client's instructions, if any. The Company's sole responsibility is to its Client and this document does not exonerate parties to a transaction from exercising all their rights and obligations under the transaction documents. This document cannot be reproduced except in full, without prior written approval of the Company. Any unauthorized alteration, forgery or falsification of the content or appearance of this document is unlawful and offenders may be prosecuted to the fullest extent of the law.

SGS Taiwan Ltd.

No. 134, WuKungRoad, New Taipei Industrial Park, Wuku District, New Taipei City, Taiwan 24803 / 新北市五股區新北產業園區五工路 134 號

台灣檢驗科技股份有限公司

t (886-2) 2299-3279

f (886-2) 2298-0488

www.tw.sgs.com

Member of SGS Group

Operation Mode : BLE                      Test Date : 2017/8/4  
 Fundamental Frequency : 2480 MHz      Temp. / Humi. : 22.7 deg\_C/57RH  
 Operation Band : BE CH High      Test Engineer : Ashton  
 EUT Pol. : H                              Measurement Antenna Pol. : Horizontal

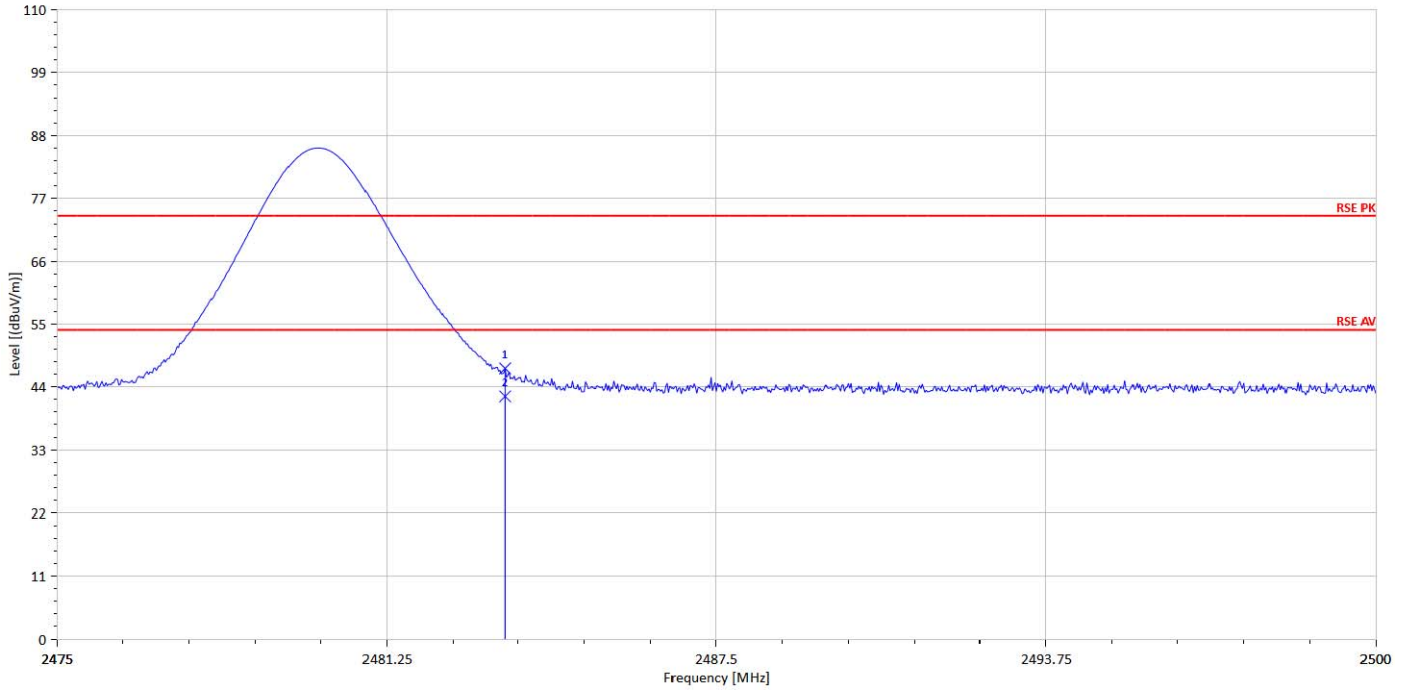

Freq. MHz	Note F/H/E/S	Detector Mode PK/QP/AV	Spectrum Reading Level dBµV	Factor dB	Actual FS dBµV/m	Limit @3m dBµV/m	Margin dB
2483.50	E	Peak	46.09	1.16	47.25	74	-26.75
2483.50	E	Average	41.19	1.16	42.35	54	-11.65

Unless otherwise stated the results shown in this test report refer only to the sample(s) tested and such sample(s) are retained for 90 days only.

除非另有說明，此報告結果僅對測試之樣品負責，同時此樣品僅保留90天。本報告未經本公司書面許可，不可部份複製。

This document is issued by the Company subject to its General Conditions of Service printed overleaf, available on request or accessible at [www.sgs.com/terms\\_and\\_conditions.htm](http://www.sgs.com/terms_and_conditions.htm) and, for electronic format documents, subject to Terms and Conditions for Electronic Documents at [www.sgs.com/terms\\_e-document.htm](http://www.sgs.com/terms_e-document.htm). Attention is drawn to the limitation of liability, indemnification and jurisdiction issues defined therein. Any holder of this document is advised that information contained hereon reflects the Company's findings at the time of its intervention only and within the limits of Client's instructions, if any. The Company's sole responsibility is to its Client and this document does not exonerate parties to a transaction from exercising all their rights and obligations under the transaction documents. This document cannot be reproduced except in full, without prior written approval of the Company. Any unauthorized alteration, forgery or falsification of the content or appearance of this document is unlawful and offenders may be prosecuted to the fullest extent of the law.

SGS Taiwan Ltd.

No. 134, WuKungRoad, New Taipei Industrial Park, Wuku District, New Taipei City, Taiwan 24803 / 新北市五股區新北產業園區五工路 134 號

台灣檢驗科技股份有限公司

t (886-2) 2299-3279

f (886-2) 2298-0488

www.tw.sgs.com

Member of SGS Group

### Radiated Spurious Emission Measurement Result (BLE mode) For Frequency from 30MHz to 1000MHz

Operation Mode :	BLE	Test Date :	2017/8/4
Fundamental Frequency :	2402 MHz	Temp. / Humi. :	22.7 deg_C/57RH
Operation Band :	Tx CH Low	Test Engineer :	Ashton
EUT Pol. :	H	Measurement Antenna Pol. :	Vertical

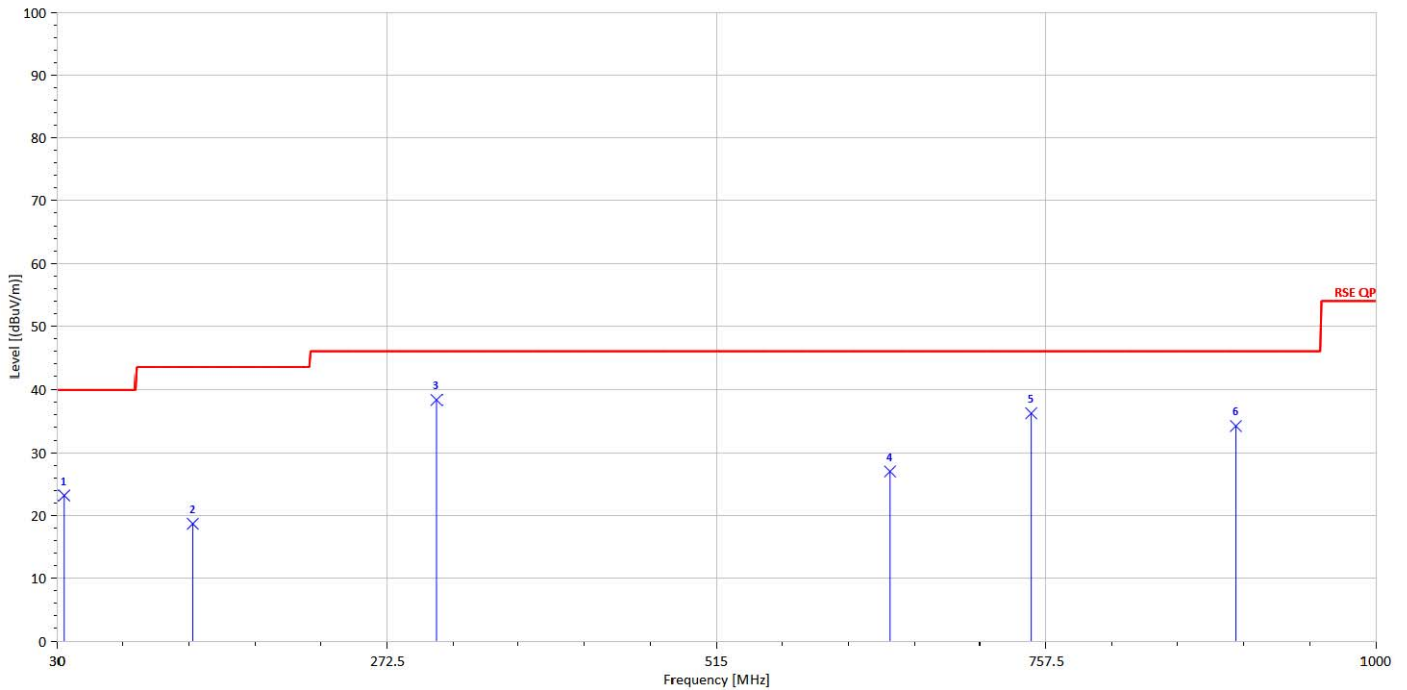

Freq. MHz	Note F/H/E/S	Detector Mode PK/QP/AV	Spectrum Reading Level dBuV	Factor dB	Actual FS dBuV/m	Limit @3m dBuV/m	Margin dB
34.85	S	Peak	32.97	-9.78	23.19	40	-16.81
129.91	S	Peak	34.35	-15.67	18.68	43.5	-24.82
309.36	S	Peak	51.02	-12.62	38.41	46	-7.59
643.04	S	Peak	32.11	-5.09	27.02	46	-18.98
746.83	S	Peak	40.52	-4.23	36.29	46	-9.71
897.18	S	Peak	36.62	-2.37	34.25	46	-11.75

Unless otherwise stated the results shown in this test report refer only to the sample(s) tested and such sample(s) are retained for 90 days only.

除非另有說明，此報告結果僅對測試之樣品負責，同時此樣品僅保留90天。本報告未經本公司書面許可，不可部份複製。

This document is issued by the Company subject to its General Conditions of Service printed overleaf, available on request or accessible at [www.sgs.com/terms\\_and\\_conditions.htm](http://www.sgs.com/terms_and_conditions.htm) and, for electronic format documents, subject to Terms and Conditions for Electronic Documents at [www.sgs.com/terms\\_e-document.htm](http://www.sgs.com/terms_e-document.htm). Attention is drawn to the limitation of liability, indemnification and jurisdiction issues defined therein. Any holder of this document is advised that information contained hereon reflects the Company's findings at the time of its intervention only and within the limits of Client's instructions, if any. The Company's sole responsibility is to its Client and this document does not exonerate parties to a transaction from exercising all their rights and obligations under the transaction documents. This document cannot be reproduced except in full, without prior written approval of the Company. Any unauthorized alteration, forgery or falsification of the content or appearance of this document is unlawful and offenders may be prosecuted to the fullest extent of the law.

Operation Mode : BLE                      Test Date : 2017/8/4  
 Fundamental Frequency : 2402 MHz      Temp. / Humi. : 22.7 deg\_C/57RH  
 Operation Band : Tx CH Low              Test Engineer : Ashton  
 EUT Pol. : H                                  Measurement Antenna Pol. : Horizontal

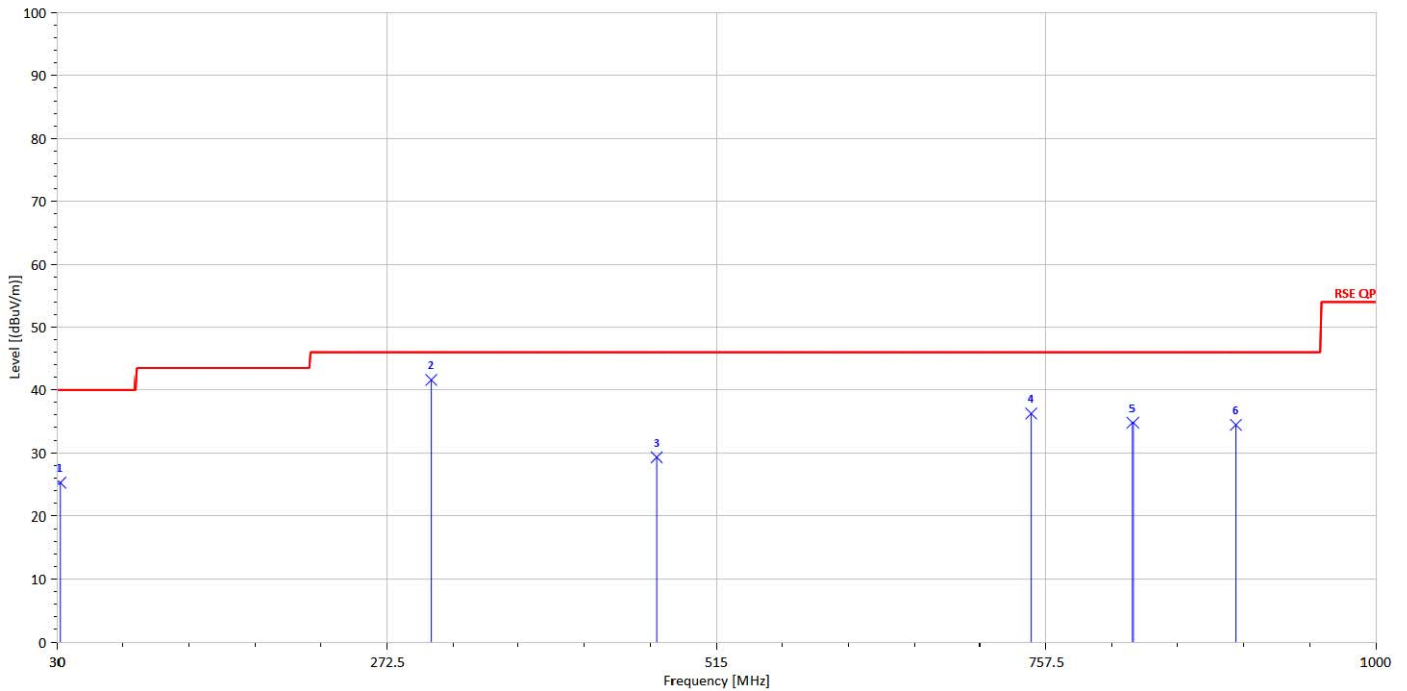

Freq. MHz	Note F/H/E/S	Detector Mode PK/QP/AV	Spectrum Reading Level dBuV	Factor dB	Actual FS dBuV/m	Limit @3m dBuV/m	Margin dB
31.94	S	Peak	33.45	-8.22	25.23	40	-14.77
305.48	S	QP	54.46	-12.86	41.60	46	-4.40
471.35	S	Peak	37.09	-7.81	29.28	46	-16.72
746.83	S	Peak	40.49	-4.23	36.25	46	-9.75
821.52	S	Peak	37.46	-2.66	34.80	46	-11.20
897.18	S	Peak	36.82	-2.37	34.44	46	-11.56

Unless otherwise stated the results shown in this test report refer only to the sample(s) tested and such sample(s) are retained for 90 days only.

除非另有說明，此報告結果僅對測試之樣品負責，同時此樣品僅保留90天。本報告未經本公司書面許可，不可部份複製。

This document is issued by the Company subject to its General Conditions of Service printed overleaf, available on request or accessible at [www.sgs.com/terms\\_and\\_conditions.htm](http://www.sgs.com/terms_and_conditions.htm) and, for electronic format documents, subject to Terms and Conditions for Electronic Documents at [www.sgs.com/terms\\_e-document.htm](http://www.sgs.com/terms_e-document.htm). Attention is drawn to the limitation of liability, indemnification and jurisdiction issues defined therein. Any holder of this document is advised that information contained hereon reflects the Company's findings at the time of its intervention only and within the limits of Client's instructions, if any. The Company's sole responsibility is to its Client and this document does not exonerate parties to a transaction from exercising all their rights and obligations under the transaction documents. This document cannot be reproduced except in full, without prior written approval of the Company. Any unauthorized alteration, forgery or falsification of the content or appearance of this document is unlawful and offenders may be prosecuted to the fullest extent of the law.

SGS Taiwan Ltd.

No. 134, WuKungRoad, New Taipei Industrial Park, Wuku District, New Taipei City, Taiwan 24803/新北市五股區新北產業園區五工路 134 號

台灣檢驗科技股份有限公司

t (886-2) 2299-3279

f (886-2) 2298-0488

www.tw.sgs.com

Member of SGS Group

Operation Mode : BLE                      Test Date : 2017/8/4  
 Fundamental Frequency : 2440 MHz      Temp. / Humi. : 22.7 deg\_C/57RH  
 Operation Band : Tx CH Mid              Test Engineer : Ashton  
 EUT Pol. : H                                  Measurement Antenna Pol. : Vertical

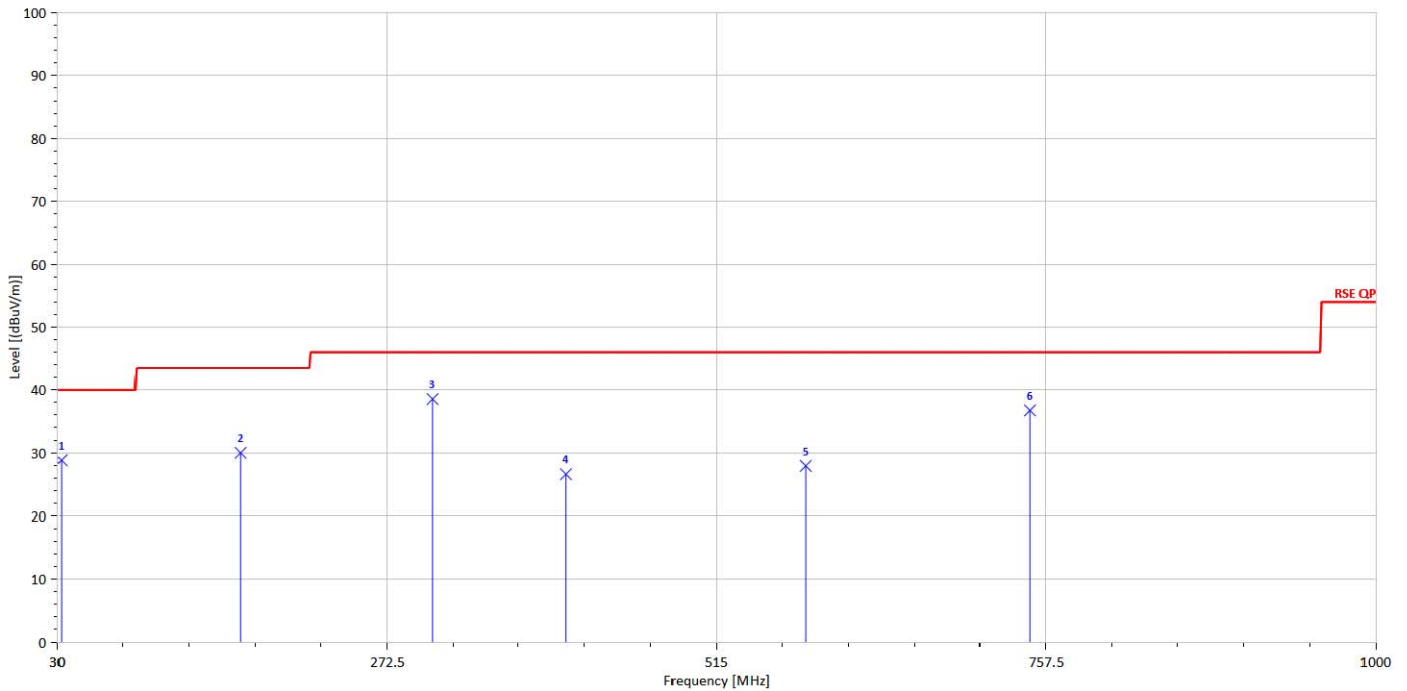

Freq. MHz	Note F/H/E/S	Detector Mode PK/QP/AV	Spectrum Reading Level dBuV	Factor dB	Actual FS dBuV/m	Limit @3m dBuV/m	Margin dB
32.91	S	Peak	37.55	-8.75	28.80	40	-11.20
164.83	S	Peak	47.77	-17.78	29.99	43.5	-13.51
306.45	S	Peak	51.33	-12.79	38.55	46	-7.45
404.42	S	Peak	36.26	-9.67	26.59	46	-19.41
580.96	S	Peak	34.03	-6.11	27.92	46	-18.08
745.86	S	Peak	41.09	-4.35	36.74	46	-9.26

Unless otherwise stated the results shown in this test report refer only to the sample(s) tested and such sample(s) are retained for 90 days only.

除非另有說明，此報告結果僅對測試之樣品負責，同時此樣品僅保留90天。本報告未經本公司書面許可，不可部份複製。

This document is issued by the Company subject to its General Conditions of Service printed overleaf, available on request or accessible at [www.sgs.com/terms\\_and\\_conditions.htm](http://www.sgs.com/terms_and_conditions.htm) and, for electronic format documents, subject to Terms and Conditions for Electronic Documents at [www.sgs.com/terms\\_e-document.htm](http://www.sgs.com/terms_e-document.htm). Attention is drawn to the limitation of liability, indemnification and jurisdiction issues defined therein. Any holder of this document is advised that information contained hereon reflects the Company's findings at the time of its intervention only and within the limits of Client's instructions, if any. The Company's sole responsibility is to its Client and this document does not exonerate parties to a transaction from exercising all their rights and obligations under the transaction documents. This document cannot be reproduced except in full, without prior written approval of the Company. Any unauthorized alteration, forgery or falsification of the content or appearance of this document is unlawful and offenders may be prosecuted to the fullest extent of the law.

SGS Taiwan Ltd.

No.134,WuKungRoad,NewTaipeiIndustrialPark,WukuDistrict,NewTaipeiCity,Taiwan24803/新北市五股區新北產業園區五工路 134 號

台灣檢驗科技股份有限公司

t (886-2) 2299-3279

f (886-2) 2298-0488

www.tw.sgs.com

Member of SGS Group

Operation Mode : BLE                      Test Date : 2017/8/4  
 Fundamental Frequency : 2440 MHz      Temp. / Humi. : 22.7 deg\_C/57RH  
 Operation Band : Tx CH Mid              Test Engineer : Ashton  
 EUT Pol. : H                                  Measurement Antenna Pol. : Horizontal

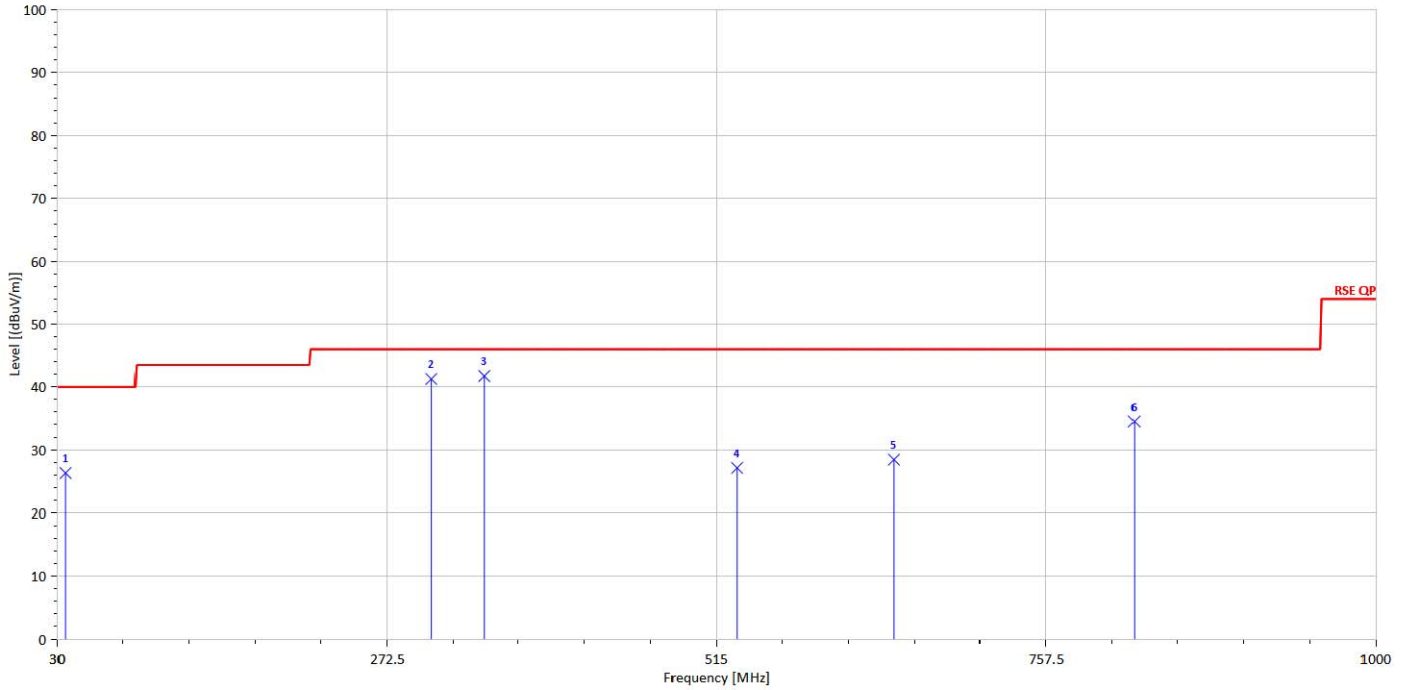

Freq. MHz	Note F/H/E/S	Detector Mode PK/QP/AV	Spectrum Reading Level dBuV	Factor dB	Actual FS dBuV/m	Limit @3m dBuV/m	Margin dB
35.82	S	Peak	36.64	-10.35	26.30	40	-13.70
305.48	S	QP	54.13	-12.86	41.27	46	-4.73
344.28	S	Peak	53.24	-11.50	41.74	46	-4.26
530.52	S	Peak	34.31	-7.20	27.11	46	-18.89
645.95	S	Peak	33.21	-4.79	28.42	46	-17.58
822.49	S	Peak	37.09	-2.59	34.50	46	-11.50

Unless otherwise stated the results shown in this test report refer only to the sample(s) tested and such sample(s) are retained for 90 days only.

除非另有說明，此報告結果僅對測試之樣品負責，同時此樣品僅保留90天。本報告未經本公司書面許可，不可部份複製。

This document is issued by the Company subject to its General Conditions of Service printed overleaf, available on request or accessible at [www.sgs.com/terms\\_and\\_conditions.htm](http://www.sgs.com/terms_and_conditions.htm) and, for electronic format documents, subject to Terms and Conditions for Electronic Documents at [www.sgs.com/terms\\_e-document.htm](http://www.sgs.com/terms_e-document.htm). Attention is drawn to the limitation of liability, indemnification and jurisdiction issues defined therein. Any holder of this document is advised that information contained hereon reflects the Company's findings at the time of its intervention only and within the limits of Client's instructions, if any. The Company's sole responsibility is to its Client and this document does not exonerate parties to a transaction from exercising all their rights and obligations under the transaction documents. This document cannot be reproduced except in full, without prior written approval of the Company. Any unauthorized alteration, forgery or falsification of the content or appearance of this document is unlawful and offenders may be prosecuted to the fullest extent of the law.

SGS Taiwan Ltd.

No.134,WuKungRoad,NewTaipeiIndustrialPark,WukuDistrict,NewTaipeiCity,Taiwan24803/新北市五股區新北產業園區五工路 134 號

台灣檢驗科技股份有限公司

t (886-2) 2299-3279

f (886-2) 2298-0488

www.tw.sgs.com

Member of SGS Group



Operation Mode : BLE                      Test Date : 2017/8/4  
 Fundamental Frequency : 2480 MHz      Temp. / Humi. : 22.7 deg\_C/57RH  
 Operation Band : Tx CH High              Test Engineer : Ashton  
 EUT Pol. : H                                  Measurement Antenna Pol. : Vertical

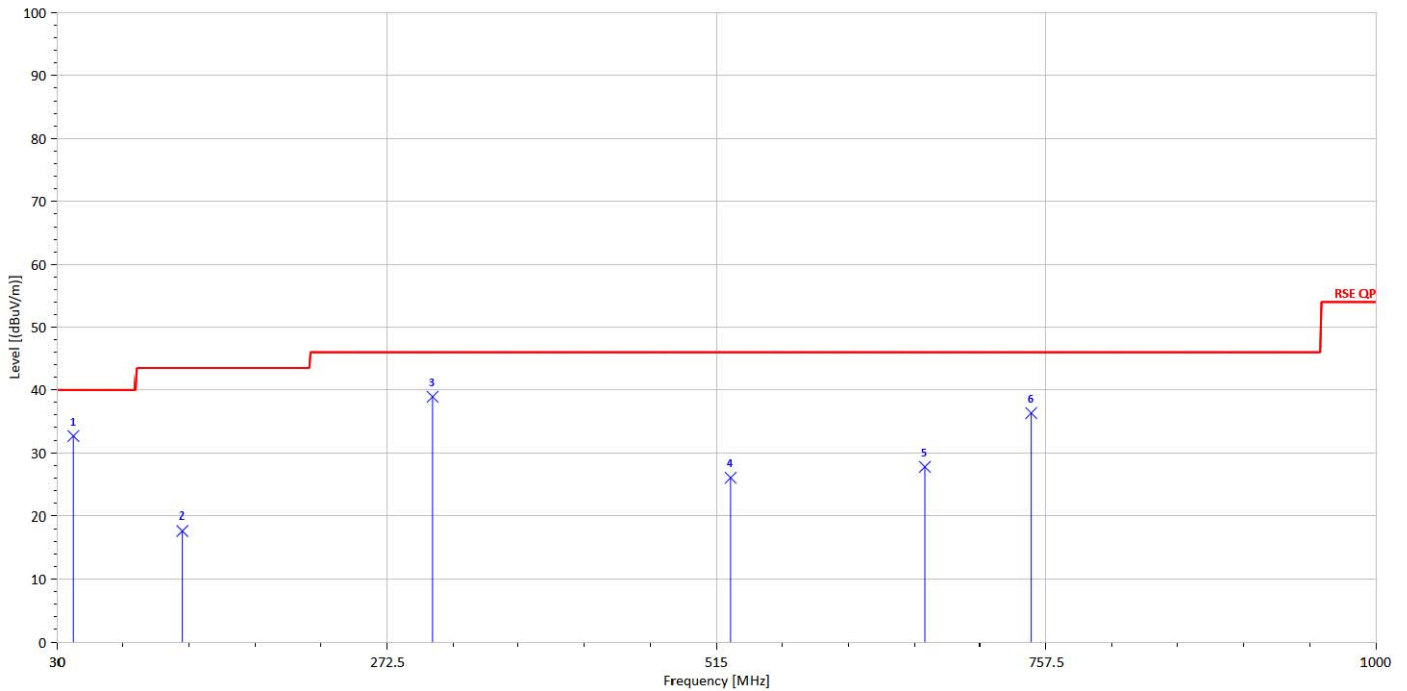

Freq. MHz	Note F/H/E/S	Detector Mode PK/QP/AV	Spectrum Reading Level dBuV	Factor dB	Actual FS dBuV/m	Limit @3m dBuV/m	Margin dB
41.64	S	Peak	46.62	-13.95	32.67	40	-7.33
122.15	S	Peak	33.46	-15.77	17.69	43.5	-25.81
306.45	S	Peak	51.70	-12.79	38.91	46	-7.09
525.67	S	Peak	33.49	-7.47	26.02	46	-19.98
668.26	S	Peak	33.21	-5.46	27.75	46	-18.25
746.83	S	Peak	40.55	-4.23	36.32	46	-9.68

Unless otherwise stated the results shown in this test report refer only to the sample(s) tested and such sample(s) are retained for 90 days only.

除非另有說明，此報告結果僅對測試之樣品負責，同時此樣品僅保留90天。本報告未經本公司書面許可，不可部份複製。

This document is issued by the Company subject to its General Conditions of Service printed overleaf, available on request or accessible at [www.sgs.com/terms\\_and\\_conditions.htm](http://www.sgs.com/terms_and_conditions.htm) and, for electronic format documents, subject to Terms and Conditions for Electronic Documents at [www.sgs.com/terms\\_e-document.htm](http://www.sgs.com/terms_e-document.htm). Attention is drawn to the limitation of liability, indemnification and jurisdiction issues defined therein. Any holder of this document is advised that information contained hereon reflects the Company's findings at the time of its intervention only and within the limits of Client's instructions, if any. The Company's sole responsibility is to its Client and this document does not exonerate parties to a transaction from exercising all their rights and obligations under the transaction documents. This document cannot be reproduced except in full, without prior written approval of the Company. Any unauthorized alteration, forgery or falsification of the content or appearance of this document is unlawful and offenders may be prosecuted to the fullest extent of the law.

SGS Taiwan Ltd.

No.134,WuKungRoad,NewTaipeiIndustrialPark,WukuDistrict,NewTaipeiCity,Taiwan24803/新北市五股區新北產業園區五工路 134 號

台灣檢驗科技股份有限公司

t (886-2) 2299-3279

f (886-2) 2298-0488

www.tw.sgs.com

Member of SGS Group

Operation Mode : BLE                      Test Date : 2017/8/4  
 Fundamental Frequency : 2480 MHz      Temp. / Humi. : 22.7 deg\_C/57RH  
 Operation Band : Tx CH High              Test Engineer : Ashton  
 EUT Pol. : H                                  Measurement Antenna Pol. : Horizontal

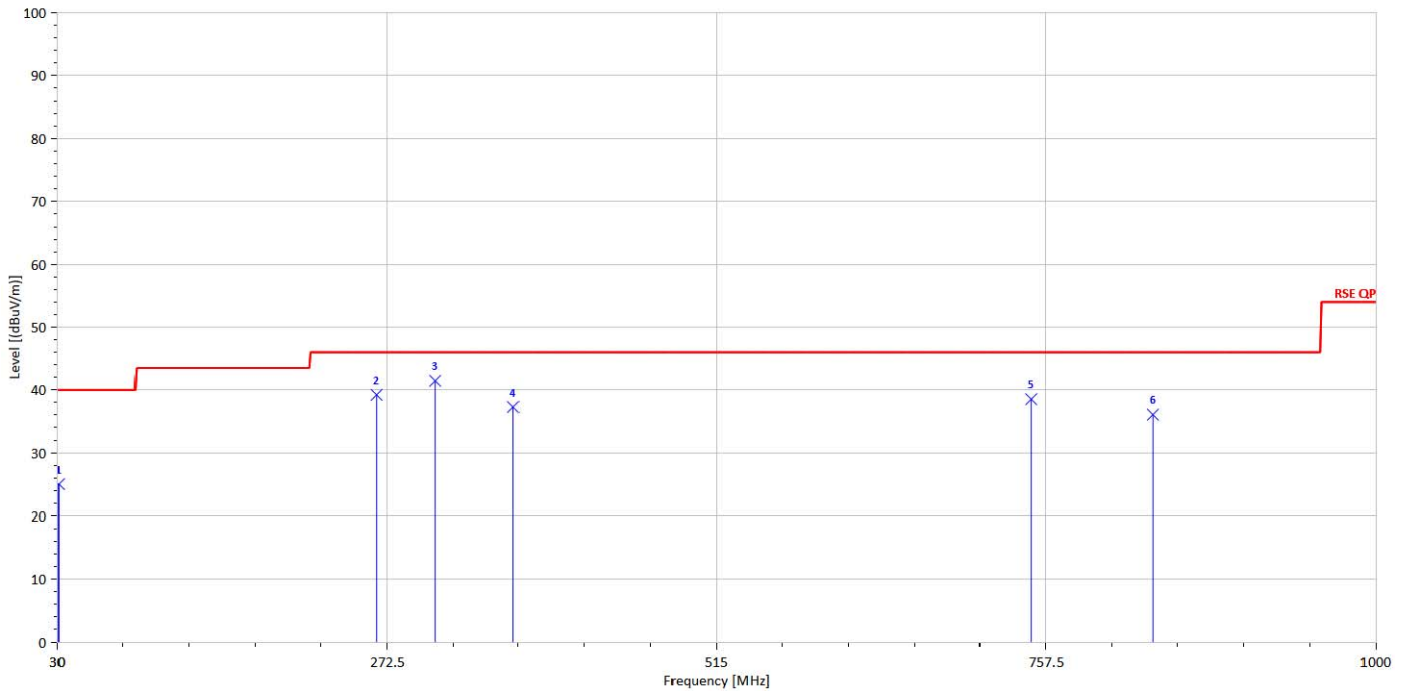

Freq. MHz	Note F/H/E/S	Detector Mode PK/QP/AV	Spectrum Reading Level dBuV	Factor dB	Actual FS dBuV/m	Limit @3m dBuV/m	Margin dB
30.97	S	Peak	32.72	-7.70	25.01	40	-14.99
264.74	S	Peak	52.97	-13.76	39.22	46	-6.78
308.39	S	QP	54.19	-12.74	41.45	46	-4.55
365.62	S	Peak	48.18	-10.89	37.29	46	-8.71
746.83	S	Peak	42.76	-4.23	38.53	46	-7.47
836.07	S	Peak	39.08	-3.01	36.07	46	-9.93

Unless otherwise stated the results shown in this test report refer only to the sample(s) tested and such sample(s) are retained for 90 days only.

除非另有說明，此報告結果僅對測試之樣品負責，同時此樣品僅保留90天。本報告未經本公司書面許可，不可部份複製。

This document is issued by the Company subject to its General Conditions of Service printed overleaf, available on request or accessible at [www.sgs.com/terms\\_and\\_conditions.htm](http://www.sgs.com/terms_and_conditions.htm) and, for electronic format documents, subject to Terms and Conditions for Electronic Documents at [www.sgs.com/terms\\_e-document.htm](http://www.sgs.com/terms_e-document.htm). Attention is drawn to the limitation of liability, indemnification and jurisdiction issues defined therein. Any holder of this document is advised that information contained hereon reflects the Company's findings at the time of its intervention only and within the limits of Client's instructions, if any. The Company's sole responsibility is to its Client and this document does not exonerate parties to a transaction from exercising all their rights and obligations under the transaction documents. This document cannot be reproduced except in full, without prior written approval of the Company. Any unauthorized alteration, forgery or falsification of the content or appearance of this document is unlawful and offenders may be prosecuted to the fullest extent of the law.

SGS Taiwan Ltd.

No.134,WuKungRoad,NewTaipeiIndustrialPark,WukuDistrict,NewTaipeiCity,Taiwan24803/新北市五股區新北產業園區五工路 134 號

台灣檢驗科技股份有限公司

t (886-2) 2299-3279

f (886-2) 2298-0488

www.tw.sgs.com

Member of SGS Group

### Radiated Spurious Emission Measurement Result (BLE mode) For Frequency above 1GHz

Operation Mode :	BLE	Test Date :	2017/8/4
Fundamental Frequency :	2402 MHz	Temp. / Humi. :	22.7 deg_C/57RH
Operation Band :	Tx CH Low	Test Engineer :	Ashton
EUT Pol. :	H	Measurement Antenna Pol. :	Vertical

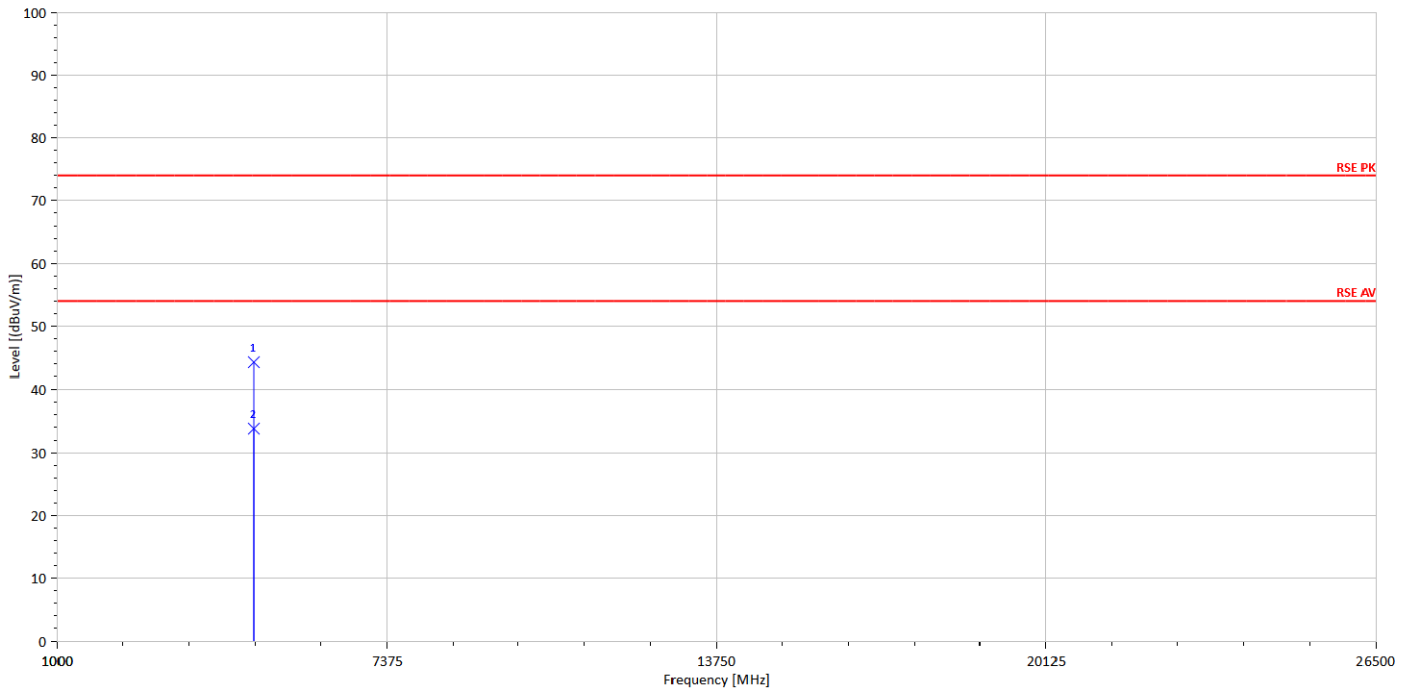

Freq. MHz	Note F/H/E/S	Detector Mode PK/QP/AV	Spectrum Reading Level dB $\mu$ V	Factor dB	Actual FS dB $\mu$ V/m	Limit @3m dB $\mu$ V/m	Margin dB
4804.00	H	Peak	36.61	7.66	44.27	74	-29.73
4804.00	H	Average	26.18	7.66	33.84	54	-20.16

Unless otherwise stated the results shown in this test report refer only to the sample(s) tested and such sample(s) are retained for 90 days only.

除非另有說明，此報告結果僅對測試之樣品負責，同時此樣品僅保留90天。本報告未經本公司書面許可，不可部份複製。

This document is issued by the Company subject to its General Conditions of Service printed overleaf, available on request or accessible at [www.sgs.com/terms\\_and\\_conditions.htm](http://www.sgs.com/terms_and_conditions.htm) and, for electronic format documents, subject to Terms and Conditions for Electronic Documents at [www.sgs.com/terms\\_e-document.htm](http://www.sgs.com/terms_e-document.htm). Attention is drawn to the limitation of liability, indemnification and jurisdiction issues defined therein. Any holder of this document is advised that information contained hereon reflects the Company's findings at the time of its intervention only and within the limits of Client's instructions, if any. The Company's sole responsibility is to its Client and this document does not exonerate parties to a transaction from exercising all their rights and obligations under the transaction documents. This document cannot be reproduced except in full, without prior written approval of the Company. Any unauthorized alteration, forgery or falsification of the content or appearance of this document is unlawful and offenders may be prosecuted to the fullest extent of the law.

SGS Taiwan Ltd.

No. 134, WuKungRoad, New Taipei Industrial Park, Wuku District, New Taipei City, Taiwan 24803/新北市五股區新北產業園區五工路 134 號

台灣檢驗科技股份有限公司

t (886-2) 2299-3279

f (886-2) 2298-0488

www.tw.sgs.com

Member of SGS Group

Operation Mode : BLE                      Test Date : 2017/8/4  
 Fundamental Frequency : 2402 MHz      Temp. / Humi. : 22.7 deg\_C/57RH  
 Operation Band : Tx CH Low              Test Engineer : Ashton  
 EUT Pol. : H                                  Measurement Antenna Pol. : Horizontal

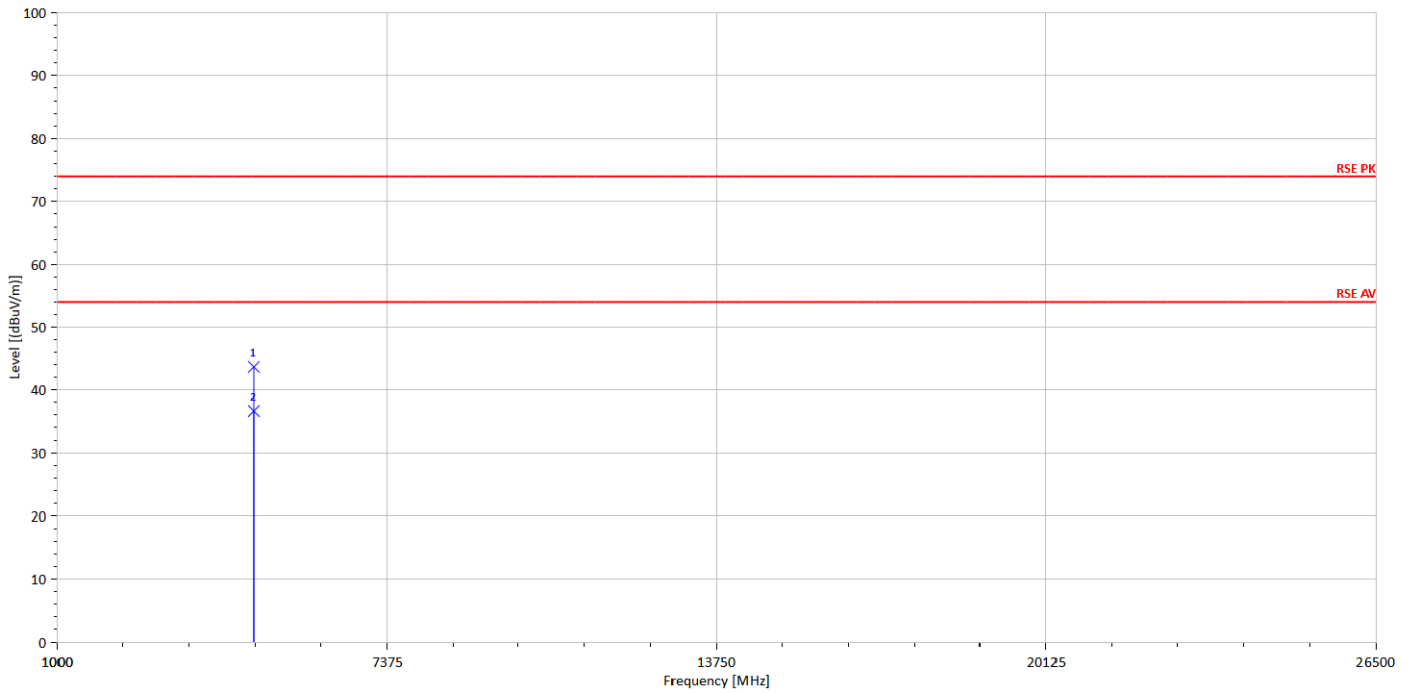

Freq. MHz	Note F/H/E/S	Detector Mode PK/QP/AV	Spectrum Reading Level dBµV	Factor dB	Actual FS dBµV/m	Limit @3m dBµV/m	Margin dB
4804.00	H	Peak	36.01	7.66	43.67	74	-30.33
4804.00	H	Average	28.98	7.66	36.64	54	-17.36

Unless otherwise stated the results shown in this test report refer only to the sample(s) tested and such sample(s) are retained for 90 days only.

除非另有說明，此報告結果僅對測試之樣品負責，同時此樣品僅保留90天。本報告未經本公司書面許可，不可部份複製。

This document is issued by the Company subject to its General Conditions of Service printed overleaf, available on request or accessible at [www.sgs.com/terms\\_and\\_conditions.htm](http://www.sgs.com/terms_and_conditions.htm) and, for electronic format documents, subject to Terms and Conditions for Electronic Documents at [www.sgs.com/terms\\_e-document.htm](http://www.sgs.com/terms_e-document.htm). Attention is drawn to the limitation of liability, indemnification and jurisdiction issues defined therein. Any holder of this document is advised that information contained hereon reflects the Company's findings at the time of its intervention only and within the limits of Client's instructions, if any. The Company's sole responsibility is to its Client and this document does not exonerate parties to a transaction from exercising all their rights and obligations under the transaction documents. This document cannot be reproduced except in full, without prior written approval of the Company. Any unauthorized alteration, forgery or falsification of the content or appearance of this document is unlawful and offenders may be prosecuted to the fullest extent of the law.

SGS Taiwan Ltd.

No.134,WuKungRoad,NewTaipeiIndustrialPark,WukuDistrict,NewTaipeiCity,Taiwan24803/新北市五股區新北產業園區五工路 134 號

台灣檢驗科技股份有限公司

t (886-2) 2299-3279

f (886-2) 2298-0488

www.tw.sgs.com

Member of SGS Group

Operation Mode : BLE                      Test Date : 2017/8/4  
 Fundamental Frequency : 2440 MHz      Temp. / Humi. : 22.7 deg\_C/57RH  
 Operation Band : Tx CH Mid              Test Engineer : Ashton  
 EUT Pol. : H                                  Measurement Antenna Pol. : Vertical

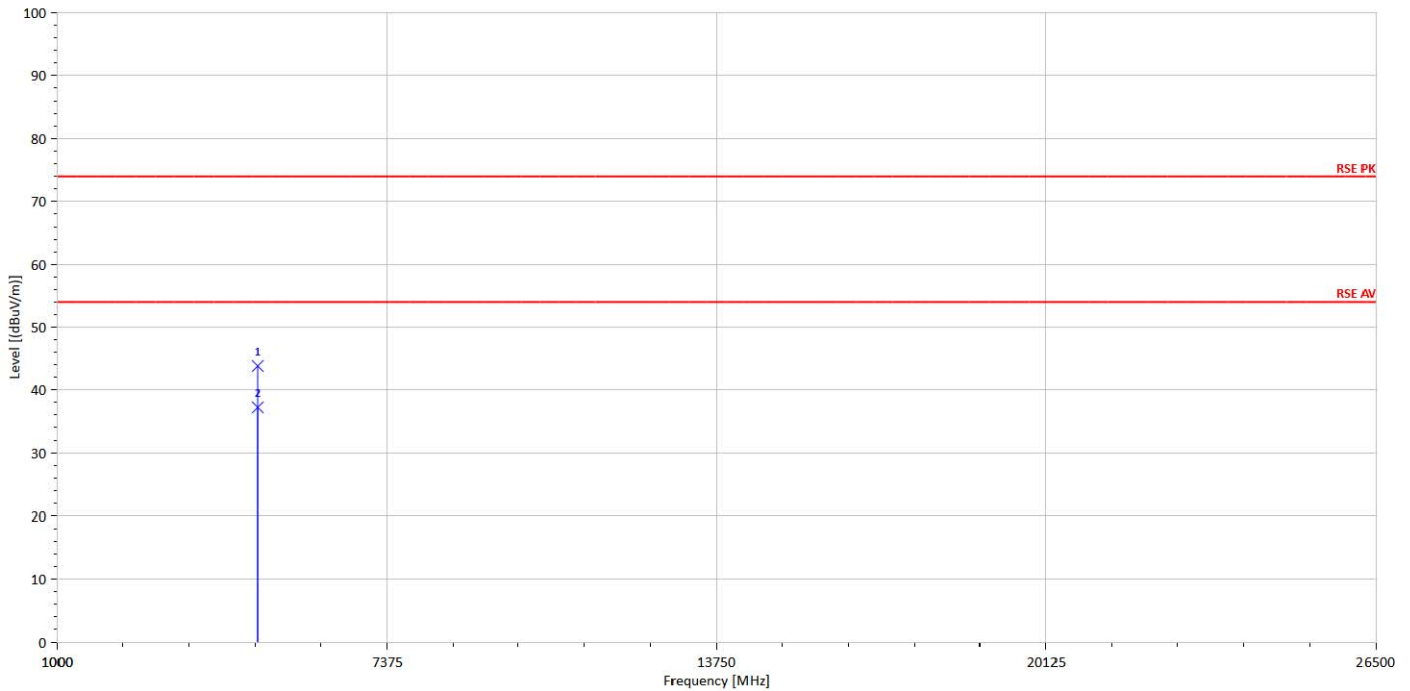

Freq. MHz	Note F/H/E/S	Detector Mode PK/QP/AV	Spectrum Reading Level dB $\mu$ V	Factor dB	Actual FS dB $\mu$ V/m	Limit @3m dB $\mu$ V/m	Margin dB
4880.00	H	Peak	36.04	7.78	43.82	74	-30.18
4880.00	H	Average	29.46	7.78	37.24	54	-16.76

Unless otherwise stated the results shown in this test report refer only to the sample(s) tested and such sample(s) are retained for 90 days only.

除非另有說明，此報告結果僅對測試之樣品負責，同時此樣品僅保留90天。本報告未經本公司書面許可，不可部份複製。

This document is issued by the Company subject to its General Conditions of Service printed overleaf, available on request or accessible at [www.sgs.com/terms\\_and\\_conditions.htm](http://www.sgs.com/terms_and_conditions.htm) and, for electronic format documents, subject to Terms and Conditions for Electronic Documents at [www.sgs.com/terms\\_e-document.htm](http://www.sgs.com/terms_e-document.htm). Attention is drawn to the limitation of liability, indemnification and jurisdiction issues defined therein. Any holder of this document is advised that information contained hereon reflects the Company's findings at the time of its intervention only and within the limits of Client's instructions, if any. The Company's sole responsibility is to its Client and this document does not exonerate parties to a transaction from exercising all their rights and obligations under the transaction documents. This document cannot be reproduced except in full, without prior written approval of the Company. Any unauthorized alteration, forgery or falsification of the content or appearance of this document is unlawful and offenders may be prosecuted to the fullest extent of the law.

SGS Taiwan Ltd.

No.134,WuKungRoad,NewTaipeiIndustrialPark,WukuDistrict,NewTaipeiCity,Taiwan24803/新北市五股區新北產業園區五工路 134 號

台灣檢驗科技股份有限公司

t (886-2) 2299-3279

f (886-2) 2298-0488

www.tw.sgs.com

Member of SGS Group

Operation Mode : BLE                      Test Date : 2017/8/4  
 Fundamental Frequency : 2440 MHz      Temp. / Humi. : 22.7 deg\_C/57RH  
 Operation Band : Tx CH Mid              Test Engineer : Ashton  
 EUT Pol. : H                                  Measurement Antenna Pol. : Horizontal

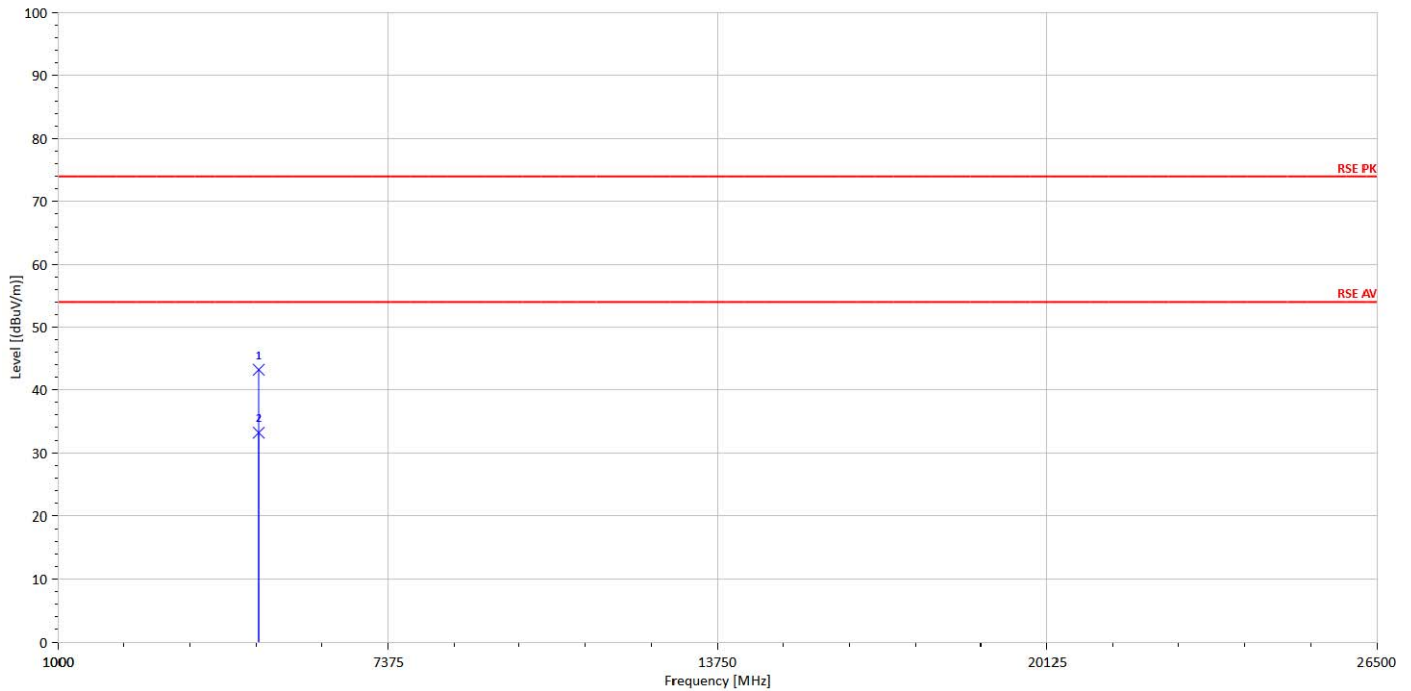

Freq. MHz	Note F/H/E/S	Detector Mode PK/QP/AV	Spectrum Reading Level dBµV	Factor dB	Actual FS dBµV/m	Limit @3m dBµV/m	Margin dB
4880.00	H	Peak	35.44	7.78	43.22	74	-30.78
4880.00	H	Average	25.41	7.78	33.19	54	-20.81

Unless otherwise stated the results shown in this test report refer only to the sample(s) tested and such sample(s) are retained for 90 days only.

除非另有說明，此報告結果僅對測試之樣品負責，同時此樣品僅保留90天。本報告未經本公司書面許可，不可部份複製。

This document is issued by the Company subject to its General Conditions of Service printed overleaf, available on request or accessible at [www.sgs.com/terms\\_and\\_conditions.htm](http://www.sgs.com/terms_and_conditions.htm) and, for electronic format documents, subject to Terms and Conditions for Electronic Documents at [www.sgs.com/terms\\_e-document.htm](http://www.sgs.com/terms_e-document.htm). Attention is drawn to the limitation of liability, indemnification and jurisdiction issues defined therein. Any holder of this document is advised that information contained hereon reflects the Company's findings at the time of its intervention only and within the limits of Client's instructions, if any. The Company's sole responsibility is to its Client and this document does not exonerate parties to a transaction from exercising all their rights and obligations under the transaction documents. This document cannot be reproduced except in full, without prior written approval of the Company. Any unauthorized alteration, forgery or falsification of the content or appearance of this document is unlawful and offenders may be prosecuted to the fullest extent of the law.

SGS Taiwan Ltd.

No.134,WuKungRoad,NewTaipeiIndustrialPark,WukuDistrict,NewTaipeiCity,Taiwan24803/新北市五股區新北產業園區五工路 134 號

台灣檢驗科技股份有限公司

t (886-2) 2299-3279

f (886-2) 2298-0488

www.tw.sgs.com

Member of SGS Group

Operation Mode : BLE                      Test Date : 2017/8/4  
 Fundamental Frequency : 2480 MHz      Temp. / Humi. : 22.7deg\_C/57RH  
 Operation Band : Tx CH High              Test Engineer : Ashton  
 EUT Pol. : H                                  Measurement Antenna Pol. : Vertical

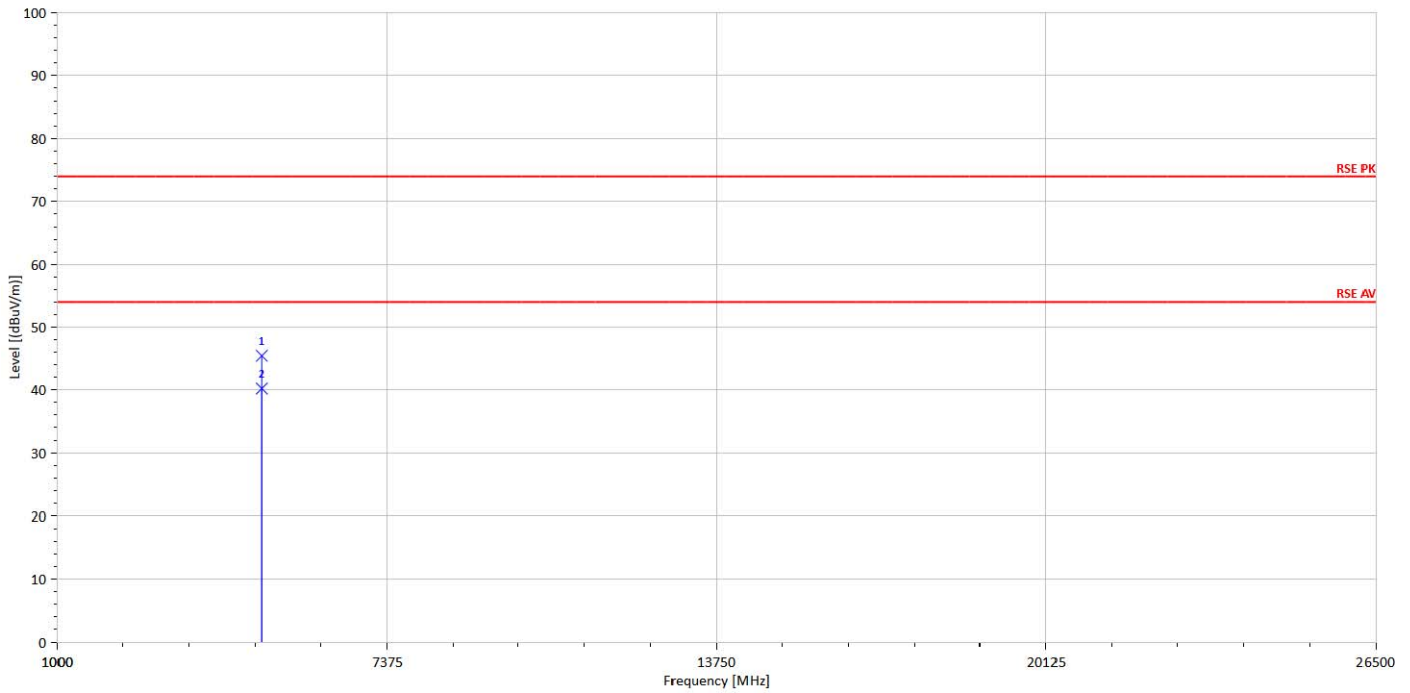

Freq. MHz	Note F/H/E/S	Detector Mode PK/QP/AV	Spectrum Reading Level dB $\mu$ V	Factor dB	Actual FS dB $\mu$ V/m	Limit @3m dB $\mu$ V/m	Margin dB
4960.00	H	Peak	37.76	7.69	45.45	74	-28.55
4960.00	H	Average	32.54	7.69	40.23	54	-13.77

Unless otherwise stated the results shown in this test report refer only to the sample(s) tested and such sample(s) are retained for 90 days only.

除非另有說明，此報告結果僅對測試之樣品負責，同時此樣品僅保留90天。本報告未經本公司書面許可，不可部份複製。

This document is issued by the Company subject to its General Conditions of Service printed overleaf, available on request or accessible at [www.sgs.com/terms\\_and\\_conditions.htm](http://www.sgs.com/terms_and_conditions.htm) and, for electronic format documents, subject to Terms and Conditions for Electronic Documents at [www.sgs.com/terms\\_e-document.htm](http://www.sgs.com/terms_e-document.htm). Attention is drawn to the limitation of liability, indemnification and jurisdiction issues defined therein. Any holder of this document is advised that information contained hereon reflects the Company's findings at the time of its intervention only and within the limits of Client's instructions, if any. The Company's sole responsibility is to its Client and this document does not exonerate parties to a transaction from exercising all their rights and obligations under the transaction documents. This document cannot be reproduced except in full, without prior written approval of the Company. Any unauthorized alteration, forgery or falsification of the content or appearance of this document is unlawful and offenders may be prosecuted to the fullest extent of the law.

SGS Taiwan Ltd.

No.134,WuKungRoad,NewTaipeiIndustrialPark,WukuDistrict,NewTaipeiCity,Taiwan24803/新北市五股區新北產業園區五工路 134 號

台灣檢驗科技股份有限公司

t (886-2) 2299-3279

f (886-2) 2298-0488

www.tw.sgs.com

Member of SGS Group

Operation Mode : BLE                      Test Date : 2017/8/4  
 Fundamental Frequency : 2480 MHz      Temp. / Humi. : 22.7deg\_C/57RH  
 Operation Band : Tx CH High      Test Engineer : Ashton  
 EUT Pol. : H                      Measurement Antenna Pol. : Horizontal

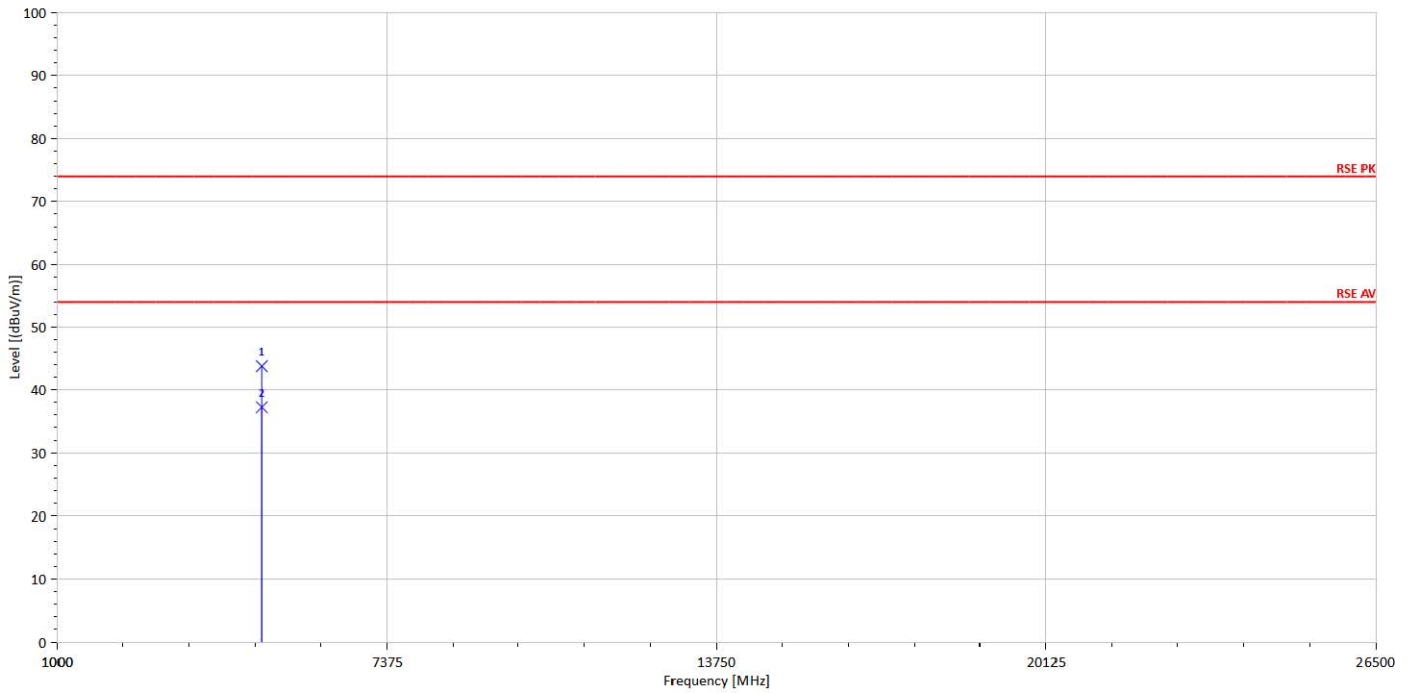

Freq. MHz	Note F/H/E/S	Detector Mode PK/QP/AV	Spectrum Reading Level dBµV	Factor dB	Actual FS dBµV/m	Limit @3m dBµV/m	Margin dB
4960.00	H	Peak	36.10	7.69	43.79	74	-30.21
4960.00	H	Average	29.56	7.69	37.25	54	-16.75

Unless otherwise stated the results shown in this test report refer only to the sample(s) tested and such sample(s) are retained for 90 days only.

除非另有說明，此報告結果僅對測試之樣品負責，同時此樣品僅保留90天。本報告未經本公司書面許可，不可部份複製。

This document is issued by the Company subject to its General Conditions of Service printed overleaf, available on request or accessible at [www.sgs.com/terms\\_and\\_conditions.htm](http://www.sgs.com/terms_and_conditions.htm) and, for electronic format documents, subject to Terms and Conditions for Electronic Documents at [www.sgs.com/terms\\_e-document.htm](http://www.sgs.com/terms_e-document.htm). Attention is drawn to the limitation of liability, indemnification and jurisdiction issues defined therein. Any holder of this document is advised that information contained hereon reflects the Company's findings at the time of its intervention only and within the limits of Client's instructions, if any. The Company's sole responsibility is to its Client and this document does not exonerate parties to a transaction from exercising all their rights and obligations under the transaction documents. This document cannot be reproduced except in full, without prior written approval of the Company. Any unauthorized alteration, forgery or falsification of the content or appearance of this document is unlawful and offenders may be prosecuted to the fullest extent of the law.

SGS Taiwan Ltd.

No.134,WuKungRoad,NewTaipeiIndustrialPark,WukuDistrict,NewTaipeiCity,Taiwan24803/新北市五股區新北產業園區五工路 134 號

台灣檢驗科技股份有限公司

t (886-2) 2299-3279

f (886-2) 2298-0488

www.tw.sgs.com

Member of SGS Group



## 11 PEAK POWER SPECTRAL DENSITY

### 11.1 Standard Applicable:

The power spectral density conducted from the intentional radiator to the antenna shall not be greater than 8dBm in any 3 kHz band during any time interval of continuous transmission.

### 11.2 Measurement Equipment Used:

Conducted Emission Test Site					
EQUIPMENT TYPE	MFR	MODEL NUMBER	SERIAL NUMBER	LAST CAL.	CAL DUE.
Spectrum Analyzer	KEYSIGHT	N9010A	MY51440113	06/20/2017	06/19/2018
Coaxial Cable 30cm	WOKEN	00100A1F1A 195C	RF01	12/12/2016	12/11/2017
DC Block	PASTERNAK	PE8210	RF29	12/12/2016	12/11/2017
Attenuator	WOKEN	218FS-10	RF23	12/12/2016	12/11/2017

### 11.3 Test Set-up:

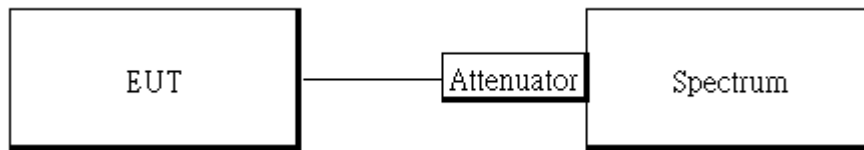

### 11.4 Measurement Procedure:

1. Set analyzer center frequency to DTS channel center frequency.
2. The testing follows the Measurement Procedure of FCC KDB 558074 D01 DTS Meas. Guidance .
3. Set the span to 1.5 times the DTS channel bandwidth.
4. Set the RBW = 3 kHz. & the VBW = 10 kHz
5. Detector = peak.
6. Sweep time = auto couple.
7. Trace mode = max hold.
8. Allow trace to fully stabilize.
9. Use the peak marker function to determine the maximum amplitude level.

Unless otherwise stated the results shown in this test report refer only to the sample(s) tested and such sample(s) are retained for 90 days only.

除非另有說明，此報告結果僅對測試之樣品負責，同時此樣品僅保留90天。本報告未經本公司書面許可，不可部份複製。

This document is issued by the Company subject to its General Conditions of Service printed overleaf, available on request or accessible at [www.sgs.com/terms\\_and\\_conditions.htm](http://www.sgs.com/terms_and_conditions.htm) and, for electronic format documents, subject to Terms and Conditions for Electronic Documents at [www.sgs.com/terms\\_e-document.htm](http://www.sgs.com/terms_e-document.htm). Attention is drawn to the limitation of liability, indemnification and jurisdiction issues defined therein. Any holder of this document is advised that information contained hereon reflects the Company's findings at the time of its intervention only and within the limits of Client's instructions, if any. The Company's sole responsibility is to its Client and this document does not exonerate parties to a transaction from exercising all their rights and obligations under the transaction documents. This document cannot be reproduced except in full, without prior written approval of the Company. Any unauthorized alteration, forgery or falsification of the content or appearance of this document is unlawful and offenders may be prosecuted to the fullest extent of the law.

SGS Taiwan Ltd.

No.134,WuKungRoad,NewTaipeiIndustrialPark,WukuDistrict,NewTaipeiCity,Taiwan24803/新北市五股區新北產業園區五工路 134 號

台灣檢驗科技股份有限公司

t (886-2) 2299-3279

f (886-2) 2298-0488

www.tw.sgs.com

Member of SGS Group

11.5 Measurement Result:

BLE mode

BLE mode

Frequency (MHz)	RF Power Density (dBm)	Maximum Limit (dBm)	Result
2402	-15.20	8	PASS
2442	-15.31	8	PASS
2480	-14.85	8	PASS

NOTE: cable loss as 1.4dB that offsets in the spectrum

BLE mode  
Power Spectral Density Test Plot (CH-Low)



Unless otherwise stated the results shown in this test report refer only to the sample(s) tested and such sample(s) are retained for 90 days only.

除非另有說明，此報告結果僅對測試之樣品負責，同時此樣品僅保留90天。本報告未經本公司書面許可，不可部份複製。

This document is issued by the Company subject to its General Conditions of Service printed overleaf, available on request or accessible at [www.sgs.com/terms\\_and\\_conditions.htm](http://www.sgs.com/terms_and_conditions.htm) and, for electronic format documents, subject to Terms and Conditions for Electronic Documents at [www.sgs.com/terms\\_e-document.htm](http://www.sgs.com/terms_e-document.htm). Attention is drawn to the limitation of liability, indemnification and jurisdiction issues defined therein. Any holder of this document is advised that information contained hereon reflects the Company's findings at the time of its intervention only and within the limits of Client's instructions, if any. The Company's sole responsibility is to its Client and this document does not exonerate parties to a transaction from exercising all their rights and obligations under the transaction documents. This document cannot be reproduced except in full, without prior written approval of the Company. Any unauthorized alteration, forgery or falsification of the content or appearance of this document is unlawful and offenders may be prosecuted to the fullest extent of the law.

SGS Taiwan Ltd.

No. 134, WuKungRoad, New Taipei Industrial Park, Wuku District, New Taipei City, Taiwan 24803/新北市五股區新北產業園區五工路 134 號

台灣檢驗科技股份有限公司

t (886-2) 2299-3279

f (886-2) 2298-0488

www.tw.sgs.com

Member of SGS Group

### Power Spectral Density Test Plot (CH-Mid)



### Power Spectral Density Test Plot (CH-High)



Unless otherwise stated the results shown in this test report refer only to the sample(s) tested and such sample(s) are retained for 90 days only.

除非另有說明，此報告結果僅對測試之樣品負責，同時此樣品僅保留90天。本報告未經本公司書面許可，不可部份複製。

This document is issued by the Company subject to its General Conditions of Service printed overleaf, available on request or accessible at [www.sgs.com/terms\\_and\\_conditions.htm](http://www.sgs.com/terms_and_conditions.htm) and, for electronic format documents, subject to Terms and Conditions for Electronic Documents at [www.sgs.com/terms\\_e-document.htm](http://www.sgs.com/terms_e-document.htm). Attention is drawn to the limitation of liability, indemnification and jurisdiction issues defined therein. Any holder of this document is advised that information contained hereon reflects the Company's findings at the time of its intervention only and within the limits of Client's instructions, if any. The Company's sole responsibility is to its Client and this document does not exonerate parties to a transaction from exercising all their rights and obligations under the transaction documents. This document cannot be reproduced except in full, without prior written approval of the Company. Any unauthorized alteration, forgery or falsification of the content or appearance of this document is unlawful and offenders may be prosecuted to the fullest extent of the law.

SGS Taiwan Ltd.

No. 134, WuKungRoad, NewTaipeiIndustrialPark, WukuDistrict, New Taipei City, Taiwan 24803/新北市五股區新北產業園區五工路 134 號

台灣檢驗科技股份有限公司

t (886-2) 2299-3279

f (886-2) 2298-0488

www.tw.sgs.com

Member of SGS Group

## 12 ANTENNA REQUIREMENT

### 12.1 Standard Applicable:

For intentional device, according to §15.203, an intentional radiator shall be designed to ensure that no antenna other than furnished by the responsible party shall be used with the device.

If the transmitting antenna is greater than 6dBi, the power shall be reduced by the same level in dB comparing to gain minus 6dBi.

In case of point-to-point operation, the power shall be reduced by the one dB for every 3 dB that the directional gain of antenna exceeds 6dBi.

### 12.2 Antenna Connected Construction:

An embedded-in antenna design is used.

The antenna is designed as permanently attached and has no consideration of replacement. Please see EUT photo and antenna spec. for details.

## PHOTOGRAPHS OF EUT

**Please refer to the attached file(EUT Photo)**

*~ End of Report ~*

Unless otherwise stated the results shown in this test report refer only to the sample(s) tested and such sample(s) are retained for 90 days only.

除非另有說明，此報告結果僅對測試之樣品負責，同時此樣品僅保留90天。本報告未經本公司書面許可，不可部份複製。

This document is issued by the Company subject to its General Conditions of Service printed overleaf, available on request or accessible at [www.sgs.com/terms\\_and\\_conditions.htm](http://www.sgs.com/terms_and_conditions.htm) and, for electronic format documents, subject to Terms and Conditions for Electronic Documents at [www.sgs.com/terms\\_e-document.htm](http://www.sgs.com/terms_e-document.htm). Attention is drawn to the limitation of liability, indemnification and jurisdiction issues defined therein. Any holder of this document is advised that information contained hereon reflects the Company's findings at the time of its intervention only and within the limits of Client's instructions, if any. The Company's sole responsibility is to its Client and this document does not exonerate parties to a transaction from exercising all their rights and obligations under the transaction documents. This document cannot be reproduced except in full, without prior written approval of the Company. Any unauthorized alteration, forgery or falsification of the content or appearance of this document is unlawful and offenders may be prosecuted to the fullest extent of the law.

SGS Taiwan Ltd.

No.134,WuKungRoad,NewTaipeiIndustrialPark,WukuDistrict,NewTaipeiCity,Taiwan24803/新北市五股區新北產業園區五工路 134 號

台灣檢驗科技股份有限公司

t (886-2) 2299-3279

f (886-2) 2298-0488

www.tw.sgs.com

Member of SGS Group