

# BRAUN

Bluetooth®

## ExactFit™ 5 Connect



BUA 6350

# Product description



BUA6350

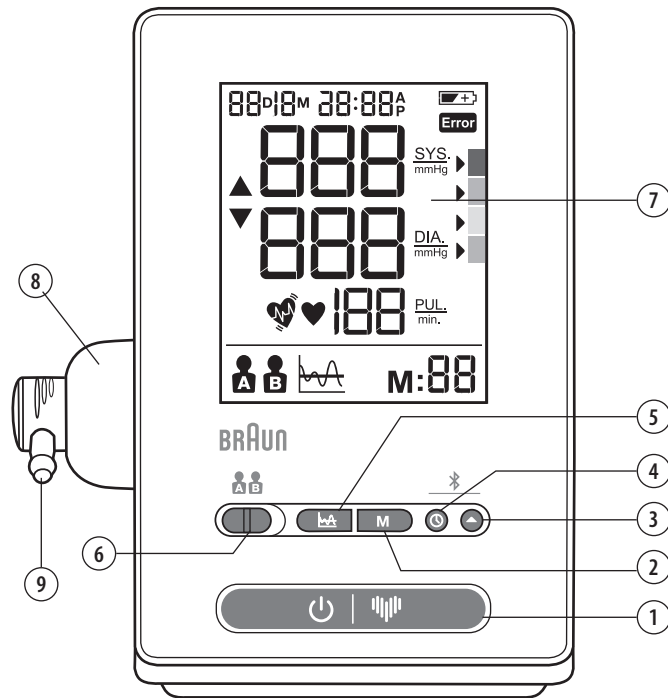

Fig. 1

## Intended use of Braun ExactFit™ 5 Connect

Braun upper arm blood pressure monitor has been developed for accurate and comfortable blood pressure measurements. The measuring accuracy of Braun's upper arm blood pressure monitor was tested at the time of manufacture and was proven by clinical research in accordance with ESH.

## What you should know about blood pressure

Blood pressure constantly changes throughout the day. It rises sharply in the early morning and declines during the late morning. Blood pressure rises again in the afternoon and finally drops to a low level at night. Also, it may vary in a short period of time. Therefore, readings from successive measurements can fluctuate.

This device will display your blood pressure reading referring to two values: systolic and diastolic. The systolic blood pressure (the upper number) indicates how much pressure your blood is exerting against your artery walls when the heart beats. The diastolic blood pressure (the lower number) indicates how much pressure your blood is exerting against your artery walls while the heart is resting between beats. The pulse value is also displayed after each measurement.

Blood pressure measured in a doctor's office only provides a momentary value. Repeated measurements at home better reflect one's actual blood pressure values under everyday conditions.

Moreover, many people have a different blood pressure when they measure at home because they tend to be more relaxed than when in the doctor's office. Regular blood pressure measurements taken at home can provide your doctor with valuable information on your normal blood pressure values under actual «everyday» conditions.

The ESH (European Society of Hypertension) and WHO (World Health Organisation) have set up the following standard blood pressure values when measured with a resting pulse at home:

Blood pressure (mmHg)	Normal values	Grade 1 mild hypertension	Grade 2 moderate hypertension	Grade 3 severe hypertension
SYS = systole (upper value)	up to 134	135-159	160-179	≥180
DIA = diastole (lower value)	up to 84	85-99	100-109	≥110

## Safety information and important precautions

To ensure accurate measuring results, read the complete instructions for use carefully.

People suffering from cardiac arrhythmia, vascular constriction, arteriosclerosis in the extremities, diabetes or users of cardiac pacemakers should consult their doctor before measuring their blood pressure themselves. Deviations in blood pressure values may occur in such cases.

If your blood pressure reading is in the severe hypertension range with values of 180 mmHg systolic and above, and/or 110 mmHg diastolic and above; and you find you have one or two readings in this range - please see your doctor straight away.

If you are under medical treatment or taking any medication, please consult your doctor first.

The use of this blood pressure monitor is not intended as a substitute for a consultation with your doctor.

## Key rules for accurate blood pressure measurement

Always take readings at the same time of day, under the same conditions.

Do not take a measurement within 30 minutes of smoking, drinking coffee or tea or any form of exertion. These factors will influence the measurement.





Ensure at least 5 minutes of quiet rest before measurements. If possible, it is recommended to rest 10 minutes before taking the measurement. Try to always use the same resting time before taking a measurement.

Always measure on the same arm. The left arm is recommended. Do not move or speak. Keep your legs uncrossed and feet flat on the floor.

Place the cuff in direct contact with the skin. Do not wrap the cuff over a jacket, sweater or shirt.

If you want to take multiple measurements, wait approximately 3 minutes before repeating a measurement.

## Product description (See page 2-3)

1. Start button 
2. Memory button 
3. Date / time adjust button 
4. Set button 
5. Average button 
6. User A / B switch
7. LCD display
8. Hose port
9. Connector
10. Arm cuff (supplied with 2 cuffs)
11. Air hose
12. Battery compartment cover (4 X 1.5V type AA (LR6) batteries)

## Inserting batteries (See Fig. 2-3)

- Remove the battery compartment cover at the bottom of the unit and insert 4 AA LR6 alkaline batteries with correct polarity (see symbol in the battery compartment).
- Note: always re-set date and time after replacing new batteries to make sure the measurement results are stored with correct date and time.



Only discard empty batteries. They should not be disposed of in the household waste, but at appropriate collection sites or at your retailer.

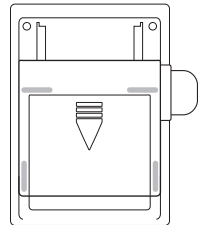

Fig. 2

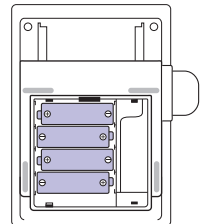

Fig. 3

## Choosing the right cuff

For accurate measurement, it is important to choose the correct size cuff which best fits your upper arm. Choose the cuff size according to your arm circumference and make sure the bottom of the cuff is 2~3cm above your elbow.

- Small/Medium Cuff = 22~32cm arm circumference
- Large/XLarge Cuff = 32~42cm arm circumference

See point 7 below and Fig. 8 to confirm cuff size.

## Applying the arm cuff

1. Slide the end of arm cuff furthest from the tube through the metal ring to a loop. The smooth cloth should be on the inside of the cuff.

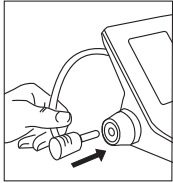

Fig. 4

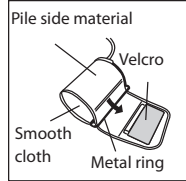

Fig. 5

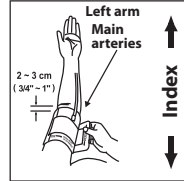

Fig. 6

2. Plug the air hose into the connector (Fig. 4).
3. If the cuff is located correctly, the velcro will be on the outside of the cuff and the metal ring will not touch the skin (Fig. 5).
4. Put your left arm through the cuff loop. The bottom of the cuff should be approximately (2~3 cm) above elbow. The tube should lie over the brachial artery on the inside of the arm (Fig. 6).

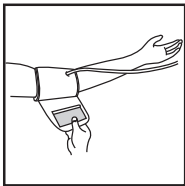

Fig. 7

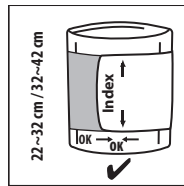

Fig. 8

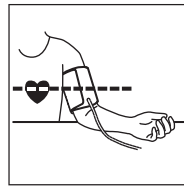
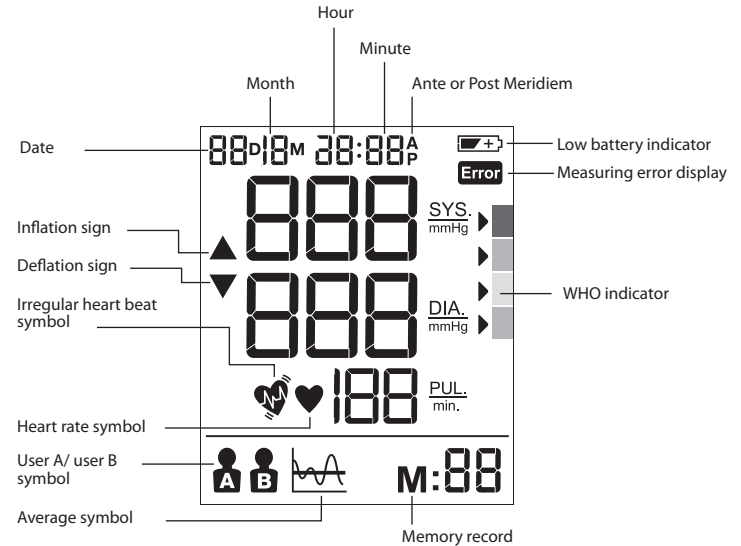

Fig. 9

5. Pull the cuff so that the top and bottom edges are tightened around your arm (Fig. 7).
6. When the cuff is positioned properly, press the Velcro firmly against the pile side of the cuff.
7. This cuff is suitable for use if the <<index>> mark falls within the <<ok range>> marked by two arrows when the cuff is tightened around your arm (Fig. 8).
8. Sit on a chair and place your arm on the table so that the cuff is at the same level as your heart (Fig. 9).

## Braun ExactFit™ 5 Connect Display BUA6350



### How to select user A /user B

- Make sure the Product is in power off mode.
- Slide the user switch to user A or user B, the current user mode will flash on the LCD display.











### The WHO/ESH indicator to evaluate blood pressure data

RED >	!!!
ORANGE >	!!
YELLOW >	!
GREEN >	✓

This device has a blood pressure level indicator established according to WHO and the European Hypertension Society Guidelines (ESH). For every measurement displayed on the screen, the cursor will indicate the blood pressure level with the corresponding color code, from green to red. You can use this classification daily to guide you to understand your blood pressure level. If you are really concerned by the classification level, you should consult your doctor as soon as possible.

If your blood pressure reading is in the severe hypertension range with values of 180 mmHg systolic or above, and/or 110 mmHg diastolic and above, and if you find you have one or two readings in this range - please see your doctor straight away.

## Setting month, date and time



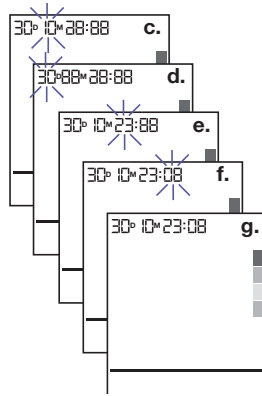

- Switch off the device for the date/time setting.
- Press set button  (4) to start the year setting, then the "year" will blink on display. Press  (3) to adjust year by 1 step.
- Press set button  (4) to start the month setting, then the "month" will blink on display, user can press adjust  (3) to adjust month by 1 step.
- Press set button  (4) to start the day setting, then the "day" will blink on display, user can press adjust  (3) to adjust day by 1 step.
- Press set button  (4) to start the hour setting, then the "hour" will blink on display, user can press adjust  (3) to adjust hour by 1 step.
- Press set button  (4) to start the minute setting, then the "minute" will blink on display, user can press adjust  (3) to adjust minute by 1 step.
- Press set button  (4) to end all the date/time setting, all blinking stops.



Note: Holding the adjust button will scroll the value.



## Taking a measurement

Wrap the cuff around the arm (see "applying the arm cuff" section above).

- Sit upright on the chair to have a correct posture.
- Press and release start button  |  (1), date/time and current user will be displayed.
- Set user A/B switch (6) to A for user A or B for user B, LCD display will show user A or B symbol.
- Press and release the start button  |  (1), all icons on display will be shown for 2 seconds. Air pressure will automatically pump up to certain pressure level and start measurement.  
Do not move or talk in the midst of taking blood pressure measurement. During the measurement, keep your legs uncrossed and feet flat on the floor.
- After the air pressure has increased, the pulse is detected, the heart rate symbol  will start flashing.
- LCD Display will show the results and WHO indicator arrow after measurement.

After using the device, turn it off by pressing the start button  |  (1) or it will automatically turn off after 1 minute.

This device is not intended as a substitute for regular check-ups by your doctor, please continue to visit your doctor on a regular basis for a professional reading.

## Connection to Smartphone and Braun Healthy Heart app

Your ExactFit™ 5 Connect can be connected by Bluetooth® to your Smartphone (iOS and Android) to download stored readings automatically. The device can upload up to 200 readings per user by using the Bluetooth memory.

Switch on the Bluetooth function on your Smartphone.

Make sure the Braun Healthy Heart app has been downloaded onto your Smartphone and the app is open.

If you are using the app for the first time, it will guide you in pairing your Braun ExactFit™ 5 Connect. If you already used the app before, go to the "Connect device" function available in the app menu and follow the instructions.

Once pairing is complete, the app will show a confirmation message.



## Memory function

Your blood pressure monitor can store the latest 60 readings for each user.

### Storing measurement data

After each blood pressure measurement, the systolic pressure, diastolic pressure, pulse rate and the time & date of specific day will be automatically stored. Memory #01 is always the most recent one. Once the memory is full, the oldest values will be overwritten.

Press memory button **M** (2) to review the stored data. The last memory data (sys/dia/pul) with measurement date/time, IHB and WHO indicator will show on LCD. Press memory button **M** (2) again to show the previous data. Ensure that the correct user; A or B, is selected before use.

### Average function

Press the average button  (5) to show last 3 readings average on LCD.

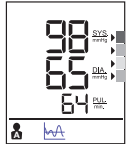

### Erasing data

Switch off the device, press and hold memory button **M** (2) for more than 5 seconds, LCD display will blink "dEL ALL". Ensure that the correct user; A or B, is selected before use.

Press memory button **M** (2) again, LCD will display "—" to show all the stored data of corresponding user have been deleted.

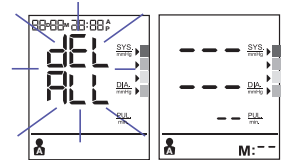

### Irregular heart beat detector

The appearance of this symbol  signifies that a certain pulse irregularity was detected during the measurement. Talking, moving, shaking or an irregular pulse during the measurement can result in the appearance of this icon. Usually this is not a cause for concern, however if the symbol appears often, we recommend you seek medical advice. The device does not replace a cardiac examination, but serves to detect pulse irregularities at an early stage.



### Low battery indicator

When the low battery indicator  flashes on the display, it means the battery is low and the four batteries need to be replaced with alkaline LR6 (AA) batteries.

### Storage and cleaning

- Always keep the unit in the carrying case after its use.
- Do not put the item directly under the sunlight, in high temperature or humid and dusty places.
- Do not store in extremely low (less than -20°C) or high (more than 60°C) temperature.
- Use a piece of cloth with water or mild cleansing agent to clean the case and then use a piece of dry cloth to wipe it dry. Use a piece of dry cloth to wipe the cuff when it is dirty.
- Do not use any strong cleansers to clean it.
- When the unit is not to be used for a long time, remove the batteries. (Batteries may leak or cause harm).
- Do not modify the device. NEVER open the device! This will make the manufacturer's warranty invalid.

## What to do if .....

Problem	Reason	Solution
Heart rate symbol 	Appears in the measurement condition and flashes when pulse is detected.	• Measurement in progress, remain quiet.
Low battery indicator 	Appears when the battery voltage is excessively low or the positions of the batteries are incorrect.	• Replace all four batteries with new ones. Insert the batteries in the correct positions. Be aware of +/- positions.
Measuring error <b>Error</b>	Appears when the accurate blood pressure and pulse could not be obtained.	<ul style="list-style-type: none"> <li>• Press "start/stop" button again and remeasure.</li> <li>• Check if cuff is wrapped according to instructions.</li> <li>• Check that there are no kinks in tube.</li> <li>• Check that hand is relaxed.</li> <li>• Check if talking or moving during measurement.</li> <li>• Check if posture is correct.</li> </ul>
E0 shows	The measurement process does not detect the pulse signal.	• Loosen the clothing on the arm and then measure again.
E1 shows	The cuff is not secure.	• Refasten the cuff and then measure again.
E2 shows	The result out of measurement range.	• Relax for a moment and then measure again.
E3 shows	Inflation timeout when you measurement.	• Loosen the clothing on the arm and then measure again.
E254	Calibration error or other hardware problem.	• Reload the battery for re-measurement, if the problem persists, contact the retailer or our customer service department for further assistance, if you need return or repair, please see the instructions on the warranty card.
E255	Calibrate device errors or store read and write errors.	• Reload the battery for re-measurement, if the problem persists, contact the retailer or our customer service department for further assistance.
E256	Bluetooth upload failed	• Restart the device and Re-operate according to the update firmware operation mode.

## Specifications

Method of measurement  
Model number  
Range of measurement

## Accuracy

Inflation  
Display  
Sets of device memory  
Sets of Bluetooth memory  
Cuff size

Operating temperature  
Storage temperature  
Operating atmospheric pressure  
Unit weight  
Power supply  
Battery life  
Auto power off  
Accessories

## Wireless communication

## Service life:

**Important**

Read the operating instructions.

If the device is not used within the specified temperature, humidity and atmospheric pressure ranges, the technical accuracy of the measurement cannot be guaranteed.

**Classification:**

Internally powered equipment  
Type BF applied parts

**IP22**

Protected against solid foreign objects of 12.5 mm diameter and larger.  
Protected against water drops falling vertically when the device is tilted up to 15°.

Not suitable for use in the presence of flammable anaesthetic mixtures with air, oxygen or nitrous oxide.

Continuous operation with short-time loading.

 Operating temperature

 Storage temperature

 Storage humidity

Subject to change without notice.



MEDICAL ELECTRICAL EQUIPMENT needs special precautions regarding EMC.  
For detailed description of EMC requirements visit [www.hot-europe.com/support](http://www.hot-europe.com/support).

Portable and mobile RF communications equipment can affect medical electrical equipment.



Please do not dispose of the product in the household waste at the end of its useful life.  
Disposal can take place at your local retailer or at appropriate collection points provided in your country.

## Warranty

Please read all instructions before attempting to use this device. Please retain the receipt as proof of and date of purchase. The receipt must be presented when making any claim within the relevant warranty period. Any claim under the warranty will not be valid without a proof of purchase.

Your device is warrantied for two years (2 years) from date of purchase.

This warranty covers defects in materials or workmanship that occur under normal use; defective devices meeting these criteria will be replaced free of charge.

The warranty DOES NOT cover defects or damage resulting from abuse or failure to follow the user instructions. The warranty becomes void if the device is opened, tampered with, or used with non-Braun branded parts or accessories, or if repairs are undertaken by unauthorised persons.

Accessories and consumables are excluded from any warranty.

For support requests, please visit [www.hot-europe.com/support](http://www.hot-europe.com/support) or find service contact information at the end of this owner's manual.

This warranty is applicable to Europe, Russia, Middle East and Africa only.

UK Only: This does not affect your consumer statutory rights.

The LOT and SN of your device are printed on the rating label on the back of the product.

Production date is given by the LOT located in the back of the device. The first 3 numeric digits after the LOT No. represents the day of the year of manufacture. The next 2 numeric digits represent the last two numbers of the calendar year of manufacture and the letters at the end designate the manufacturer of the product. E.g. LOT 15614TRA, this product was made on day 156, year 2014, at manufacturer identifier TRA.

## FCC Statement

FCC ID : 2ABRGBUA6350

This device complies with Part 15 of the FCC Rules. Operation is subject to the following two conditions: (1) this device may not cause harmful interference, and (2) this device must accept any interference received, including interference that may cause undesired operation.

Caution: The user is cautioned that changes or modifications not expressly approved by the party responsible for compliance could void the user's authority to operate the equipment.

NOTE: This equipment has been tested and found to comply with the limits for a Class B digital device, pursuant to Part 15 of the FCC Rules.

These limits are designed to provide reasonable protection against harmful interference in a residential installation. This equipment generates, uses and can radiate radio frequency energy and, if not installed and used in accordance with the instructions, may cause harmful interference to radio communications. However, there is no guarantee that interference will not occur in a particular installation. If this equipment does cause harmful interference to radio or television reception, which can be determined by turning the equipment off and on, the user is encouraged to try to correct the interference by one or more of the following measures:

- Reorient or relocate the receiving antenna.
- Increase the separation between the equipment and receiver.
- Connect the equipment into an outlet on a circuit different from that to which the receiver is connected.
- Consult the dealer or an experienced radio/TV technician for help.

FCC Radiation Exposure Statement:

This equipment complies with FCC radiation exposure limits set forth for an uncontrolled environment.

This transmitter must not be co-located or operating in conjunction with any other antenna or transmitter.