

## FCC Test Report

**Report No.:** RF180509C32A

**FCC ID:** 2ABRC-ACWZZN

**Test Model:** ACWZZN

**Series Model:** WUSB (Refer to section 3.2 for more detail)

**Received Date:** May 17, 2018

**Test Date:** May 18, 2018 ~ Jun. 05, 2018

**Issued Date:** Jul. 10, 2018

**Applicant:** Optoma Corporation

**Address:** 12F., No. 213, Sec. 3, Beixin Rd., Xindian Dist., New Taipei City, Taiwan 231

**Issued By:** Bureau Veritas Consumer Products Services (H.K.) Ltd., Taoyuan Branch

**Lab Address:** No. 47-2, 14th Ling, Chia Pau Vil., Lin Kou Dist., New Taipei City, Taiwan ( R.O.C )

**Test Location:** No.19, Hwa Ya 2nd Rd., Wen Hwa Vil., Kwei Shan Dist., Taoyuan City 33383, Taiwan, R.O.C.

**FCC Registration /  
Designation Number:** 788550 / TW0003



This report is for your exclusive use. Any copying or replication of this report to or for any other person or entity, or use of our name or trademark, is permitted only with our prior written permission. This report sets forth our findings solely with respect to the test samples identified herein. The results set forth in this report are not indicative or representative of the quality or characteristics of the lot from which a test sample was taken or any similar or identical product unless specifically and expressly noted. Our report includes all of the tests requested by you and the results thereof based upon the information that you provided to us. You have 60 days from date of issuance of this report to notify us of any material error or omission caused by our negligence, provided, however, that such notice shall be in writing and shall specifically address the issue you wish to raise. A failure to raise such issue within the prescribed time shall constitute your unqualified acceptance of the completeness of this report, the tests conducted and the correctness of the report contents. Unless specific mention, the uncertainty of measurement has been explicitly taken into account to declare the compliance or non-compliance to the specification. The report must not be used by the client to claim product certification, approval, or endorsement by TAF or any government agencies.

## Table of Contents

<b>Release Control Record</b> .....	<b>4</b>
<b>1 Certificate of Conformity</b> .....	<b>5</b>
<b>2 Summary of Test Results</b> .....	<b>6</b>
2.1 Measurement Uncertainty .....	6
2.2 Modification Record .....	6
<b>3 General Information</b> .....	<b>7</b>
3.1 General Description of EUT .....	7
3.2 Description of Test Modes .....	8
3.2.1 Test Mode Applicability and Tested Channel Detail .....	9
3.3 Duty Cycle of Test Signal .....	11
3.4 Description of Support Units .....	12
3.4.1 Configuration of System under Test .....	12
3.5 General Description of Applied Standards .....	12
<b>4 Test Types and Results</b> .....	<b>13</b>
4.1 Radiated Emission and Bandedge Measurement .....	13
4.1.1 Limits of Radiated Emission and Bandedge Measurement .....	13
4.1.2 Test Instruments .....	14
4.1.3 Test Procedures .....	15
4.1.4 Deviation from Test Standard .....	16
4.1.5 Test Set Up .....	17
4.1.6 EUT Operating Conditions .....	18
4.1.7 Test Results .....	19
4.2 Conducted Emission Measurement .....	32
4.2.1 Limits of Conducted Emission Measurement .....	32
4.2.2 Test Instruments .....	32
4.2.3 Test Procedures .....	33
4.2.4 Deviation from Test Standard .....	33
4.2.5 Test Setup .....	33
4.2.6 EUT Operating Conditions .....	33
4.2.7 Test Results .....	34
4.3 6 dB Bandwidth Measurement .....	36
4.3.1 Limits of 6 dB Bandwidth Measurement .....	36
4.3.2 Test Setup .....	36
4.3.3 Test Instruments .....	36
4.3.4 Test Procedure .....	36
4.3.5 Deviation from Test Standard .....	36
4.3.6 EUT Operating Conditions .....	36
4.3.7 Test Results .....	37
4.4 Occupied Bandwidth Measurement .....	39
4.4.1 Test Setup .....	39
4.4.2 Test Instruments .....	39
4.4.3 Test Procedure .....	39
4.4.4 Deviation from Test Standard .....	39
4.4.5 EUT Operating Conditions .....	39
4.4.6 Test Results .....	40
4.5 Conducted Output Power Measurement .....	42
4.5.1 Limits of Conducted Output Power Measurement .....	42
4.5.2 Test Setup .....	42
4.5.3 Test Instruments .....	42
4.5.4 Test Procedures .....	42
4.5.5 Deviation from Test Standard .....	42
4.5.6 EUT Operating Conditions .....	42
4.5.7 Test Results .....	43

4.6	Power Spectral Density Measurement .....	44
4.6.1	Limits of Power Spectral Density Measurement.....	44
4.6.2	Test Setup.....	44
4.6.3	Test Instruments .....	44
4.6.4	Test Procedure .....	44
4.6.5	Deviation from Test Standard .....	44
4.6.6	EUT Operating Condition .....	44
4.6.7	Test Results .....	45
4.7	Conducted Out of Band Emission Measurement .....	47
4.7.1	Limits of Conducted Out of Band Emission Measurement.....	47
4.7.2	Test Setup.....	47
4.7.3	Test Instruments .....	47
4.7.4	Test Procedure .....	47
4.7.5	Deviation from Test Standard .....	47
4.7.6	EUT Operating Condition .....	47
4.7.7	Test Results .....	48
<b>5</b>	<b>Pictures of Test Arrangements.....</b>	<b>60</b>
	<b>Appendix – Information on the Testing Laboratories .....</b>	<b>61</b>

### Release Control Record

Issue No.	Description	Date Issued
RF180509C32A	Original Release	Jul. 10, 2018

## 1 Certificate of Conformity

**Product:** WIRELESS DONGLE MODULE

**Brand:** Optoma

**Test Model:** ACWZZN

**Series Model:** WUSB (Refer to section 3.2 for more detail)

**Sample Status:** Identical Prototype

**Applicant:** Optoma Corporation

**Test Date:** May 18, 2018 ~ Jun. 05, 2018

**Standards:** 47 CFR FCC Part 15, Subpart C (Section 15.247)  
ANSI C63.10:2013

The above equipment has been tested by **Bureau Veritas Consumer Products Services (H.K.) Ltd., Taoyuan Branch**, and found compliance with the requirement of the above standards. The test record, data evaluation & Equipment Under Test (EUT) configurations represented herein are true and accurate accounts of the measurements of the sample's RF characteristics under the conditions specified in this report.

**Prepared by :**

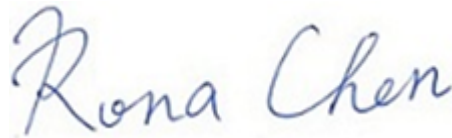

,

**Date:**

Jul. 10, 2018

Rona Chen / Specialist

**Approved by :**

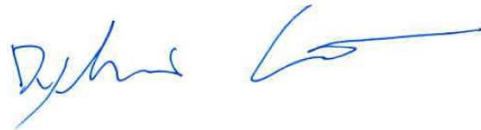

,

**Date:**

Jul. 10, 2018

Dylan Chiou / Project Engineer

## 2 Summary of Test Results

47 CFR FCC Part 15, Subpart C (Section 15.247)			
FCC Clause	Test Item	Result	Remarks
15.207	AC Power Conducted Emission	Pass	Meet the requirement of limit. Minimum passing margin is -16.47 dB at 0.15000 MHz.
15.205 / 15.209 / 15.247(d)	Radiated Emissions and Band Edge Measurement	Pass	Meet the requirement of limit. Minimum passing margin is -0.25 dB at 4824 MHz.
15.247(d)	Antenna Port Emission	Pass	Meet the requirement of limit.
15.247(a)(2)	6 dB Bandwidth	Pass	Meet the requirement of limit.
---	Occupied Bandwidth Measurement	Pass	Reference only
15.247(b)	Conducted power	Pass	Meet the requirement of limit.
15.247(e)	Power Spectral Density	Pass	Meet the requirement of limit.
15.203	Antenna Requirement	Pass	Antenna connector is i-pex (MHF) type.

### 2.1 Measurement Uncertainty

Where relevant, the following measurement uncertainty levels have been estimated for tests performed on the EUT:

The listed uncertainties are the worst case uncertainty for the entire range of measurement. Please note that the uncertainty values are provided for informational purposes only and are not used in determining the PASS/FAIL results.

Measurement	Frequency	Expanded Uncertainty (k=2) ( $\pm$ )
Conducted Emissions at mains ports	150 kHz ~ 30 MHz	2.44 dB
Radiated Emissions up to 1 GHz	30 MHz ~ 200 MHz	2.93 dB
	200 MHz ~ 1000 MHz	2.95 dB
Radiated Emissions above 1 GHz	1 GHz ~ 18 GHz	2.26 dB
	18 GHz ~ 40 GHz	1.94 dB

### 2.2 Modification Record

There were no modifications required for compliance.

### 3 General Information

#### 3.1 General Description of EUT

<b>Product</b>	WIRELESS DONGLE MODULE	
<b>Brand</b>	Optoma	
<b>Test Model</b>	ACWZZN	
<b>Series Model</b>	WUSB	
<b>Status of EUT</b>	Identical Prototype	
<b>Power Supply Rating</b>	5.0 Vdc (Host equipment)	
<b>Modulation Type</b>	CCK, DQPSK, DBPSK for DSSS 64QAM, 16QAM, QPSK, BPSK for OFDM	
<b>Modulation Technology</b>	DSSS, OFDM	
<b>Transfer Rate</b>	802.11b: 11.0 / 5.5 / 2.0 / 1.0 Mbps 802.11g: 54.0 / 48.0 / 36.0 / 24.0 / 18.0 / 12.0 / 9.0 / 6.0 Mbps 802.11n: up to 300.0 Mbps	
<b>Operating Frequency</b>	2412 ~ 2462 MHz	
<b>Number of Channel</b>	11 for 802.11b, 802.11g, 802.11n (HT20) 7 for 802.11n (HT40)	
<b>Output Power</b>	977.873 mW	
<b>Antenna Type</b>	PIFA antenna with gain	0.5 dBi (Chain 0) 0.3 dBi (Chain 1)
<b>Antenna Connector</b>	i-pex (MHF)	
<b>Accessory Device</b>	N/A	
<b>Data Cable Supplied</b>	N/A	

Note:

- The EUT incorporates a MIMO function. Physically, the EUT provides two completed transmitters and two receivers.

Modulation Mode	Tx Function
802.11b	1TX
802.11g	1TX
802.11n (HT20)	2TX
802.11n (HT40)	2TX

- All models are listed as below.

Brand	Model	Difference
Optoma	ACWZZN	All models are electrically identical, different model names are for marketing purpose.
	WUSB	

- The above EUT information is declared by manufacturer and for more detailed features description, please refers to the manufacturer's specifications or user's manual.

### 3.2 Description of Test Modes

11 channels are provided for 802.11b, 802.11g and 802.11n (HT20):

Channel	Frequency (MHz)	Channel	Frequency (MHz)
1	2412	7	2442
2	2417	8	2447
3	2422	9	2452
4	2427	10	2457
5	2432	11	2462
6	2437		

7 channels are provided for 802.11n (HT40):

Channel	Frequency (MHz)	Channel	Frequency (MHz)
3	2422	7	2442
4	2427	8	2447
5	2432	9	2452
6	2437		



### 3.2.1 Test Mode Applicability and Tested Channel Detail

EUT Configure Mode	Applicable To				Description
	RE $\geq$ 1G	RE<1G	PLC	APCM	
-	√	√	√	√	-

Where **RE $\geq$ 1G**: Radiated Emission above 1 GHz      **RE<1G**: Radiated Emission below 1 GHz  
**PLC**: Power Line Conducted Emission      **APCM**: Antenna Port Conducted Measurement

**NOTE:** The EUT had been pre-tested on the positioned of each 3 axis. The worst case was found when positioned on **X-plane**.

#### **Radiated Emission Test (Above 1 GHz):**

- Pre-Scan has been conducted to determine the worst-case mode from all possible combinations between available modulations, data rates and antenna ports (if EUT with antenna diversity architecture).
- Following channel(s) was (were) selected for the final test as listed below.

EUT Configure Mode	Mode	Available Channel	Tested Channel	Modulation Technology	Modulation Type	Data Rate (Mbps)
-	802.11b	1 to 11	1, 6, 11	DSSS	DBPSK	1.0
-	802.11g	1 to 11	1, 6, 11	OFDM	BPSK	6.0
-	802.11n (HT20)	1 to 11	1, 6, 11	OFDM	BPSK	6.5
-	802.11n (HT40)	3 to 9	3, 6, 9	OFDM	BPSK	13.5

#### **Radiated Emission Test (Below 1 GHz):**

- Pre-Scan has been conducted to determine the worst-case mode from all possible combinations between available modulations, data rates and antenna ports (if EUT with antenna diversity architecture).
- Following channel(s) was (were) selected for the final test as listed below.

EUT Configure Mode	Mode	Available Channel	Tested Channel	Modulation Technology	Modulation Type	Data Rate (Mbps)
-	802.11b	1 to 11	1	DSSS	DBPSK	1.0

#### **Power Line Conducted Emission Test:**

- Pre-Scan has been conducted to determine the worst-case mode from all possible combinations between available modulations, data rates and antenna ports (if EUT with antenna diversity architecture).
- Following channel(s) was (were) selected for the final test as listed below.

EUT Configure Mode	Mode	Available Channel	Tested Channel	Modulation Technology	Modulation Type	Data Rate (Mbps)
-	802.11b	1 to 11	1	DSSS	DBPSK	1.0

### Antenna Port Conducted Measurement:

- This item includes all test value of each mode, but only includes spectrum plot of worst value of each mode.
- Pre-Scan has been conducted to determine the worst-case mode from all possible combinations between available modulations, data rates and antenna ports (if EUT with antenna diversity architecture).
- Following channel(s) was (were) selected for the final test as listed below.

EUT Configure Mode	Mode	Available Channel	Tested Channel	Modulation Technology	Modulation Type	Data Rate (Mbps)
-	802.11b	1 to 11	1, 6, 11	DSSS	DBPSK	1.0
-	802.11g	1 to 11	1, 6, 11	OFDM	BPSK	6.0
-	802.11n (HT20)	1 to 11	1, 6, 11	OFDM	BPSK	6.5
-	802.11n (HT40)	3 to 9	3, 6, 9	OFDM	BPSK	13.5

### Test Condition:

Applicable To	Environmental Conditions	Input Power	Tested by
RE $\geq$ 1G	25 deg. C, 65 % RH	120 Vac, 60 Hz	Jisyong Wang
RE<1G	25 deg. C, 65 % RH	120 Vac, 60 Hz	Jisyong Wang
PLC	25 deg. C, 65 % RH	120 Vac, 60 Hz	Getaz Yang
APCM	25 deg. C, 65 % RH	3.3 Vdc	Gavin Wu

### 3.3 Duty Cycle of Test Signal

**802.11b:** Duty cycle of test signal is  $\geq 98\%$ , duty factor is not required.

**802.11g:** Duty cycle =  $1.392/1.514 = 0.919$ , Duty factor =  $10 * \log(1/0.919) = 0.36$

**802.11n (HT20):** Duty cycle =  $0.674/0.757 = 0.890$ , Duty factor =  $10 * \log(1/0.890) = 0.50$

**802.11n (HT40):** Duty cycle =  $0.347/0.464 = 0.748$ , Duty factor =  $10 * \log(1/0.748) = 1.26$

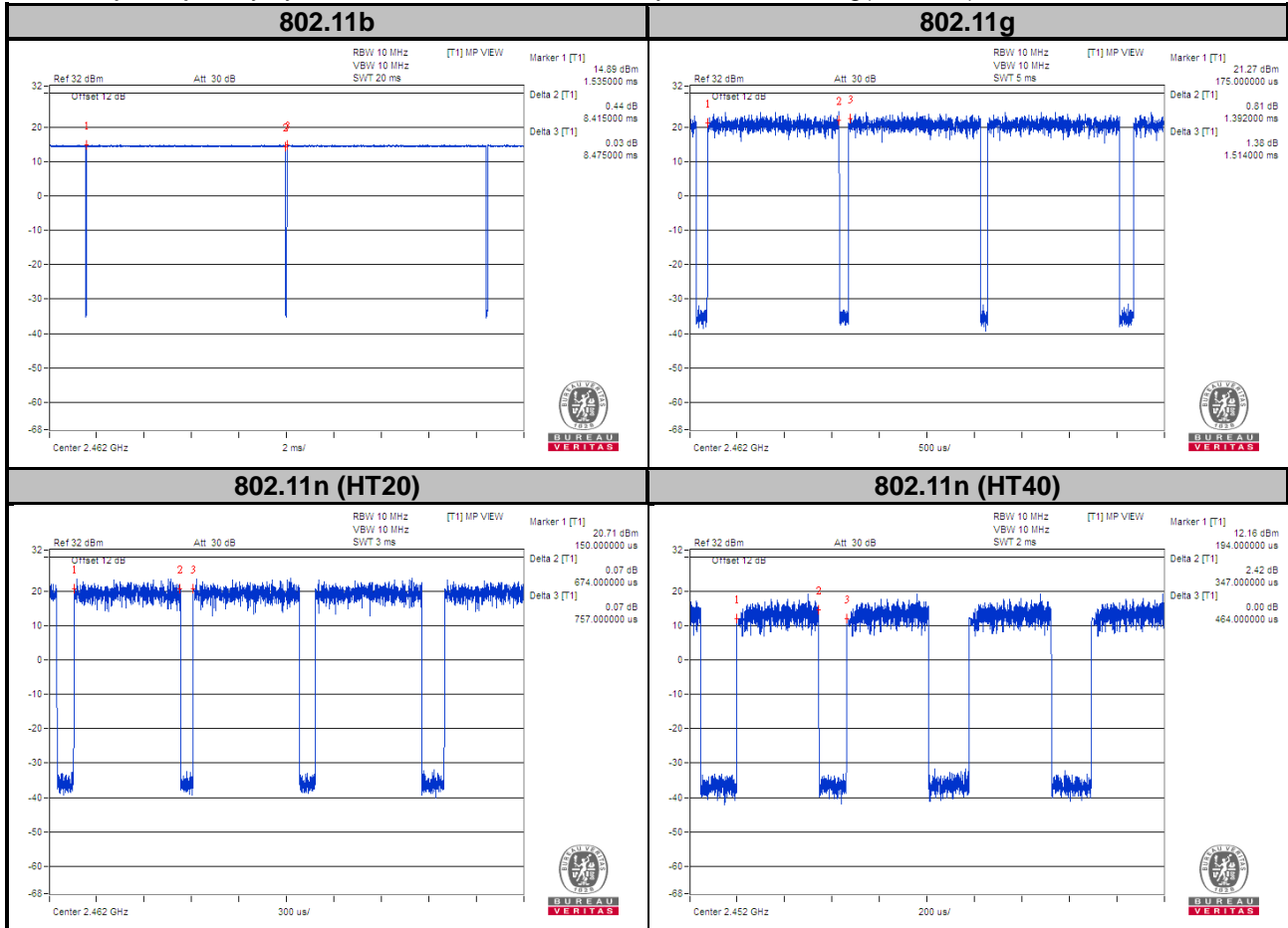

### 3.4 Description of Support Units

The EUT has been tested as an independent unit together with other necessary accessories or support units. The following support units or accessories were used to form a representative test configuration during the tests.

No.	Product	Brand	Model No.	Serial No.	FCC ID
1.	Notebook	DELL	Inspiron 14R	8LRKKW1	N/A

No.	Signal Cable Description of The Above Support Units
1.	N/A

Note:

1. All power cords of the above support units are non-shielded (1.8m).

#### 3.4.1 Configuration of System under Test

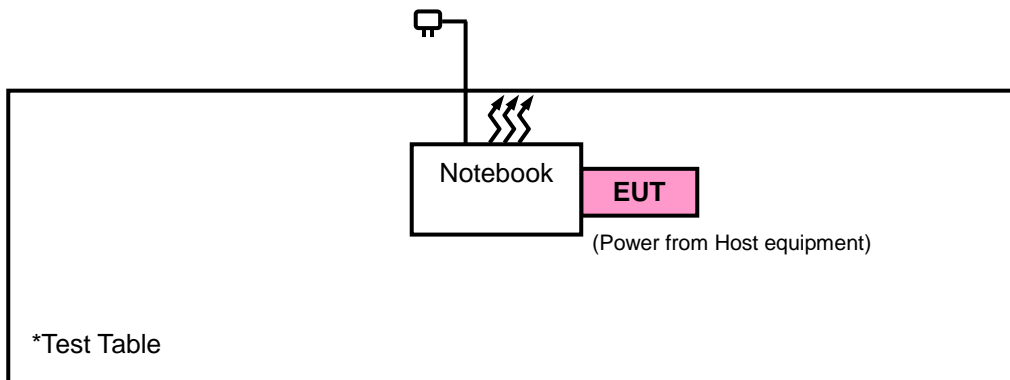

### 3.5 General Description of Applied Standards

The EUT is a RF Product. According to the specifications of the manufacturer, it must comply with the requirements of the following standards:

**FCC Part 15, Subpart C (15.247)**

**558074 D01 DTS Meas Guidance v04**

**662911 D01 Multiple Transmitter Output v02r01**

ANSI C63.10-2013

All test items have been performed and recorded as per the above standards.

## 4 Test Types and Results

### 4.1 Radiated Emission and Bandedge Measurement

#### 4.1.1 Limits of Radiated Emission and Bandedge Measurement

Radiated emissions which fall in the restricted bands must comply with the radiated emission limits specified as below table. Other emissions shall be at least 20 dB below the highest level of the desired power:

Frequencies (MHz)	Field Strength (microvolts/meter)	Measurement Distance (meters)
0.009 ~ 0.490	2400/F (kHz)	300
0.490 ~ 1.705	24000/F (kHz)	30
1.705 ~ 30.0	30	30
30 ~ 88	100	3
88 ~ 216	150	3
216 ~ 960	200	3
Above 960	500	3

**NOTE:**

1. The lower limit shall apply at the transition frequencies.
2. Emission level (dBuV/m) = 20 log Emission level (uV/m).
3. For frequencies above 1000 MHz, the field strength limits are based on average detector, however, the peak field strength of any emission shall not exceed the maximum permitted average limits, specified above by more than 20 dB under any condition of modulation.

#### 4.1.2 Test Instruments

Description & Manufacturer	Model No.	Serial No.	Date of Calibration	Due Date of Calibration
Test Receiver Agilent	N9038A	MY51210203	Mar. 16, 2018	Mar. 15, 2019
Spectrum Analyzer Agilent	N9010A	MY52220314	Nov. 24, 2017	Nov. 23, 2018
Spectrum Analyzer ROHDE & SCHWARZ	FSU43	101261	Jan. 11, 2018	Jan. 10, 2019
Double Ridge Guide Horn Antenna EMCO	3115	5619	Nov. 30, 2017	Nov. 29, 2018
BILOG Antenna SCHWARZBECK	VULB 9168	9168-153	Dec. 06, 2017	Dec. 05, 2018
Fixed Attenuator Mini-Circuits	BW-N10W5+	1301	Aug. 14, 2017	Aug. 13, 2018
Loop Antenna	EM-6879	269	Aug. 11, 2017	Aug. 10, 2018
Preamplifier EMCI	EMC001340	980201	Nov. 01, 2017	Oct. 30, 2018
Preamplifier EMCI	EMC 012645	980115	Oct. 20, 2017	Oct. 19, 2018
Preamplifier EMCI	EMC 184045	980116	Oct. 20, 2017	Oct. 19, 2018
Preamplifier EMCI	EMC 330H	980112	Oct. 13, 2017	Oct. 12, 2018
Power Meter Anritsu	ML2495A	1012010	Aug. 15, 2017	Aug. 14, 2018
Power Sensor Anritsu	MA2411B	1315050	Aug. 15, 2017	Aug. 14, 2018
RF Coaxial Cable HUBER+SUHNNER	EMC104-SM-SM-800 0&3000	140811+170717	Oct. 20, 2017	Oct. 19, 2018
RF Coaxial Cable HUBER+SUHNNER	SUCOFLEX 104	EMC104-SM-SM-100 0(140807)	Oct. 20, 2017	Oct. 19, 2018
RF Coaxial Cable Worken	8D-FB	Cable-Ch10-01	Oct. 20, 2017	Oct. 19, 2018
Software BV ADT	E3 6.120103	NA	NA	NA
Antenna Tower MF	MFA-440H	NA	NA	NA
Turn Table MF	MFT-201SS	NA	NA	NA
Antenna Tower & Turn Table Controller MF	MF-7802	NA	NA	NA

- Note: 1. The calibration interval of the above test instruments is 12 months and the calibrations are traceable to NML/ROC and NIST/USA.
2. The test was performed in HwaYa Chamber 10.
3. The horn antenna and preamplifier (model: EMC 184045) are used only for the measurement of emission frequency above 1 GHz if tested.
4. The IC Site Registration No. is IC7450F-10.

#### 4.1.3 Test Procedures

##### **For Radiated Emission below 30 MHz**

- a. The EUT was placed on the top of a rotating table 0.8 meters above the ground at a 3 meter chamber room. The table was rotated 360 degrees to determine the position of the highest radiation.
- b. The EUT was set 3 meters away from the interference-receiving antenna, which was mounted on the top of a variable-height antenna tower.
- c. Parallel, perpendicular, and ground-parallel orientations of the antenna are set to make the measurement.
- d. For each suspected emission, the EUT was arranged to its worst case and the rotatable table was turned from 0 degrees to 360 degrees to find the maximum reading.
- e. The test-receiver system was set to Quasi-Peak Detect Function and Specified Bandwidth with Maximum Hold Mode.

##### **Note:**

1. The resolution bandwidth and video bandwidth of test receiver/spectrum analyzer is 9 kHz at frequency below 30 MHz.

##### **For Radiated Emission above 30 MHz**

- a. The EUT was placed on the top of a rotating table 0.8 meters (for 30 MHz ~ 1 GHz) / 1.5 meters (for above 1 GHz) above the ground at 3 meter chamber room for test. The table was rotated 360 degrees to determine the position of the highest radiation.
- b. The EUT was set 3 meters away from the interference-receiving antenna, which was mounted on the top of a variable-height antenna tower.
- c. The height of antenna is varied from one meter to four meters above the ground to determine the maximum value of the field strength. Both horizontal and vertical polarizations of the antenna are set to make the measurement.
- d. For each suspected emission, the EUT was arranged to its worst case and then the antenna was tuned to heights from 1 meter to 4 meters and the rotatable table was turned from 0 degrees to 360 degrees to find the maximum reading.
- e. The test-receiver system was set to quasi-peak detect function and specified bandwidth with maximum hold mode when the test frequency is below 1 GHz.
- f. The test-receiver system was set to peak and average detected function and specified bandwidth with maximum hold mode when the test frequency is above 1 GHz. If the peak reading value also meets average limit, measurement with the average detector is unnecessary.

##### **Note:**

1. The resolution bandwidth and video bandwidth of test receiver/spectrum analyzer is 120 kHz for Quasi-peak detection (QP) at frequency below 1 GHz.
2. The resolution bandwidth of test receiver/spectrum analyzer is 1 MHz and the video bandwidth is 3 MHz for Peak detection (PK) at frequency above 1 GHz.
3. The resolution bandwidth of test receiver/spectrum analyzer is 1 MHz and the video bandwidth is  $\geq 1/T$  (Duty cycle < 98 %) or 10 Hz (Duty cycle  $\geq 98$  %) for Average detection (AV) at frequency above 1 GHz.  
(11b: RBW = 1 MHz, VBW = 300 Hz ; 11g: RBW = 1 MHz, VBW = 1 kHz ;  
11n (HT20): RBW = 1 MHz, VBW = 3 kHz ; 11n (HT40): RBW = 1 MHz, VBW = 3 kHz)
4. All modes of operation were investigated and the worst-case emissions are reported.

#### 4.1.4 Deviation from Test Standard

No deviation.



4.1.5 Test Set Up

<Radiated Emission below 30 MHz>

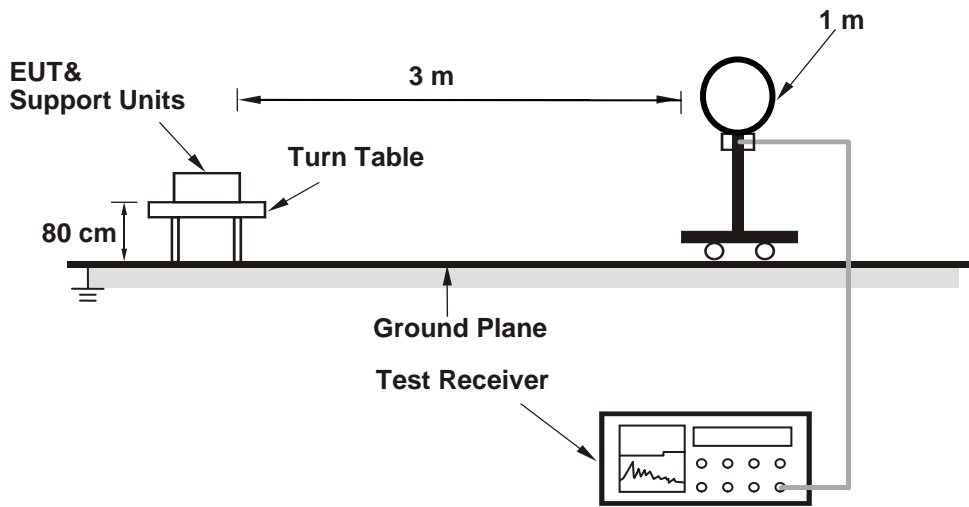

<Radiated Emission 30 MHz to 1 GHz>

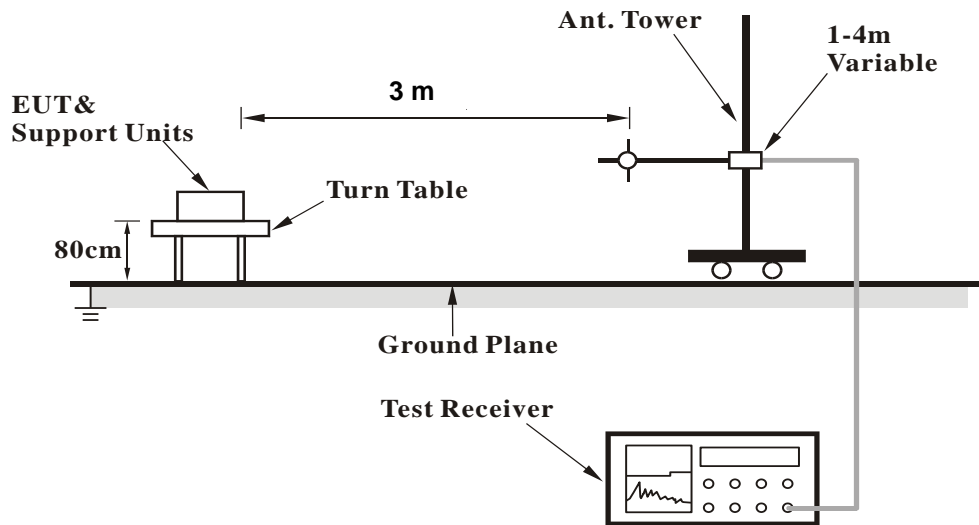

### <Radiated Emission above 1 GHz>

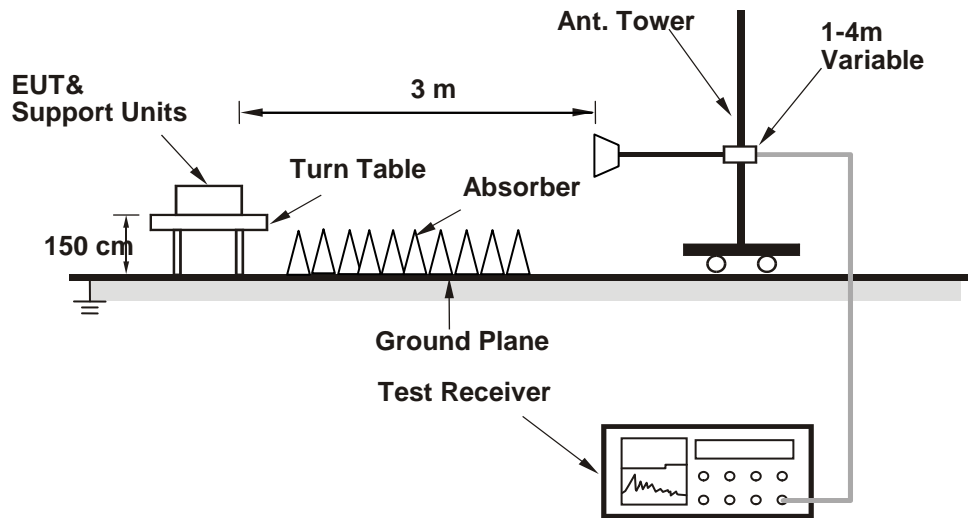

For the actual test configuration, please refer to the attached file (Test Setup Photo).

#### 4.1.6 EUT Operating Conditions

- a. Placed the EUT on a testing table.
- b. Use the software to control the EUT under transmission condition continuously at specific channel frequency.

4.1.7 Test Results

Above 1 GHz Data :  
802.11b

EUT Test Condition		Measurement Detail	
Channel	Channel 1	Frequency Range	1 GHz ~ 25 GHz
Input Power	120 Vac, 60 Hz	Detector Function	Peak (PK) Average (AV)
Environmental Conditions	25 deg. C, 65 % RH	Tested By	Jisyong Wang

Antennal Polarity & Test Distance: Horizontal at 3 m										
Frequency (MHz)	Emission Level (dBuV/m)	Read Level (dBuV)	Limit (dBuV/m)	Margin (dB)	Antenna Factor (dB/m)	Cable Loss (dB)	Preamp Factor (dB)	Antenna Height (cm)	Table Angle (Degree)	Remark
2384.06	35.08	41.15	54	-18.92	27.08	4.35	37.5	101	73	Average
2384.06	47.97	54.04	74	-26.03	27.08	4.35	37.5	101	73	Peak
2412	91.66	97.57			27.23	4.38	37.52	101	73	Average
2412	96.71	102.62			27.23	4.38	37.52	101	73	Peak
4824	49.35	64.26	54	-4.65	31.17	6.81	52.89	100	184	Average
4824	51.71	66.62	74	-22.29	31.17	6.81	52.89	100	184	Peak

Antennal Polarity & Test Distance: Vertical at 3 m										
Frequency (MHz)	Emission Level (dBuV/m)	Read Level (dBuV)	Limit (dBuV/m)	Margin (dB)	Antenna Factor (dB/m)	Cable Loss (dB)	Preamp Factor (dB)	Antenna Height (cm)	Table Angle (Degree)	Remark
2386.58	35.72	41.7	54	-18.28	27.16	4.36	37.5	137	335	Average
2386.58	48.29	54.27	74	-25.71	27.16	4.36	37.5	137	335	Peak
2412	93.86	99.77			27.23	4.38	37.52	137	335	Average
2412	99.47	105.38			27.23	4.38	37.52	137	335	Peak
<b>4824</b>	<b>53.75</b>	<b>68.66</b>	<b>54</b>	<b>-0.25</b>	<b>31.17</b>	<b>6.81</b>	<b>52.89</b>	<b>146</b>	<b>278</b>	<b>Average</b>
4824	54.54	69.45	74	-19.46	31.17	6.81	52.89	146	278	Peak

Remarks:

- Emission Level = Read Level + Antenna Factor + Cable Loss - Preamp Factor  
Margin value = Emission level – Limit value
- 2412 MHz: Fundamental frequency.
- The other emission levels were very low against the limit.

EUT Test Condition		Measurement Detail	
Channel	Channel 6	Frequency Range	1 GHz ~ 25 GHz
Input Power	120 Vac, 60 Hz	Detector Function	Peak (PK) Average (AV)
Environmental Conditions	25 deg. C, 65 % RH	Tested By	Jisyong Wang

Antennal Polarity & Test Distance: Horizontal at 3 m										
Frequency (MHz)	Emission Level (dBuV/m)	Read Level (dBuV)	Limit (dBuV/m)	Margin (dB)	Antenna Factor (dB/m)	Cable Loss (dB)	Preamp Factor (dB)	Antenna Height (cm)	Table Angle (Degree)	Remark
2389.66	34.2	40.18	54	-19.8	27.16	4.36	37.5	137	349	Average
2389.66	47.58	53.56	74	-26.42	27.16	4.36	37.5	137	349	Peak
2437	97.76	103.44			27.38	4.4	37.46	137	349	Average
2437	102.78	108.46			27.38	4.4	37.46	137	349	Peak
2490.88	36.63	41.91	54	-17.37	27.61	4.43	37.32	137	349	Average
2490.88	49.05	54.33	74	-24.95	27.61	4.43	37.32	137	349	Peak
4874	53.3	68.05	54	-0.7	31.25	6.86	52.86	139	297	Average
4874	56.31	71.06	74	-17.69	31.25	6.86	52.86	139	297	Peak

Antennal Polarity & Test Distance: Vertical at 3 m										
Frequency (MHz)	Emission Level (dBuV/m)	Read Level (dBuV)	Limit (dBuV/m)	Margin (dB)	Antenna Factor (dB/m)	Cable Loss (dB)	Preamp Factor (dB)	Antenna Height (cm)	Table Angle (Degree)	Remark
2385.46	34.14	40.21	54	-19.86	27.08	4.35	37.5	101	72	Average
2385.46	47.39	53.46	74	-26.61	27.08	4.35	37.5	101	72	Peak
2437	92.03	97.71			27.38	4.4	37.46	101	72	Average
2437	97.47	103.15			27.38	4.4	37.46	101	72	Peak
2495.84	35.61	40.81	54	-18.39	27.61	4.44	37.25	101	72	Average
2495.84	48.7	53.9	74	-25.3	27.61	4.44	37.25	101	72	Peak
4874	51.68	66.43	54	-2.32	31.25	6.86	52.86	141	331	Average
4874	53.57	68.32	74	-20.43	31.25	6.86	52.86	141	331	Peak

Remarks:

- Emission Level = Read Level + Antenna Factor + Cable Loss - Preamp Factor  
Margin value = Emission level – Limit value
- 2437 MHz: Fundamental frequency.
- The other emission levels were very low against the limit.

EUT Test Condition		Measurement Detail	
Channel	Channel 11	Frequency Range	1 GHz ~ 25 GHz
Input Power	120 Vac, 60 Hz	Detector Function	Peak (PK) Average (AV)
Environmental Conditions	25 deg. C, 65 % RH	Tested By	Jisyong Wang

Antennal Polarity & Test Distance: Horizontal at 3 m										
Frequency (MHz)	Emission Level (dBuV/m)	Read Level (dBuV)	Limit (dBuV/m)	Margin (dB)	Antenna Factor (dB/m)	Cable Loss (dB)	Preamp Factor (dB)	Antenna Height (cm)	Table Angle (Degree)	Remark
2462	97.2	102.72			27.46	4.41	37.39	137	347	Average
2462	101.63	107.15			27.46	4.41	37.39	137	347	Peak
2483.52	37.89	43.25	54	-16.11	27.53	4.43	37.32	137	347	Average
2483.52	50.75	56.11	74	-23.25	27.53	4.43	37.32	137	347	Peak
4924	53.59	68.25	54	-0.41	31.34	6.89	52.89	123	295	Average
4924	54.93	69.59	74	-19.07	31.34	6.89	52.89	123	295	Peak
Antennal Polarity & Test Distance: Vertical at 3 m										
Frequency (MHz)	Emission Level (dBuV/m)	Read Level (dBuV)	Limit (dBuV/m)	Margin (dB)	Antenna Factor (dB/m)	Cable Loss (dB)	Preamp Factor (dB)	Antenna Height (cm)	Table Angle (Degree)	Remark
2462	92.33	97.85			27.46	4.41	37.39	102	70	Average
2462	96.68	102.2			27.46	4.41	37.39	102	70	Peak
2484.88	35.32	40.68	54	-18.68	27.53	4.43	37.32	102	70	Average
2484.88	48.68	54.04	74	-25.32	27.53	4.43	37.32	102	70	Peak
4924	50.88	65.54	54	-3.12	31.34	6.89	52.89	134	5	Average
4924	52.15	66.81	74	-21.85	31.34	6.89	52.89	134	5	Peak

Remarks:

- Emission Level = Read Level + Antenna Factor + Cable Loss - Preamp Factor  
Margin value = Emission level – Limit value
- 2462 MHz: Fundamental frequency.
- The other emission levels were very low against the limit.

## 802.11g

EUT Test Condition		Measurement Detail	
Channel	Channel 1	Frequency Range	1 GHz ~ 25 GHz
Input Power	120 Vac, 60 Hz	Detector Function	Peak (PK) Average (AV)
Environmental Conditions	25 deg. C, 65 % RH	Tested By	Jisyong Wang

**Antennal Polarity & Test Distance: Horizontal at 3 m**

Frequency (MHz)	Emission Level (dBuV/m)	Read Level (dBuV)	Limit (dBuV/m)	Margin (dB)	Antenna Factor (dB/m)	Cable Loss (dB)	Preamp Factor (dB)	Antenna Height (cm)	Table Angle (Degree)	Remark
2389.94	52	58	54	-2	27.16	4.36	37.52	172	60	Average
2389.94	66.85	72.85	74	-7.15	27.16	4.36	37.52	172	60	Peak
2412	93.58	99.49			27.23	4.38	37.52	172	60	Average
2412	103.84	109.75			27.23	4.38	37.52	172	60	Peak
4824	44.59	59.5	54	-9.41	31.17	6.81	52.89	111	152	Average
4824	54.61	69.52	74	-19.39	31.17	6.81	52.89	111	152	Peak

**Antennal Polarity & Test Distance: Vertical at 3 m**

Frequency (MHz)	Emission Level (dBuV/m)	Read Level (dBuV)	Limit (dBuV/m)	Margin (dB)	Antenna Factor (dB/m)	Cable Loss (dB)	Preamp Factor (dB)	Antenna Height (cm)	Table Angle (Degree)	Remark
2389.66	49.35	55.33	54	-4.65	27.16	4.36	37.5	100	135	Average
2389.66	63.58	69.56	74	-10.42	27.16	4.36	37.5	100	135	Peak
2412	89.62	95.53			27.23	4.38	37.52	100	135	Average
2412	98.54	104.45			27.23	4.38	37.52	100	135	Peak
4824	45.71	60.62	54	-8.29	31.17	6.81	52.89	152	231	Average
4824	55.72	70.63	74	-18.28	31.17	6.81	52.89	152	231	Peak

## Remarks:

- Emission Level = Read Level + Antenna Factor + Cable Loss - Preamp Factor  
Margin value = Emission level – Limit value
- 2412 MHz: Fundamental frequency.
- The other emission levels were very low against the limit.

EUT Test Condition		Measurement Detail	
Channel	Channel 6	Frequency Range	1 GHz ~ 25 GHz
Input Power	120 Vac, 60 Hz	Detector Function	Peak (PK) Average (AV)
Environmental Conditions	25 deg. C, 65 % RH	Tested By	Jisyong Wang

Antennal Polarity & Test Distance: Horizontal at 3 m										
Frequency (MHz)	Emission Level (dBuV/m)	Read Level (dBuV)	Limit (dBuV/m)	Margin (dB)	Antenna Factor (dB/m)	Cable Loss (dB)	Preamp Factor (dB)	Antenna Height (cm)	Table Angle (Degree)	Remark
2389.66	37.12	43.1	54	-16.88	27.16	4.36	37.5	174	34	Average
2389.66	52.11	58.09	74	-21.89	27.16	4.36	37.5	174	34	Peak
2437	92.8	98.48			27.38	4.4	37.46	174	34	Average
2437	101.48	107.16			27.38	4.4	37.46	174	34	Peak
2484.2	39.55	44.91	54	-14.45	27.53	4.43	37.32	174	34	Average
2484.2	53.7	59.06	74	-20.3	27.53	4.43	37.32	174	34	Peak
4874	45.92	60.67	54	-8.08	31.25	6.86	52.86	167	345	Average
4874	56.25	71	74	-17.75	31.25	6.86	52.86	167	345	Peak

Antennal Polarity & Test Distance: Vertical at 3 m										
Frequency (MHz)	Emission Level (dBuV/m)	Read Level (dBuV)	Limit (dBuV/m)	Margin (dB)	Antenna Factor (dB/m)	Cable Loss (dB)	Preamp Factor (dB)	Antenna Height (cm)	Table Angle (Degree)	Remark
2389.94	35.41	41.41	54	-18.59	27.16	4.36	37.52	111	133	Average
2389.94	50.14	56.14	74	-23.86	27.16	4.36	37.52	111	133	Peak
2437	90.79	96.47			27.38	4.4	37.46	111	133	Average
2437	100.31	105.99			27.38	4.4	37.46	111	133	Peak
2489.8	37.51	42.79	54	-16.49	27.61	4.43	37.32	111	133	Average
2489.8	50.43	55.71	74	-23.57	27.61	4.43	37.32	111	133	Peak
4874	47.85	62.6	54	-6.15	31.25	6.86	52.86	151	292	Average
4874	60.01	74.76	74	-13.99	31.25	6.86	52.86	151	292	Peak

Remarks:

- Emission Level = Read Level + Antenna Factor + Cable Loss - Preamp Factor  
Margin value = Emission level – Limit value
- 2437 MHz: Fundamental frequency.
- The other emission levels were very low against the limit.

EUT Test Condition		Measurement Detail	
Channel	Channel 11	Frequency Range	1 GHz ~ 25 GHz
Input Power	120 Vac, 60 Hz	Detector Function	Peak (PK) Average (AV)
Environmental Conditions	25 deg. C, 65 % RH	Tested By	Jisyong Wang

Antennal Polarity & Test Distance: Horizontal at 3 m										
Frequency (MHz)	Emission Level (dBuV/m)	Read Level (dBuV)	Limit (dBuV/m)	Margin (dB)	Antenna Factor (dB/m)	Cable Loss (dB)	Preamp Factor (dB)	Antenna Height (cm)	Table Angle (Degree)	Remark
2462	96.82	102.34			27.46	4.41	37.39	150	33	Average
2462	105.85	111.37			27.46	4.41	37.39	150	33	Peak
2483.52	53.32	58.68	54	-0.68	27.53	4.43	37.32	150	33	Average
2483.52	68.46	73.82	74	-5.54	27.53	4.43	37.32	150	33	Peak
4924	45.84	60.5	54	-8.16	31.34	6.89	52.89	152	231	Average
4924	55.92	70.58	74	-18.08	31.34	6.89	52.89	152	231	Peak
Antennal Polarity & Test Distance: Vertical at 3 m										
Frequency (MHz)	Emission Level (dBuV/m)	Read Level (dBuV)	Limit (dBuV/m)	Margin (dB)	Antenna Factor (dB/m)	Cable Loss (dB)	Preamp Factor (dB)	Antenna Height (cm)	Table Angle (Degree)	Remark
2462	90.56	96.08			27.46	4.41	37.39	121	116	Average
2462	99.48	105			27.46	4.41	37.39	121	116	Peak
2483.52	47.7	53.06	54	-6.3	27.53	4.43	37.32	121	116	Average
2483.52	62.04	67.4	74	-11.96	27.53	4.43	37.32	121	116	Peak
4924	46.04	60.7	54	-7.96	31.34	6.89	52.89	111	132	Average
4924	56.09	70.75	74	-17.91	31.34	6.89	52.89	111	132	Peak

Remarks:

- Emission Level = Read Level + Antenna Factor + Cable Loss - Preamp Factor  
Margin value = Emission level – Limit value
- 2462 MHz: Fundamental frequency.
- The other emission levels were very low against the limit.



### 802.11n (HT20)

EUT Test Condition		Measurement Detail	
Channel	Channel 1	Frequency Range	1 GHz ~ 25 GHz
Input Power	120 Vac, 60 Hz	Detector Function	Peak (PK) Average (AV)
Environmental Conditions	25 deg. C, 65 % RH	Tested By	Jisyong Wang

#### Antennal Polarity & Test Distance: Horizontal at 3 m

Frequency (MHz)	Emission Level (dBuV/m)	Read Level (dBuV)	Limit (dBuV/m)	Margin (dB)	Antenna Factor (dB/m)	Cable Loss (dB)	Preamp Factor (dB)	Antenna Height (cm)	Table Angle (Degree)	Remark
2389.8	53.53	59.53	54	-0.47	27.16	4.36	37.52	139	64	Average
2389.8	69.24	75.24	74	-4.76	27.16	4.36	37.52	139	64	Peak
2412	95.36	101.27			27.23	4.38	37.52	147	60	Average
2412	103.71	109.62			27.23	4.38	37.52	147	60	Peak
4824	42.59	57.5	54	-11.41	31.17	6.81	52.89	102	231	Average
4824	52.79	67.7	74	-21.21	31.17	6.81	52.89	102	231	Peak

#### Antennal Polarity & Test Distance: Vertical at 3 m

Frequency (MHz)	Emission Level (dBuV/m)	Read Level (dBuV)	Limit (dBuV/m)	Margin (dB)	Antenna Factor (dB/m)	Cable Loss (dB)	Preamp Factor (dB)	Antenna Height (cm)	Table Angle (Degree)	Remark
2389.94	48.46	54.46	54	-5.54	27.16	4.36	37.52	112	136	Average
2389.94	64.23	70.23	74	-9.77	27.16	4.36	37.52	112	136	Peak
2412	91.29	97.2			27.23	4.38	37.52	110	145	Average
2412	100.24	106.15			27.23	4.38	37.52	110	145	Peak
4824	43.39	58.3	54	-10.61	31.17	6.81	52.89	152	231	Average
4824	53.47	68.38	74	-20.53	31.17	6.81	52.89	152	231	Peak

#### Remarks:

- Emission Level = Read Level + Antenna Factor + Cable Loss - Preamp Factor  
Margin value = Emission level – Limit value
- 2412 MHz: Fundamental frequency.
- The other emission levels were very low against the limit.

EUT Test Condition		Measurement Detail	
Channel	Channel 6	Frequency Range	1 GHz ~ 25 GHz
Input Power	120 Vac, 60 Hz	Detector Function	Peak (PK) Average (AV)
Environmental Conditions	25 deg. C, 65 % RH	Tested By	Jisyong Wang

Antennal Polarity & Test Distance: Horizontal at 3 m										
Frequency (MHz)	Emission Level (dBuV/m)	Read Level (dBuV)	Limit (dBuV/m)	Margin (dB)	Antenna Factor (dB/m)	Cable Loss (dB)	Preamp Factor (dB)	Antenna Height (cm)	Table Angle (Degree)	Remark
2389.52	35.38	41.36	54	-18.62	27.16	4.36	37.5	200	58	Average
2389.52	50.95	56.93	74	-23.05	27.16	4.36	37.5	200	58	Peak
2437	87.93	93.61			27.38	4.4	37.46	165	61	Average
2437	96.91	102.59			27.38	4.4	37.46	165	61	Peak
2484.48	36.4	41.76	54	-17.6	27.53	4.43	37.32	200	58	Average
2484.48	50.34	55.7	74	-23.66	27.53	4.43	37.32	200	58	Peak
4874	45.28	60.03	54	-8.72	31.25	6.86	52.86	152	231	Average
4874	55.29	70.04	74	-18.71	31.25	6.86	52.86	152	231	Peak
Antennal Polarity & Test Distance: Vertical at 3 m										
Frequency (MHz)	Emission Level (dBuV/m)	Read Level (dBuV)	Limit (dBuV/m)	Margin (dB)	Antenna Factor (dB/m)	Cable Loss (dB)	Preamp Factor (dB)	Antenna Height (cm)	Table Angle (Degree)	Remark
2345.56	34.33	40.58	54	-19.67	26.93	4.31	37.49	108	112	Average
2345.56	47.9	54.15	74	-26.1	26.93	4.31	37.49	108	112	Peak
2437	83.09	88.77			27.38	4.4	37.46	111	113	Average
2437	92.59	98.27			27.38	4.4	37.46	111	113	Peak
2497.8	35.9	41.1	54	-18.1	27.61	4.44	37.25	108	112	Average
2497.8	48.62	53.82	74	-25.38	27.61	4.44	37.25	108	112	Peak
4874	44.35	59.1	54	-9.65	31.25	6.86	52.86	201	152	Average
4874	54.35	69.1	74	-19.65	31.25	6.86	52.86	201	152	Peak

Remarks:

- Emission Level = Read Level + Antenna Factor + Cable Loss - Preamp Factor  
Margin value = Emission level – Limit value
- 2437 MHz: Fundamental frequency.
- The other emission levels were very low against the limit.

EUT Test Condition		Measurement Detail	
Channel	Channel 11	Frequency Range	1 GHz ~ 25 GHz
Input Power	120 Vac, 60 Hz	Detector Function	Peak (PK) Average (AV)
Environmental Conditions	25 deg. C, 65 % RH	Tested By	Jisyong Wang

Antennal Polarity & Test Distance: Horizontal at 3 m										
Frequency (MHz)	Emission Level (dBuV/m)	Read Level (dBuV)	Limit (dBuV/m)	Margin (dB)	Antenna Factor (dB/m)	Cable Loss (dB)	Preamp Factor (dB)	Antenna Height (cm)	Table Angle (Degree)	Remark
2462	93.85	99.37			27.46	4.41	37.39	172	35	Average
2462	102.79	108.31			27.46	4.41	37.39	172	35	Peak
2483.52	53.55	58.91	54	-0.45	27.53	4.43	37.32	152	351	Average
2483.52	66.79	72.15	74	-7.21	27.53	4.43	37.32	152	351	Peak
4924	44.32	58.98	54	-9.68	31.34	6.89	52.89	152	231	Average
4924	54.32	68.98	74	-19.68	31.34	6.89	52.89	152	231	Peak

Antennal Polarity & Test Distance: Vertical at 3 m										
Frequency (MHz)	Emission Level (dBuV/m)	Read Level (dBuV)	Limit (dBuV/m)	Margin (dB)	Antenna Factor (dB/m)	Cable Loss (dB)	Preamp Factor (dB)	Antenna Height (cm)	Table Angle (Degree)	Remark
2462	89.72	95.24			27.46	4.41	37.39	125	112	Average
2462	98.34	103.86			27.46	4.41	37.39	125	112	Peak
2483.52	47.02	52.38	54	-6.98	27.53	4.43	37.32	122	117	Average
2483.52	60.59	65.95	74	-13.41	27.53	4.43	37.32	122	117	Peak
4924	42.66	57.32	54	-11.34	31.34	6.89	52.89	111	152	Average
4924	52.67	67.33	74	-21.33	31.34	6.89	52.89	111	152	Peak

Remarks:

- Emission Level = Read Level + Antenna Factor + Cable Loss - Preamp Factor  
Margin value = Emission level – Limit value
- 2462 MHz: Fundamental frequency.
- The other emission levels were very low against the limit.

802.11n (HT40)

EUT Test Condition		Measurement Detail	
Channel	Channel 3	Frequency Range	1 GHz ~ 25 GHz
Input Power	120 Vac, 60 Hz	Detector Function	Peak (PK) Average (AV)
Environmental Conditions	25 deg. C, 65 % RH	Tested By	Jisyong Wang

**Antennal Polarity & Test Distance: Horizontal at 3 m**

Frequency (MHz)	Emission Level (dBuV/m)	Read Level (dBuV)	Limit (dBuV/m)	Margin (dB)	Antenna Factor (dB/m)	Cable Loss (dB)	Preamp Factor (dB)	Antenna Height (cm)	Table Angle (Degree)	Remark
2389.8	53.02	59.02	54	-0.98	27.16	4.36	37.52	141	63	Average
2389.8	64.92	70.92	74	-9.08	27.16	4.36	37.52	141	63	Peak
2422	88.88	94.64			27.31	4.39	37.46	135	59	Average
2422	98.08	103.84			27.31	4.39	37.46	135	59	Peak
2485.6	39.51	44.87	54	-14.49	27.53	4.43	37.32	141	63	Average
2485.6	53.16	58.52	74	-20.84	27.53	4.43	37.32	141	63	Peak
4844	40.91	55.76	54	-13.09	31.2	6.83	52.88	152	123	Average
4844	50.92	65.77	74	-23.08	31.2	6.83	52.88	152	123	Peak

**Antennal Polarity & Test Distance: Vertical at 3 m**

Frequency (MHz)	Emission Level (dBuV/m)	Read Level (dBuV)	Limit (dBuV/m)	Margin (dB)	Antenna Factor (dB/m)	Cable Loss (dB)	Preamp Factor (dB)	Antenna Height (cm)	Table Angle (Degree)	Remark
2389.94	48.04	54.04	54	-5.96	27.16	4.36	37.52	112	134	Average
2389.94	60.04	66.04	74	-13.96	27.16	4.36	37.52	112	134	Peak
2422	85.6	91.36			27.31	4.39	37.46	115	132	Average
2422	94.51	100.27			27.31	4.39	37.46	115	132	Peak
2488	37.52	42.8	54	-16.48	27.61	4.43	37.32	112	134	Average
2488	50.65	55.93	74	-23.35	27.61	4.43	37.32	112	134	Peak
4844	42.33	57.18	54	-11.67	31.2	6.83	52.88	152	111	Average
4844	52.33	67.18	74	-21.67	31.2	6.83	52.88	152	111	Peak

Remarks:

- Emission Level = Read Level + Antenna Factor + Cable Loss - Preamp Factor  
Margin value = Emission level – Limit value
- 2422 MHz: Fundamental frequency.
- The other emission levels were very low against the limit.

EUT Test Condition		Measurement Detail	
Channel	Channel 6	Frequency Range	1 GHz ~ 25 GHz
Input Power	120 Vac, 60 Hz	Detector Function	Peak (PK) Average (AV)
Environmental Conditions	25 deg. C, 65 % RH	Tested By	Jisyong Wang

Antennal Polarity & Test Distance: Horizontal at 3 m										
Frequency (MHz)	Emission Level (dBuV/m)	Read Level (dBuV)	Limit (dBuV/m)	Margin (dB)	Antenna Factor (dB/m)	Cable Loss (dB)	Preamp Factor (dB)	Antenna Height (cm)	Table Angle (Degree)	Remark
2389.66	49.21	55.19	54	-4.79	27.16	4.36	37.5	176	352	Average
2389.66	61.98	67.96	74	-12.02	27.16	4.36	37.5	176	352	Peak
2437	90.19	95.87			27.38	4.4	37.46	192	34	Average
2437	99.7	105.38			27.38	4.4	37.46	192	34	Peak
2483.52	48.24	53.6	54	-5.76	27.53	4.43	37.32	176	352	Average
2483.52	61.14	66.5	74	-12.86	27.53	4.43	37.32	176	352	Peak
4874	43.1	57.85	54	-10.9	31.25	6.86	52.86	125	142	Average
4874	53	67.75	74	-21	31.25	6.86	52.86	125	142	Peak

Antennal Polarity & Test Distance: Vertical at 3 m										
Frequency (MHz)	Emission Level (dBuV/m)	Read Level (dBuV)	Limit (dBuV/m)	Margin (dB)	Antenna Factor (dB/m)	Cable Loss (dB)	Preamp Factor (dB)	Antenna Height (cm)	Table Angle (Degree)	Remark
2389.94	42.91	48.91	54	-11.09	27.16	4.36	37.52	100	118	Average
2389.94	55.65	61.65	74	-18.35	27.16	4.36	37.52	100	118	Peak
2437	86.42	92.1			27.38	4.4	37.46	125	111	Average
2437	95.42	101.1			27.38	4.4	37.46	125	111	Peak
2483.72	44.93	50.29	54	-9.07	27.53	4.43	37.32	100	118	Average
2483.72	58.87	64.23	74	-15.13	27.53	4.43	37.32	100	118	Peak
4874	42.5	57.25	54	-11.5	31.25	6.86	52.86	111	165	Average
4874	52.5	67.25	74	-21.5	31.25	6.86	52.86	111	165	Peak

Remarks:

- Emission Level = Read Level + Antenna Factor + Cable Loss - Preamp Factor  
Margin value = Emission level – Limit value
- 2437 MHz: Fundamental frequency.
- The other emission levels were very low against the limit.

EUT Test Condition		Measurement Detail	
Channel	Channel 9	Frequency Range	1 GHz ~ 25 GHz
Input Power	120 Vac, 60 Hz	Detector Function	Peak (PK) Average (AV)
Environmental Conditions	25 deg. C, 65 % RH	Tested By	Jisyong Wang

Antennal Polarity & Test Distance: Horizontal at 3 m										
Frequency (MHz)	Emission Level (dBuV/m)	Read Level (dBuV)	Limit (dBuV/m)	Margin (dB)	Antenna Factor (dB/m)	Cable Loss (dB)	Preamp Factor (dB)	Antenna Height (cm)	Table Angle (Degree)	Remark
2389.94	36.3	42.3	54	-17.7	27.16	4.36	37.52	151	348	Average
2389.94	50.41	56.41	74	-23.59	27.16	4.36	37.52	151	348	Peak
2452	88.02	93.62			27.38	4.41	37.39	166	70	Average
2452	97.5	103.1			27.38	4.41	37.39	166	70	Peak
2483.72	53.51	58.87	54	-0.49	27.53	4.43	37.32	151	348	Average
2483.72	67	72.36	74	-7	27.53	4.43	37.32	151	348	Peak
4904	39.43	54.09	54	-14.57	31.31	6.88	52.85	152	213	Average
4904	49.38	64.04	74	-24.62	31.31	6.88	52.85	152	213	Peak
Antennal Polarity & Test Distance: Vertical at 3 m										
Frequency (MHz)	Emission Level (dBuV/m)	Read Level (dBuV)	Limit (dBuV/m)	Margin (dB)	Antenna Factor (dB/m)	Cable Loss (dB)	Preamp Factor (dB)	Antenna Height (cm)	Table Angle (Degree)	Remark
2383.64	34.94	41.01	54	-19.06	27.08	4.35	37.5	100	120	Average
2383.64	48.07	54.14	74	-25.93	27.08	4.35	37.5	100	120	Peak
2452	84.73	90.33			27.38	4.41	37.39	152	111	Average
2452	93.93	99.53			27.38	4.41	37.39	152	111	Peak
2485.28	47.26	52.62	54	-6.74	27.53	4.43	37.32	100	120	Average
2485.28	59.95	65.31	74	-14.05	27.53	4.43	37.32	100	120	Peak
4904	40.86	55.52	54	-13.14	31.31	6.88	52.85	111	152	Average
4904	50.65	65.31	74	-23.35	31.31	6.88	52.85	111	152	Peak

Remarks:

- Emission Level = Read Level + Antenna Factor + Cable Loss - Preamp Factor  
Margin value = Emission level – Limit value
- 2452 MHz: Fundamental frequency.
- The other emission levels were very low against the limit.

### 9 kHz ~ 30 MHz Data:

The amplitude of spurious emissions attenuated more than 20 dB below the permissible value is not required to be report.

### 30 MHz ~ 1 GHz Worst-Case Data:

#### 802.11b

EUT Test Condition		Measurement Detail	
Channel	Channel 1	Frequency Range	30 MHz ~ 1 GHz
Input Power	120 Vac, 60 Hz	Detector Function	Peak (PK) Quasi-peak (QP)
Environmental Conditions	25 deg. C, 65 % RH	Tested By	Jisyong Wang

Antennal Polarity & Test Distance: Horizontal at 3 m										
Frequency (MHz)	Emission Level (dBuV/m)	Read Level (dBuV)	Limit (dBuV/m)	Margin (dB)	Antenna Factor (dB/m)	Cable Loss (dB)	Preamp Factor (dB)	Antenna Height (cm)	Table Angle (Degree)	Remark
216.24	38.33	58.63	46	-7.67	10.05	1.31	31.66	152	213	Peak
304.51	40.09	57.25	46	-5.91	13.06	1.67	31.89	111	165	Peak
380.17	37.22	52.3	46	-8.78	14.87	2	31.95	111	214	Peak
458.74	31.22	44.4	46	-14.78	16.5	2.31	31.99	165	254	Peak
722.58	36.69	43.79	46	-9.31	21.13	3.41	31.64	111	132	Peak
902.03	30.74	35.19	46	-15.26	23.52	4.05	32.02	102	298	Peak
Antennal Polarity & Test Distance: Vertical at 3 m										
Frequency (MHz)	Emission Level (dBuV/m)	Read Level (dBuV)	Limit (dBuV/m)	Margin (dB)	Antenna Factor (dB/m)	Cable Loss (dB)	Preamp Factor (dB)	Antenna Height (cm)	Table Angle (Degree)	Remark
45.52	35.03	52.18	40	-4.97	13.5	0.51	31.16	165	231	Peak
216.24	33.06	53.36	46	-12.94	10.05	1.31	31.66	111	145	Peak
381.14	34.65	49.71	46	-11.35	14.89	2.01	31.96	102	258	Peak
573.2	28.6	38.91	46	-17.4	18.99	2.79	32.09	165	231	Peak
655.65	31.02	39.59	46	-14.98	20.28	3.13	31.98	185	265	Peak
942.77	36.73	40.69	46	-9.27	23.75	4.19	31.9	165	231	Peak

#### Remarks:

- Emission Level = Read Level + Antenna Factor + Cable Loss - Preamp Factor  
Margin value = Emission level – Limit value
- The other emission levels were very low against the limit.

## 4.2 Conducted Emission Measurement

### 4.2.1 Limits of Conducted Emission Measurement

Frequency (MHz)	Conducted Limit (dBuV)	
	Quasi-Peak	Average
0.15 - 0.5	66 - 56	56 - 46
0.50 - 5.0	56	46
5.0 - 30.0	60	50

- Note: 1. The lower limit shall apply at the transition frequencies.  
 2. The limit decreases in line with the logarithm of the frequency in the range of 0.15 to 0.50 MHz.

### 4.2.2 Test Instruments

Description & Manufacturer	Model No.	Serial No.	Date of Calibration	Due Date of Calibration
Test Receiver ROHDE & SCHWARZ	ESCI	100613	Nov. 23, 2017	Nov. 22, 2018
RF signal cable (with 10dB PAD) Woken	5D-FB	Cable-cond1-01	Sep. 05, 2017	Sep. 04, 2018
LISN ROHDE & SCHWARZ (EUT)	ESH3-Z5	835239/001	Mar. 06, 2018	Mar. 05, 2019
LISN ROHDE & SCHWARZ (Peripheral)	ESH3-Z5	100311	Aug. 15, 2017	Aug. 14, 2018
Software ADT	BV ADT_Cond_ V7.3.7.4	NA	NA	NA

- Note: 1. The calibration interval of the above test instruments is 12 months and the calibrations are traceable to NML/ROC and NIST/USA.  
 2. The test was performed in HwaYa Shielded Room 1.  
 3. The VCCI Site Registration No. is C-2040.



#### 4.2.3 Test Procedures

- a. The EUT was placed 0.4 meters from the conducting wall of the shielded room with EUT being connected to the power mains through a line impedance stabilization network (LISN). Other support units were connected to the power mains through another LISN. The two LISNs provide 50 ohm/50 uH of coupling impedance for the measuring instrument.
- b. Both lines of the power mains connected to the EUT were checked for maximum conducted interference.
- c. The frequency range from 150 kHz to 30 MHz was searched. Emission levels under (Limit – 20 dB) was not recorded.

**Note:** The resolution bandwidth and video bandwidth of test receiver is 9 kHz for quasi-peak detection (QP) and average detection (AV) at frequency 0.15 MHz – 30 MHz.

#### 4.2.4 Deviation from Test Standard

No deviation.

#### 4.2.5 Test Setup

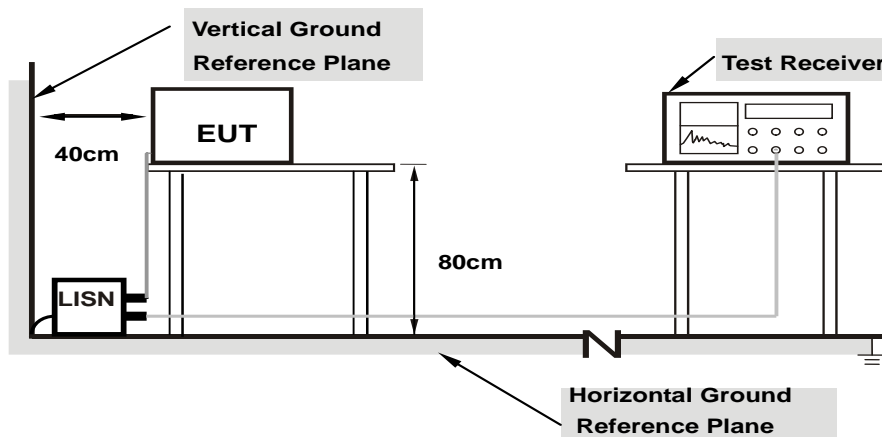

**Note:** 1.Support units were connected to second LISN.

For the actual test configuration, please refer to the attached file (Test Setup Photo).

#### 4.2.6 EUT Operating Conditions

- a. Placed the EUT on a testing table.
- b. Use the software to control the EUT under transmission condition continuously at specific channel frequency.

#### 4.2.7 Test Results

Frequency Range	150kHz ~ 30MHz	Detector Function & Resolution Bandwidth	Quasi-Peak (QP) / Average (AV), 9kHz
Input Power	120Vac, 60Hz	Environmental Conditions	25°C, 65%RH
Tested by	Getaz Yang	Test Date	2018/5/24

Phase Of Power : Line (L)										
No	Frequency (MHz)	Correction Factor (dB)	Reading Value (dBuV)		Emission Level (dBuV)		Limit (dBuV)		Margin (dB)	
			Q.P.	AV.	Q.P.	AV.	Q.P.	AV.	Q.P.	AV.
1	0.16569	10.10	36.22	16.83	46.32	26.93	65.17	55.17	-18.85	-28.24
2	0.19305	10.10	35.73	24.39	45.83	34.49	63.90	53.90	-18.07	-19.41
3	0.34550	10.11	23.55	10.12	33.66	20.23	59.07	49.07	-25.41	-28.84
4	0.67394	10.13	22.35	10.47	32.48	20.60	56.00	46.00	-23.52	-25.40
5	7.80969	10.50	19.27	5.73	29.77	16.23	60.00	50.00	-30.23	-33.77
6	21.57289	11.24	25.33	10.53	36.57	21.77	60.00	50.00	-23.43	-28.23

Remarks:

1. Q.P. and AV. are abbreviations of quasi-peak and average individually.
2. The emission levels of other frequencies were very low against the limit.
3. Margin value = Emission level – Limit value
4. Correction factor = Insertion loss + Cable loss
5. Emission Level = Correction Factor + Reading Value

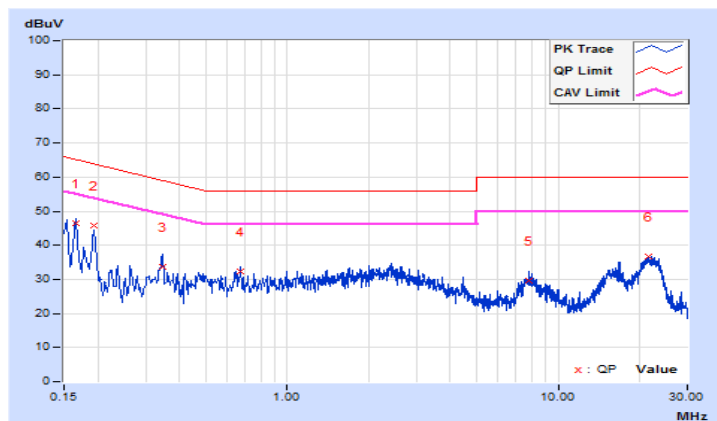

Frequency Range	150kHz ~ 30MHz	Detector Function & Resolution Bandwidth	Quasi-Peak (QP) / Average (AV), 9kHz
Input Power	120Vac, 60Hz	Environmental Conditions	25°C, 65%RH
Tested by	Getaz Yang	Test Date	2018/5/24

Phase Of Power : Neutral (N)										
No	Frequency (MHz)	Correction Factor (dB)	Reading Value (dBuV)		Emission Level (dBuV)		Limit (dBuV)		Margin (dB)	
			Q.P.	AV.	Q.P.	AV.	Q.P.	AV.	Q.P.	AV.
1	0.15000	10.10	39.43	25.38	49.53	35.48	66.00	56.00	-16.47	-20.52
2	0.20084	10.10	35.05	18.99	45.15	29.09	63.58	53.58	-18.43	-24.49
3	0.34550	10.11	22.87	10.23	32.98	20.34	59.07	49.07	-26.09	-28.73
4	2.55074	10.20	21.95	10.26	32.15	20.46	56.00	46.00	-23.85	-25.54
5	16.65020	10.80	19.18	5.54	29.98	16.34	60.00	50.00	-30.02	-33.66
6	22.28060	10.97	25.25	10.72	36.22	21.69	60.00	50.00	-23.78	-28.31

Remarks:

1. Q.P. and AV. are abbreviations of quasi-peak and average individually.
2. The emission levels of other frequencies were very low against the limit.
3. Margin value = Emission level – Limit value
4. Correction factor = Insertion loss + Cable loss
5. Emission Level = Correction Factor + Reading Value

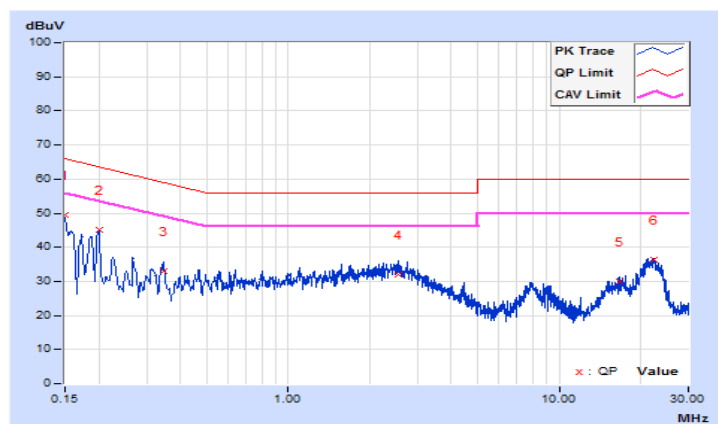

### 4.3 6 dB Bandwidth Measurement

#### 4.3.1 Limits of 6 dB Bandwidth Measurement

The minimum of 6 dB Bandwidth Measurement is 0.5 MHz.

#### 4.3.2 Test Setup

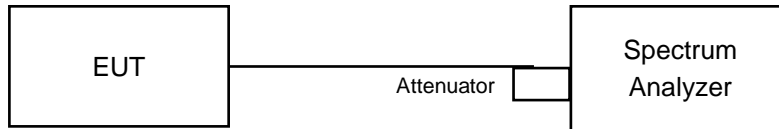

#### 4.3.3 Test Instruments

Refer to section 4.1.2 to get information of above instrument.

#### 4.3.4 Test Procedure

- a. Set resolution bandwidth (RBW) = 100 kHz
- b. Set the video bandwidth (VBW)  $\geq 3 \times$  RBW, Detector = Peak.
- c. Trace mode = max hold.
- d. Sweep = auto couple.
- e. Measure the maximum width of the emission that is constrained by the frequencies associated with the two amplitude points (upper and lower) that are attenuated by 6 dB relative to the maximum level measured in the fundamental emission

#### 4.3.5 Deviation from Test Standard

No deviation.

#### 4.3.6 EUT Operating Conditions

The software provided by client to enable the EUT under transmission condition continuously at lowest, middle and highest channel frequencies individually.

## 4.3.7 Test Results

## 802.11b

Channel	Frequency (MHz)	6 dB Bandwidth (MHz)	Minimum Limit (MHz)	Pass / Fail
1	2412	10.11	0.5	Pass
6	2437	10.11	0.5	Pass
11	2462	10.11	0.5	Pass

## 802.11g

Channel	Frequency (MHz)	6 dB Bandwidth (MHz)	Minimum Limit (MHz)	Pass / Fail
1	2412	16.38	0.5	Pass
6	2437	16.41	0.5	Pass
11	2462	16.42	0.5	Pass

## 802.11n (HT20)

Channel	Frequency (MHz)	6 dB Bandwidth (MHz)		Minimum Limit (MHz)	Pass / Fail
		Chain 0	Chain 1		
1	2412	17.62	17.64	0.5	Pass
6	2437	17.62	17.64	0.5	Pass
11	2462	17.63	17.66	0.5	Pass

## 802.11n (HT40)

Channel	Frequency (MHz)	6 dB Bandwidth (MHz)		Minimum Limit (MHz)	Pass / Fail
		Chain 0	Chain 1		
3	2422	35.47	35.80	0.5	Pass
6	2437	35.52	35.79	0.5	Pass
9	2452	35.29	35.80	0.5	Pass

### Spectrum Plot of Worst Value

#### 802.11b

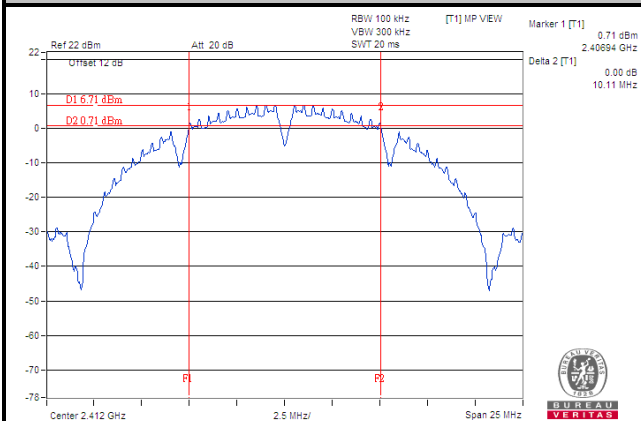

#### 802.11g

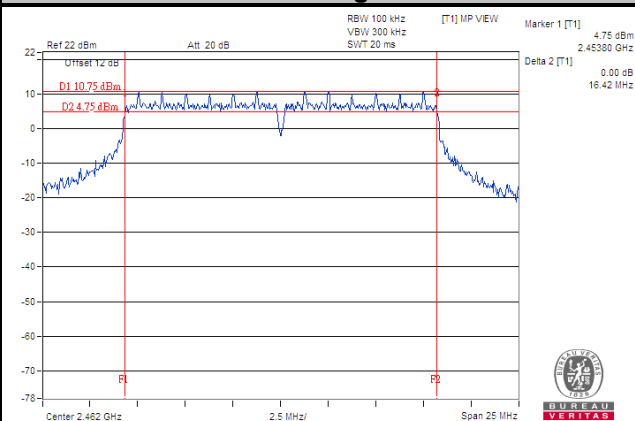

#### 802.11n (HT20)

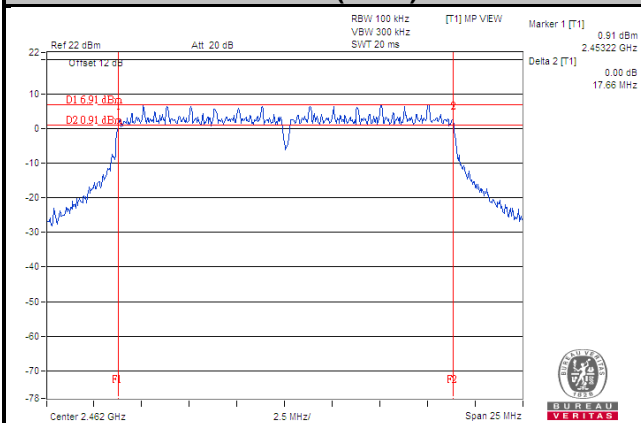

#### 802.11n (HT40)

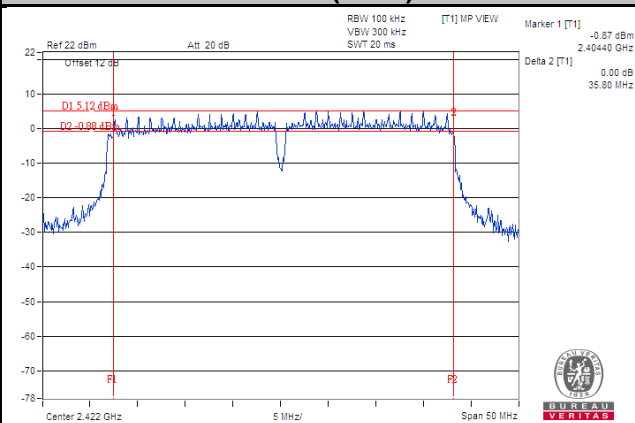

## 4.4 Occupied Bandwidth Measurement

### 4.4.1 Test Setup

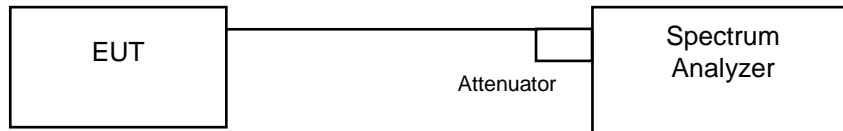

### 4.4.2 Test Instruments

Refer to section 4.1.2 to get information of above instrument.

### 4.4.3 Test Procedure

The transmitter output was connected to the spectrum analyzer through an attenuator. The bandwidth of the fundamental frequency was measured by spectrum analyzer with resolution bandwidth in the range of 1 % to 5 % of the anticipated emission bandwidth, and a video bandwidth at least 3x the resolution bandwidth and set the detector to PEAK. The width of a frequency band such that, below the lower and above the upper frequency limits, the mean powers emitted are each equal to a specified percentage 0.5 % of the total mean power of a given emission.

### 4.4.4 Deviation from Test Standard

No deviation.

### 4.4.5 EUT Operating Conditions

The software provided by client to enable the EUT under transmission condition continuously at lowest, middle and highest channel frequencies individually.

#### 4.4.6 Test Results

##### 802.11b

Channel	Frequency (MHz)	Occupied Bandwidth (MHz)	Pass / Fail
1	2412	15.20	Pass
6	2437	15.10	Pass
11	2462	15.10	Pass

##### 802.11g

Channel	Frequency (MHz)	Occupied Bandwidth (MHz)	Pass / Fail
1	2412	17.21	Pass
6	2437	18.56	Pass
11	2462	17.50	Pass

##### 802.11n (HT20)

Channel	Frequency (MHz)	Occupied Bandwidth (MHz)		Pass / Fail
		Chain 0	Chain 1	
1	2412	18.26	18.08	Pass
6	2437	18.75	18.17	Pass
11	2462	18.08	18.07	Pass

##### 802.11n (HT40)

Channel	Frequency (MHz)	Occupied Bandwidth (MHz)		Pass / Fail
		Chain 0	Chain 1	
3	2422	36.54	36.64	Pass
6	2437	36.64	36.73	Pass
9	2452	36.44	36.44	Pass



### Spectrum Plot of Worst Value

#### 802.11b

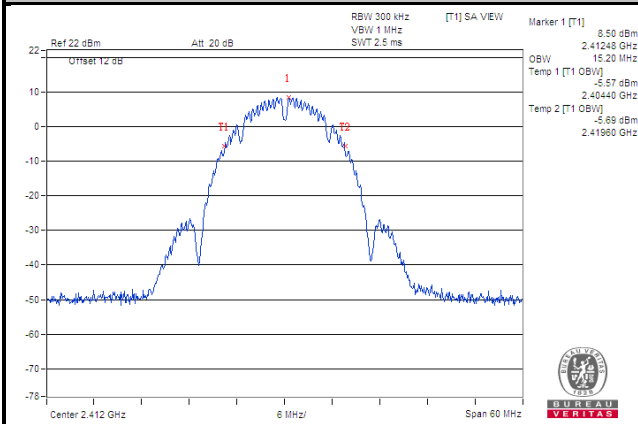

#### 802.11g

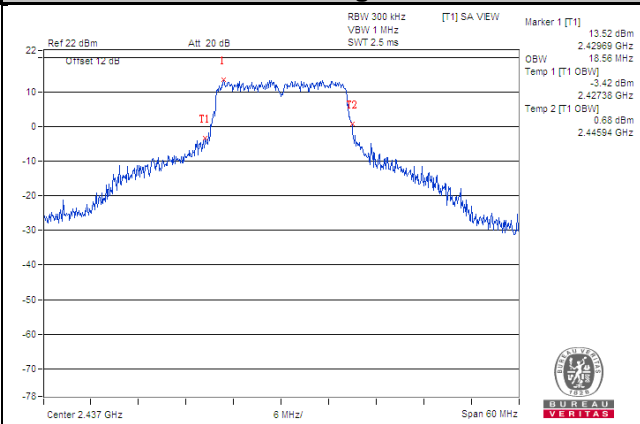

#### 802.11n (HT20)

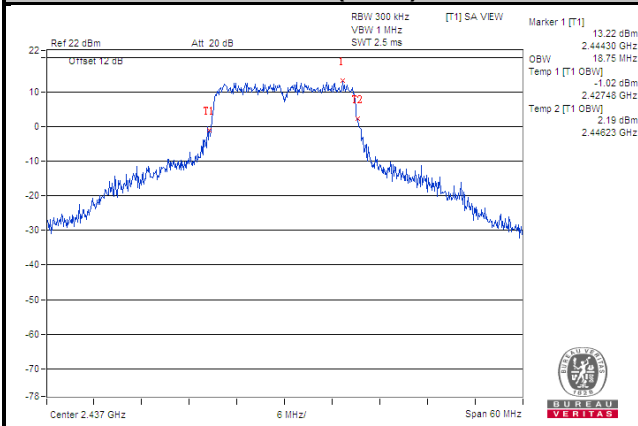

#### 802.11n (HT40)

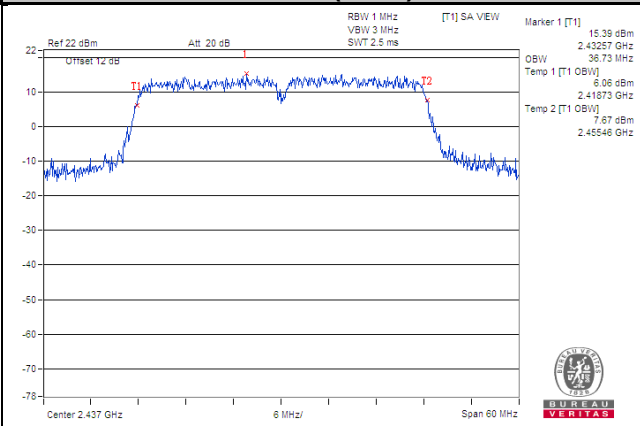

## 4.5 Conducted Output Power Measurement

### 4.5.1 Limits of Conducted Output Power Measurement

For systems using digital modulation in the 2400–2483.5 MHz bands: 1 Watt (30 dBm)

Per KDB 662911 D01 Multiple Transmitter Output Method of conducted output power measurement on IEEE 802.11 devices,

Array Gain = 0 dB (i.e., no array gain) for NANT  $\leq$  4;

Array Gain = 0 dB (i.e., no array gain) for channel widths  $\geq$  40 MHz for any NANT;

Array Gain =  $5 \log(\text{NANT}/\text{NSS})$  dB or 3 dB, whichever is less for 20 MHz channel widths with NANT  $\geq$  5.

For power measurements on all other devices: Array Gain =  $10 \log(\text{NANT}/\text{NSS})$  dB.

### 4.5.2 Test Setup

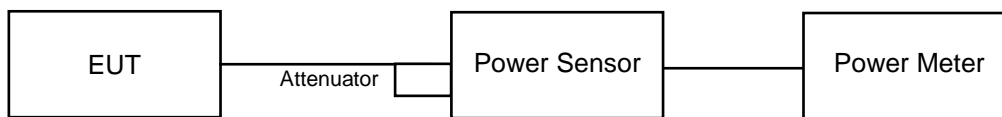

### 4.5.3 Test Instruments

Refer to section 4.1.2 to get information of above instrument.

### 4.5.4 Test Procedures

A peak power sensor was used on the output port of the EUT. A power meter was used to read the response of the peak power sensor. Record the power level.

### 4.5.5 Deviation from Test Standard

No deviation.

### 4.5.6 EUT Operating Conditions

The software provided by client to enable the EUT under transmission condition continuously at lowest, middle and highest channel frequencies individually.

## 4.5.7 Test Results

## 802.11b

Channel	Frequency (MHz)	Peak Power (mW)	Peak Power (dBm)	Limit (dBm)	Pass / Fail
1	2412	93.541	19.71	30	Pass
6	2437	101.391	20.06	30	Pass
11	2462	97.499	19.89	30	Pass

## 802.11g

Channel	Frequency (MHz)	Peak Power (mW)	Peak Power (dBm)	Limit (dBm)	Pass / Fail
1	2412	533.335	27.27	30	Pass
6	2437	599.791	27.78	30	Pass
11	2462	515.229	27.12	30	Pass

## 802.11n (HT20)

Channel	Frequency (MHz)	Peak Power (dBm)		Total Power (mW)	Total Power (dBm)	Limit (dBm)	Pass / Fail
		Chain 0	Chain 1				
1	2412	26.98	26.08	904.393	29.56	30	Pass
6	2437	27.21	26.55	977.873	29.90	30	Pass
11	2462	26.84	26.01	882.084	29.46	30	Pass

## 802.11n (HT40)

Channel	Frequency (MHz)	Peak Power (dBm)		Total Power (mW)	Total Power (dBm)	Limit (dBm)	Pass / Fail
		Chain 0	Chain 1				
3	2422	26.67	25.90	853.56	29.31	30	Pass
6	2437	27.11	26.52	962.789	29.84	30	Pass
9	2452	26.34	26.15	842.625	29.26	30	Pass

## 4.6 Power Spectral Density Measurement

### 4.6.1 Limits of Power Spectral Density Measurement

The Maximum of Power Spectral Density Measurement is 8 dBm in any 3 kHz.

### 4.6.2 Test Setup

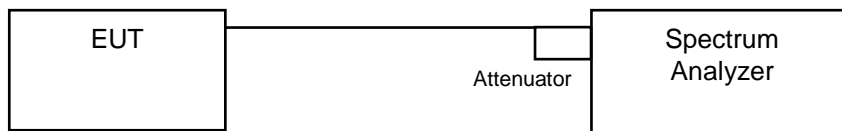

### 4.6.3 Test Instruments

Refer to section 4.1.2 to get information of above instrument.

### 4.6.4 Test Procedure

- a. Set analyzer center frequency to DTS channel center frequency.
- b. Set the span to 1.5 times the DTS bandwidth.
- c. Set the RBW to:  $3 \text{ kHz} \leq \text{RBW} \leq 100 \text{ kHz}$ .
- d. Set the VBW  $\geq 3 \times \text{RBW}$ .
- e. Detector = peak.
- f. Sweep time = auto couple.
- g. Trace mode = max hold.
- h. Allow trace to fully stabilize.
- i. Use the peak marker function to determine the maximum amplitude level within the RBW.

### 4.6.5 Deviation from Test Standard

No deviation.

### 4.6.6 EUT Operating Condition

The software provided by client to enable the EUT under transmission condition continuously at lowest, middle and highest channel frequencies individually.

#### 4.6.7 Test Results

##### 802.11b

Channel	Frequency (MHz)	PSD (dBm/3 kHz)	Limit (dBm/3 kHz)	Pass / Fail
1	2412	-6.34	8	Pass
6	2437	-5.91	8	Pass
11	2462	-6.11	8	Pass

##### 802.11g

Channel	Frequency (MHz)	PSD (dBm/3 kHz)	Duty Factor (dB)	Total PSD (dBm/3 kHz)	Limit (dBm/3 kHz)	Pass / Fail
1	2412	-5.22	0.36	-4.86	8	Pass
6	2437	-3.03	0.36	-2.67	8	Pass
11	2462	-4.23	0.36	-3.87	8	Pass

##### 802.11n (HT20)

TX Chain	Channel	Freq. (MHz)	PSD (dBm/3 kHz)	10 log (N=2) dB	Duty Factor (dB)	Total PSD (dBm/3 kHz)	Limit (dBm/3 kHz)	Pass / Fail
0	1	2412	-7.25	3.01	0.50	-3.74	8	Pass
	6	2437	-4.65	3.01	0.50	-1.14	8	Pass
	11	2462	-7.93	3.01	0.50	-4.42	8	Pass
1	1	2412	-8.00	3.01	0.50	-4.49	8	Pass
	6	2437	-5.10	3.01	0.50	-1.59	8	Pass
	11	2462	-7.64	3.01	0.50	-4.13	8	Pass

**Note:**

Directional gain =  $10 \log[(10^{G1/20} + 10^{G2/20} + \dots + 10^{GN/20})^2 / N_{ANT}]$  dBi =  $10 \log[(10^{0.5/20} + 10^{0.3/20})^2 / 2]$  = 3.41 dBi < 6 dBi, so the limit no need to reduced.

### 802.11n (HT40)

TX Chain	Channel	Freq. (MHz)	PSD (dBm/3 kHz)	10 log (N=2) dB	Duty Factor (dB)	Total PSD (dBm/3 kHz)	Limit (dBm/3 kHz)	Pass / Fail
0	3	2422	-10.21	3.01	1.26	-5.94	8	Pass
	6	2437	-8.06	3.01	1.26	-3.79	8	Pass
	9	2452	-12.61	3.01	1.26	-8.34	8	Pass
1	3	2422	-11.83	3.01	1.26	-7.56	8	Pass
	6	2437	-9.73	3.01	1.26	-5.46	8	Pass
	9	2452	-12.19	3.01	1.26	-7.92	8	Pass

**Note:**

Directional gain =  $10 \log[(10^{G1/20} + 10^{G2/20} + \dots + 10^{GN/20})^2 / N_{ANT}]$  dBi =  $10 \log[(10^{0.5/20} + 10^{0.3/20})^2 / 2]$  = 3.41 dBi < 6 dBi, so the limit no need to reduced.

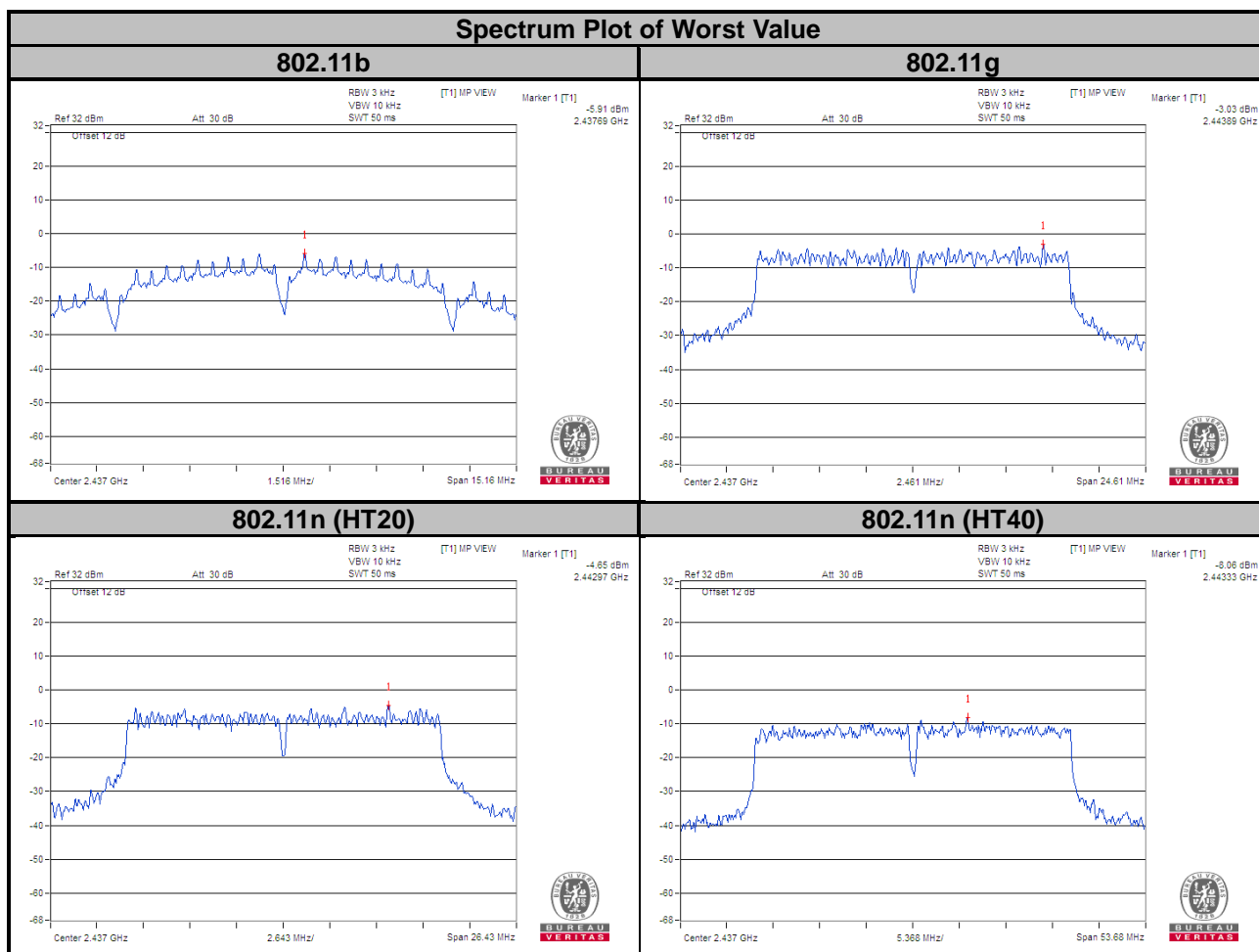

## 4.7 Conducted Out of Band Emission Measurement

### 4.7.1 Limits of Conducted Out of Band Emission Measurement

Below -20 dB of the highest emission level of operating band (in 100 kHz Resolution Bandwidth).

### 4.7.2 Test Setup

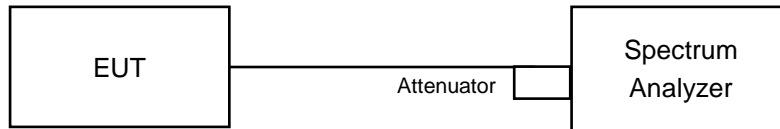

### 4.7.3 Test Instruments

Refer to section 4.1.2 to get information of above instrument.

### 4.7.4 Test Procedure

#### MEASUREMENT PROCEDURE REF

1. Set the RBW = 100 kHz.
2. Set the VBW  $\geq$  300 kHz.
3. Detector = peak.
4. Sweep time = auto couple.
5. Trace mode = max hold.
6. Allow trace to fully stabilize.
7. Use the peak marker function to determine the maximum power level in any 100 kHz band segment within the fundamental EBW.

#### MEASUREMENT PROCEDURE OOB

1. Set RBW = 100 kHz.
2. Set VBW  $\geq$  300 kHz.
3. Detector = peak.
4. Sweep = auto couple.
5. Trace Mode = max hold.
6. Allow trace to fully stabilize.
7. Use the peak marker function to determine the maximum amplitude level.

### 4.7.5 Deviation from Test Standard

No deviation.

### 4.7.6 EUT Operating Condition

The software provided by client to enable the EUT under transmission condition continuously at lowest, middle and highest channel frequencies individually.

### 4.7.7 Test Results

The conducted emission test is performed on each TX port of operating mode without summing or adding 10log (N) since the limit is relative emission limit.

The spectrum plots are attached on the following images. D1 line indicates the highest level, and D2 line indicates the 20 dB offset below D1. It shows compliance with the requirement.

#### 802.11b

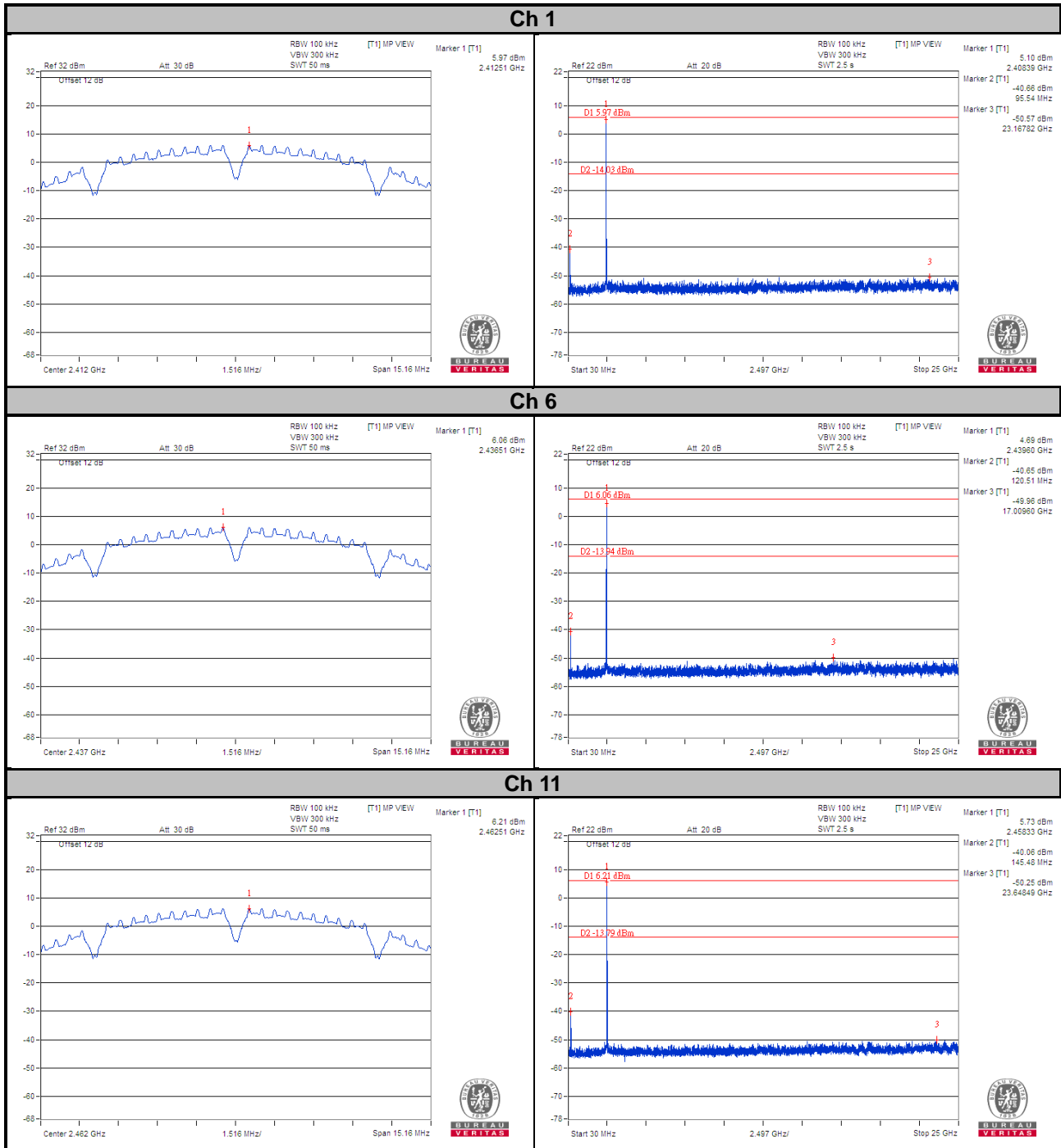



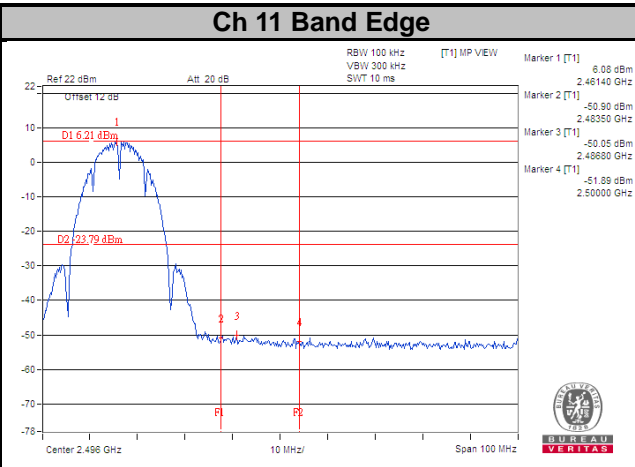
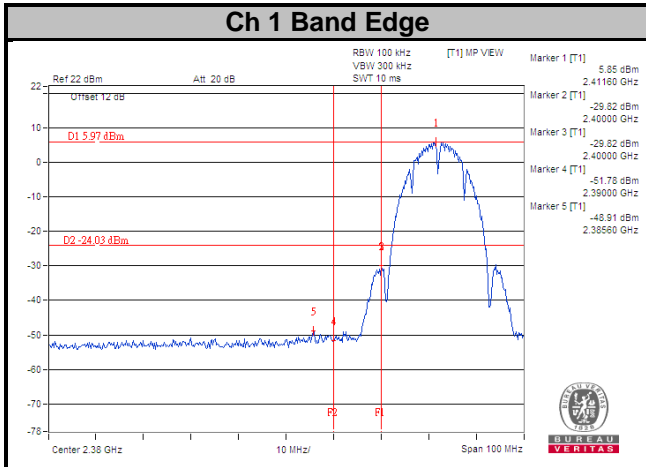

# 802.11g

## Ch 1

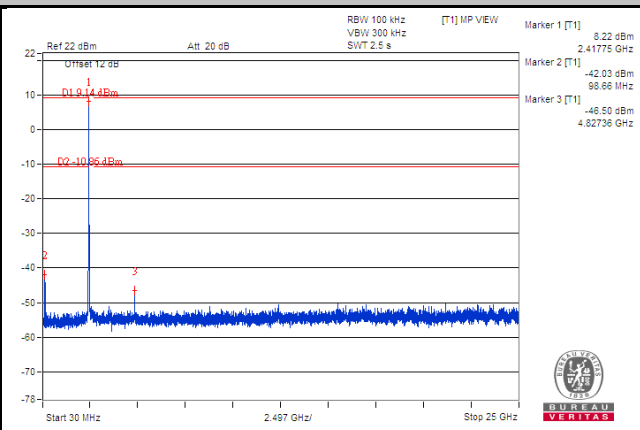
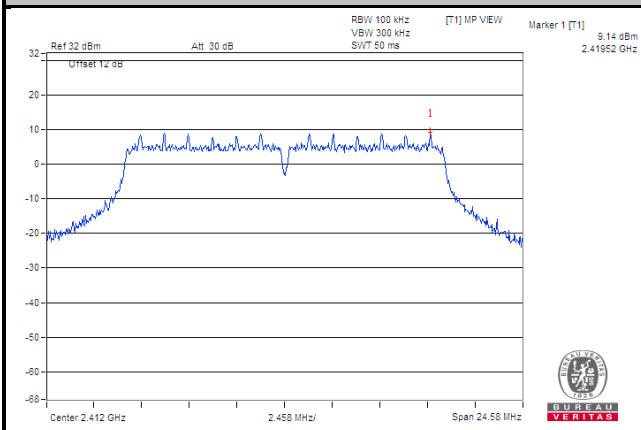

## Ch 6

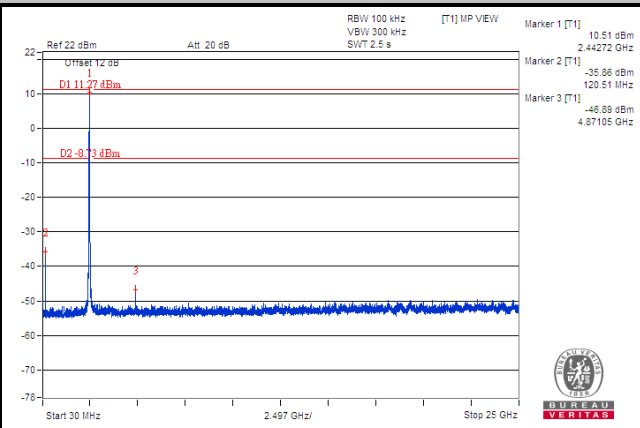
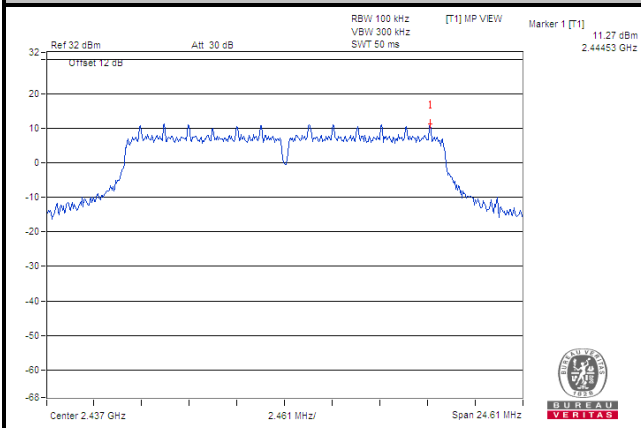

## Ch 11

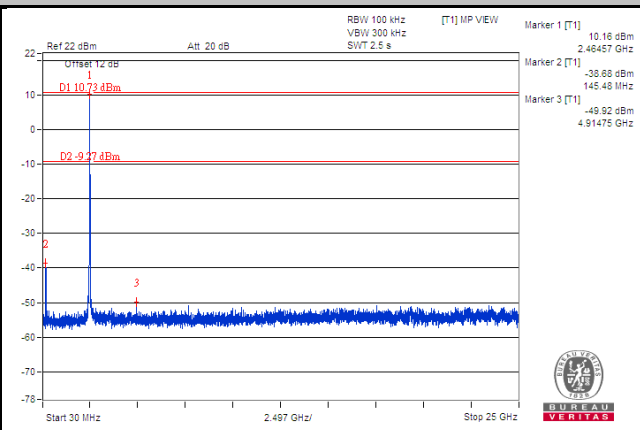
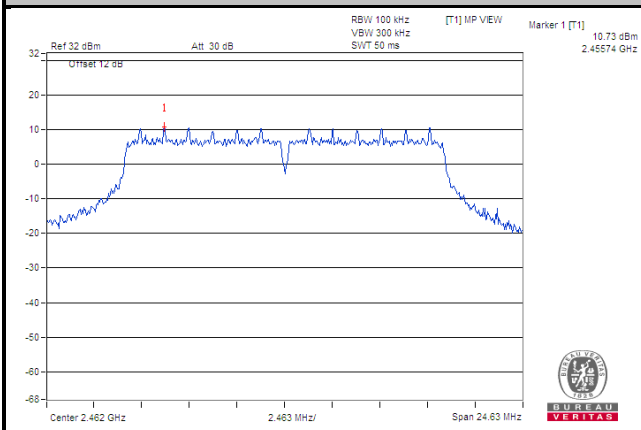

### Ch 1 Band Edge

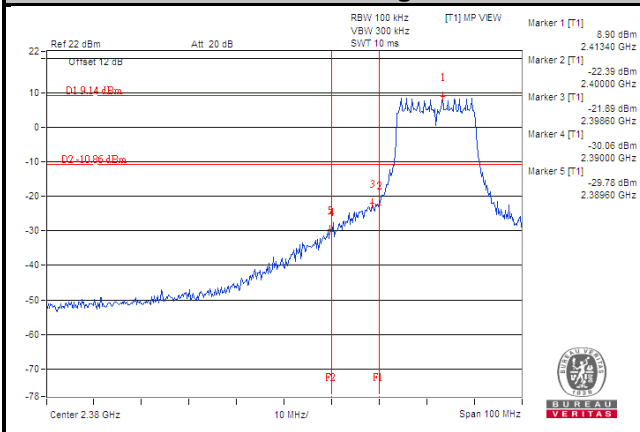

### Ch 11 Band Edge

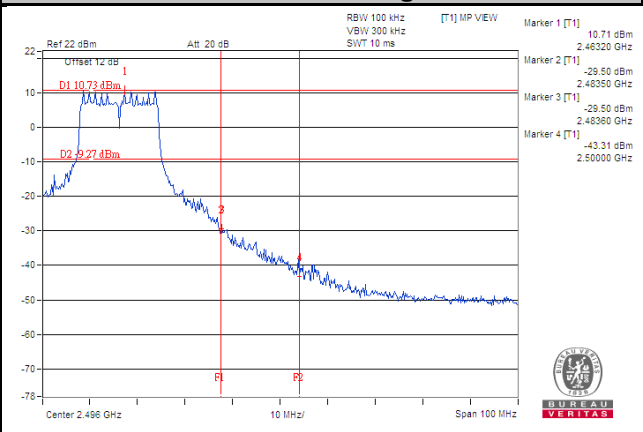

**802.11n (HT20)**  
**CHAIN 0**

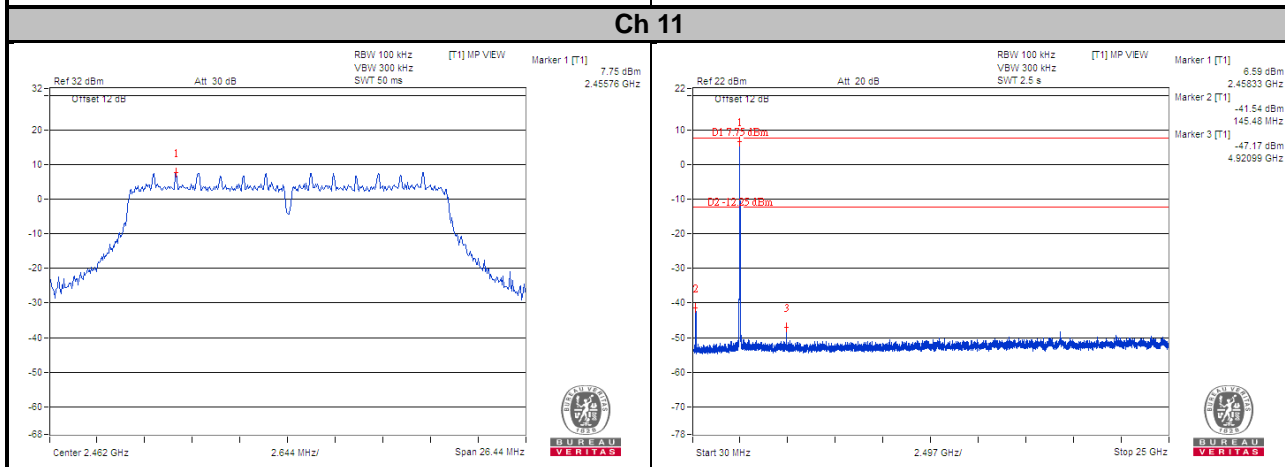
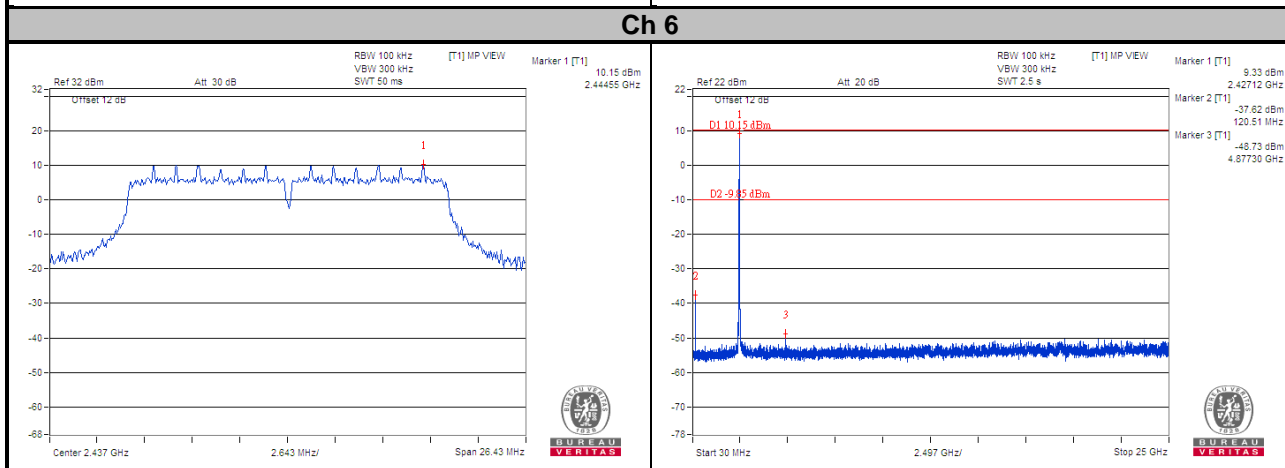
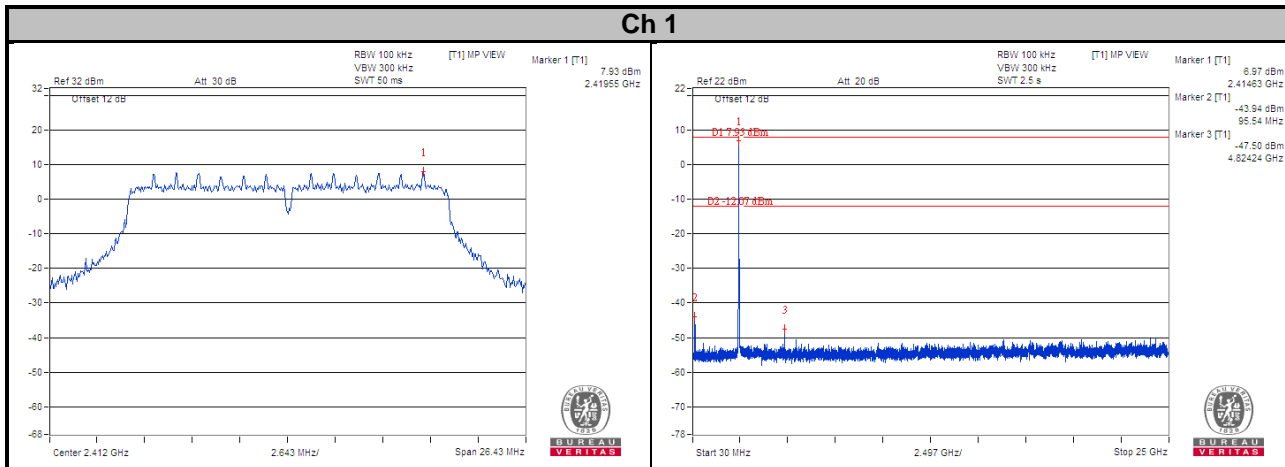

### Ch 1 Band Edge

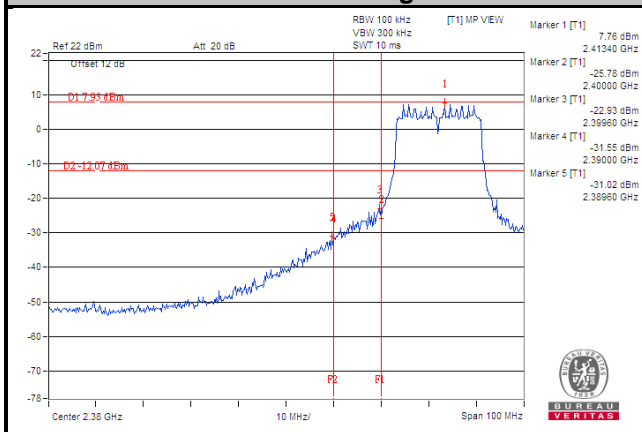

### Ch 11 Band Edge

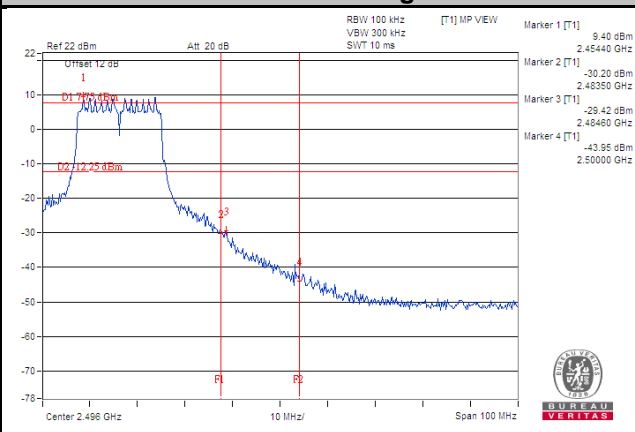

# CHAIN 1

## Ch 1

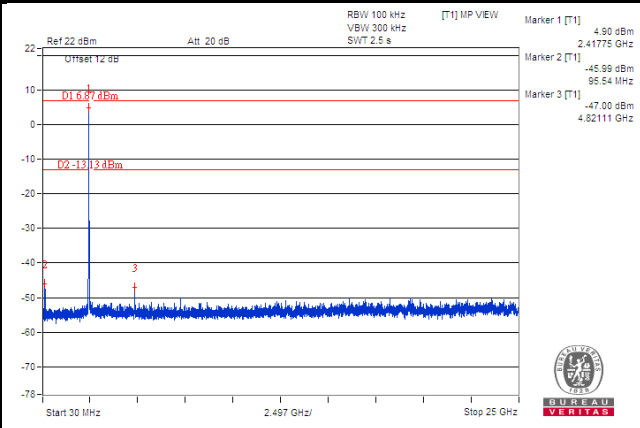
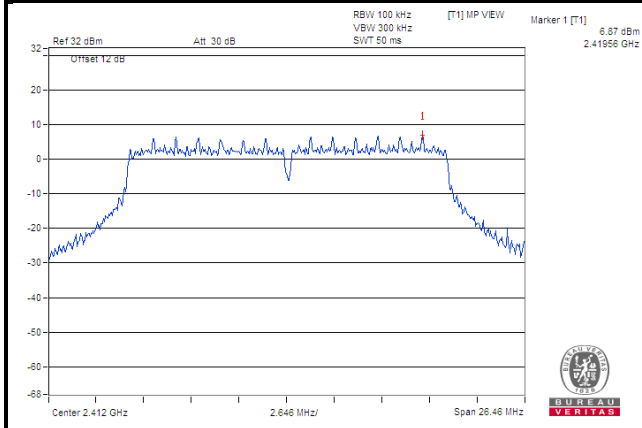

## Ch 6

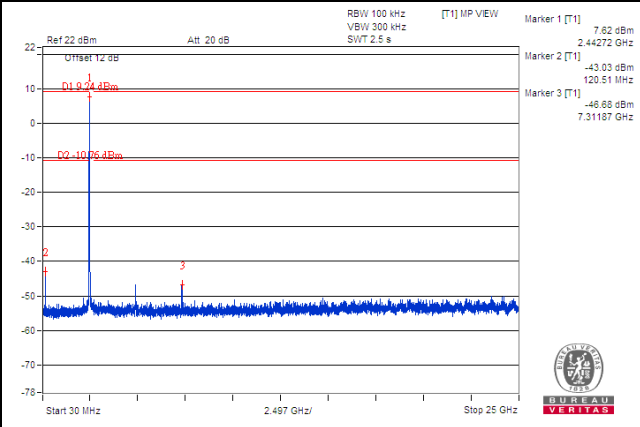
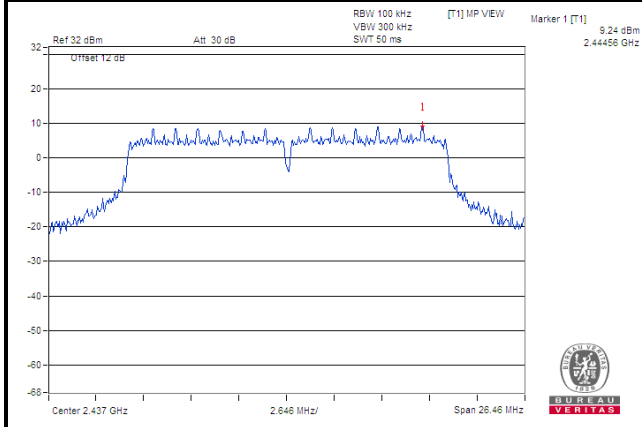

## Ch 11

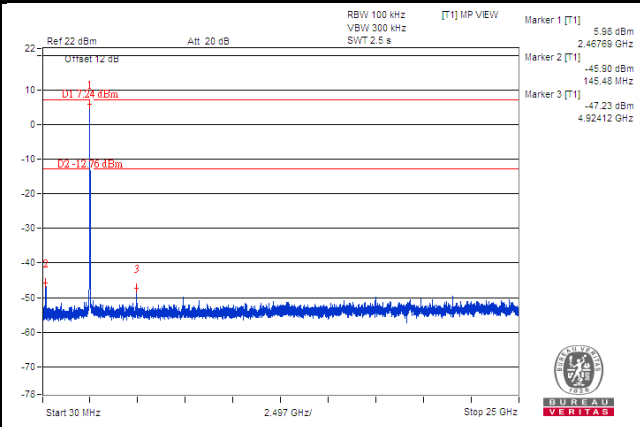
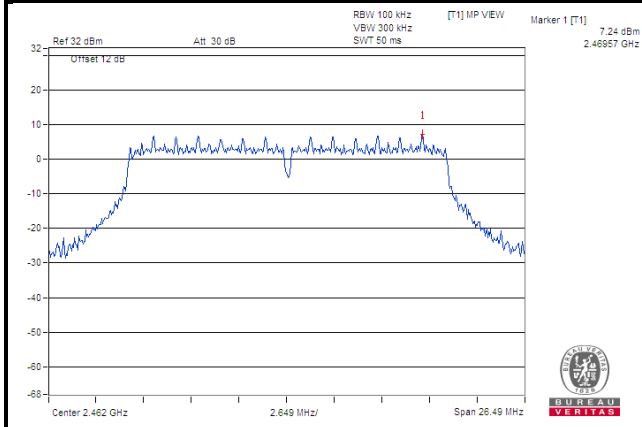

### Ch 1 Band Edge

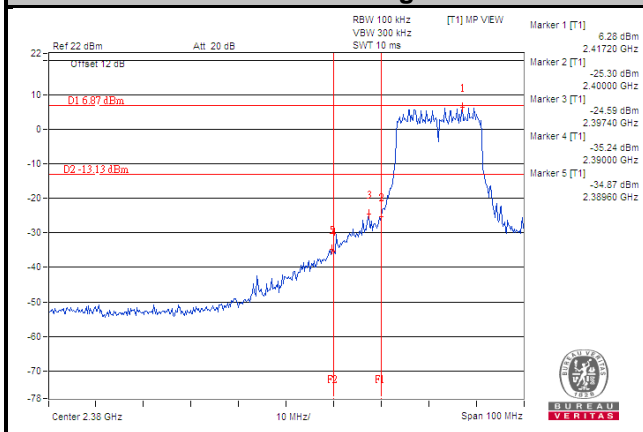

### Ch 11 Band Edge

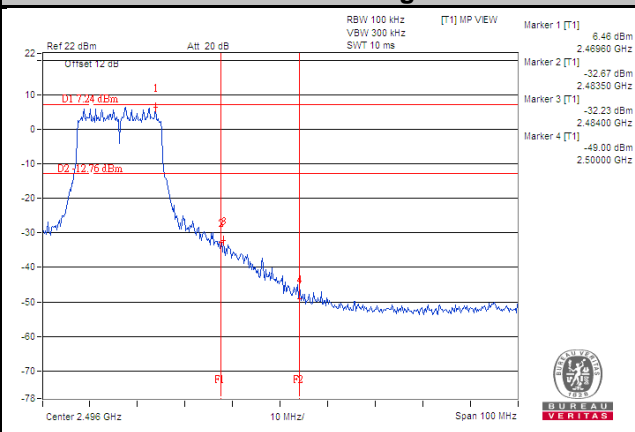

**802.11n (HT40)**  
**CHAIN 0**

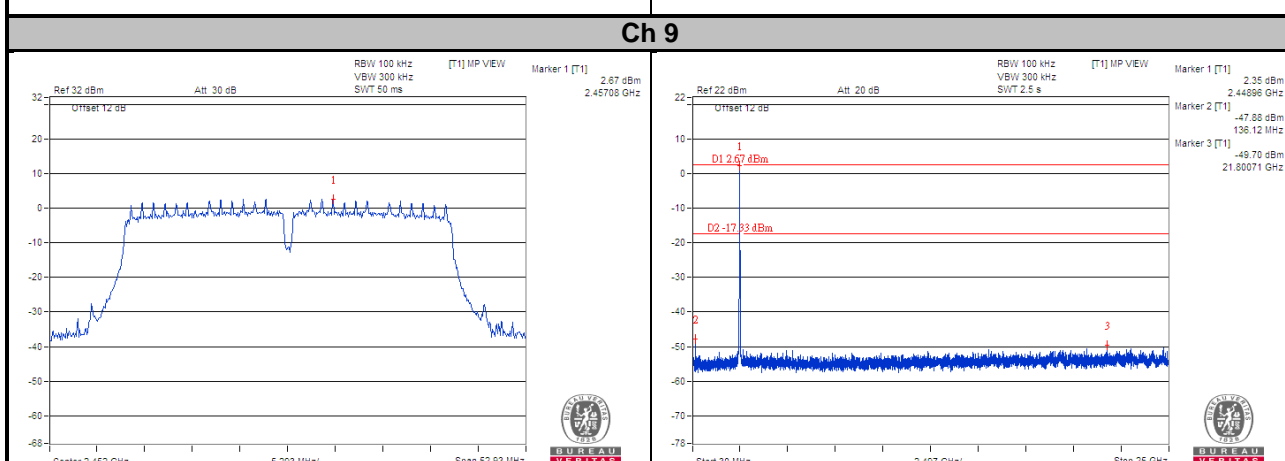
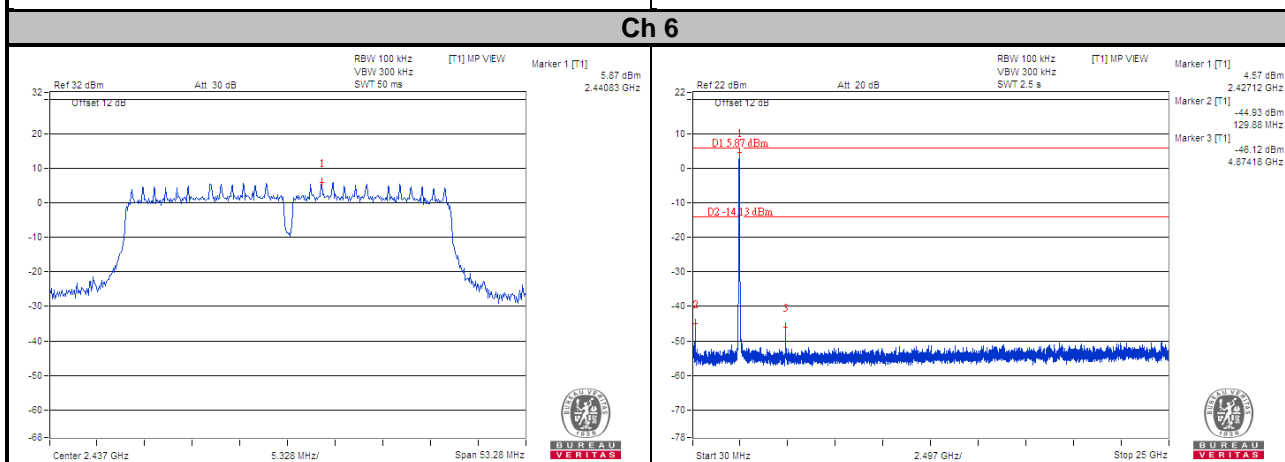
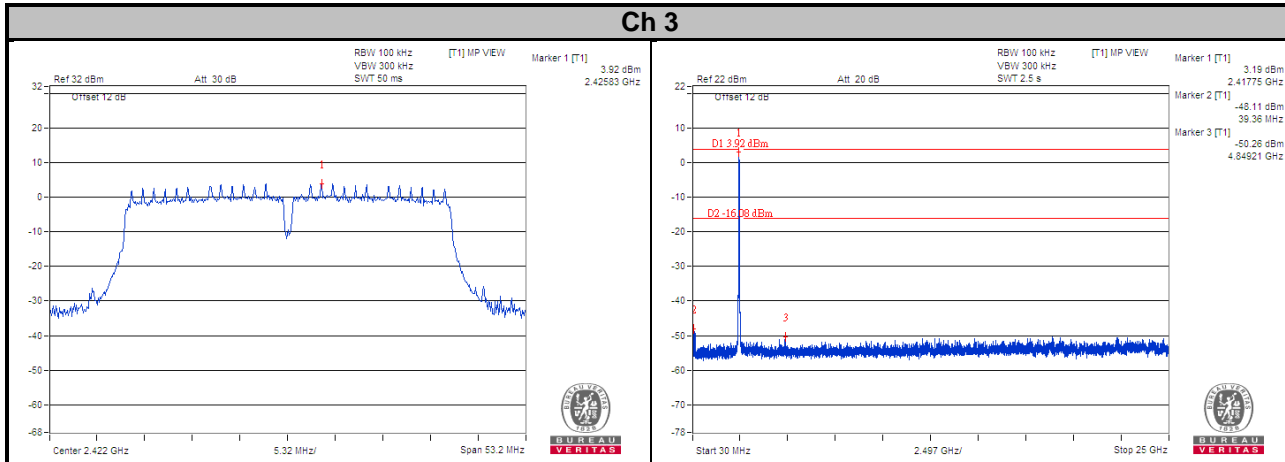



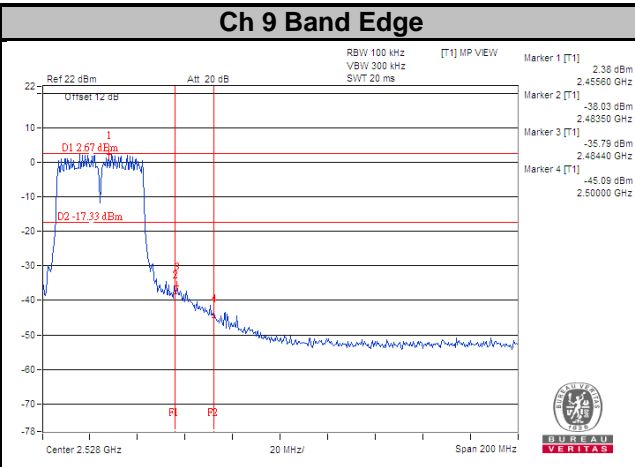
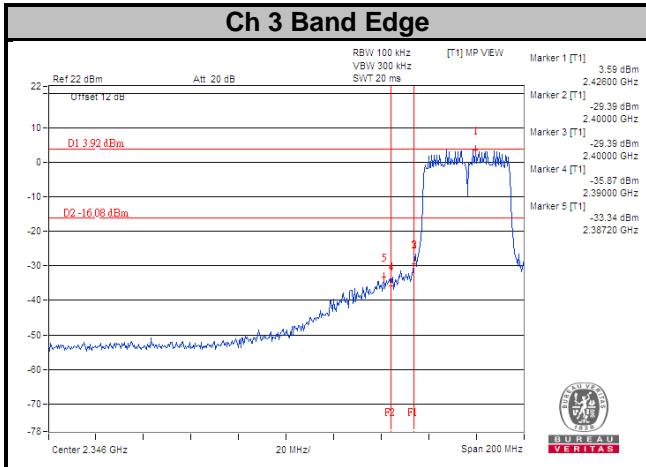

# CHAIN 1

## Ch 3

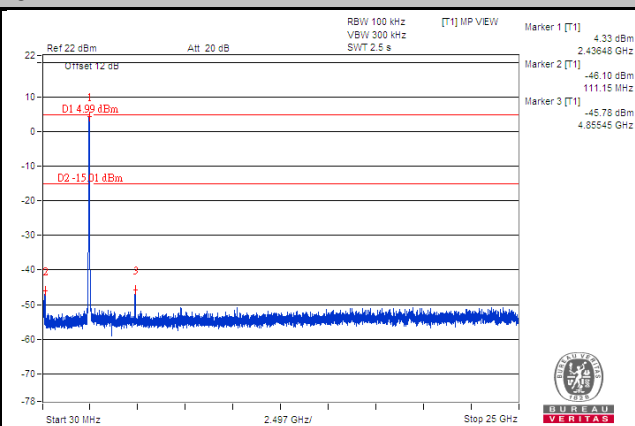
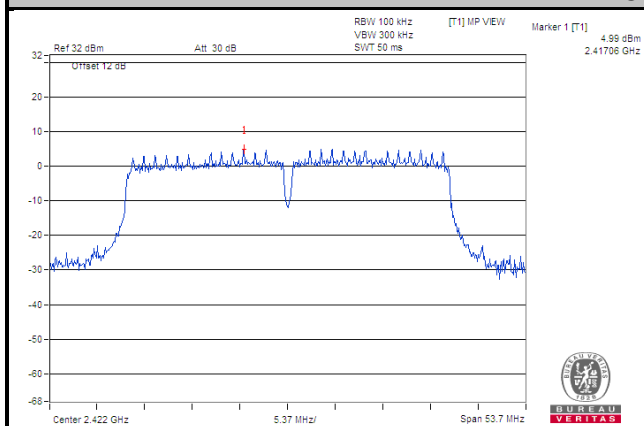

## Ch 6

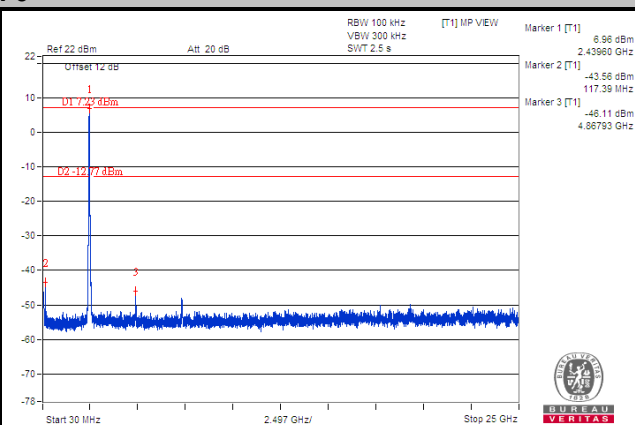
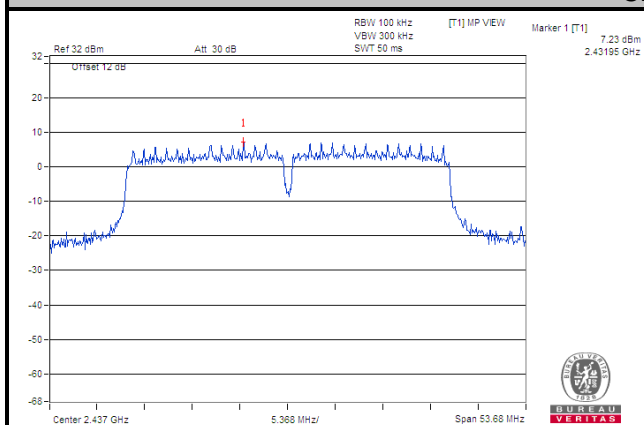

## Ch 9

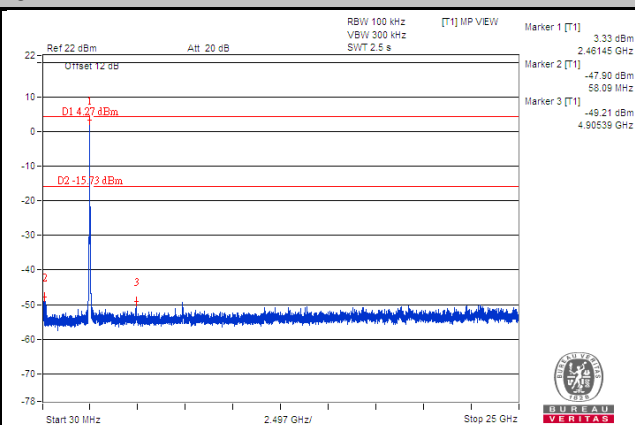
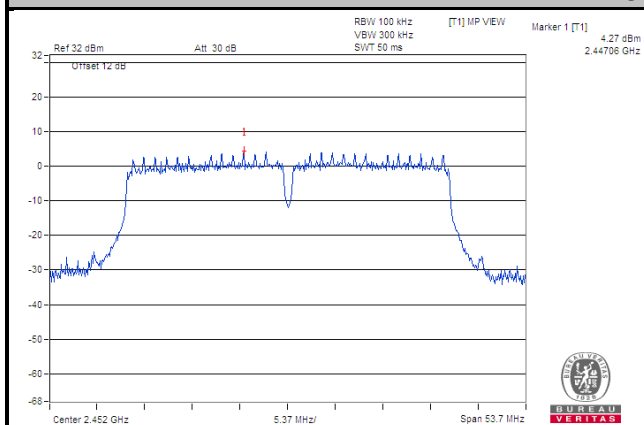

### Ch 3 Band Edge

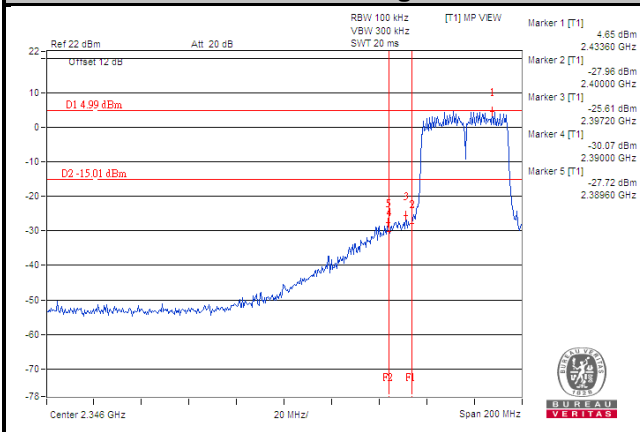

### Ch 9 Band Edge

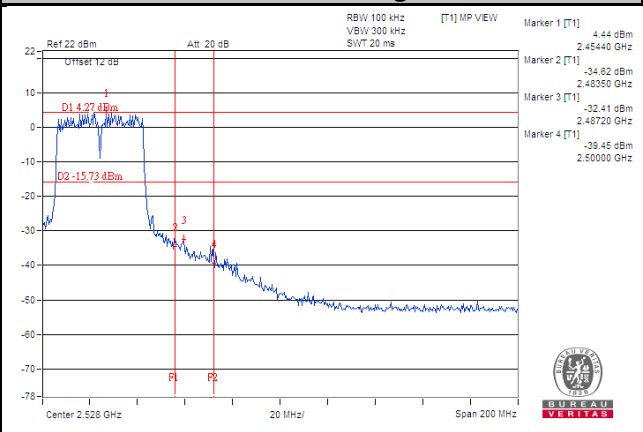

## 5 Pictures of Test Arrangements

Please refer to the attached file (Test Setup Photo).

## Appendix – Information on the Testing Laboratories

We, Bureau Veritas Consumer Products Services (H.K.) Ltd., Taoyuan Branch, were founded in 1988 to provide our best service in EMC, Radio, Telecom and Safety consultation. Our laboratories are FCC recognized accredited test firms and accredited according to ISO/IEC 17025.

If you have any comments, please feel free to contact us at the following:

**Linko EMC/RF Lab**

Tel: 886-2-26052180

Fax: 886-2-26051924

**Hsin Chu EMC/RF/Telecom Lab**

Tel: 886-3-6668565

Fax: 886-3-6668323

**Hwa Ya EMC/RF/Safety Lab**

Tel: 886-3-3183232

Fax: 886-3-3270892

**Email:** [service.adt@tw.bureauveritas.com](mailto:service.adt@tw.bureauveritas.com)

**Web Site:** [www.bureauveritas-adt.com](http://www.bureauveritas-adt.com)

The address and road map of all our labs can be found in our web site also.

--- END ---