

**BEFORE OPERATING THE UNIT, PLEASE READ THIS MANUAL
THOROUGHLY AND RETAIN IT FOR FUTURE REFERENCE**



OWNER'S RECORD

THE MODEL AND SERIAL NUMBERS ARE LOCATED ON THE BOTTOM OF THE UNIT.
RECORD THE SERIAL NUMBER IN THE SPACE PROVIDED BELOW.
REFER TO THESE NUMBERS WHENEVER YOU CALL UPON YOUR DEALER
REGARDING THIS PRODUCT.

CONTENTS

FCC Warning Statement	2
Notes on installation.....	3
Precautions.....	4-5
Control Panel Layout.....	6
Remote Control Layout.....	7
Wiring Diagram	8
Basic Operation	9-10
Radio Operation.....	11
Aux & IPOD Operation	12
Multimedia playing	12-13
Multimedia playing setup	14-17
Replace the battery of IR handset	18
Install the unit	19-20
Specifications	21

FCC Warning Statement

Changes or modifications not expressly approved by the party responsible for compliance could void the user's authority to operate the equipment.

This equipment has been tested and found to comply with the limits for a Class B digital device, pursuant to Part 15 of the FCC Rules. These limits are designed to provide reasonable protection against harmful interference in a residential installation. This equipment generates uses and can radiate radio frequency energy and, if not installed and used in accordance with the instructions, may cause harmful interference to radio communications. However, there is no guarantee that interference will not occur in a particular installation. If this equipment does cause harmful interference to radio or television reception, which can be determined by turning the equipment off and on, the user is encouraged to try to correct the interference by one or more of the following measures:

- Reorient or relocate the receiving antenna.
- Increase the separation between the equipment and receiver.
- Connect the equipment into an outlet on a circuit different from that to which the receiver is connected.
- Consult the dealer or an experienced radio/TV technician for help.

FCC Radiation Exposure Statement

The antennas used for this transmitter must be installed to provide a separation distance of at least 20 cm from all persons and must be located for operating in conjunction with any other antenna or transmitter.

The unit is designed for 12V DC, negative ground operation systems only. Before installing the unit, make sure your vehicle is connected to 12V DC negative grounded electrical system.





The negative battery terminal must be disconnected before making connections, which can prevent damage to the unit from short circuiting.

Be sure to connect the correct speaker to the correct terminal. Never connect the left and right channel speaker cables to each other or to the vehicle body. Do not block vents or radiator panels. Doing so will cause heat to build up and may result in fire.

After completion of installation and replacement of battery, press the reset button on the front panel with a pointed object (such as a ball point pen) to set the unit to its initial status.

Precautions

The unit can play the following discs only

Type of Disc	Label On The Disc	Recorded Material	Size of disc
DVD		Video and Audio	12cm
VCD	VCD	Video and Audio	12cm
CD		Audio	12cm
MPEG4 / DIVX	MPEG4 	Video and Audio	12cm
MP3 / WMA/JPEG	MP3 	Compressed Digital Audio	12cm

Note: The unit is compatible with DVD,DVD+/-R, VCD 1.0/2.0/3.0, SVCD, CD, CD-R, CD-RW and JPEG

- ❗ DO NOT ATTEMPT TO MODIFY THE UNIT, MODIFYING THE UNIT MAY CAUSE AN ACCIDENT.
- ❗ STOP THE VEHICLE BEFORE CARRYING OUT ANY OPERATION THAT COULD INTERFERE WITH YOUR DRIVING
- ❗ DO NOT TURN ON THE UNIT IF THE TEMPERATURE INSIDE THE VEHICLE IS -20C TO 60C
- ❗ THIS PRODUCT IS DESIGNED FOR ONE SINGLE VIDEO OUTPUT, PLEASE USE A SPLITTER IF YOU WOULD LIKE TO CONNECT FOR MULTIPLE VIDEO OUTPUTS



Handle the disc by its edge to keep the disc clean, and do not touch the surface.

Do not use your CDs with paste residue or ink attached.



Do not use CD's with labels or stickers attached. Labels or stickers may leave a sticky residue when peeling off.



Clean the discs with an optional cleaning cloth. Wipe each disc from center out.

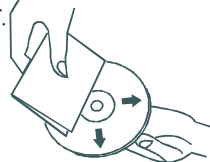

Precautions



WARNING: TO REDUCE THE RISK OF FIRE OR ELECTRIC SHOCK, DO NOT EXPOSE THIS APPLIANCE TO RAIN OR MOISTURE.

CAUTION: TO REDUCE THE RISK OF ELECTRIC SHOCK, DO NOT REMOVE COVER(OR BACK).NO USER SERVICEABLE PARTS INSIDE, REFER SERVICING TO QUALIFIED SERVICE PERSONNEL.



The lightning bolt with arrowhead symbol, within an equilateral triangle, is intended to alert the user to the presence of uninsulated dangerous voltage with in the products enclosure that may be of sufficient magnitude to constitute a risk of electric shock to persons.



The exclamation point within an equilateral triangle in intended to alert user to the presence of important operating and maintenance(servicing) instructions in the literature accompanying the appliance.

CLASS 1 LASER PRODUCT

Laser product symbol: located on the rear panel of the unit, indicate this player is a class laser product, only use weak laser and no hazardous radiation outside of the unit.

- 1.Read through this instruction manual before installation and use.
- 2.Do not touch the power plug with wet hand.
- 3.Switch off the main power when the unit is not in use.(Disconnect the power plug from the power outlet when you do not intend to use the unit for a prolonged period of time.) Before moving the unit, remove the disc from the unit/tray first.
- 4.Do not open the cover or touch any of the components exposed out of the unit, only for qualified technicians.
- 5.Do not expose the unit under direct sunlight or nearby objects that radiate heat to avoid damaging the unit.
- 6.Do not place the unit in moist and humid conditions.
- 7.Place the unit on a flat surface and ventilative condition, Please ensure the ventilation holes are not covered to avoid overheating and malfunction.
- 8.Clear the panel and case with soft dry cloth only, do not apply any kind of thinner, alcohol or sprays.
- 9.The apparatus shall not be exposed to dripping or splashing and that no objects filled with liquids, such as vases, shall be placed on the apparatus.

Control Panel Layout

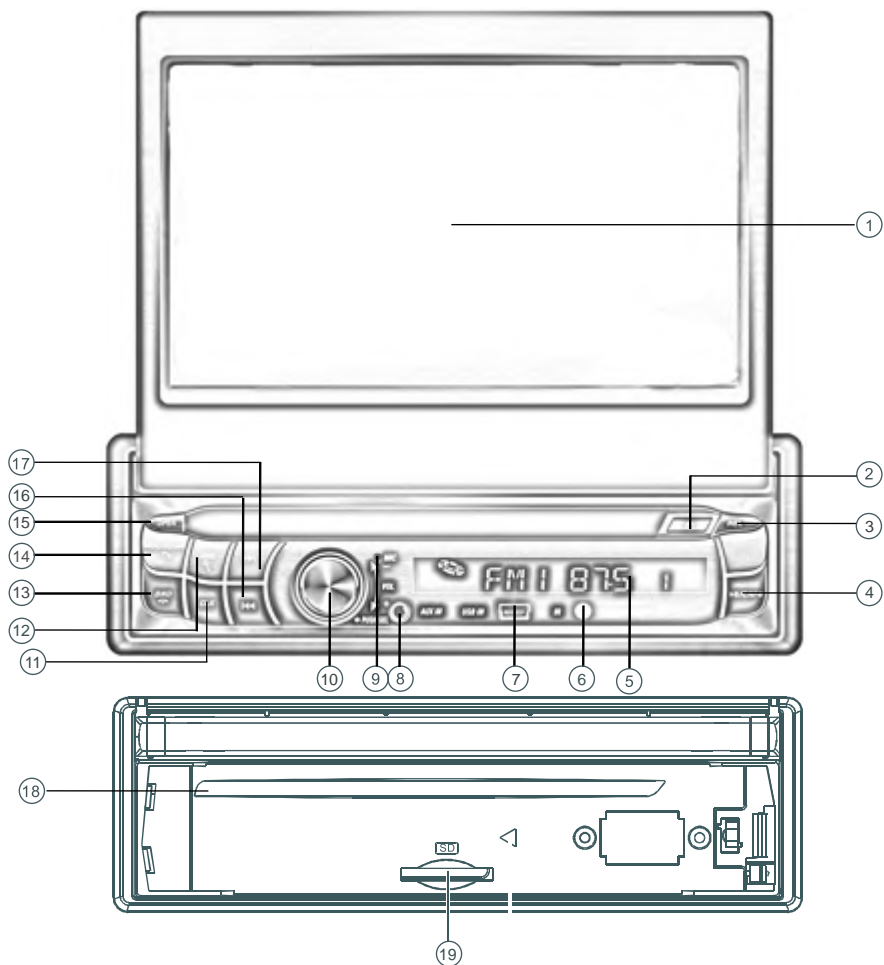

1. TFT-LCD Display

2. EJECT Button

3. Release Key

4. Play/Pause

5. LCD Display

6. IR

7. USB Socket

8. AUX-IN

9. MIC

10. Audio Volume/SEL Button

11. Real Time Clock

12. AMS Button

13. BAND (OFF Phone) Button

14. Power/ON Phone Button

15. OPEN Button

16. Fast Reverse Button/Next Track

17. Fast Forward Button/Previous Track

18. Disc Slot

19. SD Card Slot

Remote Control Layout

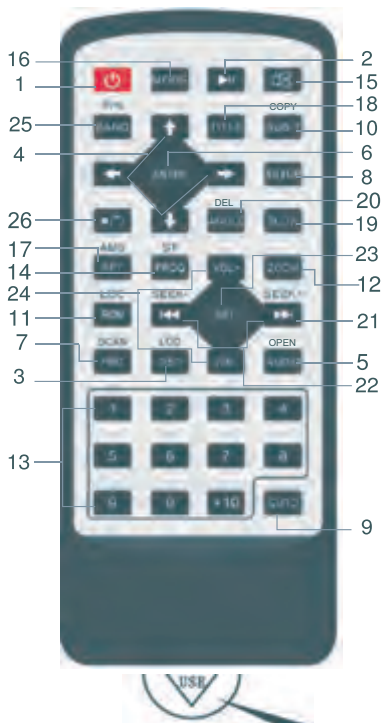

Remove this tab before using the remote control

1. Power On/Off Control
2. Play & Pause Control
3. Play Time Setting Button
4. Directional Keys
5. Audio Steup
6. Select and Enter
7. Play Back Control(VCD)
8. DVD Setup Menu
9. Goto Playing Point
10. DVD Sub Title Select
11. LOC/RDM
12. DVD Zoom Playing
13. Munber Keypad
14. Programed Paying Setting
15. Sound Mute Control
16. Mode Selector
17. Disc/Track Repeat Control/AMS
18. DVD Title Menu
19. DVD Slow Playing
20. DVD Angle Playing
21. Fast Forward/Rewind Control
22. Tuning / Track Select Control
23. Audio Control & Function Selector
24. Volume Control
25. Video System Select(P/N)
26. Stop Mode

Note

Printings & symbols on the above drawing of remote control handset apply to various version of the unit and some keys are not valid for operation. Refer to the unit for features and functions.

Wiring Diagram

AUTO MULTI-MEDIA PLAYER

CAUTION:

DC Power:12V

Speaker Impedance:4Ω

RECEIVING:
RANGE:

AM 530-1710KHz
FM 87.5-107.9MHz

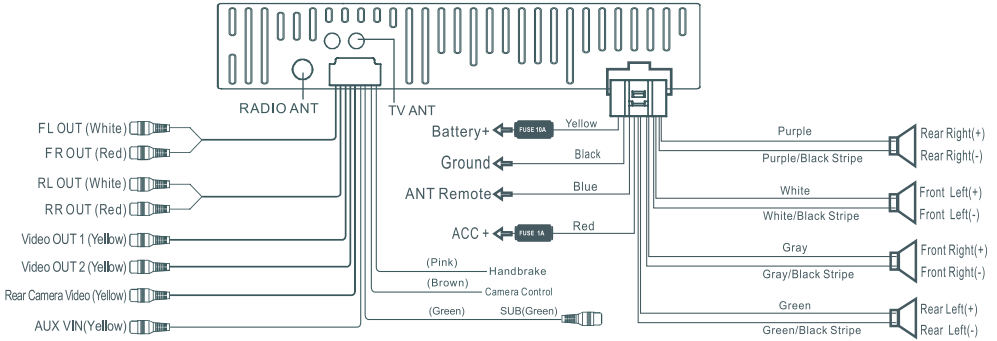

BASIC OPERATION

Initial System Starts Up

Operating the unit for the first time or after replacing the car battery, Press **RESET** button with a pointed object (such as a ballpoint pen) to set the unit to its initial procedure.

NOTE: When some errors occur in the LCD display, you can also press **RESET** button to resume to normal. it will erase the clock setting and some memorized functions.

Turning the Unit ON/OFF

Press **POWER** button to turn on the unit. When the unit is on:

Short press **POWER** button, turn off the monitor, press **POWER** button again to turn on the monitor.

Long press **POWER** button to turn off the unit.

Volume Control

Press **VOLUME +/-** button to increase or decrease the sound volume.

Mute Function

Press Remote Control **MUTE** button shortly to cut down the sound output, The "MUTE" icon will appear in the LCD display. Press it again to restore previous volume level.

Viewing Angle

Long Press the button "OPEN" on the front Panel or repeatedly on the remote control to adjust the angle view.

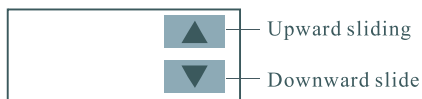

Touch screen Calibrate

If the touch screen calibration is off, access the touch screen calibrate mode interface to calibrate.

Click the icon  to access the touch screen calibrate mode interface; Long Press the remote control to access the "6" Setting on the mode interface.

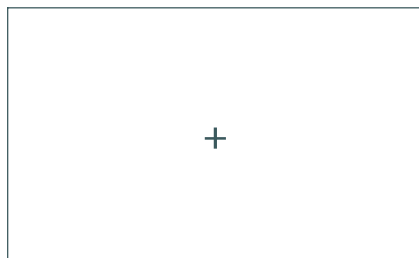

Aim at the "+" and tap it, the symbol will moves around the touch screen, tap it six times, system will finish calibration automatically and exit calibration mode.

Menu Function

Press **MENU** button. Main menu display screen will appear. Touch icons to enter different working modes.



BASIC OPERATION

Setting the general & display & audio setup

Touch  icon in the screen to enter setting mode, as shown below. You can touch the screen to set up the audio, display, time parameters etc.

General Setup

This item is for General Setup.

1. Select time format (12-hour or 24-hour).
2. ON/OFF Beep.



Display Setup

This item is for Selecting a Display.

You can adjust each item by pressing the icon ◀ or ▶ in the touch screen.

- Brightness: 00~50
- Color: 00~50
- Saturation: 00~50

Click the icon “     ” to access the System Default setup .



Audio Setup

This item is for Selecting a Audio.

You can adjust each item by pressing the icon ◀ or ▶ in the touch screen.

- BASS: -7 / +7
- TREBLE: -7 / +7
- LOUD: ON/OFF

-Click the “Left/Right ”to access the Balance Setup.

-Click the “Front/Rear ”to access the Fader Setup.

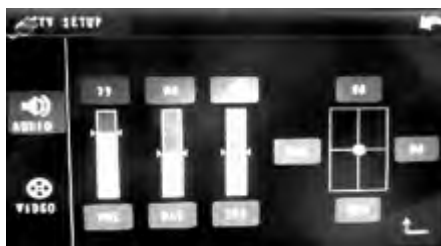
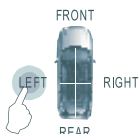

Click the icon “      ” to access the EQ setup .

After finishing setup , click the icon  to exit the menu setup interface.

IR Sensor

Receiver for wireless IR remote control.

Radio Operation

1. Touch the radio icon in the main menu display screen to select radio mode .The LCD will display as following:



2. Touch the icon “BAND” repeatedly to select bands in the following:



3. Touch the icon “APS” or press **[APS]** key in IR handset shortly to activate automatic memory storing function.
4. Press **[SEEKING+]** or **[SEEKING-]** or icon ◀ / ▶ shortly to manually seek the radio station
5. Long press **[SEEKING+]** or **[SEEKING-]** or icon ◀ / ▶ to automatically seek the radio station
6. Touch the frequency bar in the display screen to select preset memory station.
7. Long press icon “APS” to scan each preset memory station for 10Seconds.
8. Touch the icon “ST” or Press ST key in IR handset to set stereo or mono receiving mode.
9. During radio mode, repeat press SEL button to select the desired mode in the following order:



After finishing setup , click the icon  to exit the menu setup interface.



AUX & IPOD Operation

AV-IN Operation

1. Press the icon  to enter main menu display screen.
2. You can touch icon “AV-IN” to switch to your desired av-in mode.

Multimedia Playing

Playing USB storage device and SD Card

To enjoy the music and video in your SD card and USB storage device, insert USB and SD card into the slot, unit Will play automatically. press **[MENU]** button and touch the media icon  or  to switch to Play USB storage or SD card.

Pause the playing

Touch the icon  to pause the playing, touch it again to restore playing.

Playing the next /previous chapter

Touch the icon  or  shortly to skip to the next or previous chapter.

Fast forward or rewind playing

Long touch the icon  or  to fast forward or rewind the disc.

Repeat playing

Touch the icon “RPT” to play one track repeatedly, Press **[RPT]** key in IR handset to play the track repeatedly.

Stop the playback

Press **[STOP]** key in IR handset to suspend the playback, press it again to stop the playback.

Multi-angle selector

Press **[ANGLE]** key in IR handset to watch the DVD content from different angles if supported by disc.

Go to Title

Press **[TITLE]** key in IR handset to show all track titles on screen. Then press nbr keys or arrow keys to choose your desired track nbr and press **[ENTER]** key or **[PLAY/PAUSE]** key to start.

Random Playing

Touch the icon “RDM” or Press **[RDM]** key in IR handset to play any track randomly.

On Screen Display

Press **[OSD]** key in IR handset. The screen will display Track/Chapter nbr, current playing time etc.

Program Playing

Press **[PROG]** key in IR handset to enter programming page, press arrow key and number key in IR handset to program the tracks to be played.

Multimedia Playing

Audio selector

Repeatedly press **AUDIO** key in IR handset to change the different audio track mode.

Subtitle selector

Press **SUB-T** key in IR handset to select language.

Setting Disc playback time

Press **GOTO** key in IR handset to set the specific time to play, use arrow keys and number keys to set track/chapter on time, and press **ENTER** key to play.

Multimedia Playing Setup (enter setup mode)

Enter setup model

1. Press **SETUP** key in IR handset in the stop mode when playing multimedia.
2. The main page of setup menu is displayed.



3. Select the preferred item by using the arrow keys
4. Press **ENTER** key to confirm setting.

Multimedia Playing Setup (system setup menu)

System Setup

The setup page includes TV system, screen saver, TV type, password, rating & default features

TV system setup menu

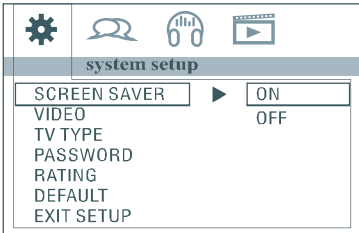

This player can play discs recorded in either PAL or NTSC format. Select NTSC format when you are connected to NTSC TV. Select PAL format when you are connected to PAL TV. If you select AUTO, the unit will auto select the format (PAL/NTSC) according to your disc content.

Video Setup Menu

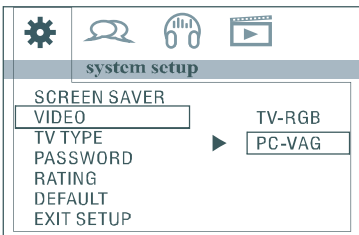

TV Type Setup Menu

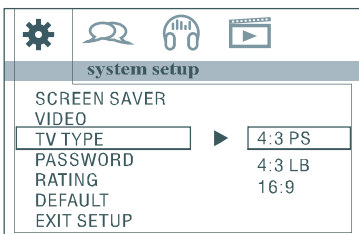

1. 4:3 PS

Playback in the PAN & SCAN style. (If connected to wide-screen TV, the left and right edges are cut off)

2. 4:3 LB

Playback in LETTER BOX style. (If connected to wide-screen TV, black bands appear at top and bottom of the screen).

3. 16:9

Select when a wide-screen TV set is connected.

Password Setup Menu

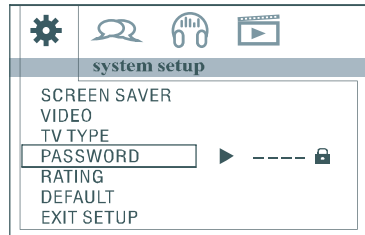

Enter the password and press ENTER button. Type the old password (The initial factory code is 0000) Enter the 4 character password that you want to use . Type again to confirm password.

Multimedia Playing Setup (system setup and language setup menu)

Rating setup menu

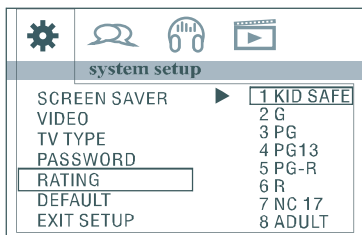

Select suitable guidance rating using the cursor buttons and confirm by pressing ENTER key.

Rating 1: [KIDSAFE]

Select this for kid-safe viewing programs.

Rating 2: [G]

Select this to allow admission to persons of all ages.

Rating 3: [PG]

Select following when children under 13 are forbidden to view

Rating 4: [PG13]

Select following when children under 13 are forbidden to view.

Rating 5: [PG-R]

Select this when PG-R is printed on the DVD disc.

Rating 6: [R]

Select this when children under 17 are forbidden to view.

Rating 7: [NC 17]

Select this when children under 17 are forbidden to view.

Rating 8: [ADULT]

Select this to only allow admission to all adults.

Default setup menu

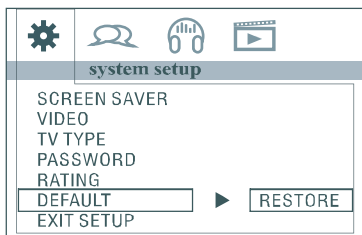

Select restore to restore initial factory settings.

Language Setup

This setup page includes OSD language, Audio language, Subtitle Language and Menu Language features.

OSD Language Setup

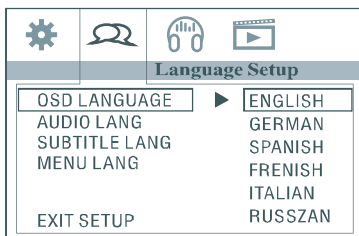

Audio Language Setup

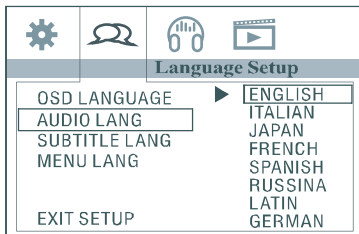

Subtitle Language Setup

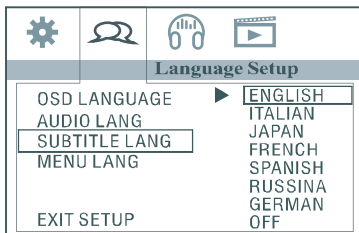

Menu Language Setup

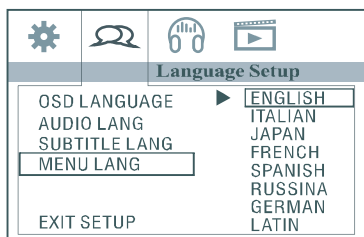

Key Setup Menu

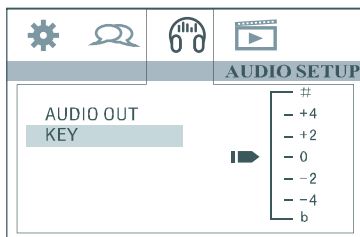

AUDIO SETUP

This setup page includes all the items for AUDIO.

Audio Out Setup

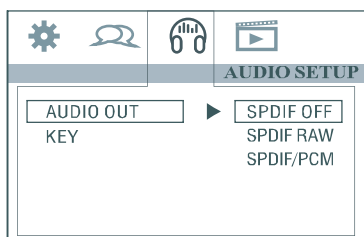

This is to activate the audio output from SPDIF OFF mode to SPDIF RAW mode or SPDIF PCM mode.

SPDIF OFF:

Analog or optical output port has no output signal at all.

SPDIF RAW:

When the player is connected with the power amplifier by the analog or optical port, please select this item when the playing disc is recorded in Dolby Digital, DTS or MPEG. The analog or optical output signal of the unit will be the same as the digital signal (RAW format) of the playing disc. The power amplifier function must be set as Dolby Digital, DTS or MPEG.

SPDIF PCM:

Select this when the player is connected with the 2 channels, digital stereo amplifier. If the disc is recorded in Dolby Digital or MPEG, the analog/optical output will be modulated to 2 channels.

This is to select Treble or Bass according to your needs.

This is for the user to set Brightness, Contrast, Hue and Saturation of the picture by pressing the left/right arrow buttons.

Press ENTER key to confirm the change.

NOTE: Video Setup is only available in TV/AV mode.

VIDEO SETUP

This setup page includes all the items for VIDEO.

Brightness Setup Menu

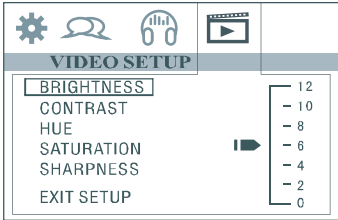

Contrast Setup Menu

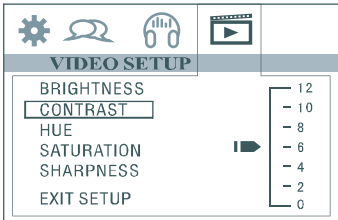

HUE Setup Menu

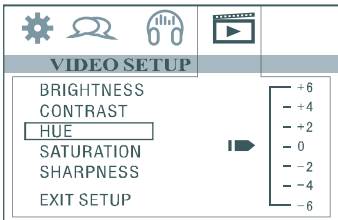

Saturation Setup Menu

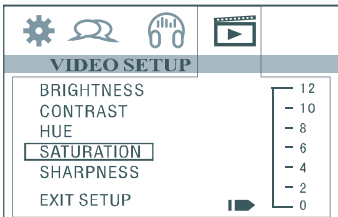

Sharpness Setup Menu

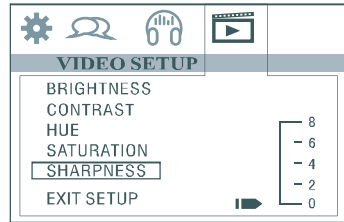

Replace the Battery of IR Handset

Replace the Battery

When the operational range of the remote control becomes short or non-functional, replace battery with a new CR2025 battery. Check the battery polarity before replacement.

1. Pull out the battery holder while pressing the stopper 1.

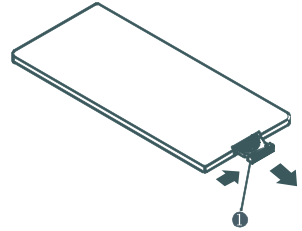

2. Place battery with (+) mark facing up into the battery holder.

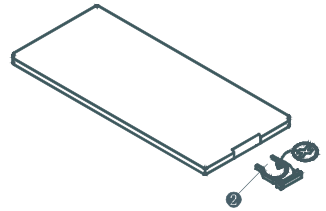

3. Insert the battery holder into the remote controller.

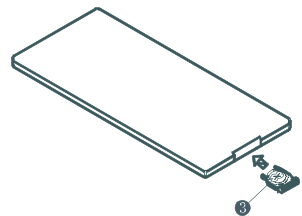

Install the unit (DIN front mount)

DIN FRONT-MOUNT (method A)

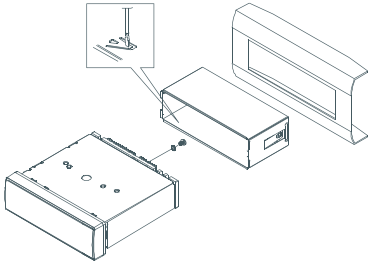

Installing the Unit

1. Dashboard
2. Holder

After inserting the holder into the dashboard, select the appropriate tab according to the thickness of the dashboard material and bend them inwards to secure the holder in place.

3. Screw

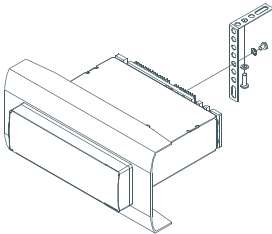

1. Dashboard
2. Nut (5mm)
3. Plain washer
4. Screw (5x25mm)
5. Screw
6. Strap

Be sure to use the strap to secure the back of the unit in place. The strap can be bent by hand to the desired angle.

7. Plain Washer

Remove the Unit

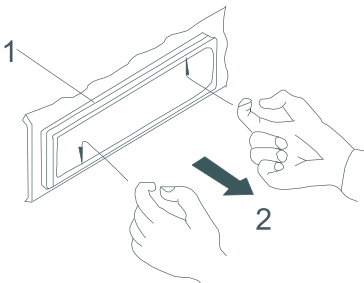

1. Frame

2. Insert fingers into the groove in the front of frame and pull out to remove the frame. (When reattaching the frame, point the side with a groove downwards and attach it.)

3. Lever

Insert the levers supplied with the unit into the grooves at both sides of the unit as shown in figure until they click. Pulling the levers makes it possible to remove the unit from the dashboard.

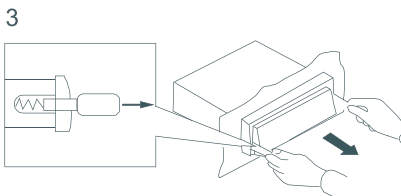

Install the unit (DIN rear mount) & Install and remove the front panel

DIN REAR MOUNT (method B)

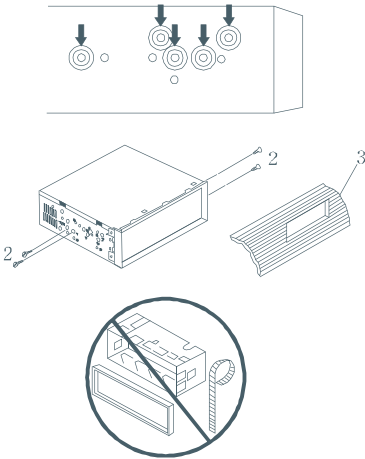

Installation using the screw holes on the sides of the unit.

Fastening the unit to the factory radio mounting bracket:

1. Select a position where the screw holes of the bracket and the screw holes of the main unit become aligned (are fitted) and tighten the screws at 2 places on each side. Use either truss screws (5x5 mm) or flush surface screw (4x5 mm).

2. Screw ("T" Position).

3. Dashboard or Console.

NOTE:

The mounting box, outer trim ring, and half-sleeve are not used for method B installation.

Install and Remove the Front Panel

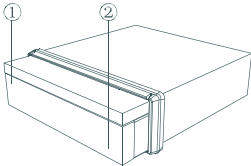

Remove the front panel

Press "PWR" button in the upper left corner .

Please see picture ① .

Press "REL" button in the and the pull it out.

Please see picture ② .

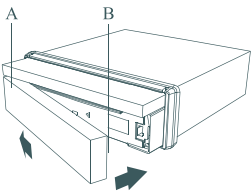

Install the front panel

Put notch A (shown as picture) onto buckle B, and then slightly press into the right side.

Please see picture

NOTE:

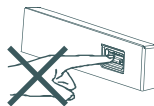
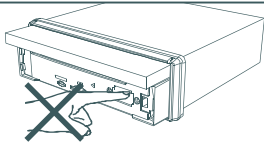

Please don't insert finger in control panel. If connector is dirty, use a clean soft cloth to wipe it clean.

Specification

General

Operating Current:	600MA
Operating Voltage:	DC:10V-15.7V
Max. Power Output:	45W x 4CH
Rated Power:	1W
Dimensions:	Approx. 182 x 160 x 53mm (D x W x H)
Mounting Dimensions:	Approx. 160 x 180 x 50mm (D x W x H)
Signal Amplitude:	1V
Remote Contro:	IR/IR Receiver
POWER IC:	TDA7388
Decoding IC:	SHE8202TQ
Screen drive IC:	MST-703
Colour:	Black Front Panel / White Text Printing Button / Yellow Text Printing

Multi Media Deck Section

Disc played:	Multi Media
Video System:	Auto/PAL/NTSC
Mounting Angle:	0 ~ 30 degree
Viewing Angle :	60/60/40/60(TYP)
Operating Temperature :	+50-20°
Storage Temperature :	+80-40°

Video Section

Screen Size:	164.9MM(W)x100(H)x5.7MM(D) 7" Colour Screen
Viewing Angle :	60/60/40/60(TYP)
Screen Resolution:	480(W)x3(RGB)x234(H)
Screen Brightness:	350cd/m2

Audio Section

RCA Maximum Output :	520MV
Frequency Response:	20Hz ~ 20KHz
Signal to Noise ratio:	85dB
Separation:	80dB
AUX Input :	750MV

FM Tuner Section

Tuning Range:	87.5 ~ 107.9MHz
IF Range:	10.7MHz
Usable Sensitivity (-30dB):	12dBu
Signal to Noise ratio:	60dB
Stereo Separation:	30dB (1KHz)
Frequency Response:	30 ~ 15KHz

AM Tuner Section

Frequency Range:	530 ~ 1710KHz
IF Range:	450KHz
Usable Sensitivity (-20dB):	25dBu

NOTE: Due to continuous product improvement, specifications and design will change without notice.

* This feature is optional, please refer to unit. Under compressed motion pictures , file name under extension file can be played back.

iPod®, iPhone®, iPad®, Mac™ are registered trademarks of Apple Computer Inc. This Product is not Designed, Manufactured, Licensed or Distributed by Apple Computer Inc. All other Trademarks & Trade Names belong to their respective owners.