



FCC RF Test Report

APPLICANT : Lyve Minds, Inc.
EQUIPMENT : Set Top Box
BRAND NAME : Lyve
MODEL NAME : BPH01
MARKETING NAME : LyveHome
FCC ID : 2ABQW-BPH
STANDARD : FCC Part 15 Subpart C §15.247
CLASSIFICATION : (DSS) Spread Spectrum Transmitter

The product was received on Feb. 13, 2014 and testing was completed on Mar. 17, 2014. We, SPORTON INTERNATIONAL INC., would like to declare that the tested sample has been evaluated in accordance with the procedures and shown to be compliant with the applicable technical standards.

The test results in this report apply exclusively to the tested model / sample. Without written approval of SPORTON INTERNATIONAL INC., the test report shall not be reproduced except in full.

Reviewed by: Joseph Lin / Supervisor

Approved by: Jones Tsai / Manager



SPORTON INTERNATIONAL INC.

No. 52, Hwa Ya 1st Rd., Hwa Ya Technology Park, Kwei-Shan Hsiang, Tao Yuan Hsien, Taiwan, R.O.C.

SPORTON INTERNATIONAL INC.
TEL : 886-3-327-3456
FAX : 886-3-328-4978
FCC ID : 2ABQW-BPH

Page Number : 1 of 73
Report Issued Date : Apr. 02, 2014
Report Version : Rev. 01



TABLE OF CONTENTS

REVISION HISTORY..... 3

SUMMARY OF TEST RESULT 4

1 GENERAL DESCRIPTION..... 5

 1.1 Applicant..... 5

 1.2 Manufacturer..... 5

 1.3 Feature of Equipment Under Test..... 5

 1.4 Product Specification of Equipment Under Test..... 6

 1.5 Modification of EUT 6

 1.6 Testing Site..... 6

 1.7 Applied Standards 7

2 TEST CONFIGURATION OF EQUIPMENT UNDER TEST..... 8

 2.1 Descriptions of Test Mode..... 8

 2.2 Test Mode..... 9

 2.3 Connection Diagram of Test System..... 10

 2.4 Support Unit used in test configuration and system..... 11

 2.5 EUT Operation Test Setup 11

 2.6 Measurement Results Explanation Example..... 11

3 TEST RESULT 12

 3.1 Number of Channel Measurement 12

 3.2 Hopping Channel Separation Measurement 14

 3.3 Dwell Time Measurement..... 21

 3.4 20dB and 99% Bandwidth Measurement 24

 3.5 Peak Output Power Measurement 37

 3.6 Conducted Band Edges Measurement 39

 3.7 Conducted Spurious Emission Measurement 46

 3.8 Radiated Band Edges and Spurious Emission Measurement 56

 3.9 AC Conducted Emission Measurement..... 67

 3.10 Antenna Requirements..... 71

4 LIST OF MEASURING EQUIPMENT..... 72

5 UNCERTAINTY OF EVALUATION..... 73

APPENDIX A. SETUP PHOTOGRAPHS



REVISION HISTORY

REPORT NO.	VERSION	DESCRIPTION	ISSUED DATE
FR421348A	Rev. 01	Initial issue of report	Apr. 02, 2014



SUMMARY OF TEST RESULT

Report Section	FCC Rule	IC Rule	Description	Limit	Result	Remark
3.1	15.247(a)(1)	RSS-210 A8.4(2)	Number of Channels	≥ 15Chs	Pass	-
3.2	15.247(a)(1)	RSS-210 A8.1(b)	Hopping Channel Separation	≥ 2/3 of 20dB BW	Pass	-
3.3	15.247(a)(1)	RSS-210 A8.1(d)	Dwell Time of Each Channel	≤ 0.4sec in 31.6sec period	Pass	-
3.4	15.247(a)(1)	RSS-210 A8.1(a)	20dB Bandwidth	NA	Pass	-
3.4	-	RSS-Gen 4.6.1	99% Bandwidth	-	Pass	-
3.5	15.247(b)(1)	RSS-210 A8.1(b)	Peak Output Power	≤ 125 mW	Pass	-
3.6	15.247(d)	RSS-210 A8.5	Conducted Band Edges	≤ 20dBc	Pass	-
3.7	15.247(d)	RSS-210 A8.5	Conducted Spurious Emission	≤ 20dBc	Pass	-
3.8	15.247(d)	RSS-210 A8.5	Radiated Band Edges and Radiated Spurious Emission	15.209(a) & 15.247(d)	Pass	Under limit 11.93 dB at 2483.500 MHz
3.9	15.207	RSS-Gen 7.2.4	AC Conducted Emission	15.207(a)	Pass	Under limit 12.70 dB at 0.262 MHz
3.10	15.203 & 15.247(b)	RSS-210 A8.4	Antenna Requirement	N/A	Pass	-



1 General Description

1.1 Applicant

Lyve Minds, Inc.

10001 N. De Anza Blvd, Ste 300 Cupertino, CA 95014

1.2 Manufacturer

FIH Mobile Limited

No. 4, Mingsheng St., Tu-Cheng Dist., New Taipei City 23679, Taiwan

1.3 Feature of Equipment Under Test

Product Feature	
Equipment	Set Top Box
Brand Name	Lyve
Model Name	BPH01
Marketing Name	LyveHome
FCC ID	2ABQW-BPH
EUT supports Radios application	WLAN 11a/b/g/n (HT20/HT40) WLAN 11ac (VHT20/VHT40/VHT80) Bluetooth v2.1 + EDR Bluetooth v4.0 + LE
HW Version	DVT
SW Version	V0.150
EUT Stage	Production Unit

Remark: The above EUT's information was declared by manufacturer. Please refer to the specifications or user's manual for more detailed description.

1.4 Product Specification of Equipment Under Test

Product Specification subjective to this standard	
Tx/Rx Frequency Range	2402 MHz ~ 2480 MHz
Number of Channels	79
Carrier Frequency of Each Channel	2402+n*1 MHz; n=0~78
Maximum Output Power to Antenna	Bluetooth BR(1Mbps) : 7.63 dBm (0.0058 W) Bluetooth EDR (2Mbps) : 6.43 dBm (0.0044 W) Bluetooth EDR (3Mbps) : 6.80 dBm (0.0048 W)
99% Occupied Bandwidth	Bluetooth BR(1Mbps) : 0.90MHz Bluetooth EDR (2Mbps) : 1.20MHz Bluetooth EDR (3Mbps) : 1.18MHz
Antenna Type	PIFA Antenna type with gain 4.83 dBi
Type of Modulation	Bluetooth BR (1Mbps) : GFSK Bluetooth EDR (2Mbps) : $\pi/4$ -DQPSK Bluetooth EDR (3Mbps) : 8-DPSK

1.5 Modification of EUT

No modifications are made to the EUT during all test items.

1.6 Testing Site

Test Site	SPORTON INTERNATIONAL INC.			
Test Site Location	No. 52, Hwa Ya 1 st Rd., Hwa Ya Technology Park, Kwei-Shan Hsiang, Tao Yuan Hsien, Taiwan, R.O.C. TEL: +886-3-3273456 / FAX: +886-3-3284978			
Test Site No.	Sporton Site No.			FCC/IC Registration No.
	TH02-HY	CO05-HY	03CH08-HY	636805/4086B-2

Note: The test site complies with ANSI C63.4 2003 requirement.



1.7 Applied Standards

According to the specifications of the manufacturer, the EUT must comply with the requirements of the following standards:

- ♦ FCC Part 15 Subpart C §15.247
- ♦ FCC Public Notice DA 00-705
- ♦ ANSI C63.4-2003

Remark:

1. All test items were verified and recorded according to the standards and without any deviation during the test.
2. This EUT has also been tested and complied with the requirements of FCC Part 15, Subpart B, recorded in a separate test report.

2 Test Configuration of Equipment Under Test

2.1 Descriptions of Test Mode

Preliminary tests were performed in different data rates and recorded the RF output power in the following table:

Channel	Frequency	Bluetooth RF Output Power		
		Data Rate / Modulation		
		GFSK	$\pi/4$ -DQPSK	8-DPSK
		1Mbps	2Mbps	3Mbps
Ch00	2402MHz	7.63 dBm	6.43 dBm	6.80 dBm
Ch39	2441MHz	6.39 dBm	4.62 dBm	4.73 dBm
Ch78	2480MHz	7.19 dBm	5.63 dBm	5.98 dBm

Remark:

1. All the test data for each data rate were verified, but only the worst case was reported.
 2. The data rate was set in 1Mbps for all the test items due to the highest RF output power.
- a. The EUT has been associated with peripherals and configuration operated in a manner tended to maximize its emission characteristics in a typical application. Frequency range investigated: conduction (150 kHz to 30 MHz), radiation (9 kHz to the 10th harmonic of the highest fundamental frequency or to 40 GHz, whichever is lower). Pre-scanned tests, X, Y, Z in three orthogonal panels, and different data rates were conducted to determine the final configuration (X plane as worst plane) from all possible combinations, and the worst mode of radiated spurious emissions is Bluetooth 1Mbps mode, and recorded in this report.
- b. AC power line Conducted Emission was tested under maximum output power.

2.2 Test Mode

The following summary table is showing all test modes to demonstrate in compliance with the standard.

Summary table of Test Cases			
Test Item	Data Rate / Modulation		
	Bluetooth BR 1Mbps GFSK	Bluetooth EDR 2Mbps $\pi/4$ -DQPSK	Bluetooth EDR 3Mbps 8-DPSK
Conducted Test Cases	Mode 1: CH00_2402 MHz	Mode 4: CH00_2402 MHz	Mode 7: CH00_2402 MHz
	Mode 2: CH39_2441 MHz	Mode 5: CH39_2441 MHz	Mode 8: CH39_2441 MHz
	Mode 3: CH78_2480 MHz	Mode 6: CH78_2480 MHz	Mode 9: CH78_2480 MHz
Radiated Test Cases	Bluetooth BR 1Mbps GFSK		
	Mode 1: CH00_2402 MHz		
	Mode 2: CH39_2441 MHz		
	Mode 3: CH78_2480 MHz		
AC Conducted Emission	Mode 1 :Bluetooth Link + WLAN (2.4GHz) Link + HDMI + Speaker + RJ-45 (Load) + Mouse + SD Card + MPEG4 + Adapter		
	Mode 2 :Bluetooth Link + WLAN (5GHz) Link + HDMI + Speaker + RJ-45 (Load) + Mouse + SD Card + MPEG4 + Adapter		
Remark:			
1. For radiated test cases, the worst mode data rate 1Mbps was reported only, because this data rate has the highest RF output power at preliminary tests, and the conducted spurious emissions and conducted band edge measurement for each data rate are no worse than 1Mbps, and no other significantly frequencies found in conducted spurious emission.			
2. The worst case of conducted emission is mode 1; only the test data of it was reported.			

2.3 Connection Diagram of Test System

<Bluetooth Tx Mode>

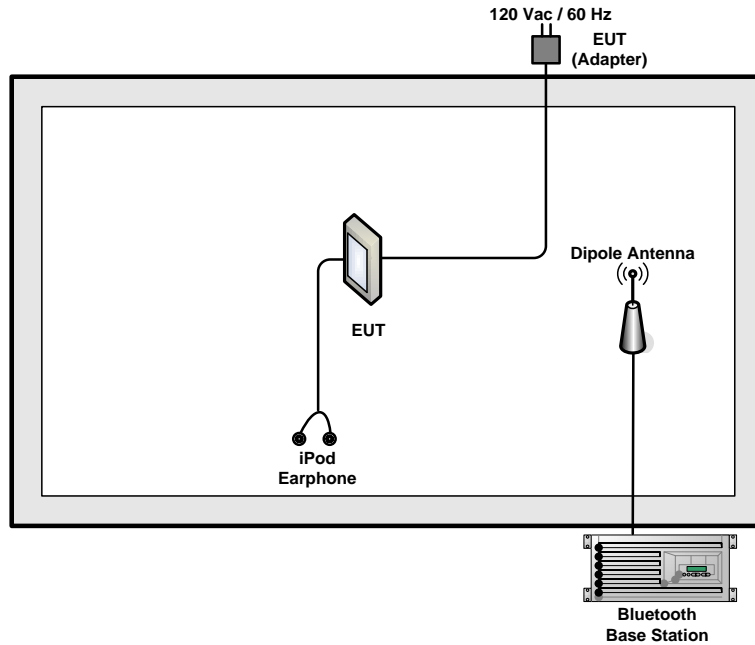

<AC Conducted Emission Mode>

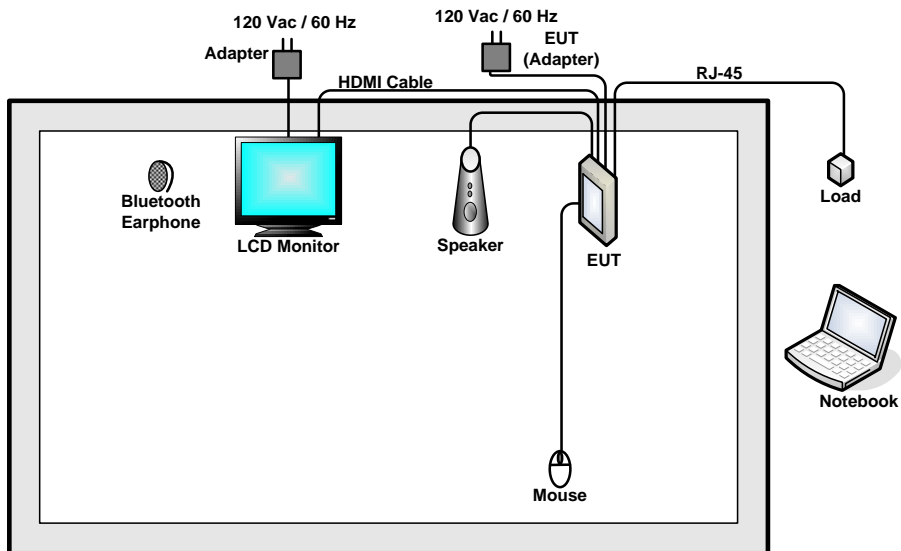

2.4 Support Unit used in test configuration and system

Item	Equipment	Trade Name	Model Name	FCC ID	Data Cable	Power Cord
1.	Bluetooth Base Station	R&S	CBT32	N/A	N/A	Unshielded, 1.8 m
2.	Notebook	DELL	Latitude E6320	FCC DoC	N/A	AC I/P: Unshielded, 1.2 m DC O/P: Shielded, 1.8 m
3.	LCD Monitor	DELL	ST2220Lb	FCC DoC	Shielded, 1.6m	Unshielded,1.8m
4.	Bluetooth Earphone	Sony Ericsson	MW600	PY7DDA-2029	N/A	N/A
5.	(USB) Mouse	Lenovo	M4806	FCC DoC	N/A	Unshielded, 1.8 m
6.	Speaker	N/A	N/A	N/A	N/A	Unshielded, 1.4 m
7.	SD Card	SanDisk	MicroSD HC	FCC DoC	N/A	N/A

2.5 EUT Operation Test Setup

For Bluetooth function, the RF utility, "BT test" was installed in EUT which was programmed in order to make the EUT get into the engineering modes to contact with Bluetooth base station for continuous transmitting and receiving signals.

2.6 Measurement Results Explanation Example

For all conducted test items:

The offset level is set in the spectrum analyzer to compensate the RF cable loss and attenuator factor between EUT conducted output port and spectrum analyzer. With the offset compensation, the spectrum analyzer reading level is exactly the EUT RF output level.

Example:

The spectrum analyzer offset is derived from RF cable loss and attenuator factor.

Offset = RF cable loss + attenuator factor.

Following shows an offset computation example with cable loss 4.2 dB and 10dB attenuator.

$$\begin{aligned}
 \text{Offset(dB)} &= \text{RF cable loss(dB)} + \text{attenuator factor(dB)} \\
 &= 4.2 + 10 = 14.2 \text{ (dB)}
 \end{aligned}$$

3 Test Result

3.1 Number of Channel Measurement

3.1.1 Limits of Number of Hopping Frequency

Frequency hopping systems in the 2400-2483.5 MHz band shall use at least 15 channels.

3.1.2 Measuring Instruments

The measuring equipment is listed in the section 4 of this test report.

3.1.3 Test Procedure

1. The testing follows FCC Public Notice DA 00-705 Measurement Guidelines.
2. The RF output of EUT was connected to the spectrum analyzer by RF cable and attenuator. The path loss was compensated to the results for each measurement.
3. Set to the maximum power setting and enable the EUT transmit continuously.
4. Enable the EUT hopping function.
5. Use the following spectrum analyzer settings: Span = the frequency band of operation; RBW \geq 1% of the span; VBW \geq RBW; Sweep = auto; Detector function = peak; Trace = max hold.
6. The number of hopping frequency used is defined as the number of total channel.
7. Record the measurement data derived from spectrum analyzer.

3.1.4 Test Setup

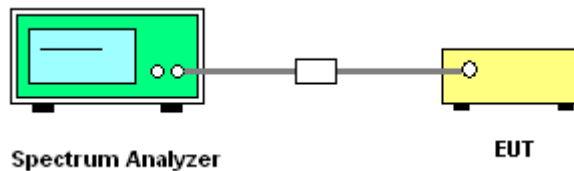

3.1.5 Test Result of Number of Hopping Frequency

Test Mode :	3Mbps	Temperature :	24~26°C
Test Engineer :	Alex Lee	Relative Humidity :	50~53%

Number of Hopping (Channel)	Adaptive Frequency Hopping (Channel)	Limits (Channel)	Pass/Fail
79	20	> 15	Pass



Number of Hopping Channel Plot on Channel 00 - 78

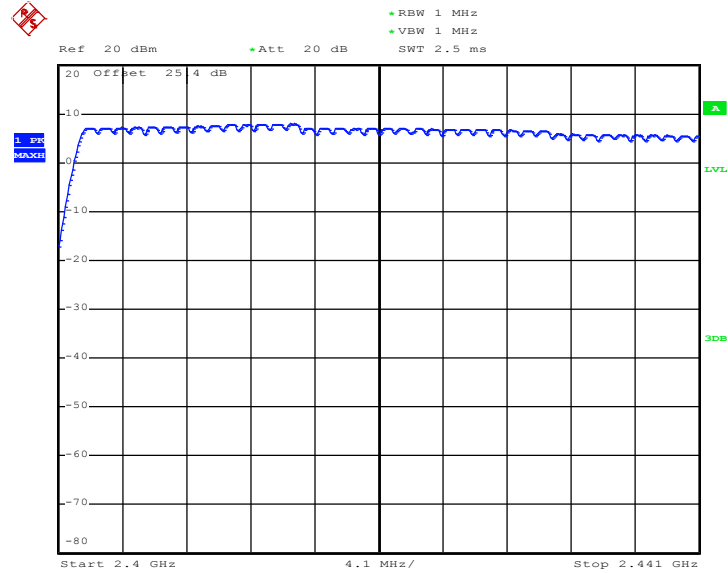

Date: 13.MAR.2014 10:05:22

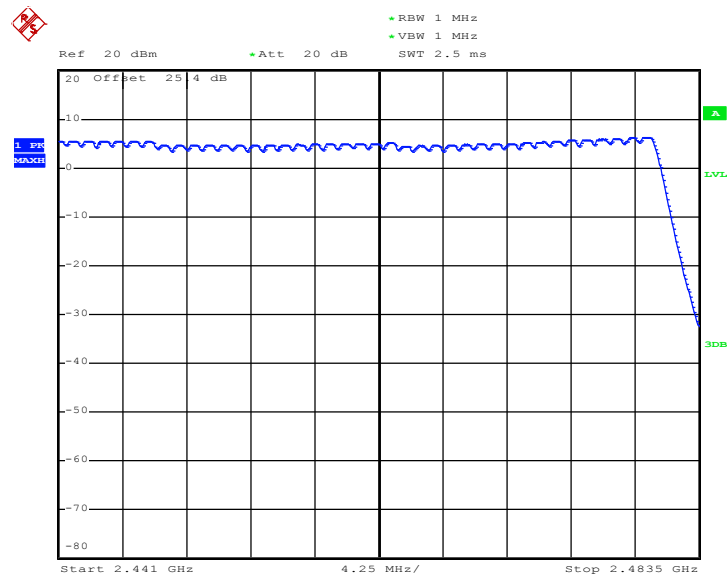

Date: 13.MAR.2014 10:06:08

3.2 Hopping Channel Separation Measurement

3.2.1 Limit of Hopping Channel Separation

Frequency hopping systems operating in the 2400-2483.5 MHz band may have hopping channel carrier frequencies that are separated by 25 kHz or two-thirds of the 20 dB bandwidth of the hopping channel, whichever is greater.

3.2.2 Measuring Instruments

The measuring equipment is listed in the section 4 of this test report.

3.2.3 Test Procedures

1. The testing follows FCC Public Notice DA 00-705 Measurement Guidelines.
2. The RF output of EUT was connected to the spectrum analyzer by RF cable and attenuator. The path loss was compensated to the results for each measurement.
3. Set to the maximum power setting and enable the EUT transmit continuously.
4. Enable the EUT hopping function.
5. Use the following spectrum analyzer settings:
Span = wide enough to capture the peaks of two adjacent channels; RBW \geq 1% of the span;
VBW \geq RBW; Sweep = auto; Detector function = peak; Trace = max hold.
6. Measure and record the results in the test report.

3.2.4 Test Setup

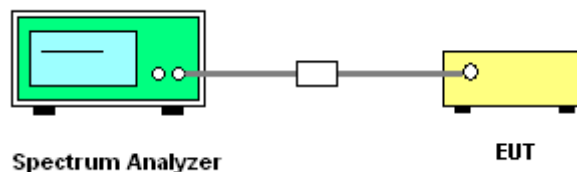



3.2.5 Test Result of Hopping Channel Separation

Test Mode :	1Mbps	Temperature :	24~26°C
Test Engineer :	Alex Lee	Relative Humidity :	50~53%

Channel	Frequency (MHz)	Frequency Separation (MHz)	(2/3 of 20dB BW) Limits (MHz)	Pass/Fail
00	2402	1.002	0.6480	Pass
39	2441	1.002	0.6453	Pass
78	2480	1.002	0.6507	Pass

Channel Separation Plot on Channel 00 - 01

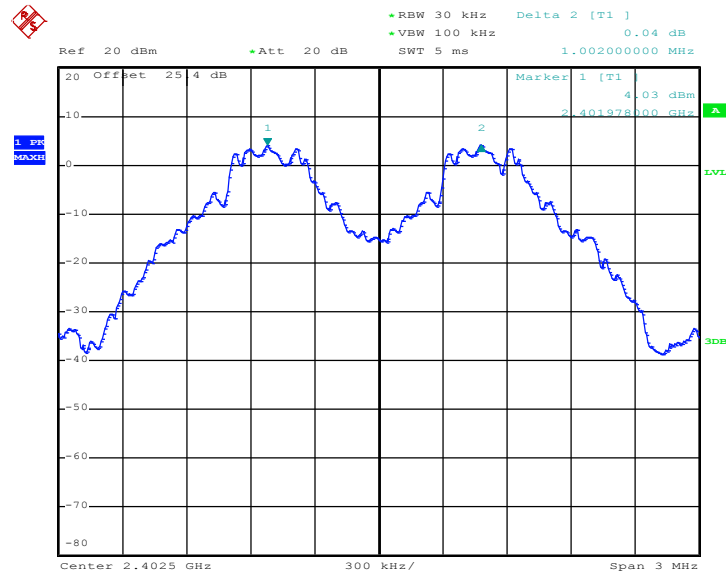

Date: 11.MAR.2014 14:53:56



Channel Separation Plot on Channel 39 - 40

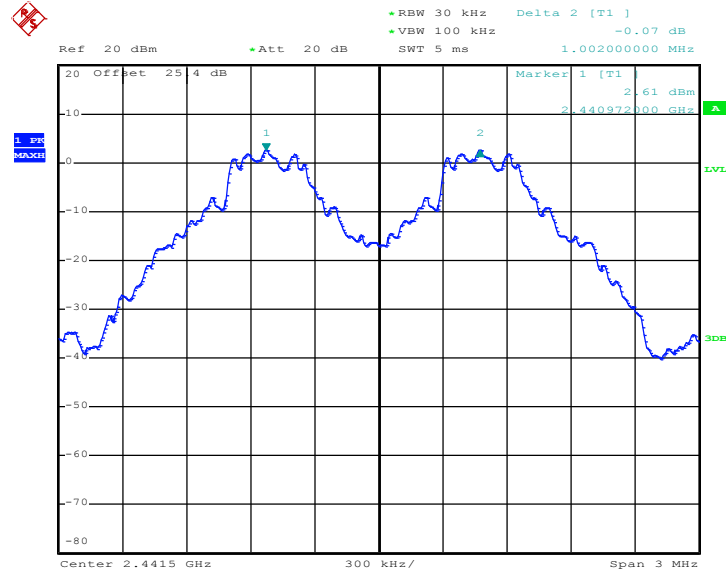

Date: 11.MAR.2014 14:58:56

Channel Separation Plot on Channel 77 - 78

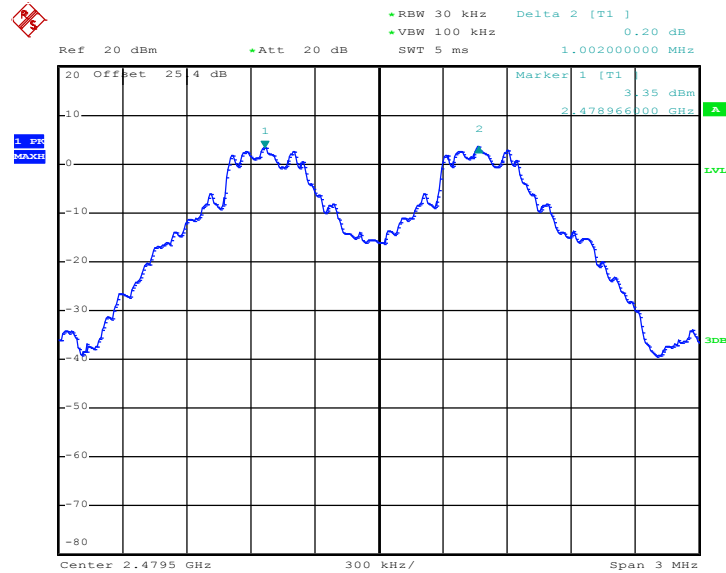

Date: 11.MAR.2014 15:01:54



Test Mode :	2Mbps	Temperature :	24~26°C
Test Engineer :	Alex Lee	Relative Humidity :	50~53%

Channel	Frequency (MHz)	Frequency Separation (MHz)	(2/3 of 20dB BW) Limits (MHz)	Pass/Fail
00	2402	1.002	0.9040	Pass
39	2441	1.002	0.9040	Pass
78	2480	1.002	0.9040	Pass

Channel Separation Plot on Channel 00 - 01

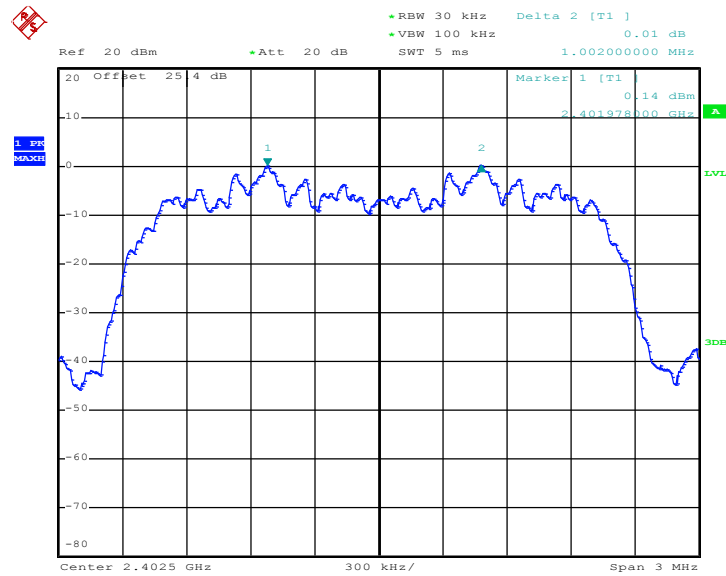

Date: 11.MAR.2014 15:16:38



Channel Separation Plot on Channel 39 - 40

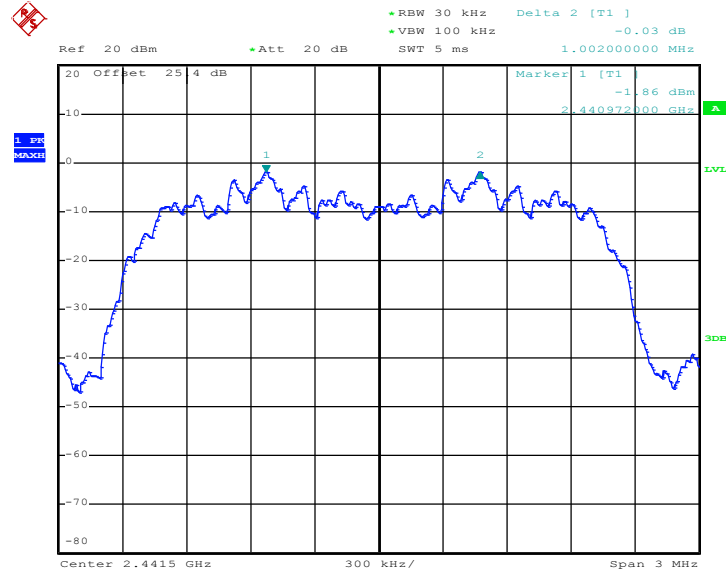

Date: 11.MAR.2014 15:13:39

Channel Separation Plot on Channel 77 - 78

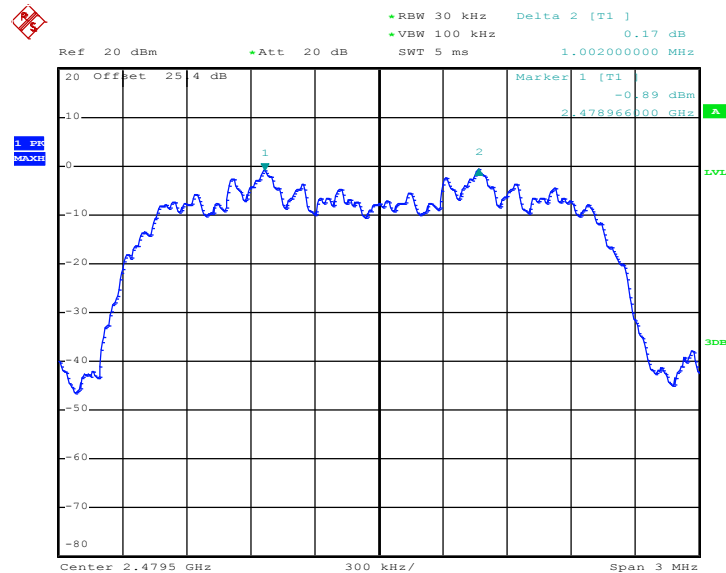

Date: 11.MAR.2014 15:08:36



Test Mode :	3Mbps	Temperature :	24~26°C
Test Engineer :	Alex Lee	Relative Humidity :	50~53%

Channel	Frequency (MHz)	Frequency Separation (MHz)	(2/3 of 20dB BW) Limits (MHz)	Pass/Fail
00	2402	1.002	0.8800	Pass
39	2441	1.002	0.8760	Pass
78	2480	1.002	0.8800	Pass

Channel Separation Plot on Channel 00 - 01

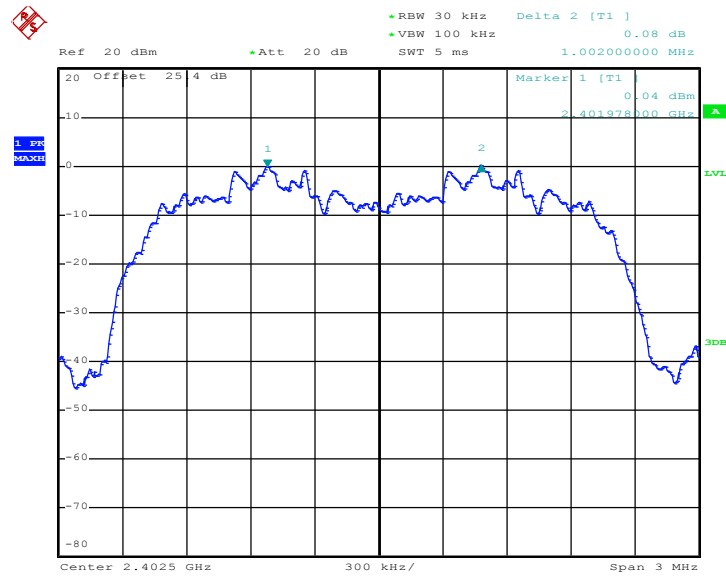

Date: 11.MAR.2014 15:24:33



Channel Separation Plot on Channel 39 - 40

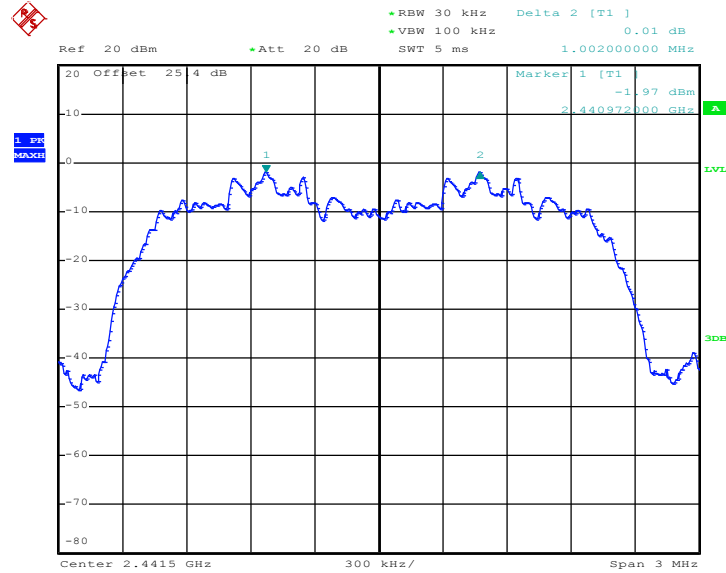

Date: 11.MAR.2014 15:32:51

Channel Separation Plot on Channel 77 - 78

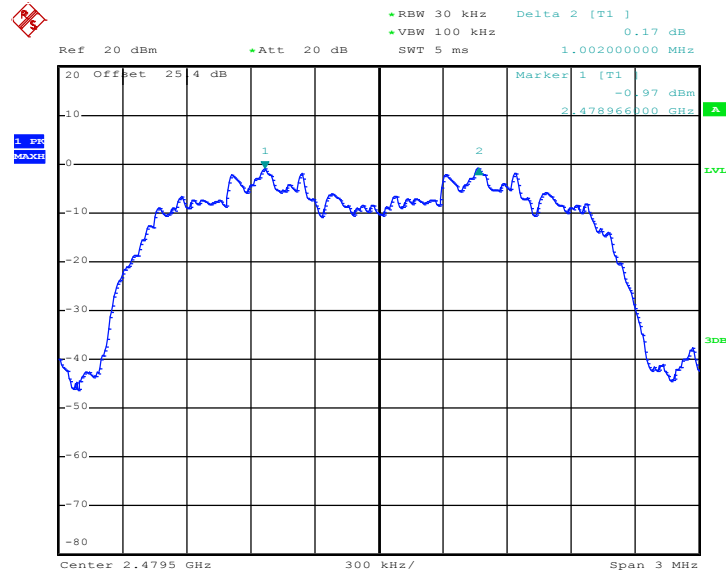

Date: 11.MAR.2014 15:35:50

3.3 Dwell Time Measurement

3.3.1 Limit of Dwell Time

The average time of occupancy on any channel shall not be greater than 0.4 seconds within a period of 0.4 seconds multiplied by the number of hopping channels employed.

3.3.2 Measuring Instruments

The measuring equipment is listed in the section 4 of this test report.

3.3.3 Test Procedures

1. The testing follows FCC Public Notice DA 00-705 Measurement Guidelines.
2. The RF output of EUT was connected to the spectrum analyzer by RF cable and attenuator. The path loss was compensated to the results for each measurement.
3. Set to the maximum power setting and enable the EUT transmit continuously.
4. Enable the EUT hopping function.
5. Use the following spectrum analyzer settings: Span = zero span, centered on a hopping channel; RBW = 1 MHz; VBW \geq RBW; Sweep = as necessary to capture the entire dwell time per hopping channel; Detector function = peak; Trace = max hold.
6. Measure and record the results in the test report.

3.3.4 Test Setup

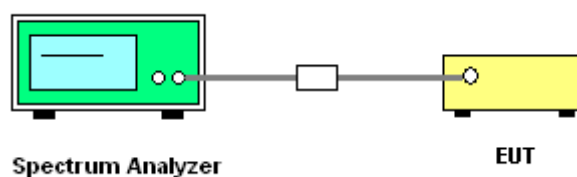



3.3.5 Test Result of Dwell Time

Test Mode :	DH5	Temperature :	24~26°C
Test Engineer :	Alex Lee	Relative Humidity :	50~53%

Mode	Hopping Channel Number	Hops Over Occupancy Time(hops)	Package Transfer Time (msec)	Dwell Time (sec)	Limits (sec)	Pass/Fail
Normal	79	106.67	2.90	0.31	0.4	Pass
AFH	20	53.33	2.90	0.15	0.4	Pass

Remark:

1. In normal mode, hopping rate is 1600 hops/s with 6 slots in 79 hopping channels.
With channel hopping rate (1600 / 6 / 79) in Occupancy Time Limit (0.4 x 79) (s),
Hops Over Occupancy Time comes to (1600 / 6 / 79) x (0.4 x 79) = 106.67 hops.
2. In AFH mode, hopping rate is 800 hops/s with 6 slots in 20 hopping channels.
With channel hopping rate (800 / 6 / 20) in Occupancy Time Limit (0.4 x 20) (s),
Hops Over Occupancy Time comes to (800 / 6 / 20) x (0.4 x 20) = 53.33 hops.
3. Dwell Time(s) = Hops Over Occupancy Time (hops) x Package Transfer Time



Package Transfer Time Plot

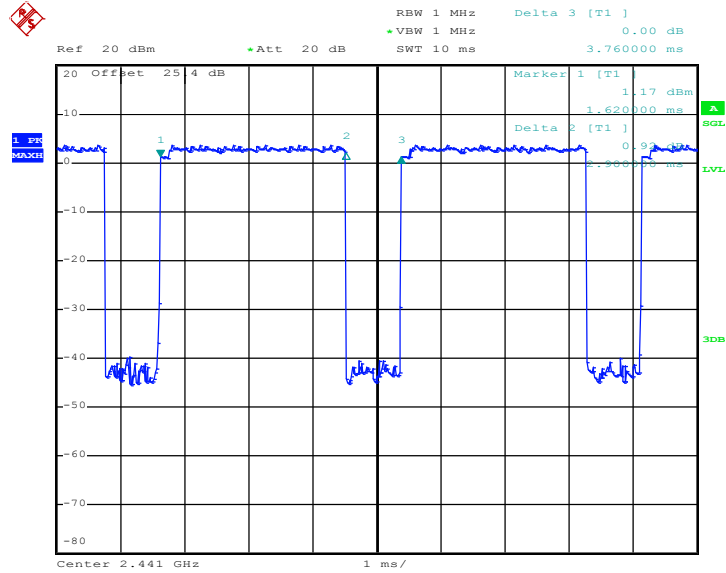

Date: 6.MAR.2014 23:32:01

3.4 20dB and 99% Bandwidth Measurement

3.4.1 Limit of 20dB and 99% Bandwidth

Reporting only

3.4.2 Measuring Instruments

The measuring equipment is listed in the section 4 of this test report.

3.4.3 Test Procedures

1. The testing follows FCC Public Notice DA 00-705 Measurement Guidelines.
2. The RF output of EUT was connected to the spectrum analyzer by RF cable and attenuator. The path loss was compensated to the results for each measurement.
3. Set to the maximum power setting and enable the EUT transmit continuously.
4. Use the following spectrum analyzer settings for 20dB Bandwidth measurement.
Span = approximately 2 to 3 times the 20 dB bandwidth, centered on a hopping channel;
RBW \geq 1% of the 20 dB bandwidth; VBW \geq RBW; Sweep = auto; Detector function = peak;
Trace = max hold.
5. Use the following spectrum analyzer settings for 99 % Bandwidth measurement.
For 99% Bandwidth measurement, the RBW=30kHz, and VBW = 100kHz. Sweep = auto ;
Detector function = sample. Trace = max hold.
6. Measure and record the results in the test report.

3.4.4 Test Setup

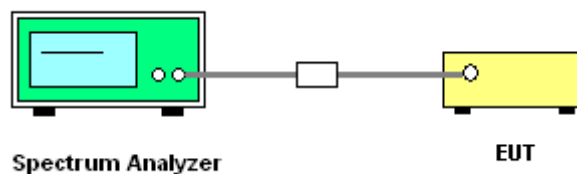



3.4.5 Test Result of 20dB Bandwidth

Test Mode :	1Mbps	Temperature :	24~26°C
Test Engineer :	Alex Lee	Relative Humidity :	50~53%

Channel	Frequency (MHz)	20dB Bandwidth (MHz)
00	2402	0.972
39	2441	0.968
78	2480	0.976

20 dB Bandwidth Plot on Channel 00

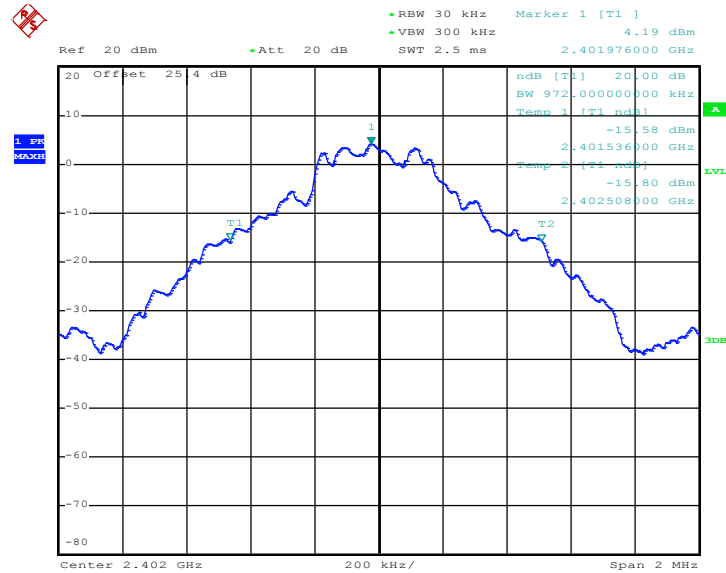

Date: 11.MAR.2014 14:54:27



20 dB Bandwidth Plot on Channel 39

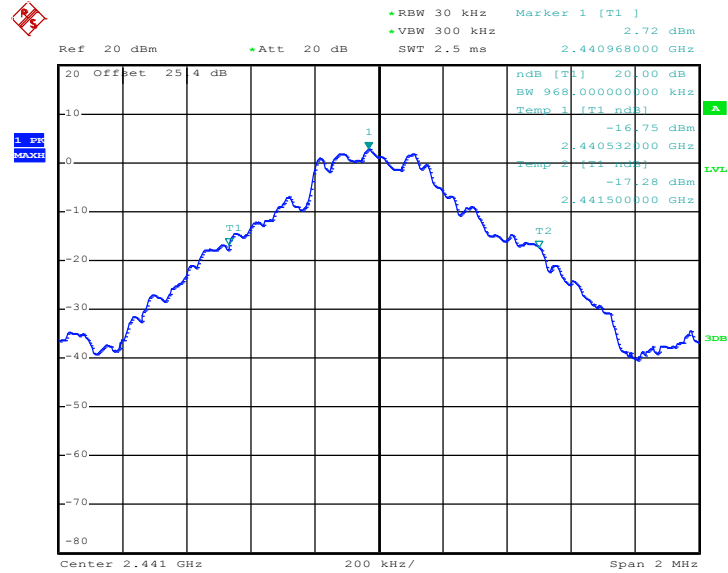

Date: 11.MAR.2014 14:59:20

20 dB Bandwidth Plot on Channel 78

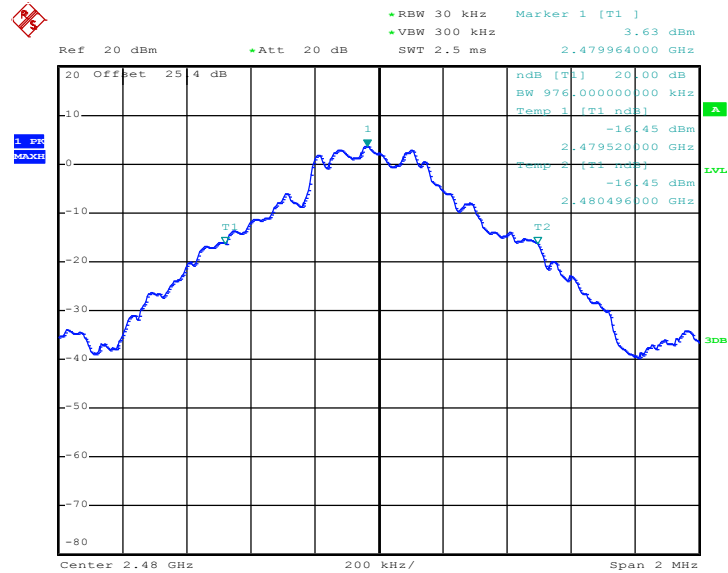

Date: 11.MAR.2014 15:02:21



Test Mode :	2Mbps	Temperature :	24~26°C
Test Engineer :	Alex Lee	Relative Humidity :	50~53%

Channel	Frequency (MHz)	20dB Bandwidth (MHz)
00	2402	1.356
39	2441	1.356
78	2480	1.356

20 dB Bandwidth Plot on Channel 00

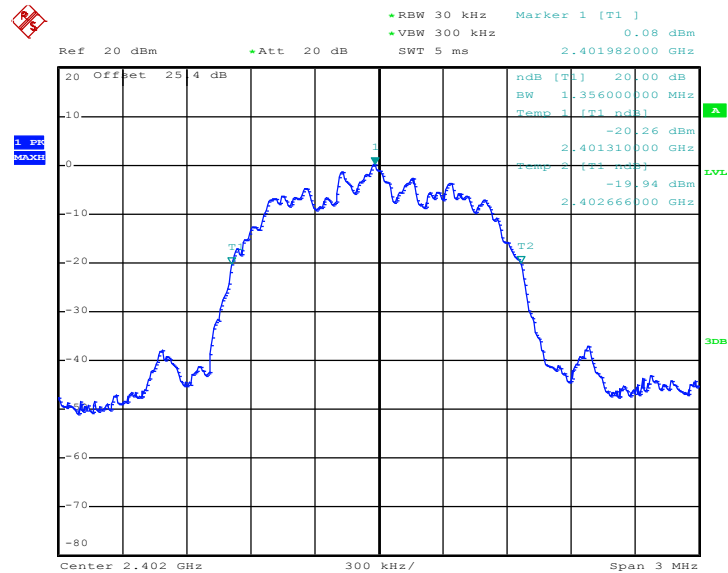

Date: 11.MAR.2014 15:17:01



20 dB Bandwidth Plot on Channel 39

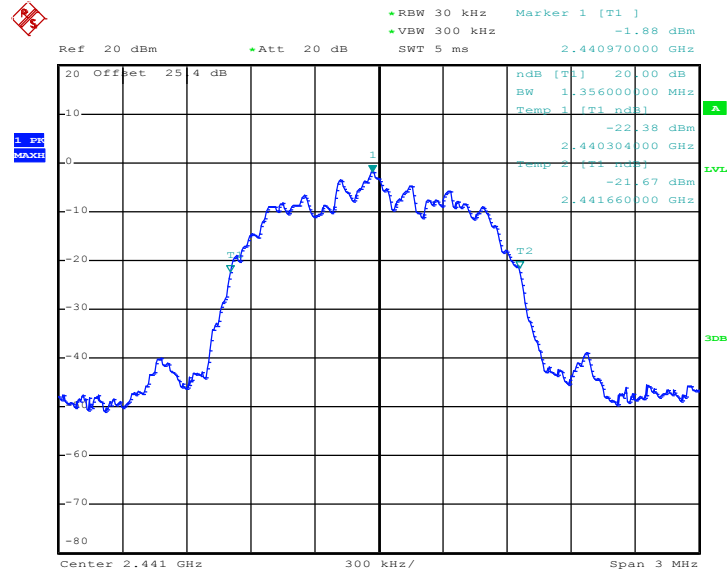

Date: 11.MAR.2014 15:14:04

20 dB Bandwidth Plot on Channel 78

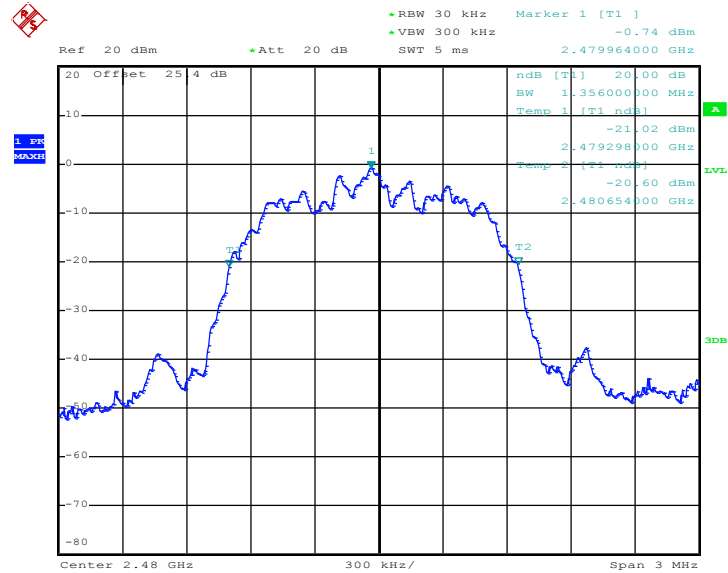

Date: 11.MAR.2014 15:09:03



Test Mode :	3Mbps	Temperature :	24~26°C
Test Engineer :	Alex Lee	Relative Humidity :	50~53%

Channel	Frequency (MHz)	20dB Bandwidth (MHz)
00	2402	1.320
39	2441	1.314
78	2480	1.320

20 dB Bandwidth Plot on Channel 00

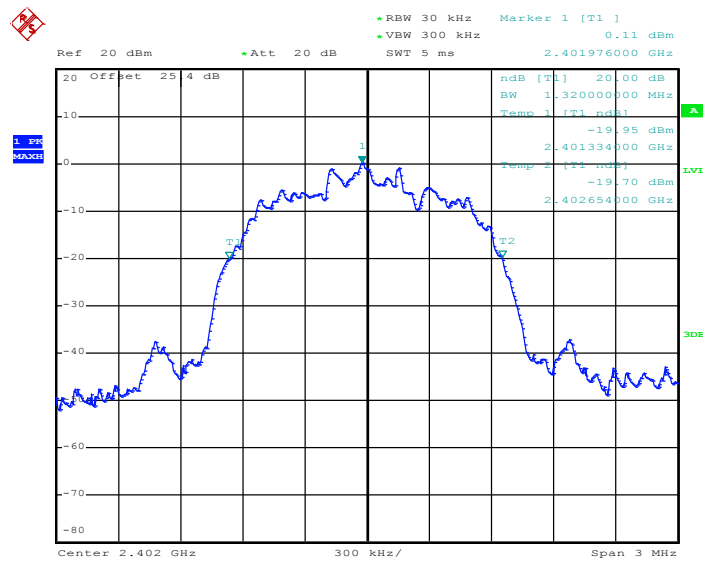

Date: 11.MAR.2014 15:24:57



20 dB Bandwidth Plot on Channel 39

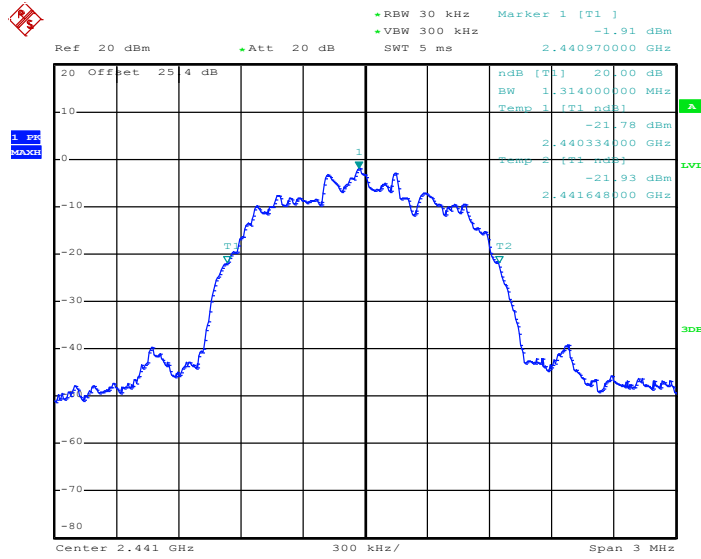

Date: 11.MAR.2014 15:33:17

20 dB Bandwidth Plot on Channel 78

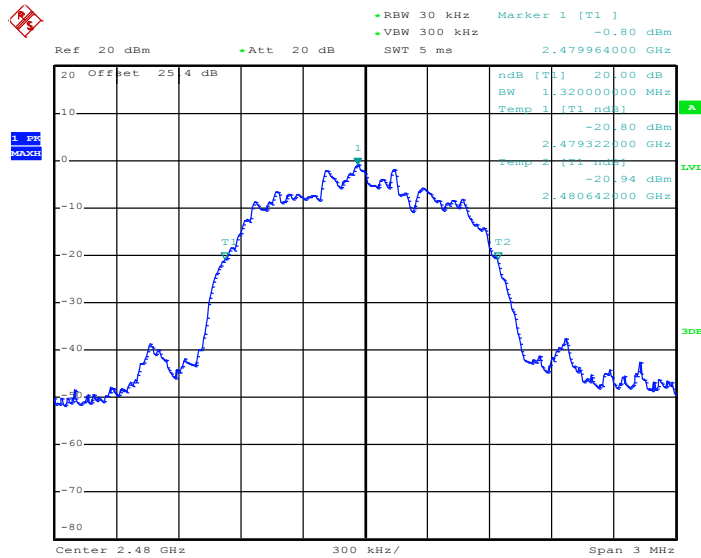

Date: 11.MAR.2014 15:37:31



3.4.6 Test Result of 99% Occupied Bandwidth

Test Mode :	1Mbps	Temperature :	24~26°C
Test Engineer :	Alex Lee	Relative Humidity :	50~53%

Channel	Frequency (MHz)	99% Occupied Bandwidth (MHz)
00	2402	0.896
39	2441	0.896
78	2480	0.896

99% Occupied Bandwidth Plot on Channel 00

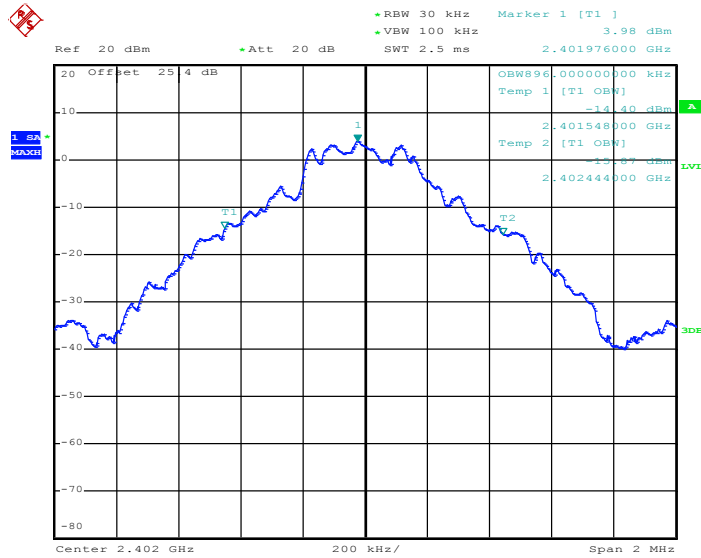

Date: 17.MAR.2014 13:59:45



99% Occupied Bandwidth Plot on Channel 39

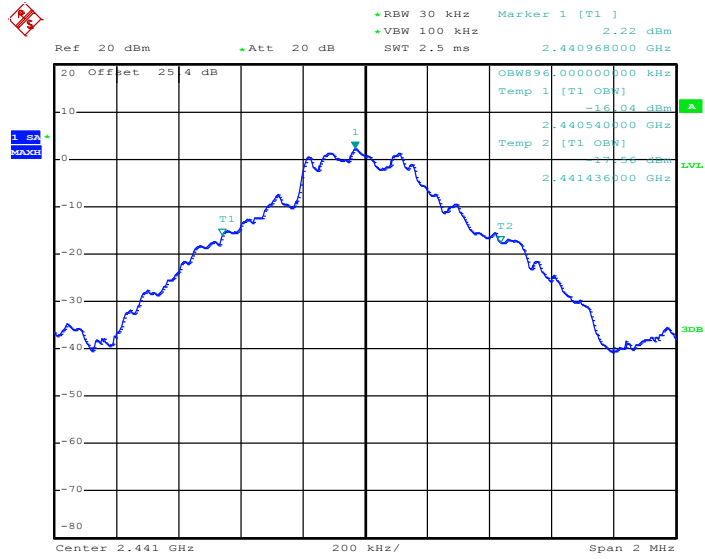

Date: 17.MAR.2014 14:00:21

99% Occupied Bandwidth Plot on Channel 78

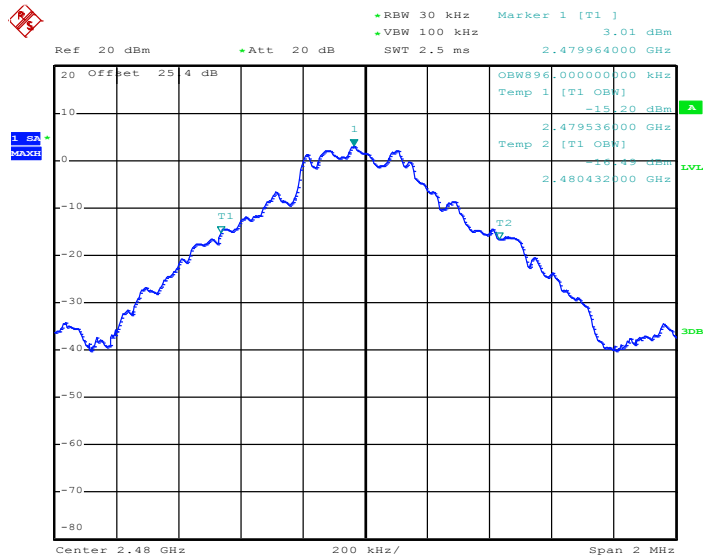

Date: 17.MAR.2014 14:00:57



Test Mode :	2Mbps	Temperature :	24~26°C
Test Engineer :	Alex Lee	Relative Humidity :	50~53%

Channel	Frequency (MHz)	99% Occupied Bandwidth (MHz)
00	2402	1.192
39	2441	1.204
78	2480	1.204

99% Occupied Bandwidth Plot on Channel 00

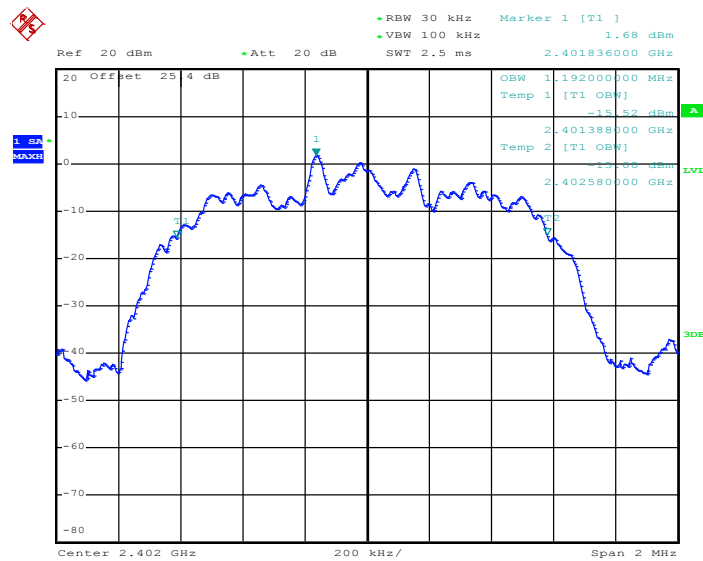

Date: 17.MAR.2014 14:01:33



99% Occupied Bandwidth Plot on Channel 39

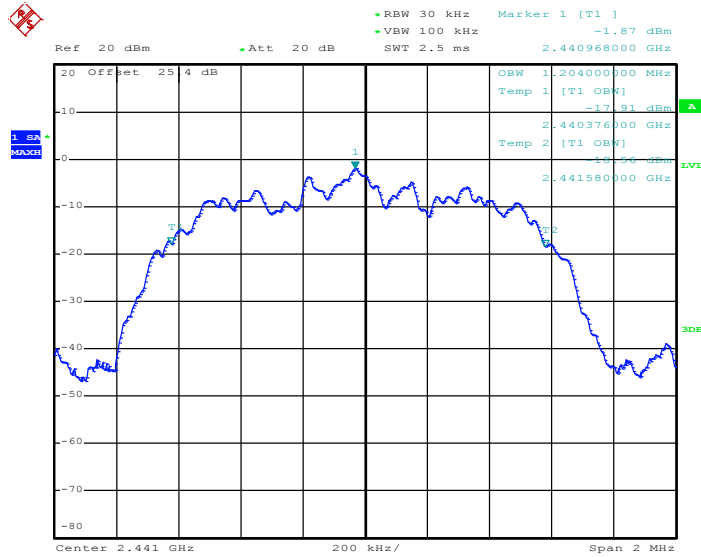

Date: 17.MAR.2014 14:02:09

99% Occupied Bandwidth Plot on Channel 78

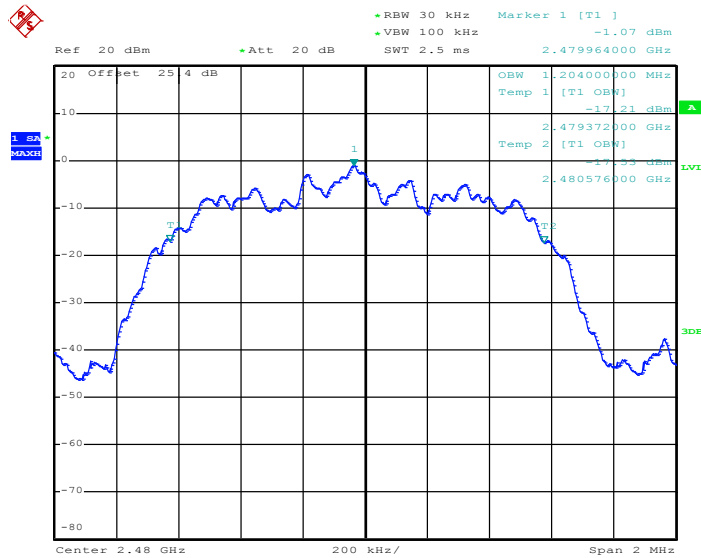

Date: 17.MAR.2014 14:02:46



Test Mode :	3Mbps	Temperature :	24~26°C
Test Engineer :	Alex Lee	Relative Humidity :	50~53%

Channel	Frequency (MHz)	99% Occupied Bandwidth (MHz)
00	2402	1.184
39	2441	1.184
78	2480	1.184

99% Occupied Bandwidth Plot on Channel 00

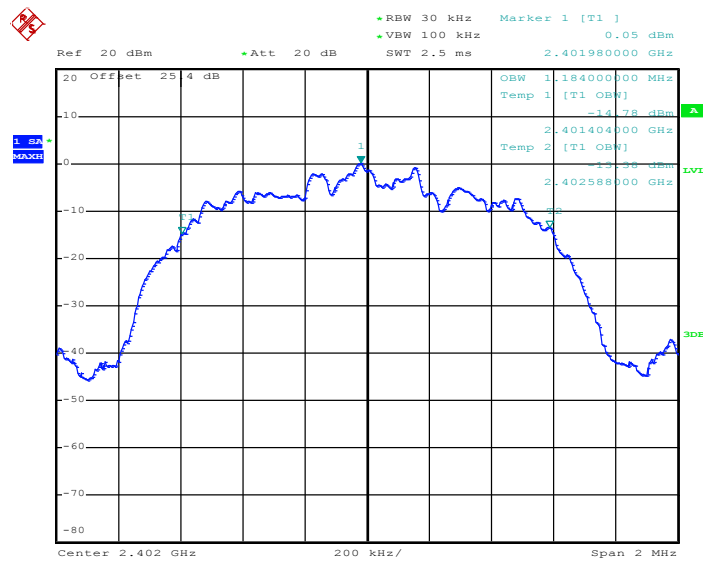

Date: 17.MAR.2014 14:03:22



99% Occupied Bandwidth Plot on Channel 39

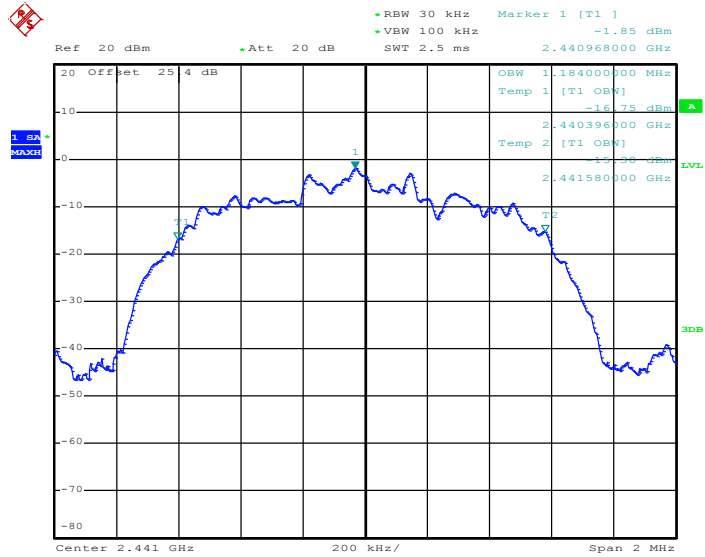

Date: 17.MAR.2014 14:03:58

99% Occupied Bandwidth Plot on Channel 78

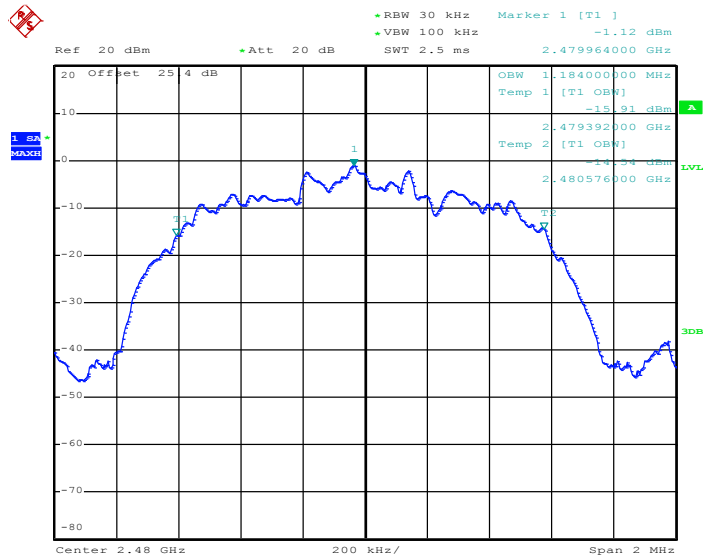

Date: 17.MAR.2014 14:04:34

Note: The occupied channel bandwidth is maintained within the band of operation for all of the modulations.

3.5 Peak Output Power Measurement

3.5.1 Limit of Peak Output Power

Section 15.247 (b) The maximum peak conducted output power of the intentional radiator shall not exceed the following: (1) For frequency hopping systems operating in the 2400-2483.5 MHz band employing at least 75 non-overlapping hopping channels, and all frequency hopping systems in the 5725-5850 MHz band: 1 watt. For all other frequency hopping systems in the 2400-2483.5 MHz band 0.125 watts. The power limit for 1Mbps is 1watt, and for 2Mbps, 3Mbps and AFH are 0.125 watts.

3.5.2 Measuring Instruments

The measuring equipment is listed in the section 4 of this test report.

3.5.3 Test Procedures

1. The testing follows FCC Public Notice DA 00-705 Measurement Guidelines.
2. The RF output of EUT was connected to the power meter by RF cable and attenuator. The path loss was compensated to the results for each measurement.
3. Set to the maximum power setting and enable the EUT transmit continuously.
4. Measure the conducted output power with cable loss and record the results in the test report.
5. Measure and record the results in the test report.

3.5.4 Test Setup

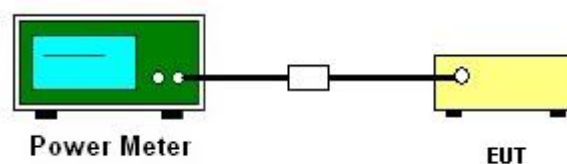



3.5.5 Test Result of Peak Output Power

Test Mode :	1Mbps	Temperature :	24~26°C
Test Engineer :	Alex Lee	Relative Humidity :	50~53%

Channel	Frequency (MHz)	RF Power (dBm)		
		GFSK	Max. Limits (dBm)	Pass/Fail
		1 Mbps		
00	2402	7.63	20.97	Pass
39	2441	6.39	20.97	Pass
78	2480	7.19	20.97	Pass

Note: For AFH mode using 20 hopping channels, the maximum output power limit is 20.97dBm.

Test Mode :	2Mbps	Temperature :	24~26°C
Test Engineer :	Alex Lee	Relative Humidity :	50~53%

Channel	Frequency (MHz)	RF Power (dBm)		
		$\pi/4$ -DQPSK	Max. Limits (dBm)	Pass/Fail
		2 Mbps		
00	2402	6.43	20.97	Pass
39	2441	4.62	20.97	Pass
78	2480	5.63	20.97	Pass

Test Mode :	3Mbps	Temperature :	24~26°C
Test Engineer :	Alex Lee	Relative Humidity :	50~53%

Channel	Frequency (MHz)	RF Power (dBm)		
		8-DPSK	Max. Limits (dBm)	Pass/Fail
		3 Mbps		
00	2402	6.80	20.97	Pass
39	2441	4.73	20.97	Pass
78	2480	5.98	20.97	Pass

3.6 Conducted Band Edges Measurement

3.6.1 Limit of Band Edges

In any 100 kHz bandwidth outside the intentional radiation frequency band, the radio frequency power shall be at least 20 dB below the highest level of the radiated power. In addition, radiated emissions which fall in the restricted bands must also comply with the radiated emission limits.

3.6.2 Measuring Instruments

The measuring equipment is listed in the section 4 of this test report.

3.6.3 Test Procedures

1. The testing follows the guidelines in Band-edge Compliance of RF Conducted Emissions of FCC Public Notice DA 00-705 Measurement Guidelines.
2. Set to the maximum power setting and enable the EUT transmit continuously.
3. Set RBW = 100kHz ($\geq 1\%$ span=10MHz), VBW = 300kHz (\geq RBW). Band edge emissions must be at least 20 dB down from the highest emission level within the authorized band as measured with a 100kHz RBW. The attenuation shall be 30 dB instead of 20 dB when RMS conducted output power procedure is used.
4. Enable hopping function of the EUT and then repeat step 2. and 3.
5. Measure and record the results in the test report.

3.6.4 Test Setup

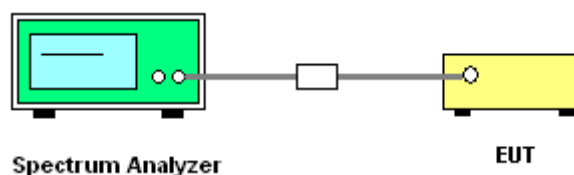



3.6.6 Test Result of Conducted Band Edges

Test Mode :	1Mbps	Temperature :	24~26°C
Test Channel :	00 and 78	Relative Humidity :	50~53%
		Test Engineer :	Alex Lee

Low Band Edge Plot on Channel 00

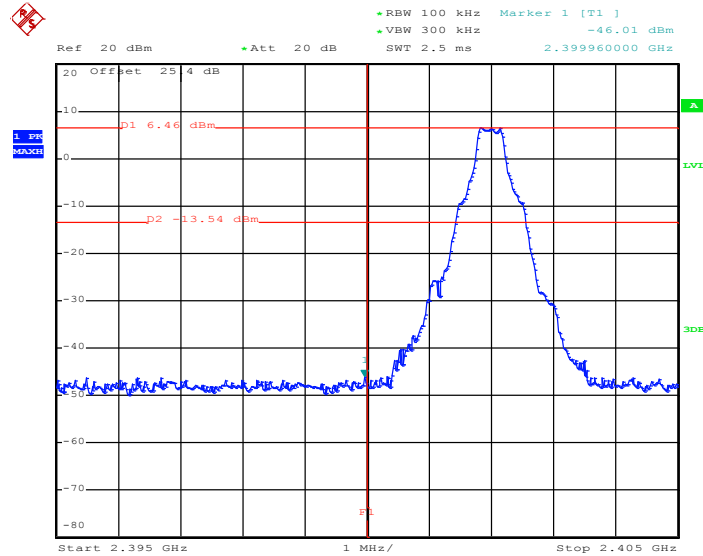

Date: 11.MAR.2014 14:55:58

High Band Edge Plot on Channel 78

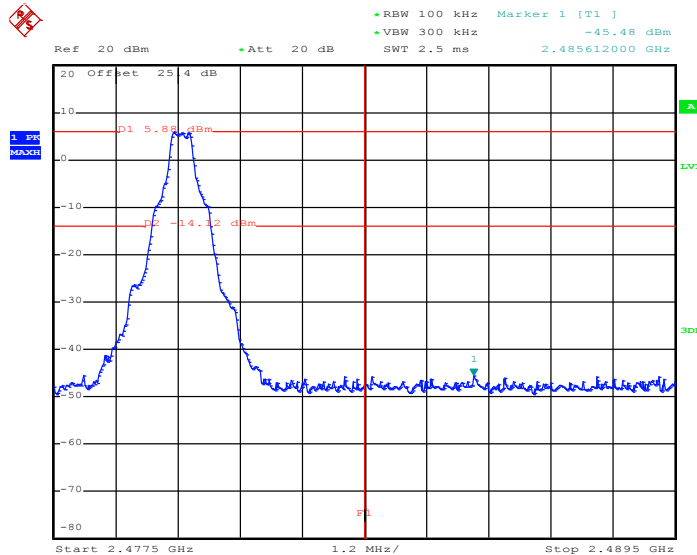

Date: 11.MAR.2014 15:06:46



Test Mode :	2Mbps	Temperature :	24~26°C
Test Channel :	00 and 78	Relative Humidity :	50~53%
		Test Engineer :	Alex Lee

Low Band Edge Plot on Channel 00

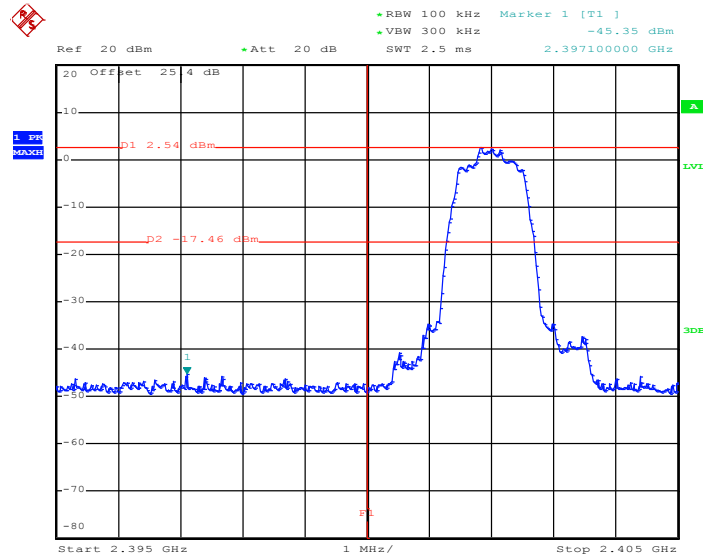

Date: 11.MAR.2014 15:21:44

High Band Edge Plot on Channel 78

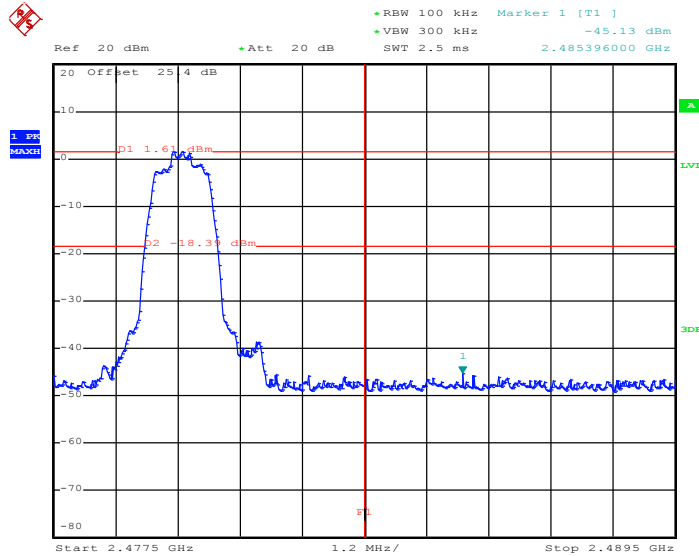

Date: 11.MAR.2014 15:12:47



Test Mode :	3Mbps	Temperature :	24~26°C
Test Channel :	00 and 78	Relative Humidity :	50~53%
		Test Engineer :	Alex Lee

Low Band Edge Plot on Channel 00

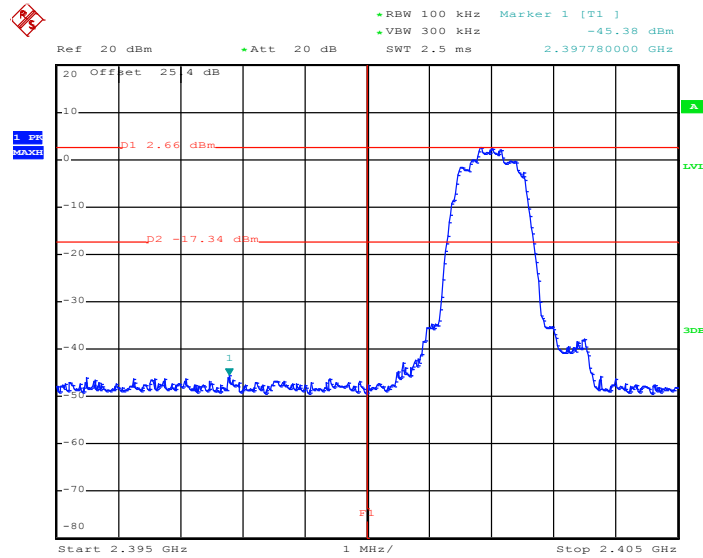

Date: 11.MAR.2014 15:30:05

High Band Edge Plot on Channel 78

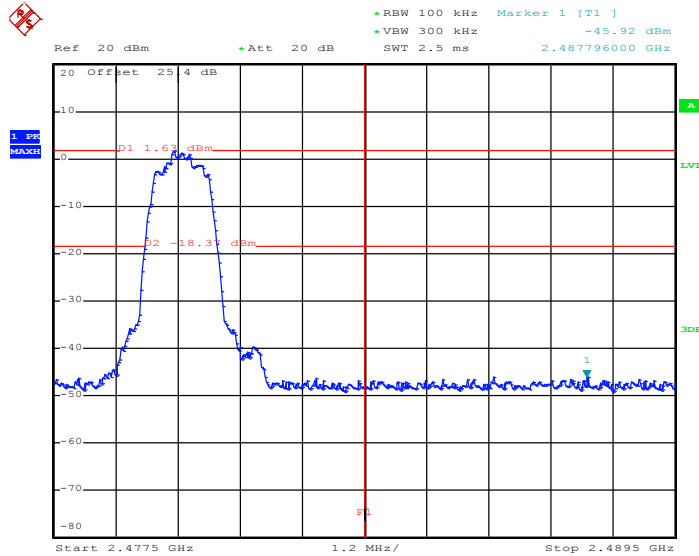

Date: 11.MAR.2014 15:41:33



3.6.7 Test Result of Conducted Hopping Mode Band Edges

Test Mode :	1Mbps	Temperature :	24~26°C
Test Engineer :	Alex Lee	Relative Humidity :	50~53%

1Mbps Hopping Mode Low Band Edge Plot

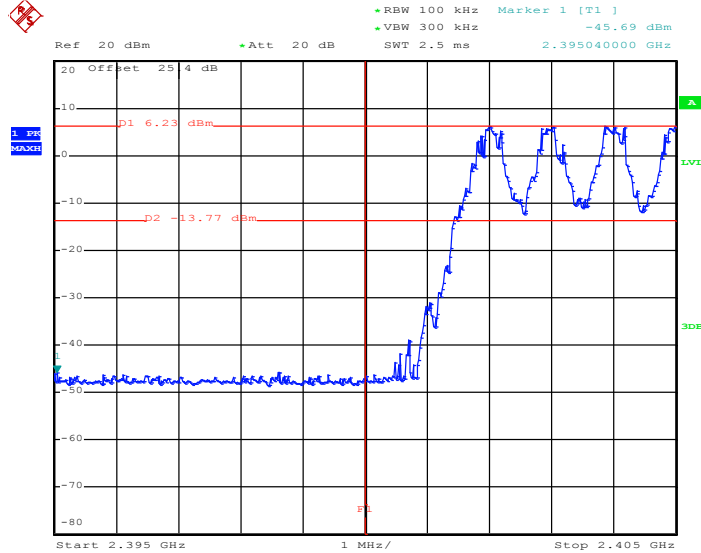

Date: 11.MAR.2014 14:55:36

1Mbps Hopping Mode High Band Edge Plot

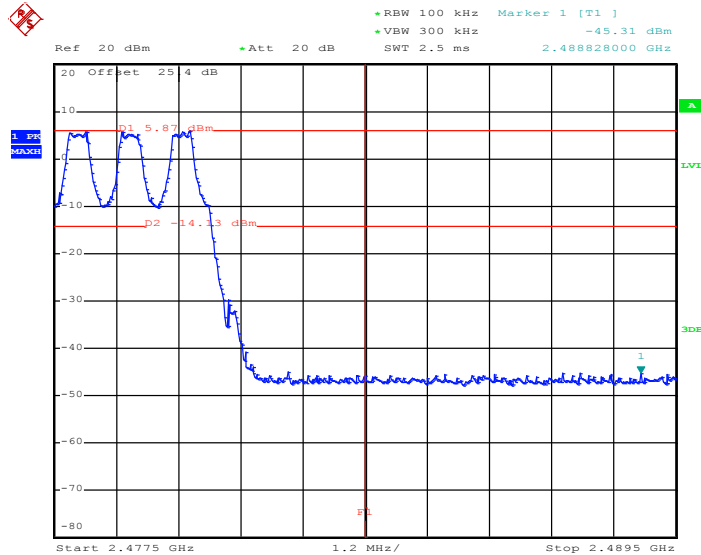

Date: 11.MAR.2014 15:06:28



Test Mode :	2Mbps	Temperature :	24~26°C
Test Engineer :	Alex Lee	Relative Humidity :	50~53%

2Mbps Hopping Mode Low Band Edge Plot

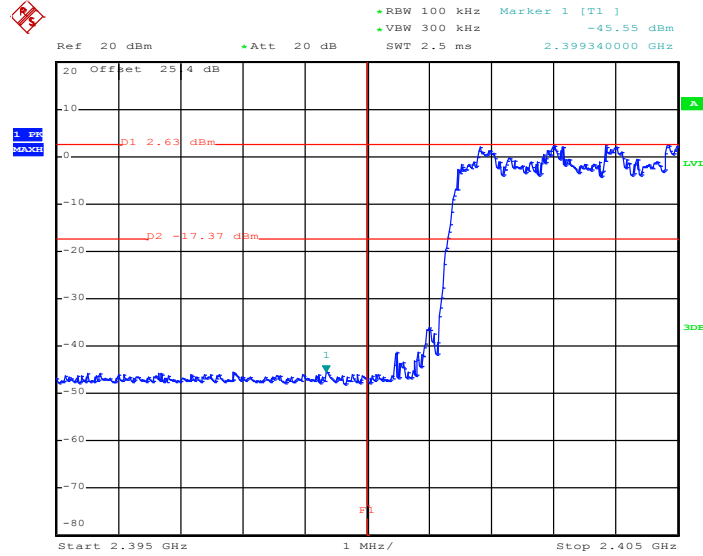

Date: 11.MAR.2014 15:21:26

2Mbps Hopping Mode High Band Edge Plot

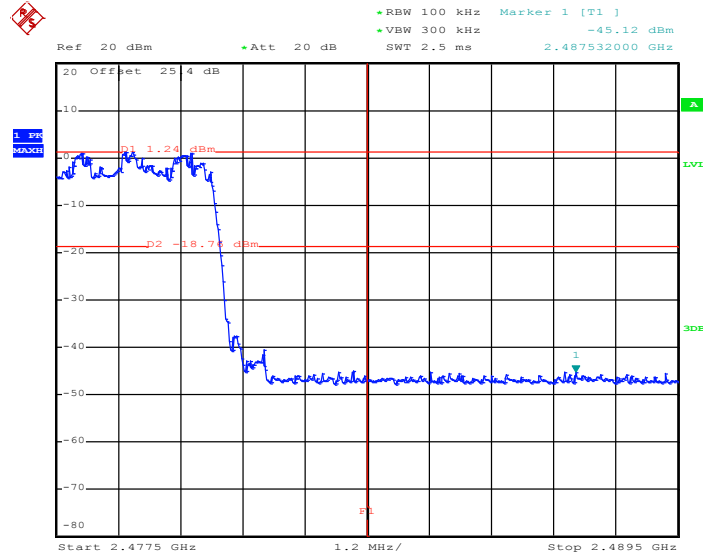

Date: 11.MAR.2014 15:12:27



Test Mode :	3Mbps	Temperature :	24~26°C
Test Engineer :	Alex Lee	Relative Humidity :	50~53%

3Mbps Hopping Mode Low Band Edge Plot

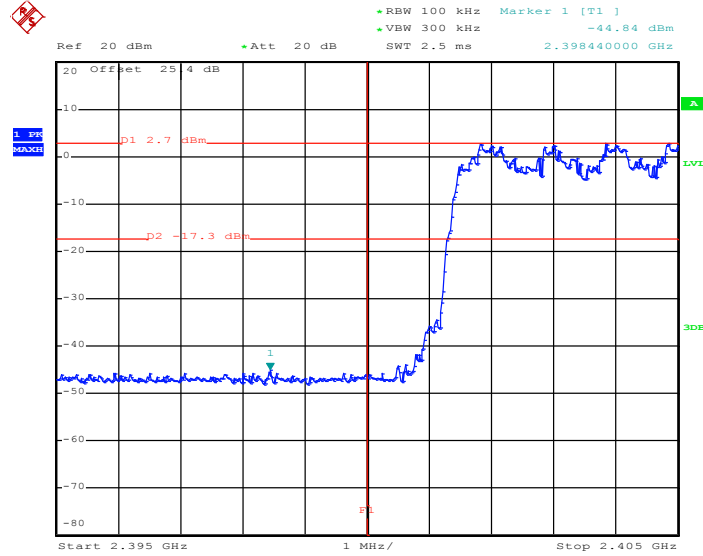

Date: 11.MAR.2014 15:29:47

3Mbps Hopping Mode High Band Edge Plot

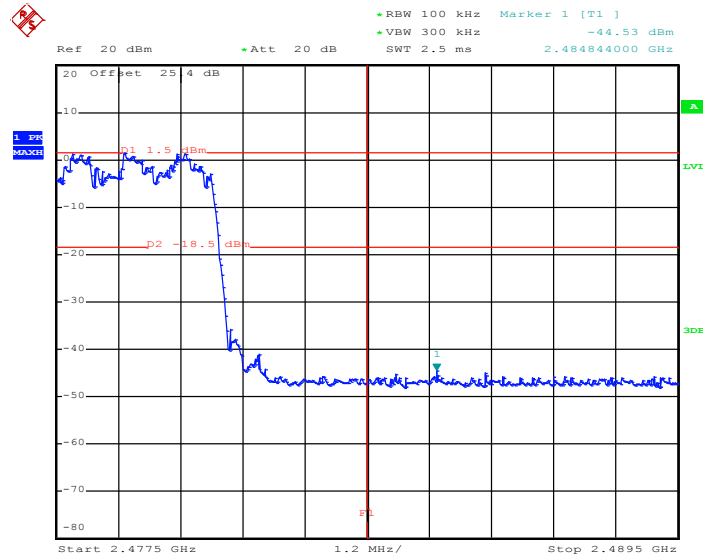

Date: 11.MAR.2014 15:41:16

3.7 Conducted Spurious Emission Measurement

3.7.1 Limit of Spurious Emission Measurement

In any 100 kHz bandwidth outside the intentional radiation frequency band, the radio frequency power shall be at least 20 dB below the highest level of the radiated power. In addition, radiated emissions which fall in the restricted bands must also comply with the radiated emission limits.

3.7.2 Measuring Instruments

The measuring equipment is listed in the section 4 of this test report.

3.7.3 Test Procedure

1. The testing follows the guidelines in Spurious RF Conducted Emissions of FCC Public Notice DA 00-705 Measurement Guidelines
2. The RF output of EUT was connected to the spectrum analyzer by RF cable and attenuator. The path loss was compensated to the results for each measurement.
3. Set to the maximum power setting and enable the EUT transmit continuously.
4. Set RBW = 100 kHz, VBW = 300kHz, scan up through 10th harmonic. All harmonics / spurs must be at least 20 dB down from the highest emission level within the authorized band as measured with a 100 kHz RBW.
5. Measure and record the results in the test report.
6. The RF fundamental frequency should be excluded against the limit line in the operating frequency band.

3.7.4 Test Setup

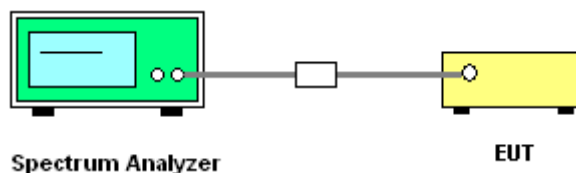

3.7.5 Test Result of Conducted Spurious Emission

Test Mode :	1Mbps	Temperature :	24~26°C
Test Channel :	00	Relative Humidity :	50~53%
		Test Engineer :	Alex Lee

1Mbps CSE Plot on Ch 00 between 30MHz ~ 3 GHz

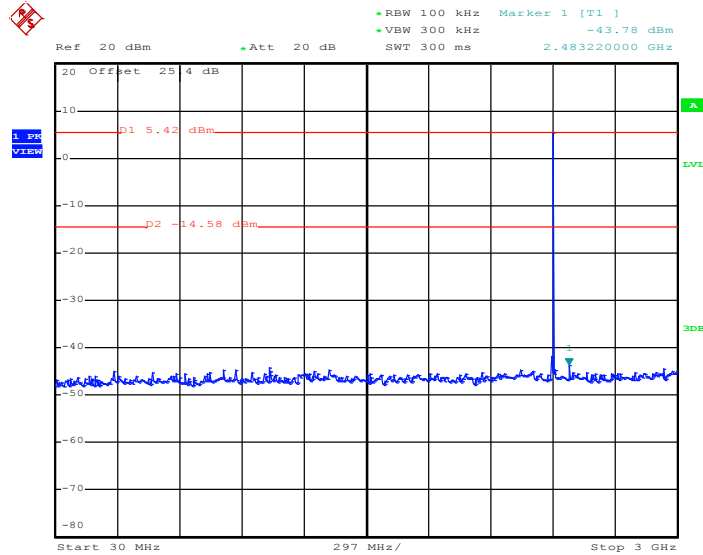

Date: 17.MAR.2014 14:26:04

1Mbps CSE Plot on Ch 00 between 2 GHz ~ 25 GHz

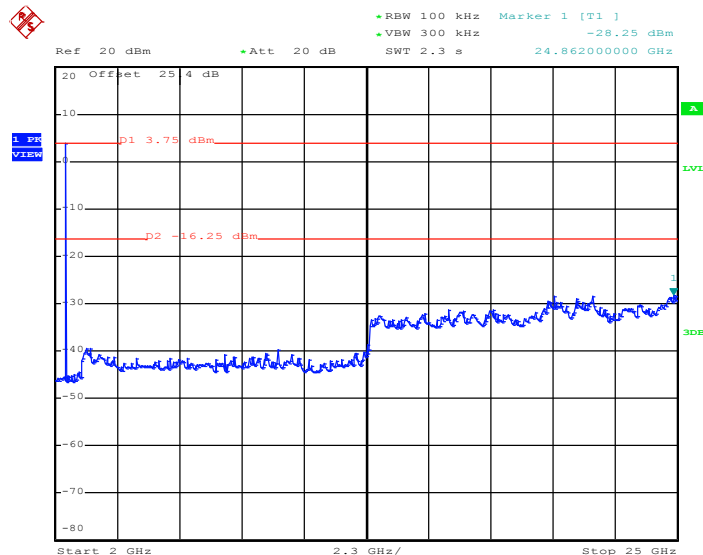

Date: 17.MAR.2014 14:26:26



Test Mode :	1Mbps	Temperature :	24~26°C
Test Channel :	39	Relative Humidity :	50~53%
		Test Engineer :	Alex Lee

1Mbps CSE Plot on Ch 39 between 30MHz ~ 3 GHz

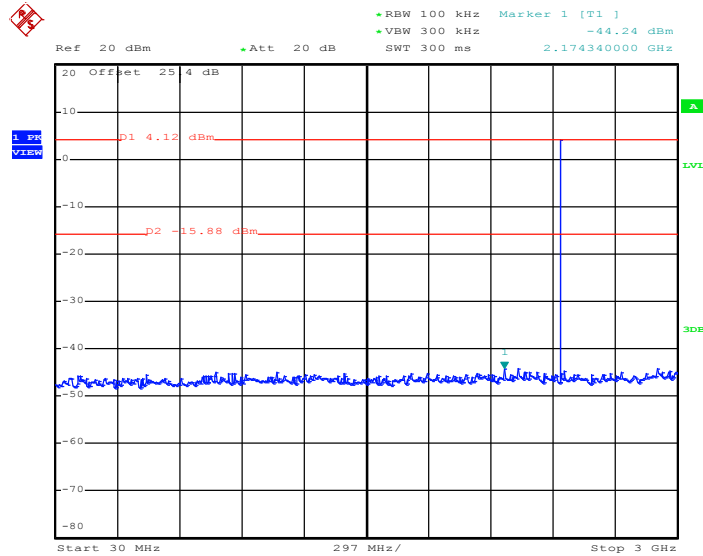

Date: 17.MAR.2014 14:37:19

1Mbps CSE Plot on Ch 39 between 2 GHz ~ 25 GHz

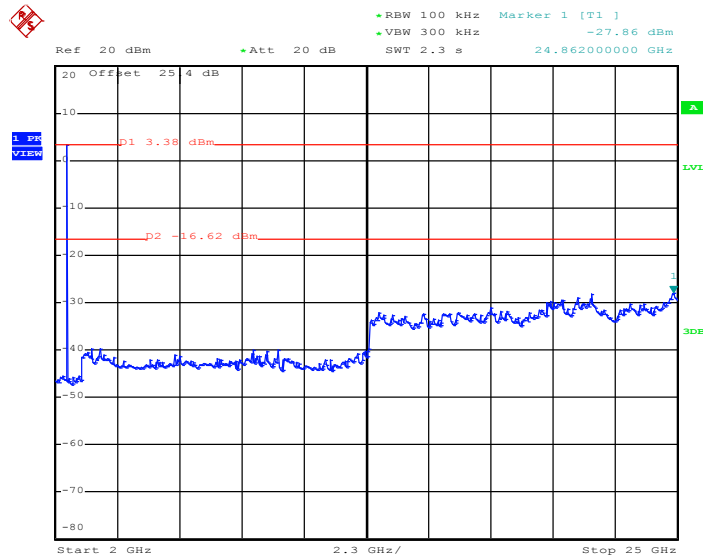

Date: 17.MAR.2014 14:37:41



Test Mode :	1Mbps	Temperature :	24~26°C
Test Channel :	78	Relative Humidity :	50~53%
		Test Engineer :	Alex Lee

1Mbps CSE Plot on Ch 78 between 30MHz ~ 3 GHz

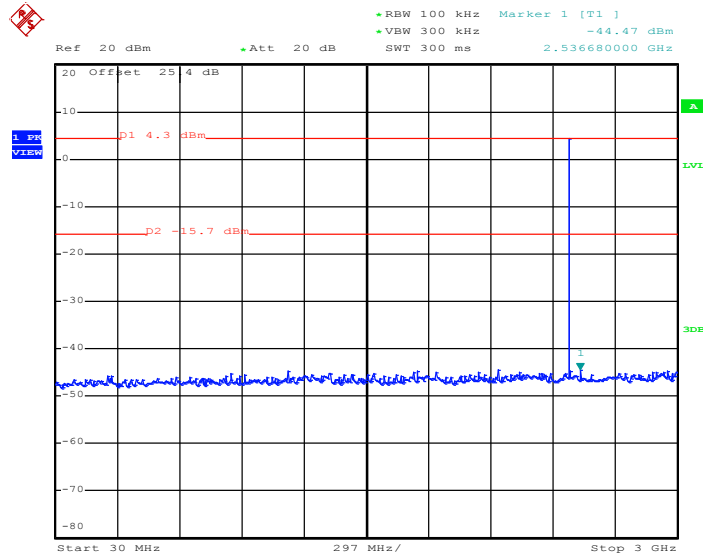

Date: 17.MAR.2014 14:38:11

1Mbps CSE Plot on Ch 78 between 2 GHz ~ 25 GHz

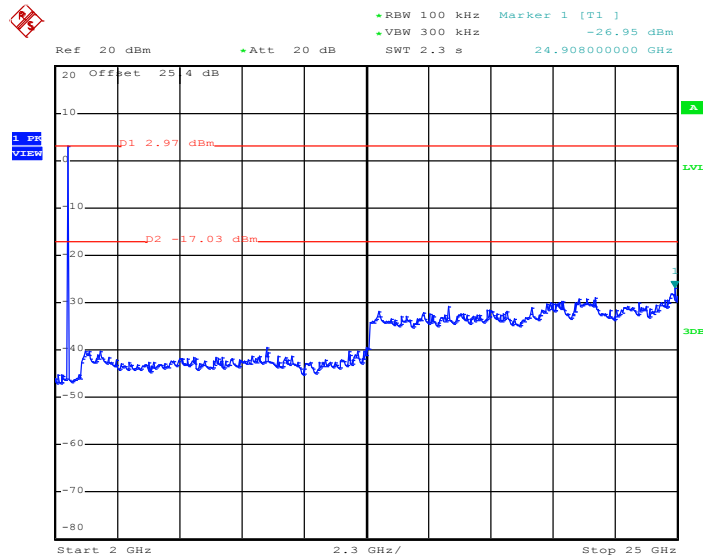

Date: 17.MAR.2014 14:38:32



Test Mode :	2Mbps	Temperature :	24~26°C
Test Channel :	00	Relative Humidity :	50~53%
		Test Engineer :	Alex Lee

2Mbps CSE Plot on Ch 00 between 30MHz ~ 3 GHz

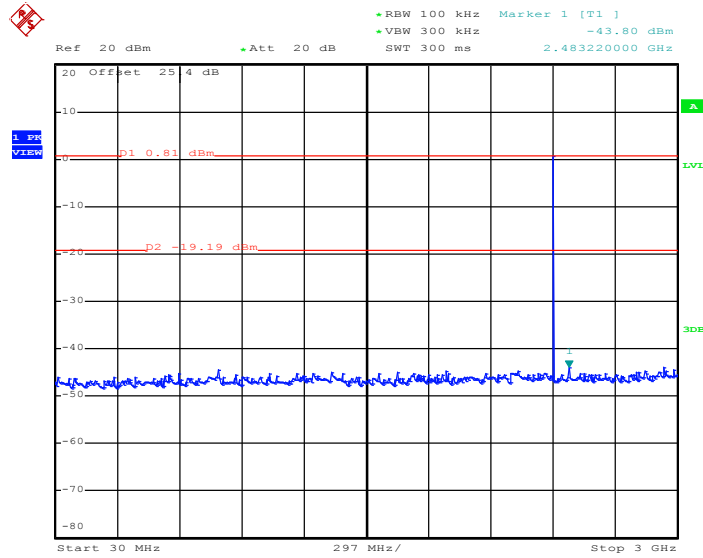

Date: 17.MAR.2014 14:41:06

2Mbps CSE Plot on Ch 00 between 2 GHz ~ 25 GHz

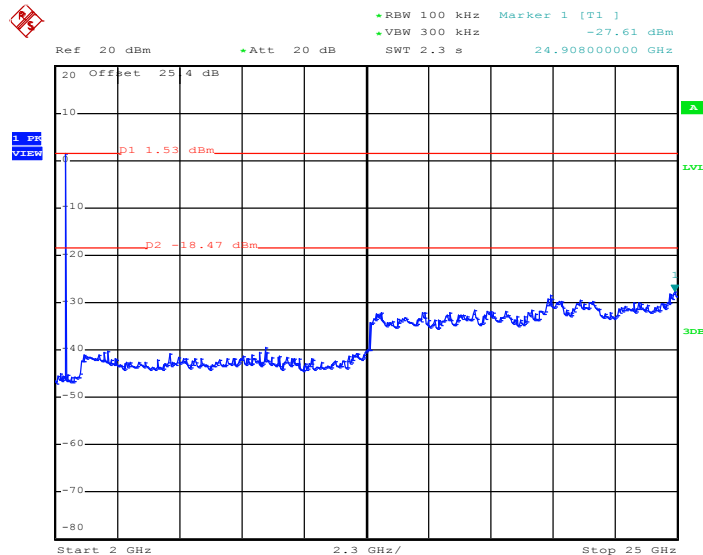

Date: 17.MAR.2014 14:41:28



Test Mode :	2Mbps	Temperature :	24~26°C
Test Channel :	39	Relative Humidity :	50~53%
		Test Engineer :	Alex Lee

2Mbps CSE Plot on Ch 39 between 30MHz ~ 3 GHz

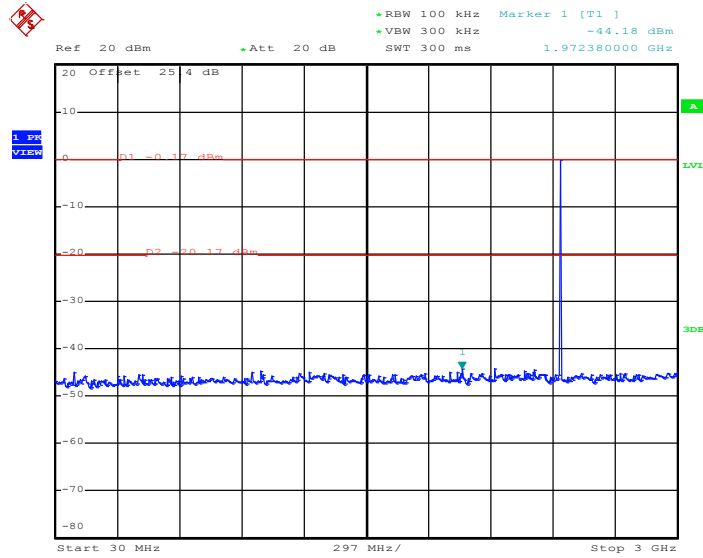

Date: 17.MAR.2014 14:40:10

2Mbps CSE Plot on Ch 39 between 2 GHz ~ 25 GHz

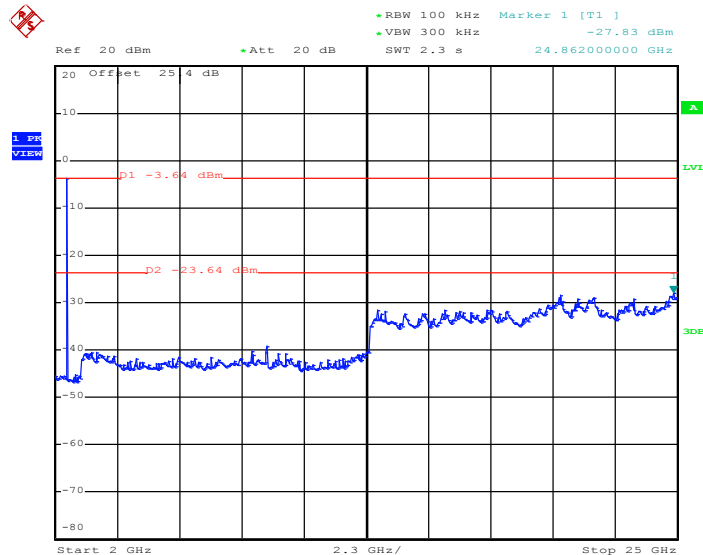

Date: 17.MAR.2014 14:40:32



Test Mode :	2Mbps	Temperature :	24~26°C
Test Channel :	78	Relative Humidity :	50~53%
		Test Engineer :	Alex Lee

2Mbps CSE Plot on Ch 78 between 30MHz ~ 3 GHz

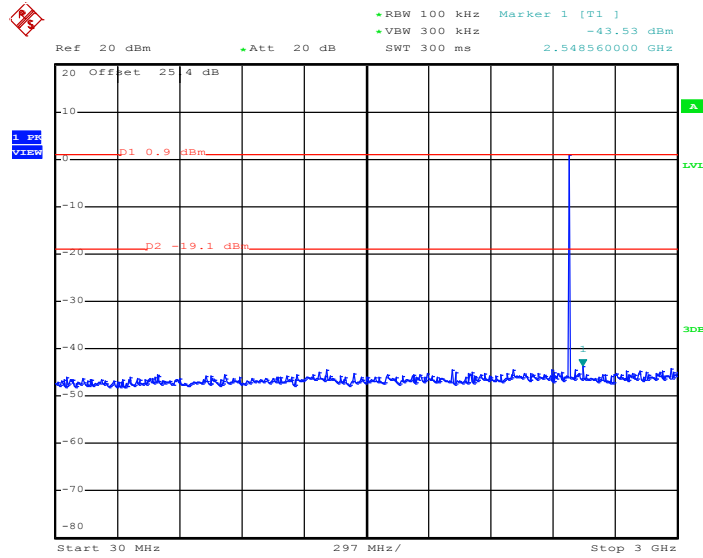

Date: 17.MAR.2014 14:39:18

2Mbps CSE Plot on Ch 78 between 2 GHz ~ 25 GHz

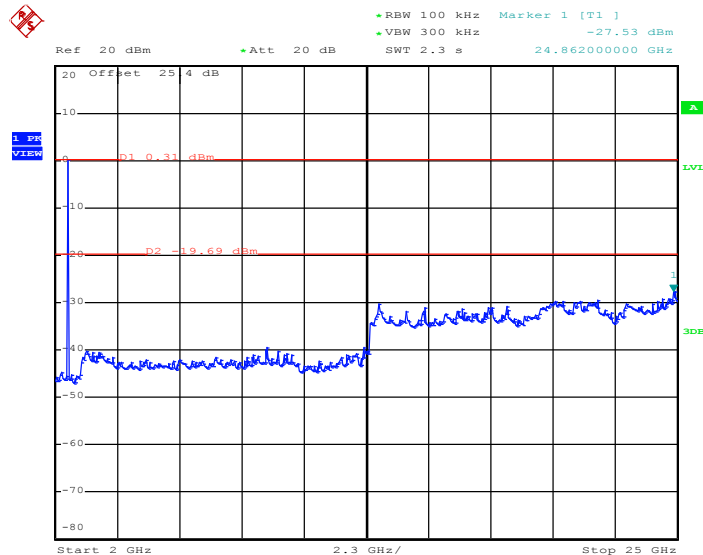

Date: 17.MAR.2014 14:39:40



Test Mode :	3Mbps	Temperature :	24~26°C
Test Channel :	00	Relative Humidity :	50~53%
		Test Engineer :	Alex Lee

3Mbps CSE Plot on Ch 00 between 30MHz ~ 3 GHz

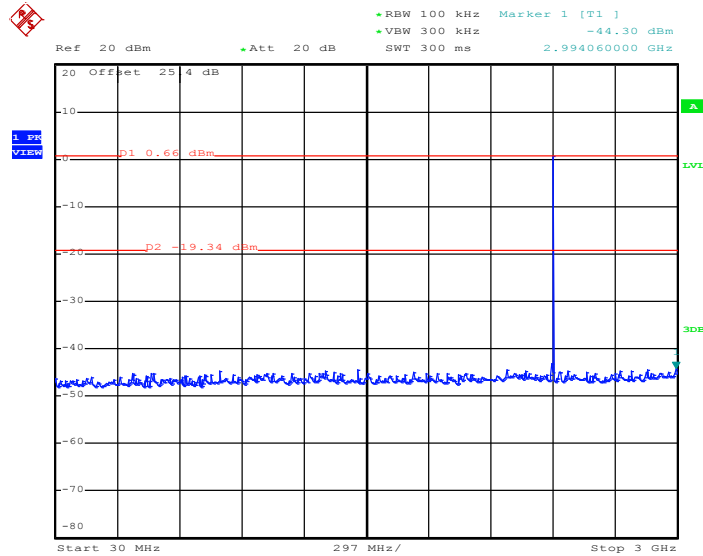

Date: 17.MAR.2014 14:41:58

3Mbps CSE Plot on Ch 00 between 2 GHz ~ 25 GHz

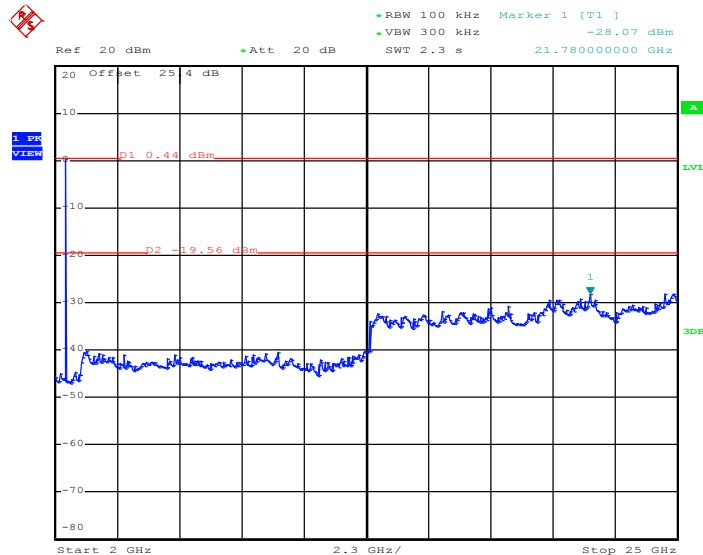

Date: 17.MAR.2014 14:42:20



Test Mode :	3Mbps	Temperature :	24~26°C
Test Channel :	39	Relative Humidity :	50~53%
		Test Engineer :	Alex Lee

3Mbps CSE Plot on Ch 39 between 30MHz ~ 3 GHz

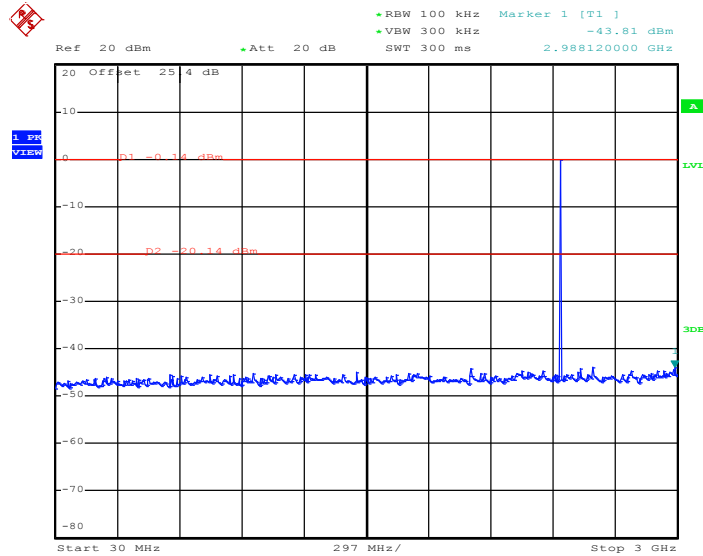

Date: 17.MAR.2014 14:43:14

3Mbps CSE Plot on Ch 39 between 2 GHz ~ 25 GHz

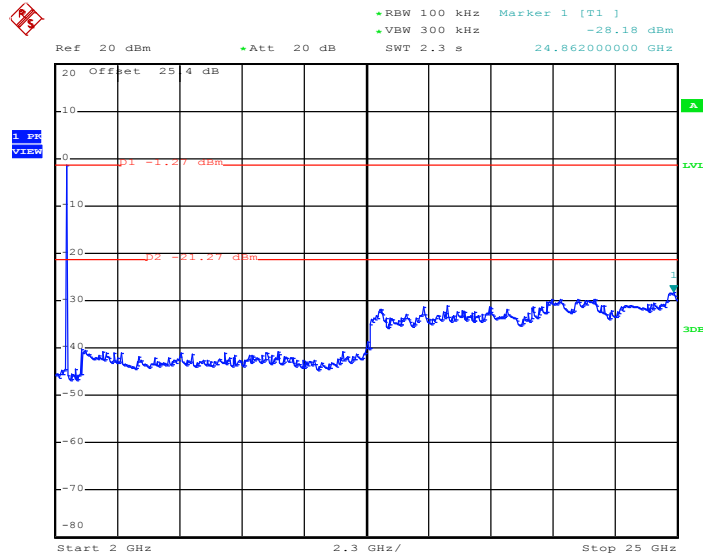

Date: 17.MAR.2014 14:43:36



Test Mode :	3Mbps	Temperature :	24~26°C
Test Channel :	78	Relative Humidity :	50~53%
		Test Engineer :	Alex Lee

3Mbps CSE Plot on Ch 78 between 30MHz ~ 3 GHz

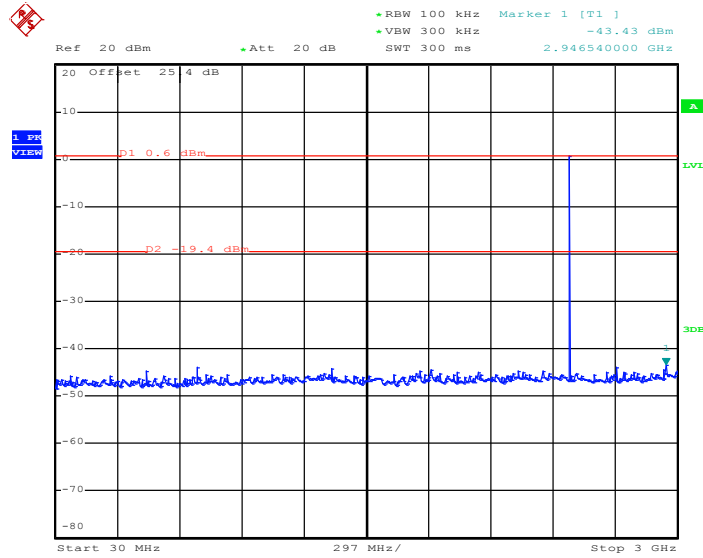

Date: 17.MAR.2014 14:44:09

3Mbps CSE Plot on Ch 78 between 2 GHz ~ 25 GHz

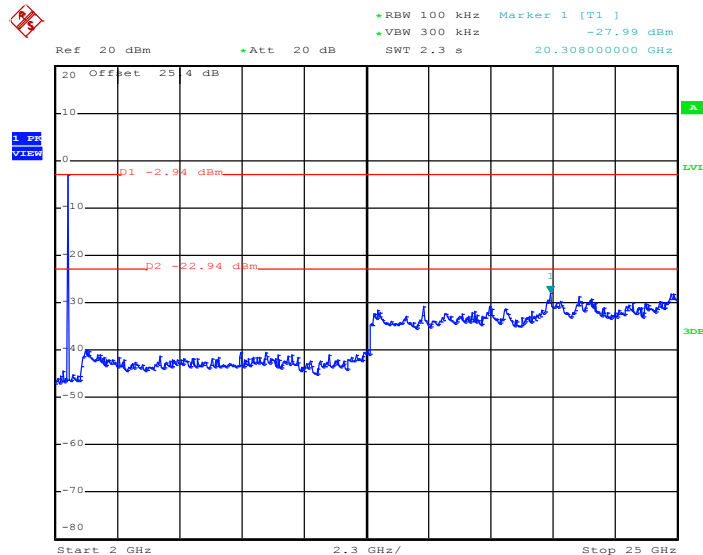

Date: 17.MAR.2014 14:44:31

3.8 Radiated Band Edges and Spurious Emission Measurement

3.8.1 Limit of Radiated Band Edges and Spurious Emission

In any 100 kHz bandwidth outside the intentional radiator frequency band, all harmonics/spurious must be at least 20 dB below the highest emission level within the authorized band. In addition, radiated emissions which fall in the restricted bands must also comply with the FCC section 15.209 limits as below.

Frequency (MHz)	Field Strength (microvolts/meter)	Measurement Distance (meters)
0.009 – 0.490	2400/F(kHz)	300
0.490 – 1.705	24000/F(kHz)	30
1.705 – 30.0	30	30
30 – 88	100	3
88 – 216	150	3
216 - 960	200	3
Above 960	500	3

3.8.2 Measuring Instruments

The measuring equipment is listed in the section 4 of this test report.



3.8.3 Test Procedures

1. The testing follows the guidelines in Spurious Radiated Emissions of FCC Public Notice DA 00-705 Measurement Guidelines.
2. The EUT was placed on a turntable with 0.8 meter above ground.
3. The EUT was set 3 meters from the interference receiving antenna, which was mounted on the top of a variable height antenna tower.
4. For each suspected emission, the EUT was arranged to its worst case and then tune the Antenna tower (from 1 m to 4 m) and turntable (from 0 degree to 360 degrees) to find the maximum reading. A pre-amp and a high pass filter are used for the test in order to get better signal level to comply with the guidelines.
5. Set to the maximum power setting and enable the EUT transmit continuously.
6. Use the following spectrum analyzer settings:
 - (1) Span shall wide enough to fully capture the emission being measured;
 - (2) Set RBW=100 kHz for $f < 1$ GHz, RBW=1MHz for $f > 1$ GHz ; VBW \geq RBW; Sweep = auto; Detector function = peak; Trace = max hold for peak
 - (3) For average measurement: use duty cycle correction factor method per 15.35(c).
Duty cycle = On time/100 milliseconds
On time = $N_1 * L_1 + N_2 * L_2 + \dots + N_{n-1} * L_{n-1} + N_n * L_n$
Where N_1 is number of type 1 pulses, L_1 is length of type 1 pulses, etc.
Average Emission Level = Peak Emission Level + $20 * \log(\text{Duty cycle})$
7. Corrected Reading: Antenna Factor + Cable Loss + Read Level - Preamp Factor = Level

Note: The average levels were calculated from the peak level corrected with duty cycle correction factor (-24.76dB) derived from $20 \log(\text{dwell time}/100\text{ms})$. This correction is only for signals that hop with the fundamental signal, such as band-edge and harmonic. Other spurious signals that are independent of the hopping signal would not use this correction.

3.8.4 Test Setup

For radiated emissions below 30MHz

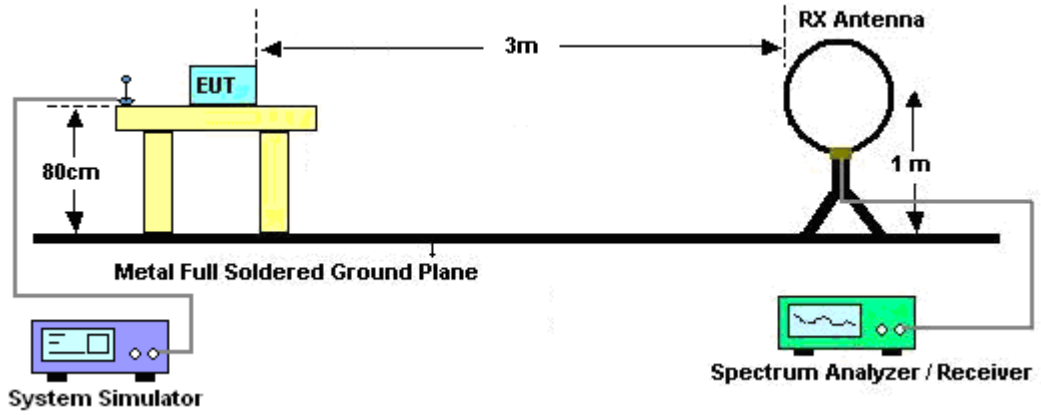

For radiated emissions from 30MHz to 1GHz

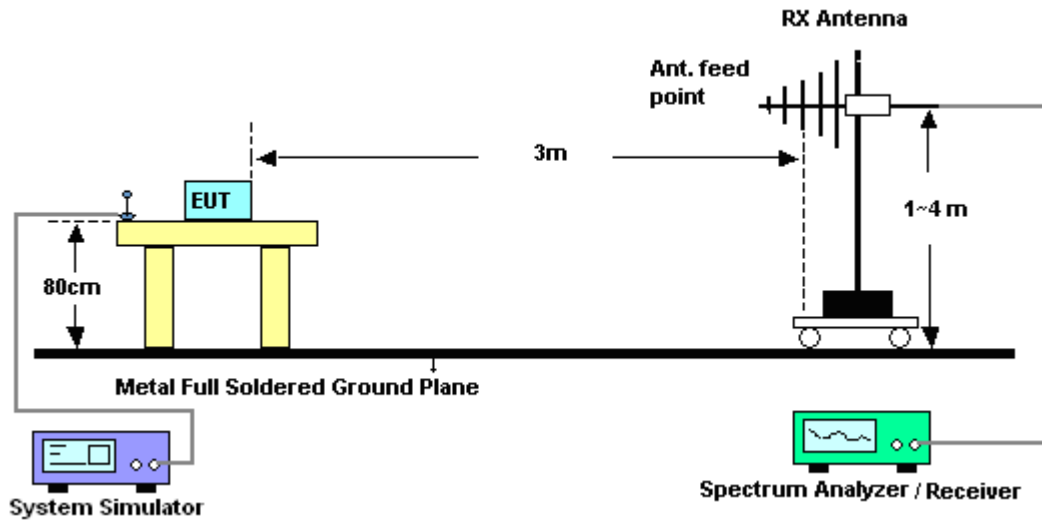

For radiated emissions above 1GHz

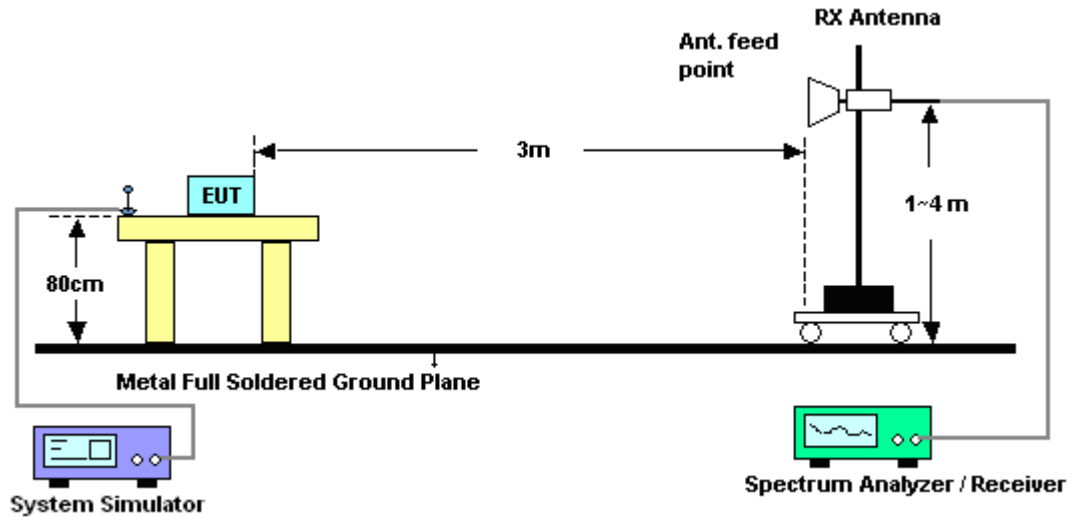

3.8.5 Test Results of Radiated Spurious Emissions (9 kHz ~ 30 MHz)

The low frequency, which started from 9 kHz to 30MHz, was pre-scanned and the result which was 20dB lower than the limit line per 15.31(o) was not reported.

3.8.6 Duty cycle correction factor for average measurement

DH5 on time (One Pulse) Plot on Channel 39

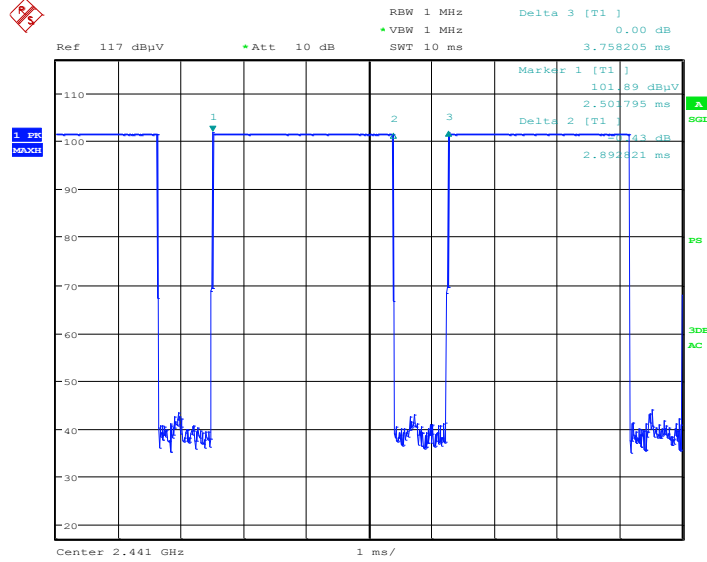

Date: 7.MAR.2014 01:06:44

DH5 on time (Count Pulses) Plot on Channel 39

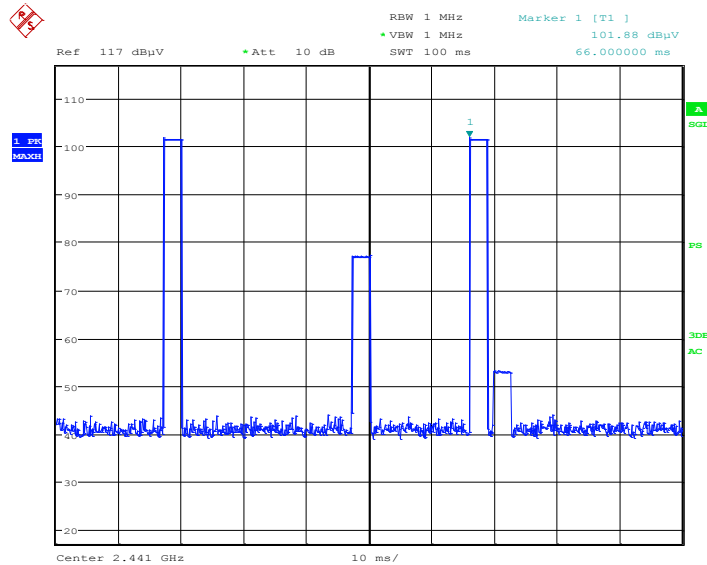

Date: 7.MAR.2014 01:08:00

Note:

1. Worst case Duty cycle = on time/100 milliseconds = $2 * 2.89 / 100 = 5.78 \%$
2. Worst case Duty cycle correction factor = $20 * \log(\text{Duty cycle}) = -24.76 \text{ dB}$
3. DH5 has the highest duty cycle worst case and is reported.



Duty Cycle Correction Factor Consideration for AFH mode:

Bluetooth normal hopping rate is 1600Hz and reduced to 800Hz in AFH mode; due to the reduced number of hopping frequencies, with the same packet configuration the dwell time in each channel frequency within 100msec period is longer in AFH mode than normal mode.

In AFH mode, the minimum hopping frequencies are 20, to get the longest dwell time DH5 packet is observed; the period to have DH5 packet completing one hopping sequence is

$$2.89 \text{ ms} \times 20 \text{ channels} = 57.8 \text{ ms}$$

There cannot be 2 complete hopping sequences within 100ms period, considering the random hopping behavior, maximum 2 hops can be possibly observed within the period. $[100\text{ms} / 57.6\text{ms}] = 2$ hops

Thus, the maximum possible ON time:

$$2.89 \text{ ms} \times 2 = 5.78 \text{ ms}$$

Worst case Duty Cycle Correction factor, which is derived from the maximum possible ON time,

$$20 \times \log(5.78 \text{ ms}/100\text{ms}) = -24.76 \text{ dB}$$



3.8.7 Test Result of Radiated Spurious at Band Edges

Test Mode :	1Mbps	Temperature :	22~24°C
Test Channel :	00	Relative Humidity :	50~52%
		Test Engineer :	Kyle Jhuang

ANTENNA POLARITY : HORIZONTAL										
Frequency (MHz)	Level (dBμV/m)	Over Limit (dB)	Limit Line (dBμV/m)	Read Level (dBμV)	Antenna Factor (dB)	Cable Loss (dB)	Preamp Factor (dB)	Ant Pos (cm)	Table Pos (deg)	Remark
2359.14	48	-26	74	45.12	32.22	6.21	35.55	129	360	Peak
2359.14	23.24	-30.76	54	-	-	-	-	-	-	Average

ANTENNA POLARITY : VERTICAL										
Frequency (MHz)	Level (dBμV/m)	Over Limit (dB)	Limit Line (dBμV/m)	Read Level (dBμV)	Antenna Factor (dB)	Cable Loss (dB)	Preamp Factor (dB)	Ant Pos (cm)	Table Pos (deg)	Remark
2361.21	47.92	-26.08	74	45.04	32.22	6.21	35.55	107	86	Peak
2361.21	23.16	-30.84	54	-	-	-	-	-	-	Average

Test Mode :	1Mbps	Temperature :	22~24°C
Test Channel :	78	Relative Humidity :	50~52%
		Test Engineer :	Kyle Jhuang

ANTENNA POLARITY : HORIZONTAL										
Frequency (MHz)	Level (dBμV/m)	Over Limit (dB)	Limit Line (dBμV/m)	Read Level (dBμV)	Antenna Factor (dB)	Cable Loss (dB)	Preamp Factor (dB)	Ant Pos (cm)	Table Pos (deg)	Remark
2483.5	62.07	-11.93	74	58.58	32.47	6.45	35.43	121	360	Peak
2483.5	37.31	-16.69	54	-	-	-	-	-	-	Average

ANTENNA POLARITY : VERTICAL										
Frequency (MHz)	Level (dBμV/m)	Over Limit (dB)	Limit Line (dBμV/m)	Read Level (dBμV)	Antenna Factor (dB)	Cable Loss (dB)	Preamp Factor (dB)	Ant Pos (cm)	Table Pos (deg)	Remark
2483.5	53.76	-20.24	74	50.27	32.47	6.45	35.43	107	86	Peak
2483.5	29	-25	54	-	-	-	-	-	-	Average

Note: Average Emission Level = Peak Emission Level + duty cycle correction factor(-24.76dB)



3.8.8 Test Result of Radiated Spurious Emission (30MHz ~ 10th Harmonic)

Note: Pre-scanned all test modes and only choose the worst case mode recorded in the test report for radiated spurious emission below 1GHz.

Test Mode :	1Mbps	Temperature :	22~24°C
Test Channel :	00	Relative Humidity :	50~52%
Test Engineer :	Kyle Jhuang	Polarization :	Horizontal
Remark :	2402 MHz is fundamental signal which can be ignored.		

Frequency (MHz)	Level (dBμV/m)	Over Limit (dB)	Limit Line (dBμV/m)	Read Level (dBμV)	Antenna Factor (dB)	Cable Loss (dB)	Preamp Factor (dB)	Ant Pos (cm)	Table Pos (deg)	Remark
2402	106.81	-	-	103.8	32.29	6.22	35.5	129	360	Peak
2402	82.05	-	-	-	-	-	-	-	-	Average
4803	39.75	-34.25	74	55.83	34.89	8	58.97	100	0	Peak
4803	14.99	-39.01	54	-	-	-	-	-	-	Average

- Note:** 1. Other harmonics are lower than background noise.
 2. Average Emission Level = Peak Emission Level + duty cycle correction factor(-24.76)

Test Mode :	1Mbps	Temperature :	22~24°C
Test Channel :	00	Relative Humidity :	50~52%
Test Engineer :	Kyle Jhuang	Polarization :	Vertical
Remark :	2402 MHz is fundamental signal which can be ignored.		

Frequency (MHz)	Level (dBμV/m)	Over Limit (dB)	Limit Line (dBμV/m)	Read Level (dBμV)	Antenna Factor (dB)	Cable Loss (dB)	Preamp Factor (dB)	Ant Pos (cm)	Table Pos (deg)	Remark
2402	97.15	-	-	94.14	32.29	6.22	35.5	107	86	Peak
2402	72.39	-	-	-	-	-	-	-	-	Average
4803	38.72	-35.28	74	54.8	34.89	8	58.97	100	0	Peak
4803	13.96	-40.04	54	-	-	-	-	-	-	Average

- Note:** 1. Other harmonics are lower than background noise.
 2. Average Emission Level = Peak Emission Level + duty cycle correction factor(-24.76)



Test Mode :	1Mbps	Temperature :	22~24°C
Test Channel :	39	Relative Humidity :	50~52%
Test Engineer :	Kyle Jhuang	Polarization :	Horizontal
Remark :	2442 MHz is fundamental signal which can be ignored.		

Frequency (MHz)	Level (dBµV/m)	Over Limit (dB)	Limit Line (dBµV/m)	Read Level (dBµV)	Antenna Factor (dB)	Cable Loss (dB)	Preamp Factor (dB)	Ant Pos (cm)	Table Pos (deg)	Remark
2442	105.64	-	-	102.36	32.4	6.34	35.46	122	360	Peak
2442	80.88	-	-	-	-	-	-	-	-	Average
4881	40.68	-33.32	74	56.47	34.93	8.15	58.87	100	0	Peak
4881	15.92	-38.08	54	-	-	-	-	-	-	Average
7323	40.21	-33.79	74	51.6	36.63	10.47	58.49	100	0	Peak
7323	15.45	-38.55	54	-	-	-	-	-	-	Average

- Note:** 1. Other harmonics are lower than background noise.
 2. Average Emission Level = Peak Emission Level + duty cycle correction factor(-24.76)

Test Mode :	1Mbps	Temperature :	22~24°C
Test Channel :	39	Relative Humidity :	50~52%
Test Engineer :	Kyle Jhuang	Polarization :	Vertical
Remark :	2442 MHz is fundamental signal which can be ignored.		

Frequency (MHz)	Level (dBµV/m)	Over Limit (dB)	Limit Line (dBµV/m)	Read Level (dBµV)	Antenna Factor (dB)	Cable Loss (dB)	Preamp Factor (dB)	Ant Pos (cm)	Table Pos (deg)	Remark
2442	94.02	-	-	90.74	32.4	6.34	35.46	107	86	Peak
2442	69.26	-	-	-	-	-	-	-	-	Average
4881	38.84	-35.16	74	54.63	34.93	8.15	58.87	100	0	Peak
4881	14.08	-39.92	54	-	-	-	-	-	-	Average
7323	39.21	-34.79	74	50.6	36.63	10.47	58.49	100	0	Peak
7323	14.45	-39.55	54	-	-	-	-	-	-	Average

- Note:** 1. Other harmonics are lower than background noise.
 2. Average Emission Level = Peak Emission Level + duty cycle correction factor(-24.76)



Test Mode :	1Mbps	Temperature :	22~24°C
Test Channel :	78	Relative Humidity :	50~52%
Test Engineer :	Kyle Jhuang	Polarization :	Horizontal
Remark :	2480 MHz is fundamental signal which can be ignored.		

Frequency (MHz)	Level (dBμV/m)	Over Limit (dB)	Limit Line (dBμV/m)	Read Level (dBμV)	Antenna Factor (dB)	Cable Loss (dB)	Preamp Factor (dB)	Ant Pos (cm)	Table Pos (deg)	Remark
92.91	13.35	-30.15	43.5	34.56	9.42	1.12	31.75	-	-	Peak
197.67	20.76	-22.74	43.5	42.06	8.82	1.63	31.75	-	-	Peak
230.07	25.88	-20.12	46	46.05	9.8	1.77	31.74	-	-	Peak
638.1	28.49	-17.51	46	38.8	18.82	2.91	32.04	-	-	Peak
689.9	32.2	-13.8	46	42.37	18.82	3.03	32.02	100	15	Peak
750.1	31.41	-14.59	46	40.29	19.96	3.15	31.99	-	-	Peak
2480	106.12	-	-	102.63	32.47	6.45	35.43	121	360	Peak
2480	81.36	-	-	-	-	-	-	-	-	Average
4962	42.88	-31.12	74	58.39	34.98	8.26	58.75	100	0	Peak
4962	18.12	-35.88	54	-	-	-	-	-	-	Average
7440	39.67	-34.33	74	51.3	36.61	10.47	58.71	100	0	Peak
7440	14.91	-39.09	54	-	-	-	-	-	-	Average

Note: 1. Other harmonics are lower than background noise.

2. Average Emission Level = Peak Emission Level + duty cycle correction factor(-24.76)



Test Mode :	1Mbps	Temperature :	22~24°C
Test Channel :	78	Relative Humidity :	50~52%
Test Engineer :	Kyle Jhuang	Polarization :	Vertical
Remark :	2480 MHz is fundamental signal which can be ignored.		

Frequency (MHz)	Level (dBμV/m)	Over Limit (dB)	Limit Line (dBμV/m)	Read Level (dBμV)	Antenna Factor (dB)	Cable Loss (dB)	Preamp Factor (dB)	Ant Pos (cm)	Table Pos (deg)	Remark
56.19	21.02	-18.98	40	46.33	5.59	0.88	31.78	-	-	Peak
74.82	19.12	-20.88	40	43.47	6.41	1.01	31.77	-	-	Peak
230.07	27.71	-18.29	46	47.55	10.13	1.77	31.74	-	-	Peak
598.2	25.83	-20.17	46	36.19	18.87	2.83	32.06	-	-	Peak
689.9	29.1	-16.9	46	39.23	18.86	3.03	32.02	100	116	Peak
750.1	24.66	-21.34	46	33.46	20.04	3.15	31.99	-	-	Peak
2480	97.3	-	-	93.81	32.47	6.45	35.43	107	86	Peak
2480	72.54	-	-	-	-	-	-	-	-	Average
4959	39.19	-34.81	74	54.7	34.98	8.26	58.75	100	0	Peak
4959	14.43	-39.57	54	-	-	-	-	-	-	Average
7440	39.38	-34.62	74	51.01	36.61	10.47	58.71	100	0	Peak
7440	14.62	-39.38	54	-	-	-	-	-	-	Average

Note: 1. Other harmonics are lower than background noise.

2. Average Emission Level = Peak Emission Level + duty cycle correction factor(-24.76)

3.9 AC Conducted Emission Measurement

3.9.1 Limit of AC Conducted Emission

For equipment that is designed to be connected to the public utility (AC) power line, the radio frequency voltage that is conducted back onto the AC power line on any frequency or frequencies within the band 150 kHz to 30 MHz shall not exceed the limits in the following table.

Frequency of emission (MHz)	Conducted limit (dB μ V)	
	Quasi-peak	Average
0.15-0.5	66 to 56*	56 to 46*
0.5-5	56	46
5-30	60	50

*Decreases with the logarithm of the frequency.

3.9.2 Measuring Instruments

The measuring equipment is listed in the section 4 of this test report.

3.9.3 Test Procedures

1. The EUT was placed 0.4 meter from the conducting wall of the shielding room was kept at least 80 centimeters from any other grounded conducting surface.
2. Connect EUT to the power mains through a line impedance stabilization network (LISN).
3. All the support units are connecting to the other LISN.
4. The LISN provides 50 ohm coupling impedance for the measuring instrument.
5. The FCC states that a 50 ohm, 50 microhenry LISN should be used.
6. Both sides of AC line were checked for maximum conducted interference.
7. The frequency range from 150 kHz to 30 MHz was searched.
8. Set the test-receiver system to Peak Detect Function and specified bandwidth with Maximum Hold Mode.

3.9.4 Test Setup

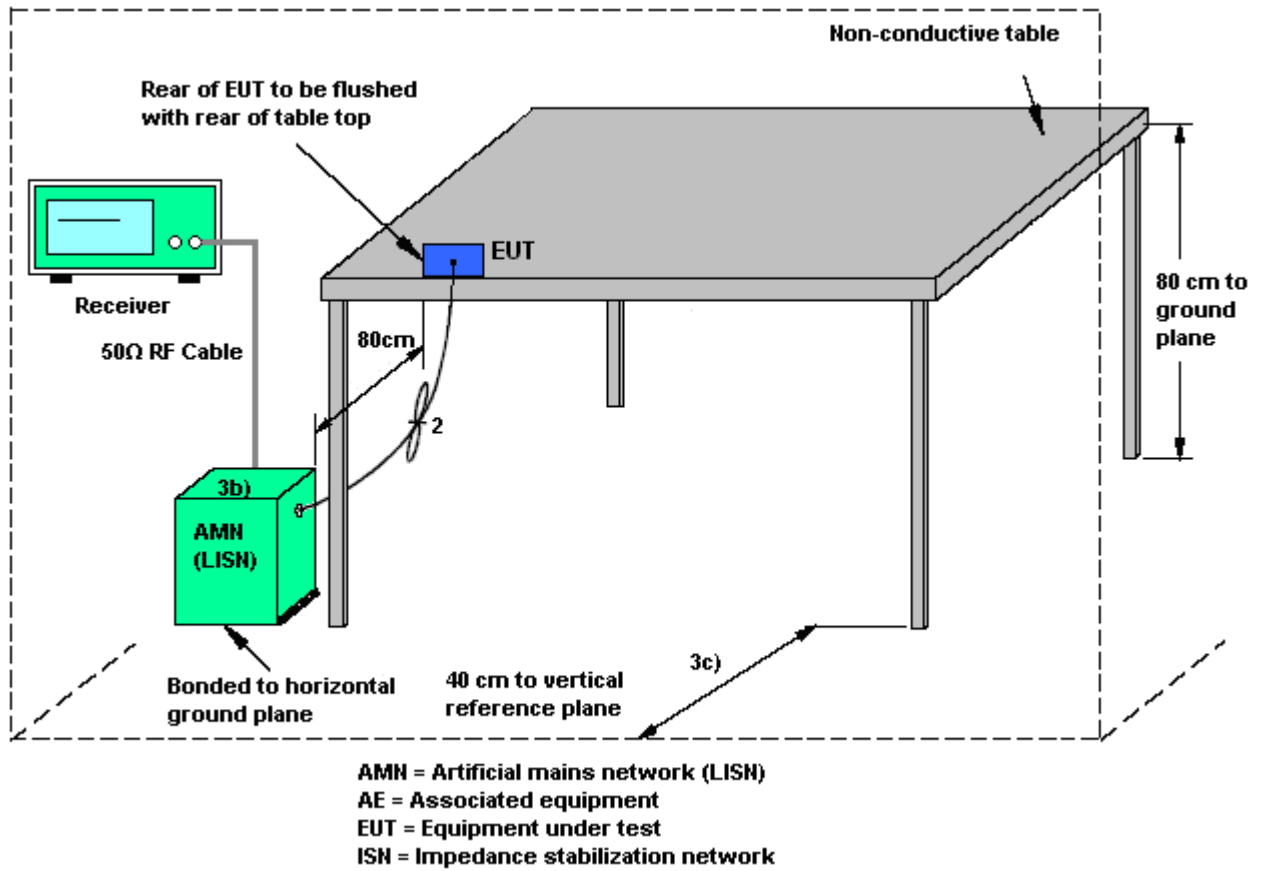

3.9.5 Test Result of AC Conducted Emission

Test Mode :	Mode 1	Temperature :	20~22°C
Test Engineer :	Cosmo Xu	Relative Humidity :	45~47%
Test Voltage :	120Vac / 60Hz	Phase :	Line
Function Type :	Bluetooth Link + WLAN (2.4GHz) Link + HDMI + Speaker + RJ-45 (Load) + Mouse + SD Card + MPEG4 + Adapter		

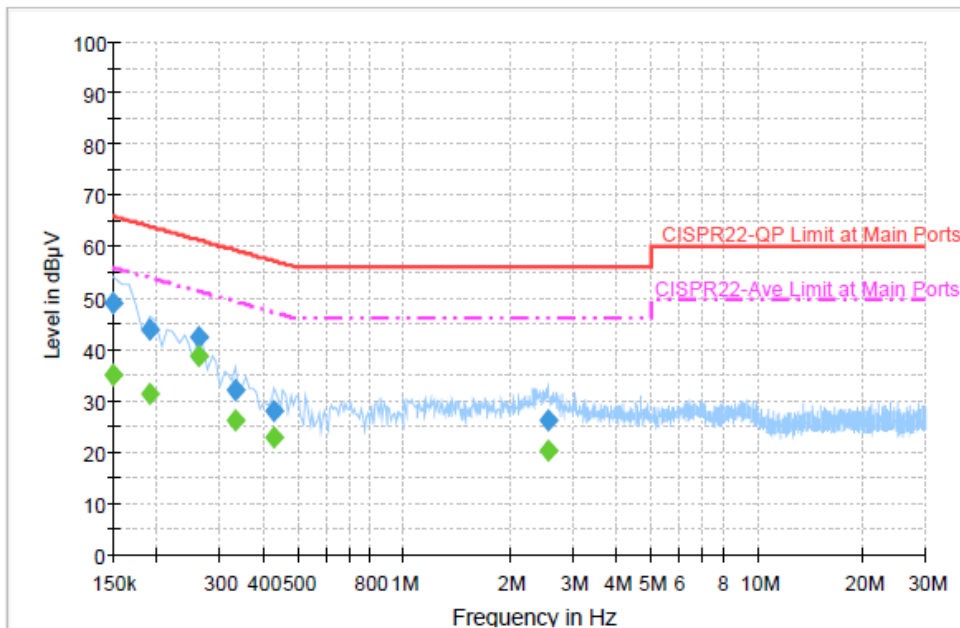

Final Result : Quasi-Peak

Frequency (MHz)	Quasi-Peak (dBμV)	Filter	Line	Corr. (dB)	Margin (dB)	Limit (dBμV)
0.150000	49.0	Off	L1	19.4	17.0	66.0
0.190000	44.1	Off	L1	19.4	19.9	64.0
0.262000	42.3	Off	L1	19.3	19.1	61.4
0.334000	32.0	Off	L1	19.4	27.4	59.4
0.430000	28.1	Off	L1	19.4	29.2	57.3
2.550000	26.1	Off	L1	19.6	29.9	56.0

Final Result : Average

Frequency (MHz)	Average (dBμV)	Filter	Line	Corr. (dB)	Margin (dB)	Limit (dBμV)
0.150000	35.1	Off	L1	19.4	20.9	56.0
0.190000	31.3	Off	L1	19.4	22.7	54.0
0.262000	38.7	Off	L1	19.3	12.7	51.4
0.334000	26.3	Off	L1	19.4	23.1	49.4
0.430000	23.1	Off	L1	19.4	24.2	47.3
2.550000	20.2	Off	L1	19.6	25.8	46.0

Test Mode :	Mode 1	Temperature :	20~22°C
Test Engineer :	Cosmo Xu	Relative Humidity :	45~47%
Test Voltage :	120Vac / 60Hz	Phase :	Neutral
Function Type :	Bluetooth Link + WLAN (2.4GHz) Link + HDMI + Speaker + RJ-45 (Load) + Mouse + SD Card + MPEG4 + Adapter		

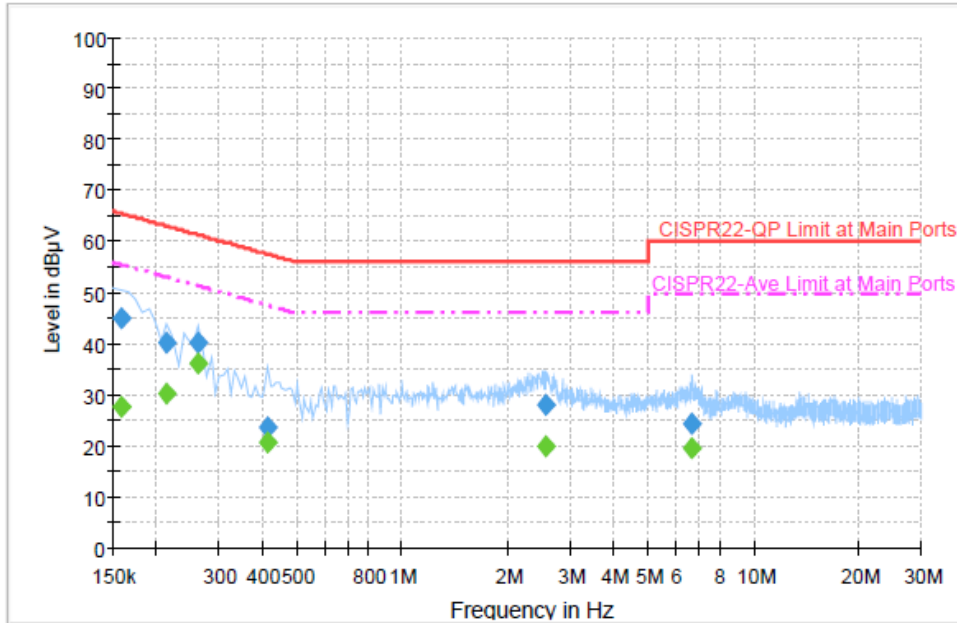

Final Result : Quasi-Peak

Frequency (MHz)	Quasi-Peak (dBµV)	Filter	Line	Corr. (dB)	Margin (dB)	Limit (dBµV)
0.158000	45.2	Off	N	19.3	20.4	65.6
0.214000	40.2	Off	N	19.4	22.8	63.0
0.262000	40.1	Off	N	19.4	21.3	61.4
0.414000	23.6	Off	N	19.4	34.0	57.6
2.566000	28.0	Off	N	19.6	28.0	56.0
6.702000	24.3	Off	N	19.6	35.7	60.0

Final Result : Average

Frequency (MHz)	Average (dBµV)	Filter	Line	Corr. (dB)	Margin (dB)	Limit (dBµV)
0.158000	27.8	Off	N	19.3	27.8	55.6
0.214000	30.4	Off	N	19.4	22.6	53.0
0.262000	36.3	Off	N	19.4	15.1	51.4
0.414000	20.7	Off	N	19.4	26.9	47.6
2.566000	20.0	Off	N	19.6	26.0	46.0
6.702000	19.5	Off	N	19.6	30.5	50.0



3.10 Antenna Requirements

3.10.1 Standard Applicable

If directional gain of transmitting antennas is greater than 6dBi, the power shall be reduced by the same level in dB comparing to gain minus 6dBi. The use of a permanently attached antenna or of an antenna that uses a unique coupling to the intentional radiator shall be considered sufficient to comply with the FCC rule.

3.10.2 Antenna Anti-Replacement Construction

An embedded-in antenna design is used.

3.10.3 Antenna Gain

The antenna peak gain of EUT is less than 6 dBi. Therefore, it is not necessary to reduce maximum peak output power limit.



4 List of Measuring Equipment

Instrument	Manufacturer	Model No.	Serial No.	Characteristics	Calibration Date	Test Date	Due Date	Remark
Spectrum Analyzer	Rohde & Schwarz	FSP40	100055	9kHz~40GHz	Jun. 07, 2013	Mar. 06, 2014 ~ Mar. 17, 2014	Jun. 06, 2014	Conducted (TH02-HY)
Power Meter	Agilent	E4416A	GB41292344	300MHz~40GHz	Jan. 28, 2014	Mar. 06, 2014 ~ Mar. 17, 2014	Jan. 27, 2015	Conducted (TH02-HY)
Power Sensor	Agilent	E9327A	US40441548	300MHz~40GHz	Jan. 28, 2014	Mar. 06, 2014 ~ Mar. 17, 2014	Jan. 27, 2015	Conducted (TH02-HY)
EMI Test Receiver	Rohde & Schwarz	ESU26	100472	20Hz – 26.5GHz	Jan. 15, 2014	Mar. 07, 2014	Jan. 14, 2015	Radiation (03CH08-HY)
Bilog Antenna	Teseq GmbH	CBL6112D	35379	30MHz~2GHz	Oct. 10, 2013	Mar. 07, 2014	Oct. 09, 2014	Radiation (03CH08-HY)
Horn Antenna	ESCO	3117	000143261	1GHz~18GHz	Jan. 16, 2014	Mar. 07, 2014	Jan. 15, 2015	Radiation (03CH08-HY)
SHF-EHF Horn Antenna	SCHWARZBECK	BBHA 9170	BBHA9170251	15GHz~40GHz	Oct. 03, 2013	Mar. 07, 2014	Oct. 02, 2014	Radiation (03CH08-HY)
Amplifier	SONOMA	310N	187231	9kHz~1GHz	May 15, 2013	Mar. 07, 2014	May 14, 2014	Radiation (03CH08-HY)
Preamplifier	MITEQ	AMF-7D-0010 1800-30-10P	1590074	1GHz~18GHz	Jul. 09, 2013	Mar. 07, 2014	Jul. 08, 2014	Radiation (03CH08-HY)
Pre Amplifier	Agilent	8449B	3008A02665	1GHz~26.5GHz	Sep. 04, 2013	Mar. 07, 2014	Sep. 03, 2014	Radiation (03CH08-HY)
Turn Table	Chaintek	Chaintek 3000	N/A	0~360 Degree	N/A	Mar. 07, 2014	N/A	Radiation (03CH08-HY)
Antenna Mast	MF	MFA520BS	N/A	1m~4m	N/A	Mar. 07, 2014	N/A	Radiation (03CH08-HY)
Loop Antenna	Rohde & Schwarz	HFH2-Z2	860004/0001	9 kHz~30 MHz	Jul. 03, 2012	Mar. 07, 2014	Jul. 03, 2014	Radiation (03CH08-HY)
EMI Test Receiver	Rohde & Schwarz	ESCS 30	100356	9kHz ~ 2.75GHz	Nov. 15, 2013	Mar. 06, 2014	Nov. 14, 2014	Conduction (CO05-HY)
LISN (for auxiliary equipment)	Rohde & Schwarz	ENV216	100081	9kHz ~ 30MHz	Dec. 12, 2013	Mar. 06, 2014	Dec. 11, 2014	Conduction (CO05-HY)
LISN	Rohde & Schwarz	ENV216	100080	9kHz ~ 30MHz	Dec. 04, 2013	Mar. 06, 2014	Dec. 03, 2014	Conduction (CO05-HY)
AC Power Source	ChainTek	APC-1000W	N/A	N/A	N/A	Mar. 06, 2014	N/A	Conduction (CO05-HY)



5 Uncertainty of Evaluation

Uncertainty of Conducted Emission Measurement (150 kHz ~ 30 MHz)

Measuring Uncertainty for a Level of Confidence of 95% ($U = 2Uc(y)$)	2.26
---	------

Uncertainty of Radiated Emission Measurement (30 MHz ~ 1000 MHz)

Measuring Uncertainty for a Level of Confidence of 95% ($U = 2Uc(y)$)	4.30
---	------

