

S

T

S

L

A

B



FCC Part 15B TEST REPORT

Report No: STS1510021E01

Issued for

Inspira Technologies LLC

1901 4th Ave Suite 210 San Diego, CA 92101 United States

Product Name:	Tablet PC
Brand Name:	Astro Tab
Model No.:	A735
Series Model:	N/A
FCC ID:	2ABQ6A735
Test Standard:	FCC Part 15B

Any reproduction of this document must be done in full. No single part of this document may be reproduced without permission from STS, All Test Data Presented in this report is only applicable to presented Test sample.





TEST RESULT CERTIFICATION

Applicant's name..... Inspira Technologies LLC

Address..... 1901 4th Ave Suite 210 San Diego, CA 92101 United States

Manufacture's Name SHENZHEN HENGLONGSHENG TECHNOLOGY CO. LIMITED

Address..... 4F,B4 Building,3rd Industrial Zone,Fenghuanggang,Bao'an District Shenzhen, China

Product description

Product name..... Tablet PC

Brand name..... Astro Tab

Model and/or type reference... A735

Standards..... FCC Part 15B

Test procedure ANSI C63.4-2014

This device described above has been tested by STS, and the test results show that the equipment under test (EUT) is in compliance with the FCC requirements. And it is applicable only to the tested sample identified in the report.

This report shall not be reproduced except in full, without the written approval of STS, this document may be altered or revised by STS, personal only, and shall be noted in the revision of the document.

Date of Test.....

Date of performance of tests .. 14 Oct. 2015 ~21 Oct. 2015

Date of Issue 22 Oct. 2015

Test Result Pass

Testing Engineer :

Hakim Hou

(Hakim Hou)

Technical Manager :

Vita Li

(Vita Li)

Authorized Signatory :

Bovey Yang

(Bovey Yang)





Table of Contents

1. SUMMARY OF TEST RESULTS	5
1.1 TEST FACTORY	5
1.2 MEASUREMENT UNCERTAINTY	5
2. GENERAL INFORMATION	6
2.1 GENERAL DESCRIPTION OF EUT	6
2.2 DESCRIPTION OF TEST MODES	7
2.3 BLOCK DIGRAM SHOWING THE CONFIGURATION OF SYSTEM TESTED	7
2.4 DESCRIPTION OF SUPPORT UNITS	8
2.5 EQUIPMENTS LIST FOR ALL TEST ITEMS	9
3. EMC EMISSION TEST	10
3.1 CONDUCTED EMISSION MEASUREMENT	10
3.1.1 POWER LINE CONDUCTED EMISSION LIMITS	10
3.1.2 TEST PROCEDURE	11
3.1.3 DEVIATION FROM TEST STANDARD	11
3.1.4 TEST SETUP	11
3.1.5 EUT OPERATING CONDITIONS	11
3.1.6 TEST RESULTS	12
3.2 RADIATED EMISSION MEASUREMENT	14
3.2.1 RADIATED EMISSION LIMITS	14
3.2.2 TEST PROCEDURE	15
3.2.3 DEVIATION FROM TEST STANDARD	15
3.2.4 TEST SETUP	16
3.2.5 EUT OPERATING CONDITIONS	17
3.2.6 TEST RESULTS	18
4. PHOTOS OF TEST SETUP	22



Revision History

Rev.	Issue Date	Report NO.	Effect Page	Contents
00	22 Oct. 2015	STS1510021E01	ALL	Initial Issue





1. SUMMARY OF TEST RESULTS

Test procedures according to the technical standards:

EMISSION			
Standard	Item	Result	Remarks
FCC 47 CFR Part 15 Subpart B (10-1-05 Edition)	Conducted Emission	PASS	Meet Class B limit
	Radiated Emission	PASS	Meet Class B limit

NOTE:

(1) " N/A" denotes test is not applicable in this Test Report

1.1 TEST FACTORY

Shenzhen STS Test Services Co., Ltd.
 Add.: 1/F., Building B, Zhuoke Science Park, No.190,Chongqing Road,
 Fuyong Street, Bao'an District, Shenzhen, Guangdong,China
 CNAS Registration No.: L7649;
 FCC Registration No.: 842334; IC Registration No.: 12108A-1

1.2 MEASUREMENT UNCERTAINTY

The reported uncertainty of measurement $y \pm U$, where expended uncertainty U is based on a standard uncertainty multiplied by a coverage factor of $k=2$, providing a level of confidence of approximately 95 % .

No.	Item	Uncertainty
1	Conducted Emission (9KHz-150KHz)	$\pm 2.88\text{dB}$
2	Conducted Emission (150KHz-30MHz)	$\pm 2.67\text{dB}$
3	RF power,conducted	$\pm 0.70\text{dB}$
4	Spurious emissions,conducted	$\pm 1.19\text{dB}$
5	All emissions,radiated(<1G) 30MHz-200MHz	$\pm 2.83\text{dB}$
6	All emissions,radiated(<1G) 200MHz-1000MHz	$\pm 2.94\text{dB}$
7	All emissions,radiated(>1G)	$\pm 3.03\text{dB}$
8	Temperature	$\pm 0.5^{\circ}\text{C}$
9	Humidity	$\pm 2\%$



2. GENERAL INFORMATION

2.1 GENERAL DESCRIPTION OF EUT

Equipment	Tablet PC
Trade Name	Astro Tab
Model Name	A735
Series Model	N/A
Model Difference	N/A
Channel List	Please refer to the Note 2.
Power Rating	Adapter: Input:AC 100-240V,50/60Hz,350mA Output:DC 5V,1500mA Battery: Rated Voltage:3.7V capacity : 2600mAh
Hardware version number	N/A
Software versioning number	N/A
Connecting I/O Port(s)	USB Port/ Earphone Port

Note: For a more detailed features description, please refer to the manufacturer's specifications or the User's Manual.



2.2 DESCRIPTION OF TEST MODES

To investigate the maximum EMI emission characteristics generates from EUT, the test system was pre-scanning tested base on the consideration of following EUT operation mode or test configuration mode which possible have effect on EMI emission level. Each of these EUT operation mode(s) or test configuration mode(s) mentioned above was evaluated respectively.

Pretest Mode	Description
Mode 1	USB port do data communication with PC

For Conducted Test	
Final Test Mode	Description
Mode 1	USB port do data communication with PC

For Radiated Test	
Final Test Mode	Description
Mode 1	USB port do data communication with PC

NOTE:

1. Due to the different configuration and test, in this list only some worse mode. The worst test data of the worse modeis reported by this report.
2. We have be tested for all avaiable U.S. voltage and frequencies(For 120V, 50/60Hz and 240V, 50/60Hz) for which the device is capable of operation.

2.3 BLOCK DIGRAM SHOWING THE CONFIGURATION OF SYSTEM TESTED

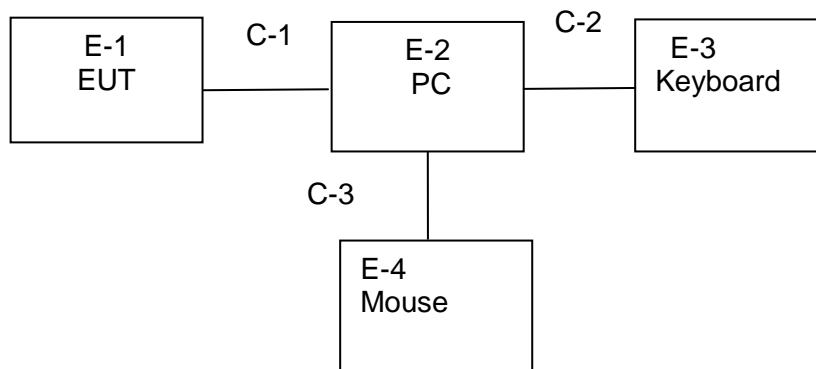



2.4 DESCRIPTION OF SUPPORT UNITS

The EUT has been tested as an independent unit together with other necessary accessories or support units. The following support units or accessories were used to form a representative test configuration during the tests.

Item	Equipment	Mfr/Brand	Model/Type No.	Serial No.	Note
E-1	Tablet PC	Astro Tab	A735	N/A	EUT
E-2	PC	4CV428DQXR	500-320cx	N/A	N/A
E-3	Keyboard	HP	PR1101U	N/A	N/A
E-4	Mouse	MOTOSPEED	F66	N/A	N/A

Item	Shielded Type	Ferrite Core	Length	Note
C-1	unshielded	NO	78cm	N/A
C-2	unshielded	NO	80cm	N/A
C-3	unshielded	NO	100cm	N/A

Note:

- (1) The support equipment was authorized by Declaration of Confirmation.
- (2) For detachable type I/O cable should be specified the length in cm in 『Length』 column.
- (3) “YES” is means “shielded” “with core”; “NO” is means “unshielded” “without core”.
- (4) E-1 ,E-2 ,E-3,E-4 are the FCC DOC is approved.



2.5 EQUIPMENTS LIST FOR ALL TEST ITEMS

The EUT has been tested as an independent unit together with other necessary accessories or support units. The following support units or accessories were used to form a representative test configuration during the tests.

Radiation Test equipment

Kind of Equipment	Manufacturer	Type No.	Serial No.	Last Calibration	Calibrated Until
EMI Test Receiver	R&S	ESCI	101427	2014.10.25	2015.10.24
Loop Antenna	Daze	ZN30900N	SEL0097	2014.10.27	2015.10.26
Bilog Antenna	TESEQ	CBL6111D	34678	2014.11.25	2015.11.24
Horn Antenna	Schwarzbeck	BBHA 9120D(1201)	9120D-1343	2015.03.06	2016.03.05
PreAmplifier	Agilent	8449B	60538	2014.10.25	2015.10.24
Temperature & Humidity	Mieo	HH660	N/A	2014.10.28	2015.10.27
Unversal radio communication tester	R&S	CMU200	111764	2014.10.25	2015.10.24
Spectrum Analyzer	Agilent	E4407B	MY50140340	2014.10.25	2015.10.24

Conduction Test equipment

Kind of Equipment	Manufacturer	Type No.	Serial No.	Last Calibration	Calibrated Until
EMI Test Receiver	R&S	ESPI	102086	2014.11.20	2015.11.19
LISN	R&S	ENV216	101242	2014.10.25	2015.10.24
LISN	EMCO	3810/2NM	000-23625	2014.10.25	2015.10.24
Absorbing clamp	R&S	MDS-21	100668	2014.10.27	2015.10.26



3. EMC EMISSION TEST

3.1 CONDUCTED EMISSION MEASUREMENT

3.1.1 POWER LINE CONDUCTED EMISSION Limits

FREQUENCY (MHz)	Class A (dBuV)		Class B (dBuV)		Standard
	Quasi-peak	Average	Quasi-peak	Average	
0.15 -0.5	79.00	66.00	66 - 56 *	56 - 46 *	CISPR
0.50 -5.0	73.00	60.00	56.00	46.00	CISPR
5.0 -30.0	73.00	60.00	60.00	50.00	CISPR

0.15 -0.5	79.00	66.00	66 - 56 *	56 - 46 *	FCC
0.50 -5.0	73.00	60.00	56.00	46.00	FCC
5.0 -30.0	73.00	60.00	60.00	50.00	FCC

Note:

- (1) The tighter limit applies at the band edges.
- (2) The limit of " * " marked band means the limitation decreases linearly with the logarithm of the frequency in the range.

The following table is the setting of the receiver

Receiver Parameters	Setting
Attenuation	10 dB
Start Frequency	0.15 MHz
Stop Frequency	30 MHz
IF Bandwidth	9 kHz

3.1.2 TEST PROCEDURE

The EUT was placed 0.4 meters from the horizontal ground plane with EUT being connected

- a. to the power mains through a line impedance stabilization network (LISN). All other support equipments powered from additional LISN(s). The LISN provide 50 Ohm/ 50uH of coupling impedance for the measuring instrument.
- b. Interconnecting cables that hang closer than 40 cm to the ground plane shall be folded back and forth in the center forming a bundle 30 to 40 cm long.
- c. I/O cables that are not connected to a peripheral shall be bundled in the center. The end of the cable may be terminated, if required, using the correct terminating impedance. The overall length shall not exceed 1 m.
- d. LISN at least 80 cm from nearest part of EUT chassis.
- e. For the actual test configuration, please refer to the related Item –EUT Test Photos.

3.1.3 DEVIATION FROM TEST STANDARD

No deviation

3.1.4 TEST SETUP

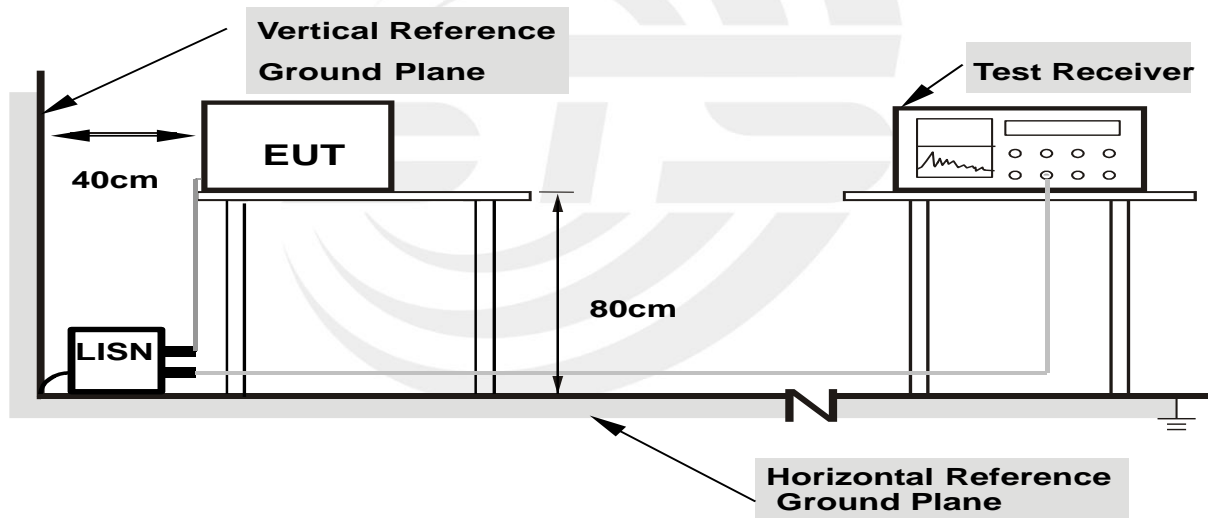

- Note:**
- 1.Support units were connected to second LISN.
 - 2.Both of LISNs (AMN) are 80 cm from EUT and at least 80 from other units and other metal planes

3.1.5 EUT OPERATING CONDITIONS

The EUT was configured for testing in a typical fashion (as a customer would normally use it). The EUT has been programmed to continuously transmit during test. This operating condition was tested and used to collect the included data.



3.1.6 TEST RESULTS

EUT:	Tablet PC	Model Name.:	A735
Temperature:	26 °C	Relative Humidity:	54%
Pressure:	1010hPa	Phase:	L
Test Voltage:	DC 5V	Test Mode:	Mode 1

No.	Frequency (MHz)	Reading (dBuV)	Factor (dB)	Result (dBuV)	Limit (dBuV)	Margin (dB)	Detector
1	0.1945	47.45	10.00	57.45	63.84	-6.39	QP
2	0.1945	27.61	10.00	37.61	53.84	-16.23	AVG
3	0.3860	35.98	10.16	46.14	58.15	-12.01	QP
4	0.3860	15.30	10.16	25.46	48.15	-22.69	AVG
5	0.6660	33.11	9.98	43.09	56.00	-12.91	QP
6	0.6660	8.07	9.98	18.05	46.00	-27.95	AVG
7	1.3260	33.44	9.93	43.37	56.00	-12.63	QP
8	1.3260	11.51	9.93	21.44	46.00	-24.56	AVG
9	3.5380	27.58	10.18	37.76	56.00	-18.24	QP
10	3.5380	5.11	10.18	15.29	46.00	-30.71	AVG
11	27.3060	28.96	10.52	39.48	60.00	-20.52	QP
12	27.3060	11.79	10.52	22.31	50.00	-27.69	AVG

Remark:

1. Factor = Antenna Factor + Cable Loss – Pre-amplifier.

100.0 dBuV

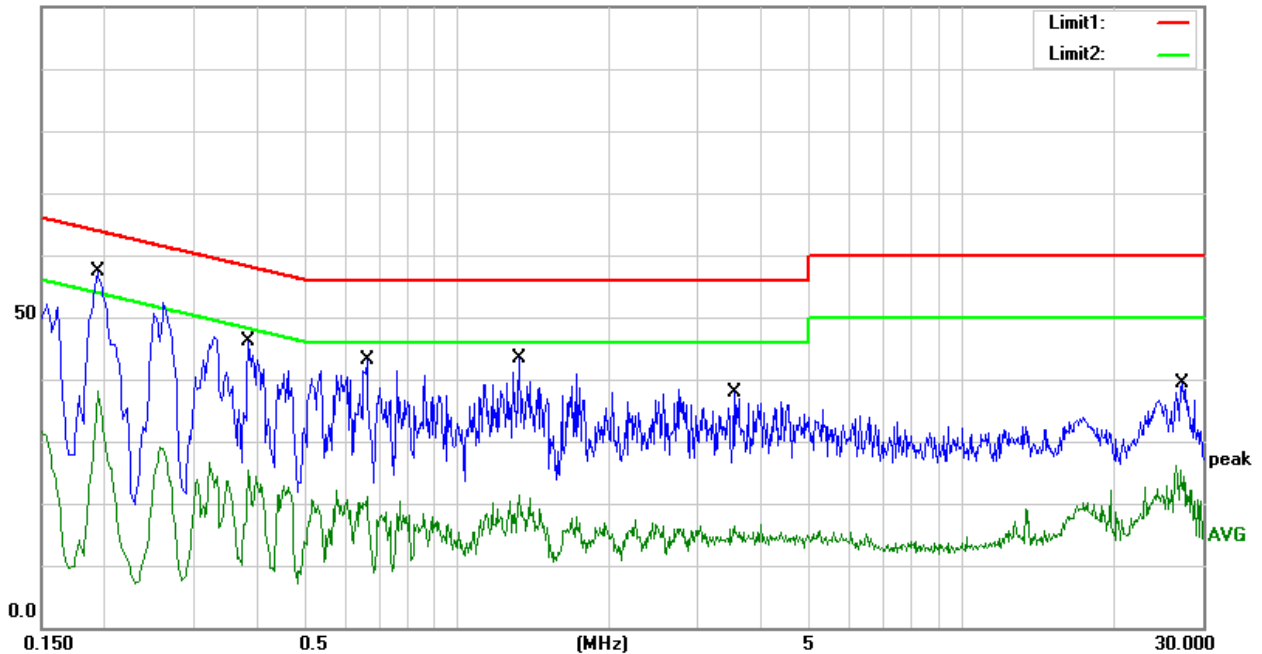



EUT:	Tablet PC	Model Name.:	A735
Temperature:	26 °C	Relative Humidity:	54%
Pressure:	1010hPa	Phase:	N
Test Voltage:	DC 5V	Test Mode:	Mode 1

No.	Frequency (MHz)	Reading (dBuV)	Factor (dB)	Result (dBuV)	Limit (dBuV)	Margin (dB)	Detector
1	0.1945	46.60	10.00	56.60	63.84	-7.24	QP
2	0.1945	26.00	10.00	36.00	53.84	-17.84	AVG
3	0.3831	36.11	9.98	46.09	58.21	-12.12	QP
4	0.3831	15.22	9.98	25.20	48.21	-23.01	AVG
5	1.2060	28.54	10.00	38.54	56.00	-17.46	QP
6	1.2060	11.48	10.00	21.48	46.00	-24.52	AVG
7	3.6580	26.43	10.19	36.62	56.00	-19.38	QP
8	3.6580	6.30	10.19	16.49	46.00	-29.51	AVG
9	8.3460	23.64	10.23	33.87	60.00	-26.13	QP
10	8.3460	4.34	10.23	14.57	50.00	-35.43	AVG
11	27.5460	28.41	10.66	39.07	60.00	-20.93	QP
12	27.5460	14.57	10.66	25.23	50.00	-24.77	AVG

Remark:

1. Factor = Antenna Factor + Cable Loss – Pre-amplifier.

100.0 dBuV

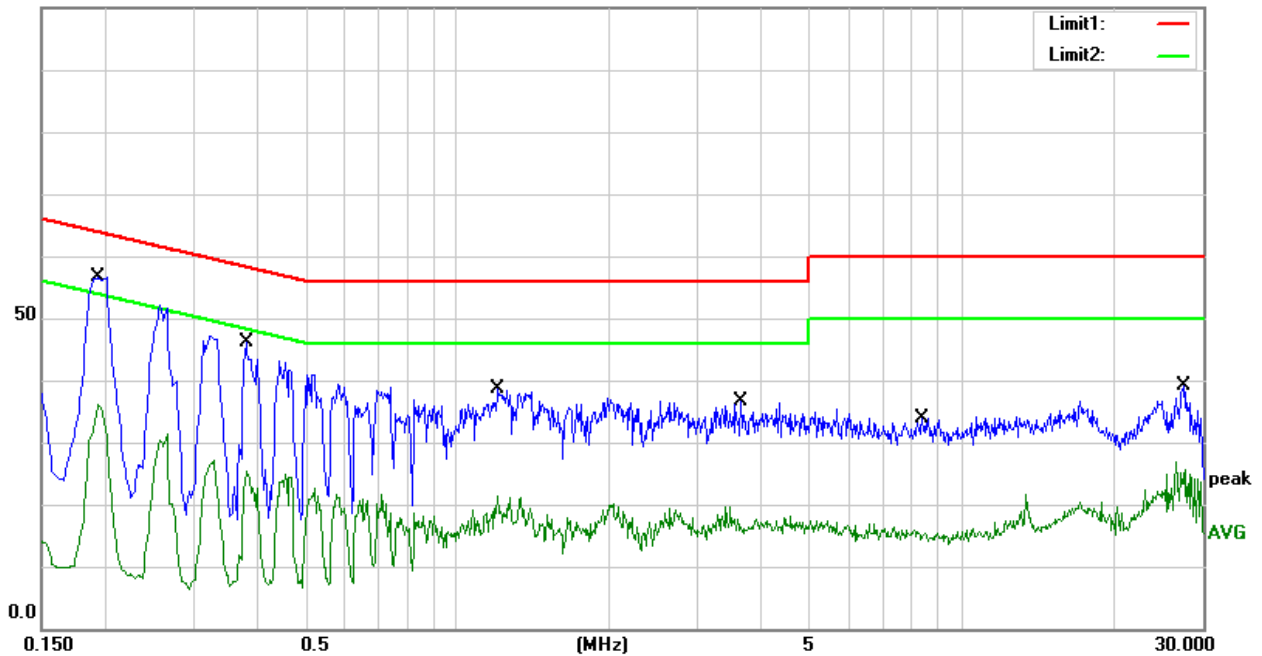



3.2 RADIATED EMISSION MEASUREMENT

3.2.1 Radiated Emission Limits

In the emission fall within the restricted band specified on 15.105(a), then the 15.109(a) limit in the table below has to be followed.

Frequencies (MHz)	Field Strength (microrvolts/meter)	Measurement Distance (meters)
0.009~0.490	2400/F(KHz)	300
0.490~1.705	24000/F(KHz)	30
1.705~30.0	30	30
30~88	100	3
88~216	150	3
216~960	200	3
Above 960	500	3

LIMITS OF RADIATED EMISSION MEASUREMENT (Above 1000MHz)

FREQUENCY (MHz)	Class A (dBuV/m) (at 3M)		Class B (dBuV/m) (at 3M)	
	PEAK	AVERAGE	PEAK	AVERAGE
Above 1000	80	60	74	54

Note:

- (1) The limit for radiated test was performed according to FCC PART 15C.
- (2) The tighter limit applies at the band edges.
- (3) Emission level (dBuV/m)=20log Emission level (uV/m).

FREQUENCY RANGE OF RADIATED MEASUREMENT (For unintentional radiators)

Highest frequency generated or Upper frequency of measurement used in the device or on which the device operates or tunes (MHz)	Range (MHz)
Below 1.705	30
1.705 – 108	1000
108 – 500	2000
500 – 1000	5000
Above 1000	5 th harmonic of the highest frequency or 40 GHz, whichever is lower
Spectrum Parameter	Setting



Attenuation	Auto
Detector	Peak
Start Frequency	1000 MHz(Peak/AV)
Stop Frequency	10th carrier harmonic(Peak/AV)
RB / VB (emission in restricted band)	1MHz /10 Hz

Receiver Parameter	Setting
Attenuation	Auto
Start ~ Stop Frequency	9kHz~150kHz/RB 200Hz for QP
Start ~ Stop Frequency	150kHz~30MHz/RB 9kHz for QP
Start ~ Stop Frequency	30MHz~1000MHz/RB 120kHz for QP

3.2.2 TEST PROCEDURE

- a. The measuring distance of at 3 m shall be used for measurements at frequency up to 1GHz. For frequencies above 1GHz, any suitable measuring distance may be used.
The EUT was placed on the top of a rotating table 0.8 meters above the ground at a 3 meter open area test site. The table was rotated 360 degrees to determine the position of the highest radiation.
- b.
- c. the height of the antenna shall vary between 1m to 4 m. Both horizontal and vertical polarizations of the antenna are set to make the measurement.
The initial step in collecting conducted emission data is a spectrum analyzer peak detector mode pre-scanning the measurement frequency range. Significant peaks are then marked and then Quasi Peak detector mode re-measured.
- d.
- e. If the Peak Mode measured value compliance with and lower than Quasi Peak Mode Limit, the EUT shall be deemed to meet QP Limits and then no additional QP Mode measurement performed.
- f. For the actual test configuration, please refer to the related Item –EUT Test Photos.

Note: Both horizontal and vertical antenna polarities were tested and performed pretest to three orthogonal axis. The worst case emissions were reported

3.2.3 DEVIATION FROM TEST STANDARD

No deviation

3.2.4 TEST SETUP

(A) Radiated Emission Test-Up Frequency Below 30MHz

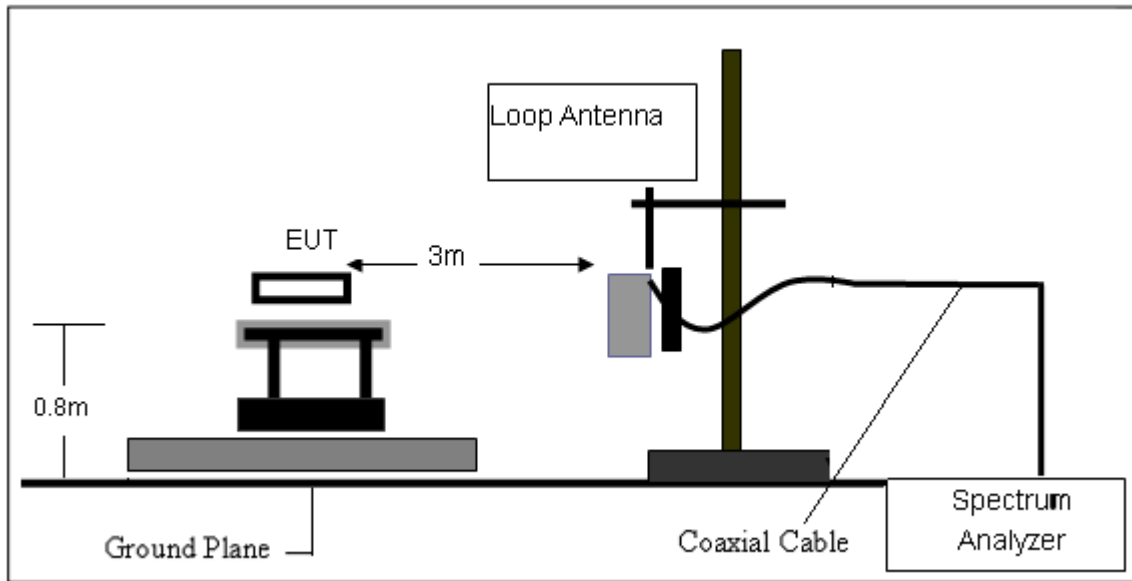

(B) Radiated Emission Test-Up Frequency 30MHz~1GHz

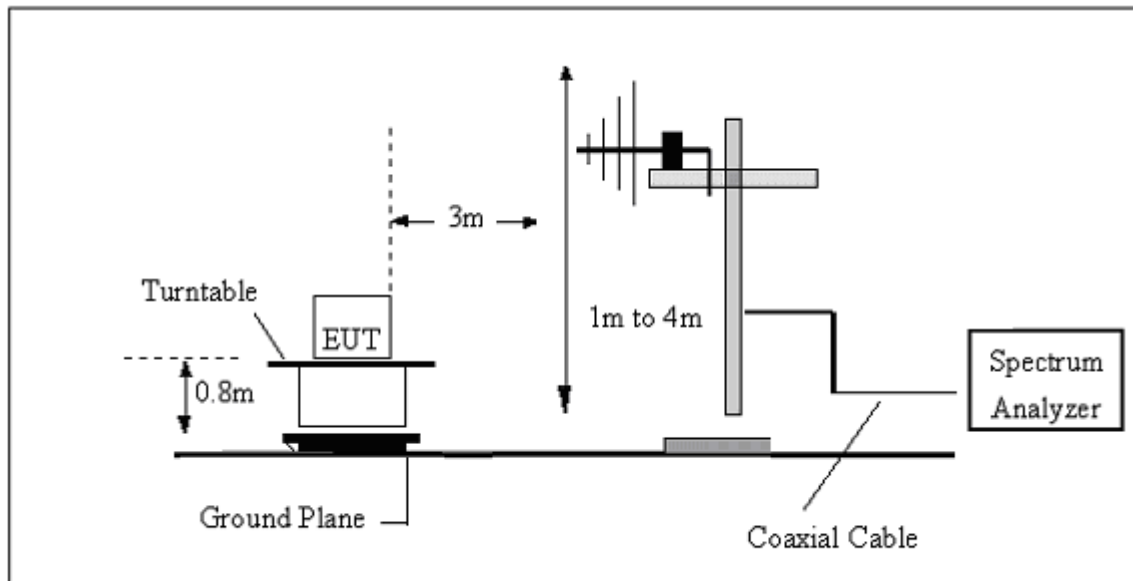

(C) Radiated Emission Test-Up Frequency Above 1GHz

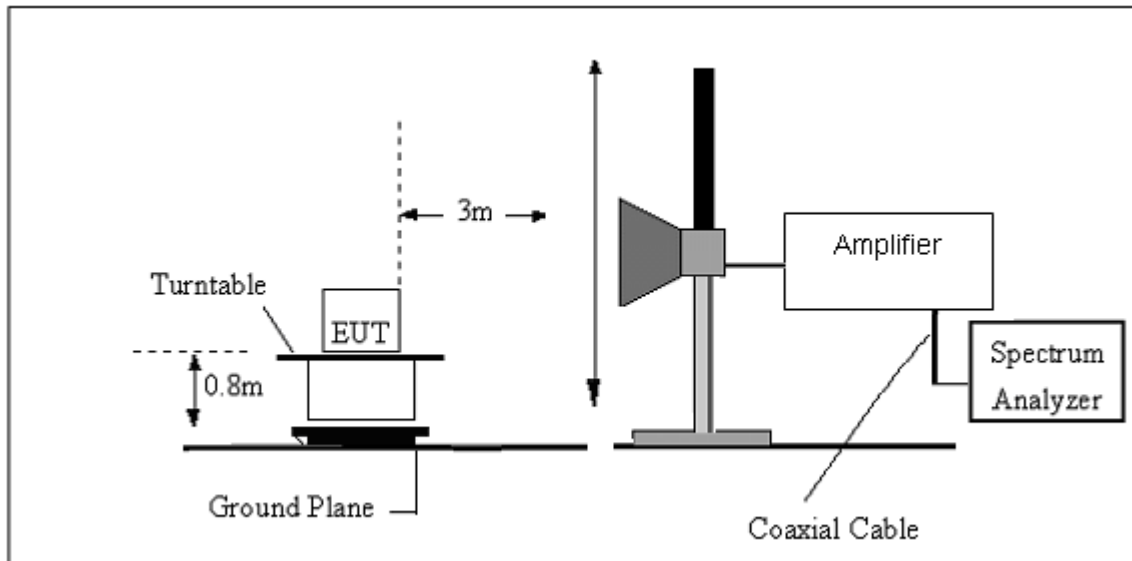

3.2.5 EUT OPERATING CONDITIONS

The EUT tested system was configured as the statements of 2.4 Unless otherwise a special operating condition is specified in the follows during the testing.



3.2.6 TEST RESULTS

Below 30MHz

EUT:	Tablet PC	Model Name.:	A735
Temperature:	26 °C	Relative Humidity:	54%
Pressure:	1010hPa	Phase:	N/A
Test Voltage:	DC 5V	Test Mode:	N/A

No.	Frequency (MHz)	Results (dBuV/m)	Factor (dB)	Limit (dBuV/m)	Margin (dB)	Detector	Table (o)	Height (cm)	ANT	Verdict
---	---	---	---	---	---	---	---	---	---	---
---	---	---	---	---	---	---	---	---	---	---

NOTE:

The amplitude of spurious emissions which are attenuated by more than 20dB below the permissible value has no need to be reported.

Distance extrapolation factor = $40 \log(\text{specific distance}/\text{test distance})$ (dB);

Limit line = specific limits(dBuv) + distance extrapolation factor.

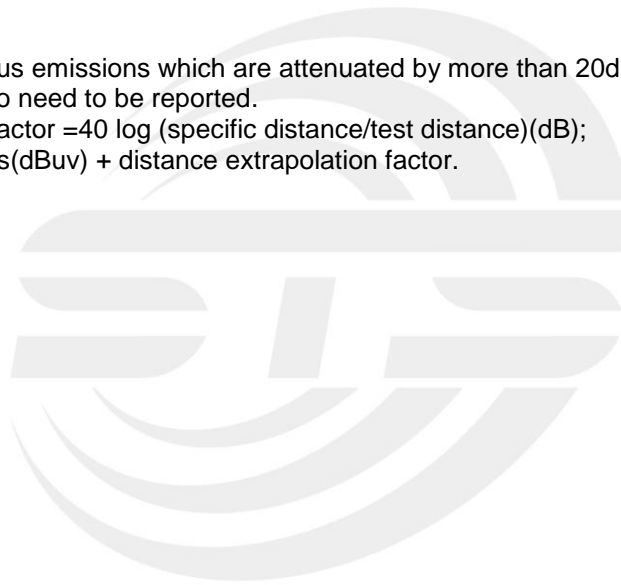



Between 30-1000MHz

EUT:	Tablet PC	Model Name.:	A735
Temperature:	26 °C	Relative Humidity:	54%
Pressure:	1010hPa	Phase:	Horizontal
Test Voltage:	DC 5V	Test Mode:	Mode 1

No.	Frequency (MHz)	Reading (dBuV)	Factor (dB)	Results (dBuV/m)	Limit (dBuV/m)	Margin (dB)	Detector
1	98.8324	26.24	11.41	37.65	43.50	-5.85	QP
2	171.3925	27.50	11.67	39.17	43.50	-4.33	QP
3	247.6820	22.12	14.80	36.92	46.00	-9.08	QP
4	408.9460	17.38	20.40	37.78	46.00	-8.22	QP
5	552.8831	13.98	24.91	38.89	46.00	-7.11	QP
6	793.3960	12.84	28.28	41.12	46.00	-4.88	QP

Remark:

1. All readings are Quasi-Peak and Average values.
2. Factor = Antenna Factor + Cable Loss.
3. N/A means All Data have pass Limit

80.0 dBuV/m

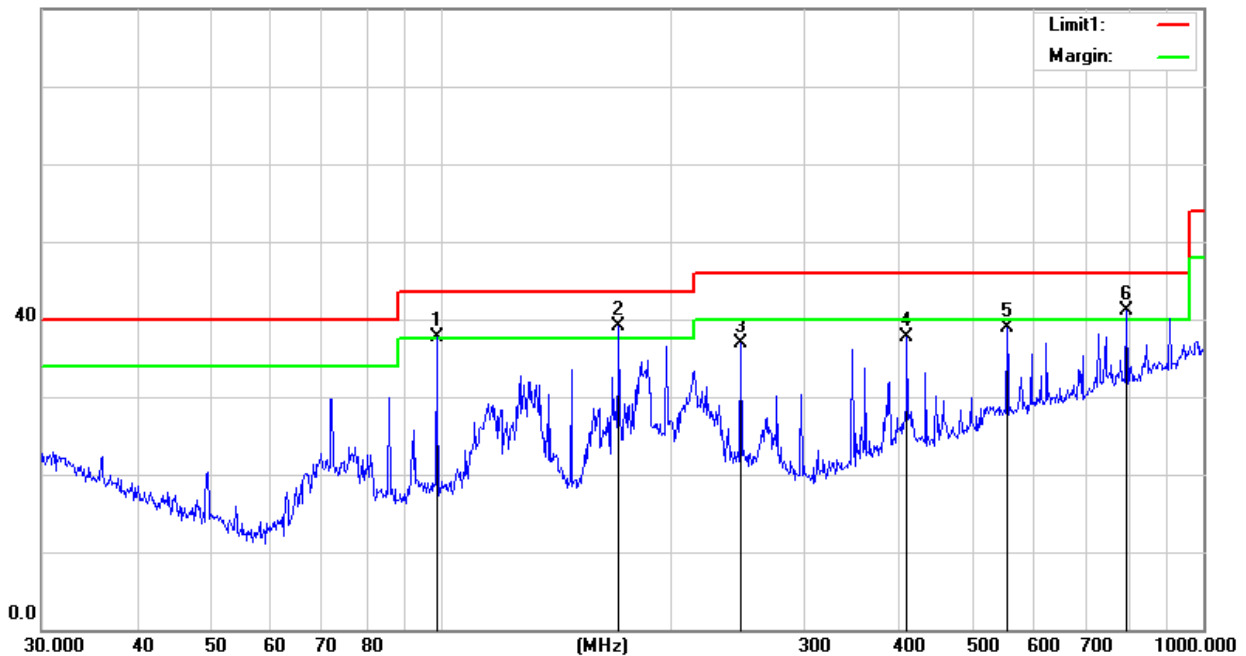



EUT:	Tablet PC	Model Name.:	A735
Temperature:	26 °C	Relative Humidity:	54%
Pressure:	1010hPa	Phase:	Vertical
Test Voltage:	DC 5V	Test Mode:	Mode 1

No.	Frequency (MHz)	Reading (dBUV)	Factor (dB)	Results (dBUV/m)	Limit (dBUV/m)	Margin (dB)	Detector
1	36.0007	19.35	16.01	35.36	40.00	-4.64	QP
2	98.8324	22.10	11.41	33.51	43.50	-9.99	QP
3	197.8926	25.64	10.42	36.06	43.50	-7.44	QP
4	386.6338	16.77	19.24	36.01	46.00	-9.99	QP
5	552.8832	13.80	24.91	38.71	46.00	-7.29	QP
6	793.3960	12.16	28.28	40.44	46.00	-5.56	QP

Remark:

1. All readings are Quasi-Peak and Average values.
2. Factor = Antenna Factor + Cable Loss.
3. N/A means All Data have pass Limit

80.0 dBUV/m

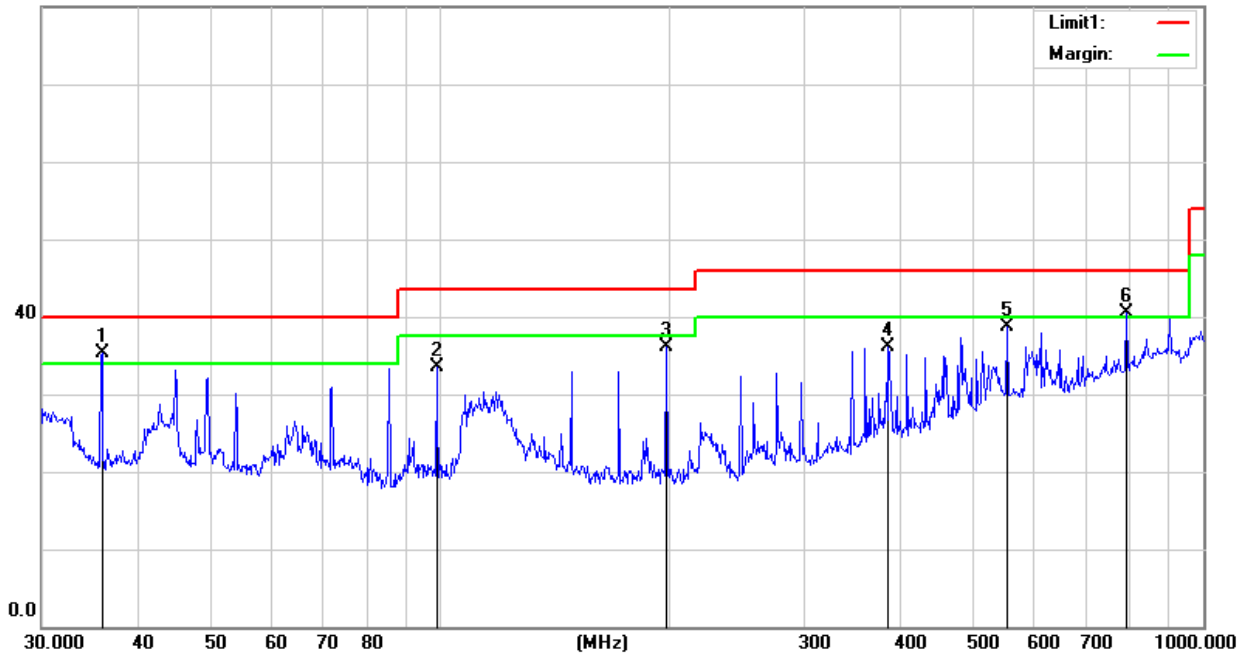



Above 1GHz

The worst test data above 1 GHz was showed as thefollow:

EUT:	Tablet PC	Model Name.:	A735
Temperature:	26 °C	Relative Humidity:	54%
Pressure:	1010hPa	Test Mode:	Mode 1

Freq. (MHz)	Ant. Pol H/V	Peak Reading (dBuV)	AV Reading (dBuV)	Ant./CL CF (dB)	Actual Fs		Peak Limit (dBuV/m)	AV Limit (dBuV/m)	Peak margin (dBuV/m)	AV margin (dBuV/
					Peak (dBuV/m)	AV (dBuV/m)				
1097.54	H	57.65	41.28	5.15	62.80	46.43	74.00	54.00	-11.20	-7.57
2866.85	H	52.47	38.29	9.45	61.92	47.74	74.00	54.00	-12.08	-6.26
N/A										
1069.77	V	52.85	37.55	5.15	58.00	42.70	74.00	54.00	-16.00	-11.30
2896.79	V	49.11	32.14	9.45	58.56	41.59	74.00	54.00	-15.44	-12.41
N/A										

Notes:

1. Measuring frequencies from 1 GHz to 7.5GHz.
2. Radiated emissions measured in frequency above 1000MHz were made with an instrument using Peak detector mode of the emission shown in Actual FS column.
3. The frequency that above 3GHz is mainly from the environment noise.

4. PHOTOS OF TEST SETUP

Radiated Measurement Photos

30MHz- 1GHz

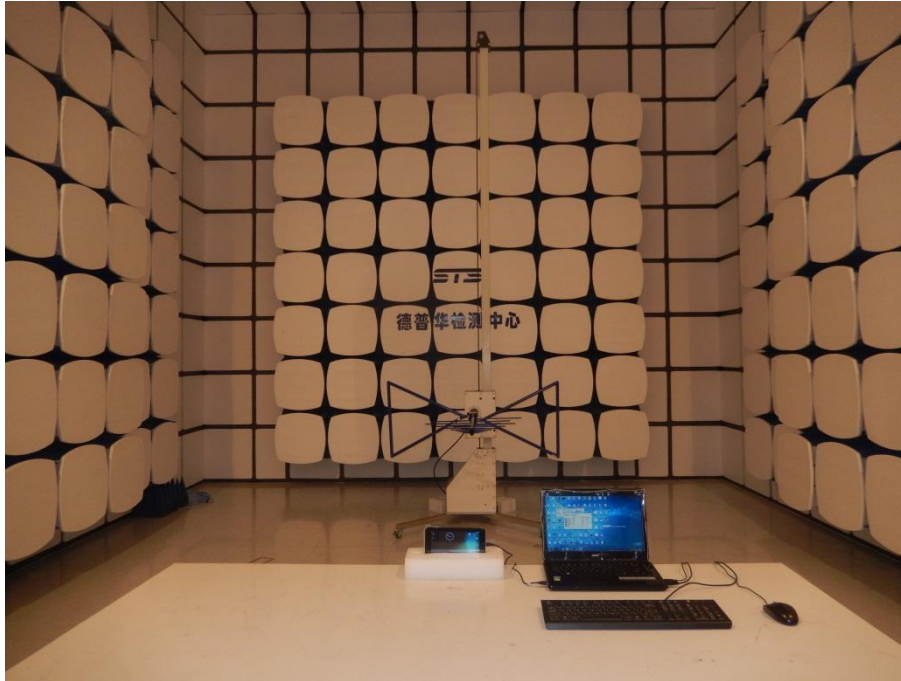

Above 1GHz

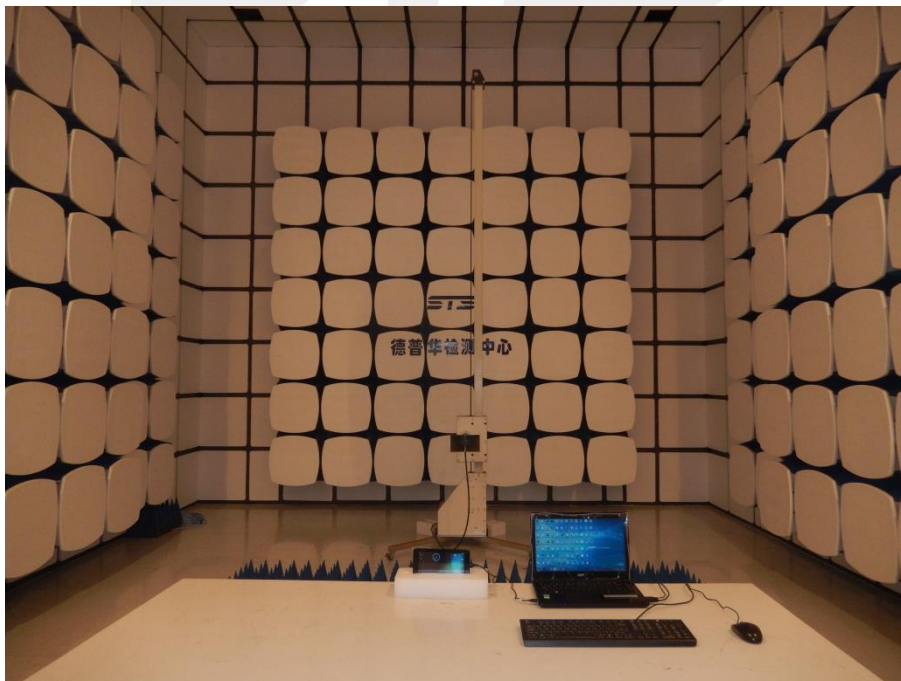

Conducted Measurement Photos



*****END OF THE REPORT*****