

## TEST REPORT

### SPECIFIC ABSORPTION RATE (SAR) EVALUATION REPORT

For VR360 Camera

Model Number: VR002

Brand Name: Systech Electronics Ltd.

FCC ID: 2ABQ3-SVR002

Prepared for  
Systech Electronics Ltd.  
Unit 802, 8/F., Sunbeam Centre, 27 Shing Yip Street,  
Kwun Tong, Kowloon, Hong Kong.

**PREPARED AND CHECKED BY:**

**APPROVED BY:**

Signed On File

Luk Ka Fung, David

Assistant Engineer

Date: June 01, 2018

Chan Chi Hung, Terry

Manager

Date: June 01, 2018

Intertek's standard Terms and Conditions can be obtained at our website <http://www.intertek.com/terms/>.

The test report only allows to be revised within the retention period unless further standard or the requirement was noticed.

This report is for the exclusive use of Intertek's Client and is provided pursuant to the agreement between Intertek and its Client. Intertek's responsibility and liability are limited to the terms and conditions of the agreement. Intertek assumes no liability to any party, other than to the Client in accordance with the agreement, for any loss, expense or damage occasioned by the use of this report. Only the Client is authorized to permit copying or distribution of this report and then only in its entirety. Any use of the Intertek name or one of its marks for the sale or advertisement of the tested material, product or service must first be approved in writing by Intertek. The observations and test results in this report are relevant only to the sample tested. This report by itself does not imply that the material, product, or service is or has ever been under an Intertek certification program.

© 2017 Intertek

**TEST REPORT**

**TABLE OF CONTENTS**

1 Test Result Summary..... 3

2 General Information..... 4

3 SAR Measurement System Description..... 7

4 Tissue Verificaiton ..... 15

5 SAR Measurement System Verification ..... 18

6 SAR Evaluation..... 20

7 Test Equipment List ..... 32

8 Measurement Uncertainty..... 33

9 E-Field Probe and Dipole Antenna Calibration..... 33

APPENDIX A – System Check Data ..... 34

APPENDIX B – SAR Evaluation Data ..... 35

APPENDIX C – E-Field Probe and Dipole Antenna Calibration ..... 36

**TEST REPORT**

**1. TEST RESULT SUMMARY**

<b>Applicant:</b>	Systech Electronics Ltd.
<b>Applicant Address:</b>	Unit 802, 8/F., Sunbeam Centre, 27 Shing Yip Street, Kwun Tong, Kowloon, Hong Kong.
<b>Model:</b>	VR002
<b>Brand Name:</b>	Systech Electronics Ltd.
<b>Serial Number:</b>	N/A
<b>FCC ID:</b>	2ABQ3-SVR002
<b>Test Device:</b>	Production Unit
<b>Exposure Category:</b>	General Population/Uncontrolled Exposure
<b>Date of Test:</b>	May 24, 2018
<b>Place of Testing:</b>	Intertek Testing Services Hong Kong Unit 3, G/F, World-Wide Industrial Centre, 43-47 Shan Mei Street, Fo Tan, Sha Tin.
<b>Environmental Conditions:</b>	Temperature: +18 to 25°C Humidity 25 to 75%
<b>Test Specification:</b>	ANSI/IEEE C95.1 IEEE Std 1528: 2013 FCC KDB Publication 447498 D01 v06 FCC KDB Publication 865664 D01 v01r04 FCC KDB Publication 865664 D02 v01r02 FCC KDB Publication 248227 D01 v02r02

The maximum spatial peak SAR value for the sample device averaged over 1g was found to be:

Band	Operating Mode	TX Frequency (MHz)	Highest Reported SAR	
			1 g Body	10g Limb-worn
IEEE 802.11b	Data	2412 – 2462	1.034 W/kg	0.512 W/kg

This wireless portable device has been shown to be capable of compliance for localized specific absorption rate (SAR) for uncontrolled environment / general population exposure limits specified in ANSI/IEEE C95.1.

## TEST REPORT

### 2. GENERAL INFORMATION

#### 2.1. Description of Equipment under test (EUT)

<b>Manufacturer:</b>	Systech Electronics Ltd.
<b>Manufacturer Address:</b>	Unit 802, 8/F., Sunbeam Centre, 27 Shing Yip Street, Kwun Tong, Kowloon, Hong Kong.
<b>Device dimension (L x W) :</b>	130.8 (mm) x 48.0 (mm)
<b>Device thickness:</b>	28 (mm)
<b>Antenna Gain:</b>	1.5 dBi
<b>Operating Configuration(s) / mode:</b>	Body (Data) Limb-worn (Data)
<b>Tx Frequency (MHz):</b>	2412MHz to 2462MHz
<b>Duty Cycle*:</b>	100%
<b>H/W Version:</b>	N/A
<b>S/W Version:</b>	N/A
<b>Battery Type:</b>	3.7VDC (1 x 3.7V 2000mAh rechargeable battery pack)
<b>Body-worn Accessories:</b>	N/A

**TEST REPORT**

**2.2. EUT Antenna Locations**

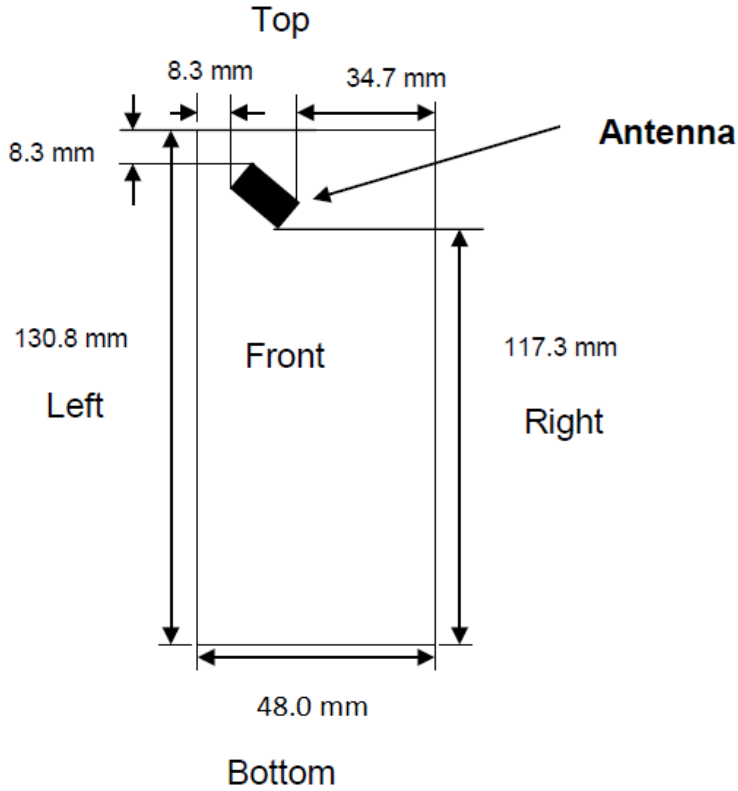

Exposure Position	Separation Distance from the Antenna to the Outer Surface
Front	9.2 mm
Top	8.3 mm
Left	8.3 mm
Right	34.7 mm
Back	7.7 mm
Bottom	117.3 mm

Details of antenna specification are shown in separate antenna dimension document.

## TEST REPORT

### 2.3. Nominal and Maximum Output Power Specifications

The EUT operates using the following maximum and nominal output power specifications. SAR values were scaled to the maximum allowed power to determine compliance per KDB Publication 447498.

Band	Operating Mode	TX Frequency (MHz)	Output Power	
			Nominal (dBm)	Maximum (dBm)
IEEE 802.11b (2.4GHz)	Data	2412 – 2462	12.0	15.5
IEEE 802.11g (2.4GHz)	Data	2412 – 2462	12.0	15.5
IEEE 802.11n (2.4GHz) HT20	Data	2412 – 2462	12.0	15.5

## TEST REPORT

### 3. SAR MEASUREMENT SYSTEM DESCRIPTION

SAR is related to the rate at which energy is absorbed per unit mass in object exposed to a radio field. The SAR distribution in a biological body is complicated and is usually carried out by experimental techniques or numerical modeling. The standard recommends limits for two tiers of groups, occupational/controlled and occupational/uncontrolled, based on a person's awareness and ability to exercise control over his or her exposure. In general, occupational/controlled exposure limits are higher than the limits for general population/uncontrolled.

The SAR definition is the time derivative (rate) of the incremental energy (dW) absorbed by (dissipated in) an incremental mass (dm) contained in a volume element (dv) of given mass density ( $\rho$ ). The equation description is as below:

$$SAR = \frac{d}{dt} \left( \frac{dW}{dm} \right) = \frac{d}{dt} \left( \frac{dW}{\rho dV} \right)$$

SAR is expressed in units of Watts per kilogram (W/Kg)

SAR can be obtained using either of the following equations:

$$SAR = \frac{\sigma E^2}{\rho}$$

$$SAR = c_h \left. \frac{dT}{dt} \right|_{t=0}$$

Where

- SAR is the specific absorption rate in watts per kilogram;
- E is the r.m.s. value of the electric field strength in the tissue in volts per meter;
- $\sigma$  is the conductivity of the tissue in siemens per metre;
- $\rho$  is the density of the tissue in kilograms per cubic metre;
- $c_h$  is the heat capacity of the tissue in joules per kilogram and Kelvin;

$\left. \frac{dT}{dt} \right|_{t=0}$  is the initial time derivative of temperature in the tissue in kelvins per second

## TEST REPORT

An SAR measurement system usually consists of a small diameter isotropic electric field probe, a multiple axis probe positioning system, a test device holder, one or more phantom models, the field probe instrumentation, a computer and other electronic equipment for controlling the probe and making the measurements. Other supporting equipment, such as a network analyzer, power meters and RF signal generators, are also required to measure the dielectric parameters of the simulated tissue media and to verify the measurement accuracy of the SAR system.

The SAR measurement system being used is COMOSAR system, which consists following items for performing compliance tests

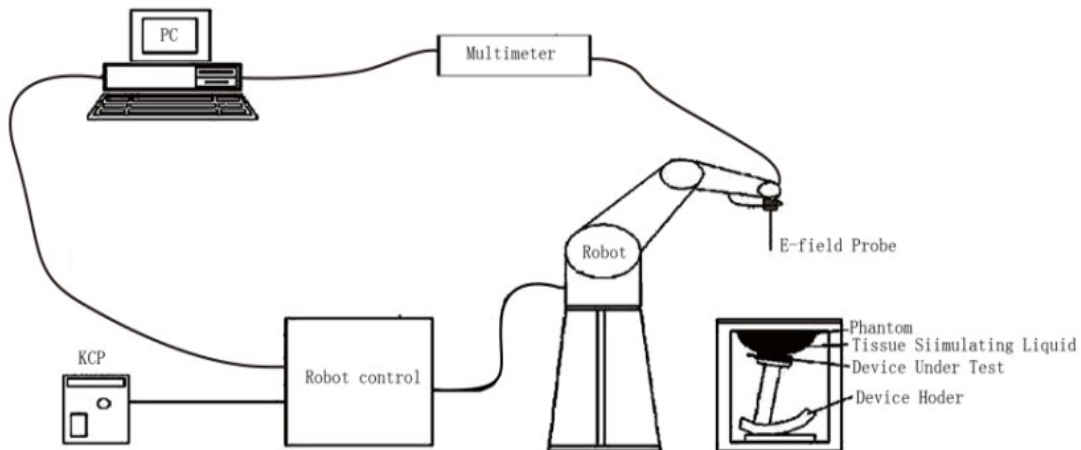

*Figure 1: Schematic diagram of the SAR measurement system*

- The PC. It controls most of the bench devices and stores measurement data. A computer running WinXP and the Opensar software
- The E-Field probe. The probe is a 3-axis system made of 3 distinct dipoles. Each dipole returns a voltage in function of the ambient electric field.
- The Keithley multimeter measures each probe dipole voltages.
- The SAM phantom simulates a human head. The measurement of the electric field is made inside the phantom.
- The liquids simulate the dielectric properties of the human head tissues
- The network emulator controls the mobile phone under test.
- The validation dipoles are used to measure a reference SAR. They are used to periodically check the bench to make sure that there is no drift of the system characteristics over time.
- The phantom, the device holder and other accessories according to the targeted measurement.



## TEST REPORT

### ROBOT

The COMOSAR system uses the KUKA robot from SATIMO SA (France). For the 6-axis controller COMOSAR system, the KUKA robot controller version from SATIMO is used.

The XL robot series have many features that are important for our application:

- High precision (repeatability 0.02 mm)
- High reliability (industrial design)
- Jerk-free straight movements
- Low ELF interference (the closed metallic construction shields against motor control fields)
- 6-axis controller



**TEST REPORT**

**COMOSAR E-FIELD PROBE**

The SAR measurement is conducted with the dissymmetric probe manufactured by SATIMO. The probe is specially designed and calibrated for use in liquid with high permittivity. The dissymmetric probe has special calibration in liquid at different frequency. SATIMO conducts the probe calibration in compliance with international and national standards (e.g. IEEE Std 1528-2013 and relevant KDB files). The calibration data are in Appendix C.

<b>Model</b>	SSE2
<b>Manufacture</b>	MVG
<b>Frequency</b>	0.4GHz-6GHz Linearity:±0.08dB
<b>Dynamic Range</b>	0.01W/Kg-100W/Kg Linearity:±0.08dB
<b>Dimensions</b>	Overall length:330mm Length of individual dipoles:2mm Maximum external diameter:8mm Probe Tip external diameter:2.5mm Distance between dipoles/ probe extremity:1mm



## TEST REPORT

### VIDEO POSITIONING SYSTEM

The video positioning system is used in OpenSAR to check the probe. Which is composed of a camera, LED, mirror and mechanical parts. The camera is piloted by the main computer with firewire link.

During the process, the actual position of the probe tip with respect to the robot arm is measured, as well as the probe length and the horizontal probe offset. The software then corrects all movements, such that the robot coordinates are valid for the probe tip.

The repeatability of this process is better than 0.1 mm. If a position has been taught with an aligned probe, the same position will be reached with another aligned probe within 0.1 mm, even if the other probe has different dimensions. During probe rotations, the probe tip will keep its actual position.

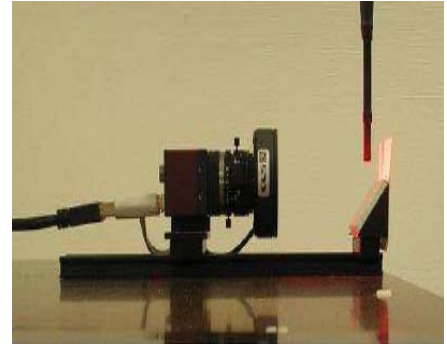

## TEST REPORT

### SAM TWIN PHANTOM

The SAM twin phantom is a fiberglass shell phantom with  $2\text{mm} \pm 0.2\text{ mm}$  shell thickness (except the ear region where shell thickness increases to  $6\text{mm} \pm 0.2\text{ mm}$ ), relative permittivity  $\epsilon_r = 3.4$  and loss tangent  $\delta = 0.02$ . It has three measurement areas:

- Left head
- Right head
- Flat phantom



The bottom plate contains three pair of bolts for locking the device holder. The device holder positions are adjusted to the standard measurement positions in the three sections. A white cover is provided to tap the phantom during off-periods to prevent water evaporation and changes in the liquid parameters. On the phantom top, three reference markers are provided to identify the phantom position with respect to the robot.

## TEST REPORT

### ELLIPTICAL PHANTOM

The elliptical phantom is a fiberglass shell phantom with

- $2\text{mm} \pm 0.2\text{ mm}$  shell thickness
- relative permittivity  $\epsilon_r = 3.4$
- loss tangent  $\delta = 0.02$



### DEVICE HOLDER

The COMOSAR device holder is designed to cope with different positions given in the standard. It has two scales for the device rotation (with respect to the body axis) and the device inclination (with respect to the line between the ear reference points). The rotation center for both scales is the ear reference point (EPR).

Thus the device needs no repositioning when changing the angles.

The COMOSAR device holder has been made out of low-loss POM material having the following dielectric parameters: relative permittivity  $\epsilon_r = 3.7$  and loss tangent  $\delta = 0.005$ . The amount of dielectric material has been reduced in the closest vicinity of the device, since measurements have suggested that the influence of the clamp on the test results could thus be lowered.

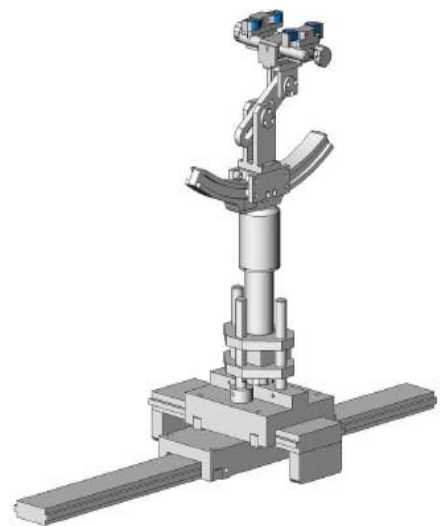

## TEST REPORT

During measurement, the system first does an area (2D) scan at a fixed depth within the liquid from the inside wall of the phantom scanning area is greater than the projection of EUT and antenna.

Area Scan Parameters extracted from KDB 865664

	≤ 3 GHz	> 3 GHz
Maximum distance from closest measurement point (geometric center of probe sensors) to phantom surface	5 mm ± 1 mm	$\frac{1}{2} \cdot \delta \cdot \ln(2)$ mm ± 0.5 mm
Maximum probe angle from probe axis to phantom surface normal at the measurement location	30° ± 1°	20° ± 1°
Maximum area scan spatial resolution: $\Delta x_{Area}$ , $\Delta y_{Area}$	≤ 2 GHz: ≤ 15 mm 2 – 3 GHz: ≤ 12 mm	3 – 4 GHz: ≤ 12 mm 4 – 6 GHz: ≤ 10 mm
	When the x or y dimension of the test device, in the measurement plane orientation, is smaller than the above, the measurement resolution must be ≤ the corresponding x or y dimension of the test device with at least one measurement point on the test device.	

When the maximum SAR point has been found, the system will then carry out a zoom (3D) scan centered at that point to determine volume averaged SAR level.

Zoom Scan Parameters extracted from KDB 865664

Maximum zoom scan spatial resolution: $\Delta x_{Zoom}$ , $\Delta y_{Zoom}$		≤ 2 GHz: ≤ 8 mm 2 – 3 GHz: ≤ 5 mm*	3 – 4 GHz: ≤ 5 mm* 4 – 6 GHz: ≤ 4 mm*	
Maximum zoom scan spatial resolution, normal to phantom surface	uniform grid: $\Delta z_{Zoom}(n)$	≤ 5 mm	3 – 4 GHz: ≤ 4 mm 4 – 5 GHz: ≤ 3 mm 5 – 6 GHz: ≤ 2 mm	
	graded grid	$\Delta z_{Zoom}(1)$ : between 1 <sup>st</sup> two points closest to phantom surface	≤ 4 mm	3 – 4 GHz: ≤ 3 mm 4 – 5 GHz: ≤ 2.5 mm 5 – 6 GHz: ≤ 2 mm
		$\Delta z_{Zoom}(n>1)$ : between subsequent points	≤ 1.5 · $\Delta z_{Zoom}(n-1)$ mm	
Minimum zoom scan volume	x, y, z	≥ 30 mm	3 – 4 GHz: ≥ 28 mm 4 – 5 GHz: ≥ 25 mm 5 – 6 GHz: ≥ 22 mm	
Note: $\delta$ is the penetration depth of a plane-wave at normal incidence to the tissue medium; see IEEE Std 1528-2013 for details. * When zoom scan is required and the <i>reported</i> SAR from the <i>area scan based 1-g SAR estimation</i> procedures of KDB Publication 447498 is ≤ 1.4 W/kg, ≤ 8 mm, ≤ 7 mm and ≤ 5 mm zoom scan resolution may be applied, respectively, for 2 GHz to 3 GHz, 3 GHz to 4 GHz and 4 GHz to 6 GHz.				

**TEST REPORT**

**4. TISSUE VERIFICATION**

For SAR measurement of field distribution inside phantom, homogeneous tissue simulating liquid as below liquid recipes were filled to a depth of 15cm ± 0.5cm for below 3GHz measurement and of 10cm ± 0.5cm for above 3GHz.

**HEAD TISSUE RECIPES**

Frequency	De-ionized Water	Ingredients				
		Salt	1,2 propanediol	DGBE	DGMH	Triton X100
450 MHz	33.5%	3.4%	63.1%			
750 MHz	34.2%	1.4%	64.4%			
900 MHz	35.3%	1.0%	63.7%			
1800 MHz	55.2%	0.6%		13.8%		30.4%
1900 MHz	55.3%	0.5%		13.8%		30.4%
2000 MHz	55.3%	0.4%		13.8%		30.5%
2450 MHz	55.7%	0.3%		18.7%		25.3%
5000 MHz	65.3%				17.2%	17.5%

**BODY TISSUE RECIPES**

Frequency	De-ionized Water	Ingredients				
		Salt	1,2 propanediol	DGBE	DGMH	Triton X100
450 MHz	52.4%	1.9%	45.7%			
750 MHz	55.4%	1.3%	43.3%			
900 MHz	52.9%	1.0%	46.1%			
1800 MHz	70.8%	0.5%		8.7%		20.0%
1900 MHz	70.1%	0.4%		8.9%		20.6%
2000 MHz	70.2%	0.3%		8.6%		20.9%
2450 MHz	70.8%	0.3%		8.7%		20.2%
5000 MHz	77.8%				11.7%	11.5%

## TEST REPORT

The head tissue dielectric parameters recommended by the IEEE Std 1528 have been incorporated in the following table. These head parameters are derived from planar layer models simulating the highest expected SAR for the dielectric properties and tissue thickness variations in a human head. For other head and body tissue parameters, they are recommended by KDB 865664.

Target Frequency (MHz)	head		body	
	$\epsilon_r$	$\sigma$ (S/m)	$\epsilon_r$	$\sigma$ (S/m)
300	45.3	0.87	58.2	0.92
450	43.5	0.87	56.7	0.94
835	41.5	0.90	55.2	0.97
900	41.5	0.97	55.0	1.05
915	41.5	1.01	55.0	1.06
1450	40.5	1.20	54.0	1.30
1610	40.3	1.29	53.8	1.40
1800 – 2000	40.0	1.40	53.3	1.52
2450	39.2	1.80	52.7	1.95
3000	38.5	2.40	52.0	2.73
5800	35.3	5.27	48.2	6.00

( $\epsilon_r$  = relative permittivity,  $\sigma$  = conductivity and  $\rho = 1000$  kg/m<sup>3</sup>)

When a transmission band overlaps with one of the target frequencies, the tissue dielectric parameters of the tissue medium at the middle of a device transmission band should be within  $\pm 5\%$  of the parameters specified at that target frequency.



## TEST REPORT

The dielectric parameters of the liquids were verified prior to the SAR evaluation using SATIMO Dielectric Probe Kit and R&S Network Analyzer ZVL6.

The dielectric parameters were:

### Body Liquid

Freq. (MHz)	Temp. (°C)	$\epsilon_r$ / Relative Permittivity			$\sigma$ / Conductivity			$\rho$ ** (kg/m <sup>3</sup> )
		measured	Target*	$\Delta$ ( $\pm 5\%$ )	measured	Target*	$\Delta$ ( $\pm 5\%$ )	
2410	20.8	52.62	52.70	-0.15	1.86	1.95	-4.62	1000
2440	20.8	51.74	52.70	1.82	1.91	1.95	-2.05	1000
2450	20.8	50.81	52.70	-3.59	1.91	1.95	-2.05	1000
2460	20.8	54.55	52.70	3.51	2.03	1.95	4.10	1000

\* Target values refer to KDB 865664

\*\* Worst-case assumption

### Note:

1. Date of tissue verification measurement: May 24, 2018
2. Ambient temperature: 23.9 deg C
3. The temperature condition is within +/- 2 deg. C during the SAR measurements.

**TEST REPORT**

**5. SAR MEASUREMENT SYSTEM VERIFICATION**

Each SATIMO system is equipped with one or more system check kits. These units, together with the predefined measurement procedures within the SATIMO software, enable user to conduct the system check. System kit includes a dipole, and dipole device holder.

The system check verifies that the system operates within its specifications. It's performed daily or before every SAR measurement. The system check uses normal SAR measurement in the flat section of the phantom with a matched dipole at a specified distance. The system check setup is shown as below.

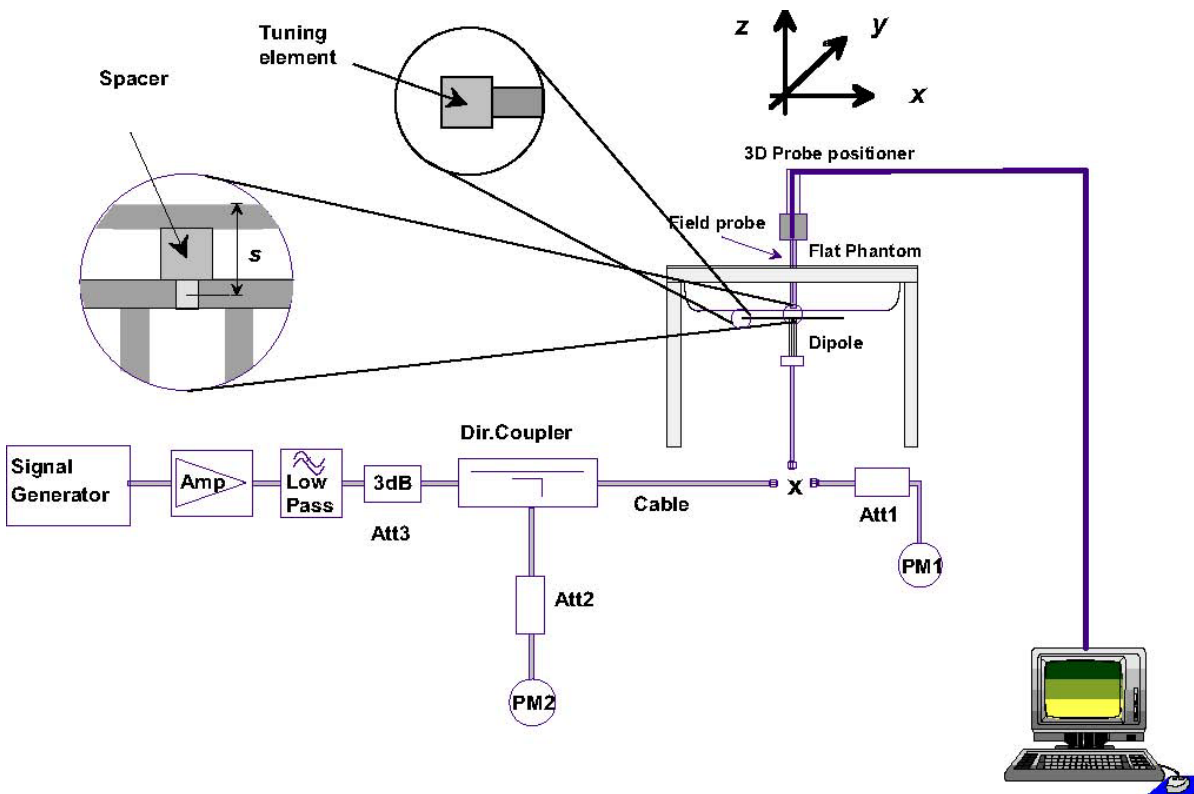

**TEST REPORT**

**VALIDATION DIPOLE**



The dipoles used is based on the IEEE Std 1528, and is complied with mechanical and electrical specifications in line with the requirements of both FCC and KDB requirement.

**SYSTEM CHECK RESULTS**

Date	Freq. (MHz)	Liquid Type	System Diople	System Verification				
				Serial No.	Target SAR <sub>1g</sub> (W/kg)	Measured SAR <sub>1g</sub> (W/kg)	Normalized SAR <sub>1g</sub> (W/kg)	Deviation (±10%)
May 24, 2018	2450	Body	2450MHz	SN 22/16 DIP 2G450-411	52.08	5.313	53.13	2.02

\* the target was quoted from dipole calibration report  
\* Input power level = 20dBm (0.1W)

Date	Freq. (MHz)	Liquid Type	System Diople	System Verification				
				Serial No.	Target SAR <sub>10g</sub> (W/kg)	Measured SAR <sub>10g</sub> (W/kg)	Normalized SAR <sub>10g</sub> (W/kg)	Deviation (±10%)
May 24, 2018	2450	Body	2450MHz	SN 22/16 DIP 2G450-411	23.97	2.425	24.25	1.17

\* the target was quoted from dipole calibration report  
\* Input power level = 20dBm (0.1W)

SAR<sub>1g</sub> ambient measured value < 12 mW/kg

Details of System Verification plot is shown in the Appendix A - plot 1.

## TEST REPORT

### 6. SAR EVALUATION

#### 6.1. Device test positions relative to the head

This practice specifies two handset test positions against the head phantom—the “cheek” position and the “tilt” position. These two test positions are defined in the following subclauses. The handset should be tested in both positions on left and right sides of the SAM phantom. If handset construction is such that the handset positioning procedures described below to represent normal use conditions cannot be used, e.g., some asymmetric handsets, alternative alignment procedures should be adapted with all details provided in the test report. These alternative procedures should replicate intended use conditions as closely as possible according to the intent of the procedures described in this subclause.

## TEST REPORT

### DEFINITION OF THE CHEEK POSITION

The cheek position is established as follows:

1. Ready the handset for talk operation, if necessary. For example, for handsets with a cover piece (flip cover), open the cover. If the handset can transmit with the cover closed, both configurations must be tested.
2. Define two imaginary lines on the handset—the vertical centerline and the horizontal line. The vertical centerline passes through two points on the front side of the handset—the midpoint of the width  $w_t$  of the handset at the level of the acoustic output (point A in below figure), and the midpoint of the width  $w_b$  of the bottom of the handset (point B). The horizontal line is perpendicular to the vertical centerline and passes through the center of the acoustic output (see below left figure). The two lines intersect at point A. Note that for many handsets, point A coincides with the center of the acoustic output; however, the acoustic output may be located elsewhere on the horizontal line. Also note that the vertical centerline is not necessarily parallel to the front face of the handset (see right figure), especially for clamshell handsets, handsets with flip covers, and other irregularly-shaped handsets.
3. Position the handset close to the surface of the phantom such that point A is on the (virtual) extension of the line passing through points RE and LE on the phantom (see the figure as next page), such that the plane defined by the vertical centerline and the horizontal line of the handset is approximately parallel to the sagittal plane of the phantom.
4. Translate the handset towards the phantom along the line passing through RE and LE until handset point A touches the pinna at the ERP.

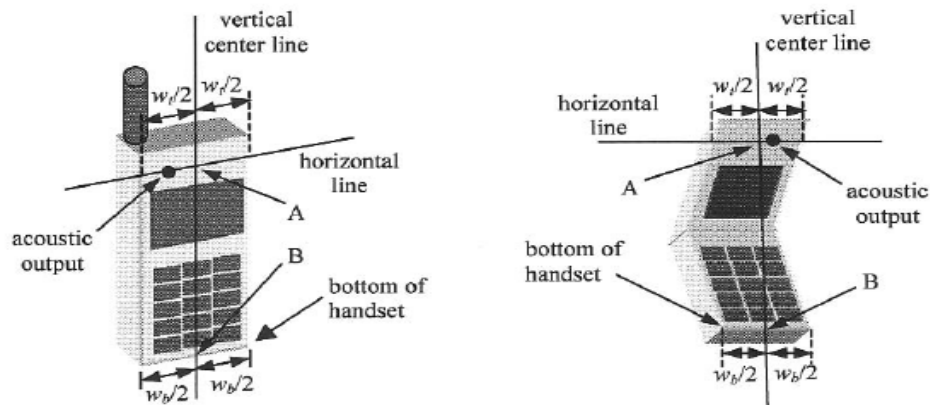

## TEST REPORT

5. While maintaining the handset in this plane, rotate it around the LE-RE line until the vertical centerline is in the plane normal to the plane containing B-M and N-F lines, i.e., the Reference Plane.
6. Rotate the handset around the vertical centerline until the handset (horizontal line) is parallel to the N-F line.
7. While maintaining the vertical centerline in the Reference Plane, keeping point A on the line passing through RE and LE, and maintaining the handset contact with the pinna, rotate the handset about the N-F line until any point on the handset is in contact with a phantom point below the pinna on the cheek.

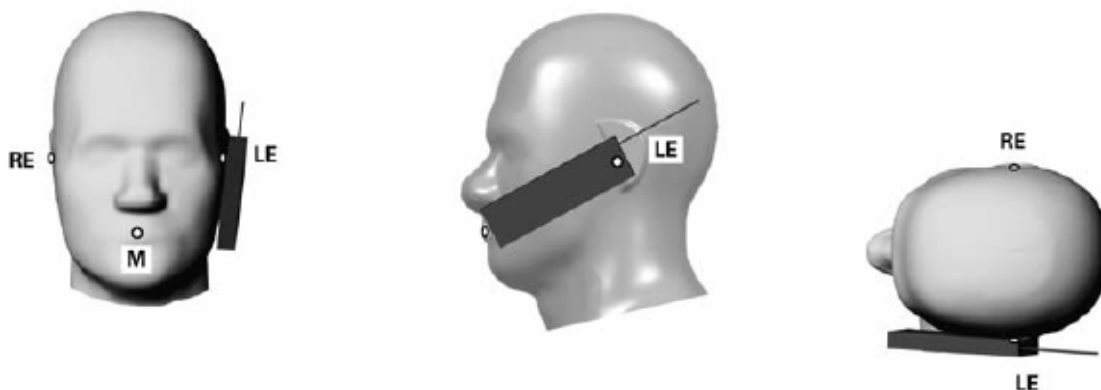

## TEST REPORT

### DEFINITION OF THE TILT POSITION

The tilt position is established as follows:

1. Repeat steps to place the device in the cheek position.
2. While maintaining the orientation of the handset, move the handset away from the pinna along the line passing through RE and LE far enough to allow a rotation of the handset away from the cheek by 15°.
3. Rotate the handset around the horizontal line by 15°.
4. While maintaining the orientation of the handset, move the handset towards the phantom on the line passing through RE and LE until any part of the handset touches the ear. The tilt position is obtained when the contact point is on the pinna. See the figure as below. If contact occurs at any location other than the pinna, e.g., the antenna at the back of the phantom head, the angle of the handset should be reduced.
5. In this case, the tilt position is obtained if any point on the handset is in contact with the pinna and a second point on the handset is in contact with the phantom, e.g., the antenna with the back of the head.

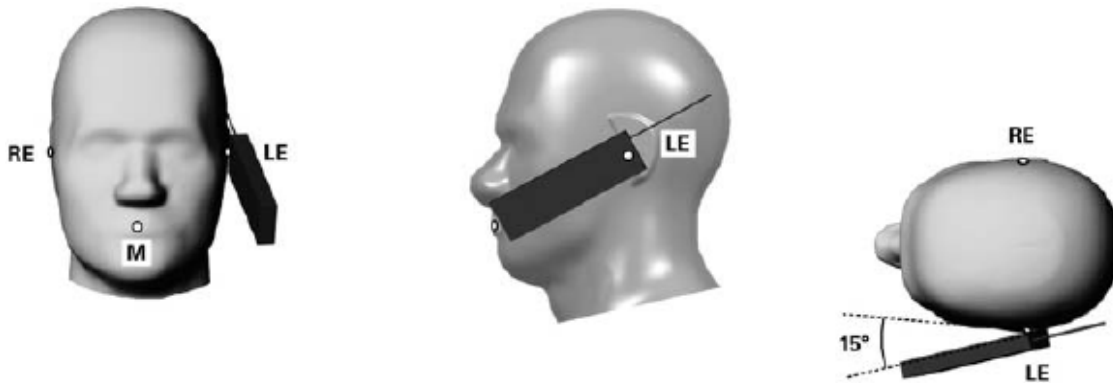

## TEST REPORT

### 6.2. Device test positions relative to body-worn accessory

Body-worn operating configurations are tested with the belt-clips and holsters attached to the device and positioned against a flat phantom in a normal use configuration. Per FCC KDB Publication 648474, Body-worn accessory exposure is typically related to voice mode operations when handsets are carried in body worn accessories. The body-worn accessory procedures in FCC KDB Publication 447498 should be used to test for body-worn accessory SAR compliance, without a headset connected to it. This enables the test results for such configuration to be compatible with that required for hotspot mode when the body-worn accessory test separation distance is greater than or equal to that required for hotspot mode, when applicable. When the reported SAR for a body-worn accessory, measured without a headset connected to the handset, is  $>1.2\text{W/kg}$ , the highest reported SAR configuration for that wireless mode and frequency band should be reported for that body-worn accessory with a headset attached to the handset.

SAR evaluation is required for body-worn accessories supplied with the host device. The test configurations must be conservative for supporting the body-worn accessory use conditions expected by users. Body-worn accessories that do not contain metallic or conductive components may be tested according to worst-case exposure configurations, typically according to the smallest test separation distance required for the group of body-worn accessories with similar operating and exposure characteristics. All body-worn accessories containing metallic components, either supplied with the product or available as an option from the device manufacturer, must be tested in conjunction with the host device to demonstrate compliance

Body-worn accessories may not always be supplied or available as options for some devices intended to be authorized for body-worn use. In this case, a test configuration with a separation distance between the back of the device and the flat phantom is used. Test position spacing was documented. Transmitters that are designed to operate in front of a person's face, as in push-to-talk configurations, are tested for SAR compliance with the front of the device positioned to face the flat phantom in head fluid.



## TEST REPORT

### 6.3. General Device Setup

The device was first charged over a duration defined by the applicant to make sure the installed battery was fully charged.

The device was then placed into test mode to simulate the worst case configuration through the highest power channel, where the operating parameters established in this test mode is identical to those programmed in production units, including output power levels, amplifier gain settings and other RF performance tuning parameters. The test frequency is corresponded to actual channel frequencies defined for domestic use.

During testing, the device was evaluated with a fully charged battery, power saving function disabled and was configured to operate at maximum output power. A receive antenna and a spectrum analyzer were placed with a distance > 50cm away from the device to monitor the transmission states.

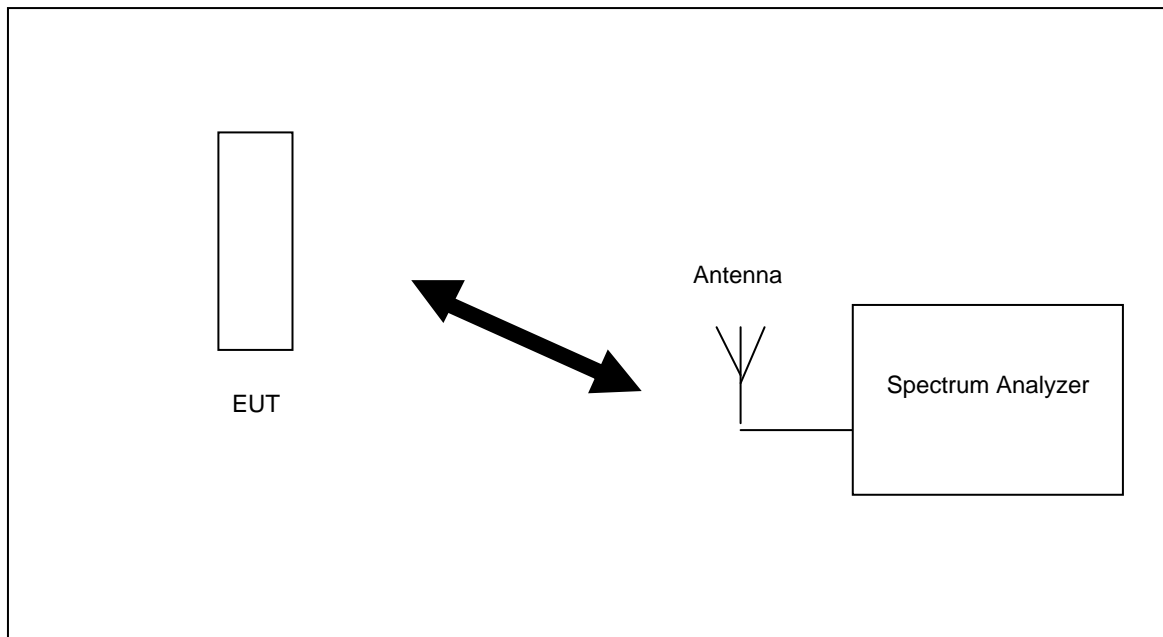

## TEST REPORT

### 6.4. RF Output Power Measurements

Operating Mode / Band	Date Rate	Channel	Freq. (MHz)	Measured Time-averaged Conducted Power (dBm)
IEEE 802.11b	1M	1	2412	14.61
		6	2437	14.73
		11	2462	14.27
IEEE 802.11g	6M	1	2412	13.96
		6	2437	13.58
		11	2462	13.53
IEEE 802.11n (HT20)	MCS0	1	2412	13.76
		6	2437	13.51
		11	2462	13.56

Note:

1. Time Average power (dBm) = Peak power (dBm) + Time Average factor.
2. Time Average factor =  $10 \cdot \log(\text{duty cycle})$
3. Per KDB 447498, the tested device was within the specified tune-up tolerances range, but not more than 2dB lower than the maximum tune-up tolerance limit.
4. Per KDB 447498, when antenna port was not available on the device to support conducted power measurement and test software was used to establish transmitter power levels, the power level was verified separately according to design and component specifications and product development information specified by the manufacturer.

**TEST REPORT****6.5. Exposure Conditions****Body and Limb-worn Exposure Conditions**

<b>Test Configurations</b>	<b>Distance to phantom</b>	<b>Operation Mode</b>	<b>SAR Required</b>	<b>Note</b>
Front	0 mm	Data	Yes	
Top	0 mm	Data	Yes	
Left	0 mm	Data	Yes	
Right	0 mm	Data	No	SAR test exclusion applied
Back	0 mm	Data	Yes	
Bottom	0 mm	Data	No	SAR test exclusion applied

**Note:**

1. Per KDB 447498 D01, SAR test exclusion can be applied to determine the test configuration for adjacent edge.

**TEST REPORT**

**6.6. SAR Test Exclusion Consideration for Adjacent Edges**

The SAR test Exclusion Thresholds Evaluation in KDB 447498 D01 can be applied to determine SAR test exclusion for adjacent edge configurations.

The test separation distance for SAR test exclusion of adjacent edges is determined by the closest distance between the antenna and outer housing on the adjacent edge of the device.

According to the antenna to outer housing separation distance and maximum time-averaged output power as below, SAR evaluation of **Right & Bottom** edges are not required.

Exposure Position	Antenna to exposure position separation distance	Calculated SAR Exclusion Threshold	Maximum Time-averaged Conducted Power	SAR Exclusion Result
Front	9.2 mm	17.6 mW	15.5 dBm = 35.48 mW	Test required
Top	8.3 mm	15.9 mW		Test required
Left	8.3 mm	15.9 mW		Test required
Right	34.7 mm	66.3 mW		Excluded
Back	7.7 mm	14.7 mW		Test required
Bottom	117.3 mm	768.6 mW		Excluded

## TEST REPORT

### 6.7. Test Result

The results on the following page(s) were obtained when the device was tested in the condition described in this report. Detailed measurement data and plots, which reveal information about the location of the maximum SAR with respect to the device, are reported in Appendix B.

#### 1g Body and 10g Limb-worn SAR

Measurement Result													
Chan	Freq. (MHz)	Battery	Mode	Test Position	Maximum Allowed Power (dBm)	Measured Power (dBm)	SAR Drift (%)	Measured SAR <sub>1g</sub> (W/kg)	Measured SAR <sub>10g</sub> (W/kg)	Scaling factor	Reported SAR <sub>1g</sub> (W/kg)	Reported SAR <sub>10g</sub> (W/kg)	Plot
6	2437	3.7V	Data	Front 0mm	15.50	14.73	-4.29	0.746	0.373	1.194	0.891	0.445	
1	2412	3.7V	Data	Front 0mm	15.50	14.61	-1.29	0.701	0.351	1.227	0.860	0.431	
6	2437	3.7V	Data	Top 0mm	15.50	14.73	-4.94	0.845	0.384	1.194	1.009	0.459	
6 (repeated)	2437	3.7V	Data	Top 0mm	15.50	14.73	-1.24	0.774	0.371	1.194	0.924	0.443	
1	2412	3.7V	Data	Top 0mm	15.50	14.61	-4.86	0.771	0.352	1.227	0.946	0.432	
6	2437	3.7V	Data	Left 0mm	15.50	14.73	4.27	0.344	0.182	1.194	0.411	0.217	
6	2437	3.7V	Data	Back 0mm	15.50	14.73	-4.03	0.866	0.429	1.194	1.034	0.512	1
6 (repeated)	2437	3.7V	Data	Back 0mm	15.50	14.73	4.93	0.821	0.392	1.194	0.980	0.468	
1	2412	3.7V	Data	Back 0mm	15.50	14.61	-4.37	0.697	0.347	1.227	0.855	0.426	

**Note:**

- Fully charged batteries were used at the beginning of each SAR measurement.
- There was no power reduction used for any band / mode implemented in this device.
- There was no proximity sensor installed in the device.
- Reported SAR results were scaled to the maximum allowed power with the scaling factor equation  $-10^{((Maximum\ power - measured\ power) / 10)}$ .
- Per KDB 248227 D01, the highest measured maximum output power channel for DSSS (802.11b) was selected for SAR measurement.
- Per KDB 447498 D01, when the reported SAR is > 0.8 W/kg, SAR is required for that exposure configuration using the next highest measured output power channel. When any reported SAR is > 1.2 W/kg, SAR is required for the third channel; i.e., all channels require testing.
- Per KDB 865664 D02, SAR plot is required for the highest measured SAR in each exposure configuration, wireless mode and frequency band combination.
- Per KDB 248227 D01, when the highest reported SAR for DSSS (2.4GHz 802.11b) for initial test position adjusted by the ratio of OFDM to DSSS specified maximum output power is  $\leq 1.2$  W/kg, SAR measurement is not required for 2.4 GHz 802.11g/n OFDM configurations.

**TEST REPORT**

**6.7. Test Result (Cont'd)**

9. Per KDB 865664 D01, repeated measurement was required when the original highest measured SAR was > 0.8W/kg and analysis details were shown as below,

**Measurement Variability**

Per KDB 865664 D01, measurement variability was assessed using the following procedures,

- 1) When the original highest measured SAR is  $\geq 0.80$  W/kg, repeat that measurement once.
- 2) Perform a second repeated measurement only if the ratio of largest to smallest SAR for the original and first repeated measurements is  $> 1.20$  or when the original or repeated measurement is  $\geq 1.45$  W/kg (~ 10% from the 1-g SAR limit).
- 3) Perform a third repeated measurement only if the original, first or second repeated measurement is  $\geq 1.5$  W/kg and the ratio of largest to smallest SAR for the original, first and second repeated measurements is  $> 1.20$ .

Measurement Variability Result										
Chan	Freq. (MHz)	Mode	Test Position	Measured SAR <sub>1g</sub> (W/kg)	1 <sup>st</sup> repeated SAR <sub>1g</sub> (W/kg)	Ratio	2 <sup>nd</sup> repeated SAR <sub>1g</sub> (W/kg)	Ratio	3 <sup>rd</sup> repeated SAR <sub>1g</sub> (W/kg)	Ratio
6	2437	Data	Top 0mm	0.845	0.774	1.092	N/A	N/A	N/A	N/A
6	2437	Data	Back 0mm	0.866	0.821	1.055	N/A	N/A	N/A	N/A

**TEST REPORT**

**6.8. SAR Limits**

The following FCC limits (Std. C95.1-1992) for SAR apply to devices operate in General Population/Uncontrolled Exposure and Controlled environment:

**GENERAL POPULATION / UNCONTROLLED ENVIRONMENTS:**

Defined as location where there is the exposure of individuals who have no knowledge or control of their exposure.

<b>EXPOSURE (General Population/Uncontrolled Exposure environment)</b>	<b>SAR (W/kg)</b>
Spatial Peak SAR (Head)*	1.60
Spatial Peak SAR (Partial Body)*	1.60
Spatial Peak SAR (Whole Body)*	0.08
Spatial Peak SAR (Hands / Wrists / Feet / Ankles)**	4.00

**OCCUPATIONAL / CONTROLLED ENVIRONMENTS:**

Defined as location where there is the exposure that may be incurred by persons who are aware of the potential for exposure, (i.e. as a result of employment or occupation)

<b>EXPOSURE (Occupational/Controlled Exposure environment)</b>	<b>SAR (W/kg)</b>
Spatial Peak SAR (Head)*	8.00
Spatial Peak SAR (Partial Body)*	8.00
Spatial Peak SAR (Whole Body)*	0.40
Spatial Peak SAR (Hands / Wrists / Feet / Ankles)**	20.00

Notes:

- \* The Spatial Peak value of the SAR averaged over any 1 gram of tissue.  
(defined as a tissue volume in the shape of a cube) and over the appropriate averaging time
- \*\* The Spatial Peak value of the SAR averaged over any 10 gram of tissue.  
(defined as a tissue volume in the shape of a cube) and over the appropriate averaging time

## TEST REPORT

### 7. TEST EQUIPMENT LIST

Equipment	Registration No.	Manufacturer	Model No.	Calibration Date	Calibration Due Date
SAR System	EW-3211	MVG	SATIMO System (OpenSAR Software V4_02_34)	N/A	N/A
Phantom	EW-3211	SATIMO	COMOSAR SAM PHANTOM	N/A	N/A
Digital Multimeter	EW-3206	KEITHLEY	2000	13 Aug 2017	13 Aug 2018
SAR Probe	EW-3210	MVG	SSE2 (SN 08/16 EPGO283)	27 Jun 2017	27 Jun 2018
SAR Dipole	EW-3212	MVG	SN 22/16 DIP 2G450-411	05 Jul 2016	05 Jul 2019
Dielectric Probe for SAR Test	EW-3213	EW-3213	Liquid Measurement Kit (SN 24/16 OCPG 76)	27 Jun 2017	27 Jun 2018
Body Liquid Tissue	N/A	MVG	Body Liquid 2450MHz	Refer to Section 4	
Network Analyzer	EW-3192	Rhode & Schwarz	ZVL6	08 Jul 2017	08 Jul 2018
Directional Coupler (2 to 18)GHz	EW-3188	KEYSIGHT	773D	30 Aug 2017	30 Aug 2018
Spectrum Analyzer	EW-2329	R&S	FSP3	28 Sep 2017	28 Sep 2018
SAR RF Amplifier for SAR System	EW-3275	SATIMO	MVG	25 Jan 2018	25 Jan 2019



## TEST REPORT

### 8. MEASUREMENT UNCERTAINTY

Per FCC KDB 865884, the extensive SAR measurement uncertainty analysis was not required when the highest measured SAR was  $< 1.5\text{W/kg}$  for all frequency band.

### 9. E-FIELD PROBE AND DIPOLE ANTENNA CALIBRATION

Probe calibration factors and dipole antenna calibration are included in Appendix C.

**TEST REPORT**

**APPENDIX A – SYSTEM CHECK DATA**

Plot #1

Operating Frequency : 2450 MHz

Test Date: 24 May 2018

Medium (Liquid Type)	: 2450 Body
Relative permittivity $\epsilon_r$	: 50.808
Conductivity $\sigma$ :	: 1.914
Probe	: Model: SSE2; Serial No.: SN 08/16 EPGO283
Crest factor	: 1.0
Conversion Factor	: 2.07
Area Scan	: dx=8mm, dy=8mm
Zoom Scan	: 7x7x8,dx=5mm dy=5mm dz=4mm
Phantom	: SAM phantom
Device Position	: Dipole
SAR Drift (%)	: -1.14%
Maximum location	: X=0.00, Y=0.00
SAR Peak (W/kg)	: 10.80 W/kg
SAR 10g (W/kg)	: 2.425 W/kg
SAR 1g (W/kg)	: 5.313 W/kg

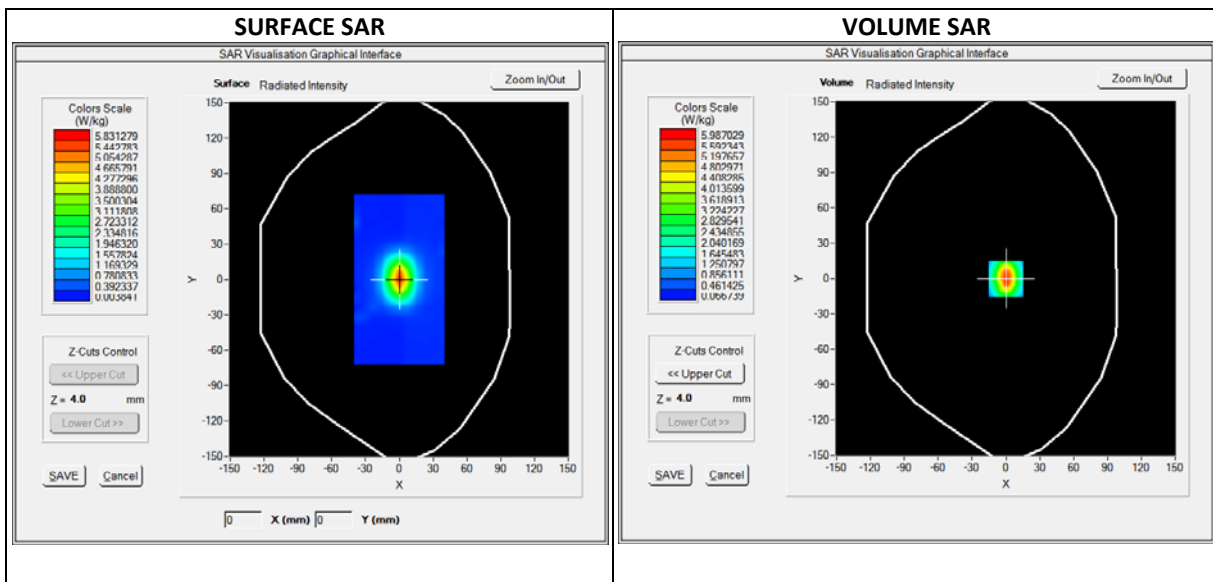

**TEST REPORT**

**APPENDIX B – SAR EVALUATION DATA**

Plot #1

Operating Frequency : 2437 MHz (IEE802.11b)

Product Description: VR360 Camera

Model: VR002

Test Date: 24 May 2018

Medium (Liquid Type)	: 2450 Body
Relative permittivity $\epsilon_r$	: 51.744
Conductivity $\sigma$ :	: 1.908
Probe	: Model: SSE2; Serial No.: SN 08/16 EPGO283
Crest factor	: 1.0
Conversion Factor	: 2.07
Area Scan	: dx=8mm, dy=8mm
Zoom Scan	: 7x7x7,dx=5mm dy=5mm dz=5mm
Phantom	: SAM phantom
Device Position	: Back 0mm separation
SAR Drift (%)	: -4.03%
Maximum location	: X=8.00, Y=35.00
SAR Peak (W/kg)	: 1.60 W/kg
SAR 10g (W/kg)	: 0.429 W/kg
SAR 1g (W/kg)	: 0.866 W/kg

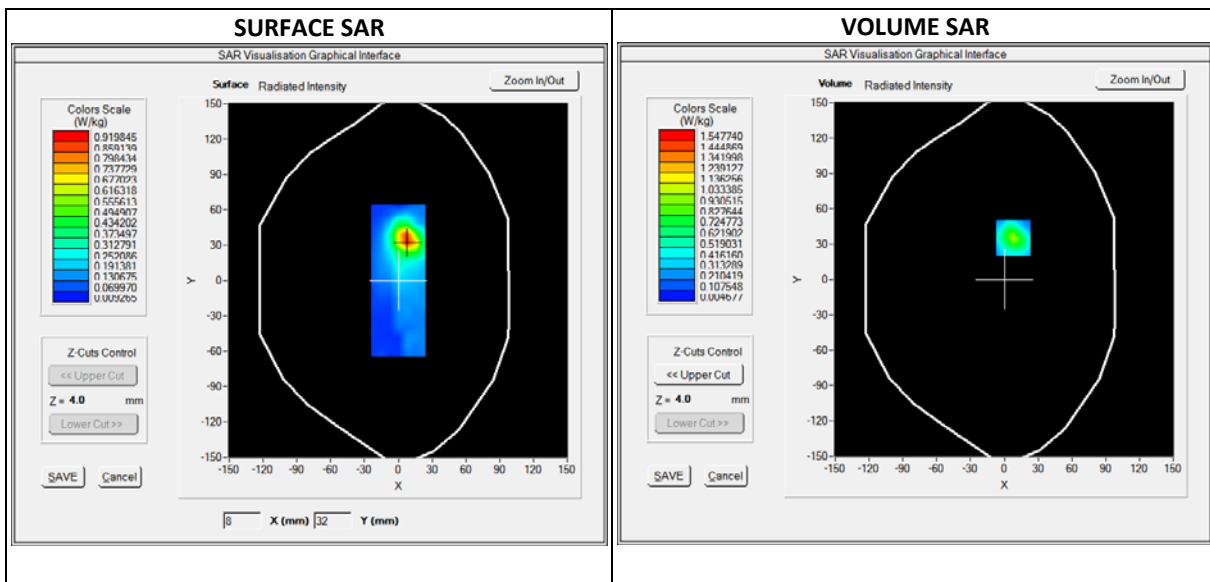

**TEST REPORT**

**APPENDIX C – E-FIELD PROBE AND DIPOLE ANTENNA CALIBRATION**



## **COMOSAR E-Field Probe Calibration Report**

Ref : ACR.178.1.17.SATU.A

### **INTERTEK TESTING SERVICES HONG KONG LIMITED**

**WORKSHOP NO. 3 G/F, WORLD-WIDE INDUSTRIAL  
CENTRE, 43-47 SHAN MEI STREET,  
FO TAN, SHA TIN, N.T. HONG KONG  
MVG COMOSAR DOSIMETRIC E-FIELD PROBE  
SERIAL NO.: SN 08/16 EPGO283**

**Calibrated at MVG US**

**2105 Barrett Park Dr. - Kennesaw, GA 30144**



**Calibration Date: 6/27/2017**

#### *Summary:*

This document presents the method and results from an accredited COMOSAR Dosimetric E-Field Probe calibration performed in MVG USA using the CALISAR / CALIBAIR test bench, for use with a COMOSAR system only. All calibration results are traceable to national metrology institutions.



	<i>Name</i>	<i>Function</i>	<i>Date</i>	<i>Signature</i>
<i>Prepared by :</i>	Jérôme LUC	Product Manager	6/27/2017	<i>JS</i>
<i>Checked by :</i>	Jérôme LUC	Product Manager	6/27/2017	<i>JS</i>
<i>Approved by :</i>	Kim RUTKOWSKI	Quality Manager	6/27/2017	<i>Kim Rutkowski</i>

	<i>Customer Name</i>
<i>Distribution :</i>	Intertek Testing Services Hong Kong Limited

<i>Issue</i>	<i>Date</i>	<i>Modifications</i>
A	6/27/2017	Initial release



**TABLE OF CONTENTS**

1 Device Under Test ..... 4

2 Product Description ..... 4

    2.1 General Information ..... 4

3 Measurement Method ..... 4

    3.1 Linearity ..... 4

    3.2 Sensitivity ..... 5

    3.3 Lower Detection Limit ..... 5

    3.4 Isotropy ..... 5

    3.5 Boundary Effect ..... 5

4 Measurement Uncertainty ..... 5

5 Calibration Measurement Results ..... 6

    5.1 Sensitivity in air ..... 6

    5.2 Linearity ..... 7

    5.3 Sensitivity in liquid ..... 7

    5.4 Isotropy ..... 8

6 List of Equipment ..... 10

## 1 DEVICE UNDER TEST

Device Under Test	
Device Type	COMOSAR DOSIMETRIC E FIELD PROBE
Manufacturer	MVG
Model	SSE2
Serial Number	SN 08/16 EPGO283
Product Condition (new / used)	Used
Frequency Range of Probe	0.4 GHz-6GHz
Resistance of Three Dipoles at Connector	Dipole 1: R1=0.193 MΩ Dipole 2: R2=0.204 MΩ Dipole 3: R3=0.201 MΩ

A yearly calibration interval is recommended.

## 2 PRODUCT DESCRIPTION

### 2.1 GENERAL INFORMATION

MVG's COMOSAR E field Probes are built in accordance to the IEEE 1528, OET 65 Bulletin C and CEI/IEC 62209 standards.



**Figure 1 – MVG COMOSAR Dosimetric E field Dipole**

Probe Length	330 mm
Length of Individual Dipoles	2 mm
Maximum external diameter	8 mm
Probe Tip External Diameter	2.5 mm
Distance between dipoles / probe extremity	1 mm

## 3 MEASUREMENT METHOD

The IEEE 1528, OET 65 Bulletin C, CENELEC EN50361 and CEI/IEC 62209 standards provide recommended practices for the probe calibrations, including the performance characteristics of interest and methods by which to assess their affect. All calibrations / measurements performed meet the fore mentioned standards.

### 3.1 LINEARITY

The evaluation of the linearity was done in free space using the waveguide, performing a power sweep to cover the SAR range 0.01W/kg to 100W/kg.



3.2 SENSITIVITY

The sensitivity factors of the three dipoles were determined using a two step calibration method (air and tissue simulating liquid) using waveguides as outlined in the standards.

3.3 LOWER DETECTION LIMIT

The lower detection limit was assessed using the same measurement set up as used for the linearity measurement. The required lower detection limit is 10 mW/kg.

3.4 ISOTROPY

The axial isotropy was evaluated by exposing the probe to a reference wave from a standard dipole with the dipole mounted under the flat phantom in the test configuration suggested for system validations and checks. The probe was rotated along its main axis from 0 - 360 degrees in 15 degree steps. The hemispherical isotropy is determined by inserting the probe in a thin plastic box filled with tissue-equivalent liquid, with the plastic box illuminated with the fields from a half wave dipole. The dipole is rotated about its axis (0°–180°) in 15° increments. At each step the probe is rotated about its axis (0°–360°).

3.5 BOUNDARY EFFECT

The boundary effect is defined as the deviation between the SAR measured data and the expected exponential decay in the liquid when the probe is oriented normal to the interface. To evaluate this effect, the liquid filled flat phantom is exposed to fields from either a reference dipole or waveguide. With the probe normal to the phantom surface, the peak spatial average SAR is measured and compared to the analytical value at the surface.

4 **MEASUREMENT UNCERTAINTY**

The guidelines outlined in the IEEE 1528, OET 65 Bulletin C, CENELEC EN50361 and CEI/IEC 62209 standards were followed to generate the measurement uncertainty associated with an E-field probe calibration using the waveguide technique. All uncertainties listed below represent an expanded uncertainty expressed at approximately the 95% confidence level using a coverage factor of k=2, traceable to the Internationally Accepted Guides to Measurement Uncertainty.

Uncertainty analysis of the probe calibration in waveguide					
ERROR SOURCES	Uncertainty value (%)	Probability Distribution	Divisor	ci	Standard Uncertainty (%)
Incident or forward power	3.00%	Rectangular	$\sqrt{3}$	1	1.732%
Reflected power	3.00%	Rectangular	$\sqrt{3}$	1	1.732%
Liquid conductivity	5.00%	Rectangular	$\sqrt{3}$	1	2.887%
Liquid permittivity	4.00%	Rectangular	$\sqrt{3}$	1	2.309%
Field homogeneity	3.00%	Rectangular	$\sqrt{3}$	1	1.732%
Field probe positioning	5.00%	Rectangular	$\sqrt{3}$	1	2.887%

Field probe linearity	3.00%	Rectangular	$\sqrt{3}$	1	1.732%
<b>Combined standard uncertainty</b>					5.831%
<b>Expanded uncertainty</b> 95 % confidence level k = 2					12.0%

## 5 CALIBRATION MEASUREMENT RESULTS

Calibration Parameters	
Liquid Temperature	21 °C
Lab Temperature	21 °C
Lab Humidity	45 %

### 5.1 SENSITIVITY IN AIR

Normx dipole 1 ( $\mu\text{V}/(\text{V}/\text{m})^2$ )	Normy dipole 2 ( $\mu\text{V}/(\text{V}/\text{m})^2$ )	Normz dipole 3 ( $\mu\text{V}/(\text{V}/\text{m})^2$ )
0.85	0.61	0.68

DCP dipole 1 (mV)	DCP dipole 2 (mV)	DCP dipole 3 (mV)
95	90	99

Calibration curves  $e_i=f(V)$  ( $i=1,2,3$ ) allow to obtain H-field value using the formula:

$$E = \sqrt{E_1^2 + E_2^2 + E_3^2}$$

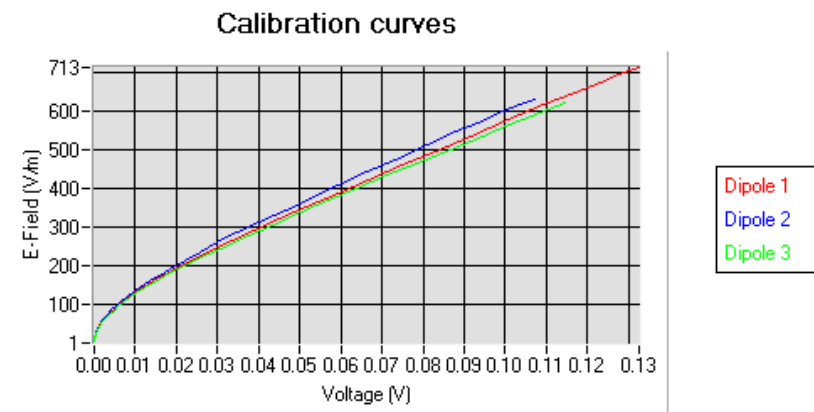

5.2 LINEARITY

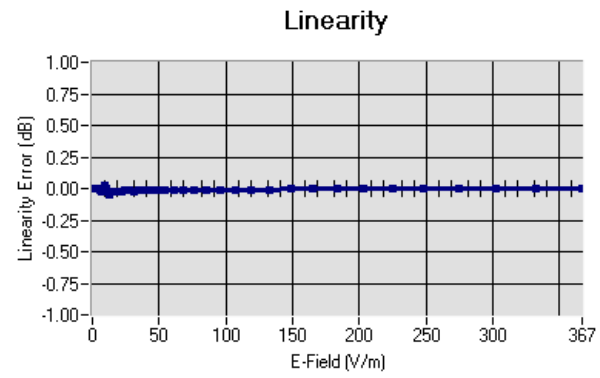

Linearity:  $\pm 1.01\%$  ( $\pm 0.04\text{dB}$ )

5.3 SENSITIVITY IN LIQUID

Liquid	Frequency (MHz +/- 100MHz)	Permittivity	Epsilon (S/m)	ConvF
HL450	450	45.29	0.86	1.66
BL450	450	57.64	0.91	1.71
HL750	750	42.09	0.91	1.42
BL750	750	55.69	0.95	1.47
HL850	835	42.71	0.89	1.51
BL850	835	57.52	1.03	1.57
HL900	900	41.94	0.93	1.50
BL900	900	52.87	1.09	1.55
HL1800	1800	40.62	1.39	1.69
BL1800	1800	53.22	1.47	1.72
HL1900	1900	41.22	1.37	1.96
BL1900	1900	50.99	1.52	2.01
HL2000	2000	40.39	1.36	1.79
BL2000	2000	54.39	1.54	1.86
HL2300	2300	38.10	1.74	2.02
BL2300	2300	53.33	1.86	2.09
HL2450	2450	40.46	1.87	1.98
BL2450	2450	54.62	1.95	2.07
HL2600	2600	38.46	2.01	2.04
BL2600	2600	51.98	2.16	2.09
HL5200	5200	35.14	4.74	2.06
BL5200	5200	49.01	5.27	2.13
HL5400	5400	34.52	4.77	2.12
BL5400	5400	49.67	5.45	2.19
HL5600	5600	37.08	5.03	2.11
BL5600	5600	47.57	5.69	2.18
HL5800	5800	34.64	5.19	2.09
BL5800	5800	49.82	5.94	2.14

LOWER DETECTION LIMIT: 8mW/kg

5.4 ISOTROPY

**HL900 MHz**

- Axial isotropy: 0.05 dB
- Hemispherical isotropy: 0.07 dB

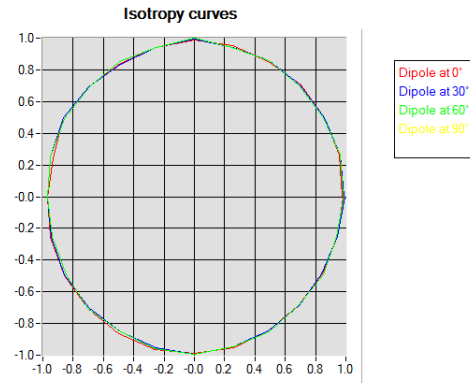

**HL1800 MHz**

- Axial isotropy: 0.05 dB
- Hemispherical isotropy: 0.08 dB

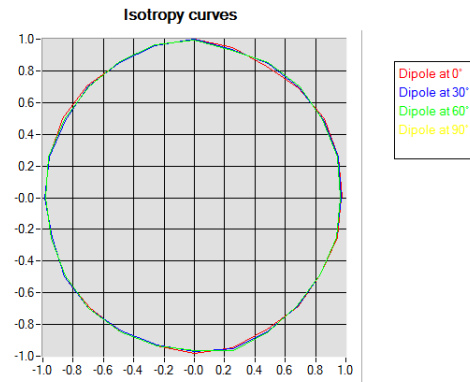

**HL5600 MHz**

- Axial isotropy: 0.06 dB
- Hemispherical isotropy: 0.09 dB

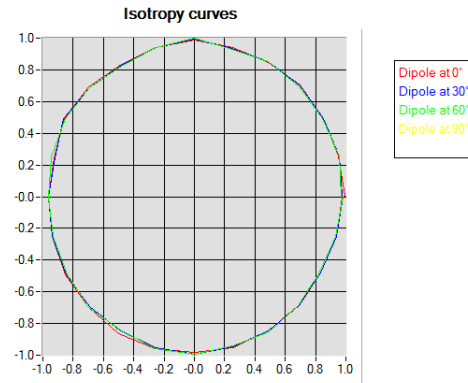



6 LIST OF EQUIPMENT

Equipment Summary Sheet				
Equipment Description	Manufacturer / Model	Identification No.	Current Calibration Date	Next Calibration Date
Flat Phantom	MVG	SN-20/09-SAM71	Validated. No cal required.	Validated. No cal required.
COMOSAR Test Bench	Version 3	NA	Validated. No cal required.	Validated. No cal required.
Network Analyzer	Rhode & Schwarz ZVA	SN100132	02/2016	02/2019
Reference Probe	MVG	EP 94 SN 37/08	10/2016	10/2017
Multimeter	Keithley 2000	1188656	01/2017	01/2020
Signal Generator	Agilent E4438C	MY49070581	01/2017	01/2020
Amplifier	Aethercomm	SN 046	Characterized prior to test. No cal required.	Characterized prior to test. No cal required.
Power Meter	HP E4418A	US38261498	01/2017	01/2020
Power Sensor	HP ECP-E26A	US37181460	01/2017	01/2020
Directional Coupler	Narda 4216-20	01386	Characterized prior to test. No cal required.	Characterized prior to test. No cal required.
Waveguide	Mega Industries	069Y7-158-13-712	Validated. No cal required.	Validated. No cal required.
Waveguide Transition	Mega Industries	069Y7-158-13-701	Validated. No cal required.	Validated. No cal required.
Waveguide Termination	Mega Industries	069Y7-158-13-701	Validated. No cal required.	Validated. No cal required.
Temperature / Humidity Sensor	Control Company	150798832	10/2015	10/2017



## **SAR Reference Dipole Calibration Report**

Ref : ACR.221.9.16.SATU.A

### **INTERTEK TESTING SERVICES HONG KONG LIMITED**

**WORKSHOP NO. 3 G/F, WORLD-WIDE INDUSTRIAL  
CENTRE, 43-47 SHAN MEI STREET,  
FO TAN, SHA TIN, N.T. HONG KONG**

**MVG COMOSAR REFERENCE DIPOLE**

**FREQUENCY: 2450 MHZ**

**SERIAL NO.: SN 22/16 DIP 2G450-411**

**Calibrated at MVG US**

**2105 Barrett Park Dr. - Kennesaw, GA 30144**



**Calibration Date: 7/5/2016**

#### *Summary:*

This document presents the method and results from an accredited SAR reference dipole calibration performed in MVG USA using the COMOSAR test bench. All calibration results are traceable to national metrology institutions.



	<i>Name</i>	<i>Function</i>	<i>Date</i>	<i>Signature</i>
<i>Prepared by :</i>	Jérôme LUC	Product Manager	8/8/2016	<i>JS</i>
<i>Checked by :</i>	Jérôme LUC	Product Manager	8/8/2016	<i>JS</i>
<i>Approved by :</i>	Kim RUTKOWSKI	Quality Manager	8/8/2016	<i>Kim Rutkowski</i>

	<i>Customer Name</i>
<i>Distribution :</i>	Intertek Testing Services Hong Kong Limited

<i>Issue</i>	<i>Date</i>	<i>Modifications</i>
A	8/8/2016	Initial release





**TABLE OF CONTENTS**

1 Introduction..... 4

2 Device Under Test ..... 4

3 Product Description ..... 4

    3.1 General Information ..... 4

4 Measurement Method ..... 5

    4.1 Return Loss Requirements ..... 5

    4.2 Mechanical Requirements ..... 5

5 Measurement Uncertainty ..... 5

    5.1 Return Loss ..... 5

    5.2 Dimension Measurement ..... 5

    5.3 Validation Measurement ..... 5

6 Calibration Measurement Results ..... 6

    6.1 Return Loss and Impedance In Head Liquid ..... 6

    6.2 Return Loss and Impedance In Body Liquid ..... 6

    6.3 Mechanical Dimensions ..... 6

7 Validation measurement ..... 7

    7.1 Head Liquid Measurement ..... 7

    7.2 SAR Measurement Result With Head Liquid ..... 8

    7.3 Body Liquid Measurement ..... 9

    7.4 SAR Measurement Result With Body Liquid ..... 10

8 List of Equipment ..... 11

## 1 INTRODUCTION

This document contains a summary of the requirements set forth by the IEEE 1528, FCC KDBs and CEI/IEC 62209 standards for reference dipoles used for SAR measurement system validations and the measurements that were performed to verify that the product complies with the fore mentioned standards.

## 2 DEVICE UNDER TEST

Device Under Test	
Device Type	COMOSAR 2450 MHz REFERENCE DIPOLE
Manufacturer	MVG
Model	SID2450
Serial Number	SN 22/16 DIP 2G450-411
Product Condition (new / used)	New

A yearly calibration interval is recommended.

## 3 PRODUCT DESCRIPTION

### 3.1 GENERAL INFORMATION

MVG’s COMOSAR Validation Dipoles are built in accordance to the IEEE 1528, FCC KDBs and CEI/IEC 62209 standards. The product is designed for use with the COMOSAR test bench only.



**Figure 1 – MVG COMOSAR Validation Dipole**

## 4 MEASUREMENT METHOD

The IEEE 1528, FCC KDBs and CEI/IEC 62209 standards provide requirements for reference dipoles used for system validation measurements. The following measurements were performed to verify that the product complies with the fore mentioned standards.

### 4.1 RETURN LOSS REQUIREMENTS

The dipole used for SAR system validation measurements and checks must have a return loss of -20 dB or better. The return loss measurement shall be performed against a liquid filled flat phantom, with the phantom constructed as outlined in the fore mentioned standards.

### 4.2 MECHANICAL REQUIREMENTS

The IEEE Std. 1528 and CEI/IEC 62209 standards specify the mechanical components and dimensions of the validation dipoles, with the dimensions frequency and phantom shell thickness dependent. The COMOSAR test bench employs a 2 mm phantom shell thickness therefore the dipoles sold for use with the COMOSAR test bench comply with the requirements set forth for a 2 mm phantom shell thickness.

## 5 MEASUREMENT UNCERTAINTY

All uncertainties listed below represent an expanded uncertainty expressed at approximately the 95% confidence level using a coverage factor of k=2, traceable to the Internationally Accepted Guides to Measurement Uncertainty.

### 5.1 RETURN LOSS

The following uncertainties apply to the return loss measurement:

Frequency band	Expanded Uncertainty on Return Loss
400-6000MHz	0.1 dB

### 5.2 DIMENSION MEASUREMENT

The following uncertainties apply to the dimension measurements:

Length (mm)	Expanded Uncertainty on Length
3 - 300	0.05 mm

### 5.3 VALIDATION MEASUREMENT

The guidelines outlined in the IEEE 1528, FCC KDBs, CENELEC EN50361 and CEI/IEC 62209 standards were followed to generate the measurement uncertainty for validation measurements.

Scan Volume	Expanded Uncertainty
1 g	20.3 %

10 g	20.1 %
------	--------

## 6 CALIBRATION MEASUREMENT RESULTS

### 6.1 RETURN LOSS AND IMPEDANCE IN HEAD LIQUID

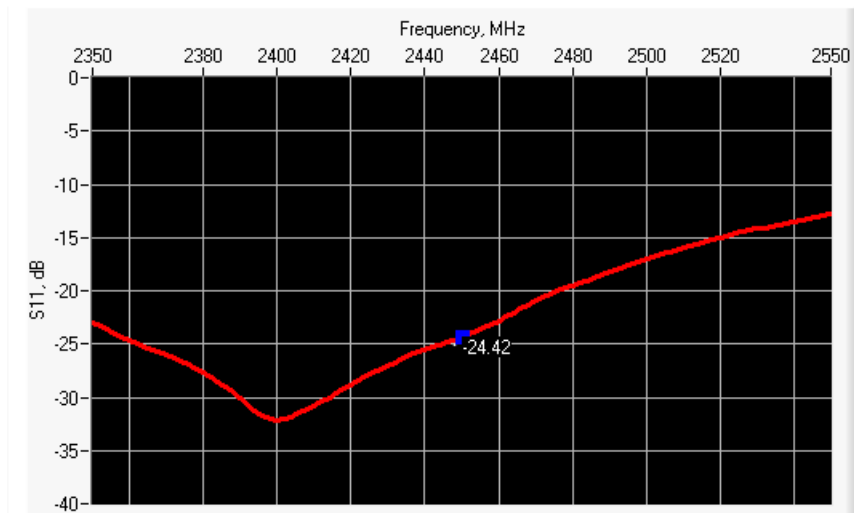

Frequency (MHz)	Return Loss (dB)	Requirement (dB)	Impedance
2450	-24.42	-20	44.1 $\Omega$ - 1.3 j $\Omega$

### 6.2 RETURN LOSS AND IMPEDANCE IN BODY LIQUID

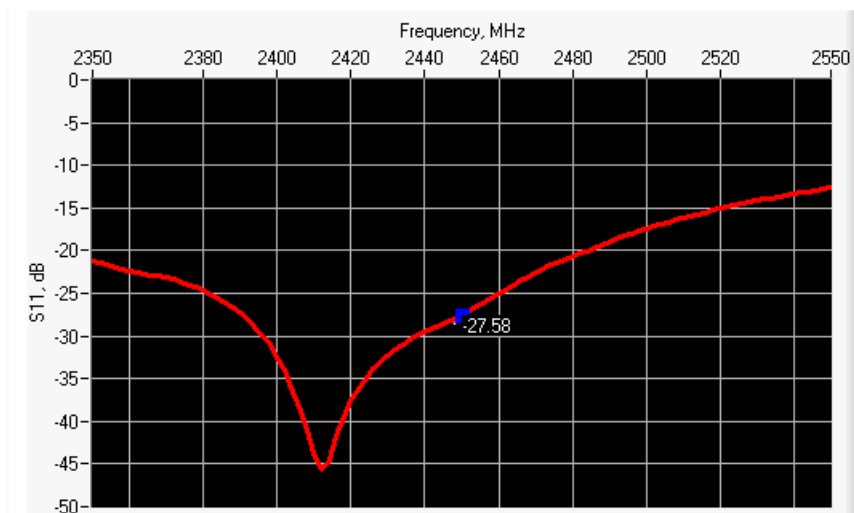

Frequency (MHz)	Return Loss (dB)	Requirement (dB)	Impedance
2450	-27.58	-20	46.9 $\Omega$ - 2.8 j $\Omega$

### 6.3 MECHANICAL DIMENSIONS

Frequency MHz	L mm		h mm		d mm	
	required	measured	required	measured	required	measured
300	420.0 $\pm$ 1 %.		250.0 $\pm$ 1 %.		6.35 $\pm$ 1 %.	



450	290.0 ±1 %.		166.7 ±1 %.		6.35 ±1 %.	
750	176.0 ±1 %.		100.0 ±1 %.		6.35 ±1 %.	
835	161.0 ±1 %.		89.8 ±1 %.		3.6 ±1 %.	
900	149.0 ±1 %.		83.3 ±1 %.		3.6 ±1 %.	
1450	89.1 ±1 %.		51.7 ±1 %.		3.6 ±1 %.	
1500	80.5 ±1 %.		50.0 ±1 %.		3.6 ±1 %.	
1640	79.0 ±1 %.		45.7 ±1 %.		3.6 ±1 %.	
1750	75.2 ±1 %.		42.9 ±1 %.		3.6 ±1 %.	
1800	72.0 ±1 %.		41.7 ±1 %.		3.6 ±1 %.	
1900	68.0 ±1 %.		39.5 ±1 %.		3.6 ±1 %.	
1950	66.3 ±1 %.		38.5 ±1 %.		3.6 ±1 %.	
2000	64.5 ±1 %.		37.5 ±1 %.		3.6 ±1 %.	
2100	61.0 ±1 %.		35.7 ±1 %.		3.6 ±1 %.	
2300	55.5 ±1 %.		32.6 ±1 %.		3.6 ±1 %.	
2450	51.5 ±1 %.	PASS	30.4 ±1 %.	PASS	3.6 ±1 %.	PASS
2600	48.5 ±1 %.		28.8 ±1 %.		3.6 ±1 %.	
3000	41.5 ±1 %.		25.0 ±1 %.		3.6 ±1 %.	
3500	37.0 ±1 %.		26.4 ±1 %.		3.6 ±1 %.	
3700	34.7 ±1 %.		26.4 ±1 %.		3.6 ±1 %.	

**7 VALIDATION MEASUREMENT**

The IEEE Std. 1528, FCC KDBs and CEI/IEC 62209 standards state that the system validation measurements must be performed using a reference dipole meeting the fore mentioned return loss and mechanical dimension requirements. The validation measurement must be performed against a liquid filled flat phantom, with the phantom constructed as outlined in the fore mentioned standards. Per the standards, the dipole shall be positioned below the bottom of the phantom, with the dipole length centered and parallel to the longest dimension of the flat phantom, with the top surface of the dipole at the described distance from the bottom surface of the phantom.

**7.1 HEAD LIQUID MEASUREMENT**

Frequency MHz	Relative permittivity ( $\epsilon_r'$ )		Conductivity ( $\sigma$ ) S/m	
	required	measured	required	measured
300	45.3 ±5 %		0.87 ±5 %	
450	43.5 ±5 %		0.87 ±5 %	
750	41.9 ±5 %		0.89 ±5 %	
835	41.5 ±5 %		0.90 ±5 %	
900	41.5 ±5 %		0.97 ±5 %	
1450	40.5 ±5 %		1.20 ±5 %	
1500	40.4 ±5 %		1.23 ±5 %	
1640	40.2 ±5 %		1.31 ±5 %	
1750	40.1 ±5 %		1.37 ±5 %	



1800	40.0 ±5 %		1.40 ±5 %	
1900	40.0 ±5 %		1.40 ±5 %	
1950	40.0 ±5 %		1.40 ±5 %	
2000	40.0 ±5 %		1.40 ±5 %	
2100	39.8 ±5 %		1.49 ±5 %	
2300	39.5 ±5 %		1.67 ±5 %	
2450	39.2 ±5 %	PASS	1.80 ±5 %	PASS
2600	39.0 ±5 %		1.96 ±5 %	
3000	38.5 ±5 %		2.40 ±5 %	
3500	37.9 ±5 %		2.91 ±5 %	

**7.2 SAR MEASUREMENT RESULT WITH HEAD LIQUID**

The IEEE Std. 1528 and CEI/IEC 62209 standards state that the system validation measurements should produce the SAR values shown below (for phantom thickness of 2 mm), within the uncertainty for the system validation. All SAR values are normalized to 1 W forward power. In bracket, the measured SAR is given with the used input power.

Software	OPENSAR V4
Phantom	SN 20/09 SAM71
Probe	SN 18/11 EPG122
Liquid	Head Liquid Values: eps' : 37.5 sigma : 1.80
Distance between dipole center and liquid	10.0 mm
Area scan resolution	dx=8mm/dy=8mm
Zoon Scan Resolution	dx=5mm/dy=5mm/dz=5mm
Frequency	2450 MHz
Input power	20 dBm
Liquid Temperature	21 °C
Lab Temperature	21 °C
Lab Humidity	45 %

Frequency MHz	1 g SAR (W/kg/W)		10 g SAR (W/kg/W)	
	required	measured	required	measured
300	2.85		1.94	
450	4.58		3.06	
750	8.49		5.55	
835	9.56		6.22	
900	10.9		6.99	
1450	29		16	
1500	30.5		16.8	
1640	34.2		18.4	
1750	36.4		19.3	
1800	38.4		20.1	

1900	39.7		20.5	
1950	40.5		20.9	
2000	41.1		21.1	
2100	43.6		21.9	
2300	48.7		23.3	
2450	52.4	54.74 (5.47)	24	24.31 (2.43)
2600	55.3		24.6	
3000	63.8		25.7	
3500	67.1		25	

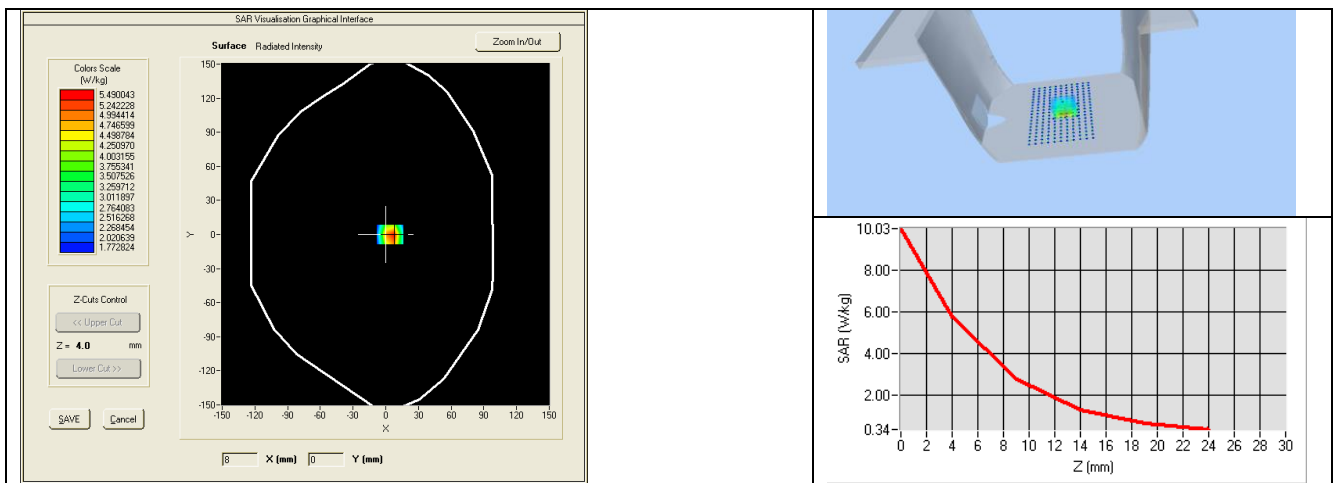

### 7.3 BODY LIQUID MEASUREMENT

Frequency MHz	Relative permittivity ( $\epsilon_r'$ )		Conductivity ( $\sigma$ ) S/m	
	required	measured	required	measured
150	61.9 ± 5 %		0.80 ± 5 %	
300	58.2 ± 5 %		0.92 ± 5 %	
450	56.7 ± 5 %		0.94 ± 5 %	
750	55.5 ± 5 %		0.96 ± 5 %	
835	55.2 ± 5 %		0.97 ± 5 %	
900	55.0 ± 5 %		1.05 ± 5 %	
915	55.0 ± 5 %		1.06 ± 5 %	
1450	54.0 ± 5 %		1.30 ± 5 %	
1610	53.8 ± 5 %		1.40 ± 5 %	
1800	53.3 ± 5 %		1.52 ± 5 %	
1900	53.3 ± 5 %		1.52 ± 5 %	
2000	53.3 ± 5 %		1.52 ± 5 %	
2100	53.2 ± 5 %		1.62 ± 5 %	
2450	52.7 ± 5 %	PASS	1.95 ± 5 %	PASS

2600	52.5 ±5 %		2.16 ±5 %	
3000	52.0 ±5 %		2.73 ±5 %	
3500	51.3 ±5 %		3.31 ±5 %	
5200	49.0 ±10 %		5.30 ±10 %	
5300	48.9 ±10 %		5.42 ±10 %	
5400	48.7 ±10 %		5.53 ±10 %	
5500	48.6 ±10 %		5.65 ±10 %	
5600	48.5 ±10 %		5.77 ±10 %	
5800	48.2 ±10 %		6.00 ±10 %	

7.4 SAR MEASUREMENT RESULT WITH BODY LIQUID

Software	OPENSAR V4
Phantom	SN 20/09 SAM71
Probe	SN 18/11 EPG122
Liquid	Body Liquid Values: eps' : 53.2 sigma : 1.89
Distance between dipole center and liquid	10.0 mm
Area scan resolution	dx=8mm/dy=8mm
Zoon Scan Resolution	dx=5mm/dy=5mm/dz=5mm
Frequency	2450 MHz
Input power	20 dBm
Liquid Temperature	21 °C
Lab Temperature	21 °C
Lab Humidity	45 %

Frequency MHz	1 g SAR (W/kg/W)	10 g SAR (W/kg/W)
	measured	measured
2450	52.08 (5.21)	23.97 (2.40)

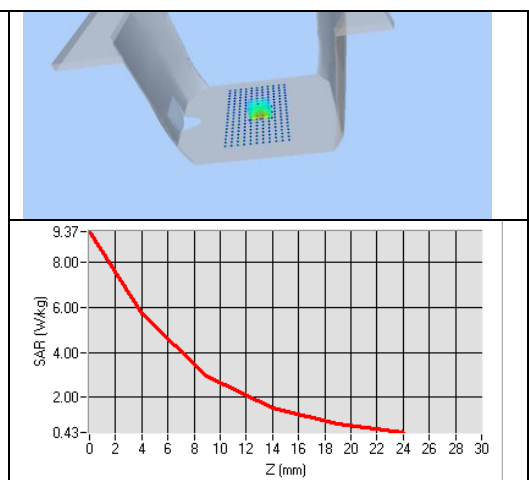
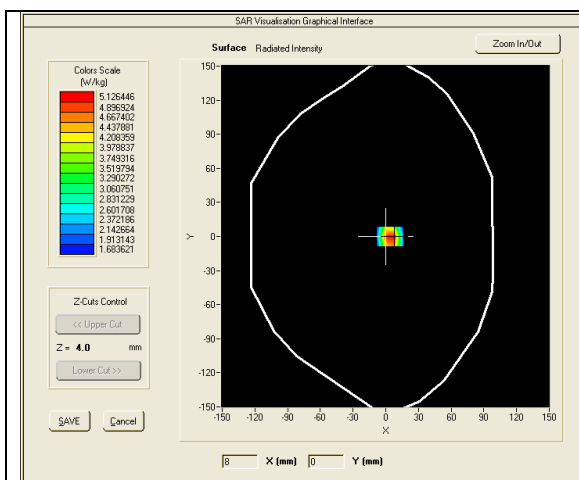





**8 LIST OF EQUIPMENT**

Equipment Summary Sheet				
Equipment Description	Manufacturer / Model	Identification No.	Current Calibration Date	Next Calibration Date
SAM Phantom	MVG	SN-20/09-SAM71	Validated. No cal required.	Validated. No cal required.
COMOSAR Test Bench	Version 3	NA	Validated. No cal required.	Validated. No cal required.
Network Analyzer	Rhode & Schwarz ZVA	SN100132	02/2016	02/2019
Calipers	Carrera	CALIPER-01	12/2013	12/2016
Reference Probe	MVG	EPG122 SN 18/11	10/2015	10/2016
Multimeter	Keithley 2000	1188656	12/2013	12/2016
Signal Generator	Agilent E4438C	MY49070581	12/2013	12/2016
Amplifier	Aethercomm	SN 046	Characterized prior to test. No cal required.	Characterized prior to test. No cal required.
Power Meter	HP E4418A	US38261498	12/2013	12/2016
Power Sensor	HP ECP-E26A	US37181460	12/2013	12/2016
Directional Coupler	Narda 4216-20	01386	Characterized prior to test. No cal required.	Characterized prior to test. No cal required.
Temperature and Humidity Sensor	Control Company	150798832	10/2015	10/2017

## Performance Verification Report

For MVG COMOSAR REFERENCE DIPOLE

Frequency: 2450 MHZ

Serial No.: SN 22/16 DIP 2G450-411

Date of Test: June 29, 2017

### PREPARED AND CHECKED BY:

  
Digitally signed by  
Chan Chun Foo, Bike  
Location: Intertek  
Testing Services  
Hong Kong Limited

Chan Chun Foo, Bike  
Senior Lead Engineer  
Date: June 29, 2017

### APPROVED BY:

  
Digitally signed by  
Terry Chan  
Location: Intertek  
Testing Services  
Hong Kong Ltd.

Chan Chi Hung, Terry  
Assistant Manager  
Date: June 29, 2017

**TEST REPORT****1. INTRODUCTION**

According to KDB 865664 SAR measurement 100MHz to 6GHz, it is necessary to re-calibrate reference dipoles at regular intervals to confirm the electrical specifications and SAR targets. A dipole must be calibrated using a fully validated SAR system according to the tissue dielectric parameters and SAR probe calibration frequency required for device testing. It is generally unacceptable to calibrate a dipole using the SAR system that has been validated by the same dipole; therefore, dipoles should be returned to the SAR system manufacturer or its designated calibration facilities for re-calibration. However, instead of the typical annual calibration recommended by measurement standards, longer calibration intervals of up to three years may be considered when it is demonstrated that the SAR target, impedance and return loss of a dipole have remain stable according to the following requirements.

1. The test laboratory must ensure that the required supporting information and documentation are included in the SAR report to qualify for the three-year extended calibration interval; otherwise, the IEEE Std 1528 recommended annual calibration applies.
2. Immediate re-calibration is required for the following conditions.
  - a. After a dipole is damaged and properly repaired to meet required specifications.
  - b. When the measured SAR deviates from the calibrated SAR value by more than 10% due to changes in physical, mechanical, electrical or other relevant dipole conditions; i.e., the error is not introduced by incorrect measurement procedures or other issues relating to the SAR measurement system.
  - c. When the most recent return-loss result, measured at least annually, deviates by more than 20% from the previous measurement (i.e. value in dB x 0.2) or not meeting the required 20 dB minimum return-loss requirement.
  - d. When the most recent measurement of the real or imaginary parts of the impedance, measured at least annually, deviates by more than 5  $\Omega$  from the previous measurement.

And the purpose of this dipole validation report is to demonstrate the SAR target, impedance and return loss of the dipole are still remain stable with reference to the annual calibration data.

## 2. MEASUREMENT CONDITIONS

Measurements were performed using a SAM TWIN phantom with 2mm wall thickness.

A Rhode & Schwarz vector network analyzer was used for the return loss measurements. The dipole was placed in a special holder made of low permittivity, low-loss materials. This holder enables the dipole to be positioned accurately in the centre of the wall of the SAM TWIN phantom used for flat surface testing and verification checks.

### 2.1. Equipment List

Equipment	Registration No.	Manufacturer	Model No.	Calibration Date	Calibration Due Date
SAR System	EW-3211	MVG	SATIMO System (OpenSAR Software V4_02_34)	N/A	N/A
Phantom	EW-3211	SATIMO	COMOSAR SAM PHANTOM	N/A	N/A
Digital Multimeter	EW-3206	KEITHLEY	2000	16 Aug 2016	16 Aug 2017
SAR Probe	EW-3210	MVG	SSE2 (SN 08/16 EPGO283)	27 Jun 2017	27 Jun 2018
SAR Dipole	EW-3212	MVG	SN 22/16 DIP 2G450-411	05 Jul 2016	05 Jul 2019
Dielectric Probe for SAR Test	EW-3213	EW-3213	Liquid Measurement Kit (SN 24/16 OCPG 76)	27 Jun 2017	27 Jun 2018
Head Liquid Tissue	N/A	MVG	Head Liquid 2450MHz	Refer to Section 2.2	
Body Liquid Tissue	N/A	MVG	Body Liquid 2450MHz	Refer to Section 2.2	
Network Analyzer	EW-3192	Rhode & Schwarz	ZVL6	08 Jul 2017	08 Jul 2018
Signal Generator (250kHz to 40GHz)	EW-1983	AGILENTTECH	E8247C	25 May 2016	25 May 2018
Directional Coupler (2 to 18)GHz	EW-3188	KEYSIGHT	773D	23 Aug 2016	23 Aug 2017
RF Power Meter	EW-2270	AGILENTTECH	N1911A	08 Jan 2017	08 Jan 2018
SAR RF Amplifier for SAR System	EW-3275	SATIMO	MVG	04 Jan 2017	04 Jan 2018

## TEST REPORT

### 2.2. Tissue Simulating Liquid

For SAR measurement of field distribution inside phantom, homogeneous tissue simulating liquid as below liquid recipes were filled to a depth of 15cm  $\pm$  0.5cm for below 3GHz measurement and of 10cm  $\pm$  0.5cm for above 3GHz.

#### HEAD TISSUE RECIPES

Frequency	De-ionized Water	Ingredients				
		Salt	1,2 propanediol	DGBE	DGMH	Triton X100
450 MHz	33.5%	3.4%	63.1%			
750 MHz	34.2%	1.4%	64.4%			
900 MHz	35.3%	1.0%	63.7%			
1800 MHz	55.2%	0.6%		13.8%		30.4%
1900 MHz	55.3%	0.5%		13.8%		30.4%
2000 MHz	55.3%	0.4%		13.8%		30.5%
2450 MHz	55.7%	0.3%		18.7%		25.3%
5000 MHz	65.3%				17.2%	17.5%

#### BODY TISSUE RECIPES

Frequency	De-ionized Water	Ingredients				
		Salt	1,2 propanediol	DGBE	DGMH	Triton X100
450 MHz	52.4%	1.9%	45.7%			
750 MHz	55.4%	1.3%	43.3%			
900 MHz	52.9%	1.0%	46.1%			
1800 MHz	70.8%	0.5%		8.7%		20.0%
1900 MHz	70.1%	0.4%		8.9%		20.6%
2000 MHz	70.2%	0.3%		8.6%		20.9%
2450 MHz	70.8%	0.3%		8.7%		20.2%
5000 MHz	77.8%				11.7%	11.5%

## TEST REPORT

The head tissue dielectric parameters recommended by the IEEE Std 1528 have been incorporated in the following table. These head parameters are derived from planar layer models simulating the highest expected SAR for the dielectric properties and tissue thickness variations in a human head. For other head and body tissue parameters, they are recommended by KDB 865664.

Target Frequency (MHz)	head		body	
	$\epsilon_r$	$\sigma$ (S/m)	$\epsilon_r$	$\sigma$ (S/m)
300	45.3	0.87	58.2	0.92
450	43.5	0.87	56.7	0.94
835	41.5	0.90	55.2	0.97
900	41.5	0.97	55.0	1.05
915	41.5	1.01	55.0	1.06
1450	40.5	1.20	54.0	1.30
1610	40.3	1.29	53.8	1.40
1800 – 2000	40.0	1.40	53.3	1.52
2450	39.2	1.80	52.7	1.95
3000	38.5	2.40	52.0	2.73
5800	35.3	5.27	48.2	6.00

( $\epsilon_r$  = relative permittivity,  $\sigma$  = conductivity and  $\rho = 1000 \text{ kg/m}^3$ )

When a transmission band overlaps with one of the target frequencies, the tissue dielectric parameters of the tissue medium at the middle of a device transmission band should be within  $\pm 5\%$  of the parameters specified at that target frequency.

The dielectric parameters of the liquids were verified prior to the SAR evaluation using SATIMO Dielectric Probe Kit and R&S Network Analyzer ZVL6.

The dielectric parameters were:

## Head Liquid

Freq. (MHz)	Temp. (°C)	$\epsilon_r$ / Relative Permittivity			$\sigma$ / Conductivity			$\rho$ **(kg/m <sup>3</sup> )
		measured	Target*	$\Delta$ ( $\pm 5\%$ )	measured	Target*	$\Delta$ ( $\pm 5\%$ )	
2450	21.7	39.54	39.20	0.87	1.87	1.80	3.89	1000

\* Target values refer to KDB 865664

\*\* Worst-case assumption

### Note:

1. Date of tissue verification measurement: June 29, 2017
2. Ambient temperature: 21.7 deg C
3. The temperature condition is within +/- 2 deg. C during the SAR measurements.

## Body Liquid

Freq. (MHz)	Temp. (°C)	$\epsilon_r$ / Relative Permittivity			$\sigma$ / Conductivity			$\rho$ **(kg/m <sup>3</sup> )
		measured	Target*	$\Delta$ ( $\pm 5\%$ )	measured	Target*	$\Delta$ ( $\pm 5\%$ )	
2450	21.7	51.08	52.70	-3.07	1.99	1.95	2.05	1000

\* Target values refer to KDB 865664

\*\* Worst-case assumption

### Note:

1. Date of tissue verification measurement: June 29, 2017
2. Ambient temperature: 21.7 deg C
3. The temperature condition is within +/- 2 deg. C during the SAR measurements.

### 3. DIPOLE IMPEDANCE AND RETURN LOSS

The dipoles are designed to have low return loss ONLY when presented against a lossy-phantom at the specified distance. A Vector Network Analyzer (VNA) was used to perform a return loss measurement on the specific dipole when in the measurement-location against the SAM TWIN phantom. The distance was as specified in the standard i.e. 10mm from the liquid (for 2450MHz).

The impedance was measured at the SMA-connector with the network analyzer.

#### Head Liquid

#### DIPOLE IMPEDANCE

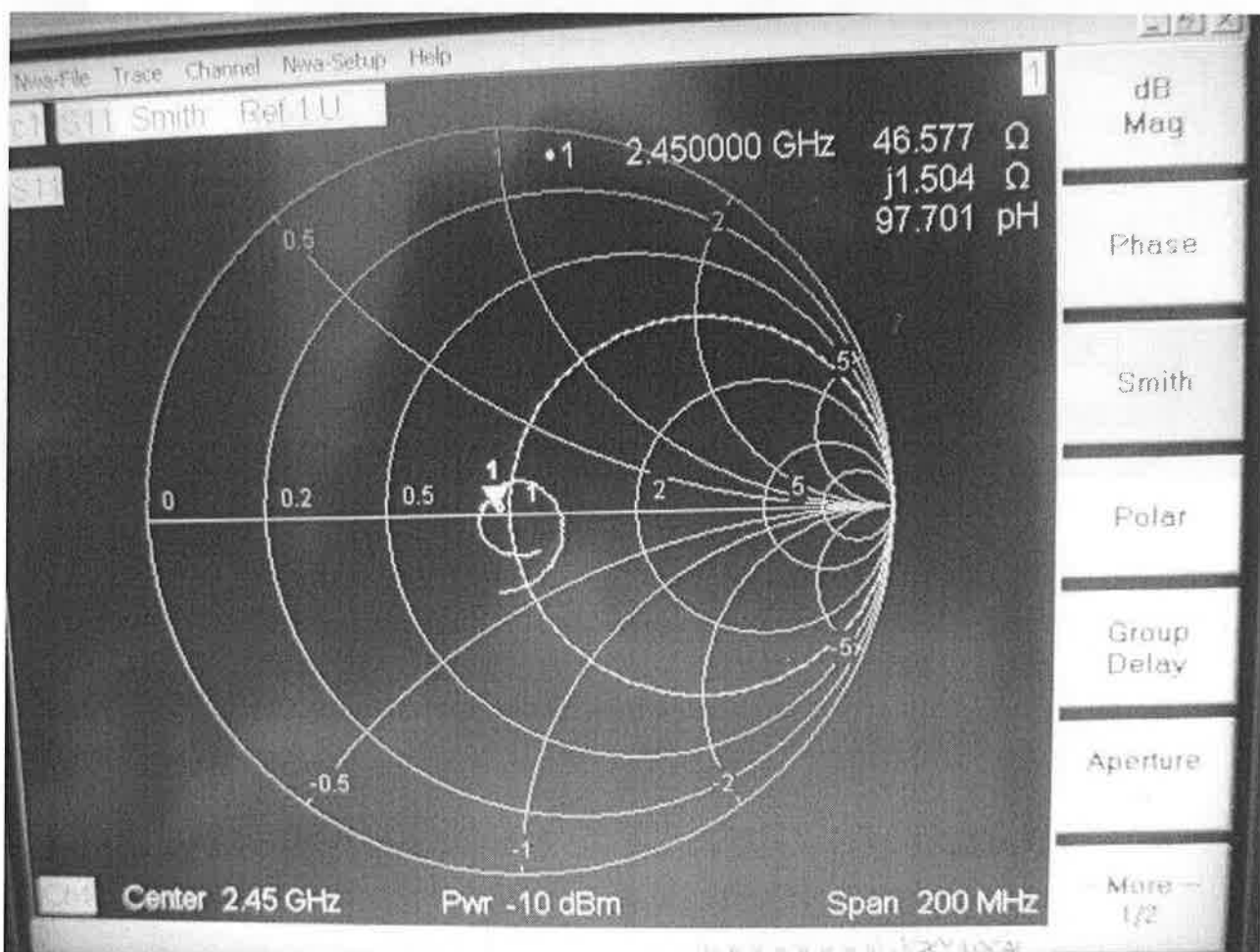

Freq. (MHz)	Temp. (°C)	Dipole impedance Re{Z}			Dipole impedance Im{Z}		
		measured	Target*	Δ (±5Ω)	measured	Target*	Δ (±5Ω)
2450	21.7	46.6	44.1	2.5	1.5	-1.3	2.8



## TEST REPORT

### RETURN LOSS

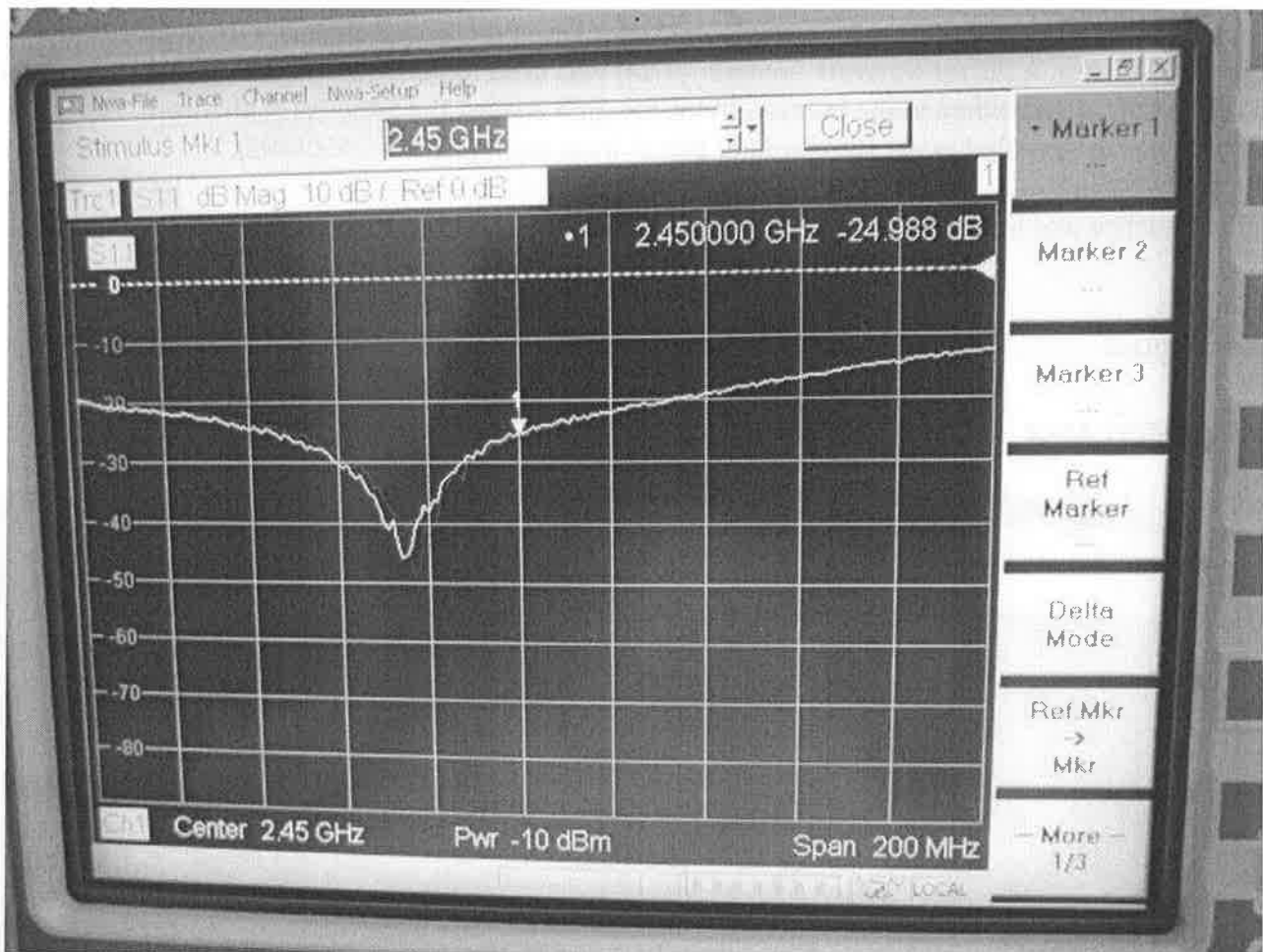

Freq. (MHz)	Temp. (°C)	Return loss		
		measured	Target*	$\Delta$ ( $\pm 20\%$ )
2450	21.7	-24.99	-24.42	-12.30%

\* the target was quoted from dipole calibration report

## TEST REPORT

## Body Liquid

### DIPOLE IMPEDANCE

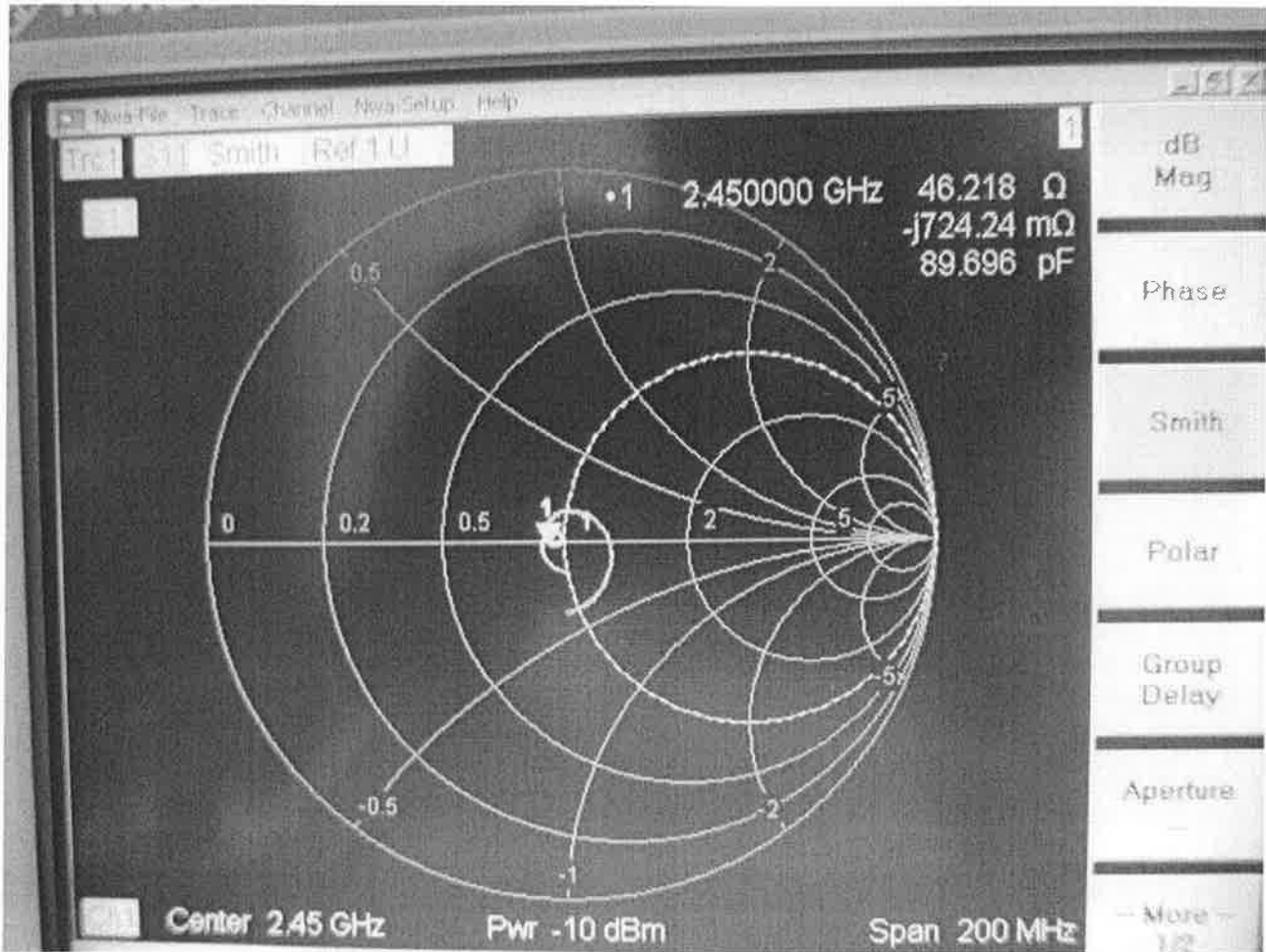

Freq. (MHz)	Temp. (°C)	Dipole impedance Re{Z}			Dipole impedance Im{Z}		
		measured	Target*	Δ (±5Ω)	measured	Target*	Δ (±5Ω)
2450	21.7	46.2	46.9	-0.7	-0.7	-2.8	2.1

## RETURN LOSS



Freq. (MHz)	Temp. (°C)	Return loss		
		measured	Target*	$\Delta$ ( $\pm 20\%$ )
2450	21.7	-27.70	-27.58	-2.73%

\* the target was quoted from dipole calibration report

### 4. SAR MEASUREMENT SYSTEM VERIFICATION

Routine record keeping procedures should be established for tracking the calibration and performance of SAR measurement system. When SAR measurements are performed, the entire measurement system should be checked daily within the device transmitting frequency ranges to verify system accuracy. A flat phantom irradiated by a half-wavelength dipole is typically used to verify the measurement accuracy of a system. According to KDB 865664, at 300MHz to 6GHz, measurements must be within  $\pm 100\text{MHz}$  of the probe calibration point frequency or the valid frequency range supported by the probe calibration, whichever is less. The measured one-gram SAR should be within 10% of the expected target values specified for the specific phantom and RF source used in the system verification measurement.

The system check verifies that the system operates within its specifications. It's performed daily or before every SAR measurement. The system check uses normal SAR measurement in the flat section of the phantom with a matched dipole at a specified distance. The system check setup is shown as below.

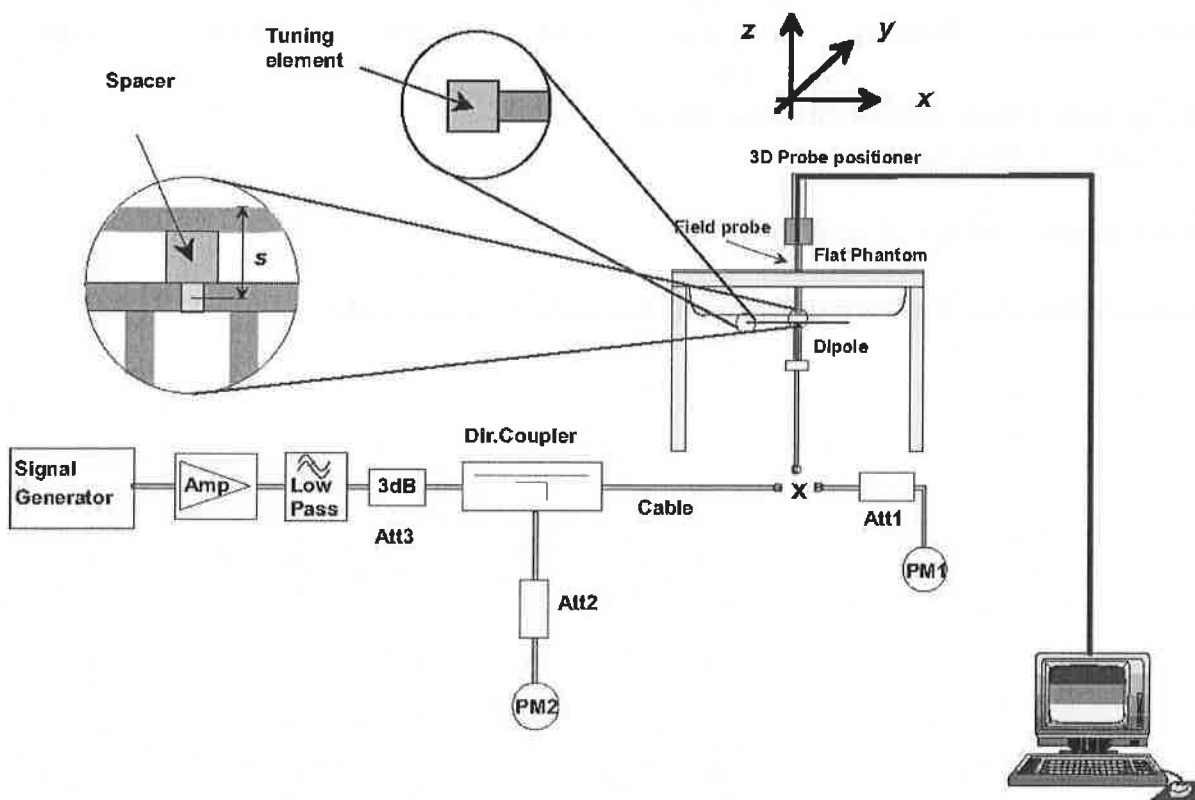

## SYSTEM CHECK RESULTS

Date	Freq. (MHz)	Liquid Type	System Diople	System Verification				
				Serial No.	Target SAR <sub>1g</sub> (W/kg)	Measured SAR <sub>1g</sub> (W/kg)	Normalized SAR <sub>1g</sub> (W/kg)	Deviation (±10%)
June 29	2450	Head	2450MHz	SN 22/16 DIP 2G450- 411	54.74	5.561	55.61	1.59

\* the target was quoted from dipole calibration report

\* Input power level = 20dBm (0.1W)

Date	Freq. (MHz)	Liquid Type	System Diople	System Verification				
				Serial No.	Target SAR <sub>1g</sub> (W/kg)	Measured SAR <sub>1g</sub> (W/kg)	Normalized SAR <sub>1g</sub> (W/kg)	Deviation (±10%)
June 29	2450	Body	2450MHz	SN 22/16 DIP 2G450- 411	52.08	5.081	50.81	-2.44

\* the target was quoted from dipole calibration report

\* Input power level = 20dBm (0.1W)

SAR<sub>1g</sub> ambient measured value < 12 mW/kg

Details of System Verification plots are shown in the Appendix A - plot 1 and 2.

## TEST REPORT

### APPENDIX A – SYSTEM CHECK DATA

Plot #1

Operating Frequency : 2450MHz

Test Date: June 29 2017

Medium (Liquid Type)	: 2450 Head
Relative permittivity $\epsilon_r$	: 39.542
Conductivity $\sigma$ :	: 1.874
Probe	: Model: SSE2; Serial No.: SN 08/16 EPGO283
Crest factor	: 1.0
Conversion Factor	: 1.98
Area Scan	: dx=8mm, dy=8mm
Zoom Scan	: 7x7x7, dx=5mm dy=5mm dz=5mm
Phantom	: SAM phantom
Device Position	: Dipole
SAR Drift (%)	: 1.90%
Maximum location	: X=1.00, Y=0.00
SAR Peak (W/kg)	: 10.51 W/kg
SAR 10g (W/kg)	: 2.581 W/kg
SAR 1g (W/kg)	: 5.561 W/kg

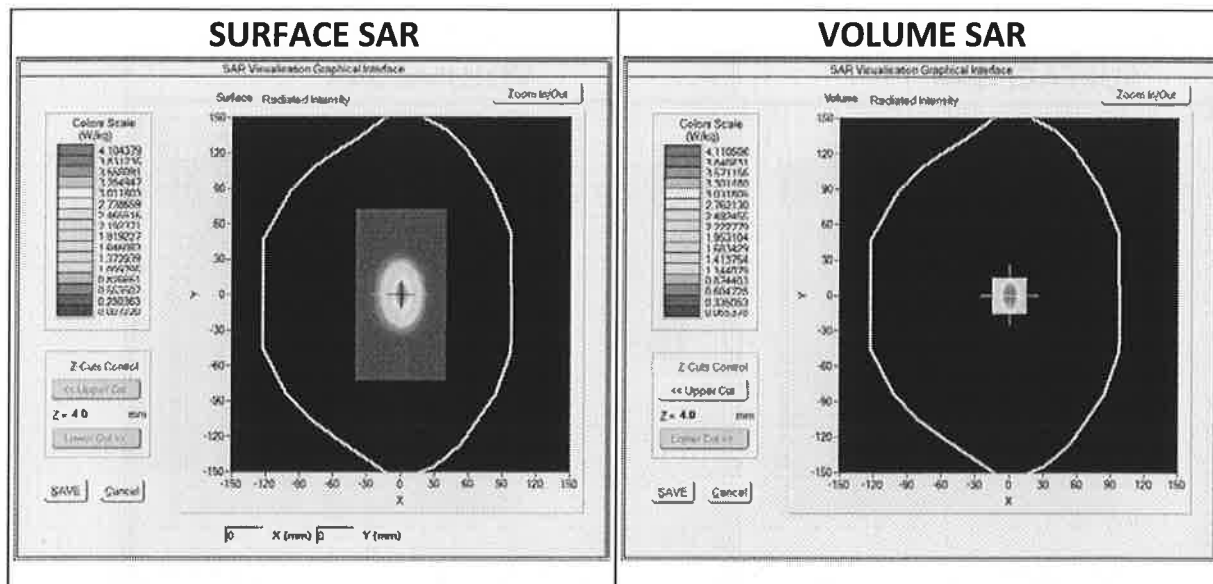

## APPENDIX A – SYSTEM CHECK DATA (CONT'D)

Plot #2

Operating Frequency : 2450MHz

Test Date: June 29 2017

Medium (Liquid Type)	: 2450 Body
Relative permittivity $\epsilon_r$	: 51.084
Conductivity $\sigma$ :	: 1.993
Probe	: Model: SSE2; Serial No.: SN 08/16 EPGO283
Crest factor	: 1.0
Conversion Factor	: 2.07
Area Scan	: dx=8mm, dy=8mm
Zoom Scan	: 7x7x7, dx=5mm dy=5mm dz=5mm
Phantom	: SAM phantom
Device Position	: Dipole
SAR Drift (%)	: -0.72%
Maximum location	: X=-1.00, Y=-1.00
SAR Peak (W/kg)	: 9.43 W/kg
SAR 10g (W/kg)	: 2.311 W/kg
SAR 1g (W/kg)	: 5.081 W/kg

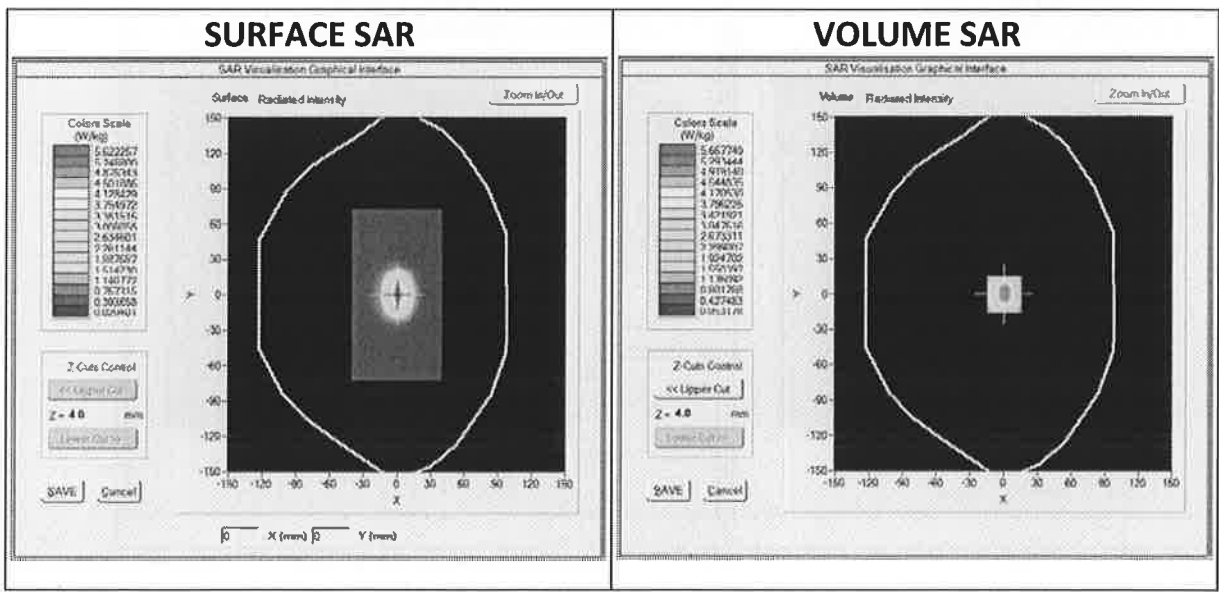

**TEST REPORT**

**APPENDIX D – SAR SYSTEM VALIDATION**

Per KDB 865664, SAR system validation status should be documented to confirm measurement accuracy. SAR measurement systems are validated according to procedures in KDB 865664. The validation status is documented according to the validation date(s), measurement frequencies, SAR probe and tissue dielectric parameters. When multiple SAR system is used, the validation status of each SAR system is needed to be documented separately according to the associated system components.

A tabulated summary of the system validation status including the validation date(s), measurement frequencies, SAR probe and tissue dielectric parameters are shown as below.

Date	Probe S/N	Tested Freq. (MHz)	Tissue Type	Perm	Cond	CW Validation			Mod. Validation		Peak to average power ratio
						Sensitivity	Probe Linearity	Probe Isotropy	Mod. Type	Duty Factor	
14/07/2017	EPGO 283	1900	Head	40.95	1.42	PASS	PASS	PASS	GFSK	PASS	PASS
14/07/2017	EPGO 283	1900	Body	53.63	1.58	PASS	PASS	PASS	GFSK	PASS	PASS
14/07/2017	EPGO 283	450	Head	41.82	0.86	PASS	PASS	PASS	FM	PASS	PASS
14/07/2017	EPGO 283	450	Body	57.86	0.93	PASS	PASS	PASS	FM	PASS	PASS
17/07/2017	EPGO 283	1800	Head	38.25	1.45	PASS	PASS	PASS	GFSK	PASS	PASS
17/07/2017	EPGO 283	1800	Body	52.77	1.55	PASS	PASS	PASS	GFSK	PASS	PASS
18/07/2017	EPGO 283	2450	Head	38.23	1.88	PASS	PASS	PASS	FHSS	PASS	PASS
18/07/2017	EPGO 283	2450	Body	50.27	1.86	PASS	PASS	PASS	FHSS	PASS	PASS
18/07/2017	EPGO 283	2450	Head	38.23	1.88	PASS	PASS	PASS	OFDM	N/A	PASS
18/07/2017	EPGO 283	2450	Body	50.27	1.86	PASS	PASS	PASS	OFDM	N/A	PASS
18/07/2017	EPGO 283	2450	Head	38.23	1.88	PASS	PASS	PASS	DSSS	PASS	N/A
18/07/2017	EPGO 283	2450	Body	50.27	1.86	PASS	PASS	PASS	DSSS	PASS	N/A