



# SPORTON International Inc.

No. 52, Hwa Ya 1st Rd., Hwa Ya Technology Park, Kwei-Shan Hsiang, Tao Yuan Hsien, Taiwan, R.O.C.  
Ph: 886-3-327-3456 / FAX: 886-3-327-0973 / www.sporton.com.tw

## FCC RADIO TEST REPORT

Applicant's company	Zentri Pty Ltd
Applicant Address	Level 9, 191 Clarence St., Sydney, NSW, 2000 Australia
FCC ID	2ABPY-5B9198

Product Name	Spectre
Brand Name	Zentri
Model No.	AMW007
Test Rule	47 CFR FCC Part 15 Subpart C § 15.247
Test Freq. Range	2400 ~ 2483.5MHz
Received Date	Apr. 18, 2016
Final Test Date	May 06, 2016
Submission Type	Original Equipment

### Statement

**Test result included in this report is for the IEEE 802.11n and IEEE 802.11b/g of the product.**

The test result in this report refers exclusively to the presented test model / sample.

Without written approval of SPORTON International Inc., the test report shall not be reproduced except in full.

The measurements and test results shown in this test report were made in accordance with the procedures and found in compliance with the limit given in **ANSI C63.10-2013, 47 CFR FCC Part 15 Subpart C, KDB558074 D01 v03r05.**

The test equipment used to perform the test is calibrated and traceable to NML/ROC.



## Table of Contents

<b>1. VERIFICATION OF COMPLIANCE</b> .....	<b>1</b>
<b>2. SUMMARY OF THE TEST RESULT</b> .....	<b>2</b>
<b>3. GENERAL INFORMATION</b> .....	<b>3</b>
3.1. Product Details.....	3
3.2. Accessories.....	5
3.3. Table for Filed Antenna.....	6
3.4. Table for Carrier Frequencies .....	6
3.5. Table for Test Modes.....	7
3.6. Table for Testing Locations.....	8
3.7. Table for Supporting Units .....	9
3.8. Table for Parameters of Test Software Setting .....	10
3.9. EUT Operation during Test .....	11
3.10. Duty Cycle.....	12
3.11. Test Configurations .....	13
<b>4. TEST RESULT</b> .....	<b>16</b>
4.1. AC Power Line Conducted Emissions Measurement.....	16
4.2. Maximum Conducted Output Power Measurement.....	20
4.3. Power Spectral Density Measurement .....	26
4.4. 6dB Spectrum Bandwidth Measurement .....	43
4.5. Radiated Emissions Measurement .....	65
4.6. Emissions Measurement .....	117
4.7. Antenna Requirements .....	179
<b>5. LIST OF MEASURING EQUIPMENTS</b> .....	<b>180</b>
<b>6. MEASUREMENT UNCERTAINTY</b> .....	<b>182</b>
<b>APPENDIX A. TEST PHOTOS</b> .....	<b>A1 ~ A15</b>



## History of This Test Report

REPORT NO.	VERSION	DESCRIPTION	ISSUED DATE
FR641926	Rev. 01	Initial issue of report	May 31, 2016



## 1. VERIFICATION OF COMPLIANCE

Product Name : Spectre  
Brand Name : Zentri  
Model No. : AMW007  
Applicant : Zentri Pty Ltd  
Test Rule Part(s) : 47 CFR FCC Part 15 Subpart C § 15.247

Sporton International as requested by the applicant to evaluate the EMC performance of the product sample received on Apr. 18, 2016 would like to declare that the tested sample has been evaluated and found to be in compliance with the tested rule parts. The data recorded as well as the test configuration specified is true and accurate for showing the sample's EMC nature.

A handwritten signature in black ink, appearing to read "Sam Chen".

Sam Chen

SPORTON INTERNATIONAL INC.



## 2. SUMMARY OF THE TEST RESULT

Applied Standard: 47 CFR FCC Part 15 Subpart C			
Part	Rule Section	Description of Test	Result
4.1	15.207	AC Power Line Conducted Emissions	Complies
4.2	15.247(b)(3)	Maximum Conducted Output Power	Complies
4.3	15.247(e)	Power Spectral Density	Complies
4.4	15.247(a)(2)	6dB Spectrum Bandwidth	Complies
4.5	15.247(d)	Radiated Emissions	Complies
4.6	15.247(d)	Band Edge Emissions	Complies
4.7	15.203	Antenna Requirements	Complies

Note: The EUT supports 20MHz only.

### 3. GENERAL INFORMATION

#### 3.1. Product Details

Items	Description
Product Type	1TX, 1RX
Radio Type	Intentional Transceiver
Power Type	From host system
Modulation	IEEE 802.11b: DSSS IEEE 802.11g: OFDM IEEE 802.11n: see the below table
Data Modulation	IEEE 802.11b: DSSS (BPSK / QPSK / CCK) IEEE 802.11g/n: OFDM (BPSK / QPSK / 16QAM / 64QAM)
Data Rate (Mbps)	IEEE 802.11b: DSSS (1/ 2/ 5.5/11) IEEE 802.11g: OFDM (6/9/12/18/24/36/48/54) IEEE 802.11n: see the below table
Frequency Range	2400 ~ 2483.5MHz
Channel Number	11 for 20MHz bandwidth
Channel Band Width (99%)	<p><b>&lt;Mode 1: Ant. 1 (PCB Ant.)&gt;</b>            IEEE 802.11b: 17.37 MHz            IEEE 802.11g: 23.44 MHz            IEEE 802.11n MCS0 (HT20): 17.54 MHz</p> <p><b>&lt;Mode 2: Ant. 2 (PCB Ant.)&gt;</b>            IEEE 802.11b: 17.11 MHz            IEEE 802.11g: 25.79 MHz            IEEE 802.11n MCS0 (HT20): 17.80 MHz</p> <p><b>&lt;Mode 3: Ant. 3 (Wire Ant.)&gt;</b>            IEEE 802.11b: 17.11 MHz            IEEE 802.11g: 20.84 MHz            IEEE 802.11n MCS0 (HT20): 21.62 MHz</p> <p><b>&lt;Mode 4: Ant. 4 (Dipole Ant.)&gt;</b>            IEEE 802.11b: 17.11 MHz            IEEE 802.11g: 22.32 MHz            IEEE 802.11n MCS0 (HT20): 23.62 MHz</p> <p><b>&lt;Mode 5: Ant. 6 (Chip Ant.)&gt;</b>            IEEE 802.11b: 17.19 MHz            IEEE 802.11g: 28.13 MHz            IEEE 802.11n MCS0 (HT20): 30.30 MHz</p>

Maximum Conducted Output Power	<p><b>&lt;Mode 1: Ant. 1 (PCB Ant.)&gt;</b>          IEEE 802.11b: 21.87 dBm          IEEE 802.11g: 21.08 dBm          IEEE 802.11n MCS0 (HT20): 21.17 dBm</p> <p><b>&lt;Mode 2: Ant. 2 (PCB Ant.)&gt;</b>          IEEE 802.11b: 22.35 dBm          IEEE 802.11g: 21.61 dBm          IEEE 802.11n MCS0 (HT20): 21.57 dBm</p> <p><b>&lt;Mode 3: Ant. 3 (Wire Ant.)&gt;</b>          IEEE 802.11b: 20.62 dBm          IEEE 802.11g: 19.39 dBm          IEEE 802.11n MCS0 (HT20): 18.69 dBm</p> <p><b>&lt;Mode 4: Ant. 4 (Dipole Ant.)&gt;</b>          IEEE 802.11b: 16.68 dBm          IEEE 802.11g: 20.57 dBm          IEEE 802.11n MCS0 (HT20): 20.76 dBm</p> <p><b>&lt;Mode 5: Ant. 6 (Chip Ant.)&gt;</b>          IEEE 802.11b: 21.02 dBm          IEEE 802.11g: 21.12 dBm          IEEE 802.11n MCS0 (HT20): 21.27 dBm</p>
Carrier Frequencies	Please refer to section 3.4
Antenna	Please refer to section 3.3

Items	Description	
Beamforming Function	<input type="checkbox"/> With beamforming	<input checked="" type="checkbox"/> Without beamforming

**Antenna and Band width**

Antenna	Single (TX)
Band width Mode	20 MHz
IEEE 802.11b	V
IEEE 802.11g	V
IEEE 802.11n	V

**IEEE 11n Spec.**

Protocol	Number of Transmit Chains (NTX)	Data Rate / MCS
802.11n (HT20)	1	MCS 0-7
802.11n (HT40)	1	MCS 0-7
Note 1: IEEE Std. 802.11n modulation consists of HT20 and HT40 (HT: High Throughput). Then EUT supports HT20. Note 2: Modulation modes consist of below configuration: HT20: IEEE 802.11n		

**3.2. Accessories**

N/A

### 3.3. Table for Filed Antenna

Ant.	Brand	Model Name	Antenna Type	Connector	Gain (dBi)
1	ACKme Networks Inc.	ACA-PIFA-2458	PCB Ant.	N/A	3.18
2	ACKme Networks Inc.	ACA-PIFA-2430	PCB Ant.	N/A	3.30
3	ACKme Networks Inc.	ACA-WIRE-2458	Wire Ant.	N/A	2.11
4	ACKme Networks Inc.	ACA-4HSRPP-2458	Dipole Ant.	Reversed-SMA	1
5	ACKme Networks Inc.	ACA-1SSRPP-2400	Dipole Ant.	Reversed-SMA	0.6
6	Johanson Technology, Inc.	2450AT42A100	Chip Ant.	N/A	0

Note: 1. The EUT has five antennas.

2. Ant. 4 & Ant. 5 are the same type antennas, only the higher gain antenna "Ant. 4" was tested.

<For IEEE 802.11b/g/n mode (1TX/1RX)>:

Chain 1 can be used as transmitting/receiving antenna.

### 3.4. Table for Carrier Frequencies

There is one bandwidth system.

For 20MHz bandwidth systems, use Channel 1~Channel 11.

Frequency Band	Channel No.	Frequency	Channel No.	Frequency
2400~2483.5MHz	1	2412 MHz	7	2442 MHz
	2	2417 MHz	8	2447 MHz
	3	2422 MHz	9	2452 MHz
	4	2427 MHz	10	2457 MHz
	5	2432 MHz	11	2462 MHz
	6	2437 MHz	-	-

### 3.5. Table for Test Modes

Preliminary tests were performed in different data rate to find the worst radiated emission. The data rate shown in the table below is the worst-case rate with respect to the specific test item. Investigation has been done on all the possible configurations for searching the worst cases. The following table is a list of the test modes shown in this test report.

Test Items	Mode	Data Rate	Channel	Chain
AC Power Line Conducted Emissions	Normal Link	-	-	-
Maximum Conducted Output Power	11b/CCK	1 Mbps	1/6/11	1
	11g/BPSK	6 Mbps	1/6/11	1
	11n HT20	MCS0	1/6/11	1
Power Spectral Density	11b/CCK	1 Mbps	1/6/11	1
	11g/BPSK	6 Mbps	1/6/11	1
	11n HT20	MCS0	1/6/11	1
6dB Spectrum Bandwidth	11b/CCK	1 Mbps	1/6/11	1
	11g/BPSK	6 Mbps	1/6/11	1
	11n HT20	MCS0	1/6/11	1
Radiated Emissions 9kHz~1GHz	Normal Link	-	-	-
Radiated Emissions 1GHz~10 <sup>th</sup> Harmonic	11b/CCK	1 Mbps	1/6/11	1
	11g/BPSK	6 Mbps	1/6/11	1
	11n HT20	MCS0	1/6/11	1
Band Edge Emissions	11b/CCK	1 Mbps	1/6/11	1
	11g/BPSK	6 Mbps	1/6/11	1
	11n HT20	MCS0	1/6/11	1

The following test modes were performed for all tests:

**For Conducted Emission test:**

Mode 1. EUT with Ant. 1 (PCB Ant.)

Mode 2. EUT with Ant. 2 (PCB Ant.)

Mode 3. EUT with Ant. 3 (Wire Ant.)

Mode 4. EUT with Ant. 4 (Dipole Ant.)

Mode 5. EUT with Ant. 6 (Chip Ant.)

Mode 1 is the worst case, so it was selected to record in this test report.

#### For Radiated Emission test <Below 1GHz>:

The EUT was performed at Y axis and Z axis position. The worst case was found at Z axis, so it was selected to perform test and its test result was written in the report.

Mode 1. EUT Z axis with Ant. 1 (PCB Ant.)

Mode 2. EUT Z axis with Ant. 2 (PCB Ant.)

Mode 3. EUT Z axis with Ant. 3 (Wire Ant.)

Mode 4. EUT Z axis with Ant. 4 (Dipole Ant.)

Mode 5. EUT Z axis with Ant. 6 (Chip Ant.)

Mode 4 is the worst case, so it was selected to record in this test report.

#### For Radiated Emission test <Above 1GHz>:

The EUT was performed at X axis, Y axis and Z axis position. The worst case was found at Y axis, so it was selected to perform test and its test result was written in the report.

Mode 1. EUT Y axis with Ant. 1 (PCB Ant.)

Mode 2. EUT Y axis with Ant. 2 (PCB Ant.)

Mode 3. EUT Y axis with Ant. 3 (Wire Ant.)

Mode 4. EUT Y axis with Ant. 4 (Dipole Ant.)

Mode 5. EUT Y axis with Ant. 6 (Chip Ant.)

All test results were recorded in the report.

### 3.6. Table for Testing Locations

Test Site Location				
Address:	No.8, Lane 724, Bo-ai St., Jhubei City, Hsinchu County 302, Taiwan, R.O.C.			
TEL:	886-3-656-9065			
FAX:	886-3-656-9085			
Test Site No.	Site Category	Location	FCC Designation No.	IC File No.
03CH01-CB	SAC	Hsin Chu	TW0006	IC 4086D
CO01-CB	Conduction	Hsin Chu	TW0006	IC 4086D
TH01-CB	OVEN Room	Hsin Chu	-	-

Open Area Test Site (OATS); Semi Anechoic Chamber (SAC).

### 3.7. Table for Supporting Units

For Test Site No: CO01-CB

Support Unit	Brand	Model	FCC ID
AP Router	Planex	GW-AP54SGX	KA220030603014-1
NB	DELL	E6430	DoC
DC Power supply	MOTECH	LPS-305	DoC
Test Fixture	Zentri	ATG002	N/A
Test Fixture	Zentri	AMW007-A3P	N/A

For Test Site No: 03CH01-CB <Below 1GHz>

Support Unit	Brand	Model	FCC ID
AP Router	Planex	GW-AP54SGX	KA220030603014-1
NB	DELL	E4300	DoC
DC Power supply	MOTECH	LPS-305	DoC
Test Fixture	Zentri	ATG002	N/A
Test Fixture	Zentri	AMW006-A02	N/A

For Test Site No: 03CH01-CB <Above 1GHz>

Support Unit	Brand	Model	FCC ID
NB	DELL	E4300	DoC
Test Fixture	Zentri	ATG002	N/A
Test Fixture (For Ant. 1)	Zentri	AMW007-A3P	N/A
Test Fixture (For Ant. 2)	Zentri	AMW007-E03	N/A
Test Fixture (For Ant. 3 ~ Ant. 4)	Zentri	AMW006-A02	N/A
Test Fixture (For Ant. 6)	ACKme	AMW006-E05	N/A



## For Test Site No: TH01-CB

Support Unit	Brand	Model	FCC ID
NB	DELL	E4300	DoC
Test Fixture	Zentri	ATG002	N/A
Test Fixture (For Ant. 1)	Zentri	AMW007-A3P	N/A
Test Fixture (For Ant. 2)	Zentri	AMW007-E03	N/A
Test Fixture (For Ant. 3 ~ Ant. 4)	Zentri	AMW006-A02	N/A
Test Fixture (For Ant. 6)	ACKme	AMW006-E05	N/A

### 3.8. Table for Parameters of Test Software Setting

During testing, Channel and Power Controlling Software provided by the customer was used to control the operating channel as well as the output power level. The RF output power selection is for the setting of RF output power expected by the customer and is going to be fixed on the firmware of the final end product.

#### <Mode 1: Ant. 1 (PCB Ant.)>

Test Software Version	Zentri Cert Tool		
Mode	Test Frequency (MHz)		
	NCB: 20MHz		
	2412 MHz	2437 MHz	2462 MHz
802.11b	-0.75	1.5	1.25
802.11g	0.75	-1	-0.25
802.11n MCS0 HT20	0.75	-0.75	-0.5

#### <Mode 2: Ant. 2 (PCB Ant.)>

Test Software Version	Zentri Cert Tool		
Mode	Test Frequency (MHz)		
	NCB: 20MHz		
	2412 MHz	2437 MHz	2462 MHz
802.11b	-4.25	1	3
802.11g	1.75	2	2.25
802.11n MCS0 HT20	1.25	2.5	2.25

**<Mode 3: Ant. 3 (Wire Ant.)>**

Test Software Version	Zentri Cert Tool		
Mode	Test Frequency (MHz)		
	NCB: 20MHz		
	2412 MHz	2437 MHz	2462 MHz
802.11b	-1.25	-1	-2
802.11g	-0.5	-4	-4
802.11n MCS0 HT20	-1.5	-3.5	-4

**<Mode 4: Ant. 4 (Dipole Ant.)>**

Test Software Version	Zentri Cert Tool		
Mode	Test Frequency (MHz)		
	NCB: 20MHz		
	2412 MHz	2437 MHz	2462 MHz
802.11b	-5.25	-5.25	-5.25
802.11g	0	0	0
802.11n MCS0 HT20	0.5	0.5	0.5

**<Mode 5: Ant. 6 (Chip Ant.)>**

Test Software Version	Zentri Cert Tool		
Mode	Test Frequency (MHz)		
	NCB: 20MHz		
	2412 MHz	2437 MHz	2462 MHz
802.11b	-2	0.5	-0.5
802.11g	3	2.25	-0.5
802.11n MCS0 HT20	3.5	2	-0.5

### 3.9. EUT Operation during Test

The EUT was programmed to be in continuously transmitting mode.

### 3.10. Duty Cycle

#### <Mode 1: Ant. 1 (PCB Ant.)>

Mode	On Time (ms)	On+Off Time (ms)	Duty Cycle (%)	Duty Factor (dB)	1/T Minimum VBW (kHz)
802.11b	1.000	1.000	100.00%	0.00	0.01
802.11g	1.000	1.000	100.00%	0.00	0.01
802.11n MCS0 HT20	124.000	148.000	83.78%	0.77	0.01

#### <Mode 2: Ant. 2 (PCB Ant.)>

Mode	On Time (ms)	On+Off Time (ms)	Duty Cycle (%)	Duty Factor (dB)	1/T Minimum VBW (kHz)
802.11b	1.000	1.000	100.00%	0.00	0.01
802.11g	1.000	1.000	100.00%	0.00	0.01
802.11n MCS0 HT20	0.918	0.963	95.33%	0.21	1.09

#### <Mode 3: Ant. 3 (Wire Ant.)>

Mode	On Time (ms)	On+Off Time (ms)	Duty Cycle (%)	Duty Factor (dB)	1/T Minimum VBW (kHz)
802.11b	1.000	1.000	100.00%	0.00	0.01
802.11g	1.000	1.000	100.00%	0.00	0.01
802.11n MCS0 HT20	1.000	1.000	100.00%	0.00	0.01

#### <Mode 4: Ant. 4 (Dipole Ant.)>

Mode	On Time (ms)	On+Off Time (ms)	Duty Cycle (%)	Duty Factor (dB)	1/T Minimum VBW (kHz)
802.11b	1.000	1.000	100.00%	0.00	0.01
802.11g	1.000	1.000	100.00%	0.00	0.01
802.11n MCS0 HT20	124.000	148.000	83.78%	0.77	0.01

#### <Mode 5: Ant. 6 (Chip Ant.)>

Mode	On Time (ms)	On+Off Time (ms)	Duty Cycle (%)	Duty Factor (dB)	1/T Minimum VBW (kHz)
802.11b	1.000	1.000	100.00%	0.00	0.01
802.11g	1.000	1.000	100.00%	0.00	0.01
802.11n MCS0 HT20	1.000	1.000	100.00%	0.00	0.01

### 3.11. Test Configurations

#### 3.11.1. AC Power Line Conduction Emissions Test Configuration

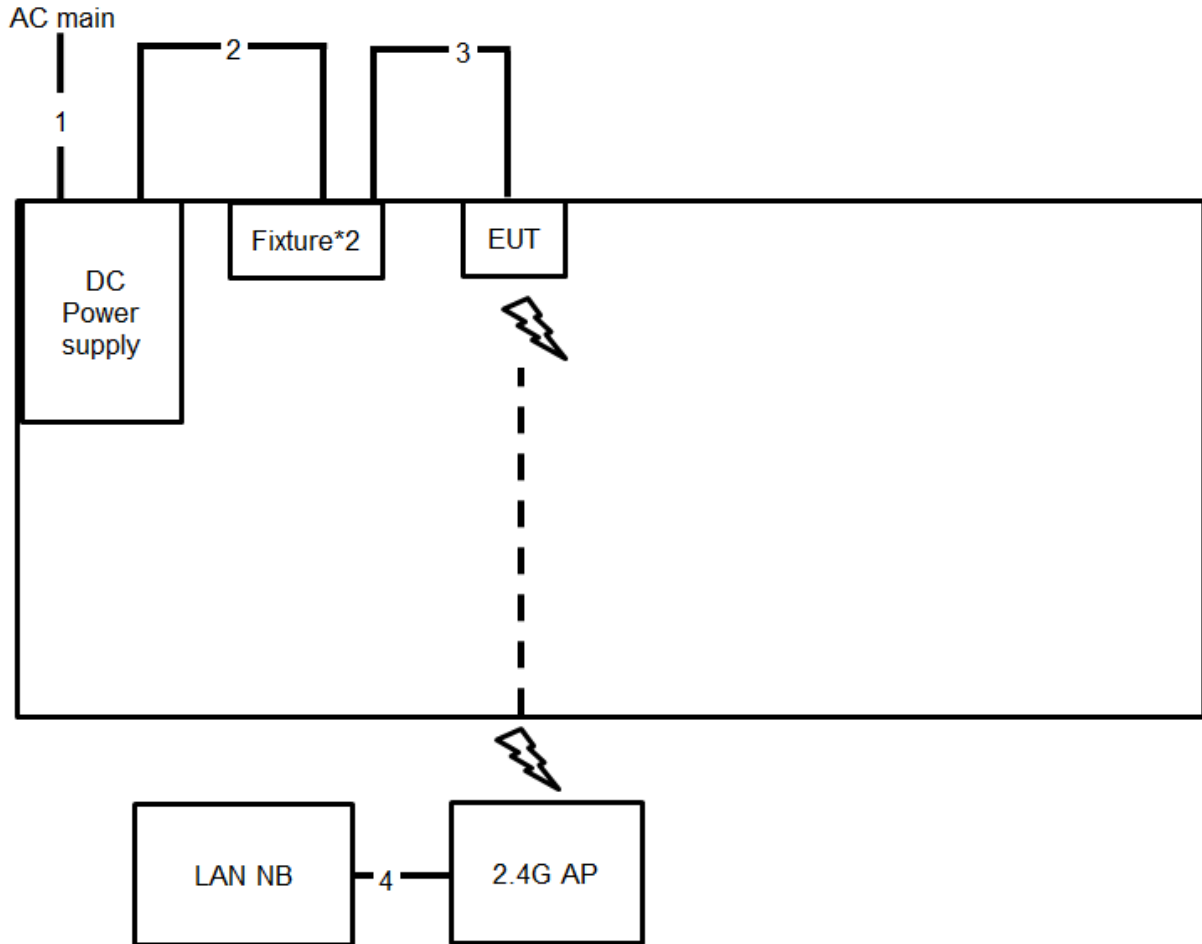

Item	Connection	Shielded	Length
1	Power cable	No	1.8m
2	DC Power cable*2	No	1.5m
3	Bus cable	No	0.2m
4	RJ-45 cable	No	1m

### 3.11.2. Radiation Emissions Test Configuration

Test Configuration: 30MHz~1GHz

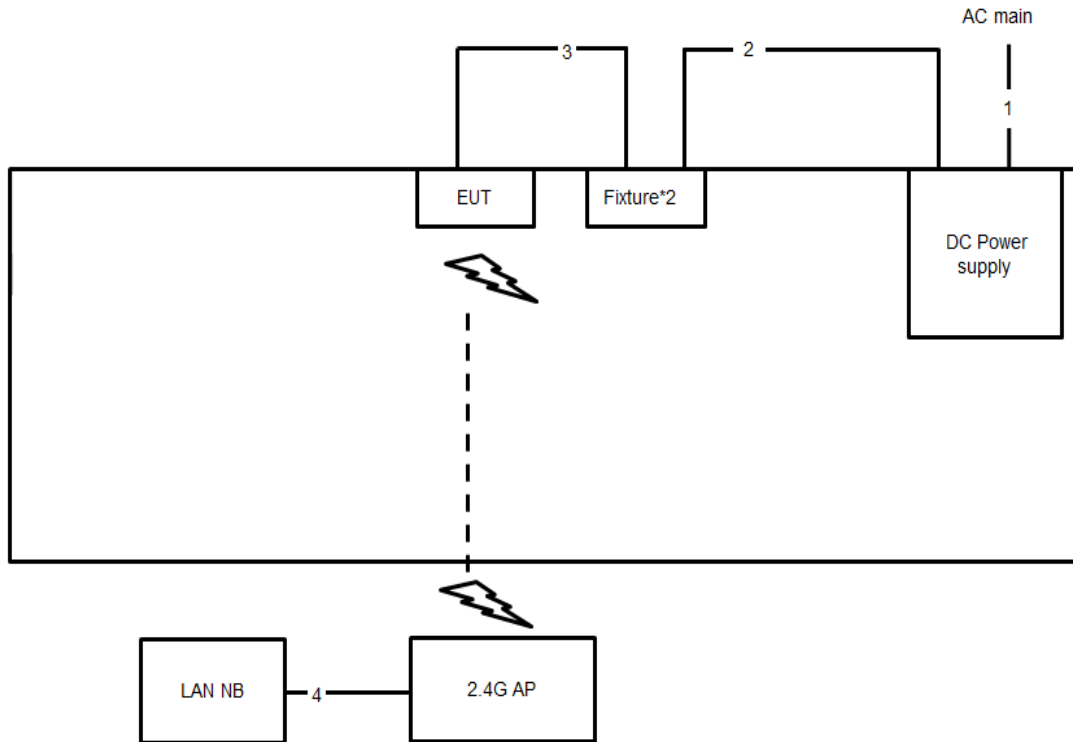

Item	Connection	Shielded	Length
1	Power cable	No	1.8m
2	DC Power cable*2	No	1.5m
3	Bus cable	No	0.2m
4	RJ-45 cable	No	1m

Test Configuration: above 1GHz

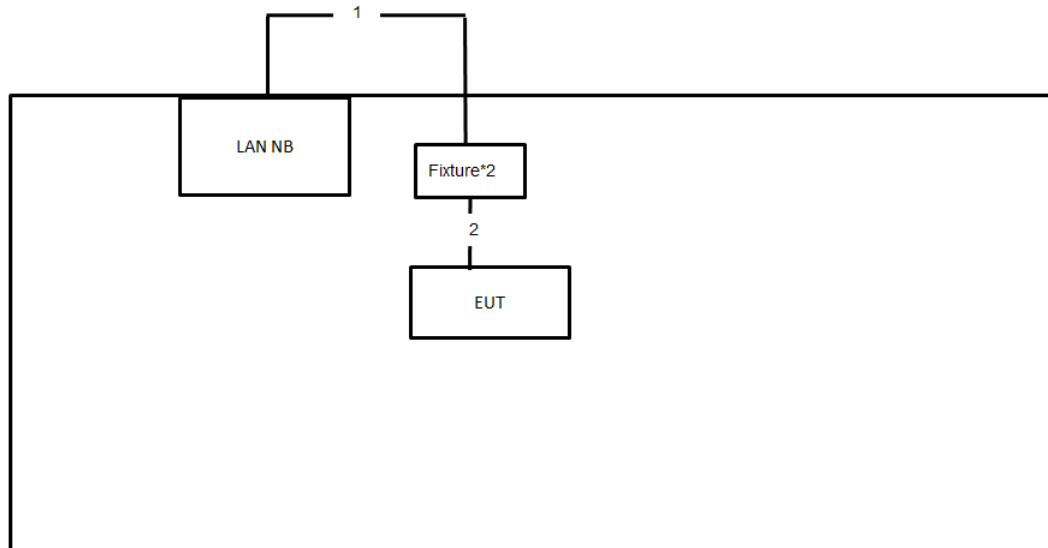

Item	Connection	Shielded	Length
1	USB cable	No	1m
2	Bus cable	No	0.2m

## 4. TEST RESULT

### 4.1. AC Power Line Conducted Emissions Measurement

#### 4.1.1. Limit

For this product which is designed to be connected to the AC power line, the radio frequency voltage that is conducted back onto the AC power line on any frequency or frequencies within the band 150 kHz to 30 MHz shall not exceed below limits table.

Frequency (MHz)	QP Limit (dBuV)	AV Limit (dBuV)
0.15~0.5	66~56	56~46
0.5~5	56	46
5~30	60	50

#### 4.1.2. Measuring Instruments and Setting

Please refer to section 5 of equipments list in this report. The following table is the setting of the receiver.

Receiver Parameters	Setting
Attenuation	10 dB
Start Frequency	0.15 MHz
Stop Frequency	30 MHz
IF Bandwidth	9 kHz

#### 4.1.3. Test Procedures

1. Configure the EUT according to ANSI C63.10. The EUT or host of EUT has to be placed 0.4 meter far from the conducting wall of the shielding room and at least 80 centimeters from any other grounded conducting surface.
2. Connect EUT or host of EUT to the power mains through a line impedance stabilization network (LISN).
3. All the support units are connected to the other LISNs. The LISN should provide 50uH/50ohms coupling impedance.
4. The frequency range from 150 kHz to 30 MHz was searched.
5. Set the test-receiver system to Peak Detect Function and Specified Bandwidth with Maximum Hold Mode.
6. The measurement has to be done between each power line and ground at the power terminal.





4.1.7. Results of AC Power Line Conducted Emissions Measurement

Temperature	22°C	Humidity	55%
Test Engineer	Deven Huang	Phase	Line
Configuration	Normal Link	Test Mode	Mode 1

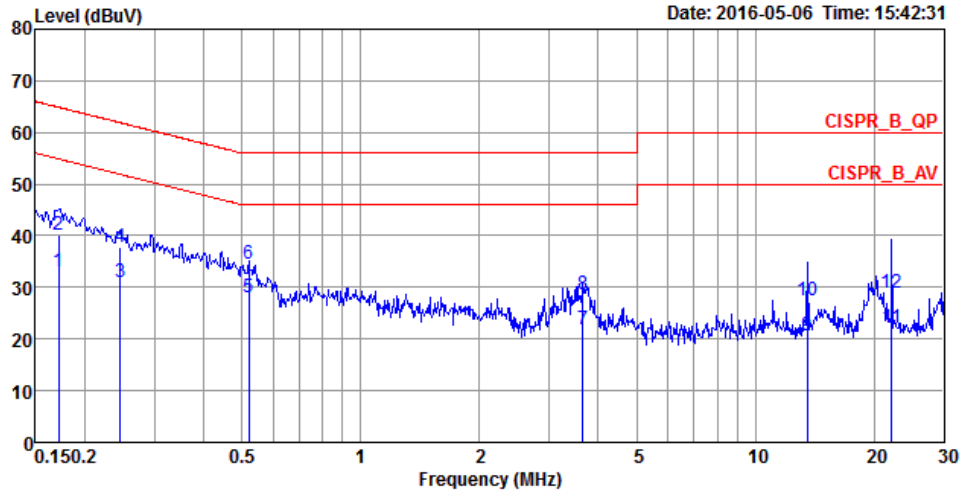

	Freq	Level	Over Limit	Limit Line	Read Level	LISN Factor	Cable Loss	Pol/Phase	Remark
	MHz	dBuV	dB	dBuV	dBuV	dB	dB		
1	0.1712	33.09	-21.81	54.90	23.05	10.02	0.02	LINE	Average
2	0.1712	40.06	-24.84	64.90	30.02	10.02	0.02	LINE	QP
3	0.2455	30.92	-20.99	51.91	20.97	9.92	0.03	LINE	Average
4	0.2455	37.90	-24.01	61.91	27.95	9.92	0.03	LINE	QP
5	0.5210	28.14	-17.86	46.00	18.18	9.92	0.04	LINE	Average
6	0.5210	34.47	-21.53	56.00	24.51	9.92	0.04	LINE	QP
7	3.6611	21.75	-24.25	46.00	11.70	9.99	0.06	LINE	Average
8	3.6611	28.64	-27.36	56.00	18.59	9.99	0.06	LINE	QP
9	13.5509	20.62	-29.38	50.00	10.16	10.21	0.25	LINE	Average
10	13.5509	27.41	-32.59	60.00	16.95	10.21	0.25	LINE	QP
11	22.1801	22.02	-27.98	50.00	11.38	10.37	0.27	LINE	Average
12	22.1801	28.86	-31.14	60.00	18.22	10.37	0.27	LINE	QP

Temperature	22°C	Humidity	55%
Test Engineer	Deven Huang	Phase	Neutral
Configuration	Normal Link	Test Mode	Mode 1

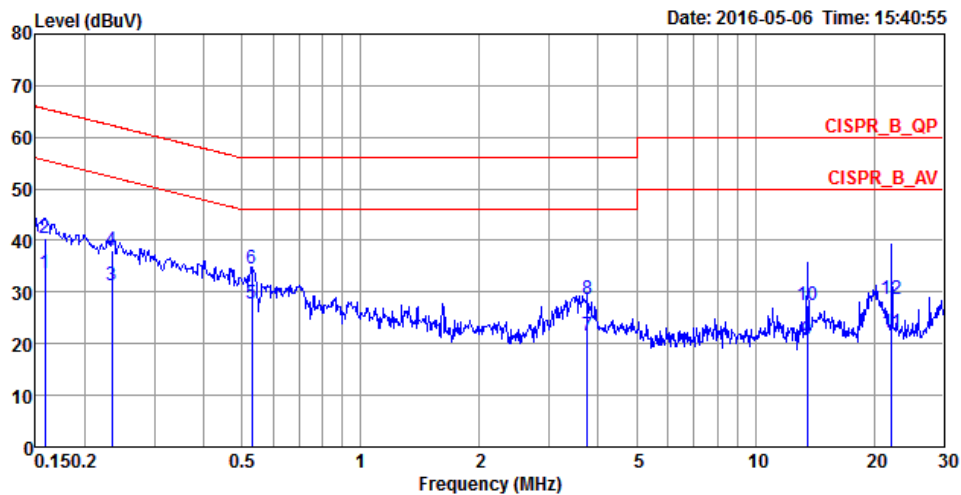

	Freq	Level	Over	Limit	Read	LISN	Cable		
	MHz	dBuV	Limit	Line	Level	Factor	Loss	Pol/Phase	Remark
			dB	dBuV	dBuV	dB	dB		
1	0.1582	33.70	-21.86	55.56	23.66	10.02	0.02	NEUTRAL	Average
2	0.1582	40.42	-25.14	65.56	30.38	10.02	0.02	NEUTRAL	QP
3	0.2341	31.19	-21.11	52.30	21.24	9.92	0.03	NEUTRAL	Average
4	0.2341	38.07	-24.23	62.30	28.12	9.92	0.03	NEUTRAL	QP
5	0.5293	27.70	-18.30	46.00	17.74	9.92	0.04	NEUTRAL	Average
6	0.5293	34.46	-21.54	56.00	24.50	9.92	0.04	NEUTRAL	QP
7	3.7594	21.55	-24.45	46.00	11.49	9.99	0.07	NEUTRAL	Average
8	3.7594	28.53	-27.47	56.00	18.47	9.99	0.07	NEUTRAL	QP
9	13.5509	20.71	-29.29	50.00	10.25	10.21	0.25	NEUTRAL	Average
10	13.5509	27.41	-32.59	60.00	16.95	10.21	0.25	NEUTRAL	QP
11	22.1801	22.06	-27.94	50.00	11.42	10.37	0.27	NEUTRAL	Average
12	22.1801	28.69	-31.31	60.00	18.05	10.37	0.27	NEUTRAL	QP

Note:

Level = Read Level + LISN Factor + Cable Loss.

## 4.2. Maximum Conducted Output Power Measurement

### 4.2.1. Limit

The limit for output power is 30dBm.

### 4.2.2. Measuring Instruments and Setting

Please refer to section 5 of equipments list in this report. The following table is the setting of the power meter.

Power Meter Parameter	Setting
Bandwidth	50MHz bandwidth is greater than the EUT emission bandwidth
Detector	Average

### 4.2.3. Test Procedures

1. Test procedures refer KDB558074 D01 v03r05 section 9.2.3.2 Measurement using a power meter (PM).
2. This procedure provides an alternative for determining the RMS output power using a broadband RF average power meter with a thermocouple detector.

### 4.2.4. Test Setup Layout

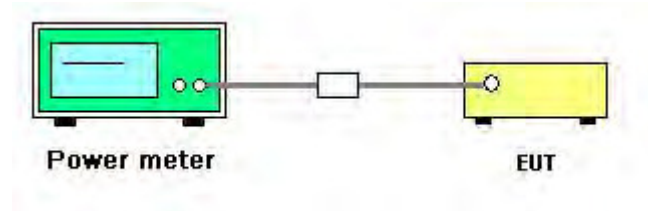

### 4.2.5. Test Deviation

There is no deviation with the original standard.

### 4.2.6. EUT Operation during Test

The EUT was programmed to be in continuously transmitting mode.

#### 4.2.7. Test Result of Maximum Conducted Output Power

<Mode 1: Ant. 1 (PCB Ant.)>

Temperature	26.5°C	Humidity	54%
Test Engineer	Peter Wu	Test Date	Apr. 30, 2016

Mode	Frequency	Conducted Power (dBm)	Max. Limit (dBm)	Result
		Chain 1		
802.11b	2412 MHz	20.62	30.00	Complies
	2437 MHz	21.87	30.00	Complies
	2462 MHz	21.56	30.00	Complies
802.11g	2412 MHz	21.08	30.00	Complies
	2437 MHz	20.12	30.00	Complies
	2462 MHz	20.51	30.00	Complies
802.11n MCS0 HT20	2412 MHz	21.17	30.00	Complies
	2437 MHz	20.35	30.00	Complies
	2462 MHz	20.44	30.00	Complies

## &lt;Mode 2: Ant. 2 (PCB Ant.)&gt;

<b>Temperature</b>	26.5°C	<b>Humidity</b>	54%
<b>Test Engineer</b>	Peter Wu	<b>Test Date</b>	Apr. 30, 2016

Mode	Frequency	Conducted Power (dBm)	Max. Limit (dBm)	Result
		Chain 1		
802.11b	2412 MHz	17.50	30.00	Complies
	2437 MHz	21.35	30.00	Complies
	2462 MHz	22.35	30.00	Complies
802.11g	2412 MHz	21.44	30.00	Complies
	2437 MHz	21.55	30.00	Complies
	2462 MHz	21.61	30.00	Complies
802.11n MCS0 HT20	2412 MHz	21.11	30.00	Complies
	2437 MHz	21.19	30.00	Complies
	2462 MHz	21.57	30.00	Complies

**<Mode 3: Ant. 3 (Wire Ant.)>**

<b>Temperature</b>	26.5°C	<b>Humidity</b>	54%
<b>Test Engineer</b>	Peter Wu	<b>Test Date</b>	Apr. 30, 2016

Mode	Frequency	Conducted Power (dBm)	Max. Limit (dBm)	Result
		Chain 1		
802.11b	2412 MHz	20.62	30.00	Complies
	2437 MHz	19.94	30.00	Complies
	2462 MHz	18.56	30.00	Complies
802.11g	2412 MHz	19.39	30.00	Complies
	2437 MHz	17.04	30.00	Complies
	2462 MHz	16.53	30.00	Complies
802.11n MCS0 HT20	2412 MHz	18.69	30.00	Complies
	2437 MHz	17.27	30.00	Complies
	2462 MHz	16.43	30.00	Complies

## &lt;Mode 4: Ant. 4 (Dipole Ant.)&gt;

<b>Temperature</b>	26.5°C	<b>Humidity</b>	54%
<b>Test Engineer</b>	Peter Wu	<b>Test Date</b>	Apr. 30, 2016

Mode	Frequency	Conducted Power (dBm)	Max. Limit (dBm)	Result
		Chain 1		
802.11b	2412 MHz	16.62	30.00	Complies
	2437 MHz	16.58	30.00	Complies
	2462 MHz	16.68	30.00	Complies
802.11g	2412 MHz	20.57	30.00	Complies
	2437 MHz	20.54	30.00	Complies
	2462 MHz	20.51	30.00	Complies
802.11n MCS0 HT20	2412 MHz	20.76	30.00	Complies
	2437 MHz	20.76	30.00	Complies
	2462 MHz	20.68	30.00	Complies

**<Mode 5: Ant. 6 (Chip Ant.)>**

<b>Temperature</b>	26.5°C	<b>Humidity</b>	54%
<b>Test Engineer</b>	Peter Wu	<b>Test Date</b>	Apr. 30, 2016

Mode	Frequency	Conducted Power (dBm)	Max. Limit (dBm)	Result
		Chain 1		
802.11b	2412 MHz	20.21	30.00	Complies
	2437 MHz	21.02	30.00	Complies
	2462 MHz	19.91	30.00	Complies
802.11g	2412 MHz	21.12	30.00	Complies
	2437 MHz	20.87	30.00	Complies
	2462 MHz	19.02	30.00	Complies
802.11n MCS0 HT20	2412 MHz	21.27	30.00	Complies
	2437 MHz	20.74	30.00	Complies
	2462 MHz	18.82	30.00	Complies



### 4.3. Power Spectral Density Measurement

#### 4.3.1. Limit

For digitally modulated systems, the power spectral density conducted from the intentional radiator to the antenna shall not be greater than 8 dBm in any 3 kHz band during any time interval of continuous transmission.

#### 4.3.2. Measuring Instruments and Setting

Please refer to section 5 of equipments list in this report. The following table is the setting of the spectrum analyzer.

Spectrum Parameter	Setting
Attenuation	Auto
Span Frequency	Set the span to 1.5 times the DTS channel bandwidth.
RBW	$3 \text{ kHz} \leq \text{RBW} \leq 100\text{kHz}$
VBW	$\geq 3 \times \text{RBW}$
Detector	Peak
Trace	Max Hold
Sweep Time	Auto couple

#### 4.3.3. Test Procedures

1. Test was performed in accordance with KDB558074 D01 v03r05 for Performing Compliance Measurements on Digital Transmission Systems (DTS) - section 10.2 Method PKPSD (peak PSD), Use this procedure when the maximum conducted output power in the fundamental emission is used to demonstrate compliance. The EUT must be configured to transmit continuously at full power over the measurement duration.
2. Ensure that the number of measurement points in the sweep  $\geq 2 \times \text{span}/\text{RBW}$  (use of a greater number of measurement points than this minimum requirement is recommended).
3. Use the peak marker function to determine the maximum level in any 3 kHz band segment within the fundamental EBW.
4. The resulting PSD level must be  $\leq 8 \text{ dBm}$ .

#### 4.3.4. Test Setup Layout

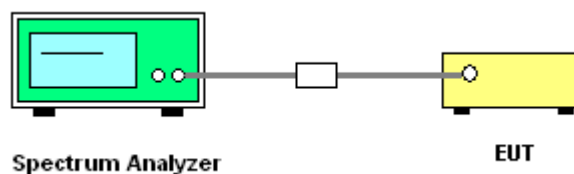

#### **4.3.5. Test Deviation**

There is no deviation with the original standard.

#### **4.3.6. EUT Operation during Test**

The EUT was programmed to be in continuously transmitting mode.

#### 4.3.7. Test Result of Power Spectral Density

<Mode 1: Ant. 1 (PCB Ant.)>

Temperature	26.5°C	Humidity	54%
Test Engineer	Peter Wu		

Mode	Frequency	Power Density (dBm/3kHz)	Power Density Limit (dBm/3kHz)	Result
		Chain 1		
802.11b	2412 MHz	-15.78	8.00	Complies
	2437 MHz	-14.62	8.00	Complies
	2462 MHz	-15.40	8.00	Complies
802.11g	2412 MHz	-4.78	8.00	Complies
	2437 MHz	-6.03	8.00	Complies
	2462 MHz	-5.62	8.00	Complies
802.11n MCS0 HT20	2412 MHz	-4.88	8.00	Complies
	2437 MHz	-5.58	8.00	Complies
	2462 MHz	-5.70	8.00	Complies

Note: All the test values were listed in the report.

For plots, only the channel with worse result was shown.

Power Density Plot on Configuration IEEE 802.11b / 2437 MHz / Chain 1

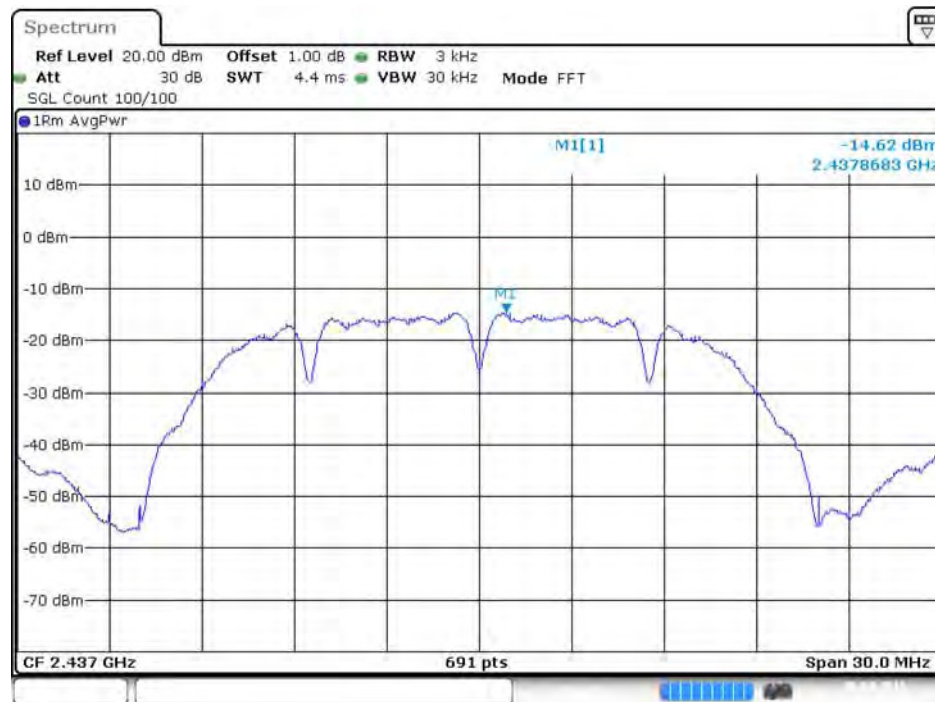

Date: 30.APR 2016 09:47:51

Power Density Plot on Configuration IEEE 802.11g / 2412 MHz / Chain 1

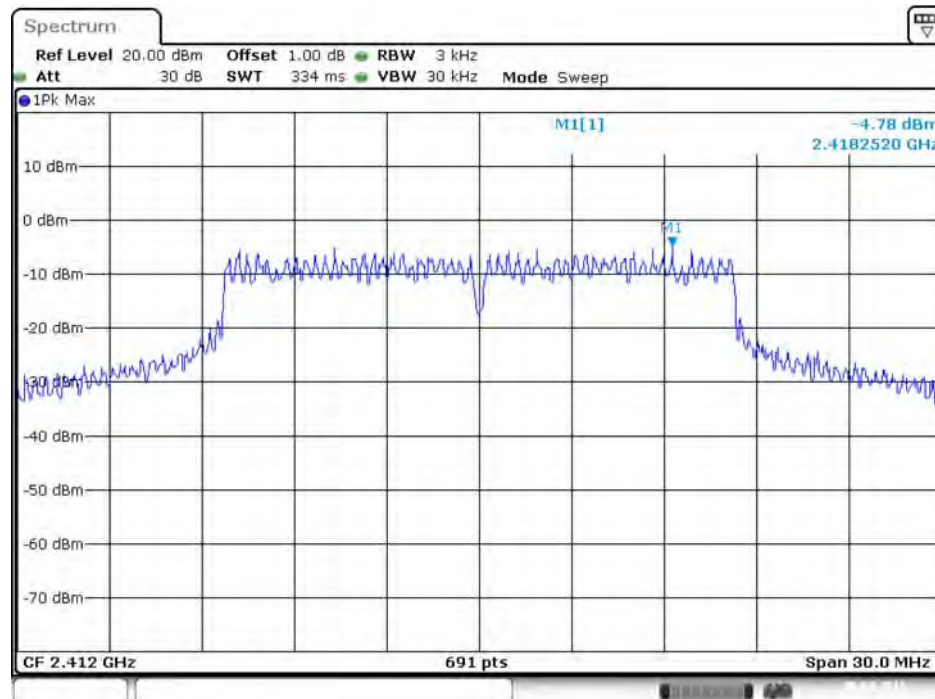

Date: 30.APR 2016 10:14:56

Power Density Plot on Configuration IEEE 802.11n MCS0 HT20 / 2412 MHz / Chain 1

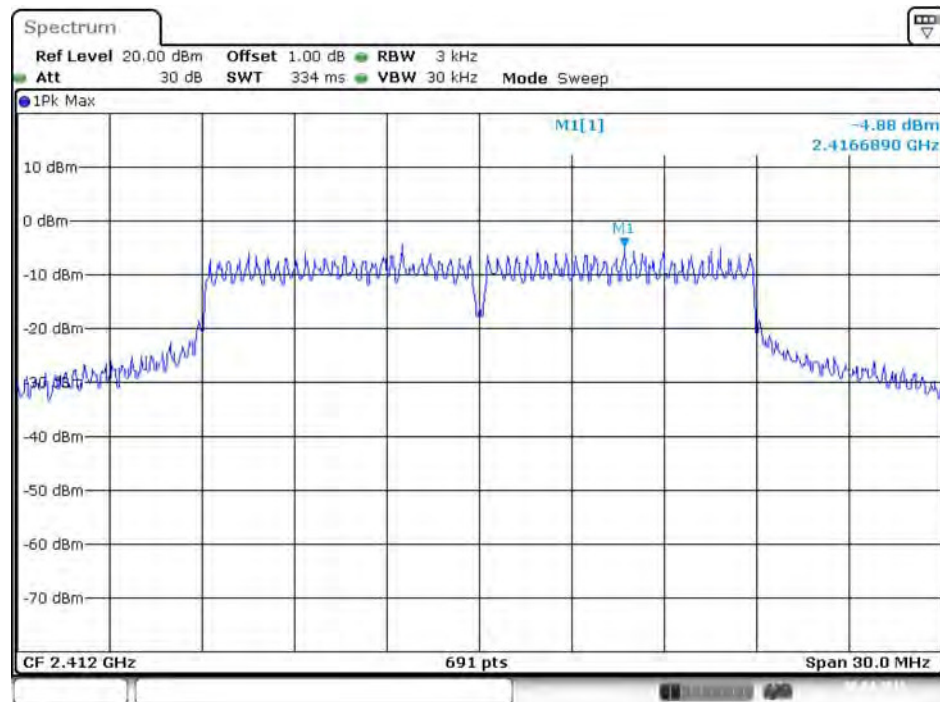

Date: 30.APR 2016 10:31:31

## &lt;Mode 2: Ant. 2 (PCB Ant.)&gt;

<b>Temperature</b>	26.5°C	<b>Humidity</b>	54%
<b>Test Engineer</b>	Peter Wu		

Mode	Frequency	Power Density (dBm/3kHz)	Power Density Limit (dBm/3kHz)	Result
		Chain 1		
802.11b	2412 MHz	-19.53	8.00	Complies
	2437 MHz	-14.67	8.00	Complies
	2462 MHz	-16.99	8.00	Complies
802.11g	2412 MHz	-4.18	8.00	Complies
	2437 MHz	-4.16	8.00	Complies
	2462 MHz	-3.82	8.00	Complies
802.11n MCS0 HT20	2412 MHz	-4.93	8.00	Complies
	2437 MHz	-4.73	8.00	Complies
	2462 MHz	-6.06	8.00	Complies

Note: All the test values were listed in the report.

For plots, only the channel with worse result was shown.

**Power Density Plot on Configuration IEEE 802.11b / 2437 MHz / Chain 1**

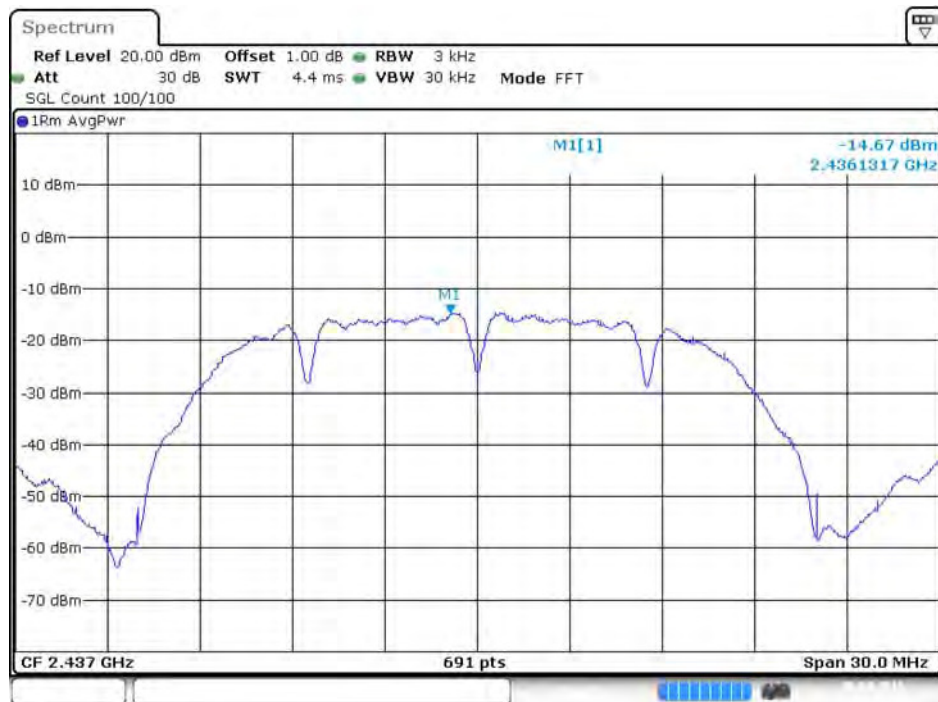

Date: 30.APR 2016 09:47:01

**Power Density Plot on Configuration IEEE 802.11g / 2462 MHz / Chain 1**

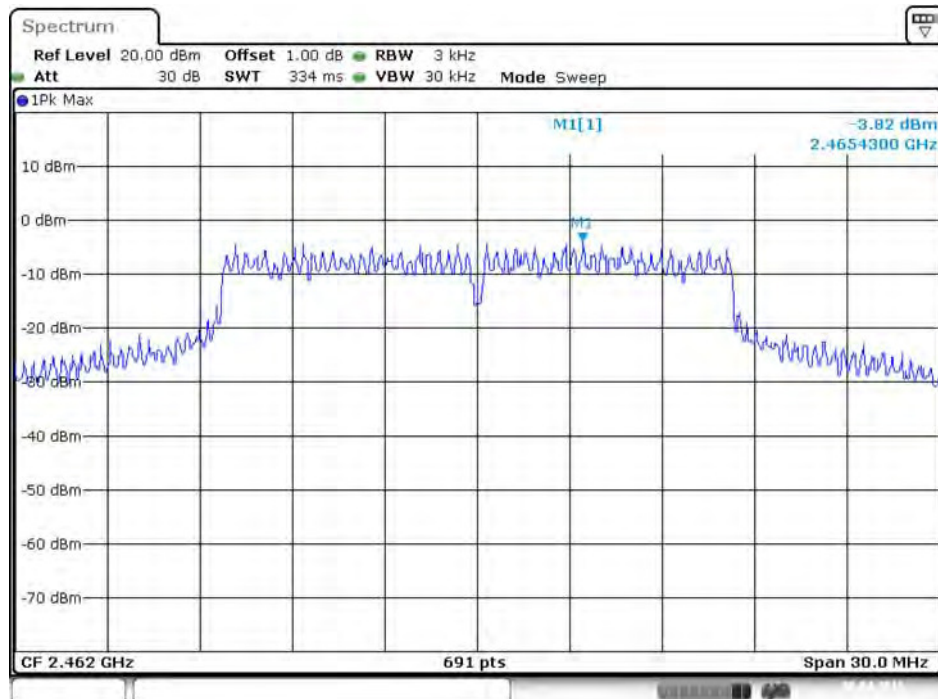

Date: 30.APR 2016 10:00:27

Power Density Plot on Configuration IEEE 802.11n MCS0 HT20 / 2437 MHz / Chain 1

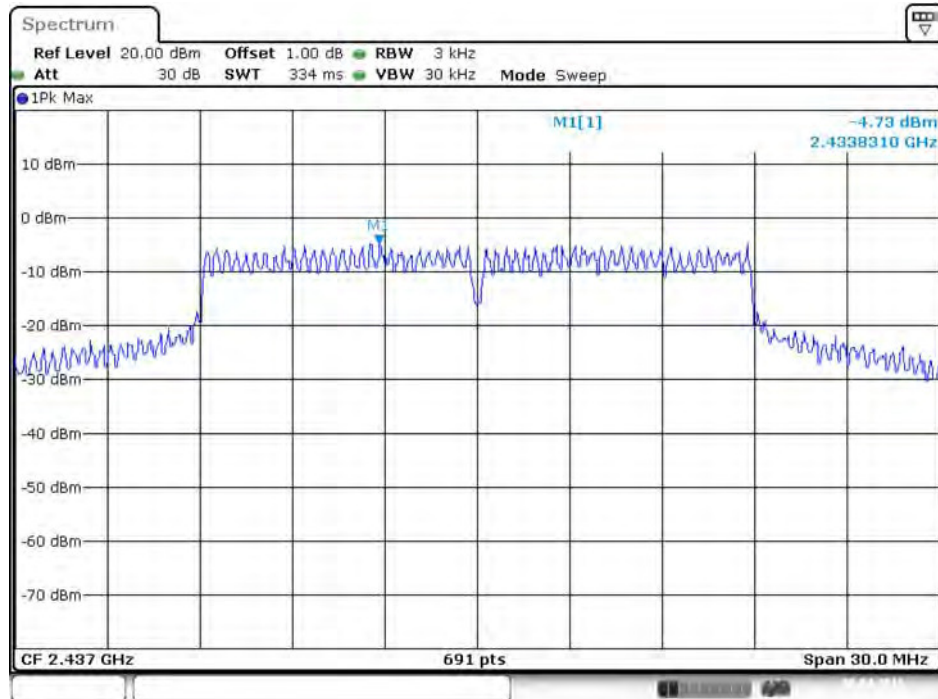

Date: 30.APR 2016 10:33:56



**<Mode 3: Ant. 3 (Wire Ant.)>**

<b>Temperature</b>	26.5°C	<b>Humidity</b>	54%
<b>Test Engineer</b>	Peter Wu		

Mode	Frequency	Power Density (dBm/3kHz)	Power Density Limit (dBm/3kHz)	Result
		Chain 1		
802.11b	2412 MHz	-16.38	8.00	Complies
	2437 MHz	-16.21	8.00	Complies
	2462 MHz	-16.21	8.00	Complies
802.11g	2412 MHz	-5.63	8.00	Complies
	2437 MHz	-8.25	8.00	Complies
	2462 MHz	-8.00	8.00	Complies
802.11n MCS0 HT20	2412 MHz	-6.65	8.00	Complies
	2437 MHz	-7.96	8.00	Complies
	2462 MHz	-8.01	8.00	Complies

Note: All the test values were listed in the report.

For plots, only the channel with worse result was shown.

Power Density Plot on Configuration IEEE 802.11b / 2437 MHz / Chain 1

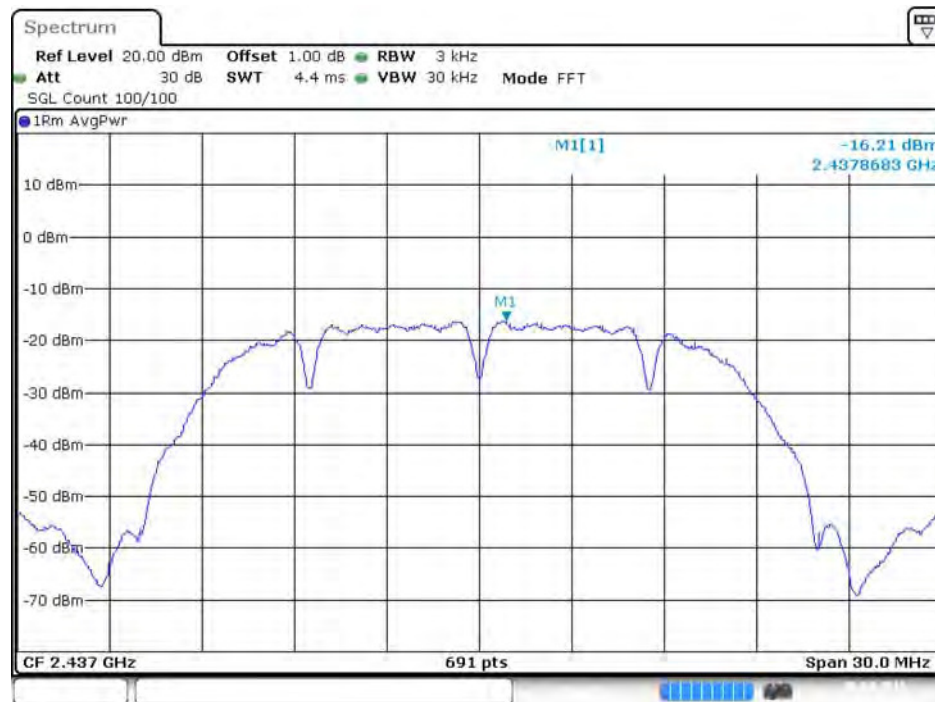

Date: 30.APR 2016 09:49:00

Power Density Plot on Configuration IEEE 802.11g / 2412 MHz / Chain 1

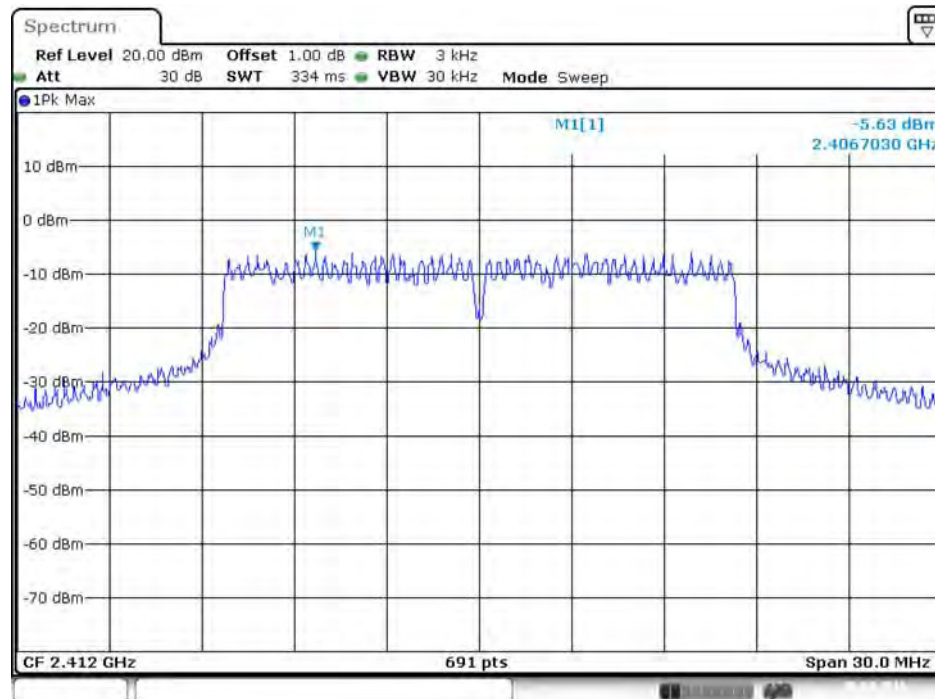

Date: 30.APR 2016 10:16:37

### Power Density Plot on Configuration IEEE 802.11n MCS0 HT20 / 2412 MHz / Chain 1

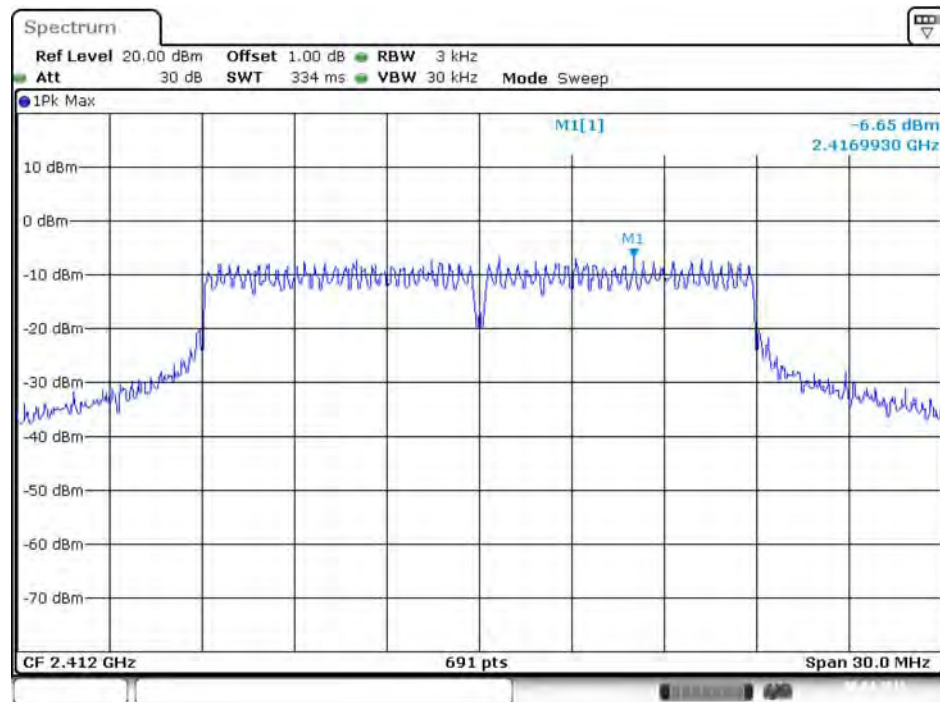

Date: 30.APR.2016 10:30:11

**<Mode 4: Ant. 4 (Dipole Ant.)>**

<b>Temperature</b>	26.5°C	<b>Humidity</b>	54%
<b>Test Engineer</b>	Peter Wu		

Mode	Frequency	Power Density (dBm/3kHz)	Power Density Limit (dBm/3kHz)	Result
		Chain 1		
802.11b	2412 MHz	-19.77	8.00	Complies
	2437 MHz	-19.37	8.00	Complies
	2462 MHz	-19.21	8.00	Complies
802.11g	2412 MHz	-4.68	8.00	Complies
	2437 MHz	-5.29	8.00	Complies
	2462 MHz	-4.86	8.00	Complies
802.11n MCS0 HT20	2412 MHz	-4.36	8.00	Complies
	2437 MHz	-5.54	8.00	Complies
	2462 MHz	-5.02	8.00	Complies

Note: All the test values were listed in the report.

For plots, only the channel with worse result was shown.

**Power Density Plot on Configuration IEEE 802.11b / 2462 MHz / Chain 1**



Date: 30.APR 2016 09:54:59

**Power Density Plot on Configuration IEEE 802.11g / 2412 MHz / Chain 1**

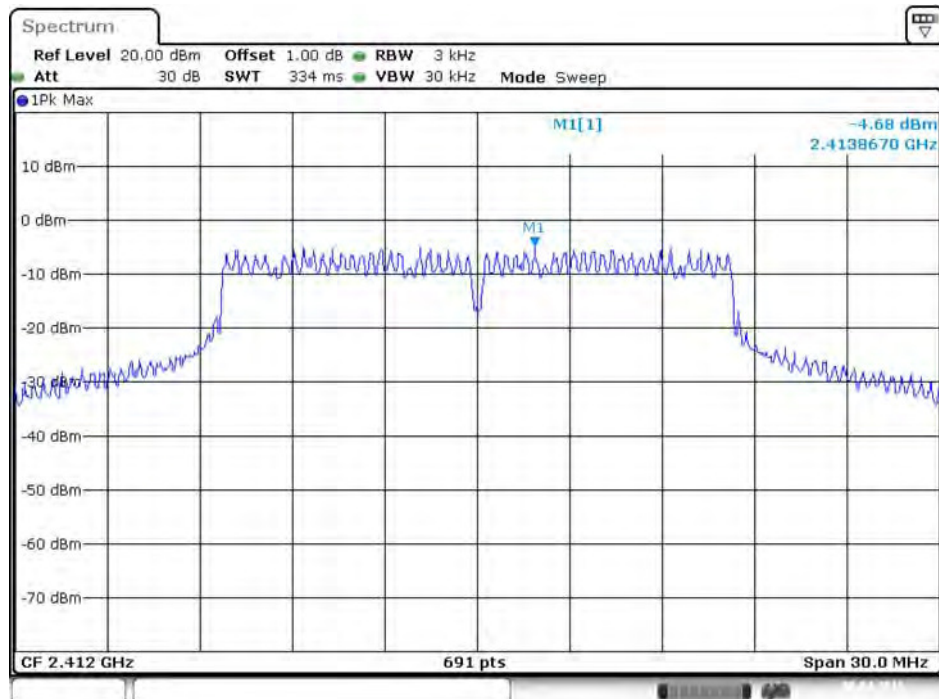

Date: 30.APR 2016 10:22:39

Power Density Plot on Configuration IEEE 802.11n MCS0 HT20 / 2412 MHz / Chain 1

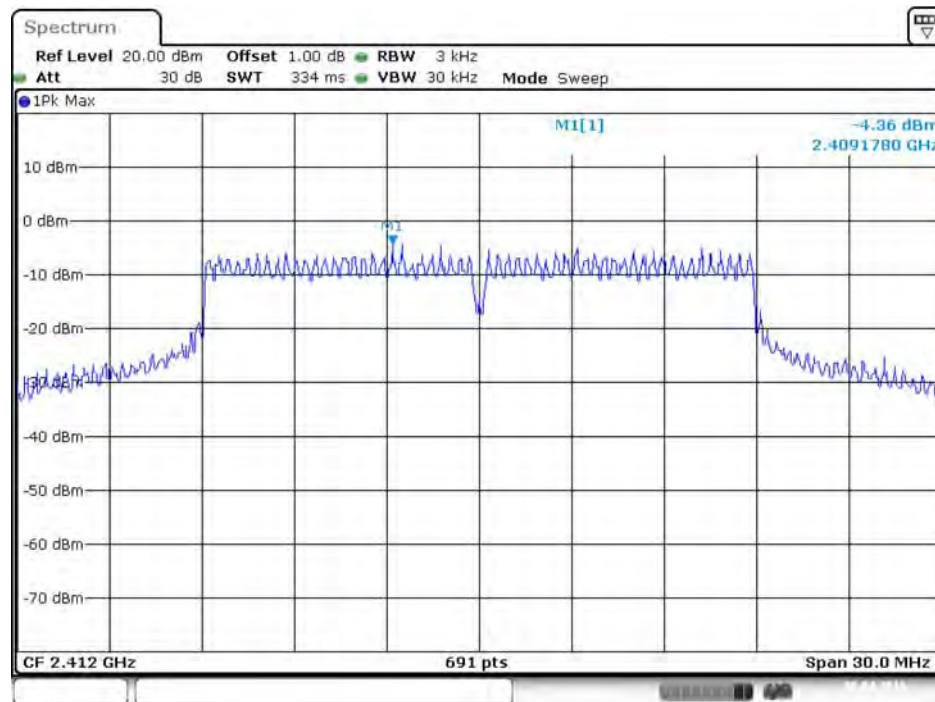

Date: 30.APR 2016 10:29:12

**<Mode 5: Ant. 6 (Chip Ant.)>**

<b>Temperature</b>	26.5°C	<b>Humidity</b>	54%
<b>Test Engineer</b>	Peter Wu		

Mode	Frequency	Power Density (dBm/3kHz)	Power Density Limit (dBm/3kHz)	Result
		Chain 1		
802.11b	2412 MHz	-16.43	8.00	Complies
	2437 MHz	-15.20	8.00	Complies
	2462 MHz	-15.15	8.00	Complies
802.11g	2412 MHz	-3.69	8.00	Complies
	2437 MHz	-4.81	8.00	Complies
	2462 MHz	-5.87	8.00	Complies
802.11n MCS0 HT20	2412 MHz	-3.94	8.00	Complies
	2437 MHz	-3.44	8.00	Complies
	2462 MHz	-5.58	8.00	Complies

Note: All the test values were listed in the report.

For plots, only the channel with worse result was shown.



Power Density Plot on Configuration IEEE 802.11b / 2462 MHz / Chain 1

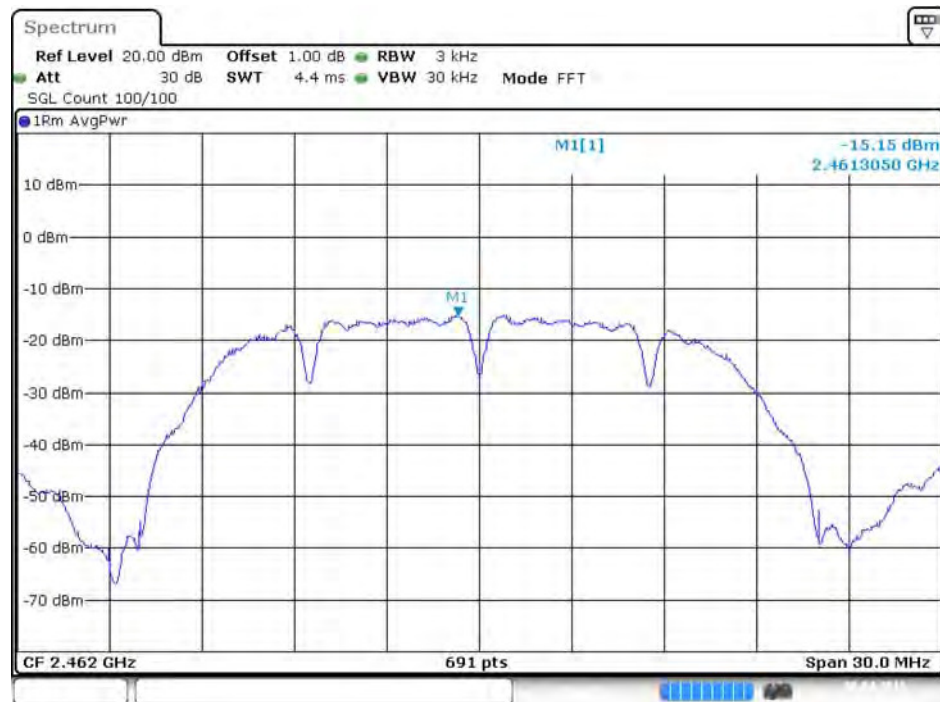

Date: 30.APR.2016 09:53:53

Power Density Plot on Configuration IEEE 802.11g / 2412 MHz / Chain 1

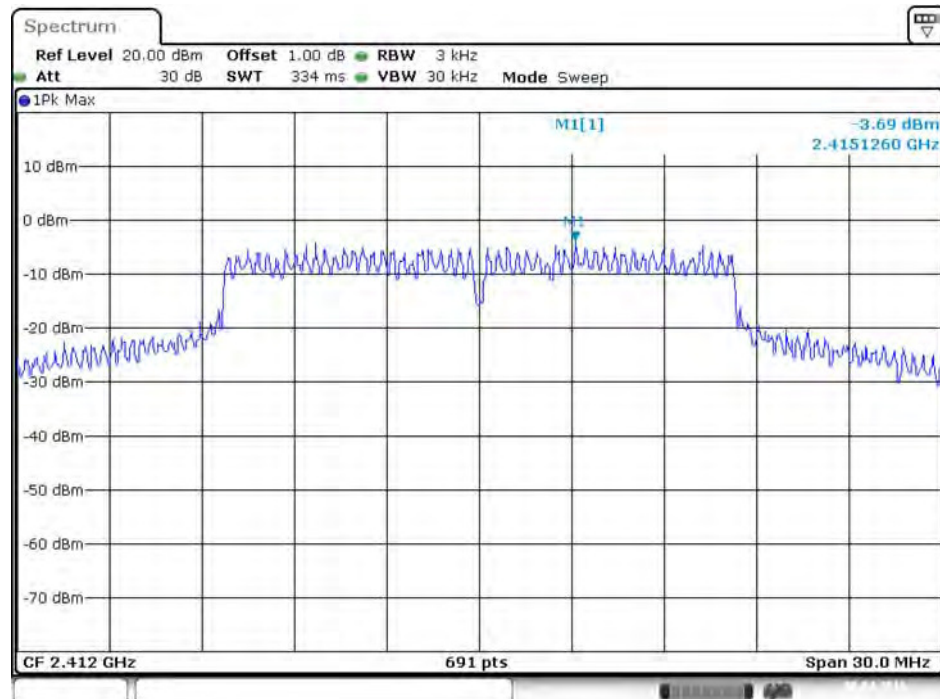

Date: 30.APR.2016 10:23:42



Power Density Plot on Configuration IEEE 802.11n MCS0 HT20 / 2437 MHz / Chain 1

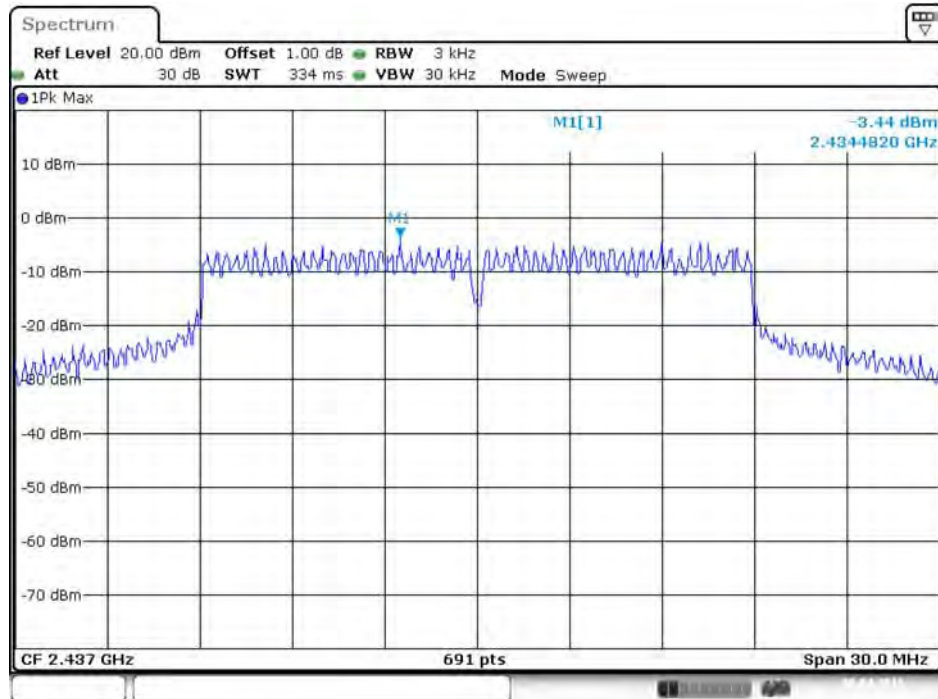

Date: 30.APR 2016 10:40:52

## 4.4. 6dB Spectrum Bandwidth Measurement

### 4.4.1. Limit

For digital modulation systems, the minimum 6 dB bandwidth shall be at least 500 kHz.

### 4.4.2. Measuring Instruments and Setting

Please refer to section 5 of equipments list in this report. The following table is the setting of the Spectrum Analyzer.

6dB Spectrum Bandwidth	
Spectrum Parameters	Setting
Attenuation	Auto
Span Frequency	> 6dB Bandwidth
RBW	100kHz
VBW	$\geq 3 \times \text{RBW}$
Detector	Peak
Trace	Max Hold
Sweep Time	Auto
99% Occupied Bandwidth	
Spectrum Parameters	Setting
Span	1.5 times to 5.0 times the OBW
RBW	1 % to 5 % of the OBW
VBW	$\geq 3 \times \text{RBW}$
Detector	Peak
Trace	Max Hold

### 4.4.3. Test Procedures

For Radiated 6dB Bandwidth Measurement:

1. The transmitter was radiated to the spectrum analyzer in peak hold mode.
2. Test was performed in accordance with KDB558074 D01 v03r05 for Performing Compliance Measurements on Digital Transmission Systems (DTS) - section 8.0 DTS bandwidth = > 8.1 Option 1.
3. Measured the spectrum width with power higher than 6dB below carrier.

### 4.4.4. Test Setup Layout

For Radiated 6dB Bandwidth Measurement:

This test setup layout is the same as that shown in section 4.5.4.

#### 4.4.5. Test Deviation

There is no deviation with the original standard.

#### 4.4.6. EUT Operation during Test

The EUT was programmed to be in continuously transmitting mode.

#### 4.4.7. Test Result of 6dB Spectrum Bandwidth

<Mode 1: Ant. 1 (PCB Ant.)>

<b>Temperature</b>	26.5°C	<b>Humidity</b>	54%
<b>Test Engineer</b>	Peter Wu		

Mode	Frequency	6dB Bandwidth (MHz)	99% Occupied Bandwidth (MHz)	Min. Limit (kHz)	Test Result
802.11b	2412 MHz	15.07	17.11	500	Complies
	2437 MHz	14.09	17.37	500	Complies
	2462 MHz	14.55	17.37	500	Complies
802.11g	2412 MHz	16.35	23.44	500	Complies
	2437 MHz	16.35	20.06	500	Complies
	2462 MHz	16.35	16.67	500	Complies
802.11n MCS0 HT20	2412 MHz	17.57	17.54	500	Complies
	2437 MHz	17.62	17.45	500	Complies
	2462 MHz	17.62	17.54	500	Complies

Note: All the test values were listed in the report.

For plots, only the channel with worse result was shown.

6 dB Bandwidth Plot on Configuration IEEE 802.11b / 2437 MHz / Chain 1

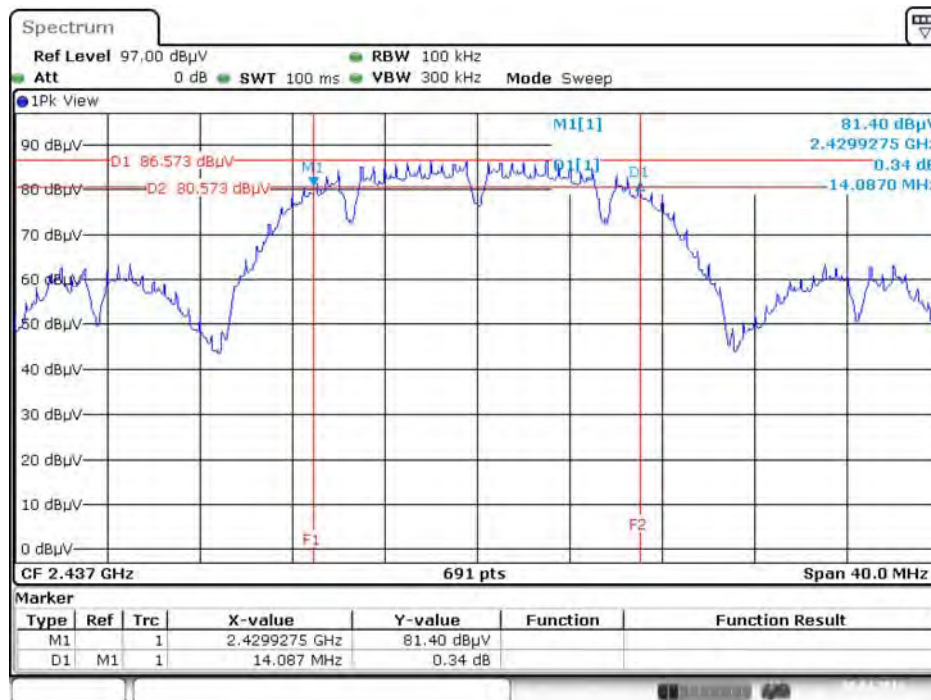

99% Occupied Bandwidth Plot on Configuration IEEE 802.11b / 2437 MHz / Chain 1

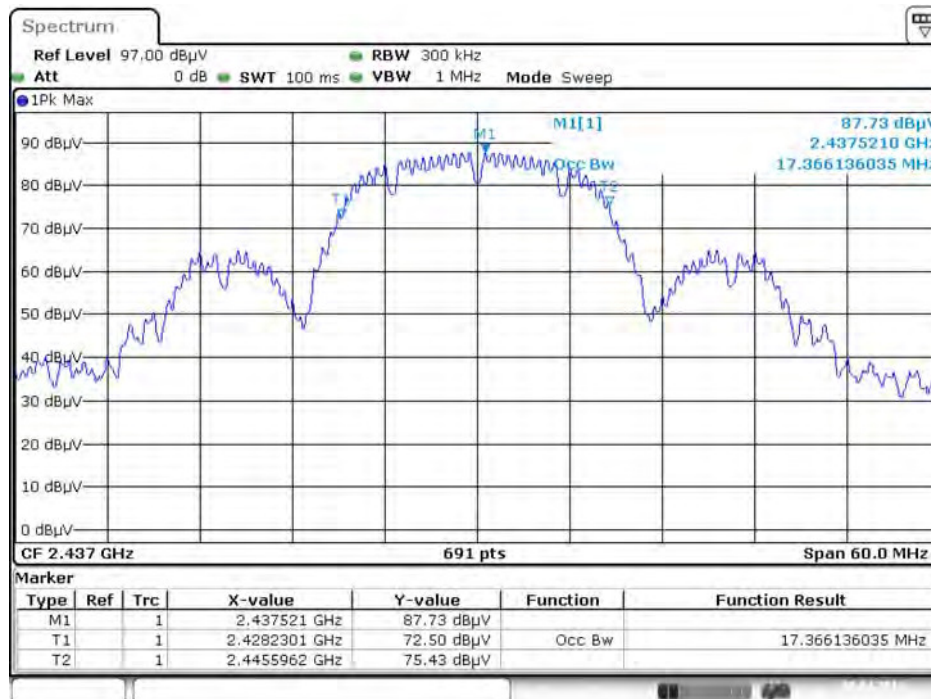

6 dB Bandwidth Plot on Configuration IEEE 802.11g / 2412 MHz / Chain 1

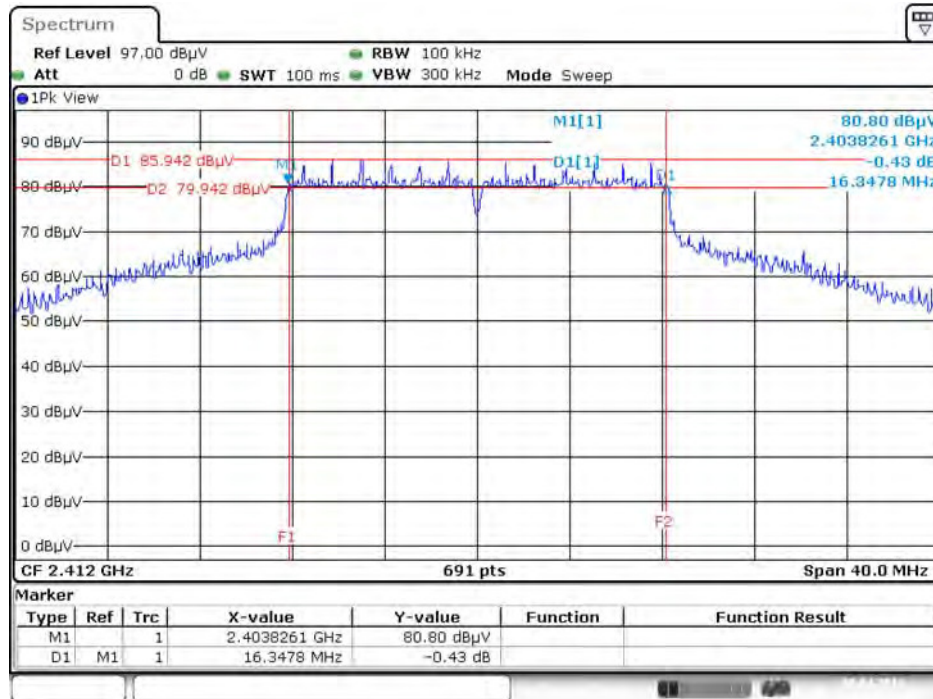

Date: 30.APR 2016 14:15:15

99% Occupied Bandwidth Plot on Configuration IEEE 802.11g / 2412 MHz / Chain 1

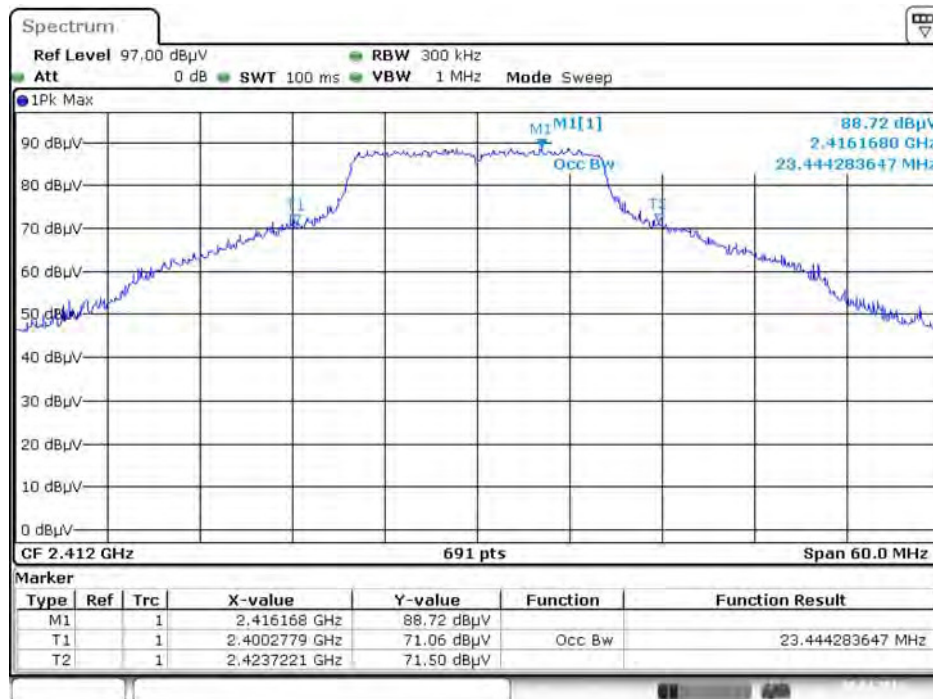

Date: 30.APR 2016 12:53:33



6 dB Bandwidth Plot on Configuration IEEE 802.11n MCS0 HT20 / 2412 MHz / Chain 1

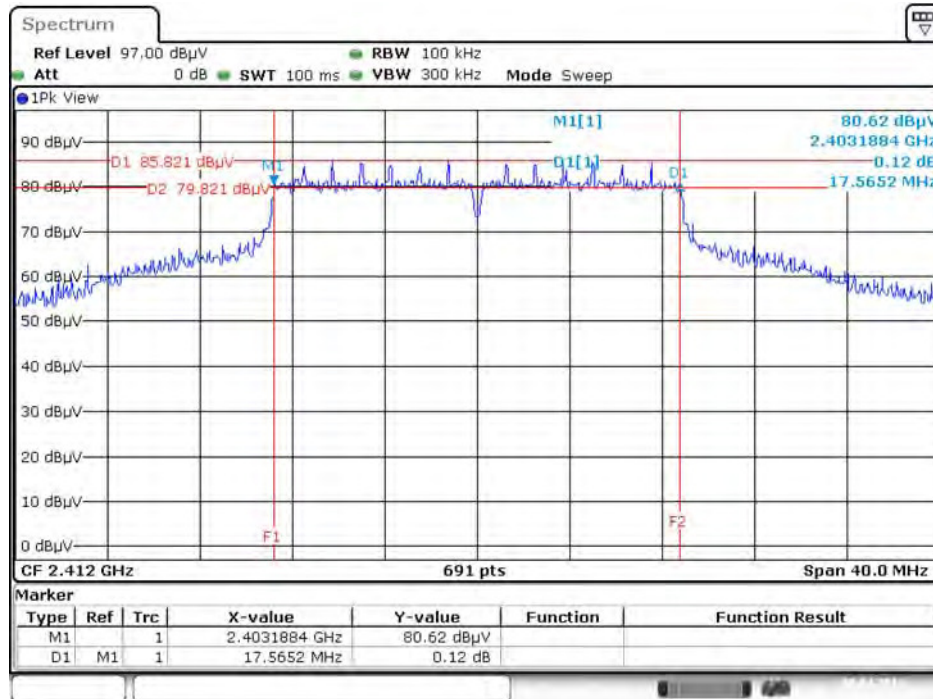

Date: 30.APR 2016 14:23:25

99% Occupied Bandwidth Plot on Configuration IEEE 802.11n MCS0 HT20 / 2412 MHz / Chain 1



Date: 30.APR 2016 13:26:23

**<Mode 2: Ant. 2 (PCB Ant.)>**

<b>Temperature</b>	26.5°C	<b>Humidity</b>	54%
<b>Test Engineer</b>	Peter Wu		

Mode	Frequency	6dB Bandwidth (MHz)	99% Occupied Bandwidth (MHz)	Min. Limit (kHz)	Test Result
802.11b	2412 MHz	14.55	17.02	500	Complies
	2437 MHz	14.55	17.11	500	Complies
	2462 MHz	13.62	17.11	500	Complies
802.11g	2412 MHz	16.35	24.14	500	Complies
	2437 MHz	16.35	25.79	500	Complies
	2462 MHz	16.35	16.50	500	Complies
802.11n MCS0 HT20	2412 MHz	17.51	17.54	500	Complies
	2437 MHz	17.51	17.80	500	Complies
	2462 MHz	17.57	17.80	500	Complies

Note: All the test values were listed in the report.

For plots, only the channel with worse result was shown.



6 dB Bandwidth Plot on Configuration IEEE 802.11b / 2462 MHz / Chain 1

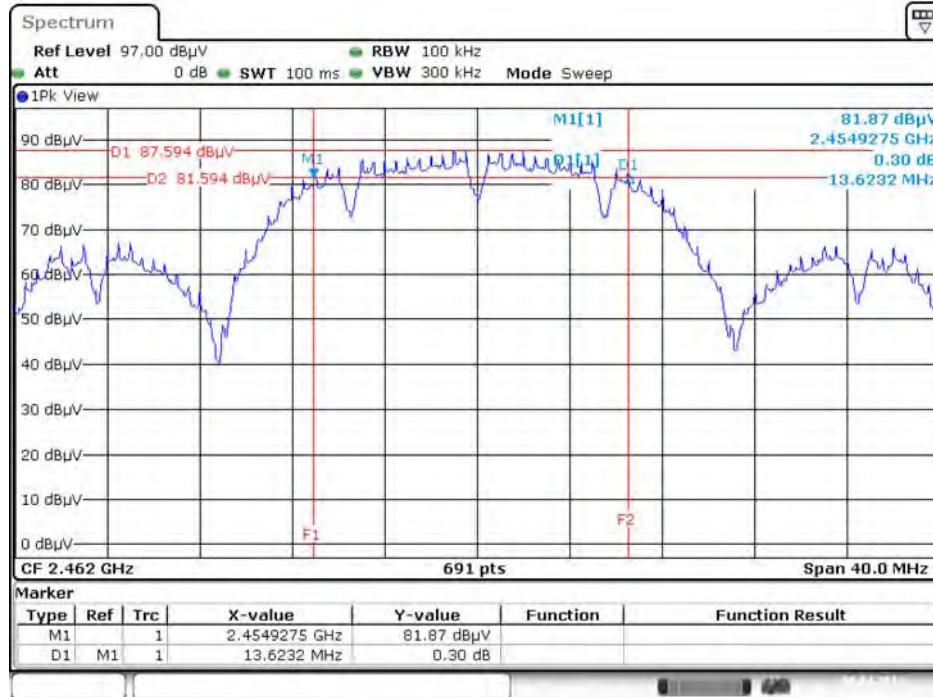

Date: 30.APR 2016 13:59:02

99% Occupied Bandwidth Plot on Configuration IEEE 802.11b / 2437 MHz / Chain 1

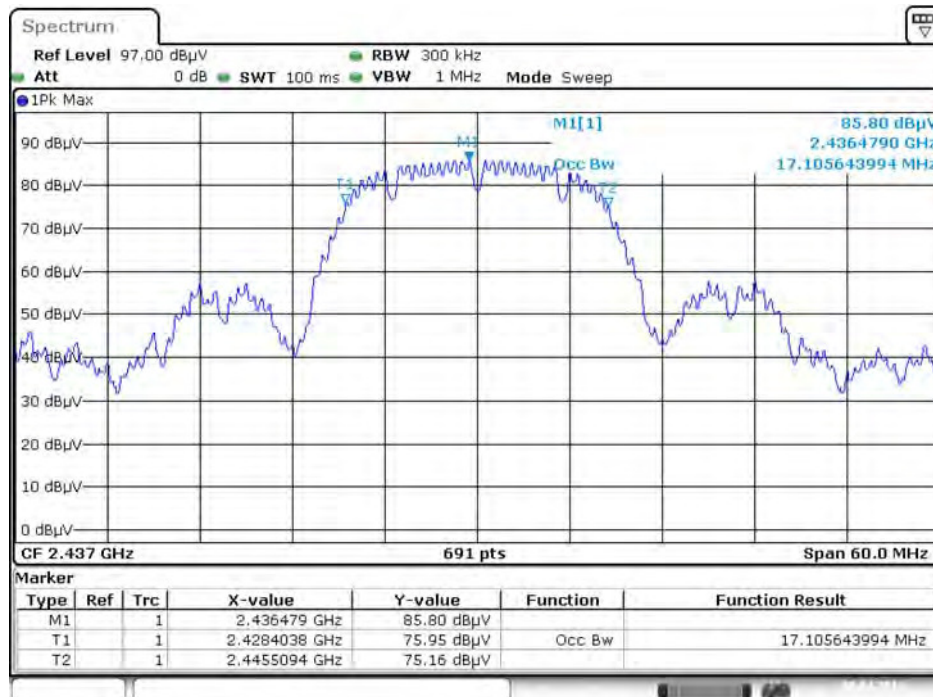

Date: 30.APR 2016 11:18:33

6 dB Bandwidth Plot on Configuration IEEE 802.11g / 2412 MHz / Chain 1

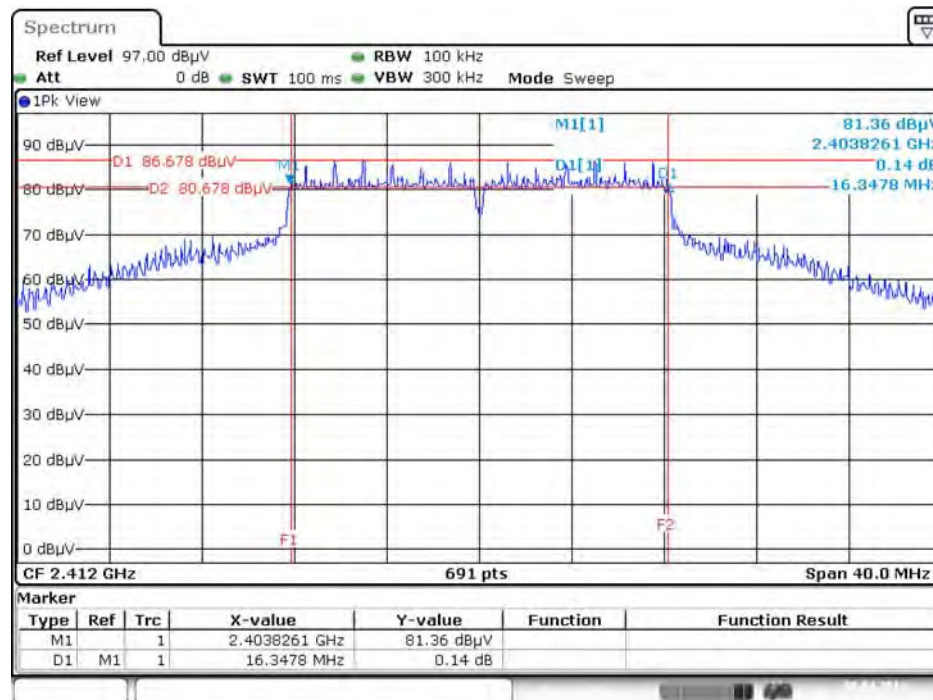

Date: 30.APR 2016 14:14:29

99% Occupied Bandwidth Plot on Configuration IEEE 802.11g / 2437 MHz / Chain 1



Date: 30.APR 2016 12:56:15

6 dB Bandwidth Plot on Configuration IEEE 802.11n MCS0 HT20 / 2412 MHz / Chain 1

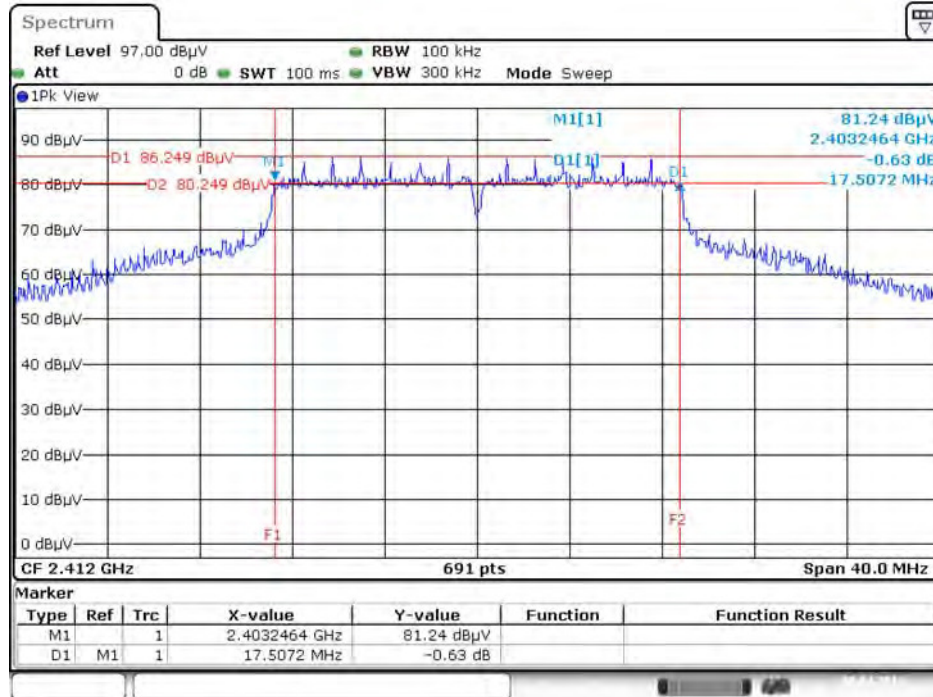

99% Occupied Bandwidth Plot on Configuration IEEE 802.11n MCS0 HT20 / 2437 MHz / Chain 1



**<Mode 3: Ant. 3 (Wire Ant.)>**

<b>Temperature</b>	26.5°C	<b>Humidity</b>	54%
<b>Test Engineer</b>	Peter Wu		

Mode	Frequency	6dB Bandwidth (MHz)	99% Occupied Bandwidth (MHz)	Min. Limit (kHz)	Test Result
802.11b	2412 MHz	15.01	17.11	500	Complies
	2437 MHz	14.55	17.11	500	Complies
	2462 MHz	14.55	17.11	500	Complies
802.11g	2412 MHz	16.35	20.84	500	Complies
	2437 MHz	16.35	18.15	500	Complies
	2462 MHz	16.35	18.67	500	Complies
802.11n MCS0 HT20	2412 MHz	17.57	21.62	500	Complies
	2437 MHz	17.62	17.37	500	Complies
	2462 MHz	17.62	17.37	500	Complies

Note: All the test values were listed in the report.

For plots, only the channel with worse result was shown.



6 dB Bandwidth Plot on Configuration IEEE 802.11b / 2437 MHz / Chain 1

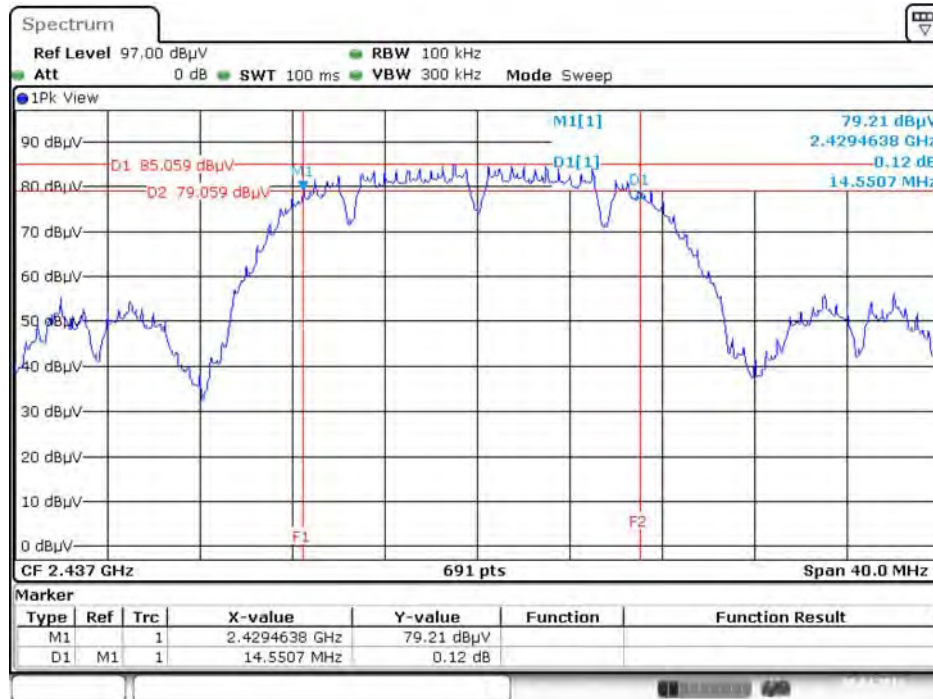

Date: 30.APR 2016 13:53:31

99% Occupied Bandwidth Plot on Configuration IEEE 802.11b / 2412 MHz / Chain 1

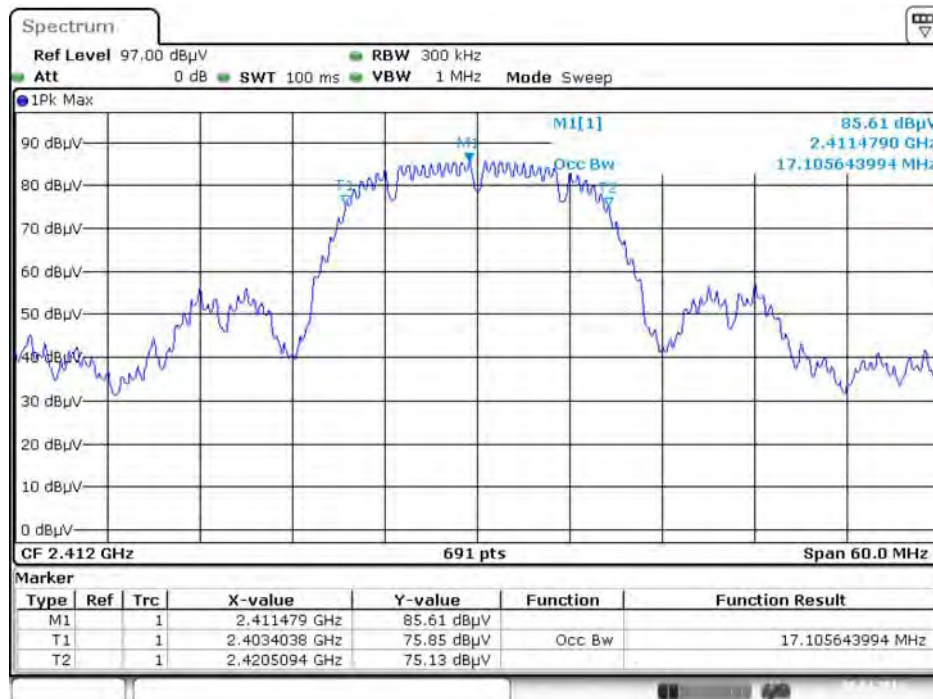

Date: 30.APR 2016 11:15:09

6 dB Bandwidth Plot on Configuration IEEE 802.11g / 2412 MHz / Chain 1

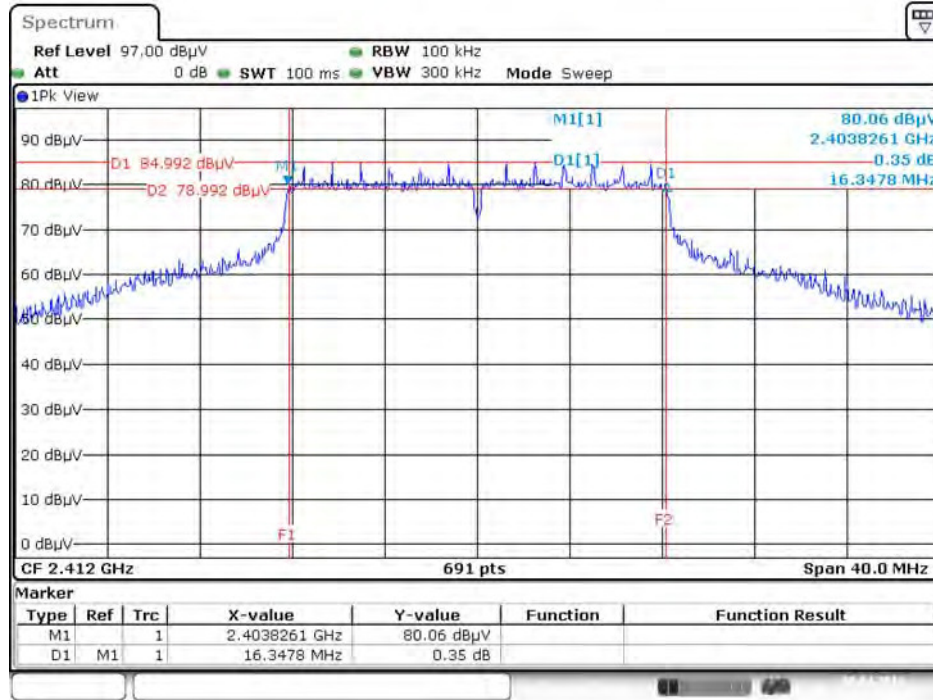

Date: 30.APR 2016 14:15:55

99% Occupied Bandwidth Plot on Configuration IEEE 802.11g / 2412 MHz / Chain 1



Date: 30.APR 2016 12:52:40

6 dB Bandwidth Plot on Configuration IEEE 802.11n MCS0 HT20 / 2412 MHz / Chain 1

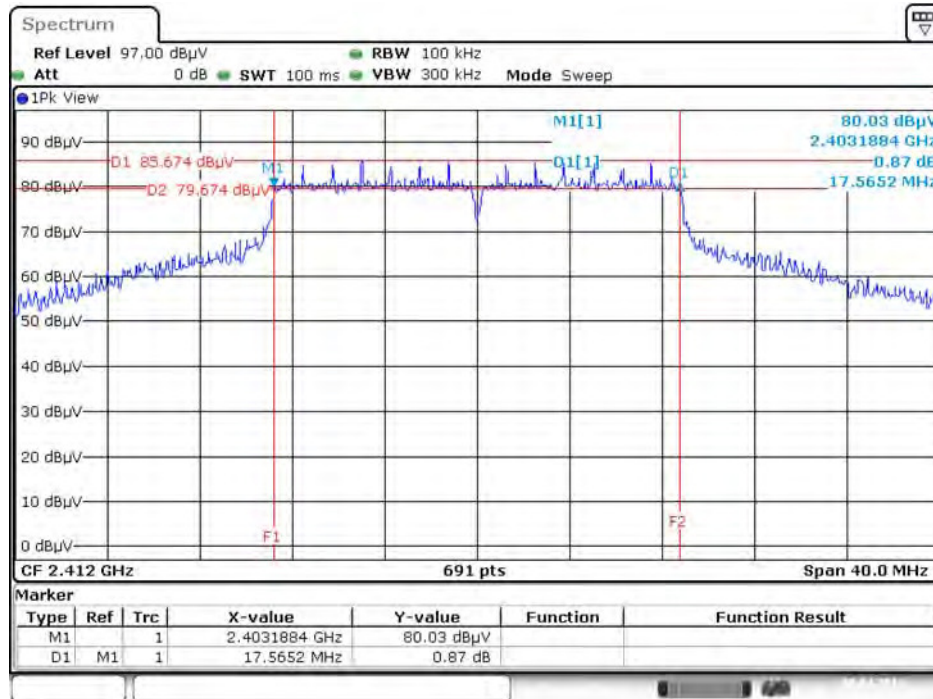

Date: 30.APR 2016 14:19:06

99% Occupied Bandwidth Plot on Configuration IEEE 802.11n MCS0 HT20 / 2412 MHz / Chain 1



Date: 30.APR 2016 13:27:39

## &lt;Mode 4: Ant. 4 (Dipole Ant.)&gt;

<b>Temperature</b>	26.5°C	<b>Humidity</b>	54%
<b>Test Engineer</b>	Peter Wu		

Mode	Frequency	6dB Bandwidth (MHz)	99% Occupied Bandwidth (MHz)	Min. Limit (kHz)	Test Result
802.11b	2412 MHz	15.07	17.11	500	Complies
	2437 MHz	15.01	17.02	500	Complies
	2462 MHz	15.07	17.11	500	Complies
802.11g	2412 MHz	16.35	21.97	500	Complies
	2437 MHz	16.35	21.53	500	Complies
	2462 MHz	16.35	22.32	500	Complies
802.11n MCS0 HT20	2412 MHz	17.51	23.62	500	Complies
	2437 MHz	17.57	17.54	500	Complies
	2462 MHz	17.62	17.54	500	Complies

Note: All the test values were listed in the report.

For plots, only the channel with worse result was shown.



6 dB Bandwidth Plot on Configuration IEEE 802.11b / 2437 MHz / Chain 1

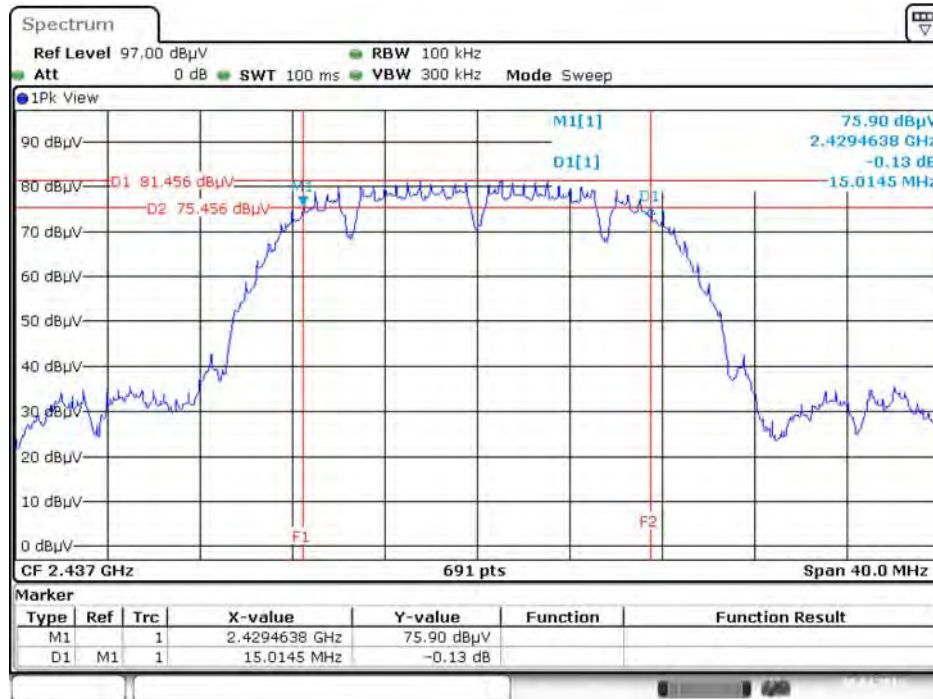

Date: 30.APR 2016 13:54:46

99% Occupied Bandwidth Plot on Configuration IEEE 802.11b / 2412 MHz / Chain 1



Date: 30.APR 2016 11:13:03

6 dB Bandwidth Plot on Configuration IEEE 802.11g / 2412 MHz / Chain 1

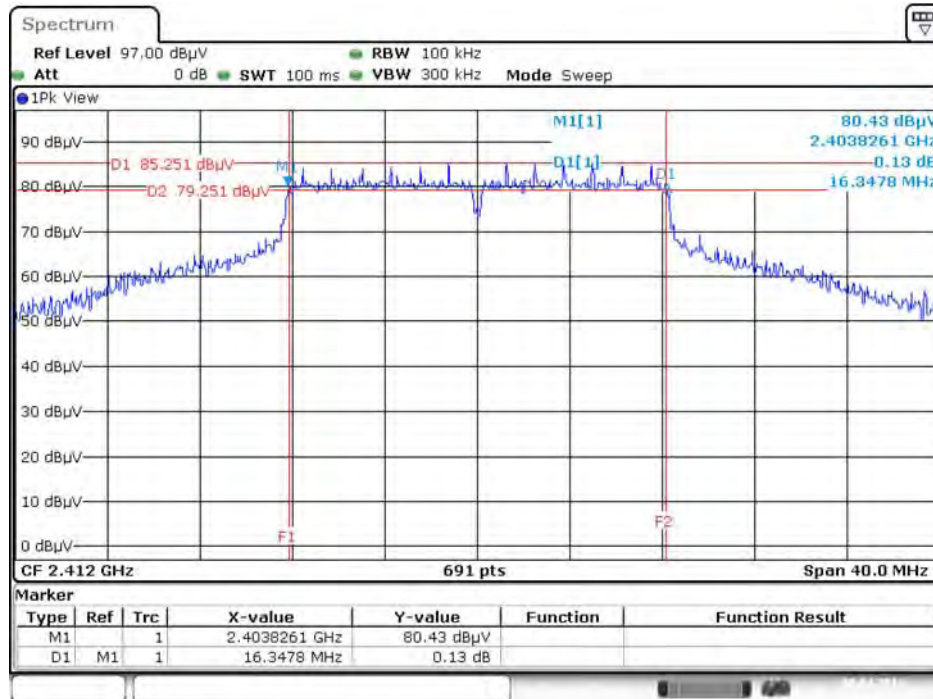

Date: 30.APR 2016 14:16:35

99% Occupied Bandwidth Plot on Configuration IEEE 802.11g / 2462 MHz / Chain 1



Date: 30.APR 2016 13:03:15

6 dB Bandwidth Plot on Configuration IEEE 802.11n MCS0 HT20 / 2412 MHz / Chain 1

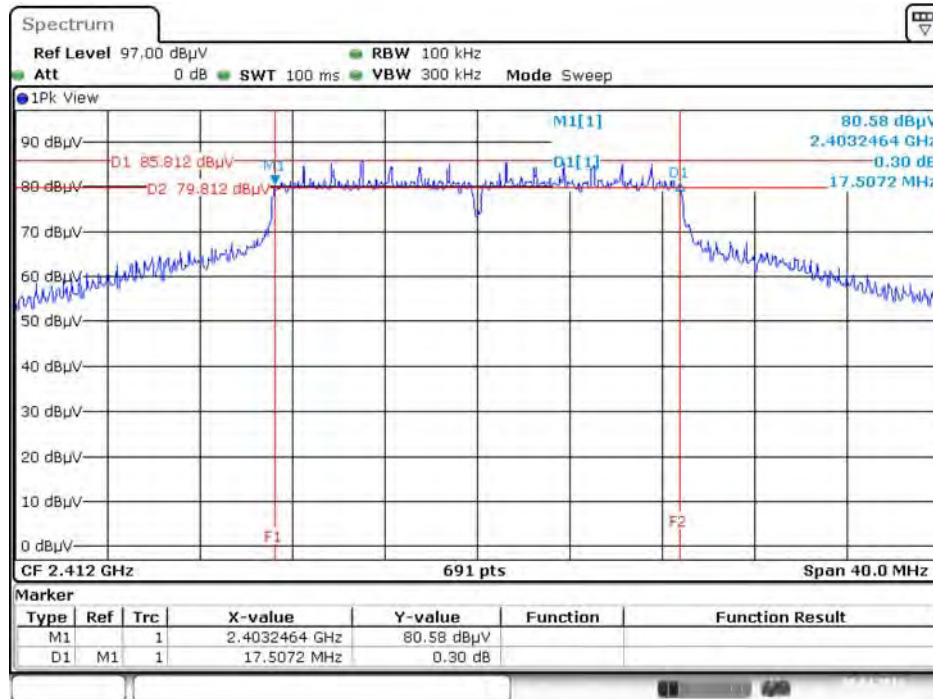

Date: 30.APR 2016 14:18:14

99% Occupied Bandwidth Plot on Configuration IEEE 802.11n MCS0 HT20 / 2412 MHz / Chain 1

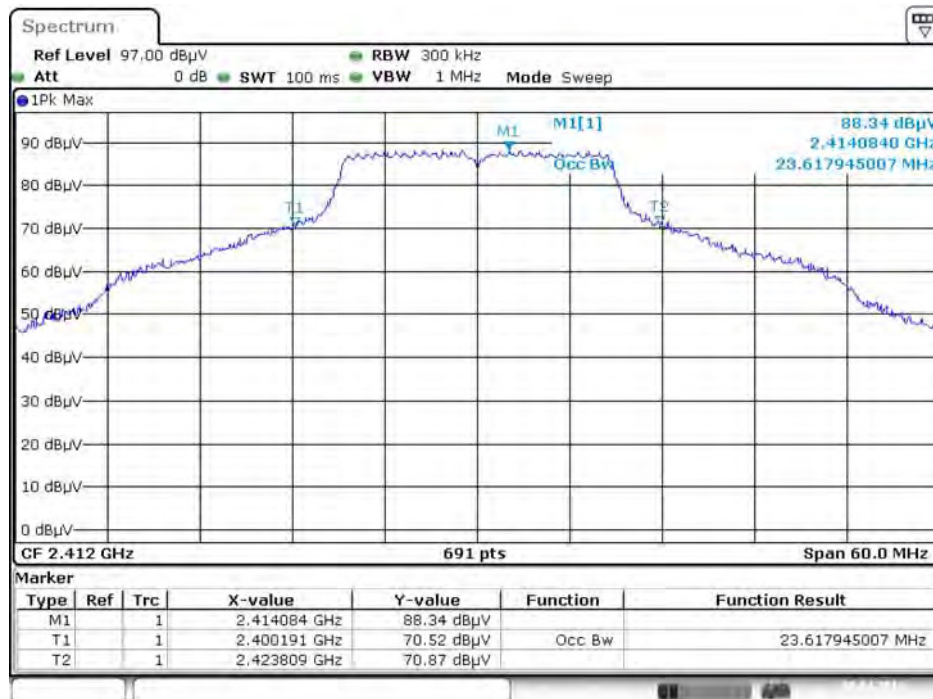

Date: 30.APR 2016 13:28:57

## &lt;Mode 5: Ant. 6 (Chip Ant.)&gt;

<b>Temperature</b>	26.5°C	<b>Humidity</b>	54%
<b>Test Engineer</b>	Peter Wu		

Mode	Frequency	6dB Bandwidth (MHz)	99% Occupied Bandwidth (MHz)	Min. Limit (kHz)	Test Result
802.11b	2412 MHz	15.07	17.11	500	Complies
	2437 MHz	14.55	17.19	500	Complies
	2462 MHz	14.55	17.11	500	Complies
802.11g	2412 MHz	16.35	28.13	500	Complies
	2437 MHz	16.35	26.40	500	Complies
	2462 MHz	16.35	21.45	500	Complies
802.11n MCS0 HT20	2412 MHz	17.51	30.30	500	Complies
	2437 MHz	17.33	17.80	500	Complies
	2462 MHz	17.51	17.54	500	Complies

Note: All the test values were listed in the report.

For plots, only the channel with worse result was shown.



6 dB Bandwidth Plot on Configuration IEEE 802.11b / 2437 MHz / Chain 1

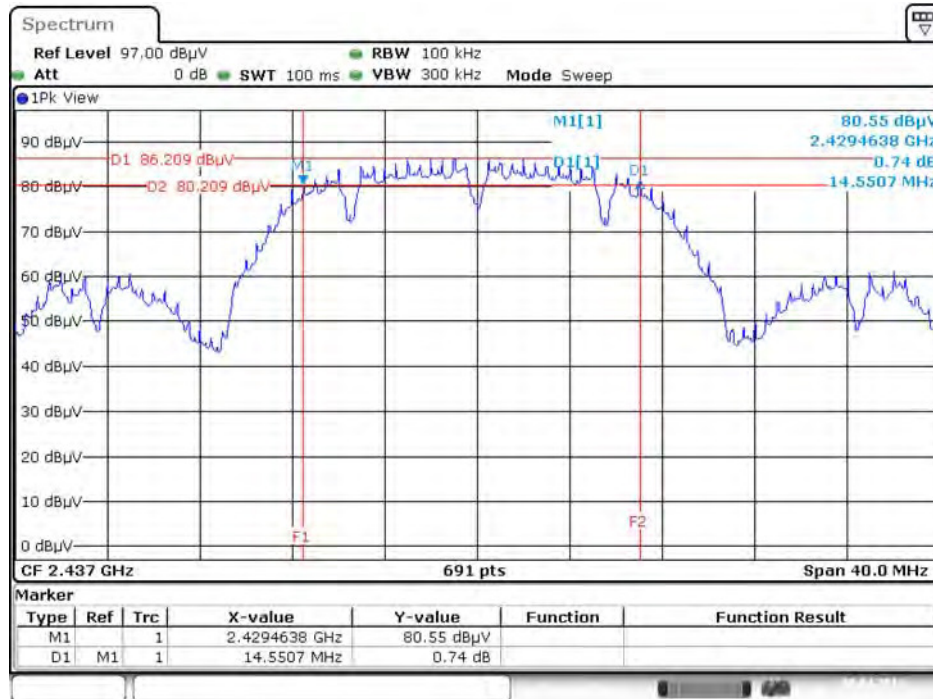

Date: 30.APR 2016 13:55:23

99% Occupied Bandwidth Plot on Configuration IEEE 802.11b / 2437 MHz / Chain 1

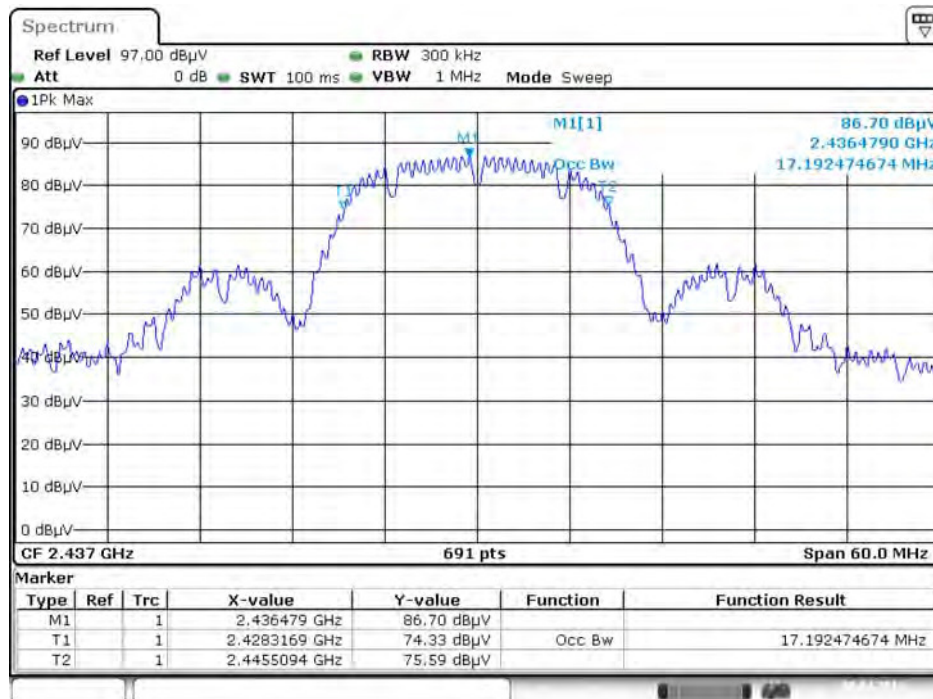

Date: 30.APR 2016 11:22:36

6 dB Bandwidth Plot on Configuration IEEE 802.11g / 2412 MHz / Chain 1

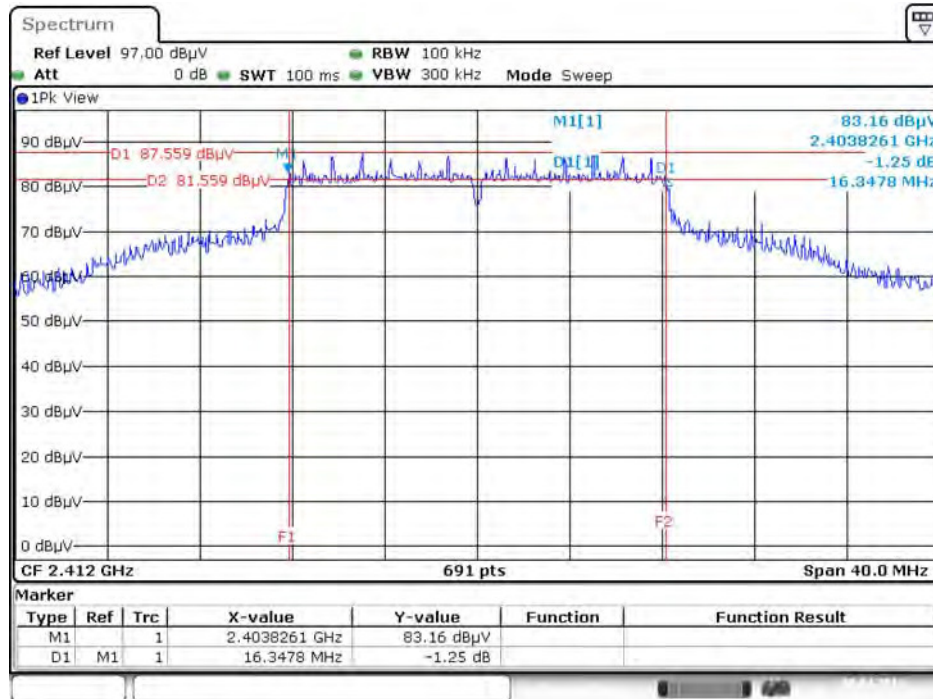

99% Occupied Bandwidth Plot on Configuration IEEE 802.11g / 2412 MHz / Chain 1

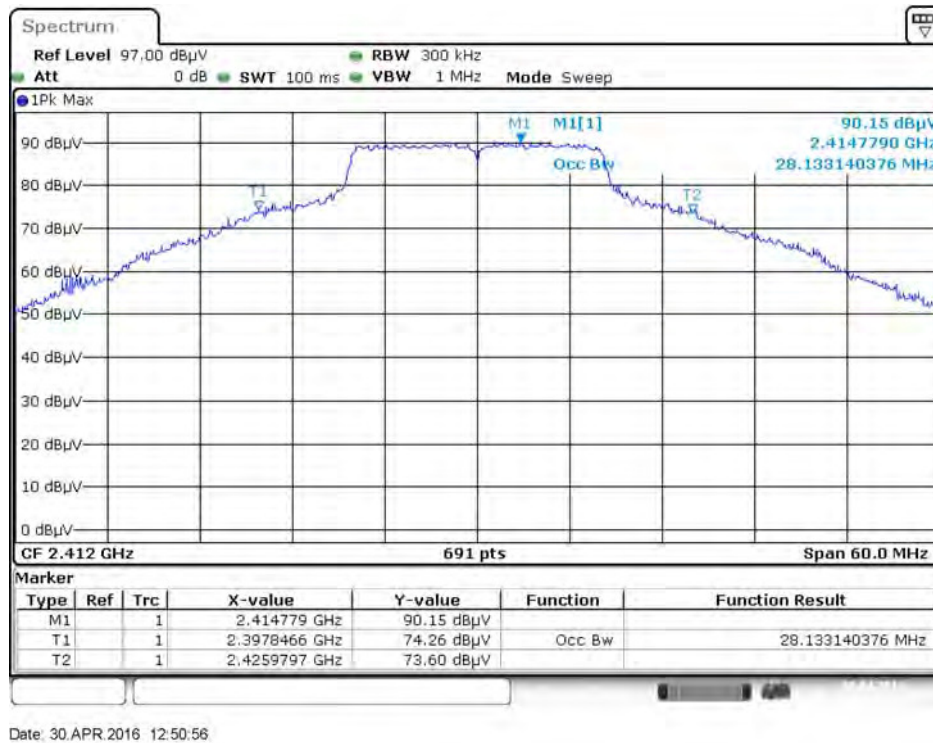

6 dB Bandwidth Plot on Configuration IEEE 802.11n MCS0 HT20 / 2437 MHz / Chain 1

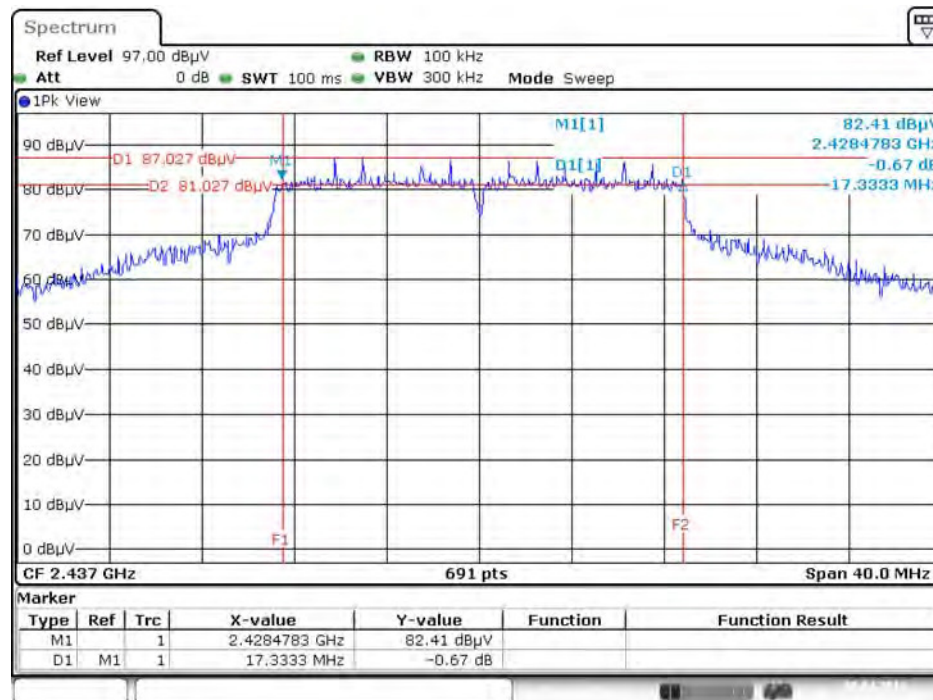

99% Occupied Bandwidth Plot on Configuration IEEE 802.11n MCS0 HT20 / 2412 MHz / Chain 1

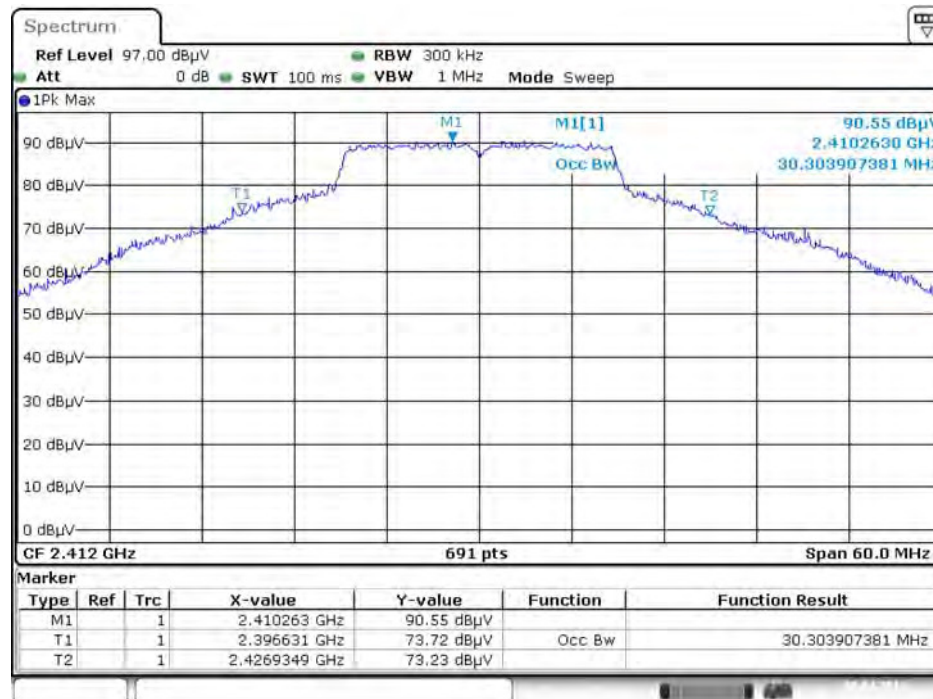

## 4.5. Radiated Emissions Measurement

### 4.5.1. Limit

30dBc in any 100 kHz bandwidth outside the operating frequency band. In case the emission fall within the restricted band specified on 15.205(a), then the 15.209(a) limit in the table below has to be followed.

Frequencies (MHz)	Field Strength (micorvolts/meter)	Measurement Distance (meters)
0.009~0.490	2400/F(kHz)	300
0.490~1.705	24000/F(kHz)	30
1.705~30.0	30	30
30~88	100	3
88~216	150	3
216~960	200	3
Above 960	500	3

### 4.5.2. Measuring Instruments and Setting

Please refer to section 5 of equipments list in this report. The following table is the setting of spectrum analyzer and receiver.

Spectrum Parameter	Setting
Attenuation	Auto
Start Frequency	1000 MHz
Stop Frequency	10th carrier harmonic
RBW / VBW (Emission in restricted band)	1MHz / 3MHz for Peak, 1MHz / 1/T for Average
RBW / VBW (Emission in non-restricted band)	100kHz / 300kHz for peak

Receiver Parameter	Setting
Attenuation	Auto
Start ~ Stop Frequency	9kHz~150kHz / RBW 200Hz for QP
Start ~ Stop Frequency	150kHz~30MHz / RBW 9kHz for QP
Start ~ Stop Frequency	30MHz~1000MHz / RBW 120kHz for QP



#### 4.5.3. Test Procedures

1. Configure the EUT according to ANSI C63.10. The EUT was placed on the top of the turntable 1.5 meter above ground. The phase center of the receiving antenna mounted on the top of a height-variable antenna tower was placed 1m & 3m far away from the turntable.
2. Power on the EUT and all the supporting units. The turntable was rotated by 360 degrees to determine the position of the highest radiation.
3. The height of the broadband receiving antenna was varied between one meter and four meters above ground to find the maximum emissions field strength of both horizontal and vertical polarization.
4. For each suspected emissions, the antenna tower was scan (from 1 m to 4 m) and then the turntable was rotated (from 0 degree to 360 degrees) to find the maximum reading.
5. Set the test-receiver system to Peak or CISPR quasi-peak Detect Function with specified bandwidth under Maximum Hold Mode.
6. For emissions above 1GHz, use 1MHz VBW and 3MHz RBW for peak reading. Then 1MHz RBW and 1/T VBW for average reading in spectrum analyzer.
7. If the emissions level of the EUT in peak mode was 3 dB lower than the average limit specified, then testing will be stopped and peak values of EUT will be reported, otherwise, the emissions which do not have 3 dB margin will be repeated one by one using the quasi-peak method for below 1GHz.
8. For testing above 1GHz, the emissions level of the EUT in peak mode was lower than average limit (that means the emissions level in peak mode also complies with the limit in average mode), then testing will be stopped and peak values of EUT will be reported, otherwise, the emissions will be measured in average mode again and reported.
9. In case the emission is lower than 30MHz, loop antenna has to be used for measurement and the recorded data should be QP measured by receiver. High – Low scan is not required in this case.

#### 4.5.4. Test Setup Layout

For Radiated Emissions: 9kHz ~30MHz

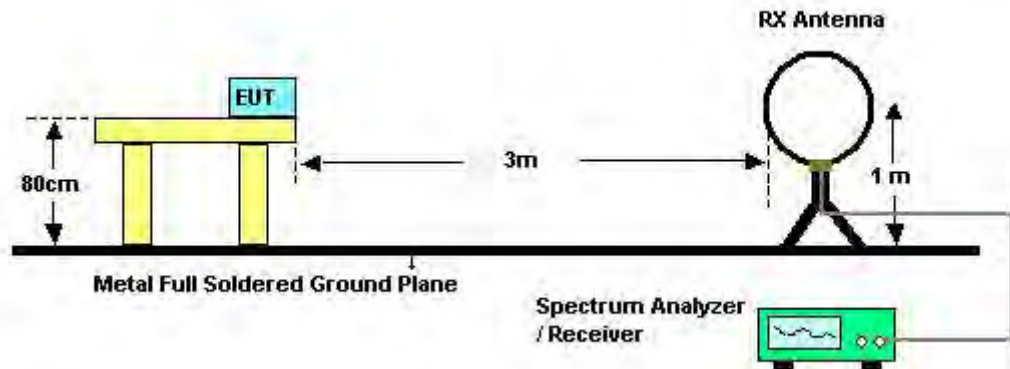

For Radiated Emissions: 30MHz~1GHz

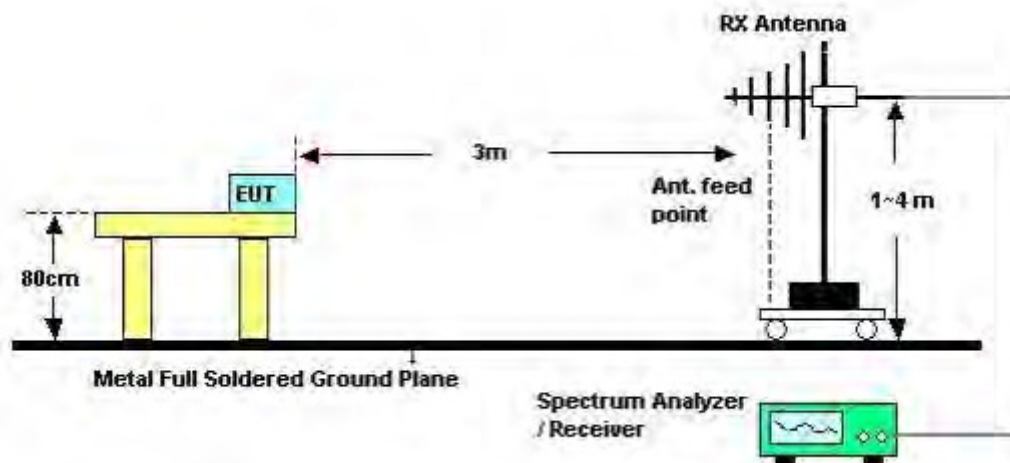

For Radiated Emissions: Above 1GHz

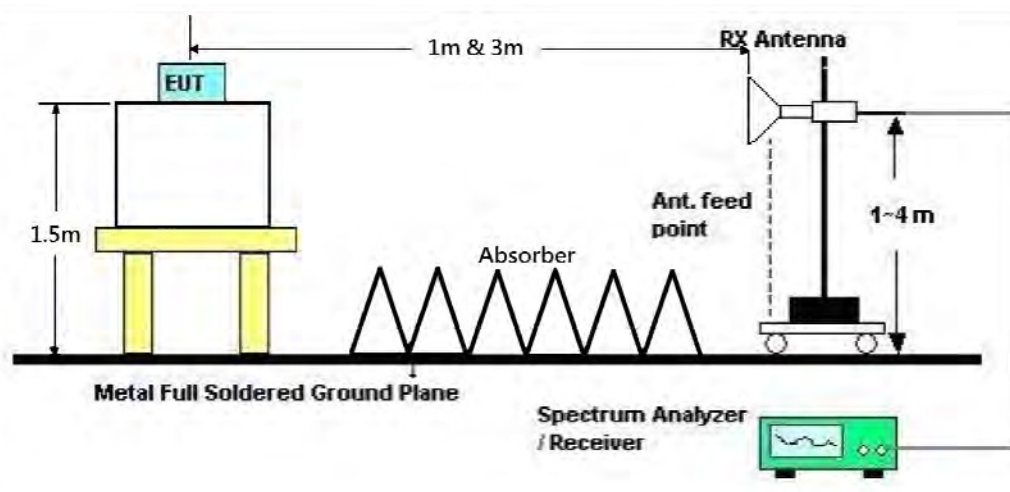

#### **4.5.5. Test Deviation**

There is no deviation with the original standard.

#### **4.5.6. EUT Operation during Test**

The EUT was programmed to be in continuously transmitting mode.

#### 4.5.7. Results of Radiated Emissions (9kHz~30MHz)

Temperature	27°C	Humidity	58%
Test Engineer	Peter Wu	Configurations	Normal Link
Test Date	Apr. 21, 2016	Test Mode	Mode 4

Freq. (MHz)	Level (dBuV)	Over Limit (dB)	Limit Line (dBuV)	Remark
-	-	-	-	See Note

**Note:**

The amplitude of spurious emissions which are attenuated by more than 20 dB below the permissible value has no need to be reported.

Distance extrapolation factor =  $40 \log(\text{specific distance} / \text{test distance})$  (dB);

Limit line = specific limits (dBuV) + distance extrapolation factor.

4.5.8. Results of Radiated Emissions (30MHz~1GHz)

Temperature	27°C	Humidity	58%
Test Engineer	Peter Wu	Configurations	Normal Link
Test Mode	Mode 4		

Horizontal

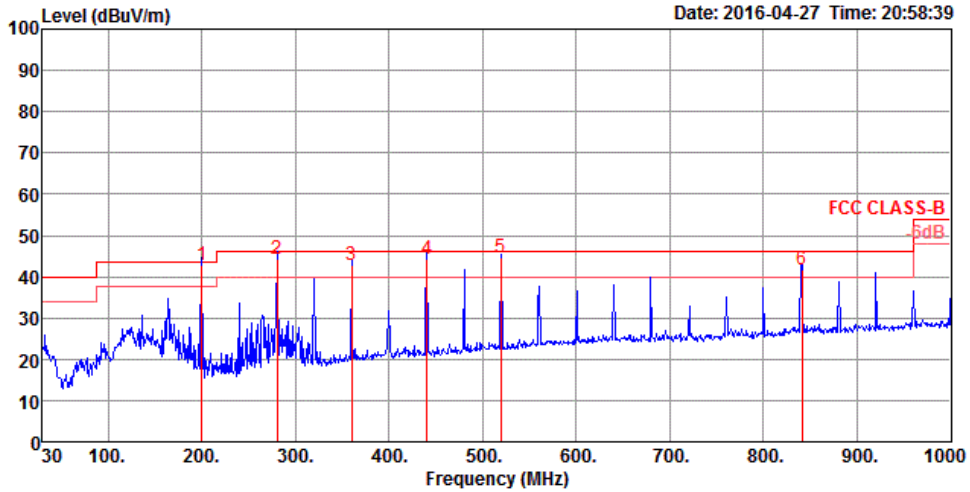

	Freq	Level	Limit Line	Over Limit	Read Level	CableAntenna Loss	Preamp Factor	A/Pos	T/Pos	Remark	Pol/Phase
	MHz	dBuV/m	dBuV/m	dB	dBuV	dB	dB/m	dB	cm	deg	
1	199.75	42.78	43.50	-0.72	57.19	1.22	16.70	32.33	150	86 QP	HORIZONTAL
2	280.26	44.10	46.00	-1.90	55.26	1.43	19.70	32.29	150	357 QP	HORIZONTAL
3	359.80	42.74	46.00	-3.26	51.78	1.63	21.64	32.31	100	7 QP	HORIZONTAL
4	440.31	44.37	46.00	-1.63	51.78	1.82	23.11	32.34	100	217 QP	HORIZONTAL
5	519.85	44.70	46.00	-1.30	50.77	1.98	24.31	32.36	200	360 QP	HORIZONTAL
6	840.92	41.86	46.00	-4.14	44.09	2.51	27.30	32.04	200	217 QP	HORIZONTAL

**Vertical**

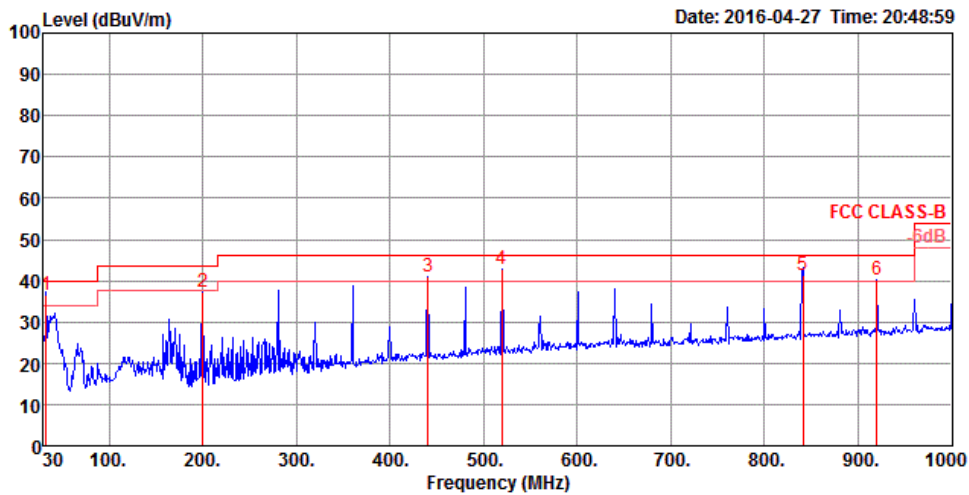

	Freq	Level	Limit	Over	Read	CableAntenna	Preamp	A/Pos	T/Pos	Remark	Pol/Phase
	MHz	dBuV/m	dBuV/m	dB	dBuV	dB	dB/m	dB	cm	deg	
1	32.91	36.53	40.00	-3.47	44.18	0.51	24.24	32.40	100	138 QP	VERTICAL
2	199.75	37.36	43.50	-6.14	51.77	1.22	16.70	32.33	200	22 Peak	VERTICAL
3	440.31	40.95	46.00	-5.05	48.36	1.82	23.11	32.34	100	165 Peak	VERTICAL
4	519.85	42.77	46.00	-3.23	48.84	1.98	24.31	32.36	200	50 Peak	VERTICAL
5	840.92	41.19	46.00	-4.81	43.42	2.51	27.30	32.04	150	204 QP	VERTICAL
6	920.46	40.05	46.00	-5.95	41.12	2.61	27.86	31.54	150	336 Peak	VERTICAL

**Note:**

The amplitude of spurious emissions which are attenuated by more than 20 dB below the permissible value has no need to be reported.

Emission level (dBuV/m) = 20 log Emission level (uV/m).

Corrected Reading: Antenna Factor + Cable Loss + Read Level - Preamp Factor = Level.

#### 4.5.9. Results for Radiated Emissions (1GHz~10<sup>th</sup> Harmonic)

<Mode 1: Ant. 1 (PCB Ant.)>

Temperature	27°C	Humidity	58%
Test Engineer	Peter Wu	Configurations	IEEE 802.11b CH 1 / Chain 1
Test Date	Apr. 21, 2016		

##### Horizontal

	Freq	Level	Limit Line	Over Limit	Read Level	CableAntenna Loss	Antenna Factor	Preamp Factor	A/Pos	T/Pos	Remark	Pol/Phase
	MHz	dBuV/m	dBuV/m	dB	dBuV	dB	dB/m	dB	cm	deg		
1	4829.16	53.69	54.00	-0.31	48.49	7.08	31.14	33.02	192	210	Average	HORIZONTAL
2	4829.42	60.79	74.00	-13.21	55.59	7.08	31.14	33.02	192	210	Peak	HORIZONTAL

##### Vertical

	Freq	Level	Limit Line	Over Limit	Read Level	CableAntenna Loss	Antenna Factor	Preamp Factor	A/Pos	T/Pos	Remark	Pol/Phase
	MHz	dBuV/m	dBuV/m	dB	dBuV	dB	dB/m	dB	cm	deg		
1	4829.16	49.87	54.00	-4.13	44.67	7.08	31.14	33.02	100	272	Average	VERTICAL
2	4829.48	57.40	74.00	-16.60	52.20	7.08	31.14	33.02	100	272	Peak	VERTICAL

<b>Temperature</b>	27°C	<b>Humidity</b>	62%
<b>Test Engineer</b>	Peter Wu	<b>Configurations</b>	IEEE 802.11b CH 6 / Chain 1
<b>Test Date</b>	Apr. 21, 2016		

### Horizontal

	Freq	Level	Limit Line	Over Limit	Read Level	CableAntenna Loss	Antenna Factor	Preamp Factor	A/Pos	T/Pos	Remark	Pol/Phase
	MHz	dBuV/m	dBuV/m	dB	dBuV	dB	dB/m	dB	cm	deg		
1	4879.16	53.82	54.00	-0.18	48.53	7.08	31.21	33.00	213	210	Average	HORIZONTAL
2	4879.48	61.60	74.00	-12.40	56.31	7.08	31.21	33.00	213	210	Peak	HORIZONTAL
3	7309.24	62.54	74.00	-11.46	51.96	8.77	35.99	34.18	242	212	Peak	HORIZONTAL
4	7316.45	53.04	54.00	-0.96	42.41	8.78	36.03	34.18	242	212	Average	HORIZONTAL

### Vertical

	Freq	Level	Limit Line	Over Limit	Read Level	CableAntenna Loss	Antenna Factor	Preamp Factor	A/Pos	T/Pos	Remark	Pol/Phase
	MHz	dBuV/m	dBuV/m	dB	dBuV	dB	dB/m	dB	cm	deg		
1	4879.19	49.28	54.00	-4.72	43.99	7.08	31.21	33.00	206	353	Average	VERTICAL
2	4879.45	56.20	74.00	-17.80	50.91	7.08	31.21	33.00	206	353	Peak	VERTICAL
3	7315.49	63.95	74.00	-10.05	53.37	8.77	35.99	34.18	215	237	Peak	VERTICAL
4	7316.45	53.77	54.00	-0.23	43.14	8.78	36.03	34.18	215	237	Average	VERTICAL



<b>Temperature</b>	27°C	<b>Humidity</b>	58%
<b>Test Engineer</b>	Peter Wu	<b>Configurations</b>	IEEE 802.11b CH 11 / Chain 1
<b>Test Date</b>	Apr. 21, 2016		

### Horizontal

	Freq	Level	Limit Line	Over Limit	Read Level	CableAntenna Loss	Antenna Factor	Preamp Factor	A/Pos	T/Pos	Remark	Pol/Phase
	MHz	dBuV/m	dBuV/m	dB	dBuV	dB	dB/m	dB	cm	deg		
1	4929.19	53.59	54.00	-0.41	48.21	7.07	31.29	32.98	199	209	Average	HORIZONTAL
2	4929.55	61.33	74.00	-12.67	55.95	7.07	31.29	32.98	199	209	Peak	HORIZONTAL
3	7393.69	51.37	54.00	-2.63	40.63	8.82	36.17	34.25	247	213	Average	HORIZONTAL
4	7394.17	62.10	74.00	-11.90	51.36	8.82	36.17	34.25	247	213	Peak	HORIZONTAL

### Vertical

	Freq	Level	Limit Line	Over Limit	Read Level	CableAntenna Loss	Antenna Factor	Preamp Factor	A/Pos	T/Pos	Remark	Pol/Phase
	MHz	dBuV/m	dBuV/m	dB	dBuV	dB	dB/m	dB	cm	deg		
1	4929.21	51.02	54.00	-2.98	45.64	7.07	31.29	32.98	242	21	Average	VERTICAL
2	4929.45	57.11	74.00	-16.89	51.73	7.07	31.29	32.98	242	21	Peak	VERTICAL
3	7393.45	53.85	54.00	-0.15	43.11	8.82	36.17	34.25	174	272	Average	VERTICAL
4	7393.98	63.18	74.00	-10.82	52.44	8.82	36.17	34.25	174	272	Peak	VERTICAL



<b>Temperature</b>	27°C	<b>Humidity</b>	58%
<b>Test Engineer</b>	Peter Wu	<b>Configurations</b>	IEEE 802.11g CH 1 / Chain 1
<b>Test Date</b>	Apr. 21, 2016		

**Horizontal**

	Freq	Level	Limit Line	Over Limit	Read Level	CableAntenna Loss	Antenna Factor	Preamp Factor	A/Pos	T/Pos	Remark	Pol/Phase
	MHz	dBuV/m	dBuV/m	dB	dBuV	dB	dB/m	dB	cm	deg		
1	4825.12	47.68	54.00	-6.32	42.49	7.08	31.14	33.03	100	274	Average	HORIZONTAL
2	4829.77	62.74	74.00	-11.26	57.54	7.08	31.14	33.02	100	274	Peak	HORIZONTAL

**Vertical**

	Freq	Level	Limit Line	Over Limit	Read Level	CableAntenna Loss	Antenna Factor	Preamp Factor	A/Pos	T/Pos	Remark	Pol/Phase
	MHz	dBuV/m	dBuV/m	dB	dBuV	dB	dB/m	dB	cm	deg		
1	4822.56	62.15	74.00	-11.85	56.98	7.08	31.12	33.03	100	273	Peak	VERTICAL
2	4824.80	46.52	54.00	-7.48	41.35	7.08	31.12	33.03	100	273	Average	VERTICAL

<b>Temperature</b>	27°C	<b>Humidity</b>	58%
<b>Test Engineer</b>	Peter Wu	<b>Configurations</b>	IEEE 802.11g CH 6 / Chain 1
<b>Test Date</b>	Apr. 21, 2016		

### Horizontal

	Freq	Level	Limit Line	Over Limit	Read Level	CableAntenna Loss	Antenna Factor	Preamp Factor	A/Pos	T/Pos	Remark	Pol/Phase
	MHz	dBuV/m	dBuV/m	dB	dBuV	dB	dB/m	dB	cm	deg		
1	4874.00	45.54	54.00	-8.46	40.26	7.08	31.21	33.01	192	197	Average	HORIZONTAL
2	4874.80	61.20	74.00	-12.80	55.92	7.08	31.21	33.01	192	197	Peak	HORIZONTAL
3	7310.68	52.08	54.00	-1.92	41.50	8.77	35.99	34.18	100	204	Average	HORIZONTAL
4	7324.94	70.18	74.00	-3.82	59.57	8.78	36.03	34.20	100	204	Peak	HORIZONTAL

### Vertical

	Freq	Level	Limit Line	Over Limit	Read Level	CableAntenna Loss	Antenna Factor	Preamp Factor	A/Pos	T/Pos	Remark	Pol/Phase
	MHz	dBuV/m	dBuV/m	dB	dBuV	dB	dB/m	dB	cm	deg		
1	4872.88	56.28	74.00	-17.72	51.00	7.08	31.21	33.01	100	59	Peak	VERTICAL
2	4874.80	43.41	54.00	-10.59	38.13	7.08	31.21	33.01	100	59	Average	VERTICAL
3	7311.32	53.50	54.00	-0.50	42.92	8.77	35.99	34.18	200	234	Average	VERTICAL
4	7312.76	71.72	74.00	-2.28	61.14	8.77	35.99	34.18	200	234	Peak	VERTICAL

<b>Temperature</b>	27°C	<b>Humidity</b>	62%
<b>Test Engineer</b>	Peter Wu	<b>Configurations</b>	IEEE 802.11g CH 11 / Chain 1
<b>Test Date</b>	Apr. 21, 2016		

### Horizontal

	Freq	Level	Limit Line	Over Limit	Read Level	CableAntenna Loss	Antenna Factor	Preamp Factor	A/Pos	T/Pos	Remark	Pol/Phase
	MHz	dBuV/m	dBuV/m	dB	dBuV	dB	dB/m	dB	cm	deg		
1	4924.00	47.51	54.00	-6.49	42.14	7.07	31.29	32.99	200	200	Average	HORIZONTAL
2	4928.17	60.51	74.00	-13.49	55.13	7.07	31.29	32.98	200	200	Peak	HORIZONTAL
3	7383.60	53.20	54.00	-0.80	42.46	8.82	36.17	34.25	179	32	Average	HORIZONTAL
4	7384.72	71.52	74.00	-2.48	60.78	8.82	36.17	34.25	179	32	Peak	HORIZONTAL

### Vertical

	Freq	Level	Limit Line	Over Limit	Read Level	CableAntenna Loss	Antenna Factor	Preamp Factor	A/Pos	T/Pos	Remark	Pol/Phase
	MHz	dBuV/m	dBuV/m	dB	dBuV	dB	dB/m	dB	cm	deg		
1	4923.84	44.73	54.00	-9.27	39.36	7.07	31.29	32.99	100	278	Average	VERTICAL
2	4925.12	58.45	74.00	-15.55	53.07	7.07	31.29	32.98	100	278	Peak	VERTICAL
3	7382.15	70.53	74.00	-3.47	59.79	8.82	36.17	34.25	106	222	Peak	VERTICAL
4	7385.36	53.46	54.00	-0.54	42.72	8.82	36.17	34.25	106	222	Average	VERTICAL

<b>Temperature</b>	27°C	<b>Humidity</b>	58%
<b>Test Engineer</b>	Peter Wu	<b>Configurations</b>	IEEE 802.11n MCS0 HT20 CH 1 / Chain 1
<b>Test Date</b>	Apr. 21, 2016		

### Horizontal

	Freq	Level	Limit Line	Over Limit	Read Level	CableAntenna Loss	Preamp Factor	A/Pos	T/Pos	Remark	Pol/Phase	
	MHz	dBuV/m	dBuV/m	dB	dBuV	dB	dB/m	dB	cm	deg		
1	4823.68	48.85	54.00	-5.15	43.68	7.08	31.12	33.03	198	207	Average	HORIZONTAL
2	4825.44	60.31	74.00	-13.69	55.12	7.08	31.14	33.03	198	207	Peak	HORIZONTAL

### Vertical

	Freq	Level	Limit Line	Over Limit	Read Level	CableAntenna Loss	Preamp Factor	A/Pos	T/Pos	Remark	Pol/Phase	
	MHz	dBuV/m	dBuV/m	dB	dBuV	dB	dB/m	dB	cm	deg		
1	4824.48	45.97	54.00	-8.03	40.80	7.08	31.12	33.03	100	268	Average	VERTICAL
2	4825.92	59.98	74.00	-14.02	54.79	7.08	31.14	33.03	100	268	Peak	VERTICAL

<b>Temperature</b>	27°C	<b>Humidity</b>	58%
<b>Test Engineer</b>	Peter Wu	<b>Configurations</b>	IEEE 802.11n MCS0 HT20 CH 6 / Chain 1
<b>Test Date</b>	Apr. 21, 2016		

### Horizontal

	Freq	Level	Limit Line	Over Limit	Read Level	CableAntenna Loss	Preamp Factor	A/Pos	T/Pos	Remark	Pol/Phase
	MHz	dBuV/m	dBuV/m	dB	dBuV	dB	dB/m	dB	cm	deg	
1	4874.32	59.33	74.00	-14.67	54.05	7.08	31.21	33.01	196	194 Peak	HORIZONTAL
2	4875.28	46.78	54.00	-7.22	41.50	7.08	31.21	33.01	196	194 Average	HORIZONTAL
3	7313.72	53.44	54.00	-0.56	42.86	8.77	35.99	34.18	242	212 Average	HORIZONTAL
4	7316.13	71.39	74.00	-2.61	60.76	8.78	36.03	34.18	242	212 Peak	HORIZONTAL

### Vertical

	Freq	Level	Limit Line	Over Limit	Read Level	CableAntenna Loss	Preamp Factor	A/Pos	T/Pos	Remark	Pol/Phase
	MHz	dBuV/m	dBuV/m	dB	dBuV	dB	dB/m	dB	cm	deg	
1	4871.44	57.24	74.00	-16.76	51.96	7.08	31.21	33.01	105	278 Peak	VERTICAL
2	4876.24	43.84	54.00	-10.16	38.56	7.08	31.21	33.01	105	278 Average	VERTICAL
3	7310.52	53.28	54.00	-0.72	42.70	8.77	35.99	34.18	193	226 Average	VERTICAL
4	7314.05	71.82	74.00	-2.18	61.24	8.77	35.99	34.18	193	226 Peak	VERTICAL

<b>Temperature</b>	27°C	<b>Humidity</b>	58%
<b>Test Engineer</b>	Peter Wu	<b>Configurations</b>	IEEE 802.11n MCS0 HT20 CH 11 / Chain 1
<b>Test Date</b>	Apr. 21, 2016		

### Horizontal

	Freq	Level	Limit Line	Over Limit	Read Level	Cable Loss	Antenna Factor	Preamp Factor	A/Pos	T/Pos	Remark	Pol/Phase
	MHz	dBuV/m	dBuV/m	dB	dBuV	dB	dB/m	dB	cm	deg		
1	4922.24	60.17	74.00	-13.83	54.82	7.07	31.27	32.99	192	192	Peak	HORIZONTAL
2	4924.48	46.96	54.00	-7.04	41.59	7.07	31.29	32.99	192	192	Average	HORIZONTAL
3	7377.19	68.50	74.00	-5.50	57.82	8.81	36.12	34.25	207	134	Peak	HORIZONTAL
4	7385.20	51.34	54.00	-2.66	40.60	8.82	36.17	34.25	207	134	Average	HORIZONTAL

### Vertical

	Freq	Level	Limit Line	Over Limit	Read Level	Cable Loss	Antenna Factor	Preamp Factor	A/Pos	T/Pos	Remark	Pol/Phase
	MHz	dBuV/m	dBuV/m	dB	dBuV	dB	dB/m	dB	cm	deg		
1	4917.91	55.70	74.00	-18.30	50.35	7.07	31.27	32.99	106	44	Peak	VERTICAL
2	4925.12	43.56	54.00	-10.44	38.18	7.07	31.29	32.98	106	44	Average	VERTICAL
3	7383.76	72.20	74.00	-1.80	61.46	8.82	36.17	34.25	197	226	Peak	VERTICAL
4	7386.00	53.66	54.00	-0.34	42.92	8.82	36.17	34.25	197	226	Average	VERTICAL

### Note:

The amplitude of spurious emissions that are attenuated by more than 20dB below the permissible value has no need to be reported.

Emission level (dBuV/m) = 20 log Emission level (uV/m).

Corrected Reading: Antenna Factor + Cable Loss + Read Level - Preamp Factor = Level.

## &lt;Mode 2: Ant. 2 (PCB Ant.)&gt;

<b>Temperature</b>	27°C	<b>Humidity</b>	58%
<b>Test Engineer</b>	Peter Wu	<b>Configurations</b>	IEEE 802.11b CH 1 / Chain 1
<b>Test Date</b>	Apr. 19, 2016		

**Horizontal**

	Freq	Level	Limit Line	Over Limit	Read Level	CableAntenna Loss	Antenna Factor	Preamp Factor	A/Pos	T/Pos	Remark	Pol/Phase
	MHz	dBuV/m	dBuV/m	dB	dBuV	dB	dB/m	dB	cm	deg		
1	4818.52	60.82	74.00	-13.18	55.65	7.08	31.12	33.03	232	140	Peak	HORIZONTAL
2	4818.84	53.89	54.00	-0.11	48.72	7.08	31.12	33.03	232	140	Average	HORIZONTAL

**Vertical**

	Freq	Level	Limit Line	Over Limit	Read Level	CableAntenna Loss	Antenna Factor	Preamp Factor	A/Pos	T/Pos	Remark	Pol/Phase
	MHz	dBuV/m	dBuV/m	dB	dBuV	dB	dB/m	dB	cm	deg		
1	4818.52	51.16	74.00	-22.84	45.99	7.08	31.12	33.03	100	44	Peak	VERTICAL
2	4829.22	42.25	54.00	-11.75	37.05	7.08	31.14	33.02	100	44	Average	VERTICAL



<b>Temperature</b>	27°C	<b>Humidity</b>	62%
<b>Test Engineer</b>	Peter Wu	<b>Configurations</b>	IEEE 802.11b CH 6 / Chain 1
<b>Test Date</b>	Apr. 19, 2016		

### Horizontal

	Freq	Level	Limit Line	Over Limit	Read Level	CableAntenna Loss	Antenna Factor	Preamp Factor	A/Pos	T/Pos	Remark	Pol/Phase
	MHz	dBuV/m	dBuV/m	dB	dBuV	dB	dB/m	dB	cm	deg		
1	4868.84	53.57	54.00	-0.43	48.29	7.08	31.21	33.01	231	142	Average	HORIZONTAL
2	4869.29	63.10	74.00	-10.90	57.82	7.08	31.21	33.01	231	142	Peak	HORIZONTAL
3	7302.92	63.37	74.00	-10.63	52.79	8.77	35.99	34.18	211	134	Peak	HORIZONTAL
4	7303.44	53.75	54.00	-0.25	43.17	8.77	35.99	34.18	211	134	Average	HORIZONTAL

### Vertical

	Freq	Level	Limit Line	Over Limit	Read Level	CableAntenna Loss	Antenna Factor	Preamp Factor	A/Pos	T/Pos	Remark	Pol/Phase
	MHz	dBuV/m	dBuV/m	dB	dBuV	dB	dB/m	dB	cm	deg		
1	4868.87	47.94	54.00	-6.06	42.66	7.08	31.21	33.01	152	94	Average	VERTICAL
2	4869.32	58.25	74.00	-15.75	52.97	7.08	31.21	33.01	152	94	Peak	VERTICAL
3	7303.15	58.90	74.00	-15.10	48.32	8.77	35.99	34.18	181	198	Peak	VERTICAL
4	7303.44	49.53	54.00	-4.47	38.95	8.77	35.99	34.18	181	198	Average	VERTICAL

<b>Temperature</b>	27°C	<b>Humidity</b>	58%
<b>Test Engineer</b>	Peter Wu	<b>Configurations</b>	IEEE 802.11b CH 11 / Chain 1
<b>Test Date</b>	Apr. 19, 2016		

### Horizontal

	Freq	Level	Limit Line	Over Limit	Read Level	CableAntenna Loss	Antenna Factor	Preamp Factor	A/Pos	T/Pos	Remark	Pol/Phase
	MHz	dBuV/m	dBuV/m	dB	dBuV	dB	dB/m	dB	cm	deg		
1	4929.19	53.81	54.00	-0.19	48.43	7.07	31.29	32.98	227	141	Average	HORIZONTAL
2	4929.45	65.27	74.00	-8.73	59.89	7.07	31.29	32.98	227	141	Peak	HORIZONTAL
3	7378.31	52.72	54.00	-1.28	42.04	8.81	36.12	34.25	281	184	Average	HORIZONTAL
4	7394.33	62.09	74.00	-11.91	51.38	8.82	36.17	34.28	281	184	Peak	HORIZONTAL

### Vertical

	Freq	Level	Limit Line	Over Limit	Read Level	CableAntenna Loss	Antenna Factor	Preamp Factor	A/Pos	T/Pos	Remark	Pol/Phase
	MHz	dBuV/m	dBuV/m	dB	dBuV	dB	dB/m	dB	cm	deg		
1	4929.22	49.90	54.00	-4.10	44.52	7.07	31.29	32.98	225	95	Average	VERTICAL
2	4929.55	61.24	74.00	-12.76	55.86	7.07	31.29	32.98	225	95	Peak	VERTICAL
3	7377.83	59.01	74.00	-14.99	48.33	8.81	36.12	34.25	165	200	Peak	VERTICAL
4	7378.39	49.39	54.00	-4.61	38.71	8.81	36.12	34.25	165	200	Average	VERTICAL



<b>Temperature</b>	27°C	<b>Humidity</b>	58%
<b>Test Engineer</b>	Peter Wu	<b>Configurations</b>	IEEE 802.11g CH 1 / Chain 1
<b>Test Date</b>	Apr. 19, 2016		

**Horizontal**

	Freq	Level	Limit Line	Over Limit	Read Level	CableAntenna Loss	Antenna Factor	Preamp Factor	A/Pos	T/Pos	Remark	Pol/Phase
	MHz	dBuV/m	dBuV/m	dB	dBuV	dB	dB/m	dB	cm	deg		
1	4822.96	66.54	74.00	-7.46	61.37	7.08	31.12	33.03	216	34	Peak	HORIZONTAL
2	4823.44	52.78	54.00	-1.22	47.61	7.08	31.12	33.03	216	34	Average	HORIZONTAL

**Vertical**

	Freq	Level	Limit Line	Over Limit	Read Level	CableAntenna Loss	Antenna Factor	Preamp Factor	A/Pos	T/Pos	Remark	Pol/Phase
	MHz	dBuV/m	dBuV/m	dB	dBuV	dB	dB/m	dB	cm	deg		
1	4818.39	63.32	74.00	-10.68	58.15	7.08	31.12	33.03	100	84	Peak	VERTICAL
2	4824.00	50.68	54.00	-3.32	45.51	7.08	31.12	33.03	100	84	Average	VERTICAL

<b>Temperature</b>	27°C	<b>Humidity</b>	58%
<b>Test Engineer</b>	Peter Wu	<b>Configurations</b>	IEEE 802.11g CH 6 / Chain 1
<b>Test Date</b>	Apr. 19, 2016		

### Horizontal

	Freq	Level	Limit Line	Over Limit	Read Level	Cable Loss	Antenna Factor	Preamp Factor	A/Pos	T/Pos	Remark	Pol/Phase
	MHz	dBuV/m	dBuV/m	dB	dBuV	dB	dB/m	dB	cm	deg		
1	4872.72	49.57	54.00	-4.43	44.29	7.08	31.21	33.01	236	33	Average	HORIZONTAL
2	4872.72	64.33	74.00	-9.67	59.05	7.08	31.21	33.01	236	33	Peak	HORIZONTAL
3	7308.28	70.29	74.00	-3.71	59.71	8.77	35.99	34.18	202	44	Peak	HORIZONTAL
4	7310.52	53.72	54.00	-0.28	43.14	8.77	35.99	34.18	202	44	Average	HORIZONTAL

### Vertical

	Freq	Level	Limit Line	Over Limit	Read Level	Cable Loss	Antenna Factor	Preamp Factor	A/Pos	T/Pos	Remark	Pol/Phase
	MHz	dBuV/m	dBuV/m	dB	dBuV	dB	dB/m	dB	cm	deg		
1	4873.68	48.62	54.00	-5.38	43.34	7.08	31.21	33.01	198	269	Average	VERTICAL
2	4881.37	63.42	74.00	-10.58	58.11	7.08	31.23	33.00	198	269	Peak	VERTICAL
3	7310.36	51.90	54.00	-2.10	41.32	8.77	35.99	34.18	101	194	Average	VERTICAL
4	7311.64	66.68	74.00	-7.32	56.10	8.77	35.99	34.18	101	194	Peak	VERTICAL

<b>Temperature</b>	27°C	<b>Humidity</b>	62%
<b>Test Engineer</b>	Peter Wu	<b>Configurations</b>	IEEE 802.11g CH 11 / Chain 1
<b>Test Date</b>	Apr. 19, 2016		

### Horizontal

	Freq	Level	Limit Line	Over Limit	Read Level	CableAntenna Loss	Antenna Factor	Preamp Factor	A/Pos	T/Pos	Remark	Pol/Phase
	MHz	dBuV/m	dBuV/m	dB	dBuV	dB	dB/m	dB	cm	deg		
1	4924.16	50.21	54.00	-3.79	44.84	7.07	31.29	32.99	234	21	Average	HORIZONTAL
2	4924.80	65.09	74.00	-8.91	59.72	7.07	31.29	32.99	234	21	Peak	HORIZONTAL
3	7387.12	52.85	54.00	-1.15	42.11	8.82	36.17	34.25	200	35	Average	HORIZONTAL
4	7387.92	69.32	74.00	-4.68	58.58	8.82	36.17	34.25	200	35	Peak	HORIZONTAL

### Vertical

	Freq	Level	Limit Line	Over Limit	Read Level	CableAntenna Loss	Antenna Factor	Preamp Factor	A/Pos	T/Pos	Remark	Pol/Phase
	MHz	dBuV/m	dBuV/m	dB	dBuV	dB	dB/m	dB	cm	deg		
1	4923.20	49.86	54.00	-4.14	44.51	7.07	31.27	32.99	104	88	Average	VERTICAL
2	4929.93	64.46	74.00	-9.54	59.08	7.07	31.29	32.98	104	88	Peak	VERTICAL
3	7383.28	51.72	54.00	-2.28	40.98	8.82	36.17	34.25	101	191	Average	VERTICAL
4	7385.36	67.44	74.00	-6.56	56.70	8.82	36.17	34.25	101	191	Peak	VERTICAL



<b>Temperature</b>	27°C	<b>Humidity</b>	58%
<b>Test Engineer</b>	Peter Wu	<b>Configurations</b>	IEEE 802.11n MCS0 HT20 CH 1 / Chain 1
<b>Test Date</b>	Apr. 19, 2016		

**Horizontal**

	Freq	Level	Limit Line	Over Limit	Read Level	CableAntenna Loss	Antenna Factor	Preamp Factor	A/Pos	T/Pos	Remark	Pol/Phase
	MHz	dBuV/m	dBuV/m	dB	dBuV	dB	dB/m	dB	cm	deg		
1	4822.72	51.66	54.00	-2.34	46.49	7.08	31.12	33.03	203	208	Average	HORIZONTAL
2	4824.72	67.76	74.00	-6.24	62.59	7.08	31.12	33.03	203	208	Peak	HORIZONTAL

**Vertical**

	Freq	Level	Limit Line	Over Limit	Read Level	CableAntenna Loss	Antenna Factor	Preamp Factor	A/Pos	T/Pos	Remark	Pol/Phase
	MHz	dBuV/m	dBuV/m	dB	dBuV	dB	dB/m	dB	cm	deg		
1	4821.76	65.02	74.00	-8.98	59.85	7.08	31.12	33.03	222	275	Peak	VERTICAL
2	4822.80	50.21	54.00	-3.79	45.04	7.08	31.12	33.03	222	275	Average	VERTICAL

<b>Temperature</b>	27°C	<b>Humidity</b>	58%
<b>Test Engineer</b>	Peter Wu	<b>Configurations</b>	IEEE 802.11n MCS0 HT20 CH 6 / Chain 1
<b>Test Date</b>	Apr. 19, 2016		

### Horizontal

	Freq	Level	Limit Line	Over Limit	Read Level	CableAntenna Loss	Preamp Factor	A/Pos	T/Pos	Remark	Pol/Phase	
	MHz	dBuV/m	dBuV/m	dB	dBuV	dB	dB/m	dB	cm	deg		
1	4872.00	68.21	74.00	-5.79	62.93	7.08	31.21	33.01	208	206	Peak	HORIZONTAL
2	4872.72	53.36	54.00	-0.64	48.08	7.08	31.21	33.01	208	206	Average	HORIZONTAL
3	7308.60	53.76	54.00	-0.24	43.18	8.77	35.99	34.18	223	193	Average	HORIZONTAL
4	7316.77	70.32	74.00	-3.68	59.69	8.78	36.03	34.18	223	193	Peak	HORIZONTAL

### Vertical

	Freq	Level	Limit Line	Over Limit	Read Level	CableAntenna Loss	Preamp Factor	A/Pos	T/Pos	Remark	Pol/Phase	
	MHz	dBuV/m	dBuV/m	dB	dBuV	dB	dB/m	dB	cm	deg		
1	4872.64	52.15	54.00	-1.85	46.87	7.08	31.21	33.01	300	120	Average	VERTICAL
2	4874.80	66.86	74.00	-7.14	61.58	7.08	31.21	33.01	300	120	Peak	VERTICAL
3	7308.52	53.35	54.00	-0.65	42.77	8.77	35.99	34.18	190	207	Average	VERTICAL
4	7317.01	69.37	74.00	-4.63	58.74	8.78	36.03	34.18	190	207	Peak	VERTICAL

<b>Temperature</b>	27°C	<b>Humidity</b>	58%
<b>Test Engineer</b>	Peter Wu	<b>Configurations</b>	IEEE 802.11n MCS0 HT20 CH 11 / Chain 1
<b>Test Date</b>	Apr. 19, 2016		

### Horizontal

	Freq	Level	Limit Line	Over Limit	Read Level	CableAntenna Loss	Preamp Factor	A/Pos	T/Pos	Remark	Pol/Phase	
	MHz	dBuV/m	dBuV/m	dB	dBuV	dB	dB/m	dB	cm	deg		
1	4924.96	68.06	74.00	-5.94	62.69	7.07	31.29	32.99	209	206	Peak	HORIZONTAL
2	4925.36	50.83	54.00	-3.17	45.45	7.07	31.29	32.98	209	206	Average	HORIZONTAL
3	7385.76	69.43	74.00	-4.57	58.69	8.82	36.17	34.25	214	192	Peak	HORIZONTAL
4	7388.72	52.94	54.00	-1.06	42.20	8.82	36.17	34.25	214	192	Average	HORIZONTAL

### Vertical

	Freq	Level	Limit Line	Over Limit	Read Level	CableAntenna Loss	Preamp Factor	A/Pos	T/Pos	Remark	Pol/Phase	
	MHz	dBuV/m	dBuV/m	dB	dBuV	dB	dB/m	dB	cm	deg		
1	4924.88	64.11	74.00	-9.89	58.74	7.07	31.29	32.99	226	290	Peak	VERTICAL
2	4925.28	47.57	54.00	-6.43	42.19	7.07	31.29	32.98	226	290	Average	VERTICAL
3	7383.92	53.32	54.00	-0.68	42.58	8.82	36.17	34.25	192	210	Average	VERTICAL
4	7391.93	68.38	74.00	-5.62	57.64	8.82	36.17	34.25	192	210	Peak	VERTICAL

### Note:

The amplitude of spurious emissions that are attenuated by more than 20dB below the permissible value has no need to be reported.

Emission level (dBuV/m) = 20 log Emission level (uV/m).

Corrected Reading: Antenna Factor + Cable Loss + Read Level - Preamp Factor = Level.



**<Mode 3: Ant. 3 (Wire Ant.)>**

<b>Temperature</b>	27°C	<b>Humidity</b>	58%
<b>Test Engineer</b>	Peter Wu	<b>Configurations</b>	IEEE 802.11b CH 1 / Chain 1
<b>Test Date</b>	Apr. 26, 2016		

**Horizontal**

	Freq	Level	Limit Line	Over Limit	Read Level	CableAntenna Loss	Antenna Factor	Preamp Factor	A/Pos	T/Pos	Remark	Pol/Phase
	MHz	dBuV/m	dBuV/m	dB	dBuV	dB	dB/m	dB	cm	deg		
1	4818.46	53.44	74.00	-20.56	47.11	7.48	32.58	33.73	100	61	Peak	HORIZONTAL
2	4818.87	45.81	54.00	-8.19	39.48	7.48	32.58	33.73	100	61	Average	HORIZONTAL

**Vertical**

	Freq	Level	Limit Line	Over Limit	Read Level	CableAntenna Loss	Antenna Factor	Preamp Factor	A/Pos	T/Pos	Remark	Pol/Phase
	MHz	dBuV/m	dBuV/m	dB	dBuV	dB	dB/m	dB	cm	deg		
1	4818.42	60.66	74.00	-13.34	54.33	7.48	32.58	33.73	236	332	Peak	VERTICAL
2	4818.81	53.70	54.00	-0.30	47.37	7.48	32.58	33.73	236	332	Average	VERTICAL

<b>Temperature</b>	27°C	<b>Humidity</b>	62%
<b>Test Engineer</b>	Peter Wu	<b>Configurations</b>	IEEE 802.11b CH 6 / Chain 1
<b>Test Date</b>	Apr. 26, 2016		

### Horizontal

	Freq	Level	Limit Line	Over Limit	Read Level	CableAntenna Loss	Antenna Factor	Preamp Factor	A/Pos	T/Pos	Remark	Pol/Phase
	MHz	dBuV/m	dBuV/m	dB	dBuV	dB	dB/m	dB	cm	deg		
1	4868.42	55.22	74.00	-18.78	48.69	7.56	32.68	33.71	104	60	Peak	HORIZONTAL
2	4868.78	47.22	54.00	-6.78	40.69	7.56	32.68	33.71	104	60	Average	HORIZONTAL

### Vertical

	Freq	Level	Limit Line	Over Limit	Read Level	CableAntenna Loss	Antenna Factor	Preamp Factor	A/Pos	T/Pos	Remark	Pol/Phase
	MHz	dBuV/m	dBuV/m	dB	dBuV	dB	dB/m	dB	cm	deg		
1	4868.55	60.58	74.00	-13.42	20.34	7.56	32.68	0.00	240	327	Peak	VERTICAL
2	4868.81	53.82	54.00	-0.18	47.29	7.56	32.68	33.71	240	327	Average	VERTICAL



<b>Temperature</b>	27°C	<b>Humidity</b>	58%
<b>Test Engineer</b>	Peter Wu	<b>Configurations</b>	IEEE 802.11b CH 11 / Chain 1
<b>Test Date</b>	Apr. 26, 2016		

**Horizontal**

	Freq	Level	Limit Line	Over Limit	Read Level	CableAntenna Loss	Antenna Factor	Preamp Factor	A/Pos	T/Pos	Remark	Pol/Phase
	MHz	dBuV/m	dBuV/m	dB	dBuV	dB	dB/m	dB	cm	deg		
1	4929.19	46.26	54.00	-7.74	39.51	7.65	32.78	33.68	107	74	Average	HORIZONTAL
2	4929.51	54.11	74.00	-19.89	47.36	7.65	32.78	33.68	107	74	Peak	HORIZONTAL

**Vertical**

	Freq	Level	Limit Line	Over Limit	Read Level	CableAntenna Loss	Antenna Factor	Preamp Factor	A/Pos	T/Pos	Remark	Pol/Phase
	MHz	dBuV/m	dBuV/m	dB	dBuV	dB	dB/m	dB	cm	deg		
1	4929.16	53.84	54.00	-0.16	47.09	7.65	32.78	33.68	223	332	Average	VERTICAL
2	4929.45	60.59	74.00	-13.41	53.84	7.65	32.78	33.68	223	332	Peak	VERTICAL

<b>Temperature</b>	27°C	<b>Humidity</b>	58%
<b>Test Engineer</b>	Peter Wu	<b>Configurations</b>	IEEE 802.11g CH 1 / Chain 1
<b>Test Date</b>	Apr. 26, 2016		

### Horizontal

	Freq	Level	Limit Line	Over Limit	Read Level	CableAntenna Loss	Preamp Factor	A/Pos	T/Pos	Remark	Pol/Phase
	MHz	dBuV/m	dBuV/m	dB	dBuV	dB	dB/m	dB	cm	deg	
1	4823.76	43.61	54.00	-10.39	37.28	7.48	32.58	33.73	102	60 Average	HORIZONTAL
2	4824.32	58.53	74.00	-15.47	52.20	7.48	32.58	33.73	102	60 Peak	HORIZONTAL

### Vertical

	Freq	Level	Limit Line	Over Limit	Read Level	CableAntenna Loss	Preamp Factor	A/Pos	T/Pos	Remark	Pol/Phase
	MHz	dBuV/m	dBuV/m	dB	dBuV	dB	dB/m	dB	cm	deg	
1	4822.16	64.34	74.00	-9.66	58.01	7.48	32.58	33.73	233	335 Peak	VERTICAL
2	4823.92	48.91	54.00	-5.09	42.58	7.48	32.58	33.73	233	335 Average	VERTICAL

<b>Temperature</b>	27°C	<b>Humidity</b>	58%
<b>Test Engineer</b>	Peter Wu	<b>Configurations</b>	IEEE 802.11g CH 6 / Chain 1
<b>Test Date</b>	Apr. 26, 2016		

### Horizontal

	Freq	Level	Limit Line	Over Limit	Read Level	CableAntenna Loss	Antenna Factor	Preamp Factor	A/Pos	T/Pos	Remark	Pol/Phase
	MHz	dBuV/m	dBuV/m	dB	dBuV	dB	dB/m	dB	cm	deg		
1	4872.40	53.27	74.00	-20.73	46.74	7.56	32.68	33.71	102	61	Peak	HORIZONTAL
2	4874.48	39.90	54.00	-14.10	33.37	7.56	32.68	33.71	102	61	Average	HORIZONTAL
3	7313.64	47.01	54.00	-6.99	34.81	9.18	37.24	34.22	231	310	Average	HORIZONTAL
4	7322.22	64.54	74.00	-9.46	52.34	9.16	37.27	34.23	231	310	Peak	HORIZONTAL

### Vertical

	Freq	Level	Limit Line	Over Limit	Read Level	CableAntenna Loss	Antenna Factor	Preamp Factor	A/Pos	T/Pos	Remark	Pol/Phase
	MHz	dBuV/m	dBuV/m	dB	dBuV	dB	dB/m	dB	cm	deg		
1	4873.12	44.86	54.00	-9.14	38.33	7.56	32.68	33.71	239	316	Average	VERTICAL
2	4873.60	59.54	74.00	-14.46	53.01	7.56	32.68	33.71	239	316	Peak	VERTICAL
3	7311.72	53.68	54.00	-0.32	41.48	9.18	37.24	34.22	221	21	Average	VERTICAL
4	7312.28	73.30	74.00	-0.70	61.10	9.18	37.24	34.22	221	21	Peak	VERTICAL

Temperature	27°C	Humidity	62%
Test Engineer	Peter Wu	Configurations	IEEE 802.11g CH 11 / Chain 1
Test Date	Apr. 26, 2016		

### Horizontal

	Freq	Level	Limit	Over	Read	CableAntenna	Preamp	A/Pos	T/Pos	Remark	Pol/Phase
	MHz	dBuV/m	dBuV/m	dB	dBuV	dB	dB/m	dB	cm	deg	
1	4926.32	40.68	54.00	-13.32	33.93	7.65	32.78	33.68	103	77 Average	HORIZONTAL
2	4928.73	54.38	74.00	-19.62	47.63	7.65	32.78	33.68	103	77 Peak	HORIZONTAL
3	7384.80	64.18	74.00	-9.82	52.00	9.10	37.35	34.27	100	314 Peak	HORIZONTAL
4	7389.13	48.28	54.00	-5.72	36.10	9.10	37.35	34.27	100	314 Average	HORIZONTAL

### Vertical

	Freq	Level	Limit	Over	Read	CableAntenna	Preamp	A/Pos	T/Pos	Remark	Pol/Phase
	MHz	dBuV/m	dBuV/m	dB	dBuV	dB	dB/m	dB	cm	deg	
1	4923.12	60.64	74.00	-13.36	53.94	7.63	32.75	33.68	220	323 Peak	VERTICAL
2	4924.40	47.23	54.00	-6.77	40.48	7.65	32.78	33.68	220	323 Average	VERTICAL
3	7386.48	53.92	54.00	-0.08	41.74	9.10	37.35	34.27	233	27 Average	VERTICAL
4	7387.68	73.16	74.00	-0.84	60.98	9.10	37.35	34.27	233	27 Peak	VERTICAL

<b>Temperature</b>	27°C	<b>Humidity</b>	58%
<b>Test Engineer</b>	Peter Wu	<b>Configurations</b>	IEEE 802.11n MCS0 HT20 CH 1 / Chain 1
<b>Test Date</b>	Apr. 26, 2016		

### Horizontal

	Freq	Level	Limit Line	Over Limit	Read Level	CableAntenna Loss	Antenna Factor	Preamp Factor	A/Pos	T/Pos	Remark	Pol/Phase
	MHz	dBuV/m	dBuV/m	dB	dBuV	dB	dB/m	dB	cm	deg		
1	4823.60	41.13	54.00	-12.87	34.80	7.48	32.58	33.73	115	75	Average	HORIZONTAL
2	4825.84	56.06	74.00	-17.94	49.68	7.50	32.61	33.73	115	75	Peak	HORIZONTAL

### Vertical

	Freq	Level	Limit Line	Over Limit	Read Level	CableAntenna Loss	Antenna Factor	Preamp Factor	A/Pos	T/Pos	Remark	Pol/Phase
	MHz	dBuV/m	dBuV/m	dB	dBuV	dB	dB/m	dB	cm	deg		
1	4823.36	46.67	54.00	-7.33	40.34	7.48	32.58	33.73	244	338	Average	VERTICAL
2	4826.72	61.29	74.00	-12.71	54.91	7.50	32.61	33.73	244	338	Peak	VERTICAL

<b>Temperature</b>	27°C	<b>Humidity</b>	58%
<b>Test Engineer</b>	Peter Wu	<b>Configurations</b>	IEEE 802.11n MCS0 HT20 CH 6 / Chain 1
<b>Test Date</b>	Apr. 26, 2016		

### Horizontal

	Freq	Level	Limit Line	Over Limit	Read Level	CableAntenna Loss	Preamp Factor	A/Pos	T/Pos	Remark	Pol/Phase
	MHz	dBuV/m	dBuV/m	dB	dBuV	dB	dB/m	dB	cm	deg	
1	4873.46	54.27	74.00	-19.73	47.74	7.56	32.68	33.71	100	59 Peak	HORIZONTAL
2	4874.67	40.00	54.00	-14.00	33.47	7.56	32.68	33.71	100	59 Average	HORIZONTAL
3	7312.70	47.57	54.00	-6.43	35.37	9.18	37.24	34.22	295	313 Average	HORIZONTAL
4	7315.87	65.92	74.00	-8.08	53.71	9.16	37.27	34.22	295	313 Peak	HORIZONTAL

### Vertical

	Freq	Level	Limit Line	Over Limit	Read Level	CableAntenna Loss	Preamp Factor	A/Pos	T/Pos	Remark	Pol/Phase
	MHz	dBuV/m	dBuV/m	dB	dBuV	dB	dB/m	dB	cm	deg	
1	4873.92	59.77	74.00	-14.23	53.24	7.56	32.68	33.71	229	330 Peak	VERTICAL
2	4875.36	45.76	54.00	-8.24	39.23	7.56	32.68	33.71	229	330 Average	VERTICAL
3	7311.13	71.12	74.00	-2.88	58.92	9.18	37.24	34.22	100	49 Peak	VERTICAL
4	7311.27	53.61	54.00	-0.39	41.41	9.18	37.24	34.22	100	49 Average	VERTICAL



<b>Temperature</b>	27°C	<b>Humidity</b>	58%
<b>Test Engineer</b>	Peter Wu	<b>Configurations</b>	IEEE 802.11n MCS0 HT20 CH 11 / Chain 1
<b>Test Date</b>	Apr. 26, 2016		

### Horizontal

	Freq	Level	Limit Line	Over Limit	Read Level	CableAntenna Loss	Preamp Factor	A/Pos	T/Pos	Remark	Pol/Phase	
	MHz	dBuV/m	dBuV/m	dB	dBuV	dB	dB/m	dB	cm	deg		
1	4923.28	41.42	54.00	-12.58	34.72	7.63	32.75	33.68	102	62	Average	HORIZONTAL
2	4924.37	54.96	74.00	-19.04	48.21	7.65	32.78	33.68	102	62	Peak	HORIZONTAL
3	7388.48	68.94	74.00	-5.06	56.76	9.10	37.35	34.27	293	309	Peak	HORIZONTAL
4	7388.81	48.64	54.00	-5.36	36.46	9.10	37.35	34.27	293	309	Average	HORIZONTAL

### Vertical

	Freq	Level	Limit Line	Over Limit	Read Level	CableAntenna Loss	Preamp Factor	A/Pos	T/Pos	Remark	Pol/Phase	
	MHz	dBuV/m	dBuV/m	dB	dBuV	dB	dB/m	dB	cm	deg		
1	4923.44	46.18	54.00	-7.82	39.48	7.63	32.75	33.68	223	327	Average	VERTICAL
2	4923.44	59.22	74.00	-14.78	52.52	7.63	32.75	33.68	223	327	Peak	VERTICAL
3	7383.60	53.60	54.00	-0.40	41.42	9.10	37.35	34.27	218	22	Average	VERTICAL
4	7384.40	73.22	74.00	-0.78	61.04	9.10	37.35	34.27	218	22	Peak	VERTICAL

### Note:

The amplitude of spurious emissions that are attenuated by more than 20dB below the permissible value has no need to be reported.

Emission level (dBuV/m) = 20 log Emission level (uV/m).

Corrected Reading: Antenna Factor + Cable Loss + Read Level - Preamp Factor = Level.

**<Mode 4: Ant. 4 (Dipole Ant.)>**

<b>Temperature</b>	27°C	<b>Humidity</b>	58%
<b>Test Engineer</b>	Peter Wu	<b>Configurations</b>	IEEE 802.11b CH 1 / Chain 1
<b>Test Date</b>	Apr. 20, 2016		

**Horizontal**

	Freq	Level	Limit Line	Over Limit	Read Level	CableAntenna Loss	Antenna Factor	Preamp Factor	A/Pos	T/Pos	Remark	Pol/Phase
	MHz	dBuV/m	dBuV/m	dB	dBuV	dB	dB/m	dB	cm	deg		
1	4818.84	46.63	54.00	-7.37	40.96	7.08	31.12	32.53	114	337	Average	HORIZONTAL
2	4829.39	54.46	74.00	-19.54	48.76	7.08	31.14	32.52	114	337	Peak	HORIZONTAL

**Vertical**

	Freq	Level	Limit Line	Over Limit	Read Level	CableAntenna Loss	Antenna Factor	Preamp Factor	A/Pos	T/Pos	Remark	Pol/Phase
	MHz	dBuV/m	dBuV/m	dB	dBuV	dB	dB/m	dB	cm	deg		
1	4829.19	53.67	54.00	-0.33	47.97	7.08	31.14	32.52	100	272	Average	VERTICAL
2	4829.55	60.54	74.00	-13.46	54.84	7.08	31.14	32.52	100	272	Peak	VERTICAL

<b>Temperature</b>	27°C	<b>Humidity</b>	62%
<b>Test Engineer</b>	Peter Wu	<b>Configurations</b>	IEEE 802.11b CH 6 / Chain 1
<b>Test Date</b>	Apr. 20, 2016		

### Horizontal

	Freq	Level	Limit	Over	Read	CableAntenna	Preamp	A/Pos	T/Pos	Remark	Pol/Phase	
	MHz	dBuV/m	dBuV/m	dB	dBuV	dB	dB/m	dB	cm	deg		
1	4879.19	49.26	54.00	-4.74	43.44	7.08	31.21	32.47	270	354	Average	HORIZONTAL
2	4879.45	55.80	74.00	-18.20	49.98	7.08	31.21	32.47	270	354	Peak	HORIZONTAL
3	7303.23	54.05	74.00	-19.95	40.93	8.77	35.99	31.64	103	76	Peak	HORIZONTAL
4	7303.55	44.06	54.00	-9.94	30.94	8.77	35.99	31.64	103	76	Average	HORIZONTAL

### Vertical

	Freq	Level	Limit	Over	Read	CableAntenna	Preamp	A/Pos	T/Pos	Remark	Pol/Phase	
	MHz	dBuV/m	dBuV/m	dB	dBuV	dB	dB/m	dB	cm	deg		
1	4879.19	53.89	54.00	-0.11	48.07	7.08	31.21	32.47	239	339	Average	VERTICAL
2	4879.51	60.49	74.00	-13.51	54.67	7.08	31.21	32.47	239	339	Peak	VERTICAL
3	7318.61	48.12	54.00	-5.88	34.93	8.78	36.03	31.62	147	109	Average	VERTICAL
4	7318.85	58.28	74.00	-15.72	45.09	8.78	36.03	31.62	147	109	Peak	VERTICAL

<b>Temperature</b>	27°C	<b>Humidity</b>	58%
<b>Test Engineer</b>	Peter Wu	<b>Configurations</b>	IEEE 802.11b CH 11 / Chain 1
<b>Test Date</b>	Apr. 20, 2016		

### Horizontal

	Freq	Level	Limit	Over	Read	CableAntenna	Preamp	A/Pos	T/Pos	Remark	Pol/Phase	
	MHz	dBuV/m	dBuV/m	dB	dBuV	dB	dB/m	dB	cm	deg		
1	4929.19	49.48	54.00	-4.52	43.54	7.07	31.29	32.42	260	354	Average	HORIZONTAL
2	4929.55	56.33	74.00	-17.67	50.39	7.07	31.29	32.42	260	354	Peak	HORIZONTAL
3	7377.91	55.06	74.00	-18.94	41.70	8.81	36.12	31.57	100	71	Peak	HORIZONTAL
4	7378.47	44.06	54.00	-9.94	30.70	8.81	36.12	31.57	100	71	Average	HORIZONTAL

### Vertical

	Freq	Level	Limit	Over	Read	CableAntenna	Preamp	A/Pos	T/Pos	Remark	Pol/Phase	
	MHz	dBuV/m	dBuV/m	dB	dBuV	dB	dB/m	dB	cm	deg		
1	4929.16	53.61	54.00	-0.39	47.67	7.07	31.29	32.42	222	334	Average	VERTICAL
2	4929.51	60.14	74.00	-13.86	54.20	7.07	31.29	32.42	222	334	Peak	VERTICAL
3	7378.31	55.60	74.00	-18.40	42.24	8.81	36.12	31.57	151	271	Peak	VERTICAL
4	7378.47	46.08	54.00	-7.92	32.72	8.81	36.12	31.57	151	271	Average	VERTICAL

<b>Temperature</b>	27°C	<b>Humidity</b>	58%
<b>Test Engineer</b>	Peter Wu	<b>Configurations</b>	IEEE 802.11g CH 1 / Chain 1
<b>Test Date</b>	Apr. 20, 2016		

### Horizontal

	Freq	Level	Limit Line	Over Limit	Read Level	CableAntenna Loss	Antenna Factor	Preamp Factor	A/Pos	T/Pos	Remark	Pol/Phase
	MHz	dBuV/m	dBuV/m	dB	dBuV	dB	dB/m	dB	cm	deg		
1	4824.51	47.55	54.00	-6.45	41.87	7.08	31.12	32.52	100	334	Average	HORIZONTAL
2	4828.52	62.07	74.00	-11.93	56.37	7.08	31.14	32.52	100	334	Peak	HORIZONTAL

### Vertical

	Freq	Level	Limit Line	Over Limit	Read Level	CableAntenna Loss	Antenna Factor	Preamp Factor	A/Pos	T/Pos	Remark	Pol/Phase
	MHz	dBuV/m	dBuV/m	dB	dBuV	dB	dB/m	dB	cm	deg		
1	4824.16	67.97	74.00	-6.03	62.29	7.08	31.12	32.52	100	278	Peak	VERTICAL
2	4824.58	53.67	54.00	-0.33	47.99	7.08	31.12	32.52	100	278	Average	VERTICAL

<b>Temperature</b>	27°C	<b>Humidity</b>	58%
<b>Test Engineer</b>	Peter Wu	<b>Configurations</b>	IEEE 802.11g CH 6 / Chain 1
<b>Test Date</b>	Apr. 20, 2016		

### Horizontal

	Freq	Level	Limit	Over	Read	CableAntenna	Preamp	A/Pos	T/Pos	Remark	Pol/Phase	
	MHz	dBuV/m	dBuV/m	dB	dBuV	dB	dB/m	dB	cm	deg		
1	4872.96	62.84	74.00	-11.16	57.02	7.08	31.21	32.47	100	336	Peak	HORIZONTAL
2	4873.76	48.63	54.00	-5.37	42.81	7.08	31.21	32.47	100	336	Average	HORIZONTAL
3	7310.76	59.23	74.00	-14.77	46.09	8.77	35.99	31.62	118	340	Peak	HORIZONTAL
4	7311.24	44.47	54.00	-9.53	31.33	8.77	35.99	31.62	118	340	Average	HORIZONTAL

### Vertical

	Freq	Level	Limit	Over	Read	CableAntenna	Preamp	A/Pos	T/Pos	Remark	Pol/Phase	
	MHz	dBuV/m	dBuV/m	dB	dBuV	dB	dB/m	dB	cm	deg		
1	4873.68	53.81	54.00	-0.19	47.99	7.08	31.21	32.47	100	268	Average	VERTICAL
2	4874.08	67.95	74.00	-6.05	62.13	7.08	31.21	32.47	100	268	Peak	VERTICAL
3	7308.12	63.18	74.00	-10.82	50.06	8.77	35.99	31.64	116	121	Peak	VERTICAL
4	7310.92	47.65	54.00	-6.35	34.51	8.77	35.99	31.62	116	121	Average	VERTICAL

<b>Temperature</b>	27°C	<b>Humidity</b>	62%
<b>Test Engineer</b>	Peter Wu	<b>Configurations</b>	IEEE 802.11g CH 11 / Chain 1
<b>Test Date</b>	Apr. 20, 2016		

### Horizontal

	Freq	Level	Limit Line	Over Limit	Read Level	CableAntenna Loss	Antenna Factor	Preamp Factor	A/Pos	T/Pos	Remark	Pol/Phase
	MHz	dBuV/m	dBuV/m	dB	dBuV	dB	dB/m	dB	cm	deg		
1	4923.20	62.59	74.00	-11.41	56.67	7.07	31.27	32.42	104	336	Peak	HORIZONTAL
2	4924.90	48.36	54.00	-5.64	42.42	7.07	31.29	32.42	104	336	Average	HORIZONTAL
3	7378.71	58.99	74.00	-15.01	45.63	8.81	36.12	31.57	103	67	Peak	HORIZONTAL
4	7386.16	44.40	54.00	-9.60	30.97	8.82	36.17	31.56	103	67	Average	HORIZONTAL

### Vertical

	Freq	Level	Limit Line	Over Limit	Read Level	CableAntenna Loss	Antenna Factor	Preamp Factor	A/Pos	T/Pos	Remark	Pol/Phase
	MHz	dBuV/m	dBuV/m	dB	dBuV	dB	dB/m	dB	cm	deg		
1	4923.49	68.45	74.00	-5.55	62.53	7.07	31.27	32.42	100	271	Peak	VERTICAL
2	4924.74	53.72	54.00	-0.28	47.78	7.07	31.29	32.42	100	271	Average	VERTICAL
3	7379.83	61.38	74.00	-12.62	47.96	8.82	36.17	31.57	293	119	Peak	VERTICAL
4	7386.08	46.08	54.00	-7.92	32.65	8.82	36.17	31.56	293	119	Average	VERTICAL

<b>Temperature</b>	27°C	<b>Humidity</b>	58%
<b>Test Engineer</b>	Peter Wu	<b>Configurations</b>	IEEE 802.11n MCS0 HT20 CH 1 / Chain 1
<b>Test Date</b>	Apr. 20, 2016		

### Horizontal

	Freq	Level	Limit Line	Over Limit	Read Level	CableAntenna Loss	Antenna Factor	Preamp Factor	A/Pos	T/Pos	Remark	Pol/Phase
	MHz	dBuV/m	dBuV/m	dB	dBuV	dB	dB/m	dB	cm	deg		
1	4824.80	47.91	54.00	-6.09	42.23	7.08	31.12	32.52	106	335	Average	HORIZONTAL
2	4826.81	61.74	74.00	-12.26	56.04	7.08	31.14	32.52	106	335	Peak	HORIZONTAL

### Vertical

	Freq	Level	Limit Line	Over Limit	Read Level	CableAntenna Loss	Antenna Factor	Preamp Factor	A/Pos	T/Pos	Remark	Pol/Phase
	MHz	dBuV/m	dBuV/m	dB	dBuV	dB	dB/m	dB	cm	deg		
1	4819.99	67.35	74.00	-6.65	61.68	7.08	31.12	32.53	100	277	Peak	VERTICAL
2	4824.80	53.84	54.00	-0.16	48.16	7.08	31.12	32.52	100	277	Average	VERTICAL



<b>Temperature</b>	27°C	<b>Humidity</b>	58%
<b>Test Engineer</b>	Peter Wu	<b>Configurations</b>	IEEE 802.11n MCS0 HT20 CH 6 / Chain 1
<b>Test Date</b>	Apr. 20, 2016		

### Horizontal

	Freq	Level	Limit Line	Over Limit	Read Level	CableAntenna Loss	Antenna Factor	Preamp Factor	A/Pos	T/Pos	Remark	Pol/Phase
	MHz	dBuV/m	dBuV/m	dB	dBuV	dB	dB/m	dB	cm	deg		
1	4873.20	63.99	74.00	-10.01	58.17	7.08	31.21	32.47	100	335	Peak	HORIZONTAL
2	4873.28	48.23	54.00	-5.77	42.41	7.08	31.21	32.47	100	335	Average	HORIZONTAL
3	7312.28	45.21	54.00	-8.79	32.07	8.77	35.99	31.62	100	344	Average	HORIZONTAL
4	7319.49	60.21	74.00	-13.79	47.02	8.78	36.03	31.62	100	344	Peak	HORIZONTAL

### Vertical

	Freq	Level	Limit Line	Over Limit	Read Level	CableAntenna Loss	Antenna Factor	Preamp Factor	A/Pos	T/Pos	Remark	Pol/Phase
	MHz	dBuV/m	dBuV/m	dB	dBuV	dB	dB/m	dB	cm	deg		
1	4874.32	67.96	74.00	-6.04	62.14	7.08	31.21	32.47	100	270	Peak	VERTICAL
2	4874.56	53.85	54.00	-0.15	48.03	7.08	31.21	32.47	100	270	Average	VERTICAL
3	7310.68	48.04	54.00	-5.96	34.90	8.77	35.99	31.62	207	105	Average	VERTICAL
4	7317.57	64.08	74.00	-9.92	50.89	8.78	36.03	31.62	207	105	Peak	VERTICAL

<b>Temperature</b>	27°C	<b>Humidity</b>	58%
<b>Test Engineer</b>	Peter Wu	<b>Configurations</b>	IEEE 802.11n MCS0 HT20 CH 11 / Chain 1
<b>Test Date</b>	Apr. 20, 2016		

### Horizontal

	Freq	Level	Limit Line	Over Limit	Read Level	CableAntenna Loss	Preamp Factor	A/Pos	T/Pos	Remark	Pol/Phase	
	MHz	dBuV/m	dBuV/m	dB	dBuV	dB	dB/m	dB	cm	deg		
1	4922.97	63.35	74.00	-10.65	57.43	7.07	31.27	32.42	258	353	Peak	HORIZONTAL
2	4923.74	50.12	54.00	-3.88	44.18	7.07	31.29	32.42	258	353	Average	HORIZONTAL
3	7385.68	45.27	54.00	-8.73	31.84	8.82	36.17	31.56	100	70	Average	HORIZONTAL
4	7389.85	58.67	74.00	-15.33	45.24	8.82	36.17	31.56	100	70	Peak	HORIZONTAL

### Vertical

	Freq	Level	Limit Line	Over Limit	Read Level	CableAntenna Loss	Preamp Factor	A/Pos	T/Pos	Remark	Pol/Phase	
	MHz	dBuV/m	dBuV/m	dB	dBuV	dB	dB/m	dB	cm	deg		
1	4925.44	53.78	54.00	-0.22	47.84	7.07	31.29	32.42	101	270	Average	VERTICAL
2	4926.16	68.20	74.00	-5.80	62.26	7.07	31.29	32.42	101	270	Peak	VERTICAL
3	7382.15	62.00	74.00	-12.00	48.58	8.82	36.17	31.57	293	122	Peak	VERTICAL
4	7387.12	47.45	54.00	-6.55	34.02	8.82	36.17	31.56	293	122	Average	VERTICAL

### Note:

The amplitude of spurious emissions that are attenuated by more than 20dB below the permissible value has no need to be reported.

Emission level (dBuV/m) = 20 log Emission level (uV/m).

Corrected Reading: Antenna Factor + Cable Loss + Read Level - Preamp Factor = Level.

**<Mode 5: Ant. 6 (Chip Ant.)>**

<b>Temperature</b>	27°C	<b>Humidity</b>	58%
<b>Test Engineer</b>	Peter Wu	<b>Configurations</b>	IEEE 802.11b CH 1 / Chain 1
<b>Test Date</b>	Apr. 27, 2016		

**Horizontal**

	Freq	Level	Limit Line	Over Limit	Read Level	CableAntenna Loss	Antenna Factor	Preamp Factor	A/Pos	T/Pos	Remark	Pol/Phase
	MHz	dBuV/m	dBuV/m	dB	dBuV	dB	dB/m	dB	cm	deg		
1	4818.49	60.64	74.00	-13.36	54.31	7.48	32.58	33.73	100	47	Peak	HORIZONTAL
2	4818.87	53.37	54.00	-0.63	47.04	7.48	32.58	33.73	100	47	Average	HORIZONTAL

**Vertical**

	Freq	Level	Limit Line	Over Limit	Read Level	CableAntenna Loss	Antenna Factor	Preamp Factor	A/Pos	T/Pos	Remark	Pol/Phase
	MHz	dBuV/m	dBuV/m	dB	dBuV	dB	dB/m	dB	cm	deg		
1	4818.55	60.71	74.00	-13.29	54.38	7.48	32.58	33.73	100	249	Peak	VERTICAL
2	4818.84	53.78	54.00	-0.22	47.45	7.48	32.58	33.73	100	249	Average	VERTICAL

<b>Temperature</b>	27°C	<b>Humidity</b>	62%
<b>Test Engineer</b>	Peter Wu	<b>Configurations</b>	IEEE 802.11b CH 6 / Chain 1
<b>Test Date</b>	Apr. 27, 2016		

### Horizontal

	Freq	Level	Limit Line	Over Limit	Read Level	CableAntenna Loss	Antenna Factor	Preamp Factor	A/Pos	T/Pos	Remark	Pol/Phase
	MHz	dBuV/m	dBuV/m	dB	dBuV	dB	dB/m	dB	cm	deg		
1	4868.49	59.18	74.00	-14.82	52.65	7.56	32.68	33.71	239	346	Peak	HORIZONTAL
2	4868.87	51.49	54.00	-2.51	44.96	7.56	32.68	33.71	239	346	Average	HORIZONTAL
3	7318.76	51.68	54.00	-2.32	39.47	9.16	37.27	34.22	224	312	Average	HORIZONTAL
4	7319.27	61.38	74.00	-12.62	49.17	9.16	37.27	34.22	224	312	Peak	HORIZONTAL

### Vertical

	Freq	Level	Limit Line	Over Limit	Read Level	CableAntenna Loss	Antenna Factor	Preamp Factor	A/Pos	T/Pos	Remark	Pol/Phase
	MHz	dBuV/m	dBuV/m	dB	dBuV	dB	dB/m	dB	cm	deg		
1	4868.46	57.70	74.00	-16.30	51.17	7.56	32.68	33.71	102	245	Peak	VERTICAL
2	4868.81	49.77	54.00	-4.23	43.24	7.56	32.68	33.71	102	245	Average	VERTICAL
3	7318.66	53.70	54.00	-0.30	41.49	9.16	37.27	34.22	101	310	Average	VERTICAL
4	7319.37	62.90	74.00	-11.10	50.69	9.16	37.27	34.22	101	310	Peak	VERTICAL

<b>Temperature</b>	27°C	<b>Humidity</b>	58%
<b>Test Engineer</b>	Peter Wu	<b>Configurations</b>	IEEE 802.11b CH 11 / Chain 1
<b>Test Date</b>	Apr. 27, 2016		

### Horizontal

	Freq	Level	Limit Line	Over Limit	Read Level	CableAntenna Loss	Antenna Factor	Preamp Factor	A/Pos	T/Pos	Remark	Pol/Phase
	MHz	dBuV/m	dBuV/m	dB	dBuV	dB	dB/m	dB	cm	deg		
1	4929.19	49.31	54.00	-4.69	42.56	7.65	32.78	33.68	280	343	Average	HORIZONTAL
2	4929.48	56.74	74.00	-17.26	49.99	7.65	32.78	33.68	280	343	Peak	HORIZONTAL
3	7378.31	51.62	54.00	-2.38	39.44	9.12	37.33	34.27	222	320	Average	HORIZONTAL
4	7379.85	60.75	74.00	-13.25	48.57	9.10	37.35	34.27	222	320	Peak	HORIZONTAL

### Vertical

	Freq	Level	Limit Line	Over Limit	Read Level	CableAntenna Loss	Antenna Factor	Preamp Factor	A/Pos	T/Pos	Remark	Pol/Phase
	MHz	dBuV/m	dBuV/m	dB	dBuV	dB	dB/m	dB	cm	deg		
1	4929.19	50.67	54.00	-3.33	43.92	7.65	32.78	33.68	259	129	Average	VERTICAL
2	4929.51	57.80	74.00	-16.20	51.05	7.65	32.78	33.68	259	129	Peak	VERTICAL
3	7377.80	63.34	74.00	-10.66	51.16	9.12	37.33	34.27	119	281	Peak	VERTICAL
4	7378.44	53.95	54.00	-0.05	41.77	9.12	37.33	34.27	119	281	Average	VERTICAL



<b>Temperature</b>	27°C	<b>Humidity</b>	58%
<b>Test Engineer</b>	Peter Wu	<b>Configurations</b>	IEEE 802.11g CH 1 / Chain 1
<b>Test Date</b>	Apr. 27, 2016		

**Horizontal**

	Freq	Level	Limit Line	Over Limit	Read Level	CableAntenna Loss	Antenna Factor	Preamp Factor	A/Pos	T/Pos	Remark	Pol/Phase
	MHz	dBuV/m	dBuV/m	dB	dBuV	dB	dB/m	dB	cm	deg		
1	4823.49	51.67	54.00	-2.33	45.34	7.48	32.58	33.73	291	222	Average	HORIZONTAL
2	4823.49	65.66	74.00	-8.34	59.33	7.48	32.58	33.73	291	222	Peak	HORIZONTAL

**Vertical**

	Freq	Level	Limit Line	Over Limit	Read Level	CableAntenna Loss	Antenna Factor	Preamp Factor	A/Pos	T/Pos	Remark	Pol/Phase
	MHz	dBuV/m	dBuV/m	dB	dBuV	dB	dB/m	dB	cm	deg		
1	4819.29	62.35	74.00	-11.65	56.02	7.48	32.58	33.73	100	225	Peak	VERTICAL
2	4820.19	48.98	54.00	-5.02	42.65	7.48	32.58	33.73	100	225	Average	VERTICAL

<b>Temperature</b>	27°C	<b>Humidity</b>	58%
<b>Test Engineer</b>	Peter Wu	<b>Configurations</b>	IEEE 802.11g CH 6 / Chain 1
<b>Test Date</b>	Apr. 27, 2016		

### Horizontal

	Freq	Level	Limit Line	Over Limit	Read Level	CableAntenna Loss	Antenna Factor	Preamp Factor	A/Pos	T/Pos	Remark	Pol/Phase
	MHz	dBuV/m	dBuV/m	dB	dBuV	dB	dB/m	dB	cm	deg		
1	4873.07	46.45	54.00	-7.55	39.92	7.56	32.68	33.71	254	319	Average	HORIZONTAL
2	4876.15	63.31	74.00	-10.69	56.78	7.56	32.68	33.71	254	319	Peak	HORIZONTAL
3	7307.44	70.53	74.00	-3.47	58.33	9.18	37.24	34.22	270	194	Peak	HORIZONTAL
4	7309.88	53.60	54.00	-0.40	41.40	9.18	37.24	34.22	270	194	Average	HORIZONTAL

### Vertical

	Freq	Level	Limit Line	Over Limit	Read Level	CableAntenna Loss	Antenna Factor	Preamp Factor	A/Pos	T/Pos	Remark	Pol/Phase
	MHz	dBuV/m	dBuV/m	dB	dBuV	dB	dB/m	dB	cm	deg		
1	4876.12	60.19	74.00	-13.81	53.66	7.56	32.68	33.71	100	230	Peak	VERTICAL
2	4876.47	42.84	54.00	-11.16	36.31	7.56	32.68	33.71	100	230	Average	VERTICAL
3	7311.90	53.74	54.00	-0.26	41.54	9.18	37.24	34.22	100	36	Average	VERTICAL
4	7313.24	71.03	74.00	-2.97	58.83	9.18	37.24	34.22	100	36	Peak	VERTICAL

<b>Temperature</b>	27°C	<b>Humidity</b>	62%
<b>Test Engineer</b>	Peter Wu	<b>Configurations</b>	IEEE 802.11g CH 11 / Chain 1
<b>Test Date</b>	Apr. 27, 2016		

### Horizontal

	Freq	Level	Limit Line	Over Limit	Read Level	CableAntenna Loss	Antenna Factor	Preamp Factor	A/Pos	T/Pos	Remark	Pol/Phase
	MHz	dBuV/m	dBuV/m	dB	dBuV	dB	dB/m	dB	cm	deg		
1	4921.40	67.99	74.00	-6.01	61.29	7.63	32.75	33.68	101	318	Peak	HORIZONTAL
2	4925.67	51.48	54.00	-2.52	44.73	7.65	32.78	33.68	101	318	Average	HORIZONTAL
3	7384.08	53.51	54.00	-0.49	41.33	9.10	37.35	34.27	257	33	Average	HORIZONTAL
4	7388.28	72.29	74.00	-1.71	60.11	9.10	37.35	34.27	257	33	Peak	HORIZONTAL

### Vertical

	Freq	Level	Limit Line	Over Limit	Read Level	CableAntenna Loss	Antenna Factor	Preamp Factor	A/Pos	T/Pos	Remark	Pol/Phase
	MHz	dBuV/m	dBuV/m	dB	dBuV	dB	dB/m	dB	cm	deg		
1	4925.03	67.91	74.00	-6.09	61.16	7.65	32.78	33.68	101	316	Peak	VERTICAL
2	4925.99	51.14	54.00	-2.86	44.39	7.65	32.78	33.68	101	316	Average	VERTICAL
3	7386.16	52.47	54.00	-1.53	40.29	9.10	37.35	34.27	107	42	Average	VERTICAL
4	7386.69	71.72	74.00	-2.28	59.54	9.10	37.35	34.27	107	42	Peak	VERTICAL



<b>Temperature</b>	27°C	<b>Humidity</b>	58%
<b>Test Engineer</b>	Peter Wu	<b>Configurations</b>	IEEE 802.11n MCS0 HT20 CH 1 / Chain 1
<b>Test Date</b>	Apr. 27, 2016		

### Horizontal

	Freq	Level	Limit Line	Over Limit	Read Level	CableAntenna Loss	Preamp Factor	A/Pos	T/Pos	Remark	Pol/Phase	
	MHz	dBuV/m	dBuV/m	dB	dBuV	dB	dB/m	dB	cm	deg		
1	4817.49	64.80	74.00	-9.20	58.47	7.48	32.58	33.73	288	222	Peak	HORIZONTAL
2	4822.72	52.01	54.00	-1.99	45.68	7.48	32.58	33.73	288	222	Average	HORIZONTAL

### Vertical

	Freq	Level	Limit Line	Over Limit	Read Level	CableAntenna Loss	Preamp Factor	A/Pos	T/Pos	Remark	Pol/Phase	
	MHz	dBuV/m	dBuV/m	dB	dBuV	dB	dB/m	dB	cm	deg		
1	4821.47	49.42	54.00	-4.58	43.09	7.48	32.58	33.73	100	23	Average	VERTICAL
2	4821.60	62.05	74.00	-11.95	55.72	7.48	32.58	33.73	100	23	Peak	VERTICAL

<b>Temperature</b>	27°C	<b>Humidity</b>	58%
<b>Test Engineer</b>	Peter Wu	<b>Configurations</b>	IEEE 802.11n MCS0 HT20 CH 6 / Chain 1
<b>Test Date</b>	Apr. 27, 2016		

### Horizontal

	Freq	Level	Limit Line	Over Limit	Read Level	CableAntenna Loss	Antenna Factor	Preamp Factor	A/Pos	T/Pos	Remark	Pol/Phase
	MHz	dBuV/m	dBuV/m	dB	dBuV	dB	dB/m	dB	cm	deg		
1	4871.63	63.37	74.00	-10.63	56.84	7.56	32.68	33.71	100	315	Peak	HORIZONTAL
2	4876.92	45.78	54.00	-8.22	39.24	7.56	32.68	33.70	100	315	Average	HORIZONTAL
3	7310.17	71.26	74.00	-2.74	59.06	9.18	37.24	34.22	102	23	Peak	HORIZONTAL
4	7311.58	53.30	54.00	-0.70	41.10	9.18	37.24	34.22	102	23	Average	HORIZONTAL

### Vertical

	Freq	Level	Limit Line	Over Limit	Read Level	CableAntenna Loss	Antenna Factor	Preamp Factor	A/Pos	T/Pos	Remark	Pol/Phase
	MHz	dBuV/m	dBuV/m	dB	dBuV	dB	dB/m	dB	cm	deg		
1	4870.54	43.01	54.00	-10.99	36.48	7.56	32.68	33.71	100	223	Average	VERTICAL
2	4876.85	59.22	74.00	-14.78	52.68	7.56	32.68	33.70	100	223	Peak	VERTICAL
3	7314.13	53.82	54.00	-0.18	41.62	9.18	37.24	34.22	103	42	Average	VERTICAL
4	7319.17	70.94	74.00	-3.06	58.73	9.16	37.27	34.22	103	42	Peak	VERTICAL

<b>Temperature</b>	27°C	<b>Humidity</b>	58%
<b>Test Engineer</b>	Peter Wu	<b>Configurations</b>	IEEE 802.11n MCS0 HT20 CH 11 / Chain 1
<b>Test Date</b>	Apr. 27, 2016		

### Horizontal

	Freq	Level	Limit Line	Over Limit	Read Level	CableAntenna Loss	Antenna Factor	Preamp Factor	A/Pos	T/Pos	Remark	Pol/Phase
	MHz	dBuV/m	dBuV/m	dB	dBuV	dB	dB/m	dB	cm	deg		
1	4920.99	69.36	74.00	-4.64	62.66	7.63	32.75	33.68	102	317	Peak	HORIZONTAL
2	4925.31	52.87	54.00	-1.13	46.12	7.65	32.78	33.68	102	317	Average	HORIZONTAL
3	7384.94	53.59	54.00	-0.41	41.41	9.10	37.35	34.27	102	22	Average	HORIZONTAL
4	7391.22	72.34	74.00	-1.66	60.16	9.10	37.35	34.27	102	22	Peak	HORIZONTAL

### Vertical

	Freq	Level	Limit Line	Over Limit	Read Level	CableAntenna Loss	Antenna Factor	Preamp Factor	A/Pos	T/Pos	Remark	Pol/Phase
	MHz	dBuV/m	dBuV/m	dB	dBuV	dB	dB/m	dB	cm	deg		
1	4924.99	50.89	54.00	-3.11	44.14	7.65	32.78	33.68	103	316	Average	VERTICAL
2	4926.18	67.59	74.00	-6.41	60.84	7.65	32.78	33.68	103	316	Peak	VERTICAL
3	7382.51	52.76	54.00	-1.24	40.58	9.10	37.35	34.27	100	28	Average	VERTICAL
4	7383.34	70.97	74.00	-3.03	58.79	9.10	37.35	34.27	100	28	Peak	VERTICAL

### Note:

The amplitude of spurious emissions that are attenuated by more than 20dB below the permissible value has no need to be reported.

Emission level (dBuV/m) = 20 log Emission level (uV/m).

Corrected Reading: Antenna Factor + Cable Loss + Read Level - Preamp Factor = Level.

## 4.6. Emissions Measurement

### 4.6.1. Limit

30dBc in any 100 kHz bandwidth outside the operating frequency band. In case the emission fall within the restricted band specified on 15.205(a), then the 15.209(a) limit in the table below has to be followed.

Frequencies (MHz)	Field Strength (micovolts/meter)	Measurement Distance (meters)
0.009~0.490	2400/F(kHz)	300
0.490~1.705	24000/F(kHz)	30
1.705~30.0	30	30
30~88	100	3
88~216	150	3
216~960	200	3
Above 960	500	3

### 4.6.2. Measuring Instruments and Setting

Please refer to section 5 of equipments list in this report. The following table is the setting of the spectrum analyzer.

Spectrum Parameter	Setting
Attenuation	Auto
Span Frequency	100 MHz
RBW / VBW (Emission in restricted band)	1MHz / 3MHz for Peak, 1MHz / 1/T for Average
RBW / VBW (30dBc in any 100 kHz bandwidth emission)	100 kHz / 300 kHz for Peak

### 4.6.3. Test Procedures

For Radiated band edges Measurement:

1. The test procedure is the same as section 4.5.3.

For Radiated Out of Band Emission Measurement:

1. Test was performed in accordance with KDB558074 D01 v03r05 for Performing Compliance Measurements on Digital Transmission Systems (DTS) Operating Under §15.247 section 11.0 Unwanted Emissions into Non-Restricted Frequency Bands Measurement Procedure.

#### 4.6.4. Test Setup Layout

For Radiated band edges Measurement:

This test setup layout is the same as that shown in section 4.5.4.

For Radiated Out of Band Emission Measurement:

This test setup layout is the same as that shown in section 4.5.4.

#### 4.6.5. Test Deviation

There is no deviation with the original standard.

#### 4.6.6. EUT Operation during Test

The EUT was programmed to be in continuously transmitting mode.

#### 4.6.7. Test Result of Band Edge and Fundamental Emissions

<Mode 1: Ant. 1 (PCB Ant.)>

Temperature	27°C	Humidity	58%
Test Engineer	Peter Wu	Configurations	IEEE 802.11b CH 1, 6, 11 / Chain 1
Test Date	Apr. 21, 2016		

##### Channel 1

	Freq	Level	Limit Line	Over Limit	Read Level	Cable Loss	Antenna Factor	Preamp Factor	A/Pos	T/Pos	Remark	Pol/Phase
	MHz	dBuV/m	dBuV/m	dB	dBuV	dB	dB/m	dB	cm	deg		
1	2383.80	58.21	74.00	-15.79	26.83	4.33	27.05	0.00	163	300	Peak	VERTICAL
2	2387.96	47.08	54.00	-6.92	15.70	4.33	27.05	0.00	163	300	Average	VERTICAL
3	2412.00	100.75			69.29	4.35	27.11	0.00	163	300	Average	VERTICAL
4	2412.64	107.81			76.35	4.35	27.11	0.00	163	300	Peak	VERTICAL

Item 3, 4 are the fundamental frequency at 2412 MHz.

##### Channel 6

	Freq	Level	Limit Line	Over Limit	Read Level	Cable Loss	Antenna Factor	Preamp Factor	A/Pos	T/Pos	Remark	Pol/Phase
	MHz	dBuV/m	dBuV/m	dB	dBuV	dB	dB/m	dB	cm	deg		
1	2373.86	58.34	74.00	-15.66	27.01	4.31	27.02	0.00	209	175	Peak	VERTICAL
2	2385.40	46.73	54.00	-7.27	15.35	4.33	27.05	0.00	209	175	Average	VERTICAL
3	2437.00	101.90			70.37	4.37	27.16	0.00	209	175	Average	VERTICAL
4	2437.64	109.01			77.48	4.37	27.16	0.00	209	175	Peak	VERTICAL
5	2483.80	59.60	74.00	-14.40	27.91	4.42	27.27	0.00	209	175	Peak	VERTICAL
6	2485.10	47.43	54.00	-6.57	15.74	4.42	27.27	0.00	209	175	Average	VERTICAL

Item 3, 4 are the fundamental frequency at 2437 MHz.

##### Channel 11

	Freq	Level	Limit Line	Over Limit	Read Level	Cable Loss	Antenna Factor	Preamp Factor	A/Pos	T/Pos	Remark	Pol/Phase
	MHz	dBuV/m	dBuV/m	dB	dBuV	dB	dB/m	dB	cm	deg		
1	2462.00	103.57			71.95	4.40	27.22	0.00	119	314	Average	VERTICAL
2	2462.64	110.75			79.13	4.40	27.22	0.00	119	314	Peak	VERTICAL
3	2484.78	47.15	54.00	-6.85	15.46	4.42	27.27	0.00	119	314	Average	VERTICAL
4	2497.10	60.37	74.00	-13.63	28.63	4.44	27.30	0.00	119	314	Peak	VERTICAL

Item 1, 2 are the fundamental frequency at 2462 MHz.

<b>Temperature</b>	27°C	<b>Humidity</b>	58%
<b>Test Engineer</b>	Peter Wu	<b>Configurations</b>	IEEE 802.11g CH 1, 6, 11 / Chain 1
<b>Test Date</b>	Apr. 21, 2016		

**Channel 1**

	Freq	Level	Limit Line	Over Limit	Read Level	CableAntenna Loss	Preamp Factor	A/Pos	T/Pos	Remark	Pol/Phase
	MHz	dBuV/m	dBuV/m	dB	dBuV	dB	dB/m	dB	cm	deg	
1	2390.00	53.57	54.00	-0.43	22.19	4.33	27.05	0.00	126	314 Average	VERTICAL
2	2390.00	68.67	74.00	-5.33	37.29	4.33	27.05	0.00	126	314 Peak	VERTICAL
3	2413.60	95.60			64.14	4.35	27.11	0.00	126	314 Average	VERTICAL
4	2418.41	106.12			74.63	4.36	27.13	0.00	126	314 Peak	VERTICAL

Item 3, 4 are the fundamental frequency at 2412 MHz.

**Channel 6**

	Freq	Level	Limit Line	Over Limit	Read Level	CableAntenna Loss	Preamp Factor	A/Pos	T/Pos	Remark	Pol/Phase
	MHz	dBuV/m	dBuV/m	dB	dBuV	dB	dB/m	dB	cm	deg	
1	2355.27	59.08	74.00	-14.92	27.81	4.30	26.97	0.00	121	316 Peak	VERTICAL
2	2386.68	46.78	54.00	-7.22	15.40	4.33	27.05	0.00	121	316 Average	VERTICAL
3	2435.72	107.04			75.51	4.37	27.16	0.00	121	316 Peak	VERTICAL
4	2439.56	97.26			65.70	4.38	27.18	0.00	121	316 Average	VERTICAL
5	2489.27	47.39	54.00	-6.61	15.68	4.43	27.28	0.00	121	316 Average	VERTICAL
6	2494.08	57.99	74.00	-16.01	26.28	4.43	27.28	0.00	121	316 Peak	VERTICAL

Item 3, 4 are the fundamental frequency at 2437 MHz.

**Channel 11**

	Freq	Level	Limit Line	Over Limit	Read Level	CableAntenna Loss	Preamp Factor	A/Pos	T/Pos	Remark	Pol/Phase
	MHz	dBuV/m	dBuV/m	dB	dBuV	dB	dB/m	dB	cm	deg	
1	2464.08	107.14			75.52	4.40	27.22	0.00	140	306 Peak	VERTICAL
2	2465.53	96.53			64.91	4.40	27.22	0.00	140	306 Average	VERTICAL
3	2483.80	53.59	54.00	-0.41	21.90	4.42	27.27	0.00	140	306 Average	VERTICAL
4	2483.96	73.67	74.00	-0.33	41.98	4.42	27.27	0.00	140	306 Peak	VERTICAL

Item 1, 2 are the fundamental frequency at 2462 MHz.



<b>Temperature</b>	27°C	<b>Humidity</b>	58%
<b>Test Engineer</b>	Peter Wu	<b>Configurations</b>	IEEE 802.11n MCS0 HT20 CH 1, 6, 11 / Chain 1
<b>Test Date</b>	Apr. 21, 2016		

**Channel 1**

	Freq	Level	Limit Line	Over Limit	Read Level	CableAntenna Loss	Preamp Factor	A/Pos	T/Pos	Remark	Pol/Phase	
	MHz	dBuV/m	dBuV/m	dB	dBuV	dB	dB/m	dB	cm	deg		
1	2389.56	68.02	74.00	-5.98	36.64	4.33	27.05	0.00	144	178	Peak	VERTICAL
2	2390.00	53.60	54.00	-0.40	22.22	4.33	27.05	0.00	144	178	Average	VERTICAL
3	2418.41	95.28			63.79	4.36	27.13	0.00	144	178	Average	VERTICAL
4	2418.73	105.32			73.83	4.36	27.13	0.00	144	178	Peak	VERTICAL

Item 3, 4 are the fundamental frequency at 2412 MHz.

**Channel 6**

	Freq	Level	Limit Line	Over Limit	Read Level	CableAntenna Loss	Preamp Factor	A/Pos	T/Pos	Remark	Pol/Phase	
	MHz	dBuV/m	dBuV/m	dB	dBuV	dB	dB/m	dB	cm	deg		
1	2353.35	58.69	74.00	-15.31	27.42	4.30	26.97	0.00	123	309	Peak	VERTICAL
2	2387.32	46.84	54.00	-7.16	15.46	4.33	27.05	0.00	123	309	Average	VERTICAL
3	2437.96	107.51			75.98	4.37	27.16	0.00	123	309	Peak	VERTICAL
4	2439.56	97.18			65.62	4.38	27.18	0.00	123	309	Average	VERTICAL
5	2491.51	47.52	54.00	-6.48	15.81	4.43	27.28	0.00	123	309	Average	VERTICAL
6	2492.15	59.56	74.00	-14.44	27.85	4.43	27.28	0.00	123	309	Peak	VERTICAL

Item 3, 4 are the fundamental frequency at 2437 MHz.

**Channel 11**

	Freq	Level	Limit Line	Over Limit	Read Level	CableAntenna Loss	Preamp Factor	A/Pos	T/Pos	Remark	Pol/Phase	
	MHz	dBuV/m	dBuV/m	dB	dBuV	dB	dB/m	dB	cm	deg		
1	2464.89	96.14			64.52	4.40	27.22	0.00	122	308	Average	VERTICAL
2	2465.85	106.52			74.90	4.40	27.22	0.00	122	308	Peak	VERTICAL
3	2483.50	53.43	54.00	-0.57	21.74	4.42	27.27	0.00	122	308	Average	VERTICAL
4	2483.50	71.77	74.00	-2.23	40.08	4.42	27.27	0.00	122	308	Peak	VERTICAL

Item 1, 2 are the fundamental frequency at 2462 MHz.

Note:

Emission level (dBuV/m) = 20 log Emission level (uV/m).

Corrected Reading: Antenna Factor + Cable Loss + Read Level - Preamp Factor = Level.



**For Emission not in Restricted Band**

**Plot on Configuration IEEE 802.11b / Reference Level**

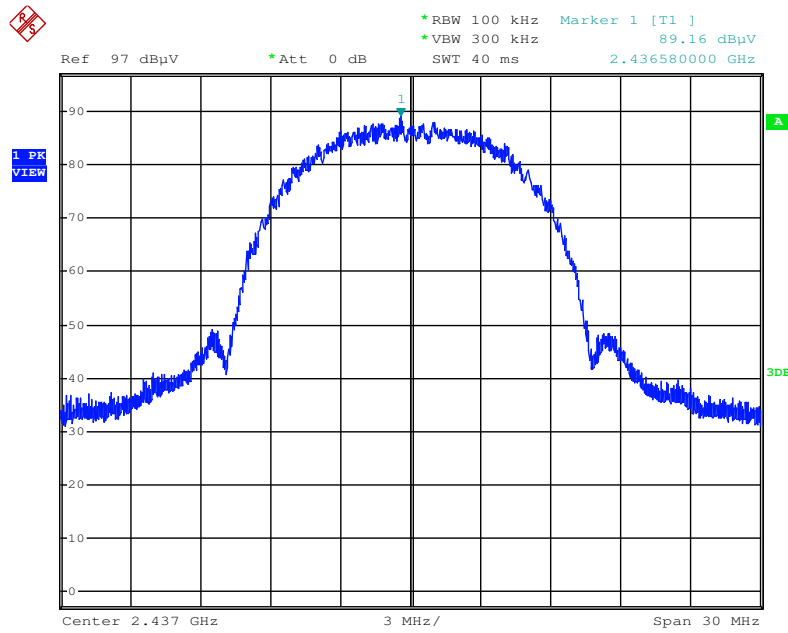

Date: 22.APR.2016 12:34:05

**Plot on Configuration IEEE 802.11b / CH 1 / 30MHz~2400MHz (down 30dBc)**

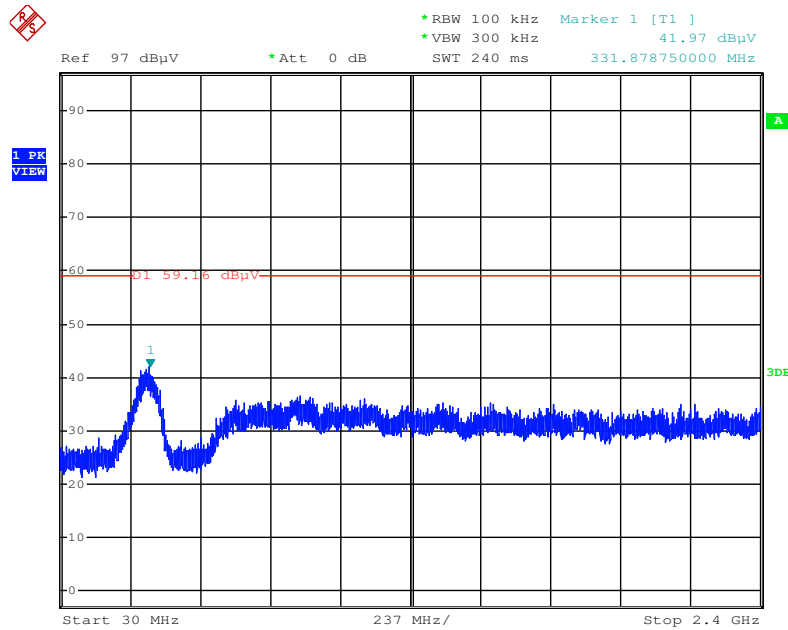

Date: 22.APR.2016 12:37:59

Plot on Configuration IEEE 802.11b / CH 1 / 2483.5MHz~26500MHz (down 30dBc)

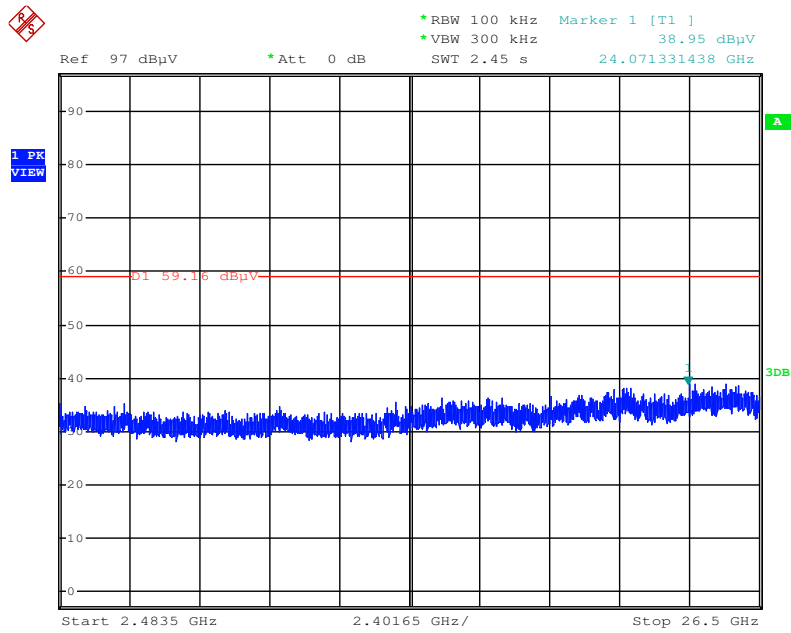

Date: 22.APR.2016 12:38:51

Plot on Configuration IEEE 802.11b / CH 11 / 30MHz~2400MHz (down 30dBc)

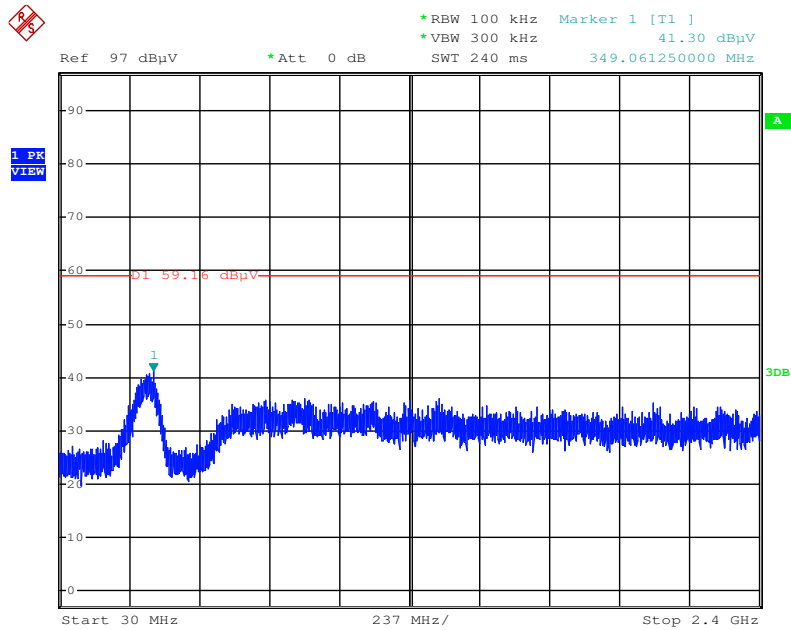

Date: 22.APR.2016 12:40:22

Plot on Configuration IEEE 802.11b / CH 11 / 2483.5MHz~26500MHz (down 30dBc)

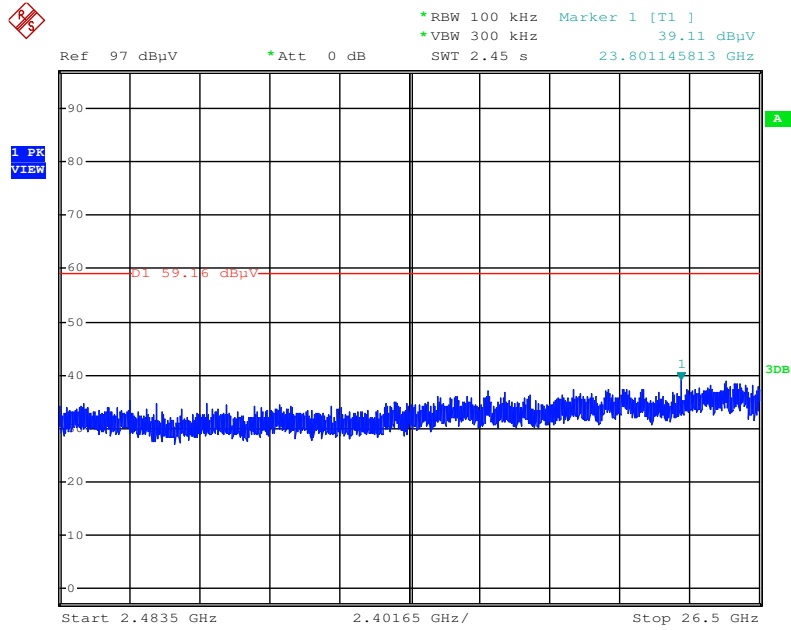

Date: 22.APR.2016 12:39:34

Plot on Configuration IEEE 802.11g / Reference Level

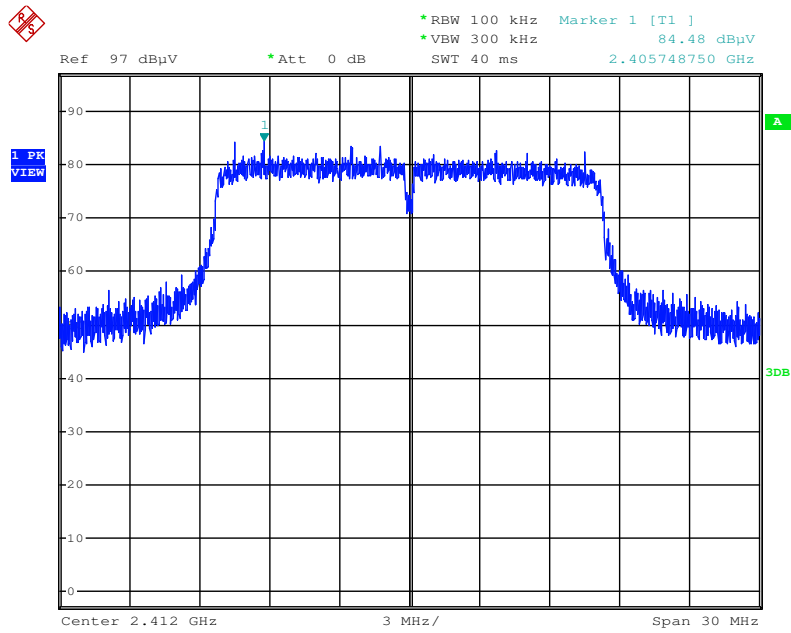

Date: 22.APR.2016 12:48:17

Plot on Configuration IEEE 802.11g / CH 1 / 30MHz~2400MHz (down 30dBc)

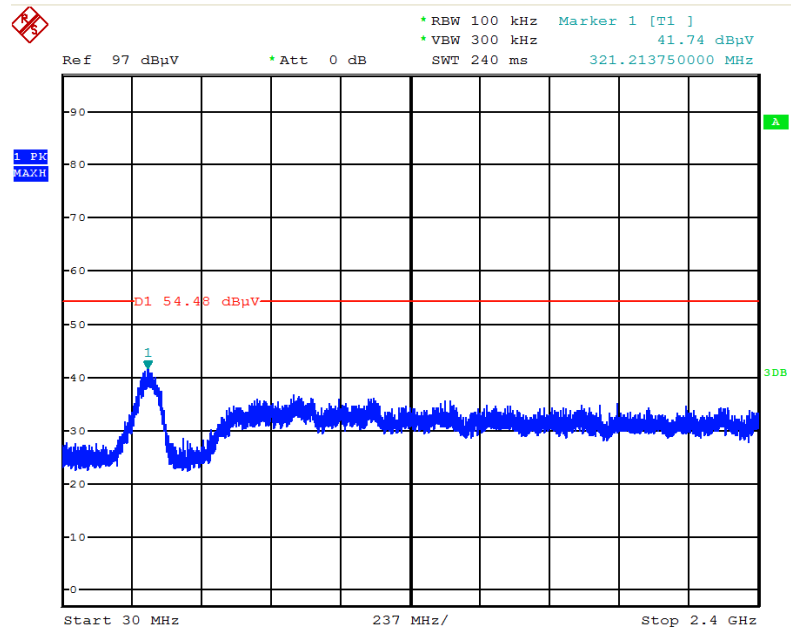

Date: 22.APR.2016 12:50:45

Plot on Configuration IEEE 802.11g / CH 1 / 2483.5MHz~26500MHz (down 30dBc)

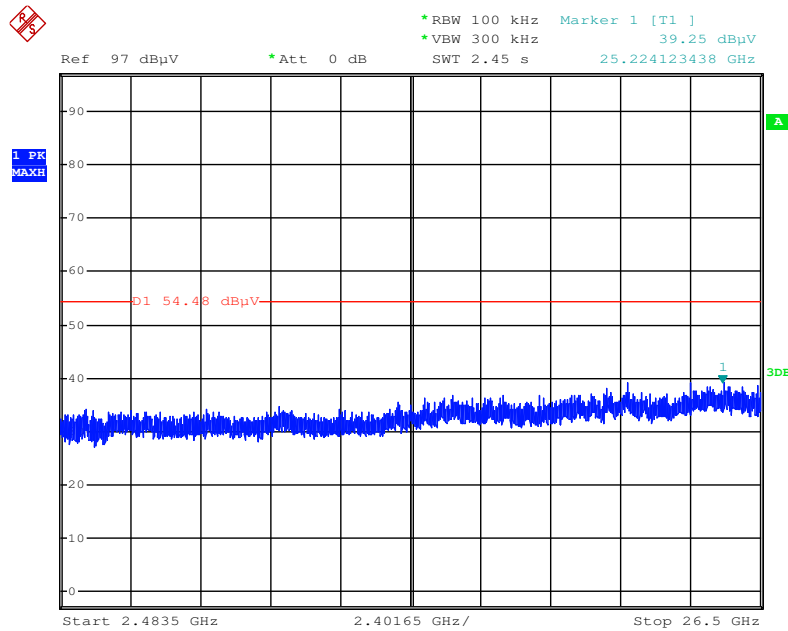

Date: 22.APR.2016 12:51:32

Plot on Configuration IEEE 802.11g / CH 11 / 30MHz~2400MHz (down 30dBc)

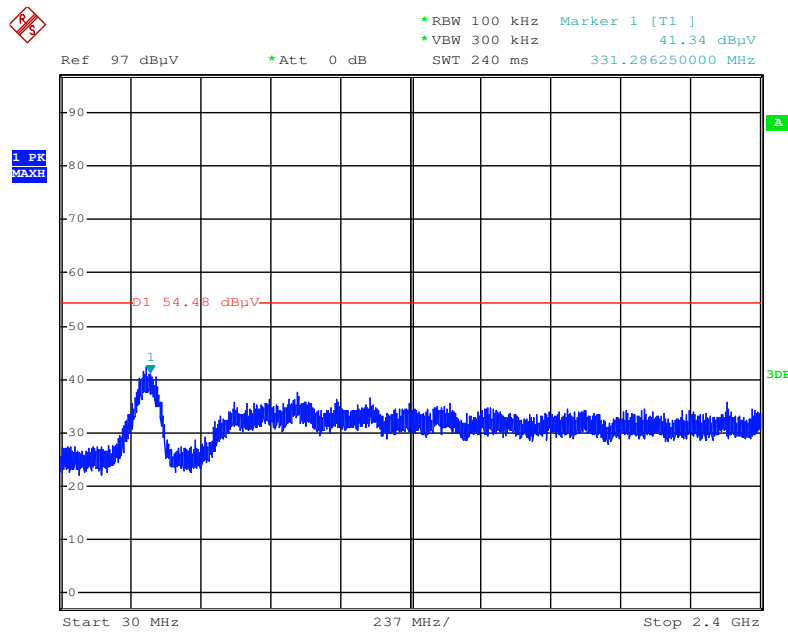

Date: 22.APR.2016 12:53:17

Plot on Configuration IEEE 802.11g / CH 11 / 2483.5MHz~26500MHz (down 30dBc)

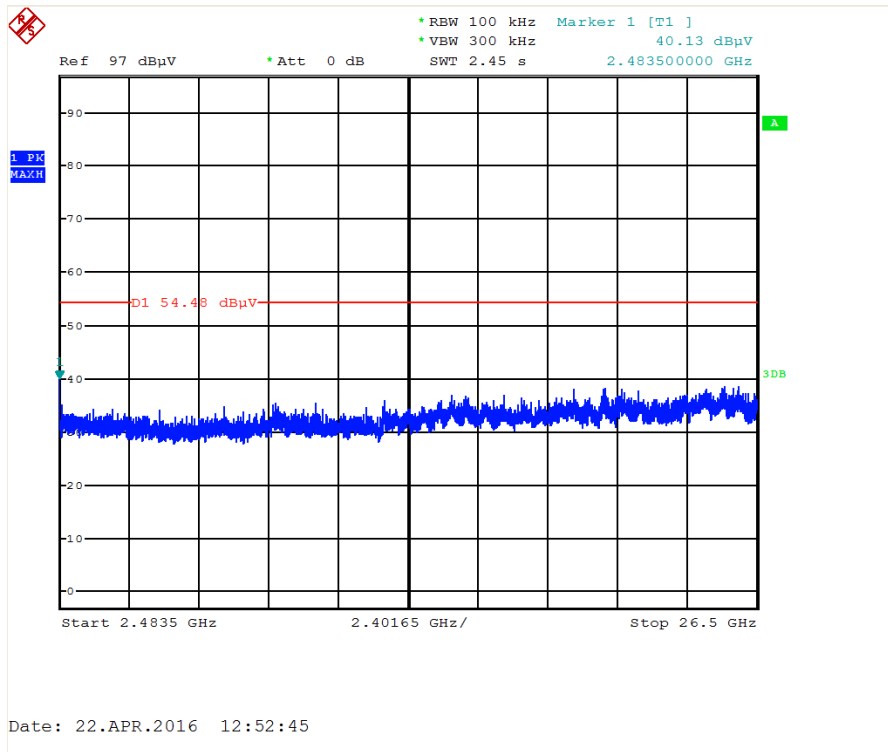

Plot on Configuration IEEE 802.11n MCS0 HT20 / Reference Level

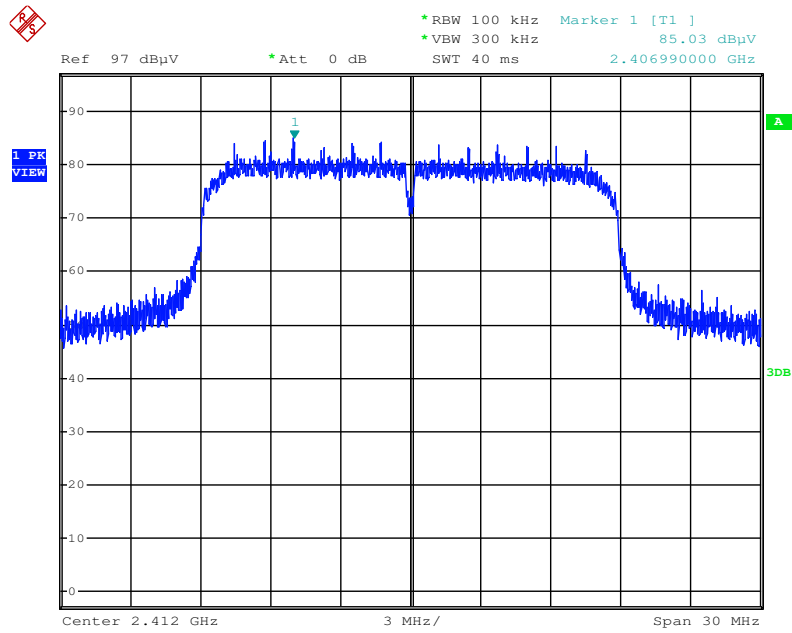

Date: 22.APR.2016 12:58:23

Plot on Configuration IEEE 802.11n MCS0 HT20 / CH 1 / 30MHz~2400MHz (down 30dBc)

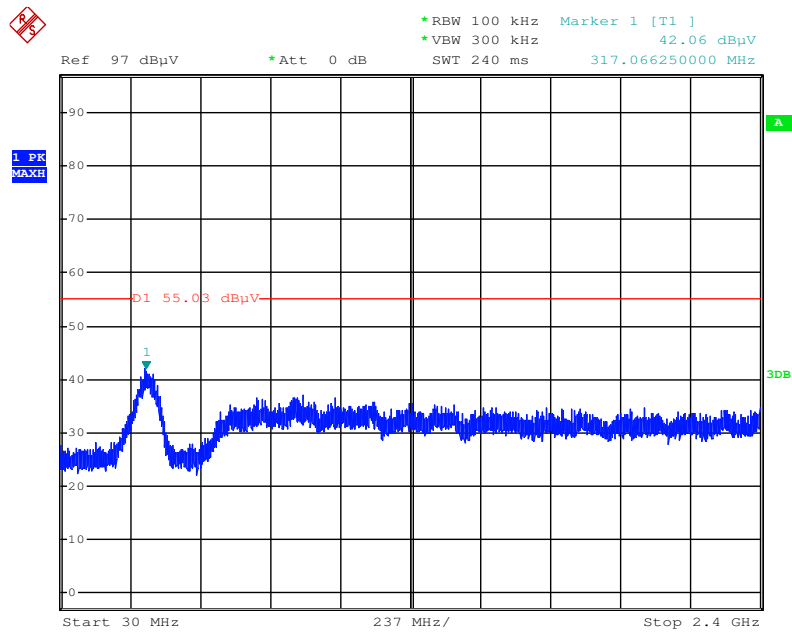

Date: 22.APR.2016 13:05:21

Plot on Configuration IEEE 802.11n MCS0 HT20 / CH 1 / 2483.5MHz~26500MHz (down 30dBc)

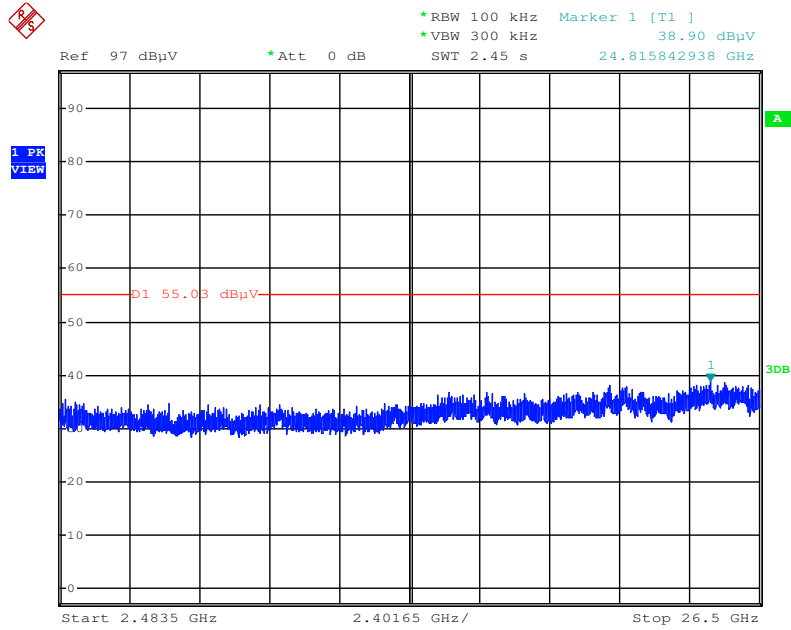

Date: 22.APR.2016 13:06:26

Plot on Configuration IEEE 802.11n MCS0 HT20 / CH 11 / 30MHz~2400MHz (down 30dBc)

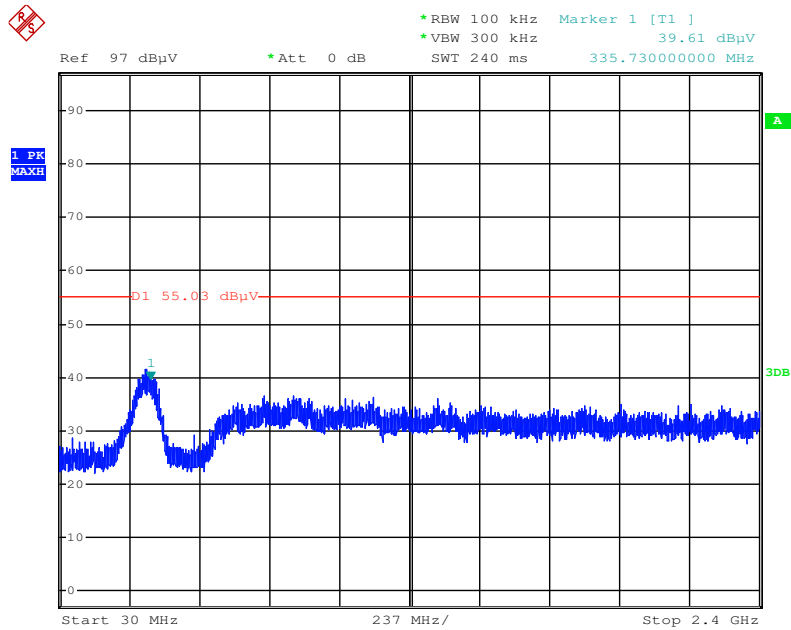

Date: 22.APR.2016 13:09:32



Plot on Configuration IEEE 802.11n MCS0 HT20 / CH 11 / 2483.5MHz~26500MHz (down 30dBc)

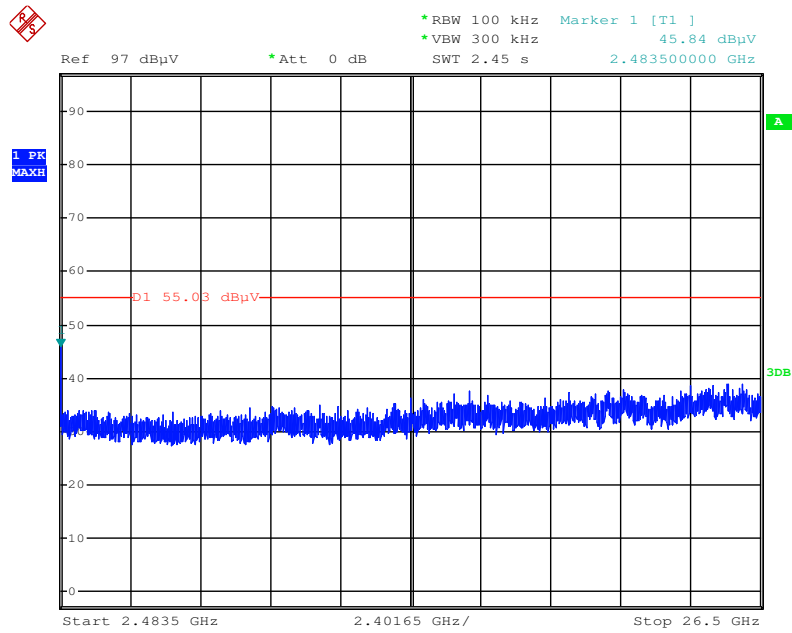

Date: 22.APR.2016 13:08:52

## &lt;Mode 2: Ant. 2 (PCB Ant.)&gt;

Temperature	27°C	Humidity	58%
Test Engineer	Peter Wu	Configurations	IEEE 802.11b CH 1, 6, 11 / Chain 1
Test Date	Apr. 19, 2016		

## Channel 1

	Freq	Level	Limit Line	Over Limit	Read Level	CableAntenna Loss	Antenna Factor	Preamp Factor	A/Pos	T/Pos	Remark	Pol/Phase
	MHz	dBuV/m	dBuV/m	dB	dBuV	dB	dB/m	dB	cm	deg		
1	2374.98	59.58	74.00	-14.42	27.75	4.81	27.02	0.00	153	278	Peak	VERTICAL
2	2389.72	46.91	54.00	-7.09	15.03	4.83	27.05	0.00	153	278	Average	VERTICAL
3	2410.88	97.07			65.12	4.85	27.10	0.00	153	278	Average	VERTICAL
4	2412.32	104.85			72.89	4.85	27.11	0.00	153	278	Peak	VERTICAL

Item 3, 4 are the fundamental frequency at 2412 MHz.

## Channel 6

	Freq	Level	Limit Line	Over Limit	Read Level	CableAntenna Loss	Antenna Factor	Preamp Factor	A/Pos	T/Pos	Remark	Pol/Phase
	MHz	dBuV/m	dBuV/m	dB	dBuV	dB	dB/m	dB	cm	deg		
1	2387.64	47.54	54.00	-6.46	15.66	4.83	27.05	0.00	109	229	Average	VERTICAL
2	2390.00	59.59	74.00	-14.41	27.71	4.83	27.05	0.00	109	229	Peak	VERTICAL
3	2436.36	110.87			78.84	4.87	27.16	0.00	109	229	Peak	VERTICAL
4	2437.00	103.64			71.61	4.87	27.16	0.00	109	229	Average	VERTICAL
5	2483.82	48.10	54.00	-5.90	15.91	4.92	27.27	0.00	109	229	Average	VERTICAL
6	2494.08	59.45	74.00	-14.55	27.24	4.93	27.28	0.00	109	229	Peak	VERTICAL

Item 3, 4 are the fundamental frequency at 2437 MHz.

## Channel 11

	Freq	Level	Limit Line	Over Limit	Read Level	CableAntenna Loss	Antenna Factor	Preamp Factor	A/Pos	T/Pos	Remark	Pol/Phase
	MHz	dBuV/m	dBuV/m	dB	dBuV	dB	dB/m	dB	cm	deg		
1	2461.36	111.43			79.31	4.90	27.22	0.00	101	218	Peak	VERTICAL
2	2462.00	103.95			71.83	4.90	27.22	0.00	101	218	Average	VERTICAL
3	2484.44	48.11	54.00	-5.89	15.92	4.92	27.27	0.00	101	218	Average	VERTICAL
4	2489.27	59.42	74.00	-14.58	27.21	4.93	27.28	0.00	101	218	Peak	VERTICAL

Item 1, 2 are the fundamental frequency at 2462 MHz.

<b>Temperature</b>	27°C	<b>Humidity</b>	58%
<b>Test Engineer</b>	Peter Wu	<b>Configurations</b>	IEEE 802.11g CH 1, 6, 11 / Chain 1
<b>Test Date</b>	Apr. 19, 2016		

**Channel 1**

	Freq	Level	Limit Line	Over Limit	Read Level	CableAntenna Loss	Preamp Factor	A/Pos	T/Pos	Remark	Pol/Phase	
	MHz	dBuV/m	dBuV/m	dB	dBuV	dB	dB/m	dB	cm	deg		
1	2390.00	53.14	54.00	-0.86	21.76	4.33	27.05	0.00	101	217	Average	VERTICAL
2	2390.00	72.20	74.00	-1.80	40.82	4.33	27.05	0.00	101	217	Peak	VERTICAL
3	2413.92	97.46			66.00	4.35	27.11	0.00	101	217	Average	VERTICAL
4	2416.49	108.25			76.79	4.35	27.11	0.00	101	217	Peak	VERTICAL

Item 3, 4 are the fundamental frequency at 2412 MHz.

**Channel 6**

	Freq	Level	Limit Line	Over Limit	Read Level	CableAntenna Loss	Preamp Factor	A/Pos	T/Pos	Remark	Pol/Phase	
	MHz	dBuV/m	dBuV/m	dB	dBuV	dB	dB/m	dB	cm	deg		
1	2385.40	58.55	74.00	-15.45	27.17	4.33	27.05	0.00	149	273	Peak	VERTICAL
2	2390.00	47.25	54.00	-6.75	15.87	4.33	27.05	0.00	149	273	Average	VERTICAL
3	2439.24	98.26			66.70	4.38	27.18	0.00	149	273	Average	VERTICAL
4	2442.77	107.78			76.22	4.38	27.18	0.00	149	273	Peak	VERTICAL
5	2483.50	59.45	74.00	-14.55	27.76	4.42	27.27	0.00	149	273	Peak	VERTICAL
6	2487.32	47.49	54.00	-6.51	15.80	4.42	27.27	0.00	149	273	Average	VERTICAL

Item 3, 4 are the fundamental frequency at 2437 MHz.

**Channel 11**

	Freq	Level	Limit Line	Over Limit	Read Level	CableAntenna Loss	Preamp Factor	A/Pos	T/Pos	Remark	Pol/Phase	
	MHz	dBuV/m	dBuV/m	dB	dBuV	dB	dB/m	dB	cm	deg		
1	2456.87	97.27			65.67	4.39	27.21	0.00	106	214	Average	VERTICAL
2	2459.12	107.41			75.81	4.39	27.21	0.00	106	214	Peak	VERTICAL
3	2483.50	53.62	54.00	-0.38	21.93	4.42	27.27	0.00	106	214	Average	VERTICAL
4	2483.50	68.59	74.00	-5.41	36.90	4.42	27.27	0.00	106	214	Peak	VERTICAL

Item 1, 2 are the fundamental frequency at 2462 MHz.

<b>Temperature</b>	27°C	<b>Humidity</b>	58%
<b>Test Engineer</b>	Peter Wu	<b>Configurations</b>	IEEE 802.11n MCS0 HT20 CH 1, 6, 11 / Chain 1
<b>Test Date</b>	Apr. 19, 2016		

**Channel 1**

	Freq	Level	Limit Line	Over Limit	Read Level	CableAntenna Loss	Preamp Factor	A/Pos	T/Pos	Remark	Pol/Phase	
	MHz	dBuV/m	dBuV/m	dB	dBuV	dB	dB/m	dB	cm	deg		
1	2389.89	70.38	74.00	-3.62	39.00	4.33	27.05	0.00	117	249	Peak	VERTICAL
2	2390.00	53.59	54.00	-0.41	22.21	4.33	27.05	0.00	117	249	Average	VERTICAL
3	2410.72	92.87			61.42	4.35	27.10	0.00	117	249	Average	VERTICAL
4	2416.33	109.00			77.54	4.35	27.11	0.00	117	249	Peak	VERTICAL

Item 3, 4 are the fundamental frequency at 2412 MHz.

**Channel 6**

	Freq	Level	Limit Line	Over Limit	Read Level	CableAntenna Loss	Preamp Factor	A/Pos	T/Pos	Remark	Pol/Phase	
	MHz	dBuV/m	dBuV/m	dB	dBuV	dB	dB/m	dB	cm	deg		
1	2389.56	67.11	74.00	-6.89	35.23	4.83	27.05	0.00	103	240	Peak	VERTICAL
2	2390.00	48.24	54.00	-5.76	16.36	4.83	27.05	0.00	103	240	Average	VERTICAL
3	2438.28	94.06			62.03	4.87	27.16	0.00	103	240	Average	VERTICAL
4	2439.24	109.88			77.82	4.88	27.18	0.00	103	240	Peak	VERTICAL
5	2483.50	69.06	74.00	-4.94	36.87	4.92	27.27	0.00	103	240	Peak	VERTICAL
6	2483.80	47.89	54.00	-6.11	15.70	4.92	27.27	0.00	103	240	Average	VERTICAL

Item 3, 4 are the fundamental frequency at 2437 MHz.

**Channel 11**

	Freq	Level	Limit Line	Over Limit	Read Level	CableAntenna Loss	Preamp Factor	A/Pos	T/Pos	Remark	Pol/Phase	
	MHz	dBuV/m	dBuV/m	dB	dBuV	dB	dB/m	dB	cm	deg		
1	2460.72	93.63			61.51	4.90	27.22	0.00	125	255	Average	VERTICAL
2	2467.93	109.22			77.07	4.91	27.24	0.00	125	255	Peak	VERTICAL
3	2483.50	53.89	54.00	-0.11	21.70	4.92	27.27	0.00	125	255	Average	VERTICAL
4	2484.28	72.00	74.00	-2.00	39.81	4.92	27.27	0.00	125	255	Peak	VERTICAL

Item 1, 2 are the fundamental frequency at 2462 MHz.

Note:

Emission level (dBuV/m) = 20 log Emission level (uV/m).

Corrected Reading: Antenna Factor + Cable Loss + Read Level - Preamp Factor = Level.

**For Emission not in Restricted Band**

**Plot on Configuration IEEE 802.11b / Reference Level**

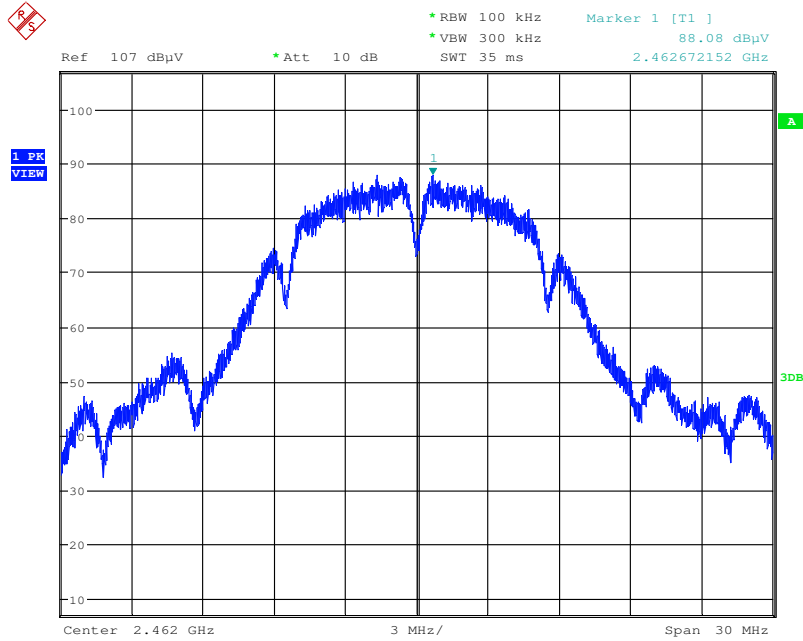

Date: 20.APR.2016 15:51:05

**Plot on Configuration IEEE 802.11b / CH 1 / 30MHz~2400MHz (down 30dBc)**

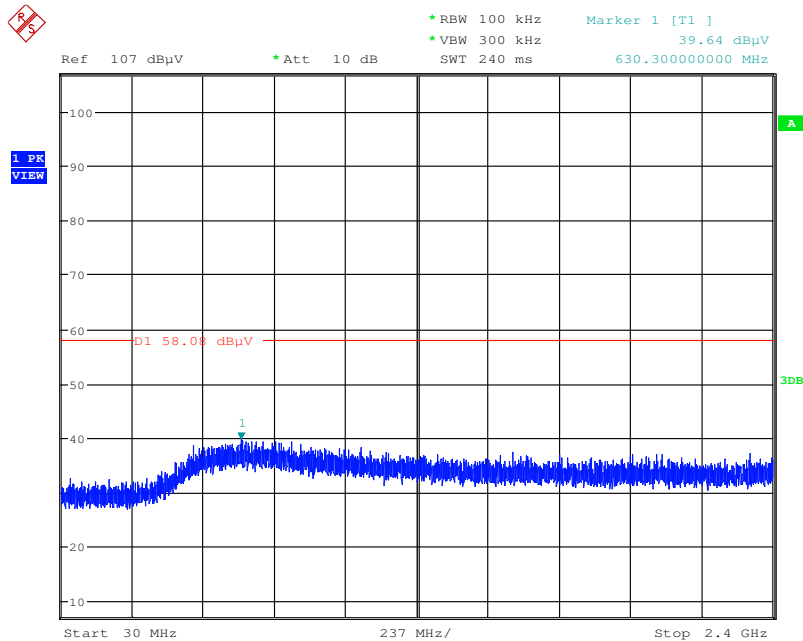

Date: 20.APR.2016 15:55:00

Plot on Configuration IEEE 802.11b / CH 1 / 2483.5MHz~26500MHz (down 30dBc)

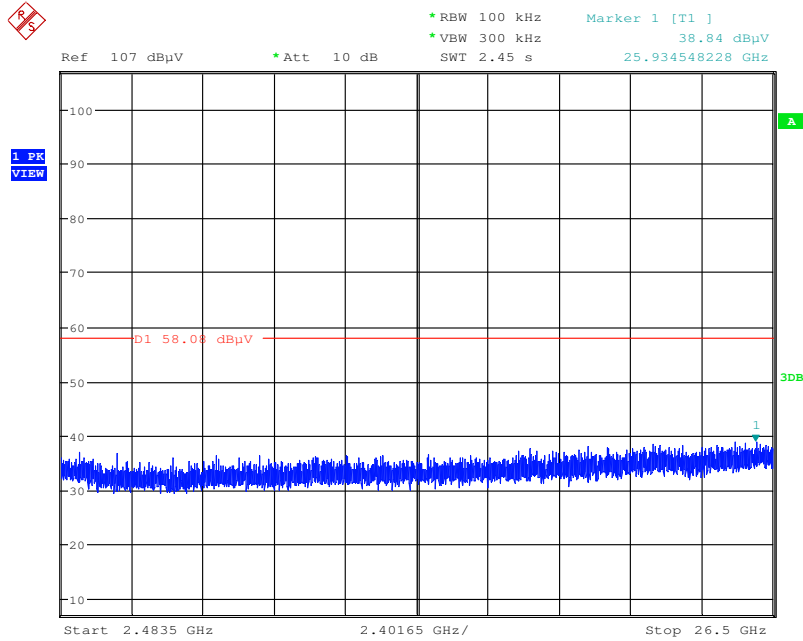

Date: 20.APR.2016 15:55:47

Plot on Configuration IEEE 802.11b / CH 11 / 30MHz~2400MHz (down 30dBc)

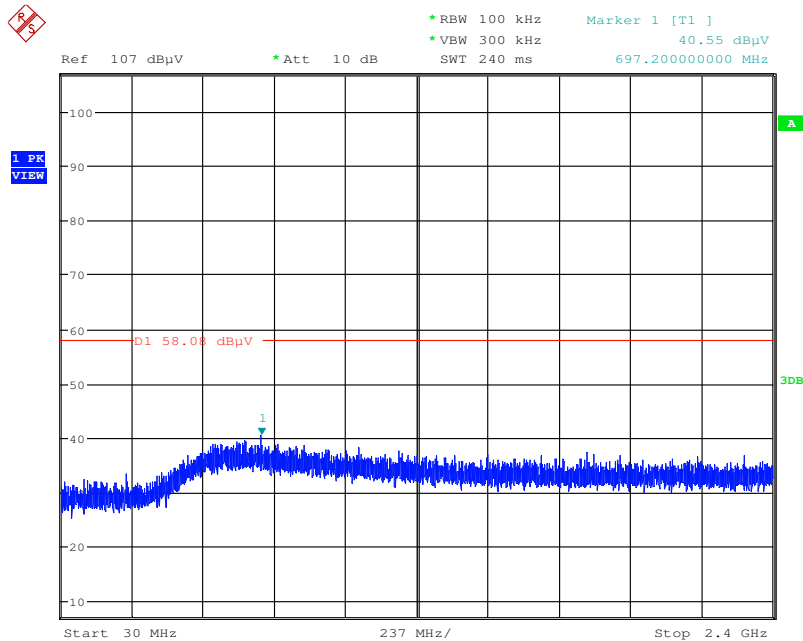

Date: 20.APR.2016 15:56:52

Plot on Configuration IEEE 802.11b / CH 11 / 2483.5MHz~26500MHz (down 30dBc)

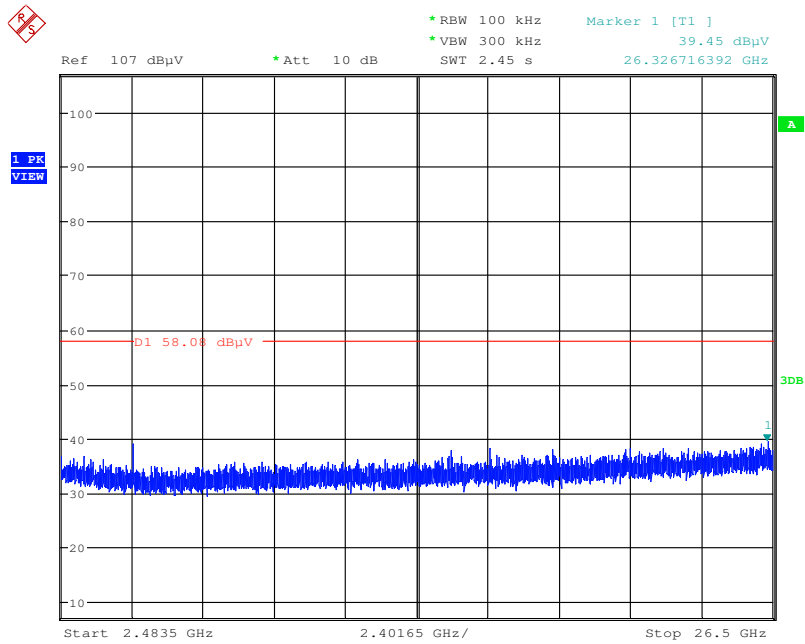

Date: 20.APR.2016 15:57:29

Plot on Configuration IEEE 802.11g / Reference Level

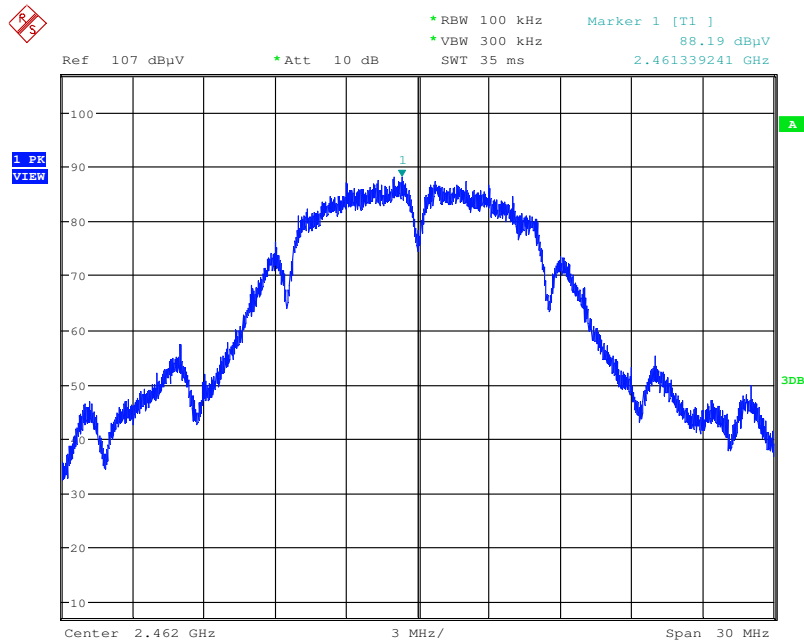

Date: 20.APR.2016 15:37:11

Plot on Configuration IEEE 802.11g / CH 1 / 30MHz~2400MHz (down 30dBc)

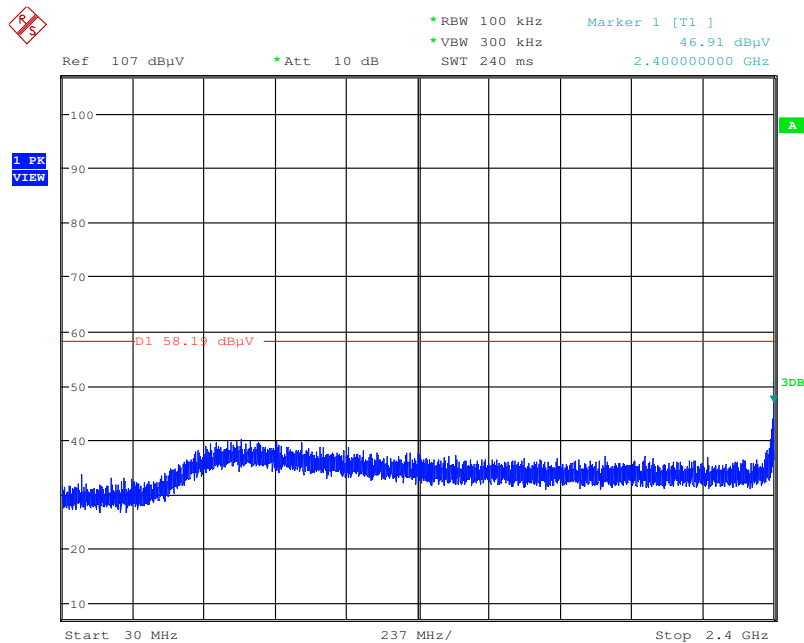

Date: 20.APR.2016 15:42:15



Plot on Configuration IEEE 802.11g / CH 1 / 2483.5MHz~26500MHz (down 30dBc)

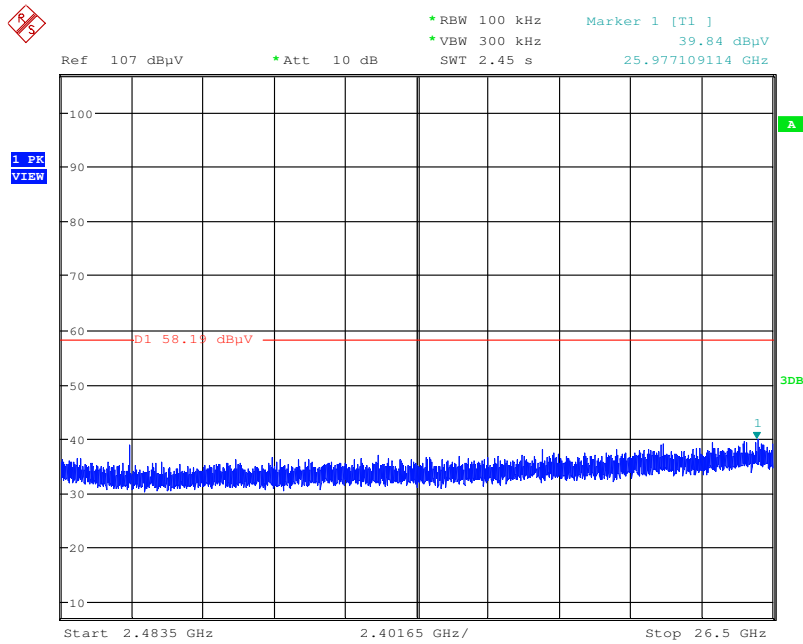

Date: 20.APR.2016 15:43:12

Plot on Configuration IEEE 802.11g / CH 11 / 30MHz~2400MHz (down 30dBc)

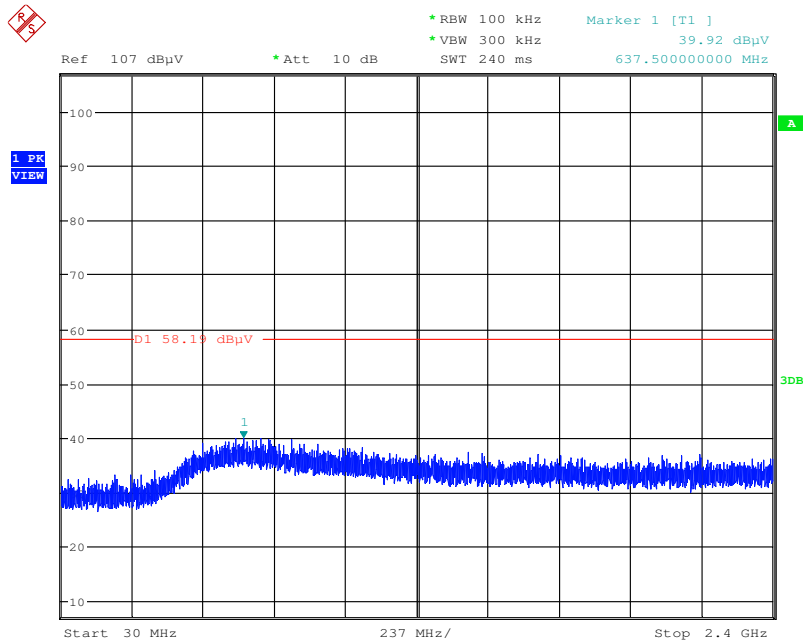

Date: 20.APR.2016 15:48:25

Plot on Configuration IEEE 802.11g / CH 11 / 2483.5MHz~26500MHz (down 30dBc)

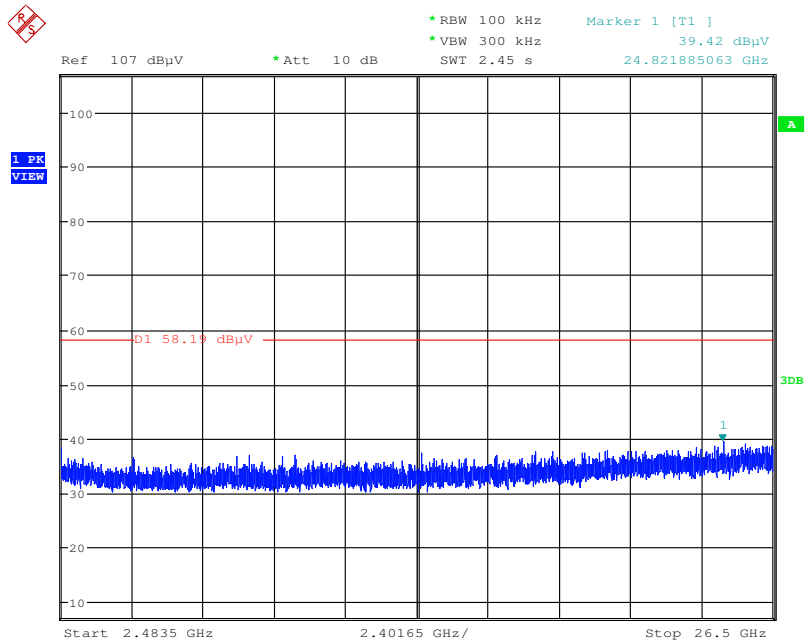

Date: 20.APR.2016 15:49:22



Plot on Configuration IEEE 802.11n MCS0 HT20 / CH 1 / 2483.5MHz~26500MHz (down 30dBc)

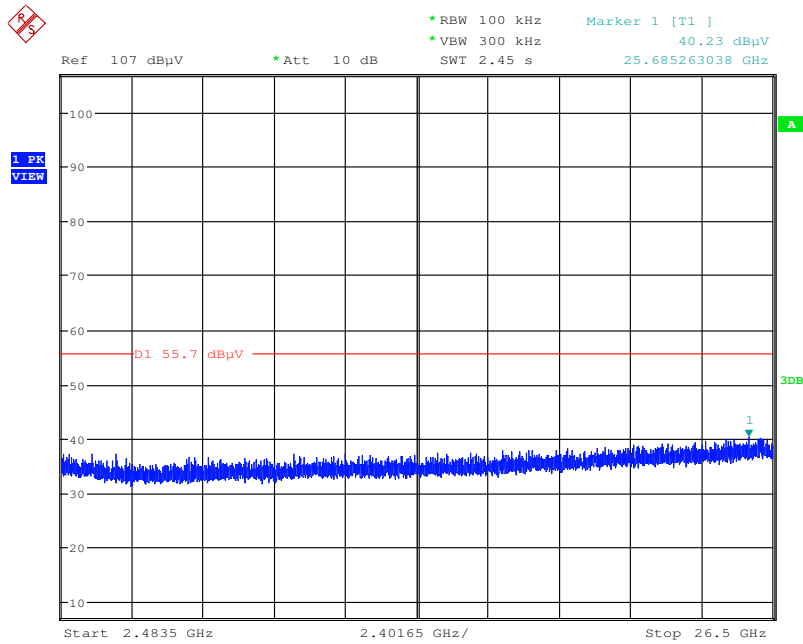

Date: 20.APR.2016 15:30:16

Plot on Configuration IEEE 802.11n MCS0 HT20 / CH 11 / 30MHz~2400MHz (down 30dBc)

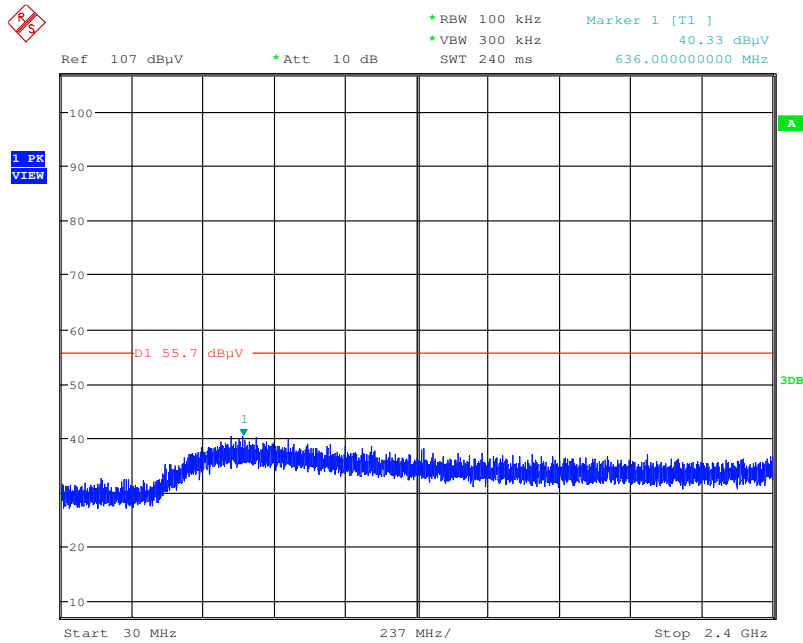

Date: 20.APR.2016 15:35:35



## &lt;Mode 3: Ant. 3 (Wire Ant.)&gt;

Temperature	27°C	Humidity	58%
Test Engineer	Peter Wu	Configurations	IEEE 802.11b CH 1, 6, 11 / Chain 1
Test Date	Apr. 26, 2016		

## Channel 1

	Freq	Level	Limit	Over	Read	CableAntenna	Preamp	A/Pos	T/Pos	Remark	Pol/Phase
	MHz	dBuV/m	dBuV/m	dB	dBuV	dB	dB/m	dB	cm	deg	
1	2390.00	48.19	54.00	-5.81	15.09	5.20	27.90	0.00	231	0 Average	VERTICAL
2	2390.00	58.39	74.00	-15.61	25.29	5.20	27.90	0.00	231	0 Peak	VERTICAL
3	2412.00	98.13			65.01	5.24	27.88	0.00	231	0 Average	VERTICAL
4	2412.32	105.25			72.13	5.24	27.88	0.00	231	0 Peak	VERTICAL

Item 3, 4 are the fundamental frequency at 2412 MHz.

## Channel 6

	Freq	Level	Limit	Over	Read	CableAntenna	Preamp	A/Pos	T/Pos	Remark	Pol/Phase
	MHz	dBuV/m	dBuV/m	dB	dBuV	dB	dB/m	dB	cm	deg	
1	2390.00	48.26	54.00	-5.74	15.16	5.20	27.90	0.00	278	214 Average	HORIZONTAL
2	2390.00	59.27	74.00	-14.73	26.17	5.20	27.90	0.00	278	214 Peak	HORIZONTAL
3	2436.68	101.64			68.51	5.27	27.86	0.00	278	214 Peak	HORIZONTAL
4	2437.00	94.45			61.32	5.27	27.86	0.00	278	214 Average	HORIZONTAL
5	2483.50	48.69	54.00	-5.31	15.54	5.34	27.81	0.00	278	214 Average	HORIZONTAL
6	2483.50	57.58	74.00	-16.42	24.43	5.34	27.81	0.00	278	214 Peak	HORIZONTAL

Item 3, 4 are the fundamental frequency at 2437 MHz.

## Channel 11

	Freq	Level	Limit	Over	Read	CableAntenna	Preamp	A/Pos	T/Pos	Remark	Pol/Phase
	MHz	dBuV/m	dBuV/m	dB	dBuV	dB	dB/m	dB	cm	deg	
1	2461.36	105.88			72.74	5.31	27.83	0.00	246	360 Peak	VERTICAL
2	2462.00	98.46			65.32	5.31	27.83	0.00	246	360 Average	VERTICAL
3	2483.50	48.79	54.00	-5.21	15.64	5.34	27.81	0.00	246	360 Average	VERTICAL
4	2484.92	61.56	74.00	-12.44	28.41	5.34	27.81	0.00	246	360 Peak	VERTICAL

Item 1, 2 are the fundamental frequency at 2462 MHz.

<b>Temperature</b>	27°C	<b>Humidity</b>	58%
<b>Test Engineer</b>	Peter Wu	<b>Configurations</b>	IEEE 802.11g CH 1, 6, 11 / Chain 1
<b>Test Date</b>	Apr. 26, 2016		

**Channel 1**

	Freq	Level	Limit Line	Over Limit	Read Level	CableAntenna Loss	Preamp Factor	A/Pos	T/Pos	Remark	Pol/Phase	
	MHz	dBuV/m	dBuV/m	dB	dBuV	dB	dB/m	dB	cm	deg		
1	2390.00	53.53	54.00	-0.47	20.43	5.20	27.90	0.00	286	350	Average	VERTICAL
2	2390.00	73.24	74.00	-0.76	40.14	5.20	27.90	0.00	286	350	Peak	VERTICAL
3	2413.76	93.54			60.42	5.24	27.88	0.00	286	350	Average	VERTICAL
4	2415.05	103.95			70.83	5.24	27.88	0.00	286	350	Peak	VERTICAL

Item 3, 4 are the fundamental frequency at 2412 MHz.

**Channel 6**

	Freq	Level	Limit Line	Over Limit	Read Level	CableAntenna Loss	Preamp Factor	A/Pos	T/Pos	Remark	Pol/Phase	
	MHz	dBuV/m	dBuV/m	dB	dBuV	dB	dB/m	dB	cm	deg		
1	2390.00	48.30	54.00	-5.70	15.20	5.20	27.90	0.00	247	360	Average	VERTICAL
2	2390.00	58.13	74.00	-15.87	25.03	5.20	27.90	0.00	247	360	Peak	VERTICAL
3	2434.76	91.29			58.16	5.27	27.86	0.00	247	360	Average	VERTICAL
4	2439.89	100.94			67.81	5.28	27.85	0.00	247	360	Peak	VERTICAL
5	2483.50	48.49	54.00	-5.51	15.34	5.34	27.81	0.00	247	360	Average	VERTICAL
6	2483.50	57.99	74.00	-16.01	24.84	5.34	27.81	0.00	247	360	Peak	VERTICAL

Item 3, 4 are the fundamental frequency at 2437 MHz.

**Channel 11**

	Freq	Level	Limit Line	Over Limit	Read Level	CableAntenna Loss	Preamp Factor	A/Pos	T/Pos	Remark	Pol/Phase	
	MHz	dBuV/m	dBuV/m	dB	dBuV	dB	dB/m	dB	cm	deg		
1	2460.08	92.73			59.59	5.30	27.84	0.00	247	0	Average	VERTICAL
2	2465.21	103.13			69.99	5.31	27.83	0.00	247	0	Peak	VERTICAL
3	2483.50	52.98	54.00	-1.02	19.83	5.34	27.81	0.00	247	0	Average	VERTICAL
4	2483.96	68.59	74.00	-5.41	35.44	5.34	27.81	0.00	247	0	Peak	VERTICAL

Item 1, 2 are the fundamental frequency at 2462 MHz.

<b>Temperature</b>	27°C	<b>Humidity</b>	58%
<b>Test Engineer</b>	Peter Wu	<b>Configurations</b>	IEEE 802.11n MCS0 HT20 CH 1, 6, 11 / Chain 1
<b>Test Date</b>	Apr. 26, 2016		

**Channel 1**

	Freq	Level	Limit Line	Over Limit	Read Level	CableAntenna Loss	Preamp Factor	A/Pos	T/Pos	Remark	Pol/Phase
	MHz	dBuV/m	dBuV/m	dB	dBuV	dB	dB/m	dB	cm	deg	
1	2390.00	53.65	54.00	-0.35	20.55	5.20	27.90	0.00	286	0 Average	VERTICAL
2	2390.00	68.23	74.00	-5.77	35.13	5.20	27.90	0.00	286	0 Peak	VERTICAL
3	2413.92	93.86			60.74	5.24	27.88	0.00	286	0 Average	VERTICAL
4	2416.01	105.03			71.91	5.24	27.88	0.00	286	0 Peak	VERTICAL

Item 3, 4 are the fundamental frequency at 2412 MHz.

**Channel 6**

	Freq	Level	Limit Line	Over Limit	Read Level	CableAntenna Loss	Preamp Factor	A/Pos	T/Pos	Remark	Pol/Phase
	MHz	dBuV/m	dBuV/m	dB	dBuV	dB	dB/m	dB	cm	deg	
1	2390.00	48.26	54.00	-5.74	15.16	5.20	27.90	0.00	225	1 Average	VERTICAL
2	2390.00	60.29	74.00	-13.71	27.19	5.20	27.90	0.00	225	1 Peak	VERTICAL
3	2435.72	101.49			68.36	5.27	27.86	0.00	225	1 Peak	VERTICAL
4	2436.04	91.82			58.69	5.27	27.86	0.00	225	1 Average	VERTICAL
5	2483.50	48.66	54.00	-5.34	15.51	5.34	27.81	0.00	225	1 Average	VERTICAL
6	2483.50	58.57	74.00	-15.43	25.42	5.34	27.81	0.00	225	1 Peak	VERTICAL

Item 3, 4 are the fundamental frequency at 2437 MHz.

**Channel 11**

	Freq	Level	Limit Line	Over Limit	Read Level	CableAntenna Loss	Preamp Factor	A/Pos	T/Pos	Remark	Pol/Phase
	MHz	dBuV/m	dBuV/m	dB	dBuV	dB	dB/m	dB	cm	deg	
1	2458.64	102.92			69.78	5.30	27.84	0.00	245	2 Peak	VERTICAL
2	2459.92	92.64			59.50	5.30	27.84	0.00	245	2 Average	VERTICAL
3	2483.50	53.55	54.00	-0.45	20.40	5.34	27.81	0.00	245	2 Average	VERTICAL
4	2484.12	68.69	74.00	-5.31	35.54	5.34	27.81	0.00	245	2 Peak	VERTICAL

Item 1, 2 are the fundamental frequency at 2462 MHz.

Note:

Emission level (dBuV/m) = 20 log Emission level (uV/m).

Corrected Reading: Antenna Factor + Cable Loss + Read Level - Preamp Factor = Level.





Plot on Configuration IEEE 802.11b / CH 1 / 2483.5MHz~26500MHz (down 30dBc)

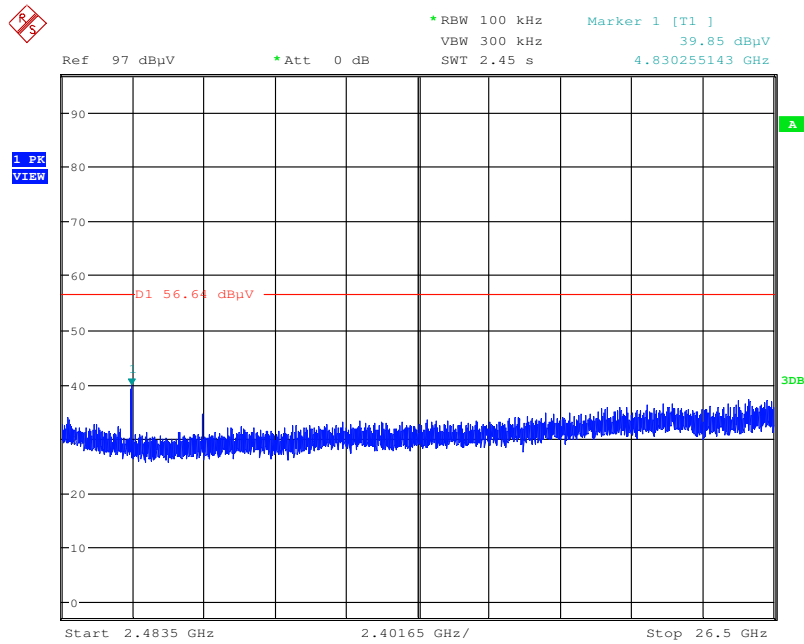

Date: 27.APR.2016 00:23:08

Plot on Configuration IEEE 802.11b / CH 11 / 30MHz~2400MHz (down 30dBc)

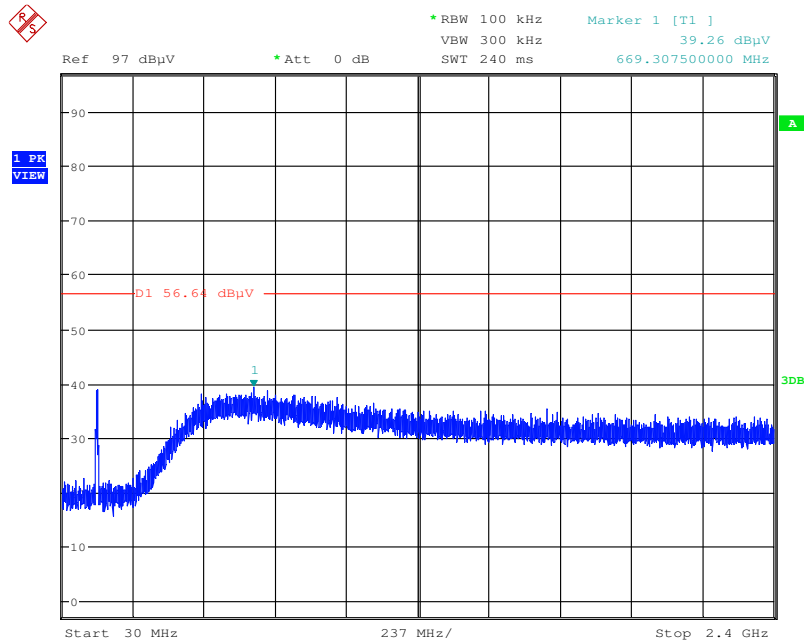

Date: 27.APR.2016 00:14:24

Plot on Configuration IEEE 802.11b / CH 11 / 2483.5MHz~26500MHz (down 30dBc)

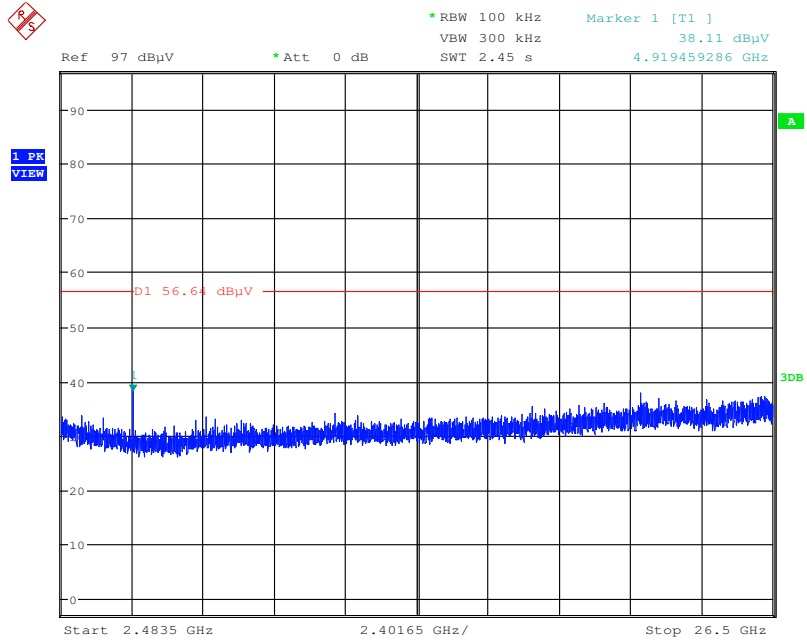

Date: 27.APR.2016 00:23:58

Plot on Configuration IEEE 802.11g / Reference Level

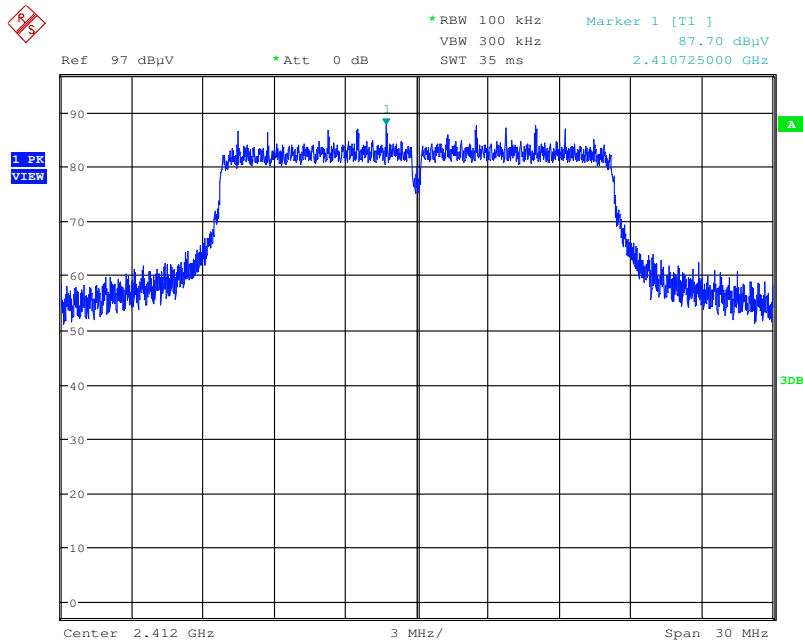

Date: 27.APR.2016 00:16:19

Plot on Configuration IEEE 802.11g / CH 1 / 30MHz~2400MHz (down 30dBc)

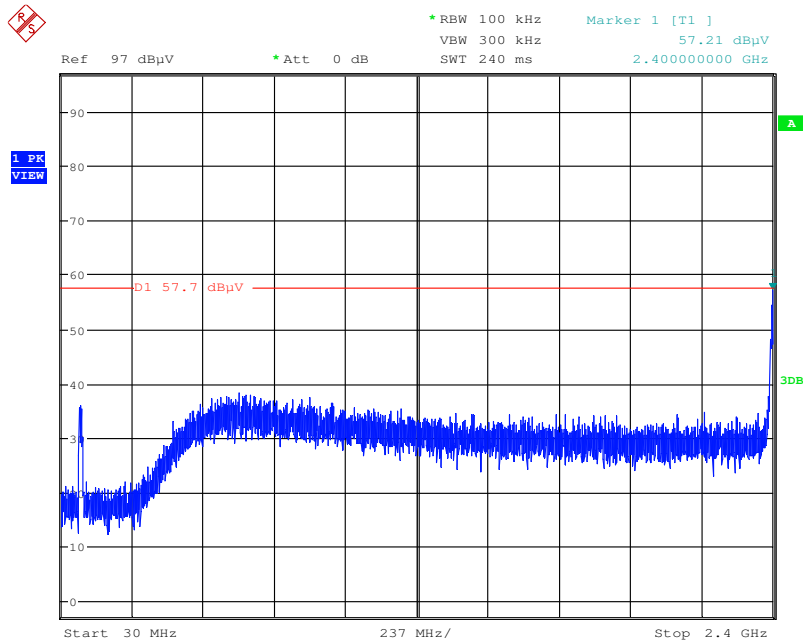

Date: 27.APR.2016 00:17:12



Plot on Configuration IEEE 802.11g / CH 11 / 2483.5MHz~26500MHz (down 30dBc)

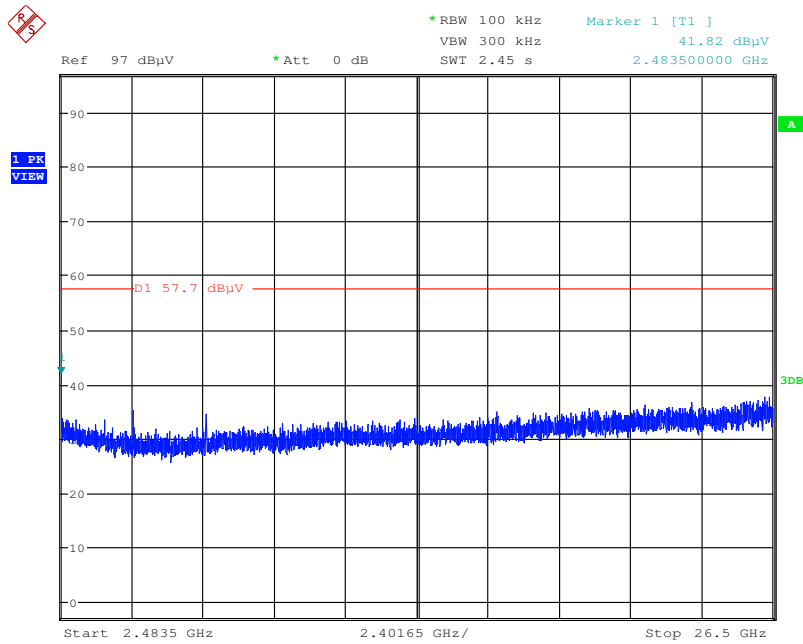

Date: 27.APR.2016 00:20:36



Plot on Configuration IEEE 802.11n MCS0 HT20 / CH 1 / 2483.5MHz~26500MHz (down 30dBc)

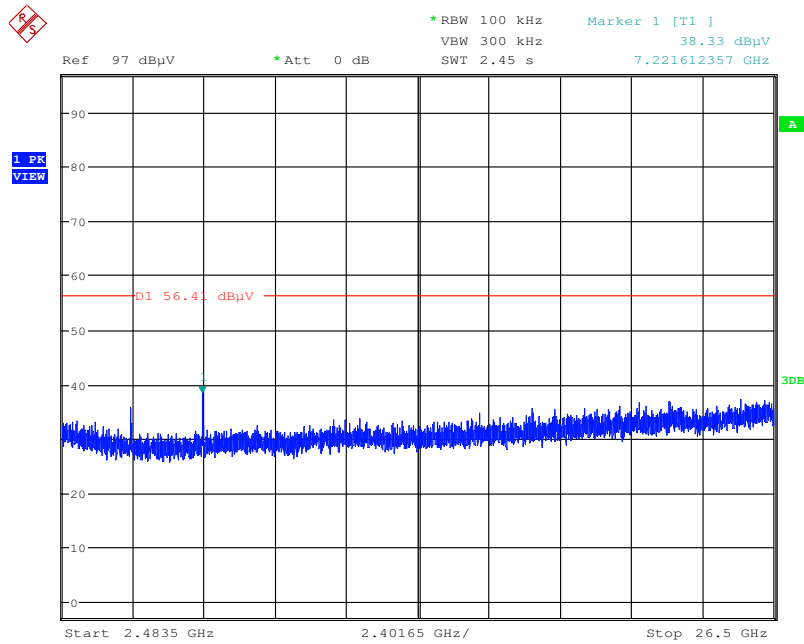

Date: 27.APR.2016 00:28:04

Plot on Configuration IEEE 802.11n MCS0 HT20 / CH 11 / 30MHz~2400MHz (down 30dBc)

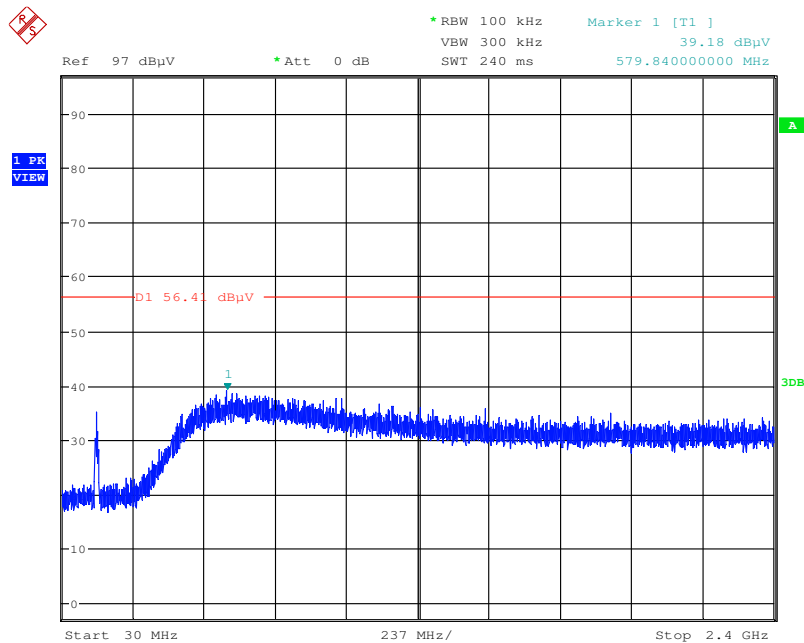

Date: 27.APR.2016 00:29:04



Plot on Configuration IEEE 802.11n MCS0 HT20 / CH 11 / 2483.5MHz~26500MHz (down 30dBc)

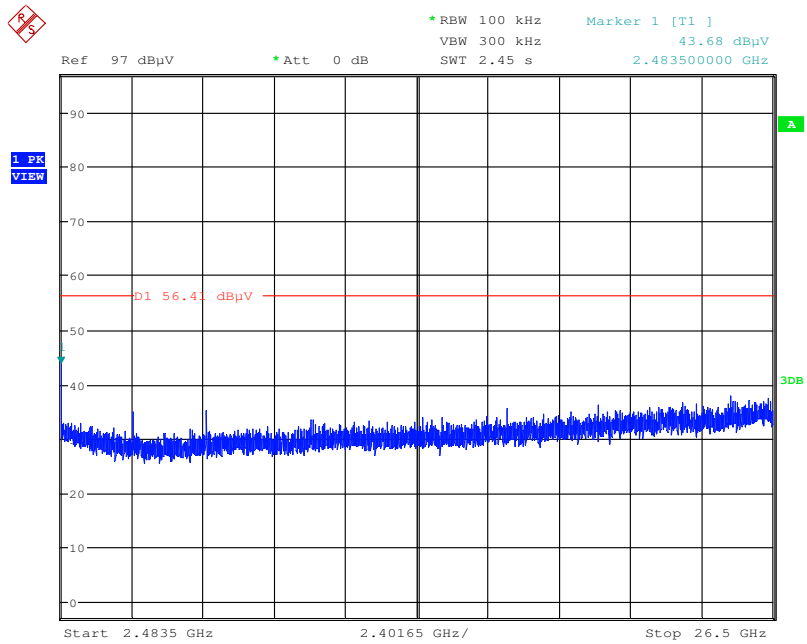

Date: 27.APR.2016 00:28:41

## &lt;Mode 4: Ant. 4 (Dipole Ant.)&gt;

Temperature	27°C	Humidity	58%
Test Engineer	Peter Wu	Configurations	IEEE 802.11b CH 1, 6, 11 / Chain 1
Test Date	Apr. 20, 2016		

## Channel 1

	Freq	Level	Limit	Over	Read	CableAntenna	Preamp	A/Pos	T/Pos	Remark	Pol/Phase
	MHz	dBuV/m	dBuV/m	dB	dBuV	dB	dB/m	dB	cm	deg	
1	2388.40	57.21	74.00	-16.79	25.83	4.33	27.05	0.00	100	66 Peak	VERTICAL
2	2389.56	46.40	54.00	-7.60	15.02	4.33	27.05	0.00	100	66 Average	VERTICAL
3	2412.00	94.52			63.06	4.35	27.11	0.00	100	66 Average	VERTICAL
4	2412.32	102.54			71.08	4.35	27.11	0.00	100	66 Peak	VERTICAL

Item 3, 4 are the fundamental frequency at 2412 MHz.

## Channel 6

	Freq	Level	Limit	Over	Read	CableAntenna	Preamp	A/Pos	T/Pos	Remark	Pol/Phase
	MHz	dBuV/m	dBuV/m	dB	dBuV	dB	dB/m	dB	cm	deg	
1	2389.68	57.60	74.00	-16.40	26.22	4.33	27.05	0.00	259	76 Peak	VERTICAL
2	2390.00	46.21	54.00	-7.79	14.83	4.33	27.05	0.00	259	76 Average	VERTICAL
3	2437.00	94.16			62.63	4.37	27.16	0.00	259	76 Average	VERTICAL
4	2437.64	101.91			70.38	4.37	27.16	0.00	259	76 Peak	VERTICAL
5	2483.50	46.86	54.00	-7.14	15.17	4.42	27.27	0.00	259	76 Average	VERTICAL
6	2484.46	58.19	74.00	-15.81	26.50	4.42	27.27	0.00	259	76 Peak	VERTICAL

Item 3, 4 are the fundamental frequency at 2437 MHz.

## Channel 11

	Freq	Level	Limit	Over	Read	CableAntenna	Preamp	A/Pos	T/Pos	Remark	Pol/Phase
	MHz	dBuV/m	dBuV/m	dB	dBuV	dB	dB/m	dB	cm	deg	
1	2462.00	95.26			63.64	4.40	27.22	0.00	259	71 Average	VERTICAL
2	2462.32	102.46			70.84	4.40	27.22	0.00	259	71 Peak	VERTICAL
3	2483.50	47.31	54.00	-6.69	15.62	4.42	27.27	0.00	259	71 Average	VERTICAL
4	2485.42	58.01	74.00	-15.99	26.32	4.42	27.27	0.00	259	71 Peak	VERTICAL

Item 1, 2 are the fundamental frequency at 2462 MHz.

<b>Temperature</b>	27°C	<b>Humidity</b>	58%
<b>Test Engineer</b>	Peter Wu	<b>Configurations</b>	IEEE 802.11g CH 1, 6, 11 / Chain 1
<b>Test Date</b>	Apr. 20, 2016		

**Channel 1**

	Freq	Level	Limit Line	Over Limit	Read Level	CableAntenna Loss	Preamp Factor	A/Pos	T/Pos	Remark	Pol/Phase
	MHz	dBuV/m	dBuV/m	dB	dBuV	dB	dB/m	dB	cm	deg	
1	2385.40	58.90	74.00	-15.10	27.52	4.33	27.05	0.00	271	69 Peak	VERTICAL
2	2390.00	47.14	54.00	-6.86	15.76	4.33	27.05	0.00	271	69 Average	VERTICAL
3	2411.04	94.16			62.71	4.35	27.10	0.00	271	69 Average	VERTICAL
4	2415.85	104.53			73.07	4.35	27.11	0.00	271	69 Peak	VERTICAL

Item 3, 4 are the fundamental frequency at 2412 MHz.

**Channel 6**

	Freq	Level	Limit Line	Over Limit	Read Level	CableAntenna Loss	Preamp Factor	A/Pos	T/Pos	Remark	Pol/Phase
	MHz	dBuV/m	dBuV/m	dB	dBuV	dB	dB/m	dB	cm	deg	
1	2386.80	58.60	74.00	-15.40	27.22	4.33	27.05	0.00	263	72 Peak	VERTICAL
2	2390.00	46.33	54.00	-7.67	14.95	4.33	27.05	0.00	263	72 Average	VERTICAL
3	2438.60	95.08			63.55	4.37	27.16	0.00	263	72 Average	VERTICAL
4	2440.21	105.95			74.39	4.38	27.18	0.00	263	72 Peak	VERTICAL
5	2483.50	47.02	54.00	-6.98	15.33	4.42	27.27	0.00	263	72 Average	VERTICAL
6	2489.59	59.80	74.00	-14.20	28.09	4.43	27.28	0.00	263	72 Peak	VERTICAL

Item 3, 4 are the fundamental frequency at 2437 MHz.

**Channel 11**

	Freq	Level	Limit Line	Over Limit	Read Level	CableAntenna Loss	Preamp Factor	A/Pos	T/Pos	Remark	Pol/Phase
	MHz	dBuV/m	dBuV/m	dB	dBuV	dB	dB/m	dB	cm	deg	
1	2458.80	105.49			73.89	4.39	27.21	0.00	257	70 Peak	VERTICAL
2	2466.49	95.12			63.50	4.40	27.22	0.00	257	70 Average	VERTICAL
3	2483.50	48.35	54.00	-5.65	16.66	4.42	27.27	0.00	257	70 Average	VERTICAL
4	2484.14	61.30	74.00	-12.70	29.61	4.42	27.27	0.00	257	70 Peak	VERTICAL

Item 1, 2 are the fundamental frequency at 2462 MHz.

<b>Temperature</b>	27°C	<b>Humidity</b>	58%
<b>Test Engineer</b>	Peter Wu	<b>Configurations</b>	IEEE 802.11n MCS0 HT20 CH 1, 6, 11 / Chain 1
<b>Test Date</b>	Apr. 20, 2016		

**Channel 1**

	Freq	Level	Limit Line	Over Limit	Read Level	CableAntenna Loss	Preamp Factor	A/Pos	T/Pos	Remark	Pol/Phase
	MHz	dBuV/m	dBuV/m	dB	dBuV	dB	dB/m	dB	cm	deg	
1	2389.36	60.47	74.00	-13.53	29.09	4.33	27.05	0.00	269	69 Peak	VERTICAL
2	2390.00	47.50	54.00	-6.50	16.12	4.33	27.05	0.00	269	69 Average	VERTICAL
3	2410.40	94.35			62.90	4.35	27.10	0.00	269	69 Average	VERTICAL
4	2413.92	105.48			74.02	4.35	27.11	0.00	269	69 Peak	VERTICAL

Item 3, 4 are the fundamental frequency at 2412 MHz.

**Channel 6**

	Freq	Level	Limit Line	Over Limit	Read Level	CableAntenna Loss	Preamp Factor	A/Pos	T/Pos	Remark	Pol/Phase
	MHz	dBuV/m	dBuV/m	dB	dBuV	dB	dB/m	dB	cm	deg	
1	2378.99	58.79	74.00	-15.21	27.43	4.32	27.04	0.00	263	69 Peak	VERTICAL
2	2390.00	46.30	54.00	-7.70	14.92	4.33	27.05	0.00	263	69 Average	VERTICAL
3	2436.36	106.42			74.89	4.37	27.16	0.00	263	69 Peak	VERTICAL
4	2438.92	95.23			63.70	4.37	27.16	0.00	263	69 Average	VERTICAL
5	2483.50	46.97	54.00	-7.03	15.28	4.42	27.27	0.00	263	69 Average	VERTICAL
6	2484.46	58.54	74.00	-15.46	26.85	4.42	27.27	0.00	263	69 Peak	VERTICAL

Item 3, 4 are the fundamental frequency at 2437 MHz.

**Channel 11**

	Freq	Level	Limit Line	Over Limit	Read Level	CableAntenna Loss	Preamp Factor	A/Pos	T/Pos	Remark	Pol/Phase
	MHz	dBuV/m	dBuV/m	dB	dBuV	dB	dB/m	dB	cm	deg	
1	2467.13	95.37			63.75	4.40	27.22	0.00	258	70 Average	VERTICAL
2	2467.77	106.26			74.61	4.41	27.24	0.00	258	70 Peak	VERTICAL
3	2483.50	49.20	54.00	-4.80	17.51	4.42	27.27	0.00	258	70 Average	VERTICAL
4	2483.50	62.21	74.00	-11.79	30.52	4.42	27.27	0.00	258	70 Peak	VERTICAL

Item 1, 2 are the fundamental frequency at 2462 MHz.

Note:

Emission level (dBuV/m) = 20 log Emission level (uV/m).

Corrected Reading: Antenna Factor + Cable Loss + Read Level - Preamp Factor = Level.

**For Emission not in Restricted Band**

**Plot on Configuration IEEE 802.11b / Reference Level**

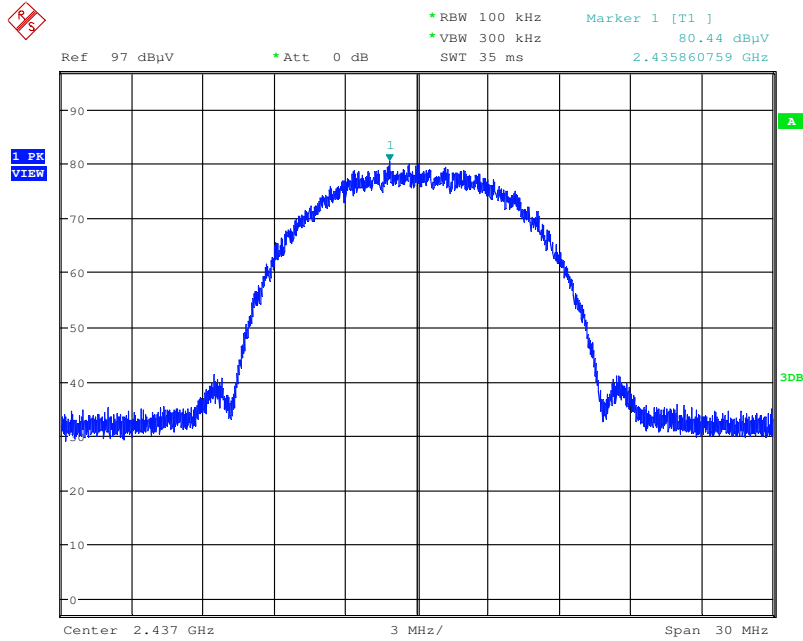

Date: 21.APR.2016 00:43:33

**Plot on Configuration IEEE 802.11b / CH 1 / 30MHz~2400MHz (down 30dBc)**

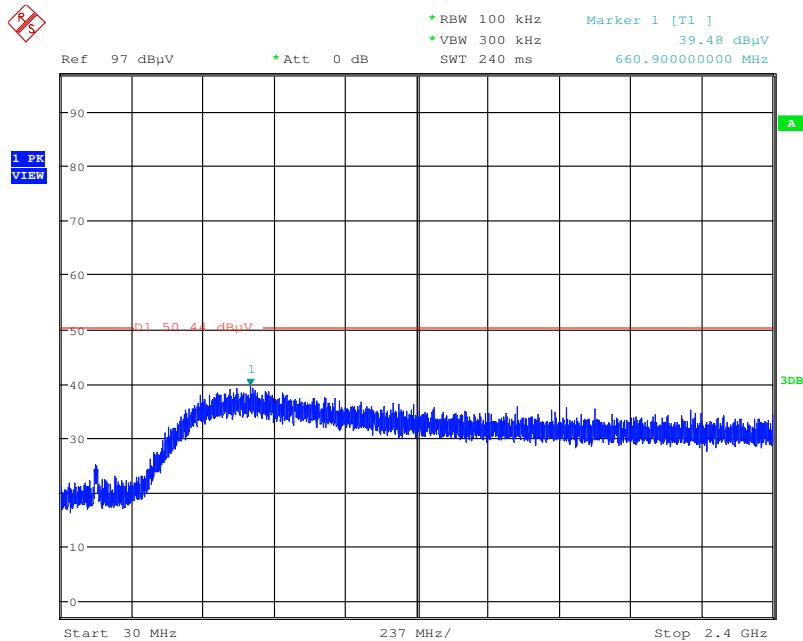

Date: 21.APR.2016 00:58:15

Plot on Configuration IEEE 802.11b / CH 1 / 2483.5MHz~26500MHz (down 30dBc)

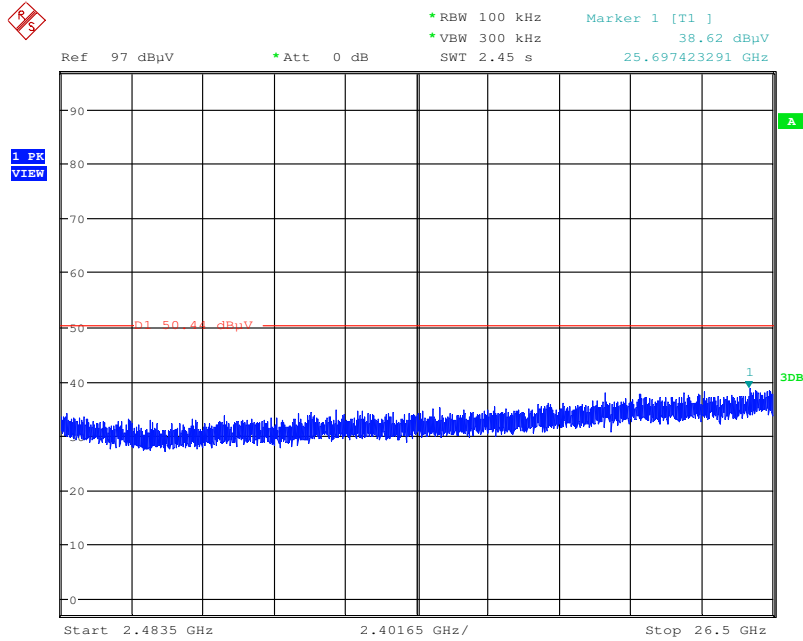

Date: 21.APR.2016 00:45:09

Plot on Configuration IEEE 802.11b / CH 11 / 30MHz~2400MHz (down 30dBc)

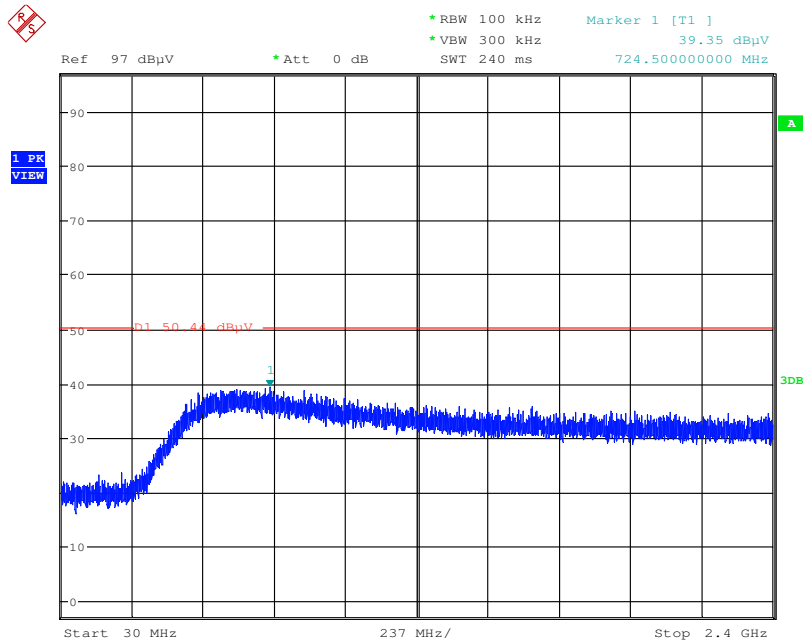

Date: 21.APR.2016 00:45:43

Plot on Configuration IEEE 802.11b / CH 11 / 2483.5MHz~26500MHz (down 30dBc)

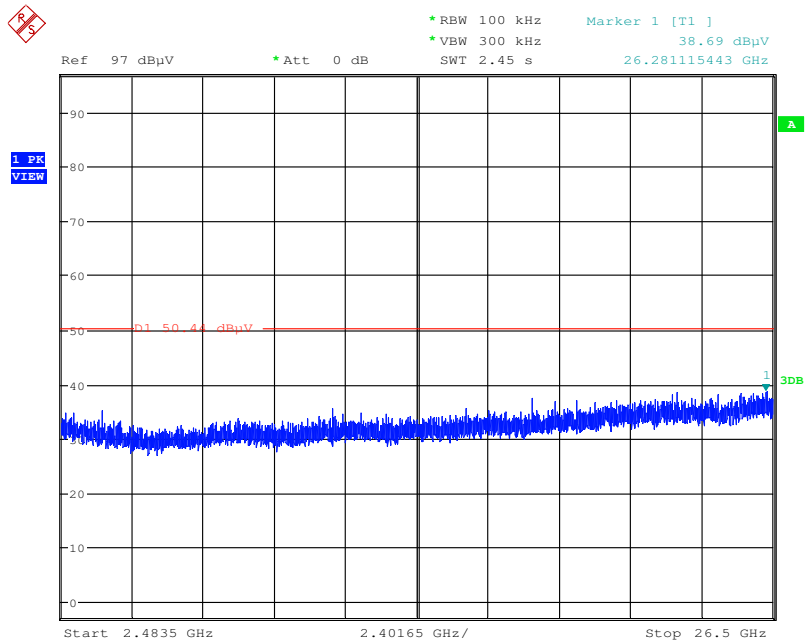

Date: 21.APR.2016 00:46:14

Plot on Configuration IEEE 802.11g / Reference Level

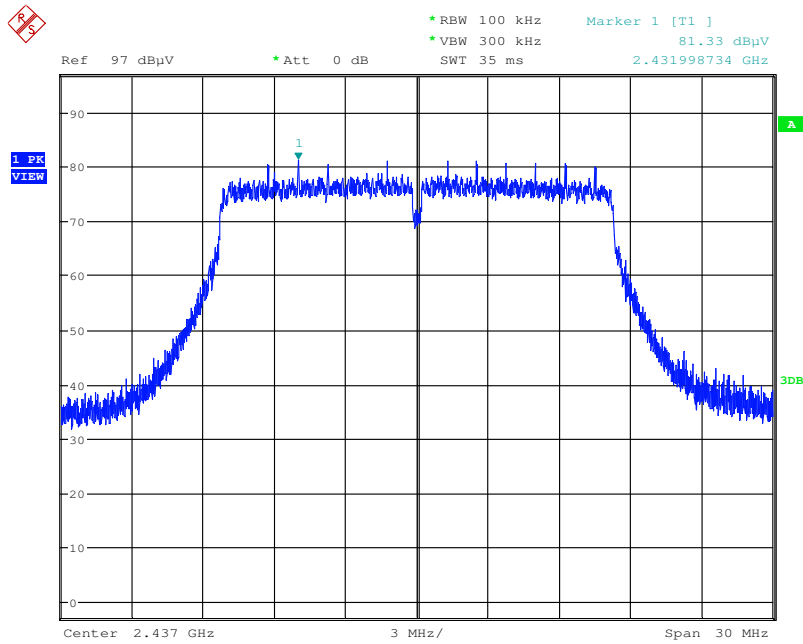

Date: 21.APR.2016 00:49:45

Plot on Configuration IEEE 802.11g / CH 1 / 30MHz~2400MHz (down 30dBc)

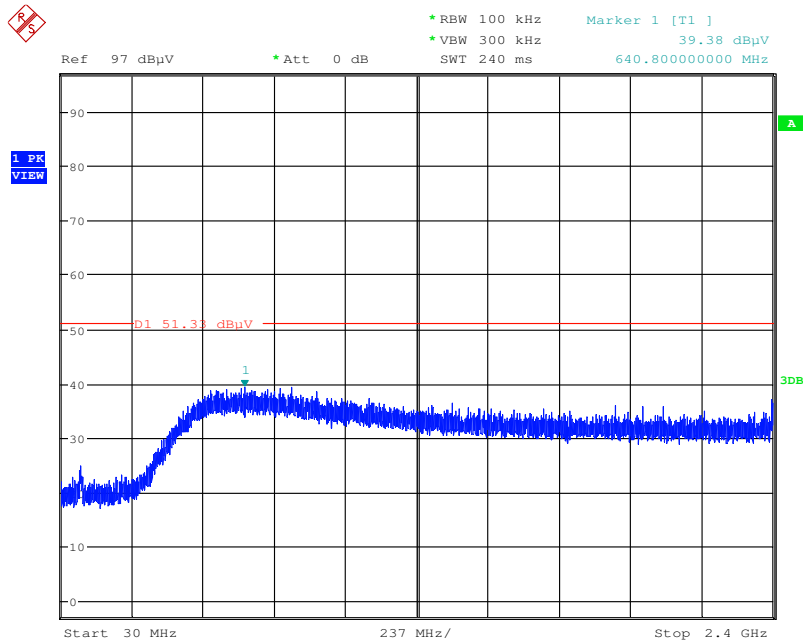

Date: 21.APR.2016 00:50:24



Plot on Configuration IEEE 802.11g / CH 1 / 2483.5MHz~26500MHz (down 30dBc)

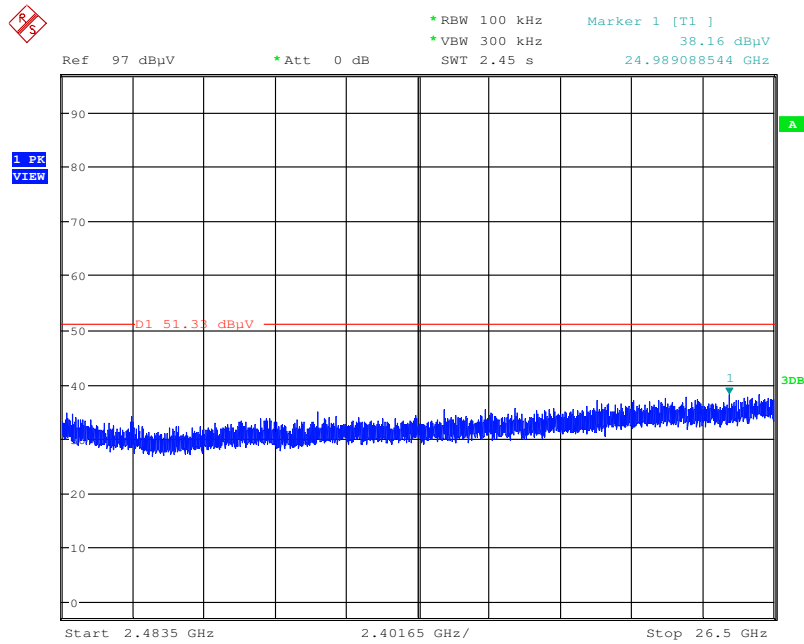

Date: 21.APR.2016 00:50:47

Plot on Configuration IEEE 802.11g / CH 11 / 30MHz~2400MHz (down 30dBc)

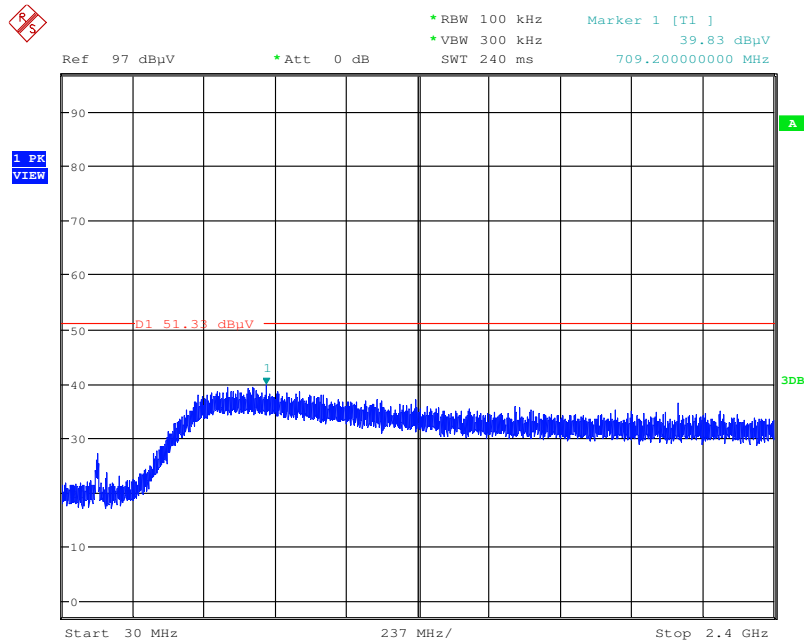

Date: 21.APR.2016 00:51:20

Plot on Configuration IEEE 802.11g / CH 11 / 2483.5MHz~26500MHz (down 30dBc)

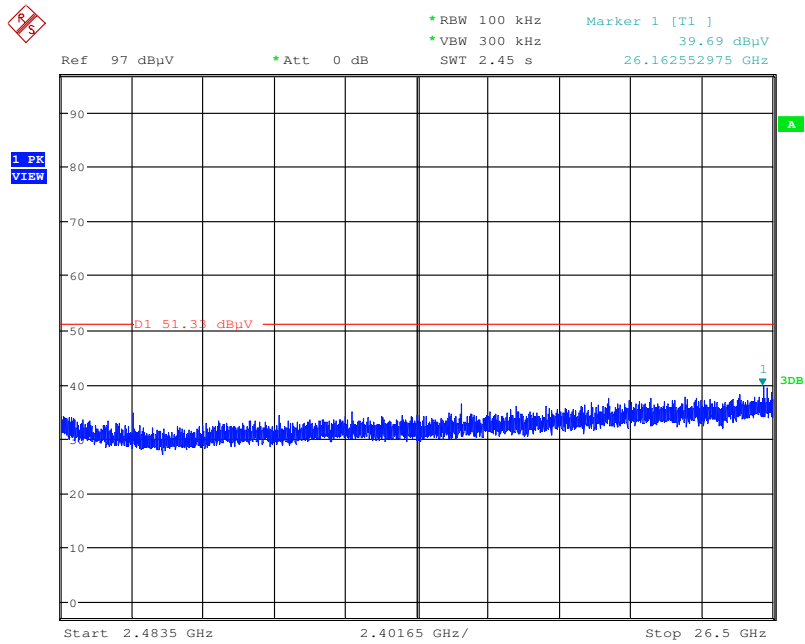

Date: 21.APR.2016 00:51:49



Plot on Configuration IEEE 802.11n MCS0 HT20 / CH 1 / 2483.5MHz~26500MHz (down 30dBc)

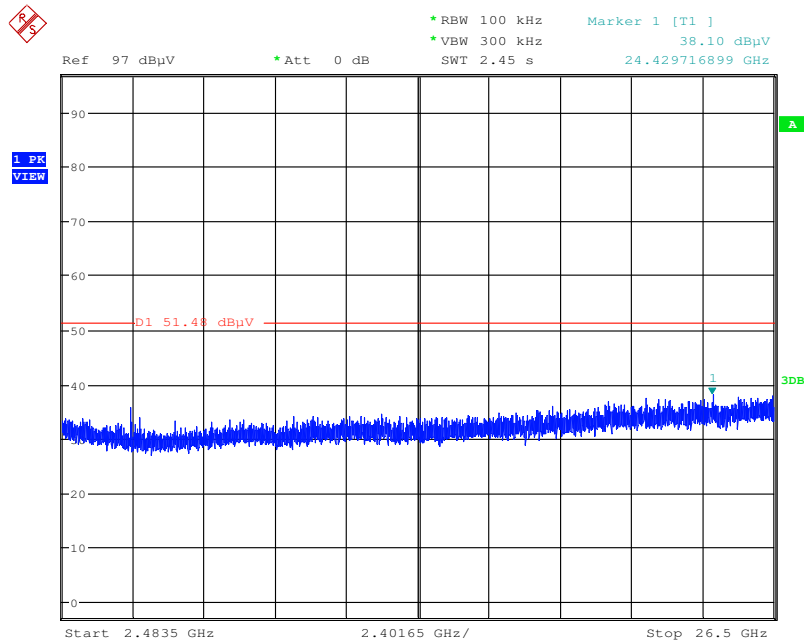

Date: 21.APR.2016 00:53:54

Plot on Configuration IEEE 802.11n MCS0 HT20 / CH 11 / 30MHz~2400MHz (down 30dBc)

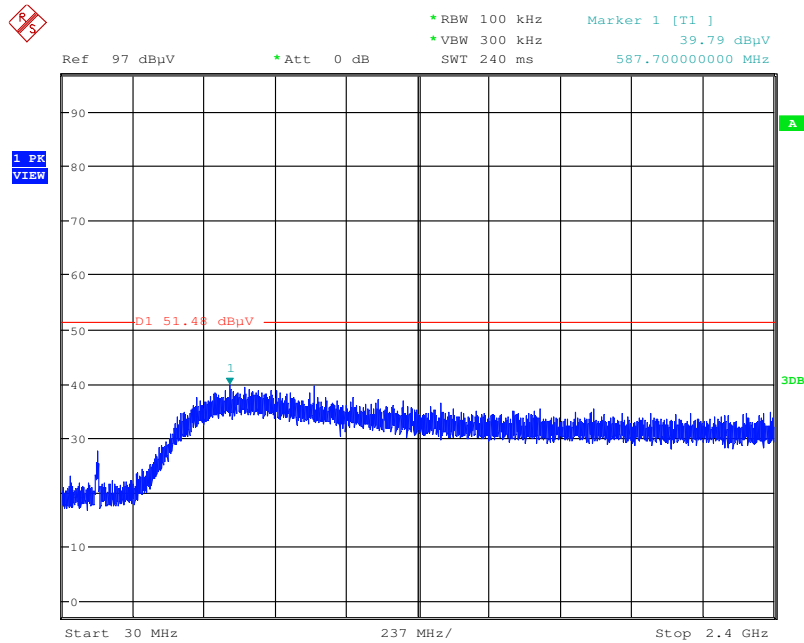

Date: 21.APR.2016 00:54:19

Plot on Configuration IEEE 802.11n MCS0 HT20 / CH 11 / 2483.5MHz~26500MHz (down 30dBc)

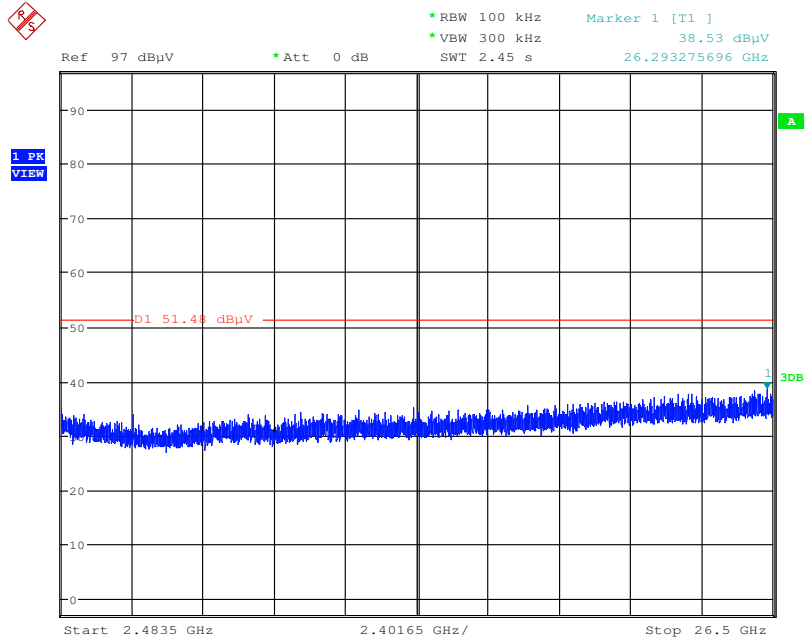

Date: 21.APR.2016 00:54:54

**<Mode 5: Ant. 6 (Chip Ant.)>**

<b>Temperature</b>	27°C	<b>Humidity</b>	58%
<b>Test Engineer</b>	Peter Wu	<b>Configurations</b>	IEEE 802.11b CH 1, 6, 11 / Chain 1
<b>Test Date</b>	Apr. 27, 2016		

**Channel 1**

	Freq	Level	Limit	Over	Read	CableAntenna	Preamp	A/Pos	T/Pos	Remark	Pol/Phase	
	MHz	dBuV/m	dBuV/m	dB	dBuV	dB	dB/m	dB	cm	deg		
1	2390.00	48.22	54.00	-5.78	15.12	5.20	27.90	0.00	221	231	Average	HORIZONTAL
2	2390.00	58.17	74.00	-15.83	25.07	5.20	27.90	0.00	221	231	Peak	HORIZONTAL
3	2412.32	104.24			71.12	5.24	27.88	0.00	221	231	Peak	HORIZONTAL
4	2413.12	96.97			63.85	5.24	27.88	0.00	221	231	Average	HORIZONTAL

Item 3, 4 are the fundamental frequency at 2412 MHz.

**Channel 6**

	Freq	Level	Limit	Over	Read	CableAntenna	Preamp	A/Pos	T/Pos	Remark	Pol/Phase	
	MHz	dBuV/m	dBuV/m	dB	dBuV	dB	dB/m	dB	cm	deg		
1	2390.00	48.48	54.00	-5.52	15.38	5.20	27.90	0.00	299	206	Average	VERTICAL
2	2390.00	59.04	74.00	-14.96	25.94	5.20	27.90	0.00	299	206	Peak	VERTICAL
3	2437.00	101.75			68.62	5.27	27.86	0.00	299	206	Average	VERTICAL
4	2437.32	108.91			75.78	5.27	27.86	0.00	299	206	Peak	VERTICAL
5	2483.50	48.70	54.00	-5.30	15.55	5.34	27.81	0.00	299	206	Average	VERTICAL
6	2483.50	59.11	74.00	-14.89	25.96	5.34	27.81	0.00	299	206	Peak	VERTICAL

Item 3, 4 are the fundamental frequency at 2437 MHz.

**Channel 11**

	Freq	Level	Limit	Over	Read	CableAntenna	Preamp	A/Pos	T/Pos	Remark	Pol/Phase	
	MHz	dBuV/m	dBuV/m	dB	dBuV	dB	dB/m	dB	cm	deg		
1	2459.28	109.87			76.73	5.30	27.84	0.00	300	186	Peak	VERTICAL
2	2460.88	102.62			69.48	5.31	27.83	0.00	300	186	Average	VERTICAL
3	2483.50	48.79	54.00	-5.21	15.64	5.34	27.81	0.00	300	186	Average	VERTICAL
4	2483.50	58.91	74.00	-15.09	25.76	5.34	27.81	0.00	300	186	Peak	VERTICAL

Item 1, 2 are the fundamental frequency at 2462 MHz.

<b>Temperature</b>	27°C	<b>Humidity</b>	58%
<b>Test Engineer</b>	Peter Wu	<b>Configurations</b>	IEEE 802.11g CH 1, 6, 11 / Chain 1
<b>Test Date</b>	Apr. 27, 2016		

**Channel 1**

	Freq	Level	Limit Line	Over Limit	Read Level	CableAntenna Loss	Preamp Factor	A/Pos	T/Pos	Remark	Pol/Phase	
	MHz	dBuV/m	dBuV/m	dB	dBuV	dB	dB/m	dB	cm	deg		
1	2390.00	53.78	54.00	-0.22	20.68	5.20	27.90	0.00	282	205	Average	VERTICAL
2	2390.00	72.23	74.00	-1.77	39.13	5.20	27.90	0.00	282	205	Peak	VERTICAL
3	2413.92	99.02			65.90	5.24	27.88	0.00	282	205	Average	VERTICAL
4	2416.49	109.98			76.86	5.24	27.88	0.00	282	205	Peak	VERTICAL

Item 3, 4 are the fundamental frequency at 2412 MHz.

**Channel 6**

	Freq	Level	Limit Line	Over Limit	Read Level	CableAntenna Loss	Preamp Factor	A/Pos	T/Pos	Remark	Pol/Phase	
	MHz	dBuV/m	dBuV/m	dB	dBuV	dB	dB/m	dB	cm	deg		
1	2390.00	48.98	54.00	-5.02	15.88	5.20	27.90	0.00	300	183	Average	VERTICAL
2	2390.00	58.21	74.00	-15.79	25.11	5.20	27.90	0.00	300	183	Peak	VERTICAL
3	2434.76	98.78			65.65	5.27	27.86	0.00	300	183	Average	VERTICAL
4	2434.76	108.94			75.81	5.27	27.86	0.00	300	183	Peak	VERTICAL
5	2483.50	48.67	54.00	-5.33	15.52	5.34	27.81	0.00	300	183	Average	VERTICAL
6	2483.50	58.91	74.00	-15.09	25.76	5.34	27.81	0.00	300	183	Peak	VERTICAL

Item 3, 4 are the fundamental frequency at 2437 MHz.

**Channel 11**

	Freq	Level	Limit Line	Over Limit	Read Level	CableAntenna Loss	Preamp Factor	A/Pos	T/Pos	Remark	Pol/Phase	
	MHz	dBuV/m	dBuV/m	dB	dBuV	dB	dB/m	dB	cm	deg		
1	2457.67	96.80			63.66	5.30	27.84	0.00	300	318	Average	VERTICAL
2	2461.84	107.12			73.98	5.31	27.83	0.00	300	318	Peak	VERTICAL
3	2483.50	51.53	54.00	-2.47	18.38	5.34	27.81	0.00	300	318	Average	VERTICAL
4	2483.50	65.37	74.00	-8.63	32.22	5.34	27.81	0.00	300	318	Peak	VERTICAL

Item 1, 2 are the fundamental frequency at 2462 MHz.

<b>Temperature</b>	27°C	<b>Humidity</b>	58%
<b>Test Engineer</b>	Peter Wu	<b>Configurations</b>	IEEE 802.11n MCS0 HT20 CH 1, 6, 11 / Chain 1
<b>Test Date</b>	Apr. 27, 2016		

**Channel 1**

	Freq	Level	Limit Line	Over Limit	Read Level	CableAntenna Loss	Preamp Factor	A/Pos	T/Pos	Remark	Pol/Phase	
	MHz	dBuV/m	dBuV/m	dB	dBuV	dB	dB/m	dB	cm	deg		
1	2390.00	53.68	54.00	-0.32	20.58	5.20	27.90	0.00	300	360	Average	VERTICAL
2	2390.00	70.96	74.00	-3.04	37.86	5.20	27.90	0.00	300	360	Peak	VERTICAL
3	2415.21	98.37			65.25	5.24	27.88	0.00	300	360	Average	VERTICAL
4	2415.37	108.12			75.00	5.24	27.88	0.00	300	360	Peak	VERTICAL

Item 3, 4 are the fundamental frequency at 2412 MHz.

**Channel 6**

	Freq	Level	Limit Line	Over Limit	Read Level	CableAntenna Loss	Preamp Factor	A/Pos	T/Pos	Remark	Pol/Phase	
	MHz	dBuV/m	dBuV/m	dB	dBuV	dB	dB/m	dB	cm	deg		
1	2390.00	48.79	54.00	-5.21	15.69	5.20	27.90	0.00	300	182	Average	VERTICAL
2	2390.00	58.95	74.00	-15.05	25.85	5.20	27.90	0.00	300	182	Peak	VERTICAL
3	2431.55	108.67			75.55	5.26	27.86	0.00	300	182	Peak	VERTICAL
4	2436.04	98.82			65.69	5.27	27.86	0.00	300	182	Average	VERTICAL
5	2483.50	48.81	54.00	-5.19	15.66	5.34	27.81	0.00	300	182	Average	VERTICAL
6	2483.50	58.54	74.00	-15.46	25.39	5.34	27.81	0.00	300	182	Peak	VERTICAL

Item 3, 4 are the fundamental frequency at 2437 MHz.

**Channel 11**

	Freq	Level	Limit Line	Over Limit	Read Level	CableAntenna Loss	Preamp Factor	A/Pos	T/Pos	Remark	Pol/Phase	
	MHz	dBuV/m	dBuV/m	dB	dBuV	dB	dB/m	dB	cm	deg		
1	2458.31	99.01			65.87	5.30	27.84	0.00	300	182	Average	VERTICAL
2	2458.31	108.91			75.77	5.30	27.84	0.00	300	182	Peak	VERTICAL
3	2483.50	51.96	54.00	-2.04	18.81	5.34	27.81	0.00	300	182	Average	VERTICAL
4	2483.64	67.70	74.00	-6.30	34.55	5.34	27.81	0.00	300	182	Peak	VERTICAL

Item 1, 2 are the fundamental frequency at 2462 MHz.

Note:

Emission level (dBuV/m) = 20 log Emission level (uV/m).

Corrected Reading: Antenna Factor + Cable Loss + Read Level - Preamp Factor = Level.





Plot on Configuration IEEE 802.11b / CH 1 / 2483.5MHz~26500MHz (down 30dBc)

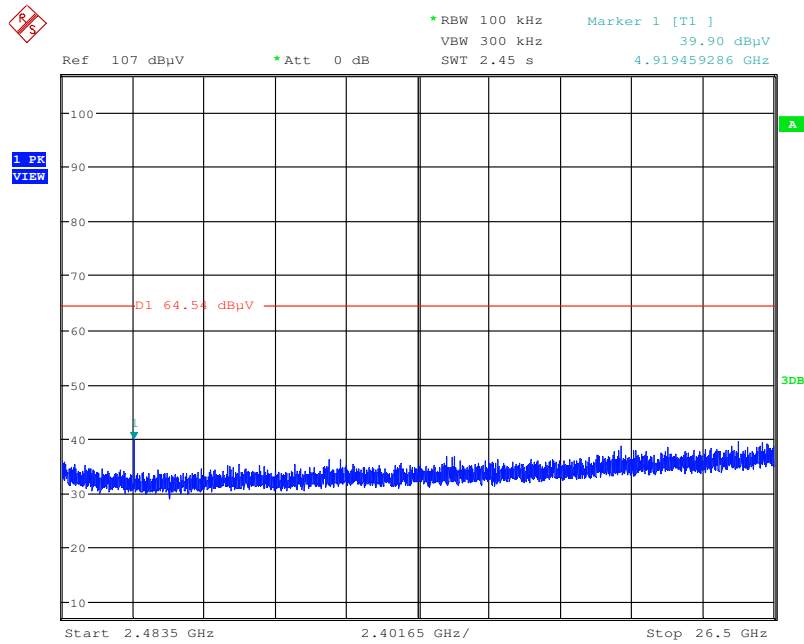

Date: 27.APR.2016 22:47:32

Plot on Configuration IEEE 802.11b / CH 11 / 30MHz~2400MHz (down 30dBc)

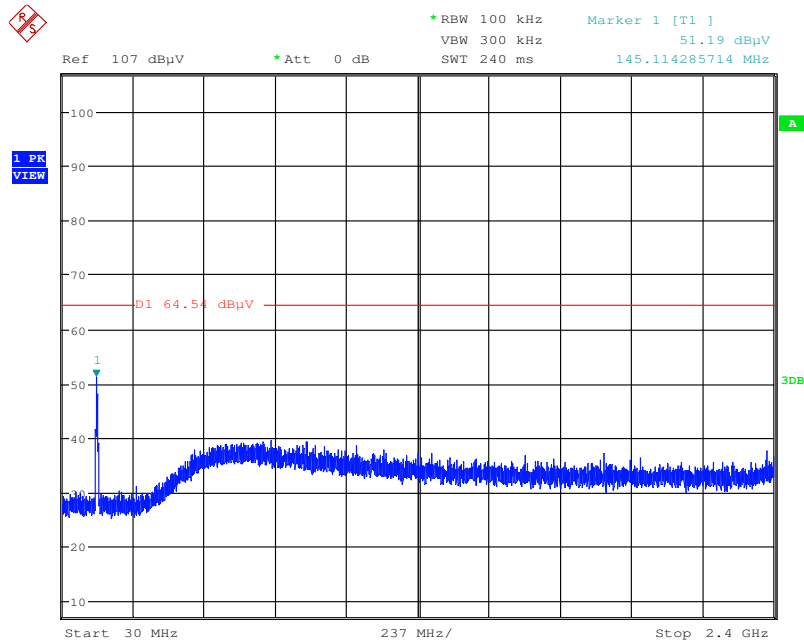

Date: 27.APR.2016 22:45:42



Plot on Configuration IEEE 802.11g / Reference Level

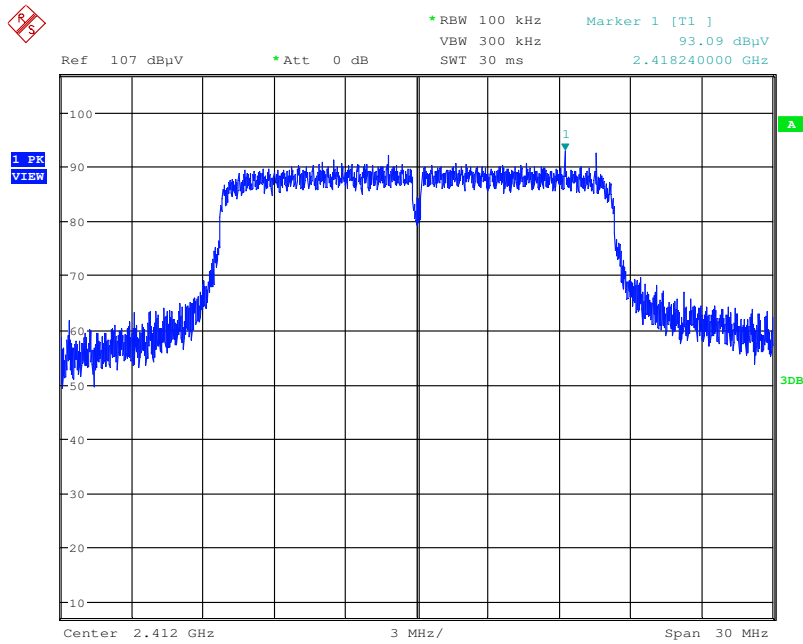

Date: 27.APR.2016 22:50:07

Plot on Configuration IEEE 802.11g / CH 1 / 30MHz~2400MHz (down 30dBc)

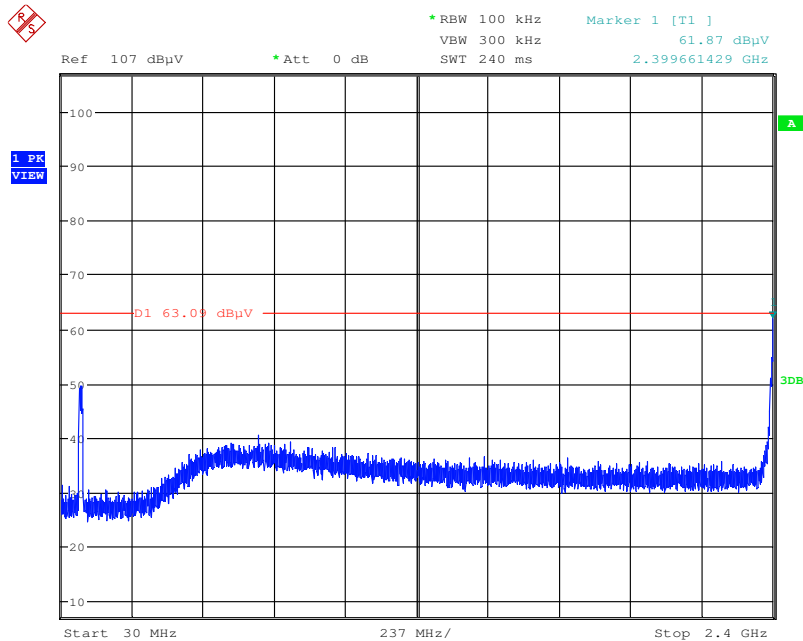

Date: 27.APR.2016 22:50:58



Plot on Configuration IEEE 802.11g / CH 11 / 2483.5MHz~26500MHz (down 30dBc)

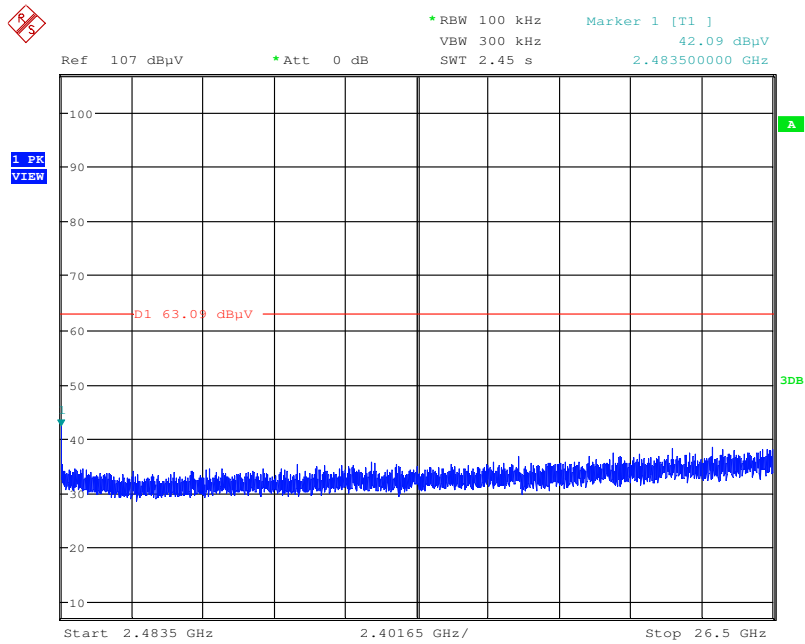

Date: 27.APR.2016 22:53:12



Plot on Configuration IEEE 802.11n MCS0 HT20 / CH 1 / 2483.5MHz~26500MHz (down 30dBc)

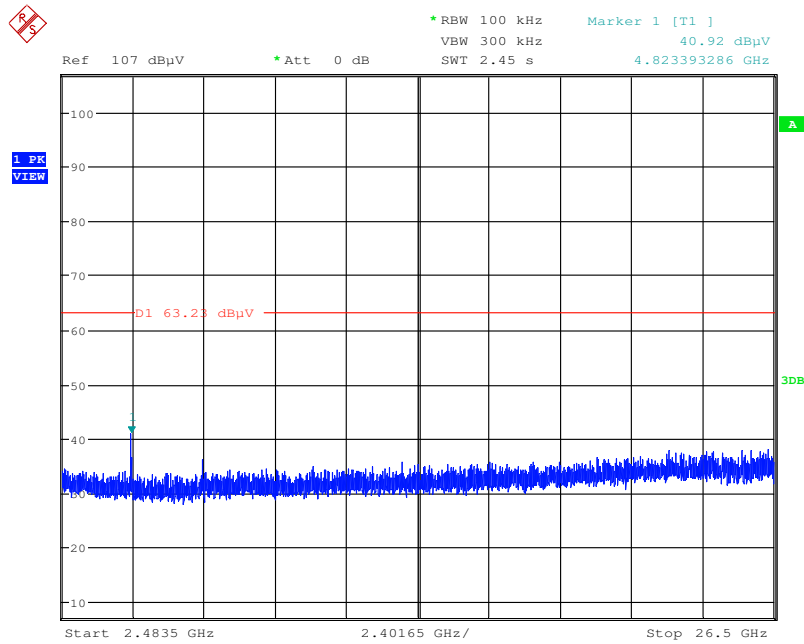

Date: 27.APR.2016 22:57:42

Plot on Configuration IEEE 802.11n MCS0 HT20 / CH 11 / 30MHz~2400MHz (down 30dBc)

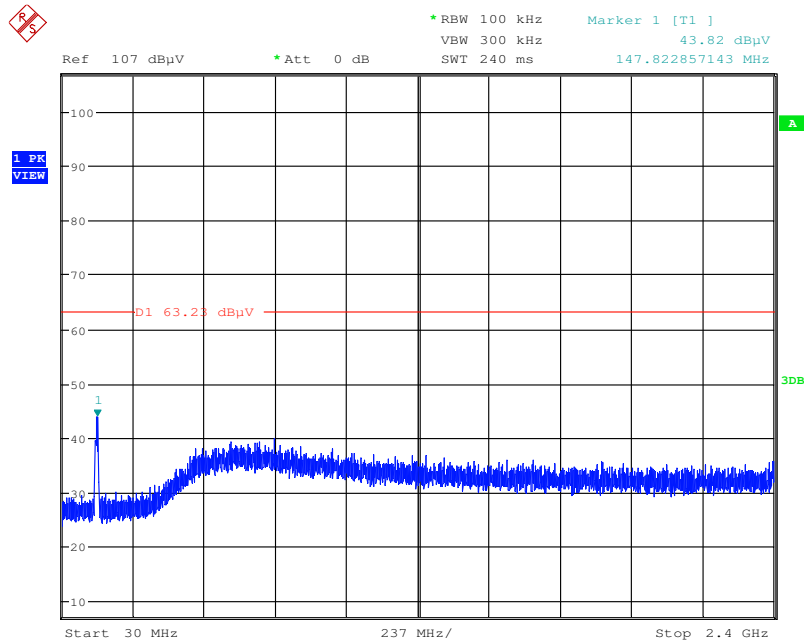

Date: 27.APR.2016 22:58:41



Plot on Configuration IEEE 802.11n MCS0 HT20 / CH 11 / 2483.5MHz~26500MHz (down 30dBc)

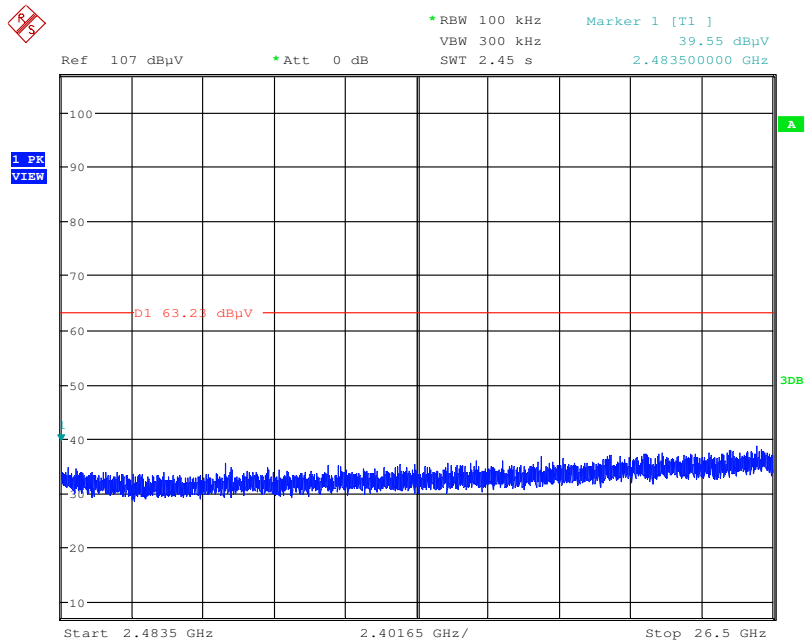

Date: 27.APR.2016 22:58:22

## 4.7. Antenna Requirements

### 4.7.1. Limit

Except for special regulations, the Low-power Radio-frequency Devices must not be equipped with any jacket for installing an antenna with extension cable. An intentional radiator shall be designed to ensure that no antenna other than that furnished by the responsible party shall be used with the device. The use of a permanently attached antenna or of an antenna that uses a unique coupling to the intentional radiator shall be considered sufficient to comply with the provisions of this Section. The manufacturer may design the unit so that the user can replace a broken antenna, but the use of a standard antenna jack or electrical connector is prohibited. Further, this requirement does not apply to intentional radiators that must be professionally installed.

### 4.7.2. Antenna Connector Construction

Please refer to section 3.3 in this test report; antenna connector complied with the requirements.

## 5. LIST OF MEASURING EQUIPMENTS

Instrument	Manufacturer	Model No.	Serial No.	Characteristics	Calibration Date	Remark
EMI Receiver	Agilent	N9038A	My52260123	9kHz ~ 8.45GHz	Jan. 27, 2016	Conduction (CO01-CB)
LISN	F.C.C.	FCC-LISN-50-16-2	04083	150kHz ~ 100MHz	Dec. 08, 2015	Conduction (CO01-CB)
LISN	Schwarzbeck	NSLK 8127	8127647	9kHz ~ 30MHz	Dec. 23, 2015	Conduction (CO01-CB)
COND Cable	Woken	Cable	01	150kHz ~ 30MHz	May 25, 2015	Conduction (CO01-CB)
Software	Audix	E3	6.120210n	-	N.C.R.	Conduction (CO01-CB)
BILOG ANTENNA	TESEQ	CBL6112D	37880	20MHz ~ 2GHz	Sep. 03, 2015	Radiation (03CH01-CB)
Horn Antenna	EMCO	3115	00075790	750MHz ~ 18GHz	Oct. 22, 2015	Radiation (03CH01-CB)
Horn Antenna	Schwarzbeck	BBHA 9170	BBHA9170252	15GHz ~ 40GHz	Jul. 21, 2015	Radiation (03CH01-CB)
Loop Antenna	Teseq	HLA 6120	24155	9kHz - 30 MHz	Mar. 16, 2016*	Radiation (03CH01-CB)
Pre-Amplifier	Agilent	8447D	2944A10991	0.1MHz ~ 1.3GHz	Mar. 15, 2016	Radiation (03CH01-CB)
Pre-Amplifier	Agilent	8449B	3008A02310	1GHz ~ 26.5GHz	Jan. 18, 2016	Radiation (03CH01-CB)
Pre-Amplifier	WM	TF-130N-R1	923365	26GHz ~ 40GHz	Nov. 13, 2015	Radiation (03CH01-CB)
Spectrum Analyzer	R&S	FSP40	100056	9kHz ~ 40GHz	Oct. 27, 2015	Radiation (03CH01-CB)
EMI Receiver	Agilent	N9038A	MY52260123	9kHz ~ 8.4GHz	Jan. 27, 2016	Radiation (03CH01-CB)
RF Cable-low	Woken	Low Cable-1	N/A	30 MHz ~ 1 GHz	Nov. 02, 2015	Radiation (03CH01-CB)
RF Cable-high	Woken	High Cable-16	N/A	1 GHz ~ 18 GHz	Nov. 02, 2015	Radiation (03CH01-CB)
RF Cable-high	Woken	High Cable-17	N/A	1 GHz ~ 18 GHz	Nov. 02, 2015	Radiation (03CH01-CB)
RF Cable-high	Woken	High Cable-40G-1	N/A	18GHz ~ 40 GHz	Nov. 02, 2015	Radiation (03CH01-CB)
RF Cable-high	Woken	High Cable-40G-2	N/A	18GHz ~ 40 GHz	Nov. 02, 2015	Radiation (03CH01-CB)
Test Software	Audix	E3	6.2009-10-7	N/A	N/A	Radiation (03CH01-CB)
Spectrum analyzer	R&S	FSV40	100979	9kHz~40GHz	Dec. 09, 2015	Conducted (TH01-CB)
RF Cable-high	Woken	RG402	High Cable-6	1 GHz ~ 26.5 GHz	Nov. 02, 2015	Conducted (TH01-CB)



Instrument	Manufacturer	Model No.	Serial No.	Characteristics	Calibration Date	Remark
RF Cable-high	Woken	RG402	High Cable-7	1 GHz – 26.5 GHz	Nov. 02, 2015	Conducted (TH01-CB)
RF Cable-high	Woken	RG402	High Cable-8	1 GHz – 26.5 GHz	Nov. 02, 2015	Conducted (TH01-CB)
RF Cable-high	Woken	RG402	High Cable-9	1 GHz – 26.5 GHz	Nov. 02, 2015	Conducted (TH01-CB)
RF Cable-high	Woken	RG402	High Cable-10	1 GHz – 26.5 GHz	Nov. 02, 2015	Conducted (TH01-CB)
Power Sensor	Agilent	U2021XA	MY53410001	50MHz~18GHz	Nov. 02, 2015	Conducted (TH01-CB)

Note: Calibration Interval of instruments listed above is one year.

“\*” Calibration Interval of instruments listed above is two years.

N.C.R. means Non-Calibration required.

## 6. MEASUREMENT UNCERTAINTY

Test Items	Uncertainty	Remark
Conducted Emission (150kHz ~ 30MHz)	3.2 dB	Confidence levels of 95%
Radiated Emission (30MHz ~ 1,000MHz)	3.6 dB	Confidence levels of 95%
Radiated Emission (1GHz ~ 18GHz)	3.7 dB	Confidence levels of 95%
Radiated Emission (18GHz ~ 40GHz)	3.5 dB	Confidence levels of 95%
Conducted Emission	1.7 dB	Confidence levels of 95%