

# **FCC REPORT**

## **(GSM & WCDMA)**

**Applicant:** SKY PHONE LLC

**Address of Applicant:** 1348 Washington Av. Suite 350, Miami Beach, FL33139

**Equipment Under Test (EUT)**

Product Name: 4G Smart Phone

Model No.: SKY Prestige

Trade mark: SKY DEVICES

**FCC ID:** 2ABOSSKYPRESTG

FCC CFR Title 47 Part 2

**Applicable standards:** FCC CFR Title 47 Part 22 Subpart H  
FCC CFR Title 47 Part 24 Subpart E

**Date of sample receipt:** 17 Sep., 2019

**Date of Test:** 18 Sep., to 31 Oct., 2019

**Date of report issued:** 01 Nov., 2019

**Test Result:** PASS\*

\* In the configuration tested, the EUT complied with the standards specified above.

Authorized Signature:



Bruce Zhang  
Laboratory Manager

This report details the results of the testing carried out on one sample. The results contained in this test report do not relate to other samples of the same product and does not permit the use of the CCIS product certification mark. The manufacturer should ensure that all products in series production are in conformity with the product sample detailed in this report.

This report may only be reproduced and distributed in full. If the product in this report is used in any configuration other than that detailed in the report, the manufacturer must ensure the new system complies with all relevant standards.

This document cannot be reproduced except in full, without prior written approval of the Company. Any unauthorized alteration, forgery or falsification of the content or appearance of this document is unlawful and offenders may be prosecuted to the fullest extent of the law. Unless otherwise stated the results shown in this test report refer only to the sample(s) tested and such sample(s) are retained for 90 days only.

## 2. Version

Version No.	Date	Description
00	01 Nov., 2019	Original

Tested by:

*Carey Chen*

Test Engineer

Date:

01 Nov., 2019

Reviewed by:

*Winner Zhang*

Project Engineer

Date:

01 Nov., 2019

## 3. Contents

	Page
<b>1. COVER PAGE</b> .....	<b>1</b>
<b>2. VERSION</b> .....	<b>2</b>
<b>3. CONTENTS</b> .....	<b>3</b>
<b>4. TEST SUMMARY</b> .....	<b>4</b>
<b>5. GENERAL INFORMATION</b> .....	<b>5</b>
5.1 CLIENT INFORMATION.....	5
5.2 GENERAL DESCRIPTION OF E.U.T.....	5
5.3 TEST MODES.....	7
5.4 DESCRIPTION OF TEST AUXILIARY EQUIPMENT.....	7
5.5 MEASUREMENT UNCERTAINTY.....	7
5.6 ADDITIONS TO, DEVIATIONS, OR EXCLUSIONS FROM THE METHOD.....	7
5.7 LABORATORY FACILITY.....	7
5.8 LABORATORY LOCATION.....	8
5.9 TEST INSTRUMENTS LIST.....	8
<b>6. TEST RESULTS</b> .....	<b>9</b>
6.1 CONDUCTED OUTPUT POWER, ERP AND EIRP.....	9
6.2 PEAK-TO-AVERAGE POWER RATIO.....	12
6.3 OCCUPY BANDWIDTH.....	15
6.4 MODULATION CHARACTERISTIC.....	23
6.5 OUT OF BAND EMISSION AT ANTENNA TERMINALS.....	23
6.6 FIELD STRENGTH OF SPURIOUS RADIATION MEASUREMENT.....	31
6.7 FREQUENCY STABILITY V.S. TEMPERATURE MEASUREMENT.....	36
6.8 FREQUENCY STABILITY V.S. VOLTAGE MEASUREMENT.....	40
<b>7 TEST SETUP PHOTO</b> .....	<b>43</b>
<b>8 EUT CONSTRUCTIONAL DETAILS</b> .....	<b>44</b>

## 4. Test Summary

Test Item	Section in CFR 47	Result
RF Exposure (SAR)	Part 1.1307 Part 2.1093	Pass (Please refer to SAR Report)
RF Output Power	Part 2.1046 Part 22.913 (a)(5) Part 24.232 (c)	Pass
Peak-to-Average Power Ratio	Part 24.232 (d)	Pass
Modulation Characteristics	Part 2.1047	Pass
99% & -26 dB Occupied Bandwidth	Part 2.1049 Part 22.917(b) Part 24.238(b)	Pass
Out of band emission at antenna terminals	Part 2.1053 Part 22.917 (a) Part 24.238 (a)	Pass
Field strength of spurious radiation	Part 22.917 (a) Part 24.238 (a)	Pass
Frequency stability vs. temperature	Part 22.355 Part 24.235 Part 2.1055(a)(1)(b)	Pass
Frequency stability vs. voltage	Part 22.355 Part 24.235 Part 2.1055(d)(2)	Pass
<b>Remark:</b> 1. Pass: The EUT complies with the essential requirements in the standard. 2. The cable insertion loss used by "RF Output Power" and other conduction measurement items is 0.5dB (provided by the customer).		
<b>Test Method:</b>	ANSI/TIA-603-E-2016 ANSI C63.26-2015	

## 5. General Information

### 5.1 Client Information

Applicant:	SKY PHONE LLC
Address:	1348 Washington Av. Suite 350, Miami Beach, FL33139
Manufacturer:	SKY PHONE LLC
Address:	1348 Washington Av. Suite 350, Miami Beach, FL33139
Factory:	GUIZHOU HANRAY ELECTRONICS CO., LTD.
Address:	West No. 9 Road, Industrial Park Xixiu District Anshun, Guizhou 56100, China

### 5.2 General Description of E.U.T.

Product Name:	4G Smart Phone
Model No.:	SKY Prestige
Operation Frequency range:	GSM 850: 824.20MHz-848.80MHz PCS1900: 1850.20MHz-1909.80MHz WCDMA Band V: 826.4MHz-846.6MHz WCDMA Band II: 1852.4 MHz-1907.6 MHz
Modulation type:	GSM/GPRS: GMSK, UMTS: QPSK, EGPRS: 8PSK
Antenna type:	Internal Antenna
Antenna gain:	GSM 850: 0.9 dBi PCS 1900: 0.95 dBi WCDMA Band V: 0.9 dBi WCDMA Band II: 0.95 dBi
Power supply:	Rechargeable Li-ion Battery DC3.7V-2000mAh
AC adapter:	Model: SKY Prestige Input: AC100-240V, 50/60Hz, 0.2A Output: DC 5.0V, 1A
Test Sample Condition:	The test samples were provided in good working order with no visible defects.

**Operation Frequency List:**

GSM 850		PCS1900	
Channel	Frequency (MHz)	Channel	Frequency (MHz)
128	824.20	512	1850.20
129	824.40	513	1850.40
....	....	....	....
189	836.40	660	1879.80
190	836.60	661	1880.00
191	836.80	662	1880.20
...	...	...	...
250	848.60	809	1909.60
251	848.80	810	1909.80
WCDMA Band V		WCDMA Band II	
Channel	Frequency (MHz)	Channel	Frequency (MHz)
4132	826.40	9262	1852.40
4133	826.60	9263	1852.60
....	....	....	....
4182	836.40	9399	1879.80
4183	836.60	9400	1880.00
4184	836.80	9401	1880.20
...	...	...	...
4232	846.40	9537	1907.40
4233	846.60	9538	1907.60

Regards to the operating frequency range over 10 MHz, the Lowest frequency, the middle frequency, and the highest frequency of channel were selected to perform the test, and the selected channel see below:

GSM850			PCS1900		
Channel	Frequency(MHz)	Channel	Frequency(MHz)		
Lowest	128	824.20	Lowest	512	1850.20
Middle	190	836.60	Middle	661	1880.00
Highest	251	848.80	Highest	810	1909.80
WCDMA Band V			WCDMA Band II		
Channel	Frequency(MHz)	Channel	Frequency(MHz)		
Lowest	4132	826.40	Lowest	9262	1852.40
Middle	4183	836.60	Middle	9400	1880.00
Highest	4233	846.60	Highest	9538	1907.60

## 5.3 Test modes

Operating Environment:	
Temperature:	Normal: 15°C ~ 35°C, Extreme: -30°C ~ +50°C
Humidity:	20 % ~ 75 % RH
Atmospheric Pressure:	1008 mbar
Voltage:	Nominal: 3.7Vdc, Extreme: Low 3.5 Vdc, High 4.2 Vdc
Test mode:	
GSM mode	Keep the EUT communication with simulated station in GSM mode
GPRS mode	Keep the EUT communication with simulated station in GPRS mode
EGPRS mode	Keep the EUT communication with simulated station in EGPRS mode
RMC mode	Keep the EUT communication with simulated station in RMC mode
HSDPA	Keep the EUT communication with simulated station in HSDPA mode
HSUPA	Keep the EUT communication with simulated station in HSUPA mode
Remark: The EUT has been tested under continuous transmitting mode. Channel Low, Mid and High for each type band with rated data rate were chosen for full testing. The field strength of spurious radiation emission was measured as EUT stand-up position (H mode) and lie down position (E1, E2 mode) for these modes with power adaptor, earphone and Data cable. Just the worst case position (H mode) shown in report.	

## 5.4 Description of Test Auxiliary Equipment

Test Equipment	Manufacturer	Model No.	Serial No.
Simulated Station	Anritsu	MT8820C	6201026545

## 5.5 Measurement Uncertainty

Parameters	Expanded Uncertainty
Radiated Emission (9kHz ~ 30MHz)	±3.12 dB (k=2)
Radiated Emission (30MHz ~ 1000MHz)	±4.32 dB (k=2)
Radiated Emission (1GHz ~ 18GHz)	±5.38 dB (k=2)
Radiated Emission (18GHz ~ 40GHz)	±3.36 dB (k=2)

## 5.6 Additions to, deviations, or exclusions from the method

No
----

## 5.7 Laboratory Facility

<p>The test facility is recognized, certified, or accredited by the following organizations:</p> <ul style="list-style-type: none"> <li>● <b>FCC - Designation No.: CN1211</b> Shenzhen Zhongjian Nanfang Testing Co., Ltd. has been accredited as a testing laboratory by FCC(Federal Communications Commission). The test firm Registration No. is 727551.</li> <li>● <b>ISED – CAB identifier.: CN0021</b> The 3m Semi-anechoic chamber of Shenzhen Zhongjian Nanfang Testing Co., Ltd. has been Registered by Certification and Engineering Bureau of Industry Canada for radio equipment testing with Registration No.: 10106A-1.</li> <li>● <b>CNAS - Registration No.: CNAS L6048</b> Shenzhen Zhongjian Nanfang Testing Co., Ltd. is accredited to ISO/IEC 17025:2005 General Requirements for the Competence of Testing and Calibration laboratories for the competence of testing. The Registration No. is CNAS L6048.</li> <li>● <b>A2LA - Registration No.: 4346.01</b> This laboratory is accredited in accordance with the recognized International Standard ISO/IEC 17025:2005 General requirements for the competence of testing and calibration laboratories. The test scope can be found as below link: <a href="https://portal.a2la.org/scopepdf/4346-01.pdf">https://portal.a2la.org/scopepdf/4346-01.pdf</a></li> </ul>
--

## 5.8 Laboratory Location

Shenzhen Zhongjian Nanfang Testing Co., Ltd. Address: No. B-C, 1/F., Building 2, Laodong No.2 Industrial Park, Xixiang Road, Bao'an District, Shenzhen, Guangdong, China Tel: +86-755-23118282, Fax: +86-755-23116366 Email: info@ccis-cb.com, Website: http://www.ccis-cb.com
--

## 5.9 Test Instruments list

Test Equipment	Manufacturer	Model No.	Serial No.	Cal. Date (mm-dd-yy)	Cal. Due date (mm-dd-yy)
3m SAC	SAEMC	9m*6m*6m	966	07-22-2017	07-21-2020
BiConiLog Antenna	SCHWARZBECK	VULB9163	497	03-18-2019	03-17-2020
Biconical Antenna	SCHWARZBECK	VUBA9117	359	06-22-2017	06-21-2020
Horn Antenna	SCHWARZBECK	BBHA9120D	916	03-18-2019	03-17-2020
Horn Antenna	SCHWARZBECK	BBHA9120D	1805	06-22-2017	06-21-2020
Horn Antenna	SCHWARZBECK	BBHA 9170	BBHA9170582	11-21-2018	11-20-2019
EMI Test Software	AUDIX	E3	Version: 6.110919b		
Pre-amplifier	HP	8447D	2944A09358	03-18-2019	03-17-2020
Pre-amplifier	CD	PAP-1G18	11804	03-18-2019	03-17-2020
Spectrum analyzer	Rohde & Schwarz	FSP30	101454	03-18-2019	03-17-2020
Spectrum analyzer	Rohde & Schwarz	FSP40	100363	11-21-2018	11-20-2019
EMI Test Receiver	Rohde & Schwarz	ESRP7	101070	03-18-2019	03-17-2020
Spectrum Analyzer	Agilent	N9020A	MY50510123	11-10-2018	11-09-2019
Signal Generator	Rohde & Schwarz	SMX	835454/016	03-18-2019	03-17-2020
Signal Generator	R&S	SMR20	1008100050	03-18-2019	03-17-2020
RF Switch Unit	MWRFTTEST	MW200	N/A	N/A	N/A
Test Software	MWRFTTEST	MTS8200	Version: 2.0.0.0		
Cable	ZDECL	Z108-NJ-NJ-81	1608458	03-18-2019	03-17-2020
Cable	MICRO-COAX	MFR64639	K10742-5	03-18-2019	03-17-2020
Cable	SUHNER	SUCOFLEX100	58193/4PE	03-18-2019	03-17-2020
DC Power Supply	XinNuoEr	WYK-10020K	1409050110020	10-31-2018	10-30-2019
Temperature Humidity Chamber	HengPu	HPGDS-500	20140828008	09-24-2018	09-23-2019
				09-24-2019	09-23-2020
Simulated Station	Rohde & Schwarz	CMW500	140493	07-16-2018	07-15-2019
				07-16-2019	07-15-2020



## 6. Test results

### 6.1 Conducted Output Power, ERP and EIRP

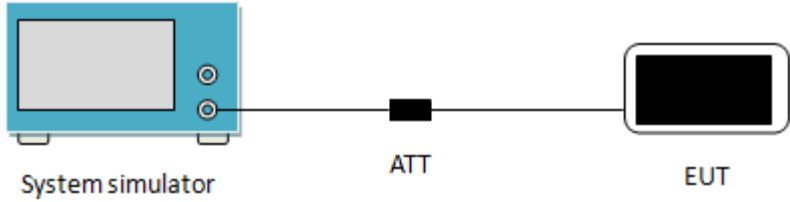
Test Requirement:	FCC part 22.913(a)(5), FCC part 24.232(c)
Limit:	GSM 850: 7W, PCS 1900: 2W WCDMA Band V: 7W, WCDMA Band II: 2W
Test setup:	 <p>The diagram illustrates the test setup. On the left is a blue 'System simulator' with a screen and two ports. A line connects one of its ports to a black rectangular 'ATT' (attenuator). Another line connects the other side of the 'ATT' to a black rectangular 'EUT' (Equipment Under Test).</p>
Test Procedure:	The transmitter output was connected to a calibrated attenuator, the other end of which was connected to the simulated station. Transmitter output power was read off in dBm.
Test Instruments:	Refer to section 5.9 for details
Test mode:	Refer to section 5.3 for details
Test results:	Passed

**Measurement Data:**

EUT Mode	Burst Average power (dBm)		
	128	190	251
	824.20 (MHz)	836.60 (MHz)	848.80 (MHz)
GSM 850	32.39	32.34	32.49
GPRS 850 (1 Uplink slot)	32.37	32.32	32.46
GPRS 850 (2 Uplink slot)	30.48	30.44	30.38
GPRS 850 (3 Uplink slot)	28.64	28.60	28.57
GPRS 850 (4 Uplink slot)	26.63	26.64	26.60
Antenna Gain (dBi)	0.90		
Max. ERP (dBm)	31.24		
ERP Limit (dBm)	38.45		
EGPRS 850 (1 Uplink slot)	25.40	25.63	25.54
EGPRS 850 (2 Uplink slot)	24.27	24.50	24.44
EGPRS 850 (3 Uplink slot)	22.22	22.45	22.26
EGPRS 850 (4 Uplink slot)	19.88	19.92	19.95
Antenna Gain (dBi)	0.90		
Max. ERP (dBm)	24.38		
ERP Limit (dBm)	38.45		
EUT Mode	Burst Average power (dBm)		
	512	661	810
	1850.20 (MHz)	1880.00 (MHz)	1909.80 (MHz)
PCS 1900	29.98	30.04	30.15
GPRS 1900 (1 Uplink slot)	29.96	30.02	30.16
GPRS 1900 (2 Uplink slot)	27.67	27.84	27.90
GPRS 1900 (3 Uplink slot)	26.22	26.38	26.46
GPRS 1900 (4 Uplink slot)	24.35	24.50	24.60
Antenna Gain (dBi)	0.95		
Max. EIRP (dBm)	31.11		
EIRP Limit (dBm)	33.00		
EGPRS 1900 (1 Uplink slot)	27.10	27.00	26.55
EGPRS 1900 (2 Uplink slot)	26.31	25.95	25.44
EGPRS 1900 (3 Uplink slot)	24.15	23.87	23.31
EGPRS 1900 (4 Uplink slot)	22.14	21.74	21.12
Antenna Gain (dBi)	0.95		
Max. EIRP (dBm)	28.05		
EIRP Limit (dBm)	33.00		
<i>Note: EIRP (dBm) = Burst Average power (dBm) + Antenna Gain (dBi).</i> <i>ERP (dBm) = EIRP (dBm) - 2.15 (dB).</i>			

EUT Mode		Burst Average power (dBm)		
		4132	4183	4233
		826.40 (MHz)	836.60 (MHz)	846.60 (MHz)
UMTS 850 HSDPA	Subtest 1	22.47	22.43	22.38
	Subtest 2	22.45	22.28	22.08
	Subtest 3	21.88	21.84	21.67
	Subtest 4	21.72	21.54	21.47
UMTS 850 HSUPA	Subtest 1	22.20	22.23	22.14
	Subtest 2	22.56	22.44	22.32
	Subtest 3	21.96	21.84	21.86
	Subtest 4	22.42	22.45	22.40
	Subtest 5	22.32	22.08	22.05
UMTS 850 RMC	12.2kbps	22.56	22.52	22.50
UMTS 850 AMR	12.2kbps	22.47	22.46	22.45
Antenna Gain (dBi)		0.90		
Max. ERP (dBm)		21.31		
ERP Limit (dBm)		38.45		
EUT Mode		Burst Average power (dBm)		
		9262	9400	9538
		1852.40 (MHz)	1880.00 (MHz)	1907.60 (MHz)
UMTS 1900 HSDPA	Subtest 1	22.68	22.80	22.52
	Subtest 2	22.55	22.61	22.42
	Subtest 3	22.24	22.32	22.64
	Subtest 4	21.93	21.98	21.84
UMTS 1900 HSUPA	Subtest 1	22.84	22.86	22.63
	Subtest 2	22.98	22.87	22.74
	Subtest 3	22.46	22.63	22.26
	Subtest 4	22.96	22.46	22.78
	Subtest 5	22.77	22.85	22.53
UMTS 1900 RMC	12.2kbps	23.04	23.03	23.02
UMTS 1900 AMR	12.2kbps	23.02	23.01	23.00
Antenna Gain (dBi)		0.95		
Max. EIRP (dBm)		23.99		
EIRP Limit (dBm)		33.00		
<p>Note: EIRP (dBm) = Burst Average power (dBm) + Antenna Gain (dBi).  ERP (dBm) = EIRP (dBm) - 2.15 (dB).</p>				

## 6.2 Peak-to-Average Power Ratio

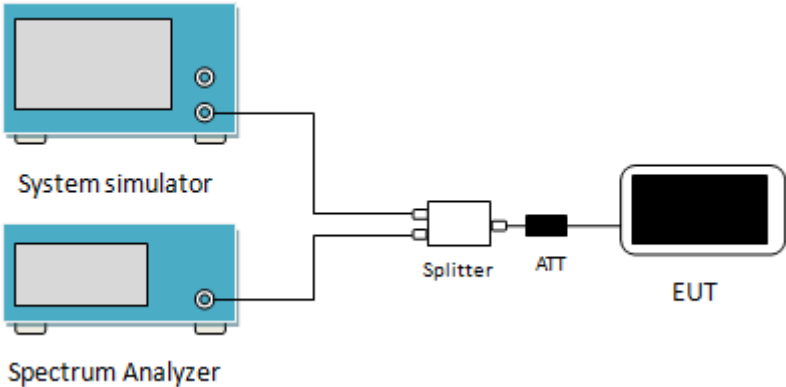
Test Requirement:	FCC part 24.232(d)
Limit:	The peak-to-average ratio (PAR) of the transmission may not exceed 13 dB.
Test setup:	 <p>The diagram shows a test setup for measuring PAR. On the left, there are two blue rectangular devices: a 'System simulator' on top and a 'Spectrum Analyzer' on the bottom. A single cable connects the right side of the System simulator to the left side of the Spectrum Analyzer. This cable then splits into two paths. One path goes to the left side of a 'Splitter' box. The other path goes to the left side of an 'ATT' (Attenuator) box. The right side of the Splitter is connected to the left side of the ATT. The right side of the ATT is connected to the left side of a black rectangular device labeled 'EUT' (Equipment Under Test).</p>
Test Procedure:	<ol style="list-style-type: none"> <li>1 The RF output of the transceiver was connected to a spectrum analyzer through appropriate attenuation.</li> <li>2 Set the CCDF option in spectrum analyzer, <math>RBW \geq OBW</math>,</li> <li>3 Set the EUT working in highest power level, measured and recorded the 0.1% as PAPR level.</li> <li>4 Repeat step 1~3 at other frequency and modulations.</li> </ol>
Test Instruments:	Refer to section 5.9 for details
Test mode:	Refer to section 5.3 for details
Test results:	Passed

### Measurement Data:

Modulation	Test channel	PAPR
GSM 850	190	0.10
EGPRS 850	190	0.19
PCS 1900	661	0.10
EGPRS 1900	661	0.29
UMTS 850 RMC	4183	2.76
UMTS 1900 RMC	9400	3.12

Test plots as below:

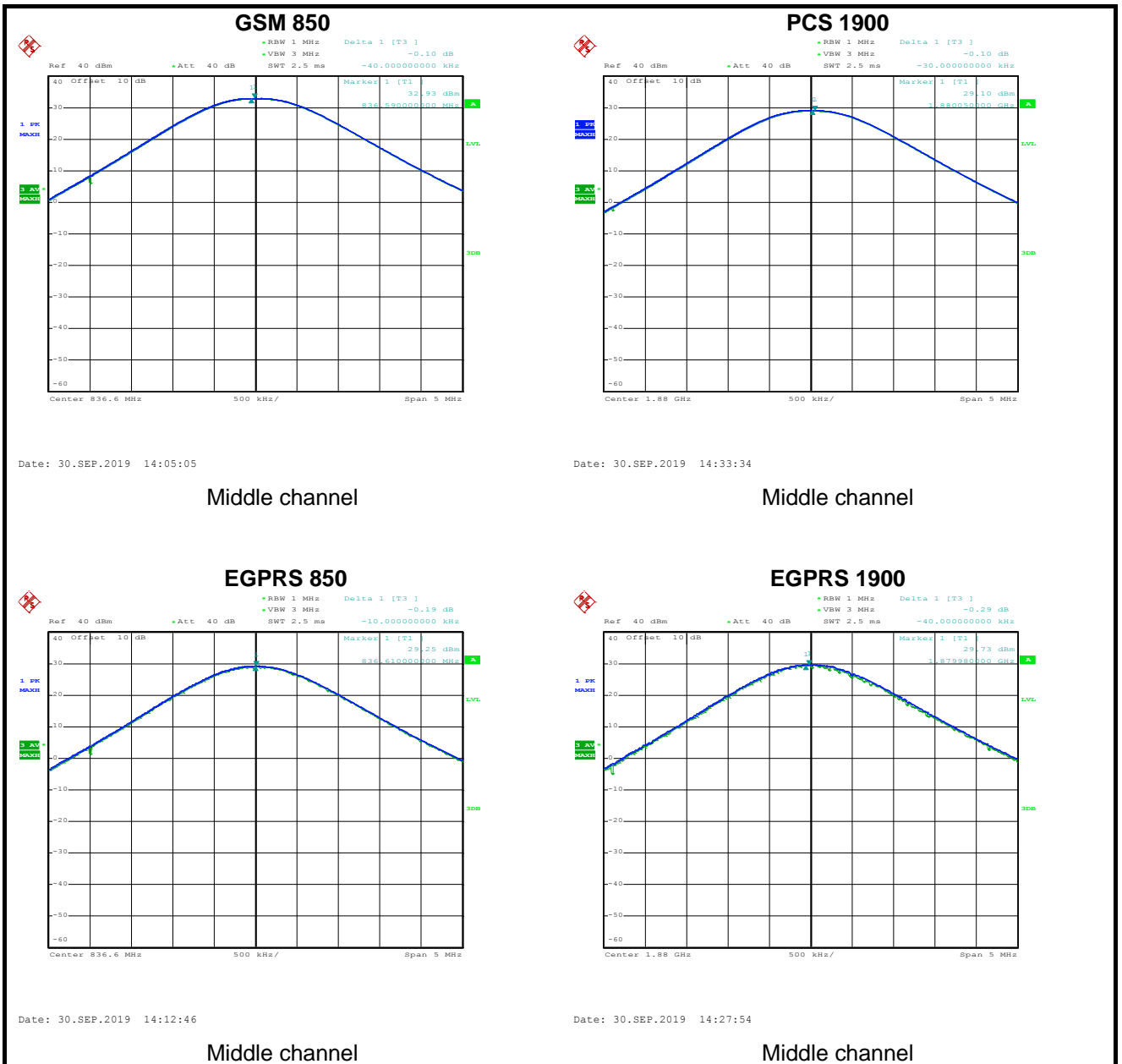

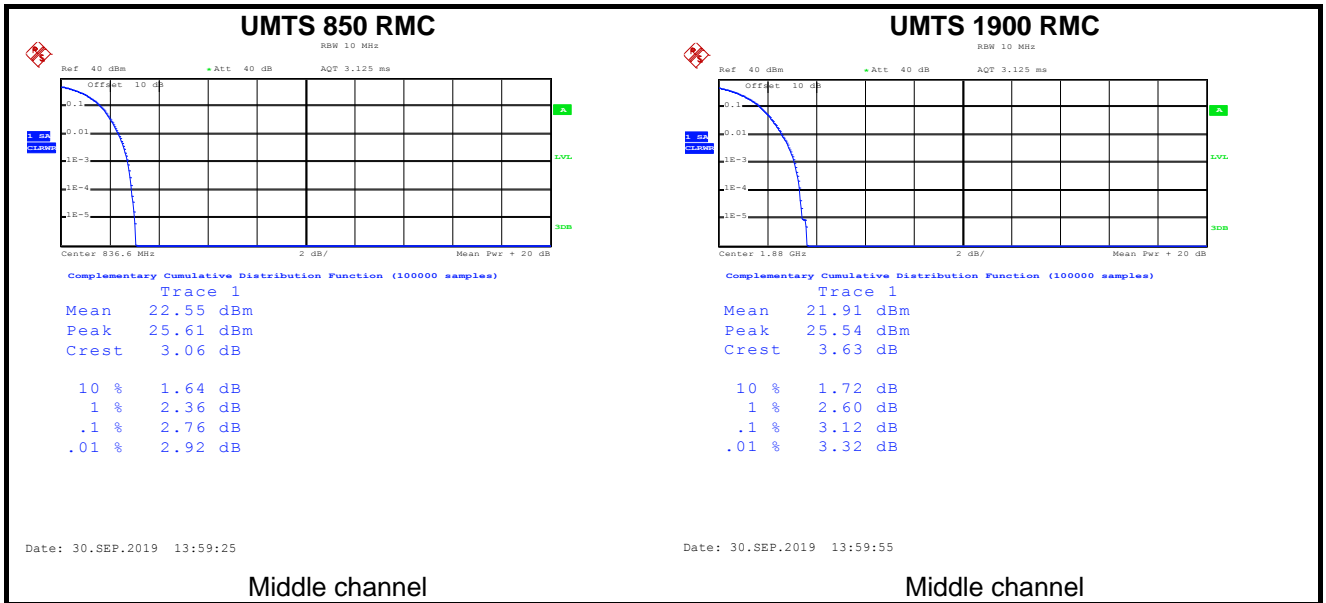

## 6.3 Occupy Bandwidth

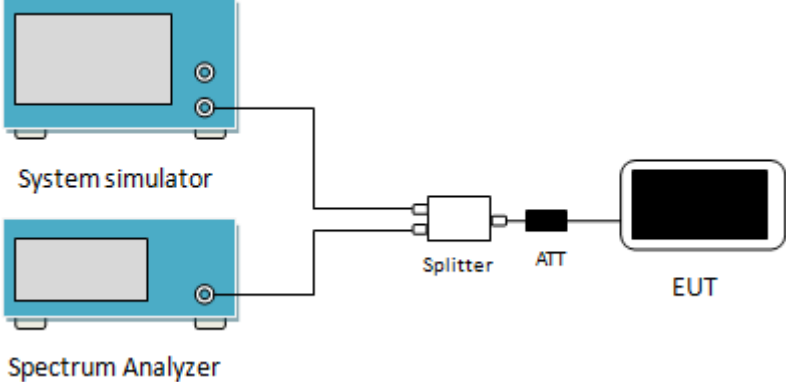
Test Requirement:	FCC part 22.917(b), FCC part 24.238(b)
Test setup:	 <p>The diagram shows a test setup. On the left, there are two blue rectangular units: the top one is labeled 'System simulator' and the bottom one is labeled 'Spectrum Analyzer'. Both have a screen and some control buttons. A cable connects the 'System simulator' to a white 'Splitter' box. Another cable connects the 'Spectrum Analyzer' to the same 'Splitter'. From the 'Splitter', one cable goes to a black 'ATT' (Attenuator) block, and another cable goes to a black 'EUT' (Equipment Under Test) block.</p>
Test Procedure:	<ol style="list-style-type: none"> <li>1. The EUT's output RF connector was connected with a short cable to the spectrum analyzer</li> <li>2. RBW was set to about 1% of emission BW, VBW= 3 times RBW.</li> <li>3. -26dBc display line was placed on the screen (or 99% bandwidth), the occupied bandwidth is the delta frequency between the two points where the display line intersects the signal trace.</li> </ol>
Test Instruments:	Refer to section 5.9 for details
Test mode:	Refer to section 5.3 for details
Test results:	Passed

**Measurement Data:**

EUT Mode	Channel	Frequency (MHz)	99% Occupy bandwidth (kHz)	-26dB bandwidth (kHz)
GSM 850	128	824.2	248	316
	190	836.6	248	318
	251	848.8	248	316
EGPRS850	128	824.2	242	304
	190	836.6	240	312
	251	848.8	246	304
PCS 1900	512	1850.2	242	312
	661	1880.0	250	320
	810	1909.8	246	318
EGPRS1900	512	1850.2	238	298
	661	1880.0	242	300
	810	1909.8	236	300
UMTS 850 12.2k RMC	4132	826.4	4160	4660
	4183	836.6	4180	4680
	4233	846.6	4160	4680
UMTS 1900 12.2k RMC	9262	1852.4	4160	4660
	9400	1880.0	4160	4680
	9538	1907.6	4160	4680

*Note:*

*GSM & GPRS use the same modulation technical (GMSK), and with the same channels, so the 99% OBW and the -26dB of GPRS not performed.*



Test plot as follows:

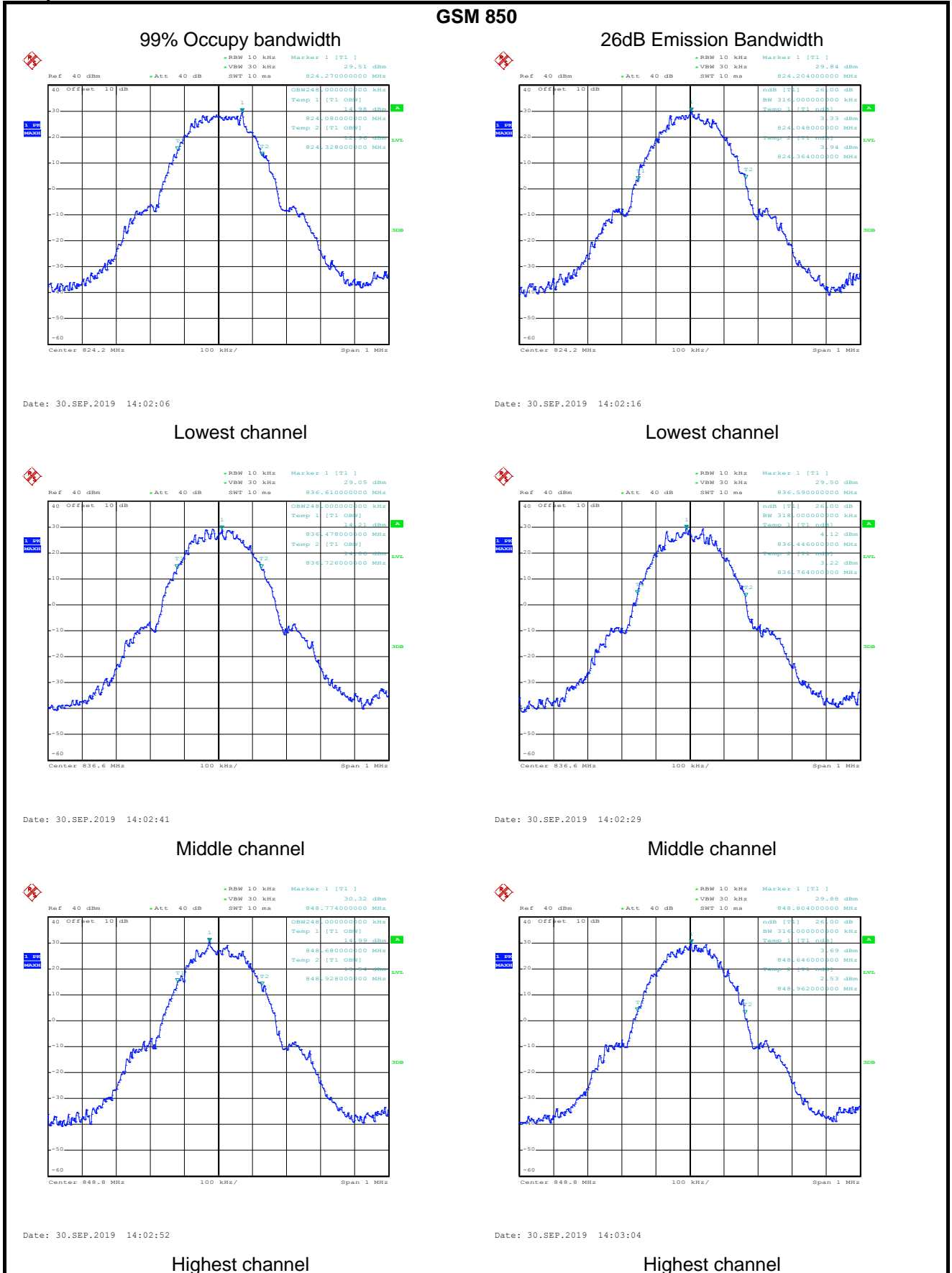

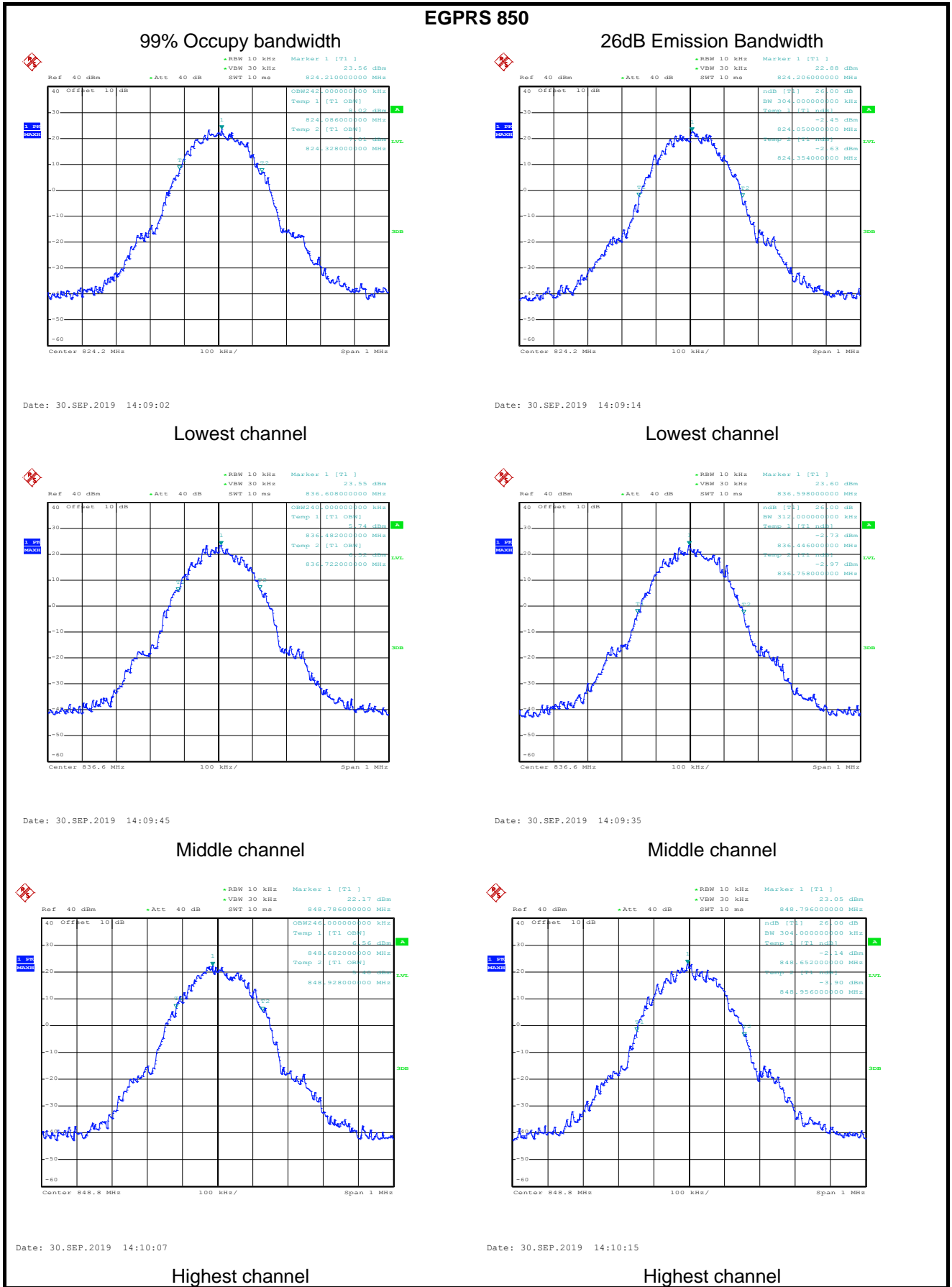

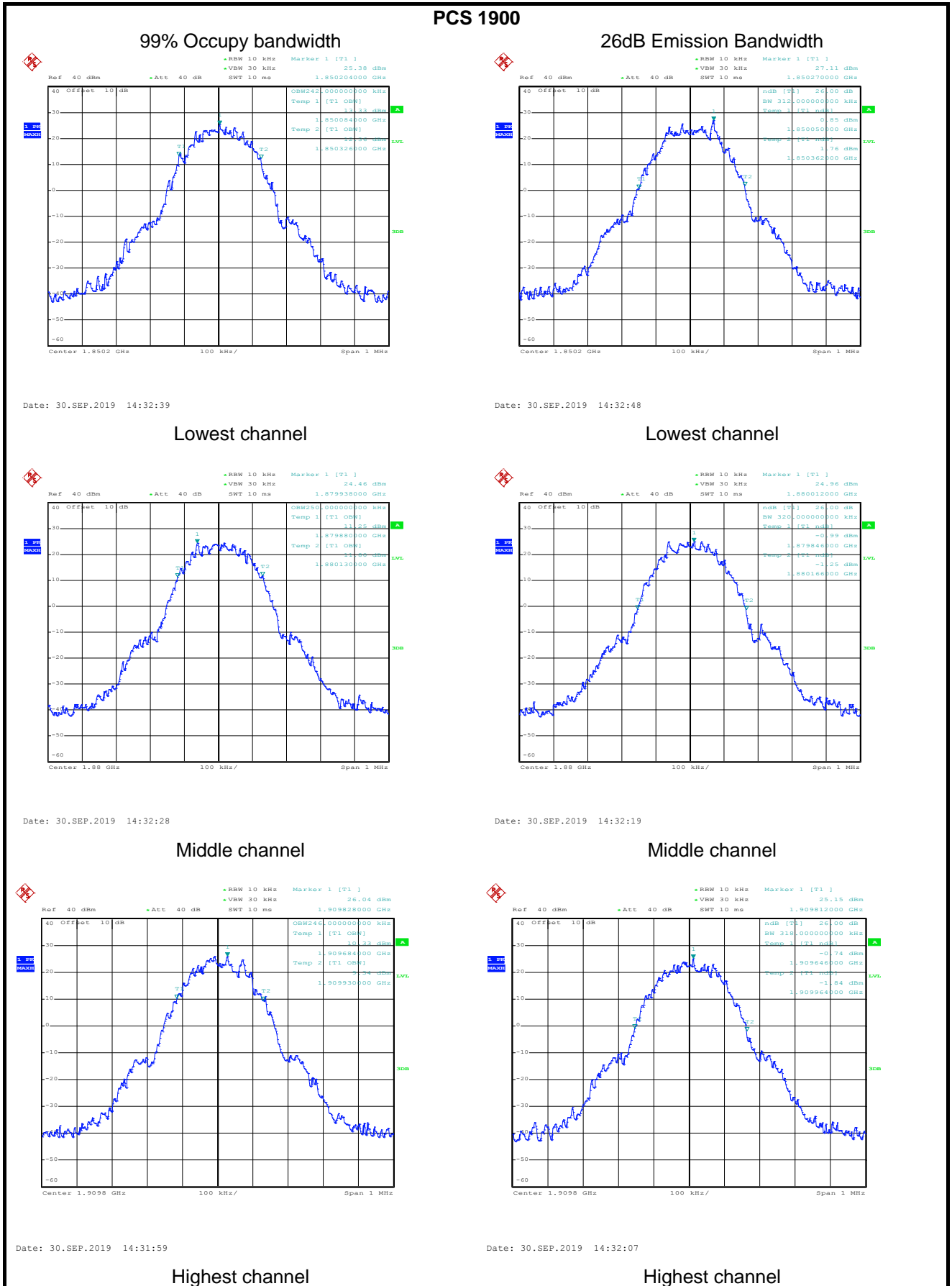

## EGPRS 1900

99% Occupy bandwidth

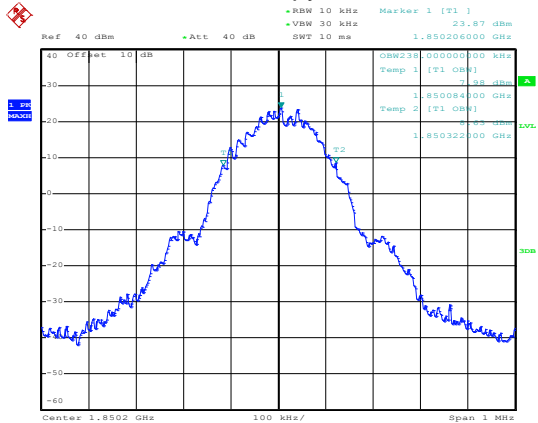

Date: 30.SEP.2019 14:29:02

26dB Emission Bandwidth

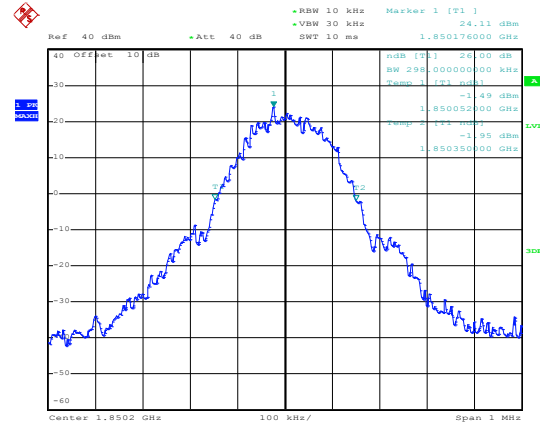

Date: 30.SEP.2019 14:28:51

Lowest channel

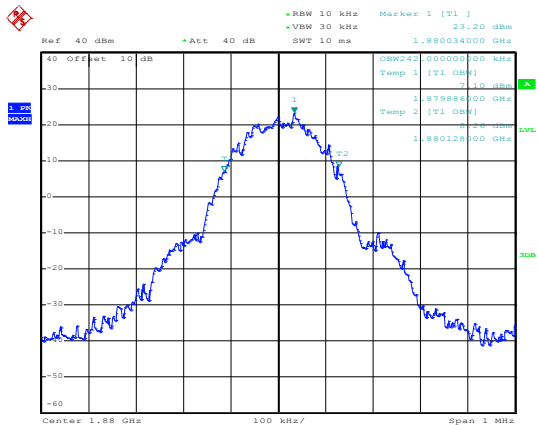

Date: 30.SEP.2019 14:28:14

Lowest channel

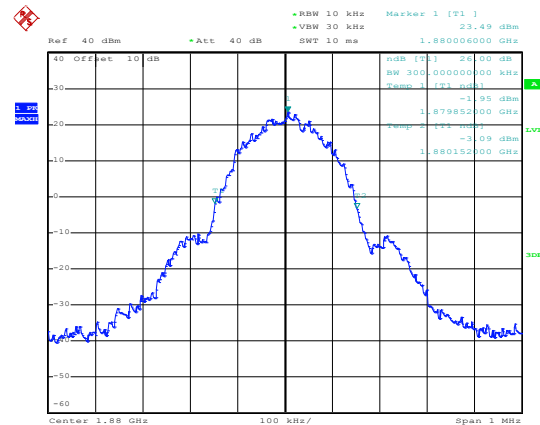

Date: 30.SEP.2019 14:28:26

Middle channel

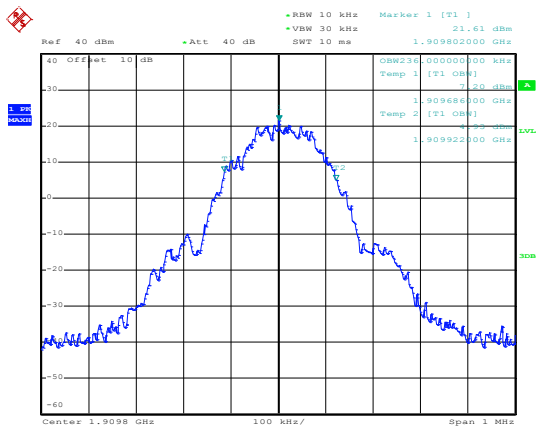

Date: 30.SEP.2019 14:29:15

Middle channel

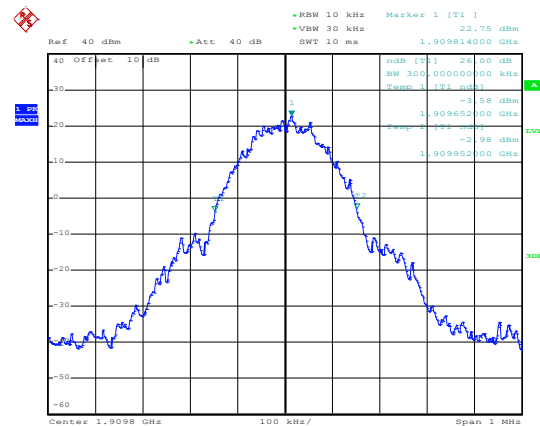

Date: 30.SEP.2019 14:29:25

Highest channel



## UMTS 850 12.2k RMC

99% Occupy bandwidth

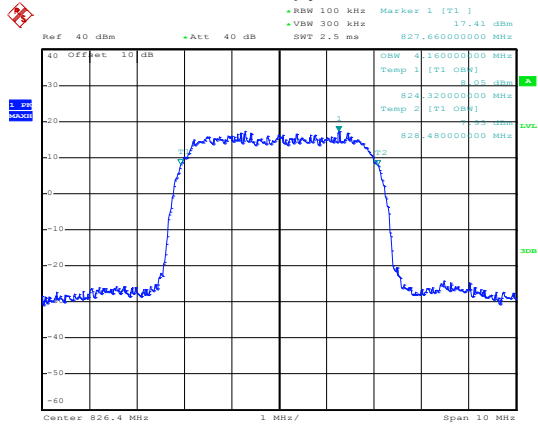

Date: 30.SEP.2019 13:52:55

26dB Emission Bandwidth

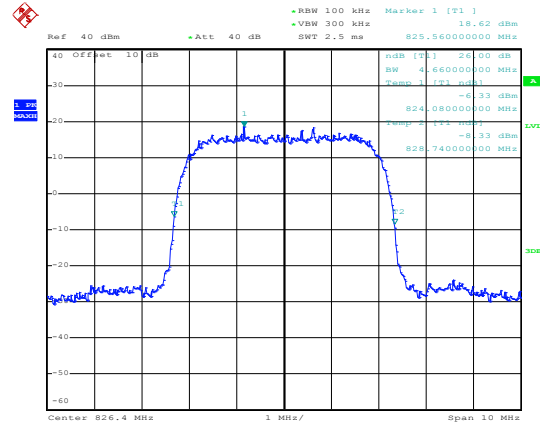

Date: 30.SEP.2019 13:53:05

Lowest channel

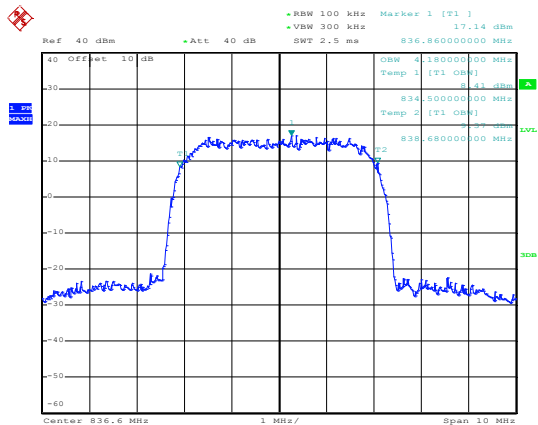

Date: 30.SEP.2019 13:52:44

Lowest channel

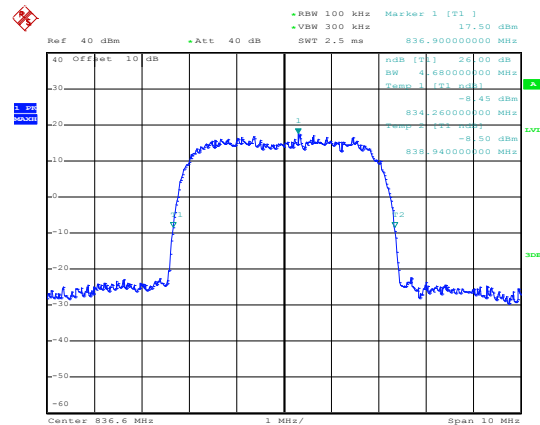

Date: 30.SEP.2019 13:52:38

Middle channel

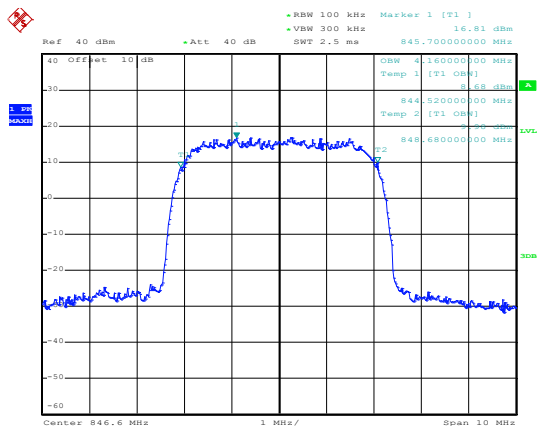

Date: 30.SEP.2019 13:52:14

Middle channel

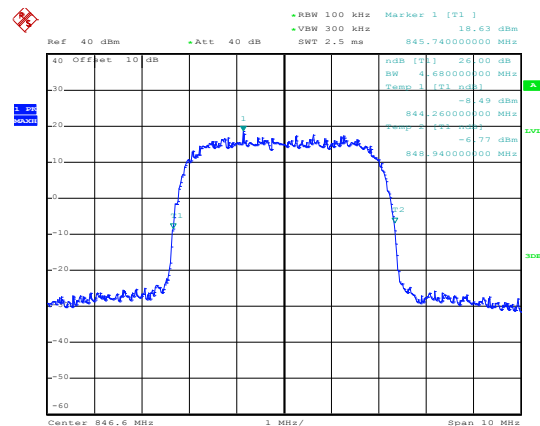

Date: 30.SEP.2019 13:52:22

Highest channel

Highest channel

## UMTS 1900 12.2k RMC

99% Occupy bandwidth

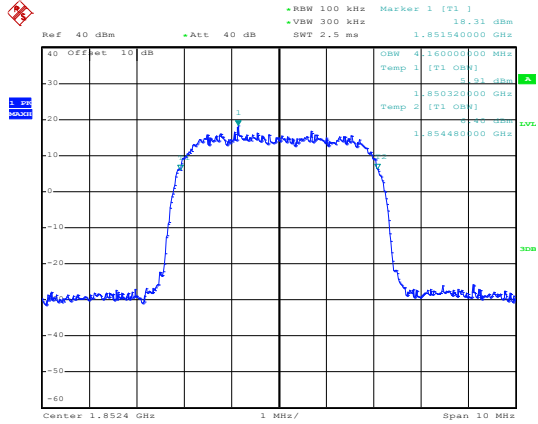

Date: 30.SEP.2019 13:54:28

26dB Emission Bandwidth

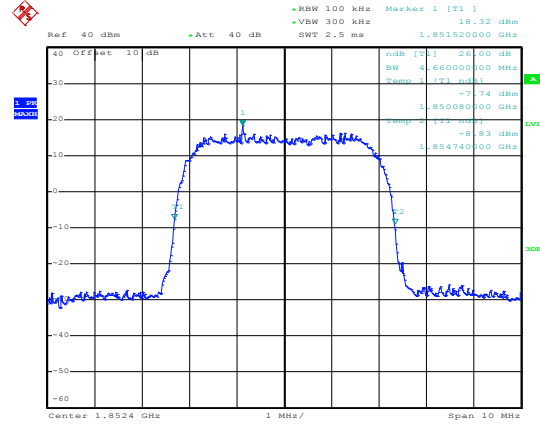

Date: 30.SEP.2019 13:54:22

Lowest channel

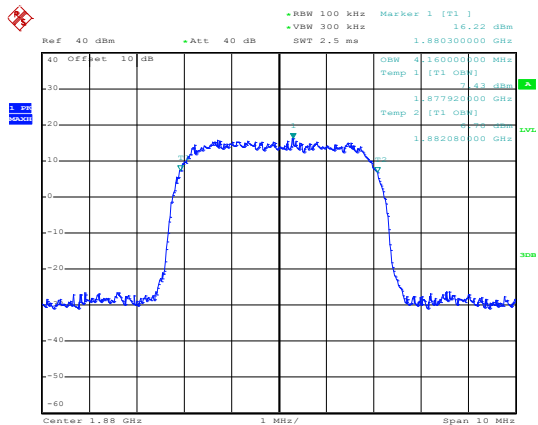

Date: 30.SEP.2019 13:53:58

Lowest channel

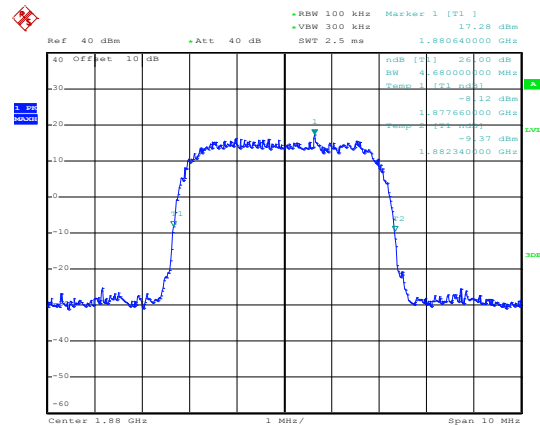

Date: 30.SEP.2019 13:54:06

Middle channel

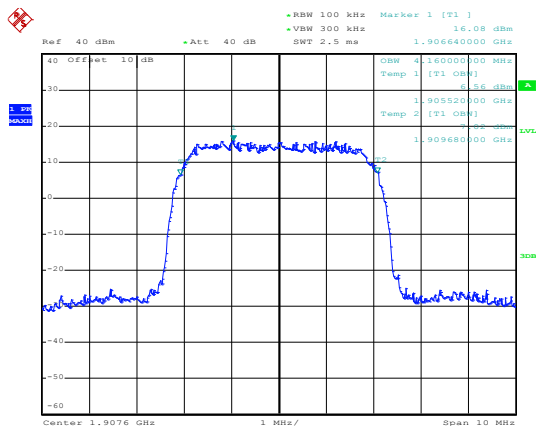

Date: 30.SEP.2019 13:53:47

Middle channel

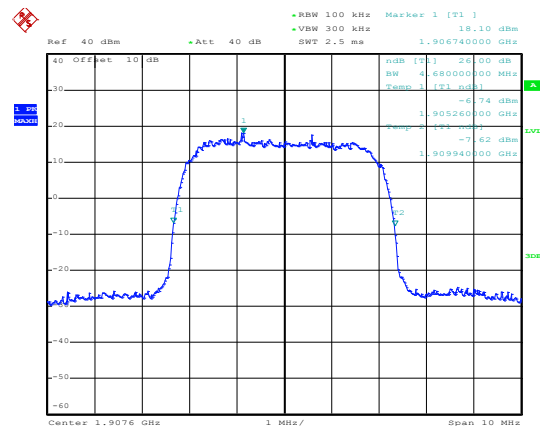

Date: 30.SEP.2019 13:53:40

Highest channel



Date: 30.SEP.2019 13:53:40

Highest channel

## 6.4 Modulation Characteristic

According to FCC § 2.1047(d), Part 22H & 24E there is no specific requirement for digital modulation, therefore modulation characteristic is not presented.

## 6.5 Out of band emission at antenna terminals

Test Requirement:	FCC part 22.917(a), FCC part 24.238(a)
Limit:	-13dBm
Test setup:	
Test Procedure:	<ol style="list-style-type: none"> <li>1 The RF output of the transceiver was connected to a spectrum analyzer through appropriate attenuation.</li> <li>2 The resolution bandwidth of the spectrum analyzer was set at 100 kHz when below 1GHz, 1MHz when above 1 GHz; sufficient scans were taken to show the out of band Emissions if any up to 10th harmonic.</li> <li>3 For the out of band: Set the RBW=100 kHz, VBW=300 kHz when below 1 GHz, RBW =1 MHz, VBW=3 MHz when above 1 GHz, Start=30MHz, Stop= 10th harmonic.</li> <li>4 Band Edge Requirements: In the 1 MHz bands immediately outside and adjacent to the frequency block, a resolution bandwidth of at least 1 percent of the emission bandwidth of the fundamental emission of the transmitter may be employed to measure the out of band Emissions.</li> </ol>
Test Instruments:	Refer to section 5.9 for details
Test mode:	Refer to section 5.3 for details
Test results:	Passed

Test plots as follows (Spurious emission):

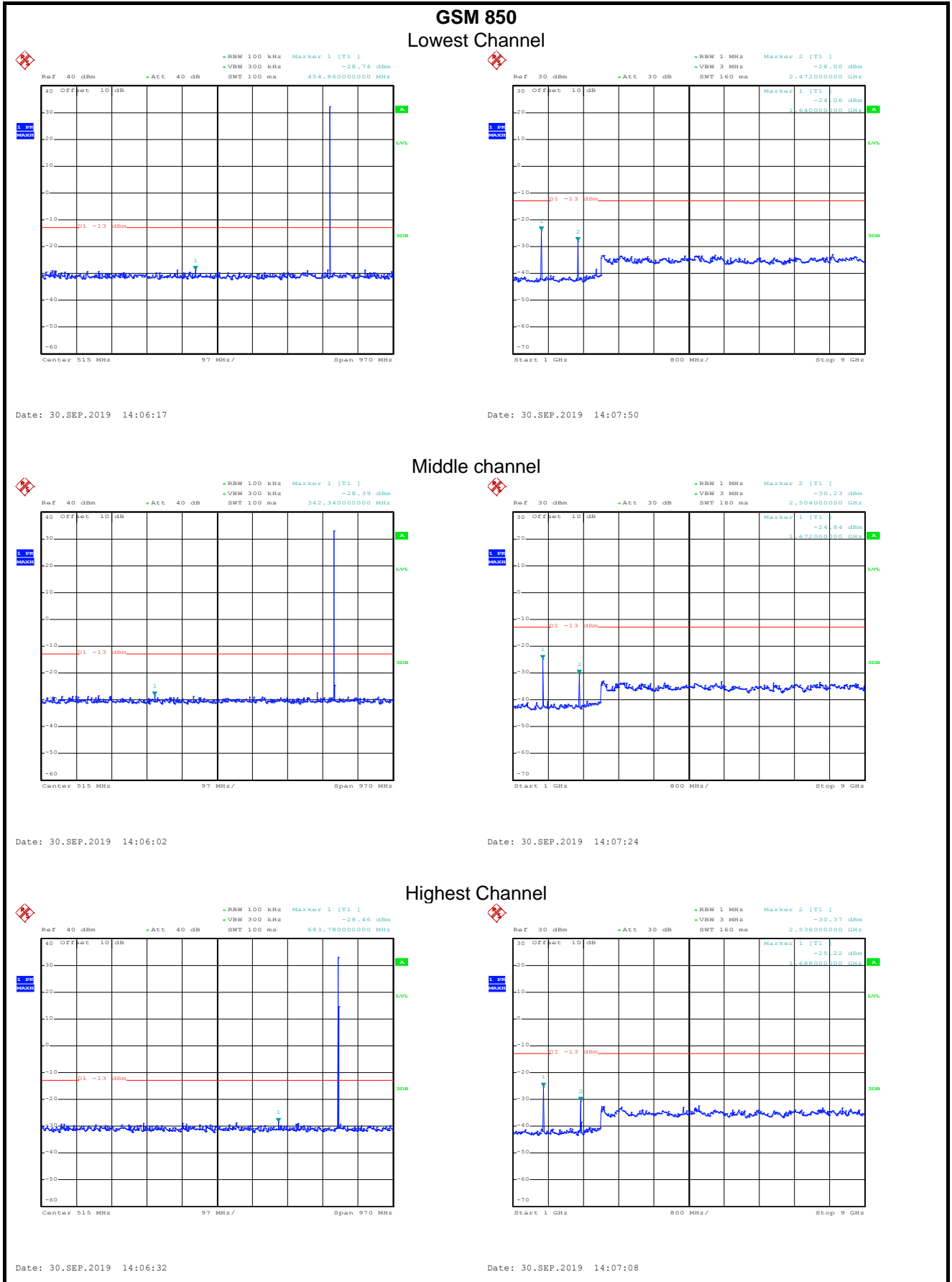



## PCS 1900 Lowest Channel

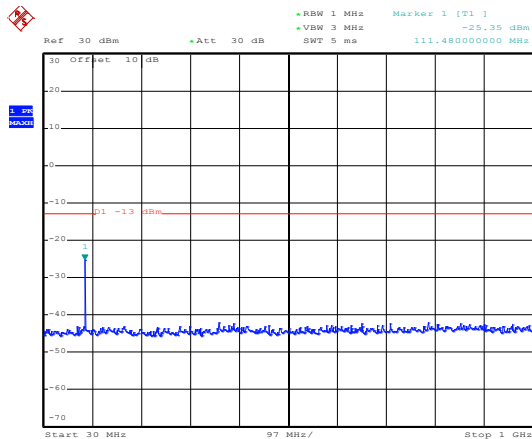

Date: 30.SEP.2019 14:34:19

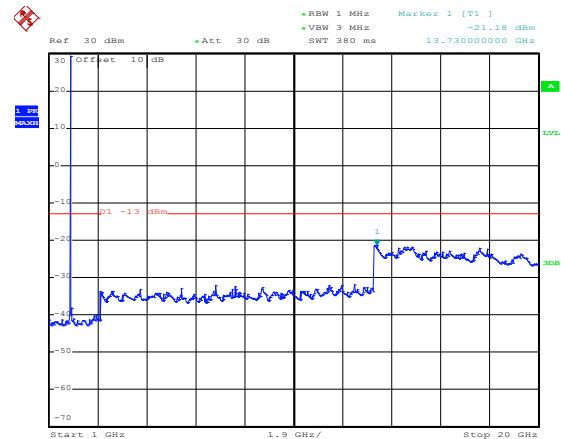

Date: 30.SEP.2019 14:35:45

## Middle Channel

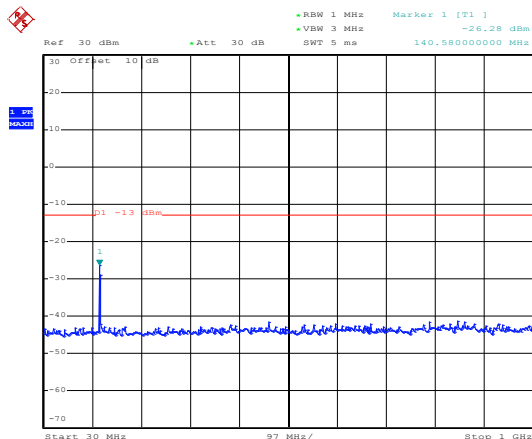

Date: 30.SEP.2019 14:34:08

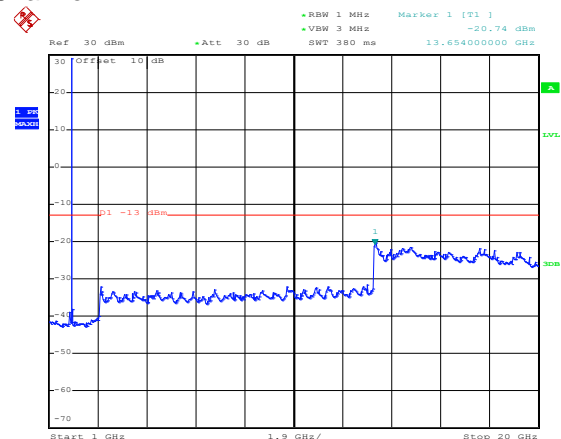

Date: 30.SEP.2019 14:35:26

## Highest Channel

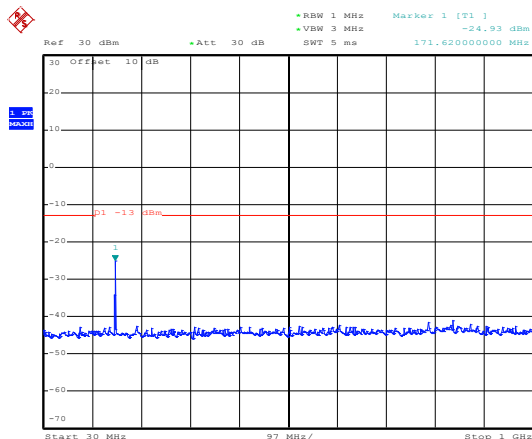

Date: 30.SEP.2019 14:34:31

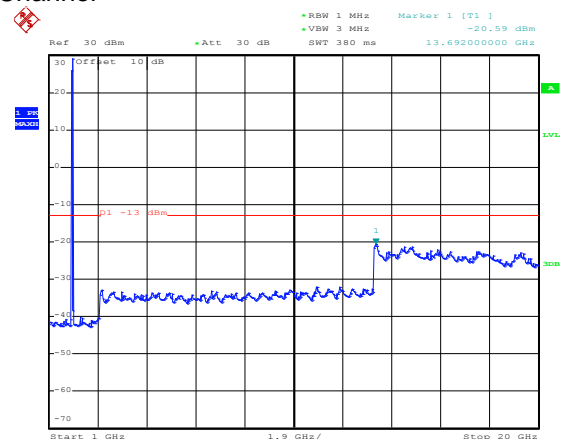

Date: 30.SEP.2019 14:35:00

## UMTS 850 12.2k RMC Lowest Channel

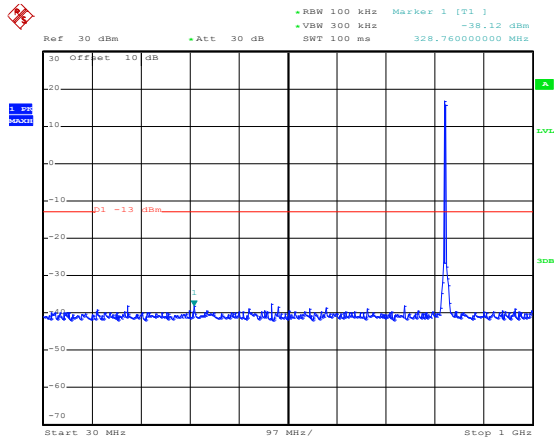

Date: 30.SEP.2019 13:58:47

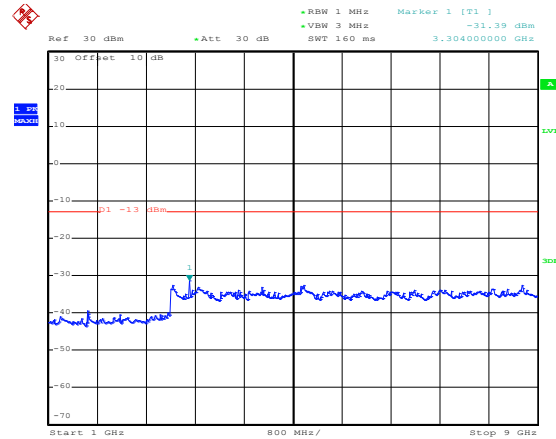

Date: 30.SEP.2019 13:57:18

## Middle Channel

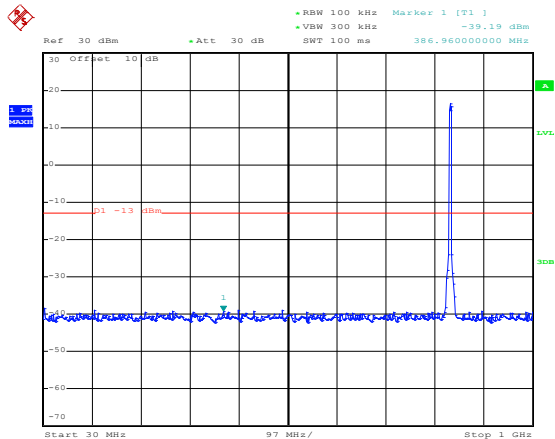

Date: 30.SEP.2019 13:58:30

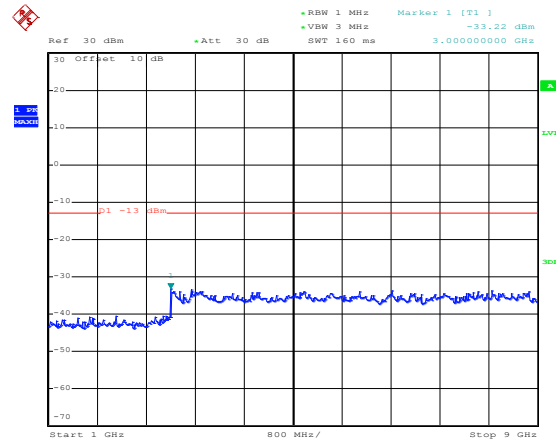

Date: 30.SEP.2019 13:57:32

## Highest Channel

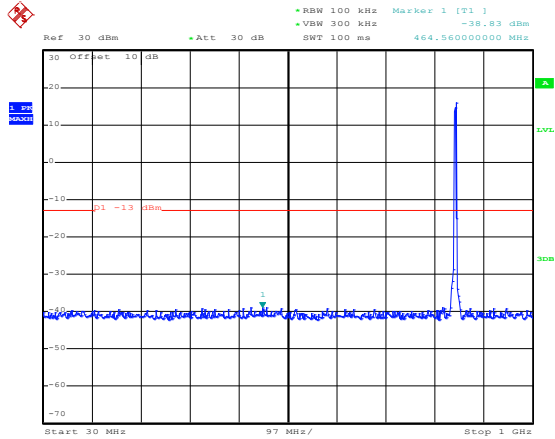

Date: 30.SEP.2019 13:58:11

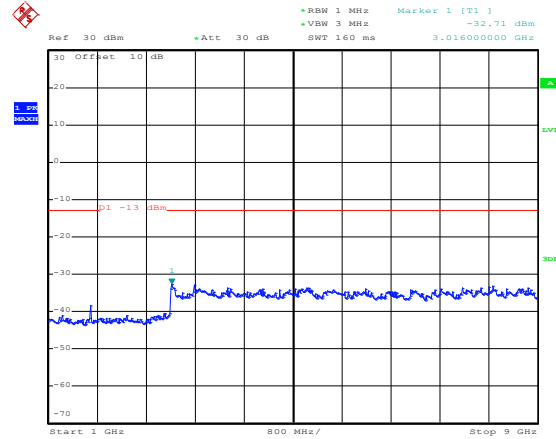

Date: 30.SEP.2019 13:57:50

## UMTS 1900 12.2k RMC Lowest Channel

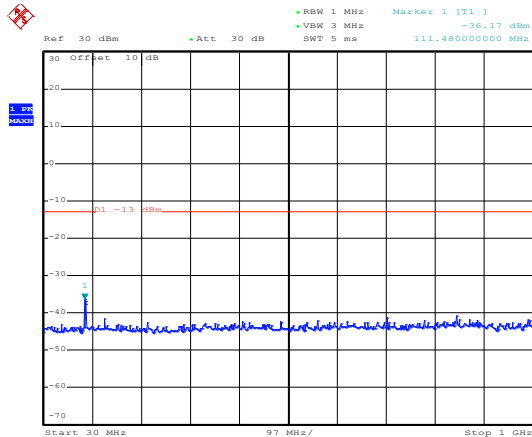

Date: 30.SEP.2019 13:55:13

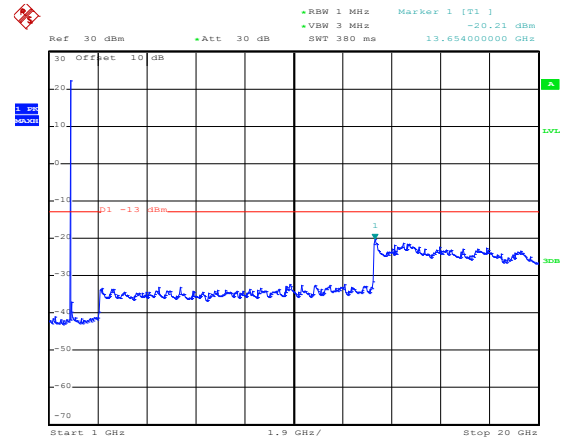

Date: 30.SEP.2019 13:56:48

## Middle Channel

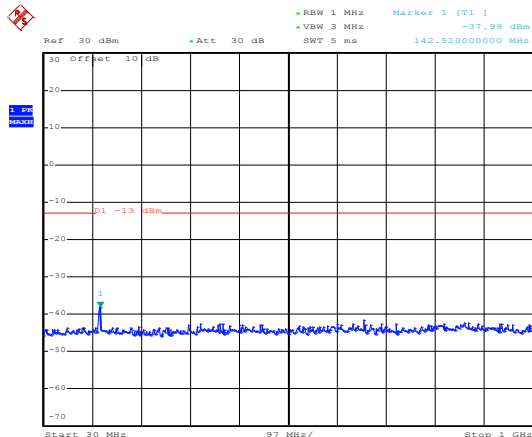

Date: 30.SEP.2019 13:55:29

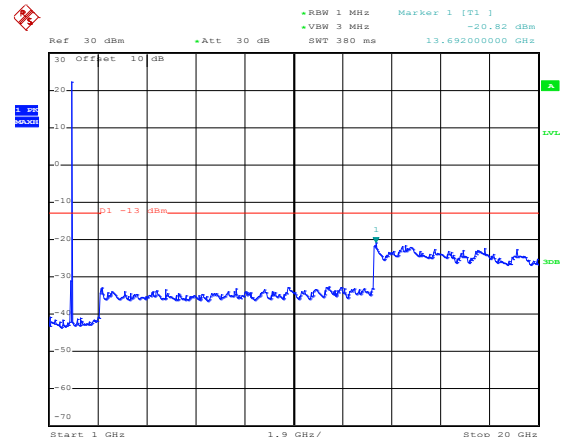

Date: 30.SEP.2019 13:56:26

## Highest Channel

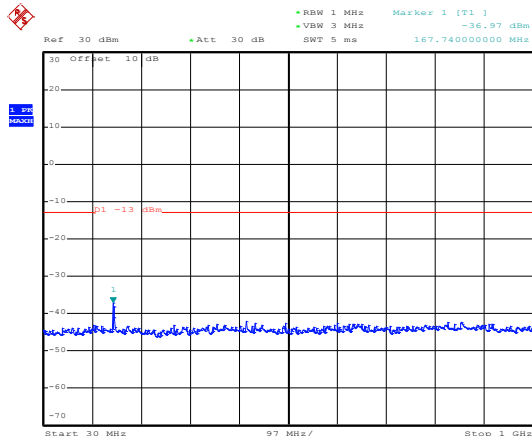

Date: 30.SEP.2019 13:55:43

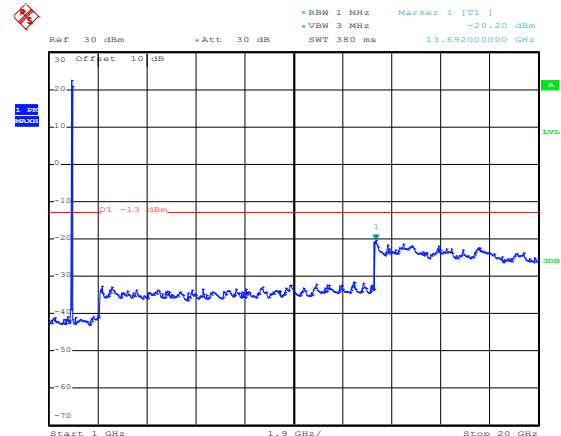

Date: 30.SEP.2019 13:56:07

**Band edge emission:**

**GSM850**

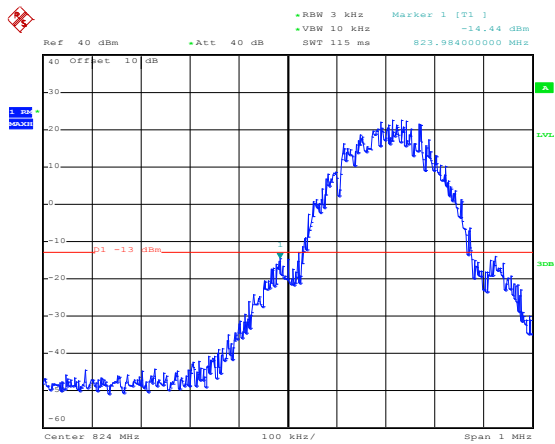

Date: 30.SEP.2019 14:04:26

Lowest channel

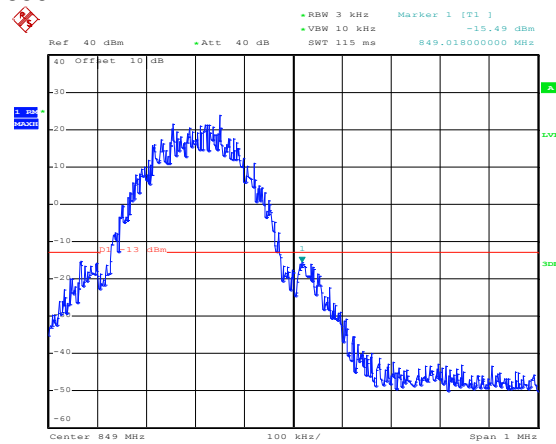

Date: 30.SEP.2019 14:03:48

Highest channel

**PCS1900**

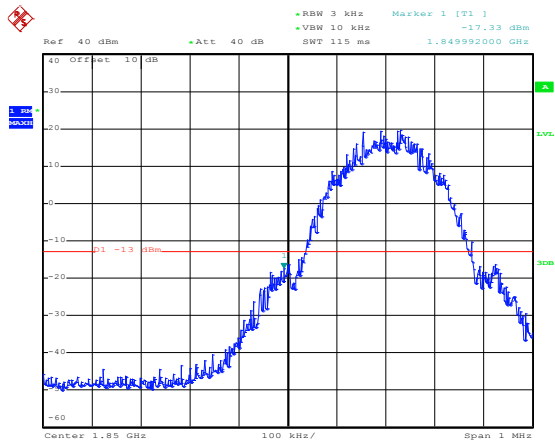

Date: 30.SEP.2019 14:31:15

Lowest channel

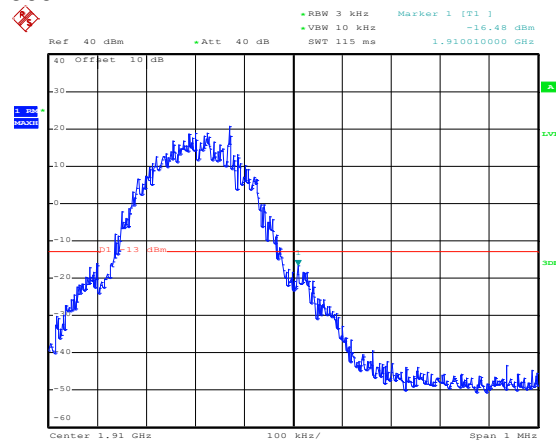

Date: 30.SEP.2019 14:31:34

Highest channel

## EGPRS850

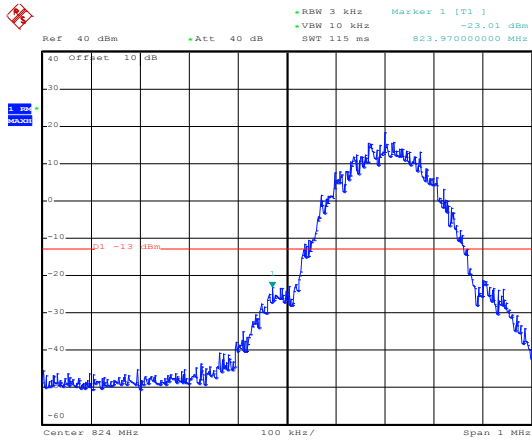

Date: 30.SEP.2019 14:11:17

Lowest channel

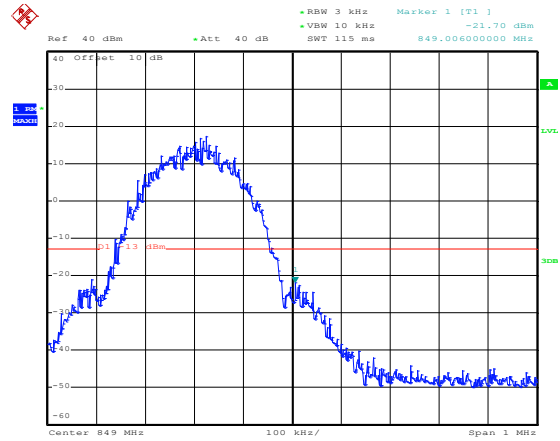

Date: 30.SEP.2019 14:10:58

Highest channel

## EGPRS1900

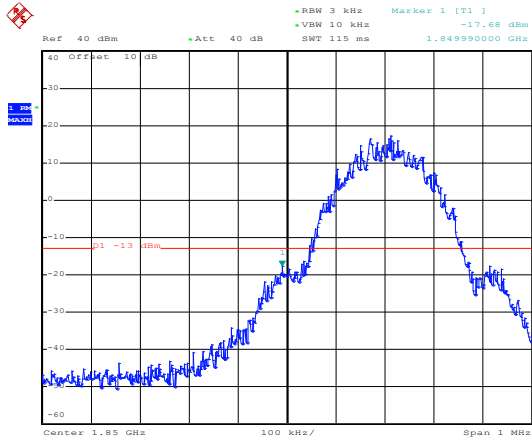

Date: 30.SEP.2019 14:30:15

Lowest channel

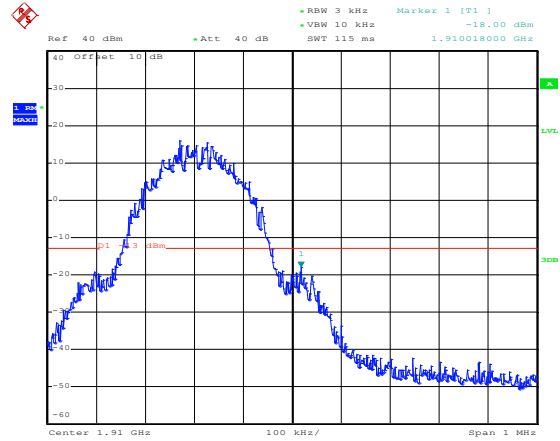

Date: 30.SEP.2019 14:29:59

Highest channel

## UMTS 850 RMC 12.2kbps

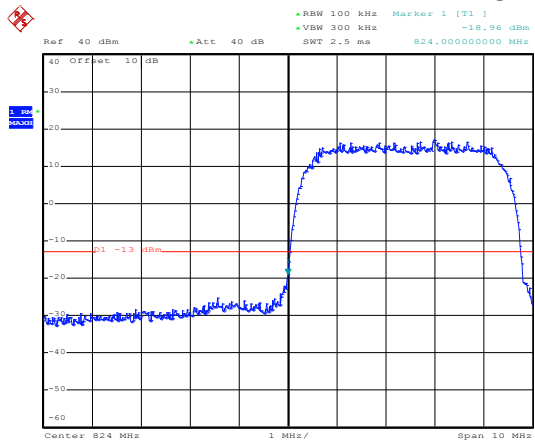

Date: 30.SEP.2019 13:51:35

Lowest channel

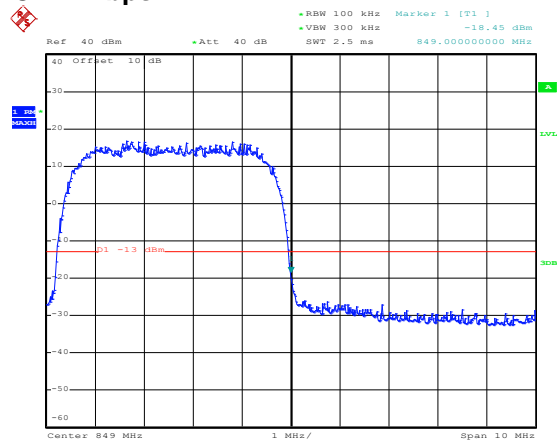

Date: 30.SEP.2019 13:51:52

Highest channel

## UMTS 1900 RMC 12.2kbps

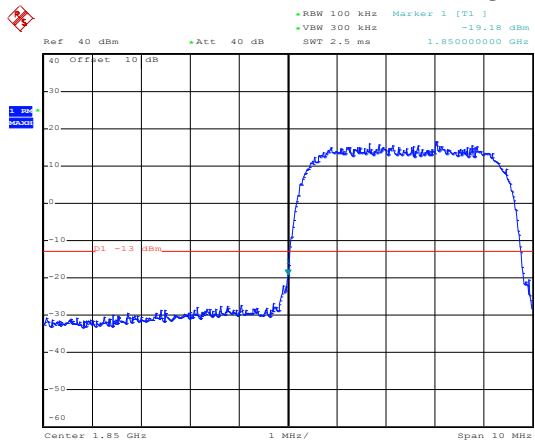

Date: 30.SEP.2019 13:50:33

Lowest channel

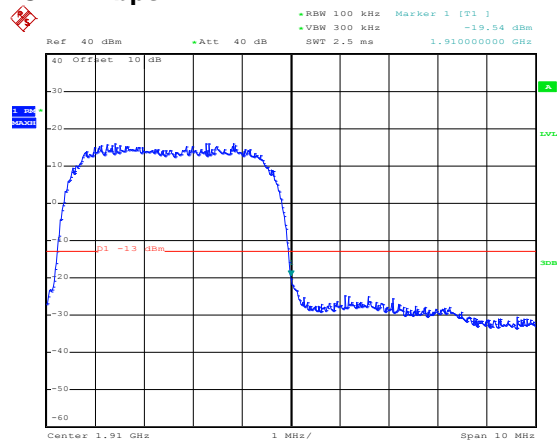

Date: 30.SEP.2019 13:51:02

Highest channel

## 6.6 Field strength of spurious radiation measurement

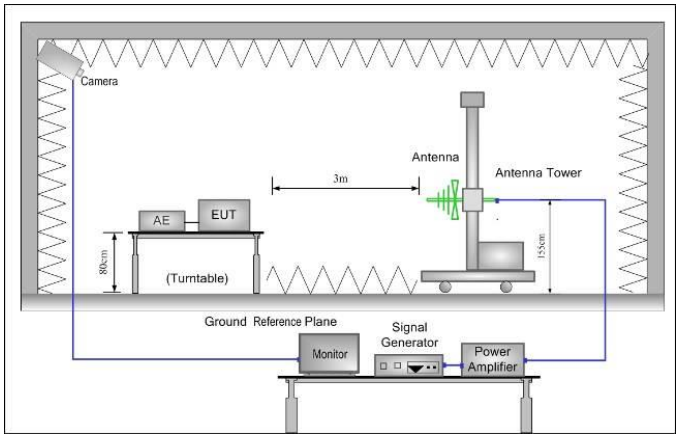
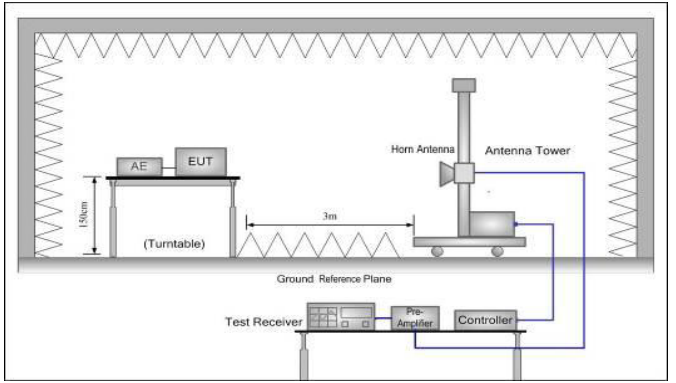
Test Requirement:	FCC part 22.917(a), FCC part 24.238(a)
Limit:	-13dBm
Test setup:	<p>Below 1GHz</p>  <p>Above 1GHz</p> 
Test Procedure:	<ol style="list-style-type: none"> <li>1. The EUT was placed on a non-conductive turntable using a non-conductive support. The radiated emission at the fundamental frequency was measured at 3 m with a test antenna and EMI spectrum analyzer.</li> <li>2. During the tests, the antenna height and the EUT azimuth were varied in order to identify the maximum level of emissions from the EUT. This maximization process was repeated with the EUT positioned in each of its three orthogonal orientations.</li> <li>3. The frequency range up to tenth harmonic was investigated for each of three fundamental frequency (low, middle and high channels). Once spurious emission was identified, the power of the emission was determined using the substitution method.</li> <li>4. The spurious emissions attenuation was calculated as the difference between radiated power at the fundamental frequency and the spurious emissions frequency.           <math display="block">\text{ERP / EIRP} = \text{S.G. output (dBm)} + \text{Antenna Gain(dB/dBi)} - \text{Cable Loss (dB)}</math> </li> </ol>
Test Instruments:	Refer to section 5.9 for details
Test mode:	Refer to section 5.3 for details.
Test results:	Passed

**Measurement Data (worst case):**

<b>GSM850</b>				
<b>Lowest channel</b>				
Frequency (MHz)	Spurious Emission		Limit (dBm)	Result
	Polarization	Level (dBm)		
1648.40	Vertical	-43.72	-13.00	Pass
2472.60	V	-38.70		
3296.80	V	-50.66		
1648.40	Horizontal	-43.89	-13.00	Pass
2472.60	H	-43.80		
3296.80	H	-50.89		
<b>Middle channel</b>				
Frequency (MHz)	Spurious Emission		Limit (dBm)	Result
	Polarization	Level (dBm)		
1673.20	Vertical	-43.91	-13.00	Pass
2509.80	V	-38.45		
3346.40	V	-50.39		
1673.20	Horizontal	-43.55	-13.00	Pass
2509.80	H	-43.48		
3346.40	H	-50.96		
<b>Highest channel</b>				
Frequency (MHz)	Spurious Emission		Limit (dBm)	Result
	Polarization	Level (dBm)		
1697.60	Vertical	-43.89	-13.00	Pass
2546.40	V	-38.81		
3395.20	V	-50.15		
1697.60	Horizontal	-43.48	-13.00	Pass
2546.40	H	-43.96		
3395.20	H	-51.96		
<i>Remark:</i>				
1. The emission levels of below 1 GHz are very lower than the limit and not show in test report.				



PCS1900				
Lowest channel				
Frequency (MHz)	Spurious Emission		Limit (dBm)	Result
	Polarization	Level (dBm)		
3700.40	Vertical	-51.09	-13.00	Pass
5550.60	V	-44.33		
3700.40	Horizontal	-51.21	-13.00	Pass
5550.60	H	-44.52		
Middle channel				
Frequency (MHz)	Spurious Emission		Limit (dBm)	Result
	Polarization	Level (dBm)		
3760.00	Vertical	-51.47	-13.00	Pass
5640.00	V	-44.82		
3760.00	Horizontal	-51.38	-13.00	Pass
5640.00	H	-45.59		
Highest channel				
Frequency (MHz)	Spurious Emission		Limit (dBm)	Result
	Polarization	Level (dBm)		
3819.60	Vertical	-52.47	-13.00	Pass
5729.40	V	-45.04		
3819.60	Horizontal	-52.12	-13.00	Pass
5729.40	H	-44.19		
<i>Remark:</i>				
1. The emission levels of below 1 GHz are very lower than the limit and not show in test report.				

WCDMA BAND V 12.2k RMC				
Lowest channel				
Frequency (MHz)	Spurious Emission		Limit (dBm)	Result
	Polarization	Level (dBm)		
1652.80	Vertical	-57.06	-13.00	Pass
2479.20	V	-45.21		
3305.60	V	-46.11		
1652.80	Horizontal	-56.36	-13.00	Pass
2479.20	H	-42.15		
3305.60	H	-46.92		
Middle channel				
Frequency (MHz)	Spurious Emission		Limit (dBm)	Result
	Polarization	Level (dBm)		
1673.20	Vertical	-57.69	-13.00	Pass
2509.80	V	-45.81		
3346.40	V	-46.93		
1673.20	Horizontal	-55.07	-13.00	Pass
2509.80	H	-44.53		
3346.40	H	-45.54		
Highest channel				
Frequency (MHz)	Spurious Emission		Limit (dBm)	Result
	Polarization	Level (dBm)		
1693.20	Vertical	-56.74	-13.00	Pass
2539.80	V	-44.54		
3386.40	V	-46.09		
1693.20	Horizontal	-56.41	-13.00	Pass
2539.80	H	-45.12		
3386.40	H	-46.26		
<i>Remark:</i>				
1. The emission levels of below 1 GHz are very lower than the limit and not show in test report.				

WCDMA Band II 12.2k RMC				
Lowest channel				
Frequency (MHz)	Spurious Emission		Limit (dBm)	Result
	Polarization	Level (dBm)		
3704.80	Vertical	-48.47	-13.00	Pass
5557.20	V	-45.02		
3704.80	Horizontal	-49.17	-13.00	Pass
5557.20	H	-45.19		
Middle channel				
Frequency (MHz)	Spurious Emission		Limit (dBm)	Result
	Polarization	Level (dBm)		
3760.00	Vertical	-49.12	-13.00	Pass
5640.00	V	-44.47		
3760.00	Horizontal	-50.26	-13.00	Pass
5640.00	H	-46.07		
Highest channel				
Frequency (MHz)	Spurious Emission		Limit (dBm)	Result
	Polarization	Level (dBm)		
3815.20	Vertical	-48.41	-13.00	Pass
5722.80	V	-45.53		
3815.20	Horizontal	-49.67	-13.00	Pass
5722.80	H	-47.11		
<i>Remark:</i>				
1. The emission levels of below 1 GHz are very lower than the limit and not show in test report.				

## 6.7 Frequency stability V.S. Temperature measurement

Test Requirement:	FCC Part 22.355, FCC Part 24.235 FCC Part 2.1055(a)(1)(b)
Limit:	±2.5 ppm for GSM 850 and WCDMA 850 Within authorized band for PCS 1900 and WCDMA 1900
Test setup:	
Test procedure:	<ol style="list-style-type: none"> <li>1. The equipment under test was connected to an external DC power supply and input rated voltage.</li> <li>2. RF output was connected to a frequency counter or spectrum analyzer via feed through attenuators.</li> <li>3. The EUT was placed inside the temperature chamber.</li> <li>4. Set the spectrum analyzer RBW low enough to obtain the desired frequency resolution and measure EUT 25°C operating frequency as reference frequency.</li> <li>5. Turn EUT off and set the chamber temperature to -30°C. After the temperature stabilized for approximately 30 minutes recorded the frequency.</li> <li>6. Repeat step measure with 10°C increased per stage until the highest temperature of +50°C reached</li> </ol>
Test Instruments:	Refer to section 5.9 for details
Test mode:	Refer to section 5.3 for details
Test results:	Passed

**Measurement Data (the worst channel):**

Reference Frequency: GSM850 Middle channel=190 channel=836.6MHz					
Power supplied (Vdc)	Temperature (°C)	Frequency error		Limit (ppm)	Result
		Hz	ppm		
3.70	-30	169	0.202008	±2.5	Pass
	-20	142	0.169735		
	-10	135	0.161367		
	0	122	0.145828		
	10	108	0.129094		
	20	160	0.191250		
	30	162	0.193641		
	40	138	0.164953		
	50	145	0.173321		

Reference Frequency: PCS1900 Middle channel=661 channel=1880MHz					
Power supplied (Vdc)	Temperature (°C)	Frequency error		Limit (ppm)	Result
		Hz	ppm		
3.70	-30	179	0.095213	Within authorized band for PCS 1900	Pass
	-20	156	0.082979		
	-10	142	0.075532		
	0	130	0.069149		
	10	126	0.067021		
	20	117	0.062234		
	30	108	0.057447		
	40	139	0.073936		
	50	147	0.078191		

*Note: Only the worst case shown in the report.*

Reference Frequency: EGPRS850 Middle channel=190 channel=836.6MHz					
Power supplied (Vdc)	Temperature (°C)	Frequency error		Limit (ppm)	Result
		Hz	ppm		
3.70	-30	190	0.227110	±2.5	Pass
	-20	152	0.181688		
	-10	143	0.170930		
	0	166	0.198422		
	10	145	0.173321		
	20	127	0.151805		
	30	148	0.176907		
	40	136	0.162563		
	50	152	0.181688		
Reference Frequency: EGPRS 1900 Middle channel=661 channel=1880MHz					
Power supplied (Vdc)	Temperature (°C)	Frequency error		Limit (ppm)	Result
		Hz	ppm		
3.70	-30	184	0.097872	Within authorized band for PCS 1900	Pass
	-20	165	0.087766		
	-10	127	0.067553		
	0	146	0.077660		
	10	120	0.063830		
	20	140	0.074468		
	30	112	0.059574		
	40	163	0.086702		
	50	107	0.056915		
<i>Note: Only the worst case shown in the report.</i>					

Reference Frequency: WCDMA BAND V 12.2k RMC Middle channel=4183 channel=836.6MHz					
Power supplied (Vdc)	Temperature (°C)	Frequency error		Limit (ppm)	Result
		Hz	ppm		
3.70	-30	174	0.207985	±2.5	Pass
	-20	155	0.185274		
	-10	136	0.162563		
	0	125	0.149414		
	10	114	0.136266		
	20	142	0.169735		
	30	139	0.166149		
	40	128	0.153000		
	50	117	0.139852		
Reference Frequency: WCDMA BAND II 12.2k RMC Middle channel=9400 channel=1880MHz					
Power supplied (Vdc)	Temperature (°C)	Frequency error		Limit (ppm)	Result
		Hz	ppm		
3.70	-30	185	0.098404	Within authorized band for PCS WCDMA 1900	Pass
	-20	146	0.077660		
	-10	117	0.062234		
	0	129	0.068617		
	10	134	0.071277		
	20	150	0.079787		
	30	167	0.088830		
	40	143	0.076064		
	50	156	0.082979		
<i>Note: Only the worst case shown in the report.</i>					

## 6.8 Frequency stability V.S. Voltage measurement

Test Requirement:	FCC Part 22.355, FCC Part 24.235 FCC Part 2.1055(d)(2)
Limit:	±2.5 ppm for GSM 850 and WCDMA 850 Within authorized band for PCS 1900 and WCDMA 1900
Test setup:	
Test procedure:	<ol style="list-style-type: none"> <li>1. Set chamber temperature to 25°C. Use a variable DC power source to power the EUT and set the voltage to rated voltage.</li> <li>2. Set the spectrum analyzer RBW low enough to obtain the desired frequency resolution and recorded the frequency.</li> <li>3. Reduce the input voltage to specify extreme voltage variation (+/- 15%) and endpoint, record the maximum frequency change.</li> </ol>
Test Instruments:	Refer to section 5.9 for details
Test mode:	Refer to section 5.3 for details
Test results:	Passed



**Measurement Data (the worst channel):**

Reference Frequency: GSM850 Middle channel=190 channel=836.6MHz					
Temperature (°C)	Power supplied (Vdc)	Frequency error		Limit (ppm)	Result
		Hz	ppm		
25	4.2	96	0.114750	±2.5	Pass
	3.7	88	0.105188		
	3.5	70	0.083672		
Reference Frequency: PCS1900 Middle channel=661 channel=1880MHz					
Temperature (°C)	Power supplied (Vdc)	Frequency error		Limit (ppm)	Result
		Hz	ppm		
25	4.2	90	0.047872	Within authorized band for PCS 1900	Pass
	3.7	74	0.039362		
	3.5	80	0.042553		
Reference Frequency: EGPRS 850 Middle channel= 190 channel=836.6MHz					
Temperature (°C)	Power supplied (Vdc)	Frequency error		Limit (ppm)	Result
		Hz	ppm		
25	4.2	85	0.101602	±2.5	Pass
	3.7	78	0.093235		
	3.5	68	0.081281		
Reference Frequency: EGPRS 1900 Middle channel= 661 channel=1880MHz					
Temperature (°C)	Power supplied (Vdc)	Frequency error		Limit (ppm)	Result
		Hz	ppm		
25	4.2	58	0.030851	Within authorized band for PCS 1900	Pass
	3.7	42	0.022340		
	3.5	36	0.019149		

*Note: Only the worst case shown in the report.*

Reference Frequency: UMTS 850 12.2k RMC Middle channel=4183 channel=836.6MHz					
Temperature (°C)	Power supplied (Vdc)	Frequency error		Limit (ppm)	Result
		Hz	ppm		
25	4.2	39	0.046617	±2.5	Pass
	3.7	21	0.025102		
	3.5	34	0.040641		
Reference Frequency: UMTS 1900 12.2k RMC Middle channel=9400 channel=1880MHz					
Temperature (°C)	Power supplied (Vdc)	Frequency error		Limit (ppm)	Result
		Hz	ppm		
25	4.2	77	0.040957	Within authorized band for WCDMA 1900	Pass
	3.7	54	0.028723		
	3.5	28	0.014894		
<i>Note: Only the worst case shown in the report.</i>					