

# FCC REPORT

## (GSM & WCDMA)

**Applicant:** SKY PHONE LLC

**Address of Applicant:** 1348 Washington Av. Suite 350, Miami Beach, FL 33139

**Equipment Under Test (EUT)**

Product Name: 3G Smart Phone

Model No.: Platinum K5

Trade mark: SKY DEVICES

**FCC ID:** 2ABOSSKYPLATK5

**Applicable standards:** FCC CFR Title 47 Part 2  
FCC CFR Title 47 Part 22 Subpart H  
FCC CFR Title 47 Part 24 Subpart E

**Date of sample receipt:** 07 Dec., 2020

**Date of Test:** 07 Dec., 2020 to 12 Jan., 2021

**Date of report issued:** 13 Jan., 2021

**Test Result:** PASS\*

\* In the configuration tested, the EUT complied with the standards specified above.

Authorized Signature:



Bruce Zhang  
Laboratory Manager

This report details the results of the testing carried out on one sample. The results contained in this test report do not relate to other samples of the same product and does not permit the use of the JYT product certification mark. The manufacturer should ensure that all products in series production are in conformity with the product sample detailed in this report.

This report may only be reproduced and distributed in full. If the product in this report is used in any configuration other than that detailed in the report, the manufacturer must ensure the new system complies with all relevant standards.

This document cannot be reproduced except in full, without prior written approval of the Company. Any unauthorized alteration, forgery or falsification of the content or appearance of this document is unlawful and offenders may be prosecuted to the fullest extent of the law. Unless otherwise stated the results shown in this test report refer only to the sample(s) tested and such sample(s) are retained for 90 days only.

**2. Version**

Version No.	Date	Description
00	13 Jan., 2021	Original

**Tested by:** Mike.ou **Date:** 13 Jan., 2021  
**Test Engineer**

**Reviewed by:** Winner Zhang **Date:** 13 Jan., 2021  
**Project Engineer**

### 3. Contents

	Page
<b>1. COVER PAGE.....</b>	<b>1</b>
<b>2. VERSION.....</b>	<b>2</b>
<b>3. CONTENTS.....</b>	<b>3</b>
<b>4. TEST SUMMARY.....</b>	<b>4</b>
<b>5. GENERAL INFORMATION.....</b>	<b>5</b>
5.1 CLIENT INFORMATION.....	5
5.2 GENERAL DESCRIPTION OF E.U.T.....	5
5.3 TEST ENVIRONMENT AND MODE .....	7
5.4 DESCRIPTION OF TEST AUXILIARY EQUIPMENT.....	7
5.5 MEASUREMENT UNCERTAINTY.....	7
5.6 ADDITIONS TO, DEVIATIONS, OR EXCLUSIONS FROM THE METHOD.....	7
5.7 LABORATORY FACILITY.....	8
5.8 LABORATORY LOCATION .....	8
5.9 TEST INSTRUMENTS LIST.....	8
<b>6. TEST RESULTS.....</b>	<b>9</b>
6.1 CONDUCTED OUTPUT POWER, ERP AND EIRP .....	9
6.2 PEAK-TO-AVERAGE POWER RATIO .....	12
6.3 OCCUPY BANDWIDTH .....	14
6.4 MODULATION CHARACTERISTIC.....	20
6.5 OUT OF BAND EMISSION AT ANTENNA TERMINALS .....	20
6.6 FIELD STRENGTH OF SPURIOUS RADIATION MEASUREMENT.....	27
6.7 FREQUENCY STABILITY V.S. TEMPERATURE MEASUREMENT.....	32
6.8 FREQUENCY STABILITY V.S. VOLTAGE MEASUREMENT .....	35
<b>7 TEST SETUP PHOTO.....</b>	<b>37</b>
<b>8 EUT CONSTRUCTIONAL DETAILS.....</b>	<b>38</b>

## 4. Test Summary

Test Item	Section in CFR 47	Result
RF Exposure (SAR)	Part 1.1307 Part 2.1093	Pass (Please refer to SAR Report)
RF Output Power	Part 2.1046 Part 22.913 (a)(5) Part 24.232 (c)	Pass
Peak-to-Average Power Ratio	Part 24.232 (d)	Pass
Modulation Characteristics	Part 2.1047	Pass
99% & -26 dB Occupied Bandwidth	Part 2.1049 Part 22.917(b) Part 24.238(b)	Pass
Out of band emission at antenna terminals	Part 2.1051 Part 22.917 (a) Part 24.238 (a)	Pass
Field strength of spurious radiation	Part 2.1053 Part 22.917 (a) Part 24.238 (a)	Pass
Frequency stability vs. temperature	Part 22.355 Part 24.235 Part 2.1055(a)(1)(b)	Pass
Frequency stability vs. voltage	Part 22.355 Part 24.235 Part 2.1055(d)(2)	Pass
<b>Remark:</b> 1. Pass: The EUT complies with the essential requirements in the standard. 2. The cable insertion loss used by "RF Output Power" and other conduction measurement items is 0.5dB(Fundamental Frequency below 1GHz)/1.0dB(Fundamental Frequency above 1GHz) (provided by the customer).		
<b>Test Method:</b>	ANSI/TIA-603-E-2016 ANSI C63.26-2015	

## 5. General Information

### 5.1 Client Information

Applicant:	SKY PHONE LLC
Address:	1348 Washington Av. Suite 350, Miami Beach, FL 33139
Manufacturer:	SKY PHONE LLC
Address:	1348 Washington Av. Suite 350, Miami Beach, FL 33139

### 5.2 General Description of E.U.T.

Product Name:	3G Smart Phone		
Model No.:	Platinum K5		
Operation Frequency range:	GSM 850:	824.20MHz-848.80MHz	
	PCS1900:	1850.20MHz-1909.80MHz	
	WCDMA Band V:	826.4MHz-846.6MHz	
	WCDMA Band II:	1852.4 MHz-1907.6 MHz	
Modulation type:	2G	<input checked="" type="checkbox"/> Voice(GMSK)	<input checked="" type="checkbox"/> GPRS(GMSK) <input type="checkbox"/> EGPRS(GMSK, 8PSK)
	3G	<input checked="" type="checkbox"/> RMC(QPSK)	<input checked="" type="checkbox"/> HSUPA(QPSK) <input checked="" type="checkbox"/> HSDPA(QPSK,16QAM)
Antenna type:	Internal Antenna		
Antenna gain:	GSM 850:	-0.8 dBi(declare by Applicant)	
	PCS 1900:	0.4 dBi(declare by Applicant)	
	WCDMA Band V:	-0.8 dBi(declare by Applicant)	
	WCDMA Band II:	0.4 dBi(declare by Applicant)	
Power supply:	Rechargeable Li-ion Battery DC3.8V-2000mAh		
AC adapter:	Input: AC100-240V, 50/60Hz, 0.2A		
	Output: DC 5.0V, 1000mA		
Test Sample Condition:	The test samples were provided in good working order with no visible defects.		

**Operation Frequency List:**

GSM 850		PCS1900	
Channel	Frequency (MHz)	Channel	Frequency (MHz)
128	824.20	512	1850.20
129	824.40	513	1850.40
....	....	....	....
189	836.40	660	1879.80
190	836.60	661	1880.00
191	836.80	662	1880.20
...	...	...	...
250	848.60	809	1909.60
251	848.80	810	1909.80
WCDMA Band V		WCDMA Band II	
Channel	Frequency (MHz)	Channel	Frequency (MHz)
4132	826.40	9262	1852.40
4133	826.60	9263	1852.60
....	....	....	....
4182	836.40	9399	1879.80
4183	836.60	9400	1880.00
4184	836.80	9401	1880.20
...	...	...	...
4232	846.40	9537	1907.40
4233	846.60	9538	1907.60

Regards to the operating frequency range over 10 MHz, the Lowest frequency, the middle frequency, and the highest frequency of channel were selected to perform the test, and the selected channel see below:

GSM850			PCS1900		
Channel	Frequency(MHz)	Channel	Frequency(MHz)		
Lowest	128	824.20	Lowest	512	1850.20
Middle	190	836.60	Middle	661	1880.00
Highest	251	848.80	Highest	810	1909.80
WCDMA Band V			WCDMA Band II		
Channel	Frequency(MHz)	Channel	Frequency(MHz)		
Lowest	4132	826.40	Lowest	9262	1852.40
Middle	4183	836.60	Middle	9400	1880.00
Highest	4233	846.60	Highest	9538	1907.60

### 5.3 Test environment and mode

Operating Environment:	
Temperature:	Normal: 15°C ~ 35°C, Extreme: -30°C ~ +50°C
Humidity:	20 % ~ 75 % RH
Atmospheric Pressure:	1008 mbar
Voltage:	Nominal: 3.8Vdc, Extreme: Low 3.5 Vdc, High 4.35 Vdc
Test mode:	
GSM mode	Keep the EUT communication with simulated station in GSM mode
GPRS mode	Keep the EUT communication with simulated station in GPRS mode
RMC mode	Keep the EUT communication with simulated station in RMC mode
HSDPA	Keep the EUT communication with simulated station in HSDPA mode
HSUPA	Keep the EUT communication with simulated station in HSUPA mode
Remark: The EUT has been tested under continuous transmitting mode. Channel Low, Mid and High for each type band with rated data rate were chosen for full testing. The field strength of spurious radiation emission was measured as EUT stand-up position (H mode) and lie down position (E1, E2 mode) for these modes. Just the worst case position (H mode) shown in report.	

### 5.4 Description of Test Auxiliary Equipment

Test Equipment	Manufacturer	Model No.	Serial No.
Simulated Station	Anritsu	MT8820C	6201026545

### 5.5 Measurement Uncertainty

Parameters	Expanded Uncertainty
Radiated Emission (9kHz ~ 30MHz)	±3.12 dB (k=2)
Radiated Emission (30MHz ~ 1000MHz)	±4.32 dB (k=2)
Radiated Emission (1GHz ~ 18GHz)	±5.16 dB (k=2)
Radiated Emission (18GHz ~ 40GHz)	±3.20 dB (k=2)

### 5.6 Additions to, deviations, or exclusions from the method

No
----

### 5.7 Laboratory Facility

The test facility is recognized, certified, or accredited by the following organizations:

● **FCC - Designation No.: CN1211**

JianYan Testing Group Shenzhen Co., Ltd. has been accredited as a testing laboratory by FCC(Federal Communications Commission). The test firm Registration No. is 727551.

● **ISED – CAB identifier.: CN0021**

The 3m Semi-anechoic chamber of JianYan Testing Group Shenzhen Co., Ltd. has been Registered by Certification and Engineering Bureau of Industry Canada for radio equipment testing with Registration No.: 10106A-1.

● **A2LA - Registration No.: 4346.01**

This laboratory is accredited in accordance with the recognized International Standard ISO/IEC 17025:2005 General requirements for the competence of testing and calibration laboratories. The test scope can be found as below link: <https://portal.a2la.org/scopepdf/4346-01.pdf>

### 5.8 Laboratory Location

Shenzhen Zhongjian Nanfang Testing Co., Ltd.

Address: No.110~116, Building B, Jinyuan Business Building, Xixiang Road, Bao'an District, Shenzhen, Guangdong, China

Tel: +86-755-23118282, Fax: +86-755-23116366

Email: info@ccis-cb.com, Website: <http://www.ccis-cb.com>

### 5.9 Test Instruments list

Test Equipment	Manufacturer	Model No.	Serial No.	Cal. Date (mm-dd-yy)	Cal. Due date (mm-dd-yy)
3m SAC	SAEMC	9m*6m*6m	966	07-22-2020	07-21-2021
BiConiLog Antenna	SCHWARZBECK	VULB9163	497	03-07-2020	03-06-2021
Biconical Antenna	SCHWARZBECK	VUBA9117	359	06-22-2020	06-21-2021
Horn Antenna	SCHWARZBECK	BBHA9120D	916	03-07-2020	03-06-2021
Horn Antenna	SCHWARZBECK	BBHA9120D	1805	06-22-2020	06-21-2021
Horn Antenna	SCHWARZBECK	BBHA 9170	BBHA9170582	11-18-2020	11-17-2021
EMI Test Software	AUDIX	E3	Version: 6.110919b		
Pre-amplifier	HP	8447D	2944A09358	03-07-2020	03-06-2021
Pre-amplifier	CD	PAP-1G18	11804	03-07-2020	03-06-2021
Spectrum analyzer	Rohde & Schwarz	FSP30	101454	03-05-2020	03-04-2021
Spectrum analyzer	Rohde & Schwarz	FSP40	100363	11-18-2020	11-17-2021
EMI Test Receiver	Rohde & Schwarz	ESRP7	101070	03-05-2020	03-04-2021
Signal Generator	Rohde & Schwarz	SMX	835454/016	03-05-2020	03-04-2021
Signal Generator	R&S	SMR20	1008100050	03-05-2020	03-04-2021
RF Switch Unit	MWRFTTEST	MW200	N/A	N/A	N/A
Test Software	MWRFTTEST	MTS8200	Version: 2.0.0.0		
Cable	ZDECL	Z108-NJ-NJ-81	1608458	03-07-2020	03-06-2021
Cable	MICRO-COAX	MFR64639	K10742-5	03-07-2020	03-06-2021
Cable	SUHNER	SUCOFLEX100	58193/4PE	03-07-2020	03-06-2021
DC Power Supply	XinNuoEr	WYK-10020K	1409050110020	09-25-2020	09-24-2021
Temperature Humidity Chamber	HengPu	HPGDS-500	20140828008	11-01-2020	11-31-2021
Simulated Station	Rohde & Schwarz	CMW500	140493	07-22-2020	07-21-2021



## 6. Test results

### 6.1 Conducted Output Power, ERP and EIRP

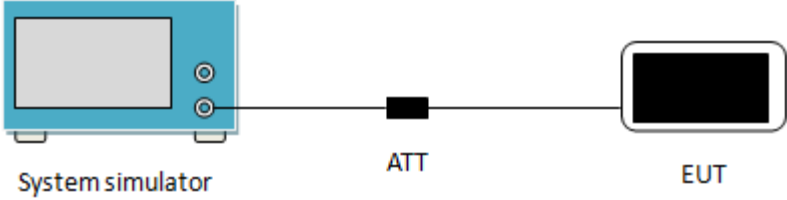
Test Requirement:	FCC part 22.913(a)(5), FCC part 24.232(c)
Limit:	GSM 850: 7W, PCS 1900: 2W WCDMA Band V: 7W, WCDMA Band II: 2W
Test setup:	 <p>The diagram illustrates the test setup. On the left is a blue 'System simulator' with a screen and two ports. A line connects it to a black square labeled 'ATT' (attenuator). Another line connects the 'ATT' to a black rectangle labeled 'EUT' (Equipment Under Test).</p>
Test Procedure:	The transmitter output was connected to a calibrated attenuator, the other end of which was connected to the simulated station. Transmitter output power was read off in dBm.
Test Instruments:	Refer to section 5.9 for details
Test mode:	Refer to section 5.3 for details
Test results:	Passed

**Measurement Data:**

EUT Mode	Burst Average power (dBm)		
	128	190	251
	824.20 (MHz)	836.60 (MHz)	848.80 (MHz)
GSM 850	31.77	31.76	31.56
GPRS 850 (1 Uplink slot)	31.64	31.65	31.43
GPRS 850 (2 Uplink slot)	30.84	30.53	30.18
GPRS 850 (3 Uplink slot)	29.38	29.06	28.75
GPRS 850 (4 Uplink slot)	27.76	27.48	27.16
Antenna Gain (dBi)	-0.8		
Max. ERP (dBm)	28.82		
ERP Limit (dBm)	38.45		
EUT Mode	Burst Average power (dBm)		
	512	661	810
	1850.20 (MHz)	1880.00 (MHz)	1909.80 (MHz)
PCS 1900	28.24	28.19	28.45
GPRS 1900 (1 Uplink slot)	27.95	27.76	27.95
GPRS 1900 (2 Uplink slot)	25.57	25.75	26.20
GPRS 1900 (3 Uplink slot)	24.46	24.71	25.11
GPRS 1900 (4 Uplink slot)	22.72	22.94	23.33
Antenna Gain (dBi)	0.4		
Max. EIRP (dBm)	28.85		
EIRP Limit (dBm)	33.00		
<i>Note: EIRP (dBm) = Burst Average power (dBm) + Antenna Gain (dBi).</i> <i>ERP (dBm) = EIRP (dBm) - 2.15 (dB).</i>			

EUT Mode		Burst Average power (dBm)		
		4132	4183	4233
		826.40 (MHz)	836.60 (MHz)	846.60 (MHz)
UMTS 850 HSDPA	Subtest 1	21.82	21.28	21.44
	Subtest 2	21.68	21.23	21.36
	Subtest 3	21.44	20.86	20.97
	Subtest 4	20.99	20.69	20.84
UMTS 850 HSUPA	Subtest 1	21.76	21.36	21.38
	Subtest 2	21.83	21.34	21.54
	Subtest 3	21.22	20.82	21.08
	Subtest 4	21.83	21.33	21.46
	Subtest 5	21.56	21.02	21.31
UMTS 850 RMC	12.2kbps	22.92	22.37	22.61
UMTS 850 AMR	12.2kbps	22.90	22.33	22.50
Antenna Gain (dBi)		-0.8		
Max. ERP (dBm)		19.55		
ERP Limit (dBm)		38.45		
EUT Mode		Burst Average power (dBm)		
		9262	9400	9538
		1852.40 (MHz)	1880.00 (MHz)	1907.60 (MHz)
UMTS 1900 HSDPA	Subtest 1	19.75	20.48	20.41
	Subtest 2	19.75	20.32	20.22
	Subtest 3	19.37	20.03	20.08
	Subtest 4	19.36	19.88	19.81
UMTS 1900 HSUPA	Subtest 1	19.75	20.37	20.31
	Subtest 2	19.78	20.47	20.59
	Subtest 3	19.38	20.05	19.92
	Subtest 4	19.84	20.54	20.48
	Subtest 5	19.73	20.38	20.25
UMTS 1900 RMC	12.2kbps	21.21	21.92	21.54
UMTS 1900 AMR	12.2kbps	20.82	21.55	21.29
Antenna Gain (dBi)		0.4		
Max. EIRP (dBm)		22.32		
EIRP Limit (dBm)		33.00		
<i>Note: EIRP (dBm) = Burst Average power (dBm) + Antenna Gain (dBi).</i> <i>ERP (dBm) = EIRP (dBm) - 2.15 (dB).</i>				

## 6.2 Peak-to-Average Power Ratio

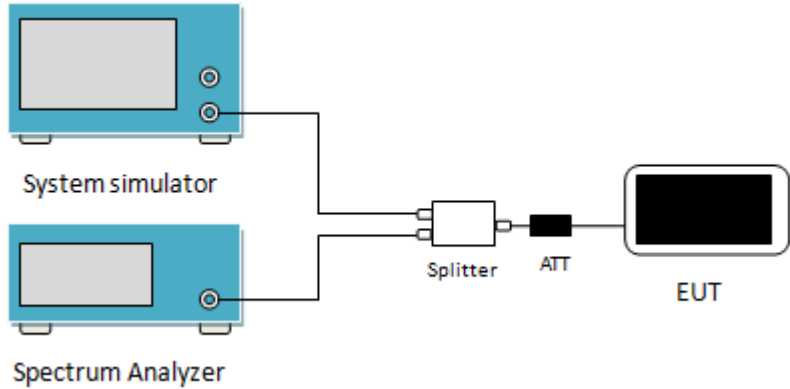
Test Requirement:	FCC part 24.232(d)
Limit:	The peak-to-average ratio (PAR) of the transmission may not exceed 13 dB.
Test setup:	 <p>The diagram shows a test setup where a System simulator and a Spectrum Analyzer are connected to a Splitter. The Splitter is connected to an ATT (Attenuator) and an EUT (Equipment Under Test).</p>
Test Procedure:	<ol style="list-style-type: none"> <li>1 The RF output of the transceiver was connected to a spectrum analyzer through appropriate attenuation.</li> <li>2 Set the CCDF option in spectrum analyzer, <math>RBW \geq OBW</math>,</li> <li>3 Set the EUT working in highest power level, measured and recorded the 0.1% as PAPR level.</li> <li>4 Repeat step 1~3 at other frequency and modulations.</li> </ol>
Test Instruments:	Refer to section 5.9 for details
Test mode:	Refer to section 5.3 for details
Test results:	Passed

### Measurement Data:

Modulation	Test channel	PAPR
GSM 850	190	2.66
PCS 1900	661	2.67
UMTS 850 RMC	4183	2.94
UMTS 1900 RMC	9400	3.03

Test plots as below:

**GSM 850**

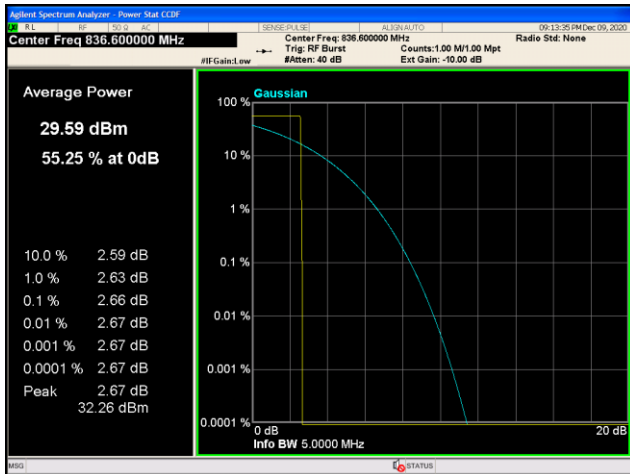

Middle channel

**PCS 1900**

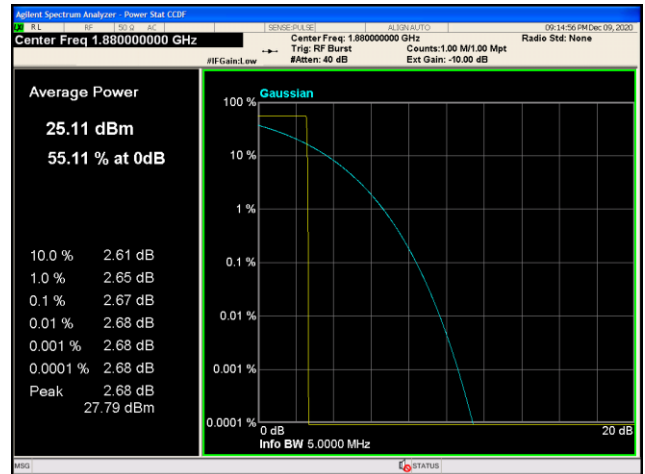

Middle channel

**UMTS 850 RMC**

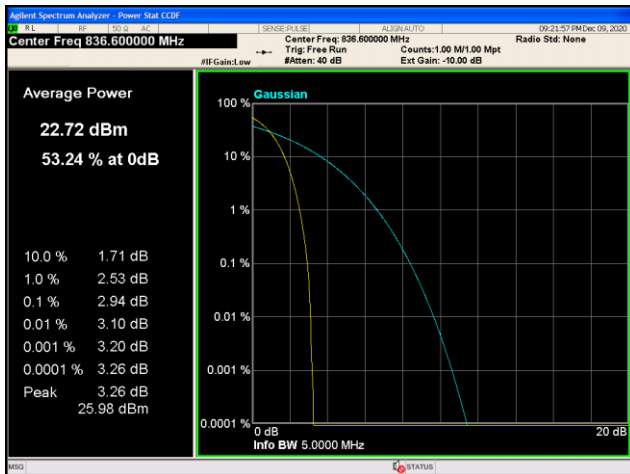

Middle channel

**UMTS 1900 RMC**

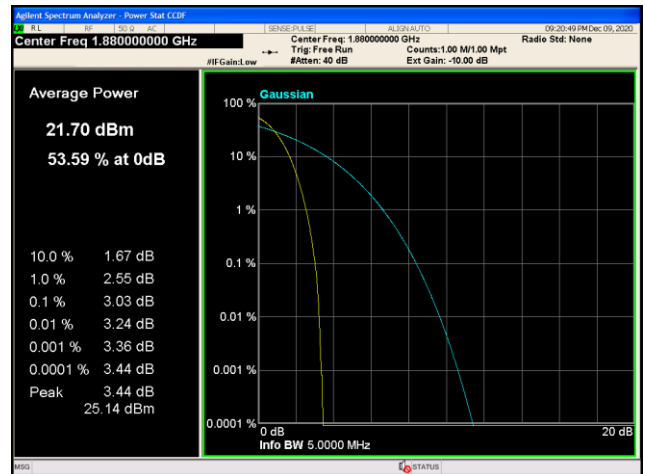

Middle channel

### 6.3 Occupy Bandwidth

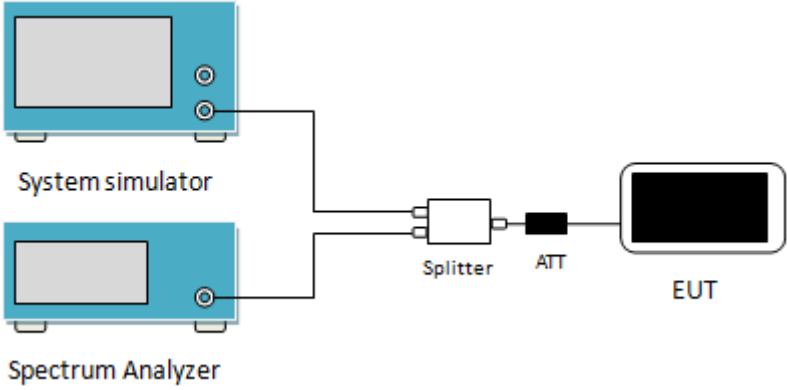
Test Requirement:	FCC part 22.917(b), FCC part 24.238(b)
Test setup:	 <p>The diagram illustrates the test setup. On the left, there are two blue rectangular units: the top one is labeled 'System simulator' and the bottom one is labeled 'Spectrum Analyzer'. Both have a single circular connector on their right side. These two connectors are joined by a single line that leads to a white rectangular 'Splitter'. From the right side of the Splitter, a line goes to a small black rectangular 'ATT' (Attenuator). Finally, a line connects the ATT to the left side of a white rectangular 'EUT' (Equipment Under Test) which has a black screen on its front.</p>
Test Procedure:	<ol style="list-style-type: none"> <li>1. The EUT's output RF connector was connected with a short cable to the spectrum analyzer</li> <li>2. RBW was set to about 1% of emission BW, VBW= 3 times RBW.</li> <li>3. -26dBc display line was placed on the screen (or 99% bandwidth), the occupied bandwidth is the delta frequency between the two points where the display line intersects the signal trace.</li> </ol>
Test Instruments:	Refer to section 5.9 for details
Test mode:	Refer to section 5.3 for details
Test results:	Passed

**Measurement Data:**

EUT Mode	Channel	Frequency (MHz)	99% Occupy bandwidth (kHz)	-26dB bandwidth (kHz)
GSM 850	128	824.2	248	320
	190	836.6	244	322
	251	848.8	250	316
PCS 1900	512	1850.2	246	322
	661	1880.0	248	316
	810	1909.8	244	318
UMTS 850 12.2k RMC	4132	826.4	4180	4680
	4183	836.6	4140	4700
	4233	846.6	4160	4700
UMTS 1900 12.2k RMC	9262	1852.4	4180	4680
	9400	1880.0	4140	4700
	9538	1907.6	4140	4700

*Note:*

*GSM & GPRS use the same modulation technical (GMSK), and with the same channels, so the 99% OBW and the -26dB of GPRS not performed.*

Test plot as follows:

**GSM 850**

99% Occupy bandwidth

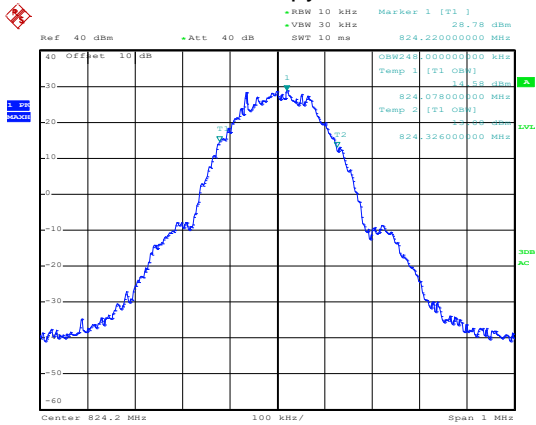

Date: 9.DEC.2020 19:23:24

26dB Emission Bandwidth

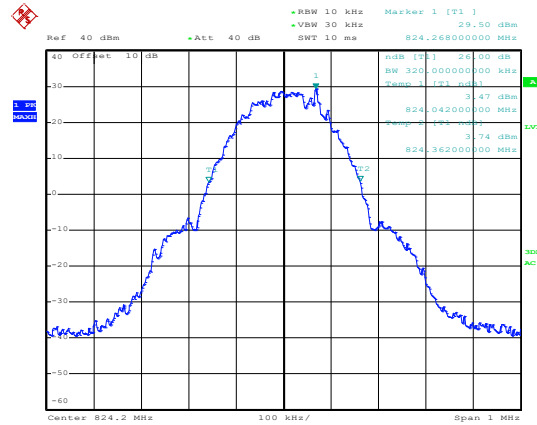

Date: 9.DEC.2020 19:23:50

Lowest channel

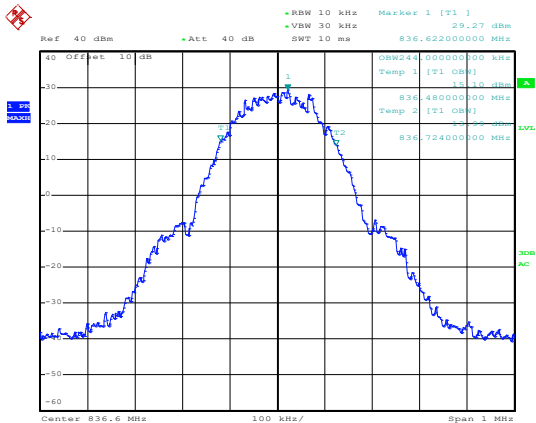

Date: 9.DEC.2020 19:24:27

Lowest channel

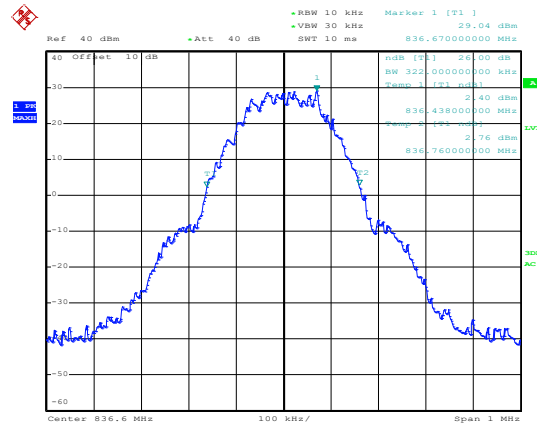

Date: 9.DEC.2020 19:24:13

Middle channel

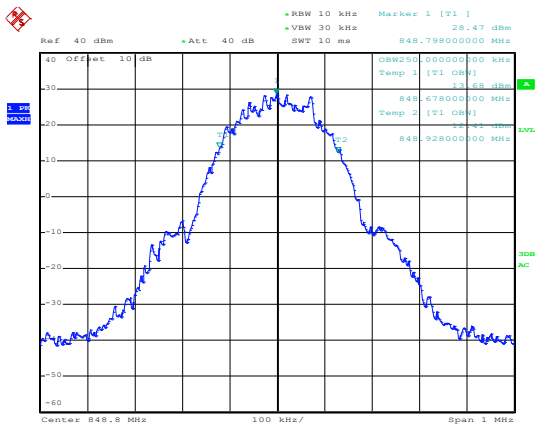

Date: 9.DEC.2020 19:24:48

Middle channel

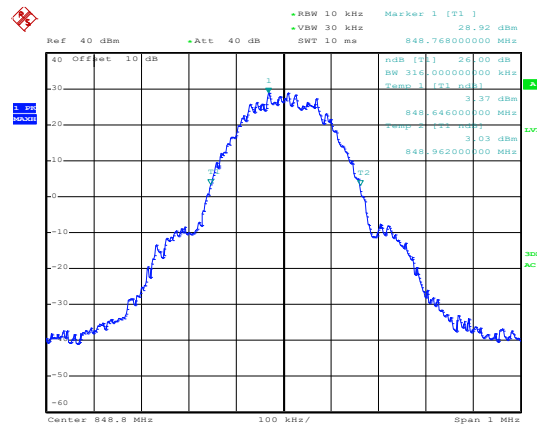

Date: 9.DEC.2020 19:25:02

Highest channel

Highest channel



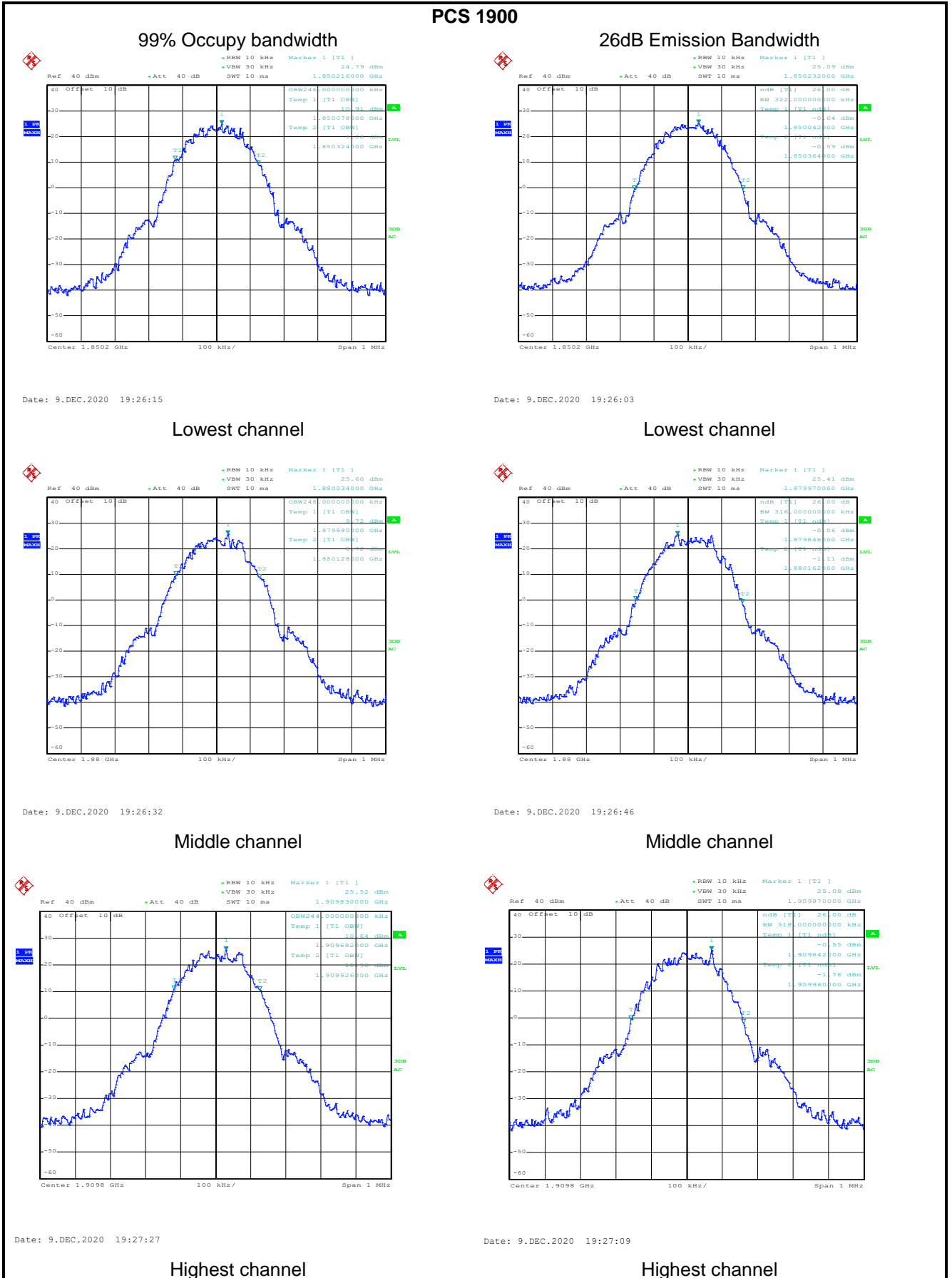

## UMTS 850 12.2k RMC

99% Occupy bandwidth

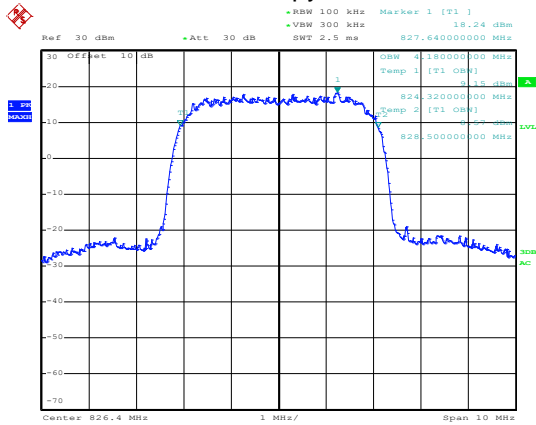

Date: 9.DEC.2020 19:13:01

26dB Emission Bandwidth

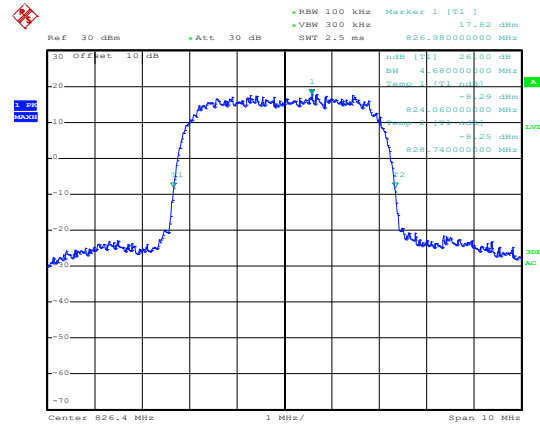

Date: 9.DEC.2020 19:12:46

Lowest channel

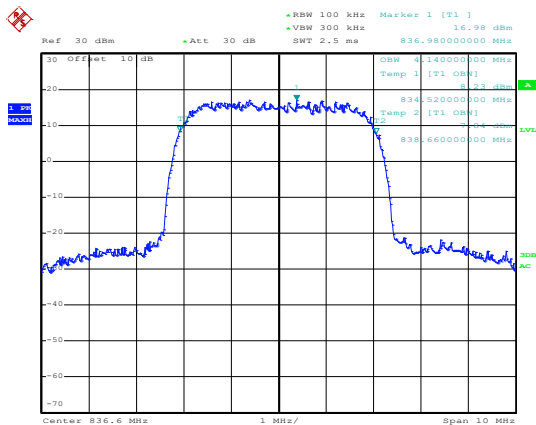

Date: 9.DEC.2020 19:12:18

Lowest channel

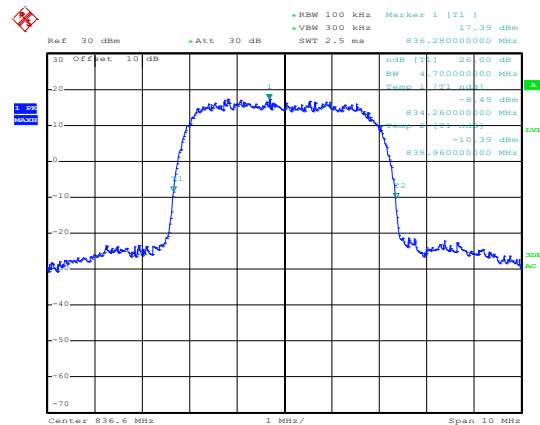

Date: 9.DEC.2020 19:12:27

Middle channel

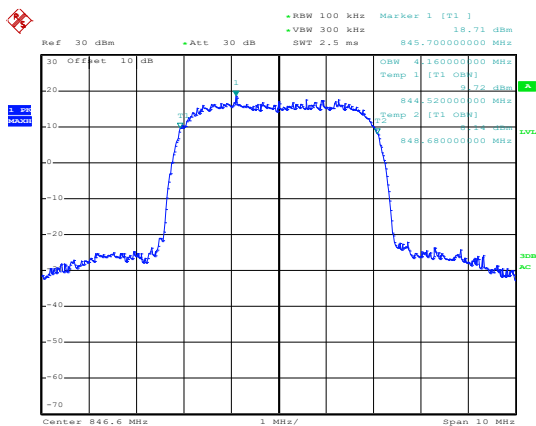

Date: 9.DEC.2020 19:12:00

Middle channel

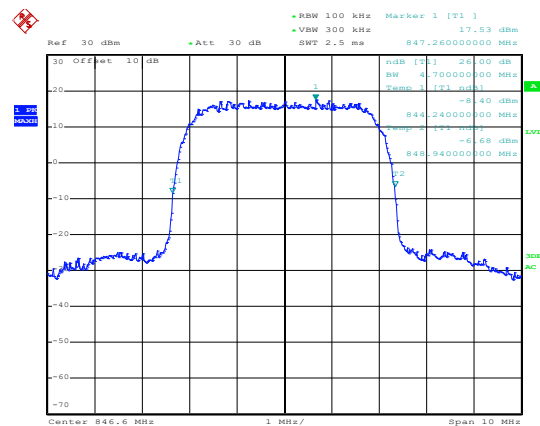

Date: 9.DEC.2020 19:11:49

Highest channel

Highest channel

UMTS 1900 12.2k RMC

99% Occupy bandwidth

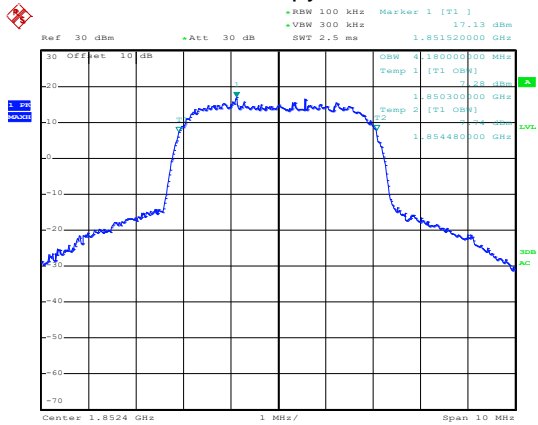

Date: 9.DEC.2020 19:09:44

26dB Emission Bandwidth

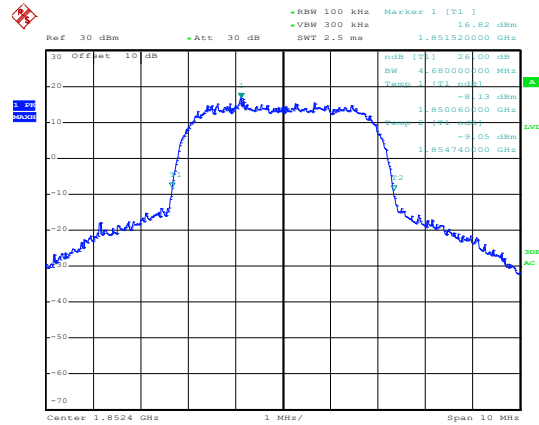

Date: 9.DEC.2020 19:09:59

Lowest channel

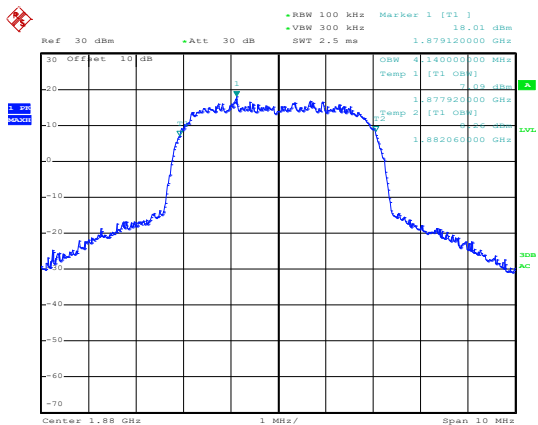

Date: 9.DEC.2020 19:10:35

Lowest channel

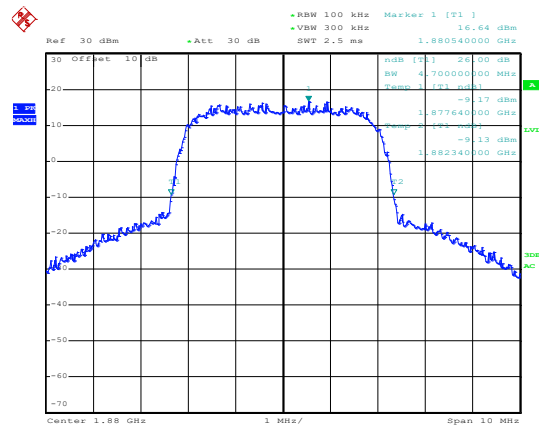

Date: 9.DEC.2020 19:10:18

Middle channel

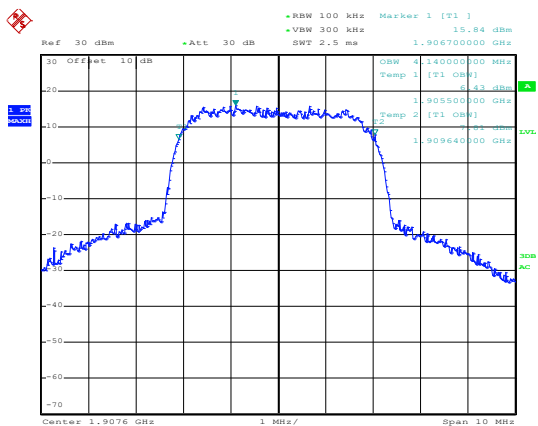

Date: 9.DEC.2020 19:11:01

Middle channel

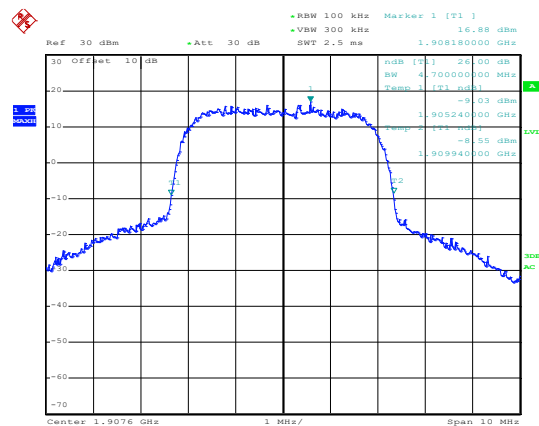

Date: 9.DEC.2020 19:11:11

Highest channel



Highest channel

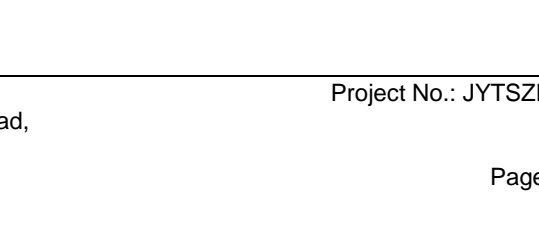

### 6.4 Modulation Characteristic

According to FCC § 2.1047(d), Part 22H & 24E there is no specific requirement for digital modulation, therefore modulation characteristic is not presented.

### 6.5 Out of band emission at antenna terminals

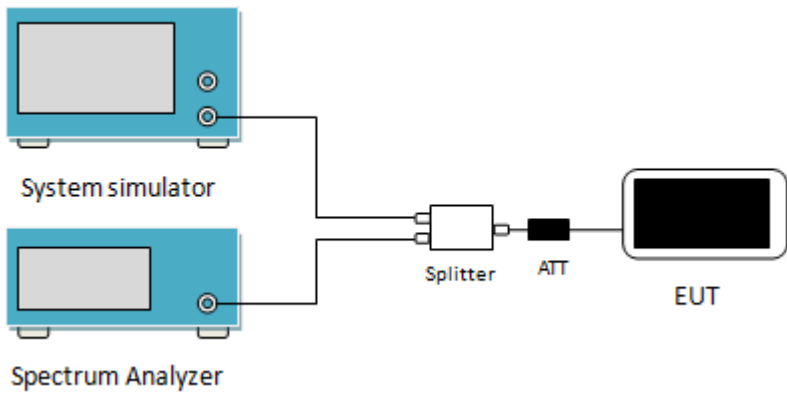
Test Requirement:	FCC part 22.917(a), FCC part 24.238(a)
Limit:	-13dBm
Test setup:	 <p>The diagram illustrates the test setup for out-of-band emission measurement. It shows a 'System simulator' and a 'Spectrum Analyzer' connected to a 'Splitter'. The 'Splitter' is connected to an 'ATT' (attenuator), which is then connected to the 'EUT' (Equipment Under Test).</p>
Test Procedure:	<ol style="list-style-type: none"> <li>1 The RF output of the transceiver was connected to a spectrum analyzer through appropriate attenuation.</li> <li>2 For the out of band: For GSM850&amp;WCDMA850 set the RBW=100 kHz, VBW=300 kHz and for PCS1900 &amp; WCDMA1900 set the RBW=1MHz, VBW=3MHz when below 1 GHz, RBW =1 MHz, VBW=3 MHz when above 1 GHz, Start=30MHz, Stop= 10th harmonic.</li> <li>3 Band Edge Requirements: In the 1 MHz bands immediately outside and adjacent to the frequency block, a resolution bandwidth of at least 1 percent of the emission bandwidth of the fundamental emission of the transmitter may be employed to measure the out of band Emissions.</li> </ol>
Test Instruments:	Refer to section 5.9 for details
Test mode:	Refer to section 5.3 for details
Test results:	Passed

Test plots as follows (Spurious emission):

### GSM 850 Lowest Channel

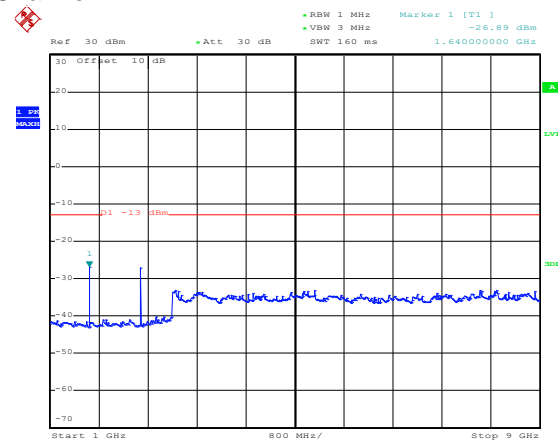
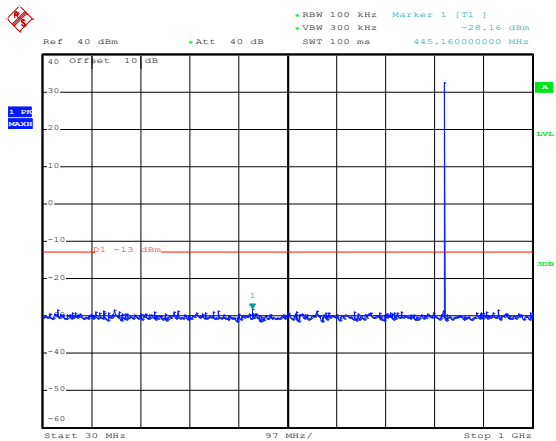

### Middle channel

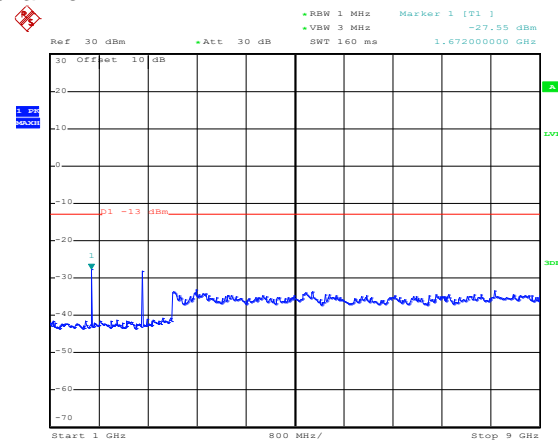
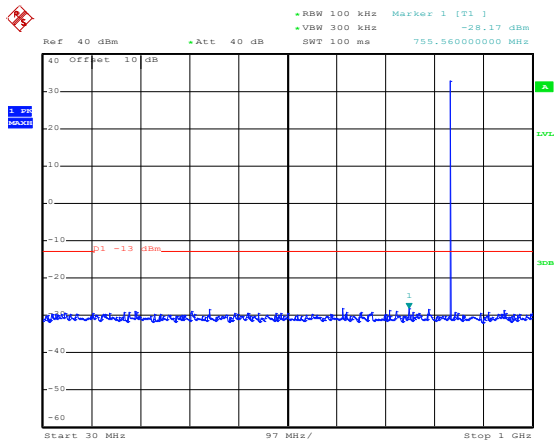

### Highest Channel

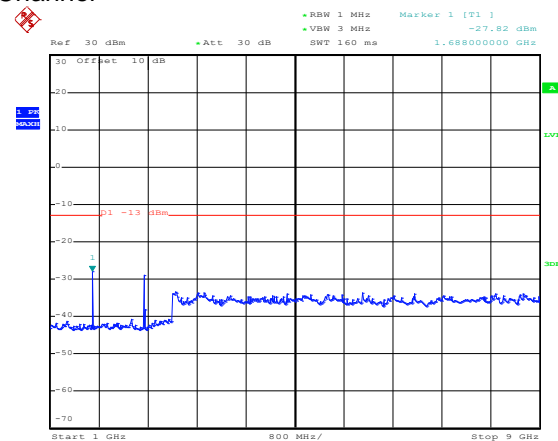
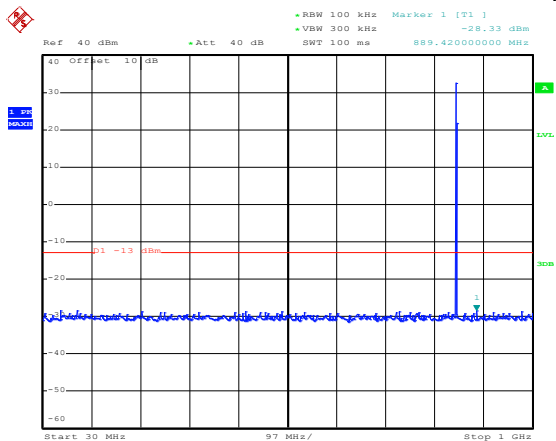

## PCS 1900 Lowest Channel

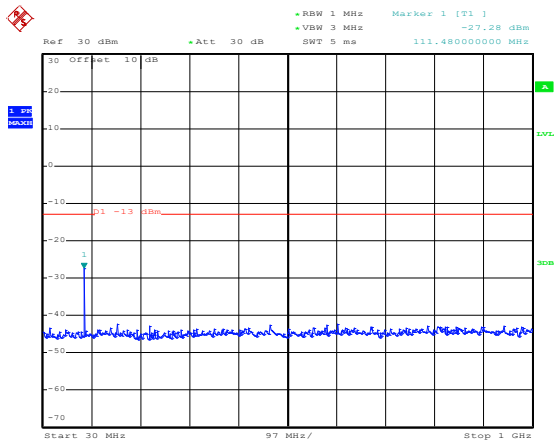

Date: 9.DEC.2020 20:49:40

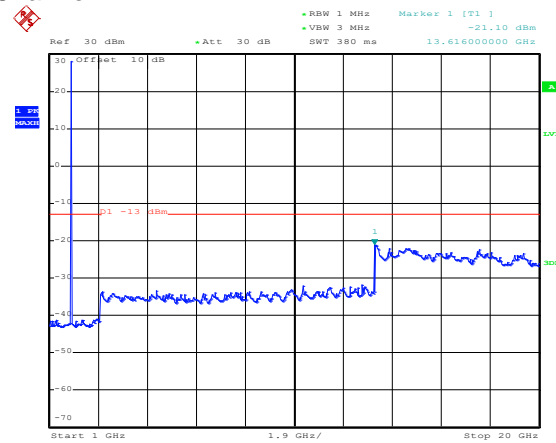

Date: 9.DEC.2020 20:50:22

## Middle Channel

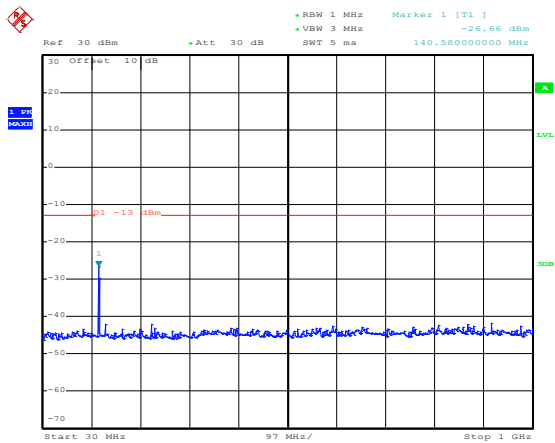

Date: 9.DEC.2020 20:49:28

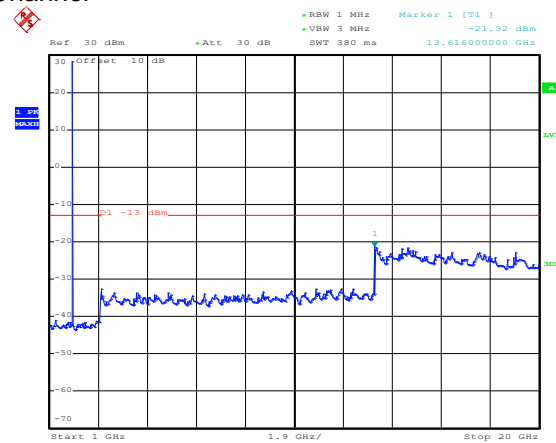

Date: 9.DEC.2020 20:50:41

## Highest Channel

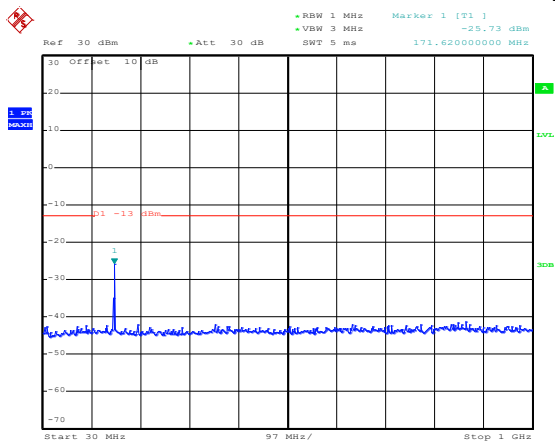

Date: 9.DEC.2020 20:49:11

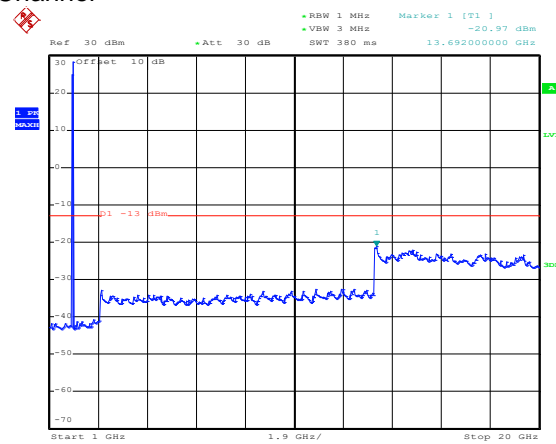

Date: 9.DEC.2020 20:51:13

## UMTS 850 12.2k RMC Lowest Channel

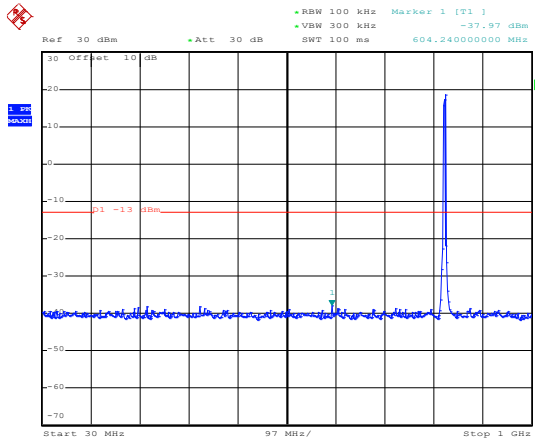

Date: 9,DEC,2020 21:01:15

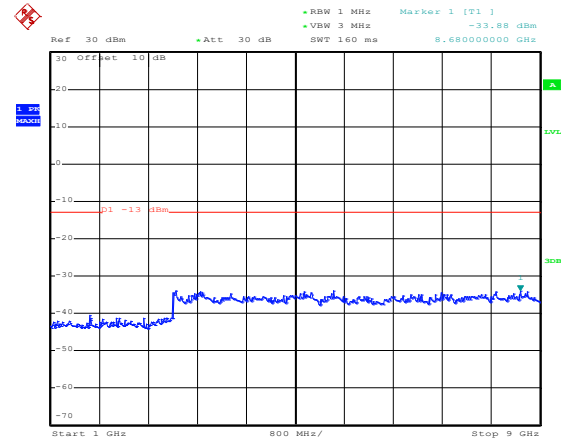

Date: 9,DEC,2020 21:00:37

## Middle Channel

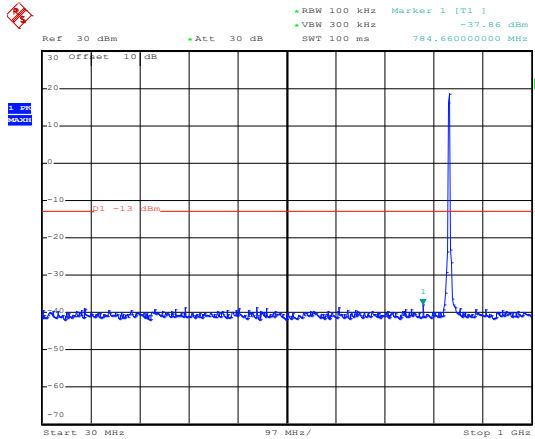

Date: 9,DEC,2020 21:01:35

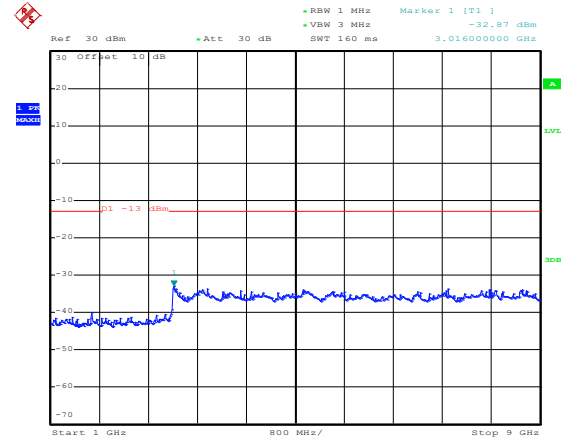

Date: 9,DEC,2020 21:00:23

## Highest Channel

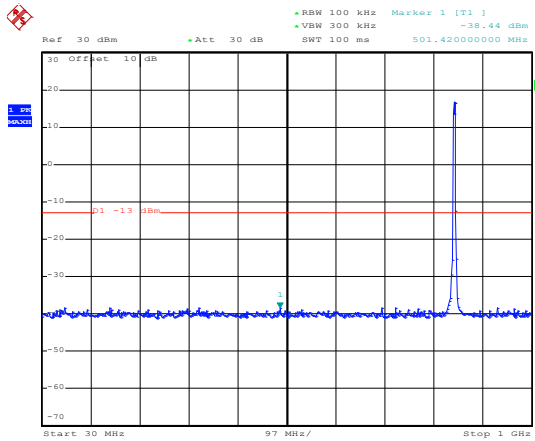

Date: 9,DEC,2020 21:02:24

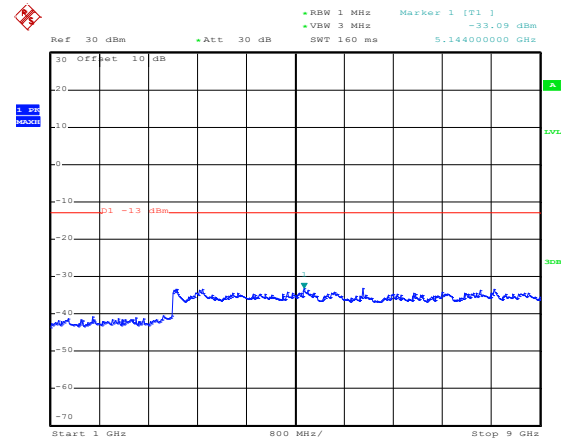

Date: 9,DEC,2020 20:59:56

## UMTS 1900 12.2k RMC Lowest Channel

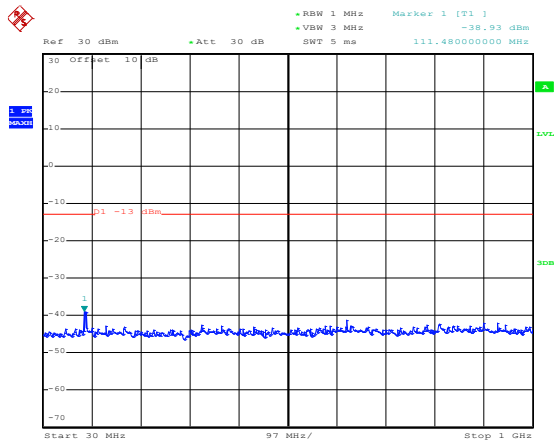

Date: 9,DEC,2020 20:57:07

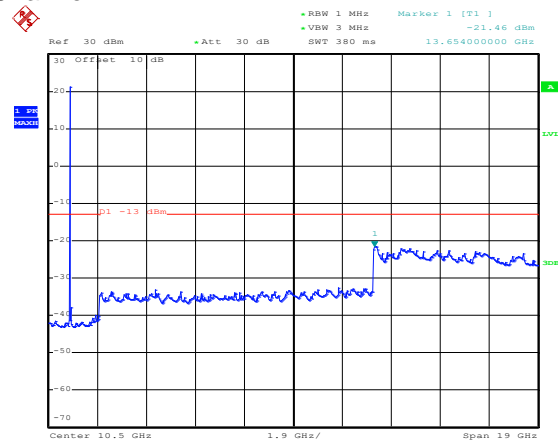

Date: 9,DEC,2020 20:59:06

## Middle Channel

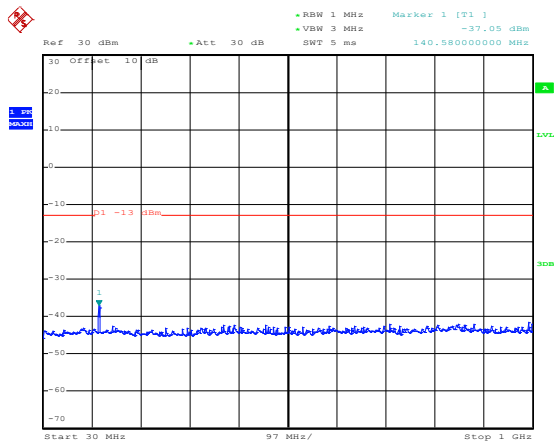

Date: 9,DEC,2020 20:56:48

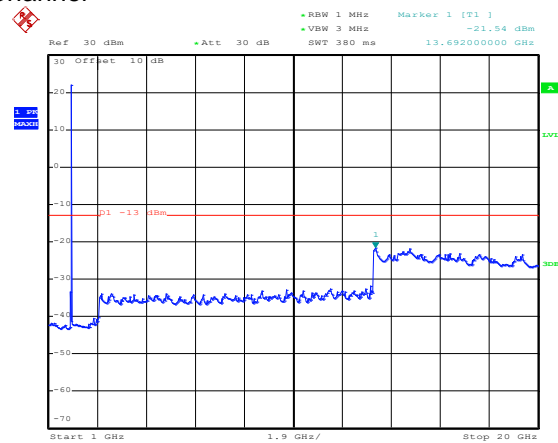

Date: 9,DEC,2020 20:58:26

## Highest Channel

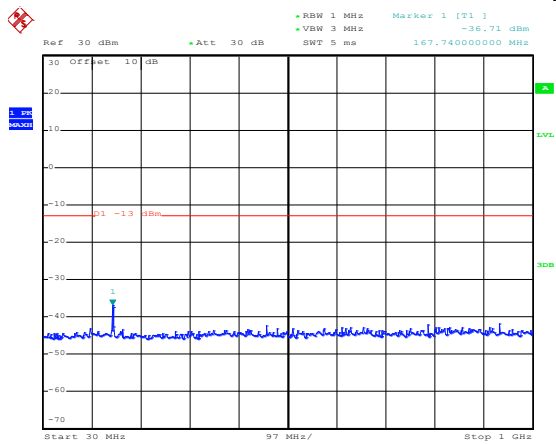

Date: 9,DEC,2020 20:57:22

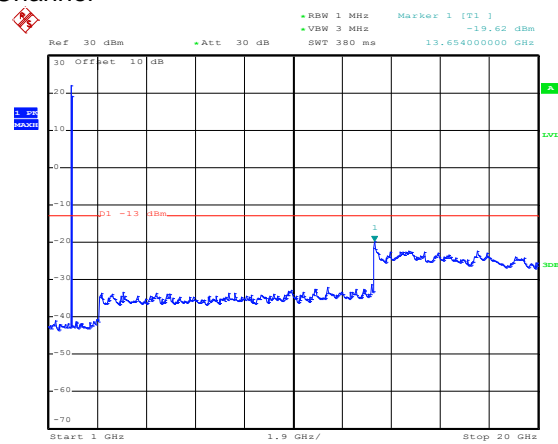

Date: 9,DEC,2020 20:58:00



**Band edge emission:**

**GSM850**

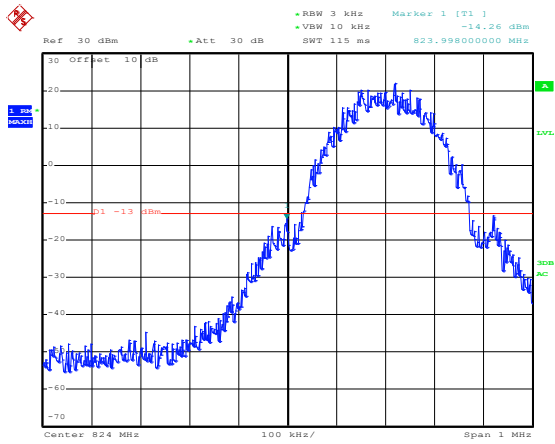

Date: 9.DEC.2020 19:20:33

Lowest channel

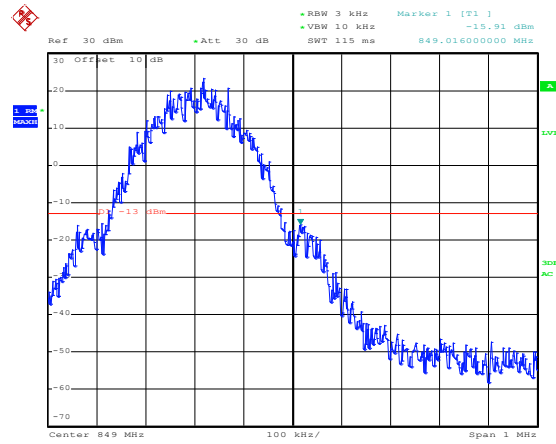

Date: 9.DEC.2020 19:20:59

Highest channel

**PCS1900**

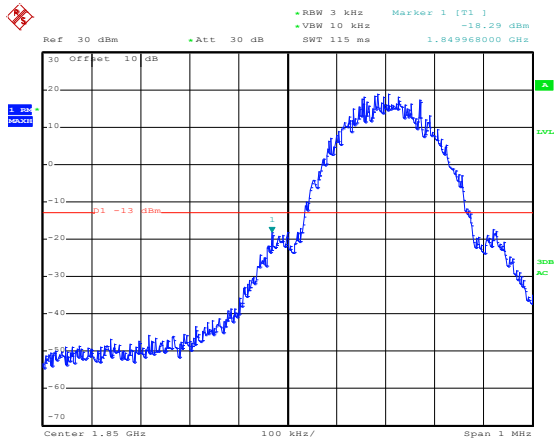

Date: 9.DEC.2020 19:18:45

Lowest channel

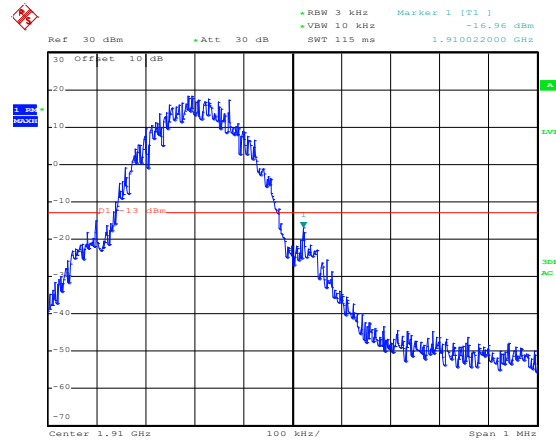

Date: 9.DEC.2020 19:19:31

Highest channel

### UMTS 850 RMC 12.2kbps

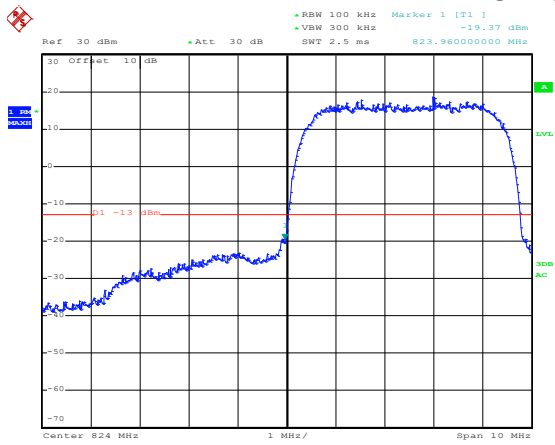

Date: 9.DEC.2020 19:14:04

Lowest channel

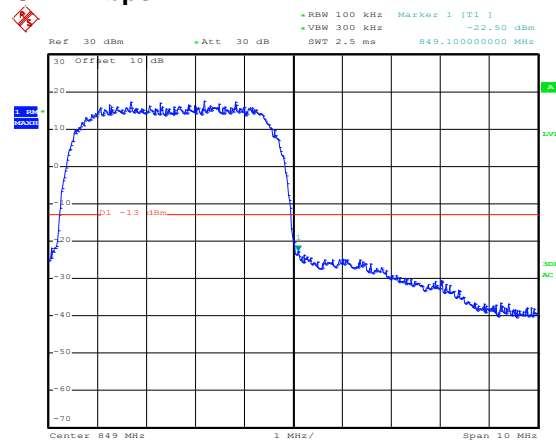

Date: 9.DEC.2020 19:14:39

Highest channel

### UMTS 1900 RMC 12.2kbps

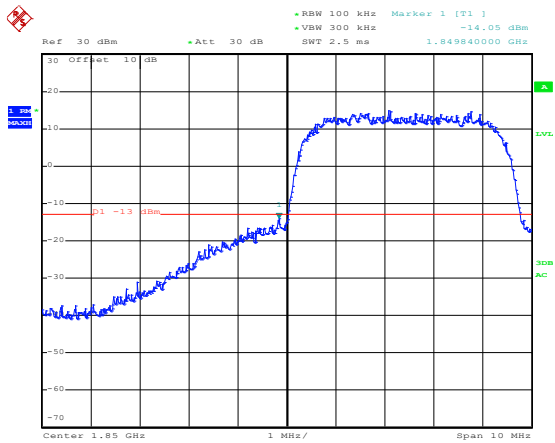

Date: 9.DEC.2020 19:15:49

Lowest channel

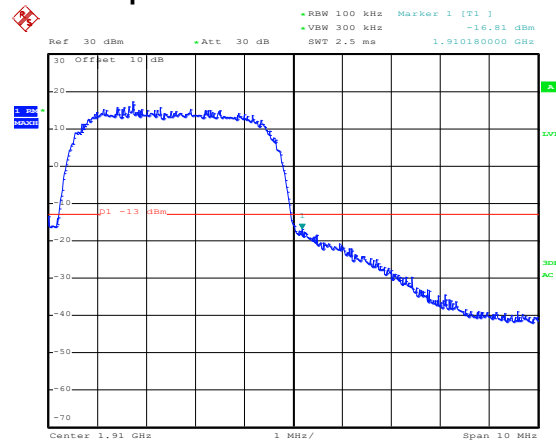

Date: 9.DEC.2020 19:15:14

Highest channel

### 6.6 Field strength of spurious radiation measurement

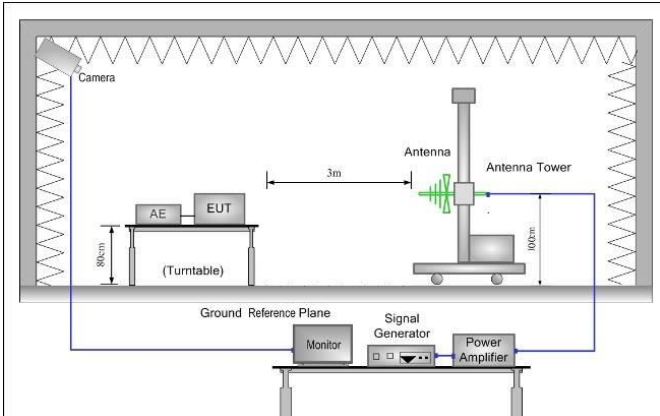
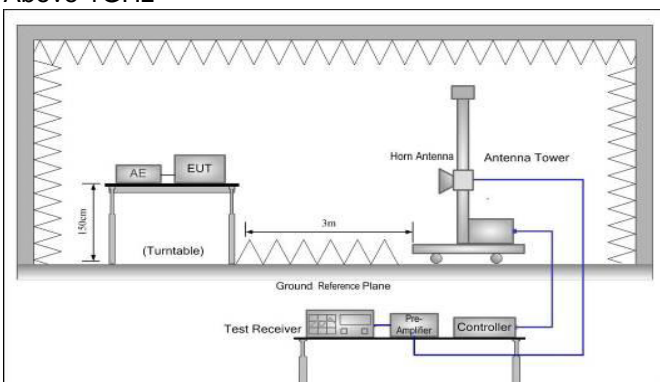
Test Requirement:	FCC part 22.917(a), FCC part 24.238(a)
Limit:	-13dBm
Test setup:	<p>Below 1GHz</p>  <p>Above 1GHz</p> 
Test Procedure:	<ol style="list-style-type: none"> <li>1. The EUT was placed on the top of a rotating table 0.8m(below 1GHz)/1.5m(above 1GHz) above the ground at a 3 meter camber. The radiated emission at the fundamental frequency was measured at 3 m with a test antenna and EMI spectrum analyzer.</li> <li>2. During the tests, the antenna height and the EUT azimuth were varied in order to identify the maximum level of emissions from the EUT. This maximization process was repeated with the EUT positioned in each of its three orthogonal orientations.</li> <li>3. The frequency range up to tenth harmonic was investigated for each of three fundamental frequency (low, middle and high channels). Once spurious emission was identified, the power of the emission was determined using the substitution method.</li> <li>4. The spurious emissions attenuation was calculated as the difference between radiated power at the fundamental frequency and the spurious emissions frequency.  <math display="block">ERP / EIRP = S.G. \text{ output (dBm)} + \text{Antenna Gain(dB/dBi)} - \text{Cable Loss (dB)}</math> </li> </ol>
Test Instruments:	Refer to section 5.9 for details
Test mode:	Refer to section 5.3 for details.
Test results:	Passed

**Measurement Data (worst case):**

GSM850							
Lowest channel							
Frequency (MHz)	Level at antenna terminals (dBm)	Substitute antenna gain (dBi)	Cable Loss (dBi)	Spurious Emission level (dBm)	Limit Line (dBm)	Over Limit (dBm)	Polarization
1648.40	-55.44	9.57	0.19	-46.06	-13.00	-33.06	Vertical
2472.60	-56.63	10.86	0.42	-46.19	-13.00	-33.19	Vertical
3296.80	-60.52	10.49	0.64	-50.67	-13.00	-37.67	Vertical
1648.40	-50.83	9.57	0.19	-41.45	-13.00	-28.45	Horizontal
2472.60	-53.00	10.86	0.42	-42.56	-13.00	-29.56	Horizontal
3296.80	-60.56	10.49	0.64	-50.71	-13.00	-37.71	Horizontal
Middle channel							
Frequency (MHz)	Level at antenna terminals (dBm)	Substitute antenna gain (dBi)	Cable Loss (dBi)	Spurious Emission level (dBm)	Limit Line (dBm)	Over Limit (dBm)	Polarization
1673.20	-55.66	9.66	0.21	-46.21	-13.00	-33.21	Vertical
2509.80	-56.71	10.91	0.46	-46.26	-13.00	-33.26	Vertical
3346.40	-62.37	12.09	0.66	-50.94	-13.00	-37.94	Vertical
1673.20	-50.52	9.66	0.21	-41.07	-13.00	-28.07	Horizontal
2509.80	-52.97	10.91	0.46	-42.52	-13.00	-29.52	Horizontal
3346.40	-62.36	12.09	0.66	-50.93	-13.00	-37.93	Horizontal
Highest channel							
Frequency (MHz)	Level at antenna terminals (dBm)	Substitute antenna gain (dBi)	Cable Loss (dBi)	Spurious Emission level (dBm)	Limit Line (dBm)	Over Limit (dBm)	Polarization
1697.60	-55.68	9.74	0.24	-46.18	-13.00	-33.18	Vertical
2546.40	-57.19	10.95	0.50	-46.74	-13.00	-33.74	Vertical
3395.20	-62.15	12.19	0.68	-50.64	-13.00	-37.64	Vertical
1697.60	-50.99	9.74	0.24	-41.49	-13.00	-28.49	Horizontal
2546.40	-53.07	10.95	0.50	-42.62	-13.00	-29.62	Horizontal
3395.20	-62.32	12.19	0.68	-50.81	-13.00	-37.81	Horizontal
<i>Remark:</i>							
1. The emission levels of below 1 GHz are lower than the limit 20dB and not show in test report.							

PCS1900							
Lowest channel							
Frequency (MHz)	Level at antenna terminals (dBm)	Substitute antenna gain (dBi)	Cable Loss (dBi)	Spurious Emission level (dBm)	Limit Line (dBm)	Over Limit (dBm)	Polarization
3700.40	-57.04	12.64	0.74	-45.14	-13.00	-32.14	Vertical
5550.60	-55.70	12.76	1.12	-44.06	-13.00	-31.06	Vertical
3700.40	-55.00	12.64	0.74	-43.10	-13.00	-30.10	Horizontal
5550.60	-55.36	12.76	1.12	-43.72	-13.00	-30.72	Horizontal
Middle channel							
Frequency (MHz)	Level at antenna terminals (dBm)	Substitute antenna gain (dBi)	Cable Loss (dBi)	Spurious Emission level (dBm)	Limit Line (dBm)	Over Limit (dBm)	Polarization
3760.00	-56.74	12.71	0.77	-44.80	-13.00	-31.80	Vertical
5640.00	-55.84	12.87	1.15	-44.12	-13.00	-31.12	Vertical
3760.00	-55.41	12.71	0.77	-43.47	-13.00	-30.47	Horizontal
5640.00	-55.73	12.87	1.15	-44.01	-13.00	-31.01	Horizontal
Highest channel							
Frequency (MHz)	Level at antenna terminals (dBm)	Substitute antenna gain (dBi)	Cable Loss (dBi)	Spurious Emission level (dBm)	Limit Line (dBm)	Over Limit (dBm)	Polarization
3819.60	-56.78	12.78	0.81	-44.81	-13.00	-31.81	Vertical
5729.40	-55.41	12.98	1.20	-43.63	-13.00	-30.63	Vertical
3819.60	-55.69	12.78	0.81	-43.72	-13.00	-30.72	Horizontal
5729.40	-56.16	12.98	1.20	-44.38	-13.00	-31.38	Horizontal
<i>Remark:</i>							
1. The emission levels of below 1 GHz are lower than the limit 20dB and not show in test report.							

<b>WCDMA BAND V 12.2k RMC</b>							
<b>Lowest channel</b>							
Frequency (MHz)	Level at antenna terminals (dBm)	Substitute antenna gain (dBi)	Cable Loss (dBi)	Spurious Emission level (dBm)	Limit Line (dBm)	Over Limit (dBm)	Polarization
1652.80	-55.64	9.58	0.20	-46.26	-13.00	-33.26	Vertical
2479.20	-64.14	10.87	0.44	-53.71	-13.00	-40.71	Vertical
3305.60	-61.60	12.01	0.65	-50.24	-13.00	-37.24	Vertical
1652.80	-55.12	9.58	0.20	-45.74	-13.00	-32.74	Horizontal
2479.20	-65.04	10.87	0.44	-54.61	-13.00	-41.61	Horizontal
3305.60	-61.95	12.01	0.65	-50.59	-13.00	-37.59	Horizontal
<b>Middle channel</b>							
Frequency (MHz)	Level at antenna terminals (dBm)	Substitute antenna gain (dBi)	Cable Loss (dBi)	Spurious Emission level (dBm)	Limit Line (dBm)	Over Limit (dBm)	Polarization
1673.20	-55.60	9.66	0.21	-46.15	-13.00	-33.15	Vertical
2509.80	-63.82	10.91	0.46	-53.37	-13.00	-40.37	Vertical
3346.40	-61.50	12.09	0.66	-50.07	-13.00	-37.07	Vertical
1673.20	-55.59	9.66	0.21	-46.14	-13.00	-33.14	Horizontal
2509.80	-65.13	10.91	0.46	-54.68	-13.00	-41.68	Horizontal
3346.40	-61.96	12.09	0.66	-50.53	-13.00	-37.53	Horizontal
<b>Highest channel</b>							
Frequency (MHz)	Level at antenna terminals (dBm)	Substitute antenna gain (dBi)	Cable Loss (dBi)	Spurious Emission level (dBm)	Limit Line (dBm)	Over Limit (dBm)	Polarization
1697.60	-56.09	9.74	0.24	-46.59	-13.00	-33.59	Vertical
2546.40	-65.34	12.09	0.50	-53.75	-13.00	-40.75	Vertical
3395.20	-61.21	12.19	0.68	-49.70	-13.00	-36.70	Vertical
1697.60	-55.81	9.74	0.24	-46.31	-13.00	-33.31	Horizontal
2546.40	-66.61	12.09	0.50	-55.02	-13.00	-42.02	Horizontal
3395.20	-62.12	12.19	0.68	-50.61	-13.00	-37.61	Horizontal
<i>Remark:</i>							
1. The emission levels of below 1 GHz are lower than the limit 20dB and not show in test report.							

WCDMA Band II 12.2k RMC							
Lowest channel							
Frequency (MHz)	Level at antenna terminals (dBm)	Substitute antenna gain (dBi)	Cable Loss (dBi)	Spurious Emission level (dBm)	Limit Line (dBm)	Over Limit (dBm)	Polarization
3704.80	-55.73	12.65	0.76	-43.84	-13.00	-30.84	Vertical
5557.20	-54.94	12.77	1.14	-43.31	-13.00	-30.31	Vertical
3704.80	-53.73	12.65	0.76	-41.84	-13.00	-28.84	Horizontal
5557.20	-56.09	12.77	1.14	-44.46	-13.00	-31.46	Horizontal
Middle channel							
Frequency (MHz)	Level at antenna terminals (dBm)	Substitute antenna gain (dBi)	Cable Loss (dBi)	Spurious Emission level (dBm)	Limit Line (dBm)	Over Limit (dBm)	Polarization
3760.00	-55.34	12.71	0.77	-43.40	-13.00	-30.40	Vertical
5640.00	-54.86	12.87	1.15	-43.14	-13.00	-30.14	Vertical
3760.00	-54.07	12.71	0.77	-42.13	-13.00	-29.13	Horizontal
5640.00	-55.88	12.87	1.15	-44.16	-13.00	-31.16	Horizontal
Highest channel							
Frequency (MHz)	Level at antenna terminals (dBm)	Substitute antenna gain (dBi)	Cable Loss (dBi)	Spurious Emission level (dBm)	Limit Line (dBm)	Over Limit (dBm)	Polarization
3815.20	-55.17	12.78	0.80	-43.19	-13.00	-30.19	Vertical
5722.80	-55.11	12.97	1.19	-43.33	-13.00	-30.33	Vertical
3815.20	-54.03	12.78	0.80	-42.05	-13.00	-29.05	Horizontal
5722.80	-55.92	12.97	1.19	-44.14	-13.00	-31.14	Horizontal
<i>Remark:</i>							
1. The emission levels of below 1 GHz are lower than the limit 20dB and not show in test report.							

### 6.7 Frequency stability V.S. Temperature measurement

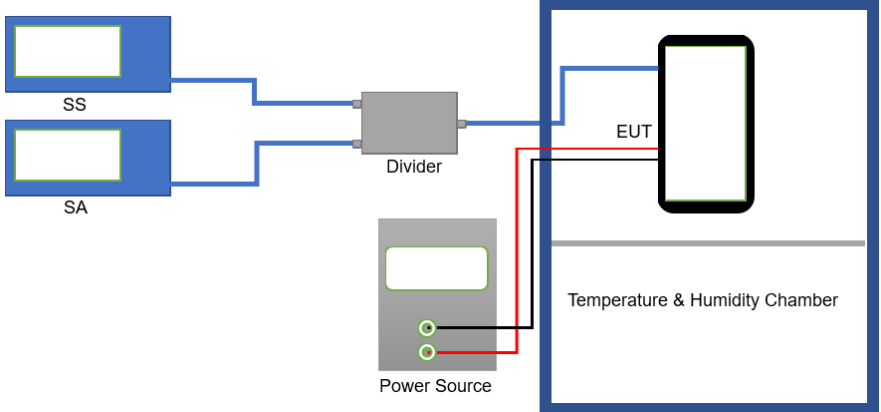
Test Requirement:	FCC Part 22.355, FCC Part 24.235, FCC Part 2.1055(a)(1)(b)
Limit:	±2.5 ppm for GSM 850 and WCDMA 850 Within authorized band for PCS 1900 and WCDMA 1900
Test setup:	
Test procedure:	<ol style="list-style-type: none"> <li>1. The equipment under test was connected to an external DC power supply and input rated voltage.</li> <li>2. RF output was connected to a frequency counter or spectrum analyzer via feed through attenuators.</li> <li>3. The EUT was placed inside the temperature chamber.</li> <li>4. Set the spectrum analyzer RBW low enough to obtain the desired frequency resolution and measure EUT 25°C operating frequency as reference frequency.</li> <li>5. Turn EUT off and set the chamber temperature to -30°C. After the temperature stabilized for approximately 30 minutes recorded the frequency.</li> <li>6. Repeat step measure with 10°C increased per stage until the highest temperature of +50°C reached</li> </ol>
Test Instruments:	Refer to section 5.9 for details
Test mode:	Refer to section 5.3 for details
Test results:	Passed



**Measurement Data (the worst channel):**

Reference Frequency: GSM850 Middle channel=190 channel=836.6MHz					
Power supplied (Vdc)	Temperature (°C)	Frequency error		Limit (ppm)	Result
		Hz	ppm		
3.80	-30	198	0.236672	±2.5	Pass
	-20	121	0.144633		
	-10	165	0.197227		
	0	131	0.156586		
	10	100	0.119531		
	20	144	0.172125		
	30	170	0.203203		
	40	180	0.215157		
	50	177	0.211571		
Reference Frequency: PCS1900 Middle channel=661 channel=1880MHz					
Power supplied (Vdc)	Temperature (°C)	Frequency error		Limit (ppm)	Result
		Hz	ppm		
3.80	-30	198	0.105319	Within authorized band for PCS 1900	Pass
	-20	121	0.064362		
	-10	165	0.087766		
	0	174	0.092553		
	10	180	0.095745		
	20	146	0.077660		
	30	150	0.079787		
	40	128	0.068085		
	50	107	0.056915		
<i>Note: Only the worst case shown in the report.</i>					

Reference Frequency: WCDMA BAND V 12.2k RMC Middle channel=4183 channel=836.6MHz					
Power supplied (Vdc)	Temperature (°C)	Frequency error		Limit (ppm)	Result
		Hz	ppm		
3.80	-30	198	0.236672	±2.5	Pass
	-20	151	0.180492		
	-10	167	0.199617		
	0	132	0.157781		
	10	144	0.172125		
	20	170	0.203203		
	30	188	0.224719		
	40	104	0.124313		
	50	118	0.141047		
Reference Frequency: WCDMA BAND II 12.2k RMC Middle channel=9400 channel=1880MHz					
Power supplied (Vdc)	Temperature (°C)	Frequency error		Limit (ppm)	Result
		Hz	ppm		
3.80	-30	195	0.103723	Within authorized band for WCDMA 1900	Pass
	-20	163	0.086702		
	-10	155	0.082447		
	0	180	0.095745		
	10	177	0.094149		
	20	160	0.085106		
	30	134	0.071277		
	40	100	0.053191		
	50	117	0.062234		
<i>Note: Only the worst case shown in the report.</i>					

### 6.8 Frequency stability V.S. Voltage measurement

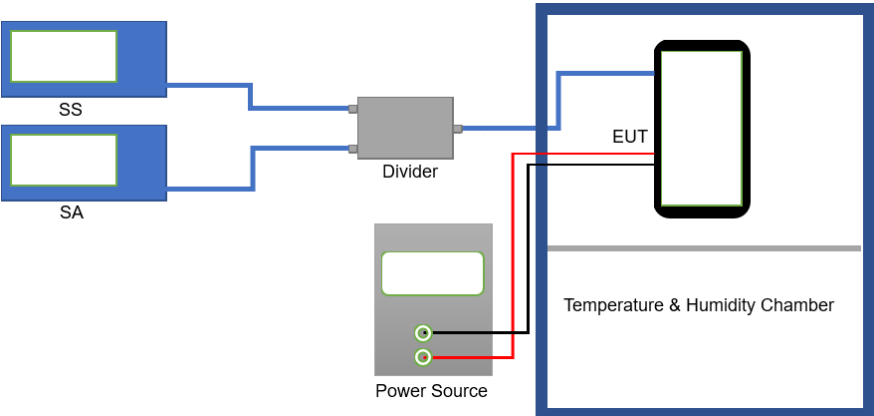
Test Requirement:	FCC Part 22.355, FCC Part 24.235, FCC Part 2.1055(d)(2)
Limit:	±2.5 ppm for GSM 850 and WCDMA 850 Within authorized band for PCS 1900 and WCDMA 1900
Test setup:	
Test procedure:	<ol style="list-style-type: none"> <li>1. Set chamber temperature to 25°C. Use a variable DC power source to power the EUT and set the voltage to rated voltage.</li> <li>2. Set the spectrum analyzer RBW low enough to obtain the desired frequency resolution and recorded the frequency.</li> <li>3. Reduce the input voltage to specify extreme voltage variation (+/- 15%) and endpoint, record the maximum frequency change.</li> </ol>
Test Instruments:	Refer to section 5.9 for details
Test mode:	Refer to section 5.3 for details
Test results:	Passed

**Measurement Data (the worst channel):**

Reference Frequency: GSM850 Middle channel=190 channel=836.6MHz					
Temperature (°C)	Power supplied (Vdc)	Frequency error		Limit (ppm)	Result
		Hz	ppm		
25	4.35	99	0.118336	±2.5	Pass
	3.80	80	0.095625		
	3.55	77	0.092039		
Reference Frequency: PCS1900 Middle channel=661 channel=1880MHz					
Temperature (°C)	Power supplied (Vdc)	Frequency error		Limit (ppm)	Result
		Hz	ppm		
25	4.35	96	0.051064	Within authorized band for PCS 1900	Pass
	3.80	83	0.044149		
	3.55	78	0.041489		
Reference Frequency: UMTS 850 12.2k RMC Middle channel=4183 channel=836.6MHz					
Temperature (°C)	Power supplied (Vdc)	Frequency error		Limit (ppm)	Result
		Hz	ppm		
25	4.35	96	0.114750	±2.5	Pass
	3.80	80	0.095625		
	3.55	74	0.088453		
Reference Frequency: UMTS 1900 12.2k RMC Middle channel=9400 channel=1880MHz					
Temperature (°C)	Power supplied (Vdc)	Frequency error		Limit (ppm)	Result
		Hz	ppm		
25	4.35	80	0.042553	Within authorized band for WCDMA 1900	Pass
	3.80	79	0.042021		
	3.55	94	0.050000		

Note: Only the worst case shown in the report.