

FCC REPORT

(Bluetooth)

Applicant: SKY PHONE LLC

Address of Applicant: 1348 Washington Av. Suite 350, Miami Beach, FL 33139

Equipment Under Test (EUT)

Product Name: 3G Tablet

Model No.: PLATINUM A7

Trade mark: SKY DEVICES

FCC ID: 2ABOSSKYPLATA7

Applicable standards: FCC CFR Title 47 Part 15 Subpart C Section 15.247

Date of sample receipt: 18 May, 2020

Date of Test: 19 May, to 11 Jun., 2020

Date of report issued: 12 Jun., 2020

Test Result: PASS *

* In the configuration tested, the EUT complied with the standards specified above.

Authorized Signature:



Bruce Zhang
Laboratory Manager

This report details the results of the testing carried out on one sample. The results contained in this test report do not relate to other samples of the same product and does not permit the use of the CCIS product certification mark. The manufacturer should ensure that all products in series production are in conformity with the product sample detailed in this report.

This report may only be reproduced and distributed in full. If the product in this report is used in any configuration other than that detailed in the report, the manufacturer must ensure the new system complies with all relevant standards.

This document cannot be reproduced except in full, without prior written approval of the Company. Any unauthorized alteration, forgery or falsification of the content or appearance of this document is unlawful and offenders may be prosecuted to the fullest extent of the law. Unless otherwise stated the results shown in this test report refer only to the sample(s) tested and such sample(s) are retained for 90 days only.

2 Version

| Version No. | Date | Description |
|-------------|---------------|-------------|
| 00 | 12 Jun., 2020 | Original |
| | | |
| | | |
| | | |
| | | |

Tested by:

Yoyo Wu

Test Engineer

Date:

12 Jun., 2020

Reviewed by:

Winner Zhang

Project Engineer

Date:

12 Jun., 2020

3 Contents

Page

| | |
|---|-----------|
| 1 COVER PAGE | 1 |
| 2 VERSION | 2 |
| 3 CONTENTS | 3 |
| 4 TEST SUMMARY | 4 |
| 5 GENERAL INFORMATION | 5 |
| 5.1 CLIENT INFORMATION..... | 5 |
| 5.2 GENERAL DESCRIPTION OF E.U.T. | 5 |
| 5.3 TEST ENVIRONMENT AND TEST MODE | 6 |
| 5.4 DESCRIPTION OF SUPPORT UNITS | 6 |
| 5.5 MEASUREMENT UNCERTAINTY..... | 6 |
| 5.6 ADDITIONS TO, DEVIATIONS, OR EXCLUSIONS FROM THE METHOD | 6 |
| 5.7 LABORATORY FACILITY..... | 6 |
| 5.8 LABORATORY LOCATION..... | 6 |
| 5.9 TEST INSTRUMENTS LIST | 7 |
| 6 TEST RESULTS AND MEASUREMENT DATA | 8 |
| 6.1 ANTENNA REQUIREMENT..... | 8 |
| 6.2 CONDUCTED EMISSIONS | 9 |
| 6.3 CONDUCTED OUTPUT POWER | 12 |
| 6.4 20DB OCCUPY BANDWIDTH..... | 15 |
| 6.5 CARRIER FREQUENCIES SEPARATION | 18 |
| 6.6 HOPPING CHANNEL NUMBER | 22 |
| 6.7 DWELL TIME | 24 |
| 6.8 PSEUDORANDOM FREQUENCY HOPPING SEQUENCE | 27 |
| 6.9 BAND EDGE..... | 28 |
| 6.9.1 Conducted Emission Method..... | 28 |
| 6.9.2 Radiated Emission Method..... | 32 |
| 6.10 SPURIOUS EMISSION..... | 45 |
| 6.10.1 Conducted Emission Method..... | 45 |
| 6.10.2 Radiated Emission Method..... | 48 |
| 7 TEST SETUP PHOTO | 53 |
| 8 EUT CONSTRUCTIONAL DETAILS | 54 |

4 Test Summary

| Test Items | Section in CFR 47 | Result |
|--|--|--------|
| Antenna Requirement | 15.203 & 15.247 (b) | Pass |
| AC Power Line Conducted Emission | 15.207 | Pass |
| Conducted Peak Output Power | 15.247 (b)(1) | Pass |
| 20dB Occupied Bandwidth | 15.247 (a)(1) | Pass |
| Carrier Frequencies Separation | 15.247 (a)(1) | Pass |
| Hopping Channel Number | 15.247 (a)(1) | Pass |
| Dwell Time | 15.247 (a)(1) | Pass |
| Spurious Emission | 15.205 & 15.209 | Pass |
| Band Edge | 15.247(d) | Pass |
| <p>Remark:</p> <ol style="list-style-type: none"> 1. Pass: The EUT complies with the essential requirements in the standard. 2. N/A: Not Applicable. 3. The cable insertion loss used by "RF Output Power" and other conduction measurement items is 0.5dB (provided by the customer). | | |
| Test Method: | ANSI C63.10-2013 KDB 558074 D01 15.247 Meas Guidance v05r02 | |

5 General Information

5.1 Client Information

| | |
|---------------|--|
| Applicant: | SKY PHONE LLC |
| Address: | 1348 Washington Av. Suite 350, Miami Beach, FL 33139 |
| Manufacturer: | SKY PHONE LLC |
| Address: | 1348 Washington Av. Suite 350, Miami Beach, FL 33139 |

5.2 General Description of E.U.T.

| | |
|------------------------|---|
| Product Name: | 3G Tablet |
| Model No.: | PLATINUM A7 |
| Operation Frequency: | 2402MHz~2480MHz |
| Transfer rate: | 1/2/3 Mbits/s |
| Number of channel: | 79 |
| Modulation type: | GFSK, $\pi/4$ -DQPSK, 8DPSK |
| Modulation technology: | FHSS |
| Antenna Type: | Internal Antenna |
| Antenna gain: | 2.0 dBi |
| Power supply: | Rechargeable Li-ion Battery DC3.7V, 2700mAh |
| AC adapter: | Input: AC100-240V, 50/60Hz, 0.25A Output: DC 5.0V, 1.5A |
| Test Sample Condition: | The test samples were provided in good working order with no visible defects. |

| Operation Frequency each of channel for GFSK, $\pi/4$ -DQPSK, 8DPSK | | | | | | | |
|---|-----------|---------|-----------|---------|-----------|---------|-----------|
| Channel | Frequency | Channel | Frequency | Channel | Frequency | Channel | Frequency |
| 0 | 2402MHz | 20 | 2422MHz | 40 | 2442MHz | 60 | 2462MHz |
| 1 | 2403MHz | 21 | 2423MHz | 41 | 2443MHz | 61 | 2463MHz |
| 2 | 2404MHz | 22 | 2424MHz | 42 | 2444MHz | 62 | 2464MHz |
| 3 | 2405MHz | 23 | 2425MHz | 43 | 2445MHz | 63 | 2465MHz |
| 4 | 2406MHz | 24 | 2426MHz | 44 | 2446MHz | 64 | 2466MHz |
| 5 | 2407MHz | 25 | 2427MHz | 45 | 2447MHz | 65 | 2467MHz |
| ... | ... | ... | ... | ... | ... | ... | ... |
| 15 | 2417MHz | 35 | 2437MHz | 55 | 2457MHz | 75 | 2477MHz |
| 16 | 2418MHz | 36 | 2438MHz | 56 | 2458MHz | 76 | 2478MHz |
| 17 | 2419MHz | 37 | 2439MHz | 57 | 2459MHz | 77 | 2479MHz |
| 18 | 2420MHz | 38 | 2440MHz | 58 | 2460MHz | 78 | 2480MHz |
| 19 | 2421MHz | 39 | 2441MHz | 59 | 2461MHz | | |

Remark: Channel 0, 39 & 78 selected for GFSK, $\pi/4$ -DQPSK and 8DPSK.

5.3 Test environment and test mode

| Operating Environment: | |
|--|---|
| Temperature: | 24.0 °C |
| Humidity: | 54 % RH |
| Atmospheric Pressure: | 1010 mbar |
| Test Modes: | |
| Non-hopping mode: | Keep the EUT in continuous transmitting mode with worst case data rate. |
| Hopping mode: | Keep the EUT in hopping mode. |
| Remark | GFSK (1 Mbps) is the worst case mode. |
| Radiated Emission: The sample was placed 0.8m (below 1GHz)/1.5m (above 1GHz) above the ground plane of 3m chamber*. Measurements in both horizontal and vertical polarities were performed. During the test, each emission was maximized by: having the EUT continuously working, investigated all operating modes, rotated about all 3 axis (X, Y & Z) and considered typical configuration to obtain worst position, manipulating interconnecting cables, rotating the turntable, varying antenna height from 1m to 4m in both horizontal and vertical polarizations. The emissions worst-case are shown in Test Results of the following pages. | |

5.4 Description of Support Units

| |
|---|
| The EUT has been tested as an independent unit. |
|---|

5.5 Measurement Uncertainty

| Parameters | Expanded Uncertainty |
|-------------------------------------|----------------------|
| Conducted Emission (9kHz ~ 30MHz) | ±1.60 dB (k=2) |
| Radiated Emission (9kHz ~ 30MHz) | ±3.12 dB (k=2) |
| Radiated Emission (30MHz ~ 1000MHz) | ±4.32 dB (k=2) |
| Radiated Emission (1GHz ~ 18GHz) | ±5.16 dB (k=2) |
| Radiated Emission (18GHz ~ 40GHz) | ±3.20 dB (k=2) |

5.6 Additions to, deviations, or exclusions from the method

| |
|----|
| No |
|----|

5.7 Laboratory Facility

| |
|--|
| <p>The test facility is recognized, certified, or accredited by the following organizations:</p> <ul style="list-style-type: none"> ● FCC - Designation No.: CN1211 Shenzhen Zhongjian Nanfang Testing Co., Ltd. has been accredited as a testing laboratory by FCC(Federal Communications Commission). The test firm Registration No. is 727551. ● ISED – CAB identifier.: CN0021 The 3m Semi-anechoic chamber of Shenzhen Zhongjian Nanfang Testing Co., Ltd. has been Registered by Certification and Engineering Bureau of Industry Canada for radio equipment testing with Registration No.: 10106A-1. ● A2LA - Registration No.: 4346.01 This laboratory is accredited in accordance with the recognized International Standard ISO/IEC 17025:2005 General requirements for the competence of testing and calibration laboratories. The test scope can be found as below link: https://portal.a2la.org/scopepdf/4346-01.pdf |
|--|

5.8 Laboratory Location

| |
|--|
| <p>Shenzhen Zhongjian Nanfang Testing Co., Ltd. Address: No.110~116, Building B, Jinyuan Business Building, Xixiang Road, Bao'an District, Shenzhen, Guangdong, China Tel: +86-755-23118282, Fax: +86-755-23116366 Email: info@ccis-cb.com, Website: http://www.ccis-cb.com</p> |
|--|

5.9 Test Instruments list

| Radiated Emission: | | | | | |
|--------------------|-----------------|---------------|--------------------|----------------------|--------------------------|
| Test Equipment | Manufacturer | Model No. | Serial No. | Cal. Date (mm-dd-yy) | Cal. Due date (mm-dd-yy) |
| 3m SAC | SAEMC | 9m*6m*6m | 966 | 07-22-2017 | 07-21-2020 |
| Loop Antenna | SCHWARZBECK | FMZB1519B | 044 | 03-07-2020 | 03-06-2021 |
| BiConiLog Antenna | SCHWARZBECK | VULB9163 | 497 | 03-07-2020 | 03-06-2021 |
| Horn Antenna | SCHWARZBECK | BBHA9120D | 916 | 03-07-2020 | 03-06-2021 |
| Horn Antenna | SCHWARZBECK | BBHA9120D | 1805 | 06-22-2017 | 06-21-2020 |
| Horn Antenna | SCHWARZBECK | BBHA 9170 | BBHA9170582 | 11-18-2019 | 11-17-2020 |
| EMI Test Software | AUDIX | E3 | Version: 6.110919b | | |
| Pre-amplifier | HP | 8447D | 2944A09358 | 03-07-2020 | 03-06-2021 |
| Pre-amplifier | CD | PAP-1G18 | 11804 | 03-07-2020 | 03-06-2021 |
| Spectrum analyzer | Rohde & Schwarz | FSP30 | 101454 | 03-05-2020 | 03-04-2021 |
| Spectrum analyzer | Rohde & Schwarz | FSP40 | 100363 | 11-18-2019 | 11-17-2020 |
| EMI Test Receiver | Rohde & Schwarz | ESRP7 | 101070 | 03-05-2020 | 03-04-2021 |
| Cable | ZDECL | Z108-NJ-NJ-81 | 1608458 | 03-07-2020 | 03-06-2021 |
| Cable | MICRO-COAX | MFR64639 | K10742-5 | 03-07-2020 | 03-06-2021 |
| Cable | SUHNER | SUCOFLEX100 | 58193/4PE | 03-07-2020 | 03-06-2021 |
| RF Switch Unit | MWRFTEST | MW200 | N/A | N/A | N/A |
| Test Software | MWRFTEST | MTS8200 | Version: 2.0.0.0 | | |

| Conducted Emission: | | | | | |
|---------------------|-----------------|------------|--------------------|----------------------|--------------------------|
| Test Equipment | Manufacturer | Model No. | Serial No. | Cal. Date (mm-dd-yy) | Cal. Due date (mm-dd-yy) |
| EMI Test Receiver | Rohde & Schwarz | ESCI | 101189 | 03-05-2020 | 03-04-2021 |
| Pulse Limiter | SCHWARZBECK | OSRAM 2306 | 9731 | 03-05-2020 | 03-04-2021 |
| LISN | CHASE | MN2050D | 1447 | 03-05-2020 | 03-04-2021 |
| LISN | Rohde & Schwarz | ESH3-Z5 | 8438621/010 | 07-21-2017 | 07-20-2020 |
| Cable | HP | 10503A | N/A | 03-05-2020 | 03-04-2021 |
| EMI Test Software | AUDIX | E3 | Version: 6.110919b | | |

6 Test results and measurement data

6.1 Antenna Requirement

| | |
|--|---------------------------------------|
| Standard requirement: | FCC Part 15 C Section 15.203 & 247(b) |
| <p>15.203 requirement: An intentional radiator shall be designed to ensure that no antenna other than that furnished by the responsible party shall be used with the device. The use of a permanently attached antenna or of an antenna that uses a unique coupling to the intentional radiator, the manufacturer may design the unit so that a broken antenna can be replaced by the user, but the use of a standard antenna jack or electrical connector is prohibited.</p> <p>15.247(b) (4) requirement: (4) The conducted output power limit specified in paragraph (b) of this section is based on the use of antennas with directional gains that do not exceed 6 dBi. Except as shown in paragraph (c) of this section, if transmitting antennas of directional gain greater than 6 dBi are used, the conducted output power from the intentional radiator shall be reduced below the stated values in paragraphs (b)(1), (b)(2), and (b)(3) of this section, as appropriate, by the amount in dB that the directional gain of the antenna exceeds 6 dBi.</p> | |

| | |
|--|--|
| E.U.T Antenna: | |
| The Bluetooth antenna is an Internal antenna which permanently attached, and the best case gain of the antenna is 2.0 dBi. | |



6.2 Conducted Emissions

| | | | |
|--|---|--------------|-----------|
| Test Requirement: | FCC Part 15 C Section 15.207 | | |
| Test Frequency Range: | 150 kHz to 30 MHz | | |
| Class / Severity: | Class B | | |
| Receiver setup: | RBW=9 kHz, VBW=30 kHz, Sweep time=auto | | |
| Limit: | Frequency range (MHz) | Limit (dBuV) | |
| | | Quasi-peak | Average |
| | 0.15-0.5 | 66 to 56* | 56 to 46* |
| | 0.5-5 | 56 | 46 |
| | 5-30 | 60 | 50 |
| * Decreases with the logarithm of the frequency. | | | |
| Test setup: | <p><i>Remark</i> E.U.T.: Equipment Under Test LISN: Line Impedance Stabilization Network Test table height=0.8m</p> | | |
| Test procedure: | <ol style="list-style-type: none"> 1. The E.U.T and simulators are connected to the main power through a line impedance stabilization network (L.I.S.N.). This provides a 50ohm/50uH coupling impedance for the measuring equipment. 2. The peripheral devices are also connected to the main power through a LISN that provides a 50ohm/50uH coupling impedance with 50ohm termination. (Please refer to the block diagram of the test setup and photographs). 3. Both sides of A.C. line are checked for maximum conducted interference. In order to find the maximum emission, the relative positions of equipment and all of the interface cables must be changed according to ANSI C63.10(latest version) on conducted measurement. | | |
| Test Instruments: | Refer to section 5.9 for details | | |
| Test mode: | Hopping mode | | |
| Test results: | Pass | | |

Measurement Data:

| | | | |
|-----------------|------------------|----------------|------------------------|
| Product name: | 3G Tablet | Product model: | PLATINUM A7 |
| Test by: | Yaro | Test mode: | BT Tx mode |
| Test frequency: | 150 kHz ~ 30 MHz | Phase: | Line |
| Test voltage: | AC 120 V/60 Hz | Environment: | Temp: 22.5°C Huni: 55% |

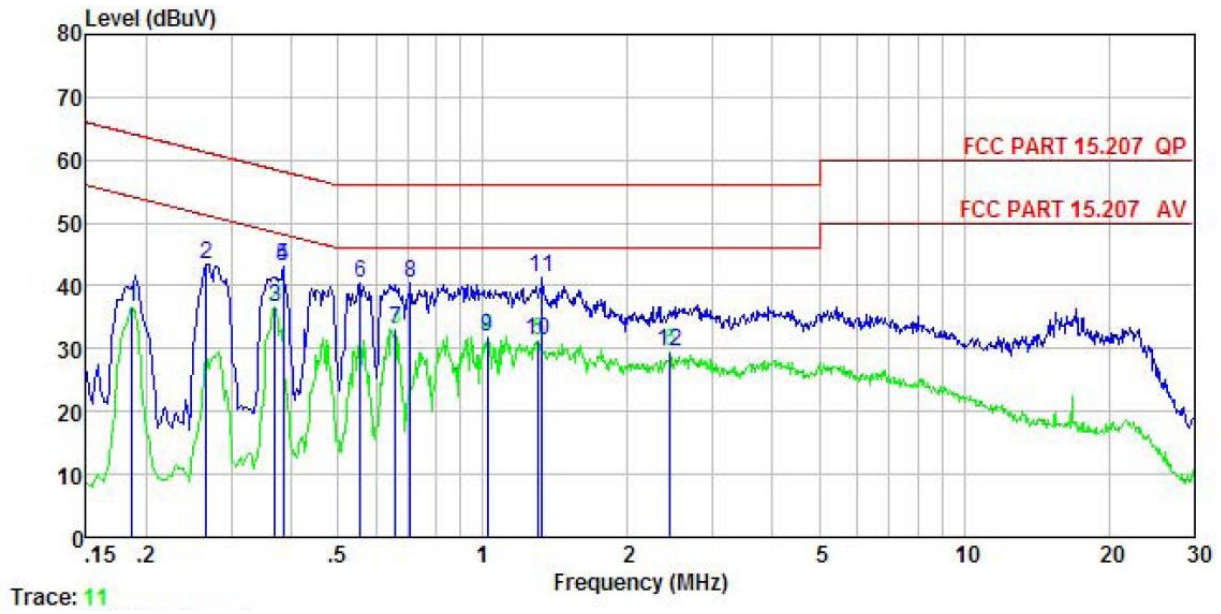

| | Freq | Read Level | LISN Factor | Aux Factor | Cable Loss | Level | Limit Line | Over Limit | Remark |
|----|-------|------------|-------------|------------|------------|-------|------------|------------|---------|
| | MHz | dBuV | dB | dB | dB | dBuV | dBuV | dB | |
| 1 | 0.186 | 26.43 | -0.59 | -0.13 | 10.76 | 36.47 | 54.20 | -17.73 | Average |
| 2 | 0.266 | 33.46 | -0.56 | -0.23 | 10.75 | 43.42 | 61.25 | -17.83 | QP |
| 3 | 0.369 | 26.19 | -0.50 | 0.23 | 10.73 | 36.65 | 48.52 | -11.87 | Average |
| 4 | 0.385 | 32.68 | -0.49 | 0.33 | 10.72 | 43.24 | 58.17 | -14.93 | QP |
| 5 | 0.385 | 32.68 | -0.49 | 0.33 | 10.72 | 43.24 | 58.17 | -14.93 | QP |
| 6 | 0.555 | 30.43 | -0.46 | -0.37 | 10.76 | 40.36 | 56.00 | -15.64 | QP |
| 7 | 0.658 | 23.10 | -0.51 | -0.39 | 10.77 | 32.97 | 46.00 | -13.03 | Average |
| 8 | 0.708 | 30.58 | -0.53 | -0.38 | 10.77 | 40.44 | 56.00 | -15.56 | QP |
| 9 | 1.021 | 21.14 | -0.62 | 0.44 | 10.87 | 31.83 | 46.00 | -14.17 | Average |
| 10 | 1.303 | 20.89 | -0.58 | 0.17 | 10.90 | 31.38 | 46.00 | -14.62 | Average |
| 11 | 1.331 | 30.95 | -0.57 | 0.14 | 10.91 | 41.43 | 56.00 | -14.57 | QP |
| 12 | 2.448 | 19.46 | -0.47 | -0.26 | 10.94 | 29.67 | 46.00 | -16.33 | Average |

Notes:

1. An initial pre-scan was performed on the line and neutral lines with peak detector.
2. Quasi-Peak and Average measurement were performed at the frequencies with maximized peak emission.
3. Final Level = Receiver Read level + LISN Factor + Aux Factor + Cable Loss.

| | | | |
|-----------------|------------------|----------------|------------------------|
| Product name: | 3G Tablet | Product model: | PLATINUM A7 |
| Test by: | Yaro | Test mode: | BT Tx mode |
| Test frequency: | 150 kHz ~ 30 MHz | Phase: | Neutral |
| Test voltage: | AC 120 V/60 Hz | Environment: | Temp: 22.5°C Humi: 55% |

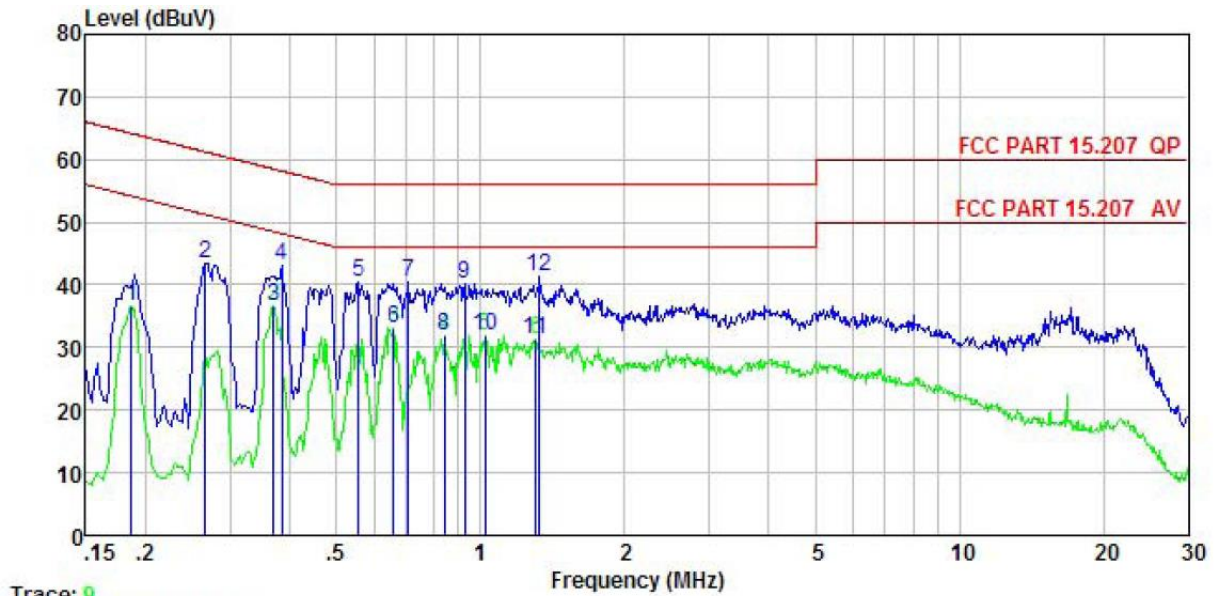

Trace: 9

| | Freq | Read Level | LISN Factor | Aux Factor | Cable Loss | Level | Limit Line | Over Limit | Remark |
|----|-------|------------|-------------|------------|------------|-------|------------|------------|---------|
| | MHz | dBuV | dB | dB | dB | dBuV | dBuV | dB | |
| 1 | 0.186 | 26.38 | -0.67 | 0.00 | 10.76 | 36.47 | 54.20 | -17.73 | Average |
| 2 | 0.266 | 33.33 | -0.67 | 0.01 | 10.75 | 43.42 | 61.25 | -17.83 | QP |
| 3 | 0.369 | 26.60 | -0.64 | -0.04 | 10.73 | 36.65 | 48.52 | -11.87 | Average |
| 4 | 0.385 | 33.21 | -0.64 | -0.05 | 10.72 | 43.24 | 58.17 | -14.93 | QP |
| 5 | 0.555 | 30.22 | -0.65 | 0.03 | 10.76 | 40.36 | 56.00 | -15.64 | QP |
| 6 | 0.658 | 22.80 | -0.64 | 0.04 | 10.77 | 32.97 | 46.00 | -13.03 | Average |
| 7 | 0.708 | 30.27 | -0.64 | 0.04 | 10.77 | 40.44 | 56.00 | -15.56 | QP |
| 8 | 0.839 | 21.69 | -0.66 | 0.06 | 10.82 | 31.91 | 46.00 | -14.09 | Average |
| 9 | 0.928 | 29.89 | -0.67 | 0.07 | 10.85 | 40.14 | 56.00 | -15.86 | QP |
| 10 | 1.021 | 21.56 | -0.68 | 0.08 | 10.87 | 31.83 | 46.00 | -14.17 | Average |
| 11 | 1.303 | 21.06 | -0.69 | 0.11 | 10.90 | 31.38 | 46.00 | -14.62 | Average |
| 12 | 1.331 | 31.09 | -0.69 | 0.12 | 10.91 | 41.43 | 56.00 | -14.57 | QP |

Notes:

1. An initial pre-scan was performed on the line and neutral lines with peak detector.
2. Quasi-Peak and Average measurement were performed at the frequencies with maximized peak emission.
3. Final Level = Receiver Read level + LISN Factor + Aux Factor + Cable Loss.

6.3 Conducted Output Power

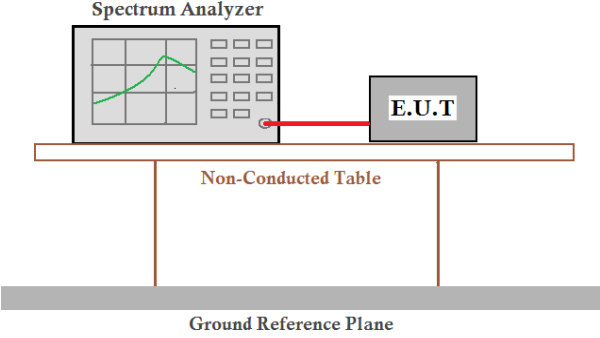
| | |
|-------------------|--|
| Test Requirement: | FCC Part 15 C Section 15.247 (b)(1) |
| Receiver setup: | RBW=1MHz, VBW=3MHz, Detector=Peak (If 20dB BW ≤1 MHz) RBW=3MHz, VBW=10MHz, Detector=Peak (If 20dB BW > 1 MHz and < 3MHz) |
| Limit: | For frequency hopping systems operating in the 2400-2483.5 MHz band employing at least 75 non-overlapping hopping channels: 1 watt. For all other frequency hopping systems in the 2400-2483.5 MHz band: 0.125 watts. |
| Test setup: |  <p>The diagram illustrates the test setup. A Spectrum Analyzer is connected via a red cable to an E.U.T. (Equipment Under Test). Both are placed on a Non-Conducted Table. The table is supported by two legs and sits on a Ground Reference Plane.</p> |
| Test Instruments: | Refer to section 5.9 for details |
| Test mode: | Non-hopping mode |
| Test results: | Pass |

Measurement Data:

| Test channel | Peak Output Power (dBm) | Limit (dBm) | Result |
|-----------------|-------------------------|-------------|--------|
| GFSK mode | | | |
| Lowest channel | -0.38 | 30.00 | Pass |
| Middle channel | -0.33 | 30.00 | Pass |
| Highest channel | -1.49 | 30.00 | Pass |
| π/4-DQPSK mode | | | |
| Lowest channel | -0.53 | 21.00 | Pass |
| Middle channel | -0.44 | 21.00 | Pass |
| Highest channel | -1.54 | 21.00 | Pass |
| 8DPSK mode | | | |
| Lowest channel | -0.44 | 21.00 | Pass |
| Middle channel | -0.32 | 21.00 | Pass |
| Highest channel | -1.48 | 21.00 | Pass |

Test plot as follows:

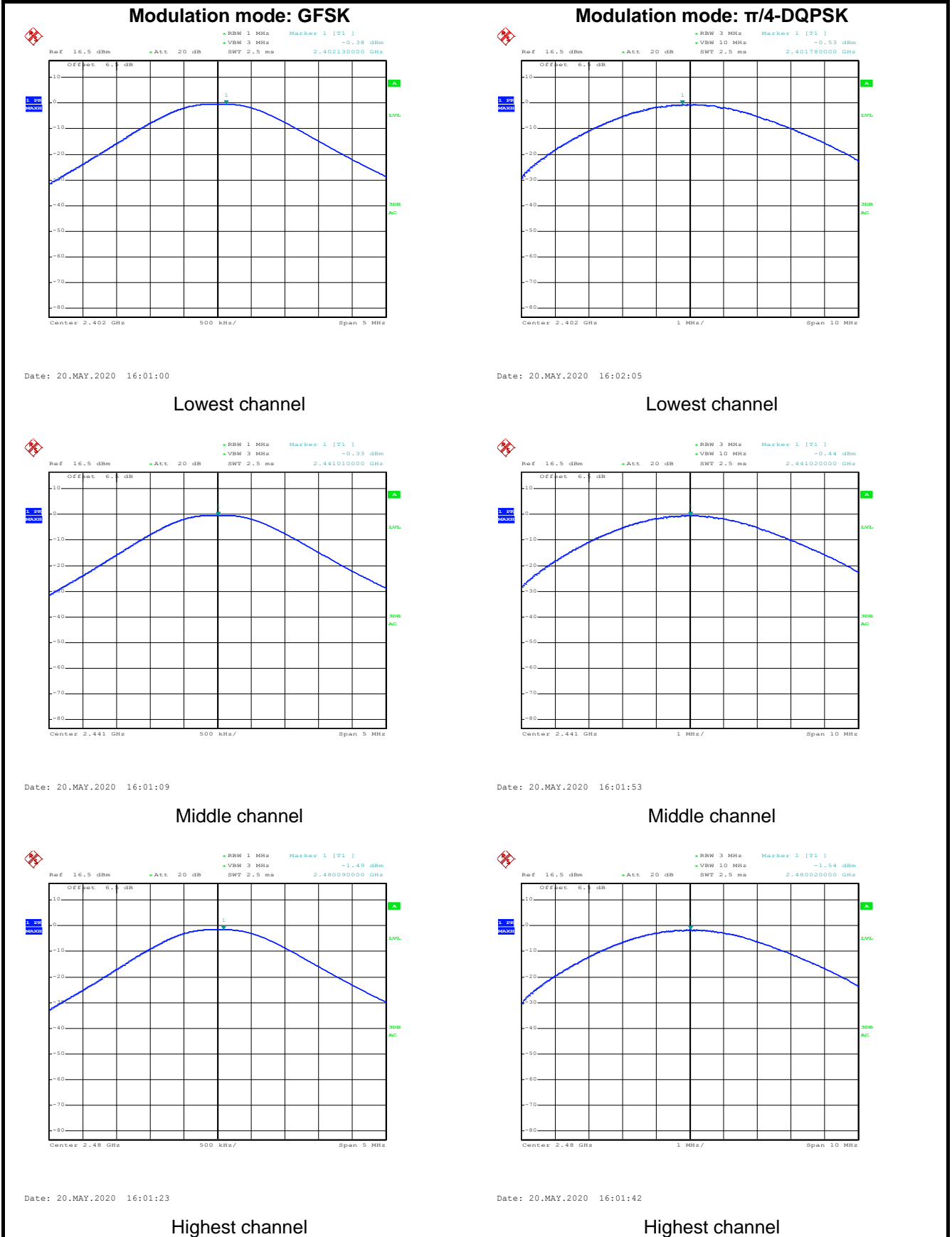

Modulation mode: 8DPSK

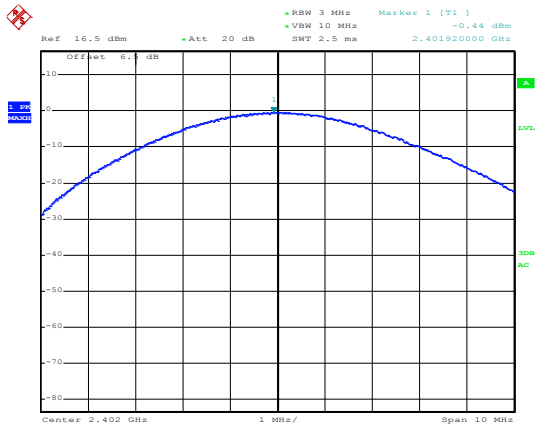

Date: 20.MAY.2020 16:02:19

Lowest channel

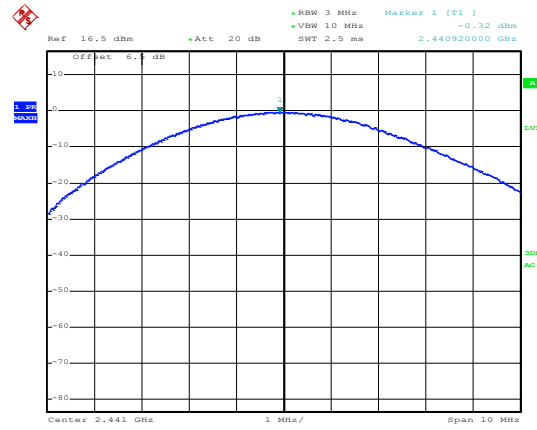

Date: 20.MAY.2020 16:02:29

Middle channel

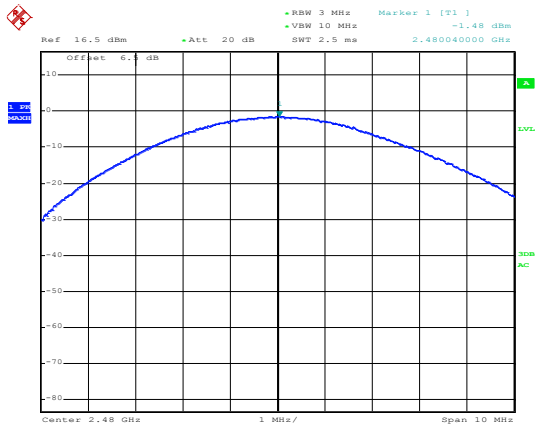

Date: 20.MAY.2020 16:02:40

Highest channel

6.4 20dB Occupy Bandwidth

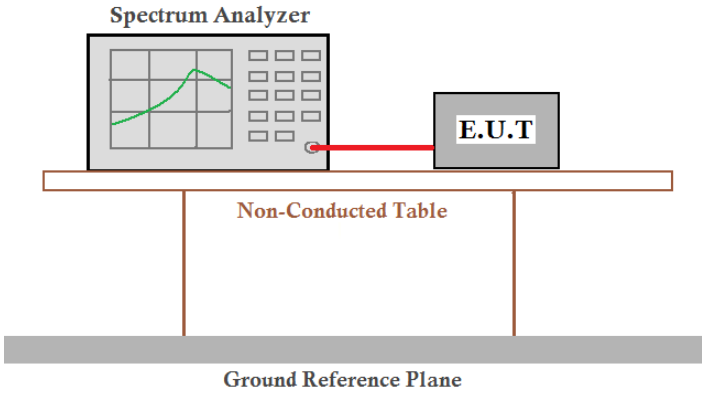
| | |
|-------------------|--|
| Test Requirement: | FCC Part 15 C Section 15.247 (a)(1) |
| Receiver setup: | RBW=30 kHz, VBW=100 kHz, detector=Peak |
| Limit: | N/A |
| Test setup: |  <p>The diagram shows a Spectrum Analyzer on the left and an E.U.T. on the right, connected by a red cable. They are both on a table labeled 'Non-Conducted Table'. Below the table is a 'Ground Reference Plane'.</p> |
| Test Instruments: | Refer to section 5.9 for details |
| Test mode: | Non-hopping mode |
| Test results: | Pass |

Measurement Data:

| Test channel | 20dB Occupy Bandwidth (kHz) | | |
|--------------|-----------------------------|----------------|-------|
| | GFSK | $\pi/4$ -DQPSK | 8DPSK |
| Lowest | 944 | 1278 | 1272 |
| Middle | 944 | 1266 | 1272 |
| Highest | 944 | 1272 | 1272 |

Test plot as follows:

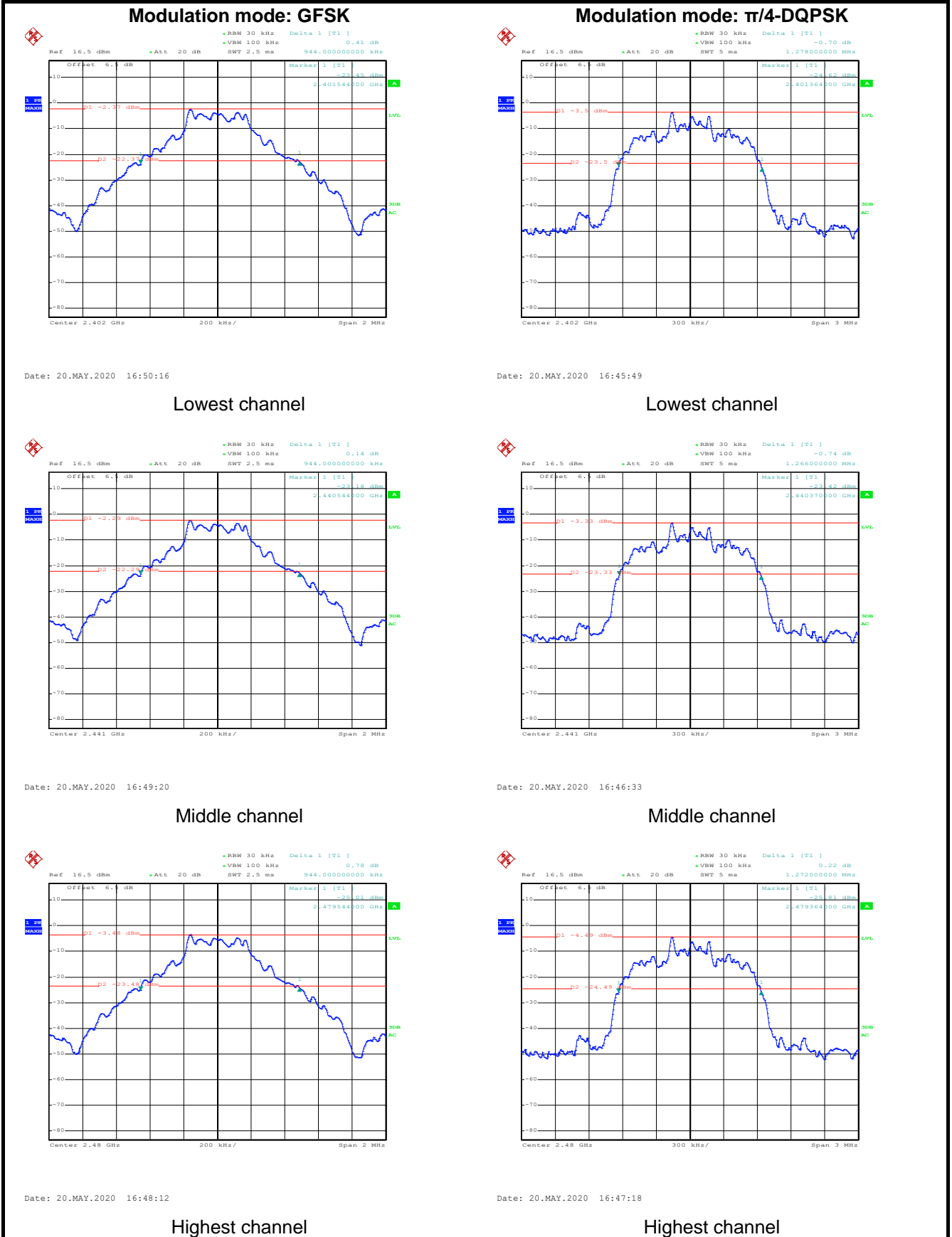

Modulation mode: 8DPSK

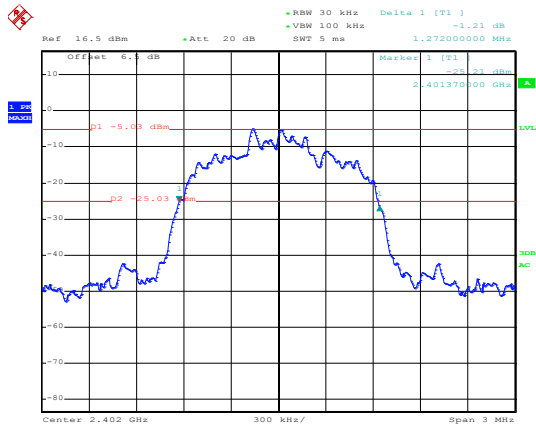

Date: 20.MAY.2020 16:44:58

Lowest channel

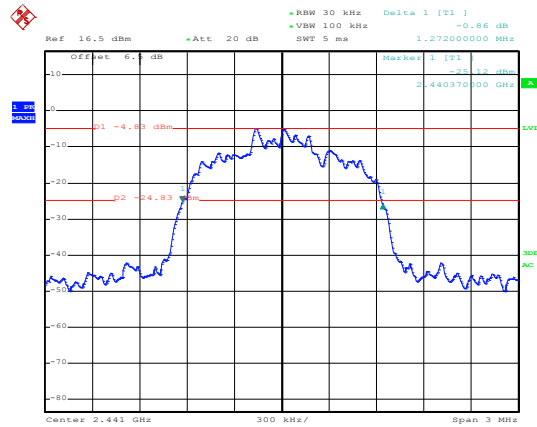

Date: 20.MAY.2020 16:44:08

Middle channel

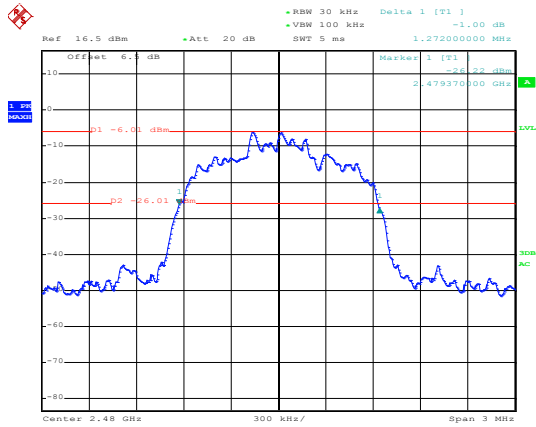

Date: 20.MAY.2020 16:42:54

Highest channel

6.5 Carrier Frequencies Separation

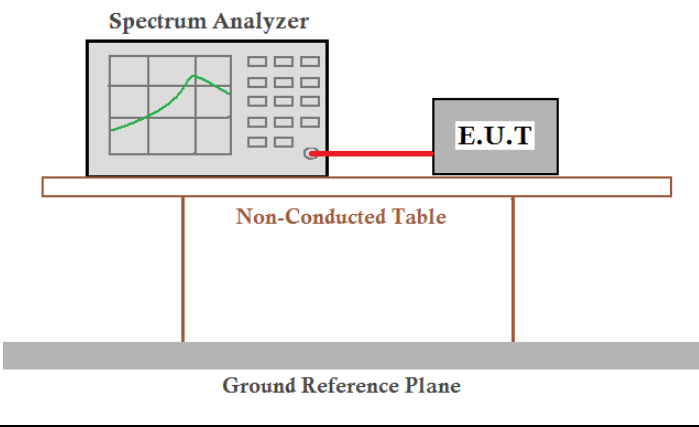
| | |
|-------------------|---|
| Test Requirement: | FCC Part 15 C Section 15.247 (a)(1) |
| Receiver setup: | RBW=100 kHz, VBW=300 kHz, detector=Peak |
| Limit: | a) 0.025MHz or the 20dB bandwidth (whichever is greater) b) 0.025MHz or two-thirds of the 20dB bandwidth (whichever is greater) |
| Test setup: |  <p>The diagram illustrates the test setup. A Spectrum Analyzer is connected to an E.U.T. (Equipment Under Test) via a red cable. Both are placed on a Non-Conducted Table, which is supported by a Ground Reference Plane.</p> |
| Test Instruments: | Refer to section 5.9 for details |
| Test mode: | Hopping mode |
| Test results: | Pass |

Measurement Data:

| Test channel | Carrier Frequencies Separation (kHz) | Limit (kHz) | Result |
|---------------------|--------------------------------------|-------------|--------|
| GFSK | | | |
| Lowest | 1000 | 944.00 | Pass |
| Middle | 1000 | 944.00 | Pass |
| Highest | 1004 | 944.00 | Pass |
| $\pi/4$ -DQPSK mode | | | |
| Lowest | 1004 | 852.00 | Pass |
| Middle | 1004 | 852.00 | Pass |
| Highest | 1004 | 852.00 | Pass |
| 8DPSK mode | | | |
| Lowest | 1004 | 848.00 | Pass |
| Middle | 1000 | 848.00 | Pass |
| Highest | 1004 | 848.00 | Pass |

Note: According to section 6.4

| Mode | 20dB bandwidth (kHz) (worse case) | Limit (kHz) (Carrier Frequencies Separation) |
|----------------|--------------------------------------|---|
| GFSK | 944 | 944.00 |
| $\pi/4$ -DQPSK | 1278 | 852.00 |
| 8DPSK | 1272 | 848.00 |

Test plot as follows:

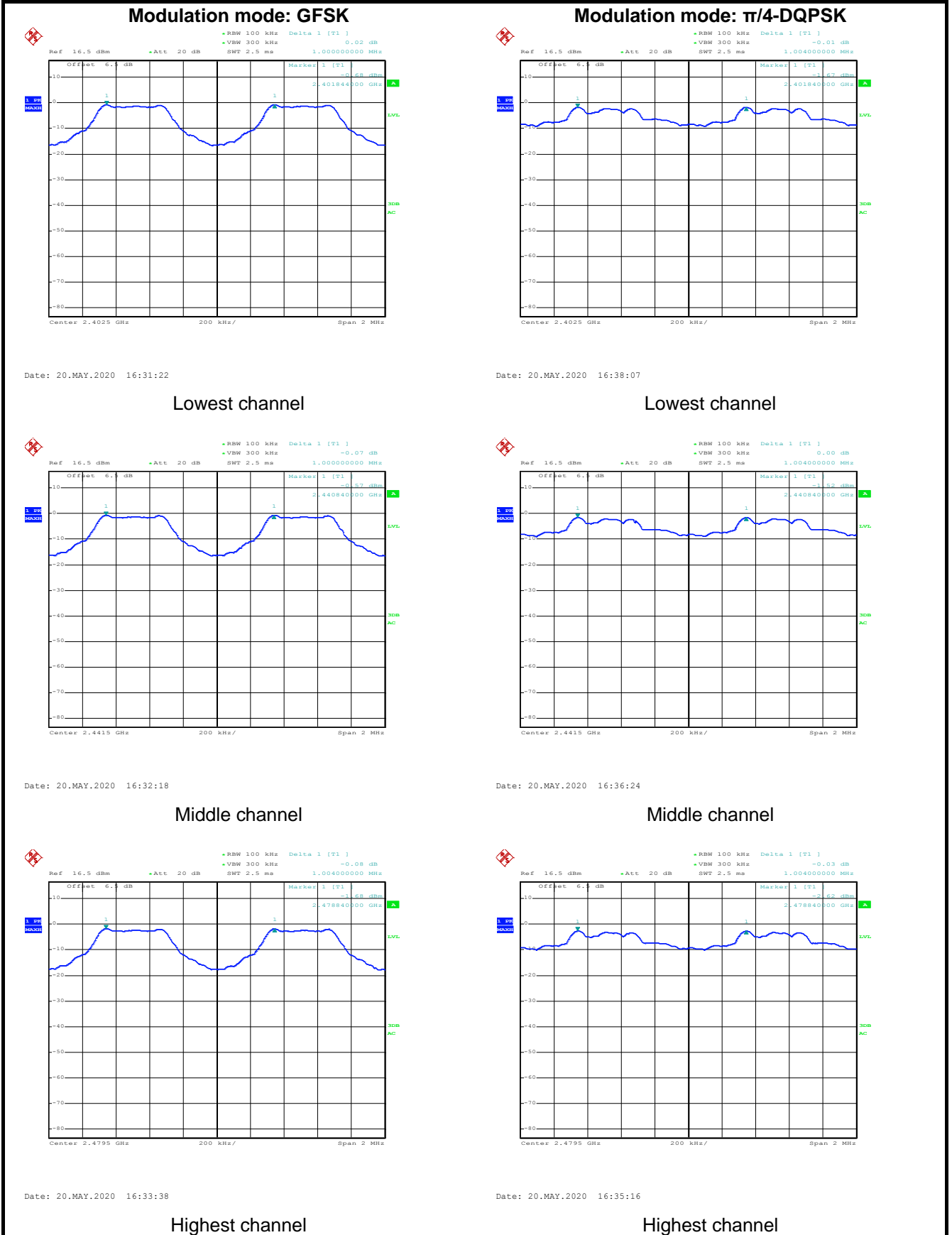

Modulation mode: 8DPSK

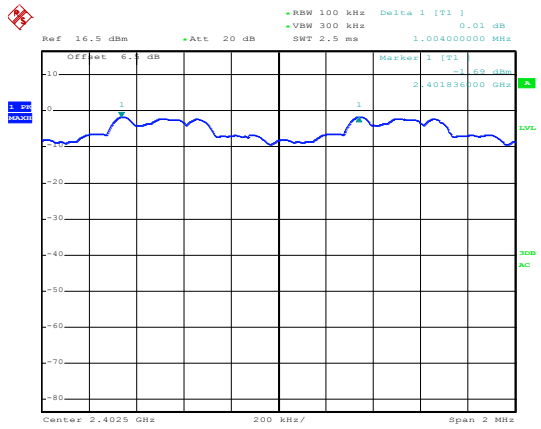

Date: 20.MAY.2020 16:39:19

Lowest channel

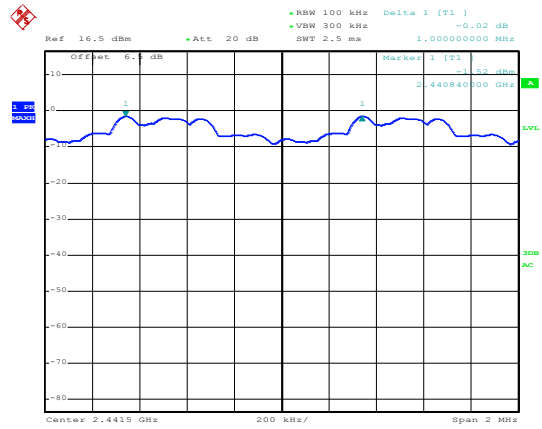

Date: 20.MAY.2020 16:40:46

Middle channel

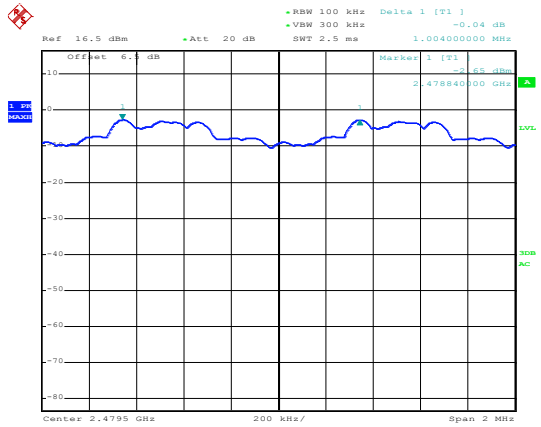

Date: 20.MAY.2020 16:41:44

Highest channel

6.6 Hopping Channel Number

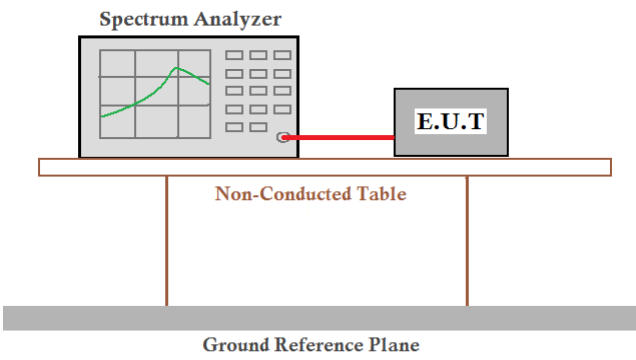
| | |
|-------------------|---|
| Test Requirement: | FCC Part 15 C Section 15.247 (a)(1) |
| Receiver setup: | RBW=100 kHz, VBW=300 kHz, Center Frequency=2441MHz, Span= 100MHz, Detector=Peak |
| Limit: | 15 channels |
| Test setup: |  <p>The diagram shows a Spectrum Analyzer and an E.U.T. (Equipment Under Test) connected by a red cable. They are positioned on a table labeled 'Non-Conducted Table'. Below the table is a 'Ground Reference Plane'.</p> |
| Test Instruments: | Refer to section 5.9 for details |
| Test mode: | Hopping mode |
| Test results: | Pass |

Measurement Data:

| Mode | Hopping channel numbers | Limit | Result |
|-----------------------------|-------------------------|-------|--------|
| GFSK, $\pi/4$ -DQPSK, 8DPSK | 79 | 15 | Pass |

Test plot as follows:

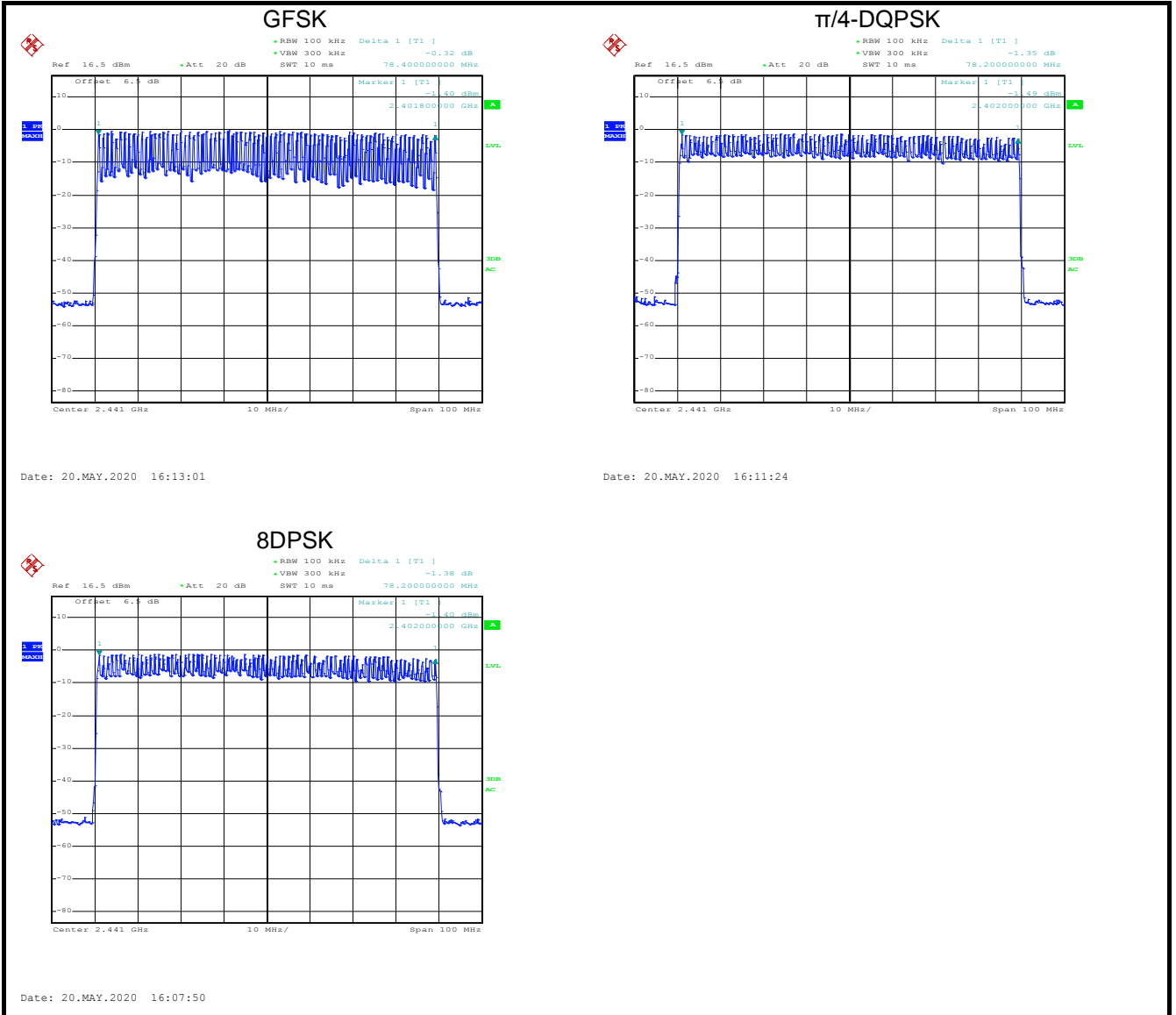

6.7 Dwell Time

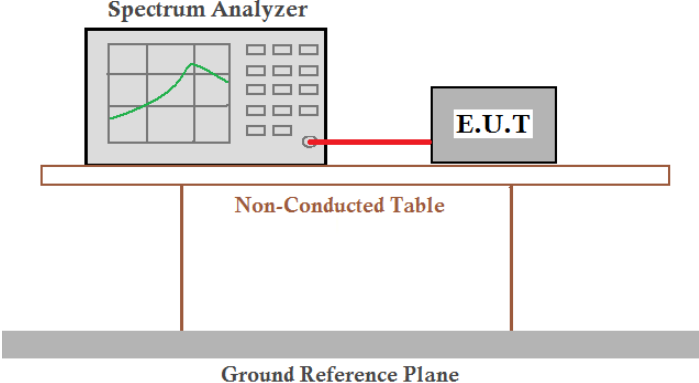
| | |
|-------------------|--|
| Test Requirement: | FCC Part 15 C Section 15.247 (a)(1) |
| Receiver setup: | RBW=1 MHz, VBW=1 MHz, Span=0 Hz, Detector=Peak |
| Limit: | 0.4 Second |
| Test setup: |  |
| Test Instruments: | Refer to section 5.9 for details |
| Test mode: | Hopping mode |
| Test results: | Pass |

Measurement Data (Worse case):

| Mode | Packet | Dwell time (second) | Limit (second) | Result |
|-----------|--------|---------------------|----------------|--------|
| GFSK | DH1 | 0.12416 | 0.4 | Pass |
| | DH3 | 0.26624 | | |
| | DH5 | 0.31147 | | |
| π/4-DQPSK | 2-DH1 | 0.12608 | 0.4 | Pass |
| | 2-DH3 | 0.26624 | | |
| | 2-DH5 | 0.31147 | | |
| 8DPSK | 3-DH1 | 0.12736 | 0.4 | Pass |
| | 3-DH3 | 0.26624 | | |
| | 3-DH5 | 0.31147 | | |

Note:

The test period = 0.4 Second/Channel x 79 Channel = 31.6 s

Calculation Formula: Dwell time = Ton time per hop * Hopping numbers * Period

For example:

DH1 time slot=0.388*(1600/ (2*79)) * 31.6=124.16ms

DH3 time slot=1.664*(1600/ (4*79)) * 31.6=266.24ms

DH5 time slot=2.920*(1600/ (6*79)) * 31.6=311.47ms

Test plot as follows:

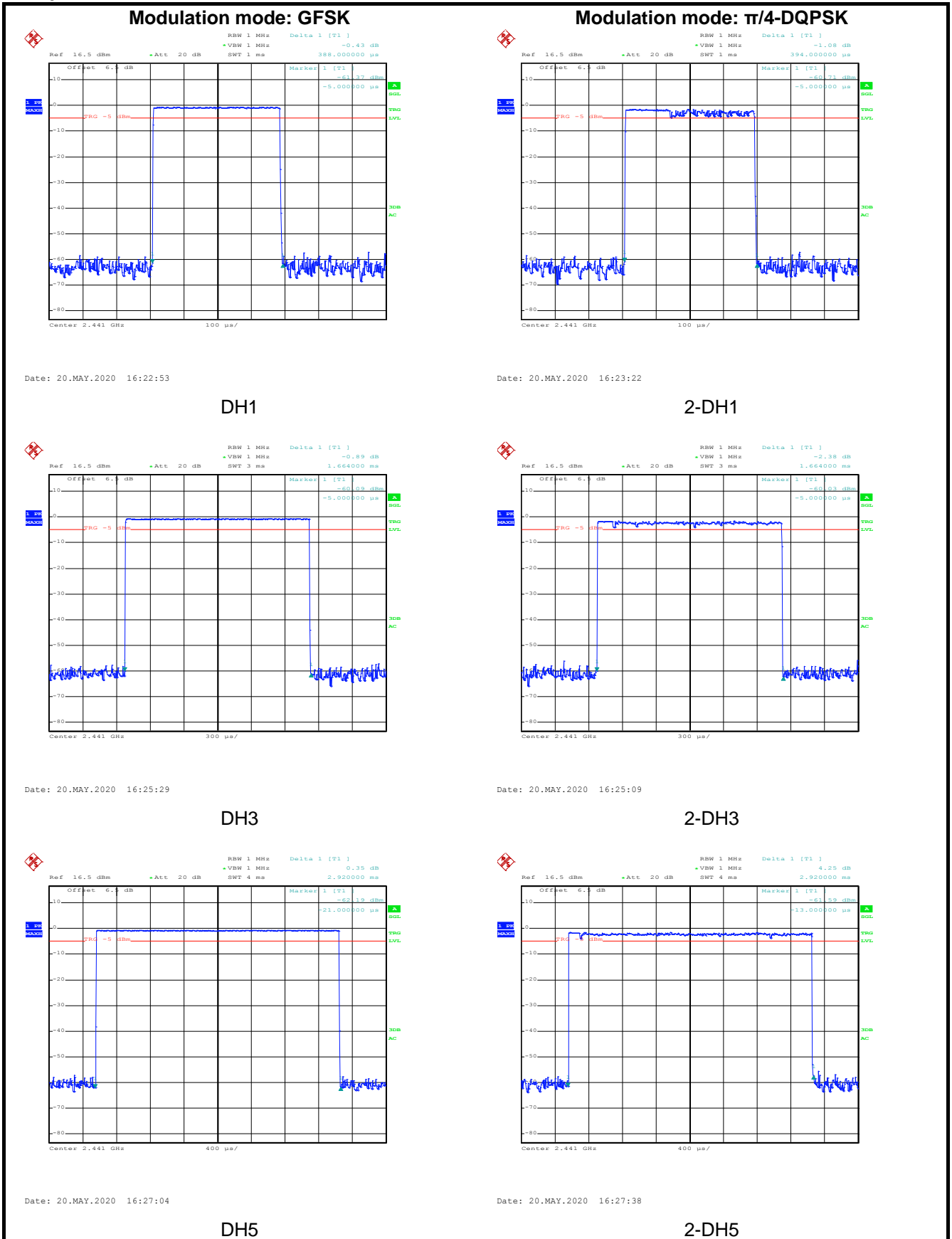

Modulation mode: 8DPSK

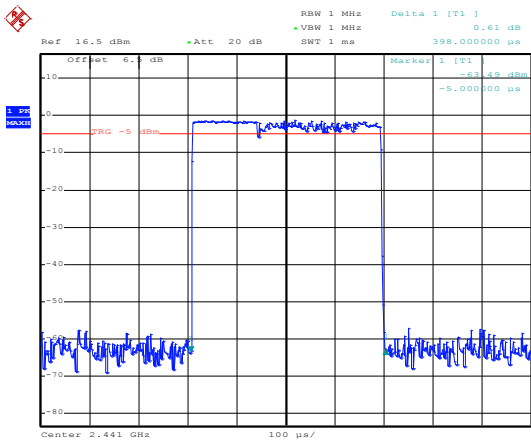

Date: 20.MAY.2020 16:23:42

3-DH1

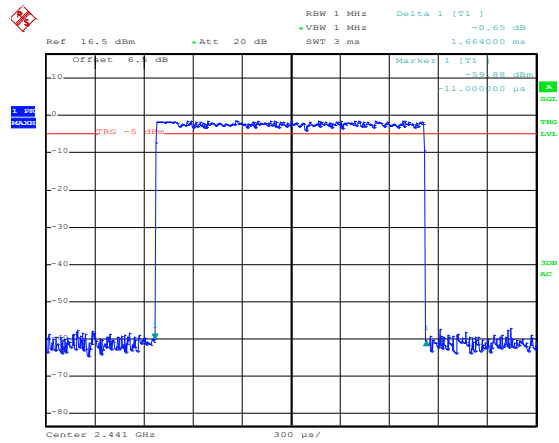

Date: 20.MAY.2020 16:24:50

3-DH3

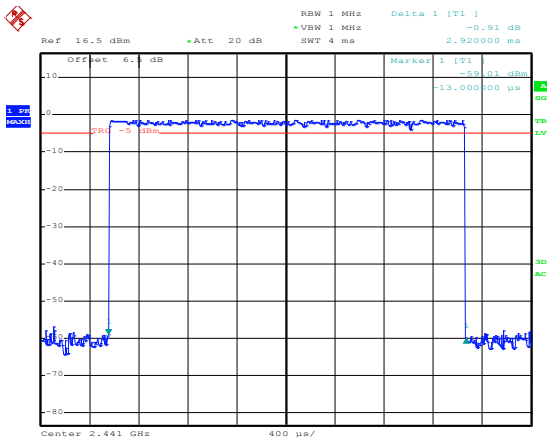

Date: 20.MAY.2020 16:28:01

3-DH5

6.8 Pseudorandom Frequency Hopping Sequence

| Test Requirement: | FCC Part 15 C Section 15.247 (a)(1) requirement: |
|--|--|
| <p>Frequency hopping systems shall have hopping channel carrier frequencies separated by a minimum of 25 kHz or the 20 dB bandwidth of the hopping channel, whichever is greater.</p> <p>Alternatively. Frequency hopping systems operating in the 2400-2483.5 MHz band may have hopping channel carrier frequencies that are separated by 25 kHz or two-thirds of the 20 dB bandwidth of the hopping channel, whichever is greater, provided the systems operate with an output power no greater than 125 mW. The system shall hop to channel frequencies that are selected at the system hopping rate from a Pseudorandom ordered list of hopping frequencies. Each frequency must be used equally on the average by each transmitter. The system receivers shall have input bandwidths that match the hopping channel bandwidths of their corresponding transmitters and shall shift frequencies in synchronization with the transmitted signals.</p> | |
| <p>EUT Pseudorandom Frequency Hopping Sequence</p> | |
| <p>The pseudorandom sequence may be generated in a nine-stage shift register whose 5th and 9th stage outputs are added in a modulo-two addition stage. And the result is fed back to the input of the first stage. The sequence begins with the first ONE of 9 consecutive ONES; i.e. the shift register is initialized with nine ones.</p> <ul style="list-style-type: none"> • Number of shift register stages: 9 • Length of pseudo-random sequence: $2^9 - 1 = 511$ bits • Longest sequence of zeros: 8 (non-inverted signal) <div data-bbox="260 846 1299 990" style="text-align: center;"> </div> <p style="text-align: center;"><i>Linear Feedback Shift Register for Generation of the PRBS sequence</i></p> <p>An example of Pseudorandom Frequency Hopping Sequence as follow:</p> <div data-bbox="260 1093 1246 1236" style="text-align: center;"> </div> <p>Each frequency used equally on the average by each transmitter.</p> <p>The system receivers have input bandwidths that match the hopping channel bandwidths of their corresponding transmitters and shift frequencies in synchronization with the transmitted signals.</p> | |

6.9 Band Edge

6.9.1 Conducted Emission Method

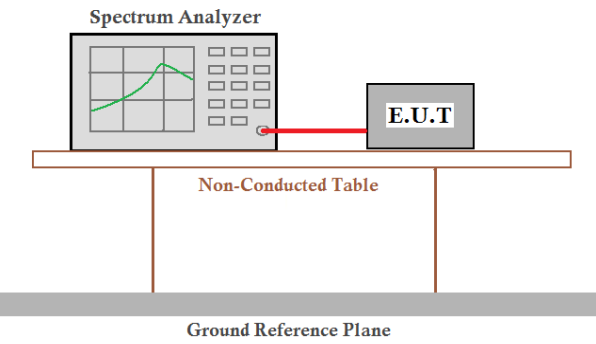
| | |
|-------------------|---|
| Test Requirement: | FCC Part 15 C Section 15.247 (d) |
| Receiver setup: | RBW=100 kHz, VBW=300 kHz, Detector=Peak |
| Limit: | In any 100 kHz bandwidth outside the frequency band in which the spread spectrum intentional radiator is operating, the radio frequency power that is produced by the intentional radiator shall be at least 20 dB below that in the 100 kHz bandwidth within the band that contains the highest level of the desired power, based on either an RF conducted or a radiated measurement. |
| Test setup: |  <p>The diagram illustrates the test setup. A Spectrum Analyzer is connected to an E.U.T. (Equipment Under Test) via a red cable. Both the Spectrum Analyzer and the E.U.T. are placed on a Non-Conducted Table. The table is supported by two legs. Below the table is a Ground Reference Plane.</p> |
| Test Instruments: | Refer to section 5.9 for details |
| Test mode: | Non-hopping mode and hopping mode |
| Test results: | Pass |

Test plot as follows:

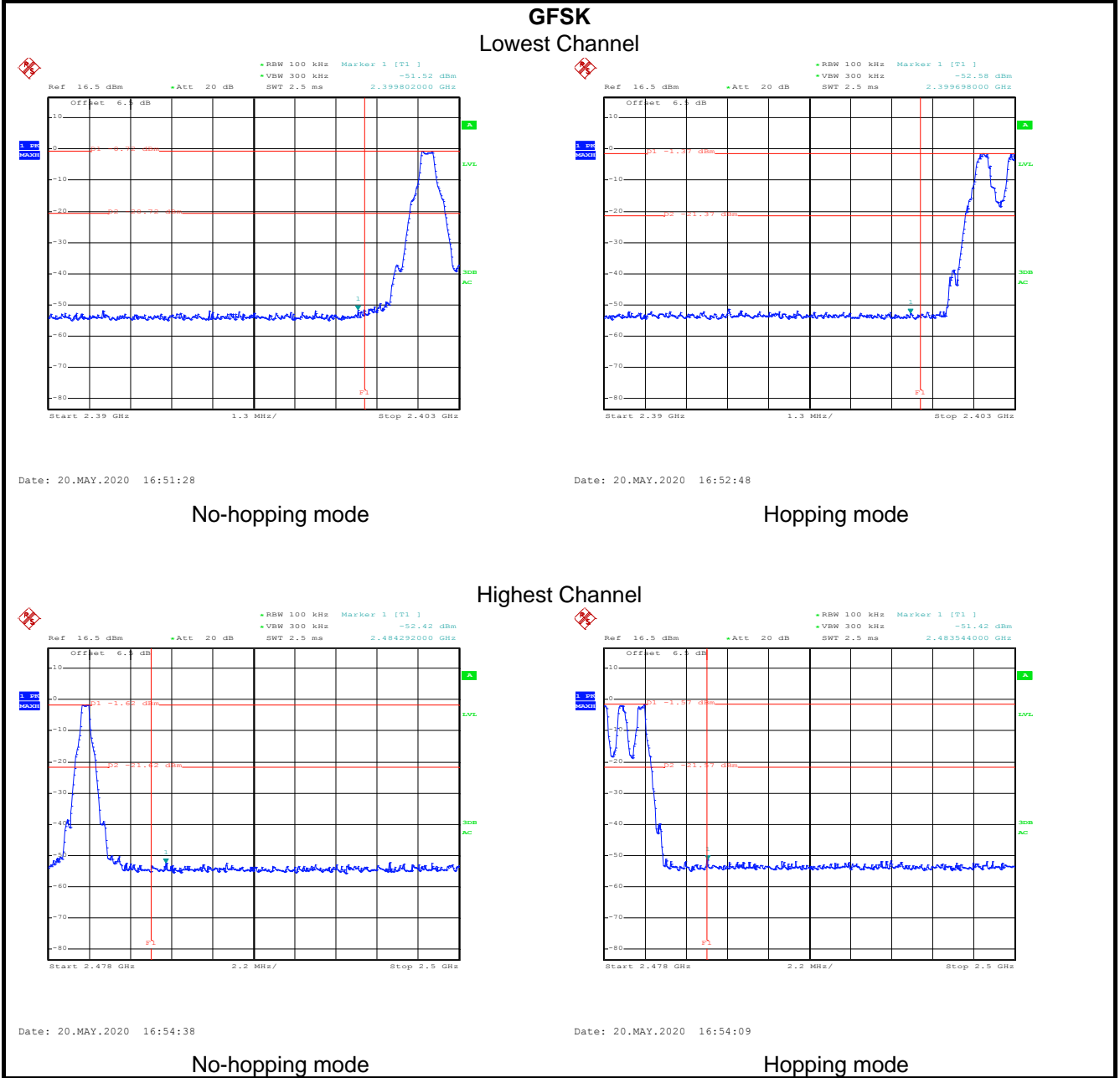

$\pi/4$ -DQPSK Lowest Channel

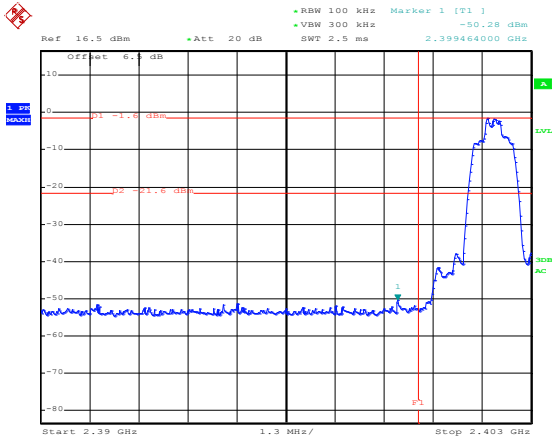

Date: 20.MAY.2020 16:59:41

No-hopping mode

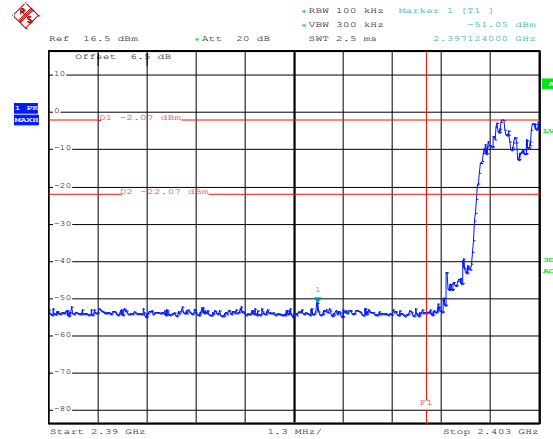

Date: 20.MAY.2020 16:58:34

Hopping mode

Highest Channel

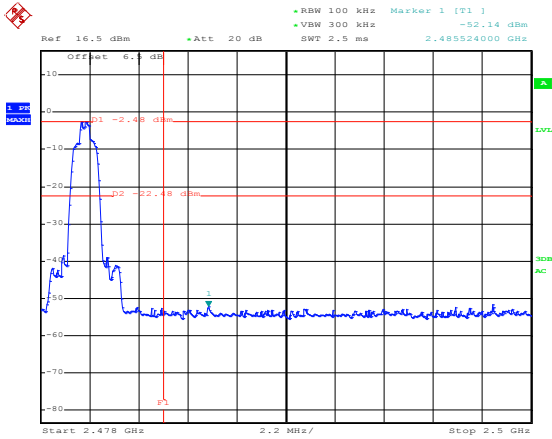

Date: 20.MAY.2020 16:55:19

No-hopping mode

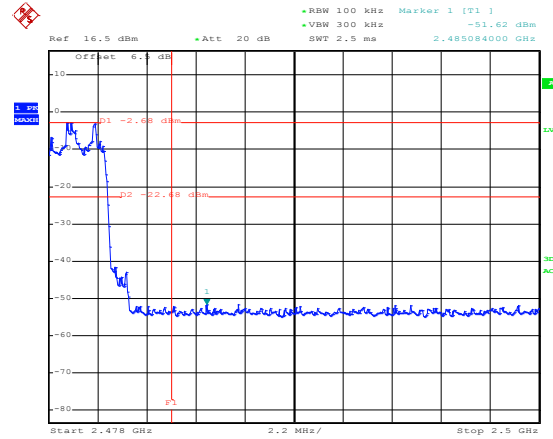

Date: 20.MAY.2020 16:56:47

Hopping mode

8DPSK Lowest Channel

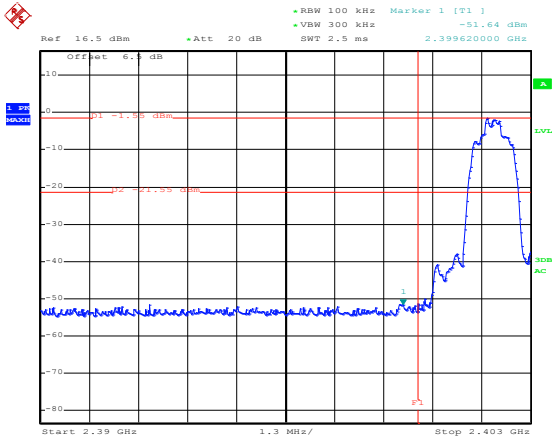

Date: 20.MAY.2020 17:00:34

No-hopping mode

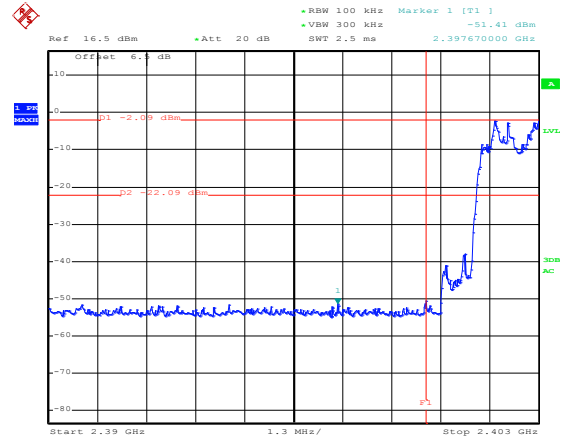

Date: 20.MAY.2020 17:05:18

Hopping mode

Highest Channel

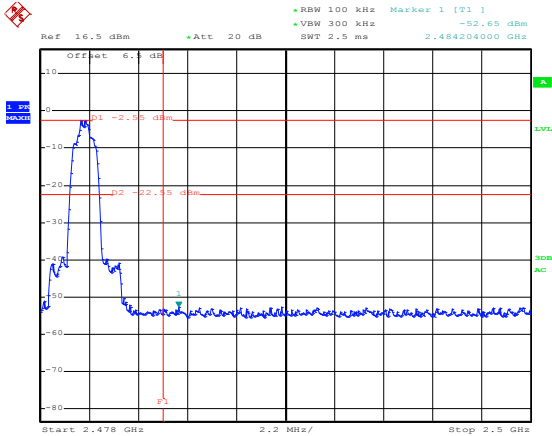

Date: 20.MAY.2020 17:04:20

No-hopping mode

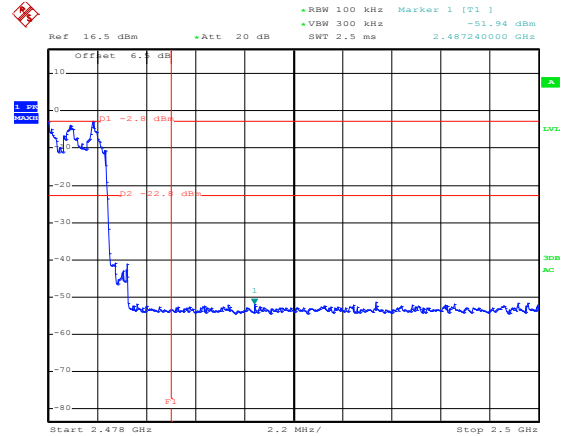

Date: 20.MAY.2020 17:03:56

Hopping mode

6.9.2 Radiated Emission Method

| | | | | | |
|-----------------------|--|--------------------|------|---------------|---------------|
| Test Requirement: | FCC Part 15 C Section 15.209 and 15.205 | | | | |
| Test Frequency Range: | 2310 MHz to 2390 MHz and 2483.5 MHz to 2500 MHz | | | | |
| Test Distance: | 3m | | | | |
| Receiver setup: | Frequency | Detector | RBW | VBW | Remark |
| | Above 1GHz | Peak | 1MHz | 3MHz | Peak Value |
| | | RMS | 1MHz | 3MHz | Average Value |
| Limit: | Frequency | Limit (dBuV/m @3m) | | Remark | |
| | Above 1GHz | 54.00 | | Average Value | |
| | | 74.00 | | Peak Value | |
| Test setup: | | | | | |
| Test Procedure: | <ol style="list-style-type: none"> 1. The EUT was placed on the top of a rotating table 1.5meters above the ground at a 3 meter camber. The table was rotated 360 degrees to determine the position of the highest radiation. 2. The EUT was set 3 meters away from the interference-receiving antenna, which was mounted on the top of a variable-height antenna tower. 3. The antenna height is varied from one meter to four meters above the ground to determine the maximum value of the field strength. Both horizontal and vertical polarizations of the antenna are set to make the measurement. 4. For each suspected emission, the EUT was arranged to its worst case and then the antenna was tuned to heights from 1 meter to 4 meters and the rota table was turned from 0 degrees to 360 degrees to find the maximum reading. 5. The test-receiver system was set to Peak Detect Function and Specified Bandwidth with Maximum Hold Mode. 6. If the emission level of the EUT in peak mode was 10dB lower than the limit specified, then testing could be stopped and the peak values of the EUT would be reported. Otherwise the emissions that did not have 10dB margin would be re-tested one by one using peak, quasi-peak or average method as specified and then reported in a data sheet. | | | | |
| Test Instruments: | Refer to section 5.9 for details | | | | |
| Test mode: | Non-hopping mode | | | | |
| Test results: | Passed | | | | |

GFSK Mode:

| | | | |
|---------------|----------------|----------------|----------------------|
| Product Name: | 3G Tablet | Product Model: | PLATINUM A7 |
| Test By: | Yaro | Test mode: | DH1 Tx mode |
| Test Channel: | Lowest channel | Polarization: | Vertical |
| Test Voltage: | AC 120/60Hz | Environment: | Temp: 24°C Humi: 57% |

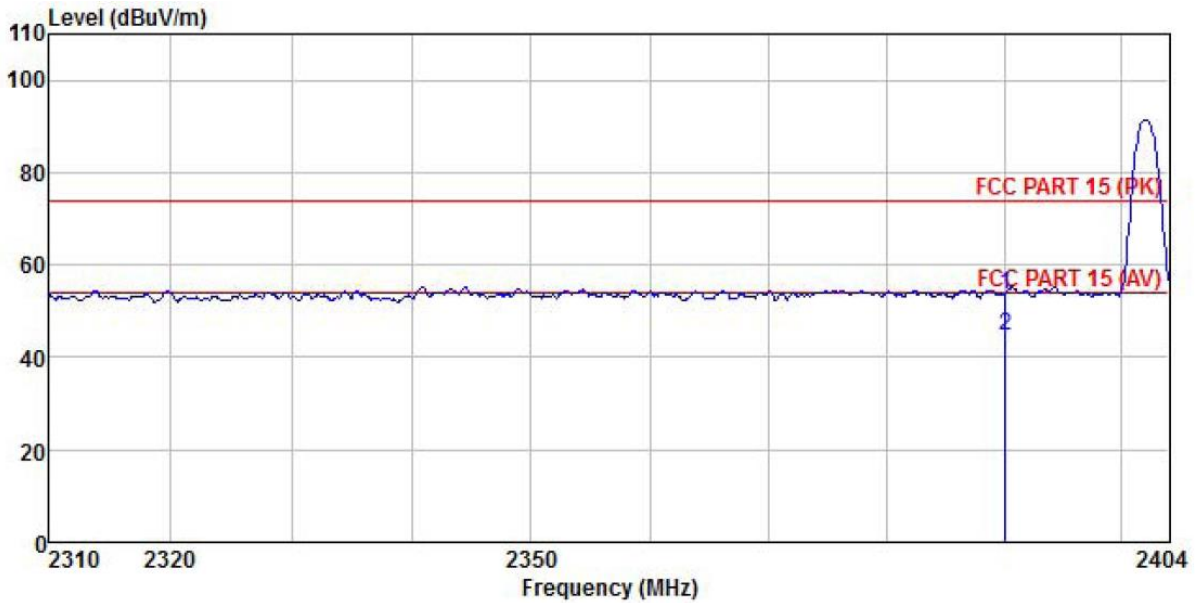

| | Freq | ReadAntenna Level | Antenna Factor | Cable Loss | Aux Factor | Preamp Factor | Level | Limit Line | Over Limit | Remark |
|---|----------|-------------------|----------------|------------|------------|---------------|--------|------------|------------|---------|
| | MHz | dBuV | dB/m | dB | dB | dB | dBuV/m | dBuV/m | dB | |
| 1 | 2390.000 | 20.22 | 27.03 | 4.69 | 1.68 | 0.00 | 53.62 | 74.00 | -20.38 | Peak |
| 2 | 2390.000 | 11.43 | 27.03 | 4.69 | 1.68 | 0.00 | 44.83 | 54.00 | -9.17 | Average |

Remark:

1. Final Level = Receiver Read level + Antenna Factor + Cable Loss – Pre-amplifier Factor.
2. The emission levels of other frequencies are lower than the limit 20dB and not show in test report.

| | | | |
|---------------|----------------|----------------|----------------------|
| Product Name: | 3G Tablet | Product Model: | PLATINUM A7 |
| Test By: | Yaro | Test mode: | DH1 Tx mode |
| Test Channel: | Lowest channel | Polarization: | Horizontal |
| Test Voltage: | AC 120/60Hz | Environment: | Temp: 24°C Huni: 57% |

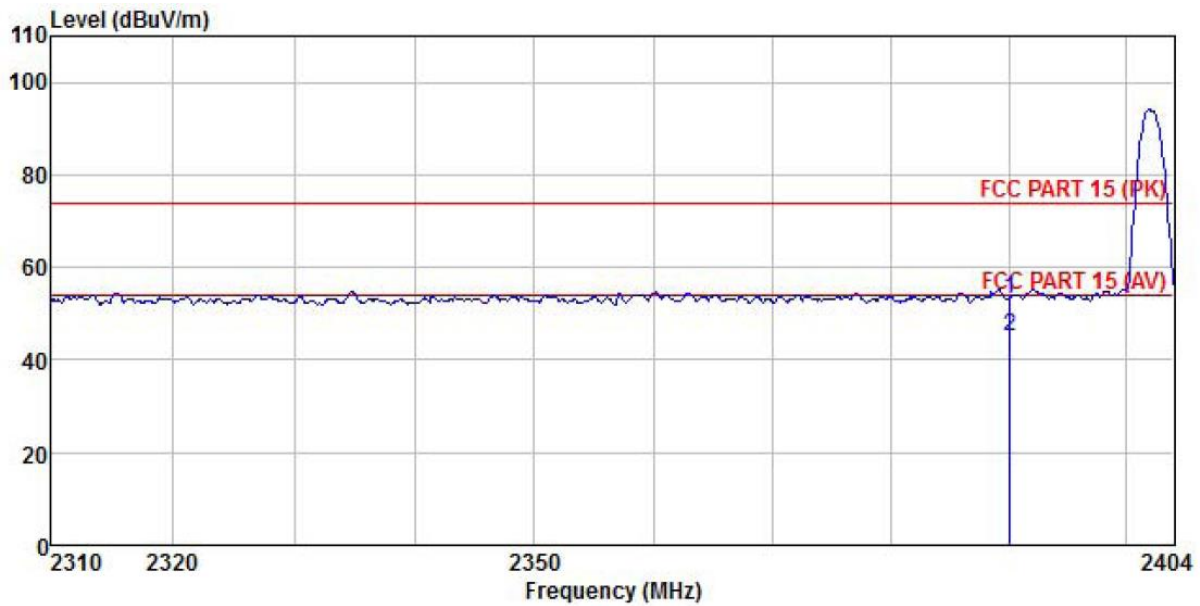

| | Freq | ReadAntenna | Cable | Aux | Preamp | Level | Limit | Over | Remark |
|---|----------|-------------|--------|------|--------|--------|--------|--------|---------------|
| | MHz | Level | Factor | Loss | Factor | Factor | Line | Limit | |
| | | dBuV | dB/m | dB | dB | dB | dBuV/m | dBuV/m | dB |
| 1 | 2390.000 | 19.97 | 27.03 | 4.69 | 1.68 | 0.00 | 53.37 | 74.00 | -20.63 Peak |
| 2 | 2390.000 | 11.77 | 27.03 | 4.69 | 1.68 | 0.00 | 45.17 | 54.00 | -8.83 Average |

Remark:

1. Final Level = Receiver Read level + Antenna Factor + Cable Loss – Pre-amplifier Factor.
2. The emission levels of other frequencies are lower than the limit 20dB and not show in test report.

| | | | |
|---------------|-----------------|----------------|----------------------|
| Product Name: | 3G Tablet | Product Model: | PLATINUM A7 |
| Test By: | Yaro | Test mode: | DH1 Tx mode |
| Test Channel: | Highest channel | Polarization: | Vertical |
| Test Voltage: | AC 120/60Hz | Environment: | Temp: 24°C Humi: 57% |

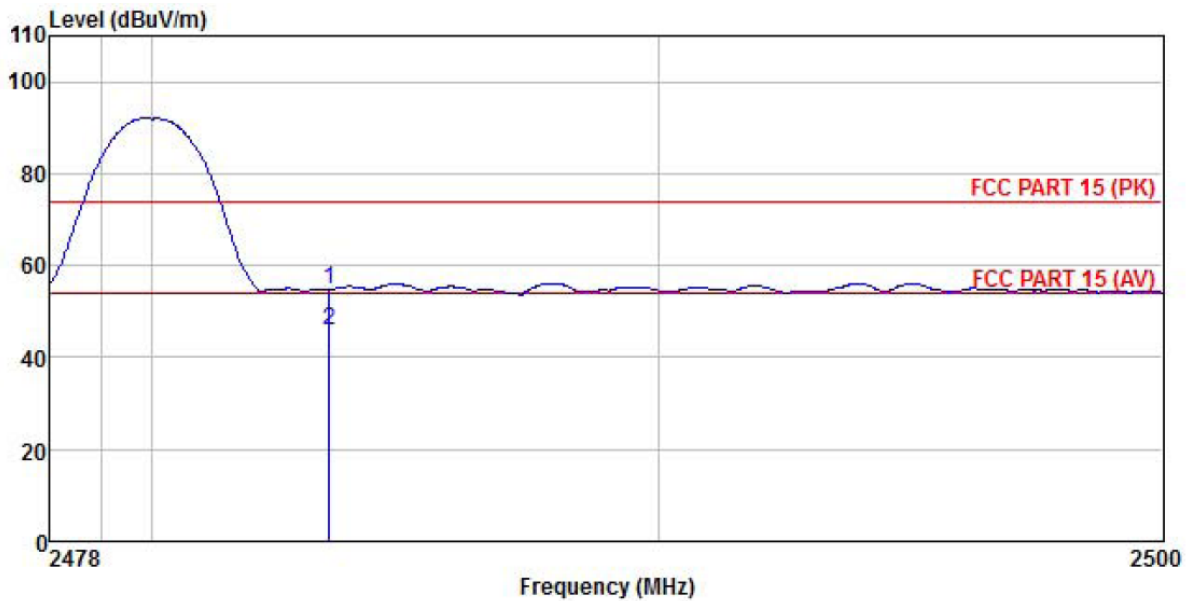

| | Read | Antenna | Cable | Aux | Preamp | Limit | Over | | |
|------|----------|---------|-------|--------|--------|--------|--------|--------|---------------|
| Freq | Level | Factor | Loss | Factor | Factor | Line | Limit | Remark | |
| MHz | dBuV | dB/m | dB | dB | dB | dBuV/m | dBuV/m | dB | |
| 1 | 2483.500 | 21.12 | 27.27 | 4.81 | 1.70 | 0.00 | 54.90 | 74.00 | -19.10 Peak |
| 2 | 2483.500 | 12.00 | 27.27 | 4.81 | 1.70 | 0.00 | 45.78 | 54.00 | -8.22 Average |

Remark:

1. Final Level = Receiver Read level + Antenna Factor + Cable Loss – Preamplifier Factor.
2. The emission levels of other frequencies are lower than the limit 20dB and not show in test report.

| | | | |
|---------------|-----------------|----------------|----------------------|
| Product Name: | 3G Tablet | Product Model: | PLATINUM A7 |
| Test By: | Yaro | Test mode: | DH1 Tx mode |
| Test Channel: | Highest channel | Polarization: | Horizontal |
| Test Voltage: | AC 120/60Hz | Environment: | Temp: 24°C Huni: 57% |

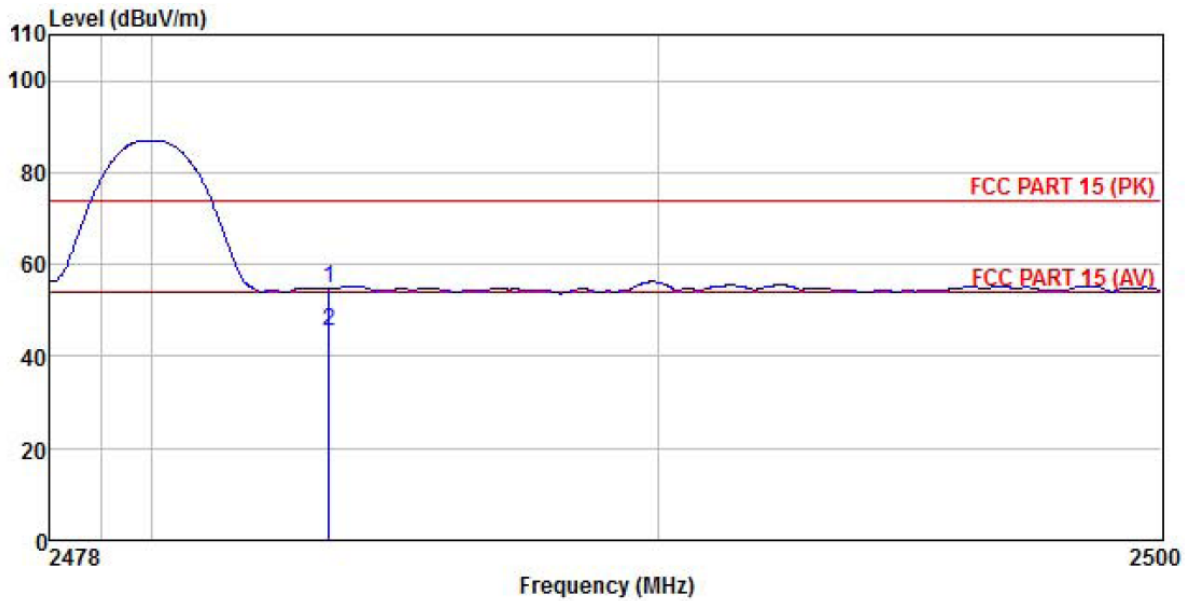

| | Read Freq | Antenna Level | Antenna Factor | Cable Loss | Aux Factor | Preamp Factor | Level | Limit Line | Over Limit | Remark |
|---|-----------|---------------|----------------|------------|------------|---------------|--------|------------|------------|---------|
| | MHz | dBuV | dB/m | dB | dB | dB | dBuV/m | dBuV/m | dB | |
| 1 | 2483.500 | 20.97 | 27.27 | 4.81 | 1.70 | 0.00 | 54.75 | 74.00 | -19.25 | Peak |
| 2 | 2483.500 | 11.52 | 27.27 | 4.81 | 1.70 | 0.00 | 45.30 | 54.00 | -8.70 | Average |

Remark:

1. Final Level = Receiver Read level + Antenna Factor + Cable Loss – Pre-amplifier Factor.
2. The emission levels of other frequencies are lower than the limit 20dB and not show in test report.

π/4-DQPSK mode

| | | | |
|----------------------|----------------|-----------------------|----------------------|
| Product Name: | 3G Tablet | Product Model: | PLATINUM A7 |
| Test By: | Yaro | Test mode: | 2DH1 Tx mode |
| Test Channel: | Lowest channel | Polarization: | Vertical |
| Test Voltage: | AC 120/60Hz | Environment: | Temp: 24°C Humi: 57% |

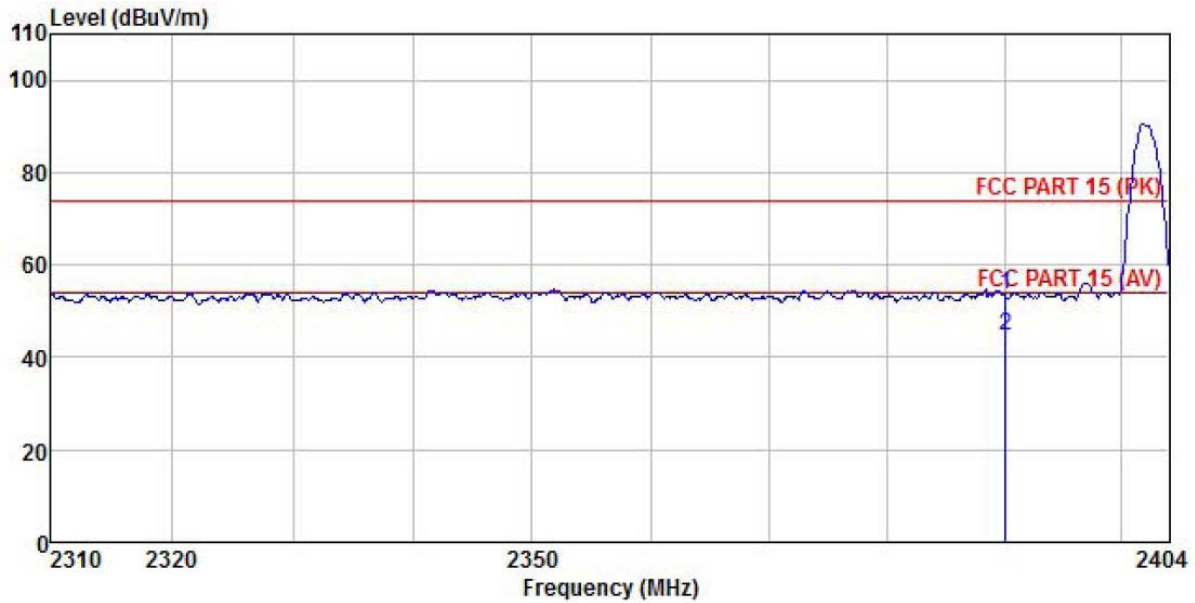

| | ReadAntenna | Cable | Aux | Preamp | Level | Limit | Over | Remark | |
|-------|-------------|--------|-------|--------|--------|--------|--------|--------|---------------|
| Freq | Level | Factor | Loss | Factor | Factor | Line | Limit | | |
| ----- | ----- | ----- | ----- | ----- | ----- | ----- | ----- | ----- | |
| MHz | dBuV | dB/m | dB | dB | dB | dBuV/m | dBuV/m | dB | |
| 1 | 2390.000 | 20.01 | 27.03 | 4.69 | 1.68 | 0.00 | 53.41 | 74.00 | -20.59 Peak |
| 2 | 2390.000 | 11.13 | 27.03 | 4.69 | 1.68 | 0.00 | 44.53 | 54.00 | -9.47 Average |

Remark:

1. Final Level = Receiver Read level + Antenna Factor + Cable Loss – Pre-amplifier Factor.
2. The emission levels of other frequencies are lower than the limit 20dB and not show in test report.

| | | | |
|---------------|----------------|----------------|----------------------|
| Product Name: | 3G Tablet | Product Model: | PLATINUM A7 |
| Test By: | Yaro | Test mode: | 2DH1 Tx mode |
| Test Channel: | Lowest channel | Polarization: | Horizontal |
| Test Voltage: | AC 120/60Hz | Environment: | Temp: 24°C Huni: 57% |

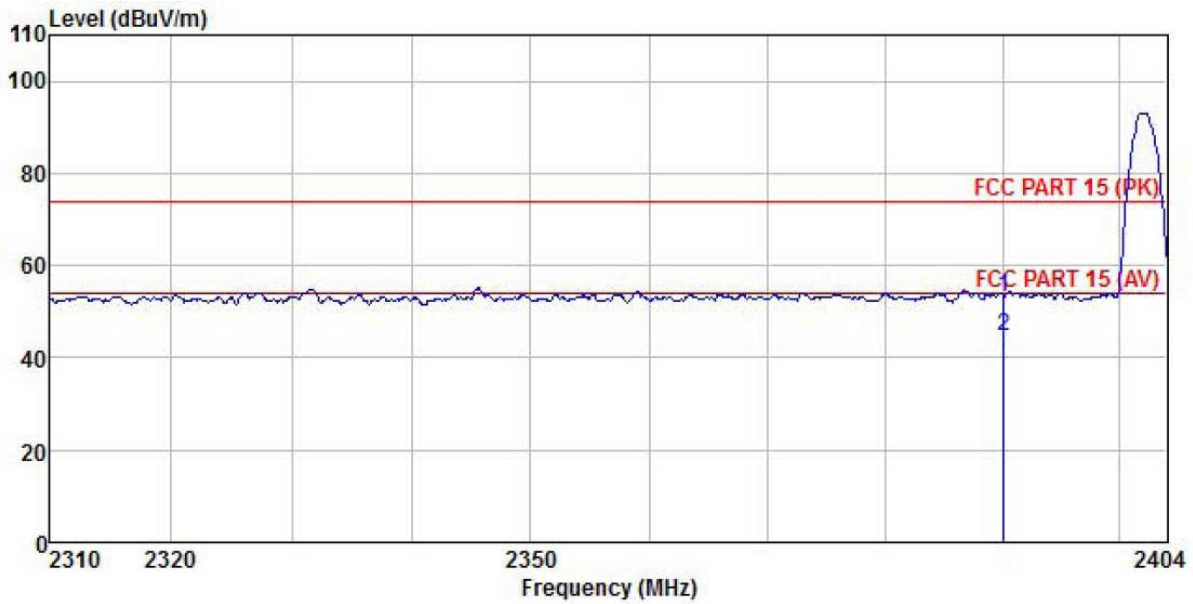

| | Read Freq | Antenna Level | Cable Factor | Aux Loss | Preamp Factor | Level | Limit | Over | Remark |
|---|-----------|---------------|--------------|----------|---------------|--------|--------|-------|---------------|
| | MHz | dBuV | dB/m | dB | dB | dBuV/m | dBuV/m | dB | |
| 1 | 2390.000 | 19.92 | 27.03 | 4.69 | 1.68 | 0.00 | 53.32 | 74.00 | -20.68 Peak |
| 2 | 2390.000 | 11.27 | 27.03 | 4.69 | 1.68 | 0.00 | 44.67 | 54.00 | -9.33 Average |

Remark:

1. Final Level = Receiver Read level + Antenna Factor + Cable Loss – Pre-amplifier Factor.
2. The emission levels of other frequencies are lower than the limit 20dB and not show in test report.

| | | | |
|---------------|-----------------|----------------|----------------------|
| Product Name: | 3G Tablet | Product Model: | PLATINUM A7 |
| Test By: | Yaro | Test mode: | 2DH1 Tx mode |
| Test Channel: | Highest channel | Polarization: | Vertical |
| Test Voltage: | AC 120/60Hz | Environment: | Temp: 24°C Huni: 57% |

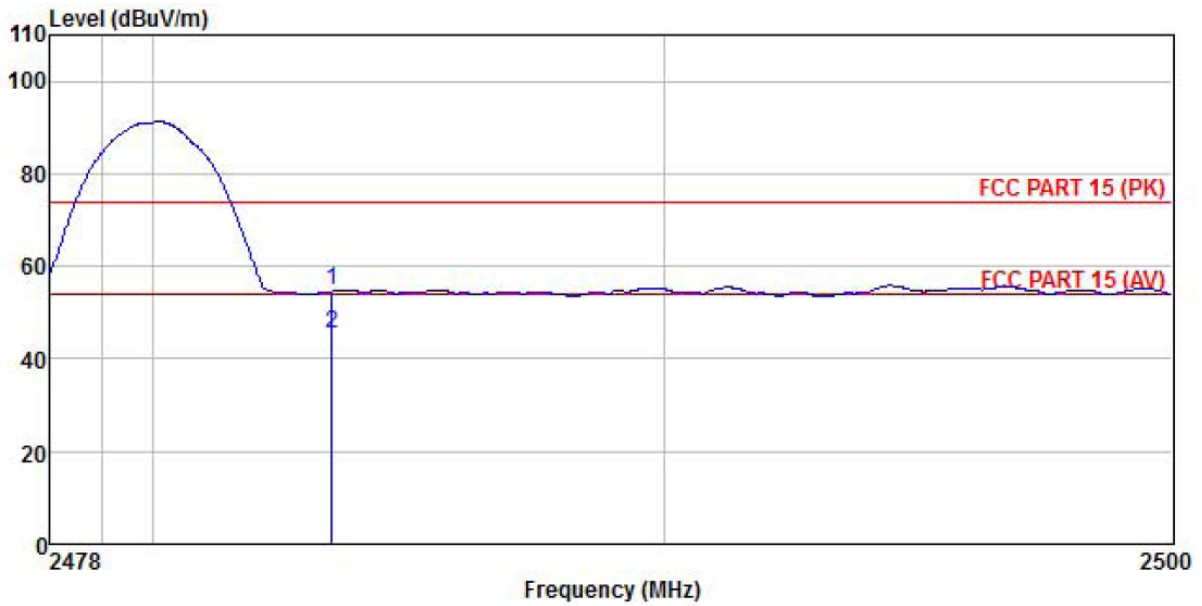

| | ReadAntenna | Cable | Aux | Preamp | Limit | Over | | |
|-------|-------------|--------|-------|--------|--------|--------|--------|---------------------|
| Freq | Level | Factor | Loss | Factor | Factor | Level | Line | Limit Remark |
| ----- | ----- | ----- | ----- | ----- | ----- | ----- | ----- | ----- |
| MHz | dBuV | dB/m | dB | dB | dB | dBuV/m | dBuV/m | dB |
| 1 | 2483.500 | 20.97 | 27.27 | 4.81 | 1.70 | 0.00 | 54.75 | 74.00 -19.25 Peak |
| 2 | 2483.500 | 11.65 | 27.27 | 4.81 | 1.70 | 0.00 | 45.43 | 54.00 -8.57 Average |

Remark:

1. Final Level = Receiver Read level + Antenna Factor + Cable Loss – Pre-amplifier Factor.
2. The emission levels of other frequencies are lower than the limit 20dB and not show in test report.

| | | | |
|---------------|-----------------|----------------|----------------------|
| Product Name: | 3G Tablet | Product Model: | PLATINUM A7 |
| Test By: | Yaro | Test mode: | 2DH1 Tx mode |
| Test Channel: | Highest channel | Polarization: | Horizontal |
| Test Voltage: | AC 120/60Hz | Environment: | Temp: 24°C Huni: 57% |

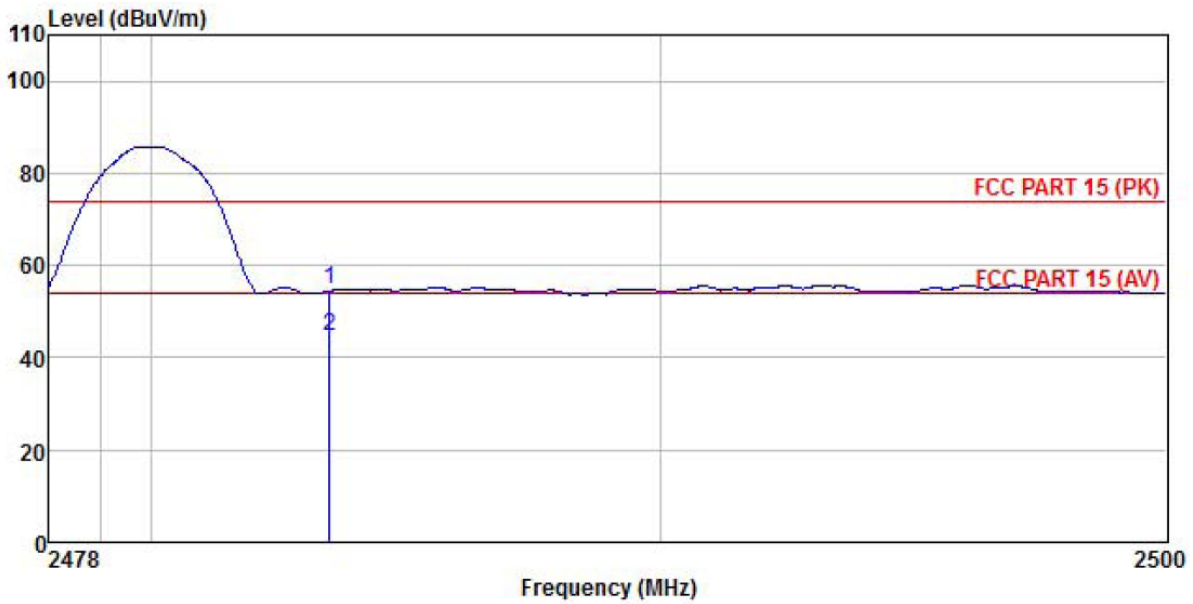

| | Freq | Read Level | Antenna Factor | Cable Loss | Aux Factor | Preamp Factor | Level | Limit Line | Over Limit | Remark |
|---|----------|------------|----------------|------------|------------|---------------|--------|------------|------------|---------|
| | MHz | dBuV | dB/m | dB | dB | dB | dBuV/m | dBuV/m | dB | |
| 1 | 2483.500 | 20.84 | 27.27 | 4.81 | 1.70 | 0.00 | 54.62 | 74.00 | -19.38 | Peak |
| 2 | 2483.500 | 11.05 | 27.27 | 4.81 | 1.70 | 0.00 | 44.83 | 54.00 | -9.17 | Average |

Remark:

- Final Level = Receiver Read level + Antenna Factor + Cable Loss – Pre-amplifier Factor.
- The emission levels of other frequencies are lower than the limit 20dB and not show in test report.

8DPSK mode

| | | | |
|----------------------|----------------|-----------------------|----------------------|
| Product Name: | 3G Tablet | Product Model: | PLATINUM A7 |
| Test By: | Yaro | Test mode: | 3DH1 Tx mode |
| Test Channel: | Lowest channel | Polarization: | Vertical |
| Test Voltage: | AC 120/60Hz | Environment: | Temp: 24°C Humi: 57% |

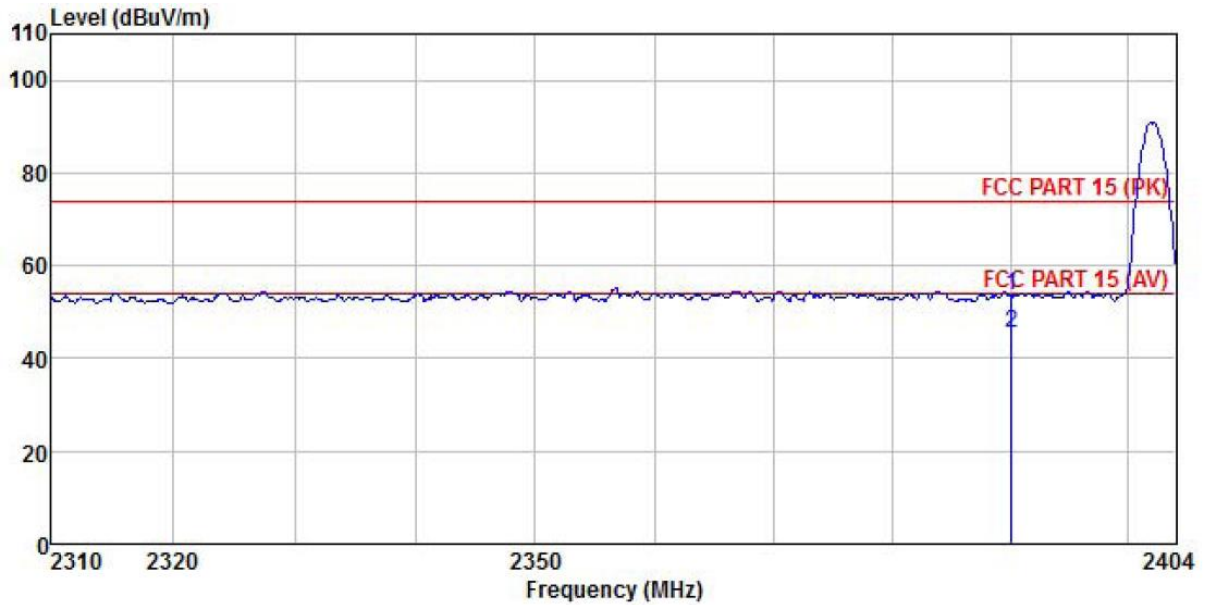

| | Freq | ReadAntenna | Cable | Aux | Preamp | Level | Limit | Over | Remark |
|---|----------|-------------|--------|------|--------|--------|--------|--------|---------------|
| | MHz | Level | Factor | Loss | Factor | Factor | Line | Limit | |
| | | dBuV | dB/m | dB | dB | dB | dBuV/m | dBuV/m | dB |
| 1 | 2390.000 | 20.03 | 27.03 | 4.69 | 1.68 | 0.00 | 53.43 | 74.00 | -20.57 Peak |
| 2 | 2390.000 | 12.09 | 27.03 | 4.69 | 1.68 | 0.00 | 45.49 | 54.00 | -8.51 Average |

Remark:

- Final Level = Receiver Read level + Antenna Factor + Cable Loss – Pre-amplifier Factor.
- The emission levels of other frequencies are lower than the limit 20dB and not show in test report.

| | | | |
|---------------|----------------|----------------|----------------------|
| Product Name: | 3G Tablet | Product Model: | PLATINUM A7 |
| Test By: | Yaro | Test mode: | 3DH1 Tx mode |
| Test Channel: | Lowest channel | Polarization: | Horizontal |
| Test Voltage: | AC 120/60Hz | Environment: | Temp: 24°C Humi: 57% |

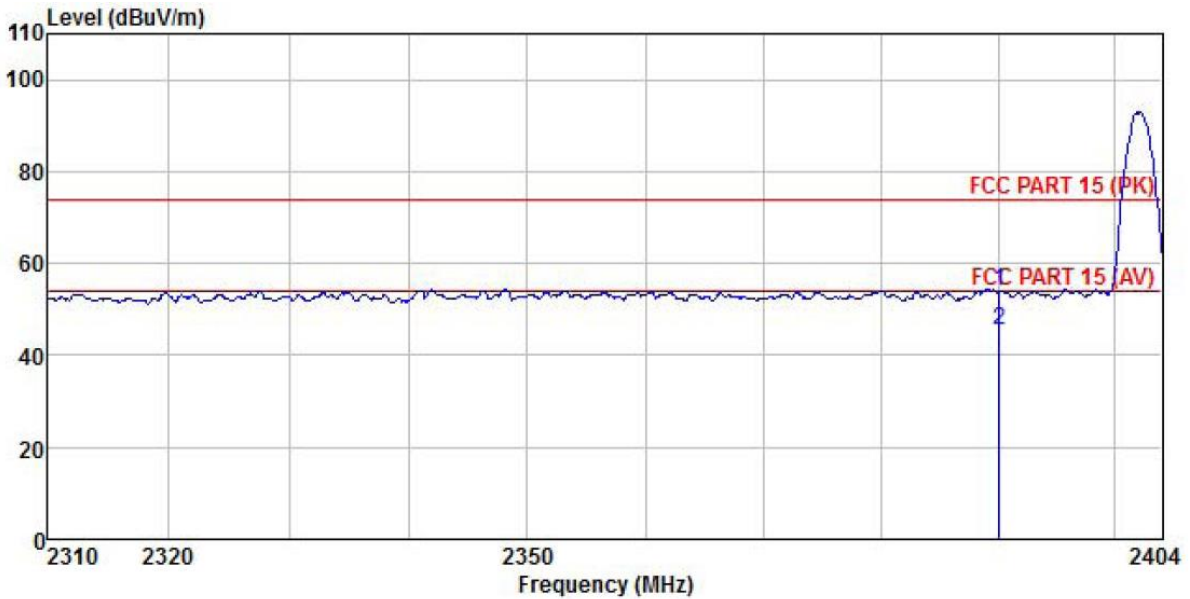

| | Freq | ReadAntenna Level | Antenna Factor | Cable Loss | Aux Factor | Preamp Factor | Level | Limit Line | Over Limit | Remark |
|---|----------|-------------------|----------------|------------|------------|---------------|--------|------------|------------|---------|
| | MHz | dBuV | dB/m | dB | dB | dB | dBuV/m | dBuV/m | dB | |
| 1 | 2390.000 | 20.70 | 27.03 | 4.69 | 1.68 | 0.00 | 54.10 | 74.00 | -19.90 | Peak |
| 2 | 2390.000 | 11.97 | 27.03 | 4.69 | 1.68 | 0.00 | 45.37 | 54.00 | -8.63 | Average |

Remark:

1. Final Level = Receiver Read level + Antenna Factor + Cable Loss – Pre-amplifier Factor.
2. The emission levels of other frequencies are lower than the limit 20dB and not show in test report.

| | | | |
|---------------|-----------------|----------------|----------------------|
| Product Name: | 3G Tablet | Product Model: | PLATINUM A7 |
| Test By: | Yaro | Test mode: | 3DH1 Tx mode |
| Test Channel: | Highest channel | Polarization: | Vertical |
| Test Voltage: | AC 120/60Hz | Environment: | Temp: 24°C Huni: 57% |

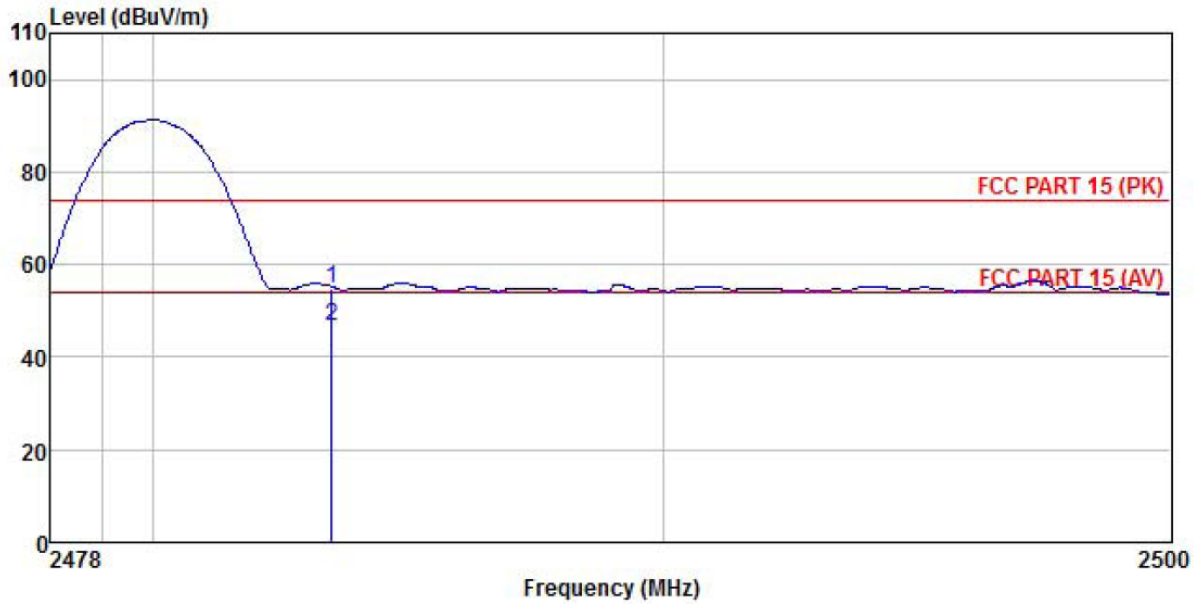

| | Read | Antenna | Cable | Aux | Preamp | Limit | Over | | |
|------|----------|---------|-------|--------|--------|--------|--------|--------|---------------|
| Freq | Level | Factor | Loss | Factor | Factor | Line | Limit | Remark | |
| MHz | dBuV | dB/m | dB | dB | dB | dBuV/m | dBuV/m | dB | |
| 1 | 2483.500 | 21.17 | 27.27 | 4.81 | 1.70 | 0.00 | 54.95 | 74.00 | -19.05 Peak |
| 2 | 2483.500 | 12.75 | 27.27 | 4.81 | 1.70 | 0.00 | 46.53 | 54.00 | -7.47 Average |

Remark:

1. Final Level = Receiver Read level + Antenna Factor + Cable Loss – Pre-amplifier Factor.
2. The emission levels of other frequencies are lower than the limit 20dB and not show in test report.

| | | | |
|----------------------|-----------------|-----------------------|----------------------|
| Product Name: | 3G Tablet | Product Model: | PLATINUM A7 |
| Test By: | Yaro | Test mode: | 3DH1 Tx mode |
| Test Channel: | Highest channel | Polarization: | Horizontal |
| Test Voltage: | AC 120/60Hz | Environment: | Temp: 24°C Huni: 57% |

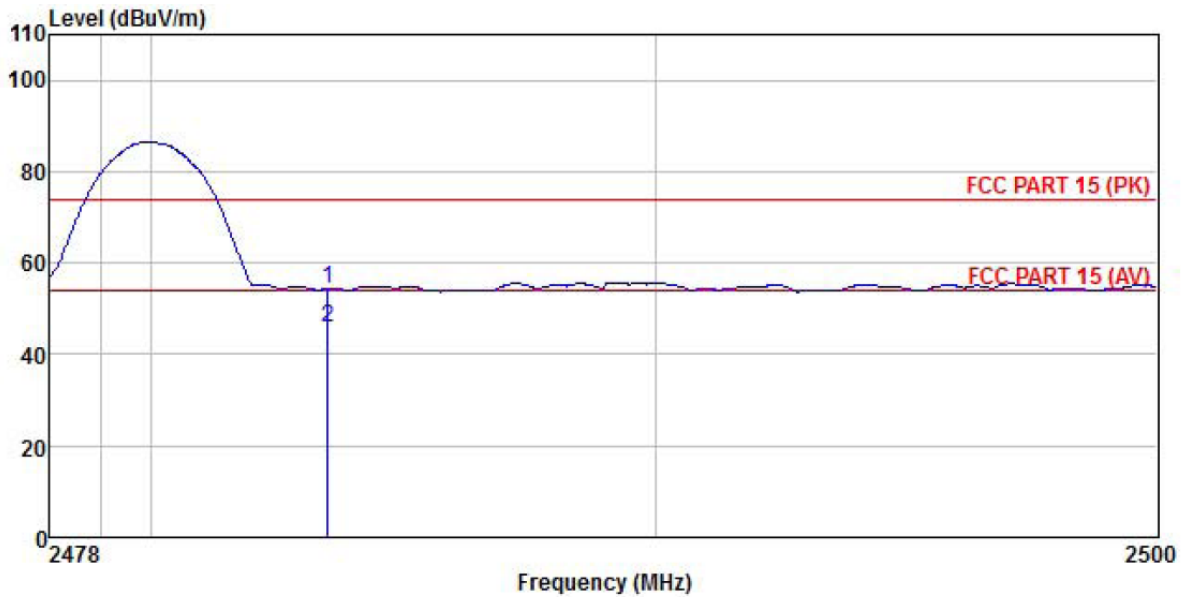

| | Read | Antenna | Cable | Aux | Preamp | Limit | Over | | |
|------|----------|---------|-------|--------|--------|--------|--------|--------|---------------|
| Freq | Level | Factor | Loss | Factor | Factor | Line | Limit | Remark | |
| MHz | dBuV | dB/m | dB | dB | dB | dBuV/m | dBuV/m | dB | |
| 1 | 2483.500 | 20.70 | 27.27 | 4.81 | 1.70 | 0.00 | 54.48 | 74.00 | -19.52 Peak |
| 2 | 2483.500 | 11.94 | 27.27 | 4.81 | 1.70 | 0.00 | 45.72 | 54.00 | -8.28 Average |

Remark:

1. Final Level = Receiver Read level + Antenna Factor + Cable Loss – Pre-amplifier Factor.
2. The emission levels of other frequencies are lower than the limit 20dB and not show in test report.

6.10 Spurious Emission

6.10.1 Conducted Emission Method

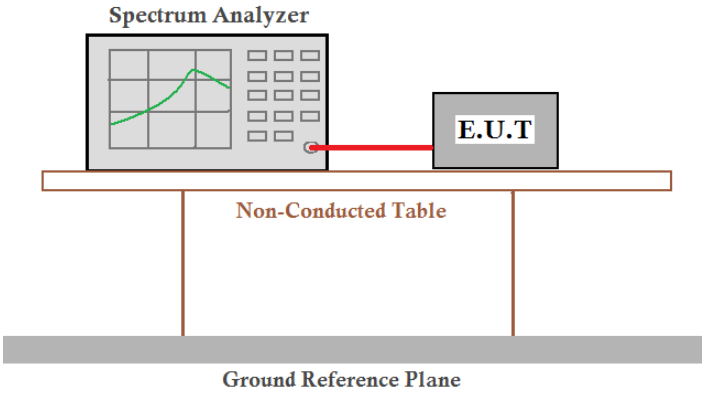
| | |
|-------------------|---|
| Test Requirement: | FCC Part 15 C Section 15.247 (d) |
| Limit: | In any 100 kHz bandwidth outside the frequency band in which the spread spectrum intentional radiator is operating, the radio frequency power that is produced by the intentional radiator shall be at least 20 dB below that in the 100 kHz bandwidth within the band that contains the highest level of the desired power, based on either an RF conducted or a radiated measurement. |
| Test setup: |  <p>The diagram illustrates the test setup. A Spectrum Analyzer is connected to an E.U.T. (Equipment Under Test) via a red cable. Both the Spectrum Analyzer and the E.U.T. are placed on a Non-Conducted Table. The table is supported by a Ground Reference Plane.</p> |
| Test Instruments: | Refer to section 5.9 for details |
| Test mode: | Non-hopping mode |
| Test results: | Pass |

Test plot as follows:

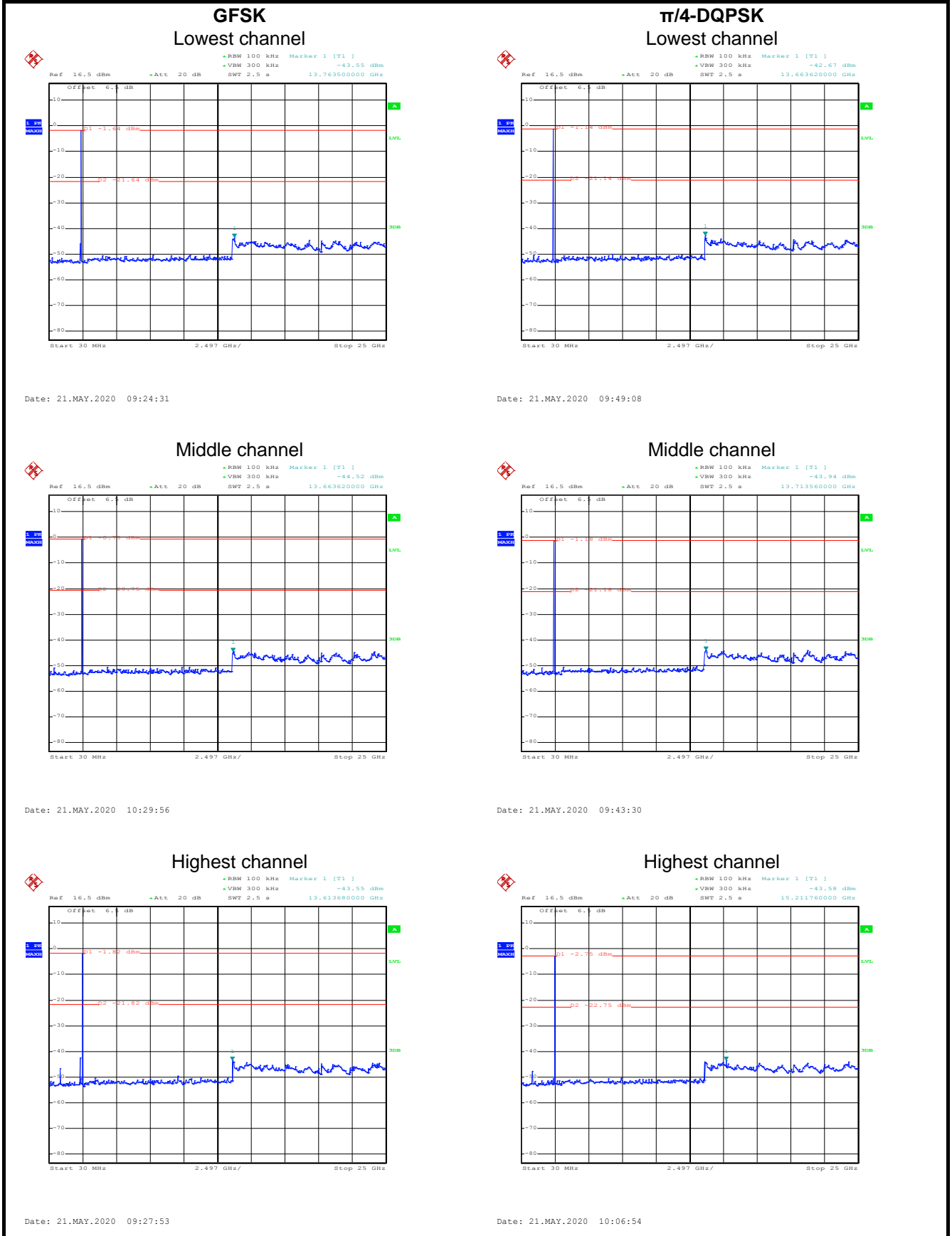

8DPSK

Lowest channel

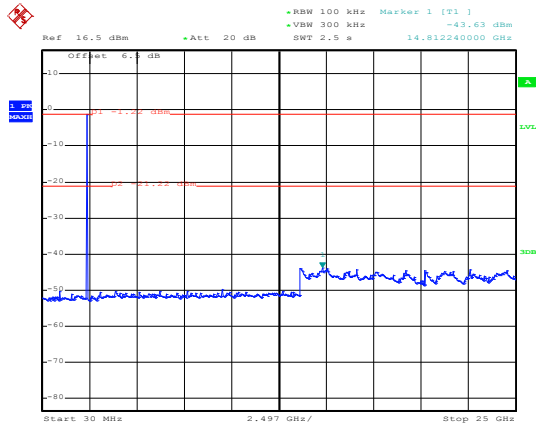

Date: 21.MAY.2020 10:28:32

Middle channel

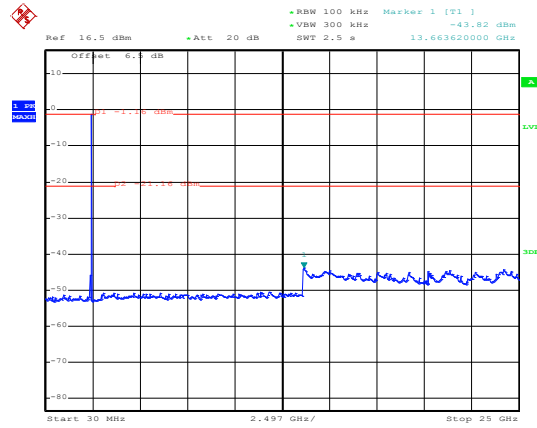

Date: 21.MAY.2020 10:19:07

Highest channel

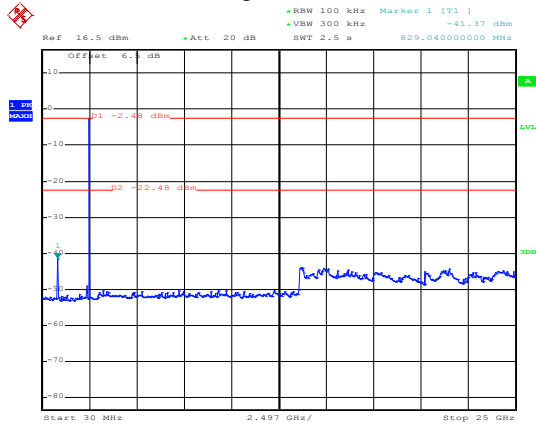

Date: 21.MAY.2020 10:13:21

6.10.2 Radiated Emission Method

| | | | | | |
|-----------------------|---|--------------------|--------|------------------|------------------|
| Test Requirement: | FCC Part 15 C Section 15.209 | | | | |
| Test Frequency Range: | 9 kHz to 25 GHz | | | | |
| Test Distance: | 3m | | | | |
| Receiver setup: | Frequency | Detector | RBW | VBW | Remark |
| | 30MHz-1GHz | Quasi-peak | 120kHz | 300kHz | Quasi-peak Value |
| | Above 1GHz | Peak | 1MHz | 3MHz | Peak Value |
| | | RMS | 1MHz | 3MHz | Average Value |
| Limit: | Frequency | Limit (dBuV/m @3m) | | Remark | |
| | 30MHz-88MHz | 40.0 | | Quasi-peak Value | |
| | 88MHz-216MHz | 43.5 | | Quasi-peak Value | |
| | 216MHz-960MHz | 46.0 | | Quasi-peak Value | |
| | Above 1GHz | 54.0 | | Average Value | |
| | | 74.0 | | Peak Value | |
| Test setup: | Below 1GHz | | | | |
| | | | | | |
| Test setup: | Above 1GHz | | | | |
| | | | | | |
| Test Procedure: | <ol style="list-style-type: none"> 1. The EUT was placed on the top of a rotating table 0.8m(below 1GHz) /1.5m(above 1GHz) above the ground at a 3 meter chamber. The table was rotated 360 degrees to determine the position of the highest radiation. 2. The EUT was set 3 meters away from the interference-receiving antenna, which was mounted on the top of a variable-height antenna | | | | |

| | |
|-------------------|--|
| | <p>tower.</p> <ol style="list-style-type: none"> 3. The antenna height is varied from one meter to four meters above the ground to determine the maximum value of the field strength. Both horizontal and vertical polarizations of the antenna are set to make the measurement. 4. For each suspected emission, the EUT was arranged to its worst case and then the antenna was tuned to heights from 1 meter to 4 meters and the rota table was turned from 0 degrees to 360 degrees to find the maximum reading. 5. The test-receiver system was set to Peak Detect Function and Specified Bandwidth with Maximum Hold Mode. 6. If the emission level of the EUT in peak mode was 10dB lower than the limit specified, then testing could be stopped and the peak values of the EUT would be reported. Otherwise the emissions that did not have 10dB margin would be re-tested one by one using peak, quasi-peak or average method as specified and then reported in a data sheet. |
| Test Instruments: | Refer to section 5.9 for details |
| Test mode: | Non-hopping mode |
| Test results: | Pass |
| Remark: | <ol style="list-style-type: none"> 1. Pre-scan all kind of the place mode (X-axis, Y-axis, Z-axis), and found the Y-axis is the worst case. 2. 9 kHz to 30 MHz is noise floor and lower than the limit 20dB, so only shows the data of above 30MHz in this report. |

Measurement Data (worst case):

Below 1GHz:

| | | | |
|------------------------|----------------|-----------------------|----------------------|
| Product Name: | 3G Tablet | Product Model: | PLATINUM A7 |
| Test By: | Yaro | Test mode: | BT Tx mode |
| Test Frequency: | 30 MHz ~ 1 GHz | Polarization: | Vertical |
| Test Voltage: | AC 120/60Hz | Environment: | Temp: 24°C Humi: 57% |

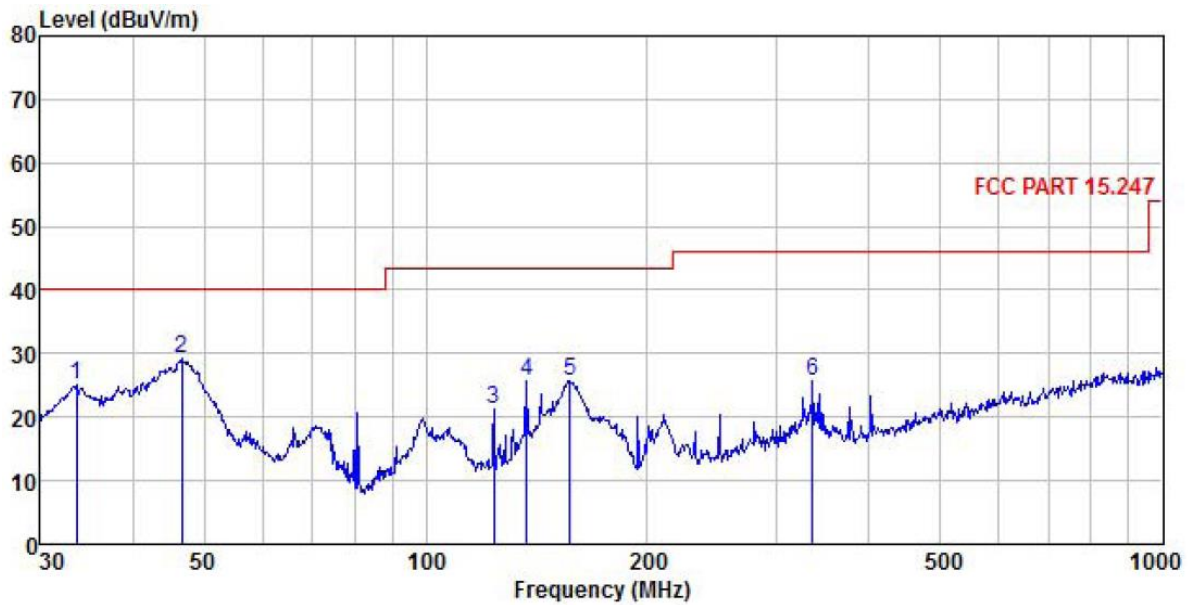

| | ReadAntenna | Cable | Aux | Preamp | Level | Limit | Over | Remark | |
|------|--------------|-------|--------|--------|-------|--------|--------|--------------|----|
| Freq | Level Factor | Loss | Factor | Factor | Level | Line | Limit | | |
| MHz | dBuV | dB/m | dB | dB | dB | dBuV/m | dBuV/m | dB | |
| 1 | 33.562 | 42.97 | 11.04 | 0.98 | 0.00 | 29.96 | 25.03 | 40.00 -14.97 | QP |
| 2 | 46.666 | 45.45 | 12.24 | 1.28 | 0.00 | 29.85 | 29.12 | 40.00 -10.88 | QP |
| 3 | 123.699 | 37.73 | 10.62 | 2.21 | 0.00 | 29.37 | 21.19 | 43.50 -22.31 | QP |
| 4 | 136.939 | 42.80 | 9.69 | 2.36 | 0.00 | 29.29 | 25.56 | 43.50 -17.94 | QP |
| 5 | 157.007 | 43.05 | 9.17 | 2.57 | 0.00 | 29.16 | 25.63 | 43.50 -17.87 | QP |
| 6 | 334.859 | 36.75 | 14.30 | 3.05 | 0.00 | 28.53 | 25.57 | 46.00 -20.43 | QP |

Remark:

- Final Level = Receiver Read level + Antenna Factor + Cable Loss – Pre-amplifier Factor.
- The emission levels of other frequencies are lower than the limit 20dB and not show in test report.

| | | | |
|-----------------|----------------|----------------|----------------------|
| Product Name: | 3G Tablet | Product Model: | PLATINUM A7 |
| Test By: | Yaro | Test mode: | BT Tx mode |
| Test Frequency: | 30 MHz ~ 1 GHz | Polarization: | Horizontal |
| Test Voltage: | AC 120/60Hz | Environment: | Temp: 24°C Huni: 57% |

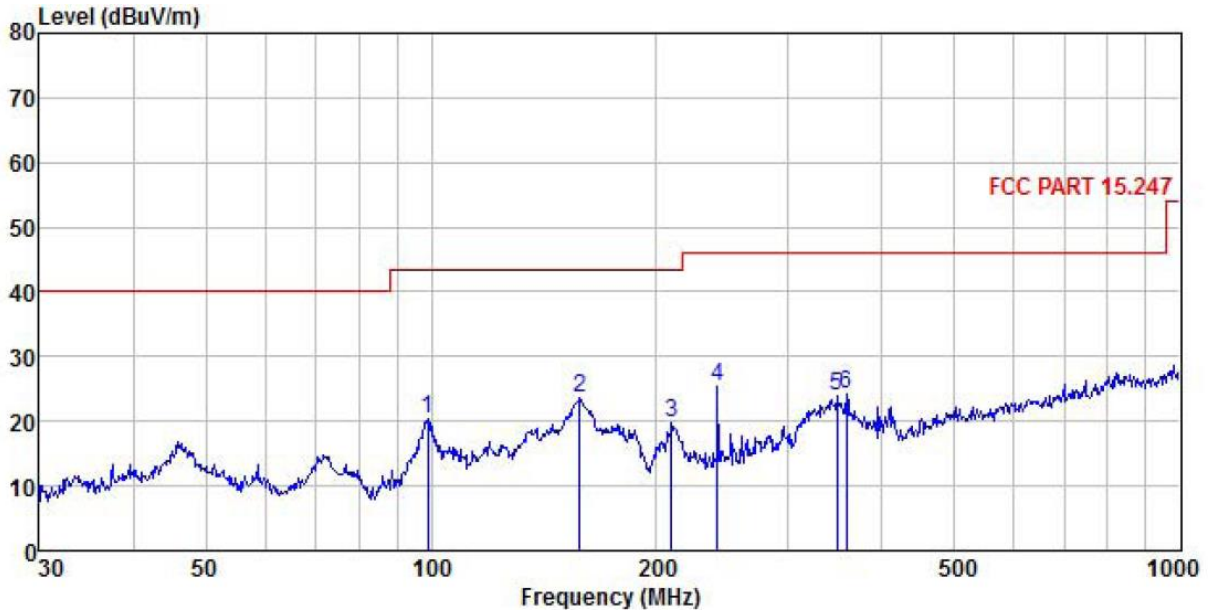

| | Read Freq | Antenna Level | Cable Factor | Aux Loss | Preamp Factor | Level | Limit | Over | Remark |
|---|-----------|---------------|--------------|----------|---------------|--------|--------|-------|-----------|
| | MHz | dBuV | dB/m | dB | dB | dBuV/m | dBuV/m | dB | |
| 1 | 98.833 | 35.81 | 12.22 | 1.97 | 0.00 | 29.53 | 20.47 | 43.50 | -23.03 QP |
| 2 | 158.112 | 41.03 | 9.22 | 2.57 | 0.00 | 29.15 | 23.67 | 43.50 | -19.83 QP |
| 3 | 209.313 | 34.68 | 11.04 | 2.86 | 0.00 | 28.77 | 19.81 | 43.50 | -23.69 QP |
| 4 | 240.830 | 38.69 | 12.34 | 2.82 | 0.00 | 28.59 | 25.26 | 46.00 | -20.74 QP |
| 5 | 348.027 | 34.92 | 14.57 | 3.09 | 0.00 | 28.56 | 24.02 | 46.00 | -21.98 QP |
| 6 | 357.929 | 35.13 | 14.71 | 3.10 | 0.00 | 28.59 | 24.35 | 46.00 | -21.65 QP |

Remark:

1. Final Level = Receiver Read level + Antenna Factor + Cable Loss – Pre-amplifier Factor.
2. The emission levels of other frequencies are lower than the limit 20dB and not show in test report.

Above 1GHz:

| Test channel: Lowest channel | | | | | | | | | |
|---|-------------------|-----------------------|-----------------|-----------------|--------------------|----------------|---------------------|-----------------|--------------|
| Detector: Peak Value | | | | | | | | | |
| Frequency (MHz) | Read Level (dBuV) | Antenna Factor (dB/m) | Cable Loss (dB) | Aux Factor (dB) | Preamp Factor (dB) | Level (dBuV/m) | Limit Line (dBuV/m) | Over Limit (dB) | Polarization |
| 4804.00 | 46.55 | 30.78 | 6.80 | 2.44 | 41.81 | 44.76 | 74.00 | -29.24 | Vertical |
| 4804.00 | 47.30 | 30.78 | 6.80 | 2.44 | 41.81 | 45.51 | 74.00 | -28.49 | Horizontal |
| Detector: Average Value | | | | | | | | | |
| Frequency (MHz) | Read Level (dBuV) | Antenna Factor (dB/m) | Cable Loss (dB) | Aux Factor (dB) | Preamp Factor (dB) | Level (dBuV/m) | Limit Line (dBuV/m) | Over Limit (dB) | Polarization |
| 4804.00 | 40.39 | 30.78 | 6.80 | 2.44 | 41.81 | 38.60 | 54.00 | -15.40 | Vertical |
| 4804.00 | 40.58 | 30.78 | 6.80 | 2.44 | 41.81 | 38.79 | 54.00 | -15.21 | Horizontal |
| Test channel: Middle channel | | | | | | | | | |
| Detector: Peak Value | | | | | | | | | |
| Frequency (MHz) | Read Level (dBuV) | Antenna Factor (dB/m) | Cable Loss (dB) | Aux Factor (dB) | Preamp Factor (dB) | Level (dBuV/m) | Limit Line (dBuV/m) | Over Limit (dB) | Polarization |
| 4882.00 | 46.18 | 30.96 | 6.86 | 2.47 | 41.84 | 44.63 | 74.00 | -29.37 | Vertical |
| 4882.00 | 47.82 | 30.96 | 6.86 | 2.47 | 41.84 | 46.27 | 74.00 | -27.73 | Horizontal |
| Detector: Average Value | | | | | | | | | |
| Frequency (MHz) | Read Level (dBuV) | Antenna Factor (dB/m) | Cable Loss (dB) | Aux Factor (dB) | Preamp Factor (dB) | Level (dBuV/m) | Limit Line (dBuV/m) | Over Limit (dB) | Polarization |
| 4882.00 | 40.14 | 30.96 | 6.86 | 2.47 | 41.84 | 38.59 | 54.00 | -15.41 | Vertical |
| 4882.00 | 40.25 | 30.96 | 6.86 | 2.47 | 41.84 | 38.70 | 54.00 | -15.30 | Horizontal |
| Test channel: Highest channel | | | | | | | | | |
| Detector: Peak Value | | | | | | | | | |
| Frequency (MHz) | Read Level (dBuV) | Antenna Factor (dB/m) | Cable Loss (dB) | Aux Factor (dB) | Preamp Factor (dB) | Level (dBuV/m) | Limit Line (dBuV/m) | Over Limit (dB) | Polarization |
| 4960.00 | 46.83 | 31.11 | 6.91 | 2.49 | 41.87 | 45.47 | 74.00 | -28.53 | Vertical |
| 4960.00 | 47.45 | 31.11 | 6.91 | 2.49 | 41.87 | 46.09 | 74.00 | -27.91 | Horizontal |
| Detector: Average Value | | | | | | | | | |
| Frequency (MHz) | Read Level (dBuV) | Antenna Factor (dB/m) | Cable Loss (dB) | Aux Factor (dB) | Preamp Factor (dB) | Level (dBuV/m) | Limit Line (dBuV/m) | Over Limit (dB) | Polarization |
| 4960.00 | 40.25 | 31.11 | 6.91 | 2.49 | 41.87 | 38.89 | 54.00 | -15.11 | Vertical |
| 4960.00 | 40.11 | 31.11 | 6.91 | 2.49 | 41.87 | 38.75 | 54.00 | -15.25 | Horizontal |
| Remark: 1. Final Level = Receiver Read level + Antenna Factor + Cable Loss + Aux Factor – Pre-amplifier Factor. 2. The emission levels of other frequencies are lower than the limit 20dB and not show in test report. | | | | | | | | | |