

SAR EVALUATION REPORT

For

Sky Phone LLC

1348 Washington Av. Suite 350, Miami Beach, Florida, United States

FCC ID: 2ABOSSKYPLAT60PL

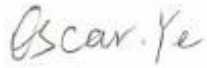
Report Type: Original Report	Product Type: 3G Smart Phone
Report Number: RSZ161216007-20A	
Report Date: 2017-03-15	
Reviewed By: Engineer	Oscar Ye 
Prepared By: Bay Area Compliance Laboratories Corp. (Kunshan) No.248 Chenghu Road, Kunshan, Jiangsu province, China. Tel: +86-0512-86175000 Fax: +86-0512-88934268 www.baclcorp.com.cn	

Attestation of Test Results			
EUT Information	Company Name	Sky Phone LLC	
	EUT Description	3G Smart Phone	
	Model Number	Platinum 6.0Plus	
	FCC ID	2ABOSSKYPLAT60PL	
	Serial Number	16121600709	
	Test Date	2016-12-19 and 2016-12-22 and 2017-3-13	
MODE		Max. SAR Level(s) Reported(W/Kg)	Limit (W/Kg)
GSM 850	1g Head SAR	0.13	1.6
	1g Body SAR	0.43	
PCS 1900	1g Head SAR	0.32	
	1g Body SAR	1.22	
WCDMA Band 5	1g Head SAR	0.18	
	1g Body SAR	0.32	
WCDMA Band 4	1g Head SAR	0.39	
	1g Body SAR	0.75	
WCDMA Band 2	1g Head SAR	0.32	
	1g Body SAR	1.13	
Simultaneous	1g Head SAR	0.66	
	1g Body SAR	1.35	
	1g Body SAR	1.35(Hotspot)	

Applicable Standards	<p>FCC 47 CFR part 2.1093 Radiofrequency radiation exposure evaluation: portable devices</p>
	<p>IEEE1528:2013 IEEE Recommended Practice for Determining the Peak Spatial-Average Specific Absorption Rate (SAR) in the Human Head from Wireless Communications Devices: Measurement Techniques</p>
	<p>IEC 62209-2:2010 Human exposure to radio frequency fields from hand-held and body-mounted wireless communication devices-Human models, instrumentation, and procedures-Part 2: Procedure to determine the specific absorption rate (SAR) for wireless communication devices used in close proximity to the human body (frequency range of 30 MHz to 6 GHz)</p>
	<p>KDB procedures KDB 447498 D01 General RF Exposure Guidance v06. KDB 648474 D04 Handset SAR v01r03. KDB 865664 D01 SAR measurement 100 MHz to 6 GHz v01r04 KDB 865664 D02 RF Exposure Reporting v01r02 KDB 941225 D01 3G SAR Procedures v03r01 KDB 941225 D06 Hotspot Mode v02r01</p>
<p>Note: This wireless device has been shown to be capable of compliance for localized specific absorption rate (SAR) for General Population/Uncontrolled Exposure limits specified in ANSI/IEEE Standards and has been tested in accordance with the measurement procedures specified in IEEE 1528-2013 and RF exposure KDB procedures. The results and statements contained in this report pertain only to the device(s) evaluated.</p>	

TABLE OF CONTENTS

DOCUMENT REVISION HISTORY5

EUT DESCRIPTION6

TECHNICAL SPECIFICATION 6

REFERENCE, STANDARDS, AND GUIDELINES7

SAR LIMITS 8

FACILITIES.....9

POWER REFERENCE MEASUREMENT 10

AREA SCAN 10

ZOOM SCAN 11

POWER DRIFT MEASUREMENT 11

Z-SCAN 11

DESCRIPTION OF TEST SYSTEM 12

EQUIPMENT LIST AND CALIBRATION 17

EQUIPMENTS LIST & CALIBRATION INFORMATION 17

SAR MEASUREMENT SYSTEM VERIFICATION 18

LIQUID VERIFICATION 18

EUT TEST STRATEGY AND METHODOLOGY27

TEST POSITIONS FOR DEVICE OPERATING NEXT TO A PERSON’S EAR..... 27

CHEEK/TOUCH POSITION 28

EAR/TILT POSITION 28

TEST POSITIONS FOR BODY-WORN AND OTHER CONFIGURATIONS 29

SAR EVALUATION PROCEDURE..... 30

CONDUCTED OUTPUT POWER MEASUREMENT31

PROVISION APPLICABLE 31

TEST PROCEDURE 31

SAR MEASUREMENT RESULTS41

MEASUREMENT UNCERTAINTY49

DOCUMENT REVISION HISTORY

Revision Number	Report Number	Description of Revision	Date of Revision
0	RSZ161216007-20A	Original Report	2017-01-17

EUT DESCRIPTION

This report has been prepared on behalf of Sky Phone LLC and their product, FCC ID: 2ABOSSKYPLAT60PL, Model: Platinum 6.0Plus or the EUT (Equipment under Test) as referred to in the rest of this report.

Note:

1. The device is capable of personal hotspot mode. WLAN Hotspot mode permits the device to share its cellular data connection with other 2.4 GHz WLAN enabled devices.
2. All measurement and test data in this report was gathered from production sample serial number: 16121600709(Assigned by BACL, Kunshan). The EUT supplied by the applicant was received on 2016-12-16.

Technical Specification

Product Type	Portable
Exposure Category:	Population / Uncontrolled
Antenna Type(s):	Internal Antenna
Body-Worn Accessories:	Headset
Face-Head Accessories:	None
Multi-slot Class:	Class12
Operation Mode :	GSM Voice, GPRS Data, WCDMA(R99 (Voice+Data),HSUPA, HSDPA) WLAN Bluetooth
Frequency Band:	GSM 850 : 824-849 MHz(TX) ; 869-894 MHz(RX) PCS 1900: 1850-1910 MHz(TX) ; 1930-1990 MHz(RX) WCDMA Band 5: 824-849 MHz(TX) ; 869-894 MHz(RX) WCDMA Band 4: 1710-1755MHz(TX); 2110-2155MHz(RX) WCDMA Band 2: 1850-1910 MHz(TX) ; 1930-1990 MHz(RX) WLAN: 2412MHz-2472 MHz/2422-2462 MHz Bluetooth:2402-2480MHz
Dimensions (L*W*H):	165.9 mm (L) × 83.8 mm (W) × 9.6 mm (H)
Power Source:	3.8 V _{DC} Rechargeable Battery
Normal Operation:	Head and Body-worn

REFERENCE, STANDARDS, AND GUIDELINES

FCC:

The Report and Order requires routine SAR evaluation prior to equipment authorization of portable transmitter devices, including portable telephones. For portable devices, the RF radiation exposure evaluation requirement was provided in part 2.1093. According to KDB447498 D01 “General RF Exposure Guidance”, the device should be evaluated at maximum output power (radiated from the antenna) under “worst-case” conditions for normal or intended use, incorporating normal antenna operating positions, device peak performance frequencies and positions for maximum RF energy coupling.

This report describes the methodology and results of experiments performed on wireless data terminal. The objective was to determine if there is RF radiation and if radiation is found, what is the extent of radiation with respect to safety limits. SAR (Specific Absorption Rate) is the measure of RF exposure determined by the amount of RF energy absorbed by human body (or its parts) – to determine how the RF energy couples to the body or head which is a primary health concern for body worn devices.

CE:

The order requires routine SAR evaluation prior to equipment authorization of portable transmitter devices, including portable telephones. For portable devices, the limitation of exposure of the general public to electromagnetic fields was recommended on Council Recommendation 1999/519/EC. According to the Standard IEC62209-1/2, the device should be evaluated at maximum output power (radiated from the antenna) under “worst-case” conditions for normal or intended use, incorporating normal antenna operating positions, device peak performance frequencies and positions for maximum RF energy coupling.

This report describes the methodology and results of experiments performed on wireless data terminal. The objective was to determine if there is RF radiation and if radiation is found, what is the extent of radiation with respect to safety limits. SAR (Specific Absorption Rate) is the measure of RF exposure determined by the amount of RF energy absorbed by human body (or its parts) – to determine how the RF energy couples to the body or head which is a primary health concern for body portable devices.

The test configurations were laid out on a specially designed test fixture to ensure the reproducibility of measurements. Each configuration was scanned for SAR. Analysis of each scan was carried out to characterize the above effects in the device.

SAR Limits

FCC Limit (1g Tissue)

EXPOSURE LIMITS	SAR (W/kg)	
	(General Population / Uncontrolled Exposure Environment)	(Occupational / Controlled Exposure Environment)
Spatial Average (averaged over the whole body)	0.08	0.4
Spatial Peak (averaged over any 1 g of tissue)	1.60	8.0
Spatial Peak (hands/wrists/feet/ankles averaged over 10 g)	4.0	20.0

CE Limit (10g Tissue)

EXPOSURE LIMITS	SAR (W/kg)	
	(General Population / Uncontrolled Exposure Environment)	(Occupational / Controlled Exposure Environment)
Spatial Average (averaged over the whole body)	0.08	0.4
Spatial Peak (averaged over any 10 g of tissue)	2.0	10
Spatial Peak (hands/wrists/feet/ankles averaged over 10 g)	4.0	20.0

Population/Uncontrolled Environments are defined as locations where there is the exposure of individual who have no knowledge or control of their exposure.

Occupational/Controlled Environments are defined as locations where there is exposure that may be incurred by people who are aware of the potential for exposure (i.e. as a result of employment or occupation).

FACILITIES

The test site used by Bay Area Compliance Laboratories Corp. (Kunshan) to collect test data is located on No.248 Chenghu Road, Kunshan, Jiangsu province, China.

DASY4 SAR Evaluation Procedure

Power Reference Measurement

The Power Reference Measurement and Power Drift Measurement jobs are useful jobs for monitoring the power drift of the device under test in the batch process. Both jobs measure the field at a specified reference position, at a selectable distance from the phantom surface. The reference position can be either the selected section's grid reference point or a user point in this section. The reference job projects the selected point onto the phantom surface, orients the probe perpendicularly to the surface, and approaches the surface using the selected detection method. The Minimum distance of probe sensors to surface determines the closest measurement point to phantom surface. By default, the Minimum distance of probe sensors to surface is 4mm. This distance can be modified by the user, but cannot be smaller than the Distance of sensor calibration points to probe tip as defined in the probe properties.

Area Scan

The Area Scan is used as a fast scan in two dimensions to find the area of high field values, before doing a finer measurement around the hot spot. The sophisticated interpolation routines implemented in DASY4 software can find the maximum locations even in relatively coarse grids.

The scanning area is defined by an editable grid. This grid is anchored at the grid reference point of the selected section in the phantom. When the Area Scan's property sheet is brought-up, grid settings can be edited by a user.

When an Area Scan has measured all reachable points, it computes the field maxima found in the scanned area, within a range of the global maximum. The range (in dB) is specified in the standards for compliance testing. For example, a 2 dB range is required in IEEE 1528-2013, IEC 62209-1:2006 and IEC 62209-2:2010 standards, whereby 3 dB is a requirement when compliance is assessed in accordance with the ARIB standard (Japan). If only one Zoom Scan follows the Area Scan, then only the absolute maximum will be taken as reference. For cases where multiple maximums are detected, the number of Zoom Scans has to be increased accordingly.

After measurement is completed, all maxima and their coordinates are listed in the Results property page. The maximum selected in the list is highlighted in the 3-D view. For the secondary maxima returned from an Area Scan, the user can specify a lower limit (peak SAR value), in addition to the Find secondary maxima within x dB condition. Only the primary maximum and any secondary maxima within x dB from the primary maximum and above this limit will be measured.

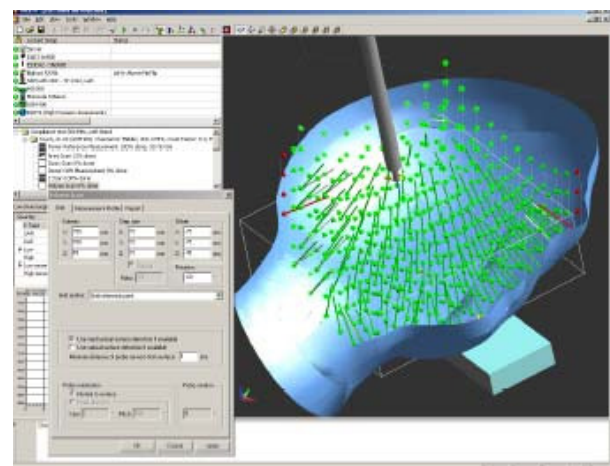
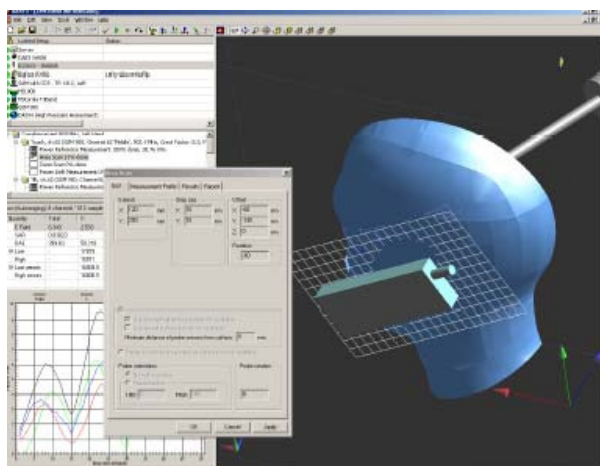

Zoom Scan

Zoom Scans are used to assess the peak spatial SAR values within a cubic averaging volume containing 1 g and 10 g of simulated tissue. The default Zoom Scan measures 5 x 5 x 7 points within a cube whose base faces are centered around the maxima found in a preceding area scan job within the same procedure. When the measurement is done, the Zoom Scan evaluates the averaged SAR for 1 g and 10 g and displays these values next to the job's label.

Power drift measurement

The Power Drift Measurement job measures the field at the same location as the most recent power reference measurement job within the same procedure, and with the same settings. The Power Drift Measurement gives the field difference in dB from the reading conducted within the last Power Reference Measurement. Several drift measurements are possible for one reference measurement. This allows a user to monitor the power drift of the device under test within a batch process. The measurement procedure is the same as Step 1.

Z-Scan

The Z Scan job measures points along a vertical straight line. The line runs along the Z axis of a one-dimensional grid. A user can anchor the grid to the section reference point, to any defined user point or to the current probe location. As with any other grids, the local Z axis of the anchor location establishes the Z axis of the grid.

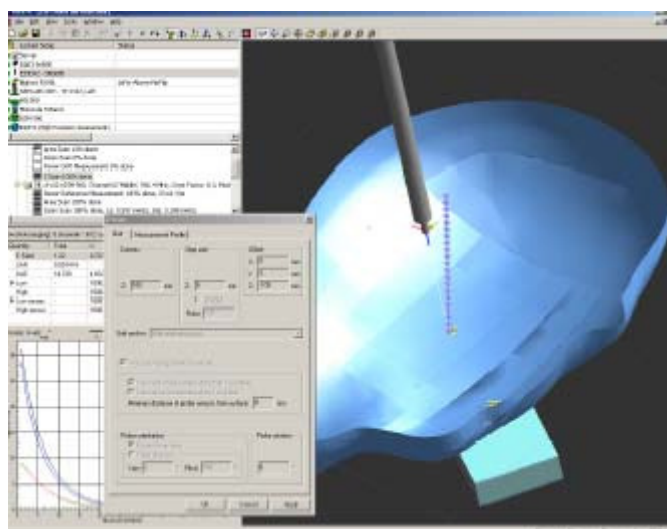

DESCRIPTION OF TEST SYSTEM

These measurements were performed with the automated near-field scanning system DASY4 from Schmid & Partner Engineering AG (SPEAG) which is the Fifth generation of the system shown in the figure hereinafter:



DASY4 System Description

The DASY4 system for performing compliance tests consists of the following items:

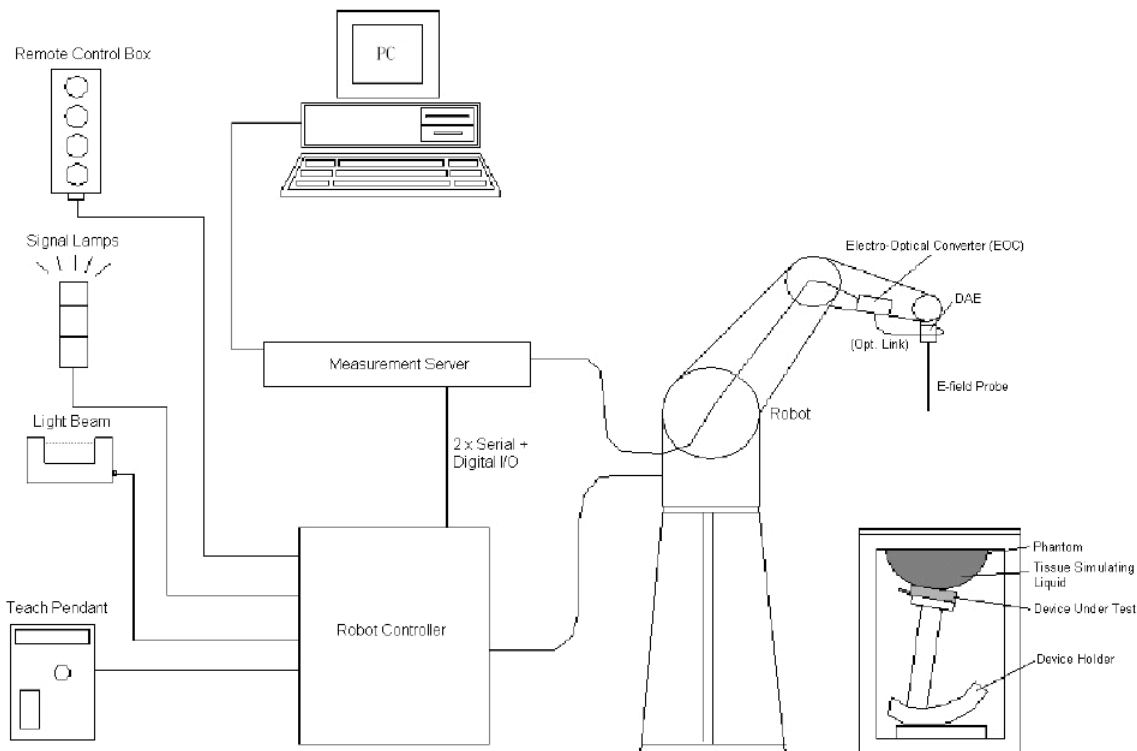

- A standard high precision 6-axis robot (Staubli TX=RX family) with controller, teach pendant and software. An arm extension for accommodating the data acquisition electronics (DAE).
- An isotropic field probe optimized and calibrated for the targeted measurement.
- A data acquisition electronics (DAE) which performs the signal amplification, signal multiplexing, AD-conversion, offset measurements, mechanical surface detection, collision detection, etc. The unit is battery powered with standard or rechargeable batteries. The signal is optically transmitted to the EOC.
- The Electro-optical converter (EOC) performs the conversion from optical to electrical signals for the digital communication to the DAE. To use optical surface detection, a special version of the EOC is required. The EOC signal is transmitted to the measurement server.
- The function of the measurement server is to perform the time critical tasks such as signal filtering, control of the robot operation and fast movement interrupts.
- The Light Beam used is for probe alignment. This improves the (absolute) accuracy of the probe positioning.
- A computer running Win7 professional operating system and the DASY42 software.
- Remote control and teach pendant as well as additional circuitry for robot safety such as warning lamps, etc.
- The phantom, the device holder and other accessories according to the targeted measurement.

DASY4 Measurement Server

The DASY4 measurement server is based on a PC/104 CPU board with a 400MHz intel ULV Celeron, 128MB chip-disk and 128MB RAM. The necessary circuits for communication with the DAE4 (or DAE3) electronics box, as well as the 16 bit AD converter system for optical detection and digital I/O interface are contained on the DASY4 I/O board, which is directly connected to the PC/104 bus of the CPU board.



The measurement server performs all real-time data evaluation of field measurements and surface detection, controls robot movements and handles safety operation. The PC operating system cannot interfere with these time critical processes. All connections are supervised by a watchdog, and disconnection of any of the cables to the measurement server will automatically disarm the robot and disable all program-controlled robot movements. Furthermore, the measurement server is equipped with an expansion port which is reserved for future applications. Please note that this expansion port does not have a standardized point out, and therefore only devices provided by SPEAG can be connected. Devices from any other supplier could seriously damage the measurement server.

Data Acquisition Electronics

The data acquisition electronics (DAE4) consist of a highly sensitive electrometer-grade preamplifier with auto-zeroing, a channel and gain-switching multiplexer, a fast 16 bit AD-converter and a command decoder with a control logic unit. Transmission to the measurement server is accomplished through an optical downlink for data and status information, as well as an optical uplink for commands and the clock.

The mechanical probe mounting device includes two different sensor systems for frontal and sideways probe contacts. They are used for mechanical surface detection and probe collision detection.

The input impedance of both the DAE4 as well as of the DAE3 box is 200M Ω ; the inputs are symmetrical and floating. Common mode rejection is above 80 dB.

EX3DV4 E-Field Probes

Frequency	10 MHz to > 6 GHz Linearity: ± 0.2 dB (30 MHz to 6 GHz)
Directivity	± 0.3 dB in TSL (rotation around probe axis) ± 0.5 dB in TSL (rotation normal to probe axis)
Dynamic Range	10 µW/g to > 100 mW/g Linearity: ± 0.2 dB (noise: typically < 1 µW/g)
Dimensions	Overall length: 337 mm (Tip: 20 mm) Tip diameter: 2.5 mm (Body: 12 mm) Typical distance from probe tip to dipole centers: 1 mm
Application	High precision dosimetric measurements in any exposure scenario (e.g., very strong gradient fields); the only probe that enables compliance testing for frequencies up to 6 GHz with precision of better 30%.
Compatibility	DASY3, DASY4, DASY42 SAR and higher, EASY4/MRI

SAM Twin Phantom

The SAM twin phantom is a fiberglass shell phantom with 2mm shell thickness (except the ear region, where shell thickness increases to 6 mm). The phantom has three measurement areas:

- _ Left hand
- _ Right hand
- _ Flat phantom

The phantom table for the DASY systems based on the TX90XL and RX160L robots have the size of 100 x 50 x 85 cm (L xWx H). The phantom table for the compact DASY systems based on the RX60L robot have the size of 100 x 75 x 91 cm (L xWx H); these tables are reinforced for mounting of the robot onto the table.



For easy dislocation these tables have fork lift cut outs at the bottom.

The bottom plate contains three pairs of bolts for locking the device holder. The device holder positions are adjusted to the standard measurement positions in the three sections. Only one device holder is necessary if two phantoms are used (e.g., for different liquids)

A white cover is provided to cover the phantom during o_-periods to prevent water evaporation and changes in the liquid parameters. Free space scans of devices on top of this phantom cover are possible.

Three reference marks are provided on the phantom counter. These reference marks are used to teach the absolute phantom position relative to the robot.

Robots

The DASY4 system uses the high precision industrial robots RX90XL from Staubli SA (France). The TX robot family is the successor of the well known RX robot family and offers the same features important for our application:

- High precision (repeatability 0.02mm)
- High reliability (industrial design)
- Low maintenance costs (virtually maintenance free due to direct drive gears; no belt drives)
- Jerk-free straight movements (brushless synchron motors; no stepper motors)
- Low ELF interference (motor control fields shielded via the closed metallic construction shields)

The above mentioned robots are controlled by the Staubli CS8c robot controllers. All information regarding the use and maintenance of the robot arm and the robot controller is contained on the CDs delivered along with the robot. Paper manuals are available upon request direct from Staubli.

Area Scans

Area scans are defined prior to the measurement process being executed with a user defined variable spacing between each measurement point (integral) allowing low uncertainty measurements to be conducted. Scans defined for FCC applications utilize a 10mm² step integral, with 1mm interpolation used to locate the peak SAR area used for zoom scan assessments.

Where the system identifies multiple SAR peaks (which are within 25% of peak value) the system will provide the user with the option of assessing each peak location individually for zoom scan averaging.

Zoom Scan (Cube Scan Averaging)

The averaging zoom scan volume utilized in the DASY4 software is in the shape of a cube and the side dimension of a 1 g or 10 g mass is dependent on the density of the liquid representing the simulated tissue. A density of 1000 kg/m³ is used to represent the head and body tissue density and not the phantom liquid density, in order to be consistent with the definition of the liquid dielectric properties, i.e. the side length of the 1 g cube is 10mm, with the side length of the 10 g cube 21,5mm.

When the cube intersects with the surface of the phantom, it is oriented so that 3 vertices touch the surface of the shell or the center of a face is tangent to the surface. The face of the cube closest to the surface is modified in order to conform to the tangent surface.

The zoom scan integer steps can be user defined so as to reduce uncertainty, but normal practice for typical test applications (including FCC) utilize a physical step of 5x5x8 (8mmx8mmx5mm) providing a volume of 32mm³ in the X & Y axis, and 35mm in the Z axis.

Tissue Dielectric Parameters for Head and Body Phantoms

The head tissue dielectric parameters recommended by the IEEE SCC-34/SC-2 in P1528 have been incorporated in the following table. These head parameters are derived from planar layer models simulating the highest expected SAR for the dielectric properties and tissue thickness variations in a human head. Other head and body tissue parameters that have not been specified in P1528 are derived from the tissue dielectric parameters computed from the 4-Cole-Cole equations described in Reference [12] and extrapolated according to the head parameters specified in P1528.

Recommended Tissue Dielectric Parameters for Head and Body

Frequency (MHz)	Head Tissue		Body Tissue	
	ϵ_r	σ (S/m)	ϵ_r	σ (S/m)
150	52.3	0.76	61.9	0.80
300	45.3	0.87	58.2	0.92
450	43.5	0.87	56.7	0.94
835	41.5	0.90	55.2	0.97
900	41.5	0.97	55.0	1.05
915	41.5	0.98	55.0	1.06
1450	40.5	1.20	54.0	1.30
1610	40.3	1.29	53.8	1.40
1800-2000	40.0	1.40	53.3	1.52
2450	39.2	1.80	52.7	1.95
3000	38.5	2.40	52.0	2.73
5800	35.3	5.27	48.2	6.00

EQUIPMENT LIST AND CALIBRATION

Equipments List & Calibration Information

Equipment	Model	S/N	Calibration Date	Calibration Due Date
Robot	RX90	5L79A1	N/A	N/A
DASY4 Test Software	DASY4.5	N/A	N/A	N/A
DASY4 Measurement Server	DASY 4.5.12	1180	N/A	N/A
Data Acquisition Electronics	DAE4	772	2016/10/25	2017/10/24
E-Field Probe	EX3DV4	7382	2016/10/26	2017/10/25
Dipole, 835 MHz	D835V2	453	2015/08/17	2018/08/16
Dipole, 1750 MHz	D1750V2	1140	2015/07/09	2018/07/08
Dipole, 1900 MHz	D1900V2	5d206	2015/07/14	2018/07/13
Mounting Device	SD 000 H01 KA	N/A	N/A	N/A
Twin SAM	Twin SAM V5.0	1909	N/A	N/A
Simulated Tissue 835 MHz Head	TS-835-H	N/A	Each Time	/
Simulated Tissue 835 MHz Body	TS-835-B	N/A	Each Time	/
Simulated Tissue 1750 MHz Head	TS-1750-H	N/A	Each Time	/
Simulated Tissue 1750 MHz Body	TS-1750-B	N/A	Each Time	/
Simulated Tissue 1900 MHz Head	TS-1900-H	N/A	Each Time	/
Simulated Tissue 1900 MHz Body	TS-1900-B	N/A	Each Time	/
Network Analyzer	8753B	2625A00809	2016/10/06	2017/10/05
S-Parameter Test Set	85047A	3033A02428	2016/10/06	2017/10/05
Dielectric probe kit	85070B	US33020324	N/A	N/A
Signal Generator	SMBV100A	261558	2016/07/04	2017/07/03
Wideband Radio Communication Test	CMU200	103113	2016/11/11	2017/11/10
Power Meter	E4419B	MY41291878	2016/01/08	2017/01/07
Power Meter Sensor	E9301A	US39210953	2016/05/30	2017/05/29
Power Amplifier	10S1G4M1	18060	N/A	N/A
Directional Coupler	488Z	N/A	N/A	N/A
Attenuator	20dB, 100W	N/A	N/A	N/A
Attenuator	3dB, 150W	N/A	N/A	N/A

SAR MEASUREMENT SYSTEM VERIFICATION

Liquid Verification

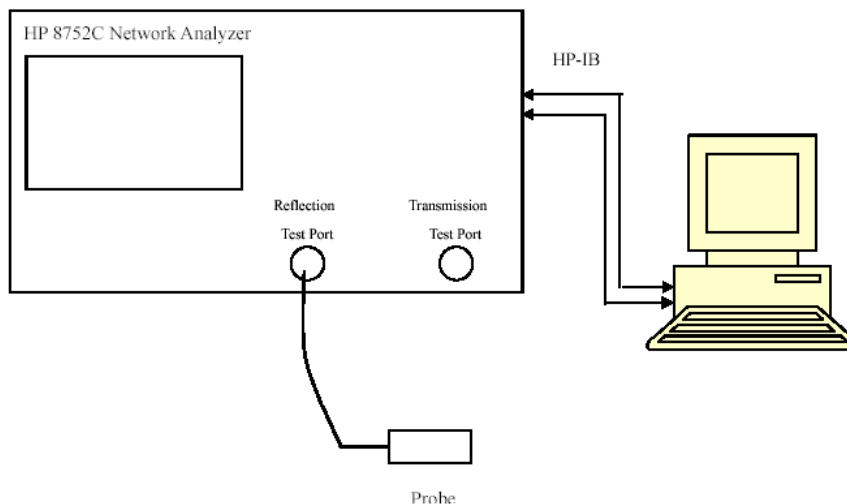

Liquid Verification Setup Block Diagram

Liquid Verification Results

Frequency (MHz)	Liquid Type	Liquid Parameter		Target Value		Delta (%)		Tolerance (%)
		ϵ_r	σ (S/m)	ϵ_r	σ (S/m)	$\Delta\epsilon_r$	$\Delta\sigma$ (S/m)	
824.2	Simulated Tissue 835MHz Head	41.02	0.91	41.56	0.90	-1.299	1.111	±5
826.4	Simulated Tissue 835MHz Head	41.13	0.91	41.54	0.90	-0.987	1.111	±5
835	Simulated Tissue 835MHz Head	41.15	0.92	41.50	0.90	-0.843	2.222	±5
836.6	Simulated Tissue 835MHz Head	41.19	0.92	41.50	0.90	-0.747	2.222	±5
846.6	Simulated Tissue 835MHz Head	41.23	0.93	41.50	0.91	-0.651	2.198	±5
848.8	Simulated Tissue 835MHz Head	41.28	0.93	41.50	0.91	-0.530	2.198	±5
824.2	Simulated Tissue 835MHz Body	54.35	1.00	55.24	0.97	-1.611	3.093	±5
826.4	Simulated Tissue 835MHz Body	54.48	0.97	55.23	0.97	-1.358	0.000	±5
835	Simulated Tissue 835MHz Body	54.55	0.98	55.20	0.97	-1.178	1.031	±5
836.6	Simulated Tissue 835MHz Body	54.59	0.98	55.20	0.97	-1.105	1.031	±5
846.6	Simulated Tissue 835MHz Body	54.69	0.98	55.20	0.98	-0.924	0.000	±5
848.8	Simulated Tissue 835MHz Body	54.75	0.99	55.20	0.98	-0.815	1.020	±5

*Liquid Verification was performed on 2016-12-19.

Frequency (MHz)	Liquid Type	Liquid Parameter		Target Value		Delta (%)		Tolerance (%)
		ϵ_r	σ (S/m)	ϵ_r	σ (S/m)	$\Delta\epsilon_r$	$\Delta\sigma$ (S/m)	
1850.2	Simulated Tissue 1900MHz Head	39.62	1.40	40.00	1.40	-0.950	0.000	±5
1852.4	Simulated Tissue 1900MHz Head	39.68	1.39	40.00	1.40	-0.800	-0.714	±5
1880	Simulated Tissue 1900MHz Head	39.72	1.40	40.00	1.40	-0.700	0.000	±5
1900	Simulated Tissue 1900MHz Head	38.89	1.43	40.00	1.40	-2.775	2.143	±5
1907.6	Simulated Tissue 1900MHz Head	39.82	1.40	40.00	1.40	-0.450	0.000	±5
1909.8	Simulated Tissue 1900MHz Head	39.94	1.40	40.00	1.40	-0.150	0.000	±5
1850.2	Simulated Tissue 1900MHz Body	52.77	1.52	53.30	1.52	-0.994	0.000	±5
1852.4	Simulated Tissue 1900MHz Body	52.81	1.52	53.30	1.52	-0.919	0.000	±5
1880	Simulated Tissue 1900MHz Body	52.96	1.52	53.30	1.52	-0.638	0.000	±5
1900	Simulated Tissue 1900MHz Body	51.86	1.53	53.30	1.52	-2.702	0.658	±5
1907.6	Simulated Tissue 1900MHz Body	53.14	1.53	53.30	1.52	-0.300	0.658	±5
1909.8	Simulated Tissue 1900MHz Body	53.20	1.53	53.30	1.52	-0.188	0.658	±5

*Liquid Verification was performed on 2016-12-22.

Frequency (MHz)	Liquid Type	Liquid Parameter		Target Value		Delta (%)		Tolerance (%)
		ϵ_r	σ (S/m)	ϵ_r	σ (S/m)	$\Delta\epsilon_r$	$\Delta\sigma$ (S/m)	
1712.4	Simulated Tissue 1750MHz Head	39.63	1.38	40.09	1.37	-1.147	0.730	±5
1732.6	Simulated Tissue 1750MHz Head	39.96	1.38	40.07	1.37	-0.275	0.730	±5
1750.0	Simulated Tissue 1750MHz Head	39.93	1.40	40.05	1.38	-0.300	1.449	±5
1752.6	Simulated Tissue 1750MHz Head	40.11	1.40	40.05	1.38	0.150	1.449	±5
1712.4	Simulated Tissue 1750MHz Body	53.15	1.49	53.45	1.48	-0.561	0.676	±5
1732.6	Simulated Tissue 1750MHz Body	52.99	1.50	53.42	1.49	-0.805	0.671	±5
1750.0	Simulated Tissue 1750MHz Body	53.22	1.51	53.39	1.50	-0.318	0.667	±5
1752.6	Simulated Tissue 1750MHz Body	53.36	1.51	53.38	1.50	-0.037	0.667	±5

*Liquid Verification was performed on 2017-3-13.

System Accuracy Verification

Prior to the assessment, the system validation kit was used to test whether the system was operating within its specifications of $\pm 10\%$. The validation results are tabulated below. And also the corresponding SAR plot is attached as well in the SAR plots files.

System Verification Setup Block Diagram

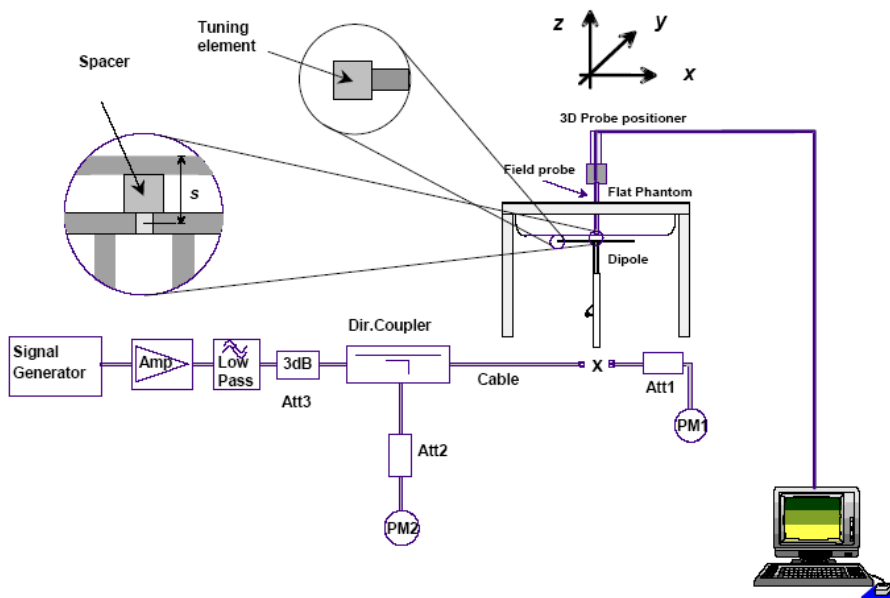

System Accuracy Check Results

Date	Frequency Band	Liquid Type	Measured SAR (W/Kg)		Target Value (W/Kg)	Delta (%)	Tolerance (%)
2016-12-19	835	Head	1g	9.75	9.43	3.393	± 10
		Body	1g	9.42	9.55	-1.361	± 10
2016-12-22	1900	Head	1g	38.9	40.7	-4.423	± 10
		Body	1g	38.6	40.4	-4.455	± 10
2017-3-13	1750	Head	1g	37.1	36.8	0.815	± 10
		Body	1g	36.8	37.2	-1.075	± 10

Note:

For 835 and 1900, the power inputted to dipole is 0.1Watt; the SAR values are normalized to 1 Watt forward power by multiplying 10 times.

SAR SYSTEM VALIDATION DATA

Test Laboratory: Bay Area Compliance Labs Corp.(Kunshan)

DUT: Dipole 835 MHz; Type: D835V2; S/N: 453

Program Name: 835 MHz Head

Communication System: CW; Frequency: 835 MHz; Duty Cycle: 1:1

Medium parameters used: $f = 835 \text{ MHz}$; $\sigma = 0.92 \text{ S/m}$; $\epsilon_r = 41.15$; $\rho = 1000 \text{ kg/m}^3$

Phantom section: Flat Section

DASY4 Configuration:

- Probe: EX3DV4 – SN7382; ConvF(10.50, 10.50, 10.50); Calibrated: 26/10/2016
- Sensor-Surface: 4mm (Mechanical Surface Detection)
- Electronics: DAE – SN772; Calibrated: 25/10/2016
- Phantom: TWIN SAM; Type: Twin SAM V5.0; Serial: 1909
- Measurement SW: DASY4, V4.5 Build 19; Postprocessing SW: SEMCAD, V1.8 Build 145

835 Head system check /Area Scan (91x151x1): Measurement grid: $dx=10\text{mm}$, $dy=10\text{mm}$

Maximum value of SAR (interpolated) = 1.34 mW/g

835 Head system check /Zoom Scan (7x7x7)/Cube 0: Measurement grid: $dx=5\text{mm}$, $dy=5\text{mm}$, $dz=5\text{mm}$

Reference Value = 39.8 V/m; Power Drift = -0.062 dB

Peak SAR (extrapolated) = 1.41 W/kg

SAR(1 g) = 0.975 mW/g; SAR(10 g) = 0.612 mW/g

Maximum value of SAR (measured) = 1.12 mW/g

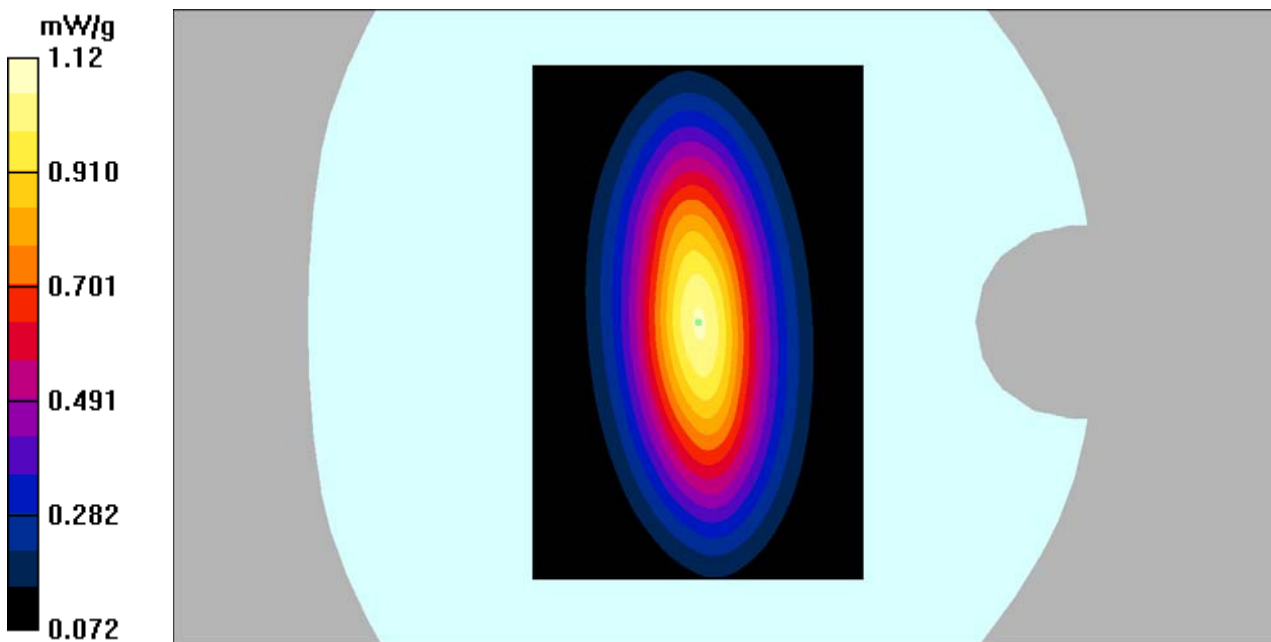

Test Laboratory: Bay Area Compliance Labs Corp.(Kunshan)

DUT: Dipole 835 MHz; Type: D835V2; S/N: 453

Program Name: 835 MHz Body

Communication System: CW; Frequency: 835 MHz; Duty Cycle: 1:1

Medium parameters used: $f = 835 \text{ MHz}$; $\sigma = 0.98 \text{ S/m}$; $\epsilon_r = 54.55$; $\rho = 1000 \text{ kg/m}^3$

Phantom section: Flat Section

DASY4 Configuration:

- Probe: EX3DV4 – SN7382; ConvF(10.54, 10.54, 10.54); Calibrated: 26/10/2016
- Sensor-Surface: 4mm (Mechanical Surface Detection)
- Electronics: DAE – SN772; Calibrated: 25/10/2016
- Phantom: TWIN SAM; Type: Twin SAM V5.0; Serial: 1909
- Measurement SW: DASY4, V4.5 Build 19; Postprocessing SW: SEMCAD, V1.8 Build 145

835 Body system check /Area Scan (91x151x1): Measurement grid: $dx=10\text{mm}$, $dy=10\text{mm}$

Maximum value of SAR (interpolated) = 1.27 mW/g

835 Body system check /Zoom Scan (7x7x7)/Cube 0: Measurement grid: $dx=5\text{mm}$, $dy=5\text{mm}$, $dz=5\text{mm}$

Reference Value = 34.3 V/m; Power Drift = -0.072 dB

Peak SAR (extrapolated) = 1.35 W/kg

SAR(1 g) = 0.942 mW/g; SAR(10 g) = 0.642 mW/g

Maximum value of SAR (measured) = 1.11 mW/g

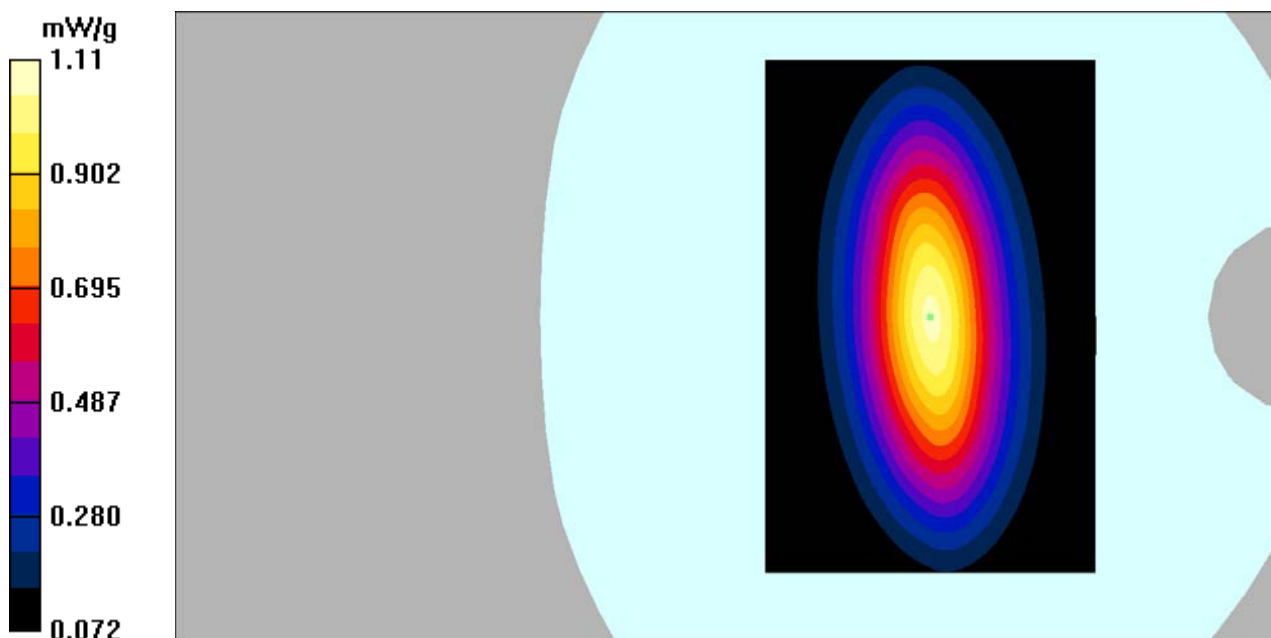

Test Laboratory: Bay Area Compliance Labs Corp.(Kunshan)

DUT: Dipole 1900 MHz; Model: D1900V2-S/N: 5d206

Program Name: 1900MHz Head

Communication System: CW; Frequency: 1900 MHz;Duty Cycle: 1:1

Medium parameters used: $f = 1900 \text{ MHz}$; $\sigma = 1.43 \text{ S/m}$; $\epsilon_r = 38.89$; $\rho = 1000 \text{ kg/m}^3$

Phantom section: Flat Section

DASY4 Configuration:

- Probe: EX3DV4 – SN7382; ConvF(8.71, 8.71, 8.71); Calibrated: 26/10/2016
- Sensor-Surface: 4mm (Mechanical Surface Detection)
- Electronics: DAE – SN772; Calibrated: 25/10/2016
- Phantom: TWIN SAM; Type: Twin SAM V5.0; Serial: 1368
- Measurement SW: DASY4, V4.5 Build 19; Postprocessing SW: SEMCAD, V1.8 Build 145

1900 head system check/Area Scan (71x91x1): Measurement grid: $dx=10\text{mm}$, $dy=10\text{mm}$

Maximum value of SAR (interpolated) = 4.16 mW/g

1900 head system check/Zoom Scan (7x7x7)/Cube 0: Measurement grid: $dx=5\text{mm}$, $dy=5\text{mm}$, $dz=5\text{mm}$

Reference Value = 45.5 V/m; Power Drift = -0.033 dB

Peak SAR (extrapolated) = 7.86 W/kg

SAR(1 g) = 3.89 mW/g; SAR(10 g) = 1.97 mW/g

Maximum value of SAR (measured) = 4.12 mW/g

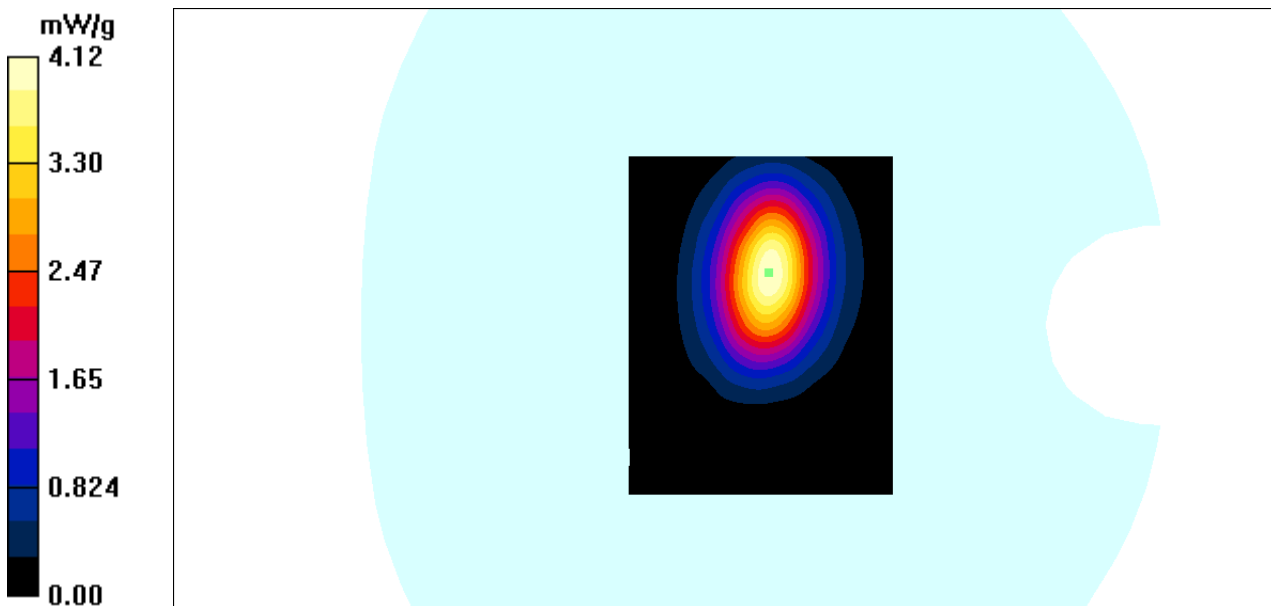

Test Laboratory: Bay Area Compliance Labs Corp.(Kunshan)

DUT: Dipole 1900 MHz; Model: D1900V2-S/N: 5d206

Program Name: 1900MHz Body

Communication System: CW; Frequency: 1900 MHz;Duty Cycle: 1:1

Medium parameters used: $f = 1900$ MHz; $\sigma = 1.53$ S/m; $\epsilon_r = 51.86$; $\rho = 1000$ kg/m³

Phantom section: Flat Section

DASY4 Configuration:

- Probe: EX3DV4 – SN7382; ConvF(8.31, 8.31, 8.31); Calibrated: 26/10/2016
- Sensor-Surface: 4mm (Mechanical Surface Detection)
- Electronics: DAE – SN772; Calibrated: 25/10/2016
- Phantom: TWIN SAM; Type: Twin SAM V5.0; Serial: 1368
- Measurement SW: DASY4, V4.5 Build 19; Postprocessing SW: SEMCAD, V1.8 Build 145

1900 head system check/Area Scan (71x91x1): Measurement grid: dx=10mm, dy=10mm

Maximum value of SAR (interpolated) = 4.11 mW/g

1900 head system check/Zoom Scan (7x7x7)/Cube 0: Measurement grid: dx=5mm, dy=5mm, dz=5mm

Reference Value = 44.3 V/m; Power Drift = 0.056 dB

Peak SAR (extrapolated) = 7.81 W/kg

SAR(1 g) = 3.86 mW/g; SAR(10 g) = 1.94 mW/g

Maximum value of SAR (measured) = 4.05 mW/g

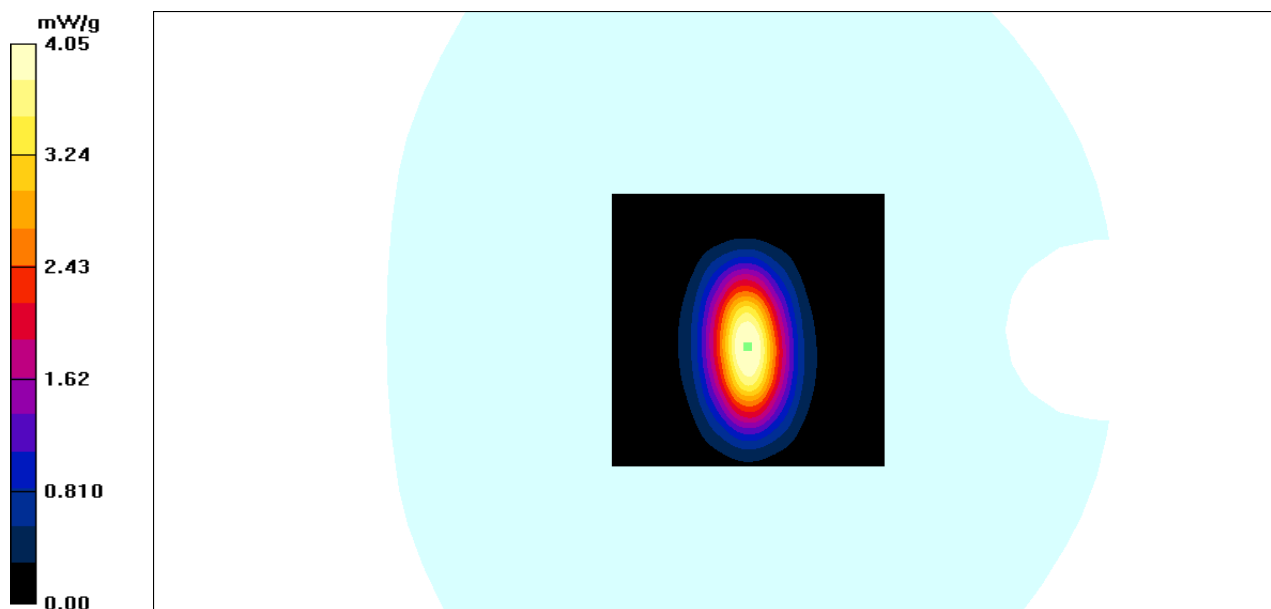

DUT: Dipole 1750 MHz; Type: D1750V2; S/N: 1140

Communication System: CW; Frequency: 1750 MHz; Duty Cycle: 1:1

Medium parameters used: $f = 1750$ MHz; $\sigma = 1.40$ S/m; $\epsilon_r = 39.93$; $\rho = 1000$ kg/m³

Phantom section: Flat Section

DASY4 Configuration:

- Probe: EX3DV4 - SN7382; ConvF(9.06, 9.06, 9.06); Calibrated: 26/10/2016
- Sensor-Surface: 4mm (Mechanical Surface Detection)
- Electronics: DAE – SN772; Calibrated: 25/10/2016
- Phantom: TWIN SAM; Type: Twin SAM V5.0; Serial: 1909
- Measurement SW: DASY4, V4.5 Build 19; Postprocessing SW: SEMCAD, V1.8 Build 145

1750 head system check/Area Scan (91x101x1): Measurement grid: dx=10mm, dy=10mm
Maximum value of SAR (interpolated) = 42.1 mW/g

1750 head system check/Zoom Scan (7x7x7)/Cube 0: Measurement grid: dx=5mm, dy=5mm, dz=5mm
Reference Value = 149.0 V/m; Power Drift = 0.113 dB
Peak SAR (extrapolated) = 74.1 W/kg
SAR(1 g) = 37.1 mW/g; SAR(10 g) = 19.8 mW/g
Maximum value of SAR (measured) = 41.1 mW/g

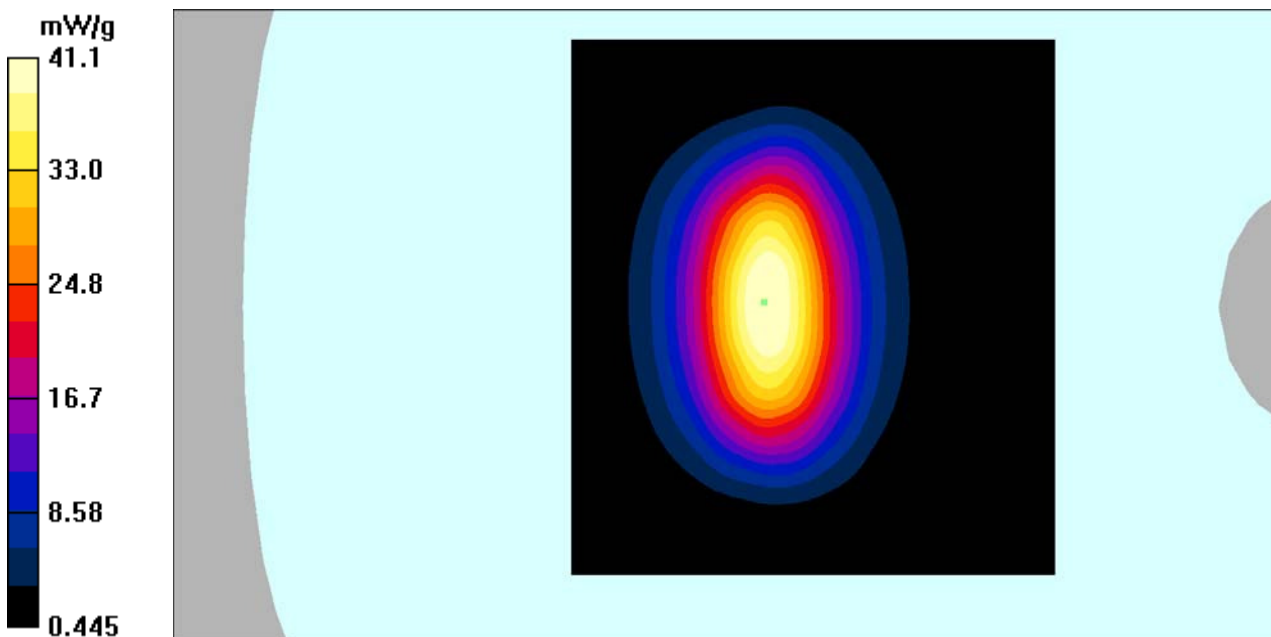

DUT: Dipole 1750 MHz; Type: D1750V2; S/N: 1140

Communication System: CW; Frequency: 1750 MHz; Duty Cycle: 1:1

Medium parameters used: $f = 1750$ MHz; $\sigma = 1.51$ S/m; $\epsilon_r = 53.22$; $\rho = 1000$ kg/m³

Phantom section: Flat Section

DASY4 Configuration:

- Probe: EX3DV4 - SN7382; ConvF(8.65, 8.65, 8.65); Calibrated: 26/10/2016
- Sensor-Surface: 4mm (Mechanical Surface Detection)
- Electronics: DAE – SN772; Calibrated: 25/10/2016
- Phantom: TWIN SAM; Type: Twin SAM V5.0; Serial: 1909
- Measurement SW: DASY4, V4.5 Build 19; Postprocessing SW: SEMCAD, V1.8 Build 145

1750 Body system check/Area Scan (91x101x1): Measurement grid: dx=10mm, dy=10mm
 Maximum value of SAR (interpolated) = 41.3 mW/g

1750 Body system check/Zoom Scan (7x7x7)/Cube 0: Measurement grid: dx=5mm, dy=5mm, dz=5mm
 Reference Value = 144.0 V/m; Power Drift = 0.016 dB
 Peak SAR (extrapolated) = 74.2 W/kg
SAR(1 g) = 36.8 mW/g; SAR(10 g) = 18.9 mW/g
 Maximum value of SAR (measured) = 38.7 mW/g

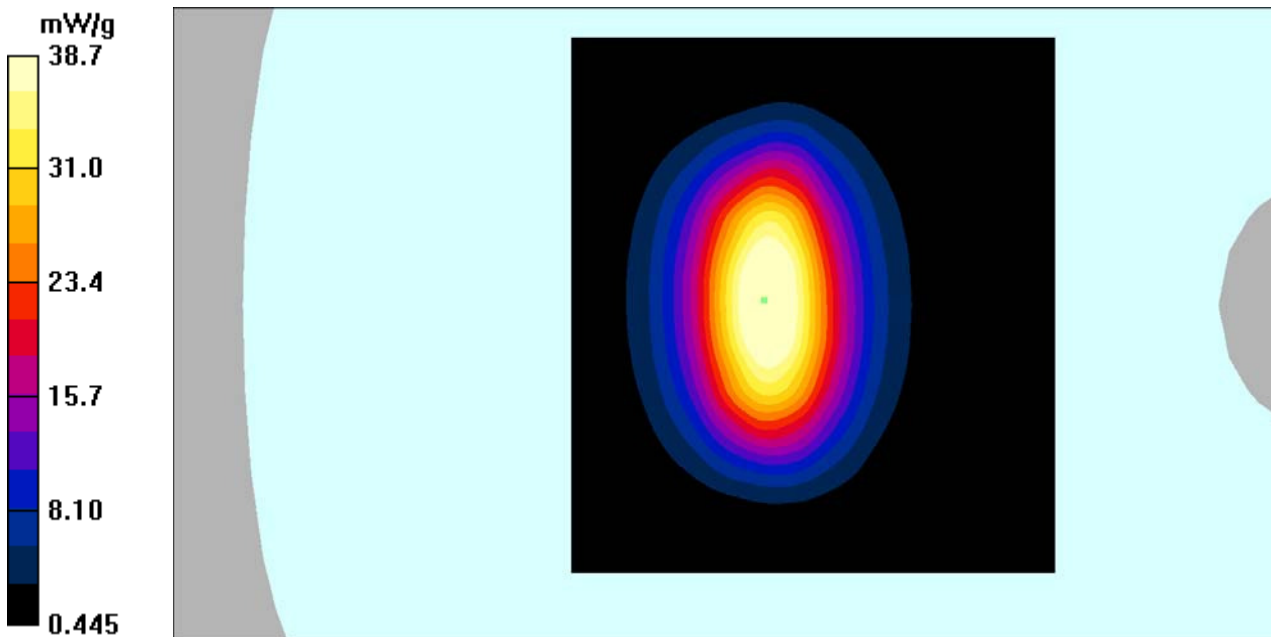

EUT TEST STRATEGY AND METHODOLOGY

Test Positions for Device Operating Next to a Person’s Ear

This category includes most wireless handsets with fixed, retractable or internal antennas located toward the top half of the device, with or without a foldout, sliding or similar keypad cover. The handset should have its earpiece located within the upper ¼ of the device, either along the centerline or off-centered, as perceived by its users. This type of handset should be positioned in a normal operating position with the “test device reference point” located along the “vertical centerline” on the front of the device aligned to the “ear reference point”. The “test device reference point” should be located at the same level as the center of the earpiece region. The “vertical centerline” should bisect the front surface of the handset at its top and bottom edges. A “ear reference point” is located on the outer surface of the head phantom on each ear spacer. It is located 1.5 cm above the center of the ear canal entrance in the “phantom reference plane” defined by the three lines joining the center of each “ear reference point” (left and right) and the tip of the mouth.

A handset should be initially positioned with the earpiece region pressed against the ear spacer of a head phantom. For the SCC-34/SC-2 head phantom, the device should be positioned parallel to the “N-F” line defined along the base of the ear spacer that contains the “ear reference point”. For interim head phantoms, the device should be positioned parallel to the cheek for maximum RF energy coupling. The “test device reference point” is aligned to the “ear reference point” on the head phantom and the “vertical centerline” is aligned to the “phantom reference plane”. This is called the “initial ear position”. While maintaining these three alignments, the body of the handset is gradually adjusted to each of the following positions for evaluating SAR:

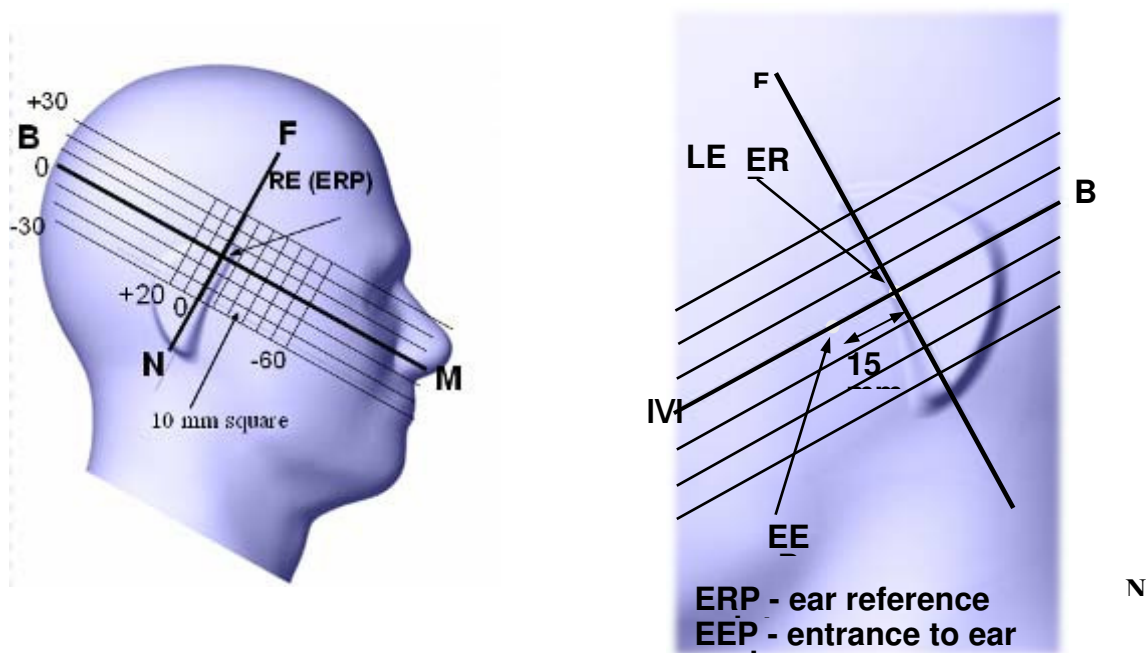

Cheek/Touch Position

The device is brought toward the mouth of the head phantom by pivoting against the “ear reference point” or along the “N-F” line for the SCC-34/SC-2 head phantom.

This test position is established:

- When any point on the display, keypad or mouthpiece portions of the handset is in contact with the phantom.
- (or) When any portion of a foldout, sliding or similar keypad cover opened to its intended self-adjusting normal use position is in contact with the cheek or mouth of the phantom.

For existing head phantoms – when the handset loses contact with the phantom at the pivoting point, rotation should continue until the device touches the cheek of the phantom or breaks its last contact from the ear spacer.

Cheek /Touch Position

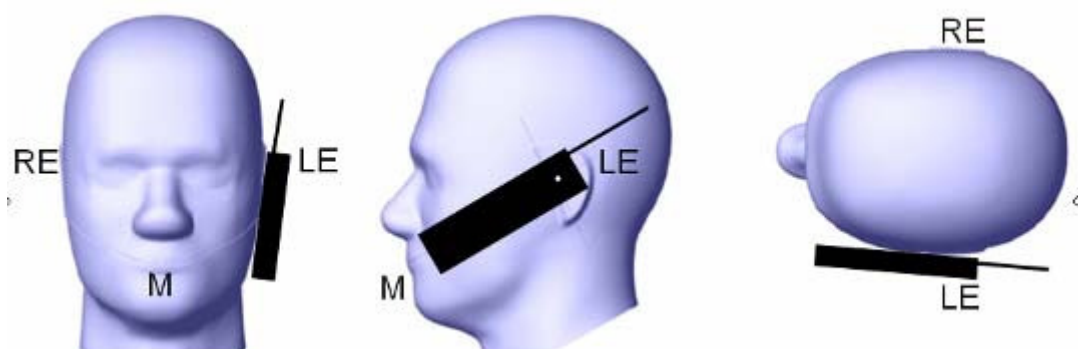

Ear/Tilt Position

With the handset aligned in the “Cheek/Touch Position”:

1) If the earpiece of the handset is not in full contact with the phantom’s ear spacer (in the “Cheek/Touch position”) and the peak SAR location for the “Cheek/Touch” position is located at the ear spacer region or corresponds to the earpiece region of the handset, the device should be returned to the “initial ear position” by rotating it away from the mouth until the earpiece is in full contact with the ear spacer.

2) (otherwise) The handset should be moved (translated) away from the cheek perpendicular to the line passes through both “ear reference points” (note: one of these ear reference points may not physically exist on a split head model) for approximate 2-3 cm. While it is in this position, the device handset is tilted away from the mouth with respect to the “test device reference point” until the inside angle between the vertical centerline on the front surface of the phone and the horizontal line passing through the ear reference point is by 15°. After the tilt, it is then moved (translated) back toward the head perpendicular to the line passes through both “ear reference points” until the device touches the phantom or the ear spacer. If the antenna touches the head first, the positioning process should be repeated with a tilt angle less than 15° so that the device and its antenna would touch the phantom simultaneously. This test position may require a device holder or positioner to achieve the translation and tilting with acceptable positioning repeatability.

If a device is also designed to transmit with its keypad cover closed for operating in the head position, such positions should also be considered in the SAR evaluation. The device should be tested on the left and right side of the head phantom in the “Cheek/Touch” and “Ear/Tilt” positions. When applicable, each configuration should be tested with the antenna in its fully extended and fully retracted positions. These test configurations should be tested at the high, middle and low frequency channels of each operating mode; for example, AMPS, CDMA, and TDMA. If the SAR measured at the middle channel for each test configuration (left, right, Cheek/Touch, Tile/Ear, extended and retracted) is at least 2.0 dB lower than the SAR limit, testing at the high and low channels is optional for such test configuration(s). If the transmission band of the test device is less than 10 MHz, testing at the high and low frequency channels is optional.

Ear /Tilt 15° Position

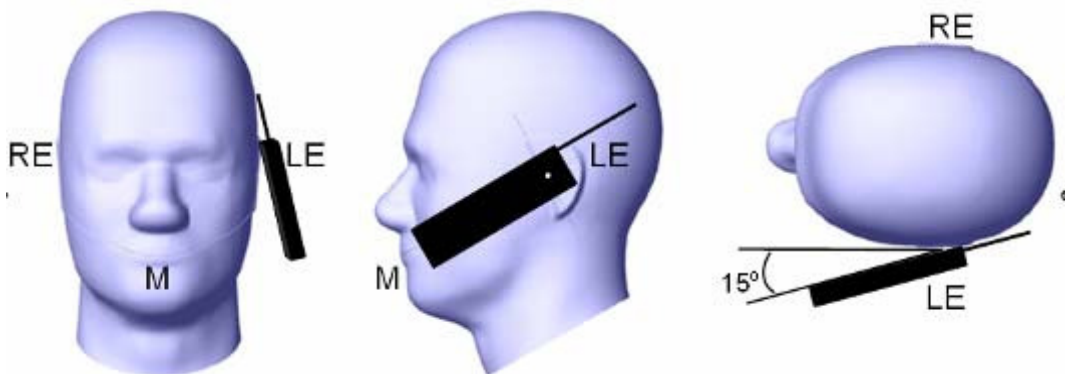

Test positions for body-worn and other configurations

Body-worn operating configurations should be tested with the belt-clips and holsters attached to the device and positioned against a flat phantom in normal use configurations. Devices with a headset output should be tested with a headset connected to the device. When multiple accessories that do not contain metallic components are supplied with the device, the device may be tested with only the accessory that dictates the closest spacing to the body. When multiple accessories that contain metallic components are supplied with the device, the device must be tested with each accessory that contains a unique metallic component. If multiple accessories share an identical metallic component (e.g., the same metallic belt-clip used with different holsters with no other metallic components), only the accessory that dictates the closest spacing to the body must be tested.

Body-worn accessories may not always be supplied or available as options for some devices that are intended to be authorized for body-worn use. A separation distance of 1.5 cm between the back of the device and a flat phantom is recommended for testing body-worn SAR compliance under such circumstances. Other separation distances may be used, but they should not exceed 2.5 cm. In these cases, the device may use body-worn accessories that provide a separation distance greater than that tested for the device provided however that the accessory contains no metallic components.

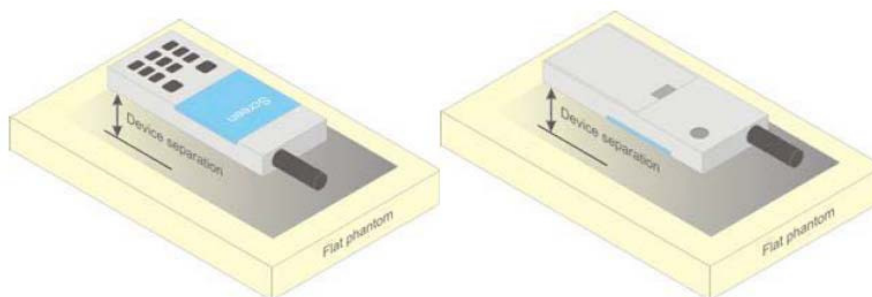

Figure 5 – Test positions for body-worn devices

SAR Evaluation Procedure

The evaluation was performed with the following procedure:

Step 1: Measurement of the SAR value at a fixed location above the ear point or central position was used as a reference value for assessing the power drop. The SAR at this point is measured at the start of the test and then again at the end of the testing.

Step 2: The SAR distribution at the exposed side of the head was measured at a distance of 4 mm from the inner surface of the shell. The area covered the entire dimension of the head or EUT and the horizontal grid spacing was 10 mm x 10 mm. Based on these data, the area of the maximum absorption was determined by spline interpolation. The first Area Scan covers the entire dimension of the EUT to ensure that the Body was correctly identified.

Step 3: Around this point, a volume of 35 mm x 35 mm x 35 mm was assessed by measuring 7x 7 x 7 points. On the basis of this data set, the spatial peak SAR value was evaluated under the following procedure:

- 1) The data at the surface were extrapolated, since the center of the dipoles is 1.2 mm away from the tip of the probe and the distance between the surface and the lowest measuring point is 1.3 mm. The extrapolation was based on a least square algorithm. A polynomial of the fourth order was calculated through the points in z-axes. This polynomial was then used to evaluate the points between the surface and the probe tip.
- 2) The maximum interpolated value was searched with a straightforward algorithm. Around this maximum the SAR values averaged over the spatial volumes (1 g or 10 g) were computed by the 3D-Spline interpolation algorithm. The 3D-Spline is composed of three one dimensional splines with the "Not a knot"-condition (in x, y and z-directions). The volume was integrated with the trapezoidal-algorithm. One thousand points (10 x 10 x 10) were interpolated to calculate the averages.

All neighboring volumes were evaluated until no neighboring volume with a higher average value was found.

Step 4: Re-measurement of the SAR value at the same location as in Step 1. If the value changed by more than 5%, the evaluation was repeated.

CONDUCTED OUTPUT POWER MEASUREMENT

Provision Applicable

The measured peak output power should be greater and within 5% than EMI measurement.

Test Procedure

The RF output of the transmitter was connected to the input of the EMI Test Receiver through sufficient attenuation.

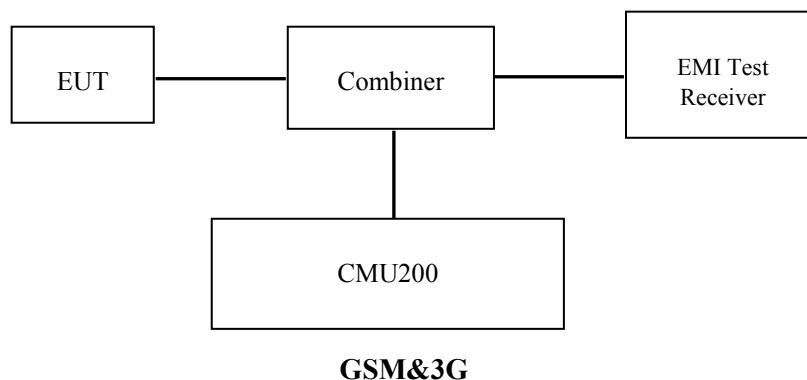

Radio Configuration

The power measurement was configured by the Wireless Communication Test Set.

GSM/GPRS/EGPRS

Function: Menu select > GSM Mobile Station > GSM 850/1900

Press Connection control to choose the different menus

Press RESET > choose all the reset all settings

Connection Press Signal Off to turn off the signal and change settings

Network Support > GSM + GPRS or GSM + EGSM

Main Service > Packet Data

Service selection > Test Mode A – Auto Slot Config. off

MS Signal Press Slot Config Bottom on the right twice to select and change the number of time slots and power setting

- > Slot configuration > Uplink/Gamma

- > 33 dBm for GPRS 850

- > 30 dBm for GPRS 1900

- > 27 dBm for EGPRS 850

- > 26 dBm for EGPRS 1900

BS Signal Enter the same channel number for TCH channel (test channel) and BCCH channel

Frequency Offset > + 0 Hz

Mode > BCCH and TCH

BCCH Level > -85 dBm (May need to adjust if link is not stable)

BCCH Channel > choose desired test channel [Enter the same channel number for TCH channel (test channel) and BCCH channel]

Channel Type > Off

P0 > 4 dB

Slot Config > Unchanged (if already set under MS signal)

TCH > choose desired test channel

Hopping > Off

Main Timeslot > 3

Network Coding Scheme > CS4 (GPRS) and MCS5 (EGPRS)

Bit Stream > 2E9-1 PSR Bit Stream

AF/RF Enter appropriate offsets for Ext. Att. Output and Ext. Att. Input

Connection Press Signal on to turn on the signal and change settings

WCDMA Release 99

The following tests were conducted according to the test requirements outlines in section 5.2 of the 3GPP TS34.121-1 specification. The EUT has a nominal maximum output power of 24dBm (+1.7/-3.7).

WCDMA General Settings	Loopback Mode	Test Mode 1
	Rel99 RMC	12.2kbps RMC
	Power Control Algorithm	Algorithm2
	β_c / β_d	8/15

HSDPA

The following tests were conducted according to the test requirements outlines in section 5.2 of the 3GPP TS34.121-1 specification.

	Mode	HSDPA	HSDPA	HSDPA	HSDPA
	Subset	1	2	3	4
WCDMA General Settings	Loopback Mode	Test Mode 1			
	Rel99 RMC	12.2kbps RMC			
	HSDPA FRC	H-Set1			
	Power Control Algorithm	Algorithm2			
	β_c	2/15	12/15	15/15	15/15
	β_d	15/15	15/15	8/15	4/15
	β_d (SF)	64			
	β_c / β_d	2/15	12/15	15/8	15/4
	β_{hs}	4/15	24/15	30/15	30/15
	MPR(dB)	0	0	0.5	0.5
HSDPA Specific Settings	DACK	8			
	DNAK	8			
	DCQI	8			
	Ack-Nack repetition factor	3			
	CQI Feedback	4ms			
	CQI Repetition Factor	2			
	A _{hs} = β_{hs} / β_c	30/15			

HSPA+

The following tests were conducted according to the test requirements in Table C.11.1.4 of 3GPP TS 34.121-1

Sub-test	β_c (Note3)	β_d	β_{hs} (Note1)	β_{ec}	β_{ed} (2xSF2) (Note 4)	β_{ed} (2xSF4) (Note 4)	CM (dB) (Note 2)	MPR (dB) (Note 2)	AG Index (Note 4)	E-TFCI (Note 5)	E-TFCI (boost)
1	1	0	30/15	30/15	β_{ed1} : 30/15 β_{ed2} : 30/15	β_{ed3} : 24/15 β_{ed4} : 24/15	3.5	2.5	14	105	105

- Note 1: $\Delta_{ACK}, \Delta_{NACK}$ and $\Delta_{CQI} = 30/15$ with $\beta_{hs} = 30/15 * \beta_c$.
- Note 2: CM = 3.5 and the MPR is based on the relative CM difference, MPR = MAX(CM-1,0).
- Note 3: DPDCH is not configured, therefore the β_c is set to 1 and $\beta_d = 0$ by default.
- Note 4: β_{ed} can not be set directly; it is set by Absolute Grant Value.
- Note 5: All the sub-tests require the UE to transmit 2SF2+2SF4 16QAM EDCH and they apply for UE using E-DPDCH category 7. E-DCH TTI is set to 2ms TTI and E-DCH table index = 2. To support these E-DCH configurations DPDCH is not allocated. The UE is signalled to use the extrapolation algorithm.

HSUPA

The following tests were conducted according to the test requirements outlines in section 5.2 of the 3GPP TS34.121-1 specification.

	Mode	HSUPA	HSUPA	HSUPA	HSUPA	HSUPA
	Subset	1	2	3	4	5
WCDMA General Settings	Loopback Mode	Test Mode 1				
	Rel99 RMC	12.2kbps RMC				
	HSDPA FRC	H-Set1				
	HSUPA Test	HSUPA Loopback				
	Power Control Algorithm	Algorithm2				
	β_c	11/15	6/15	15/15	2/15	15/15
	β_d	15/15	15/15	9/15	15/15	0
	β_{ec}	209/225	12/15	30/15	2/15	5/15
	β_c/β_d	11/15	6/15	15/9	2/15	-
	β_{hs}	22/15	12/15	30/15	4/15	5/15
	CM(dB)	1.0	3.0	2.0	3.0	1.0
MPR(dB)	0	2	1	2	0	
HSDPA Specific Settings	DACK	8				
	DNAK	8				
	DCQI	8				
	Ack-Nack repetition factor	3				
	CQI Feedback	4ms				
	CQI Repetition Factor	2				
	$A_{hs}=\beta_{hs}/\beta_c$	30/15				
HSUPA Specific Settings	DE-DPCCH	6	8	8	5	7
	DHARQ	0	0	0	0	0
	AG Index	20	12	15	17	21
	ETFCI	75	67	92	71	81
	Associated Max UL Data Rate kbps	242.1	174.9	482.8	205.8	308.9
	Reference E_FCIs	E-TFCI 11 E E-TFCI PO 4 E-TFCI 67 E-TFCI PO 18 E-TFCI 71 E-TFCI PO23 E-TFCI 75 E-TFCI PO26 E-TFCI 81 E-TFCI PO 27	E-TFCI 11 E-TFCI PO4 E-TFCI 92 E-TFCI PO 18	E-TFCI 11 E-TFCI PO 18 E-TFCI 71 E-TFCI PO23 E-TFCI 75 E-TFCI PO26 E-TFCI 81 E-TFCI PO 27	E-TFCI 11 E E-TFCI PO 4 E-TFCI 67 E-TFCI PO 18 E-TFCI 71 E-TFCI PO23 E-TFCI 75 E-TFCI PO26 E-TFCI 81 E-TFCI PO 27	

Wi-Fi

For 802.11b, 802.11g and 802.11n-HT20 mode, 13 channels are provided to testing:

Channel	Frequency (MHz)	Channel	Frequency (MHz)
1	2412	8	2447
2	2417	9	2452
3	2422	10	2457
4	2427	11	2462
5	2432	12	2467
6	2437	13	2472
7	2442	/	/

For 802.11b, 802.11g, 802.11n-HT20 mode, EUT was tested with Channel 1, 7 and 13

For 802.11n-HT40 mode, 9 channels are provided to testing:

Channel	Frequency (MHz)	Channel	Frequency (MHz)
1	2422	6	2447
2	2427	7	2452
3	2432	8	2457
4	2437	9	2462
5	2442	/	/

EUT was tested with Channel 1, 5 and 9.

Maximum Output Power among production units

Max Target Power for Production Unit (dBm)			
Mode/Band	Channel		
	Low	Middle	High
GSM 850	31.70	31.70	31.70
GPRS 1 TX Slot	31.70	31.70	31.70
GPRS 2 TX Slot	30.60	30.60	30.60
GPRS 3 TX Slot	28.60	28.60	28.60
GPRS 4 TX Slot	27.60	27.60	27.60
PCS 1900	28.20	28.20	28.20
GPRS 1 TX Slot	28.20	28.20	28.20
GPRS 2 TX Slot	27.50	27.50	27.50
GPRS 3 TX Slot	26.00	26.00	26.00
GPRS 4 TX Slot	25.20	25.20	25.20
WCDMA Band 5	Rel 99	22.60	22.60
	HSDPA	21.70	21.70
	HSUPA	21.70	21.70
	HSPA+	21.70	21.70
WCDMA Band 4	Rel 99	22.90	22.60
	HSDPA	22.00	22.00
	HSUPA	22.00	22.00
	HSPA+	21.90	21.90
WCDMA Band 2	Rel 99	22.10	22.10
	HSDPA	21.20	21.20
	HSUPA	21.10	21.10
	HSPA+	21.10	21.10
Wi-Fi(802.11b/g/n20/n40)	8.20	8.20	8.20
Bluetooth3.0	4.50	4.50	4.50
BLE	-4.00	-4.00	-4.00

Test Results:

GSM:

Band	Frequency (MHz)	Conducted Output Power (dBm)
GSM 850	824.2	31.63
	836.6	31.69
	848.8	31.68
PCS 1900	1850.2	28.10
	1880.0	28.17
	1909.8	28.15

GPRS:

Band	Channel No.	Frequency (MHz)	RF Output Power (dBm)			
			1 slot	2 slots	3 slots	4 slots
GSM 850	128	824.2	31.64	30.45	28.44	27.46
	190	836.6	31.67	30.53	28.50	27.52
	251	848.8	31.68	30.55	28.54	27.55
PCS 1900	512	1850.2	28.14	27.43	25.89	25.01
	661	1880	28.19	27.49	25.94	25.12
	810	1909.8	28.18	27.48	25.97	25.11

For SAR, the time based average power is relevant, the difference in between depends on the duty cycle of the TDMA signal.

Number of Time slot	1	2	3	4
Duty Cycle	1:8	1:4	1:2.66	1:2
Time based Ave. power compared to slotted Ave. power	-9 dB	-6 dB	-4.25 dB	-3 dB
Crest Factor	8	4	2.66	2

The time based average power for GPRS

Band	Channel No.	Frequency (MHz)	Time based average Power (dBm)			
			1 slot	2 slot	3 slots	4 slots
GSM 850	128	824.2	22.64	24.45	24.19	24.46
	190	836.6	22.67	24.53	24.25	24.52
	251	848.8	22.68	24.55	24.29	24.55
PCS 1900	512	1850.2	19.14	21.43	21.64	22.01
	661	1880	19.19	21.49	21.69	22.12
	810	1909.8	19.18	21.48	21.72	22.11

Note:

1. Rohde & Schwarz Radio Communication Tester (CMU200) was used for the measurement of GSM peak and average output power for active timeslots.
2. For GSM voice, 1 timeslot has been activated with power level 5 (850 MHz band) and 0 (1900 MHz band).
3. For GPRS, 1, 2, 3 and 4 timeslots has been activated separately with power level 3(850 MHz band) and 3(1900 MHz band).

Results (12.2kbps RMC)

WCDMA Band 5:

Test Condition	Test Mode	3GPP Sub Test	Averaged Mean Power (dBm)		
			Low Frequency	Mid Frequency	High Frequency
Normal	RMC12.2k		22.58	22.57	22.49
	HSDPA	1	21.48	21.55	21.31
		2	21.39	21.44	21.19
		3	21.61	21.67	21.40
		4	21.45	21.42	21.27
	HSUPA	1	21.49	21.58	21.39
		2	21.43	21.47	21.32
		3	21.55	21.65	21.50
		4	21.36	21.47	21.35
		5	21.54	21.63	21.49
	HSPA+	1	21.56	21.60	21.36

WCDMA Band 4:

Test Condition	Test Mode	3GPP Sub Test	Averaged Mean Power (dBm)		
			Low Frequency	Mid Frequency	High Frequency
Normal	RMC12.2k		22.80	22.51	22.05
	HSDPA	1	21.90	21.35	21.24
		2	21.81	21.28	21.16
		3	21.95	21.45	21.32
		4	21.77	21.25	21.18
	HSUPA	1	21.84	21.35	21.26
		2	21.78	21.22	21.14
		3	21.95	21.41	21.39
		4	21.75	21.26	21.17
		5	21.97	21.47	21.35
	HSPA+	1	21.81	21.27	21.26

WCDMA Band 2:

Test Condition	Test Mode	3GPP Sub Test	Averaged Mean Power (dBm)		
			Low Frequency	Mid Frequency	High Frequency
Normal	RMC12.2k		21.95	22.08	21.92
	HSDPA	1	20.93	20.98	20.92
		2	20.85	20.89	20.82
		3	20.98	21.11	21.04
		4	20.85	20.88	20.88
	HSUPA	1	20.86	20.99	20.94
		2	20.81	20.96	20.83
		3	20.95	21.08	21.06
		4	20.80	20.89	20.83
		5	20.96	21.05	21.03
	HSPA+	1	20.86	21.07	20.91

Note:

1. The default test configuration is to measure SAR with an established radio link between the EUT and a communication test set using a 12.2 kbps RMC (reference measurement Channel) Configured in Test Loop Model 1.
2. KDB 941225 D01-Body SAR is not required for HSDPA/HSUPA/ HSPA+ when the maximum average output of each RF channel is less than ¼ dB higher than measured 12.2kbps RMC or the maximum SAR for 12.2kbps RMC is < 75% of SAR limit.

Bluetooth

Mode	Channel No.	Channel frequency (MHz)	Conducted Output Power (dBm)
BDR(GFSK)	0	2402	3.41
	39	2441	4.08
	78	2480	3.96
EDR(4-DQPSK)	0	2402	3.25
	39	2441	3.93
	78	2480	3.81
EDR-8DPSK	0	2402	3.17
	39	2441	3.89
	78	2480	3.76
BLE	0	2402	-4.44
	19	2440	-5.10
	39	2480	-5.23

Wi-Fi

Mode	Channel No.	Channel frequency (MHz)	Conducted Output Power (dBm)
802.11b	1	2412	7.98
	7	2442	8.10
	13	2472	8.15
802.11g	1	2412	7.53
	7	2442	7.77
	13	2472	8.03
802.11n HT20	1	2412	7.49
	7	2442	8.05
	13	2472	8.01
802.11n HT40	1	2422	7.49
	5	2442	8.05
	9	2462	8.01

SAR MEASUREMENT RESULTS

This page summarizes the results of the performed dosimetric evaluation.

SAR Test Data

Environmental Conditions

Temperature:	21.8-22.5 °C	22.7-23.4 °C	22.6-23.5 °C
Relative Humidity:	51 %	46 %	47 %
ATM Pressure:	1015 mbar	1011 mbar	1013 mbar
Test Date:	2016-12-19	2016-12-22	2017-03-13

Testing was performed by Jack Xu, Apple Wu, Judy Huang.

Mobile Hot-Spot Test Result

The DUT is capable of functioning as a Wi-Fi to Cellular Mobile hotspot. Additional SAR testing was performed according to KDB 941225 D06. Testing was performed with a separation of 1cm between the DUT and the flat phantom. The DUT was positioned for SAR tests with the front and back surfaces facing the phantom, and also with the edges facing the phantom in which the transmitting antenna is <2.5 cm from the edge. Each transmit band was utilized for SAR testing. The tested mode has been selected within each band that exhibits the highest time average output power.

KDB 678474: DUT to the limitation of the SAM phantom, the flat phantom was used to stimulate Head SAR test, under section 10.

GSM 850:

EUT Position	Frequency (MHz)	Test Mode	Max. Meas. Power (dBm)	Max. Rated Power (dBm)	1g SAR (W/Kg)			
					Scaled Factor	Meas. SAR	Scaled SAR	Plot
Head Cheek	836.6	GSM	31.69	31.70	1.002	0.126	0.126	1#
Body Worn (10 mm)	836.6	GSM	31.69	31.70	1.002	0.241	0.242	2#
Hotspot Back (10 mm)	836.6	GPRS	27.52	27.60	1.019	0.419	0.427	3#
Hotspot Left (10 mm)	836.6	GPRS	27.52	27.60	1.019	0.248	0.253	4#
Hotspot Right (10 mm)	836.6	GPRS	27.52	27.60	1.019	0.084	0.086	5#
Hotspot Bottom (10 mm)	836.6	GPRS	27.52	27.60	1.019	0.178	0.181	6#

PCS 1900:

EUT Position	Frequency (MHz)	Test Mode	Max. Meas. Power (dBm)	Max. Rated Power (dBm)	1g SAR (W/Kg)			
					Scaled Factor	Meas. SAR	Scaled SAR	Plot
Head Cheek	1880.0	GSM	28.17	28.20	1.007	0.321	0.323	7#
Body Worn (10 mm)	1880.0	GSM	28.17	28.20	1.007	0.176	0.177	8#
Hotspot Back (10 mm)	1880.0	GPRS	25.12	25.20	1.019	0.192	0.196	9#
Hotspot Left (10 mm)	1880.0	GPRS	25.12	25.20	1.019	0.061	0.062	10#
Hotspot Right (10 mm)	1880.0	GPRS	25.12	25.20	1.019	0.076	0.077	11#
Hotspot Bottom (10 mm)	1850.2	GPRS	25.01	25.20	1.045	0.738	0.771	12#
	1880.0	GPRS	25.12	25.20	1.019	0.967	0.985	13#
	1909.8	GPRS	25.11	25.20	1.021	1.19	1.215	14#

Note:

1. When the 1-g SAR is ≤ 0.8 W/Kg, testing for other channels are optional.
2. The EUT transmit and receive through the same GSM antenna while testing SAR.
3. When SAR or MPE is not measured at the maximum power level allowed for production units, the results must be scaled to the maximum tune-up tolerance limit according to the power applied to the individual channels tested to determine compliance.
4. When the maximum output power variation across the required test channels is $> \frac{1}{2}$ dB, instead of the middle channel, the highest output power channel must be used.
5. The Multi-slot Classes of EUT is Class 12 which has maximum 4 Downlink slots and 4 Uplink slots, the maximum active slots is 5, when perform the multiple slots scan, 1DL+4UL is the worst case.

WCDMA Band 5

EUT Position	Frequency (MHz)	Test Mode	Max. Meas. Power (dBm)	Max. Rated Power (dBm)	1g SAR (W/Kg)			
					Scaled Factor	Meas. SAR	Scaled SAR	Plot
Head Cheek	836.6	RMC	22.57	22.60	1.007	0.181	0.182	15#
Hotspot Back (10 mm)	836.6	RMC	22.57	22.60	1.007	0.322	0.324	16#
Hotspot Left (10 mm)	836.6	RMC	22.57	22.60	1.007	0.194	0.195	17#
Hotspot Right (10 mm)	836.6	RMC	22.57	22.60	1.007	0.068	0.068	18#
Hotspot Bottom (10 mm)	836.6	RMC	22.57	22.60	1.007	0.138	0.139	19#

WCDMA Band 4

EUT Position	Frequency (MHz)	Test Mode	Max. Meas. Power (dBm)	Max. Rated Power (dBm)	1g SAR (W/Kg)			
					Scaled Factor	Meas. SAR	Scaled SAR	Plot
Head Cheek	1712.4	RMC	22.80	22.90	1.023	0.378	0.387	20#
Hotspot Back (10 mm)	1712.4	RMC	22.80	22.90	1.023	0.538	0.551	21#
Hotspot Left (10 mm)	1712.4	RMC	22.80	22.90	1.023	0.084	0.086	22#
Hotspot Right (10 mm)	1712.4	RMC	22.80	22.90	1.023	0.193	0.197	23#
Hotspot Bottom (10 mm)	1712.4	RMC	22.80	22.90	1.023	0.728	0.745	24#

WCDMA Band 2

EUT Position	Frequency (MHz)	Test Mode	Max. Meas. Power (dBm)	Max. Rated Power (dBm)	1g SAR (W/Kg)			
					Scaled Factor	Meas. SAR	Scaled SAR	Plot
Head Cheek	1880.0	RMC	22.08	22.10	1.005	0.317	0.318	25#
Hotspot Back (10 mm)	1880.0	RMC	22.08	22.10	1.005	0.266	0.267	26#
Hotspot Left (10 mm)	1880.0	RMC	22.08	22.10	1.005	0.078	0.078	27#
Hotspot Right (10 mm)	1880.0	RMC	22.08	22.10	1.005	0.118	0.119	28#
Hotspot Bottom (10 mm)	1852.4	RMC	21.95	22.10	1.035	1.01	1.045	29#
	1880.0	RMC	22.08	22.10	1.005	1.11	1.115	30#
	1907.6	RMC	21.92	22.10	1.042	1.08	1.126	31#

Note:

1. When the 1-g SAR is $\leq 0.8W/Kg$, testing for other channels are optional.
2. The EUT transmit and receive through the same antenna while testing SAR.
3. The default test configuration is to measure SAR with an established radio link between the EUT and a communication test set using a 12.2 kbps RMC (reference measurement Channel) Configured in Test Loop Model.
4. KDB 941225 D01-Body SAR is not required for HSDPA/HSUPA/HSPA+ when the maximum average output of each RF channel is less than 1/4 dB higher than measured 12.2kbps RMC or the maximum SAR for 12.2kbps RMC is < 75% of SAR limit.
5. When SAR or MPE is not measured at the maximum power level allowed for production units, the results must be scaled to the maximum tune-up tolerance limit according to the power applied to the individual channels tested to determine compliance.

SAR Measurement Variability

In accordance with published RF Exposure KDB procedure 865664 D01 SAR measurement 100 MHz to 6 GHz v01. These additional measurements are repeated after the completion of all measurements requiring the same head or body tissue-equivalent medium in a frequency band. The test device should be returned to ambient conditions (normal room temperature) with the battery fully charged before it is re-mounted on the device holder for the repeated measurement(s) to minimize any unexpected variations in the repeated results

- 1) Repeated measurement is not required when the original highest measured SAR is < 0.80 W/kg.
- 2) When the original highest measured SAR is ≥ 0.80 W/kg, repeat that measurement once.
- 3) Perform a second repeated measurement only if the ratio of largest to smallest SAR for the original and first repeated measurements is > 1.20 or when the original or repeated measurement is ≥ 1.45 W/kg (~ 10% from the 1-g SAR limit).
- 4) Perform a third repeated measurement only if the original, first or second repeated measurement is ≥ 1.5 W/kg and the ratio of largest to smallest SAR for the original, first and second repeated measurements is > 1.20 .

The Highest Measured SAR Configuration in Each Frequency Band

Head

Frequency Band	Freq.(MHz)	EUT Position	Meas. SAR (W/kg)		Largest to Smallest SAR Ratio
			Original	Repeated	
/	/	/	/	/	/

Body

Frequency Band	Freq.(MHz)	EUT Position	Meas. SAR (W/kg)		Largest to Smallest SAR Ratio
			Original	Repeated	
PCS 1900	1909.8	Hotspot Bottom (10 mm)	1.19	1.15	1.035
WCDMA Band 2	1880	Hotspot Bottom (10 mm)	1.11	1.02	1.088

Note:

Second Repeated Measurement is not required since the ratio of the largest to smallest SAR for the original and first repeated measurement is not > 1.20 .

SAR SIMULTANEOUS TRANSMISSION DESCRIPTION

Bluetooth & Wi-Fi and GSM&3G Antennas Location:



Simultaneous Transmission:

Description of Simultaneous Transmit Capabilities			Antennas Distance (mm)
Transmitter Combination	Simultaneous?	Body?	
GSM + WCDMA	×	×	0
GSM + Bluetooth	√	×	142
GSM + WLAN	√	√	142
WCDMA + Bluetooth	√	×	142
WCDMA + WLAN	√	√	142

Standalone SAR test exclusion considerations

Mode	Position	Max tune-up power		Distance (mm)	Calculated value	Threshold (1-g)	SAR Test Exclusion
		(dBm)	(mW)				
Bluetooth	Head	4.50	2.82	0	0.9	3.0	Yes
Bluetooth	Body	4.50	2.82	10	0.5	3.0	Yes
Wi-Fi	Head	8.20	6.61	0	2.1	3.0	Yes
Wi-Fi	Body	8.20	6.61	10	1.0	3.0	Yes

The 1-g and 10-g SAR test exclusion thresholds for 100 MHz to 6 GHz at *test separation distances* ≤ 50 mm are determined by:

$$[(\text{max. power of channel, including tune-up tolerance, mW}) / (\text{min. test separation distance, mm})] \cdot [\sqrt{f(\text{GHz})}] \leq 3.0 \text{ for 1-g SAR and } \leq 7.5 \text{ for 10-g extremity SAR, where}$$

1. f(GHz) is the RF channel transmit frequency in GHz.
2. Power and distance are rounded to the nearest mW and mm before calculation.
3. The result is rounded to one decimal place for comparison.
4. When the minimum test separation distance is < 5 mm, a distance of 5 mm is applied to determine SAR test Exclusion.

Standalone SAR estimation:

Mode	Position	Max tune-up power		Distance (mm)	Estimated ^{1-g} (W/kg)
		(dBm)	(mW)		
Bluetooth	Head	4.50	2.82	0	0.118
Bluetooth	Body	4.50	2.82	10	0.059
Wi-Fi	Head	8.20	6.61	0	0.277
Wi-Fi	Body	8.20	6.61	10	0.139

When standalone SAR test exclusion applies to an antenna that transmits simultaneously with other antennas, the standalone SAR must be estimated according to following to determine simultaneous transmission SAR test exclusion:

$$[(\text{max. power of channel, including tune-up tolerance, mW}) / (\text{min. test separation distance, mm})] \cdot [\sqrt{f(\text{GHz})} / x] \text{ W/kg for test separation distances } \leq 50 \text{ mm};$$

where $x = 7.5$ for 1-g SAR.

When the minimum test separation distance is < 5 mm, a distance of 5 mm is applied to determine SAR test Exclusion

Simultaneous SAR test exclusion considerations:

Mode(SAR1+SAR2)	Position	Reported SAR(W/kg)		ΣSAR < 1.6W/kg
		SAR1	SAR2	
GSM 850 + Bluetooth	Head Cheek	0.126	0.118	0.244
	Body Back	0.242	0.059	0.301
PCS1900 + Bluetooth	Head Cheek	0.323	0.118	0.441
	Body Back	0.177	0.059	0.236
WCDMA Band 5 + Bluetooth	Head Cheek	0.182	0.118	0.300
	Body Back	0.324	0.059	0.383
WCDMA Band 4 + Bluetooth	Head Cheek	0.387	0.118	0.505
	Body Back	0.551	0.059	0.610
WCDMA Band 2 + Bluetooth	Head Cheek	0.318	0.118	0.436
	Body Back	0.267	0.059	0.326

Mode(SAR1+SAR2)	Position	Reported SAR(W/kg)		ΣSAR < 1.6W/kg
		SAR1	SAR2	
GSM 850+ WLAN	Head Cheek	0.126	0.277	0.403
	Body Worn	0.242	0.139	0.381
GPRS 850 + WLAN	Hotspot Back	0.427	0.139	0.566
	Hotspot Left	0.253	0.139	0.392
	Hotspot Right	0.086	0.139	0.225
	Hotspot Bottom	0.181	0.139	0.32
PCS1900 + WLAN	Head Cheek	0.323	0.277	0.600
	Body Worn	0.177	0.139	0.316
GPRS 1900 + WLAN	Hotspot Back	0.196	0.139	0.335
	Hotspot Left	0.062	0.139	0.201
	Hotspot Right	0.077	0.139	0.216
	Hotspot Bottom	1.215	0.139	1.354
WCDMA Band 5+ WLAN	Head Cheek	0.182	0.277	0.459
WCDMA Band 5+ WLAN (Body)	Hotspot Back	0.324	0.139	0.463
	Hotspot Left	0.195	0.139	0.334
	Hotspot Right	0.068	0.139	0.207
	Hotspot Bottom	0.139	0.139	0.278
WCDMA Band 4+ WLAN	Head Cheek	0.387	0.277	0.664
WCDMA Band 4+ WLAN (Body)	Hotspot Back	0.551	0.139	0.690
	Hotspot Left	0.086	0.139	0.225
	Hotspot Right	0.197	0.139	0.336
	Hotspot Bottom	0.745	0.139	0.884
WCDMA Band 2+ WLAN	Head Cheek	0.318	0.277	0.595
WCDMA Band 2+ WLAN (Body)	Hotspot Back	0.267	0.139	0.406
	Hotspot Left	0.078	0.139	0.217
	Hotspot Right	0.119	0.139	0.258
	Hotspot Bottom	1.126	0.139	1.265

MEASUREMENT UNCERTAINTY

The uncertainty budget has been determined for the measurement system and is given in the following Table.

Measurement uncertainty evaluation for IEEE1528-2013 SAR test

Source of uncertainty	Tolerance/ uncertainty ± %	Probability distribution	Divisor	ci (1 g)	ci (10 g)	Standard uncertainty ± %, (1 g)	Standard uncertainty ± %, (10 g)
Measurement system							
Probe calibration	6.55	N	1	1	1	6.6	6.6
Axial Isotropy	4.7	R	$\sqrt{3}$	1	1	2.7	2.7
Hemispherical Isotropy	9.6	R	$\sqrt{3}$	0	0	0.0	0.0
Boundary effect	1.0	R	$\sqrt{3}$	1	1	0.6	0.6
Linearity	4.7	R	$\sqrt{3}$	1	1	2.7	2.7
Detection limits	1.0	R	$\sqrt{3}$	1	1	0.6	0.6
Readout electronics	0.3	N	1	1	1	0.3	0.3
Response time	0.0	R	$\sqrt{3}$	1	1	0.0	0.0
Integration time	0.0	R	$\sqrt{3}$	1	1	0.0	0.0
RF ambient conditions – noise	1.0	R	$\sqrt{3}$	1	1	0.6	0.6
RF ambient conditions–reflections	1.0	R	$\sqrt{3}$	1	1	0.6	0.6
Probe positioner mech. Restrictions	0.8	R	$\sqrt{3}$	1	1	0.5	0.5
Probe positioning with respect to phantom shell	6.7	R	$\sqrt{3}$	1	1	3.9	3.9
Post-processing	2.0	R	$\sqrt{3}$	1	1	1.2	1.2
Test sample related							
Test sample positioning	2.8	N	1	1	1	2.8	2.8
Device holder uncertainty	6.3	N	1	1	1	6.3	6.3
Drift of output power	5.0	R	$\sqrt{3}$	1	1	2.9	2.9
Phantom and set-up							
Phantom uncertainty (shape and thickness tolerances)	4.0	R	$\sqrt{3}$	1	1	2.3	2.3
Liquid conductivity target)	5.0	R	$\sqrt{3}$	0.64	0.43	1.8	1.2
Liquid conductivity meas.)	2.5	N	1	0.64	0.43	1.6	1.1
Liquid permittivity target)	5.0	R	$\sqrt{3}$	0.6	0.49	1.7	1.4
Liquid permittivity meas.)	2.5	N	1	0.6	0.49	1.5	1.2
Combined standard uncertainty		RSS				12.2	12.0
Expanded uncertainty 95 % confidence interval)						24.3	23.9

Measurement uncertainty evaluation for IEC62209-2 SAR test

Source of uncertainty	Tolerance/uncertainty ± %	Probability distribution	Divisor	ci (1 g)	ci (10 g)	Standard uncertainty ± %, (1 g)	Standard uncertainty ± %, (10 g)
Measurement system							
Probe calibration	6.55	N	1	1	1	6.6	6.6
Axial Isotropy	4.7	R	√3	1	1	2.7	2.7
Hemispherical Isotropy	9.6	R	√3	0	0	0.0	0.0
Linearity	4.7	R	√3	1	1	2.7	2.7
Modulation Response	0.0	R	√3	1	1	0.0	0.0
Detection limits	1.0	R	√3	1	1	0.6	0.6
Boundary effect	1.0	R	√3	1	1	0.6	0.6
Readout electronics	0.3	N	1	1	1	0.3	0.3
Response time	0.0	R	√3	1	1	0.0	0.0
Integration time	0.0	R	√3	1	1	0.0	0.0
RF ambient conditions – noise	1.0	R	√3	1	1	0.6	0.6
RF ambient conditions–reflections	1.0	R	√3	1	1	0.6	0.6
Probe positioner mech. Restrictions	0.8	R	√3	1	1	0.5	0.5
Probe positioning with respect to phantom shell	6.7	R	√3	1	1	3.9	3.9
Post-processing	2.0	R	√3	1	1	1.2	1.2
Test sample related							
Device holder Uncertainty	6.3	N	1	1	1	6.3	6.3
Test sample positioning	2.8	N	1	1	1	2.8	2.8
Power scaling	4.5	R	√3	1	1	2.6	2.6
Drift of output power	5.0	R	√3	1	1	2.9	2.9
Phantom and set-up							
Phantom uncertainty (shape and thickness tolerances)	4.0	R	√3	1	1	2.3	2.3
Algorithm for correcting SAR for deviations in permittivity and conductivity	1.9	N	1	1	0.84	1.1	0.9
Liquid conductivity (meas.)	2.5	N	1	0.64	0.43	1.6	1.1
Liquid permittivity (meas.)	2.5	N	1	0.6	0.49	1.5	1.2
Temp. unc. - Conductivity	1.7	R	√3	0.78	0.71	0.8	0.7
Temp. unc. - Permittivity	0.3	R	√3	0.23	0.26	0.0	0.0
Combined standard uncertainty		RSS				12.2	12.1
Expanded uncertainty 95 % confidence interval)						24.5	24.2

Appendixes

Refer to separated files for the following appendixes.

APPENDIX A PROBE & DIPOLES CALIBRATION CERTIFICATES.

APPENDIX B TEST POSITION PHOTOS.

APPENDIX C SAR plots.

******* END OF REPORT *******