SAR Test Report

Report No.: AGC00364170301FH01

FCC ID : 2ABOSSKYPLAT55C
APPLICATION PURPOSE : Original Equipment
PRODUCT DESIGNATION : Smart Phone
BRAND NAME : SKY Devices
MODEL NAME : Platinum 5.5C
CLIENT : Sky Phone LLC
DATE OF ISSUE : Mar. 31,2017
STANDARD(S) : IEEE Std. 1528:2013
FCC 47CFR § 2.1093
IEEE/ANSI C95.1:2005
REPORT VERSION : V1.0

Attestation of Global Compliance(Shenzhen) Co., Ltd.



CAUTION:

This report shall not be reproduced except in full without the written permission of the test laboratory and shall not be quoted out of context.



Report Revise Record

Report Version	Revise Time	Issued Date	Valid Version	Notes
V1.0	/	Mar. 31,2017	Valid	Original Report

Test Report Certification

Applicant Name	Sky Phone LLC
Applicant Address	1348 Washington Av. Suite 350N/A, Miami Beach Florida United States 33139
Manufacturer Name	DongGuan Tenexon Communication Technology Co., Ltd.
Manufacturer Address	L1-L3 , Block A, Building B, KeYuan 9th Road No.1, Tang Xia Town, Dongguan City, Guangdong, China
Product Designation	Smart Phone
Brand Name	SKY Devices
Model Name	Platinum 5.5C
Different Description	N/A
EUT Voltage	DC3.8V by battery
Applicable Standard	IEEE Std. 1528:2013 FCC 47CFR § 2.1093 IEEE/ANSI C95.1:2005
Test Date	Mar. 21,2017 to Mar. 24,2017
Performed Location	Attestation of Global Compliance(Shenzhen) Co., Ltd. 2 F, Building 2, No.1-No.4, Chaxi Sanwei Technical Industrial Park, Gushu, Xixiang Street, Bao'an District, Shenzhen, China
Report Template	AGCRT-US-3G3/SAR (2016-01-01)



Tested By _____
Eric Zhou(Zhou Yongkang) Mar. 24,2017



Checked By _____
Angela Li(Li Jiao) Mar. 31,2017



Authorized By _____
Solger Zhang(Zhang Hongyi)
Authorized Officer Mar. 31,2017

TABLE OF CONTENTS

1. SUMMARY OF MAXIMUM SAR VALUE	5
2. GENERAL INFORMATION.....	6
2.1. EUT DESCRIPTION.....	6
3. SAR MEASUREMENT SYSTEM.....	8
3.1. THE SATIMO SYSTEM USED FOR PERFORMING COMPLIANCE TESTS CONSISTS OF FOLLOWING ITEMS	8
3.2. COMOSAR E-FIELD PROBE	9
3.3. ROBOT.....	10
3.4. VIDEO POSITIONING SYSTEM	10
3.5. DEVICE HOLDER	11
3.6. SAM TWIN PHANTOM.....	12
4. SAR MEASUREMENT PROCEDURE.....	13
4.1. SPECIFIC ABSORPTION RATE (SAR).....	13
4.2. SAR MEASUREMENT PROCEDURE	14
4.3. RF EXPOSURE CONDITIONS	16
5. TISSUE SIMULATING LIQUID.....	18
5.1. THE COMPOSITION OF THE TISSUE SIMULATING LIQUID.....	18
5.2. TISSUE DIELECTRIC PARAMETERS FOR HEAD AND BODY PHANTOMS	18
5.3. TISSUE CALIBRATION RESULT	19
6. SAR SYSTEM CHECK PROCEDURE	21
6.1. SAR SYSTEM CHECK PROCEDURES	21
6.2. SAR SYSTEM CHECK.....	22
7. EUT TEST POSITION.....	23
7.2. CHEEK POSITION	24
7.3. TILT POSITION.....	24
7.4. BODY WORN POSITION	25
8. SAR EXPOSURE LIMITS	26
9. TEST EQUIPMENT LIST	27
10. MEASUREMENT UNCERTAINTY	28
11. CONDUCTED POWER MEASUREMENT.....	34
12. TEST RESULTS	43
12.1. SAR TEST RESULTS SUMMARY.....	43
APPENDIX A. SAR SYSTEM CHECK DATA	57
APPENDIX B. SAR MEASUREMENT DATA.....	73
APPENDIX C. TEST SETUP PHOTOGRAPHS.....	123
APPENDIX D. CALIBRATION DATA	130

1. SUMMARY OF MAXIMUM SAR VALUE

The maximum results of Specific Absorption Rate (SAR) found during testing for EUT are as follows:

Frequency Band	Highest Reported 1g-SAR(W/Kg)		SAR Test Limit (W/Kg)
	Head	Body-worn	
GSM 850	0.366	0.896	1.6
PCS 1900	0.164	1.125	
UMTS Band II	0.235	0.951	
UMTS Band IV	0.277	0.945	
UMTS Band V	0.180	0.206	
WIFI 2.4G	0.117	0.226	
Simultaneous Reported SAR	1.191		
SAR Test Result	PASS		

This device is compliance with Specific Absorption Rate (SAR) for general population/uncontrolled exposure limits (1.6W/Kg) specified in IEEE Std. 1528:2013; FCC 47CFR § 2.1093; IEEE/ANSI C95.1:2005 and the following specific FCC Test Procedures:

- KDB 447498 D01 General RF Exposure Guidance v06
- KDB 648474 D04 Handset SAR v01r03
- KDB 865664 D01 SAR Measurement 100MHz to 6GHz v01r04
- KDB 941225 D01 3G SAR Procedures v03r01
- KDB 941225 D06 Hotspot Mode v02r01
- KDB 248227 D01 802 11 Wi-Fi SAR v02r02

2. GENERAL INFORMATION

2.1. EUT Description

General Information	
Product Designation	Smart Phone
Test Model	Platinum 5.5C
Hardware Version	ZH066-MB-V3.0
Software Version	Platinum_5.5C_V01_20170207
Device Category	Portable
RF Exposure Environment	Uncontrolled
Antenna Type	Internal
GSM and GPRS	
Support Band	<input checked="" type="checkbox"/> GSM 850 <input checked="" type="checkbox"/> PCS 1900 <input type="checkbox"/> GSM 900 <input type="checkbox"/> DCS 1800
GPRS Type	Class B
GPRS Class	Class 12(1Tx+4Rx, 2Tx+3Rx, 3Tx+2Rx, 4Tx+1Rx)
TX Frequency Range	GSM 850 : 820-850MHz;; PCS 1900: 1850-1910MHz;
RX Frequency Range	GSM 850 : 869~894MHz; PCS 1900: 1930~1990MHz
Release Version	R99
Type of modulation	GMSK for GSM/GPRS;
Antenna Gain	GSM850: -1.2dBi ;PCS1900: -1.4dBi
Max. Average Power	GSM850: 31.31dBm ;PCS1900: 28.43dBm
WCDMA	
Support Band	<input checked="" type="checkbox"/> UMTS FDD Band II <input checked="" type="checkbox"/> UMTS FDD Band V <input checked="" type="checkbox"/> UMTS FDD Band IV <input type="checkbox"/> UMTS FDD Band I <input type="checkbox"/> UMTS FDD Band III <input type="checkbox"/> UMTS FDD Band VIII
HS Type	HSPA(HSUPA/HSDPA)
TX Frequency Range	FDD Band II: 1850-1910MHz; FDD Band V: 820-850MHz Band IV: 1712.4-1752.6MHz
RX Frequency Range	FDD Band II: 1930-1990MHz; FDD Band V: 869-894MHz Band IV: 2112.4-5152.6MHz
Release Version	Rel-6
Type of modulation	HSDPA:QPSK/16QAM; HSUPA:BPSK; WCDMA:QPSK
Antenna Gain	Band II: -1.2dBi; Band IV: -1.2dBi; Band V: -1.15dBi
Max. Average Power	Band II: 20.33dBm; Band IV: 20.33dBm; Band V: 20.72dBm

EUT Description(Continue)

Bluetooth	
Bluetooth Version	<input type="checkbox"/> V2.0 <input type="checkbox"/> V2.1 <input type="checkbox"/> V2.1+EDR <input checked="" type="checkbox"/> V3.0 <input type="checkbox"/> V3.0+HS <input checked="" type="checkbox"/> V4.0 <input type="checkbox"/> V4.1
Operation Frequency	2402~2480MHz
Type of modulation	<input checked="" type="checkbox"/> GFSK <input checked="" type="checkbox"/> II/4-DQPSK <input checked="" type="checkbox"/> 8-DPSK
Peak Power	4.973dBm
Antenna Gain	-1.45dBi
WIFI	
WIFI Specification	<input type="checkbox"/> 802.11a <input checked="" type="checkbox"/> 802.11b <input checked="" type="checkbox"/> 802.11g <input checked="" type="checkbox"/> 802.11n(20) <input checked="" type="checkbox"/> 802.11n(40)
Operation Frequency	2412~2462MHz
Avg. Burst Power	11b:16.37dBm,11g:14.14dBm,11n(20):14.01dBm,11n(40):13.66dBm
Antenna Gain	-1.5dBi
Accessories	
Battery	Brand name: SKY Devices Model No. : Platinum 5.5C Voltage and Capacitance: 3.8 V & 2800mAh
Adapter	Brand name: SKY Devices Model No. : Platinum 5.5C Input: AC 100-240V, 50/60Hz, 0.2A Output: DC 5V, 1000mA
Earphone	Brand name: N/A Model No. : N/A

Note:1.CMU200 can measure the average power and Peak power at the same time
2.The sample used for testing is end product.

Product	Type
	<input checked="" type="checkbox"/> Production unit <input type="checkbox"/> Identical Prototype

3. SAR MEASUREMENT SYSTEM

3.1. The SATIMO system used for performing compliance tests consists of following items

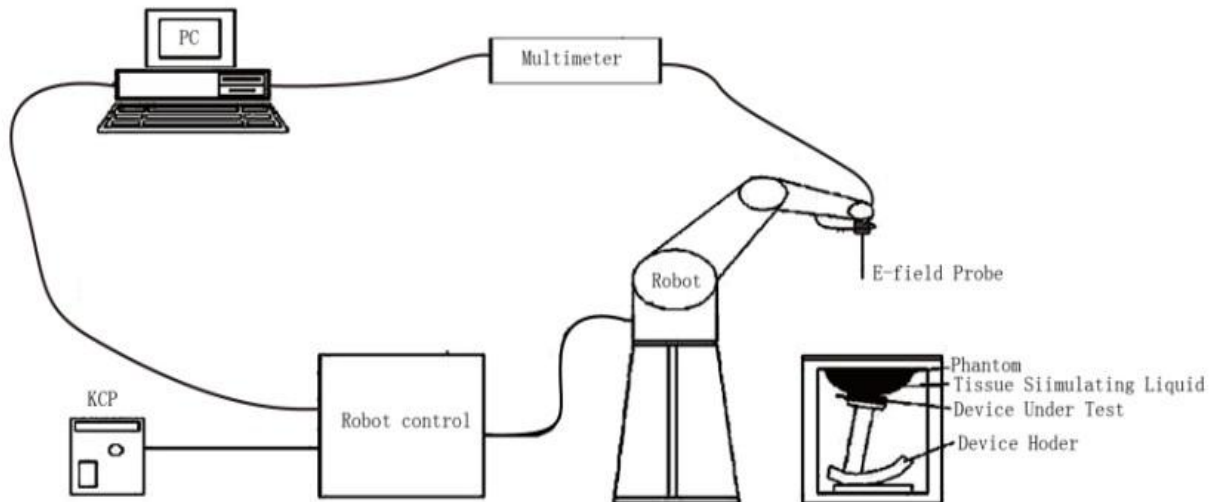

The COMOSAR system for performing compliance tests consists of the following items:

- The PC. It controls most of the bench devices and stores measurement data. A computer running WinXP and the Opensar software.
- The E-Field probe. The probe is a 3-axis system made of 3 distinct dipoles. Each dipole returns a voltage in function of the ambient electric field.
- The Keithley multimeter measures each probe dipole voltages.
- The SAM phantom simulates a human head. The measurement of the electric field is made inside the phantom.
- The liquids simulate the dielectric properties of the human head tissues.
- The network emulator controls the mobile phone under test.
- The validation dipoles are used to measure a reference SAR. They are used to periodically check the bench to make sure that there is no drift of the system characteristics over time.
- The phantom, the device holder and other accessories according to the targeted measurement.

3.2. COMOSAR E-Field Probe

The SAR measurement is conducted with the dosimetric probe manufactured by SATIMO. The probe is specially designed and calibrated for use in liquid with high permittivity. The dosimetric probe has special calibration in liquid at different frequency. SATIMO conducts the probe calibration in compliance with international and national standards (e.g. IEEE 1528 and relevant KDB files.) The calibration data are in Appendix D.

Isotropic E-Field Probe Specification

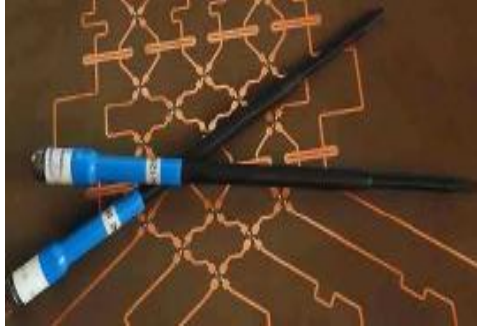
Model	SSE5	
Manufacture	MVG	
Identification No.	SN 14/16 EP308	
Frequency	0.3GHz-3.7GHz Linearity:±0.08dB(300MHz -3.7GHz)	
Dynamic Range	0.01W/Kg-100W/Kg Linearity:±0.08dB	
Dimensions	Overall length:330mm Length of individual dipoles:4.5mm Maximum external diameter:8mm Probe Tip external diameter:5mm Distance between dipoles/ probe extremity:2.7mm	
Application	High precision dosimetric measurements in any exposure scenario (e.g., very strong gradient fields). Only probe which enables compliance testing for frequencies up to 3 GHz with precision of better 30%.	

Model	SSE5	
Manufacture	MVG	
Identification No.	SN 14/16 EP307	
Frequency	0.7GHz-3GHz Linearity:±0.05dB(700MHz-3GHz)	
Dynamic Range	0.01W/Kg-100W/Kg Linearity:±0.05dB	
Dimensions	Overall length:330mm Length of individual dipoles:4.5mm Maximum external diameter:8mm Probe Tip external diameter:5mm Distance between dipoles/ probe extremity:2.7mm	
Application	High precision dosimetric measurements in any exposure scenario (e.g., very strong gradient fields). Only probe which enables compliance testing for frequencies up to 3 GHz with precision of better 30%.	

3.3. Robot

The COMOSAR system uses the KUKA robot from SATIMO SA (France). For the 6-axis controller COMOSAR system, the KUKA robot controller version from SATIMO is used.

The XL robot series have many features that are important for our application:

- High precision (repeatability 0.02 mm)
- High reliability (industrial design)
- Jerk-free straight movements
- Low ELF interference (the closed metallic construction shields against motor control fields)
- 6-axis controller



3.4. Video Positioning System

The video positioning system is used in OpenSAR to check the probe. Which is composed of a camera, LED, mirror and mechanical parts. The camera is piloted by the main computer with firewire link.

During the process, the actual position of the probe tip with respect to the robot arm is measured, as well as the probe length and the horizontal probe offset. The software then corrects all movements, such that the robot coordinates are valid for the probe tip.

The repeatability of this process is better than 0.1 mm. If a position has been taught with an aligned probe, the same position will be reached with another aligned probe within 0.1 mm, even if the other probe has different dimensions. During probe rotations, the probe tip will keep its actual position.

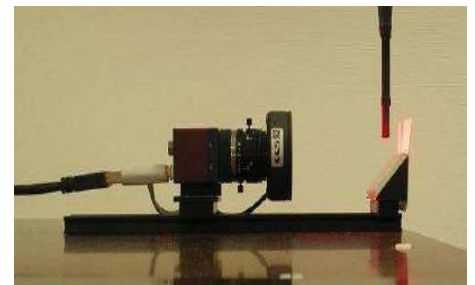

3.5. Device Holder

The COMOSAR device holder is designed to cope with different positions given in the standard. It has two scales for the device rotation (with respect to the body axis) and the device inclination (with respect to the line between the ear reference points). The rotation center for both scales is the ear reference point (EPR).

Thus the device needs no repositioning when changing the angles.

The COMOSAR device holder has been made out of low-loss POM material having the following dielectric parameters: relative permittivity

$\epsilon_r = 3$ and loss tangent $\delta = 0.02$. The amount of dielectric material has been reduced in the closest vicinity of the device, since measurements have suggested that the influence of the clamp on the test results could thus be lowered.

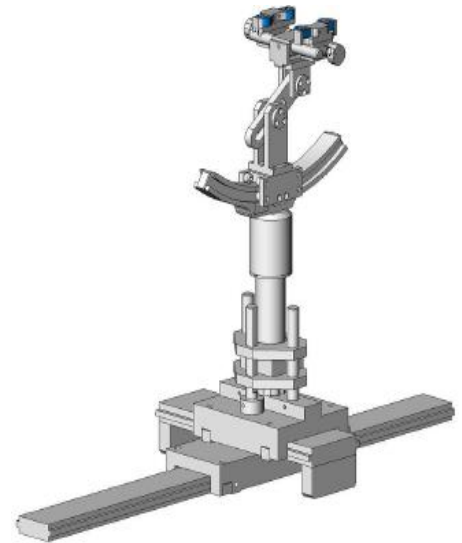

3.6. SAM Twin Phantom

The SAM twin phantom is a fiberglass shell phantom with 2mm shell thickness (except the ear region where shell thickness increases to 6mm). It has three measurement areas:

- Left head
- Right head
- Flat phantom



The bottom plate contains three pair of bolts for locking the device holder. The device holder positions are adjusted to the standard measurement positions in the three sections. A white cover is provided to tap the phantom during off-periods to prevent water evaporation and changes in the liquid parameters. On the phantom top, three reference markers are provided to identify the phantom position with respect to the robot.

4. SAR MEASUREMENT PROCEDURE

4.1. Specific Absorption Rate (SAR)

SAR is related to the rate at which energy is absorbed per unit mass in object exposed to a radio field. The SAR distribution in a biological body is complicated and is usually carried out by experimental techniques or numerical modeling. The standard recommends limits for two tiers of groups, occupational/controlled and occupational/uncontrolled, based on a person's awareness and ability to exercise control over his or her exposure. In general, occupational/controlled exposure limits are higher than the limits for general population/uncontrolled.

The SAR definition is the time derivative (rate) of the incremental energy (dW) absorbed by (dissipated in) an incremental mass (dm) contained in a volume element(dv) of given mass density (ρ). The equation description is as below:

$$SAR = \frac{d}{dt} \left(\frac{dW}{dm} \right) = \frac{d}{dt} \left(\frac{dW}{\rho dV} \right)$$

SAR is expressed in units of Watts per kilogram (W/Kg)

SAR can be obtained using either of the following equations:

$$SAR = \frac{\sigma E^2}{\rho}$$

$$SAR = c_h \left. \frac{dT}{dt} \right|_{t=0}$$

Where

SAR	is the specific absorption rate in watts per kilogram;
E	is the r.m.s. value of the electric field strength in the tissue in volts per meter;
σ	is the conductivity of the tissue in siemens per metre;
ρ	is the density of the tissue in kilograms per cubic metre;
c_h	is the heat capacity of the tissue in joules per kilogram and Kelvin;

$\left. \frac{dT}{dt} \right|_{t=0}$ is the initial time derivative of temperature in the tissue in kelvins per second

4.2. SAR Measurement Procedure

Step 1: Power Reference Measurement

The Power Reference Measurement and Power Drift Measurement are for monitoring the power drift of the device under test in the batch process. The minimum distance of probe sensors to surface is 2.7mm This distance cannot be smaller than the distance os sensor calibration points to probe tip as `defined in the probe properties,

Step 2: Area Scan

The Area Scan is used as a fast scan in two dimensions to find the area of high field values, before doing a fine measurement around the hot spot. The sophisticated interpolation routines implemented in SATIMO software can find the maximum locations even in relatively coarse grids. When an Area Scan has measured all reachable points, it computes the field maximal found in the scanned area, within a range of the global maximum. The range (in db) is specified in the standards for compliance testing. For example, a 2db range is required in IEEE Standard 1528, whereby 3db is a requirement when compliance is assessed in accordance with the ARIB standard (Japan) If one Zoom Scan follows the Area Scan, then only the absolute maximum will be taken as reference. For cases where multiple maximum are detected, the number of Zoom Scan has to be increased accordingly.

Area Scan Parameters extracted from KDB 865664 D01 SAR Measurement 100MHz to 6GHz

	≤ 3 GHz	> 3 GHz
Maximum distance from closest measurement point (geometric center of probe sensors) to phantom surface	5 ± 1 mm	$\frac{1}{2} \cdot \delta \cdot \ln(2) \pm 0.5$ mm
Maximum probe angle from probe axis to phantom surface normal at the measurement location	30° ± 1°	20° ± 1°
Maximum area scan spatial resolution: Δx_{Area} , Δy_{Area}	≤ 2 GHz: ≤ 15 mm 2 – 3 GHz: ≤ 12 mm	3 – 4 GHz: ≤ 12 mm 4 – 6 GHz: ≤ 10 mm
	When the x or y dimension of the test device, in the measurement plane orientation, is smaller than the above, the measurement resolution must be ≤ the corresponding x or y dimension of the test device with at least one measurement point on the test device.	

Step 3: Zoom Scan

Zoom Scan are used to assess the peak spatial SAR value within a cubic average volume containing 1g abd 10g of simulated tissue. The Zoom Scan measures points(refer to table below) within a cube whose base faces are centered on the maxima found in a preceding area scan job within the same procedure. When the measurement is done, the Zoom Scan evaluates the averaged SAR for 1g and 10g and displays these values next to the job's label.

Zoom Scan Parameters extracted from KDB865664 d01 SAR Measurement 100MHz to 6GHz

Maximum zoom scan spatial resolution: Δx_{Zoom} , Δy_{Zoom}		≤ 2 GHz: ≤ 8 mm 2 – 3 GHz: ≤ 5 mm*	3 – 4 GHz: ≤ 5 mm* 4 – 6 GHz: ≤ 4 mm*
Maximum zoom scan spatial resolution, normal to phantom surface	uniform grid: $\Delta z_{Zoom}(n)$	≤ 5 mm	3 – 4 GHz: ≤ 4 mm 4 – 5 GHz: ≤ 3 mm 5 – 6 GHz: ≤ 2 mm
	graded grid	$\Delta z_{Zoom}(1)$: between 1 st two points closest to phantom surface	≤ 4 mm
		$\Delta z_{Zoom}(n>1)$: between subsequent points	$\leq 1.5 \cdot \Delta z_{Zoom}(n-1)$
Minimum zoom scan volume	x, y, z	≥ 30 mm	3 – 4 GHz: ≥ 28 mm 4 – 5 GHz: ≥ 25 mm 5 – 6 GHz: ≥ 22 mm
<p>Note: δ is the penetration depth of a plane-wave at normal incidence to the tissue medium; see draft standard IEEE P1528-2011 for details.</p> <p>* When zoom scan is required and the <i>reported</i> SAR from the <i>area scan based I-g SAR estimation</i> procedures of KDB 447498 is ≤ 1.4 W/kg, ≤ 8 mm, ≤ 7 mm and ≤ 5 mm zoom scan resolution may be applied, respectively, for 2 GHz to 3 GHz, 3 GHz to 4 GHz and 4 GHz to 6 GHz.</p>			

Step 4: Power Drift Measurement

The Power Drift Measurement measures the field at the same location as the most recent power reference measurement within the same procedure, and with the same settings. The Power Drift Measurement gives the field difference in dB from the reading conducted within the same settings. This allows a user to monitor the power drift of the device under test within a batch process. The measurement procedure is the same as Step 1.

4.3. RF Exposure Conditions

Test Configuration and setting:

The EUT is a model of GSM Portable Mobile Station (MS). It supports GSM/GPRS, WCDMA/HSPA, BT, WIFI, and support hot spot mode.

For WWAN SAR testing, the device was controlled by using a base station emulator. Communication between the device and the emulator were established by air link. The distance between the EUT and the antenna is larger than 50cm, and the output power radiated from the emulator antenna is at least 30db smaller than the output power of EUT.

For WLAN testing, the EUT is configured with the WLAN continuous TX tool through engineering command.

Antenna Location: (the back view)

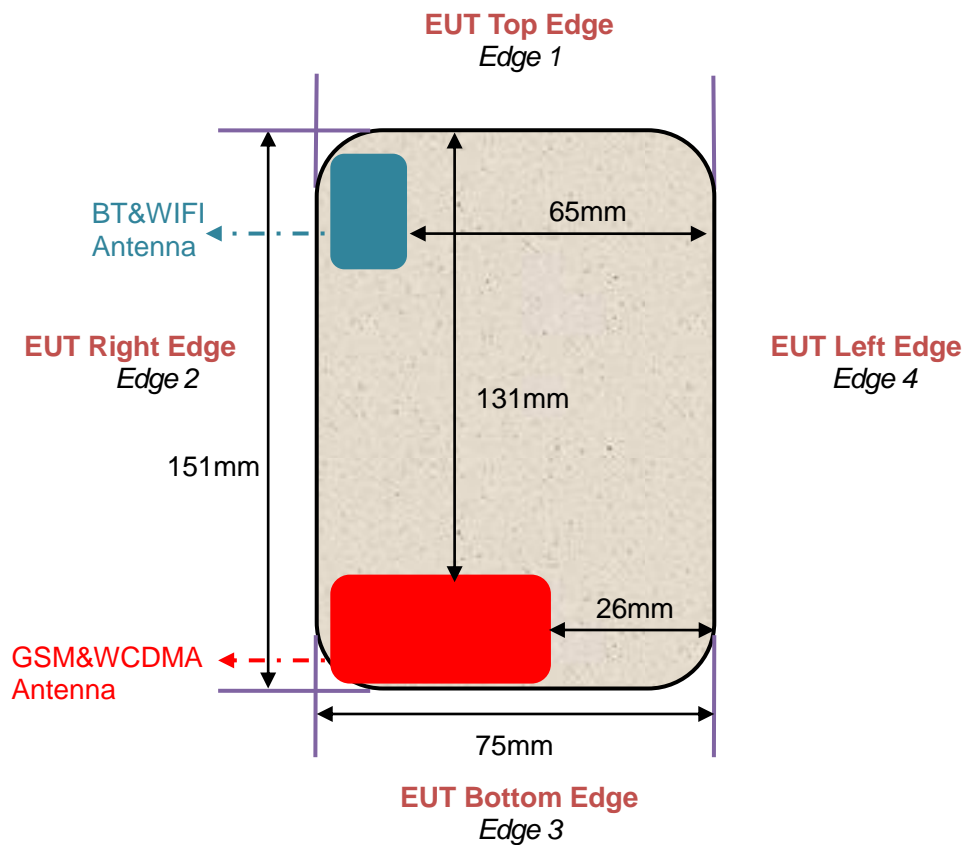

For WWAN mode:

Test Configurations	Antenna to edges/surface	SAR required	Note
Head			
Left Touch		Yes	--
Left Tilt		Yes	--
Right Touch		Yes	--
Right Tilt		Yes	--
Body			
Back	<25mm	Yes	--
Front	<25mm	Yes	--
Hotspot			
Back	<25mm	Yes	--
Front	<25mm	Yes	--
Edge 1 (Top)	131mm	No	SAR is not required for the distance between the antenna and the edge is >25mm as per KDB 941225 D06 Hotspot SAR
Edge 2 (Right)	1mm	Yes	--
Edge 3 (Bottom)	2mm	Yes	--
Edge 4 (Left)	26mm	No	SAR is not required for the distance between the antenna and the edge is >25mm as per KDB 941225 D06 Hotspot SAR

For WLAN mode:

Test Configurations	Antenna to edges/surface	SAR required	Note
Head			
Left Touch		Yes	--
Left Tilt		Yes	--
Right Touch		Yes	--
Right Tilt		Yes	--
Body			
Back	<25mm	Yes	--
Front	<25mm	Yes	--
Hotspot			
Back	<25mm	Yes	--
Front	<25mm	Yes	--
Edge 1 (Top)	2mm	Yes	--
Edge 2 (Right)	2mm	Yes	--
Edge 3 (Bottom)	127mm	No	SAR is not required for the distance between the antenna and the edge is >25mm as per KDB 941225 D06 Hotspot SAR
Edge 4 (Left)	65mm	No	SAR is not required for the distance between the antenna and the edge is >25mm as per KDB 941225 D06 Hotspot SAR

5. TISSUE SIMULATING LIQUID

For SAR measurement of the field distribution inside the phantom, the phantom must be filled with homogeneous tissue simulating liquid to a depth of at least 15cm. For head SAR testing the liquid height from the ear reference point (ERP) of the phantom to the liquid top surface is larger than 15cm For body SAR testing, the liquid height from the center of the flat phantom to the liquid top surface is larger than 15cm. The nominal dielectric values of the tissue simulating liquids in the phantom and the tolerance of 5% are listed in 5.2

5.1. The composition of the tissue simulating liquid

Ingredient (% Weight) Frequency (MHz)	Water	Nacl	Polysorbate 20	DGBE	1,2 Propanediol	Triton X-100
835 Head	50.36	1.25	48.39	0.0	0.0	0.0
835 Body	54.00	1	0.0	15	0.0	30
1750 Head	55.2	0.3	0.0	44.5	0.0	0.0
1750 Body	70	1	0.0	9	0.0	20
1900 Head	54.9	0.18	0.0	44.92	0.0	0.0
1900 Body	70	1	0.0	9	0.0	20
2450 Head	71.88	0.16	0.0	7.99	0.0	19.97
2450 Body	70	1	0.0	9	0.0	20

5.2. Tissue Dielectric Parameters for Head and Body Phantoms

The head tissue dielectric parameters recommended by the IEEE 1528 have been incorporated in the following table. These head parameters are derived from planar layer models simulating the highest expected SAR for the dielectric properties and tissue thickness variations in a human head. Other head and body tissue parameters that have not been specified in IEEE 1528 are derived from the tissue dielectric parameters computed from the 4-Cole-Cole equations described in Reference [12] and extrapolated according to the head parameters specified in IEEE 1528.

Target Frequency (MHz)	head		body	
	ϵ_r	σ (S/m)	ϵ_r	σ (S/m)
300	45.3	0.87	58.2	0.92
450	43.5	0.87	56.7	0.94
835	41.5	0.90	55.2	0.97
900	41.5	0.97	55.0	1.05
915	41.5	1.01	55.0	1.06
1450	40.5	1.20	54.0	1.30
1610	40.3	1.29	53.8	1.40
1750	40.1	1.37	53.4	1.49
1800 – 2000	40.0	1.40	53.3	1.52
2450	39.2	1.80	52.7	1.95
3000	38.5	2.40	52.0	2.73

(ϵ_r = relative permittivity, σ = conductivity and $\rho = 1000$ kg/m³)

5.3. Tissue Calibration Result

The dielectric parameters of the liquids were verified prior to the SAR evaluation using SATIMO Dielectric Probe Kit and R&S Network Analyzer ZVL6.

Tissue Stimulant Measurement for 835MHz					
	Fr. (MHz)	Dielectric Parameters ($\pm 5\%$)		Tissue Temp [°C]	Test time
		ϵ_r 41.5 (39.425-43.575)	δ [s/m] 0.90(0.855-0.945)		
Head	824.2	42.86	0.87	21.2	Mar. 21,2017
	826.4	42.31	0.88		
	835	41.97	0.89		
	836.6	41.52	0.89		
	846.6	41.09	0.90		
	848.8	40.68	0.91		
	Fr. (MHz)	Dielectric Parameters ($\pm 5\%$)		Tissue Temp [°C]	Test time
		ϵ_r 55.20(52.44-57.96)	δ [s/m]0.97(0.9215-1.0185)		
Body	824.2	56.37	0.93	21.3	Mar. 21,2017
	826.4	55.84	0.94		
	835	55.41	0.95		
	836.6	55.03	0.96		
	846.6	54.65	0.97		
	848.8	54.13	0.98		

Tissue Stimulant Measurement for 1750MHz					
	Fr. (MHz)	Dielectric Parameters ($\pm 5\%$)		Tissue Temp [°C]	Test time
		ϵ_r 40.10(38.095-42.105)	δ [s/m]1.37(1.3015-1.439)		
Head	1712.5	41.59	1.33	22.0	Mar. 22,2017
	1732.5	41.11	1.35		
	1750	40.67	1.37		
	1752.5	40.20	1.40		
	Fr. (MHz)	Dielectric Parameters ($\pm 5\%$)		Tissue Temp [°C]	Test time
		ϵ_r 53.4(50.73-56.07)	δ [s/m] 1.49(1.4155-1.5645)		
Body	1712.5	54.23	1.43	22.2	Mar. 22,2017
	1732.5	53.90	1.45		
	1750	53.41	1.47		
	1752.5	52.99	1.50		

Tissue Stimulant Measurement for 1900MHz					
	Fr. (MHz)	Dielectric Parameters ($\pm 5\%$)		Tissue Temp [°C]	Test time
		ϵ_r 40.00(38.00-42.00)	δ [s/m]1.40(1.33-1.47)		
Head	1850.2	41.53	1.35	22.1	Mar. 21,2017
	1852.4	41.11	1.37		
	1880	40.86	1.39		
	1900	40.45	1.42		
	1907.6	40.03	1.43		
	1909.8	39.56	1.45		
		Fr. (MHz)	Dielectric Parameters ($\pm 5\%$)		
ϵ_r 53.30(50.635-55.965)			δ [s/m]1.52(1.444-1.596)		
Body	1850.2	54.66	1.46	22.3	Mar. 21,2017
	1852.4	54.21	1.48		
	1880	53.86	1.50		
	1900	53.53	1.52		
	1907.6	53.10	1.53		
	1909.8	52.86	1.55		

Tissue Stimulant Measurement for 2450MHz					
	Fr. (MHz)	Dielectric Parameters ($\pm 5\%$)		Tissue Temp [°C]	Test time
		ϵ_r 39.2(37.24-41.16)	δ [s/m]1.80(1.71-1.89)		
Head	2412	40.89	1.73	21.8	Mar. 24,2017
	2437	40.42	1.75		
	2450	39.98	1.77		
	2462	39.52	1.82		
	Fr. (MHz)	Dielectric Parameters ($\pm 5\%$)		Tissue Temp [°C]	Test time
		ϵ_r 52.7(50.065-55.335)	δ [s/m]1.95(1.8525-2.0475)		
Body	2412	54.85	1.88	21.5	Mar. 24,2017
	2437	54.37	1.90		
	2450	53.96	1.93		
	2462	53.42	1.95		

6. SAR SYSTEM CHECK PROCEDURE

6.1. SAR System Check Procedures

SAR system check is required to confirm measurement accuracy, according to the tissue dielectric media, probe calibration points and other system operating parameters required for measuring the SAR of a test device. The system verification must be performed for each frequency band and within the valid range of each probe calibration point required for testing the device. The same SAR probe(s) and tissue-equivalent media combinations used with each specific SAR system for system verification must be used for device testing. When multiple probe calibration points are required to cover substantially large transmission bands, independent system verifications are required for each probe calibration point. A system verification must be performed before each series of SAR measurements using the same probe calibration point and tissue-equivalent medium. Additional system verification should be considered according to the conditions of the tissue-equivalent medium and measured tissue dielectric parameters, typically every three to four days when the liquid parameters are remeasured or sooner when marginal liquid parameters are used at the beginning of a series of measurements.

Each SATIMO system is equipped with one or more system check kits. These units, together with the predefined measurement procedures within the SATIMO software, enable the user to conduct the system check and system validation. System kit includes a dipole, and dipole device holder.

The system check verifies that the system operates within its specifications. It's performed daily or before every SAR measurement. The system check uses normal SAR measurement in the flat section of the phantom with a matched dipole at a specified distance. The system check setup is shown as below.

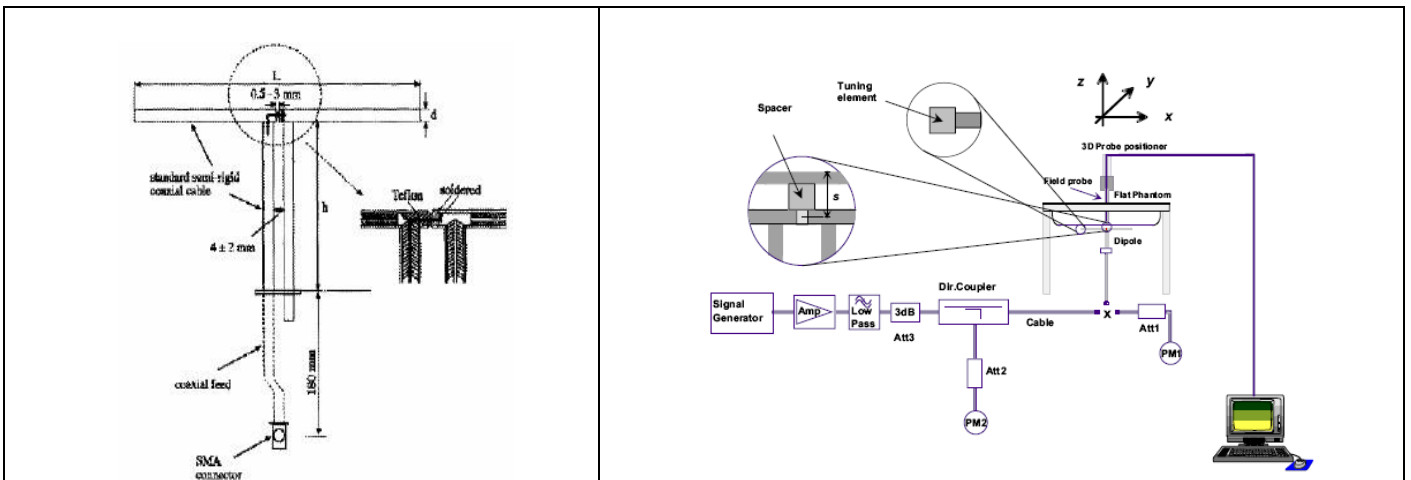

6.2. SAR System Check

6.2.1. Dipoles

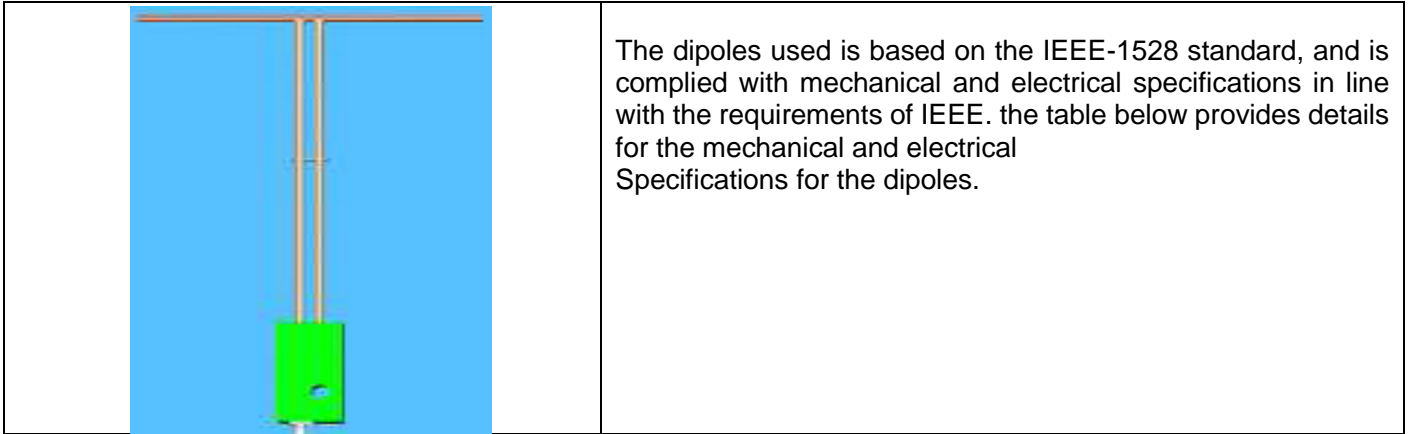

Frequency	L (mm)	h (mm)	d (mm)
835MHz	161.0	89.8	3.6
1800MHz	71.6	41.7	3.6
1900MHz	68	39.5	3.6
2450MHz	51.5	30.4	3.6

6.2.2. System Check Result

System Performance Check at 835MHz& 1800MHz &1900MHz &2450MHz for Head								
Validation Kit: SN29/15 DIP 0G835-383& SN29/15 DIP 1G800-387&SN 29/15 DIP 1G900-389& SN 29/15DIP 2G450-393								
Frequency [MHz]	Target Value(W/Kg)		Reference Result ($\pm 10\%$)		Tested Value(W/Kg)		Tissue Temp. [°C]	Test time
	1g	10g	1g	10g	1g	10g		
835	10.04	6.43	9.036-11.044	5.787 -7.073	10.581	6.514	21.2	Mar. 21,2017
1800	37.43	19.88	33.687-41.173	17.892-21.868	38.632	20.961	22.0	Mar. 22,2017
1900	41.44	21.33	37.296-45.584	19.197-23.463	38.522	20.381	22.1	Mar. 21,2017
2450	54.53	24.30	49.077-59.983	21.87-26.730	50.465	23.647	21.8	Mar. 24,2017
System Performance Check at 835 MHz& 1800MHz &1900MHz & 2450MHz for Body								
Frequency [MHz]	Target Value(W/Kg)		Reference Result ($\pm 10\%$)		Tested Value(W/Kg)		Tissue Temp. [°C]	Test time
	1g	10g	1g	10g	1g	10g		
835	9.85	6.45	8.865-10.835	5.805-7.095	9.859	6.332	21.3	Mar. 21,2017
1800	36.53	19.80	32.877-40.183	17.82-21.780	37.691	20.438	22.2	Mar. 22,2017
1900	39.38	20.86	35.442-43.318	18.774-22.946	37.586	19.964	22.3	Mar. 21,2017
2450	49.92	23.16	44.928-54.912	20.844-25.476	49.294	22.657	21.5	Mar. 24,2017

7. EUT TEST POSITION

This EUT was tested in **Right Cheek, Right Tilted, Left Cheek, Left Tilted, Body back, Body front and 4 edges.**

7.1. Define Two Imaginary Lines on the Handset

- (1) The vertical centerline passes through two points on the front side of the handset: the midpoint of the width w_t of the handset at the level of the acoustic output, and the midpoint of the width w_b of the handset.
- (2) The horizontal line is perpendicular to the vertical centerline and passes through the center of the acoustic output. The horizontal line is also tangential to the face of the handset at point A.
- (3) The two lines intersect at point A. Note that for many handsets, point A coincides with the center of the acoustic output; however, the acoustic output may be located elsewhere on the horizontal line. Also note that the vertical centerline is not necessarily to the front face of the handset, especially for clamshell handsets, handsets with flip covers, and other irregularly shaped handsets.

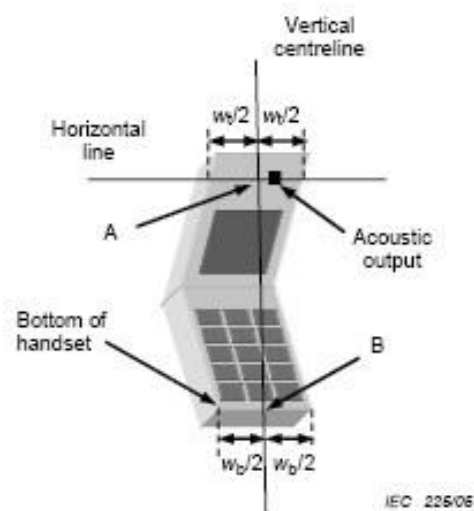
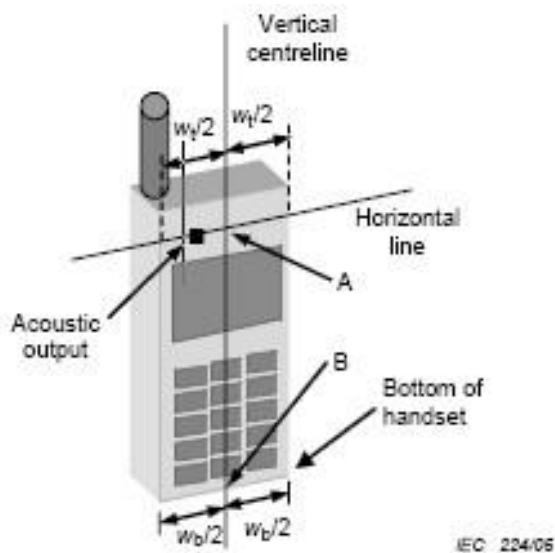

7.2. Cheek Position

- (1) To position the device with the vertical center line of the body of the device and the horizontal line crossing the center piece in a plane parallel to the sagittal plane of the phantom. While maintaining the device in this plane, align the vertical center line with the reference plane containing the ear and mouth reference point (M: Mouth, RE: Right Ear, and LE: Left Ear) and align the center of the ear piece with the line RE-LE.
- (2) To move the device towards the phantom with the ear piece aligned with the the line LE-RE until the phone touched the ear. While maintaining the device in the reference plane and maintaining the phone contact with ear, move the bottom of the phone until any point on the front side is in contact with the cheek of the phantom or until contact with the ear is lost



7.3. Tilt Position

- (1) To position the device in the “cheek” position described above.
- (2) While maintaining the device in the reference plane described above and pivoting against the ear, moves it outward away from the mouth by an angle of 15 degrees or until with the ear is lost.



7.4. Body Worn Position

- (1) To position the EUT parallel to the phantom surface.
- (2) To adjust the EUT parallel to the flat phantom.
- (3) To adjust the distance between the EUT surface and the flat phantom to **5mm**.

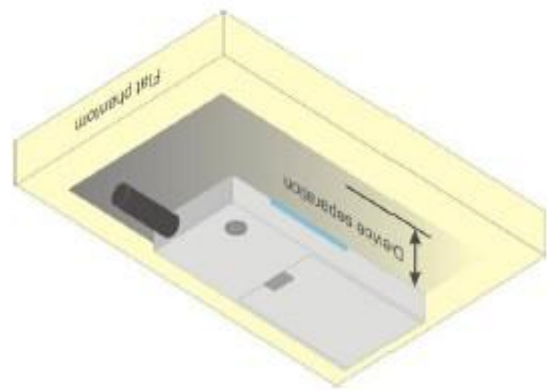
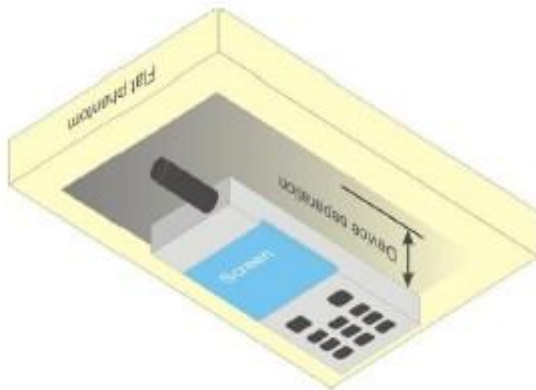

8. SAR EXPOSURE LIMITS

SAR assessments have been made in line with the requirements of IEEE-1528, and comply with ANSI/IEEE C95.1-2005 “Uncontrolled Environments” limits. These limits apply to a location which is deemed as “Uncontrolled Environment” which can be described as a situation where the general public may be exposed to an RF source with no prior knowledge or control over their exposure.

Limits for General Population/Uncontrolled Exposure (W/kg)

Type Exposure	Uncontrolled Environment Limit (W/kg)
Spatial Peak SAR (1g cube tissue for brain or body)	1.60
Spatial Average SAR (Whole body)	0.08
Spatial Peak SAR (Limbs)	4.0

9. TEST EQUIPMENT LIST

Equipment description	Manufacturer/ Model	Identification No.	Current calibration date	Next calibration date
SAR Probe	MVG	SN 14/16 EP308	12/05/2016	12/04/2017
SAR Probe	MVG	SN 14/16 EP307	07/05/2016	07/04/2017
TISSUE Probe	SATIMO	SN 23/16 OCPG 75	07/05/2016	07/04/2017
Phantom	SATIMO	SN_4511_SAM90	Validated. No cal required.	Validated. No cal required.
Liquid	SATIMO	-	Validated. No cal required.	Validated. No cal required.
Comm Tester	Agilent-8960	GB46310822	03/02/2017	03/01/2018
Comm Tester	R&S- CMW500	S/N121209	07/18/2016	07/17/2017
Multimeter	Keithley 2000	1188656	03/02/2017	03/01/2018
Dipole	SATIMO SID835	SN29/15 DIP 0G835-383	07/05/2016	07/04/2019
Dipole	SATIMO SID1800	SN29/15 DIP 1G800-387	07/05/2016	07/04/2019
Dipole	SATIMO SID1900	SN 29/15 DIP 1G900-389	07/05/2016	07/04/2019
Dipole	SATIMO SID2450	SN29/15 DIP 2G450-393	07/05/2016	07/04/2019
Signal Generator	Agilent-E4438C	US41461365	03/02/2017	03/01/2018
Vector Analyzer	Agilent / E4440A	US40420298	07/02/2016	07/01/2017
Network Analyzer	Rhode & Schwarz ZVL6	SN100132	03/02/2017	03/01/2018
Attenuator	Warison WATT-6SR1211	N/A	N/A	N/A
Attenuator	Mini-circuits / VAT-10+	N/A	N/A	N/A
Amplifier	EM30180	SN060552	03/02/2017	03/01/2018
Directional Couple	Werlatone/ C5571-10	SN99463	07/02/2016	07/01/2017
Directional Couple	Werlatone/ C6026-10	SN99482	07/02/2016	07/01/2017
Power Sensor	NRP-Z21	1137.6000.02	10/10/2016	10/09/2017
Power Sensor	NRP-Z23	US38261498	03/02/2017	03/01/2018
Power Viewer	R&S	V2.3.1.0	N/A	N/A

Note: Per KDB 865664 Dipole SAR Validation, AGC Lab has adopted 3 years calibration intervals. On annual basis, every measurement dipole has been evaluated and is in compliance with the following criteria:

1. There is no physical damage on the dipole;
2. System validation with specific dipole is within 10% of calibrated value;
3. Return-loss is within 20% of calibrated measurement;
4. Impedance is within 5Ω of calibrated measurement.

10. MEASUREMENT UNCERTAINTY

SATIMO Uncertainty-SN 14/16 EP308									
Measurement uncertainty for DUT averaged over 1 gram / 10 gram.(Head)									
Uncertainty Component	Sec.	Tol (+- %)	Prob. Dist.	Div.	Ci (1g)	Ci (10g)	1g Ui (+-%)	10g Ui (+-%)	Vi
Measurement System									
Probe calibration	E.2.1	5.831	N	1	1	1	5.83	5.83	∞
Probe Modulation	E.2.5	3.0	R	$\sqrt{3}$	1	1	1.73	1.73	∞
Axial Isotropy	E.2.2	0.6	R	$\sqrt{3}$	1	1	0.36	0.35	∞
Hemispherical Isotropy	E.2.2	0.9	R	$\sqrt{3}$	1	1	0.52	0.52	∞
Boundary effect	E.2.3	1.0	R	$\sqrt{3}$	1	1	0.58	0.58	∞
Linearity	E.2.4	1.91	R	$\sqrt{3}$	1	1	0.69	0.69	∞
System detection limits	E.2.4	1.0	R	$\sqrt{3}$	1	1	0.58	0.58	∞
Readout Electronics	E.2.6	0.02	N	□ 1	1	1	0.02	0.02	∞
Response Time	E.2.7	3.0	R	$\sqrt{3}$	1	1	1.73	1.73	∞
Integration Time	E.2.8	2.0	R	$\sqrt{3}$	1	1	1.15	1.15	∞
RF Ambient Noise	E.6.1	3.0	R	$\sqrt{3}$	1	1	1.73	1.73	∞
RF Ambient Reflection	E.6.1	3.0	R	$\sqrt{3}$	1	1	1.73	1.73	∞
Probe Positioner	E.6.2	2.0	R	$\sqrt{3}$	1	1	1.15	1.15	∞
Probe Positioning	E.6.3	0.05	R	$\sqrt{3}$	1	1	0.03	0.03	∞
Post-processing	E.5	5.0	R	$\sqrt{3}$	1	1	2.89	2.89	∞
Test sample Related									
Device Positioning	E.4.2	0.03	N	1	1	1	3.60	3.60	∞
Device Holder	E.4.1	5	N	1	1	1	2.90	2.90	∞
Measurement SAR Drift	E.2.9	0.65	R	$\sqrt{3}$	1	1	2.89	2.89	∞
Power Scaling	E.6.5	5	R	$\sqrt{3}$	1	1	0.00	0.00	∞
Phantom and set-up									
Phantom Uncertainty	E.3.1	0.05	R	$\sqrt{3}$	1	1	0.03	0.03	∞
Uncertainty in SAR correction for deviations in permittivity and conductivity	E.3.2	1.9	N	1	1	0.84	1.90	1.60	∞
Liquid Conductivity(Meas.)	E.3.3	5	N	1	0.78	0.71	3.90	3.55	M
Liquid Permittivity(Meas.)	E.3.3	5	N	1	0.23	0.26	1.15	1.30	M
Liquid Conductivity-temperature uncertainty	E.3.4	5	R	$\sqrt{3}$	0.78	0.71	2.25	2.05	∞
Liquid Permittivity-temperature uncertainty	E.3.4	5	R	$\sqrt{3}$	0.23	0.26	0.66	0.75	∞
Combined Standard Uncertainty			RSS				10.39	10.118	∞
Expanded Uncertainty (95% Confidence interval)			k				20.86	20.315	

SATIMO Uncertainty-SN 14/16 EP308									
System validation uncertainty for Dipole averaged over 1 gram / 10 gram.(Head)									
Uncertainty Component	Sec.	Tol (+-%)	Prob. Dist.	Div.	Ci (1g)	Ci (10g)	1g Ui (+-%)	10g Ui (+-%)	Vi
Measurement System									
Probe calibration	E.2.1	5.831	N	1	1	1	5.83	5.83	∞
Probe Modulation	E.2.5	3.0	R	$\sqrt{3}$	1	1	1.73	1.73	∞
Axial Isotropy	E.2.2	0.6	R	$\sqrt{3}$	1	1	1.44	1.44	∞
Hemispherical Isotropy	E.2.2	0.9	R	$\sqrt{3}$	1	1	0.52	0.52	∞
Boundary effect	E.2.3	1.0	R	$\sqrt{3}$	1	1	0.58	0.58	∞
Linearity	E.2.4	1.2	R	$\sqrt{3}$	1	1	0.69	0.69	∞
System detection limits	E.2.4	1.0	R	$\sqrt{3}$	1	1	0.58	0.58	∞
Readout Electronics	E.2.6	0.02	N	1	1	1	0.02	0.02	∞
Response Time	E.2.7	3.0	R	$\sqrt{3}$	1	1	1.73	1.73	∞
Integration Time	E.2.8	2.0	R	$\sqrt{3}$	1	1	1.15	1.15	∞
RF Ambient Noise	E.6.1	3.0	R	$\sqrt{3}$	1	1	1.73	1.73	∞
RF Ambient Reflection	E.6.1	3.0	R	$\sqrt{3}$	1	1	1.73	1.73	∞
Probe Positioner	E.6.1	2.0	R	$\sqrt{3}$	1	1	1.15	1.15	∞
Probe Positioning	E.6.2	0.05	R	$\sqrt{3}$	1	1	0.03	0.03	∞
Post-processing	E.6.3	5.0	R	$\sqrt{3}$	1	1	2.89	2.89	∞
System validation source (dipole)									
Deviation of exp. dipole	E6.4	5	R	1	1	1	5.00	5.00	∞
Dipole Axis to Liquid Dist.	8,E.6.6	5.0	R	$\sqrt{3}$	1	1	2.89	2.89	∞
Input power & SAR drift	8,6.6.4	1	R	$\sqrt{3}$	1	1	0.58	0.58	∞
Phantom and set-up									
Phantom Uncertainty	E.3.1	0.05	R	$\sqrt{3}$	1	1	0.03	0.03	∞
Uncertainty in SAR correction for deviations in permittivity and conductivity	E.3.2	1.9	N	1	1	0.84	1.90	1.60	∞
Liquid Conductivity(Meas.)	E.3.3	5	N	1	0.78	0.71	3.90	3.55	M
Liquid Permittivity(Meas.)	E.3.3	5	N	1	0.23	0.26	1.15	1.30	M
Liquid Conductivity-temperature uncertainty	E.3.4	5	R	$\sqrt{3}$	0.78	0.71	2.25	2.05	∞
Liquid Permittivity-temperature uncertainty	E.3.4	5	R	$\sqrt{3}$	0.23	0.26	0.66	0.75	∞
Combined Standard Uncertainty			RSS				11.17	10.920	∞
Expanded Uncertainty (95% Confidence interval)			k				20.879	20.333	

SATIMO Uncertainty-SN 14/16 EP308									
System Check uncertainty for Dipole averaged over 1 gram / 10 gram.(Head)									
Uncertainty Component	Sec.	Tol (+- %)	Prob. Dist.	Div.	Ci (1g)	Ci (10g)	1g Ui (+-%)	10g Ui (+-%)	Vi
Measurement System									
Modulation response	E.2.5	3.0	R	$\sqrt{3}$	0	0	0.00	0.00	∞
Boundary effect	E.2.3	1.0	R	$\sqrt{3}$	0	0	0.00	0.00	∞
System detection limits	E.2.4	1.0	R	$\sqrt{3}$	0	0	0.00	0.00	∞
Readout Electronics	E.2.6	0.02	N	1	0	0	0.00	0.00	∞
Response Time	E.2.7	3.0	R	$\sqrt{3}$	0	0	0.00	0.00	∞
Integration Time	E.2.8	2.0	R	$\sqrt{3}$	0	0	0.00	0.00	∞
RF Ambient Noise	E.6.1	3.0	R	$\sqrt{3}$	0	0	0.00	0.00	∞
RF Ambient Reflection	E.6.1	3.0	R	$\sqrt{3}$	0	0	0.00	0.00	∞
Probe Positioner	E.6.1	2.0	R	$\sqrt{3}$	1	1	1.15	1.15	∞
Probe Positioning	E.6.2	0.05	R	$\sqrt{3}$	1	1	0.03	0.03	∞
Post-processing	E.6.3	5.0	R	$\sqrt{3}$	0	0	0.00	0.00	∞
Field source									
Deviation of exp. dipole	E6.4	5	R	1	1	1	5.00	5.00	∞
Dipole Axis to Liquid Dist.	8,E.6.6	4.7	R	$\sqrt{3}$	1	1	2.71	2.71	∞
Input power & SAR drift	8,6.6.4	1	R	$\sqrt{3}$	1	1	0.58	0.58	∞
Phantom and set-up									
Phantom Uncertainty	E.3.1	0.05	R	$\sqrt{3}$	1	1	0.03	0.03	∞
Uncertainty in SAR correction for deviations in permittivity and conductivity	E.3.2	1.9	N	1	1	0.84	1.90	1.60	∞
Liquid Conductivity(Meas.)	E.3.3	5	N	1	0.78	0.71	3.90	3.55	M
Liquid Permittivity(Meas.)	E.3.3	5	N	1	0.23	0.26	1.15	1.30	M
Liquid Conductivity-temperature uncertainty	E.3.4	5	R	$\sqrt{3}$	0.78	0.71	2.25	2.05	∞
Liquid Permittivity-temperature uncertainty	E.3.4	5	R	$\sqrt{3}$	0.23	0.26	0.66	0.75	∞
Combined Standard Uncertainty			RSS				7.076	6.667	∞
Expanded Uncertainty (95% Confidence interval)			k				14.152	13.334	

SATIMO Uncertainty-SN 14/16 EP307									
Measurement uncertainty for DUT averaged over 1 gram / 10 gram.(Head)									
Uncertainty Component	Sec.	Tol (+- %)	Prob. Dist.	Div.	Ci (1g)	Ci (10g)	1g Ui (+-%)	10g Ui (+-%)	Vi
Measurement System									
Probe calibration	E.2.1	5.831	N	1	1	1	5.83	5.83	∞
Probe Modulation	E.2.5	3.0	R	$\sqrt{3}$	1	1	1.73	1.73	∞
Axial Isotropy	E.2.2	0.6	R	$\sqrt{3}$	1	1	0.36	0.35	∞
Hemispherical Isotropy	E.2.2	0.7	R	$\sqrt{3}$	1	1	0.40	0.40	∞
Boundary effect	E.2.3	1.0	R	$\sqrt{3}$	1	1	0.58	0.58	∞
Linearity	E.2.4	1.2	R	$\sqrt{3}$	1	1	0.69	0.69	∞
System detection limits	E.2.4	0.7	R	$\sqrt{3}$	1	1	0.40	0.40	∞
Readout Electronics	E.2.6	0.02	N	1	1	1	0.02	0.02	∞
Response Time	E.2.7	3.0	R	$\sqrt{3}$	1	1	1.73	1.73	∞
Integration Time	E.2.8	2.0	R	$\sqrt{3}$	1	1	1.15	1.15	∞
RF Ambient Noise	E.6.1	3.0	R	$\sqrt{3}$	1	1	1.73	1.73	∞
RF Ambient Reflection	E.6.1	3.0	R	$\sqrt{3}$	1	1	1.73	1.73	∞
Probe Positioner	E.6.2	2.0	R	$\sqrt{3}$	1	1	1.15	1.15	∞
Probe Positioning	E.6.3	0.05	R	$\sqrt{3}$	1	1	0.03	0.03	∞
Post-processing	E.5	5.0	R	$\sqrt{3}$	1	1	2.89	2.89	∞
Test sample Related									
Device Positioning	E.4.2	3.6	N	1	1	1	3.60	3.60	∞
Device Holder	E.4.1	2.9	N	1	1	1	2.90	2.90	∞
Measurement SAR Drift	E.2.9	5	R	$\sqrt{3}$	1	1	2.89	2.89	∞
Power Scaling	E.6.5	0	R	$\sqrt{3}$	1	1	0.00	0.00	∞
Phantom and set-up									
Phantom Uncertainty	E.3.1	0.05	R	$\sqrt{3}$	1	1	0.03	0.03	∞
Uncertainty in SAR correction for deviations in permittivity and conductivity	E.3.2	1.9	N	1	1	0.84	1.90	1.60	∞
Liquid Conductivity(Meas.)	E.3.3	5	N	1	0.78	0.71	3.90	3.55	M
Liquid Permittivity(Meas.)	E.3.3	5	N	1	0.23	0.26	1.15	1.30	M
Liquid Conductivity-temperature uncertainty	E.3.4	5	R	$\sqrt{3}$	0.78	0.71	2.25	2.05	∞
Liquid Permittivity-temperature uncertainty	E.3.4	5	R	$\sqrt{3}$	0.23	0.26	0.66	0.75	∞
Combined Standard Uncertainty			RSS				10.20	9.919	∞
Expanded Uncertainty (95% Confidence interval)			k				20.40	19.838	

SATIMO Uncertainty-SN 14/16 EP307									
System validation uncertainty for Dipole averaged over 1 gram / 10 gram.(Head)									
Uncertainty Component	Sec.	Tol (+-%)	Prob. Dist.	Div.	Ci (1g)	Ci (10g)	1g Ui (+-%)	10g Ui (+-%)	Vi
Measurement System									
Probe calibration	E.2.1	5.831	N	1	1	1	5.83	5.83	∞
Probe Modulation	E.2.5	3.0	R	$\sqrt{3}$	1	1	1.73	1.73	∞
Axial Isotropy	E.2.2	0.6	R	$\sqrt{3}$	1	1	1.44	1.44	∞
Hemispherical Isotropy	E.2.2	0.7	R	$\sqrt{3}$	1	1	0.40	0.40	∞
Boundary effect	E.2.3	1.0	R	$\sqrt{3}$	1	1	0.58	0.58	∞
Linearity	E.2.4	1.2	R	$\sqrt{3}$	1	1	0.69	0.69	∞
System detection limits	E.2.4	0.7	R	$\sqrt{3}$	1	1	0.40	0.40	∞
Readout Electronics	E.2.6	0.02	N	1	1	1	0.02	0.02	∞
Response Time	E.2.7	3.0	R	$\sqrt{3}$	1	1	1.73	1.73	∞
Integration Time	E.2.8	2.0	R	$\sqrt{3}$	1	1	1.15	1.15	∞
RF Ambient Noise	E.6.1	3.0	R	$\sqrt{3}$	1	1	1.73	1.73	∞
RF Ambient Reflection	E.6.1	3.0	R	$\sqrt{3}$	1	1	1.73	1.73	∞
Probe Positioner	E.6.1	2.0	R	$\sqrt{3}$	1	1	1.15	1.15	∞
Probe Positioning	E.6.2	0.05	R	$\sqrt{3}$	1	1	0.03	0.03	∞
Post-processing	E.6.3	5.0	R	$\sqrt{3}$	1	1	2.89	2.89	∞
System validation source (dipole)									
Deviation of exp. dipole	E6.4	5	R	1	1	1	5.00	5.00	∞
Dipole Axis to Liquid Dist.	8,E.6.6	4.7	R	$\sqrt{3}$	1	1	2.71	2.71	∞
Input power & SAR drift	8,6.6.4	1	R	$\sqrt{3}$	1	1	0.58	0.58	∞
Phantom and set-up									
Phantom Uncertainty	E.3.1	0.05	R	$\sqrt{3}$	1	1	0.03	0.03	∞
Uncertainty in SAR correction for deviations in permittivity and conductivity	E.3.2	1.9	N	1	1	0.84	1.90	1.60	∞
Liquid Conductivity(Meas.)	E.3.3	5	N	1	0.78	0.71	3.90	3.55	M
Liquid Permittivity(Meas.)	E.3.3	5	N	1	0.23	0.26	1.15	1.30	M
Liquid Conductivity-temperature uncertainty	E.3.4	5	R	$\sqrt{3}$	0.78	0.71	2.25	2.05	∞
Liquid Permittivity-temperature uncertainty	E.3.4	5	R	$\sqrt{3}$	0.23	0.26	0.66	0.75	∞
Combined Standard Uncertainty			RSS				10.34	10.069	∞
Expanded Uncertainty (95% Confidence interval)			k				20.69	20.137	

SATIMO Uncertainty-SN 14/16 EP307									
System Check uncertainty for Dipole averaged over 1 gram / 10 gram.(Head)									
Uncertainty Component	Sec.	Tol (+- %)	Prob. Dist.	Div.	Ci (1g)	Ci (10g)	1g Ui (+-%)	10g Ui (+-%)	Vi
Measurement System									
Modulation response	E.2.5	3.0	R	$\sqrt{3}$	0	0	0.00	0.00	∞
Boundary effect	E.2.3	1.0	R	$\sqrt{3}$	0	0	0.00	0.00	∞
System detection limits	E.2.4	0.7	R	$\sqrt{3}$	0	0	0.00	0.00	∞
Readout Electronics	E.2.6	0.02	N	1	0	0	0.00	0.00	∞
Response Time	E.2.7	3.0	R	$\sqrt{3}$	0	0	0.00	0.00	∞
Integration Time	E.2.8	2.0	R	$\sqrt{3}$	0	0	0.00	0.00	∞
RF Ambient Noise	E.6.1	3.0	R	$\sqrt{3}$	0	0	0.00	0.00	∞
RF Ambient Reflection	E.6.1	3.0	R	$\sqrt{3}$	0	0	0.00	0.00	∞
Probe Positioner	E.6.1	2.0	R	$\sqrt{3}$	1	1	1.15	1.15	∞
Probe Positioning	E.6.2	0.05	R	$\sqrt{3}$	1	1	0.03	0.03	∞
Post-processing	E.6.3	5.0	R	$\sqrt{3}$	0	0	0.00	0.00	∞
Field source									
Deviation of exp. dipole	E6.4	5	R	1	1	1	5.00	5.00	∞
Dipole Axis to Liquid Dist.	8,E.6.6	4.7	R	$\sqrt{3}$	1	1	2.71	2.71	∞
Input power & SAR drift	8,6.6.4	1	R	$\sqrt{3}$	1	1	0.58	0.58	∞
Phantom and set-up									
Phantom Uncertainty	E.3.1	0.05	R	$\sqrt{3}$	1	1	0.03	0.03	∞
Uncertainty in SAR correction for deviations in permittivity and conductivity	E.3.2	1.9	N	1	1	0.84	1.90	1.60	∞
Liquid Conductivity(Meas.)	E.3.3	5	N	1	0.78	0.71	3.90	3.55	M
Liquid Permittivity(Meas.)	E.3.3	5	N	1	0.23	0.26	1.15	1.30	M
Liquid Conductivity-temperature uncertainty	E.3.4	5	R	$\sqrt{3}$	0.78	0.71	2.25	2.05	∞
Liquid Permittivity-temperature uncertainty	E.3.4	5	R	$\sqrt{3}$	0.23	0.26	0.66	0.75	∞
Combined Standard Uncertainty			RSS				7.076	6.667	∞
Expanded Uncertainty (95% Confidence interval)			k				14.152	13.334	

11. CONDUCTED POWER MEASUREMENT GSM BAND

Mode	Frequency(MHz)	Avg. Burst Power(dBm)	Duty cycle Factor(dBm)	Frame Power(dBm)
Maximum Power <1>				
GSM 850	824.2	31.03	-9	22.03
	836.6	31.31	-9	22.31
	848.8	31.22	-9	22.22
GPRS 850 (1 Slot)	824.2	31.04	-9	22.04
	836.6	30.88	-9	21.88
	848.8	30.84	-9	21.84
GPRS 850 (2 Slot)	824.2	27.90	-6	21.90
	836.6	27.76	-6	21.76
	848.8	28.26	-6	22.26
GPRS 850 (3 Slot)	824.2	26.96	-4.26	22.70
	836.6	26.75	-4.26	22.49
	848.8	26.94	-4.26	22.68
GPRS 850 (4 Slot)	824.2	25.37	-3	22.37
	836.6	25.40	-3	22.40
	848.8	25.38	-3	22.38
Maximum Power <2>				
GSM 850	824.2	30.02	-9	21.02
	836.6	30.26	-9	21.26
	848.8	30.12	-9	21.12
GPRS 850 (1 Slot)	824.2	30.11	-9	21.11
	836.6	30.05	-9	21.05
	848.8	30.02	-9	21.02
GPRS 850 (2 Slot)	824.2	27.55	-6	21.55
	836.6	27.52	-6	21.52
	848.8	28.01	-6	22.01
GPRS 850 (3 Slot)	824.2	26.56	-4.26	22.30
	836.6	26.73	-4.26	22.47
	848.8	26.90	-4.26	22.64
GPRS 850 (4 Slot)	824.2	25.37	-3	22.37
	836.6	25.40	-3	22.40
	848.8	25.38	-3	22.38

GSM BAND CONTINUE

Mode	Frequency(MHz)	Avg. Burst Power(dBm)	Duty cycle Factor(dBm)	Frame Power(dBm)
Maximum Power <1>				
PCS1900	1850.2	28.39	-9	19.39
	1880	28.13	-9	19.13
	1909.8	28.43	-9	19.43
GPRS1900 (1 Slot)	1850.2	28.17	-9	19.17
	1880	28.08	-9	19.08
	1909.8	28.03	-9	19.03
GPRS1900 (2 Slot)	1850.2	25.62	-6	19.62
	1880	25.67	-6	19.67
	1909.8	25.71	-6	19.71
GPRS1900 (3 Slot)	1850.2	24.06	-4.26	19.80
	1880	23.87	-4.26	19.61
	1909.8	23.91	-4.26	19.65
GPRS1900 (4 Slot)	1850.2	22.66	-3	19.66
	1880	22.65	-3	19.65
	1909.8	22.72	-3	19.72
Maximum Power <2>				
PCS1900	1850.2	27.10	-9	18.10
	1880	27.15	-9	18.15
	1909.8	27.02	-9	18.02
GPRS1900 (1 Slot)	1850.2	27.02	-9	18.02
	1880	27.01	-9	18.01
	1909.8	27.06	-9	18.06
GPRS1900 (2 Slot)	1850.2	25.33	-6	19.33
	1880	25.35	-6	19.35
	1909.8	25.30	-6	19.30
GPRS1900 (3 Slot)	1850.2	23.56	-4.26	19.30
	1880	23.85	-4.26	19.59
	1909.8	23.75	-4.26	19.49
GPRS1900 (4 Slot)	1850.2	22.45	-3	19.45
	1880	22.52	-3	19.52
	1909.8	22.50	-3	19.50

Note 1:

The Frame Power (Source-based time-averaged Power) is scaled the maximum burst average power based on time slots. The calculated methods are show as following:

Frame Power = Max burst power (1 Up Slot) – 9 dB

Frame Power = Max burst power (2 Up Slot) – 6 dB

Frame Power = Max burst power (3 Up Slot) – 4.26 dB

Frame Power = Max burst power (4 Up Slot) – 3 dB

Note 2:

SAR is not required for GPRS (1 Slot) Mode because its output power is less than of Voice Mode

UMTS BAND

HSDPA Setup Configuration:

- The EUT was connected to Base Station Agilent E5515C referred to the Setup Configuration.
- The RF path losses were compensated into the measurements.
- A call was established between EUT and Based Station with following setting:
 - (1) Set Gain Factors(β_c and β_d) parameters set according to each
 - (2) Set RMC 12.2Kbps+HSDPA mode.
 - (3) Set Cell Power=-86dBm
 - (4) Set HS-DSCH Configuration Type to FRC (H-set 1, QPSK)
 - (5) Select HSDPA Uplink Parameters
 - (6) Set Delta ACK, Delta NACK and Delta CQI=8
 - (7) Set Ack - Nack Repetition Factor to 3
 - (8) Set CQI Feedback Cycle (k) to 4ms
 - (9) Set CQI Repetition Factor to 2
 - (10) Power Ctrl Mode=All Up bits
- The transmitted maximum output power was recorded.

Table C.10.2.4: β values for transmitter characteristics tests with HS-DPCCH

Sub-test	β_c (Note5)	β_d	β_d (SF)	β_c/β_d	β_{HS} (Note1, Note 2)	CM (dB) (Note 3)	MPR (dB) (Note 3)
1	2/15	15/15	64	2/15	4/15	0.0	0.0
2	12/15(Note 4)	15/15(Note 4)	64	12/15(Note 4)	24/15	1.0	0.0
3	15/15	8/15	64	15/8	30/15	1.5	0.5
4	15/15	4/15	64	15/4	30/15	1.5	0.5

Note 1: $\Delta ACK, \Delta NACK$ and $\Delta CQI = 30/15$ with $\beta_{hs} = 30/15 * \beta_c$.

Note 2: For the HS-DPCCH power mask requirement test in clause 5.2C, 5.7A, and the Error Vector Magnitude (EVM) with HS-DPCCH test in clause 5.13.1A, and HSDPA EVM with phase discontinuity in clause 5.13.1AA, ΔACK and $\Delta NACK = 30/15$ with $\beta_{hs} = 30/15 * \beta_c$, and $\Delta CQI = 24/15$ with $\beta_{hs} = 24/15 * \beta_c$.

Note 3: CM = 1 for $\beta_c/\beta_d = 12/15$, $\square_{hs}/\square_c = 24/15$. For all other combinations of DPDCH, DPCCH and HS-DPCCH the MPR is based on the relative CM difference. This is applicable for only UEs that support HSDPA in release 6 and later releases.

Note 4: For subtest 2 the \square_c/\square_d ratio of 12/15 for the TFC during the measurement period (TF1, TF0) is achieved by setting the signalled gain factors for the reference TFC (TF1, TF1) to $\square_c = 11/15$ and $\square_d = 15/15$.

HSUPA Setup Configuration:

- The EUT was connected to Base Station Agilent E5515C referred to the Setup Configuration.
- The RF path losses were compensated into the measurements.
- A call was established between EUT and Base Station with following setting * :
 - (1) Call Configs = 5.2B, 5.9B, 5.10B, and 5.13.2B with QPSK
 - (2) Set the Gain Factors (β_c and β_d) and parameters (AG Index) were set according to each specific sub-test in the following table, C11.1.3, quoted from the TS 34.121
 - (3) Set Cell Power = -86 dBm
 - (4) Set Channel Type = 12.2k + HSPA
 - (5) Set UE Target Power
 - (6) Power Ctrl Mode= Alternating bits
 - (7) Set and observe the E-TFCI
 - (8) Confirm that E-TFCI is equal to the target E-TFCI of 75 for sub-test 1, and other subtest's E-TFCI
- The transmitted maximum output power was recorded.

Table C.11.1.3: β values for transmitter characteristics tests with HS-DPCCH and E-DCH

Sub-test	β_c	β_d	β_d (SF)	β_c/β_d	β_{HS} (Note 1)	β_{ec}	β_{ed} (Note 4) (Note 5)	β_{ed} (SF)	β_{ed} (Code s)	CM (dB) (Note 2)	MPR (dB) (Note 2) (Note 6)	AG Index (Note 5)	E-TF CI
1	11/15 (Note 3)	15/15 (Note 3)	64	11/15 (Note 3)	22/15	209/225	1309/225	4	1	1.0	0.0	20	75
2	6/15	15/15	64	6/15	12/15	12/15	94/75	4	1	3.0	2.0	12	67
3	15/15	9/15	64	15/9	30/15	30/15	β_{ed1} : 47/15 β_{ed2} : 47/15	4 4	2	2.0	1.0	15	92
4	2/15	15/15	64	2/15	4/15	2/15	56/75	4	1	3.0	2.0	17	71
5	15/15	0	-	-	5/15	5/15	47/15	4	1	1.0	0.0	12	67

Note 1: For sub-test 1 to 4, ΔACK , $\Delta NACK$ and $\Delta CQI = 30/15$ with $\beta_{hs} = 30/15 * \beta_c$. For sub-test 5, ΔACK , $\Delta NACK$ and $\Delta CQI = 5/15$ with $\beta_{hs} = 5/15 * \beta_c$.

Note 2: CM = 1 for $\beta_c/\beta_d = 12/15$, $\square_{hs}/\square_c = 24/15$. For all other combinations of DPDCH, DPCCH, HS DPCCH, E-DPDCH and E-DPCCH the MPR is based on the relative CM difference.

Note 3: For subtest 1 the \square_c/\square_d ratio of 11/15 for the TFC during the measurement period (TF1, TF0) is achieved by setting the signalled gain factors for the reference TFC (TF1, TF1) to $\square_c = 10/15$ and $\square_d = 15/15$.

Note 4: In case of testing by UE using E-DPDCH Physical Layer category 1, Sub-test 3 is omitted according to TS25.306 Table 5.1g.

Note 5: β_{ed} cannot be set directly; it is set by Absolute Grant Value.

Note 6: For subtests 2, 3 and 4, UE may perform E-DPDCH power scaling at max power which could results in slightly smaller MPR values.

UMTS BAND II

Mode	Frequency (MHz)	Avg. Burst Power (dBm)
WCDMA 1900 RMC	1852.4	20.21
	1880	20.33
	1907.6	20.31
WCDMA 1900 AMR	1852.4	20.10
	1880	20.15
	1907.6	20.18
HSDPA Subtest 1	1852.4	19.86
	1880	19.69
	1907.6	19.73
HSDPA Subtest 2	1852.4	19.72
	1880	19.91
	1907.6	19.73
HSDPA Subtest 3	1852.4	19.41
	1880	19.70
	1907.6	19.76
HSDPA Subtest 4	1852.4	19.73
	1880	19.58
	1907.6	19.71
HSUPA Subtest 1	1852.4	19.64
	1880	19.55
	1907.6	19.63
HSUPA Subtest 2	1852.4	19.47
	1880	19.54
	1907.6	19.65
HSUPA Subtest 3	1852.4	19.78
	1880	19.51
	1907.6	19.57
HSUPA Subtest 4	1852.4	19.69
	1880	19.80
	1907.6	19.71
HSUPA Subtest 5	1852.4	19.47
	1880	19.63
	1907.6	19.77

UMTS BAND IV

Mode	Frequency (MHz)	Avg. Burst Power (dBm)
WCDMA 1700 RMC	1712.5	20.33
	1732.5	20.21
	1752.5	20.32
WCDMA 1700 AMR	1712.5	20.19
	1732.5	19.65
	1752.5	19.21
HSDPA Subtest 1	1712.5	19.76
	1732.5	19.69
	1752.5	19.88
HSDPA Subtest 2	1712.5	19.52
	1732.5	19.89
	1752.5	19.64
HSDPA Subtest 3	1712.5	19.44
	1732.5	19.69
	1752.5	19.83
HSDPA Subtest 4	1712.5	19.74
	1732.5	19.52
	1752.5	19.61
HSUPA Subtest 1	1712.5	19.28
	1732.5	19.56
	1752.5	19.50
HSUPA Subtest 2	1712.5	19.45
	1732.5	19.47
	1752.5	19.76
HSUPA Subtest 3	1712.5	19.75
	1732.5	19.54
	1752.5	19.61
HSUPA Subtest 4	1712.5	19.61
	1732.5	19.84
	1752.5	19.75
HSUPA Subtest 5	1712.5	19.26
	1732.5	19.69
	1752.5	19.60

UMTS BAND V

Mode	Frequency (MHz)	Avg. Burst Power (dBm)
WCDMA 850 RMC	826.4	20.64
	836.6	20.63
	846.6	20.72
WCDMA 850 AMR	826.4	20.08
	836.6	19.91
	846.6	19.83
HSDPA Subtest 1	826.4	19.74
	836.6	19.64
	846.6	19.78
HSDPA Subtest 2	826.4	19.97
	836.6	19.69
	846.6	19.36
HSDPA Subtest 3	826.4	19.51
	836.6	19.52
	846.6	19.79
HSDPA Subtest 4	826.4	19.63
	836.6	19.60
	846.6	19.61
HSUPA Subtest 1	826.4	19.70
	836.6	19.41
	846.6	19.60
HSUPA Subtest 2	826.4	19.55
	836.6	19.59
	846.6	19.82
HSUPA Subtest 3	826.4	19.58
	836.6	19.86
	846.6	19.31
HSUPA Subtest 4	826.4	19.70
	836.6	19.42
	846.6	19.37
HSUPA Subtest 5	826.4	19.41
	836.6	19.37
	846.6	19.41

According to 3GPP 25.101 sub-clause 6.2.2 , the maximum output power is allowed to be reduced by following the table.

Table 6.1aA: UE maximum output power with HS-DPCCH and E-DCH

UE Transmit Channel Configuration	CM(db)	MPR(db)
For all combinations of ,DPDCH,DPCCH HS-DPDCH,E-DPDCH and E-DPCCH	$0 \leq CM \leq 3.5$	$MAX(CM-1,0)$
Note: CM=1 for $\beta_d/\beta_{d'}=12/15$, $\beta_{hs}/\beta_c=24/15$.For all other combinations of DPDCH, DPCCH, HS-DPCCH, E-DPDCH and E-DPCCH the MPR is based on the relative CM difference.		

The device supports MPR to solve linearity issues (ACLR or SEM) due to the higher peak-to average ratios (PAR) of the HSUPA signal. This prevents saturating the full range of the TX DAC inside of device and provides a reduced power output to the RF transceiver chip according to the Cubic Metric (a function of the combinations of DPDCH, DPCCH, HS-DPCCH, E-DPDCH and E-DPCCH).

When E-DPDCH channels are present the beta gains on those channels are reduced firsts to try to get the power under the allowed limit. If the beta gains are lowered as far as possible, then a hard limiting is applied at the maximum allowed level.

The SW currently recalculates the cubic metric every time the beta gains on the E-DPDCH are reduced. The cubic metric will likely get lower each time this is done .However, there is no reported reduction of maximum output power in the HSUPA mode since the device also provides a compensation for the power back-off by increasing the gain of TX_AGC in the transceiver (PA) device.

The end effect is that the DUT output power is identical to the case where there is no MPR in the device.

WIFI

Mode	Data Rate (Mbps)	Channel	Frequency(MHz)	Avg. Burst Power(dBm)
802.11b	1	01	2412	15.83
		06	2437	15.73
		11	2462	16.37
802.11g	6	01	2412	12.07
		06	2437	13.77
		11	2462	14.14
802.11n(20)	6.5	01	2412	11.56
		06	2437	13.71
		11	2462	14.01
802.11n(40)	13.5	03	2422	13.66
		06	2437	13.46
		09	2452	13.45

Bluetooth_V3.0

Modulation	Channel	Frequency(MHz)	Peak Power (dBm)
GFSK	0	2402	4.227
	39	2441	4.961
	78	2480	4.973
π /4-DQPSK	0	2402	3.551
	39	2441	4.402
	78	2480	4.424
8-DPSK	0	2402	3.042
	39	2441	3.993
	78	2480	3.891

Bluetooth_V4.0

Modulation	Channel	Frequency(MHz)	Peak Power (dBm)
GFSK	0	2402	-3.542
	19	2440	-2.635
	39	2480	-2.624

12. TEST RESULTS

12.1. SAR Test Results Summary

12.1.1. Test position and configuration

Head SAR was performed with the device configured in the positions according to IEEE 1528-2013, Body-worn SAR was performed with the device 5mm from the phantom, and 4 Edges SAR was performed with the device 10mm from the phantom.

12.1.2. Operation Mode

1. Per KDB 447498 D01 v06 ,for each exposure position, if the highest 1-g SAR is ≤ 0.8 W/kg, testing for low and high channel is optional.
2. Per KDB 865664 D01 v01r04,for each frequency band, if the measured SAR is ≥ 0.8 W/Kg, testing for repeated SAR measurement is required , that the highest measured SAR is only to be tested. When the SAR results are near the limit, the following procedures are required for each device to verify these types of SAR measurement related variation concerns by repeating the highest measured SAR configuration in each frequency band.
 - (1) When the original highest measured SAR is ≥ 0.8 W/Kg, repeat that measurement once.
 - (2) Perform a second repeated measurement only if the ratio of largest to smallest SAR for the original and first repeated measurements is >1.20 or when the original or repeated measurement is ≥ 1.45 W/Kg.
 - (3) Perform a third repeated measurement only if the original, first and second repeated measurement is ≥ 1.5 W/Kg and ratio of largest to smallest SAR for the original, first and second measurement is ≥ 1.20 .
3. Body-worn exposure conditions are intended to voice call operations, therefore GSM voice call mode is selected to be test.
4. Per KDB 648474 D04 v01r03,when the reported SAR for a body-worn accessory measured without a headset connected to the handset is ≤ 1.2 W/Kg, SAR testing with a headset connected is not required.
5. Per KDB 248227 D01v02r02,for 2.4GHz 802.11g/n SAR testing is not required when the highest reported SAR for DSSS is adjusted by the ratio of OFDM to DSSS specified maximum output power and the adjusted SAR is ≤ 1.2 W/kg.
6. Per KDB 941225 D06 V02r01, When the same wireless mode transmission configurations for voice and data are required for SAR measurements, the more conservative configuration with a smaller separation distance should be tested for the overlapping SAR configurations.
7. Maximum Scaling SAR in order to calculate the Maximum SAR values to test under the standard Peak Power, Calculation method is as follows:
Maximum Scaling SAR =tested SAR (Max.) \times [maximum turn-up power (mw)/ maximum measurement output power(mw)]
8. Proximity sensor, just for avoiding the wrong operation in the phone screen when call, and has no influence on output power or SAR resu

12.1.3. Test Result

SAR MEASUREMENT									
Depth of Liquid (cm):>15					Relative Humidity (%): 55.5				
Product: Smart Phone									
Test Mode: GSM850 with GMSK modulation									
Position	Mode	Ch.	Fr. (MHz)	Power Drift (<±5%)	SAR (1g) (W/kg)	Max. Tune-up Power (dBm)	Meas. output Power (dBm)	Scaled SAR (W/Kg)	Limit (W/kg)
SIM 1 Card									
Left Cheek	voice	190	836.6	-0.22	0.265	31.50	31.31	0.277	1.6
Left Tilt	voice	190	836.6	0.23	0.113	31.50	31.31	0.118	1.6
Right Cheek	voice	190	836.6	1.22	0.211	31.50	31.31	0.220	1.6
Right Tilt	voice	190	836.6	0.02	0.128	31.50	31.31	0.134	1.6
Body back	voice	190	836.6	-0.36	0.720	31.50	31.31	0.752	1.6
Body front	voice	190	836.6	1.85	0.619	31.50	31.31	0.647	1.6
SIM 2 Card									
Left Cheek	GPRS-3 slot	190	836.6	0.23	0.349	26.96	26.75	0.366	1.6
Left Tilt	GPRS-3 slot	190	836.6	-0.12	0.170	26.96	26.75	0.178	1.6
Right Cheek	GPRS-3 slot	190	836.6	1.23	0.279	26.96	26.75	0.293	1.6
Right Tilt	GPRS-3 slot	190	836.6	0.02	0.182	26.96	26.75	0.191	1.6
Body back	GPRS-3 slot	128	824.2	0.23	0.604	26.96	26.96	0.604	1.6
Body back	GPRS-3 slot	190	836.6	-1.56	0.775	26.96	26.75	0.813	1.6
Body back	GPRS-3 slot	251	848.8	0.12	0.892	26.96	26.94	0.896	1.6
Body front	GPRS-3 slot	190	836.6	1.55	0.703	26.96	26.75	0.738	1.6
Edge 1 (Top)	GPRS-3 slot	190	836.6	0.02	0.038	26.96	26.75	0.040	1.6
Edge 2(Right)	GPRS-3 slot	190	836.6	-0.56	0.148	26.96	26.75	0.155	1.6
Edge 3(Bottom)	GPRS-3 slot	190	836.6	0.32	0.181	26.96	26.75	0.190	1.6
Edge 4(Left)	GPRS-3 slot	190	836.6	-0.51	0.310	26.96	26.75	0.325	1.6
SIM 2 Card									
Left Cheek	GPRS-3 slot	190	836.6	-0.23	0.340	26.96	26.73	0.358	1.6
Body back	GPRS-3 slot	251	848.8	-0.36	0.845	26.96	26.90	0.857	1.6

Note:

- When the 1-g Reported SAR is ≤ 0.8 W/kg, testing for low and high channel is optional. Refer to KDB 447498.
- The test separation for body back and body front is 5mm of all above table.
- The test separation for 4 Edges is 10mm of all above table.

SAR MEASUREMENT									
Depth of Liquid (cm):>15					Relative Humidity (%): 56.7				
Product: Smart Phone									
Test Mode: PCS1900 with GMSK modulation									
Position	Mode	Ch.	Fr. (MHz)	Power Drift (<±5%)	SAR (1g) (W/kg)	Max. Tune-up Power (dBm)	Meas. output Power (dBm)	Scaled SAR (W/Kg)	Limit (W/kg)
SIM 1 Card									
Left Cheek	voice	661	1880.0	-0.22	0.153	28.43	28.13	0.164	1.6
Left Tilt	voice	661	1880.0	0.02	0.060	28.43	28.13	0.064	1.6
Right Cheek	voice	661	1880.0	0.23	0.133	28.43	28.13	0.143	1.6
Right Tilt	voice	661	1880.0	-1.66	0.047	28.43	28.13	0.050	1.6
Body back	voice	661	1880.0	-0.32	0.709	28.43	28.13	0.760	1.6
Body front	voice	661	1880.0	0.45	0.628	28.43	28.13	0.673	1.6
Left Cheek	GPRS-3 slot	661	1880.0	-1.96	0.125	24.06	23.87	0.131	1.6
Left Tilt	GPRS-3 slot	661	1880.0	0.23	0.064	24.06	23.87	0.067	1.6
Right Cheek	GPRS-3 slot	661	1880.0	0.14	0.145	24.06	23.87	0.151	1.6
Right Tilt	GPRS-3 slot	661	1880.0	0.65	0.046	24.06	23.87	0.048	1.6
Body back	GPRS-3 slot	661	1880.0	0.32	0.518	24.06	23.87	0.541	1.6
Body front	GPRS-3 slot	661	1880.0	-0.15	0.507	24.06	23.87	0.530	1.6
Edge 1 (Top)	GPRS-3 slot	661	1880.0	0.66	0.005	24.06	23.87	0.005	1.6
Edge 2(Right)	GPRS-3 slot	661	1880.0	-0.32	0.117	24.06	23.87	0.122	1.6
Edge 3(Bottom)	GPRS-3 slot	512	1850.2	0.42	0.983	24.06	24.06	0.983	1.6
Edge 3(Bottom)	GPRS-3 slot	661	1880.0	0.96	1.077	24.06	23.87	1.125	1.6
Edge 3(Bottom)	GPRS-3 slot	810	1909.8	-0.41	1.057	24.06	23.91	1.094	1.6
Edge 4(Left)	GPRS-3 slot	661	1880.0	0.26	0.076	24.06	23.87	0.079	1.6
SIM 2 Card									
Left Cheek	voice	661	1880.0	-0.53	0.120	28.43	27.15	0.161	1.6
Edge 3(Bottom)	GPRS-3 slot	661	1880.0	-0.32	1.058	24.06	23.85	1.110	1.6

Note:

- When the 1-g Reported SAR is ≤ 0.8 W/kg, testing for low and high channel is optional. Refer to KDB 447498.
- The test separation for body back and body front is 5mm of all above table.
- The test separation for 4 Edges is 10mm of all above table.

SAR MEASUREMENT									
Depth of Liquid (cm):>15					Relative Humidity (%): 56.7				
Product: Smart Phone									
Test Mode: WCDMA Band II with QPSK modulation									
Position	Mode	Ch.	Fr. (MHz)	Power Drift ($\pm 5\%$)	SAR (1g) (W/kg)	Max. Tune-up Power (dBm)	Meas. output Power (dBm)	Scaled SAR (W/Kg)	Limit (W/kg)
Left Cheek	RMC 12.2kbps	9400	1880	-0.52	0.118	20.33	20.33	0.118	1.6
Left Tilt	RMC 12.2kbps	9400	1880	0.32	0.125	20.33	20.33	0.125	1.6
Right Cheek	RMC 12.2kbps	9400	1880	-0.23	0.235	20.33	20.33	0.235	1.6
Right Tilt	RMC 12.2kbps	9400	1880	-0.52	0.057	20.33	20.33	0.057	1.6
Body back	RMC 12.2kbps	9262	1852.4	0.23	0.864	20.33	20.21	0.888	1.6
Body back	RMC 12.2kbps	9400	1880	-1.56	0.934	20.33	20.33	0.934	1.6
Body back	RMC 12.2kbps	9538	1907.6	-0.36	0.947	20.33	20.31	0.951	1.6
Body front	RMC 12.2kbps	9400	1880	-1.22	0.529	20.33	20.33	0.529	1.6
Edge 1 (Top)	RMC 12.2kbps	9400	1880	0.02	0.003	20.33	20.33	0.003	1.6
Edge 2(Right)	RMC 12.2kbps	9400	1880	0.23	0.133	20.33	20.33	0.133	1.6
Edge 3(Bottom)	RMC 12.2kbps	9400	1880	-0.02	0.546	20.33	20.33	0.546	1.6
Edge 4(Left)	RMC 12.2kbps	9400	1880	0.35	0.101	20.33	20.33	0.101	1.6

Note:

- When the 1-g Reported SAR is ≤ 0.8 W/kg, testing for low and high channel is optional. Refer to KDB 447498.
- The test separation for body back and body front is 5mm of all above table.
- The test separation for 4 Edges is 10mm of all above table.

SAR MEASUREMENT									
Depth of Liquid (cm):>15					Relative Humidity (%): 51.4				
Product: Smart Phone									
Test Mode: WCDMA Band IV with QPSK modulation									
Position	Mode	Ch.	Fr. (MHz)	Power Drift ($\pm 5\%$)	SAR (1g) (W/kg)	Max. Tune-up Power (dBm)	Meas. output Power (dBm)	Scaled SAR (W/Kg)	Limit (W/kg)
Left Cheek	RMC 12.2kbps	8662	1732.5	-0.22	0.114	20.33	20.21	0.117	1.6
Left Tilt	RMC 12.2kbps	8662	1732.5	0.32	0.091	20.33	20.21	0.094	1.6
Right Cheek	RMC 12.2kbps	8662	1732.5	1.22	0.269	20.33	20.21	0.277	1.6
Right Tilt	RMC 12.2kbps	8662	1732.5	0.02	0.051	20.33	20.21	0.052	1.6
Body back	RMC 12.2kbps	8562	1712.5	-0.53	0.849	20.33	20.33	0.849	1.6
Body back	RMC 12.2kbps	8662	1732.5	0.36	0.919	20.33	20.21	0.945	1.6
Body back	RMC 12.2kbps	8763	1752.5	0.45	0.887	20.33	20.32	0.889	1.6
Body front	RMC 12.2kbps	8662	1732.5	-0.26	0.669	20.33	20.21	0.688	1.6
Edge 1 (Top)	RMC 12.2kbps	8662	1732.5	-0.32	0.008	20.33	20.21	0.008	1.6
Edge 2(Right)	RMC 12.2kbps	8662	1732.5	1.55	0.197	20.33	20.21	0.203	1.6
Edge 3(Bottom)	RMC 12.2kbps	8562	1712.5	-0.02	0.848	20.33	20.33	0.848	1.6
Edge 3(Bottom)	RMC 12.2kbps	8662	1732.5	0.32	0.851	20.33	20.21	0.875	1.6
Edge 3(Bottom)	RMC 12.2kbps	8763	1752.5	-0.59	0.865	20.33	20.32	0.867	1.6
Edge 4(Left)	RMC 12.2kbps	8662	1732.5	-0.23	0.109	20.33	20.21	0.112	1.6

Note:

- When the 1-g Reported SAR is ≤ 0.8 W/kg, testing for low and high channel is optional. Refer to KDB 447498.
- The test separation for body back and body front is 5mm of all above table.
- The test separation for 4 Edges is 10mm of all above table.

SAR MEASUREMENT									
Depth of Liquid (cm):>15					Relative Humidity (%): 55.5				
Product: Smart Phone									
Test Mode: WCDMA Band V with QPSK modulation									
Position	Mode	Ch.	Fr. (MHz)	Power Drift (<±5%)	SAR (1g) (W/kg)	Max. Tune-up Power (dBm)	Meas. output Power (dBm)	Scaled SAR (W/Kg)	Limit (W/kg)
Left Cheek	RMC 12.2kbps	4183	836.6	-0.23	0.042	20.72	20.63	0.043	1.6
Left Tilt	RMC 12.2kbps	4183	836.6	0.63	0.018	20.72	20.63	0.018	1.6
Right Cheek	RMC 12.2kbps	4183	836.6	0.23	0.176	20.72	20.63	0.180	1.6
Right Tilt	RMC 12.2kbps	4183	836.6	-1.55	0.112	20.72	20.63	0.114	1.6
Body back	RMC 12.2kbps	4183	836.6	0.23	0.202	20.72	20.63	0.206	1.6
Body front	RMC 12.2kbps	4183	836.6	0.45	0.135	20.72	20.63	0.138	1.6
Edge 1 (Top)	RMC 12.2kbps	4183	836.6	-0.61	0.055	20.72	20.63	0.056	1.6
Edge 2(Right)	RMC 12.2kbps	4183	836.6	0.53	0.016	20.72	20.63	0.016	1.6
Edge 3(Bottom)	RMC 12.2kbps	4183	836.6	0.56	0.013	20.72	20.63	0.013	1.6
Edge 4(Left)	RMC 12.2kbps	4183	836.6	-0.36	0.044	20.72	20.63	0.045	1.6

Note:

- When the 1-g Reported SAR is ≤ 0.8 W/kg, testing for low and high channel is optional. Refer to KDB 447498.
- The test separation for body back and body front is 5mm of all above table.
- The test separation for 4 Edges is 10mm of all above table.

SAR MEASUREMENT									
Depth of Liquid (cm):>15					Relative Humidity (%): 52.7				
Product: Smart Phone									
Test Mode:802.11b									
Position	Mode	Ch.	Fr. (MHz)	Power Drift (<±5%)	SAR (1g) (W/kg)	Max. Tune-up Power (dBm)	Meas. output Power (dBm)	Scaled SAR (W/Kg)	Limit (W/kg)
Left Cheek	DTS	11	2462	-0.55	0.117	16.37	16.37	0.117	1.6
Left Tilt	DTS	11	2462	0.23	0.078	16.37	16.37	0.078	1.6
Right Cheek	DTS	11	2462	1.63	0.062	16.37	16.37	0.062	1.6
Right Tilt	DTS	11	2462	-0.23	0.037	16.37	16.37	0.037	1.6
Body back	DTS	11	2462	0.02	0.226	16.37	16.37	0.226	1.6
Body front	DTS	11	2462	0.52	0.030	16.37	16.37	0.030	1.6
Edge 1 (Top)	DTS	11	2462	-0.23	0.042	16.37	16.37	0.042	1.6
Edge 2(Right)	DTS	11	2462	1.33	0.104	16.37	16.37	0.104	1.6
Edge 3(Bottom)	DTS	11	2462	-0.26	0.007	16.37	16.37	0.007	1.6
Edge 4(Left)	DTS	11	2462	-0.31	0.055	16.37	16.37	0.055	1.6

Note:

- According to KDB248227, SAR is not required for 802.11n HT20/HT40 channels when the maximum average output power is less than 1/4 dB higher than that measured on the corresponding 802.11a/b channels.
- All of above "DTS" means data transmitters.
- The test separation for body back and body front is 5mm of all above table.
- The test separation for 4 Edges is 10mm of all above table.

Repeated SAR										
Product: Smart Phone										
Test Mode: GSM850 & PCS1900& WCDMA Band IV										
Position	Mode	Ch.	Fr. (MHz)	Power Drift (<±5%)	Once SAR (1g) (W/kg)	Power Drift (<±5%)	Twice SAR (1g) (W/kg)	Power Drift (<±5%)	Third SAR (1g) (W/kg)	Limit (W/kg)
Body back	GPRS-3 slot	251	848.8	0.32	0.830	--	--	--	--	1.6
Edge 3(Bottom)	GPRS-3 slot	661	1880.0	1.55	0.999	--	--	--	--	1.6
Body back	RMC 12.2kbps	9538	1907.6	0.22	0.944	--	--	--	--	1.6
Body back	RMC 12.2kbps	8662	1732.5	0.36	0.893	--	--	--	--	1.6

Simultaneous Multi-band Transmission Evaluation:
Application Simultaneous Transmission information:

NO	Simultaneous state	Portable Handset		
		Head	Body-worn	Hotspot
1	GSM(voice)+WLAN 2.4GHz (data)	Yes	Yes	-
2	WCDMA(voice)+WLAN 2.4GHz (data)	Yes	Yes	-
3	GSM(voice)+Bluetooth(data)	-	Yes	-
4	WCDMA(voice)+Bluetooth(data)	-	Yes	-
5	GSM (Data) + Bluetooth(data)	-	Yes	Yes
6	GSM (Data) + WLAN 2.4GHz (data)	Yes	Yes	Yes
7	WCDMA (Data) + Bluetooth(data)	--	Yes	Yes
8	WCDMA (Data) + WLAN 2.4GHz (data)	Yes	Yes	Yes

NOTE:

1. WIFI and BT share the same antenna, and cannot transmit simultaneously.
2. Simultaneous with every transmitter must be the same test position.
3. KDB 447498 D01, BT SAR is excluded as below table.
4. KDB 447498 D01, for handsets the test separation distance is determined by the smallest distance between the outer surface of the device and the user; which is 0mm for head SAR and 5mm for body-worn SAR.
5. According to KDB 447498 D01 4.3.1, Standalone SAR test exclusion is as follow:
For 100 MHz to 6 GHz and test separation distances ≤ 50 mm, the 1-g and 10-g SAR test exclusion thresholds are determined by the following:

$$[(\text{max. power of channel, including tune-up tolerance, mW}) / (\text{min. test separation distance, mm})] \cdot [\sqrt{f(\text{GHz})}] \leq 3.0$$
for 1-g SAR, and ≤ 7.5 for 10-g extremity SAR³⁰, where
 - f(GHz) is the RF channel transmit frequency in GHz
 - Power and distance are rounded to the nearest mW and mm before calculation³¹
 - The result is rounded to one decimal place for comparison
 - The values 3.0 and 7.5 are referred to as numeric thresholds in step b) below
The test exclusions are applicable only when the minimum test separation distance is ≤ 50 mm, and for transmission frequencies between 100 MHz and 6 GHz. When the minimum test separation distance is < 5 mm, a distance of 5 mm according to 4.1 f) is applied to determine SAR test exclusion.
6. If the test separation distance is < 5 mm, 5mm is used for excluded SAR calculation.
7. According to KDB 447498 D01 4.3.2, simultaneous transmission SAR test exclusion is as follow:
 - (1) Simultaneous transmission SAR test exclusion is determined for each operating configuration and exposure condition according to the reported standalone SAR of each applicable simultaneous transmitting antenna.
 - (2) Any transmitters and antennas should be considered when calculating simultaneous mode.
 - (3) For mobile phone and PC, it's the sum of all transmitters and antennas at the same mode with same position in each applicable exposure condition
 - (4) When the standalone SAR test exclusion of section 4.3.2 is applied to an antenna that transmits simultaneously with other antennas, the standalone SAR must be estimated according to the following to det

$$(\text{max. power of channel, including tune-up tolerance, mW}) / (\text{min. test separation distance, mm}) \cdot [\sqrt{f(\text{GHz})} / x] \text{ W/kg}$$
for test separation distances ≤ 50 mm;
where $x = 7.5$ for 1-g SAR, and $x = 18.75$ for 10-g SAR.

8. When the sum of SAR is larger than the limit, SAR test exclusion is determined by the SAR to peak location separation ratio. The simultaneous transmitting antennas in each operating mode and exposure condition combination must be considered one pair at a time to determine the SAR to peak location separation ratio to qualify for test exclusion. The ratio is determined by $(SAR1 + SAR2)1.5/R_i$, rounded to two decimal digits, and must be ≤ 0.04 for all antenna pairs in the configuration to qualify for 1-g SAR test exclusion.

Estimated SAR		Max Power including Tune-up Tolerance		Separation Distance (mm)	Estimated SAR (W/kg)
		dBm	mW		
BT	Head	5	3.162	0	0.133
	Body	5	3.162	5	0.133
				10	0.066

Sum of the SAR for GSM 850 & Wi-Fi & BT:

RF Exposure Conditions	Test Position	Simultaneous Transmission Scenario			Σ1-g SAR (W/Kg)	SPLSR (Yes/No)
		GSM 850	Wi-Fi DTS Band	Bluetooth		
Head (voice)	Left Touch	0.277	0.117		0.394	No
	Left Tilt	0.118	0.078		0.196	No
	Right Touch	0.220	0.062		0.282	No
	Right Tilt	0.134	0.037		0.171	No
Body-worn (voice)	Rear	0.752	0.226		0.978	No
		0.752		0.133	0.885	No
	Front	0.647	0.030		0.677	No
		0.647		0.133	0.780	No
Head (Data)	Left Touch	0.366	0.117		0.483	No
	Left Tilt	0.178	0.078		0.256	No
	Right Touch	0.293	0.062		0.355	No
	Right Tilt	0.191	0.037		0.228	No
Body-worn (Data)	Rear	0.896		0.133	1.029	No
		0.896	0.226		1.122	No
	Front	0.738		0.133	0.871	No
		0.738	0.030		0.768	No
Body-worn (Hotspot)	Edge 1	0.040	0.042		0.082	No
	Edge 2	0.155	0.104		0.259	No
	Edge 3	0.190	0.007		0.197	No
	Edge 4	0.325	0.055		0.380	No
	Edge 1	0.040		0.066	0.106	No
	Edge 2	0.155		0.066	0.221	No
	Edge 3	0.190		0.066	0.256	No
	Edge 4	0.325		0.066	0.391	No

Note:

- According to KDB 447498 D01 General RF Exposure Guidance, when the simultaneous transmission SAR is less than 1.6 W/Kg, SPLSR assessment is not required.
- SPLSR mean is “The SAR to Peak Location Separation Ratio “

Sum of the SAR for PCS 1900 & Wi-Fi & BT:

RF Exposure Conditions	Test Position	Simultaneous Transmission Scenario			Σ1-g SAR (W/Kg)	SPLSR (Yes/No)
		PCS 1900	Wi-Fi DTS Band	Bluetooth		
Head (voice)	Left Touch	0.164	0.117		0.281	No
	Left Tilt	0.064	0.078		0.142	No
	Right Touch	0.143	0.062		0.205	No
	Right Tilt	0.050	0.037		0.087	No
Body-worn (voice)	Rear	0.760	0.226		0.986	No
		0.760		0.133	0.893	No
	Front	0.673	0.030		0.703	No
		0.673		0.133	0.806	No
Head (Data)	Left Touch	0.131	0.117		0.248	No
	Left Tilt	0.067	0.078		0.145	No
	Right Touch	0.151	0.062		0.213	No
	Right Tilt	0.048	0.037		0.085	No
Body-worn (Data)	Rear	0.541		0.133	0.674	No
		0.541	0.226		0.767	No
	Front	0.530		0.133	0.663	No
		0.530	0.030		0.560	No
Body-worn (Hotspot)	Edge 1	0.005	0.042		0.047	No
	Edge 2	0.122	0.104		0.226	No
	Edge 3	1.125	0.007		1.132	No
	Edge 4	0.079	0.055		0.134	No
	Edge 1	0.005		0.066	0.071	No
	Edge 2	0.122		0.066	0.188	No
	Edge 3	1.125		0.066	1.191	No
	Edge 4	0.079		0.066	0.145	No

Note:

- According to KDB 447498 D01 General RF Exposure Guidance, when the simultaneous transmission SAR is less than 1.6 W/Kg, SPLSR assessment is not required.
- SPLSR mean is "The SAR to Peak Location Separation Ratio "

Sum of the SAR for WCDMA Band II&Wi-Fi & BT:

RF Exposure Conditions	Test Position	Simultaneous Transmission Scenario			Σ1-g SAR (W/Kg)	SPLSR (Yes/No)
		WCDMA Band II	Wi-Fi DTS Band	Bluetooth		
Head	Left Touch	0.118	0.117		0.235	No
	Left Tilt	0.125	0.078		0.203	No
	Right Touch	0.235	0.062		0.297	No
	Right Tilt	0.057	0.037		0.094	No
Body-worn	Rear	0.951	0.226		1.177	No
	Front	0.529	0.030		0.559	No
	Edge 1	0.003	0.042		0.045	No
	Edge 2	0.133	0.104		0.237	No
	Edge 3	0.546	0.007		0.553	No
	Edge 4	0.101	0.055		0.156	No
	Rear	0.951		0.133	1.084	No
	Front	0.529		0.133	0.662	No
	Edge 1	0.003		0.066	0.069	No
	Edge 2	0.133		0.066	0.199	No
	Edge 3	0.546		0.066	0.612	No
	Edge 4	0.101		0.066	0.167	No

Note:

- According to KDB 447498 D01 General RF Exposure Guidance, when the simultaneous transmission SAR is less than 1.6 W/Kg, SPLSR assessment is not required.
- SPLSR mean is "The SAR to Peak Location Separation Ratio "

Sum of the SAR for WCDMA Band IV & Wi-Fi & BT:

RF Exposure Conditions	Test Position	Simultaneous Transmission Scenario			Σ1-g SAR (W/Kg)	SPLSR (Yes/No)
		WCDMA Band IV	Wi-Fi DTS Band	Bluetooth		
Head	Left Touch	0.117	0.117		0.234	No
	Left Tilt	0.094	0.078		0.172	No
	Right Touch	0.277	0.062		0.339	No
	Right Tilt	0.052	0.037		0.089	No
Body-worn	Rear	0.945	0.226		1.171	No
	Front	0.688	0.030		0.718	No
	Edge 1	0.008	0.042		0.050	No
	Edge 2	0.203	0.104		0.307	No
	Edge 3	0.875	0.007		0.882	No
	Edge 4	0.112	0.055		0.167	No
	Rear	0.945		0.133	1.078	No
	Front	0.688		0.133	0.821	No
	Edge 1	0.008		0.066	0.074	No
	Edge 2	0.203		0.066	0.269	No
	Edge 3	0.875		0.066	0.941	No
	Edge 4	0.112		0.066	0.178	No

Note:

- According to KDB 447498 D01 General RF Exposure Guidance, when the simultaneous transmission SAR is less than 1.6 W/Kg, SPLSR assessment is not required.
- SPLSR mean is "The SAR to Peak Location Separation Ratio"

Sum of the SAR for WCDMA Band V & Wi-Fi & BT:

RF Exposure Conditions	Test Position	Simultaneous Transmission Scenario			Σ1-g SAR (W/Kg)	SPLSR (Yes/No)
		WCDMA Band V	Wi-Fi DTS Band	Bluetooth		
Head	Left Touch	0.043	0.117		0.160	No
	Left Tilt	0.018	0.078		0.096	No
	Right Touch	0.180	0.062		0.242	No
	Right Tilt	0.114	0.037		0.151	No
Body-worn	Rear	0.206	0.226		0.432	No
	Front	0.138	0.030		0.168	No
	Edge 1	0.056	0.042		0.098	No
	Edge 2	0.016	0.104		0.120	No
	Edge 3	0.013	0.007		0.020	No
	Edge 4	0.045	0.055		0.100	No
	Rear	0.206		0.133	0.339	No
	Front	0.138		0.133	0.271	No
	Edge 1	0.056		0.066	0.122	No
	Edge 2	0.016		0.066	0.082	No
	Edge 3	0.013		0.066	0.079	No
	Edge 4	0.045		0.066	0.111	No

Note:

- According to KDB 447498 D01 General RF Exposure Guidance, when the simultaneous transmission SAR is less than 1.6 W/Kg, SPLSR assessment is not required.
- SPLSR mean is "The SAR to Peak Location Separation Ratio "

APPENDIX A. SAR SYSTEM CHECK DATA

Test Laboratory: AGC Lab

Date: Mar. 21,2017

System Check Head 835 MHz

DUT: Dipole 835 MHz Type: SID 835

Communication System CW; Communication System Band: D835 (835.0 MHz); Duty Cycle: 1:1; Conv.F=5.72

Frequency: 835 MHz; Medium parameters used: $f = 835$ MHz; $\sigma=0.89$ mho/m; $\epsilon_r =41.97$; $\rho= 1000$ kg/m³ ;

Phantom section: Flat Section; Input Power=18dBm

Ambient temperature (°C):21.8, Liquid temperature (°C): 21.2

SATIMO Configuration

- Probe: SSE5; Calibrated: 12/05/2016; Serial No.: SN 14/16 EP308
- Sensor-Surface: 4mm (Mechanical Surface Detection)
- Phantom: SAM twin phantom
- Measurement SW: OpenSAR V4_02_32

Configuration/System Check 835MHz Head/Area Scan: Measurement grid: dx=8mm, dy=8mm

Configuration/System Check 835MHz Head/Zoom Scan: Measurement grid: dx=8mm,dy=8mm, dz=5mm

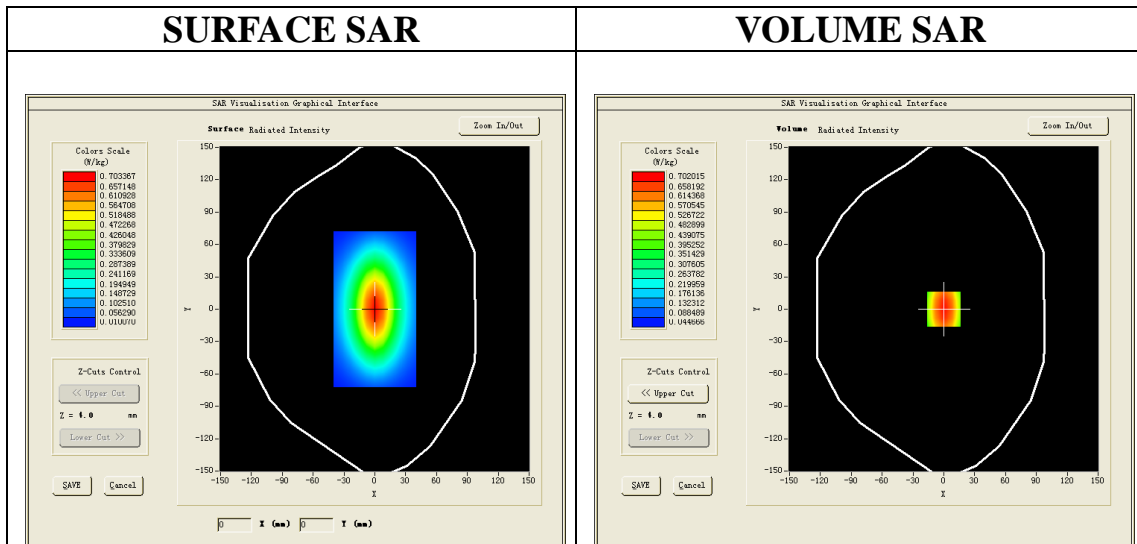

Maximum location: X=1.00, Y=1.00

SAR Peak: 1.05W/kg

SAR 10g (W/Kg)	0.411023
SAR 1g (W/Kg)	0.667591

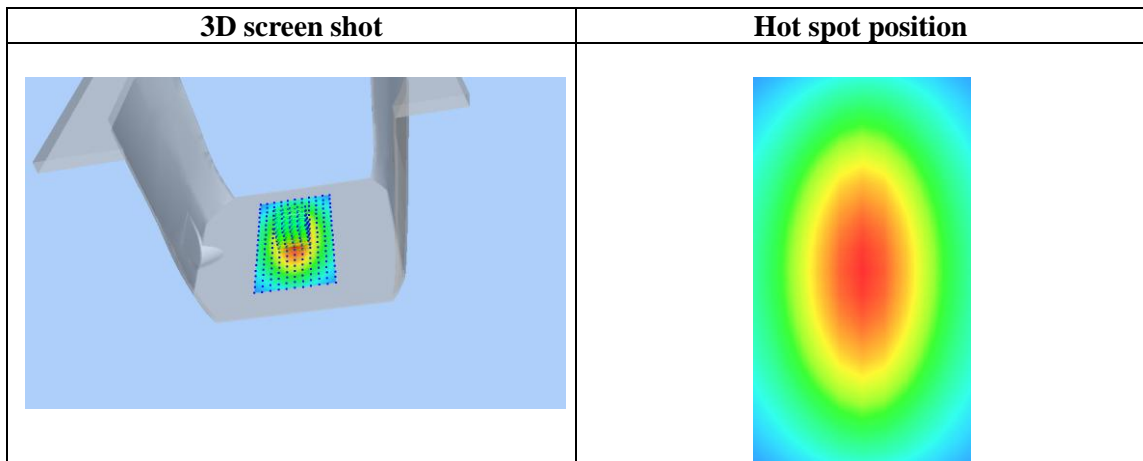
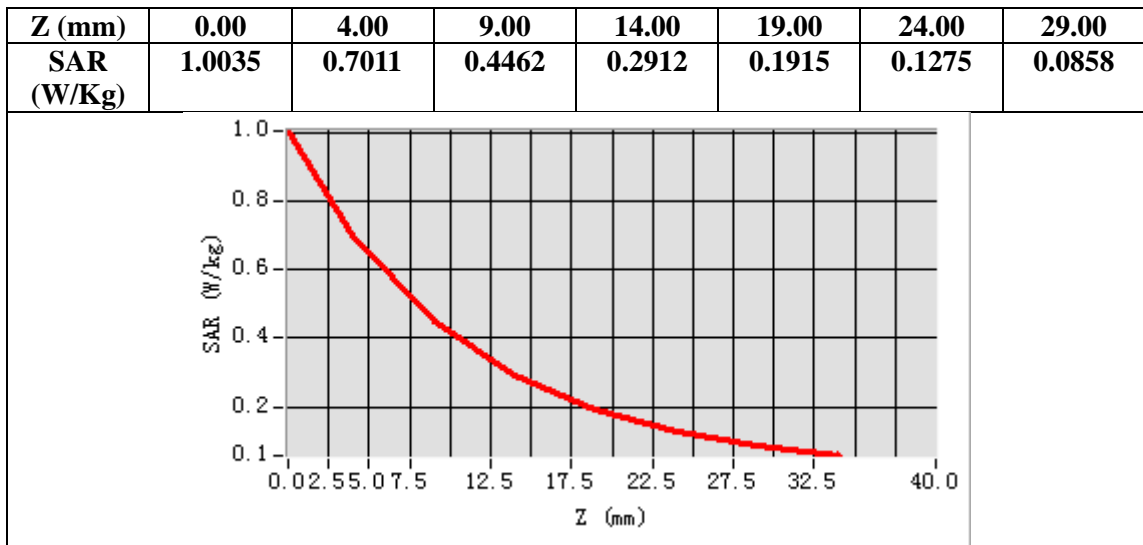

Test Laboratory: AGC Lab
System Check Body 835 MHz

Date: Mar. 21,2017

DUT: Dipole 835 MHz Type: SID 835

Communication System CW; Communication System Band: D835 (835.0 MHz); Duty Cycle: 1:1; Conv.F=5.94
 Frequency: 835 MHz; Medium parameters used: $f = 835$ MHz; $\sigma=0.95$ mho/m; $\epsilon_r =55.41$; $\rho= 1000$ kg/m³ ;
 Phantom section: Flat Section; Input Power=18dBm
 Ambient temperature (°C): 21.8, Liquid temperature (°C): 21.3

SATIMO Configuration

- Probe: SSE5; Calibrated: 12/05/2016; Serial No.: SN 14/16 EP308
- Sensor-Surface: 4mm (Mechanical Surface Detection)
- Phantom: SAM twin phantom
- Measurement SW: OpenSAR V4_02_32

Configuration/System Check 835MHz Body/Area Scan: Measurement grid: dx=8mm, dy=8mm

Configuration/System Check 835MHz Body/Zoom Scan: Measurement grid: dx=8mm,dy=8mm, dz=5mm

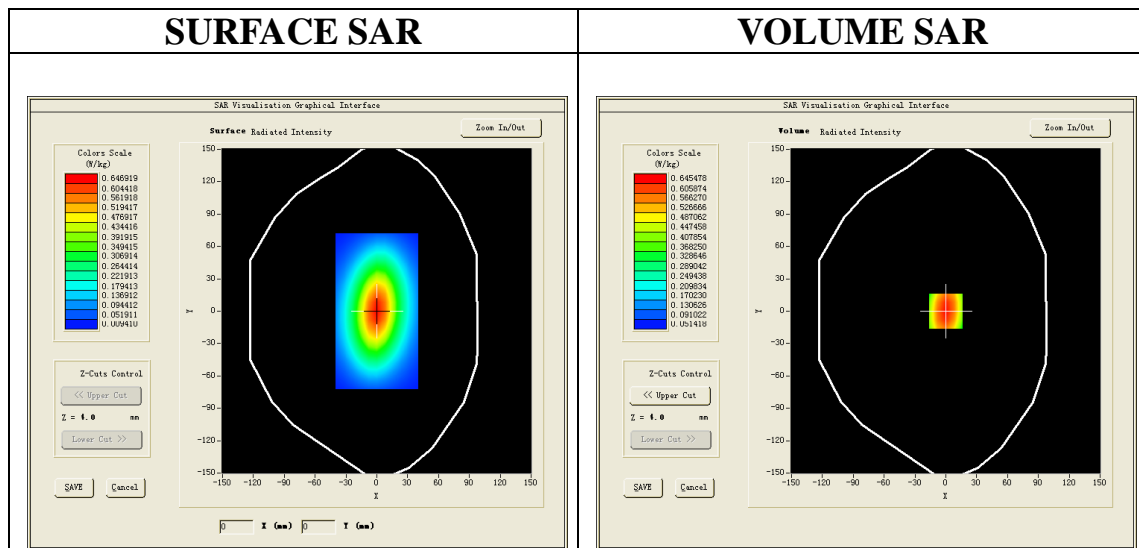

Maximum location: X=1.00, Y=0.00
SAR Peak: 0.91 W/kg

SAR 10g (W/Kg)	0.399523
SAR 1g (W/Kg)	0.622053

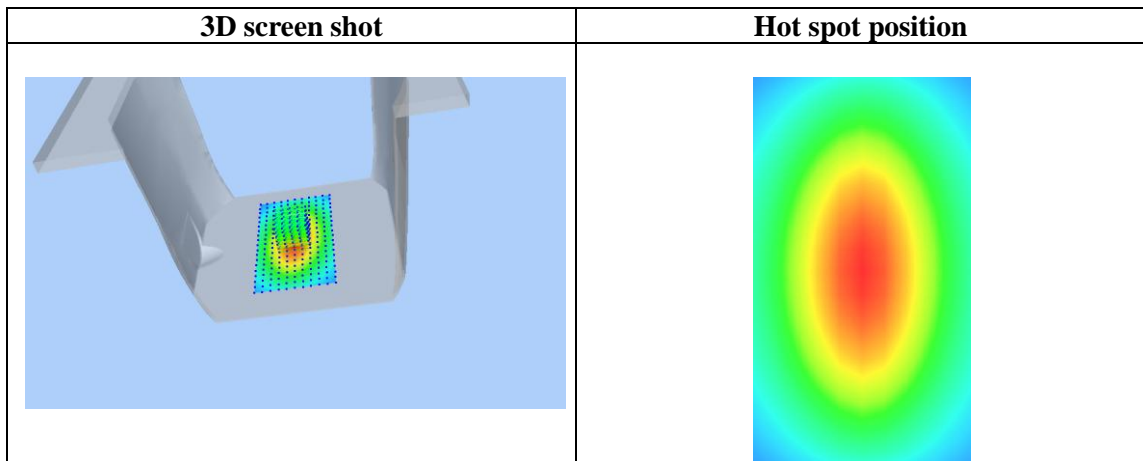
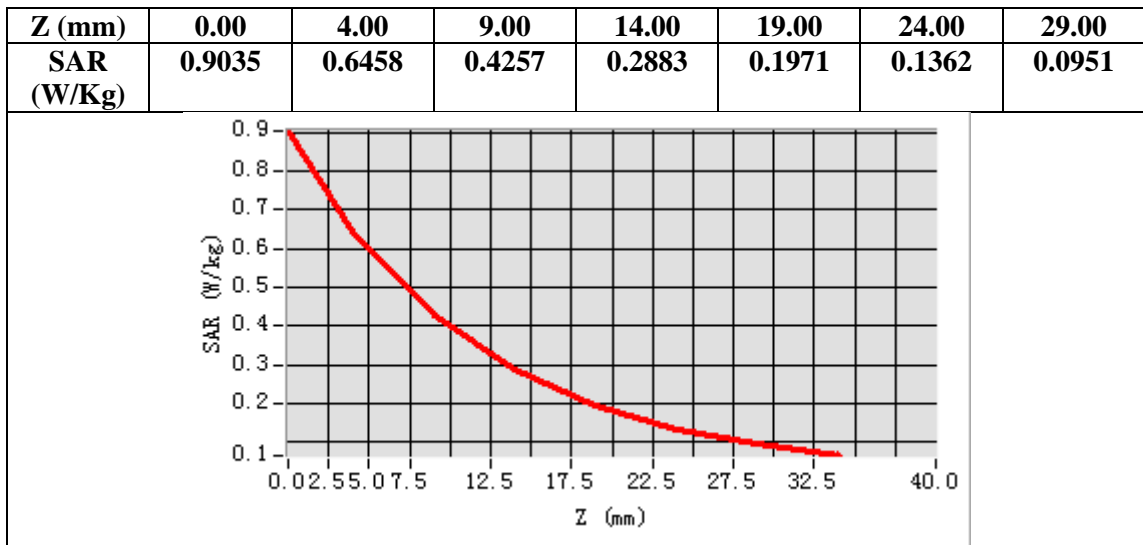

Test Laboratory: AGC Lab
System Check Head 1750MHz

Date: Mar. 22,2017

DUT: Dipole 1800 MHz; Type: SID 1800

Communication System: CW; Communication System Band: D1700 (1750.0 MHz); Duty Cycle: 1:1; Conv.F=4.92
Frequency: 1750MHz; Medium parameters used: $f = 1800$ MHz; $\sigma = 1.37$ mho/m; $\epsilon_r = 40.67$; $\rho = 1000$ kg/m³ ;
Phantom section: Flat Section; Input Power=18dBm
Ambient temperature (°C): 22.8, Liquid temperature (°C): 22.0

SATIMO Configuration:

Probe: SSE5; Calibrated: 07/05/2016; Serial No.: SN 14/16 EP307

- Sensor-Surface: 4mm (Mechanical Surface Detection)
- Phantom: SAM twin phantom
- Measurement SW: OpenSAR V4_02_35

Configuration/System Check 1750 Head/Area Scan: Measurement grid: dx=8mm, dy=8mm

Configuration/System Check 1750 Head/Zoom Scan: Measurement grid: dx=8mm,dy=8mm, dz=5mm

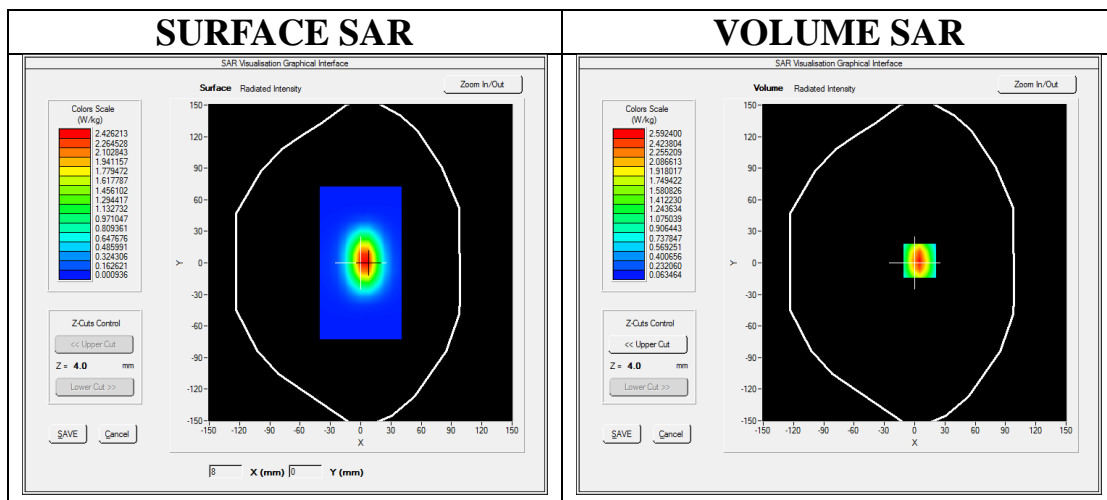

Maximum location: X=6.00, Y=3.00
SAR Peak: 3.95 W/kg

SAR 10g (W/Kg)	1.322542
SAR 1g (W/Kg)	2.437518

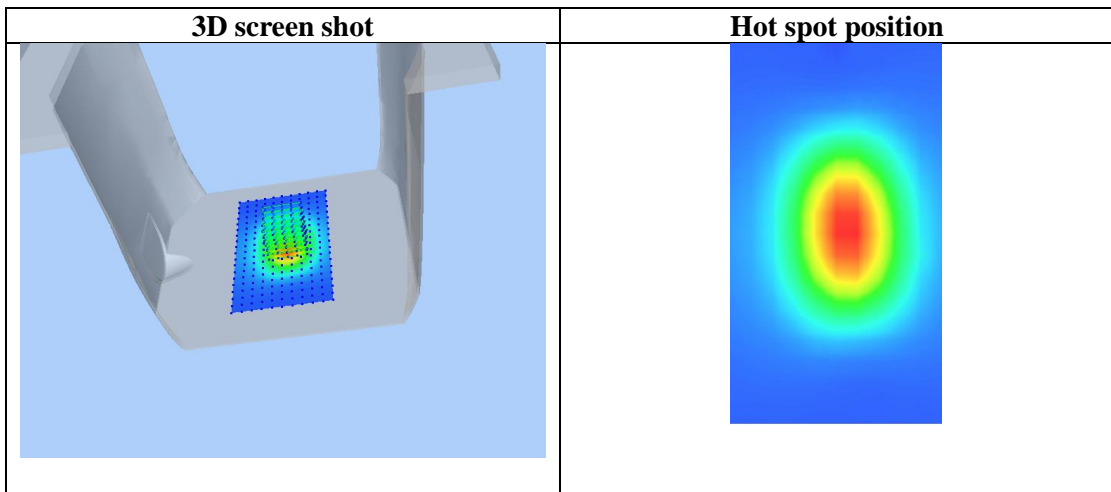
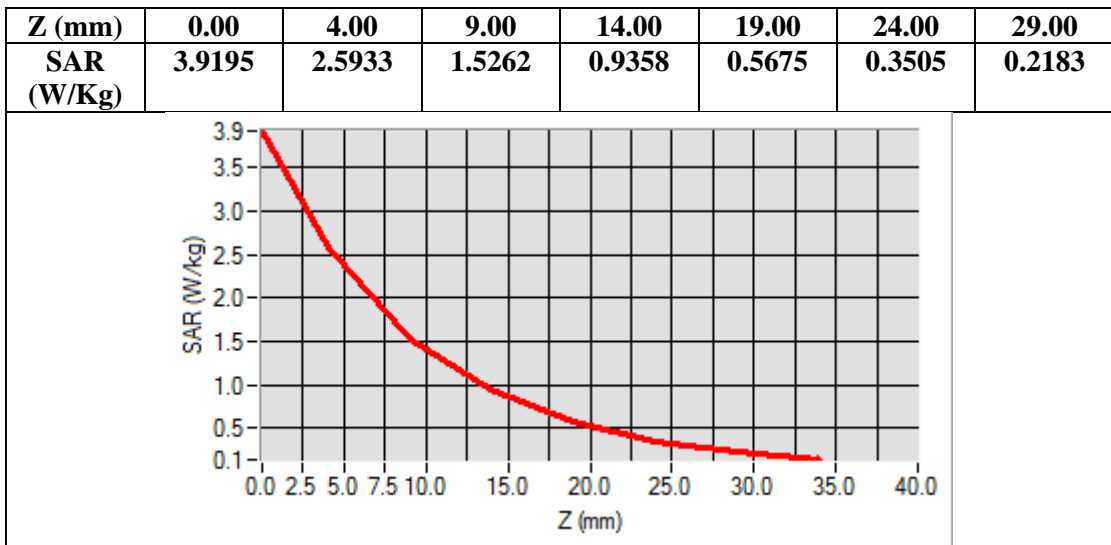

Test Laboratory: AGC Lab
System Check Body 1750MHz

Date: Mar. 22,2017

DUT: Dipole 1800 MHz; Type: SID 1800

Communication System: CW;Communication System Band: D1700 (1750.0 MHz); Duty Cycle:1:1; Conv.F=5.06
Frequency: 1750 MHz; Medium parameters used: $f = 1800\text{MHz}$; $\sigma = 1.47 \text{ mho/m}$; $\epsilon_r = 53.41$; $\rho = 1000 \text{ kg/m}^3$;
Phantom section: Flat Section; Input Power=18dBm
Ambient temperature ($^{\circ}\text{C}$): 22.8, Liquid temperature ($^{\circ}\text{C}$): 22.2

SATIMO Configuration:

Probe: SSE5; Calibrated: 07/05/2016; Serial No.: SN 14/16 EP307

- Sensor-Surface: 4mm (Mechanical Surface Detection)
- Phantom: SAM twin phantom
- Measurement SW: OpenSAR V4_02_35

Configuration/System Check 1750MHz Body/Area Scan: Measurement grid: dx=8mm,dy=8mm

Configuration/System Check 1750MHz Body/Zoom Scan: Measurement grid: dx=8mm,dy=8mm, dz=5mm

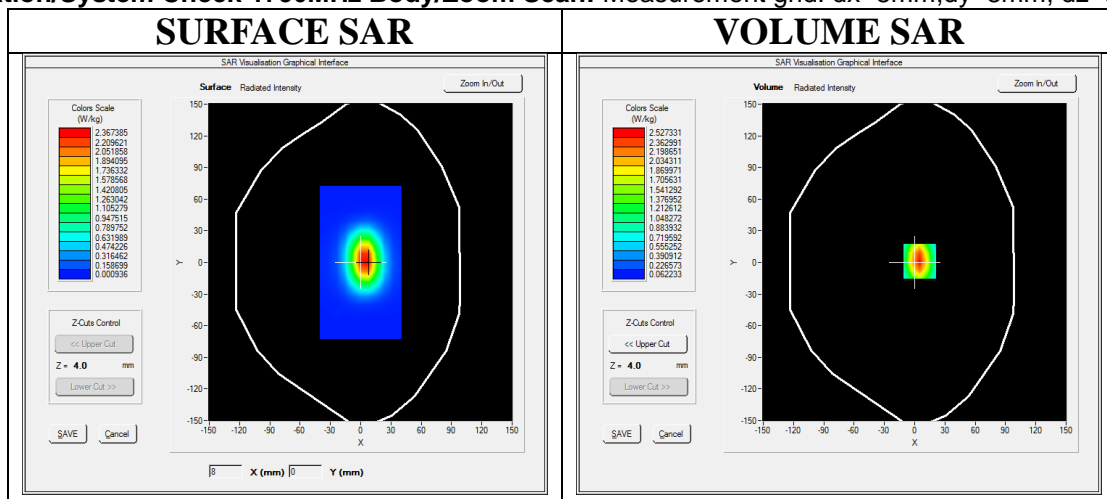

Maximum location: X=6.00, Y=0.00

SAR Peak: 3.83 W/kg

SAR 10g (W/Kg)	1.289550
SAR 1g (W/Kg)	2.378135

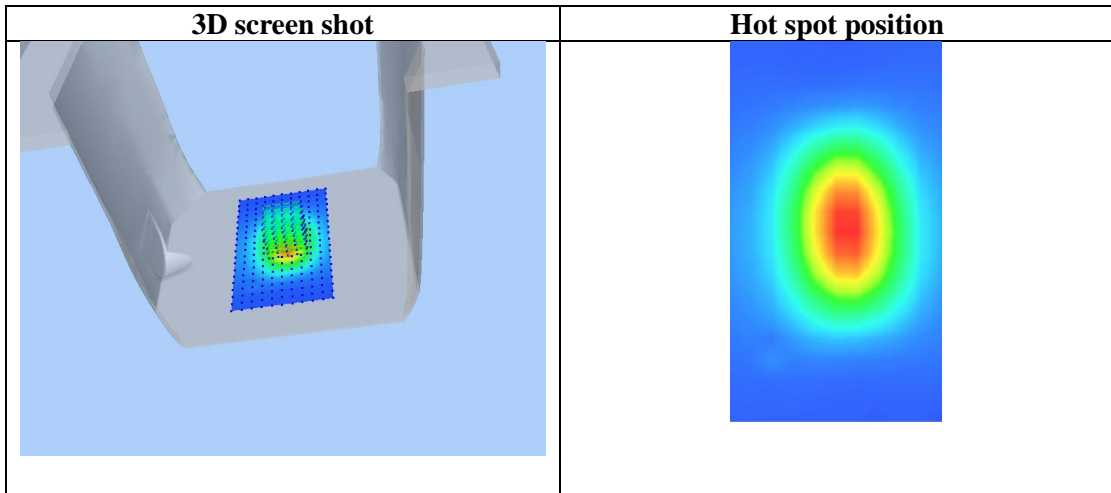
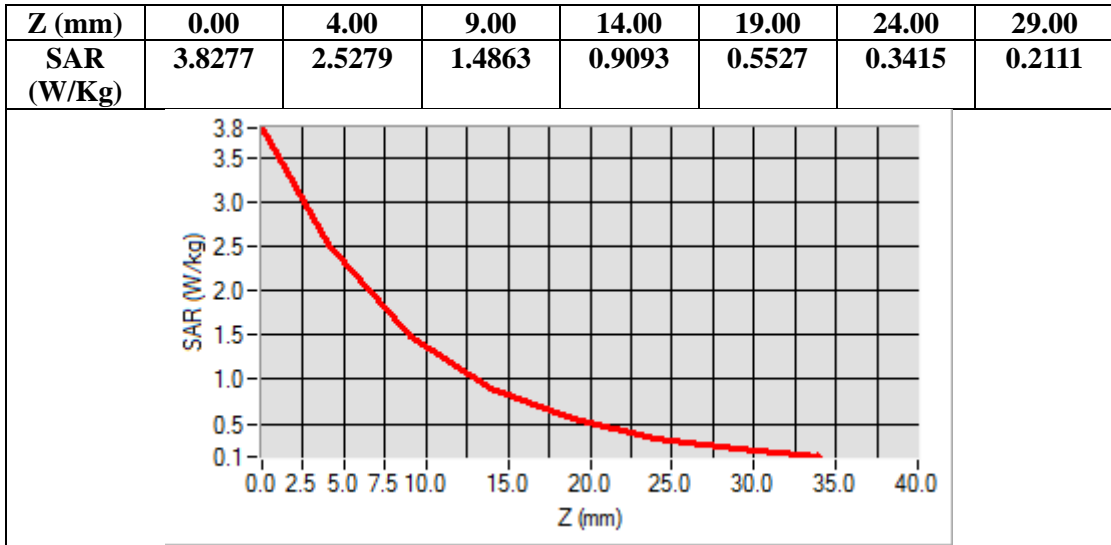

Test Laboratory: AGC Lab
System Check Head 1900MHz

Date: Mar. 21,2017

DUT: Dipole 1900 MHz; Type: SID 1900

Communication System: CW; Communication System Band: D1900 (1900.0 MHz); Duty Cycle:1:1; Conv.F=5.14
Frequency: 1900 MHz; Medium parameters used: $f = 1900$ MHz; $\sigma=1.42$ mho/m; $\epsilon_r =40.45$; $\rho= 1000$ kg/m³ ;
Phantom section: Flat Section; Input Power=18dBm
Ambient temperature (°C): 22.7, Liquid temperature (°C): 22.1

SATIMO Configuration:

Probe: SSE5; Calibrated: 07/05/2016; Serial No.: SN 14/16 EP307

- Sensor-Surface: 4mm (Mechanical Surface Detection)
- Phantom: SAM twin phantom
- Measurement SW: OpenSAR V4_02_35

Configuration/System Check 1900MHz Head/Area Scan: Measurement grid: dx=8mm, dy=8mm

Configuration/System Check 1900MHz Head/Zoom Scan: Measurement grid: dx=8mm,dy=8mm, dz=5mm

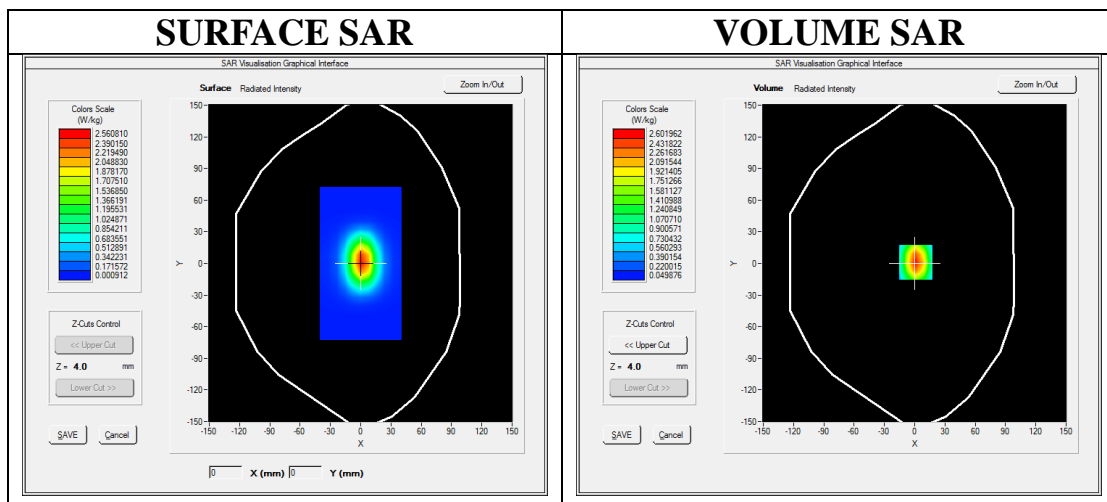

Maximum location: X=1.00, Y=1.00

SAR Peak: 4.01 W/kg

SAR 10g (W/Kg)	1.285963
SAR 1g (W/Kg)	2.430596

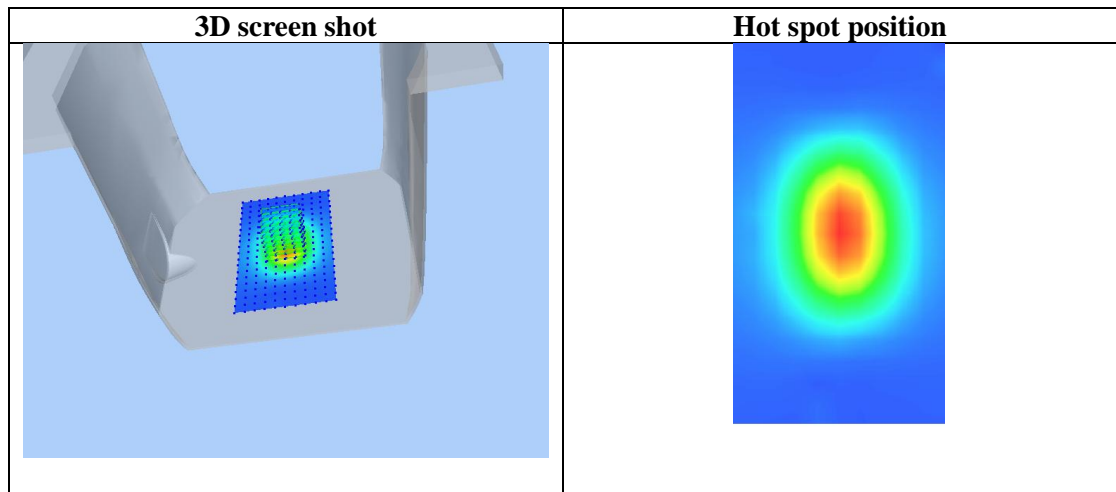
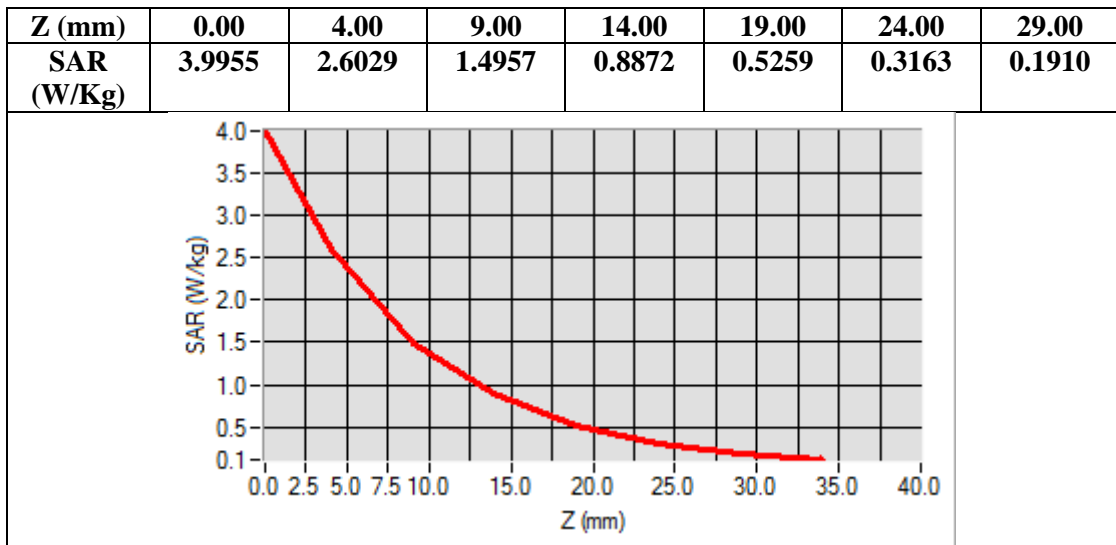

Test Laboratory: AGC Lab
System Check Body 1900MHz
DUT: Dipole 1900 MHz; Type: SID 1900

Date: Mar. 21,2017

Communication System: CW; Communication System Band: D1900 (1900.0 MHz); Duty Cycle:1:1; Conv.F=5.34
Frequency: 1900 MHz; Medium parameters used: $f = 1900$ MHz; $\sigma = 1.52$ mho/m; $\epsilon_r = 53.53$; $\rho = 1000$ kg/m³ ;
Phantom section: Flat Section; Input Power=18dBm
Ambient temperature (°C): 22.7, Liquid temperature (°C): 22.3

SATIMO Configuration:

- Probe: SSE5; Calibrated: 07/05/2016; Serial No.: SN 14/16 EP307
- Sensor-Surface: 4mm (Mechanical Surface Detection)
- Phantom: SAM twin phantom
- Measurement SW: OpenSAR V4_02_35

Configuration/System Check 1900MHz Body/Area Scan: Measurement grid: dx=8mm, dy=8mm

Configuration/System Check 1900MHz Body/Zoom Scan: Measurement grid: dx=8mm,dy=8mm, dz=5mm

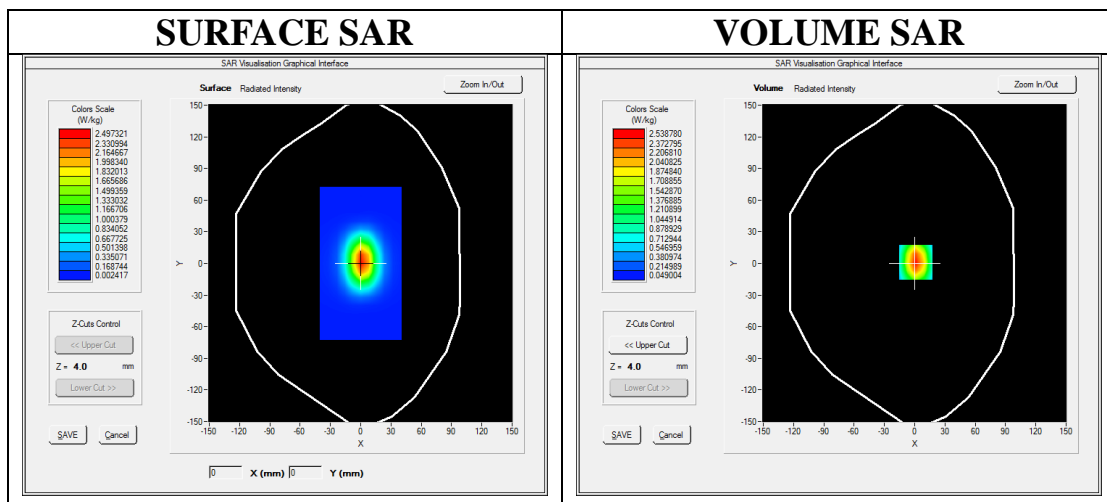

Maximum location: X=1.00, Y=1.00

SAR Peak: 3.90 W/kg

SAR 10g (W/Kg)	1.259653
SAR 1g (W/Kg)	2.371535

Z (mm)	0.00	4.00	9.00	14.00	19.00	24.00	29.00
SAR (W/Kg)	3.8949	2.5395	1.4611	0.8693	0.5148	0.3093	0.1871

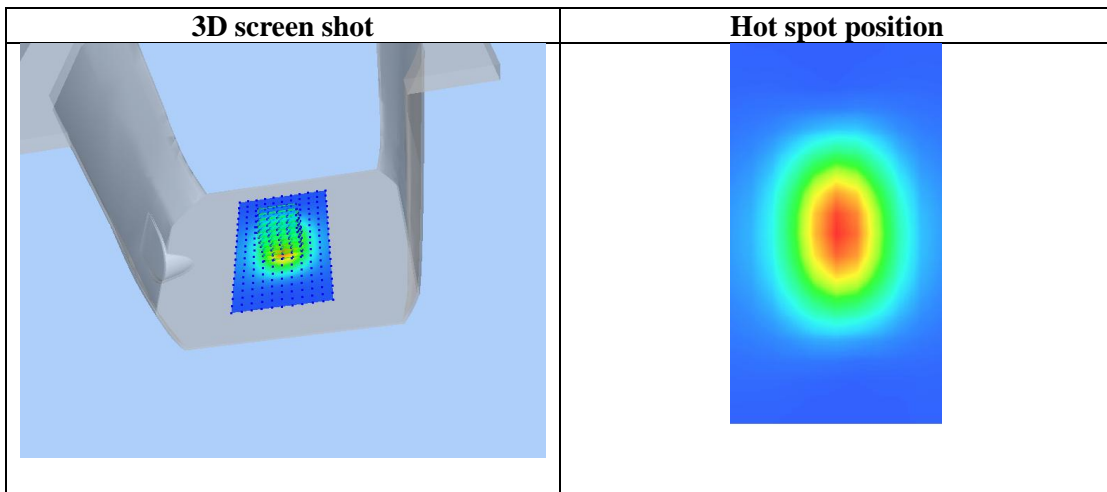
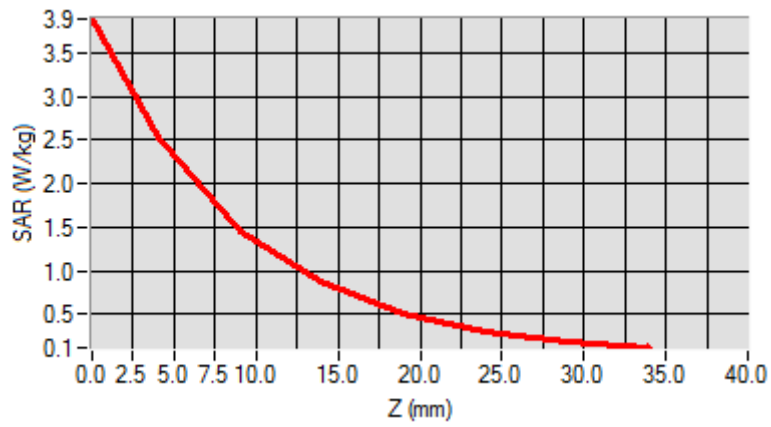

Test Laboratory: AGC Lab
System Check Head 2450 MHz

Date: Mar. 24,2017

DUT: Dipole 2450 MHz Type: SID 2450

Communication System CW; Communication System Band: D2450 (2450.0 MHz); Duty Cycle: 1:1; Conv.F=5.19
Frequency: 2450 MHz; Medium parameters used: $f = 2450$ MHz; $\sigma=1.77$ mho/m; $\epsilon_r =39.98$; $\rho= 1000$ kg/m³ ;
Phantom section: Flat Section; Input Power=18dBm
Ambient temperature (°C):22.2, Liquid temperature (°C): 21.8

SATIMO Configuration

- Probe: SSE5; Calibrated: 12/05/2016; Serial No.: SN 14/16 EP308
- Sensor-Surface: 4mm (Mechanical Surface Detection)
- Phantom: SAM twin phantom
- Measurement SW: OpenSAR V4_02_32

Configuration/System Check 2450MHz Head/Area Scan: Measurement grid: dx=8mm, dy=8mm

Configuration/System Check 2450MHz Head/Zoom Scan: Measurement grid: dx=5mm,dy=5mm, dz=5mm

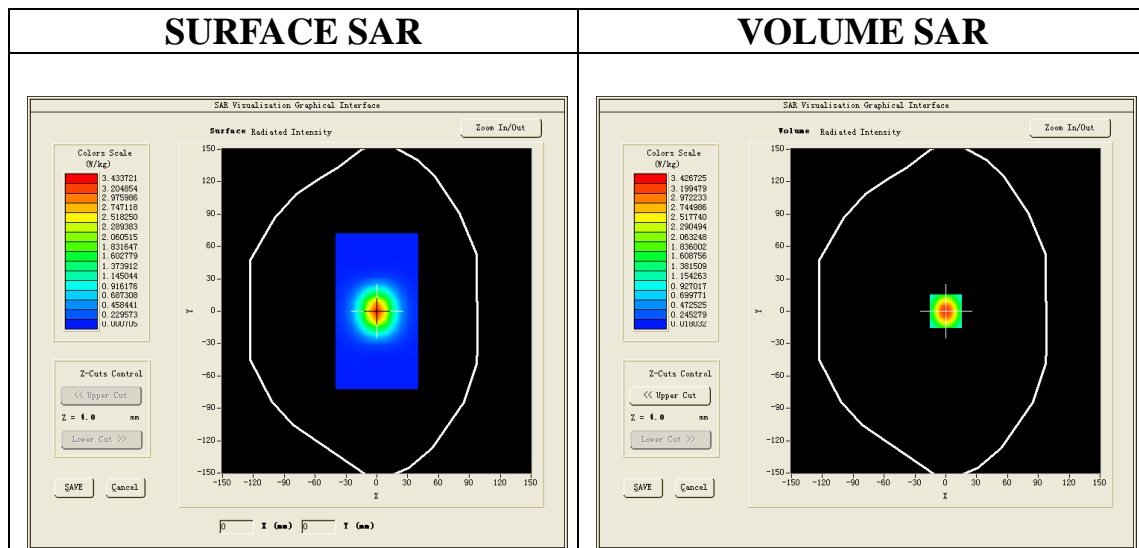

Maximum location: X=0.00, Y=0.00
SAR Peak: 5.91 W/kg

SAR 10g (W/Kg)	1.492013
SAR 1g (W/Kg)	3.184102

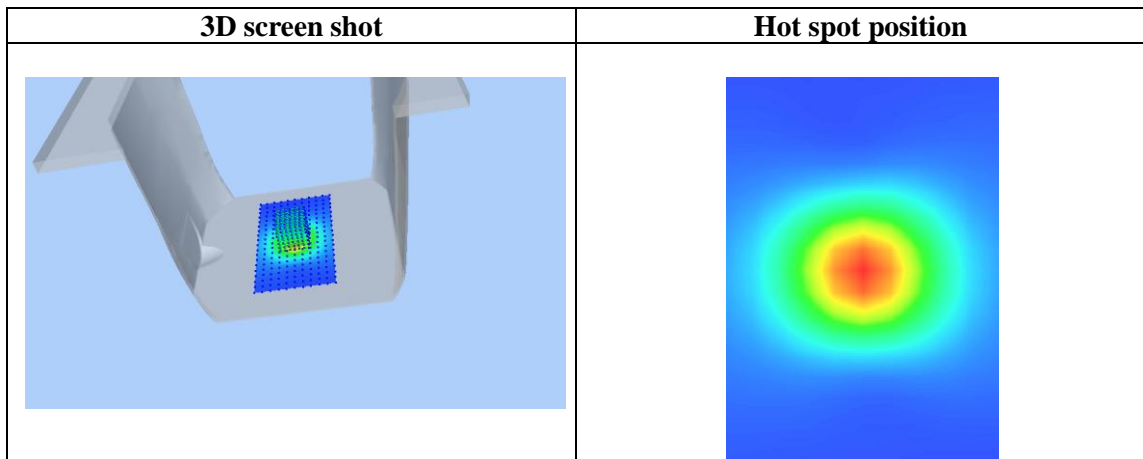
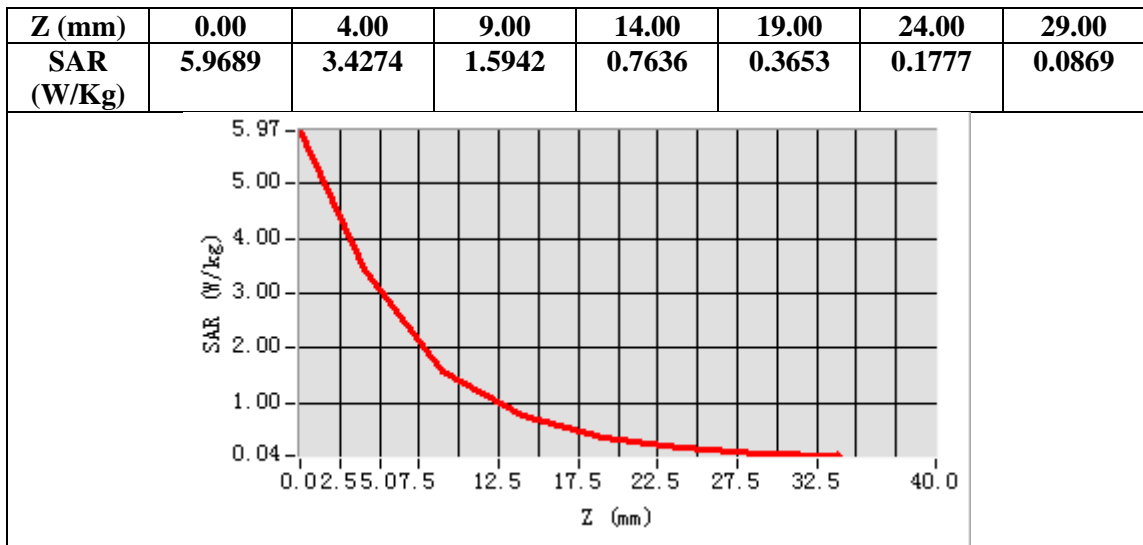

Test Laboratory: AGC Lab
System Check Body 2450 MHz

Date: Mar. 24,2017

DUT: Dipole 2450 MHz Type: SID 2450

Communication System CW; Communication System Band: D2450 (2450.0 MHz); Duty Cycle: 1:1; Conv.F=5.33
Frequency: 2450 MHz; Medium parameters used: $f = 2450$ MHz; $\sigma = 1.93$ mho/m; $\epsilon_r = 53.96$; $\rho = 1000$ kg/m³ ;
Phantom section: Flat Section; Input Power=18dBm
Ambient temperature (°C):22.2, Liquid temperature (°C): 21.5

SATIMO Configuration

- Probe: SSE5; Calibrated: 12/05/2016; Serial No.: SN 14/16 EP308
- Sensor-Surface: 4mm (Mechanical Surface Detection)
- Phantom: SAM twin phantom
- Measurement SW: OpenSAR V4_02_32

Configuration/System Check 2450MHz Body/Area Scan: Measurement grid: dx=8mm, dy=8mm

Configuration/System Check 2450MHz Body/Zoom Scan: Measurement grid: dx=5mm,dy=5mm, dz=5mm

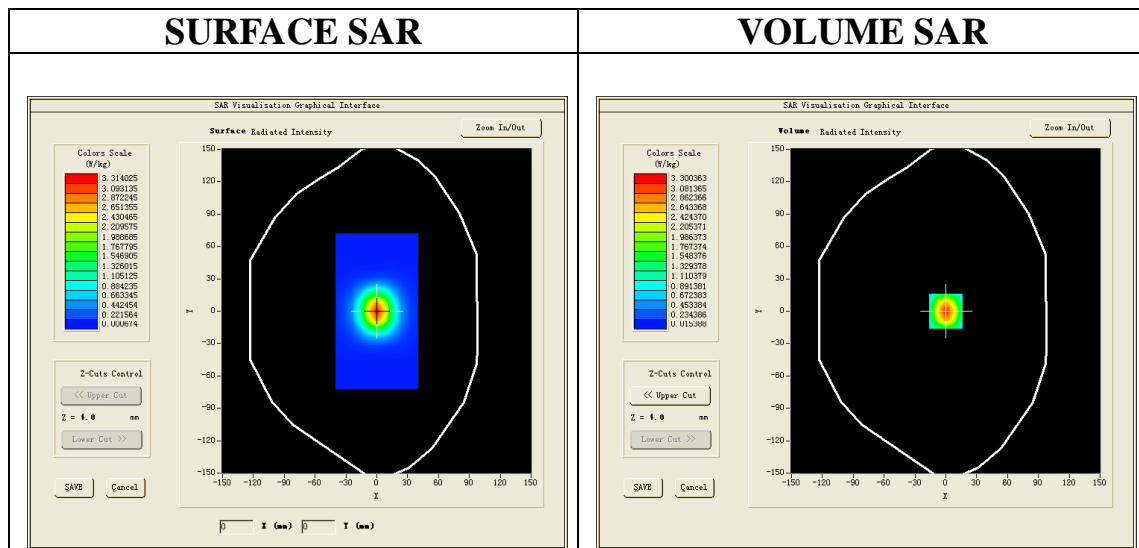

Maximum location: X=0.00, Y=0.00
SAR Peak: 5.71 W/kg

SAR 10g (W/Kg)	1.429536
SAR 1g (W/Kg)	3.110235

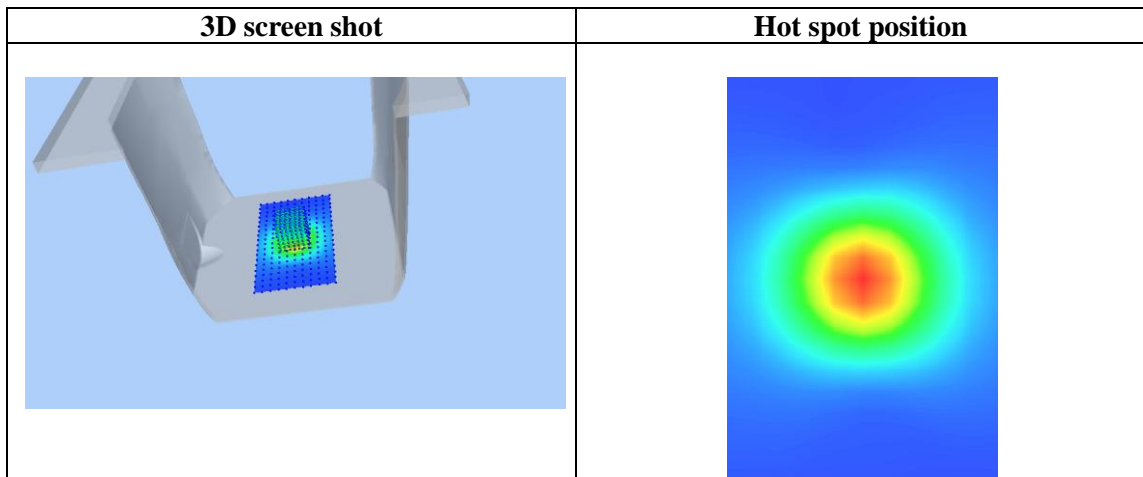
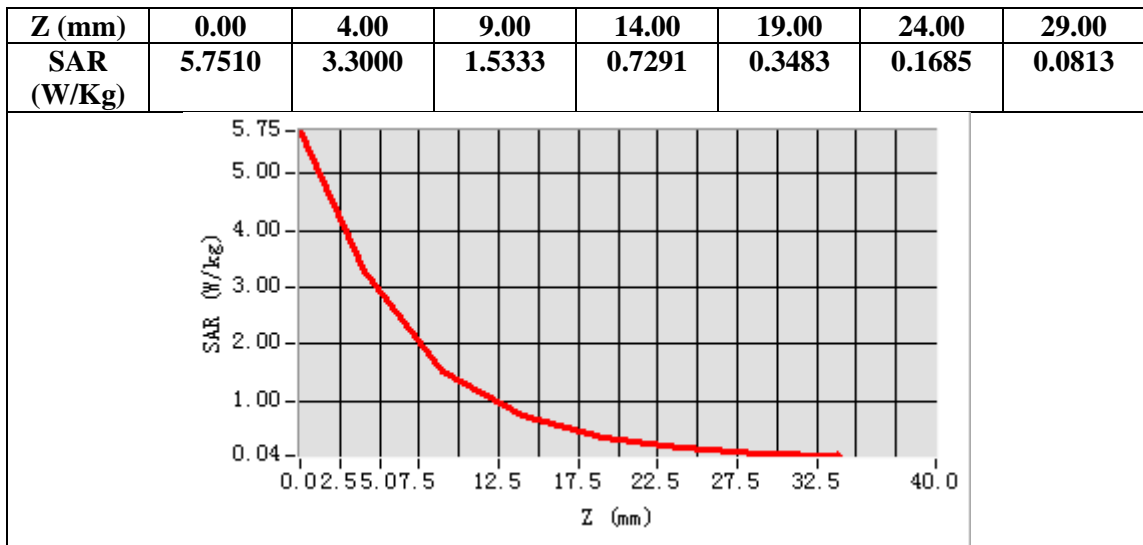

APPENDIX B. SAR MEASUREMENT DATA

Test Laboratory: AGC Lab
GSM 850 Mid-Touch-Left <SIM 1>
DUT: Smart Phone; Type: Platinum 5.5C

Date: Mar. 21,2017

Communication System: Generic GSM; Communication System Band: GSM 850; Duty Cycle: 1:8.3; Conv.F=5.72;
Frequency: 836.6 MHz; Medium parameters used: $f = 835$ MHz; $\sigma = 0.89$ mho/m; $\epsilon_r = 41.52$; $\rho = 1000$ kg/m³;
Phantom section: Left Section
Ambient temperature (°C):21.8, Liquid temperature (°C): 21.2

SATIMO Configuration:

- Probe: SSE5; Calibrated: 12/05/2016; Serial No.: SN 14/16 EP308
- Sensor-Surface: 4mm (Mechanical Surface Detection)
- Phantom: SAM twin phantom
- Measurement SW: OpenSAR V4_02_32

Configuration/GSM 850 Mid-Touch-Left/Area Scan: Measurement grid: dx=8mm, dy=8mm
Configuration/GSM 850 Mid-Touch-Left/Zoom Scan : Measurement grid: dx=8mm,dy=8mm, dz=5mm

Area Scan	sam_direct_droit2_surf8mm.txt
ZoomScan	5x5x7,dx=8mm dy=8mm dz=5mm,Complete
Phantom	Left head
Device Position	Cheek
Band	GSM 850
Channels	Middle
Signal	TDMA (Crest factor: 8.0)

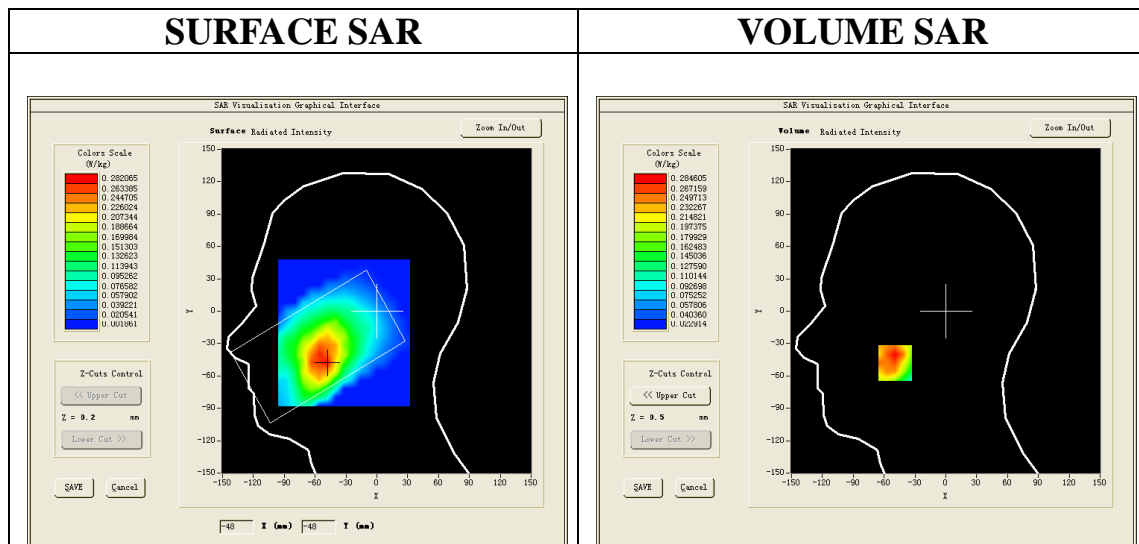

Maximum location: X=-49.00, Y=-48.00
SAR Peak: 0.36 W/kg

SAR 10g (W/Kg)	0.196827
SAR 1g (W/Kg)	0.265329

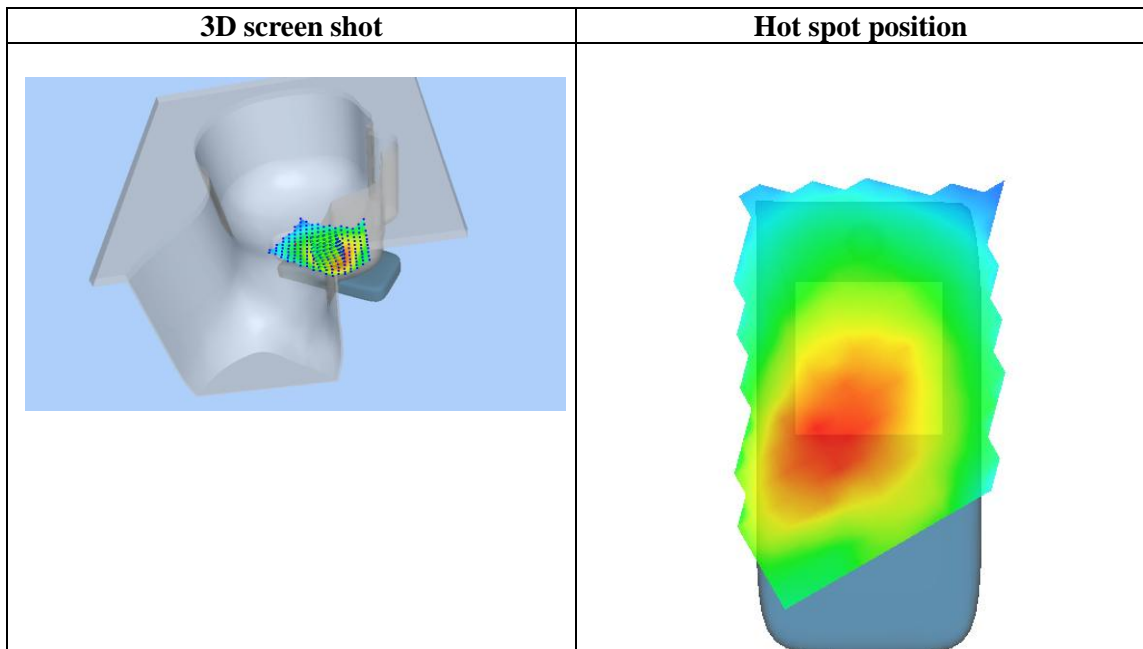
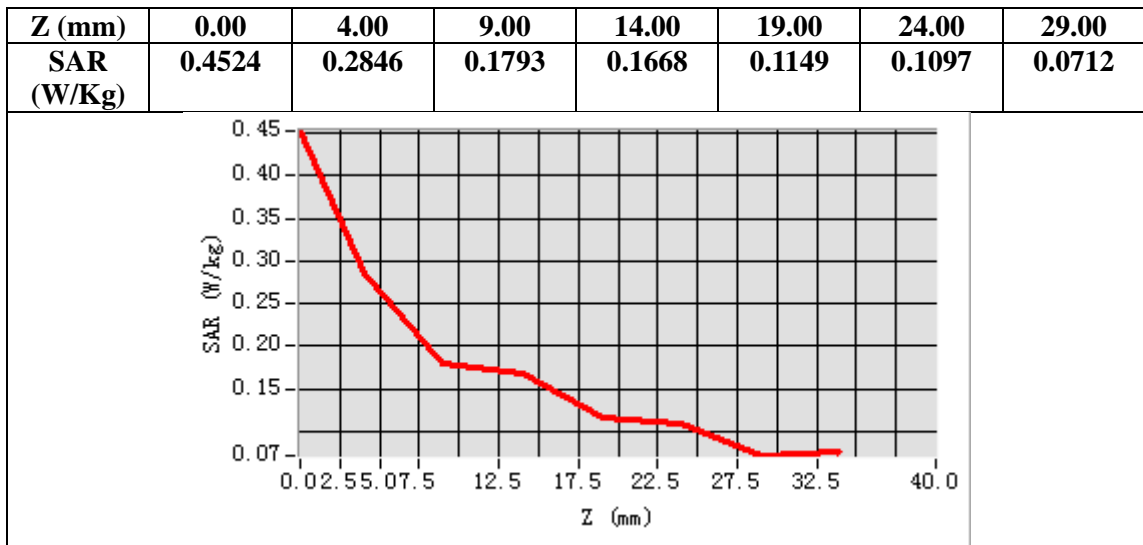

Test Laboratory: AGC Lab
GSM 850 Mid- Body- Back (MS)<SIM 1>
DUT: Smart Phone; Type: Platinum 5.5C

Date: Mar. 21,2017

Communication System: Generic GSM; Communication System Band: GSM 850; Duty Cycle: 1:8.3; Conv.F=5.94;
Frequency: 836.6 MHz; Medium parameters used: $f = 835$ MHz; $\sigma = 0.96$ mho/m; $\epsilon_r = 55.03$; $\rho = 1000$ kg/m³ ;
Phantom section: Flat Section
Ambient temperature (°C): 21.8, Liquid temperature (°C): 21.3

SATIMO Configuration:

- Probe: SSE5; Calibrated: 12/05/2016; Serial No.: SN 14/16 EP308
- Sensor-Surface: 4mm (Mechanical Surface Detection)
- Phantom: SAM twin phantom
- Measurement SW: OpenSAR V4_02_32

Configuration/GSM 850 Mid-Body-Back/Area Scan: Measurement grid: dx=8mm, dy=8mm
Configuration/GSM 850 Mid-Body-Back/Zoom Scan: Measurement grid: dx=8mm,dy=8mm, dz=5mm;

Area Scan	sam_direct_droit2_surf8mm.txt
ZoomScan	5x5x7,dx=8mm dy=8mm dz=5mm,Complete
Phantom	Validation plane
Device Position	Body Back
Band	GSM 850
Channels	Middle
Signal	TDMA (Crest factor: 8.0)

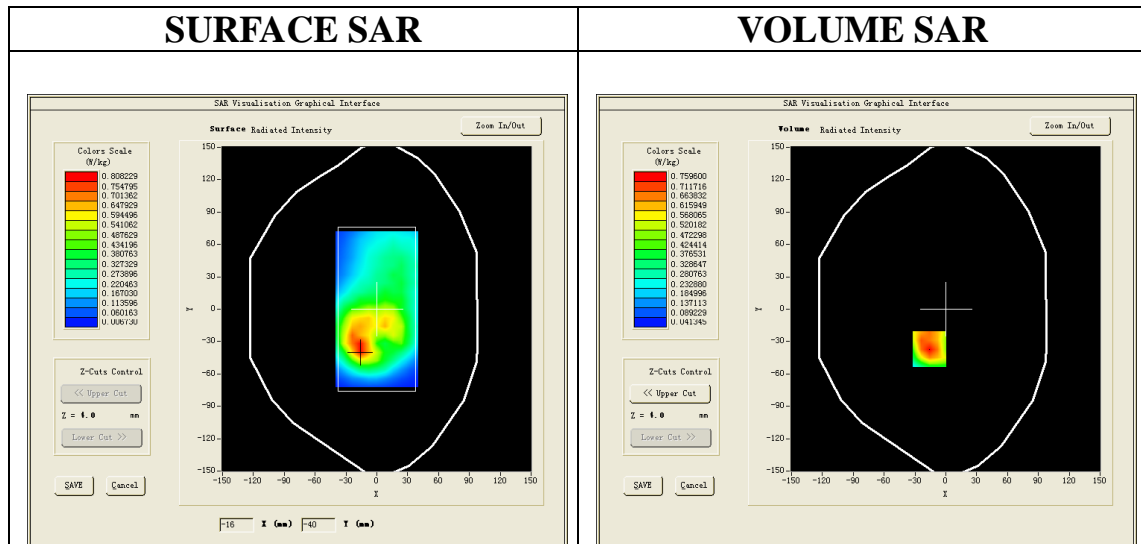

Maximum location: X=-16.00, Y=-37.00

SAR Peak: 1.10 W/kg

SAR 10g (W/Kg)	0.425223
SAR 1g (W/Kg)	0.719856

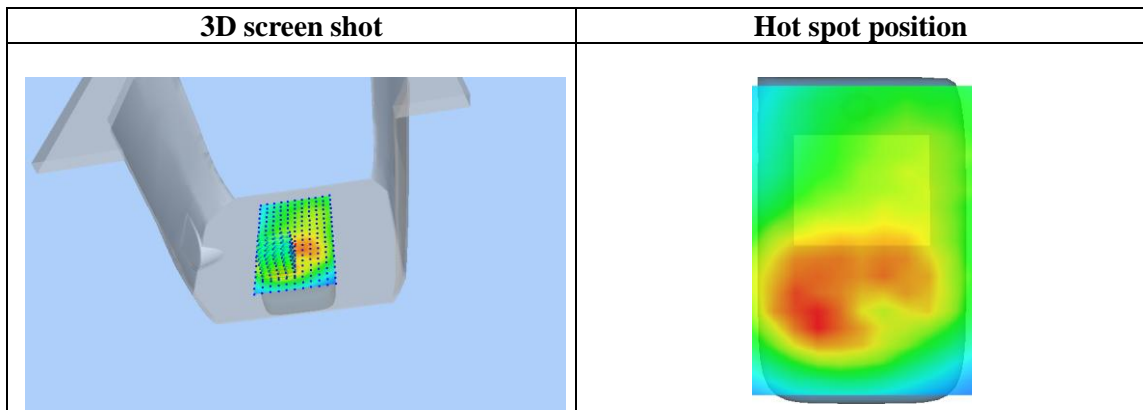
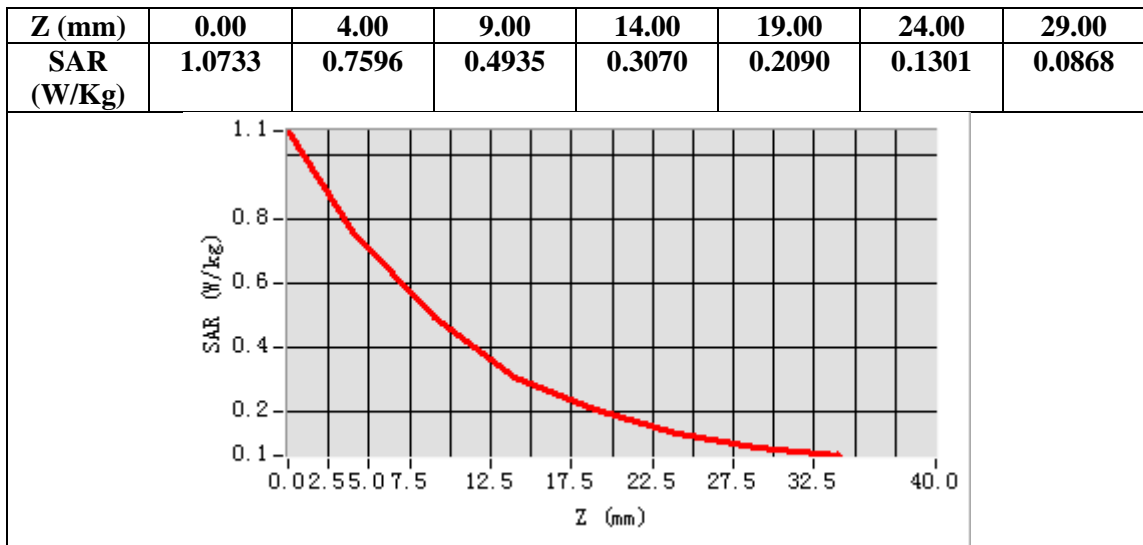

Test Laboratory: AGC Lab
GPRS 850 Mid-Touch-Left (3up) <SIM 1>
DUT: Smart Phone; Type: Platinum 5.5C

Date: Mar. 21,2017

Communication System: GPRS-3 Slot; Communication System Band: GSM 850; Duty Cycle:1:2.7; Conv.F=5.72
Frequency: 836.6 MHz; Medium parameters used: $f = 835$ MHz; $\sigma = 0.89$ mho/m; $\epsilon_r = 41.52$; $\rho = 1000$ kg/m³;
Phantom section: Left Section
Ambient temperature (°C):21.8, Liquid temperature (°C): 21.2

SATIMO Configuration:

- Probe: SSE5; Calibrated: 12/05/2016; Serial No.: SN 14/16 EP308
- Sensor-Surface: 4mm (Mechanical Surface Detection)
- Phantom: SAM twin phantom
- Measurement SW: OpenSAR V4_02_32

Configuration/GPRS 850 Mid-Touch-Left/Area Scan: Measurement grid: dx=8mm, dy=8mm

Configuration/GPRS 850 Mid-Touch-Left/Zoom Scan: Measurement grid: dx=8mm,dy=8mm, dz=5mm

Area Scan	sam_direct_droit2_surf8mm.txt
Zoom Scan	5x5x7,dx=8mm dy=8mm dz=5mm,Complete
Phantom	Left head
Device Position	Cheek
Band	GSM 850
Channels	Middle
Signal	TDMA (Crest factor: 2.7)

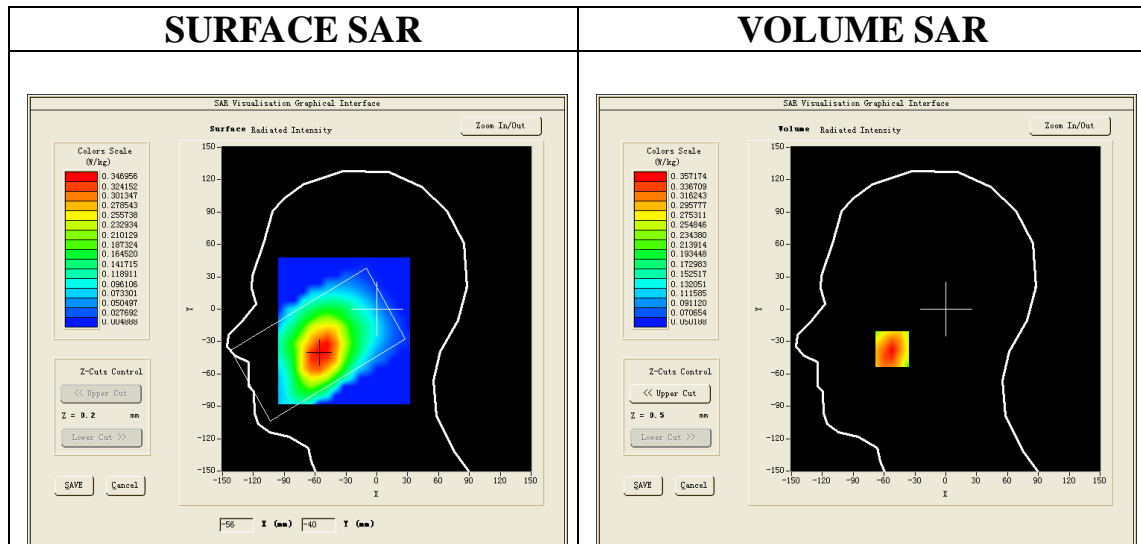

Maximum location: X=-52.00, Y=-37.00

SAR Peak: 0.47 W/kg

SAR 10g (W/Kg)	0.257074
SAR 1g (W/Kg)	0.348580

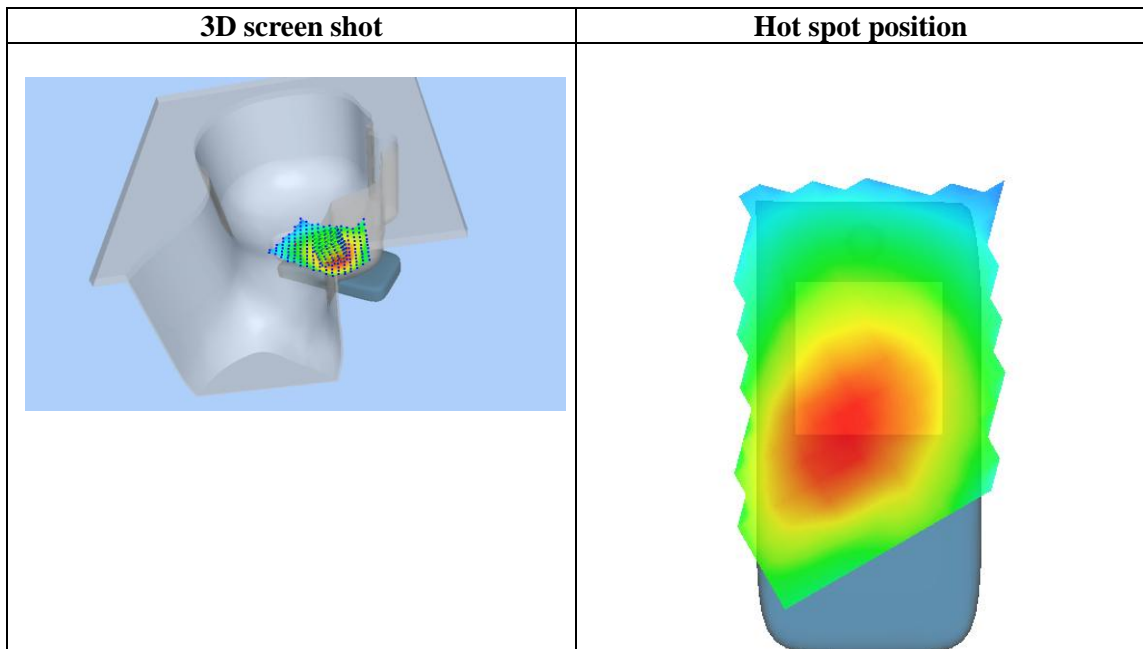
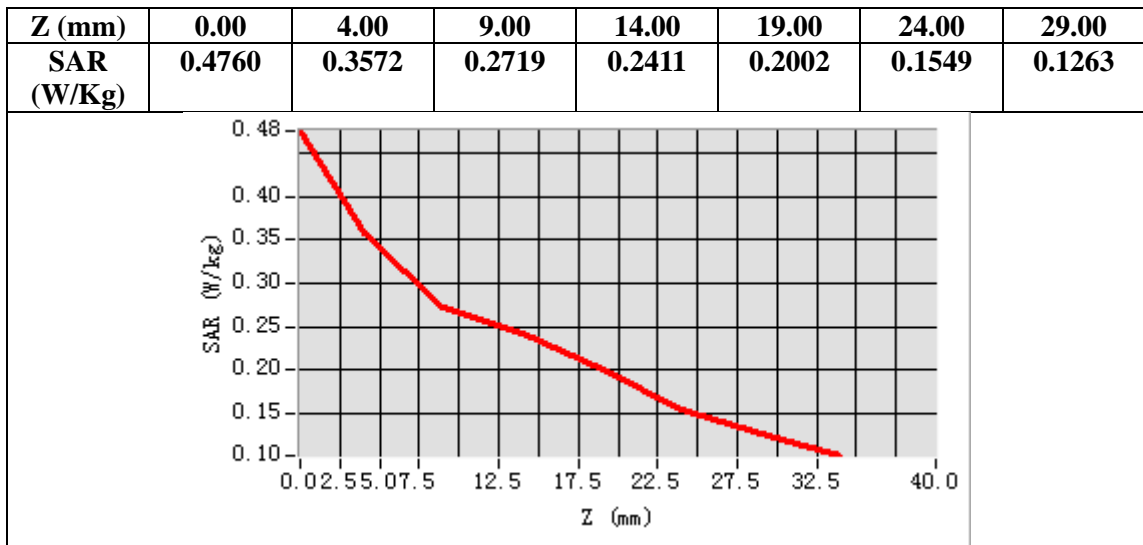

Test Laboratory: AGC Lab
GPRS 850 High- Body- Back (3up)<SIM 1>
DUT: Smart Phone; Type: Platinum 5.5C

Date: Mar. 21,2017

Communication System: GPRS-3 Slot; Communication System Band: GPRS 850; Duty Cycle:1:2.7; Conv.F=5.94;
Frequency: 848.8MHz; Medium parameters used: $f = 835$ MHz; $\sigma=0.98$ mho/m; $\epsilon_r = 54.13$; $\rho = 1000$ kg/m³ ;
Phantom section: Flat Section
Ambient temperature (°C): 21.8, Liquid temperature (°C): 21.3

SATIMO Configuration:

- Probe: SSE5; Calibrated: 12/05/2016; Serial No.: SN 14/16 EP308
- Sensor-Surface: 4mm (Mechanical Surface Detection)
- Phantom: SAM twin phantom
- Measurement SW: OpenSAR V4_02_32

Configuration/GPRS 850 High -Body-Back/Area Scan: Measurement grid: dx=8mm, dy=8mm
Configuration/GPRS 850 High -Body-Back/Zoom Scan: Measurement grid: dx=8mm,dy=8mm, dz=5mm;

Area Scan	sam_direct_droit2_surf8mm.txt
ZoomScan	5x5x7,dx=8mm dy=8mm dz=5mm,Complete
Phantom	Validation plane
Device Position	Body Back
Band	GSM 850
Channels	High
Signal	TDMA (Crest factor: 2.7)

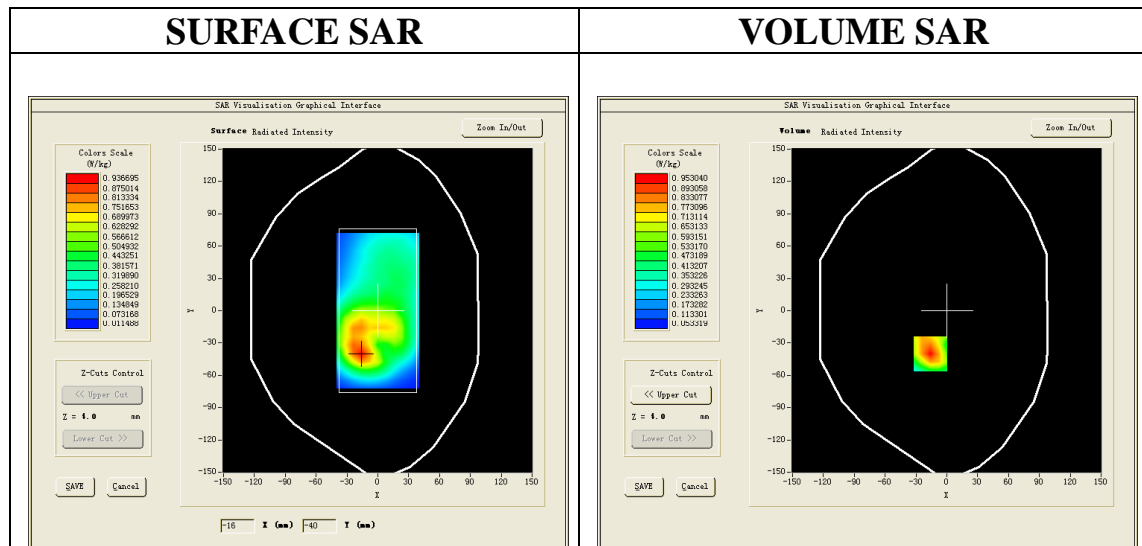

Maximum location: X=-16.00, Y=-40.00

SAR Peak: 1.34 W/kg

SAR 10g (W/Kg)	0.535846
SAR 1g (W/Kg)	0.892016

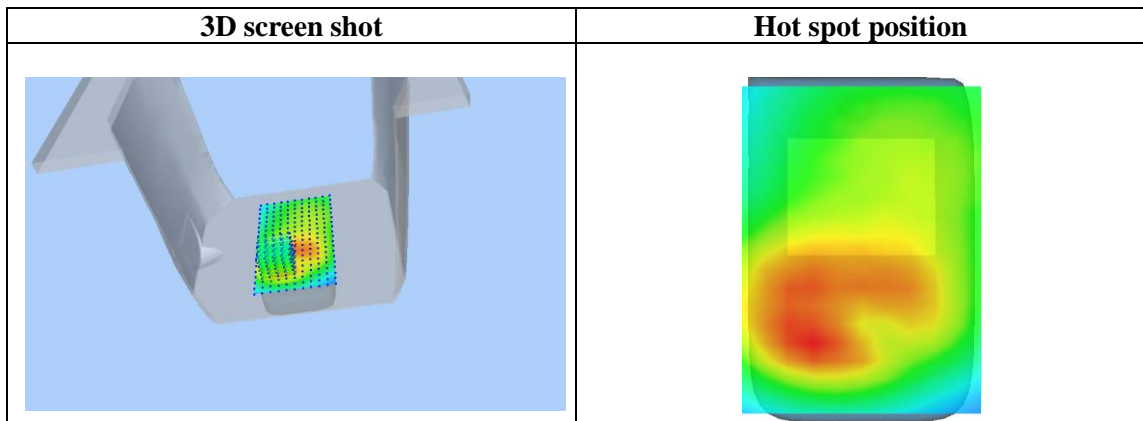
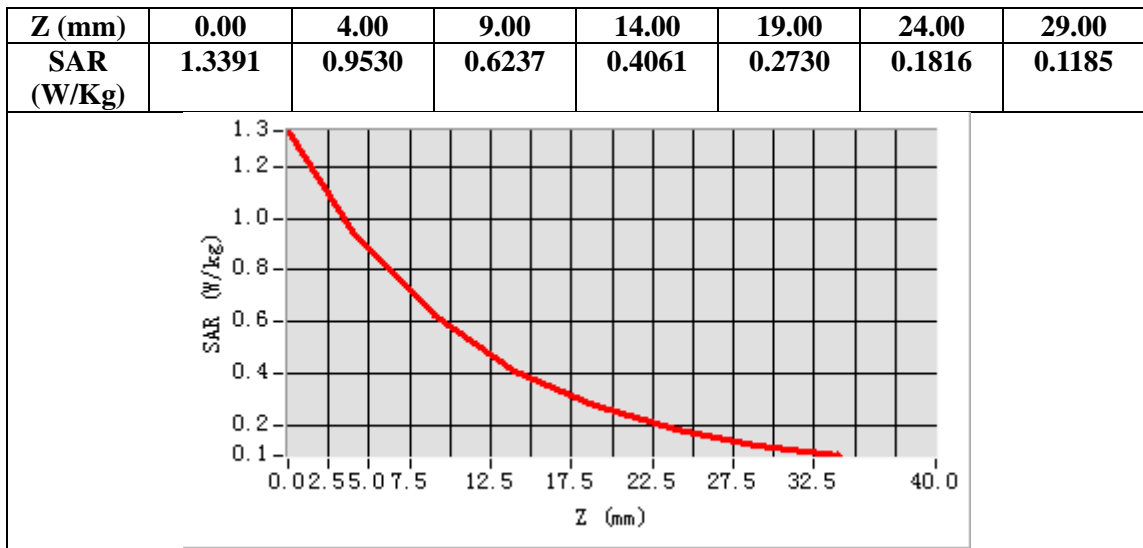

Test Laboratory: AGC Lab
GPRS 850 Mid-Touch-Left (3up) <SIM 2>
DUT: Smart Phone; Type: Platinum 5.5C

Date: Mar. 21,2017

Communication System: GPRS-3 Slot; Communication System Band: GSM 850; Duty Cycle:1:2.7; Conv.F=5.72
Frequency: 836.6 MHz; Medium parameters used: f = 835 MHz; $\sigma=0.89$ mho/m; $\epsilon_r=41.52$; $\rho= 1000$ kg/m³;
Phantom section: Left Section
Ambient temperature (°C):21.8, Liquid temperature (°C): 21.2

SATIMO Configuration:

- Probe: SSE5; Calibrated: 12/05/2016; Serial No.: SN 14/16 EP308
- Sensor-Surface: 4mm (Mechanical Surface Detection)
- Phantom: SAM twin phantom
- Measurement SW: OpenSAR V4_02_32

Configuration/GPRS 850 Mid-Touch-Left/Area Scan: Measurement grid: dx=8mm, dy=8mm
Configuration/GPRS 850 Mid-Touch-Left/Zoom Scan: Measurement grid: dx=8mm,dy=8mm, dz=5mm

Area Scan	sam_direct_droit2_surf8mm.txt
Zoom Scan	5x5x7,dx=8mm dy=8mm dz=5mm,Complete
Phantom	Left head
Device Position	Cheek
Band	GSM 850
Channels	Middle
Signal	TDMA (Crest factor: 2.7)

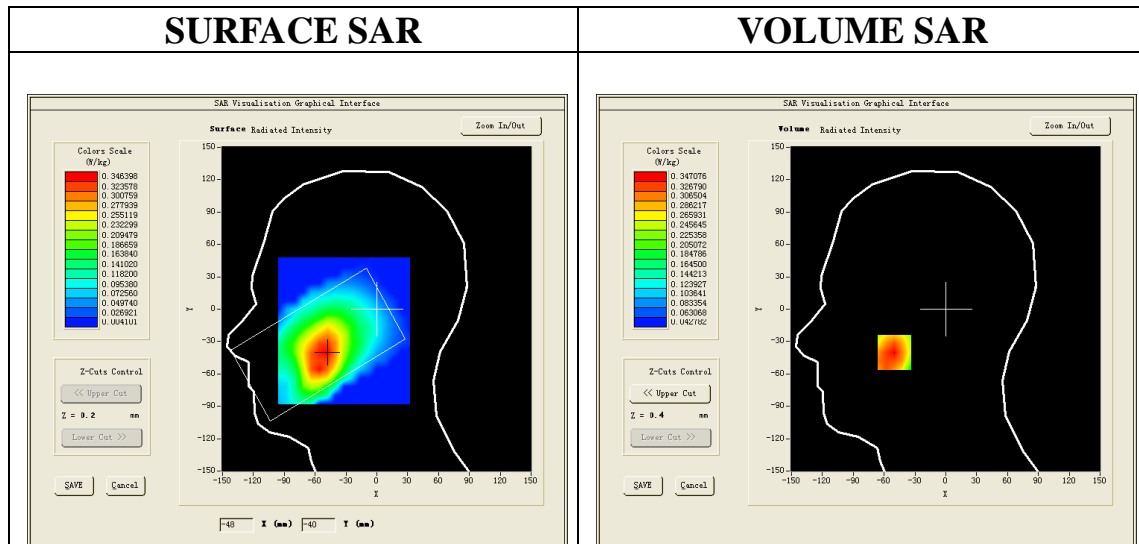

Maximum location: X=-50.00, Y=-40.00
SAR Peak: 0.45 W/kg

SAR 10g (W/Kg)	0.253287
SAR 1g (W/Kg)	0.339509

Z (mm)	0.00	4.00	9.00	14.00	19.00	24.00	29.00
SAR (W/Kg)	0.4558	0.3471	0.2691	0.2364	0.1921	0.1517	0.1179

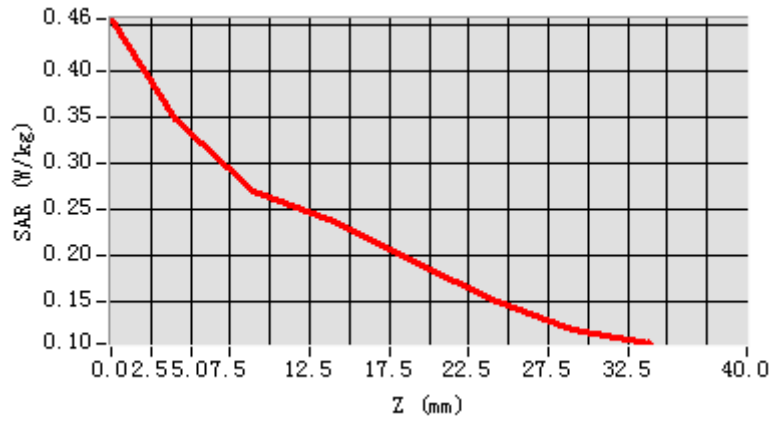

3D screen shot

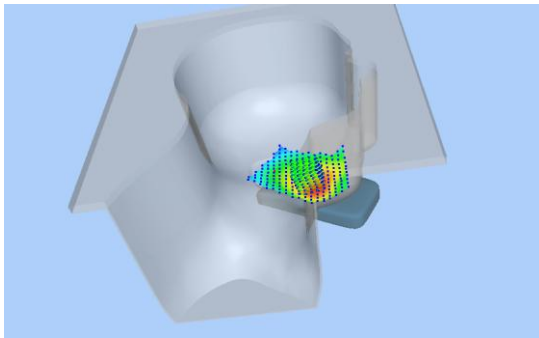

Hot spot position

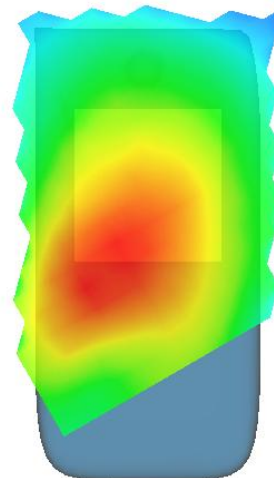

Test Laboratory: AGC Lab
GPRS 850 High- Body- Back (3up)<SIM 2>
DUT: Smart Phone; Type: Platinum 5.5C

Date: Mar. 21,2017

Communication System: GPRS-3 Slot; Communication System Band: GPRS 850; Duty Cycle:1:2.7; Conv.F=5.94;
Frequency: 848.8MHz; Medium parameters used: $f = 835$ MHz; $\sigma=0.98$ mho/m; $\epsilon_r = 54.13$; $\rho = 1000$ kg/m³ ;
Phantom section: Flat Section
Ambient temperature (°C): 21.8, Liquid temperature (°C): 21.3

SATIMO Configuration:

- Probe: SSE5; Calibrated: 12/05/2016; Serial No.: SN 14/16 EP308
- Sensor-Surface: 4mm (Mechanical Surface Detection)
- Phantom: SAM twin phantom
- Measurement SW: OpenSAR V4_02_32

Configuration/GPRS 850 High -Body-Back/Area Scan: Measurement grid: dx=8mm, dy=8mm
Configuration/GPRS 850 High -Body-Back/Zoom Scan: Measurement grid: dx=8mm,dy=8mm, dz=5mm;

Area Scan	sam_direct_droit2_surf8mm.txt
ZoomScan	5x5x7,dx=8mm dy=8mm dz=5mm,Complete
Phantom	Validation plane
Device Position	Body Back
Band	GSM 850
Channels	High
Signal	TDMA (Crest factor: 2.7)

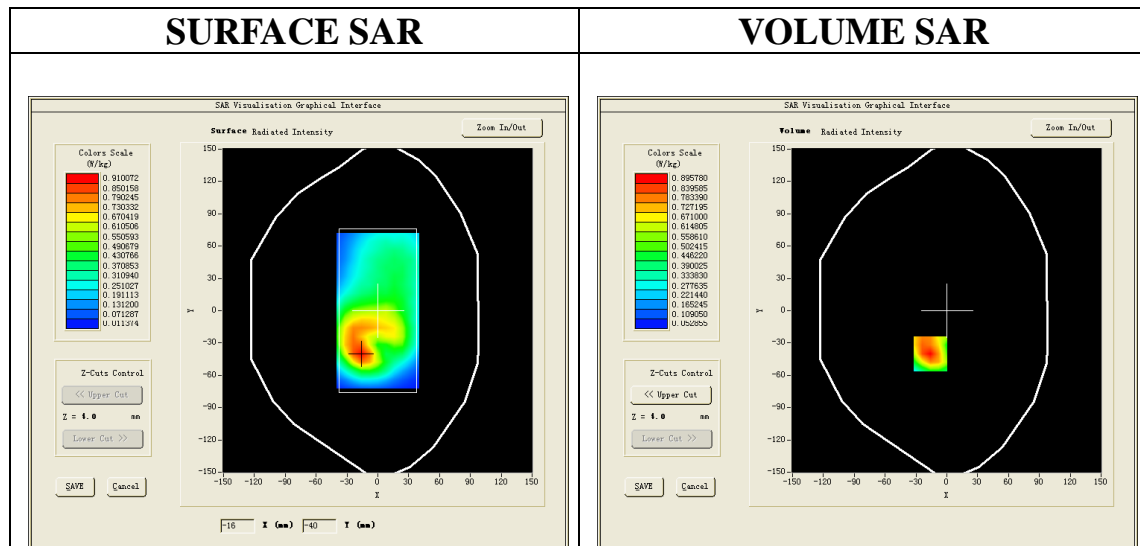

Maximum location: X=-16.00, Y=-40.00

SAR Peak: 1.23 W/kg

SAR 10g (W/Kg)	0.517882
SAR 1g (W/Kg)	0.845196

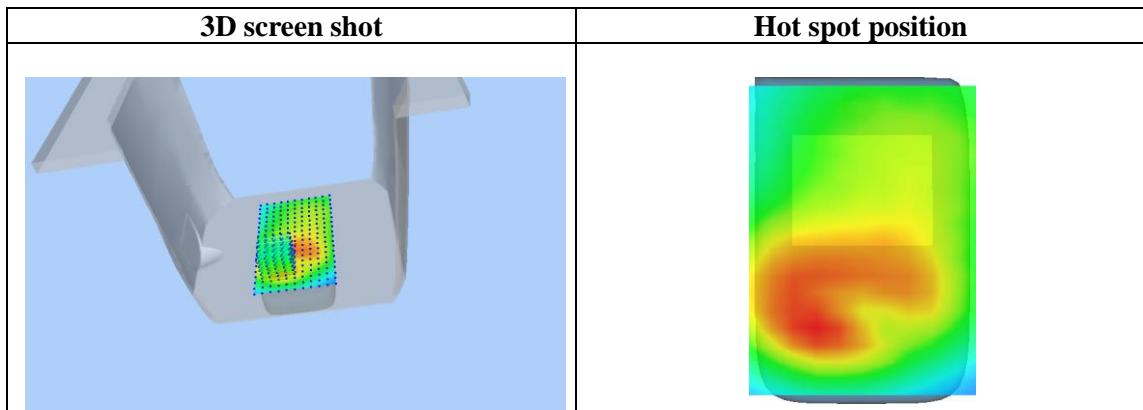
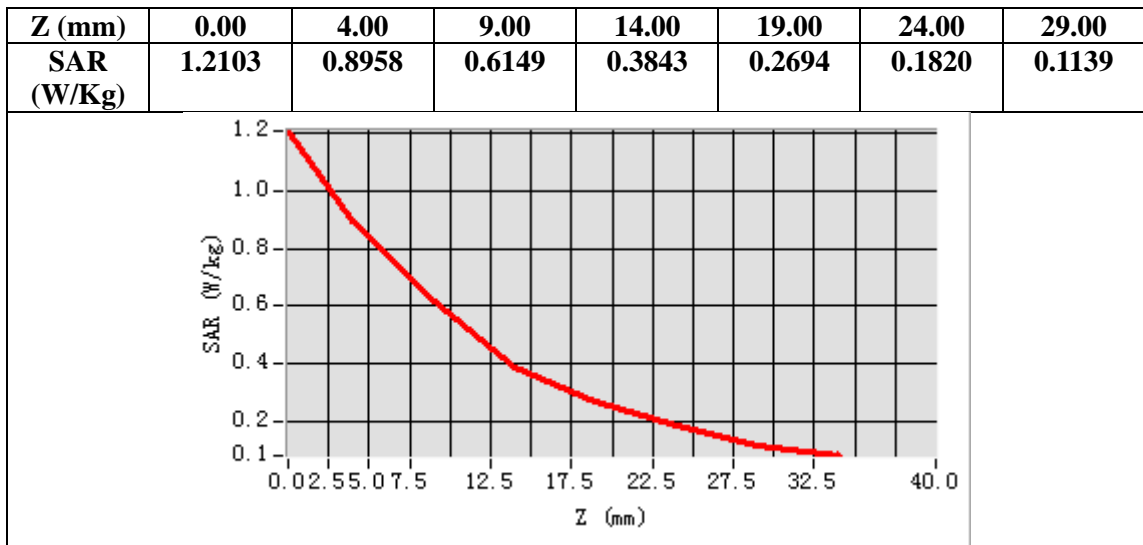

Test Laboratory: AGC Lab
PCS 1900 Mid-Touch- Left <SIM 1>
DUT: Smart Phone; Type: Platinum 5.5C

Date: Mar. 21,2017

Communication System: Generic GSM; Communication System Band: PCS 1900; Duty Cycle: 1:8.3; Conv.F=5.14;
Frequency: 1880 MHz; Medium parameters used: $f = 1900$ MHz; $\sigma = 1.39$ mho/m; $\epsilon_r = 40.86$; $\rho = 1000$ kg/m³ ;
Phantom section: Left Section
Ambient temperature (°C): 22.7, Liquid temperature (°C): 22.1

SATIMO Configuration:

- Probe: SSE5; Calibrated: 07/05/2016; Serial No.: SN 14/16 EP307
- Sensor-Surface: 4mm (Mechanical Surface Detection)
- Phantom: SAM twin phantom
- Measurement SW: OpenSAR V4_02_35

Configuration/PCS1900 Mid-Touch-Left/Area Scan: Measurement grid: dx=8mm, dy=8mm
Configuration/PCS1900 Mid-Touch-Left/Zoom Scan: Measurement grid: dx=8mm,dy=8mm, dz=5mm;

Area Scan	sam_direct_droit2_surf8mm.txt
ZoomScan	5x5x7,dx=8mm dy=8mm dz=5mm,Complete
Phantom	Left head
Device Position	Cheek
Band	PCS 1900
Channels	Middle
Signal	TDMA (Crest factor: 8.0)

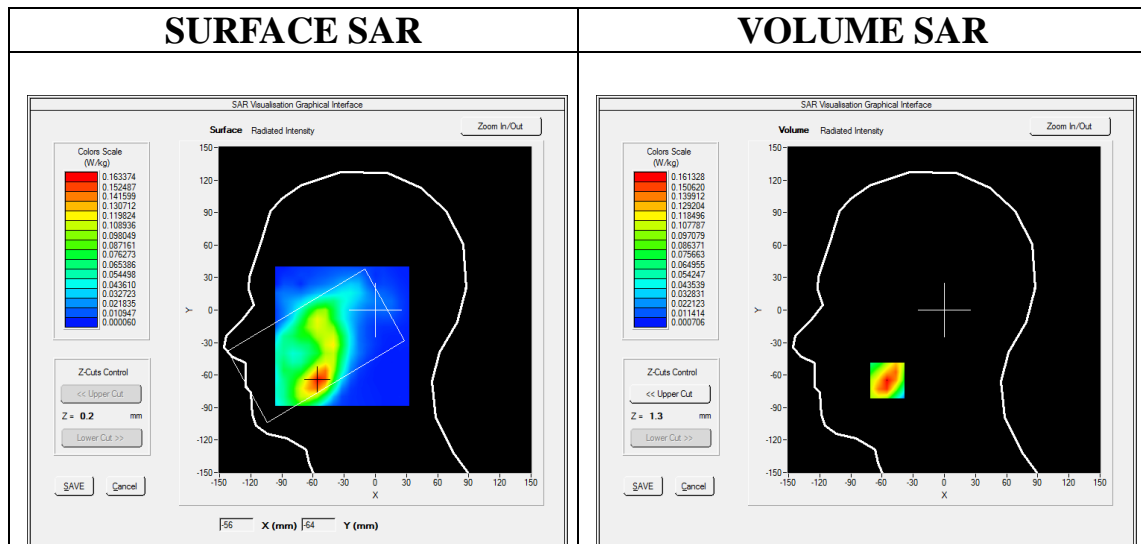

Maximum location: X=-55.00, Y=-65.00

SAR Peak: 0.24 W/kg

SAR 10g (W/Kg)	0.089262
SAR 1g (W/Kg)	0.153465

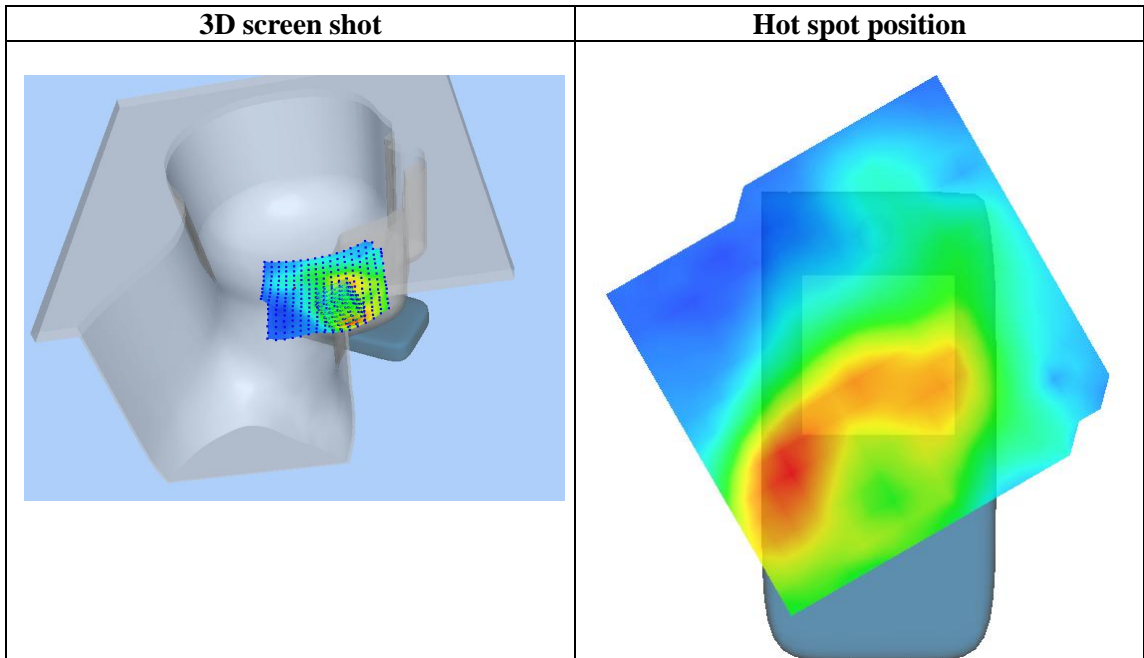
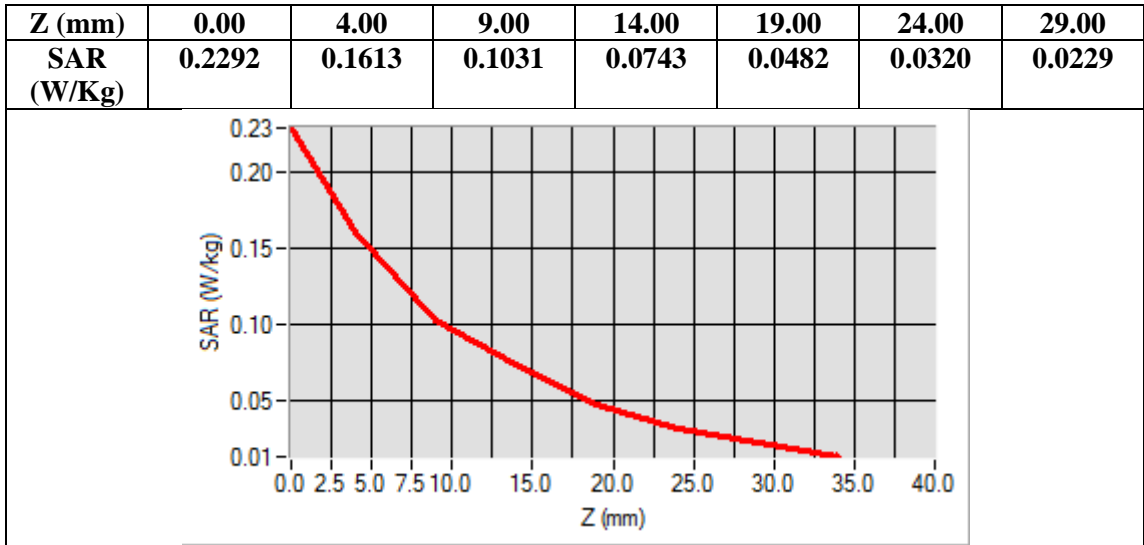

Test Laboratory: AGC Lab
PCS 1900 Mid-Body-Back (MS)<SIM 1>
DUT: Smart Phone; Type: Platinum 5.5C

Date: Mar. 21,2017

Communication System: Generic GSM; Communication System Band: PCS 1900; Duty Cycle: 1:8.3; Conv.F=5.34;
Frequency: 1880 MHz; Medium parameters used: $f = 1900$ MHz; $\sigma = 1.50$ mho/m; $\epsilon_r = 53.86$; $\rho = 1000$ kg/m³ ;
Phantom section: Flat Section
Ambient temperature (°C): 22.7, Liquid temperature (°C): 22.3

SATIMO Configuration:

- Probe: SSE5; Calibrated: 07/05/2016; Serial No.: SN 14/16 EP307
- Sensor-Surface: 4mm (Mechanical Surface Detection)
- Phantom: SAM twin phantom
- Measurement SW: OpenSAR V4_02_35

Configuration/PCS1900 Mid-Body-Back/Area Scan: Measurement grid: dx=8mm, dy=8mm
Configuration/PCS1900 Mid-Body-Back/Zoom Scan: Measurement grid: dx=8mm,dy=8mm, dz=5mm;

Area Scan	sam_direct_droit2_surf8mm.txt
ZoomScan	5x5x7,dx=8mm dy=8mm dz=5mm,Complete
Phantom	Validation plane
Device Position	Body Back
Band	PCS 1900
Channels	Middle
Signal	TDMA (Crest factor: 8.0)

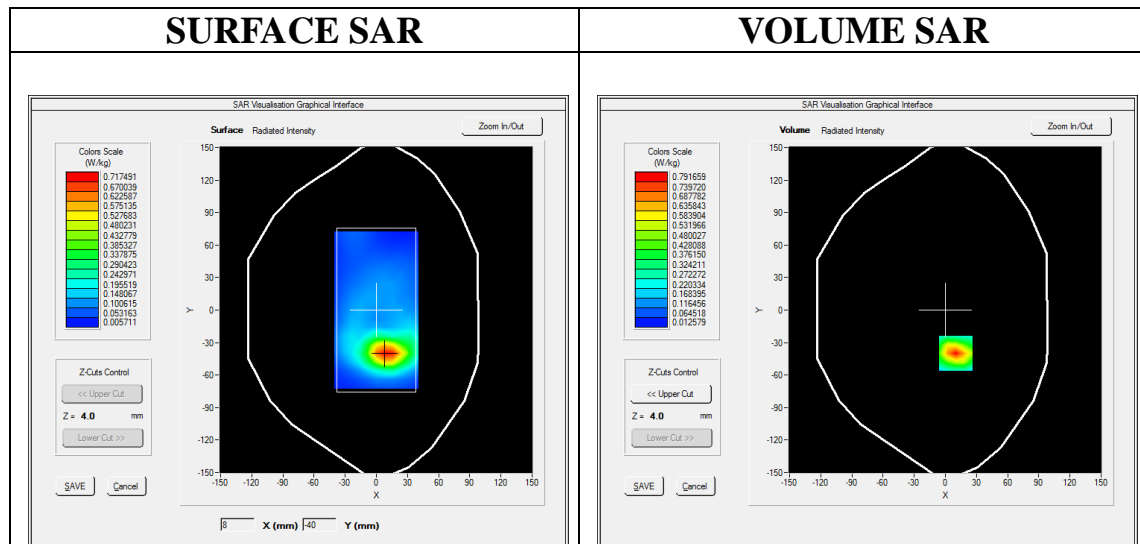

Maximum location: X=10.00, Y=-40.00

SAR Peak: 1.16 W/kg

SAR 10g (W/Kg)	0.375531
SAR 1g (W/Kg)	0.709159

Z (mm)	0.00	4.00	9.00	14.00	19.00	24.00	29.00
SAR (W/Kg)	1.1616	0.7917	0.4810	0.2712	0.1698	0.1068	0.0666

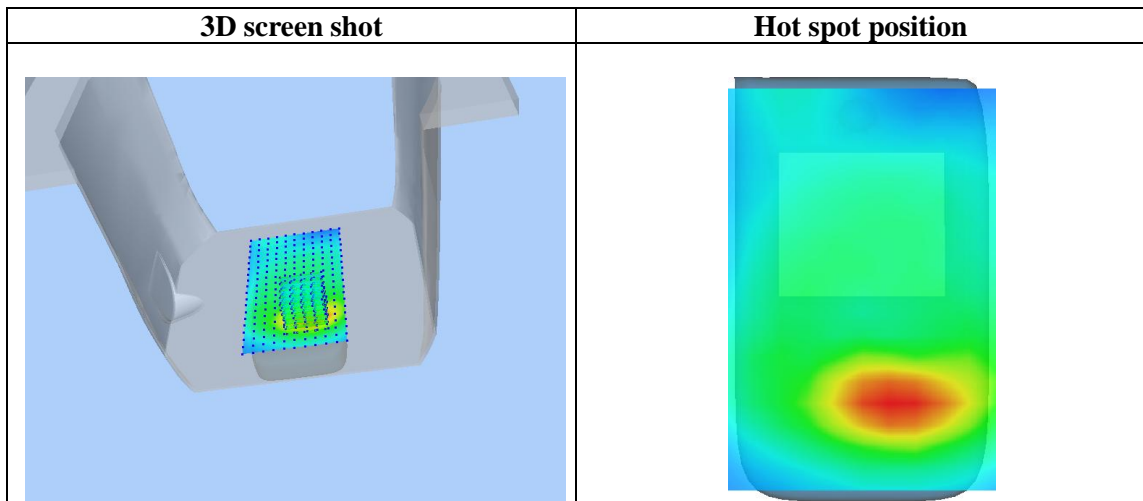
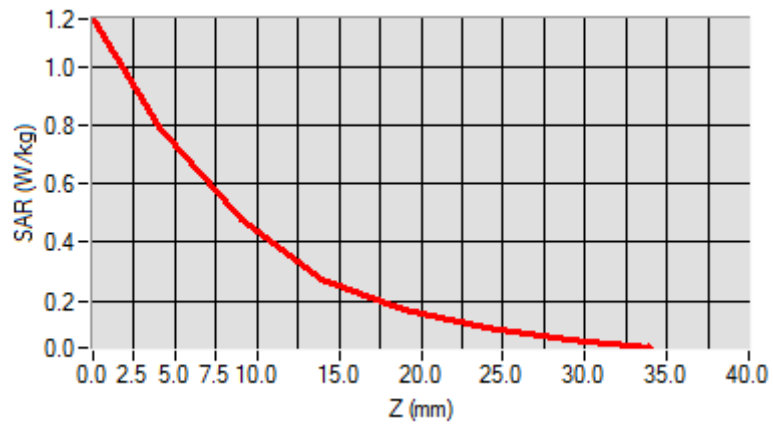

Test Laboratory: AGC Lab
GPRS1900 Mid-Touch-Right (3up) <SIM 1>
DUT: Smart Phone; Type: Platinum 5.5C

Date: Mar. 21,2017

Communication System: GPRS-3Slot; Communication System Band: PCS 1900; Duty Cycle: 1:2.7; Conv.F=5.14;
Frequency: 1880 MHz; Medium parameters used: $f = 1900$ MHz; $\sigma = 1.39$ mho/m; $\epsilon_r = 40.86$; $\rho = 1000$ kg/m³ ;
Phantom section: Right Section
Ambient temperature (°C): 22.7, Liquid temperature (°C): 22.1

SATIMO Configuration:

- Probe: SSE5; Calibrated: 07/05/2016; Serial No.: SN 14/16 EP307
- Sensor-Surface: 4mm (Mechanical Surface Detection)
- Phantom: SAM twin phantom
- Measurement SW: OpenSAR V4_02_35

Configuration/GPRS1900 Mid-Touch-Right/Area Scan: Measurement grid: dx=8mm, dy=8mm

Configuration/GPRS1900 Mid-Touch-Right/Zoom Scan: Measurement grid: dx=8mm,dy=8mm, dz=5mm;

Area Scan	sam_direct_droit2_surf8mm.txt
Zoom Scan	5x5x7,dx=8mm dy=8mm dz=5mm,Complete
Phantom	Right head
Device Position	Cheek
Band	PCS 1900
Channels	Middle
Signal	TDMA (Crest factor: 2.7)

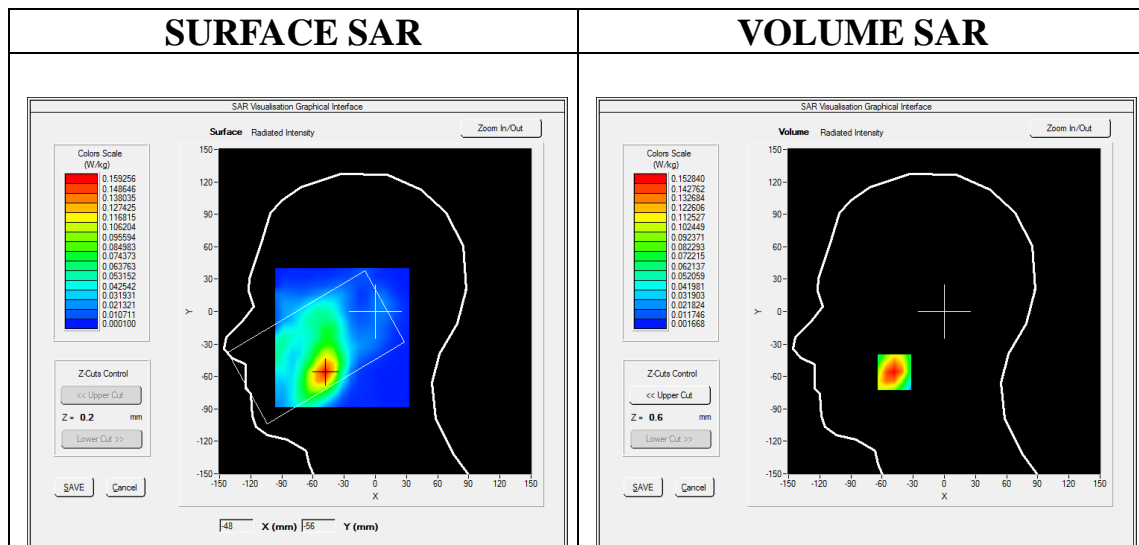

Maximum location: X=-48.00, Y=-56.00

SAR Peak: 0.22 W/kg

SAR 10g (W/Kg)	0.087070
SAR 1g (W/Kg)	0.144875

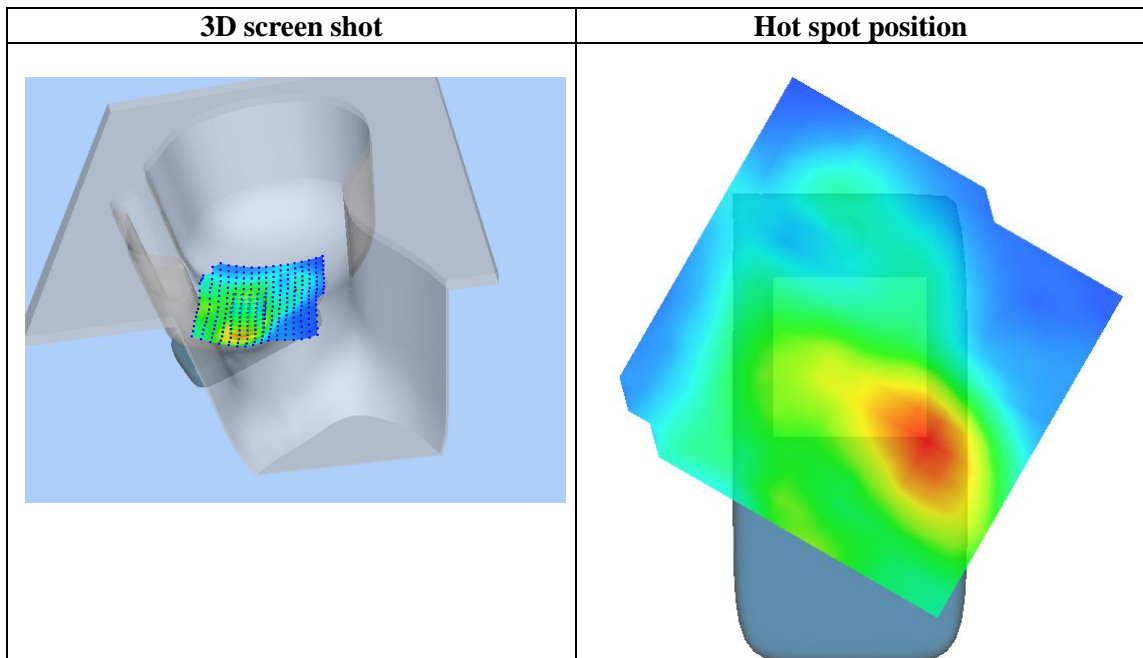
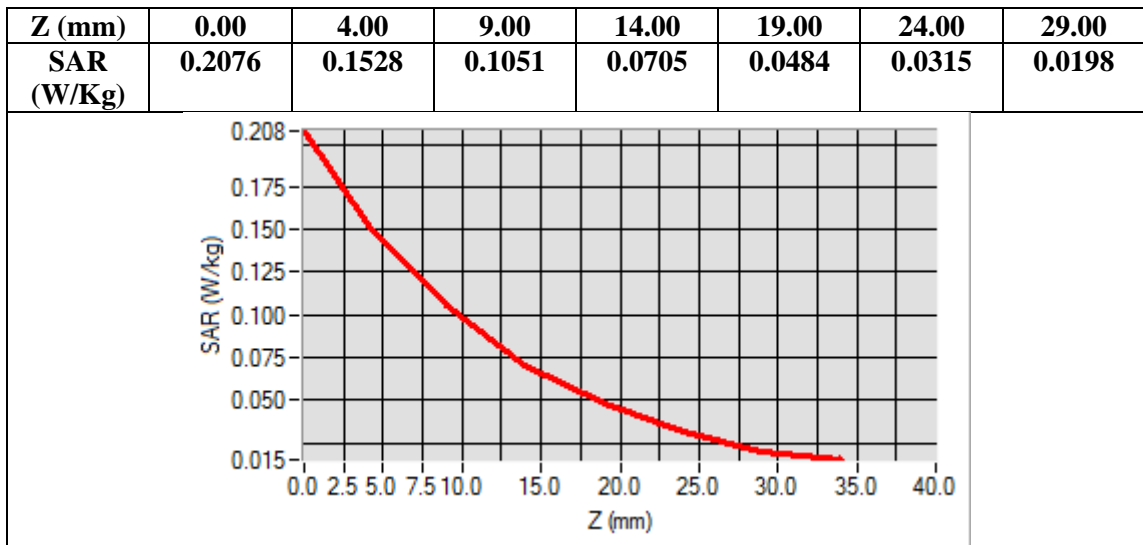

Test Laboratory: AGC Lab
GPRS 1900 Mid-Edge 3(2up) <SIM 1>
DUT: Smart Phone; Type: Platinum 5.5C

Date: Mar. 21,2017

Communication System: GPRS-3Slot; Communication System Band: PCS 1900; Duty Cycle:1:2.7; Conv.F=5.34;
Frequency: 1880 MHz; Medium parameters used: $f = 1900$ MHz; $\sigma = 1.50$ mho/m; $\epsilon_r = 53.86$; $\rho = 1000$ kg/m³ ;
Phantom section: Flat Section
Ambient temperature (°C): 22.7, Liquid temperature (°C): 22.3

SATIMO Configuration:

- Probe: SSE5; Calibrated: 07/05/2016; Serial No.: SN 14/16 EP307
- Sensor-Surface: 4mm (Mechanical Surface Detection)
- Phantom: SAM twin phantom
- Measurement SW: OpenSAR V4_02_35

Configuration/GPRS1900 Mid-Edge 3/Area Scan: Measurement grid: dx=8mm, dy=8mm
Configuration/GPRS1900 Mid-Edge 3/Zoom Scan: Measurement grid: dx=8mm,dy=8mm, dz=5mm;

Area Scan	sam_direct_droit2_surf8mm.txt
Zoom Scan	5x5x7,dx=8mm dy=8mm dz=5mm,Complete
Phantom	Validation plane
Device Position	Edge 3
Band	PCS 1900
Channels	Middle
Signal	TDMA (Crest factor: 2.7)

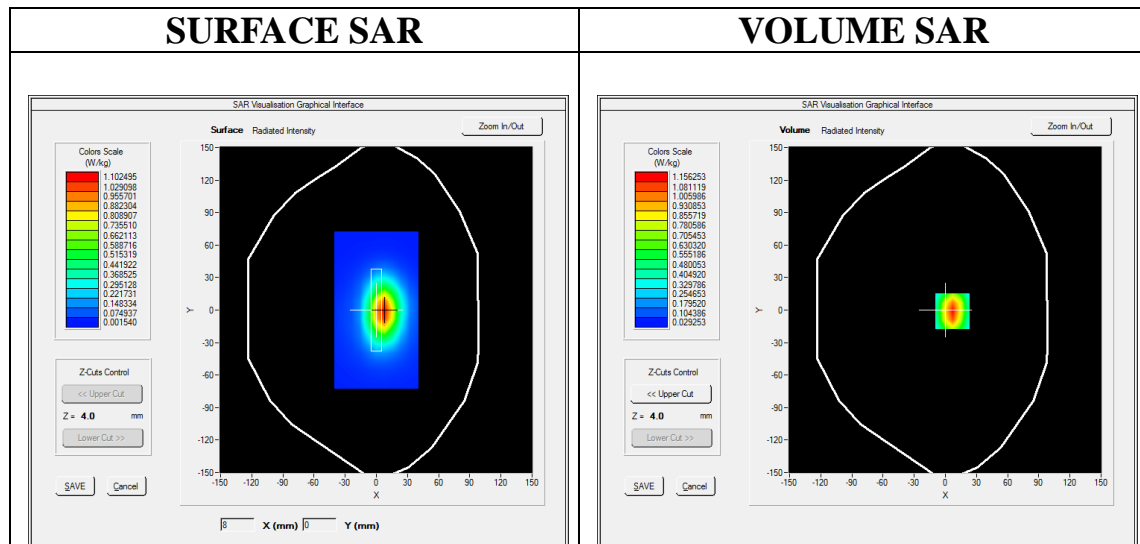

Maximum location: X=7.00, Y=-1.00

SAR Peak: 1.71 W/kg

SAR 10g (W/Kg)	0.603837
SAR 1g (W/Kg)	1.076675

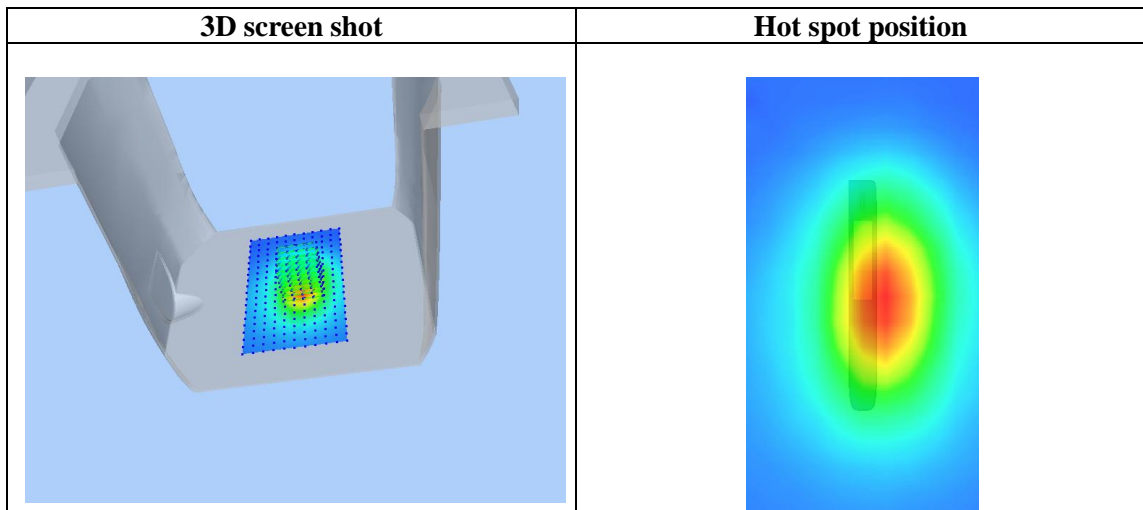
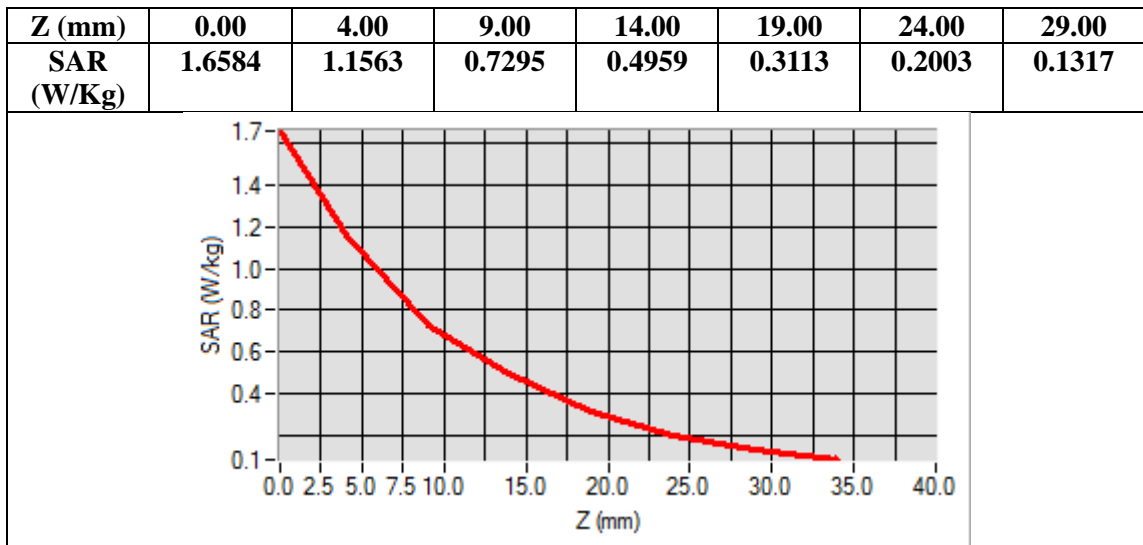

Test Laboratory: AGC Lab
PCS 1900 Mid-Touch- Left <SIM 2>
DUT: Smart Phone; Type: Platinum 5.5C

Date: Mar. 21,2017

Communication System: Generic GSM; Communication System Band: PCS 1900; Duty Cycle: 1:8.3; Conv.F=5.14;
Frequency: 1880 MHz; Medium parameters used: $f = 1900$ MHz; $\sigma = 1.39$ mho/m; $\epsilon_r = 40.86$; $\rho = 1000$ kg/m³ ;
Phantom section: Left Section
Ambient temperature (°C): 22.7, Liquid temperature (°C): 22.1

SATIMO Configuration:

- Probe: SSE5; Calibrated: 07/05/2016; Serial No.: SN 14/16 EP307
- Sensor-Surface: 4mm (Mechanical Surface Detection)
- Phantom: SAM twin phantom
- Measurement SW: OpenSAR V4_02_35

Configuration/PCS1900 Mid-Touch-Left/Area Scan: Measurement grid: dx=8mm, dy=8mm
Configuration/PCS1900 Mid-Touch-Left/Zoom Scan: Measurement grid: dx=8mm,dy=8mm, dz=5mm;

Area Scan	sam_direct_droit2_surf8mm.txt
ZoomScan	5x5x7,dx=8mm dy=8mm dz=5mm,Complete
Phantom	Left head
Device Position	Cheek
Band	PCS 1900
Channels	Middle
Signal	TDMA (Crest factor: 8.0)

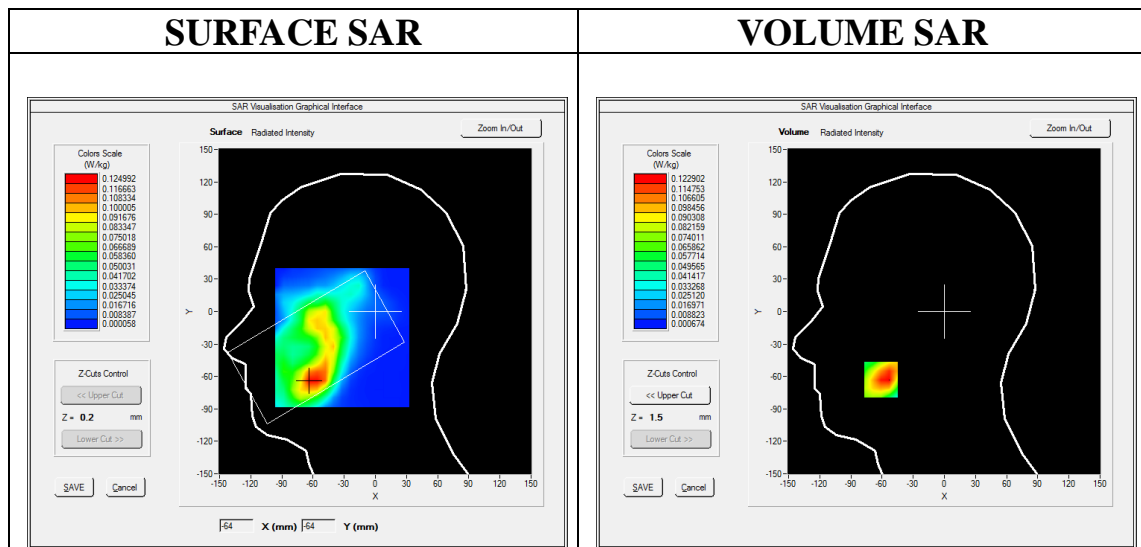

Maximum location: X=-61.00, Y=-63.00

SAR Peak: 0.19 W/kg

SAR 10g (W/Kg)	0.069980
SAR 1g (W/Kg)	0.120215

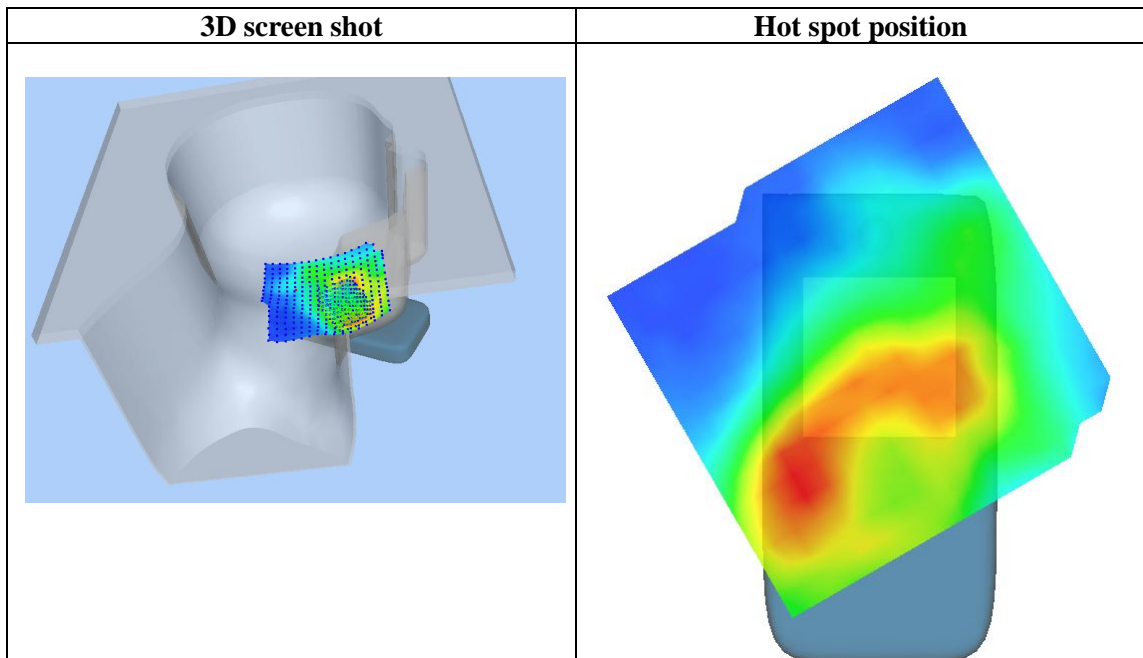
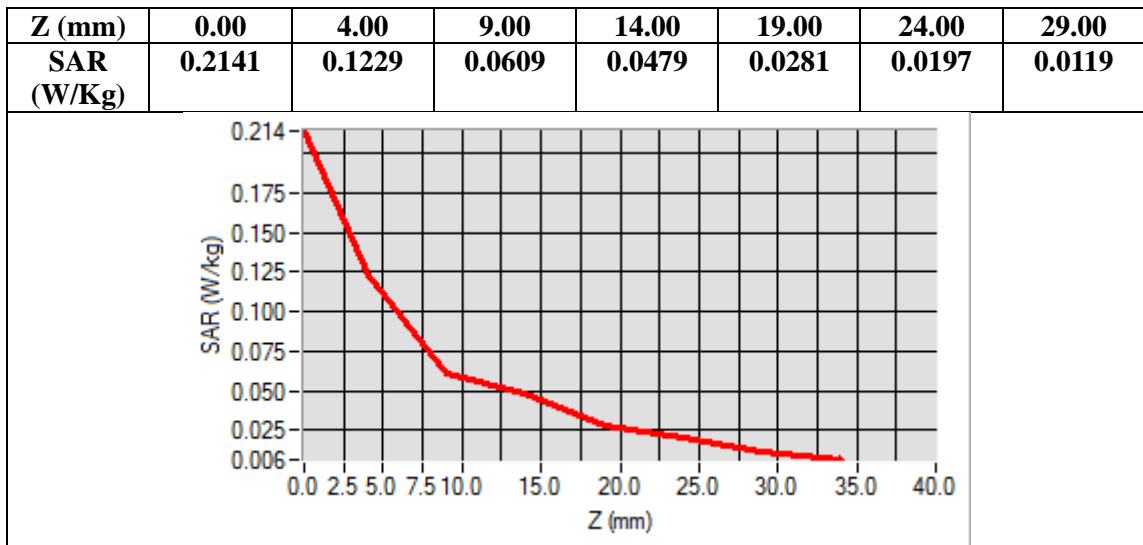

Test Laboratory: AGC Lab
GPRS 1900 Mid-Edge 3(2up) <SIM 2>
DUT: Smart Phone; Type: Platinum 5.5C

Date: Mar. 21,2017

Communication System: GPRS-3Slot; Communication System Band: PCS 1900; Duty Cycle:1:2.7; Conv.F=5.34;
Frequency: 1880 MHz; Medium parameters used: $f = 1900$ MHz; $\sigma = 1.50$ mho/m; $\epsilon_r = 53.86$; $\rho = 1000$ kg/m³ ;
Phantom section: Flat Section
Ambient temperature (°C): 22.7, Liquid temperature (°C): 22.3

SATIMO Configuration:

- Probe: SSE5; Calibrated: 07/05/2016; Serial No.: SN 14/16 EP307
- Sensor-Surface: 4mm (Mechanical Surface Detection)
- Phantom: SAM twin phantom
- Measurement SW: OpenSAR V4_02_35

Configuration/GPRS1900 Mid-Edge 3/Area Scan: Measurement grid: dx=8mm, dy=8mm
Configuration/GPRS1900 Mid-Edge 3/Zoom Scan: Measurement grid: dx=8mm,dy=8mm, dz=5mm;

Area Scan	sam_direct_droit2_surf8mm.txt
Zoom Scan	5x5x7,dx=8mm dy=8mm dz=5mm,Complete
Phantom	Validation plane
Device Position	Edge 3
Band	PCS 1900
Channels	Middle
Signal	TDMA (Crest factor: 2.7)

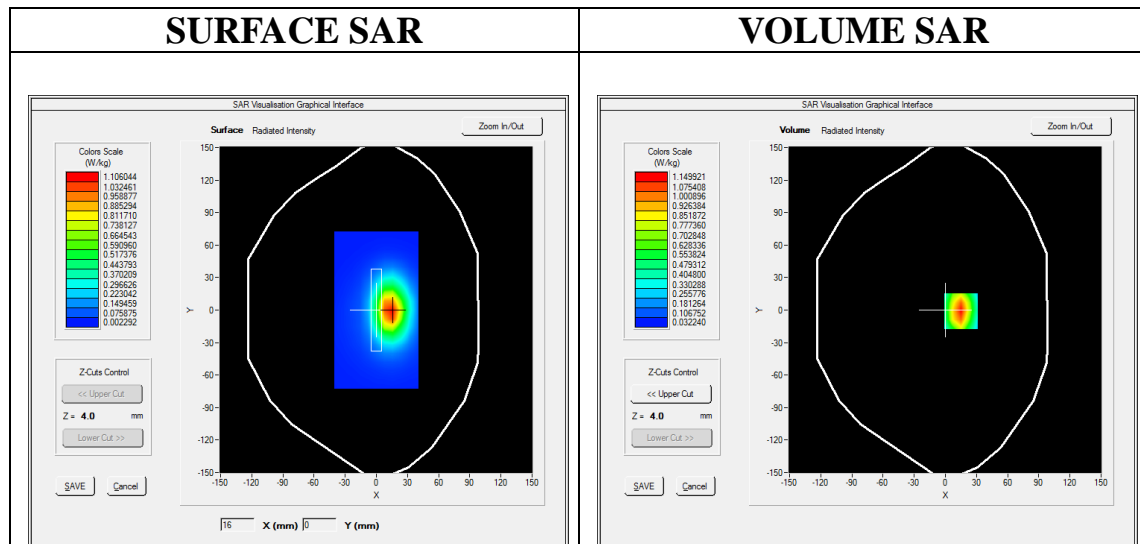

Maximum location: X=15.00, Y=-1.00

SAR Peak: 1.57 W/kg

SAR 10g (W/Kg)	0.614380
SAR 1g (W/Kg)	1.057672

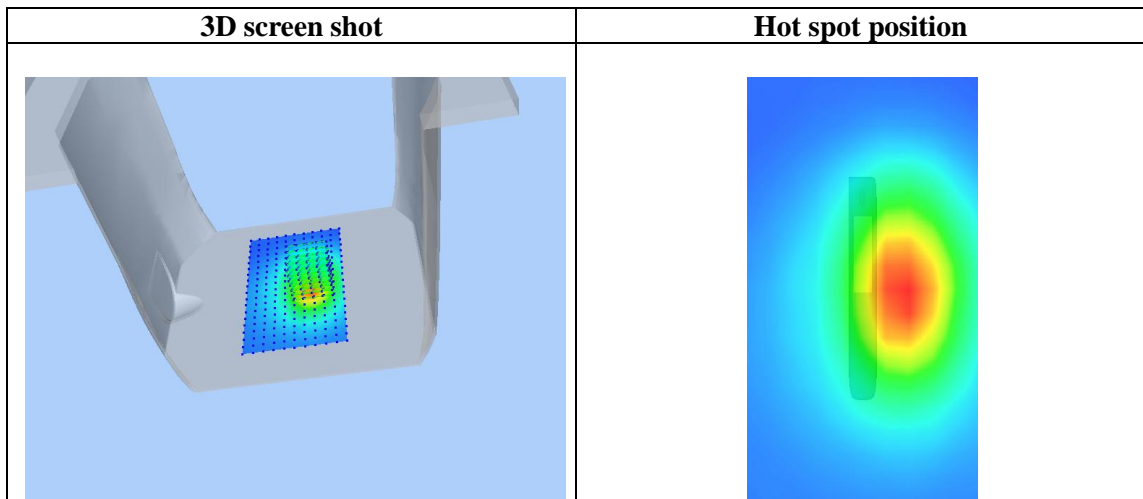
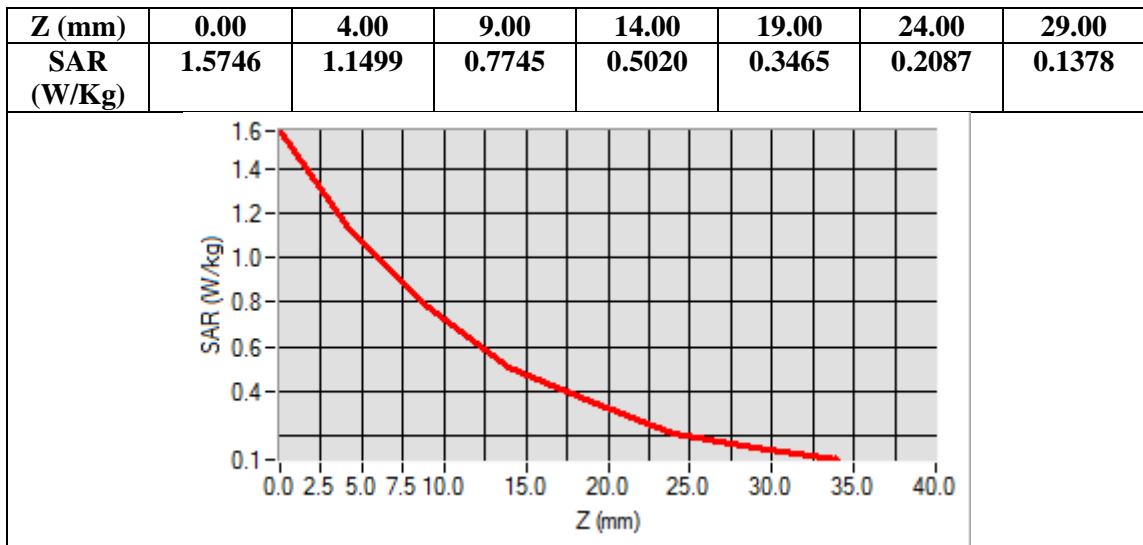

Test Laboratory: AGC Lab
WCDMA Band II Mid-Touch-Right (RMC)
DUT: Smart Phone; Type: Platinum 5.5C

Date: Mar. 21,2017

Communication System: UMTS; Communication System Band: Band II UTRA/FDD ;Duty Cycle:1:1; Conv.F=5.14;
Frequency: 1880 MHz; Medium parameters used: $f = 1900$ MHz; $\sigma = 1.39$ mho/m; $\epsilon_r = 40.86$; $\rho = 1000$ kg/m³ ;
Phantom section: Right Section
Ambient temperature (°C): 22.7, Liquid temperature (°C): 22.1

SATIMO Configuration:

- Probe: SSE5; Calibrated: 07/05/2016; Serial No.: SN 14/16 EP307
- Sensor-Surface: 4mm (Mechanical Surface Detection)
- Phantom: SAM twin phantom
- Measurement SW: OpenSAR V4_02_35

Configuration/WCDMA band II Mid-Touch-Right/Area Scan: Measurement grid: dx=8mm, dy=8mm

Configuration/WCDMA band II Mid-Touch-Right/Zoom Scan: Measurement grid: dx=8mm,dy=8mm, dz=5mm;

Area Scan	sam_direct_droit2_surf8mm.txt
ZoomScan	5x5x7,dx=8mm dy=8mm dz=5mm,Complete
Phantom	Right head
Device Position	Cheek
Band	WCDMA band II
Channels	Middle
Signal	CDMA (Crest factor: 1.0)

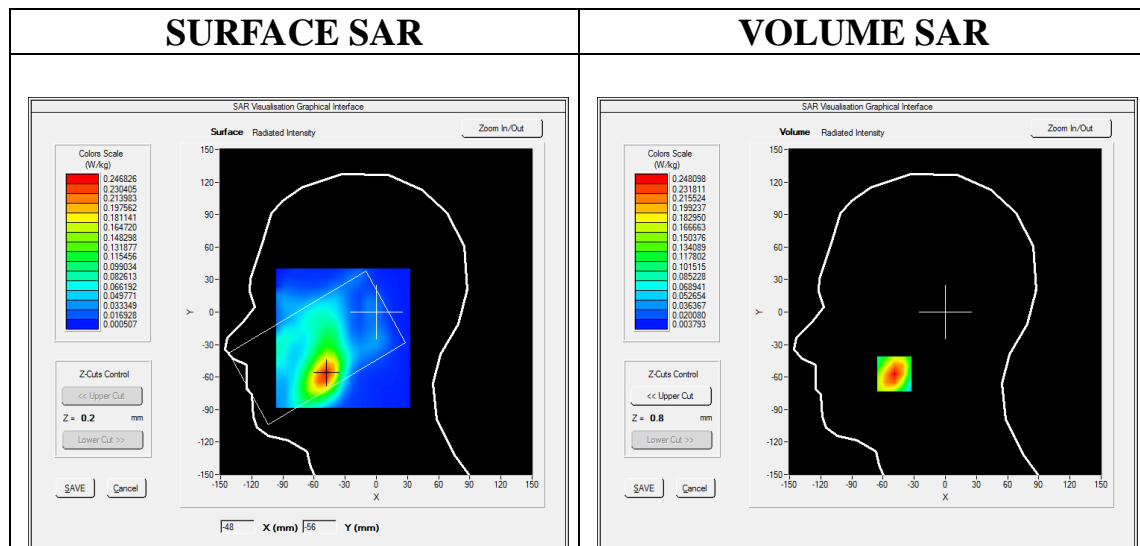

Maximum location: X=-49.00, Y=-57.00

SAR Peak: 0.35 W/kg

SAR 10g (W/Kg)	0.139803
SAR 1g (W/Kg)	0.234765

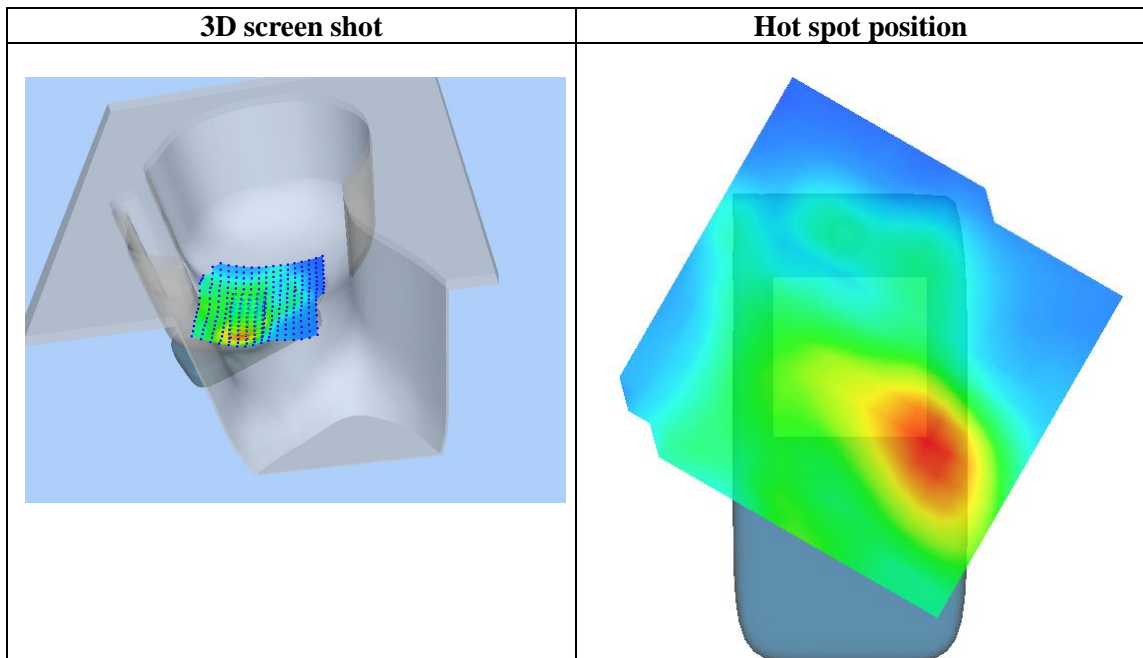
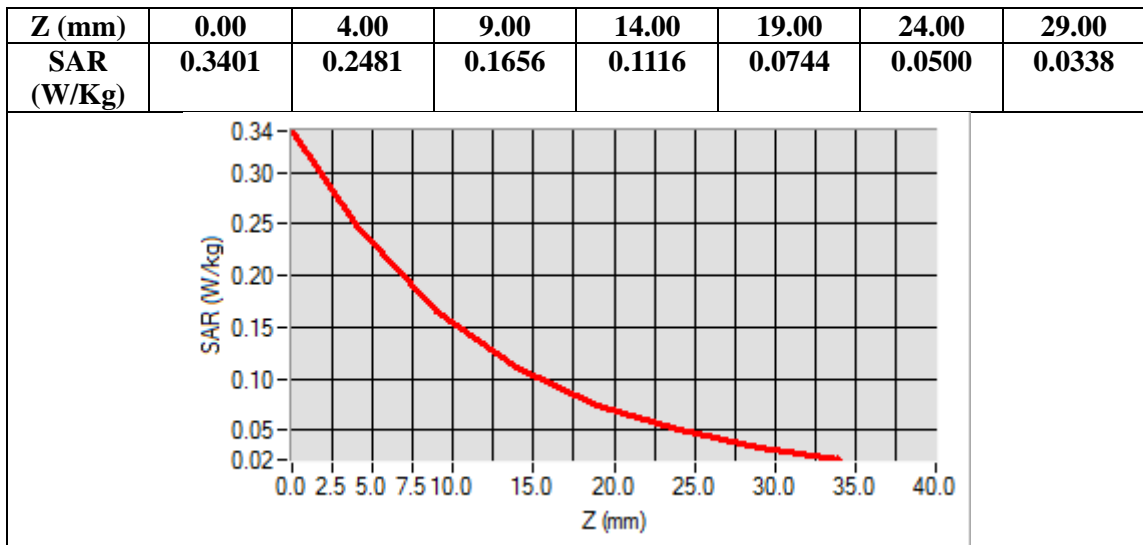

Test Laboratory: AGC Lab
WCDMA Band II High-Body-Towards Grounds (RMC 12.2kbps)
DUT: Smart Phone; Type: Platinum 5.5C

Date: Mar. 21,2017

Communication System: UMTS; Communication System Band: Band II UTRA/FDD ;Duty Cycle:1:1; Conv.F=5.34;
Frequency: 1907.6 MHz; Medium parameters used: $f = 1900$ MHz; $\sigma = 1.53$ mho/m; $\epsilon_r = 53.10$; $\rho = 1000$ kg/m³ ;
Phantom section: Flat Section
Ambient temperature (°C): 22.7, Liquid temperature (°C): 22.3

SATIMO Configuration:

- Probe: SSE5; Calibrated: 07/05/2016; Serial No.: SN 14/16 EP307
- Sensor-Surface: 4mm (Mechanical Surface Detection)
- Phantom: SAM twin phantom
- Measurement SW: OpenSAR V4_02_35

Configuration/ WCDMA band II High -Body-back/Area Scan: Measurement grid: dx=8mm, dy=8mm

Configuration/ WCDMA band II High -Body-back/Zoom Scan: Measurement grid: dx=8mm,dy=8mm, dz=5mm;

Area Scan	sam_direct_droit2_surf8mm.txt
ZoomScan	5x5x7,dx=8mm dy=8mm dz=5mm,Complete
Phantom	Validation plane
Device Position	Body Back
Band	WCDMA band II
Channels	High
Signal	CDMA (Crest factor: 1.0)

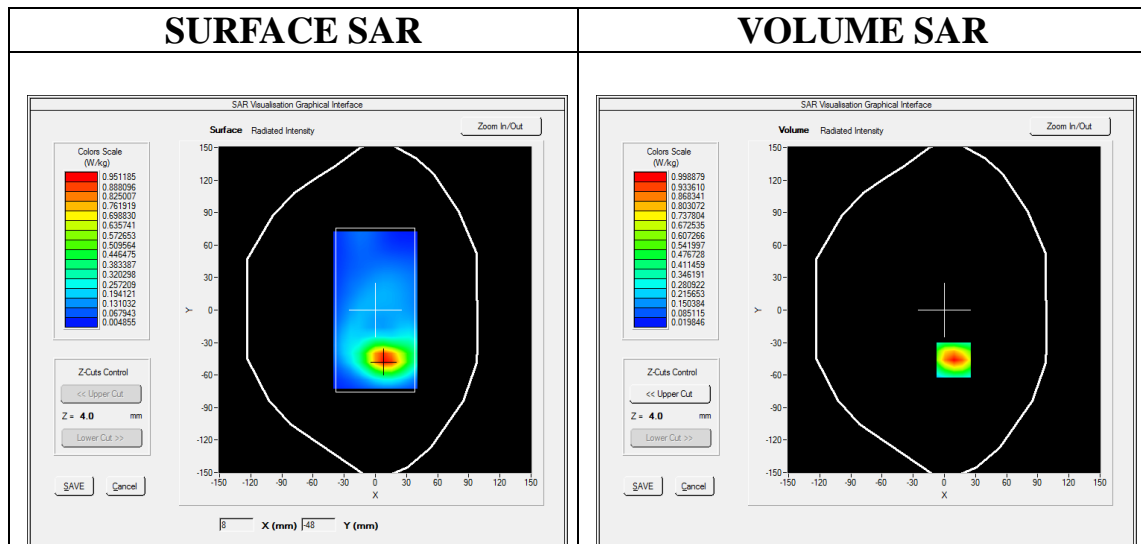

Maximum location: X=9.00, Y=-46.00

SAR Peak: 1.47 W/kg

SAR 10g (W/Kg)	0.516176
SAR 1g (W/Kg)	0.947414

Z (mm)	0.00	4.00	9.00	14.00	19.00	24.00	29.00
SAR (W/Kg)	1.4740	0.9989	0.6061	0.3827	0.2332	0.1451	0.0896

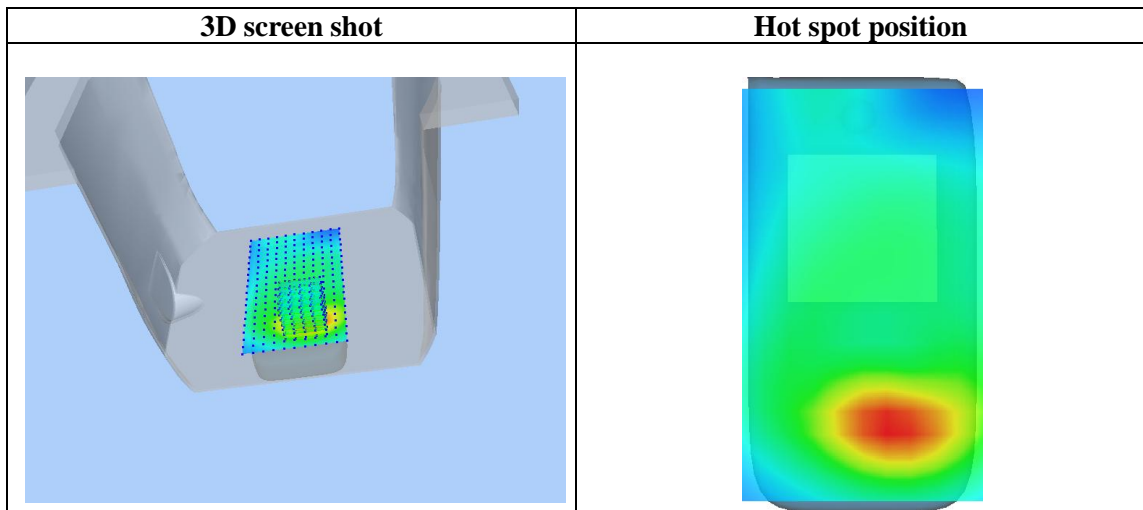
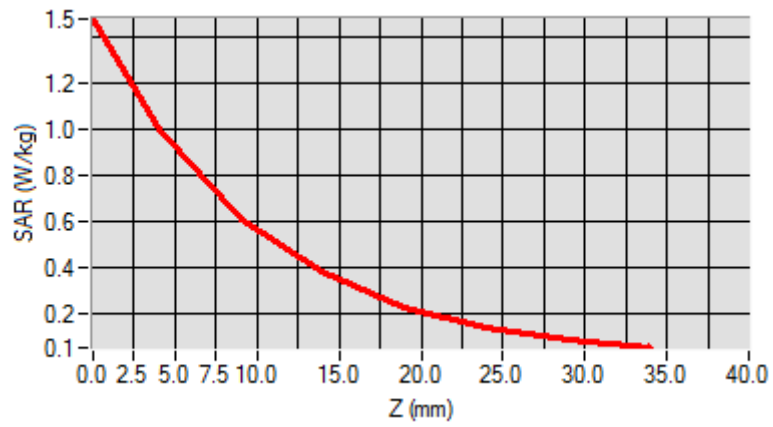

Test Laboratory: AGC Lab
WCDMA Band IV Mid-Touch-Right (RMC)
DUT: Smart Phone; Type: Platinum 5.5C

Date: Mar. 22,2017

Communication System: UMTS; Communication System Band: BAND IV UTRA/FDD; Duty Cycle:1: 1; Conv.F=4.92;
Frequency: 1732.5 MHz; Medium parameters used: $f = 1800\text{MHz}$; $\sigma=1.35\text{ mho/m}$; $\epsilon_r=41.11$; $\rho= 1000\text{ kg/m}^3$;
Phantom section: Right Section
Ambient temperature ($^{\circ}\text{C}$): 22.8, Liquid temperature ($^{\circ}\text{C}$): 22.0

SATIMO Configuration:

- Probe: SSE5; Calibrated: 07/05/2016; Serial No.: SN 14/16 EP307
- Sensor-Surface: 4mm (Mechanical Surface Detection)
- Phantom: SAM twin phantom
- Measurement SW: OpenSAR V4_02_35

Configuration/ WCDMA BandIVMid-Touch-Right/Area Scan: Measurement grid: dx=8mm, dy=8mm
Configuration/ WCDMA BandIVMid-Touch-Right/Zoom Scan: Measurement grid: dx=8mm, dy=8mm, dz=5mm

Area Scan	sam_direct_droit2_surf8mm.txt
ZoomScan	5x5x7,dx=8mm dy=8mm dz=5mm,Complete
Phantom	Right head
Device Position	Cheek
Band	WCDMA Band IV
Channels	Middle
Signal	CDMA (Crest factor: 1.0)

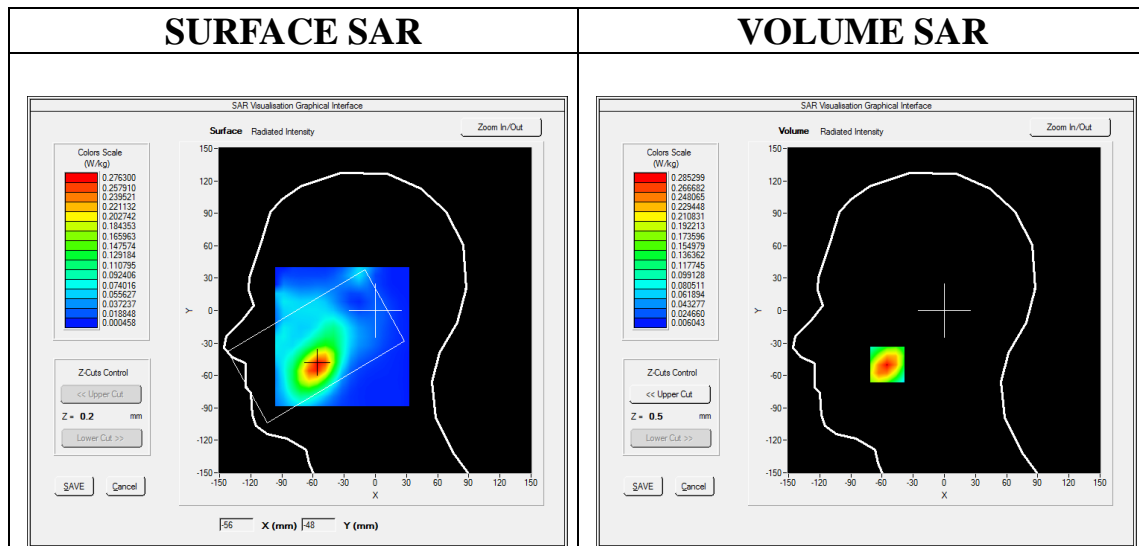

Maximum location: X=-55.00, Y=-50.00
SAR Peak: 0.40 W/kg

SAR 10g (W/Kg)	0.161318
SAR 1g (W/Kg)	0.268895

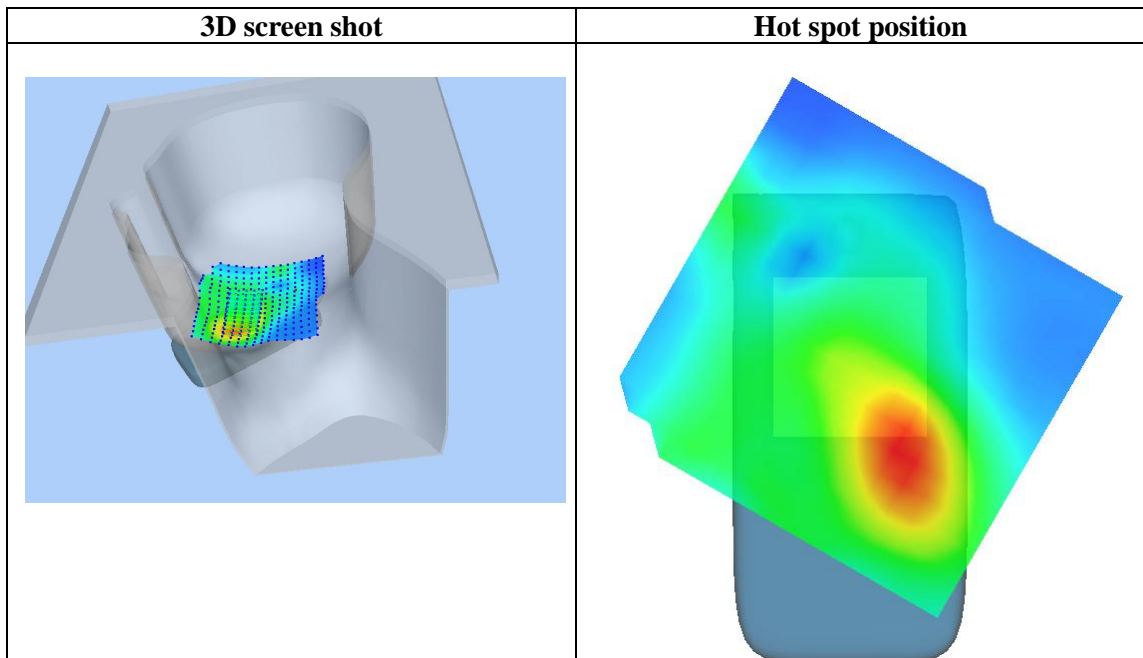
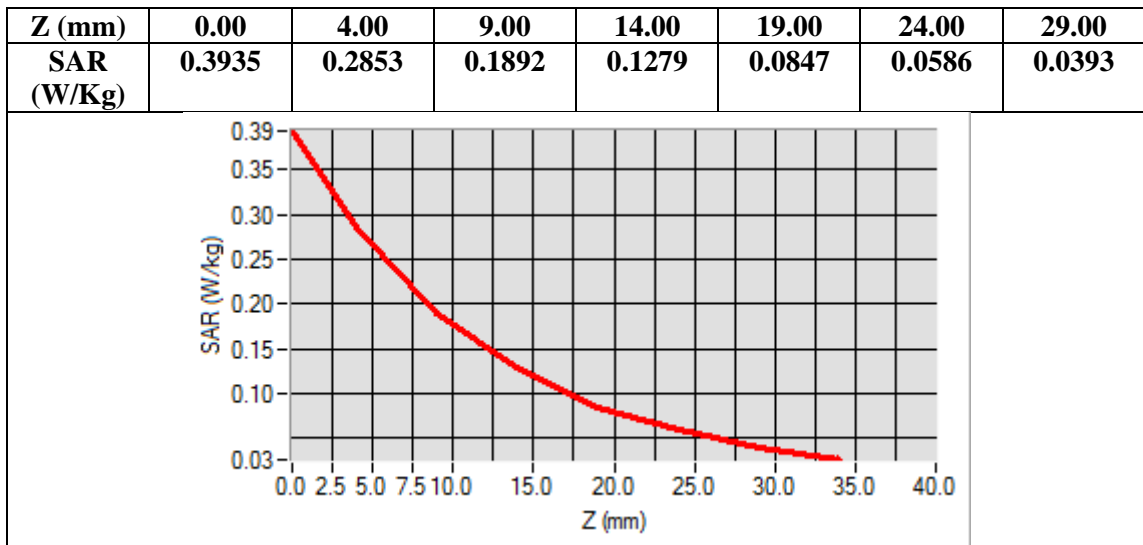

Test Laboratory: AGC Lab
WCDMA Band IV Mid-Body-Towards Grounds (RMC)
DUT: Smart Phone; Type: Platinum 5.5C

Date: Mar. 22,2017

Communication System: UMTS; Communication System Band: BAND IV UTRA/FDD;Duty Cycle:1: 1; Conv.F=5.06
Frequency: 1732.5 MHz; Medium parameters used: $f = 1800\text{MHz}$; $\sigma=1.45\text{ mho/m}$; $\epsilon_r=53.90$; $\rho= 1000\text{ kg/m}^3$;
Phantom section: Flat Section
Ambient temperature ($^{\circ}\text{C}$): 22.8, Liquid temperature ($^{\circ}\text{C}$): 22.2

SATIMO Configuration:

- Probe: SSE5; Calibrated: 07/05/2016; Serial No.: SN 14/16 EP307
- Sensor-Surface: 4mm (Mechanical Surface Detection)
- Phantom: SAM twin phantom
- Measurement SW: OpenSAR V4_02_35

Configuration/ WCDMA Band IVMid-Body-Back/Area Scan: Measurement grid: $dx=8\text{mm}$, $dy=8\text{mm}$
Configuration/ WCDMA Band IVMid-Body-Back/Zoom Scan: Measurement grid: $dx=8\text{mm}$, $dy=8\text{mm}$, $dz=5\text{mm}$;

Area Scan	sam_direct_droit2_surf8mm.txt
ZoomScan	5x5x7,dx=8mm dy=8mm dz=5mm,Complete
Phantom	Validation plane
Device Position	Body Back
Band	WCDMA Band IV
Channels	Middle
Signal	CDMA (Crest factor: 1.0)

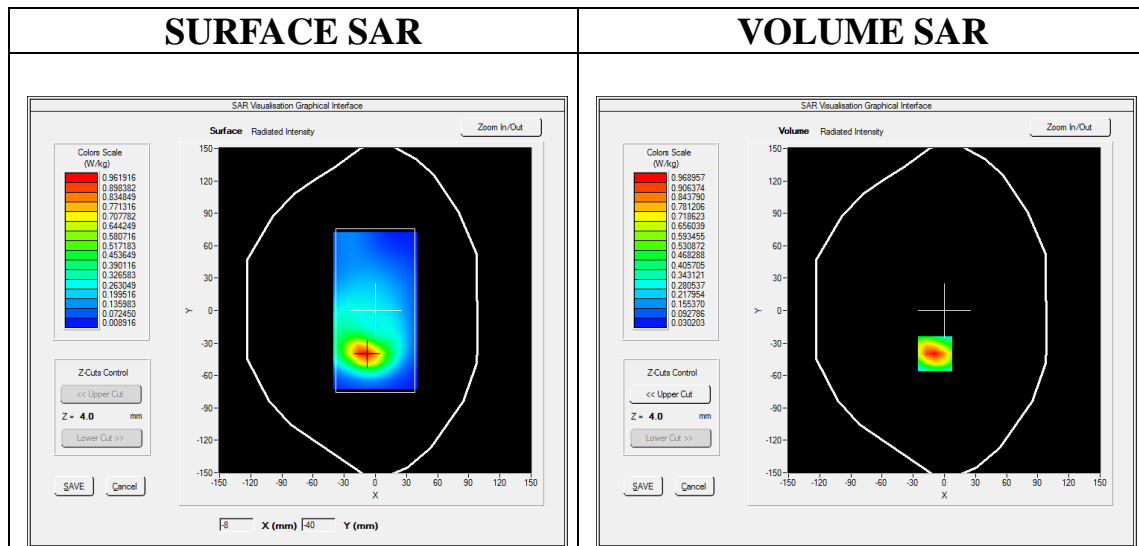

Maximum location: X=-9.00, Y=-40.00

SAR Peak: 1.40 W/kg

SAR 10g (W/Kg)	0.519046
SAR 1g (W/Kg)	0.918857

Z (mm)	0.00	4.00	9.00	14.00	19.00	24.00	29.00
SAR (W/Kg)	1.3982	0.9690	0.6096	0.3993	0.2551	0.1648	0.1056

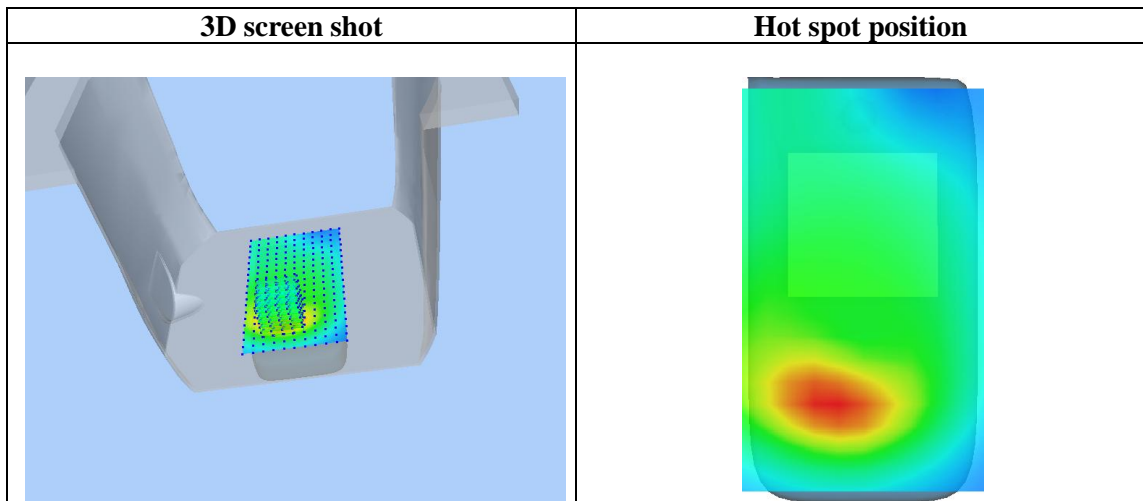
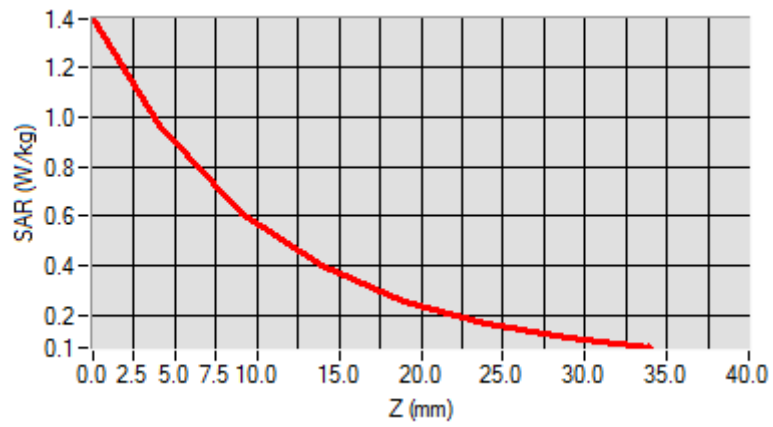

Test Laboratory: AGC Lab

Date: Mar. 21,2017

WCDMA Band V Mid- Touch-Right (RMC)

DUT: Smart Phone; Type: Platinum 5.5C

Communication System: UMTS; Communication System Band: BAND V UTRA/FDD ; Duty Cycle:1: 1; Conv.F=5.72;
Frequency: 836.6 MHz; Medium parameters used: f = 835MHz; $\sigma=0.89$ mho/m; $\epsilon_r=41.52$; $\rho= 1000$ kg/m³ ;
Phantom section: Right Section
Ambient temperature (°C):21.8, Liquid temperature (°C): 21.2

SATIMO Configuration:

- Probe: SSE5; Calibrated: 12/05/2016; Serial No.: SN 14/16 EP308
- Sensor-Surface: 4mm (Mechanical Surface Detection)
- Phantom: SAM twin phantom
- Measurement SW: OpenSAR V4_02_32

Configuration/ WCDMA Band V Mid-Touch-Right/Area Scan: Measurement grid: dx=8mm, dy=8mm

Configuration/ WCDMA Band V Mid-Touch-Right/Zoom Scan: Measurement grid: dx=8mm,dy=8mm, dz=5mm;

Area Scan	sam_direct_droit2_surf8mm.txt
ZoomScan	5x5x7,dx=8mm dy=8mm dz=5mm,Complete
Phantom	Right head
Device Position	Cheek
Band	WCDMA Band V
Channels	Middle
Signal	CDMA (Crest factor: 1.0)

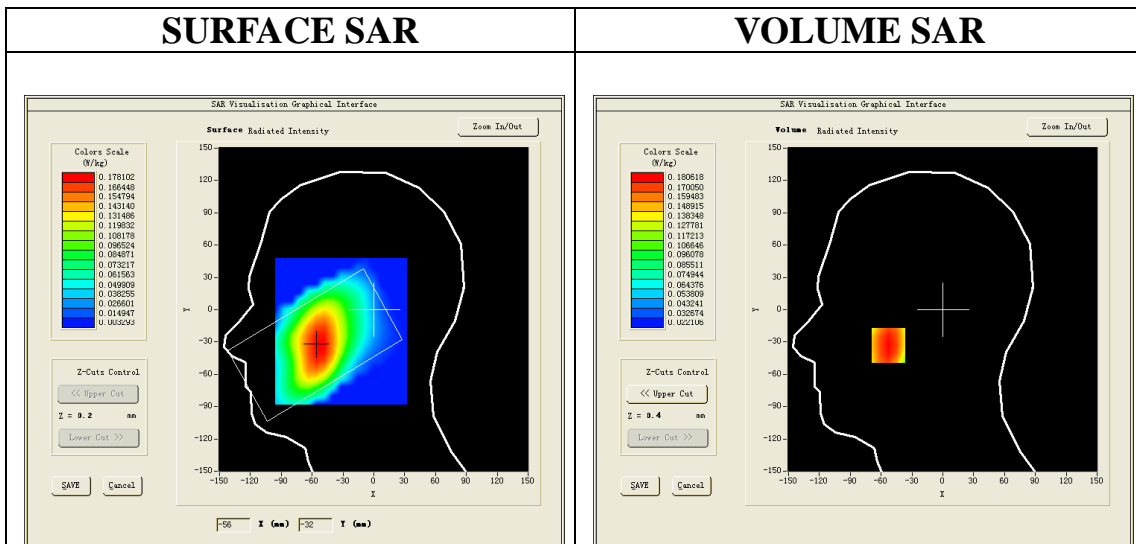

Maximum location: X=-53.00, Y=-33.00

SAR Peak: 0.22 W/kg

SAR 10g (W/Kg)	0.134933
SAR 1g (W/Kg)	0.175910

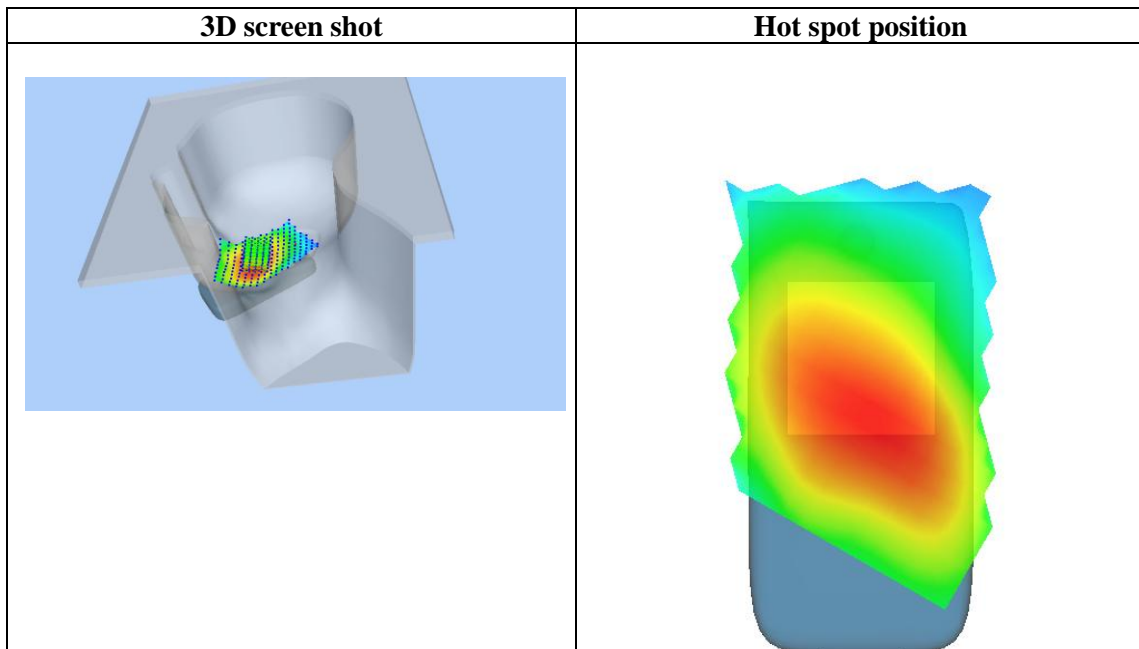
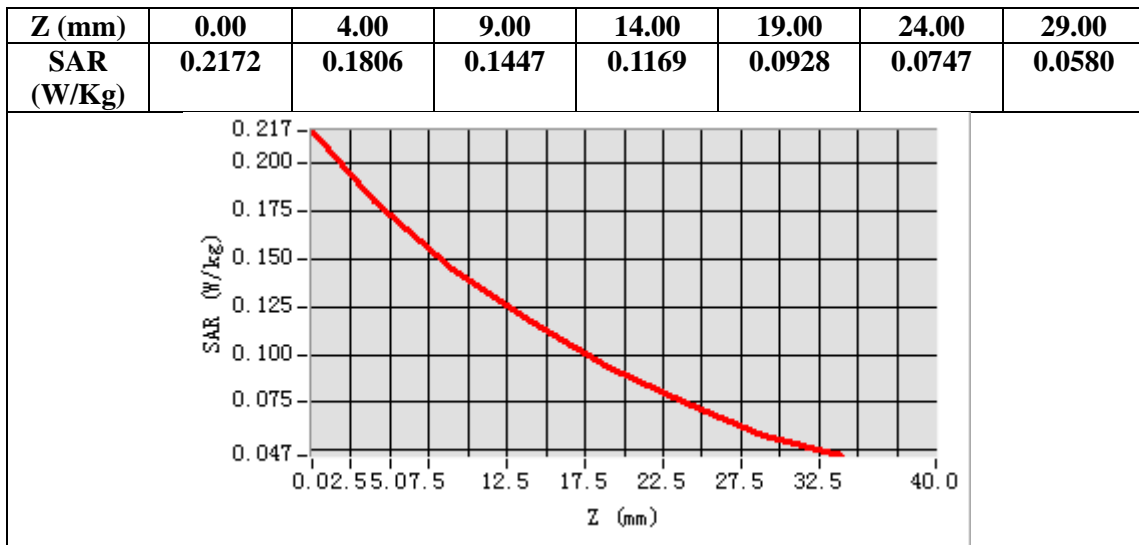

Test Laboratory: AGC Lab

Date: Mar. 21,2017

WCDMA Band V Mid-Body-Towards Grounds (RMC)

DUT: Smart Phone; Type: Platinum 5.5C

Communication System: UMTS; Communication System Band: BAND V UTRA/FDD; Duty Cycle:1: 1; Conv.F=5.94;
Frequency: 836.6 MHz; Medium parameters used: $f = 835\text{MHz}$; $\sigma = 0.96\text{mho/m}$; $\epsilon_r = 55.03$; $\rho = 1000\text{ kg/m}^3$;
Phantom section: Flat Section
Ambient temperature ($^{\circ}\text{C}$): 21.8, Liquid temperature ($^{\circ}\text{C}$): 21.3

SATIMO Configuration:

- Probe: SSE5; Calibrated: 12/05/2016; Serial No.: SN 14/16 EP308
- Sensor-Surface: 4mm (Mechanical Surface Detection)
- Phantom: SAM twin phantom
- Measurement SW: OpenSAR V4_02_32

Configuration/ WCDMA Band V Mid-Body-Back/Area Scan: Measurement grid: $dx=8\text{mm}$, $dy=8\text{mm}$

Configuration/ WCDMA Band V Mid-Body-Back/Zoom Scan: Measurement grid: $dx=8\text{mm}$, $dy=8\text{mm}$, $dz=5\text{mm}$;

Area Scan	sam_direct_droit2_surf8mm.txt
ZoomScan	5x5x7,dx=8mm dy=8mm dz=5mm,Complete
Phantom	Validation plane
Device Position	Body Back
Band	WCDMA Band V
Channels	Middle
Signal	CDMA (Crest factor: 1.0)

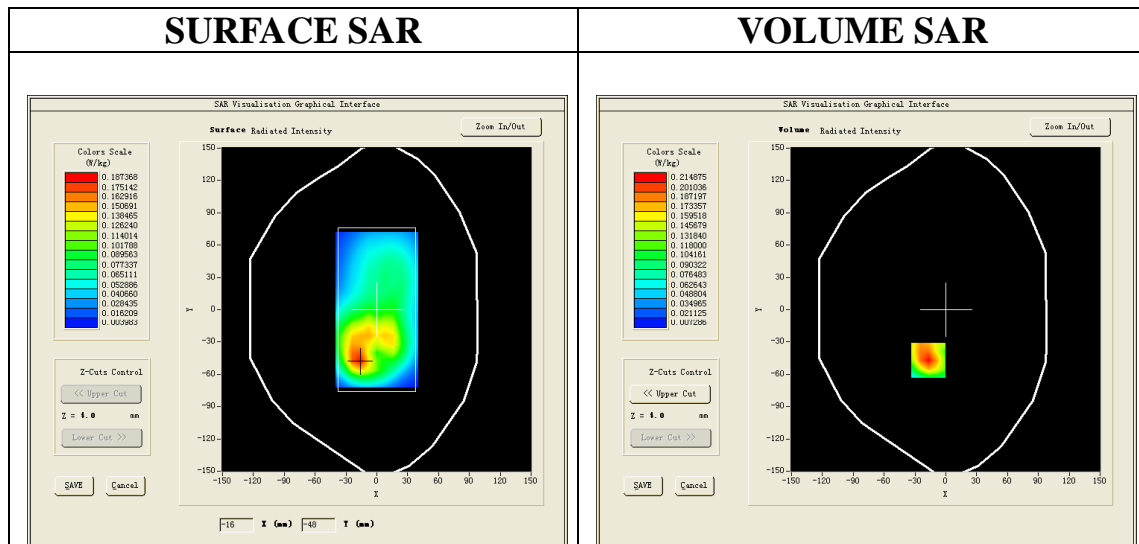

Maximum location: X=-17.00, Y=-47.00

SAR Peak: 0.33 W/kg

SAR 10g (W/Kg)	0.113368
SAR 1g (W/Kg)	0.202452

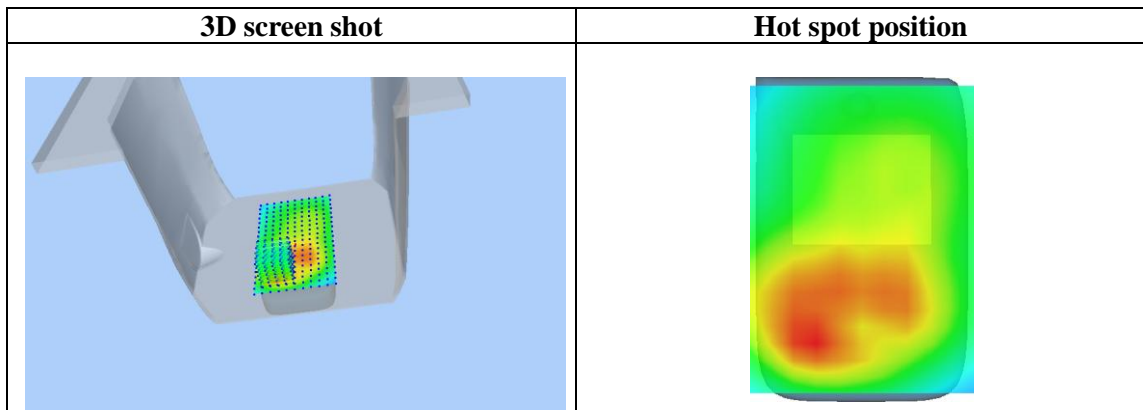
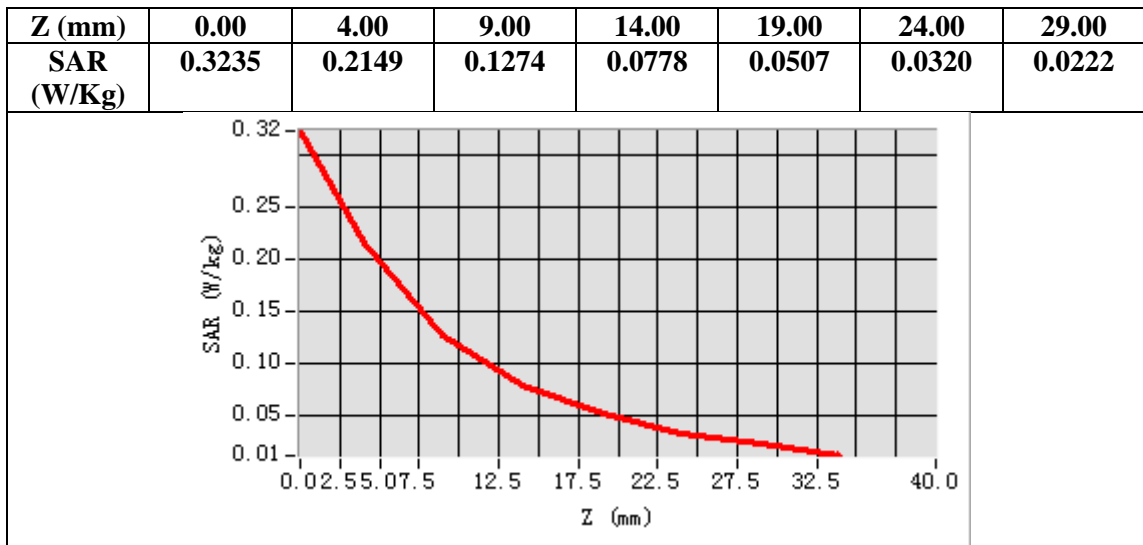

WIFI MODE

Test Laboratory: AGC Lab

Date: Mar. 24,2017

802.11b Mid- Touch- Left

DUT: Smart Phone; Type: Fuego 5.0+

Communication System: Wi-Fi; Communication System Band: 802.11b; Duty Cycle: 1:1; Conv.F=5.19;
Frequency: 2437 MHz; Medium parameters used: $f = 2450$ MHz; $\sigma = 1.75$ mho/m; $\epsilon_r = 40.42$ $\rho = 1000$ kg/m³ ;
Phantom section: Left Section
Ambient temperature (°C):22.2, Liquid temperature (°C): 21.8

SATIMO Configuration:

- Probe: SSE5; Calibrated: 12/05/2016; Serial No.: SN 14/16 EP308
- Sensor-Surface: 4mm (Mechanical Surface Detection)
- Phantom: SAM twin phantom
- Measurement SW: OpenSAR V4_02_32

Configuration/802.11b Mid- Touch- Left /Area Scan: Measurement grid: dx=8mm, dy=8mm

Configuration/802.11b Mid- Touch- Left /Zoom Scan: Measurement grid: dx=5mm,dy=5mm, dz=5mm

Area Scan	sam_direct_droit2_surf8mm.txt
ZoomScan	7x7x7,dx=5mm dy=5mm dz=5mm
Phantom	Left head
Device Position	Cheek
Band	2450MHz
Channels	Middle
Signal	Crest factor: 1.0

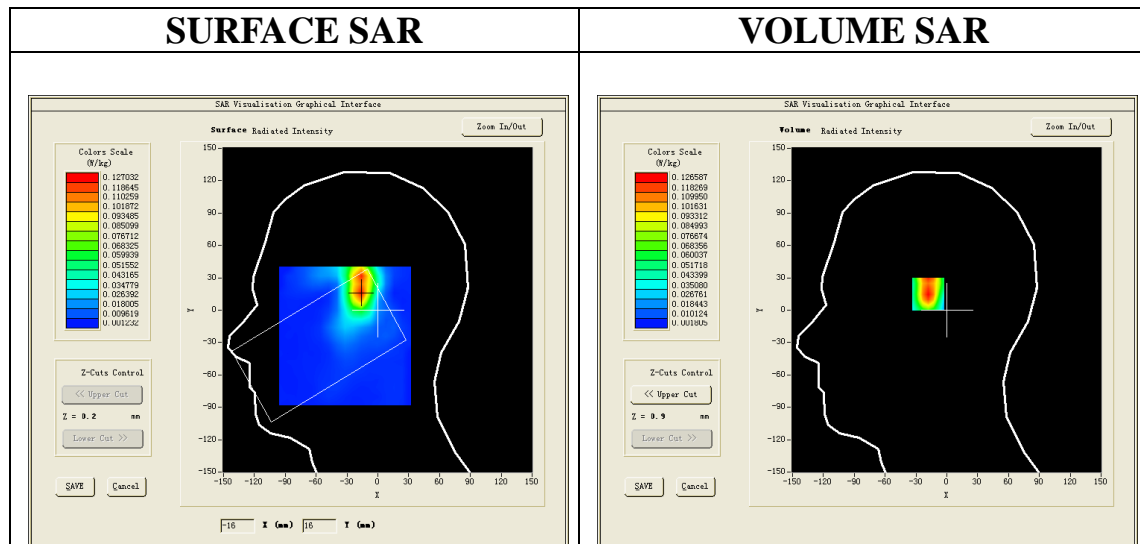

Maximum location: X=-17.00, Y=16.00
SAR Peak: 0.23 W/kg

SAR 10g (W/Kg)	0.057478
SAR 1g (W/Kg)	0.116871

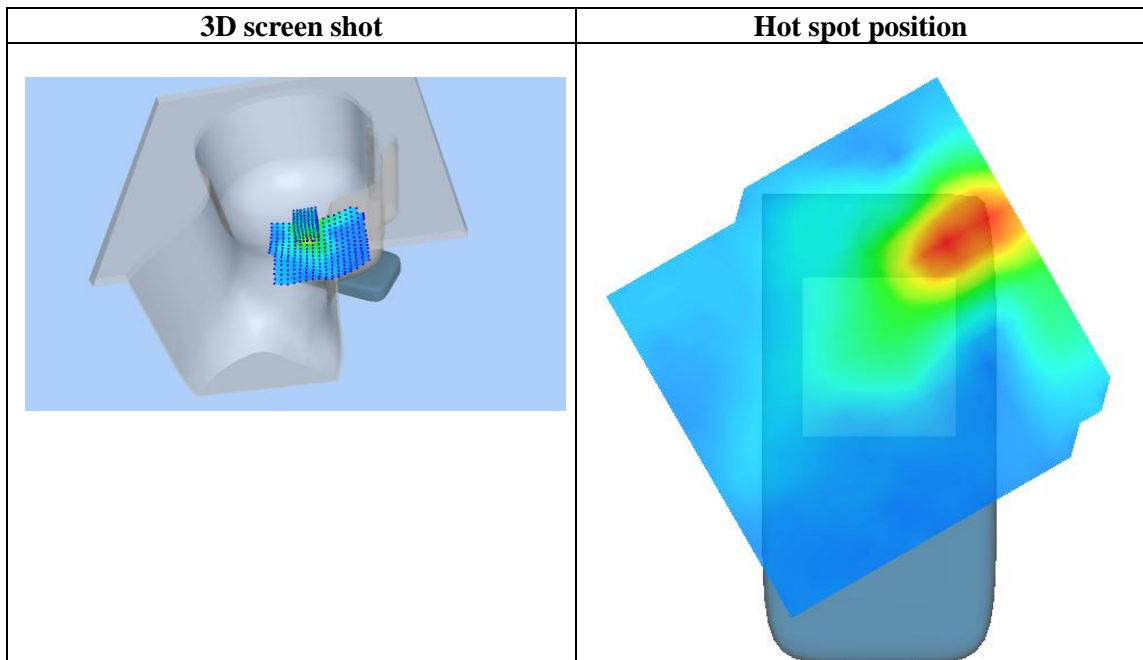
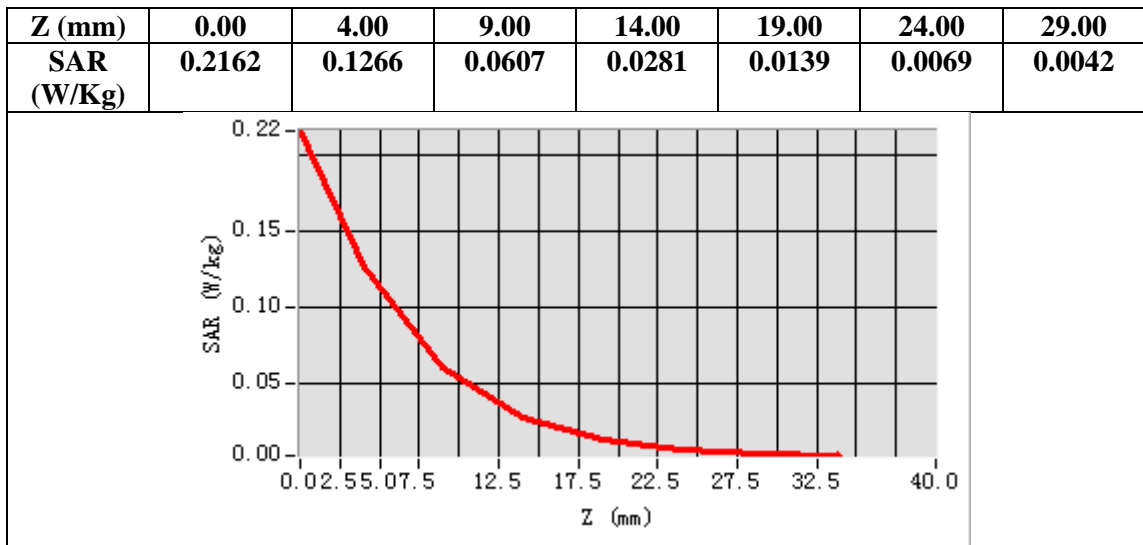

Test Laboratory: AGC Lab
802.11b Mid-Body-Worn- Back
DUT: Smart Phone; Type: Platinum 5.5C

Date: Mar. 24,2017

Communication System: Wi-Fi; Communication System Band: 802.11b; Duty Cycle: 1:1; Conv.F=5.33;
Frequency: 2437 MHz; Medium parameters used: $f = 2450$ MHz; $\sigma = 1.90$ mho/m; $\epsilon_r = 54.37$ $\rho = 1000$ kg/m³ ;
Phantom section: Flat Section
Ambient temperature (°C):22.2, Liquid temperature (°C): 21.5

SATIMO Configuration:

- Probe: SSE5; Calibrated: 12/05/2016; Serial No.: SN 14/16 EP308
- Sensor-Surface: 4mm (Mechanical Surface Detection)
- Phantom: SAM twin phantom
- Measurement SW: OpenSAR V4_02_32

Configuration/802.11b Mid- Body- Back /Area Scan: Measurement grid: dx=8mm, dy=8mm
Configuration/802.11b Mid- Body- Back /Zoom Scan: Measurement grid: dx=5mm,dy=5mm, dz=5mm;

Area Scan	sam_direct_droit2_surf8mm.txt
ZoomScan	7x7x7,dx=5mm dy=5mm dz=5mm
Phantom	Validation plane
Device Position	Body Back
Band	2450MHz
Channels	Middle
Signal	Crest factor: 1.0

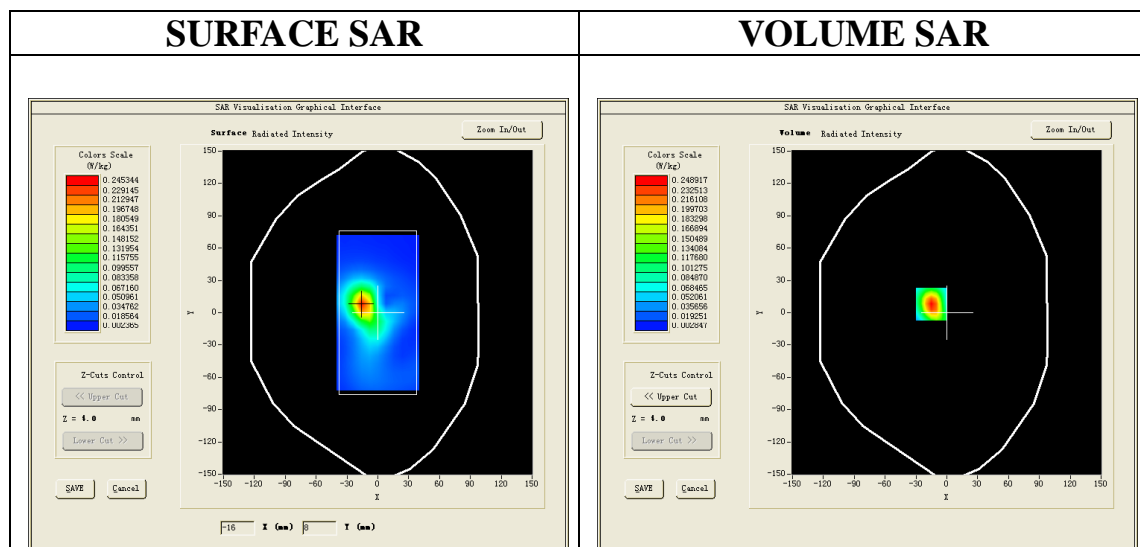

Maximum location: X=-15.00, Y=8.00
SAR Peak: 0.42 W/kg

SAR 10g (W/Kg)	0.104288
SAR 1g (W/Kg)	0.226057

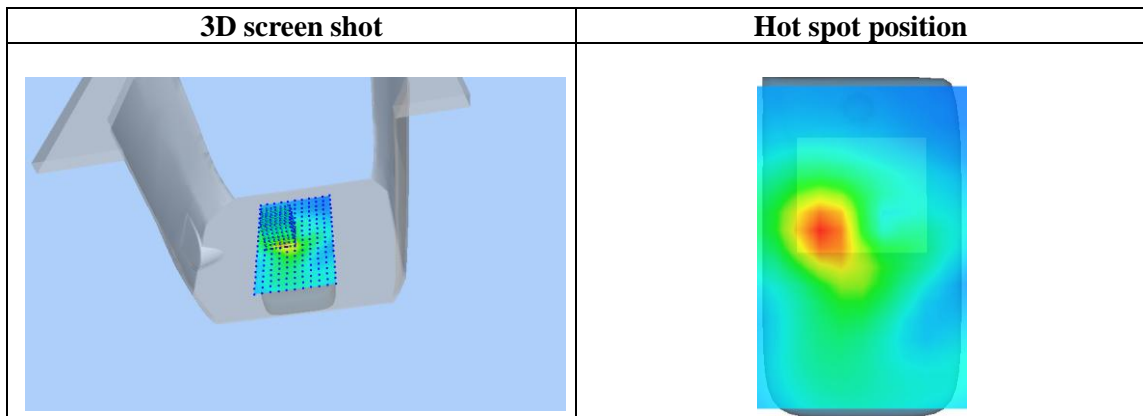
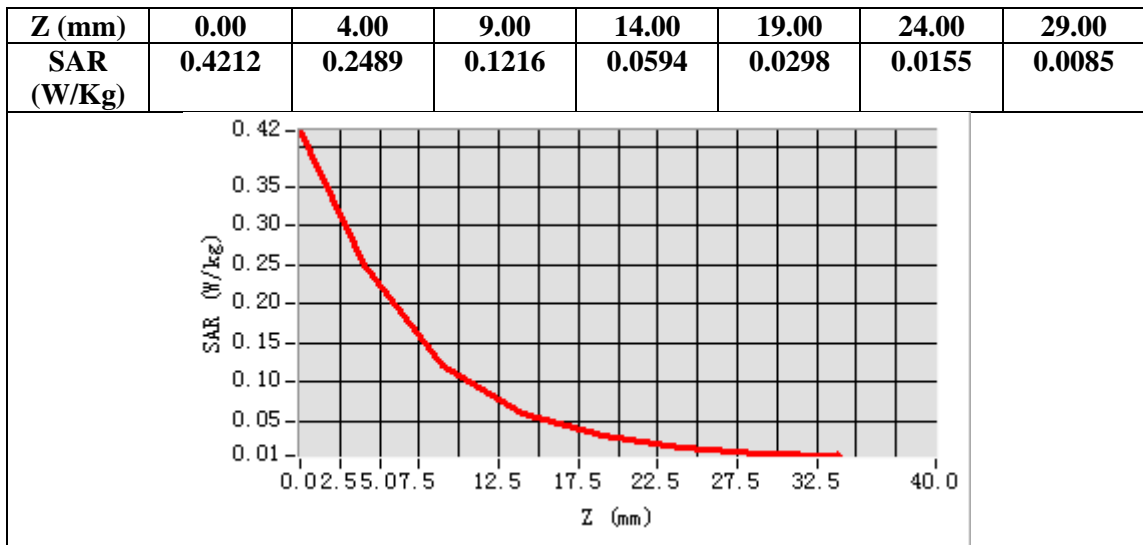

Repeated SAR

Test Laboratory: AGC Lab
GPRS 850 High- Body- Back (3up)<SIM 1>
DUT: Smart Phone; Type: Platinum 5.5C

Date: Mar. 21,2017

Communication System: GPRS-3 Slot; Communication System Band: GPRS 850; Duty Cycle:1:2.7; Conv.F=5.94;
Frequency: 848.8MHz; Medium parameters used: $f = 835$ MHz; $\sigma = 0.98$ mho/m; $\epsilon_r = 54.13$; $\rho = 1000$ kg/m³ ;
Phantom section: Flat Section
Ambient temperature (°C): 21.8, Liquid temperature (°C): 21.3

SATIMO Configuration:

- Probe: SSE5; Calibrated: 12/05/2016; Serial No.: SN 14/16 EP308
- Sensor-Surface: 4mm (Mechanical Surface Detection)
- Phantom: SAM twin phantom
- Measurement SW: OpenSAR V4_02_32

Configuration/GPRS 850 High -Body-Back/Area Scan: Measurement grid: dx=8mm, dy=8mm
Configuration/GPRS 850 High -Body-Back/Zoom Scan: Measurement grid: dx=8mm,dy=8mm, dz=5mm;

Area Scan	sam_direct_droit2_surf8mm.txt
ZoomScan	5x5x7,dx=8mm dy=8mm dz=5mm,Complete
Phantom	Validation plane
Device Position	Body Back
Band	GSM 850
Channels	High
Signal	TDMA (Crest factor: 2.7)

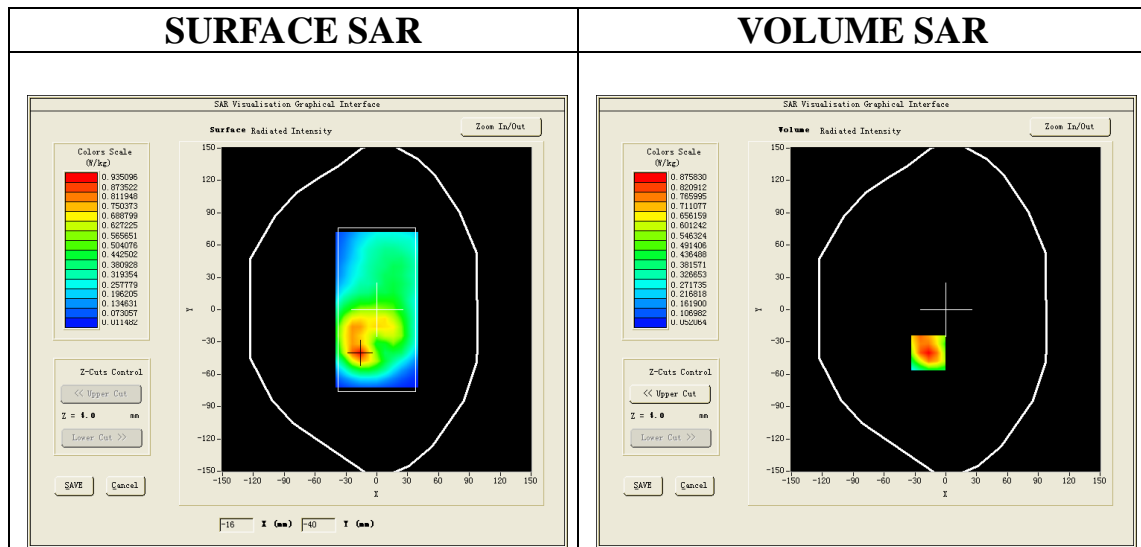

Maximum location: X=-17.00, Y=-40.00
SAR Peak: 1.21 W/kg

SAR 10g (W/Kg)	0.504758
SAR 1g (W/Kg)	0.830093

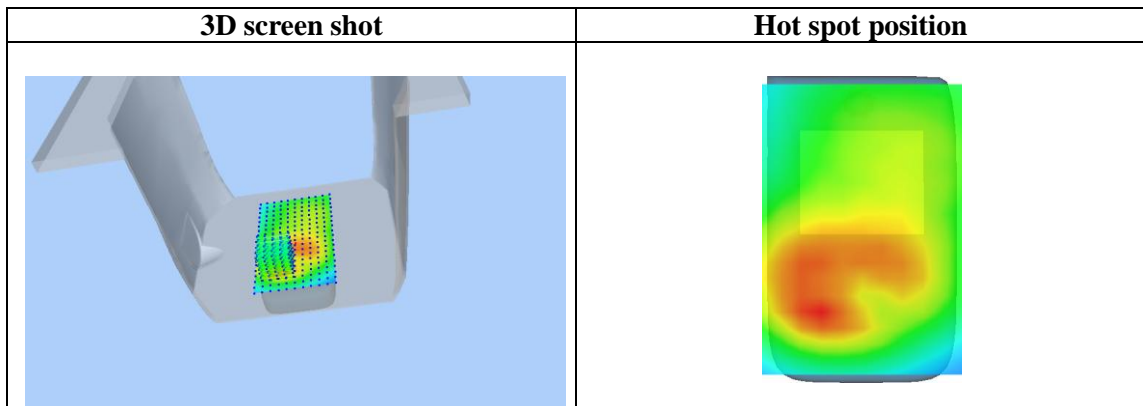
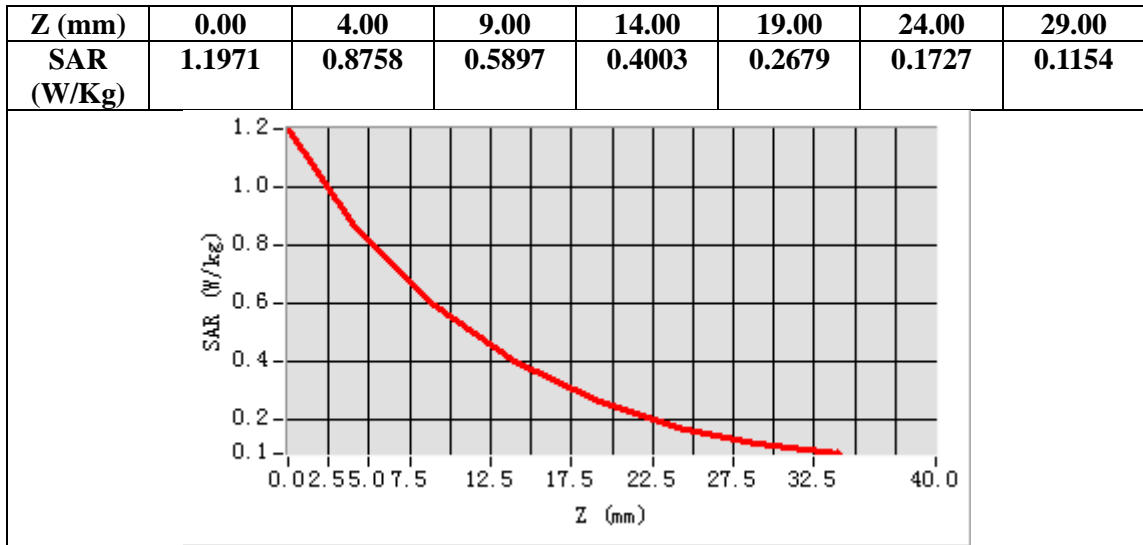

Test Laboratory: AGC Lab
GPRS 1900 Mid-Edge 3(2up) <SIM 1>
DUT: Smart Phone; Type: Platinum 5.5C

Date: Mar. 21,2017

Communication System: GPRS-3Slot; Communication System Band: PCS 1900; Duty Cycle:1:2.7; Conv.F=5.34;
Frequency: 1880 MHz; Medium parameters used: $f = 1900$ MHz; $\sigma = 1.50$ mho/m; $\epsilon_r = 53.86$; $\rho = 1000$ kg/m³ ;
Phantom section: Flat Section
Ambient temperature (°C): 22.7, Liquid temperature (°C): 22.3

SATIMO Configuration:

- Probe: SSE5; Calibrated: 07/05/2016; Serial No.: SN 14/16 EP307
- Sensor-Surface: 4mm (Mechanical Surface Detection)
- Phantom: SAM twin phantom
- Measurement SW: OpenSAR V4_02_35

Configuration/GPRS1900 Mid-Edge 3/Area Scan: Measurement grid: dx=8mm, dy=8mm
Configuration/GPRS1900 Mid-Edge 3/Zoom Scan: Measurement grid: dx=8mm,dy=8mm, dz=5mm;

Area Scan	sam_direct_droit2_surf8mm.txt
Zoom Scan	5x5x7,dx=8mm dy=8mm dz=5mm,Complete
Phantom	Validation plane
Device Position	Edge 3
Band	PCS 1900
Channels	Middle
Signal	TDMA (Crest factor: 2.7)

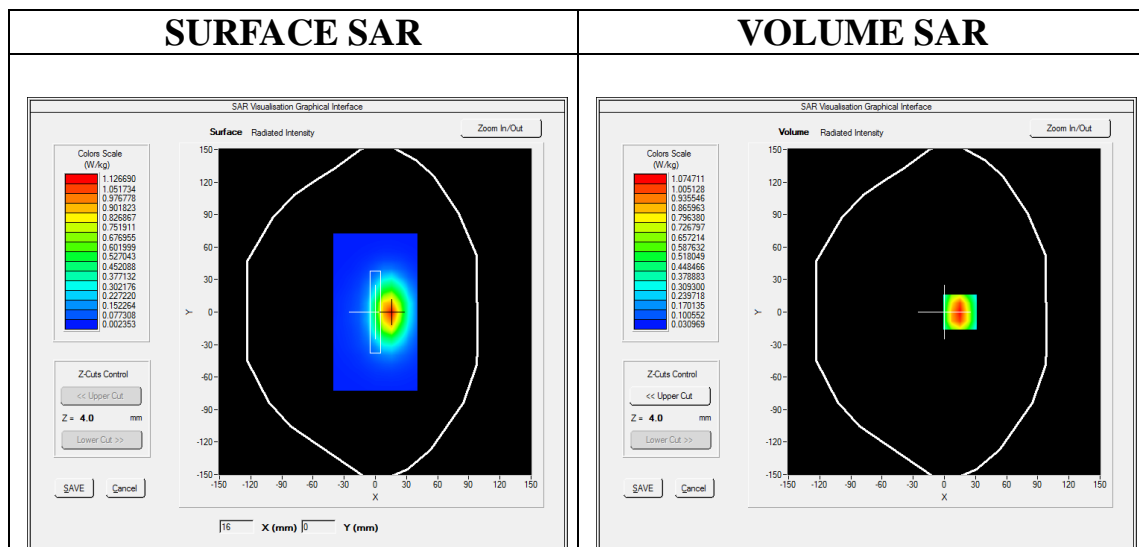

Maximum location: X=15.00, Y=0.00

SAR Peak: 1.47 W/kg

SAR 10g (W/Kg)	0.597627
SAR 1g (W/Kg)	0.999455

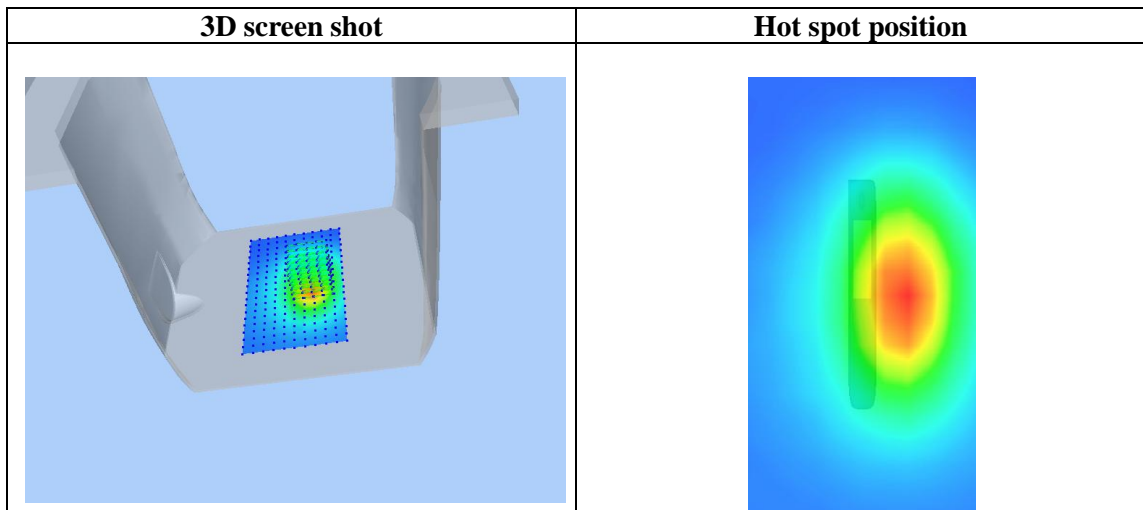
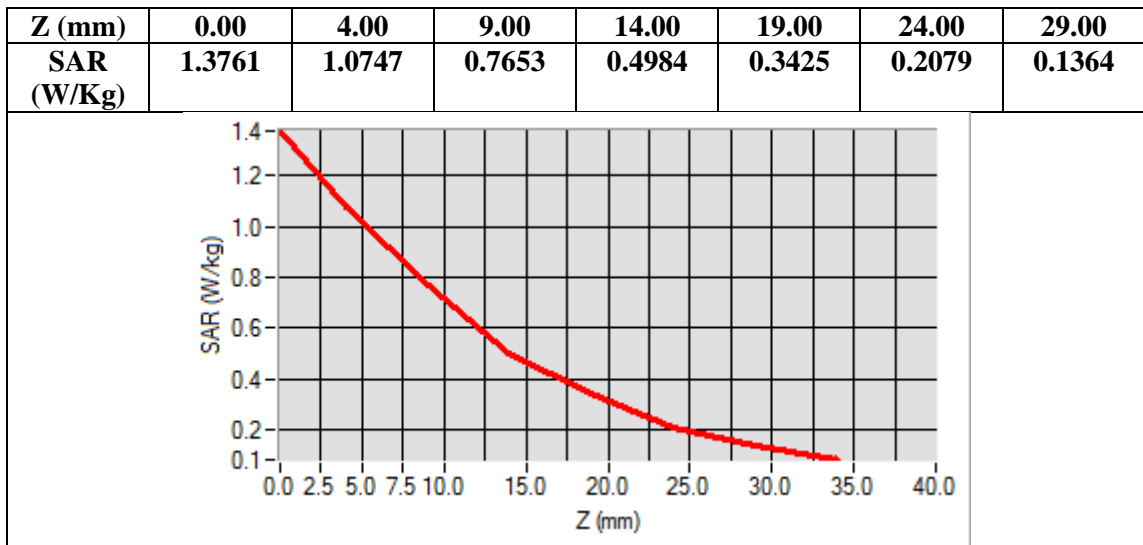

Test Laboratory: AGC Lab
WCDMA Band II High-Body-Towards Grounds (RMC 12.2kbps)
DUT: Smart Phone; Type: Platinum 5.5C

Date: Mar. 21,2017

Communication System: UMTS; Communication System Band: Band II UTRA/FDD ;Duty Cycle:1:1; Conv.F=5.34;
Frequency: 1907.6 MHz; Medium parameters used: $f = 1900$ MHz; $\sigma = 1.53$ mho/m; $\epsilon_r = 53.10$; $\rho = 1000$ kg/m³ ;
Phantom section: Flat Section
Ambient temperature (°C): 22.7, Liquid temperature (°C): 22.3

SATIMO Configuration:

- Probe: SSE5; Calibrated: 07/05/2016; Serial No.: SN 14/16 EP307
- Sensor-Surface: 4mm (Mechanical Surface Detection)
- Phantom: SAM twin phantom
- Measurement SW: OpenSAR V4_02_35

Configuration/ WCDMA band II High -Body-back/Area Scan: Measurement grid: dx=8mm, dy=8mm

Configuration/ WCDMA band II High -Body-back/Zoom Scan: Measurement grid: dx=8mm,dy=8mm, dz=5mm;

Area Scan	sam_direct_droit2_surf8mm.txt
ZoomScan	5x5x7,dx=8mm dy=8mm dz=5mm,Complete
Phantom	Validation plane
Device Position	Body Back
Band	WCDMA band II
Channels	High
Signal	CDMA (Crest factor: 1.0)

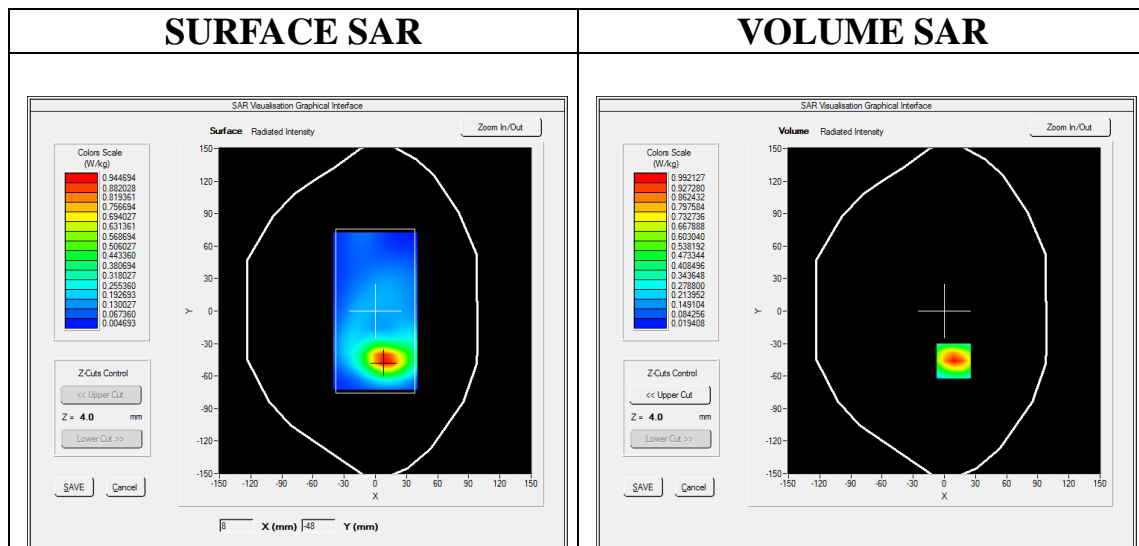

Maximum location: X=9.00, Y=-46.00

SAR Peak: 1.47 W/kg

SAR 10g (W/Kg)	0.513636
SAR 1g (W/Kg)	0.943520

Z (mm)	0.00	4.00	9.00	14.00	19.00	24.00	29.00
SAR (W/Kg)	1.4651	0.9921	0.6022	0.3805	0.2333	0.1455	0.0903

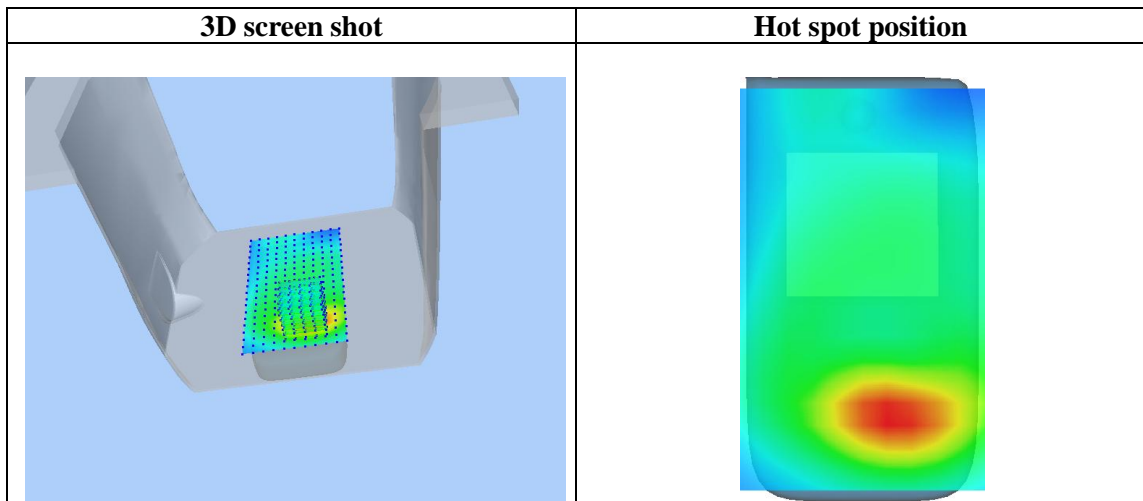
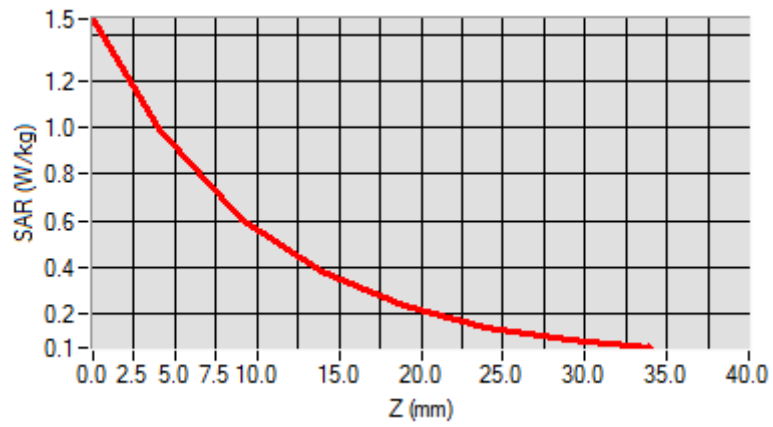

Test Laboratory: AGC Lab
WCDMA Band IV Mid-Body-Towards Grounds (RMC)
DUT: Smart Phone; Type: Platinum 5.5C

Date: Mar. 22,2017

Communication System: UMTS; Communication System Band: BAND IV UTRA/FDD;Duty Cycle:1: 1; Conv.F=5.06
Frequency: 1732.5 MHz; Medium parameters used: $f = 1800\text{MHz}$; $\sigma=1.45 \text{ mho/m}$; $\epsilon_r = 53.90$; $\rho= 1000 \text{ kg/m}^3$;
Phantom section: Flat Section
Ambient temperature ($^{\circ}\text{C}$): 22.8, Liquid temperature ($^{\circ}\text{C}$): 22.2

SATIMO Configuration:

- Probe: SSE5; Calibrated: 07/05/2016; Serial No.: SN 14/16 EP307
- Sensor-Surface: 4mm (Mechanical Surface Detection)
- Phantom: SAM twin phantom
- Measurement SW: OpenSAR V4_02_35

Configuration/ WCDMA Band IV Mid-Body-Back/Area Scan: Measurement grid: $dx=8\text{mm}$, $dy=8\text{mm}$
Configuration/ WCDMA Band IV Mid-Body-Back/Zoom Scan: Measurement grid: $dx=8\text{mm}$, $dy=8\text{mm}$, $dz=5\text{mm}$;

Area Scan	sam_direct_droit2_surf8mm.txt
ZoomScan	5x5x7,dx=8mm dy=8mm dz=5mm,Complete
Phantom	Validation plane
Device Position	Body Back
Band	WCDMA Band IV
Channels	Middle
Signal	CDMA (Crest factor: 1.0)

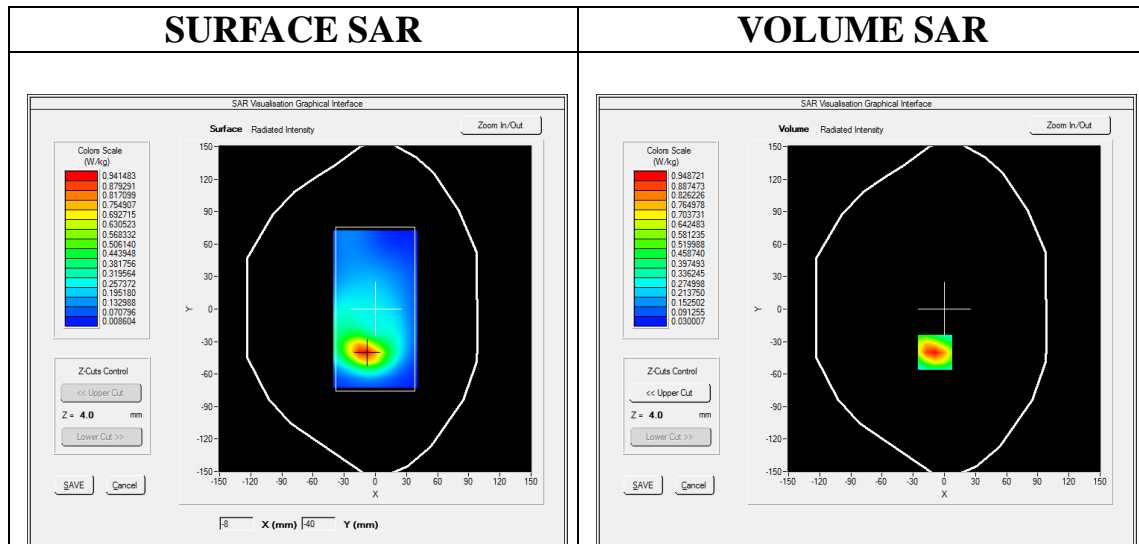

Maximum location: X=-9.00, Y=-40.00

SAR Peak: 1.37 W/kg

SAR 10g (W/Kg)	0.505390
SAR 1g (W/Kg)	0.892986

Z (mm)	0.00	4.00	9.00	14.00	19.00	24.00	29.00
SAR (W/Kg)	1.3703	0.9487	0.5965	0.3911	0.2496	0.1613	0.1031

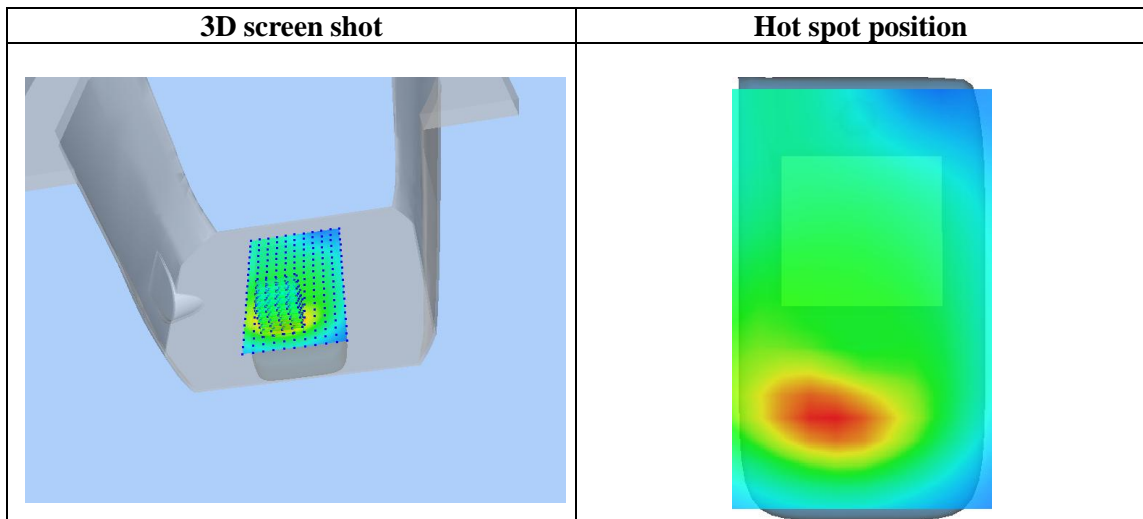
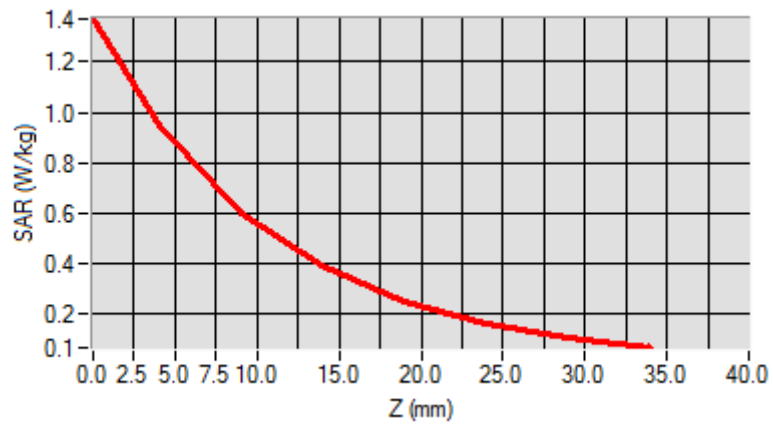

APPENDIX C. TEST SETUP PHOTOGRAPHS

LEFT- CHEEK TOUCH

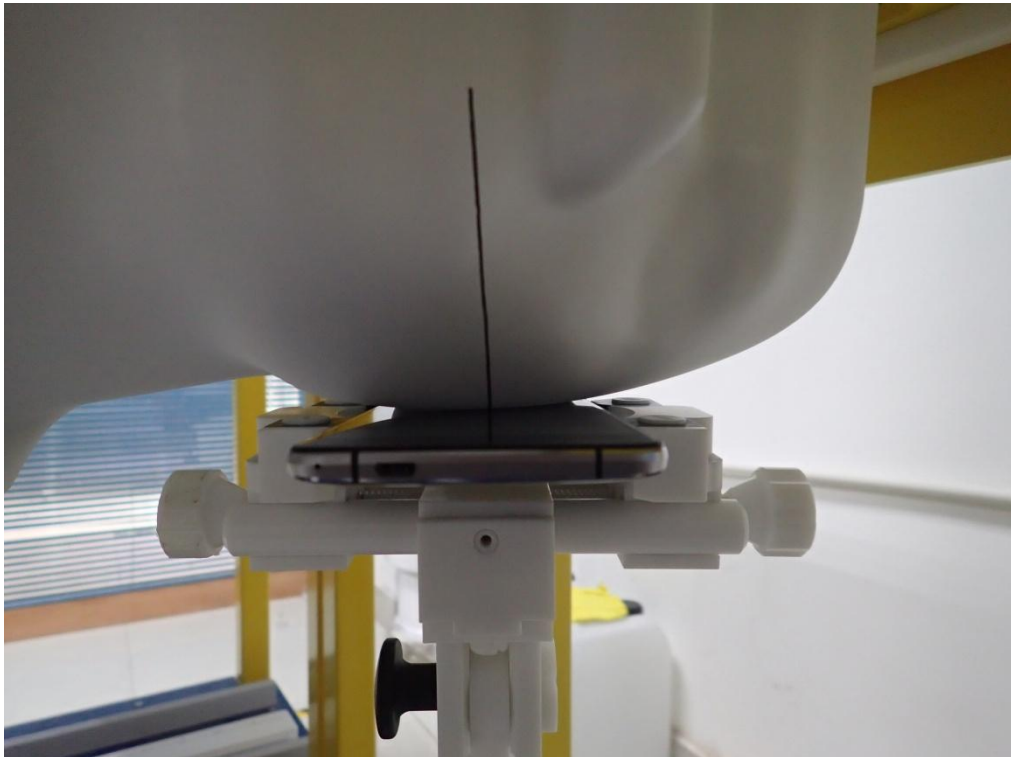

LEFT-TILT 15°

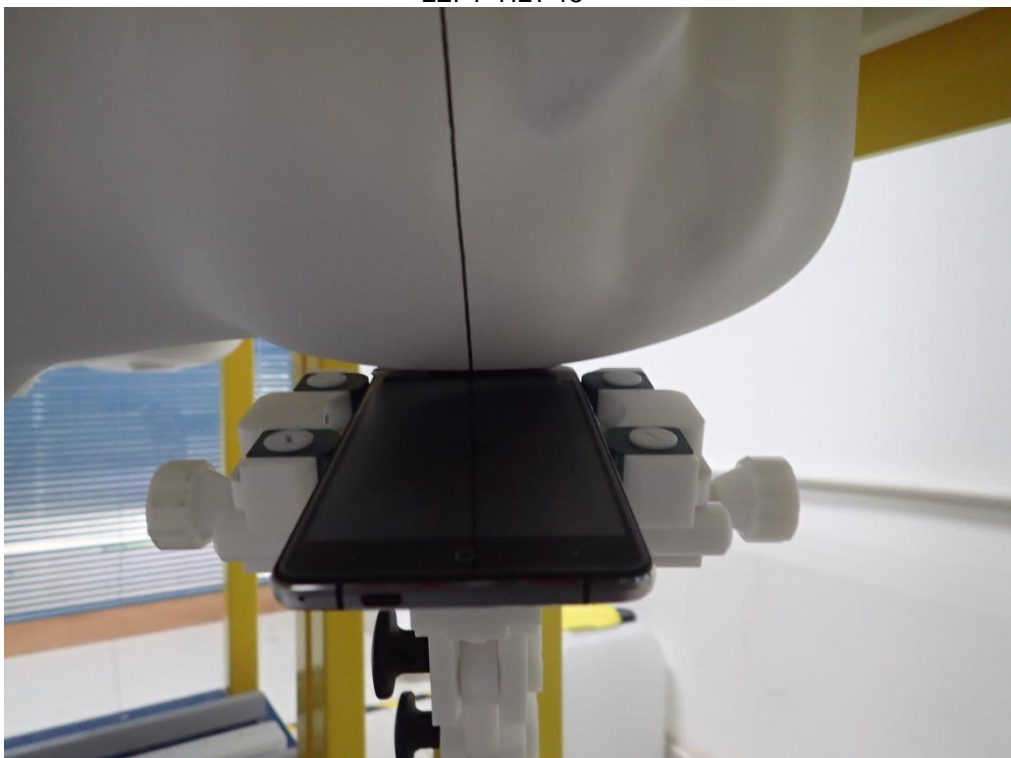

RIGHT- CHEEK TOUCH

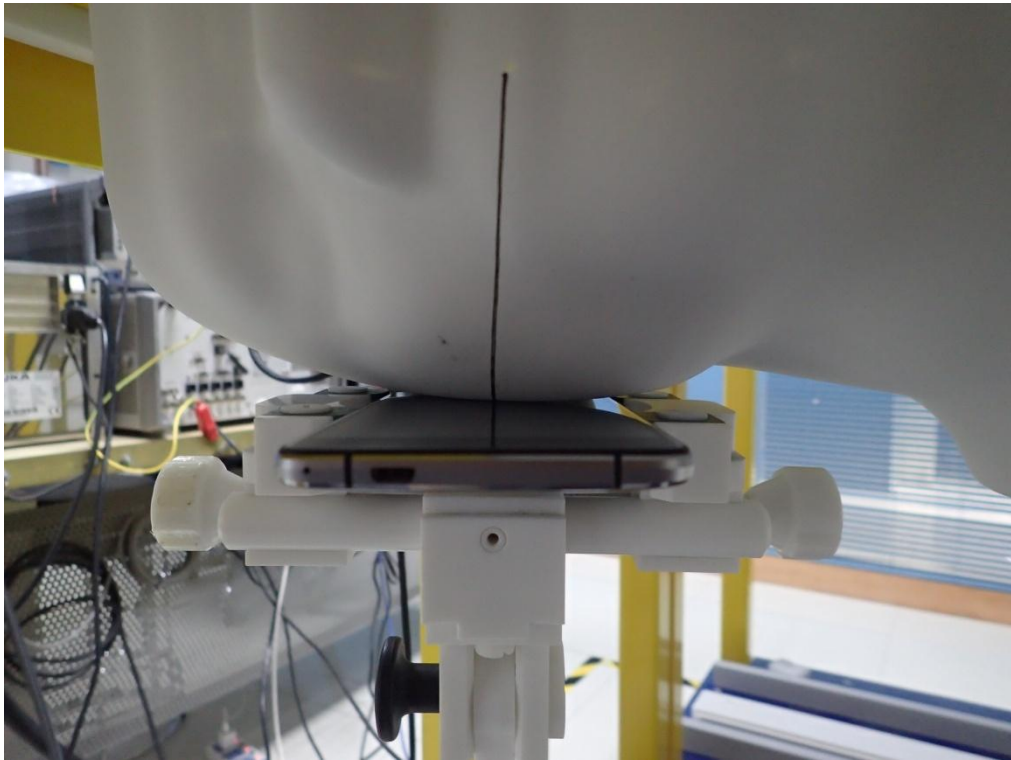

RIGHT-TILT 15°

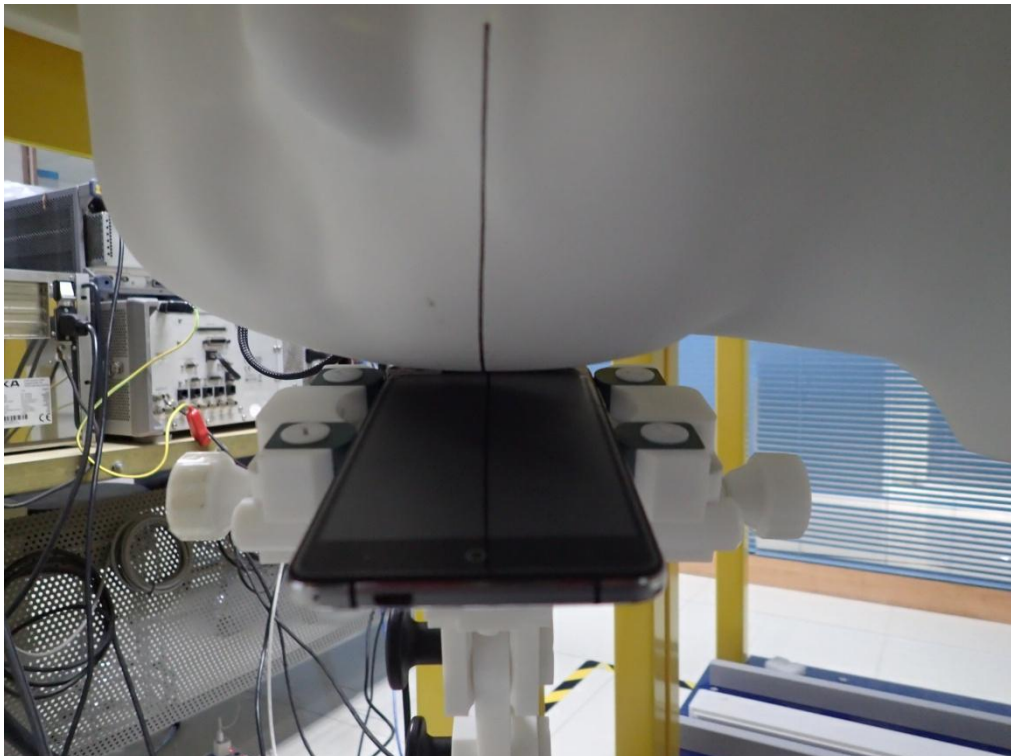

Body Back 5mm

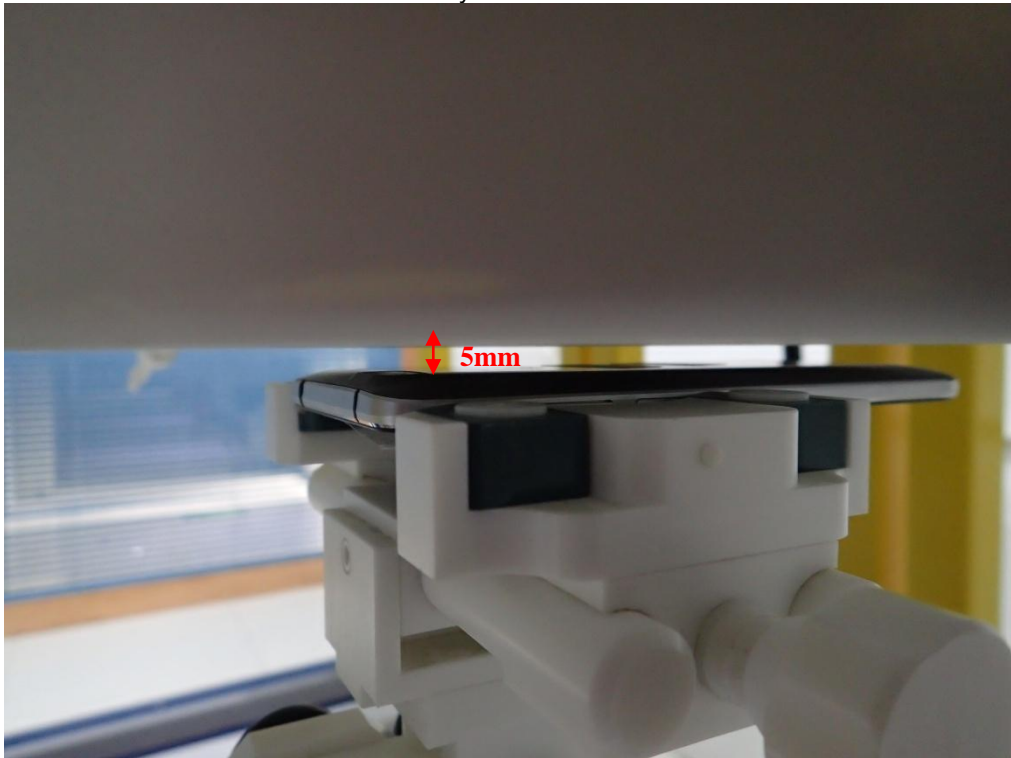

Body Front 5mm

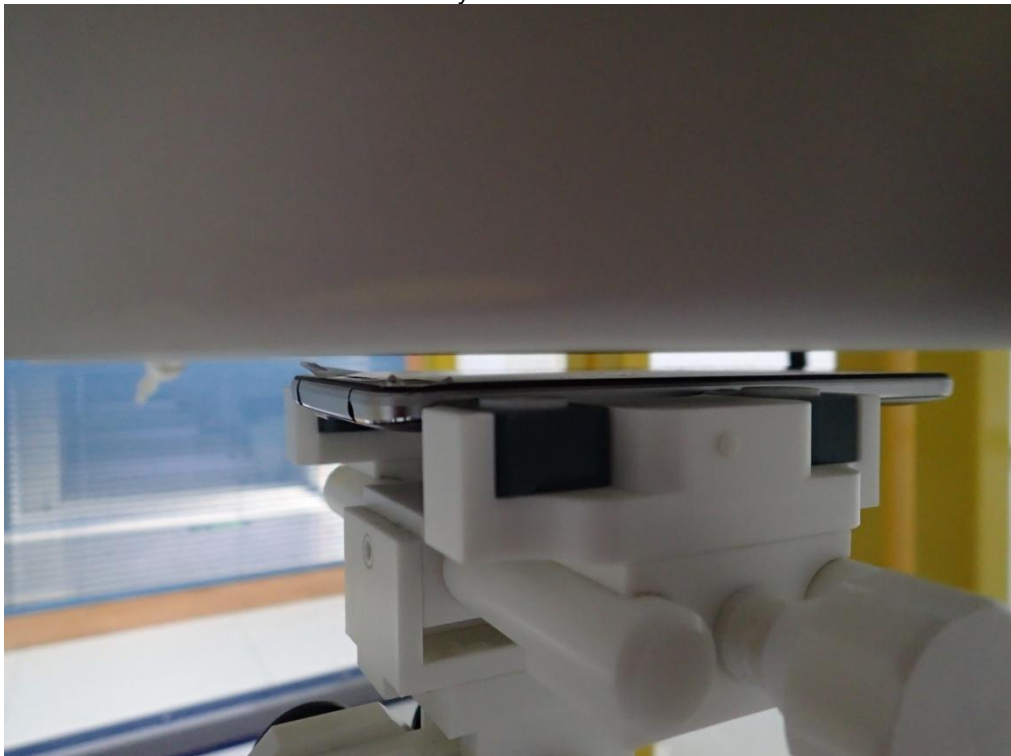

Edge 1(Top) 10mm-Hotspot Mode



Edge 2(Right) 10mm-Hotspot Mode



Edge 3(Bottom) 10mm-Hotspot Mode



Edge 4(Left) 10mm-Hotspot Mode



DEPTH OF THE LIQUID IN THE PHANTOM—ZOOM IN

Note: The position used in the measurement were according to IEEE 1528-2013

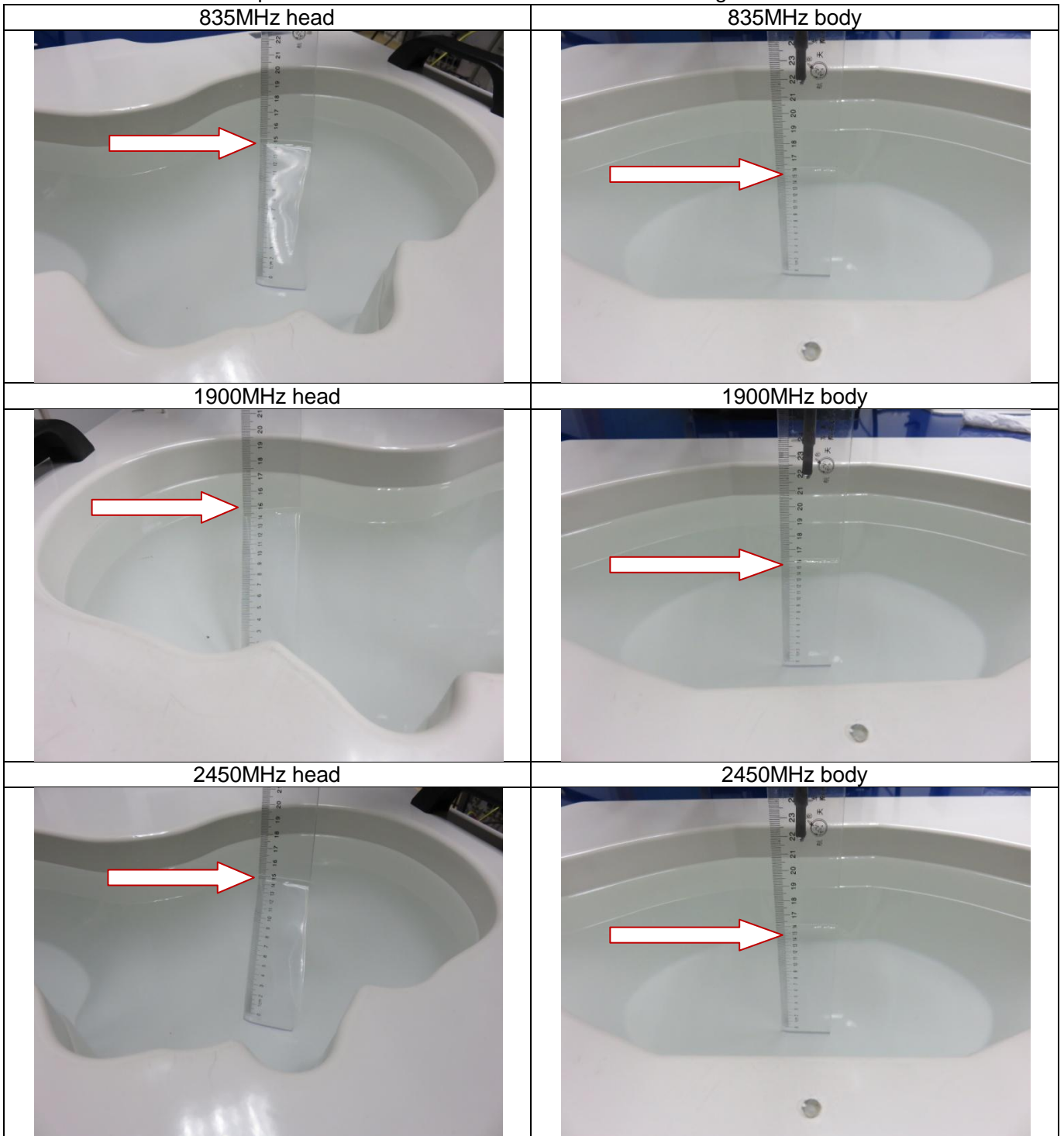

1750MHz head



1750MHz body



APPENDIX D. CALIBRATION DATA

Refer to Attached files.