FCC Test Report

Report No.: AGC00364170301FE08

FCC ID : 2ABOSSKYPLAT55C
APPLICATION PURPOSE : Original Equipment
PRODUCT DESIGNATION : Smart Phone
BRAND NAME : SKY Devices
MODEL NAME : Platinum 5.5C
CLIENT : Sky Phone LLC
DATE OF ISSUE : Mar. 31, 2017
STANDARD(S) : FCC Part 15.247
TEST PROCEDURE(S) : KDB 558074 v03r02
REPORT VERSION : V1.0

Attestation of Global Compliance (Shenzhen) Co., Ltd

CAUTION:

This report shall not be reproduced except in full without the written permission of the test laboratory and shall not be quoted out of context.



Report Revise Record

Report Version	Revise Time	Issued Date	Valid Version	Notes
V1.0	/	Mar. 31, 2017	Valid	Original Report

TABLE OF CONTENTS

1. VERIFICATION OF COMPLIANCE	5
2. GENERAL INFORMATION	6
2.1 PRODUCT DESCRIPTION.....	6
2.2 RELATED SUBMITTAL(S)/GRANT(S)	6
2.3 TEST METHODOLOGY	6
2.4 TEST FACILITY.....	6
2.5 SPECIAL ACCESSORIES.....	6
2.6 EQUIPMENT MODIFICATIONS	6
3. SYSTEM TEST CONFIGURATION	7
3.1 CONFIGURATION OF TESTED SYSTEM.....	7
3.2 EQUIPMENT USED IN TESTED SYSTEM	7
4. SUMMARY OF TEST RESULTS	9
5. DESCRIPTION OF TEST MODES	9
6. ANTENNA REQUIREMENT.....	10
6.1. STANDARD APPLICABLE	10
6.2. TEST RESULT	10
7. RADIATED EMISSION	11
7.1 MEASUREMENT PROCEDURE	11
7.2 TEST SETUP	12
7.3 LIMITS AND MEASUREMENT RESULT	13
7.4 TEST RESULT	13
8. BAND EDGE EMISSION.....	17
8.1. MEASUREMENT PROCEDURE	17
8.2. TEST SET-UP	17
8.3. RADIATED TEST RESULT	18
8.4. CONDUCTED TEST RESULT	19
9. 6DB BANDWIDTH	20
9.1. TEST PROCEDURE.....	20
9.2. SUMMARY OF TEST RESULTS/PLOTS.....	20
10. CONDUCTED OUTPUT POWER.....	21
10.1. MEASUREMENT PROCEDURE	21
10.2. TEST SET-UP (BLOCK DIAGRAM OF CONFIGURATION).....	21
10.3. LIMITS AND MEASUREMENT RESULT.....	21
11. MAXIMUM CONDUCTED OUTPUT POWER SPECTRAL DENSITY.....	22
11.1 MEASUREMENT PROCEDURE	22
11.2 TEST SET-UP (BLOCK DIAGRAM OF CONFIGURATION).....	22

11.3 LIMITS AND MEASUREMENT RESULT.....	22
12. FCC LINE CONDUCTED EMISSION TEST	23
12.1 LIMITS.....	23
12.2 TEST SETUP.....	23
12.3 PRELIMINARY PROCEDURE	24
12.4 FINAL TEST PROCEDURE	24
12.5 TEST RESULT OF POWER LINE	25
13. CONDUCTED SPURIOUS EMISSION	27
13.1. MEASUREMENT PROCEDURE	27
13.2. TEST SET-UP (BLOCK DIAGRAM OF CONFIGURATION).....	27
13.3. MEASUREMENT EQUIPMENT USED	27
13.4. LIMITS AND MEASUREMENT RESULT	27
APPENDIX A: PHOTOGRAPHS OF TEST SETUP	30

1. VERIFICATION OF COMPLIANCE

Applicant	Sky Phone LLC
Address	1348 Washington Av. Suite 350N/A, Miami Beach Florida United States 33139
Manufacturer	DongGuan Tenexon Communication Technology Co., Ltd.
Address	L1-L3 , Block A, Building B, KeYuan 9th Road No.1, Tang Xia Town, Dongguan City, Guangdong, China.
Product Designation	Smart Phone
Brand Name	SKY Devices
Test Model	Platinum 5.5C
Date of test	Mar. 10, 2017~Mar. 31, 2017
Deviation	None
Condition of Test Sample	Normal
Report Template	AGCRT-US-BLE/RF

WE HEREBY CERTIFY THAT:

The above equipment was tested by Dongguan Precise Testing Service Co., Ltd. The test data, data evaluation, test procedures, and equipment configurations shown in this report were made in accordance with the procedures given in ANSI C63.10 (2013) and the energy emitted by the sample EUT tested as described in this report is in compliance with requirement of FCC Part 15 Rules requirement.

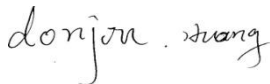
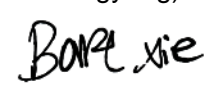
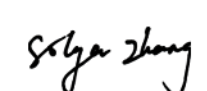
Tested By		
	_____ Donjon Huang(Huang Dongyang)	Mar. 31, 2017
Reviewed By		
	_____ Bart Xie(Xie Xiaobin)	Mar. 31, 2017
Approved By		
	_____ Solger Zhang(Zhang Hongyi) Authorized Officer	Mar. 31, 2017

2.GENERAL INFORMATION

2.1PRODUCT DESCRIPTION

The EUT is designed as “Tablet”. It is designed by way of utilizing the FHSS technology to achieve the system operation.

A major technical description of EUT is described as following

Operation Frequency	2.402 GHz to 2.480GHz
Bluetooth Version	V4.0
Modulation	GFSK
Number of channels	40 Channel(37 Hopping Channel,3 advertising Channel)
Antenna Designation	PIFA Antenna
Antenna Gain	-1.45dBi
Hardware Version	ZH066-MB-V3.0
Software Version	Platinum_5.5C_V01_20170207
Power Supply	DC3.8V by Built-in Li-ion Battery

2.2 RELATED SUBMITTAL(S)/GRANT(S)

This submittal(s) (test report) is intended for **FCC ID: 2ABOSSKYPLAT55C** filing to comply with Section 15.247of the FCC Part 15, Subpart C Rules.

2.3TEST METHODOLOGY

All measurements contained in this report were conducted with KDB 558074 D01 DTS Meas Guidance v03r02, American National Standard for Methods of Measurement of Radio-Noise Emissions from Low-Voltage Electrical and Electronic Equipment in the range of 9 kHz to 40 GHz.

The equipment under test (EUT) was configured to measure its highest possible emission level. The test modes were adapted accordingly in reference to the Operating Instructions. The EUT was tested in all three orthogonal planes and the worse case was showed.

2.4 TEST FACILITY

Site	Dongguan Precise Testing Service Co., Ltd.
Location	Building D,Baoding Technology Park,Guangming Road2,Dongcheng District, Dongguan, Guangdong, China,
FCC Registration No.	371540
Description	The test site is constructed and calibrated to meet the FCC requirements in documents ANSI C63.10:2013.

2.5 SPECIAL ACCESSORIES

Refer to section 2.2.

2.6 EQUIPMENT MODIFICATIONS

Not available for this EUT intended for grant.

3. SYSTEM TEST CONFIGURATION

3.1 CONFIGURATION OF TESTED SYSTEM

Configuration:

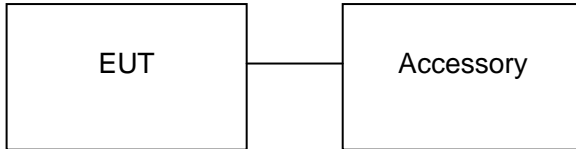

3.2 EQUIPMENT USED IN TESTED SYSTEM

Item	Equipment	Model No.	ID or Specification	Note
1	Smart Phone	Platinum 5.5C	2ABOSSKYPLAT55C	EUT
2	Adapter	Platinum 5.5C	DC5V /1A	Accessory
3	Battery	Platinum 5.5C	DC3.8V/2800mAh	Accessory
4	Earphone	N/A	N/A	Accessory
5	USB Cable	N/A	N/A	Accessory

ALL TEST EQUIPMENT LIST

FOR RADIATED EMISSION TEST (BELOW 1GHZ)

Radiated Emission Test Site					
Name of Equipment	Manufacturer	Model Number	Serial Number	Last Calibration	Due Calibration
EMI Test Receiver	Rohde & Schwarz	ESCI	101417	July 3, 2016	July 2, 2017
Trilog Broadband Antenna (25M-1GHz)	SCHWARZBECK	VULB9160	9160-3355	July 3, 2016	July 2, 2017
Signal Amplifier	SCHWARZBECK	BBV 9475	9745-0013	July 3, 2016	July 2, 2017
RF Cable	SCHWARZBECK	AK9515E	96221	July 3, 2016	July 2, 2017
3m Anechoic Chamber	CHENGYU	966	PTS-001	June 5, 2016	June 4, 2017
MULTI-DEVICE Positioning Controller	Max-Full	MF-7802	MF780208339	N/A	N/A
Active loop antenna (9K-30MHz)	Schwarzbeck	FMZB1519	1519-038	June 5, 2016	June 4, 2017
Spectrum analyzer	Agilent	E4407B	MY46185649	June 5, 2016	June 4, 2017
Power Probe	R&S	NRP-Z23	100323	July 24, 2016	July 23, 2017
RF attenuator	N/A	RFA20db	68	N/A	N/A

FOR RADIATED EMISSION TEST (1GHZ ABOVE)

Radiated Emission Test Site					
Name of Equipment	Manufacturer	Model Number	Serial Number	Last Calibration	Due Calibration
EMI Test Receiver	Rohde & Schwarz	ESCI	101417	July 3, 2016	July 2, 2017
Horn Antenna (1G-18GHz)	SCHWARZBECK	BBHA9120D	9120D-1246	July 10, 2016	July 9, 2017
Spectrum Analyzer	Agilent	E4411B	MY4511453	July 3, 2016	July 2, 2017
Signal Amplifier	SCHWARZBECK	BBV 9718	9718-269	July 6, 2016	July 5, 2017
RF Cable	SCHWARZBECK	AK9515H	96220	July 7, 2016	July 6, 2017
3m Anechoic Chamber	CHENGYU	966	PTS-001	June 5, 2016	June 4, 2017
MULTI-DEVICE Positioning Controller	Max-Full	MF-7802	MF780208339	N/A	N/A
Horn Ant (18G-40GHz)	Schwarzbeck	BBHA 9170	9170-181	June 5, 2016	June 4, 2017
Power Probe	R&S	NRP-Z23	100323	July 24,2016	July 23,2017
RF attenuator	N/A	RFA20db	68	N/A	N/A
Conducted Emission Test Site					
Name of Equipment	Manufacturer	Model Number	Serial Number	Last Calibration	Due Calibration
EMI Test Receiver	Rohde & Schwarz	ESCI	101417	July 3, 2016	July 2, 2017
Artificial Mains Network	Narda	L2-16B	000WX31025	July 7, 2016	July 6, 2017
Artificial Mains Network (AUX)	Narda	L2-16B	000WX31026	July 7, 2016	July 6, 2017
RF Cable	SCHWARZBECK	AK9515E	96222	July 3, 2016	July 2, 2017
Shielded Room	CHENGYU	843	PTS-002	June 5,2016	June 4,2017
Conducted Emission Test Site					
Name of Equipment	Manufacturer	Model Number	Serial Number	Last Calibration	Due Calibration
EMI Test Receiver	Rohde & Schwarz	ESCI	101417	July 3, 2016	July 2, 2017
Artificial Mains Network	Narda	L2-16B	000WX31025	July 7, 2016	July 6, 2017
Artificial Mains Network (AUX)	Narda	L2-16B	000WX31026	July 7, 2016	July 6, 2017
RF Cable	SCHWARZBECK	AK9515E	96222	July 3, 2016	July 2, 2017
Shielded Room	CHENGYU	843	PTS-002	June 5,2016	June 4,2017

4. SUMMARY OF TEST RESULTS

FCC RULES	DESCRIPTION OF TEST	RESULT
§ 15.203	Antenna Requirement	Compliant
§15.209 §15.247(d)	Radiated Emission	Compliant
§15.247(d)	Band Edges	Compliant
§15.247	6 dB Bandwidth	Compliant
§15.247(b)	Conducted Power	Compliant
§15.247(e)	Maximum Conducted Output Power SPECTRAL Density	Compliant
§15.207	Line Conduction Emission	Compliant
§15.207	Conduction Emission	Compliant

5. DESCRIPTION OF TEST MODES

The EUT has been operated in three modulations: GFSK independently.

NO.	TEST MODE DESCRIPTION
1	Low channel TX
2	Middle channel TX
3	High channel TX
4	Normal Operating (BT)

Note:

- All the test modes can be supply by Built-in Li-ion battery, only the result of the worst case was recorded in the report if no any records.
- For Radiated Emission, 3axis were chosen for testing for each applicable mode.
- Eut is operating at its maximum duty cycle>or equal 98%

6. ANTENNA REQUIREMENT

6.1. STANDARD APPLICABLE

According to FCC 15.203, An intentional radiator shall be designed to ensure that no antenna other than that furnished by the responsible party shall be used with the device. The use of a permanently attached antenna or of an antenna that uses a unique coupling to the intentional radiator shall be considered sufficient to comply with the provisions of this Section. The manufacturer may design the unit so that a broken antenna can be replaced by the user, but the use of a standard antenna jack or electrical connector is prohibited. This requirement does not apply to carrier current devices or to devices operated under the provisions of Sections 15.211, 15.213, 15.217, 15.219, or 15.221. Further, this requirement does not apply to intentional radiators that must be professionally installed, such as perimeter protection systems and some field disturbance sensors, or to other intentional radiators which, in accordance with Section 15.31(d), must be measured at the installation site. However, the installer shall be responsible for ensuring that the proper antenna is employed so that the limits in this Part are not exceeded.

6.2. TEST RESULT

This product has a permanent antenna, fulfill the requirement of this section.

7. RADIATED EMISSION

7.1 MEASUREMENT PROCEDURE

1. Configure the EUT according to ANSI C63.10. The EUT was placed on the top of the turntable 0.8 meter above ground. The phase center of the receiving antenna mounted on the top of a height-variable antenna tower was placed 3 meters far away from the turntable.
2. Power on the EUT and all the supporting units. The turntable was rotated by 360 degrees to determine the position of the highest radiation.
3. The height of the broadband receiving antenna was varied between one meter and four meters above ground to find the maximum emissions field strength of both horizontal and vertical polarization.
4. For each suspected emissions, the antenna tower was scan (from 1 M to 4 M) and then the turntable was rotated (from 0 degree to 360 degrees) to find the maximum reading.
5. Set the test-receiver system to Peak or CISPR quasi-peak Detect Function with specified bandwidth under Maximum Hold Mode.
6. For emissions above 1GHz, use 1MHz VBW and RBW for peak reading. Then 1MHz RBW and 10Hz VBW for average reading in spectrum analyzer. The EUT was placed on the top of the turntable 1.5 meter above ground. The phase center of the receiving antenna mounted on the top of a height-variable antenna tower was placed 3 meters far away from the turntable.
7. When the radiated emissions limits are expressed in terms of the average value of the emissions, and pulsed operation is employed, the measurement field strength shall be determined by averaging over one complete pulse train, including blanking intervals, as long as the pulse train does not exceed 0.1 seconds. As an alternative (provided the transmitter operates for longer than 0.1 seconds) or in cases where the pulse train exceeds 0.1 seconds, the measured field strength shall be determined from the average absolute voltage during a 0.1 second interval during which the field strength is at its maximum values.
8. If the emissions level of the EUT in peak mode was 3 dB lower than the average limit specified, then testing will be stopped and peak values of EUT will be reported, otherwise, the emissions which do not have 3 dB margin will be repeated one by one using the quasi-peak method for below 1GHz.
9. For testing above 1GHz, the emissions level of the EUT in peak mode was lower than average limit (that means the emissions level in peak mode also complies with the limit in average mode), then testing will be stopped and peak values of EUT will be reported, otherwise, the emissions will be measured in average mode again and reported.
10. In case the emission is lower than 30MHz, loop antenna has to be used for measurement and the recorded data should be QP measured by receiver. High - Low scan is not required in this case.

7.2 TEST SETUP

RADIATED EMISSION TEST SETUP 30MHz-1000MHz

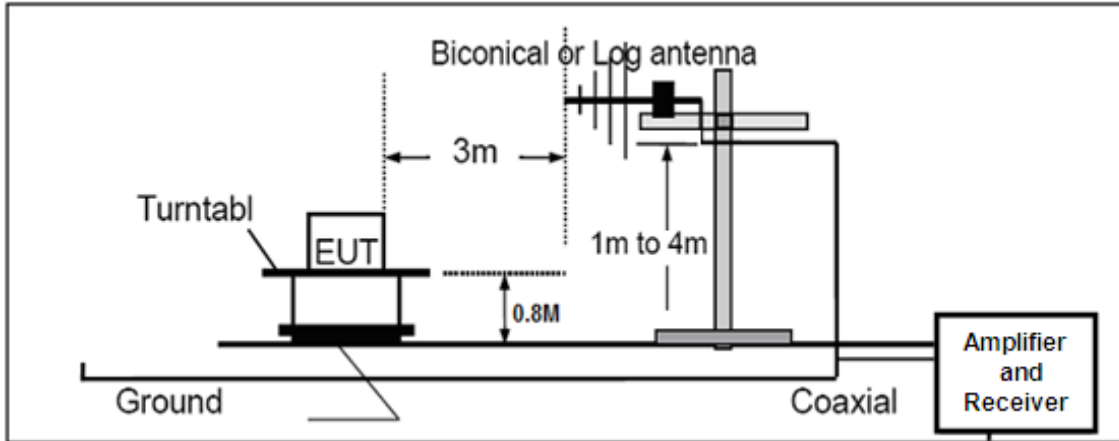

RADIATED EMISSION TEST SETUP ABOVE 1000MHz

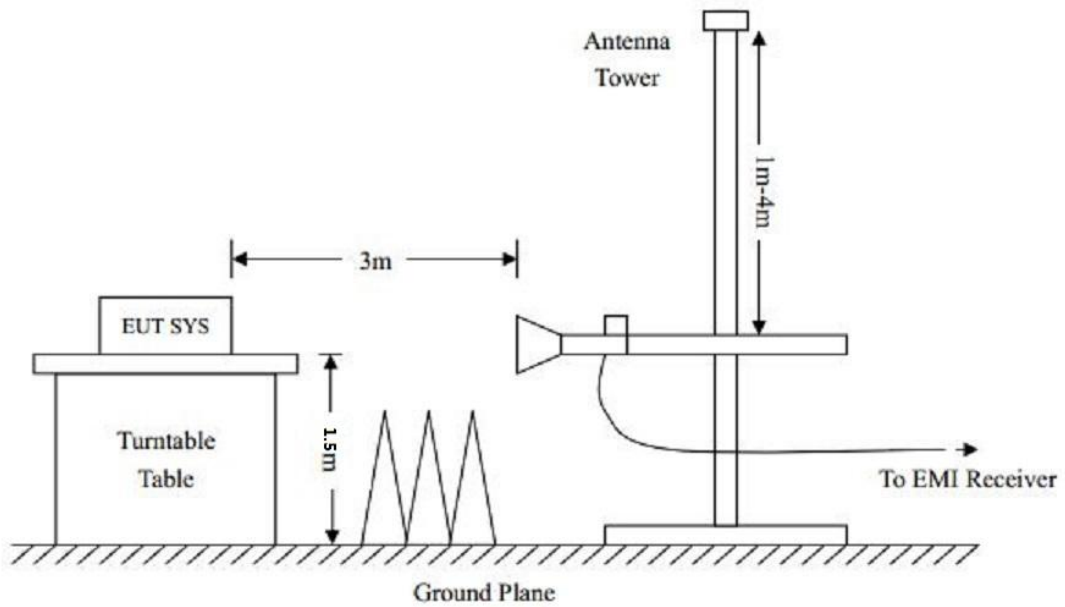

7.3 LIMITS AND MEASUREMENT RESULT

15.209 Limit in the below table has to be followed

Frequencies (MHz)	Field Strength (micorvolts/meter)	Measurement Distance (meters)
0.009~0.490	2400/F(KHz)	300
0.490~1.705	24000/F(KHz)	30
1.705~30.0	30	30
30~88	100	3
88~216	150	3
216~960	200	3
Above 960	500	3

Note: All modes were tested For restricted band radiated emission,
the test records reported below are the worst result compared to other modes.

7.4 TEST RESULT

RADIATED EMISSION BELOW 30MHZ

No emission found between lowest internal used/generated frequencies to 30MHz.

RADIATED EMISSION BELOW 1GHZ
RADIATED EMISSION TEST- (30MHZ-1GHZ) -HORIZONTAL

66.9 dBuV/m

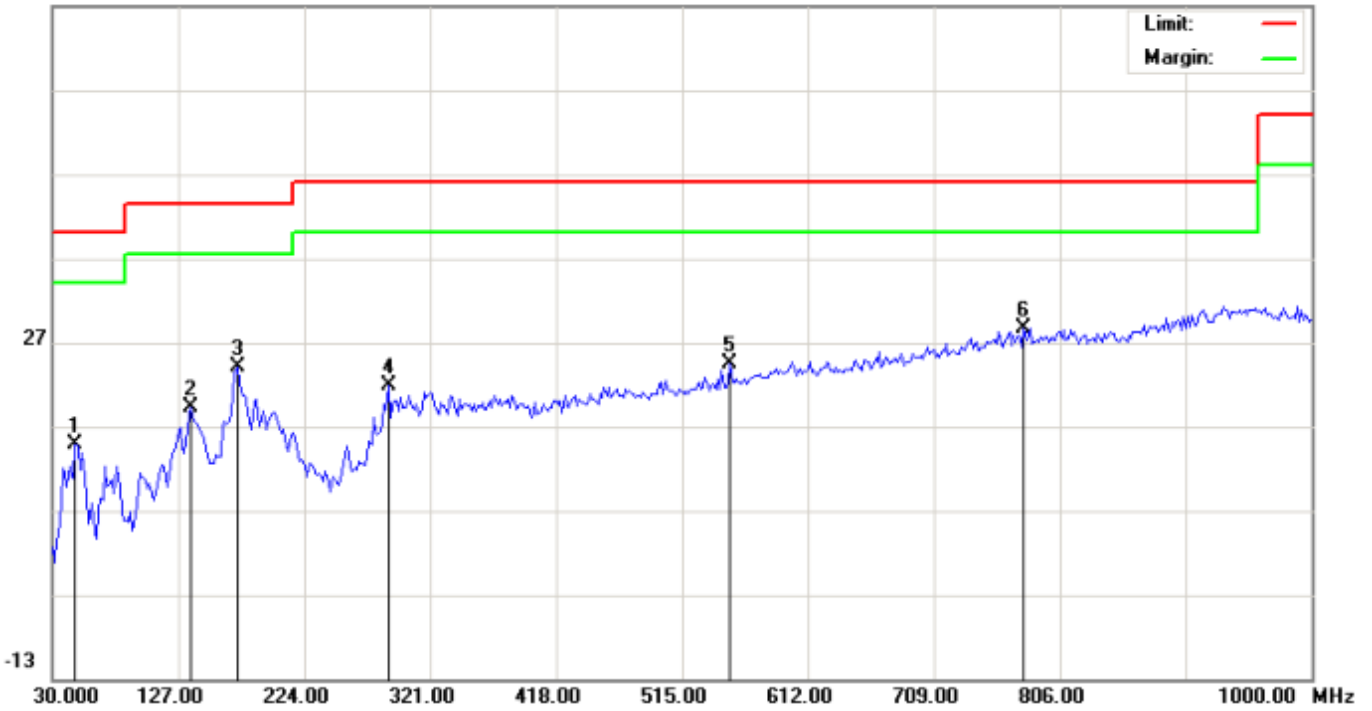

No.	Mk	Freq.	Reading	Factor	Measurement	Limit	Over	Detector	Antenna Height	Table Degree	Comment
		MHz	dBuV	dB/m	dBuV/m	dBuV/m	dB		cm	degree	
1		47.7833	3.45	11.39	14.84	40.00	-25.16	peak			
2		136.7000	5.60	13.66	19.26	43.50	-24.24	peak			
3		172.2667	13.16	10.78	23.94	43.50	-19.56	peak			
4		288.6667	8.41	13.48	21.89	46.00	-24.11	peak			
5		552.1833	1.90	22.53	24.43	46.00	-21.57	peak			
6	*	778.5167	1.67	27.02	28.69	46.00	-17.31	peak			

RESULT: PASS

RADIATED EMISSION TEST- (30MHZ-1GHZ) -VERTICAL

66.9 dBuV/m

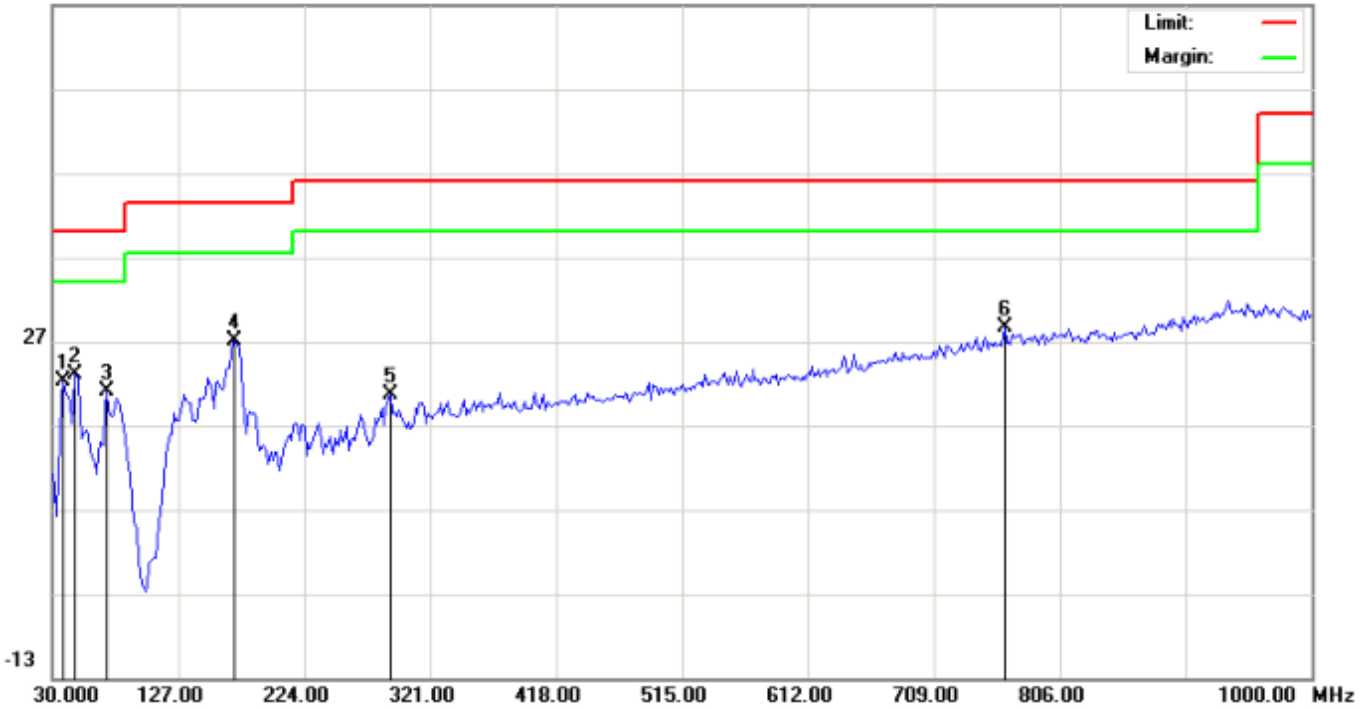

No.	Mk	Freq.	Reading	Factor	Measurement	Limit	Over	Detector	Antenna Height	Table Degree	Comment
		MHz	dBuV	dB/m	dBuV/m	dBuV/m	dB		cm	degree	
1		38.0833	15.77	6.39	22.16	40.00	-17.84	peak			
2		47.7833	14.56	8.39	22.95	40.00	-17.05	peak			
3		72.0333	17.21	3.76	20.97	40.00	-19.03	peak			
4	*	170.6500	12.39	14.66	27.05	43.50	-16.45	peak			
5		290.2833	5.58	15.12	20.70	46.00	-25.30	peak			
6		763.9667	1.75	26.82	28.57	46.00	-17.43	peak			

RESULT: PASS

Note: 1. Factor=Antenna Factor + Cable loss, Margin=Measurement-Limit.

2. The "Factor" value can be calculated automatically by software of measurement system.

3. All test modes had been pre-tested. The GFSK mode at low channel is the worst case and recorded in the report.

RADIATED EMISSION ABOVE 1GHZ

Frequency	Meter Reading	Factor	Emission Level	Limits	Margin	Detector	Comment
(MHz)	(dBµV)	(dB)	(dBµV/m)	(dBµV/m)	(dB)	Type	
Low Channel (2402 MHz)							
4804	40.22	10.44	50.66	74	-23.34	Pk	Horizontal
4804	29.38	10.44	39.82	54	-14.18	AV	Horizontal
7206	42.23	12.39	54.62	74	-19.38	pk	Horizontal
7206	28.30	12.39	40.69	54	-13.31	AV	Horizontal
4804	43.69	10.4	54.09	74	-19.91	Pk	Vertical
4804	28.19	10.4	38.59	54	-15.41	AV	Vertical
7206	33.42	12.75	46.17	74	-27.83	Pk	Vertical
7206	28.33	12.75	41.08	54	-12.92	AV	Vertical
Mid Channel (2440 MHz)							
4880	38.81	10.4	49.21	74	-24.79	Pk	Horizontal
4880	29.97	10.4	40.37	54	-13.63	AV	Horizontal
7320	40.50	12.75	53.25	74	-20.75	Pk	Horizontal
7320	30.65	12.75	43.40	54	-10.60	AV	Horizontal
4880	43.84	10.39	54.23	74	-19.77	Pk	Vertical
4880	27.56	10.44	38.00	54	-16.00	AV	Vertical
7320	40.05	12.68	52.73	74	-21.27	Pk	Vertical
7320	30.79	12.68	43.47	54	-10.53	AV	Vertical
High Channel (2480 MHz)							
4960	43.73	10.39	54.12	74	-19.88	pk	Horizontal
4960	25.94	10.39	36.33	54	-17.67	AV	Horizontal
7440	40.35	12.68	53.03	74	-20.97	pk	Horizontal
7440	30.14	12.68	42.82	54	-11.18	AV	Horizontal
4960	37.19	10.39	47.58	74	-26.42	pk	Vertical
4960	27.27	10.39	37.66	54	-16.34	AV	Vertical
7440	40.11	12.68	52.79	74	-21.21	pk	Vertical
7440	30.48	12.68	43.16	54	-10.84	AV	Vertical

RESULT: PASS

Note: 1~25GHz scan with GFSK. No recording in the test report at least have 20dB margin.

Factor = Antenna Factor + Cable Loss – Pre-amplifier.

Emission Level = Meter Reading + Factor

Margin = Emission - Leve Limit

8. BAND EDGE EMISSION

8.1. MEASUREMENT PROCEDURE

1) Radiated restricted band edge measurements

The radiated restricted band edge measurements are measured with an EMI test receiver connected to the receive antenna while the EUT is transmitting

2) Conducted Emissions at the bang edge

a) The transmitter output was connected to the spectrum analyzer

b) Set RBW=100kHz, VBW=300kHz

c) Suitable frequency span including 100kHz bandwidth from band edge

8.2. TEST SET-UP

Radiated same as 6.2

Conducted set up

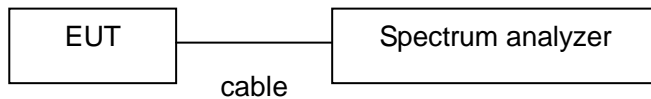

8.3. Radiated Test Result

Frequency	Meter Reading	Factor	Emission Level	Limits	Margin	Detector	Comment
(MHz)	(dBµV)	(dB)	(dBµV/m)	(dBµV/m)	(dB)	Type	
Low Channel (2402 MHz)							
2399.9	70.14	-13	57.14	74	-16.86	peak	Horizontal
2399.9	55.00	-13	42.00	54	-12.00	AVG	Horizontal
2400	66.05	-12.99	53.06	74	-20.94	peak	Horizontal
2400	51.51	-12.99	38.52	54	-15.48	AVG	Horizontal
2399.9	64.13	-12.97	51.16	74	-22.84	peak	Vertical
2399.9	52.83	-12.97	39.86	54	-14.14	AVG	Vertical
2400	66.03	-12.94	53.09	74	-20.91	peak	Vertical
2400	53.90	-12.94	40.96	54	-13.04	AVG	Vertical
High Channel (2480 MHz)							
2483.5	69.61	-12.78	56.83	74	-17.17	peak	Horizontal
2483.5	57.58	-12.78	44.80	54	-9.20	AVG	Horizontal
2483.6	67.16	-12.77	54.39	74	-19.61	peak	Horizontal
2483.6	53.64	-12.77	40.87	54	-13.13	AVG	Horizontal
2483.5	71.28	-12.76	58.52	74	-15.48	peak	Vertical
2483.5	53.03	-12.76	40.27	54	-13.73	AVG	Vertical
2483.6	65.77	-12.72	53.05	74	-20.95	peak	Vertical
2483.6	56.46	-12.72	43.74	54	-10.26	AVG	Vertical

RESULT: PASS

Note: Factor=Antenna Factor + Cable loss - Amplifier gain,

Emission Level = Meter Reading + Factor

Margin= Emission Level -Limit.

The "Factor" value can be calculated automatically by software of measurement system.

8.4. Conducted Test Result
Test Graph

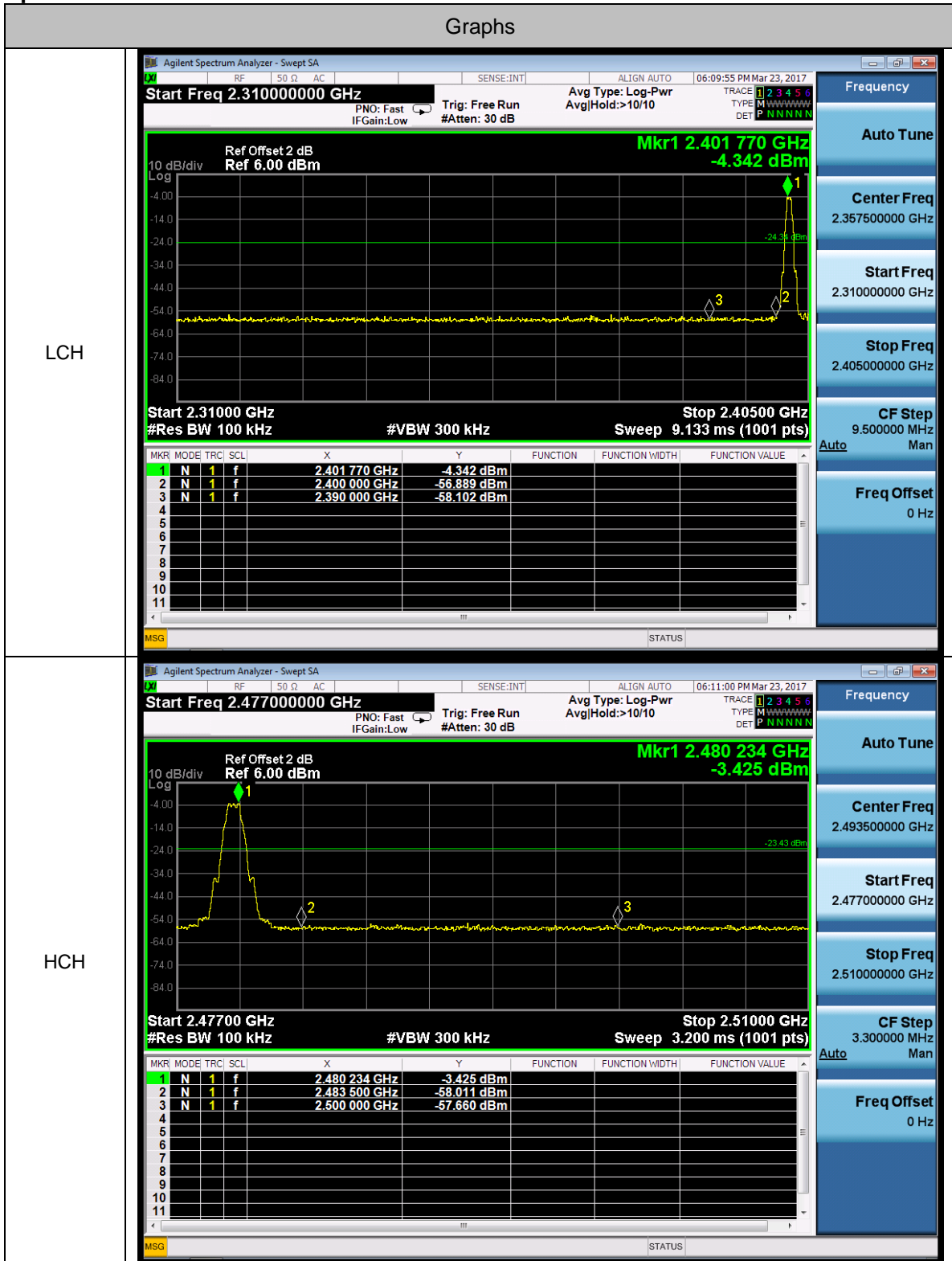

9. 6DB BANDWIDTH
9.1. TEST PROCEDURE

1. Connect EUT RF output port to the Spectrum Analyzer through an RF attenuator
2. Set the EUT Work on the top, the middle and the bottom operation frequency individually.
3. Set SPA Centre Frequency = Operation Frequency, RBW= 100 KHz, VBW ≥ RBW.
4. Set SPA Trace 1 Max hold, then View.

9.2. SUMMARY OF TEST RESULTS/PLOTS

Mode	Channel	6dB Bandwidth [KHz]	OCB [KHz]	Verdict
BLE	LCH	721.9	1078.7	PASS
BLE	MCH	720.8	1078.3	PASS
BLE	HCH	719.6	1078.3	PASS

Test Graph



10. CONDUCTED OUTPUT POWER

10.1. MEASUREMENT PROCEDURE

1. Connect EUT RF output port to the Spectrum Analyzer through an RF attenuator
2. Set the EUT Work on the top, middle and the bottom operation frequency individually.
3. Use the following spectrum analyzer settings:
 - Set the RBW \geq DTS bandwidth
 - Set the VBW \geq 3 x RBW
 - Set the span \geq 3 x RBW
 - Detector = peak
 - Sweep time = auto couple
 - Trace mode = max hold
4. Allow the trace to stabilize. Use peak marker function to determine the peak amplitude level
5. Record the result form the Spectrum Analyzer.

Note: The EUT was tested according to KDB 558074 for compliance to FCC 47CFR 15.247 requirements.

10.2. TEST SET-UP (BLOCK DIAGRAM OF CONFIGURATION)

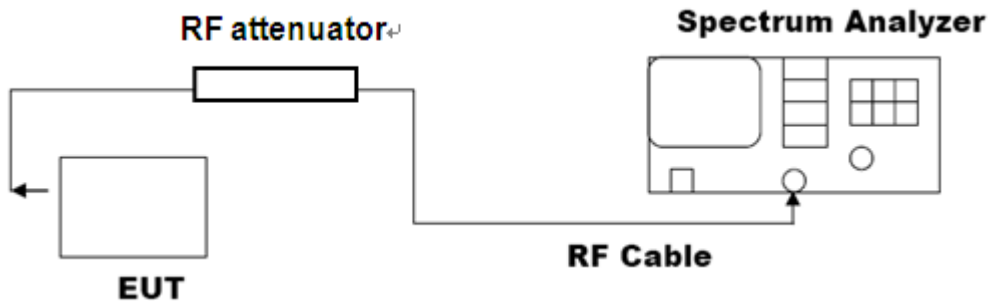

10.3. LIMITS AND MEASUREMENT RESULT

Channel	Peak Power (dBm)	Applicable Limits (dBm)	Pass/Fail
Low Channel	-3.542	20	Pass
Middle Channel	-2.635	20	Pass
High Channel	-2.624	20	Pass

11. MAXIMUM CONDUCTED OUTPUT POWER SPECTRAL DENSITY

11.1 MEASUREMENT PROCEDURE

- (1). Connect EUT RF output port to the Spectrum Analyzer through an RF attenuator
- (2). Set the EUT Work on the top, the middle and the bottom operation frequency individually.
- (3). Set SPA Trace 1 Max hold, then View.

Note: The EUT was tested according to KDB 558074 for compliance to FCC 47CFR 15.247 requirements.

11.2 TEST SET-UP (BLOCK DIAGRAM OF CONFIGURATION)

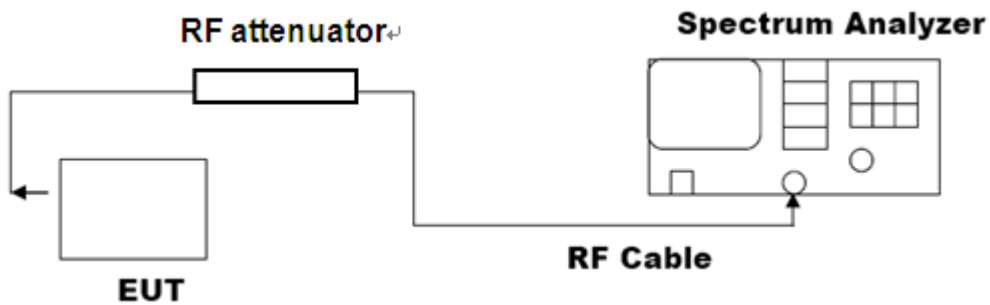

11.3 LIMITS AND MEASUREMENT RESULT

Mode	Channel	PSD [dBm/3kHz]	Limit[dBm/3kHz]	Verdict
BLE	LCH	-19.112	8	PASS
BLE	MCH	-18.242	8	PASS
BLE	HCH	-18.186	8	PASS

12. FCC LINE CONDUCTED EMISSION TEST

12.1 LIMITS

Frequency	Maximum RF Line Voltage	
	Q.P.(dBuV)	Average(dBuV)
150kHz~500kHz	66-56	56-46
500kHz~5MHz	56	46
5MHz~30MHz	60	50

****Note:** 1. The lower limit shall apply at the transition frequency.
2. The limit decreases linearly with the logarithm of the frequency in the range 0.15 MHz to 0.50 MHz

12.2 TEST SETUP

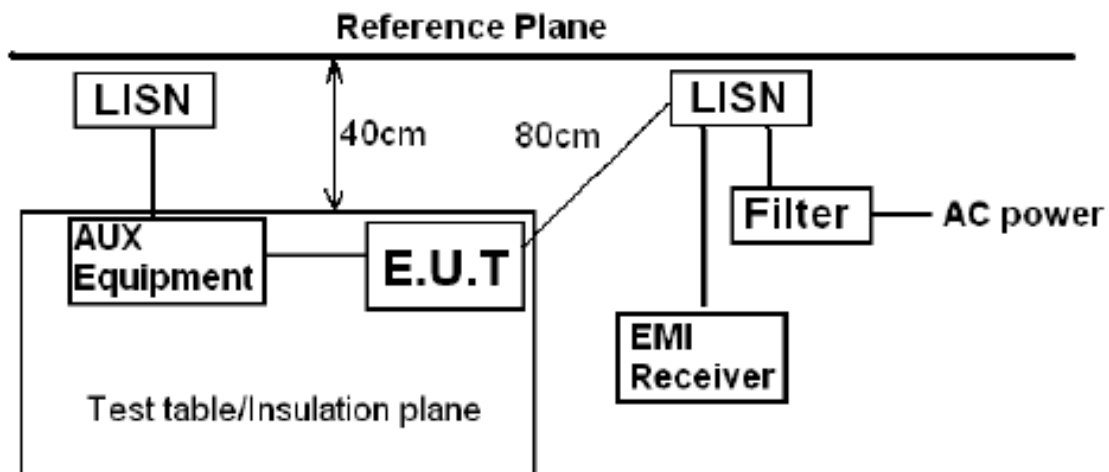

Remark:
E.U.T: Equipment Under Test
LISN: Line Impedance Stabilization Network
Test table height=0.8m

12.3 PRELIMINARY PROCEDURE

- 1) The equipment was set up as per the test configuration to simulate typical actual usage per the user's manual. When the EUT is a tabletop system, a wooden table with a height of 0.8 meters is used and is placed on the ground plane as per ANSI C63.10 (see Test Facility for the dimensions of the ground plane used). When the EUT is a floor-standing equipment, it is placed on the ground plane which has a 3-12 mm non-conductive covering to insulate the EUT from the ground plane.
- 2) Support equipment, if needed, was placed as per ANSI C63.10.
- 3) All I/O cables were positioned to simulate typical actual usage as per ANSI C63.10.
- 4) All support equipments received AC120V/60Hz power from a LISN, if any.
- 5) The EUT received power by adapter which received power by a LISN.
- 6) The test program was started. Emissions were measured on each current carrying line of the EUT using a spectrum Analyzer / Receiver connected to the LISN powering the EUT. The LISN has two monitoring points: Line 1 (Hot Side) and Line 2 (Neutral Side). Two scans were taken: one with Line 1 connected to Analyzer / Receiver and Line 2 connected to a 50 ohm load; the second scan had Line 1 connected to a 50 ohm load and Line 2 connected to the Analyzer / Receiver.
- 7) Analyzer / Receiver scanned from 150 kHz to 30MHz for emissions in each of the test modes.
- 8) During the above scans, the emissions were maximized by cable manipulation.
- 9) The following test mode(s) were scanned during the preliminary test.
Then, the EUT configuration and cable configuration of the above highest emission level were recorded for reference of final testing.

12.4 FINAL TEST PROCEDURE

- 10) EUT and support equipment was set up on the test bench as per step 2 of the preliminary test.
- 11) 2) A scan was taken on both power lines, Line 1 and Line 2, recording at least the six highest emissions. Emission frequency and amplitude were recorded into a computer in which correction factors were used to calculate the emission level and compare reading to the applicable limit. If EUT emission level was less -2dB to the A.V. limit in Peak mode, then the emission signal was re-checked using Q.P and Average detector.
- 12) 3) The test data of the worst case condition(s) was reported on the Summary Data page.

12.5 TEST RESULT OF POWER LINE

Line Conducted Emission Test Line 1-L

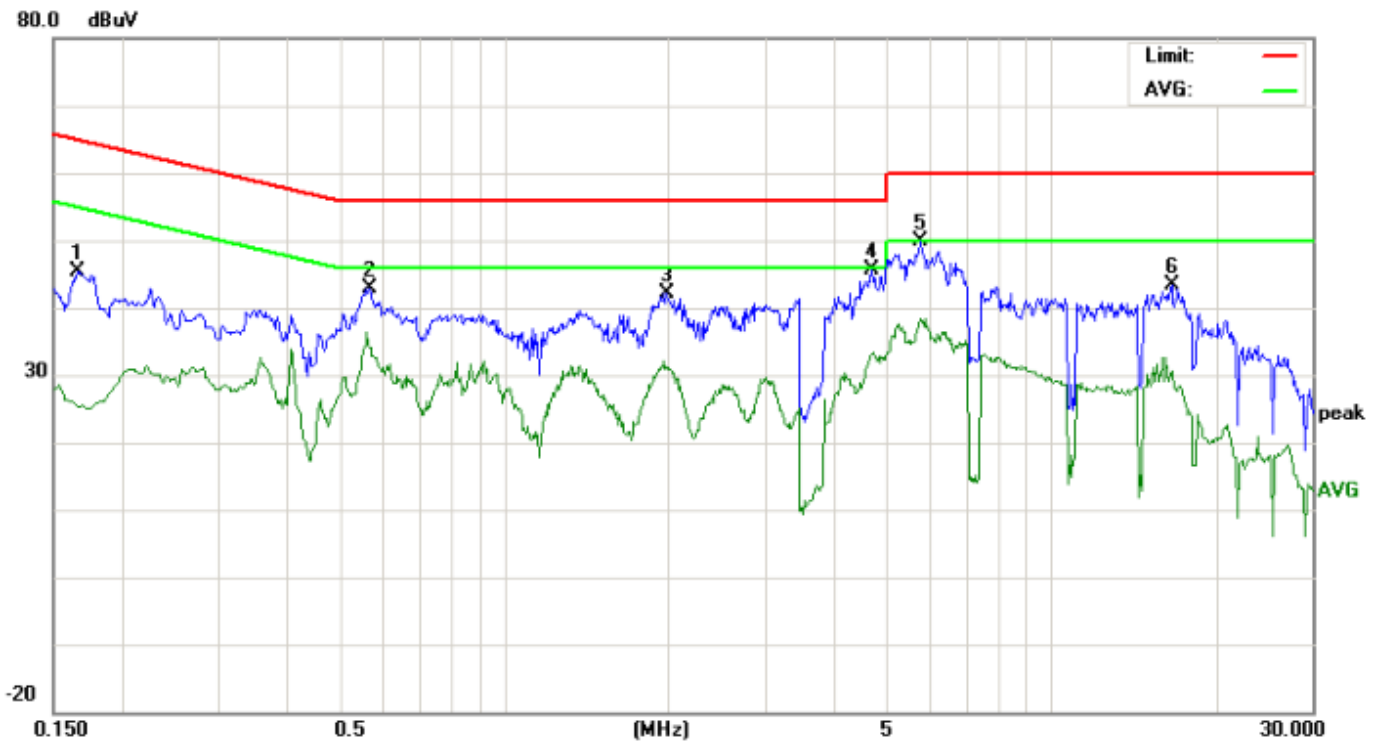

No.	Freq. (MHz)	Reading_Level (dBuV)			Correct Factor (dB)	Measurement (dBuV)			Limit (dBuV)		Margin (dB)		P/F	Comment
		Peak	QP	AVG		Peak	QP	AVG	QP	AVG	QP	AVG		
1	0.1660	35.28		15.22	10.18	45.46		25.40	65.15	55.15	-19.69	-29.75	P	
2	0.5700	32.51		23.86	10.34	42.85		34.20	56.00	46.00	-13.15	-11.80	P	
3	1.9820	31.97		20.98	10.23	42.20		31.21	56.00	46.00	-13.80	-14.79	P	
4	4.7059	35.34		22.87	10.22	45.56		33.09	56.00	46.00	-10.44	-12.91	P	
5	5.7699	39.62		28.15	10.27	49.89		38.42	60.00	50.00	-10.11	-11.58	P	
6	16.6179	33.33		20.55	10.12	43.45		30.67	60.00	50.00	-16.55	-19.33	P	

Line Conducted Emission Test Line 1-N

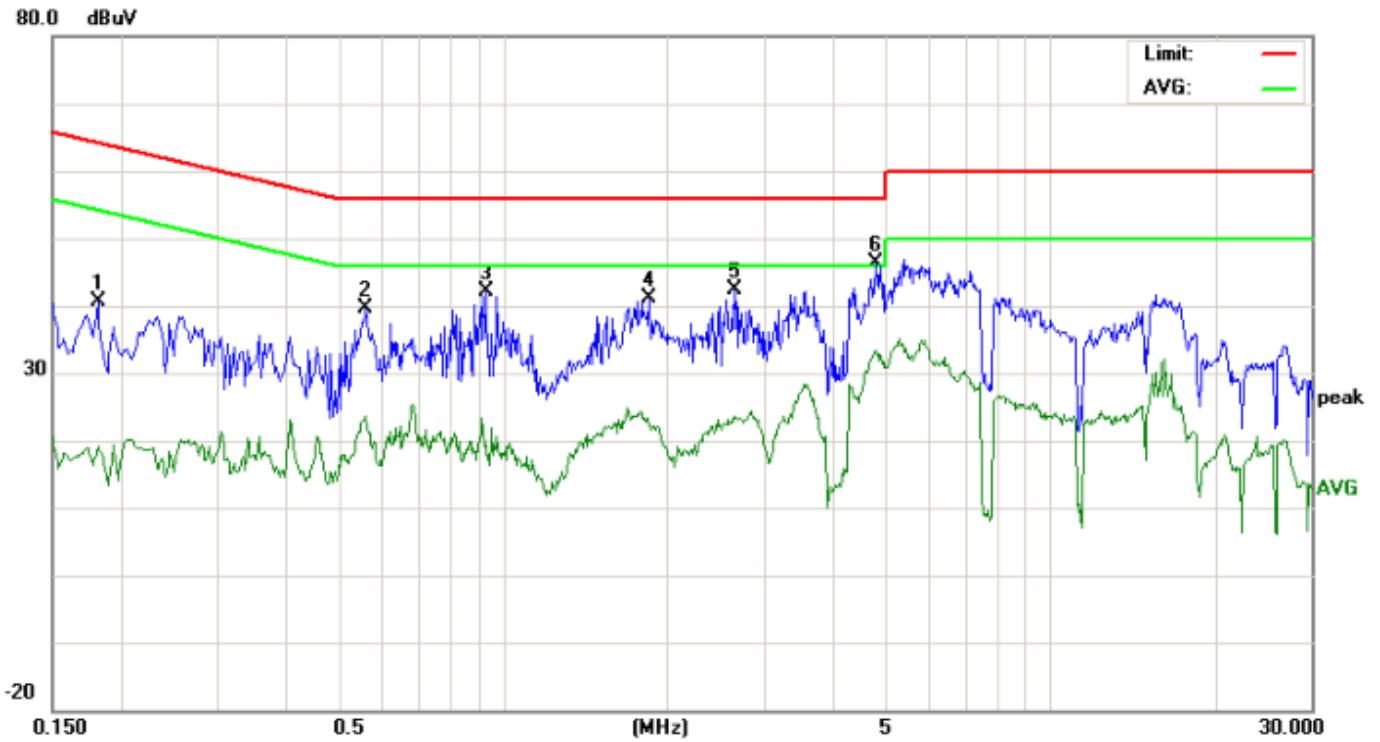

No.	Freq. (MHz)	Reading_Level (dBuV)			Correct Factor (dB)	Measurement (dBuV)			Limit (dBuV)		Margin (dB)		P/F	Comment
		Peak	QP	AVG		Peak	QP	AVG	QP	AVG	QP	AVG		
1	0.1819	30.45		8.96	10.20	40.65		19.16	64.39	54.39	-23.74	-35.23	P	
2	0.5620	29.19		13.39	10.34	39.53		23.73	56.00	46.00	-16.47	-22.27	P	
3	0.9300	31.82		8.99	10.40	42.22		19.39	56.00	46.00	-13.78	-26.61	P	
4	1.8580	30.87		12.33	10.27	41.14		22.60	56.00	46.00	-14.86	-23.40	P	
5	2.6500	31.93		13.26	10.47	42.40		23.73	56.00	46.00	-13.60	-22.27	P	
6	4.8179	36.13		23.26	10.23	46.36		33.49	56.00	46.00	-9.64	-12.51	P	

13. CONDUCTED SPURIOUS EMISSION

13.1. MEASUREMENT PROCEDURE

1. Connect EUT RF output port to the Spectrum Analyzer through an RF attenuator
2. Set the EUT Work on the top, the Middle and the bottom operation frequency individually.
3. Set the Span = wide enough to capture the peak level of the in-band emission and all spurious emissions from the lowest frequency generated in the EUT up through the 10th harmonic.
RBW = 100 kHz; VBW ≥ RBW; Sweep = auto; Detector function = peak.
4. Set SPA Trace 1 Max hold, then View.

Note: The EUT was tested according to DA000705 for compliance to FCC 47CFR 15.247 requirements. Owing to satisfy the requirements of the number of measurement points, we set the RBW=1MHz, VBW > RBW, scan up through 10th harmonic, and consider the tested results as the worst case, if the tested results conform to the requirement, we can deem that the real tested results(set the RBW=100KHz, VBW > RBW) are conform to the requirement.

13.2. TEST SET-UP (BLOCK DIAGRAM OF CONFIGURATION)

The same as described in section 8.2

13.3. MEASUREMENT EQUIPMENT USED

The same as described in section 6

13.4. LIMITS AND MEASUREMENT RESULT

LIMITS AND MEASUREMENT RESULT		
Applicable Limits	Measurement Result	
	Test Data	Criteria
In any 100 KHz Bandwidth Outside the frequency band in which the spread spectrum intentional radiator is operating, the radio frequency power that is produce by the intentional radiator shall be at least 20 dB below that in 100KHz bandwidth within the band that contains the highest level of the desired power. In addition, radiation emissions which fall in the restricted bands, as defined in §15.205(a), must also comply with the radiated emission limits specified in§15.209(a))	At least -20dBc than the limit Specified on the BOTTOM Channel	PASS
	At least -20dBc than the limit Specified on the TOP Channel	PASS

Test Graph



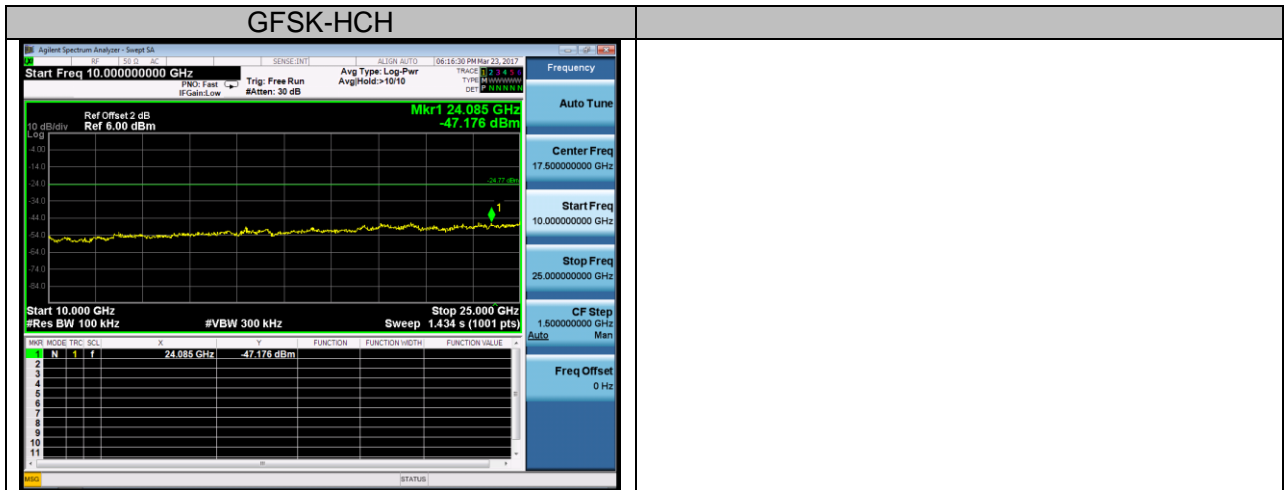
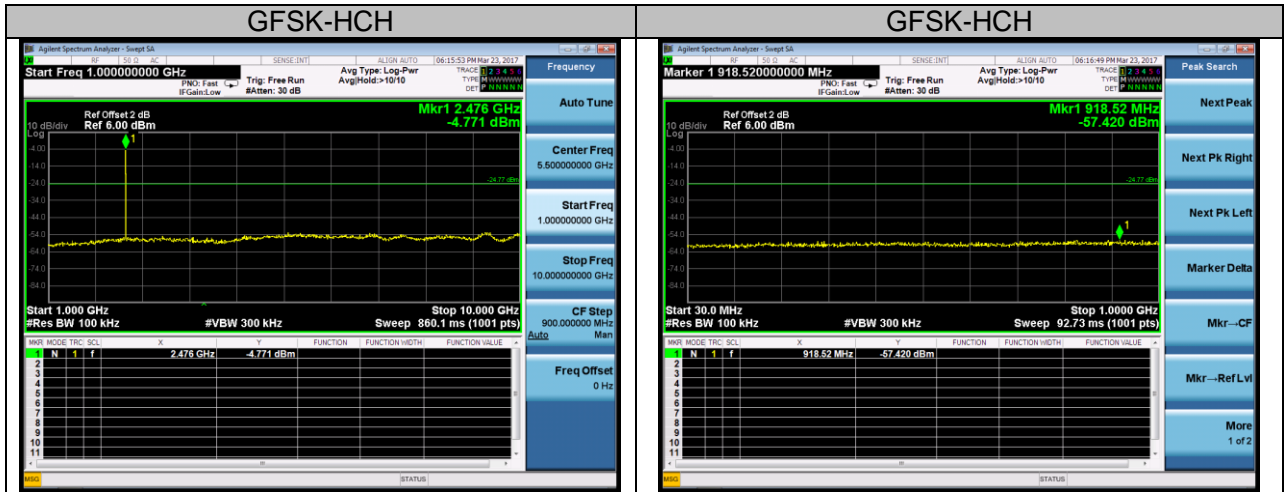

APPENDIX A: PHOTOGRAPHS OF TEST SETUP

FCC LINE CONDUCTED EMISSION TEST SETUP



FCC RADIATED EMISSION TEST SETUP

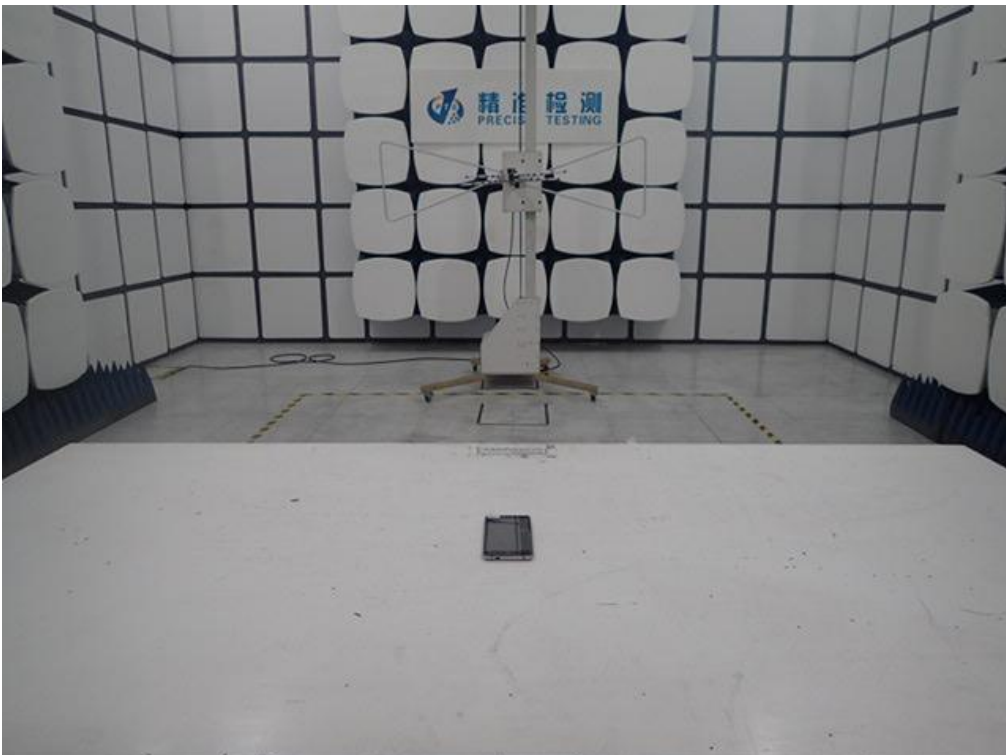



----END OF REPORT----