

LTE RADIO TEST REPORT

Report No: STS1703001F05

Issued for

Sky Phone LLC

1348 Washington Av. Suite 350, Miami Beach, FL 33139
United States

Product Name:	Mobile phone
Brand Name:	SKY DEVICES
Model Name:	ELITE 5.5 IRIS
Series Model:	N/A
FCC ID:	2ABOSSKYELITE55IRIS
Test Standard:	47 CFR Part 22H, 24E, 27

Any reproduction of this document must be done in full. No single part of this document may be reproduced without permission from BZT, All Test Data Presented in this report is only applicable to presented Test sample.

TEST RESULT CERTIFICATION

Applicant's name : Sky Phone LLC
Address : 1348 Washington Av. Suite 350, Miami Beach, FL 33139 United States
Manufacture's Name : Techain
Address : No.18, Lane1387 Zhangdong Rd, Pudong, Shanghai, 201203, P.R.C
Product name : Mobile phone
Brand name : SKY DEVICES
Model and/or type reference.. : ELITE 5.5 IRIS
Standards : 47 CFR Part 22H, 24E, 27
Test procedure : ANSI / TIA 603-D-2010

This device described above has been tested by BZT and the test results show that the equipment under test (EUT) is in compliance with the FCC requirements. And it is applicable only to the tested sample identified in the report.

This report shall not be reproduced except in full, without the written approval of BZT, this document may be altered or revised by BZT, personal only, and shall be noted in the revision of the document.

Date of Test

Date of performance of tests..... 01 Mar. 2017~06 April. 2017

Date of Issue..... 09 April. 2017

Test Result Pass

Testing Engineer : [Signature]
(Leo li)

Technical Manager : [Signature]
(Tony liu)

Authorized Signatory : [Signature]
(Vita Li)

TABLE OF CONTENTS	Page
1. SUMMARY OF TEST RESULTS	5
2. GENERAL INFORMATION	8
3. CONDUCTED OUTPUT POWER	17
4. PEAK-TO-AVERAGE RATIO	27
5. RADIATED POWER AND EFFECTIVE ISOTROPIC RADIATED POWER	29
6. OCCUPIED BANDWIDTH	41
7. CONDUCTED BAND EDGE	44
8. CONDUCTED SPURIOUS EMISSION	46
9. RADIATED SPURIOUS EMISSION	47
10. FREQUENCY STABILITY	67
PHOTOS OF TEST SETUP	72

Revision History

Rev.	Issue Date	Report NO.	Effect Page	Contents
00	09 April. 2017	STS1703001F05	ALL	Initial Issue

1. SUMMARY OF TEST RESULTS

1.1 TEST RESULTS DESCRIPTION AND LABORATORY INFORMATION

Setion	FCC Rule	Description	Limit	Result
	§2.1046	Conducted Output Power	Reporting Only	PASS
	§24.232(d)	Peak-to-Average Ratio	<13 dB	PASS
	§2.1049 §24.238(b) §27.53(h)(3) §27.53(m)(6)	Occupied Bandwidth	Reporting Only	PASS
	§2.1051) §24.238(a) §27.53(g) §27.53(h)	Conducted Band Edge Measurement (Band 2)(Band 4) (Band 17)	<43+10log10(P[Watts])	PASS
	§27.53(m)(4)	(Band 7)	<43+10log10(P[Watts])	PASS
	§2.1051 §24.238(a) §27.53(g) §27.53(h)	Conducted Spurious Emission (Band 2)(Band 4) (Band 17)	<43+10log10(P[Watts])	PASS
	§27.53(m)(4)	Conducted Spurious Emission (Band 7)	< 55+10log10(P[Watts])	PASS
	§2.1055 §24.235 §27.54	Frequency Stability Temperature & Voltage	< 2.5 ppm for Part 22 Within Authorized Band	PASS

	§27.50(c)(10)	Effective Radiated Power (Band 17)	ERP < 3 Watt	PASS
	§24.232(c) §27.50(h)(2)	Equivalent Isotropic Radiated Power (Band 2)((Band 7)	EIRP < 2Watt	PASS
	§27.50(d)(4)	Equivalent Isotropic Radiated Power (Band 4)	EIRP < 1Watt	PASS
	§2.1053 §24.238(a) §27.53(g) §27.53(h)	Radiated Spurious Emission (Band 2)(Band 4) (Band 17)	< 43+10log ₁₀ (P[Watts])	PASS
	§2.1053 §27.53(m)(4)	Radiated Spurious Emission (Band 7)	< 55+10log ₁₀ (P[Watts])	PASS

1.1.1 TEST FACTORY

BZT Testing Technology Co., Ltd

Add. : Buliding 17,Xinghua Road Xingwei industrial Park Fuyong,Baoan District,Shenzhen,
Guangdong,China

FCC Registration No.: 701733

1.1.2 MEASUREMENT UNCERTAINTY

The reported uncertainty of measurement $y \pm U$, where expanded uncertainty U is based on a standard uncertainty multiplied by a coverage factor of $k=2$, providing a level of confidence of approximately **95** %.

No.	Item	Uncertainty
1	Conducted Emission (9KHz-150KHz)	$\pm 2.88\text{dB}$
2	Conducted Emission (150KHz-30MHz)	$\pm 2.67\text{dB}$
3	RF power,conducted	$\pm 0.70\text{dB}$
4	Spurious emissions,conducted	$\pm 1.19\text{dB}$
5	All emissions,radiated(<1G) 30MHz-200MHz	$\pm 2.83\text{dB}$
6	All emissions,radiated(<1G) 200MHz-1000MHz	$\pm 2.94\text{dB}$
7	All emissions,radiated(>1G)	$\pm 3.03\text{dB}$
8	Temperature	$\pm 0.5^{\circ}\text{C}$
9	Humidity	$\pm 2\%$

2. GENERAL INFORMATION

2.1 TECHNICAL SPECIFICATIONS AND REGULATIONS

2.1.1 PRODUCT DESCRIPTION

A major technical description of EUT is described as following:

Product Designation:	Mobile phone
Hardware version:	V1.0
Software version:	Elite_5_5_Iris_V05_0214_2017
FCC ID:	2ABOSSKYELITE55IRIS
Frequency Bands:	U.S. Bands: <input checked="" type="checkbox"/> LTE FDD Band 2 <input checked="" type="checkbox"/> LTE FDD Band 4 <input type="checkbox"/> LTE FDD Band 5 <input checked="" type="checkbox"/> LTE FDD Band 7 <input type="checkbox"/> LTE FDD Band 12 <input type="checkbox"/> LTE FDD Band 13 <input checked="" type="checkbox"/> LTE FDD Band 17
SIM CARD:	SIM 1 and SIM 2 is a chipset unit and tested as single chipset, SIM 1 is used to tested
Antenna:	PIFA Antenna
Antenna gain:	LTE Band 17: -0.4dBi LTE Band 4: -0.1dBi LTE Band 2: 0dBi LTE Band 7:0.6dBi
Power Supply:	DC 3.8V by battery or DC 4.35V supplied by adapter
Battery parameter:	Capacitance: 3050mA, Rated Voltage: 3.8V
Adapter Input:	AC100-240V, 50/60Hz, 500mA
Adapter Output:	DC 5.0V, 2000mA

2.1.2 PRODUCT SPECIFICATION SUBJECTIVE TO THIS STANDARD

Product Specification Subjective To This Standard	
Tx Frequency	LTE Band 2:1850.7~1909.3MHz LTE Band 4:1710.7~1754.3MHz LTE Band 7:2502.7~2567.3MHz LTE Band 17:706.7~713.2MHz
Rx Frequency	LTE Band 2:1930.7~1989.3MHz LTE Band 4:2110.7~2154.3MHz LTE Band 7:2622.7~2687.3MHz LTE Band 17:736.3~743.3MHz
Bandwidth	LTE Band 2 : 1.4MHz / 3MHz / 5MHz / 10MHz / 15MHz / 20MHz LTE Band 4 : 1.4MHz / 3MHz / 5MHz / 10MHz / 15MHz / 20MHz LTE Band 7 : 5MHz / 10MHz / 15MHz / 20MHz LTE Band 17 : 5MHz / 10MHz
Maximum Output Power Limit	LTE Band 2 : 23.52dBm LTE Band 4 : 24.61 dBm LTE Band 7 : 24.56 dBm LTE Band 17 : 25.13 dBm
Type of Modulation	QPSK / 16QAM

2.1.3 EMISSION DESIGNATOR

LTE Band 2 BW(MHz)	Emission Designator (99%OBW)QPSK	Emission Designator (99%OBW)16QAM
1.4	1M10G7D	1M10W7D
3	2M69G7D	2M68W7D
5	4M51G7D	4M51W7D
10	8M96G7D	8M95W7D
15	13M50G7D	13M50W7D
20	17M95G7D	17M96W7D

LTE Band 4 BW(MHz)	Emission Designator (99%OBW)QPSK	Emission Designator (99%OBW)16QAM
1.4	1M10G7D	1M10W7D
3	2M68G7D	2M68W7D
5	4M52G7D	4M51W7D
10	8M95G7D	8M95W7D
15	13M51G7D	13M51W7D
20	17M95G7D	17M98W7D

LTE Band 7 BW(MHz)	Emission Designator (99%OBW)QPSK	Emission Designator (99%OBW)16QAM
5	4M52G7D	4M51W7D
10	8M95G7D	8M94W7D
15	13M49G7D	13M49W7D
20	17M95G7D	17M95W7D

LTE Band 17 BW(MHz)	Emission Designator (99%OBW)QPSK	Emission Designator (99%OBW)16QAM
5	4M52G7D	4M52W7D
10	8M96G7D	8M95W7D

2.1.4 TEST CONFIGURATION OF EQUIPMENT UNDER TEST

Antenna port conducted and radiated test items listed below are performed according to KDB 971168 D02 Power Meas. License Digital Systems with maximum output power. Radiated measurements are performed by rotating the EUT in three different orthogonal test planes to find the maximum emission.

Remark:

1. The mark "v " means that this configuration is chosen for testing
2. The mark "- " means that this bandwidth is not supported.
3. The device is investigated from 30MHz to 10 times of fundamental signal for radiated

ITEMS	Band	Bandwidth (MHz)						Modulation		RB #			Test Channel		
		1.4	3	5	10	15	20	QPSK	16QAM	1	Half	Full	L	M	H
Max. Output Power	2	v	v	v	v	v	v	v	v	v	v	v	v	v	v
	4	v	v	v	v	v	v	v	v	v	v	v	v	v	v
	7	-	-	v	v	v	v	v	v	v	v	v	v	v	v
	17	-	-	v	v	-	-	v	v	v	v	v	v	v	v
Peak&Avera Ratio	2	-	-	-	-	-	v	v	v		v	v	v	v	
	4	-	-	-	-	-									
	7	-	-			-	-								
	17	-	-			-	-								
26dB&99% Bandwidth	2	v	v	v	v	v	v	v	v			v	v	v	v
	4	v	v	v	v	v	v	v	v			v	v	v	v
	7	-	-	v	v	v	v	v	v			v	v	v	v
	17	-	-	v	v	-	-	v	v			v	v	v	v
Conducted Band Edge	2	v	v	v	v	v	v	v	v	v		v	v	v	v
	4	v	v	v	v	v	v	v	v	v		v	v	v	v
	7	-	-	v	v	v	v	v	v	v		v	v	v	v
	17	-	-	v	v	-	-	v	v	v		v	v	v	v

ITEMS	Band	Bandwidth (MHz)						Modulation		RB #			Test Channel		
		1.4	3	5	10	15	20	QPSK	16QAM	1	Half	Full	L	M	H
Conducted Spurious Emission	2	v	v	v	v	v	v	v	v	v			v	v	v
	4	v	v	v	v	v	v	v	v	v			v	v	v
	7	-	-	v	v	v	v	v	v	v			v	v	v
	17	-	-	v	v	-	-	v	v	v			v	v	v
Frequency Stability	2	-	-		v		v	v				v		v	
	4				v		v	v				v		v	
	7	-	-		v		v	v				v		v	
	17	-	-	v	v	-	-	v				v		v	
E.R.P.& E.I.R.P.	2	v	v	v	v	v	v	v	v	v			v	v	v
	4	v	v	v	v	v	v	v	v	v			v	v	v
	7	-	-	v	v	v	v	v	v	v			v	v	v
	17	-	-	v	v	-	-	v	v	v			v	v	v
Radiated Spurious Emission	2	v	v	v	v	v	v	v		v			v	v	v
	4	v	v	v	v	v	v	v		v			v	v	v
	7	-	-	v	v	v	v	v		v			v	v	v
	17	-	-	v	v	-	-	v		v			v	v	v

2.1.5 RELATED SUBMITTAL(S) / GRANT (S)

This submittal(s) (test report) is intended for filing to comply with the 47 CFR Part 22H, 24E, 27

2.1.6 SPECIAL ACCESSORIES

The battery and the charger, earphone supplied by the applicant were used as accessories and being tested with eut intended for fcc grant together.

2.1.7 EUT CONFIGURATION

The EUT configuration for testing is installed on RF field strength measurement to meet the Commission's requirement and operating in a manner which intends to maximize its emission characteristics in a continuous normal application.

2.1.8 EUT EXERCISE

The Transmitter was operated in the maximum output power mode through Communication Tester. The TX frequency was fixed which was for the purpose of the measurements.

2.1.9 CONFIGURATION OF EUT SYSTEM

The EUT configuration for testing is installed on RF field strength measurement to meet the Commission's requirement and operating in a manner which intends to maximize its emission characteristics in a continuous normal application.



Table 2-1 Equipment Used in EUT System

Item	Equipment	Model No.	Serial No.	Note
E-1	Mobile phone	ELITE 5.5 IRIS	N/A	EUT

Note:

- (1) The support equipment was authorized by Declaration of Confirmation.
- (2) For detachable type I/O cable should be specified the length in cm in 『Length』 column.

2.1.10 MEASUREMENT INSTRUMENTS

The radiated emission testing was performed according to the procedures of ansi ANSI / TIA 603-D-2010 and FCC CFR 47 rules of 2.1046, 2.1047, 2.1049, 2.1051, 2.1053, 2.1055, 2.1057.

Kind of Equipment	Manufacturer	Type No.	Serial No.	Last Calibration	Calibrated Until
Spectrum Analyzer	Agilent	E4407B	MY50140340	2016.10.23	2017.10.22
Signal Analyzer	Agilent	N9020A	MY49100060	2016.10.23	2017.10.22
Test Receiver	R&S	ESCI	101427	2016.10.23	2017.10.22
Communication Tester	Agilent	8960	MY48360751	2016.10.23	2017.10.22
Wireless Communications Test Set	R&S	CMW 500	133884	2016.10.23	2017.10.22
Test Receiver	R&S	ESCI	102086	2016.10.23	2017.10.22
Bilog Antenna	TESEQ	CBL6111D	34678	2014.11.24	2017.11.23
Bilog Antenna (Calibration antenna)	TESEQ	CBL6111D	34678	2014.11.24	2017.11.23
Horn Antenna	Schwarzbeck	BBHA 9120D	9120D-1343	2015.03.05	2018.03.04
Horn Antenna (Calibration antenna)	Schwarzbeck	BBHA 9120D	9120D-1343	2015.03.05	2018.03.04
MXA SIGNAL Analyzer	Agilent	N9020A	MY49100060	2016.10.23	2017.10.22
Double Ridge Horn Antenna	COM-POWER CORPORATION	AH-840	AHA-840	2016.03.06	2017.03.05
Low frequency cable	N/A	R01	N/A	NCR	NCR
High frequency cable	SCHWARZBECK	AK9515H	SN-96286/96287	NCR	NCR
Vector signal generator	Agilent	E8257D-521	MY45141029	2016.10.23	2017.10.22
Power amplifier	DESAY	ZHL-42W	9638	2016.10.23	2017.10.22
Band Reject filter(1920-1980MHz)	COM-MW	ZBSF-1920-1980	0092	2016.10.23	2017.10.22
Band Reject filter(880-915MHz)	COM-MW	ZBSF-C897.5-35	707	2016.10.23	2017.10.22
Band Reject filter(1710-1785MHz)	COM-MW	ZBSF-C1747.5-75	708	2016.10.23	2017.10.22
Band Reject filter(1850-1910MHz)	COM-MW	ZBSF-C1880-60	709	2016.10.23	2017.10.22
Band Reject filter(2500-2570MHz)	COM-MW	ZBSF-C2535-70	710	2016.10.23	2017.10.22
Highpass Filter	WHKX7.0/18G-8SS	Wainwright	18	2016.10.23	2017.10.22

2. 1.11 MEASUREMENT RESULTS EXPLANATION EXAMPLE

For all conducted test items:

The offset level is set in the spectrum analyzer to compensate the RF cable loss and attenuator factor between EUT conducted output port and spectrum analyzer. With the offset compensation, the spectrum analyzer reading level is exactly the EUT RF output level.

The spectrum analyzer offset is derived from RF cable loss and attenuator factor.

Offset = RF Cable Loss + Attenuator Factor.

3. CONDUCTED OUTPUT POWER

3.1 DESCRIPTION OF THE CONDUCTED OUTPUT POWER MEASUREMENT

3.1.1 MEASUREMENT METHOD

A System Simulator Was Used To Establish Communication With The EUT. Its Parameters Were Set To Force The EUT Transmitting At Maximum Output Power. The Measured Power In The Radio Frequency On The Transmitter Output Terminals Shall Be Reported. configuration follows KDB 971168 D01.

3.1.2 TEST SETUP

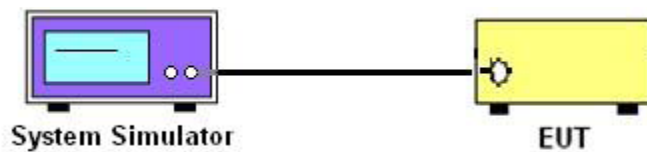

3.1.3 TEST PROCEDURES

1. The Transmitter Output Port Was Connected To The System Simulator.
2. Set EUT at maximum power through the system simulator.
3. Select lowest, middle, and highest channels for each band and different modulation.
4. Measure and record the power level from the system simulator.

3.1.4 TEST RESULTS

LTE BAND 2

LTE Band 2 Maximum Average Power [dBm]						
BW [MHz]	RB Size	RB Offset	Mod	Lowest	Middle	Highest
1.4	1	0	QPSK	23.59	23.56	23.52
1.4	1	2		23.36	23.27	23.26
1.4	1	5		23.10	23.06	23.02
1.4	3	0		22.87	22.85	22.72
1.4	3	1		22.62	22.65	22.50
1.4	3	2		22.37	22.35	22.29
1.4	6	0		22.10	22.06	22.03
1.4	1	0	16-QAM	23.33	23.31	23.29
1.4	1	2		23.05	23.05	23.00
1.4	1	5		22.82	22.83	22.70
1.4	3	0		22.55	22.59	22.48
1.4	3	1		22.34	22.35	22.26
1.4	3	2		22.11	22.06	22.05
1.4	6	0		21.89	21.80	21.78
3	1	0	QPSK	23.58	23.55	23.51
3	1	7		23.31	23.33	23.27
3	1	14		23.03	23.04	22.97
3	8	0		22.77	22.75	22.74
3	8	4		22.55	22.47	22.51
3	8	7		22.28	22.22	22.25
3	15	0		21.98	21.98	22.05
3	1	0	16-QAM	23.32	23.27	23.22
3	1	7		23.05	23.06	23.01
3	1	14		22.81	22.78	22.75
3	8	0		22.59	22.54	22.48
3	8	4		22.35	22.27	22.23
3	8	7		22.14	22.03	21.96
3	15	0		21.91	21.80	21.68

LTE BAND 2

LTE Band 2 Maximum Average Power [dBm]						
BW [MHz]	RB Size	RB Offset	Mod	Lowest	Middle	Highest
5	1	0	QPSK	23.56	23.54	23.51
5	1	12		23.32	23.32	23.24
5	1	24		23.08	23.06	22.97
5	12	0		22.82	22.78	22.72
5	12	6		22.58	22.51	22.51
5	12	11		22.37	22.25	22.24
5	25	0		22.12	21.95	21.98
5	1	0	16-QAM	23.29	23.32	23.26
5	1	12		23.06	23.04	22.97
5	1	24		22.84	22.8	22.72
5	12	0		22.58	22.59	22.49
5	12	6		22.29	22.3	22.2
5	12	11		22.06	22.07	21.98
5	25	0		21.76	21.84	21.7
10	1	0	QPSK	23.53	23.52	23.49
10	1	24		23.25	23.3	23.25
10	1	49		22.96	23.08	23.03
10	25	0		22.69	22.88	22.79
10	25	12		22.45	22.58	22.54
10	25	24		22.2	22.32	22.26
10	50	0		21.92	22.04	21.97
10	1	0	16-QAM	23.25	23.31	23.29
10	1	24		23.02	23.02	23.02
10	1	49		22.8	22.81	22.82
10	25	0		22.53	22.61	22.58
10	25	12		22.32	22.34	22.34
10	25	24		22.09	22.12	22.05
10	50	0		21.84	21.92	21.77

LTE BAND 2

LTE Band 2 Maximum Average Power [dBm]						
BW [MHz]	RB Size	RB Offset	Mod	Lowest	Middle	Highest
15	1	0	QPSK	23.57	23.53	23.52
15	1	37		23.31	23.25	23.27
15	1	74		23.10	23.04	23.01
15	36	0		22.89	22.80	22.75
15	36	18		22.60	22.50	22.55
15	36	39		22.35	22.26	22.32
15	75	0		22.13	22.04	22.09
15	1	0	16-QAM	23.34	23.30	23.30
15	1	38		23.12	23.02	23.06
15	1	75		22.83	22.79	22.83
15	36	0		22.57	22.56	22.58
15	36	18		22.36	22.32	22.30
15	36	39		22.13	22.11	22.09
15	75	0		21.90	21.83	21.89
20	1	0	QPSK	23.52	23.51	23.48
20	1	49		23.32	23.26	23.19
20	1	99		23.09	22.97	22.89
20	50	0		22.85	22.73	22.63
20	50	24		22.58	22.43	22.36
20	50	49		22.30	22.2	22.14
20	100	0		22.02	21.96	21.89
20	1	0	16-QAM	23.24	23.23	23.25
20	1	49		23.00	22.95	23.04
20	1	99		22.77	22.72	22.77
20	50	0		22.47	22.46	22.50
20	50	24		22.22	22.21	22.23
20	50	49		22.00	21.95	22.00
20	100	0		21.79	21.71	21.76

LTE BAND 4

LTE Band 4 Maximum Average Power [dBm]						
BW [MHz]	RB Size	RB Offset	Mod	Lowest	Middle	Highest
1.4	1	0	QPSK	24.68	24.65	24.63
1.4	1	2		24.44	24.36	24.34
1.4	1	5		24.17	24.16	24.06
1.4	3	0		23.96	23.91	23.85
1.4	3	1		23.71	23.65	23.63
1.4	3	2		23.42	23.43	23.43
1.4	6	0		23.14	23.16	23.20
1.4	1	0	16-QAM	24.40	24.35	24.40
1.4	1	2		24.15	24.08	24.11
1.4	1	5		23.89	23.81	23.81
1.4	3	0		23.66	23.54	23.59
1.4	3	1		23.40	23.31	23.30
1.4	3	2		23.16	23.02	23.05
1.4	6	0		22.89	22.79	22.80
3	1	0	QPSK	24.67	24.63	24.62
3	1	7		24.47	24.39	24.38
3	1	14		24.19	24.16	24.17
3	8	0		23.99	23.93	23.96
3	8	4		23.72	23.71	23.75
3	8	7		23.51	23.43	23.52
3	15	0		23.29	23.17	23.29
3	1	0	16-QAM	24.45	24.34	24.40
3	1	7		24.23	24.10	24.13
3	1	14		24.02	23.89	23.91
3	8	0		23.80	23.68	23.64
3	8	4		23.58	23.41	23.41
3	8	7		23.33	23.16	23.11
3	15	0		23.08	22.89	22.84

LTE BAND 4

LTE Band 4 Maximum Average Power [dBm]						
BW [MHz]	RB Size	RB Offset	Mod	Lowest	Middle	Highest
5	1	0	QPSK	24.66	24.62	24.62
5	1	12		24.38	24.39	24.4
5	1	24		24.11	24.16	24.12
5	12	0		23.85	23.86	23.89
5	12	6		23.57	23.61	23.59
5	12	11		23.35	23.35	23.37
5	25	0		23.07	23.06	23.13
5	1	0	16-QAM	24.46	24.34	24.32
5	1	12		24.22	24.12	24.03
5	1	24		23.94	23.85	23.77
5	12	0		23.68	23.59	23.56
5	12	6		23.39	23.29	23.29
5	12	11		23.19	23.04	23.09
5	25	0		22.91	22.83	22.79
10	1	0	QPSK	24.65	24.61	24.61
10	1	24		24.42	24.37	24.40
10	1	49		24.13	24.09	24.14
10	25	0		23.90	23.82	23.88
10	25	12		23.66	23.59	23.67
10	25	24		23.42	23.33	23.41
10	50	0		23.20	23.08	23.15
10	1	0	16-QAM	24.42	24.33	24.34
10	1	24		24.18	24.11	24.05
10	1	49		23.95	23.88	23.80
10	25	0		23.68	23.64	23.51
10	25	12		23.47	23.34	23.23
10	25	24		23.22	23.06	22.99
10	50	0		22.96	22.78	22.73

LTE BAND 4

LTE Band 4 Maximum Average Power [dBm]						
BW [MHz]	RB Size	RB Offset	Mod	Lowest	Middle	Highest
15	1	0	QPSK	24.65	24.61	24.61
15	1	37		24.36	24.38	24.37
15	1	74		24.07	24.13	24.08
15	36	0		23.83	23.91	23.81
15	36	18		23.55	23.68	23.57
15	36	39		23.29	23.43	23.36
15	75	0		23.02	23.14	23.15
15	1	0	16-QAM	24.45	24.33	24.32
15	1	38		24.21	24.13	24.11
15	1	75		23.93	23.86	23.84
15	36	0		23.70	23.59	23.59
15	36	18		23.47	23.35	23.38
15	36	39		23.26	23.11	23.10
15	75	0		23.03	22.9	22.81
20	1	0	QPSK	24.61	24.58	24.59
20	1	49		24.33	24.33	24.34
20	1	99		24.11	24.11	24.09
20	50	0		23.87	23.83	23.8
20	50	24		23.60	23.62	23.51
20	50	49		23.32	23.33	23.24
20	100	0		23.10	23.05	22.97
20	1	0	16-QAM	24.41	24.37	24.37
20	1	49		24.17	24.16	24.11
20	1	99		23.94	23.91	23.85
20	50	0		23.66	23.64	23.57
20	50	24		23.38	23.40	23.31
20	50	49		23.18	23.19	23.07
20	100	0		22.94	22.96	22.84

LTE BAND 7

LTE Band 7 Maximum Average Power [dBm]						
BW [MHz]	RB Size	RB Offset	Mod	Lowest	Middle	Highest
5	1	0	QPSK	24.53	24.52	24.56
5	1	12		24.3	24.27	24.29
5	1	24		24.07	24.04	24.03
5	12	0		23.8	23.75	23.74
5	12	6		23.51	23.52	23.51
5	12	11		23.27	23.31	23.26
5	25	0		23.07	23.05	23
5	1	0	16-QAM	24.26	24.24	24.29
5	1	12		24.01	23.94	24.09
5	1	24		23.72	23.66	23.82
5	12	0		23.5	23.42	23.53
5	12	6		23.27	23.19	23.25
5	12	11		23.07	22.9	23.04
5	25	0		22.82	22.66	22.75
10	1	0	QPSK	24.51	24.51	24.55
10	1	24		24.22	24.22	24.32
10	1	49		23.99	23.94	24.07
10	25	0		23.75	23.73	23.84
10	25	12		23.49	23.51	23.56
10	25	24		23.24	23.26	23.32
10	50	0		23.04	23.03	23.07
10	1	0	16-QAM	24.28	24.25	24.33
10	1	24		24.05	23.98	24.05
10	1	49		23.83	23.68	23.81
10	25	0		23.54	23.45	23.61
10	25	12		23.24	23.16	23.37
10	25	24		23.02	22.87	23.07
10	50	0		22.75	22.66	22.85

LTE BAND 7

LTE Band 7 Maximum Average Power [dBm]						
BW [MHz]	RB Size	RB Offset	Mod	Lowest	Middle	Highest
15	1	0	QPSK	24.51	24.52	24.53
15	1	37		24.31	24.26	24.30
15	1	74		24.08	23.99	24.05
15	36	0		23.87	23.69	23.76
15	36	18		23.57	23.42	23.49
15	36	39		23.28	23.13	23.29
15	75	0		23.02	22.86	23.05
15	1	0	16-QAM	24.28	24.23	24.28
15	1	38		24.00	23.94	24.08
15	1	75		23.77	23.64	23.79
15	36	0		23.48	23.40	23.52
15	36	18		23.28	23.18	23.27
15	36	39		22.99	22.96	22.97
15	75	0		22.69	22.74	22.68
20	1	0	QPSK	24.51	24.48	24.51
20	1	49		24.27	24.21	24.24
20	1	99		24.00	23.94	23.98
20	50	0		23.70	23.70	23.77
20	50	24		23.44	23.50	23.52
20	50	49		23.20	23.23	23.23
20	100	0		22.93	22.94	22.99
20	1	0	16-QAM	24.22	24.25	24.22
20	1	49		24.01	24.04	23.97
20	1	99		23.75	23.81	23.73
20	50	0		23.46	23.58	23.48
20	50	24		23.21	23.37	23.24
20	50	49		23.01	23.15	23.00
20	100	0		22.76	22.88	22.72

LTE BAND 17

LTE Band 4 Maximum Average Power [dBm]						
BW [MHz]	RB Size	RB Offset	Mod	Lowest	Middle	Highest
5	1	0	QPSK	25.18	25.16	25.13
5	1	12		24.94	24.88	24.86
5	1	24		24.74	24.65	24.64
5	12	0		24.53	24.36	24.37
5	12	6		24.25	24.11	24.13
5	12	11		23.96	23.87	23.92
5	25	0		23.67	23.62	23.69
5	1	0		16-QAM	24.91	24.86
5	1	12	24.65		24.66	24.66
5	1	24	24.36		24.44	24.45
5	12	0	24.06		24.17	24.22
5	12	6	23.83		23.94	24.02
5	12	11	23.58		23.71	23.78
5	25	0	23.37		23.50	23.55
10	1	0	QPSK		25.16	25.14
10	1	24		24.89	24.88	24.91
10	1	49		24.65	24.68	24.61
10	25	0		24.36	24.42	24.31
10	25	12		24.11	24.16	24.07
10	25	24		23.89	23.87	23.82
10	50	0		23.61	23.66	23.54
10	1	0		16-QAM	24.96	24.89
10	1	24	24.69		24.63	24.67
10	1	49	24.43		24.36	24.41
10	25	0	24.16		24.15	24.13
10	25	12	23.9		23.91	23.89
10	25	24	23.69		23.67	23.62
10	50	0	23.40		23.40	23.33

4.1.4 TEST RESULTS

LTE BAND 2

LTE Band 2 PAR [dBm]											
BW [MHz]	RB Size	Modulation	Lowest			Middle			Highest		
			PEAK	AVG	P-A	PEAK	AVG	P-A	PEAK	AVG	P-A
20	1	QPSK	25.63	23.52	2.11	25.49	23.51	1.98	25.5	23.48	2.02
20	100		24.53	22.02	2.51	23.97	21.96	2.01	23.98	21.89	2.09
20	1	16-QAM	25.34	23.24	2.1	25.25	23.23	2.02	25.28	23.25	2.03
20	100		23.81	21.79	2.02	23.72	21.71	2.01	23.82	21.76	2.06
Limit			≤13dBm								

5. RADIATED POWER AND EFFECTIVE ISOTROPIC RADIATED POWER

5.1 DESCRIPTION OF THE ERP/EIRP MEASUREMENT

5.1.1 MEASUREMENT METHOD

Effective radiated power output measurements by substitution method according to ANSI / TIA / EIA-603-D, and the spectrum analyzer configuration follows KDB 971168 D01 Power Meas. License Digital Systems. Mobile and portable (hand-held) stations operating are limited to average ERP, Equivalent isotropic radiated power output measurements by substitution method according to ANSI /TIA / EIA-603-D, and the spectrum analyzer configuration follows KDB 971168 D01 Power Meas ,Mobile and portable (hand-held) stations operating are limited to average EIRP.

5.1.2 TEST SETUP

The procedure of radiated spurious emissions is as follows:

a) Pre-calibration With pre-calibration method, the Radiated Spurious Emissions(RSE) is calculated as, $RSE = R_x(\text{dBuV}) + CL(\text{dB}) + SA(\text{dB}) + \text{Gain}(\text{dBi}) - 107(\text{dBuV to dBm})$ The SA is calibrated using following setup.

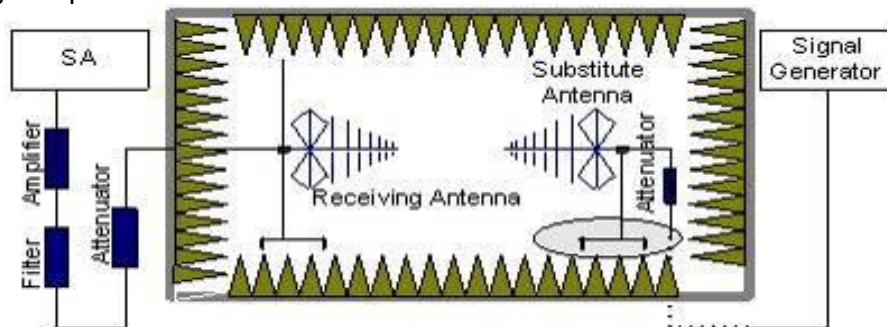

b) EUT was placed on a 1.5 meter high non-conductive stand at a 3 meter test distance from the receive antenna. A receiving antenna was placed on the antenna mast 3 meters from the test item for emission measurements. The height of receiving antenna is 0.8m. The test setup refers to figure below. Detected emissions were maximized at each frequency by rotating the test item and adjusting the receiving antenna polarization. The radiated emission measurements of all non-harmonic and harmonics of the transmit frequency through the 10th harmonic were measured with peak detector and 1MHz bandwidth.

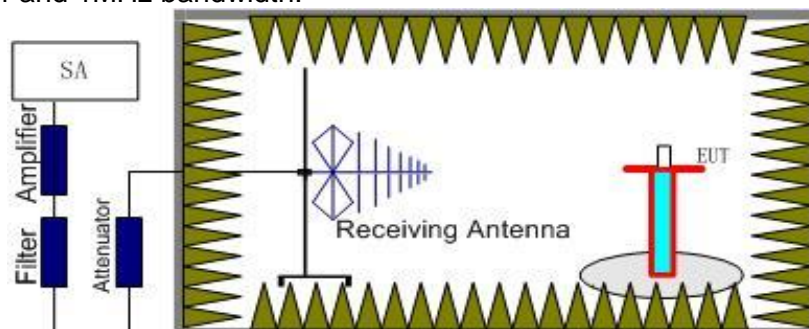

Radiated emissions measurements were made only at the upper, middle, and lower carrier frequencies It was decided that measurements at these three carrier frequencies would be sufficient to demonstrate compliance with emissions limits because it was seen that all the significant spurs occur well outside the band and no radiation was seen from a carrier in one block of any band into any of the other blocks.

The substitution method is used. Substitution values at each frequency are measured before and saved to the test software. A "reference path loss" is established and the ARpl is the attenuation of "reference path loss", and including the gain of receive antenna, the gain of the preamplifier, the cable loss and the air loss. The measurement results are obtained as described below: $\text{Power} = \text{PMea} + \text{ARpl}$

5.1.3 TEST PROCEDURES

1. The testing follows FCC KDB 971168 v02r02 Section 5.6. and ANSI / TIA-603-D-2010 Section 2.2.17.
2. The EUT was placed on a non-conductive rotating platform 1.5 meters high in a semi-anechoic chamber. The radiated emission at the fundamental frequency was measured at 3 m with a test antenna and a spectrum analyzer with Peak detector.
3. During the measurement, the system simulator parameters were set to force the EUT transmitting at maximum output power. The maximum emission was recorded from analyzer power level (LVL) from the 360 degrees rotation of the turntable and the test antenna raised and lowered over a range from 1 to 4 meters in both horizontally and vertically polarized orientations.
4. Effective Isotropic Radiated Power (EIRP) was measured by substitution method according to TIA/EIA-603-D. The EUT was replaced by dipole antenna (substitution antenna) at same location, and then a known power from S.G. was applied into the dipole antenna through a Tx cable, and then recorded the maximum Analyzer reading through raised and lowered the test antenna. The correction factor (in dB) = S.G. - Tx Cable loss + Substitution antenna gain - Analyzer reading. Then the EUT's EIRP was calculated with the correction factor, $EIRP = LVL + \text{Correction factor}$ and $ERP = EIRP - 2.15$.
5. RB Set greater than bandwidth, Vb Set spectrum analyzer Maximum support.

5.1.4 TEST RESULTS

LTE Band 2

Radiated Power (EIRP) for LTE Band 2 / 1.4M									
Modulation	RB		Channel	Result					Conclusion
	Size	Offset		S G.Level (dBm)	Cable loss	Gain (dBi)	PMeas E.R.P(dBm)	Polarization	
								Of Max. ERP	
QPSK	1	0	Lowest	-8.03	2.37	10.40	-8.03	Horizontal	Pass
	1	0	Middle	-8.03	2.39	10.42	-8.03	Vertical	Pass
	1	0	Highest	-8.04	2.40	10.44	-8.04	Horizontal	Pass
	1	0	Lowest	-8.03	2.37	10.40	-8.03	Vertical	Pass
	1	0	Middle	-8.03	2.39	10.42	-8.03	Horizontal	Pass
	1	0	Highest	-8.04	2.40	10.44	-8.04	Vertical	Pass
16QAM	1	0	Lowest	-8.03	2.37	10.40	-8.03	Horizontal	Pass
	1	0	Middle	-8.03	2.39	10.42	-8.03	Vertical	Pass
	1	0	Highest	-8.04	2.40	10.44	-8.04	Horizontal	Pass
	1	0	Lowest	-8.03	2.37	10.40	-8.03	Vertical	Pass
	1	0	Middle	-8.03	2.39	10.42	-8.03	Horizontal	Pass
	1	0	Highest	-8.04	2.40	10.44	-8.04	Vertical	Pass
Limit	EIRP<2W=33dBm								

Radiated Power (EIRP) for LTE Band 2 / 3M									
Modulation	RB		Channel	Result					Conclusion
	Size	Offset		S G.Level (dBm)	Cable loss	Gain (dBi)	PMeas E.R.P.(dBm)	Polarization	
								Of Max. ERP	
QPSK	1	0	Lowest	-8.03	2.37	10.40	-8.03	Horizontal	Pass
	1	0	Middle	-8.03	2.39	10.42	-8.03	Vertical	Pass
	1	0	Highest	-8.04	2.40	10.44	-8.04	Horizontal	Pass
	1	0	Lowest	-8.03	2.37	10.40	-8.03	Vertical	Pass
	1	0	Middle	-8.03	2.39	10.42	-8.03	Horizontal	Pass
	1	0	Highest	-8.04	2.40	10.44	-8.04	Vertical	Pass
16QAM	1	0	Lowest	-8.03	2.37	10.40	-8.03	Horizontal	Pass
	1	0	Middle	-8.03	2.39	10.42	-8.03	Vertical	Pass
	1	0	Highest	-8.04	2.40	10.44	-8.04	Horizontal	Pass
	1	0	Lowest	-8.03	2.37	10.40	-8.03	Vertical	Pass
	1	0	Middle	-8.03	2.39	10.42	-8.03	Horizontal	Pass
	1	0	Highest	-8.04	2.40	10.44	-8.04	Vertical	Pass
Limit	EIRP<2W=33dBm								

Radiated Power (EIRP) for LTE Band 2 / 5M									
Modulation	RB		Channel	Result					Conclusion
	Size	Offset		S G.Level (dBm)	Cable loss	Gain (dBi)	PMeas E.R.P.(dBm)	Polarization	
								Of Max. ERP	
QPSK	1	0	Lowest	-8.03	2.37	10.40	-8.03	Horizontal	Pass
	1	0	Middle	-8.03	2.39	10.42	-8.03	Vertical	Pass
	1	0	Highest	-8.04	2.40	10.44	-8.04	Horizontal	Pass
	1	0	Lowest	-8.03	2.37	10.40	-8.03	Vertical	Pass
	1	0	Middle	-8.03	2.39	10.42	-8.03	Horizontal	Pass
	1	0	Highest	-8.04	2.40	10.44	-8.04	Vertical	Pass
16QAM	1	0	Lowest	-8.03	2.37	10.40	-8.03	Horizontal	Pass
	1	0	Middle	-8.03	2.39	10.42	-8.03	Vertical	Pass
	1	0	Highest	-8.04	2.40	10.44	-8.04	Horizontal	Pass
	1	0	Lowest	-8.03	2.37	10.40	-8.03	Vertical	Pass
	1	0	Middle	-8.03	2.39	10.42	-8.03	Horizontal	Pass
	1	0	Highest	-8.04	2.40	10.44	-8.04	Vertical	Pass
Limit	EIRP<2W=33dBm								

Radiated Power (EIRP) for LTE Band 2 / 10M									
Modulation	RB		Channel	Result					Conclusion
	Size	Offset		S G.Level (dBm)	Cable loss	Gain (dBi)	PMeas E.R.P(dBm)	Polarization	
								Of Max. ERP	
QPSK	1	0	Lowest	-8.03	2.37	10.40	-8.03	Horizontal	Pass
	1	0	Middle	-8.03	2.39	10.42	-8.03	Vertical	Pass
	1	0	Highest	-8.04	2.40	10.44	-8.04	Horizontal	Pass
	1	0	Lowest	-8.03	2.37	10.40	-8.03	Vertical	Pass
	1	0	Middle	-8.03	2.39	10.42	-8.03	Horizontal	Pass
	1	0	Highest	-8.04	2.40	10.44	-8.04	Vertical	Pass
16QAM	1	0	Lowest	-8.03	2.37	10.40	-8.03	Horizontal	Pass
	1	0	Middle	-8.03	2.39	10.42	-8.03	Vertical	Pass
	1	0	Highest	-8.04	2.40	10.44	-8.04	Horizontal	Pass
	1	0	Lowest	-8.03	2.37	10.40	-8.03	Vertical	Pass
	1	0	Middle	-8.03	2.39	10.42	-8.03	Horizontal	Pass
	1	0	Highest	-8.04	2.40	10.44	-8.04	Vertical	Pass
Limit	EIRP<2W=33dBm								

Radiated Power (EIRP) for LTE Band 2 / 15M									
Modulation	RB		Channel	Result					Conclusion
	Size	Offset		S G.Level (dBm)	Cable loss	Gain (dBi)	PMeas E.R.P(dBm)	Polarization	
								Of Max. ERP	
QPSK	1	0	Lowest	-8.03	2.37	10.40	-8.03	Horizontal	Pass
	1	0	Middle	-8.03	2.39	10.42	-8.03	Vertical	Pass
	1	0	Highest	-8.04	2.40	10.44	-8.04	Horizontal	Pass
	1	0	Lowest	-8.03	2.37	10.40	-8.03	Vertical	Pass
	1	0	Middle	-8.03	2.39	10.42	-8.03	Horizontal	Pass
	1	0	Highest	-8.04	2.40	10.44	-8.04	Vertical	Pass
16QAM	1	0	Lowest	-8.03	2.37	10.40	-8.03	Horizontal	Pass
	1	0	Middle	-8.03	2.39	10.42	-8.03	Vertical	Pass
	1	0	Highest	-8.04	2.40	10.44	-8.04	Horizontal	Pass
	1	0	Lowest	-8.03	2.37	10.40	-8.03	Vertical	Pass
	1	0	Middle	-8.03	2.39	10.42	-8.03	Horizontal	Pass
	1	0	Highest	-8.04	2.40	10.44	-8.04	Vertical	Pass
Limit	EIRP<2W=33dBm								

Radiated Power (EIRP) for LTE Band 2 / 20M									
Modulation	RB		Channel	Result					Conclusion
	Size	Offset		S G.Level (dBm)	Cable loss	Gain (dBi)	PMeas E.R.P.(dBm)	Polarization	
								Of Max. ERP	
QPSK	1	0	Lowest	12.93	2.37	10.40	20.96	Horizontal	Pass
	1	0	Middle	14.86	2.39	10.42	22.89	Vertical	Pass
	1	0	Highest	13.11	2.40	10.44	21.15	Horizontal	Pass
	1	0	Lowest	14.83	2.37	10.40	22.86	Vertical	Pass
	1	0	Middle	12.9	2.39	10.42	20.93	Horizontal	Pass
	1	0	Highest	14.81	2.40	10.44	22.85	Vertical	Pass
16QAM	1	0	Lowest	13.06	2.37	10.40	21.09	Horizontal	Pass
	1	0	Middle	14.75	2.39	10.42	22.78	Vertical	Pass
	1	0	Highest	13.06	2.40	10.44	21.10	Horizontal	Pass
	1	0	Lowest	14.8	2.37	10.40	22.83	Vertical	Pass
	1	0	Middle	13.04	2.39	10.42	21.07	Horizontal	Pass
	1	0	Highest	14.55	2.40	10.44	22.59	Vertical	Pass
Limit	EIRP<2W=33dBm								

LTE Band 4

Radiated Power (EIRP) for LTE Band 4 / 1.4M									
Modulation	RB		Channel	Result					Conclusion
	Size	Offset		S G.Level (dBm)	Cable loss	Gain (dBi)	PMeas E.R.P(dBm)	Polarization	
								Of Max. ERP	
QPSK	1	0	Lowest	14.56	2.35	10.13	22.34	Horizontal	Pass
	1	0	Middle	16.32	2.36	10.16	24.12	Vertical	Pass
	1	0	Highest	14.46	2.37	10.22	22.31	Horizontal	Pass
	1	0	Lowest	16.3	2.35	10.13	24.08	Vertical	Pass
	1	0	Middle	14.3	2.36	10.16	22.10	Horizontal	Pass
	1	0	Highest	16.22	2.37	10.22	24.07	Vertical	Pass
16QAM	1	0	Lowest	14.36	2.35	10.13	22.14	Horizontal	Pass
	1	0	Middle	16.26	2.36	10.16	24.06	Vertical	Pass
	1	0	Highest	14.45	2.37	10.22	22.30	Horizontal	Pass
	1	0	Lowest	16.21	2.35	10.13	23.99	Vertical	Pass
	1	0	Middle	14.49	2.36	10.16	22.29	Horizontal	Pass
	1	0	Highest	16.13	2.37	10.22	23.98	Vertical	Pass
Limit	EIRP<1W=30dBm								

Radiated Power (EIRP) for LTE Band 4 / 3M									
Modulation	RB		Channel	Result					Conclusion
	Size	Offset		S G.Level (dBm)	Cable loss	Gain (dBi)	PMeas E.R.P(dBm)	Polarization	
								Of Max. ERP	
QPSK	1	0	Lowest	14.6	2.35	10.13	22.38	Horizontal	Pass
	1	0	Middle	16.29	2.36	10.16	24.09	Vertical	Pass
	1	0	Highest	14.51	2.37	10.22	22.36	Horizontal	Pass
	1	0	Lowest	16.29	2.35	10.13	24.07	Vertical	Pass
	1	0	Middle	14.45	2.36	10.16	22.25	Horizontal	Pass
	1	0	Highest	16.2	2.37	10.22	24.05	Vertical	Pass
16QAM	1	0	Lowest	14.47	2.35	10.13	22.25	Horizontal	Pass
	1	0	Middle	16.19	2.36	10.16	23.99	Vertical	Pass
	1	0	Highest	14.42	2.37	10.22	22.27	Horizontal	Pass
	1	0	Lowest	16.22	2.35	10.13	24.00	Vertical	Pass
	1	0	Middle	14.37	2.36	10.16	22.17	Horizontal	Pass
	1	0	Highest	16	2.37	10.22	23.85	Vertical	Pass
Limit	EIRP<1W=30dBm								

Radiated Power (EIRP) for LTE Band 4 / 5M									
Modulation	RB		Channel	Result					Conclusion
	Size	Offset		S G.Level (dBm)	Cable loss	Gain (dBi)	PMeas E.R.P(dBm)	Polarization	
								Of Max. ERP	
QPSK	1	0	Lowest	14.58	2.35	10.13	22.36	Horizontal	Pass
	1	0	Middle	16.26	2.36	10.16	24.06	Vertical	Pass
	1	0	Highest	14.37	2.37	10.22	22.22	Horizontal	Pass
	1	0	Lowest	16.27	2.35	10.13	24.05	Vertical	Pass
	1	0	Middle	14.5	2.36	10.16	22.30	Horizontal	Pass
	1	0	Highest	16.18	2.37	10.22	24.03	Vertical	Pass
16QAM	1	0	Lowest	14.48	2.35	10.13	22.26	Horizontal	Pass
	1	0	Middle	16.16	2.36	10.16	23.96	Vertical	Pass
	1	0	Highest	14.2	2.37	10.22	22.05	Horizontal	Pass
	1	0	Lowest	16	2.35	10.13	23.78	Vertical	Pass
	1	0	Middle	14.29	2.36	10.16	22.09	Horizontal	Pass
	1	0	Highest	15.94	2.37	10.22	23.79	Vertical	Pass
Limit	EIRP<1W=30dBm								

Radiated Power (EIRP) for LTE Band 4 / 10M									
Modulation	RB		Channel	Result					Conclusion
	Size	Offset		S G.Level (dBm)	Cable loss	Gain (dBi)	PMeas E.R.P(dBm)	Polarization	
								Of Max. ERP	
QPSK	1	0	Lowest	14.50	2.35	10.13	22.28	Horizontal	Pass
	1	0	Middle	16.23	2.36	10.16	24.03	Vertical	Pass
	1	0	Highest	14.31	2.37	10.22	22.16	Horizontal	Pass
	1	0	Lowest	16.24	2.35	10.13	24.02	Vertical	Pass
	1	0	Middle	14.40	2.36	10.16	22.20	Horizontal	Pass
	1	0	Highest	16.18	2.37	10.22	24.03	Vertical	Pass
16QAM	1	0	Lowest	14.34	2.35	10.13	22.12	Horizontal	Pass
	1	0	Middle	16.22	2.36	10.16	24.02	Vertical	Pass
	1	0	Highest	14.17	2.37	10.22	22.02	Horizontal	Pass
	1	0	Lowest	16.14	2.35	10.13	23.92	Vertical	Pass
	1	0	Middle	14.32	2.36	10.16	22.12	Horizontal	Pass
	1	0	Highest	16.04	2.37	10.22	23.89	Vertical	Pass
Limit	EIRP<1W=30dBm								

Radiated Power (EIRP) for LTE Band 4 / 15M

Modulation	RB		Channel	Result					Conclusion
	Size	Offset		S G.Level (dBm)	Cable loss	Gain (dBi)	PMeas E.R.P(dBm)	Polarization	
								Of Max. ERP	
QPSK	1	0	Lowest	14.56	2.35	10.13	22.34	Horizontal	Pass
	1	0	Middle	16.25	2.36	10.16	24.05	Vertical	Pass
	1	0	Highest	14.31	2.37	10.22	22.16	Horizontal	Pass
	1	0	Lowest	16.25	2.35	10.13	24.03	Vertical	Pass
	1	0	Middle	14.45	2.36	10.16	22.25	Horizontal	Pass
	1	0	Highest	16.17	2.37	10.22	24.02	Vertical	Pass
16QAM	1	0	Lowest	14.37	2.35	10.13	22.15	Horizontal	Pass
	1	0	Middle	16.21	2.36	10.16	24.01	Vertical	Pass
	1	0	Highest	14.4	2.37	10.22	22.25	Horizontal	Pass
	1	0	Lowest	16.09	2.35	10.13	23.87	Vertical	Pass
	1	0	Middle	14.43	2.36	10.16	22.23	Horizontal	Pass
	1	0	Highest	15.89	2.37	10.22	23.74	Vertical	Pass
Limit	EIRP<1W=30dBm								

Radiated Power (EIRP) for LTE Band 4 / 20M									
Modulation	RB		Channel	Result					Conclusion
	Size	Offset		S G.Level (dBm)	Cable loss	Gain (dBi)	PMeas E.R.P(dBm)	Polarization	
								Of Max. ERP	
QPSK	1	0	Lowest	14.53	2.35	10.13	22.31	Horizontal	Pass
	1	0	Middle	16.22	2.36	10.16	24.02	Vertical	Pass
	1	0	Highest	14.34	2.37	10.22	22.19	Horizontal	Pass
	1	0	Lowest	16.23	2.35	10.13	24.01	Vertical	Pass
	1	0	Middle	14.22	2.36	10.16	22.02	Horizontal	Pass
	1	0	Highest	16.16	2.37	10.22	24.01	Vertical	Pass
16QAM	1	0	Lowest	14.5	2.35	10.13	22.28	Horizontal	Pass
	1	0	Middle	16.06	2.36	10.16	23.86	Vertical	Pass
	1	0	Highest	14.31	2.37	10.22	22.16	Horizontal	Pass
	1	0	Lowest	16.16	2.35	10.13	23.94	Vertical	Pass
	1	0	Middle	14.42	2.36	10.16	22.22	Horizontal	Pass
	1	0	Highest	15.87	2.37	10.22	23.72	Vertical	Pass
Limit	EIRP<1W=30dBm								

LTE Band 7

Radiated Power (EIRP) for LTE Band 7 / 5M									
Modulation	RB		Channel	Result					Conclusion

	RB		Channel	S G.Level (dBm)	Cable loss	Gain (dBi)	PMeas E.R.P(dBm)	Polarization	
	Size	Offset						Of Max. ERP	
QPSK	1	0	Lowest	14.15	2.56	10.60	22.19	Horizontal	Pass
	1	0	Middle	16.01	2.67	10.65	23.99	Vertical	Pass
	1	0	Highest	14.09	2.72	10.70	22.07	Horizontal	Pass
	1	0	Lowest	15.94	2.56	10.60	23.98	Vertical	Pass
	1	0	Middle	14.07	2.67	10.65	22.05	Horizontal	Pass
	1	0	Highest	16	2.72	10.70	23.98	Vertical	Pass
16QAM	1	0	Lowest	14.07	2.56	10.60	22.11	Horizontal	Pass
	1	0	Middle	16	2.67	10.65	23.98	Vertical	Pass
	1	0	Highest	14.15	2.72	10.70	22.13	Horizontal	Pass
	1	0	Lowest	15.8	2.56	10.60	23.84	Vertical	Pass
	1	0	Middle	14.12	2.67	10.65	22.10	Horizontal	Pass
	1	0	Highest	15.72	2.72	10.70	23.70	Vertical	Pass
Limit	EIRP<2W=33dBm								

Radiated Power (EIRP) for LTE Band 7 / 10M

Modulation	RB		Channel	Result					Conclusion
	Size	Offset		S G.Level (dBm)	Cable loss	Gain (dBi)	PMeas E.R.P(dBm)	Polarization	
								Of Max. ERP	
QPSK	1	0	Lowest	14.05	2.56	10.60	22.09	Horizontal	Pass
	1	0	Middle	16.00	2.67	10.65	23.98	Vertical	Pass
	1	0	Highest	14.23	2.72	10.70	22.21	Horizontal	Pass
	1	0	Lowest	15.93	2.56	10.60	23.97	Vertical	Pass
	1	0	Middle	14.26	2.67	10.65	22.24	Horizontal	Pass
	1	0	Highest	16.01	2.72	10.70	23.99	Vertical	Pass
16QAM	1	0	Lowest	13.96	2.56	10.60	22.00	Horizontal	Pass
	1	0	Middle	15.75	2.67	10.65	23.73	Vertical	Pass
	1	0	Highest	14.01	2.72	10.70	21.99	Horizontal	Pass
	1	0	Lowest	15.63	2.56	10.60	23.67	Vertical	Pass
	1	0	Middle	14.15	2.67	10.65	22.13	Horizontal	Pass
	1	0	Highest	15.72	2.72	10.70	23.70	Vertical	Pass
Limit	EIRP<2W=33dBm								

Radiated Power (EIRP) for LTE Band 7 / 15M

Modulation	RB	Channel	Result	Conclusion
------------	----	---------	--------	------------

	RB		Channel	S G.Level (dBm)	Cable loss	Gain (dBi)	PMeas E.R.P(dBm)	Polarization	
	Size	Offset						Of Max. ERP	
QPSK	1	0	Lowest	14.15	2.56	10.60	22.19	Horizontal	Pass
	1	0	Middle	15.99	2.67	10.65	23.97	Vertical	Pass
	1	0	Highest	14.08	2.72	10.70	22.06	Horizontal	Pass
	1	0	Lowest	15.91	2.56	10.60	23.95	Vertical	Pass
	1	0	Middle	14.14	2.67	10.65	22.12	Horizontal	Pass
	1	0	Highest	15.98	2.72	10.70	23.96	Vertical	Pass
16QAM	1	0	Lowest	14.04	2.56	10.60	22.08	Horizontal	Pass
	1	0	Middle	15.95	2.67	10.65	23.93	Vertical	Pass
	1	0	Highest	14.22	2.72	10.70	22.20	Horizontal	Pass
	1	0	Lowest	15.85	2.56	10.60	23.89	Vertical	Pass
	1	0	Middle	14.06	2.67	10.65	22.04	Horizontal	Pass
	1	0	Highest	15.92	2.72	10.70	23.90	Vertical	Pass
Limit	EIRP<2W=33dBm								

Radiated Power (EIRP) for LTE Band 7 / 20M									
Modulation	RB		Channel	Result					Conclusion
	Size	Offset		S G.Level (dBm)	Cable loss	Gain (dBi)	PMeas E.R.P(dBm)	Polarization	
								Of Max. ERP	
QPSK	1	0	Lowest	14.03	2.56	10.60	22.07	Horizontal	Pass
	1	0	Middle	15.96	2.67	10.65	23.94	Vertical	Pass
	1	0	Highest	14.02	2.72	10.70	22.00	Horizontal	Pass
	1	0	Lowest	15.91	2.56	10.60	23.95	Vertical	Pass
	1	0	Middle	14.00	2.67	10.65	21.98	Horizontal	Pass
	1	0	Highest	15.95	2.72	10.70	23.93	Vertical	Pass
16QAM	1	0	Lowest	14.01	2.56	10.60	22.05	Horizontal	Pass
	1	0	Middle	15.87	2.67	10.65	23.85	Vertical	Pass
	1	0	Highest	13.99	2.72	10.70	21.97	Horizontal	Pass
	1	0	Lowest	15.71	2.56	10.60	23.75	Vertical	Pass
	1	0	Middle	14.24	2.67	10.65	22.22	Horizontal	Pass
	1	0	Highest	15.91	2.72	10.70	23.89	Vertical	Pass
Limit	EIRP<2W=33dBm								

LTE Band 17

Radiated Power (EIRP) for LTE Band 17 / 5M									
Modulation	RB		Channel	Result					Conclusion
	Size	Offset		S G.Level (dBm)	Cable loss	Gain (dBi)	PMeas E.R.P(dBm)	Polarization	
								Of Max. ERP	
QPSK	1	0	Lowest	17.6	1.21	6.40	22.79	Horizontal	Pass
	1	0	Middle	19.49	1.22	6.40	24.67	Vertical	Pass
	1	0	Highest	17.49	1.23	6.40	22.66	Horizontal	Pass
	1	0	Lowest	19.43	1.21	6.40	24.62	Vertical	Pass
	1	0	Middle	17.68	1.22	6.40	22.86	Horizontal	Pass
	1	0	Highest	19.42	1.23	6.40	24.59	Vertical	Pass
16QAM	1	0	Lowest	17.65	1.21	6.40	22.84	Horizontal	Pass
	1	0	Middle	19.31	1.22	6.40	24.49	Vertical	Pass
	1	0	Highest	17.71	1.23	6.40	22.88	Horizontal	Pass
	1	0	Lowest	19.35	1.21	6.40	24.54	Vertical	Pass
	1	0	Middle	17.53	1.22	6.40	22.71	Horizontal	Pass
	1	0	Highest	19.39	1.23	6.40	24.56	Vertical	Pass
Limit	ERP<3W=34.77dBm								

Radiated Power (EIRP) for LTE Band 17 / 10M									
Modulation	RB		Channel	Result					Conclusion
	Size	Offset		S G.Level (dBm)	Cable loss	Gain (dBi)	PMeas E.R.P(dBm)	Polarization	
								Of Max. ERP	
QPSK	1	0	Lowest	17.55	1.21	6.40	22.74	Horizontal	Pass
	1	0	Middle	19.45	1.22	6.40	24.63	Vertical	Pass
	1	0	Highest	17.63	1.23	6.40	22.80	Horizontal	Pass
	1	0	Lowest	19.42	1.21	6.40	24.61	Vertical	Pass
	1	0	Middle	17.64	1.22	6.40	22.82	Horizontal	Pass
	1	0	Highest	19.41	1.23	6.40	24.58	Vertical	Pass
16QAM	1	0	Lowest	17.74	1.21	6.40	22.93	Horizontal	Pass
	1	0	Middle	19.36	1.22	6.40	24.54	Vertical	Pass
	1	0	Highest	17.49	1.23	6.40	22.66	Horizontal	Pass
	1	0	Lowest	19.12	1.21	6.40	24.31	Vertical	Pass
	1	0	Middle	17.55	1.22	6.40	22.73	Horizontal	Pass
	1	0	Highest	19.23	1.23	6.40	24.40	Vertical	Pass
Limit	ERP<3W=34.77dBm								

6.1.4 MEASUREMENT RESULT

LTE BAND 2

LTE Band 2 Bandwidth [MHz]							
BW [MHz]	Mod	Lowest		Middle		Highest	
		26dB BW	99% BW	26dB BW	99% BW	26dB BW	99% BW
1.4	QPSK	1.272	1.0954	1.265	1.0908	1.257	1.1009
1.4	16-QAM	1.259	1.0922	1.278	1.0967	1.277	1.0928
3	QPSK	2.904	2.6853	2.902	2.6812	2.905	2.6839
3	16-QAM	2.913	2.6798	2.911	2.6798	2.916	2.6777
5	QPSK	5.086	4.5146	5.031	4.5134	5.034	4.5052
5	16-QAM	5.044	4.5101	5.054	4.5055	5.057	4.5088
10	QPSK	9.656	8.9300	9.775	8.9556	9.759	8.9473
10	16-QAM	9.700	8.9526	9.687	8.9460	9.739	8.9445
15	QPSK	14.82	13.464	14.93	13.500	14.94	13.494
15	16-QAM	14.78	13.495	14.81	13.489	14.82	13.493
20	QPSK	19.37	17.919	19.34	17.931	19.47	17.950
20	16-QAM	19.54	17.952	19.43	17.960	19.36	17.929

LTE BAND 4

LTE Band 4 Bandwidth [MHz]							
BW [MHz]	Mod	Lowest		Middle		Highest	
		26dB BW	99% BW	26dB BW	99% BW	26dB BW	99% BW
1.4	QPSK	1.283	1.0914	1.278	1.0966	1.253	1.0973
1.4	16-QAM	1.253	1.0899	1.272	1.0959	1.270	1.0934
3	QPSK	2.906	2.6849	2.899	2.6810	2.907	2.6800
3	16-QAM	2.918	2.6819	2.926	2.6774	2.899	2.6779
5	QPSK	5.074	4.5183	5.022	4.5180	5.024	4.5047
5	16-QAM	5.044	4.5125	5.057	4.5091	5.021	4.5122
10	QPSK	9.695	8.9330	9.763	8.9538	9.707	8.9311
10	16-QAM	9.737	8.9469	9.711	8.9444	9.737	8.9312
15	QPSK	14.71	13.445	14.92	13.518	14.88	13.468
15	16-QAM	14.76	13.492	14.72	13.507	14.80	13.468
20	QPSK	19.32	17.899	19.31	17.949	19.64	17.935
20	16-QAM	19.59	17.939	19.45	17.976	19.44	17.873

LTE BAND 7

LTE Band 7 Bandwidth [MHz]							
BW [MHz]	Mod	Lowest		Middle		Highest	
		26dB BW	99% BW	26dB BW	99% BW	26dB BW	99% BW
5	QPSK	5.084	4.5168	5.047	4.5103	5.042	4.5033
5	16-QAM	5.054*	4.5080	5.036	4.5068	5.065	4.5138
10	QPSK	9.720	8.9438	9.785	8.9547	9.663	8.9356
10	16-QAM	9.738	8.9369	9.661	8.9421	9.666	8.9416
15	QPSK	14.76	13.434	14.87	13.490	14.89	13.488
15	16-QAM	14.78	13.488	14.70	13.490	14.88	13.484
20	QPSK	19.62	17.947	19.33	17.923	19.36	17.914
20	16-QAM	19.42	17.908	19.41	17.954	19.57	17.920

LTE BAND 17

LTE Band XVII Bandwidth [MHz]							
BW [MHz]	Mod	Lowest		Middle		Highest	
		26dB BW	99% BW	26dB BW	99% BW	26dB BW	99% BW
5	QPSK	5.080	4.5120	5.033	4.5161	5.003	4.5068
5	16-QAM	5.028	4.5065	5.062	4.5111	5.048	4.5157
10	QPSK	9.811	8.9583	9.686	8.9415	9.757	8.9473
10	16-QAM	9.630	8.9456	9.638	8.9467	9.686	8.9486

NOTE:Test chart See Appendix A

7. CONDUCTED BAND EDGE

7.1 DESCRIPTION OF CONDUCTED BAND EDGE MEASUREMENT

7.1.1 MEASUREMENT METHOD

1. §22.917(a)

For operations in the 824 – 849 MHz band, the FCC limit is $43 + 10\log_{10}(P[\text{Watts}])$ dB below the transmitter power $P(\text{Watts})$ in a 100kHz bandwidth. However, in the 1MHz bands immediately outside and adjacent to the licensee's frequency block, a resolution bandwidth of at least one percent of the emission bandwidth of the fundamental emission of the transmitter may be employed.

2. §24.238 (a)

For operations in the 1850-1910 and 1930-1990 MHz band, the FCC limit is $43 + 10\log_{10}(P[\text{Watts}])$ dB below the transmitter power $P(\text{Watts})$ in a 1MHz bandwidth. However, in the 1 MHz bands immediately outside and adjacent to the frequency block a resolution bandwidth of at least one percent of the emission bandwidth of the fundamental emission of the transmitter may be employed

3. §27.53 (h)

For operations in the 1710 – 1755 MHz band, the FCC limit is $43 + 10\log_{10}(P[\text{Watts}])$ dB below the transmitter power $P(\text{Watts})$ in a 1 MHz bandwidth. However, in the 1MHz bands immediately outside and adjacent to the licensee's frequency block, a resolution bandwidth of at least one percent of the emission bandwidth of the fundamental emission of the transmitter may be employed.

4. §27.53(m)(4)

For operations in the 2500 MHz ~ 2570 MHz band this section, the attenuation factor shall be not less than $40 + 10 \log (P)$ dB on all frequencies between the channel edge and 5 megahertz from the channel edge, $43 + 10 \log (P)$ dB on all frequencies between 5 megahertz and X megahertz from the channel edge, and $55 + 10 \log (P)$ dB on all frequencies more than X megahertz from the channel edge, where X is the greater of 6 megahertz or the actual emission bandwidth as defined in paragraph (m)(6) of this section. In addition, the attenuation factor shall not be less than $43 + 10 \log (P)$ dB on all frequencies between 2490.5 MHz and 2496 MHz and $55 + 10 \log (P)$ dB at or below 2490.5 MHz. Mobile Satellite Service licensees operating on frequencies below 2495 MHz may also submit a documented interference complaint against BRS licensees operating on channel BRS Channel 1 on the same terms and conditions as adjacent channel BRS or EBS licensees.

5. §27.53 (g)

For operations in the 698 -746 MHz band, the FCC limit is $43 + 10\log_{10}(P[\text{Watts}])$ dB below the transmitter power $P(\text{Watts})$ in a 100 kHz bandwidth. However, in the 100 kilohertz bands immediately outside and adjacent to a licensee's frequency block, a resolution bandwidth of at least 30 kHz may be employed.

7.1.2 TEST SETUP

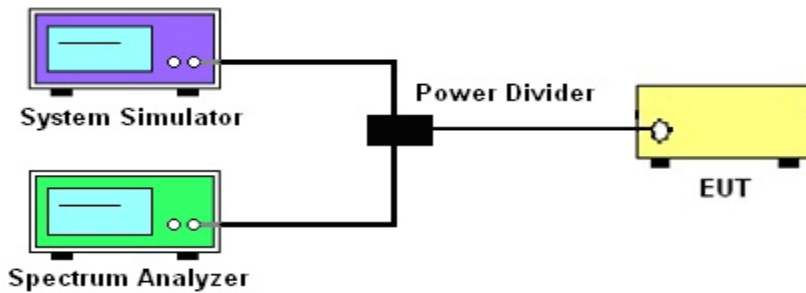

7.1.3 TEST PROCEDURES

1. The testing FCC KDB 971168 D01 v02r02 Section 6.0. and ANSI/TIA-603-D-2010-Section 2.2.13.2(d)
2. The EUT was connected to spectrum analyzer and system simulator via a power divider.
3. The band edges of low and high channels for the highest RF powers were measured. Set RBW $\geq 1\%$ EBW in the 1MHz band immediately outside and adjacent to the band edge.
4. Set spectrum analyzer with RMS/AVG detector
5. The RF fundamental frequency should be excluded against the limit line in the operating frequency band.
6. The limit line is derived from $43 + 10\log(P)$ dB below the transmitter power P(Watts)

$$= P(W) - [43 + 10\log(P)] \text{ (dB)}$$

$$= [30 + 10\log(P)] \text{ (dBm)} - [43 + 10\log(P)] \text{ (dB)}$$

$$= -13\text{dBm}.$$

Band 7:

$$= P(W) - [55 + 10\log(P)] \text{ (dB)}$$

$$= [30 + 10\log(P)] \text{ (dBm)} - [55 + 10\log(P)] \text{ (dB)}$$

$$= -25\text{dBm}.$$

	LTE					
LTE BW	1.4M	3M	5M	10M	15M	20M
Span	12MHz	13MHz	15MHz	20MHz	25MHz	30MHz
RBW	30kHz	30kHz	100kHz	100kHz	300kHz	300kHz
VBW	100kHz	100kHz	300kHz	300kHz	1000kHz	1000kHz
Detector	RMS	RMS	RMS	RMS	RMS	RMS
Trace	Max	Max	Max	Max	Max	Max
Sweep Count	Auto	Auto	Auto	Auto	Auto	Auto

7.1.4 MEASUREMENT RESULT

NOTE: Test chart See Appendix B

8. CONDUCTED SPURIOUS EMISSION

8.1 DESCRIPTION OF CONDUCTED SPURIOUS EMISSION MEASUREMENT

8.1.1 MEASUREMENT METHOD

The power of any emission outside of the authorized operating frequency ranges must be lower than the transmitter power (P) by a factor of at least $43 + 10 \log (P)$ dB.

For Band 7:

The power of any emission outside of the authorized operating frequency ranges must be lower than the transmitter power (P) by a factor of at least $55 + 10 \log (P)$ dB.

It is measured by means of a calibrated spectrum analyzer and scanned from 30 MHz up to a frequency including its 10th harmonic.

8.1.2 TEST SETUP

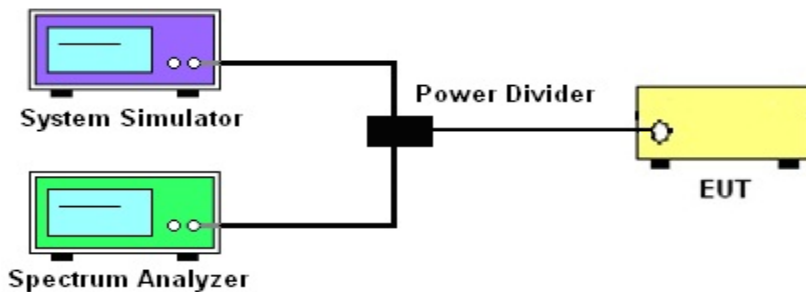

8.1.3 TEST PROCEDURES

1. The testing FCC KDB 971168 D01 v02r02 Section 6.0. and ANSI/TIA-603-D-2010-Section 2.2.13.2(d)
2. The EUT was connected to spectrum analyzer and system simulator via a power divider.
3. The RF output of EUT was connected to the spectrum analyzer by RF cable and attenuator. The path loss was compensated to the results for each measurement
4. Make the measurement with the spectrum analyzer's RBW = 1MHz, VBW = 3MHz, taking the record of maximum spurious emission.
5. The RF fundamental frequency should be excluded against the limit line in the operating frequency band.
6. The limit line is derived from $43 + 10\log(P)$ dB below the transmitter power P(Watts)
 $= P(W) - [43 + 10\log(P)] \text{ (dB)} = [30 + 10\log(P)] \text{ (dBm)} - [43 + 10\log(P)] \text{ (dB)}$
 $= -13\text{dBm}$.
 For Band 7: $P(W) - [43 + 10\log(P)] \text{ (dB)} = -25\text{dBm}$

	LTE					
LTE BW	1.4M	3M	5M	10M	15M	20M
Span	Auto	Auto	Auto	Auto	Auto	Auto
RBW	1000kHz	1000kHz	1000kHz	1000kHz	1000kHz	1000kHz
VBW	3000kHz	3000kHz	3000kHz	3000kHz	3000kHz	3000kHz
Detector	PK	PK	PK	PK	PK	PK
Trace	Max	Max	Max	Max	Max	Max

8.1.4 TEST RESULTS

NOTE: Test chart See Appendix C

9. RADIATED SPURIOUS EMISSION

9.1 DESCRIPTION OF RADIATED SPURIOUS EMISSION

9.1.1 MEASUREMENT METHOD

The radiated spurious emission was measured by substitution method according to ANSI / TIA / EIA-603-D-2010. The power of any emission outside of the authorized operating frequency ranges must be attenuated below the transmitter power (P) by a factor of at least $43 + 10 \log (P)$ dB. For Band 7 The power of any emission outside of the authorized operating frequency ranges must be attenuated below the transmitter power (P) by a factor of at least $55 + 10 \log (P)$ dB. For Band. The spectrum is scanned from 30 MHz up to a frequency including its 10th harmonic.

5.1.2 Test Setup

The procedure of radiated spurious emissions is as follows:

a) Pre-calibration With pre-calibration method, the Radiated Spurious Emissions(RSE) is calculated as, $RSE = R_x \text{ (dBuV)} + CL \text{ (dB)} + SA \text{ (dB)} + Gain \text{ (dBi)} - 107 \text{ (dBuV to dBm)}$ The SA is calibrated using following setup.

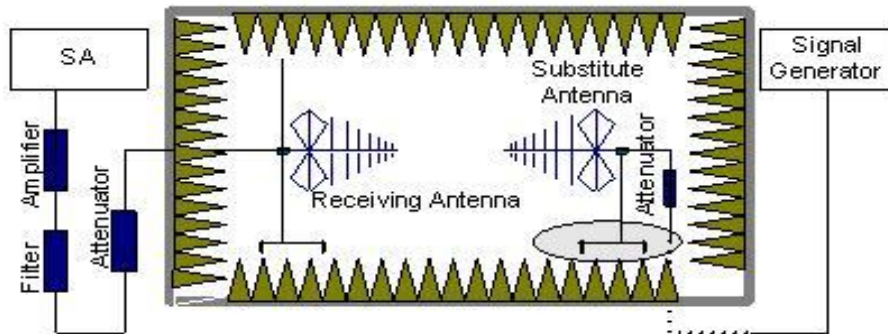

b) EUT was placed on a 1.5 meter high non-conductive stand at a 3 meter test distance from the receive antenna. A receiving antenna was placed on the antenna mast 3 meters from the test item for emission measurements. The height of receiving antenna is 0.8m. The test setup refers to figure below. Detected emissions were maximized at each frequency by rotating the test item and adjusting the receiving antenna polarization. The radiated emission measurements of all non-harmonic and harmonics of the transmit frequency through the 10th harmonic were measured with peak detector and 1MHz bandwidth.

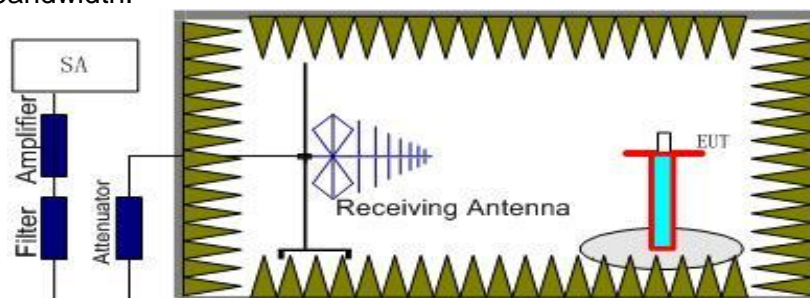

Radiated emissions measurements were made only at the upper, middle, and lower carrier frequencies. It was decided that measurements at these three carrier frequencies would be sufficient to demonstrate compliance with emissions limits because it was seen that all the significant spurs occur well outside the band and no radiation was seen from a carrier in one block of any band into any of the other blocks.

The substitution method is used. Substitution values at each frequency are measured before and saved to the test software. A "reference path loss" is established and the ARpl is the attenuation of "reference path loss", and including the gain of receive antenna, the gain of the preamplifier, the cable loss and the air loss. The measurement results are obtained as described below: Pow-

er=PMea+ARpl

9.1.3 TEST PROCEDURES

1. The testing FCC KDB 971168 D01 Section 5.8 and ANSI/TIA-603-D-2010-Section 2.2.12.2(b)
2. The EUT was placed on a rotatable wooden table with 0.8 meter above ground.
3. The EUT was set 3 meters from the receiving antenna, which was mounted on the antenna tower.
4. The table was rotated 360 degrees to determine the position of the highest spurious emission.
5. The height of the receiving antenna is varied between one meter and four meters to search the maximum spurious emission for both horizontal and vertical polarizations
6. Make the measurement with the spectrum analyzer's RBW = 1MHz, VBW = 3MHz, taking the record of maximum spurious emission.
7. A horn antenna was substituted in place of the EUT and was driven by a signal generator.
8. Tune the output power of signal generator to the same emission level with EUT maximum spurious emission.
9. Taking the record of output power at antenna port.
10. Repeat step 7 to step 8 for another polarization.
11. The RF fundamental frequency should be excluded against the limit line in the operating frequency band.

The limit line is derived from $43 + 10\log(P)$ dB below the transmitter power P(Watts)
 $= P(W) - [43 + 10\log(P)]$ (dB)
 $= [30 + 10\log(P)]$ (dBm) - $[43 + 10\log(P)]$ (dB)
 $= -13$ dBm

For Band 7:

The limit line is derived from $55 + 10\log(P)$ dB below the transmitter power P(Watts)
 $= [30 + 10\log(P)]$ (dBm) - $[55 + 10\log(P)]$ (dB)
 $= -25$ dBm

EIRP (dBm) = S.G. Power – Tx Cable Loss + Tx Antenna Gain

ERP (dBm) = EIRP - 2.15

9.1.4 TEST RESULTS

LTE BAND 2

LTE Band 2 / 1.4MHz / QPSK / RB Size 1 Offset 0/ The Worst Test Results for Lowest							
Frequency(MHz)	S G.Lev (dBm)	Ant(dBi)	Loss	PMea	Limit	Margin	Polarity
				(dBm)	(dBm)	(dBm)	
3701.03	-34.35	12.60	12.93	-34.68	-13.00	-21.68	H
5551.92	-34.81	13.10	17.11	-38.82	-13.00	-25.82	H
7402.49	-33.44	11.50	22.20	-44.14	-13.00	-31.14	H
3701.03	-34.67	12.60	12.93	-35.00	-13.00	-22.00	V
5551.92	-33.99	13.10	17.11	-38.00	-13.00	-25.00	V
7402.49	-31.92	11.50	22.20	-42.62	-13.00	-29.62	V
LTE Band 2 / 1.4MHz / QPSK / RB Size 1 Offset 0/ The Worst Test Results for Middle							
Frequency(MHz)	S G.Lev (dBm)	Ant(dBi)	Loss	PMea	Limit	Margin	Polarity
				(dBm)	(dBm)	(dBm)	
3760.13	-34.50	12.60	12.93	-34.83	-13.00	-21.83	H
5639.95	-35.41	13.10	17.11	-39.42	-13.00	-26.42	H
7519.94	-32.63	11.50	22.20	-43.33	-13.00	-30.33	H
3760.13	-35.75	12.60	12.93	-36.08	-13.00	-23.08	V
5639.95	-34.85	13.10	17.11	-38.86	-13.00	-25.86	V
7519.94	-32.86	11.50	22.20	-43.56	-13.00	-30.56	V
LTE Band 2 / 1.4MHz / QPSK / RB Size 1 Offset 0/ The Worst Test Results for Highest							
Frequency(MHz)	S G.Lev (dBm)	Ant(dBi)	Loss	PMea	Limit	Margin	Polarity
				(dBm)	(dBm)	(dBm)	
3818.32	-34.03	12.60	12.93	-34.36	-13.00	-21.36	H
5727.82	-35.18	13.10	17.11	-39.19	-13.00	-26.19	H
7636.85	-33.06	11.50	22.20	-43.76	-13.00	-30.76	H
3818.32	-34.55	12.60	12.93	-34.88	-13.00	-21.88	V
5727.82	-33.82	13.10	17.11	-37.83	-13.00	-24.83	V
7636.85	-32.73	11.50	22.20	-43.43	-13.00	-30.43	V

Remark: Spurious emissions within 30-1000MHz were found more than 20dB below limit line..

Test is divided into three directions, X/Y/Z. X pattern for the worst.

LTE BAND 2

LTE Band 2 / 3MHz / QPSK / RB Size 1 Offset 0/ The Worst Test Results for Lowest							
Frequency(MHz)	S G.Lev (dBm)	Ant(dBi)	Loss	PMea	Limit	Margin	Polarity
				(dBm)	(dBm)	(dBm)	
3703.46	-34.23	12.60	12.93	-34.56	-13.00	-21.56	H
5554.54	-35.45	13.10	17.11	-39.46	-13.00	-26.46	H
7406.81	-33.48	11.50	22.20	-44.18	-13.00	-31.18	H
3703.46	-35.66	12.60	12.93	-35.99	-13.00	-22.99	V
5554.54	-34.32	13.10	17.11	-38.33	-13.00	-25.33	V
7406.81	-32.98	11.50	22.20	-43.68	-13.00	-30.68	V
LTE Band 2 / 3MHz / QPSK / RB Size 1 Offset 0/ The Worst Test Results for Middle							
Frequency(MHz)	S G.Lev (dBm)	Ant(dBi)	Loss	PMea	Limit	Margin	Polarity
				(dBm)	(dBm)	(dBm)	
3759.84	-34.58	12.60	12.93	-34.91	-13.00	-21.91	H
5639.80	-34.20	13.10	17.11	-38.21	-13.00	-25.21	H
7520.19	-32.62	11.50	22.20	-43.32	-13.00	-30.32	H
3759.84	-35.37	12.60	12.93	-35.70	-13.00	-22.70	V
5639.80	-34.19	13.10	17.11	-38.20	-13.00	-25.20	V
7520.19	-32.54	11.50	22.20	-43.24	-13.00	-30.24	V
LTE Band 2 / 3MHz / QPSK / RB Size 1 Offset 0/ The Worst Test Results for Highest							
Frequency(MHz)	S G.Lev (dBm)	Ant(dBi)	Loss	PMea	Limit	Margin	Polarity
				(dBm)	(dBm)	(dBm)	
3816.49	-33.85	12.60	12.93	-34.18	-13.00	-21.18	H
5725.21	-34.81	13.10	17.11	-38.82	-13.00	-25.82	H
7633.16	-32.64	11.50	22.20	-43.34	-13.00	-30.34	H
3816.49	-34.62	12.60	12.93	-34.95	-13.00	-21.95	V
5725.21	-34.79	13.10	17.11	-38.80	-13.00	-25.80	V
7633.16	-31.91	11.50	22.20	-42.61	-13.00	-29.61	V

Remark: Spurious emissions within 30-1000MHz were found more than 20dB below limit line.

Test is divided into three directions, X/Y/Z. X pattern for the worst.

LTE BAND 2

LTE Band 2 / 5MHz / QPSK / RB Size 1 Offset 0/ The Worst Test Results for Lowest							
Frequency(MHz)	S G.Lev (dBm)	Ant(dBi)	Loss	PMea	Limit	Margin	Polarity
				(dBm)	(dBm)	(dBm)	
3705.42	-33.80	12.60	12.93	-34.13	-13.00	-21.13	H
5557.86	-35.31	13.10	17.11	-39.32	-13.00	-26.32	H
7410.54	-33.15	11.50	22.20	-43.85	-13.00	-30.85	H
3705.42	-35.85	12.60	12.93	-36.18	-13.00	-23.18	V
5557.86	-34.38	13.10	17.11	-38.39	-13.00	-25.39	V
7410.54	-31.87	11.50	22.20	-42.57	-13.00	-29.57	V
LTE Band 2 / 5MHz / QPSK / RB Size 1 Offset 0/ The Worst Test Results for Middle							
Frequency(MHz)	S G.Lev (dBm)	Ant(dBi)	Loss	PMea	Limit	Margin	Polarity
				(dBm)	(dBm)	(dBm)	
3760.20	-34.82	12.60	12.93	-35.15	-13.00	-22.15	H
5640.27	-34.46	13.10	17.11	-38.47	-13.00	-25.47	H
7519.92	-32.16	11.50	22.20	-42.86	-13.00	-29.86	H
3760.20	-35.00	12.60	12.93	-35.33	-13.00	-22.33	V
5640.27	-33.77	13.10	17.11	-37.78	-13.00	-24.78	V
7519.92	-32.81	11.50	22.20	-43.51	-13.00	-30.51	V
LTE Band 2 / 5MHz / QPSK / RB Size 1 Offset 0/ The Worst Test Results for Highest							
Frequency(MHz)	S G.Lev (dBm)	Ant(dBi)	Loss	PMea	Limit	Margin	Polarity
				(dBm)	(dBm)	(dBm)	
3814.38	-33.95	12.60	12.93	-34.28	-13.00	-21.28	H
5721.35	-34.44	13.10	17.11	-38.45	-13.00	-25.45	H
7628.36	-32.37	11.50	22.20	-43.07	-13.00	-30.07	H
3814.38	-35.05	12.60	12.93	-35.38	-13.00	-22.38	V
5721.35	-34.85	13.10	17.11	-38.86	-13.00	-25.86	V
7628.36	-32.98	11.50	22.20	-43.68	-13.00	-30.68	V

Remark: Spurious emissions within 30-1000MHz were found more than 20dB below limit line.
 Test is divided into three directions, X/Y/Z. X pattern for the worst.

LTE BAND 2

LTE Band 2 / 10MHz / QPSK / RB Size 1 Offset 0/ The Worst Test Results for Lowest							
Frequency(MHz)	S G.Lev (dBm)	Ant(dBi)	Loss	PMea	Limit	Margin	Polarity
				(dBm)	(dBm)	(dBm)	
3710.60	-33.89	12.60	12.93	-34.22	-13.00	-21.22	H
5565.82	-34.25	13.10	17.11	-38.26	-13.00	-25.26	H
7420.78	-32.21	11.50	22.20	-42.91	-13.00	-29.91	H
3710.60	-35.96	12.60	12.93	-36.29	-13.00	-23.29	V
5565.82	-34.71	13.10	17.11	-38.72	-13.00	-25.72	V
7420.78	-33.02	11.50	22.20	-43.72	-13.00	-30.72	V
LTE Band 2 / 10MHz / QPSK / RB Size 1 Offset 0/ The Worst Test Results for Middle							
Frequency(MHz)	S G.Lev (dBm)	Ant(dBi)	Loss	PMea	Limit	Margin	Polarity
				(dBm)	(dBm)	(dBm)	
3760.02	-33.67	12.60	12.93	-34.00	-13.00	-21.00	H
5640.08	-35.13	13.10	17.11	-39.14	-13.00	-26.14	H
7520.00	-32.23	11.50	22.20	-42.93	-13.00	-29.93	H
3760.02	-35.71	12.60	12.93	-36.04	-13.00	-23.04	V
5640.08	-34.49	13.10	17.11	-38.50	-13.00	-25.50	V
7520.00	-32.93	11.50	22.20	-43.63	-13.00	-30.63	V
LTE Band 2 / 10MHz / QPSK / RB Size 1 Offset 0/ The Worst Test Results for Highest							
Frequency(MHz)	S G.Lev (dBm)	Ant(dBi)	Loss	PMea	Limit	Margin	Polarity
				(dBm)	(dBm)	(dBm)	
3809.07	-33.44	12.60	12.93	-33.77	-13.00	-20.77	H
5713.75	-34.59	13.10	17.11	-38.60	-13.00	-25.60	H
7618.03	-33.45	11.50	22.20	-44.15	-13.00	-31.15	H
3809.07	-35.98	12.60	12.93	-36.31	-13.00	-23.31	V
5713.75	-34.90	13.10	17.11	-38.91	-13.00	-25.91	V
7618.03	-32.26	11.50	22.20	-42.96	-13.00	-29.96	V

Remark: Spurious emissions within 30-1000MHz were found more than 20dB below limit line.
 Test is divided into three directions, X/Y/Z. X pattern for the worst.

LTE BAND 2

LTE Band 2 / 15MHz / QPSK / RB Size 1 Offset 0/ The Worst Test Results for Lowest							
Frequency(MHz)	S G.Lev (dBm)	Ant(dBi)	Loss	PMea	Limit	Margin	Polarity
				(dBm)	(dBm)	(dBm)	
3715.89	-34.27	12.60	12.93	-34.60	-13.00	-21.60	H
5574.11	-35.01	13.10	17.11	-39.02	-13.00	-26.02	H
7618.41	-33.38	11.50	22.20	-44.08	-13.00	-31.08	H
3715.89	-35.31	12.60	12.93	-35.64	-13.00	-22.64	V
5574.11	-34.57	13.10	17.11	-38.58	-13.00	-25.58	V
7618.41	-32.00	11.50	22.20	-42.70	-13.00	-29.70	V
LTE Band 2 / 5MHz / QPSK / RB Size 1 Offset 0/ The Worst Test Results for Middle							
Frequency(MHz)	S G.Lev (dBm)	Ant(dBi)	Loss	PMea	Limit	Margin	Polarity
				(dBm)	(dBm)	(dBm)	
3759.84	-33.60	12.60	12.93	-33.93	-13.00	-20.93	H
5639.81	-34.96	13.10	17.11	-38.97	-13.00	-25.97	H
7520.03	-32.80	11.50	22.20	-43.50	-13.00	-30.50	H
3759.84	-35.42	12.60	12.93	-35.75	-13.00	-22.75	V
5639.81	-34.32	13.10	17.11	-38.33	-13.00	-25.33	V
7520.03	-32.84	11.50	22.20	-43.54	-13.00	-30.54	V
LTE Band 2 / 5MHz / QPSK / RB Size 1 Offset 0/ The Worst Test Results for Highest							
Frequency(MHz)	S G.Lev (dBm)	Ant(dBi)	Loss	PMea	Limit	Margin	Polarity
				(dBm)	(dBm)	(dBm)	
3803.75	-34.54	12.60	12.93	-34.87	-13.00	-21.87	H
5705.40	-35.23	13.10	17.11	-39.24	-13.00	-26.24	H
7607.23	-32.25	11.50	22.20	-42.95	-13.00	-29.95	H
3803.75	-34.68	12.60	12.93	-35.01	-13.00	-22.01	V
5705.40	-34.90	13.10	17.11	-38.91	-13.00	-25.91	V
7607.23	-32.89	11.50	22.20	-43.59	-13.00	-30.59	V

Remark: Spurious emissions within 30-1000MHz were found more than 20dB below limit line.

Test is divided into three directions, X/Y/Z. X pattern for the worst.

LTE BAND 2

LTE Band 2 / 20MHz / QPSK / RB Size 1 Offset 0/ The Worst Test Results for Lowest							
Frequency(MHz)	S G.Lev (dBm)	Ant(dBi)	Loss	PMea	Limit	Margin	Polarity
				(dBm)	(dBm)	(dBm)	
3721.06	-33.51	12.60	12.93	-33.84	-13.00	-20.84	H
5581.34	-35.31	13.10	17.11	-39.32	-13.00	-26.32	H
7441.94	-32.65	11.50	22.20	-43.35	-13.00	-30.35	H
3721.06	-35.16	12.60	12.93	-35.49	-13.00	-22.49	V
5581.34	-34.24	13.10	17.11	-38.25	-13.00	-25.25	V
7441.94	-32.21	11.50	22.20	-42.91	-13.00	-29.91	V
LTE Band 2 / 10MHz / QPSK / RB Size 1 Offset 0/ The Worst Test Results for Middle							
Frequency(MHz)	S G.Lev (dBm)	Ant(dBi)	Loss	PMea	Limit	Margin	Polarity
				(dBm)	(dBm)	(dBm)	
3760.02	-33.72	12.60	12.93	-34.05	-13.00	-21.05	H
5639.96	-34.00	13.10	17.11	-38.01	-13.00	-25.01	H
7520.21	-32.87	11.50	22.20	-43.57	-13.00	-30.57	H
3760.02	-34.64	12.60	12.93	-34.97	-13.00	-21.97	V
5639.96	-34.80	13.10	17.11	-38.81	-13.00	-25.81	V
7520.21	-33.13	11.50	22.20	-43.83	-13.00	-30.83	V
LTE Band 2 / 10MHz / QPSK / RB Size 1 Offset 0/ The Worst Test Results for Highest							
Frequency(MHz)	S G.Lev (dBm)	Ant(dBi)	Loss	PMea	Limit	Margin	Polarity
				(dBm)	(dBm)	(dBm)	
3798.53	-33.71	12.60	12.93	-34.04	-13.00	-21.04	H
5697.46	-34.91	13.10	17.11	-38.92	-13.00	-25.92	H
7596.96	-32.95	11.50	22.20	-43.65	-13.00	-30.65	H
3798.53	-34.77	12.60	12.93	-35.10	-13.00	-22.10	V
5697.46	-35.24	13.10	17.11	-39.25	-13.00	-26.25	V
7596.96	-33.16	11.50	22.20	-43.86	-13.00	-30.86	V

Remark: Spurious emissions within 30-1000MHz were found more than 20dB below limit line.

Test is divided into three directions, X/Y/Z. X pattern for the worst.

LTE BAND 4

LTE Band 4 / 1.4MHz / QPSK / RB Size 1 Offset 0/ The Worst Test Results for Lowest							
Frequency(MHz)	S G.Lev (dBm)	Ant(dBi)	Loss	PMea	Limit	Margin	Polarity
				(dBm)	(dBm)	(dBm)	
3422.28	-34.17	12.90	12.56	-33.83	-13.00	-20.83	H
5133.23	-35.23	13.10	12.46	-34.59	-13.00	-21.59	H
6844.76	-33.39	12.33	21.13	-42.19	-13.00	-29.19	H
3422.28	-35.96	12.90	12.76	-35.82	-13.00	-22.82	V
5133.23	-34.33	13.10	16.32	-37.55	-13.00	-24.55	V
6844.76	-32.85	12.33	21.13	-41.65	-13.00	-28.65	V
LTE Band 4 / 1.4MHz / QPSK / RB Size 1 Offset 0/ The Worst Test Results for Middle							
Frequency(MHz)	S G.Lev (dBm)	Ant(dBi)	Loss	PMea	Limit	Margin	Polarity
				(dBm)	(dBm)	(dBm)	
3465.96	-33.78	12.80	12.56	-33.54	-13.00	-20.54	H
5199.10	-34.10	13.10	12.46	-33.46	-13.00	-20.46	H
6931.84	-32.94	12.33	21.13	-41.74	-13.00	-28.74	H
3465.96	-34.53	12.80	12.76	-34.49	-13.00	-21.49	V
5199.10	-34.37	13.10	16.32	-37.59	-13.00	-24.59	V
6931.84	-32.52	12.33	21.13	-41.32	-13.00	-28.32	V
LTE Band 4 / 1.4MHz / QPSK / RB Size 1 Offset 0/ The Worst Test Results for Highest							
Frequency(MHz)	S G.Lev (dBm)	Ant(dBi)	Loss	PMea	Limit	Margin	Polarity
				(dBm)	(dBm)	(dBm)	
3508.46	-34.60	12.61	12.56	-34.55	-13.00	-21.55	H
5262.32	-35.10	13.12	12.46	-34.44	-13.00	-21.44	H
7015.90	-33.49	12.32	21.13	-42.30	-13.00	-29.30	H
3508.46	-35.24	12.61	12.76	-35.39	-13.00	-22.39	V
5262.32	-34.38	13.12	16.32	-37.58	-13.00	-24.58	V
7015.90	-32.75	12.32	21.13	-41.56	-13.00	-28.56	V

Remark: Spurious emissions within 30-1000MHz were found more than 20dB below limit line.

Test is divided into three directions, X/Y/Z. X pattern for the worst.

LTE BAND 4

LTE Band 4 / 3MHz / QPSK / RB Size 1 Offset 0/ The Worst Test Results for Lowest							
Frequency(MHz)	S G.Lev (dBm)	Ant(dBi)	Loss	PMea	Limit	Margin	Polarity
				(dBm)	(dBm)	(dBm)	
3424.05	-34.38	12.90	12.56	-34.04	-13.00	-21.04	H
5136.40	-34.53	13.10	12.46	-33.89	-13.00	-20.89	H
6848.95	-32.61	12.33	21.13	-41.41	-13.00	-28.41	H
3424.05	-34.54	12.90	12.76	-34.40	-13.00	-21.40	V
5136.40	-34.94	13.10	16.32	-38.16	-13.00	-25.16	V
6848.95	-31.74	12.33	21.13	-40.54	-13.00	-27.54	V
LTE Band 4 / 3MHz / QPSK / RB Size 1 Offset 0/ The Worst Test Results for Middle							
Frequency(MHz)	S G.Lev (dBm)	Ant(dBi)	Loss	PMea	Limit	Margin	Polarity
				(dBm)	(dBm)	(dBm)	
3466.14	-33.91	12.80	12.56	-33.67	-13.00	-20.67	H
5199.13	-35.01	13.10	12.46	-34.37	-13.00	-21.37	H
6931.89	-32.86	12.33	21.13	-41.66	-13.00	-28.66	H
3466.14	-35.23	12.80	12.76	-35.19	-13.00	-22.19	V
5199.13	-34.71	13.10	16.32	-37.93	-13.00	-24.93	V
6931.89	-32.85	12.33	21.13	-41.65	-13.00	-28.65	V
LTE Band 4 / 3MHz / QPSK / RB Size 1 Offset 0/ The Worst Test Results for Highest							
Frequency(MHz)	S G.Lev (dBm)	Ant(dBi)	Loss	PMea	Limit	Margin	Polarity
				(dBm)	(dBm)	(dBm)	
3506.35	-34.11	12.61	12.56	-34.06	-13.00	-21.06	H
5262.46	-34.26	13.12	12.46	-33.60	-13.00	-20.60	H
7013.17	-33.44	12.32	21.13	-42.25	-13.00	-29.25	H
3506.35	-35.31	12.61	12.76	-35.46	-13.00	-22.46	V
5262.46	-34.05	13.12	16.32	-37.25	-13.00	-24.25	V
7013.17	-32.39	12.32	21.13	-41.20	-13.00	-28.20	V

Remark: Spurious emissions within 30-1000MHz were found more than 20dB below limit line.
Test is divided into three directions, X/Y/Z. X pattern for the worst.

LTE BAND 4

LTE Band 4 / 5MHz / QPSK / RB Size 1 Offset 0/ The Worst Test Results for Lowest							
Frequency(MHz)	S G.Lev (dBm)	Ant(dBi)	Loss	PMea	Limit	Margin	Polarity
				(dBm)	(dBm)	(dBm)	
3426.27	-34.02	12.90	12.56	-33.68	-13.00	-20.68	H
5139.29	-34.74	13.10	12.46	-34.10	-13.00	-21.10	H
6852.94	-33.25	12.33	21.13	-42.05	-13.00	-29.05	H
3426.27	-35.03	12.90	12.76	-34.89	-13.00	-21.89	V
5139.29	-35.00	13.10	16.32	-38.22	-13.00	-25.22	V
6852.94	-32.52	12.33	21.13	-41.32	-13.00	-28.32	V
LTE Band 4 / 5MHz / QPSK / RB Size 1 Offset 0/ The Worst Test Results for Middle							
Frequency(MHz)	S G.Lev (dBm)	Ant(dBi)	Loss	PMea	Limit	Margin	Polarity
				(dBm)	(dBm)	(dBm)	
3465.95	-34.62	12.80	12.56	-34.38	-13.00	-21.38	H
5199.08	-34.15	13.10	12.46	-33.51	-13.00	-20.51	H
6932.15	-32.79	12.33	21.13	-41.59	-13.00	-28.59	H
3465.95	-35.97	12.80	12.76	-35.93	-13.00	-22.93	V
5199.08	-34.33	13.10	16.32	-37.55	-13.00	-24.55	V
6932.15	-32.44	12.33	21.13	-41.24	-13.00	-28.24	V
LTE Band 4 / 5MHz / QPSK / RB Size 1 Offset 0/ The Worst Test Results for Highest							
Frequency(MHz)	S G.Lev (dBm)	Ant(dBi)	Loss	PMea	Limit	Margin	Polarity
				(dBm)	(dBm)	(dBm)	
3506.56	-34.30	12.61	12.56	-34.25	-13.00	-21.25	H
5262.50	-34.78	13.12	12.46	-34.12	-13.00	-21.12	H
7013.03	-32.69	12.32	21.13	-41.50	-13.00	-28.50	H
3506.56	-35.85	12.61	12.76	-36.00	-13.00	-23.00	V
5262.50	-34.99	13.12	16.32	-38.19	-13.00	-25.19	V
7013.03	-32.72	12.32	21.13	-41.53	-13.00	-28.53	V

Remark: Spurious emissions within 30-1000MHz were found more than 20dB below limit line.

Test is divided into three directions, X/Y/Z. X pattern for the worst.

LTE BAND 4

LTE Band 4 / 10MHz / QPSK / RB Size 1 Offset 0/ The Worst Test Results for Lowest							
Frequency(MHz)	S G.Lev (dBm)	Ant(dBi)	Loss	PMea	Limit	Margin	Polarity
				(dBm)	(dBm)	(dBm)	
3436.02	-34.39	12.90	12.56	-34.05	-13.00	-21.05	H
5154.31	-34.20	13.10	12.46	-33.56	-13.00	-20.56	H
6872.88	-33.44	12.33	21.13	-42.24	-13.00	-29.24	H
3436.02	-35.64	12.90	12.76	-35.50	-13.00	-22.50	V
5154.31	-34.01	13.10	16.32	-37.23	-13.00	-24.23	V
6872.88	-32.58	12.33	21.13	-41.38	-13.00	-28.38	V
LTE Band 4 / 10MHz / QPSK / RB Size 1 Offset 0/ The Worst Test Results for Middle							
Frequency(MHz)	S G.Lev (dBm)	Ant(dBi)	Loss	PMea	Limit	Margin	Polarity
				(dBm)	(dBm)	(dBm)	
3466.03	-33.52	12.80	12.56	-33.28	-13.00	-20.28	H
5199.01	-34.54	13.10	12.46	-33.90	-13.00	-20.90	H
6931.87	-33.19	12.33	21.13	-41.99	-13.00	-28.99	H
3466.03	-35.80	12.80	12.76	-35.76	-13.00	-22.76	V
5199.01	-34.55	13.10	16.32	-37.77	-13.00	-24.77	V
6931.87	-31.73	12.33	21.13	-40.53	-13.00	-27.53	V
LTE Band 4 / 10MHz / QPSK / RB Size 1 Offset 0/ The Worst Test Results for Highest							
Frequency(MHz)	S G.Lev (dBm)	Ant(dBi)	Loss	PMea	Limit	Margin	Polarity
				(dBm)	(dBm)	(dBm)	
3494.66	-34.60	12.61	12.56	-34.55	-13.00	-21.55	H
5241.30	-35.43	13.12	12.46	-34.77	-13.00	-21.77	H
6987.99	-33.06	12.32	21.13	-41.87	-13.00	-28.87	H
3494.66	-34.68	12.61	12.76	-34.83	-13.00	-21.83	V
5241.30	-34.15	13.12	16.32	-37.35	-13.00	-24.35	V
6987.99	-32.61	12.32	21.13	-41.42	-13.00	-28.42	V

Remark: Spurious emissions within 30-1000MHz were found more than 20dB below limit line.

Test is divided into three directions, X/Y/Z. X pattern for the worst.

LTE BAND 4

LTE Band 4 / 15MHz / QPSK / RB Size 1 Offset 0/ The Worst Test Results for Lowest							
Frequency(MHz)	S G.Lev (dBm)	Ant(dBi)	Loss	PMea	Limit	Margin	Polarity
				(dBm)	(dBm)	(dBm)	
3436.41	-34.77	12.90	12.56	-34.43	-13.00	-21.43	H
5154.46	-35.02	13.10	12.46	-34.38	-13.00	-21.38	H
6872.74	-32.89	12.33	21.13	-41.69	-13.00	-28.69	H
3436.41	-35.12	12.90	12.76	-34.98	-13.00	-21.98	V
5154.46	-34.02	13.10	16.32	-37.24	-13.00	-24.24	V
6872.74	-32.29	12.33	21.13	-41.09	-13.00	-28.09	V
LTE Band 4 / 5MHz / QPSK / RB Size 1 Offset 0/ The Worst Test Results for Middle							
Frequency(MHz)	S G.Lev (dBm)	Ant(dBi)	Loss	PMea	Limit	Margin	Polarity
				(dBm)	(dBm)	(dBm)	
3465.86	-33.87	12.80	12.56	-33.63	-13.00	-20.63	H
5198.87	-34.31	13.10	12.46	-33.67	-13.00	-20.67	H
6932.16	-33.09	12.33	21.13	-41.89	-13.00	-28.89	H
3465.86	-35.31	12.80	12.76	-35.27	-13.00	-22.27	V
5198.87	-34.85	13.10	16.32	-38.07	-13.00	-25.07	V
6932.16	-32.15	12.33	21.13	-40.95	-13.00	-27.95	V
LTE Band 4 / 5MHz / QPSK / RB Size 1 Offset 0/ The Worst Test Results for Highest							
Frequency(MHz)	S G.Lev (dBm)	Ant(dBi)	Loss	PMea	Limit	Margin	Polarity
				(dBm)	(dBm)	(dBm)	
3494.77	-33.44	12.61	12.56	-33.39	-13.00	-20.39	H
5242.47	-34.30	13.12	12.46	-33.64	-13.00	-20.64	H
6989.45	-32.81	12.32	21.13	-41.62	-13.00	-28.62	H
3494.77	-35.96	12.61	12.76	-36.11	-13.00	-23.11	V
5242.47	-33.84	13.12	16.32	-37.04	-13.00	-24.04	V
6989.45	-33.01	12.32	21.13	-41.82	-13.00	-28.82	V

Remark: Spurious emissions within 30-1000MHz were found more than 20dB below limit line.

Test is divided into three directions, X/Y/Z. X pattern for the worst.

LTE BAND 4

LTE Band 4 / 20MHz / QPSK / RB Size 1 Offset 0/ The Worst Test Results for Lowest							
Frequency(MHz)	S G.Lev (dBm)	Ant(dBi)	Loss	PMea	Limit	Margin	Polarity
				(dBm)	(dBm)	(dBm)	
3440.23	-34.45	12.90	12.56	-34.11	-13.00	-21.11	H
5160.54	-34.42	13.10	12.46	-33.78	-13.00	-20.78	H
6880.67	-32.61	12.33	21.13	-41.41	-13.00	-28.41	H
3440.23	-35.86	12.90	12.76	-35.72	-13.00	-22.72	V
5160.54	-34.05	13.10	16.32	-37.27	-13.00	-24.27	V
6880.67	-32.82	12.33	21.13	-41.62	-13.00	-28.62	V
LTE Band 4 / 10MHz / QPSK / RB Size 1 Offset 0/ The Worst Test Results for Middle							
Frequency(MHz)	S G.Lev (dBm)	Ant(dBi)	Loss	PMea	Limit	Margin	Polarity
				(dBm)	(dBm)	(dBm)	
3466.09	-34.79	12.80	12.56	-34.55	-13.00	-21.55	H
5199.13	-34.41	13.10	12.46	-33.77	-13.00	-20.77	H
6932.07	-33.18	12.33	21.13	-41.98	-13.00	-28.98	H
3466.09	-35.98	12.80	12.76	-35.94	-13.00	-22.94	V
5199.13	-35.19	13.10	16.32	-38.41	-13.00	-25.41	V
6932.07	-32.35	12.33	21.13	-41.15	-13.00	-28.15	V
LTE Band 4 / 10MHz / QPSK / RB Size 1 Offset 0/ The Worst Test Results for Highest							
Frequency(MHz)	S G.Lev (dBm)	Ant(dBi)	Loss	PMea	Limit	Margin	Polarity
				(dBm)	(dBm)	(dBm)	
3490.35	-34.54	12.61	12.56	-34.49	-13.00	-21.49	H
5235.49	-35.44	13.12	12.46	-34.78	-13.00	-21.78	H
6979.86	-32.37	12.32	21.13	-41.18	-13.00	-28.18	H
3490.35	-35.51	12.61	12.76	-35.66	-13.00	-22.66	V
5235.49	-34.99	13.12	16.32	-38.19	-13.00	-25.19	V
6979.86	-32.98	12.32	21.13	-41.79	-13.00	-28.79	V

Remark: Spurious emissions within 30-1000MHz were found more than 20dB below limit line.

Test is divided into three directions, X/Y/Z. X pattern for the worst.

LTE BAND 7

LTE Band 7 / 5MHz / QPSK / RB Size 1 Offset 0/ The Worst Test Results for Lowest							
Frequency(MHz)	S G.Lev (dBm)	Ant(dBi)	Loss	PMea	Limit	Margin	Polarity
				(dBm)	(dBm)	(dBm)	
5005.34	-34.54	12.66	12.54	-34.42	-13.00	-21.42	H
7508.17	-34.82	11.46	12.57	-35.93	-13.00	-22.93	H
10010.82	-32.92	12.79	21.23	-41.36	-13.00	-28.36	H
5005.34	-35.04	12.66	12.54	-34.92	-13.00	-21.92	V
7508.17	-34.06	11.46	12.57	-35.17	-13.00	-22.17	V
10010.82	-31.83	12.79	21.23	-40.27	-13.00	-27.27	V
LTE Band 7 / 5MHz / QPSK / RB Size 1 Offset 0/ The Worst Test Results for Middle							
Frequency(MHz)	S G.Lev (dBm)	Ant(dBi)	Loss	PMea	Limit	Margin	Polarity
				(dBm)	(dBm)	(dBm)	
5070.17	-33.57	12.72	12.55	-33.40	-13.00	-20.40	H
7605.06	-33.99	11.46	12.57	-35.10	-13.00	-22.10	H
10139.90	-32.97	12.09	21.25	-42.13	-13.00	-29.13	H
5070.17	-34.85	12.80	12.55	-34.60	-13.00	-21.60	V
7605.06	-34.88	13.10	12.57	-34.35	-13.00	-21.35	V
10139.90	-32.43	12.33	21.25	-41.35	-13.00	-28.35	V
LTE Band 7 / 5MHz / QPSK / RB Size 1 Offset 0/ The Worst Test Results for Highest							
Frequency(MHz)	S G.Lev (dBm)	Ant(dBi)	Loss	PMea	Limit	Margin	Polarity
				(dBm)	(dBm)	(dBm)	
5134.07	-34.31	12.76	12.57	-34.12	-13.00	-21.12	H
7701.55	-35.24	11.45	12.58	-36.37	-13.00	-23.37	H
10268.51	-32.43	12.28	21.27	-41.42	-13.00	-28.42	H
5134.07	-34.97	12.76	12.57	-34.78	-13.00	-21.78	V
7701.55	-34.89	11.45	12.58	-36.02	-13.00	-23.02	V
10268.51	-32.84	12.28	21.27	-41.83	-13.00	-28.83	V

Remark: Spurious emissions within 30-1000MHz were found more than 20dB below limit line.

Test is divided into three directions, X/Y/Z. X pattern for the worst.

LTE BAND 7

LTE Band 7 / 10MHz / QPSK / RB Size 1 Offset 0/ The Worst Test Results for Lowest							
Frequency(MHz)	S G.Lev (dBm)	Ant(dBi)	Loss	PMea	Limit	Margin	Polarity
				(dBm)	(dBm)	(dBm)	
5010.17	-34.11	12.66	12.54	-33.99	-13.00	-20.99	H
7515.60	-34.48	11.46	12.57	-35.59	-13.00	-22.59	H
10020.85	-33.55	12.79	21.23	-41.99	-13.00	-28.99	H
5010.17	-34.73	12.66	12.54	-34.61	-13.00	-21.61	V
7515.60	-34.76	11.46	12.57	-35.87	-13.00	-22.87	V
10020.85	-31.98	12.79	21.23	-40.42	-13.00	-27.42	V
LTE Band 7 / 10MHz / QPSK / RB Size 1 Offset 0/ The Worst Test Results for Middle							
Frequency(MHz)	S G.Lev (dBm)	Ant(dBi)	Loss	PMea	Limit	Margin	Polarity
				(dBm)	(dBm)	(dBm)	
5069.83	-33.79	12.72	12.55	-33.62	-13.00	-20.62	H
7605.12	-35.27	11.46	12.57	-36.38	-13.00	-23.38	H
10140.19	-32.50	12.09	21.25	-41.66	-13.00	-28.66	H
5069.83	-35.87	12.80	12.55	-35.62	-13.00	-22.62	V
7605.12	-35.23	13.10	12.57	-34.70	-13.00	-21.70	V
10140.19	-32.74	12.33	21.25	-41.66	-13.00	-28.66	V
LTE Band 7 / 10MHz / QPSK / RB Size 1 Offset 0/ The Worst Test Results for Highest							
Frequency(MHz)	S G.Lev (dBm)	Ant(dBi)	Loss	PMea	Limit	Margin	Polarity
				(dBm)	(dBm)	(dBm)	
5129.17	-34.44	12.76	12.57	-34.25	-13.00	-21.25	H
7694.58	-34.32	11.45	12.58	-35.45	-13.00	-22.45	H
10258.91	-33.09	12.28	21.27	-42.08	-13.00	-29.08	H
5129.17	-35.28	12.76	12.57	-35.09	-13.00	-22.09	V
7694.58	-33.87	11.45	12.58	-35.00	-13.00	-22.00	V
10258.91	-31.96	12.28	21.27	-40.95	-13.00	-27.95	V

Remark: Spurious emissions within 30-1000MHz were found more than 20dB below limit line.

Test is divided into three directions, X/Y/Z. X pattern for the worst.

LTE BAND 7

LTE Band 7 / 15MHz / QPSK / RB Size 1 Offset 0/ The Worst Test Results for Lowest							
Frequency(MHz)	S G.Lev (dBm)	Ant(dBi)	Loss	PMea	Limit	Margin	Polarity
				(dBm)	(dBm)	(dBm)	
5016.01	-34.42	12.66	12.54	-34.30	-13.00	-21.30	H
7524.15	-35.20	11.46	12.57	-36.31	-13.00	-23.31	H
10032.04	-33.32	12.79	21.23	-41.76	-13.00	-28.76	H
5016.01	-35.42	12.66	12.54	-35.30	-13.00	-22.30	V
7524.15	-34.93	11.46	12.57	-36.04	-13.00	-23.04	V
10032.04	-31.89	12.79	21.23	-40.33	-13.00	-27.33	V
LTE Band 7 / 5MHz / QPSK / RB Size 1 Offset 0/ The Worst Test Results for Middle							
Frequency(MHz)	S G.Lev (dBm)	Ant(dBi)	Loss	PMea	Limit	Margin	Polarity
				(dBm)	(dBm)	(dBm)	
5069.94	-34.88	12.72	12.55	-34.71	-13.00	-21.71	H
7604.87	-35.01	11.46	12.57	-36.12	-13.00	-23.12	H
10140.17	-32.39	12.09	21.25	-41.55	-13.00	-28.55	H
5069.94	-35.74	12.80	12.55	-35.49	-13.00	-22.49	V
7604.87	-34.35	13.10	12.57	-33.82	-13.00	-20.82	V
10140.17	-32.02	12.33	21.25	-40.94	-13.00	-27.94	V
LTE Band 7 / 5MHz / QPSK / RB Size 1 Offset 0/ The Worst Test Results for Highest							
Frequency(MHz)	S G.Lev (dBm)	Ant(dBi)	Loss	PMea	Limit	Margin	Polarity
				(dBm)	(dBm)	(dBm)	
5123.82	-33.58	12.76	12.57	-33.39	-13.00	-20.39	H
7524.06	-34.31	11.45	12.58	-35.44	-13.00	-22.44	H
10032.29	-32.95	12.28	21.27	-41.94	-13.00	-28.94	H
5123.82	-34.55	12.76	12.57	-34.36	-13.00	-21.36	V
7524.06	-33.79	11.45	12.58	-34.92	-13.00	-21.92	V
10032.29	-31.81	12.28	21.27	-40.80	-13.00	-27.80	V

Remark: Spurious emissions within 30-1000MHz were found more than 20dB below limit line.

Test is divided into three directions, X/Y/Z. X pattern for the worst.

LTE BAND 7

LTE Band 7 / 20MHz / QPSK / RB Size 1 Offset 0/ The Worst Test Results for Lowest							
Frequency(MHz)	S G.Lev (dBm)	Ant(dBi)	Loss	PMea	Limit	Margin	Polarity
				(dBm)	(dBm)	(dBm)	
5021.17	-34.67	12.66	12.54	-34.55	-13.00	-21.55	H
7531.26	-34.57	11.46	12.57	-35.68	-13.00	-22.68	H
7523.97	-32.92	12.79	21.23	-41.36	-13.00	-28.36	H
5021.17	-35.50	12.66	12.54	-35.38	-13.00	-22.38	V
7531.26	-34.63	11.46	12.57	-35.74	-13.00	-22.74	V
7523.97	-33.13	12.79	21.23	-41.57	-13.00	-28.57	V
LTE Band 7 / 10MHz / QPSK / RB Size 1 Offset 0/ The Worst Test Results for Middle							
Frequency(MHz)	S G.Lev (dBm)	Ant(dBi)	Loss	PMea	Limit	Margin	Polarity
				(dBm)	(dBm)	(dBm)	
5070.13	-34.42	12.72	12.55	-34.25	-13.00	-21.25	H
7605.17	-34.54	11.46	12.57	-35.65	-13.00	-22.65	H
10139.85	-32.76	12.09	21.25	-41.92	-13.00	-28.92	H
5070.13	-35.40	12.80	12.55	-35.15	-13.00	-22.15	V
7605.17	-35.18	13.10	12.57	-34.65	-13.00	-21.65	V
10139.85	-31.90	12.33	21.25	-40.82	-13.00	-27.82	V
LTE Band 7 / 10MHz / QPSK / RB Size 1 Offset 0/ The Worst Test Results for Highest							
Frequency(MHz)	S G.Lev (dBm)	Ant(dBi)	Loss	PMea	Limit	Margin	Polarity
				(dBm)	(dBm)	(dBm)	
5118.84	-34.43	12.76	12.57	-34.24	-13.00	-21.24	H
7678.19	-34.06	11.45	12.58	-35.19	-13.00	-22.19	H
10237.91	-33.28	12.28	21.27	-42.27	-13.00	-29.27	H
5118.84	-35.53	12.76	12.57	-35.34	-13.00	-22.34	V
7678.19	-33.77	11.45	12.58	-34.90	-13.00	-21.90	V
10237.91	-32.17	12.28	21.27	-41.16	-13.00	-28.16	V

Remark: Spurious emissions within 30-1000MHz were found more than 20dB below limit line.

Test is divided into three directions, X/Y/Z. X pattern for the worst.

LTE BAND 17

LTE Band 17 / 5MHz / QPSK / RB Size 1 Offset 0/ The Worst Test Results for Lowest							
Frequency(MHz)	S G.Lev (dBm)	Ant(dBi)	Loss	PMea	Limit	Margin	Polarity
				(dBm)	(dBm)	(dBm)	
1413.24	-34.27	8.17	9.34	-35.44	-13.00	-22.44	H
2120.62	-34.38	9.53	10.42	-35.27	-13.00	-22.27	H
2826.86	-32.47	11.27	11.12	-32.32	-13.00	-19.32	H
1413.24	-34.89	8.17	9.34	-36.06	-13.00	-23.06	V
2120.62	-35.07	9.53	10.42	-35.96	-13.00	-22.96	V
2826.86	-32.81	11.27	11.12	-32.66	-13.00	-19.66	V
LTE Band 17 / 5MHz / QPSK / RB Size 1 Offset 0/ The Worst Test Results for Middle							
Frequency(MHz)	S G.Lev (dBm)	Ant(dBi)	Loss	PMea	Limit	Margin	Polarity
				(dBm)	(dBm)	(dBm)	
1420.24	-34.75	8.17	9.34	-35.92	-13.00	-22.92	H
2130.07	-35.29	9.53	10.42	-36.18	-13.00	-23.18	H
2840.13	-32.27	11.27	11.12	-32.12	-13.00	-19.12	H
1420.24	-35.86	8.17	9.34	-37.03	-13.00	-24.03	V
2130.07	-33.75	9.53	10.42	-34.64	-13.00	-21.64	V
2840.13	-32.04	11.27	11.12	-31.89	-13.00	-18.89	V
LTE Band 17 / 5MHz / QPSK / RB Size 1 Offset 0/ The Worst Test Results for Highest							
Frequency(MHz)	S G.Lev (dBm)	Ant(dBi)	Loss	PMea	Limit	Margin	Polarity
				(dBm)	(dBm)	(dBm)	
1425.97	-34.67	8.17	9.34	-35.84	-13.00	-22.84	H
2139.15	-34.71	9.53	10.42	-35.60	-13.00	-22.60	H
2852.45	-32.61	11.27	11.12	-32.46	-13.00	-19.46	H
1425.97	-35.17	8.17	9.34	-36.34	-13.00	-23.34	V
2139.15	-34.42	9.53	10.42	-35.31	-13.00	-22.31	V
2852.45	-33.20	11.27	11.12	-33.05	-13.00	-20.05	V

Remark: Spurious emissions within 30-1000MHz were found more than 20dB below limit line.
 Test is divided into three directions, X/Y/Z. X pattern for the worst.

LTE BAND 17

LTE Band 17 / 10MHz / QPSK / RB Size 1 Offset 0/ The Worst Test Results for Lowest							
Frequency(MHz)	S G.Lev (dBm)	Ant(dBi)	Loss	PMea	Limit	Margin	Polarity
				(dBm)	(dBm)	(dBm)	
1418.22	-33.80	8.17	9.34	-34.97	-13.00	-21.97	H
2127.23	-34.13	9.53	10.42	-35.02	-13.00	-22.02	H
2836.84	-33.52	11.27	11.12	-33.37	-13.00	-20.37	H
1418.22	-35.19	8.17	9.34	-36.36	-13.00	-23.36	V
2127.23	-34.04	9.53	10.42	-34.93	-13.00	-21.93	V
2836.84	-31.94	11.27	11.12	-31.79	-13.00	-18.79	V
LTE Band 17 / 10MHz / QPSK / RB Size 1 Offset 0/ The Worst Test Results for Middle							
Frequency(MHz)	S G.Lev (dBm)	Ant(dBi)	Loss	PMea	Limit	Margin	Polarity
				(dBm)	(dBm)	(dBm)	
1419.87	-33.62	8.17	9.34	-34.79	-13.00	-21.79	H
2130.29	-35.45	9.53	10.42	-36.34	-13.00	-23.34	H
2840.14	-33.64	11.27	11.12	-33.49	-13.00	-20.49	H
1419.87	-35.22	8.17	9.34	-36.39	-13.00	-23.39	V
2130.29	-34.35	9.53	10.42	-35.24	-13.00	-22.24	V
2840.14	-32.82	11.27	11.12	-32.67	-13.00	-19.67	V
LTE Band 17 / 10MHz / QPSK / RB Size 1 Offset 0/ The Worst Test Results for Highest							
Frequency(MHz)	S G.Lev (dBm)	Ant(dBi)	Loss	PMea	Limit	Margin	Polarity
				(dBm)	(dBm)	(dBm)	
1420.96	-34.74	8.17	9.34	-35.91	-13.00	-22.91	H
2131.89	-34.75	9.53	10.42	-35.64	-13.00	-22.64	H
2842.52	-32.62	11.27	11.12	-32.47	-13.00	-19.47	H
1420.96	-35.77	8.17	9.34	-36.94	-13.00	-23.94	V
2131.89	-33.99	9.53	10.42	-34.88	-13.00	-21.88	V
2842.52	-33.00	11.27	11.12	-32.85	-13.00	-19.85	V

Remark: Spurious emissions within 30-1000MHz were found more than 20dB below limit line.

Test is divided into three directions, X/Y/Z. X pattern for the worst.

10. FREQUENCY STABILITY

10.1 DESCRIPTION OF FREQUENCY STABILITY MEASUREMENT

10.1.1 MEASUREMENT METHOD

The frequency stability shall be measured by variation of ambient temperature and variation of primary supply voltage to ensure that the fundamental emission stays within the authorized frequency block. The frequency stability of the transmitter shall be maintained within $\pm 0.00025\%$ ($\pm 2.5\text{ppm}$) of the center frequency.

10.1.2 Test Setup

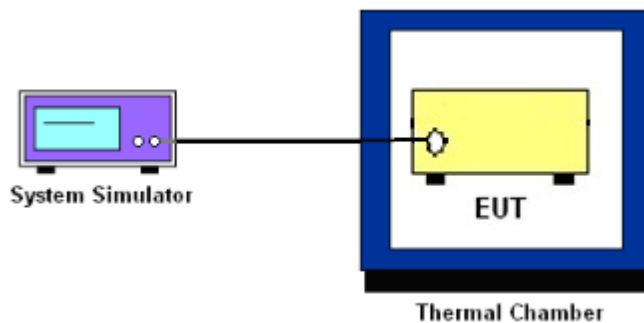

10.1.3 TEST PROCEDURES FOR TEMPERATURE VARIATION

1. The EUT was set up in the thermal chamber and connected with the system simulator.
2. With power OFF, the temperature was decreased to -30°C and the EUT was stabilized before testing. Power was applied and the maximum change in frequency was recorded within one minute.
3. With power OFF, the temperature was raised in 10°C step up to 50°C . The EUT was stabilized at each step for at least half an hour. Power was applied and the maximum frequency change was recorded within one minute.

10.1.4 TEST PROCEDURES FOR VOLTAGE VARIATION

1. The testing follows FCC KDB 971168 v02r02 Section 9.0.
2. The EUT was placed in a temperature chamber at $25\pm 5^{\circ}\text{C}$ and connected with the system simulator.
3. The power supply voltage to the EUT was varied from 85% to 115% of the nominal value measured at the input to the EUT.
4. The variation in frequency was measured for the worst case.

10.1.4 MEASUREMENT RESULT

LTE BAND 2

LTE Band 2 (QPSK) / 1880MHz / BW10M					
Temperature (°C)	Voltage	Freq. Dev.	Freq. Dev.	Limit	Result
	(Volt)	(Hz)	(ppm)		
50	Normal Voltage	24.42	0.013	2.5ppm	PASS
40		25.10	0.013		
30		17.23	0.009		
20		30.39	0.016		
10		18.52	0.010		
0		18.84	0.010		
-10		19.01	0.010		
-20		16.41	0.009		
-30		34.33	0.018		
25		Maximum Voltage	12.65		
25	BEP	15.43	0.008		

LTE Band 2 (QPSK) / 1880MHz / BW20M					
Temperature (°C)	Voltage	Freq. Dev.	Freq. Dev.	Limit	Result
	(Volt)	(Hz)	(ppm)		
50	Normal Voltage	12.53	0.007	2.5ppm	PASS
40		20.32	0.011		
30		34.41	0.018		
20		12.42	0.007		
10		27.49	0.015		
0		13.81	0.007		
-10		30.99	0.016		
-20		32.80	0.017		
-30		36.08	0.019		
25		Maximum Voltage	29.11		
25	BEP	31.88	0.017		

Note: 1. Normal Voltage = 3.8V ; Battery End Point (BEP) = 2.5 V; Maximum Voltage = 4.35 V

2. Note: The frequency fundamental emissions stay within the authorized frequency block based on the frequency deviation measured is small.

LTE BAND 4

LTE Band 4 (QPSK) / 1733MHz / BW10M					
Temperature (°C)	Voltage	Freq. Dev.	Freq. Dev.	Limit	Result
	(Volt)	(Hz)	(ppm)		
50	Normal Voltage	31.70	0.018	2.5ppm	PASS
40		34.49	0.020		
30		14.02	0.008		
20		29.73	0.017		
10		19.62	0.011		
0		24.56	0.014		
-10		11.67	0.007		
-20		12.06	0.007		
-30		32.82	0.019		
25		Maximum Voltage	21.22		
25	BEP	34.35	0.020		

LTE Band 4 (QPSK) / 1733MHz / BW20M					
Temperature (°C)	Voltage	Freq. Dev.	Freq. Dev.	Limit	Result
	(Volt)	(Hz)	(ppm)		
50	Normal Voltage	20.12	0.012	2.5ppm	PASS
40		33.37	0.019		
30		30.72	0.018		
20		17.03	0.010		
10		20.99	0.012		
0		21.06	0.012		
-10		27.55	0.016		
-20		36.12	0.021		
-30		29.39	0.017		
25		Maximum Voltage	15.42		
25	BEP	30.13	0.017		

Note:

1. Normal Voltage = 3.8V ; Battery End Point (BEP) = 2.5 V ; Maximum Voltage = 4.35 V
2. Note: The frequency fundamental emissions stay within the authorized frequency block based on the frequency deviation measured is small.

LTE BAND 7

LTE Band 4 (QPSK) / 2535MHz / BW10M					
Temperature (°C)	Voltage	Freq. Dev.	Freq. Dev.	Limit	Result
	(Volt)	(Hz)	(ppm)		
50	Normal Voltage	25.11	0.010	2.5ppm	PASS
40		15.26	0.006		
30		11.89	0.005		
20		25.79	0.010		
10		21.90	0.009		
0		15.36	0.006		
-10		31.76	0.013		
-20		13.15	0.005		
-30		34.41	0.014		
25		Maximum Voltage	34.19		
25	BEP	28.67	0.011		

LTE Band 4 (QPSK) / 2535MHz / BW20M					
Temperature (°C)	Voltage	Freq. Dev.	Freq. Dev.	Limit	Result
	(Volt)	(Hz)	(ppm)		
50	Normal Voltage	14.37	0.006	2.5ppm	PASS
40		13.60	0.005		
30		23.33	0.009		
20		36.40	0.014		
10		14.11	0.006		
0		15.99	0.006		
-10		22.98	0.009		
-20		15.05	0.006		
-30		18.87	0.007		
25		Maximum Voltage	27.86		
25	BEP	34.15	0.013		

Note: 1. Normal Voltage = 3.8V ; Battery End Point (BEP) = 2.5 V; Maximum Voltage = 4.35 V

2. Note: The frequency fundamental emissions stay within the authorized frequency block based on the frequency deviation measured is small.

LTE BAND 17

LTE Band 17 (QPSK) / 710MHz / BW5M					
Temperature (°C)	Voltage	Freq. Dev.	Freq. Dev.	Limit	Result
	(Volt)	(Hz)	(ppm)		
50	Normal Voltage	31.67	0.045	2.5ppm	PASS
40		33.28	0.047		
30		14.84	0.021		
20		14.14	0.020		
10		33.26	0.047		
0		16.22	0.023		
-10		23.81	0.003		
-20		23.11	0.033		
-30		36.11	0.051		
25		Maximum Voltage	34.72		
25	BEP	27.23	0.038		

LTE Band 17 (QPSK) / 710MHz / BW10M					
Temperature (°C)	Voltage	Freq. Dev.	Freq. Dev.	Limit	Result
	(Volt)	(Hz)	(ppm)		
50	Normal Voltage	29.28	0.041	2.5ppm	PASS
40		13.08	0.018		
30		19.25	0.027		
20		34.92	0.049		
10		19.01	0.027		
0		13.10	0.018		
-10		16.41	0.002		
-20		23.97	0.034		
-30		15.88	0.022		
25		Maximum Voltage	22.84		
25	BEP	15.61	0.022		

Note:

1. Normal Voltage = 3.8V ; Battery End Point (BEP) = 2.5 V ; Maximum Voltage = 4.35 V
2. Note: The frequency fundamental emissions stay within the authorized frequency block based on the frequency deviation measured is small.

PHOTOS OF TEST SETUP

RADIATED SPURIOUS EMISSION



※※※※END OF THE REPORT※※※※