

## FCC PART 15 SUBPART C TEST REPORT

### FCC PART 15.247

**Report Reference No.....: MWR1403002902**  
**FCC ID.....: 2ABOSSKYCOOL**

Compiled by  
 ( position+printed name+signature)..: File administrators Martin Ao



Supervised by  
 ( position+printed name+signature)..: Test Engineer Martin Ao

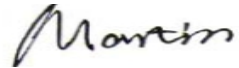

Approved by  
 ( position+printed name+signature)..: Manager Dixon Hao

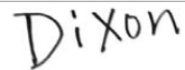

Date of issue.....: Mar 25, 2014

**Representative Laboratory Name : Maxwell International Co., Ltd.**

Address .....: Room 509, Hongfa center building, Baoan District, Shenzhen, Guangdong, China

**Testing Laboratory Name .....: DTT Services Co.,Ltd**

Address .....: 1F,2 Block, Jiaquan Building, Guanlan High-tech Park, Bao'an District, Shenzhen, Guangdong, China. 518110

**Applicant's name.....: SKY PHONE LLC**

Address .....: 1348 Washington Av. Suite 350

**Test specification .....**

Standard .....: **FCC Part 15.247: Operation within the bands 902-928 MHz, 2400-2483.5 MHz and 5725-5850 MHz**

TRF Originator.....: DTT Services Co.,Ltd

Master TRF.....: Dated 2011-05

**DTT Services Co.,Ltd All rights reserved.**

This publication may be reproduced in whole or in part for non-commercial purposes as long as the DTT Services Co.,Ltd as copyright owner and source of the material. DTT Services Co.,Ltd takes no responsibility for and will not assume liability for damages resulting from the reader's interpretation of the reproduced material due to its placement and context.

**Test item description .....** SKY Pocket TV

Trade Mark .....: 

Model/Type reference.....: MG834

Listed Models .....: MG834xy(x:0-9,y:A-Z),MS834,MS834xy(x:0-9,y:A-Z), PRO8340xy(x:0-9,y:A-Z), W100

**Manufacturer.....: SKY PHONE LLC**

Modulation Type.....: GFSK,8DPSK,π/4DQPSK

Operation Frequency.....: From 2402MHz to 2480MHz

Rating .....: DC 3.70V

Hardware version .....: M152-MB-V5.1

Software version .....: V5.1

Result.....: **PASS**

**TEST REPORT**

<b>Test Report No. :</b>	<b>MWR1403002902</b>	Mar 25, 2014
		Date of issue

Equipment under Test : Sky Cool

Model /Type : MG834

Listed Models : MG834xy(x:0-9,y:A-Z),MS834,MS834xy(x:0-9,y:A-Z),  
PRO8340xy(x:0-9,y:A-Z), W100

**Applicant** : **SKY PHONE LLC**

Address : 1348 Washington Av. Suite 350

**Manufacturer** : **SKY PHONE LLC**

Address : 1348 Washington Av. Suite 350

<b>Test Result:</b>	<b>PASS</b>
---------------------	-------------

The test report merely corresponds to the test sample.

It is not permitted to copy extracts of these test result without the written permission of the test laboratory.

## Contents

<b>1.</b>	<b><u>TEST STANDARDS.....</u></b>	<b>4</b>
<b>2.</b>	<b><u>SUMMARY .....</u></b>	<b>5</b>
2.1.	General Remarks	5
2.2.	Product Description	5
2.3.	Equipment Under Test	5
2.4.	Short description of the Equipment under Test (EUT)	5
2.5.	EUT operation mode	5
2.6.	Internal Identification of AE used during the test	6
2.7.	Related Submittal(s) / Grant (s)	7
2.8.	Modifications	7
2.9.	NOTE	7
<b>3.</b>	<b><u>TEST ENVIRONMENT.....</u></b>	<b>8</b>
3.1.	Address of the test laboratory	8
3.2.	Test Facility	8
3.3.	Environmental conditions	8
3.4.	Test Description	8
3.5.	Statement of the measurement uncertainty	8
3.6.	Equipments Used during the Test	9
<b>4.</b>	<b><u>TEST CONDITIONS AND RESULTS.....</u></b>	<b>10</b>
4.1.	AC Power Conducted Emission	10
4.2.	Radiated Emission	12
4.3.	Maximum Peak Output Power	16
4.4.	20dB Bandwidth	23
4.5.	Band Edge	29
4.6.	Frequency Separation	50
4.7.	Number of hopping frequency	57
4.8.	Time Of Occupancy(Dwell Time)	60
4.9.	Spurious RF Conducted Emission	76
4.10.	Pseudorandom Frequency Hopping Sequence	92
4.11.	Antenna Requirement	93
<b>5.</b>	<b><u>TEST SETUP PHOTOS OF THE EUT .....</u></b>	<b>94</b>
<b>6.</b>	<b><u>EXTERNAL AND INTERNAL PHOTOS OF THE EUT .....</u></b>	<b>95</b>

## **1. TEST STANDARDS**

The tests were performed according to following standards:

[FCC Rules Part 15.247](#): Frequency Hopping, Direct Spread Spectrum and Hybrid Systems that are in operation within the bands of 902-928 MHz, 2400-2483.5 MHz, and 5725-5850 MHz.

[ANSI C63.10-2009](#): American National Standard for Testing Unlicensed Wireless Devices

## 2. SUMMARY

### 2.1. General Remarks

Date of receipt of test sample	:	Mar 10, 2014
Testing commenced on	:	Mar 10, 2014
Testing concluded on	:	Mar 25, 2014

### 2.2. Product Description

The **SKY PHONE LLC**'s Model: MG384 or the "EUT" as referred to in this report; more general information as follows, for more details, refer to the user's manual of the EUT.

Name of EUT	Sky Cool
Model Number	MG834, MG834xy(x:0-9,y:A-Z),MS834,MS834xy(x:0-9,y:A-Z), PRO8340xy(x:0-9,y:A-Z), W100
FCC ID	2ABOSSKYCOOL
Modulation Type	GMSK for GSM/GPRS
Antenna Type	External
GSM/EDGE/GPRS	Supported GPRS
Extreme temp. Tolerance	-30°C to +50°C
Extreme vol. Limits	3.40VDC to 4.20VDC (nominal: 3.70VDC)
GSM Operation Frequency Band	GSM 850MHz/ PCS 1900MHz
GSM Release Version	R99
GPRS operation mode	Class B
GPRS Multislot Class	12
EGPRS Multislot Class	Not Supported

### 2.3. Equipment Under Test

#### Power supply system utilised

Power supply voltage	:	<input type="radio"/> 120V / 60 Hz	<input type="radio"/> 115V / 60Hz
		<input type="radio"/> 12 V DC	<input type="radio"/> 24 V DC
		<input checked="" type="radio"/> Other (specified in blank below)	

DC 3.70V

### 2.4. Short description of the Equipment under Test (EUT)

2.4GHz (SKY COOL (M/N: MG834))

For more details, refer to the user's manual of the EUT.

### 2.5. EUT operation mode

The EUT has been tested under typical operating condition. There are EDR (Enhanced Data Rate) and BDR (Basic Data Rate) mode. The Applicant provides communication tools software to control the EUT for staying in continuous transmitting and receiving mode for testing. There are 79 channels of EUT, and the test carried out at the lowest channel, middle channel and highest channel .

Channel	Frequency(MHz)	Channel	Frequency(MHz)
0	2402	40	2442
1	2403	41	2443
2	2404	42	2444
3	2405	43	2445
4	2406	44	2446
5	2407	45	2447
6	2408	46	2448
7	2409	47	2449
8	2410	48	2450
9	2411	49	2451
10	2412	50	2452
11	2413	51	2453
12	2414	52	2454
13	2415	53	2455
14	2416	54	2456
15	2417	55	2457
16	2418	56	2458
17	2419	57	2459
18	2420	58	2460
19	2421	59	2461
20	2422	60	2462
21	2423	61	2463
22	2424	62	2464
23	2425	63	2465
24	2426	64	2466
25	2427	65	2467
26	2428	66	2468
27	2429	67	2469
28	2430	68	2470
29	2431	69	2471
30	2432	70	2472
31	2433	71	2473
32	2434	72	2474
33	2435	73	2475
34	2436	74	2476
35	2437	75	2477
36	2438	76	2478
37	2439	77	2479
38	2440	78	2480
39	2441		

**2.6. Internal Identification of AE used during the test**

AE ID*	Description
AE1	Battery
AE2	Charger

AE1

Model: MG834  
 Manufacturer: SKY PHONE LLC  
 Capacitance: 800mAh  
 Nominal Voltage: 3.70V

AE2:

Model: MG834  
 Manufacturer: SKY PHONE LLC

\*AE ID: is used to identify the test sample in the lab internally.

## 2.7. Related Submittal(s) / Grant (s)

This submittal(s) (test report) is intended for **FCC ID: 2ABOSSKYCOOL** filing to comply with Section 15.247 of the FCC Part 15, Subpart C Rules.

## 2.8. Modifications

No modifications were implemented to meet testing criteria.

## 2.9. NOTE

1. The EUT is a Sky Cool with GSM/GPRS, WiFi and Bluetooth function, The functions of the EUT listed as below:

	Test Standards	Reference Report
GSM/GPRS	FCC Part 22/FCC Part 24	MWR1403002901
Bluetooth	FCC Part 15 C 15.247	MWR1403002902
WiFi	FCC Part 15 C 15.247	MWR1403002903
USB Port	FCC Part 15 B	MWR1403002904
SAR	FCC Part 2 §2.1093	MWR1403002905

### 3. TEST ENVIRONMENT

#### 3.1. Address of the test laboratory

**DTT Services Co.,Ltd**  
 1F,2 Block, Jiaquan Building, Guanlan High-tech Park, Bao'an District, Shenzhen, Guangdong, China.  
 518110  
 The sites are constructed in conformance with the requirements of ANSI C63.7, ANSI C63.4 (2003) and CISPR Publication 22.

#### 3.2. Test Facility

The test facility is recognized, certified, or accredited by the following organizations:

##### IC Registration No.: 9783A

The 3m alternate test site of DTT Services Co.,Ltd EMC Laboratory has been registered by Certification and Engineer Bureau of Industry Canada for the performance of with Registration NO.: 9783A on Aug, 2011.

##### FCC-Registration No.: 214666

DTT Services Co.,Ltd EMC Laboratory has been registered and fully described in a report filed with the (FCC) Federal Communications Commission. The acceptance letter from the FCC is maintained in our files. Registration 214666, Sep 19, 2011

#### 3.3. Environmental conditions

During the measurement the environmental conditions were within the listed ranges:

Temperature:	<u>15-35 ° C</u>
Humidity:	<u>30-60 %</u>
Atmospheric pressure:	<u>950-1050mbar</u>

#### 3.4. Test Description

FCC PART 15 15.247		
FCC Part 15.207	AC Power Conducted Emission	PASS
FCC Part 15.247(a)(1)(i)	20dB Bandwidth	PASS
FCC Part 15.247(d)	Spurious RF Conducted Emission	PASS
FCC Part 15.247(b)	Maximum Peak Output Power	PASS
FCC Part 15.247(b)	Pseudorandom Frequency Hopping Sequence	PASS
FCC Part 15.247(a)(1)(iii)	Number of hopping frequency& Time of Occupancy	PASS
FCC Part 15.247(a)(1)	Frequency Separation	PASS
FCC Part 15.109/ 15.205/ 15.209	Radiated Emissions	PASS
FCC Part 15.247(d)	Band Edge Compliance of RF Emission	PASS
FCC Part 15.203/15.247 (b)	Antenna Requirement	PASS

Remark: The measurement uncertainty is not included in the test result.

#### 3.5. Statement of the measurement uncertainty

The data and results referenced in this document are true and accurate. The reader is cautioned that there may be errors within the calibration limits of the equipment and facilities. The measurement uncertainty was calculated for all measurements listed in this test report acc. to CISPR 16 - 4 „Specification for radio disturbance and immunity measuring apparatus and methods – Part 4: Uncertainty in EMC Measurements“ and is documented in the DTT Services Co.,Ltd quality system acc. to DIN EN ISO/IEC 17025. Furthermore, component and process variability of devices similar to that tested may result in additional deviation. The manufacturer has the sole responsibility of continued compliance of the device.



Hereafter the best measurement capability for DTT Services Co.,Ltd laboratory is reported:

Test Items	Measurement Uncertainty	Notes
Transmitter power conducted	0.57 dB	(1)
Transmitter power Radiated	2.20 dB	(1)
Conducted spurious emission 9KHz-40 GHz	1.60 dB	(1)
Radiated spurious emission 9KHz-40 GHz	2.20 dB	(1)
Conducted Emission 9KHz-30MHz	3.39 dB	(1)
Radiated Emission 30~1000MHz	4.24 dB	(1)
Radiated Emissio 1~18GHz	5.16 dB	(1)
Radiated Emissio 18-40GHz	5.54 dB	(1)
Occupied Bandwidth	-----	(1)

(1) This uncertainty represents an expanded uncertainty expressed at approximately the 95% confidence level using a coverage factor of k=1.96.

### 3.6. Equipments Used during the Test

AC Power Conducted Emission					
Item	Test Equipment	Manufacturer	Model No.	Serial No.	Last Cal.
1	Artificial Mains	Rohde&Schwarz	ESH2-Z5	100028	2013/10/26
2	EMI Test Receiver	Rohde&Schwarz	ESCI3	100038	2013/10/26
3	Pulse Limiter	Rohde&Schwarz	ESHSZ2	100044	2013/10/26
4	EMI Test Software	Rohde&Schwarz	ES-K1 V1.71	N/A	N/A

Radiated Emission					
Item	Test Equipment	Manufacturer	Model No.	Serial No.	Last Cal.
1	Ultra-Broadband Antenna	ShwarzBeck	VULB9163	538	2013/10/27
2	EMI TEST RECEIVER	Rohde&Schwarz	ESI 26	100009	2013/10/25
3	EMI TEST Software	Audix	E3	N/A	N/A
4	EMI TEST Software	Rohde&Schwarz	ESK1	N/A	N/A
5	HORN ANTENNA	ShwarzBeck	9120D	1011	2013/10/27
6	Amplifer	Sonoma	310N	E009-13	2013/10/27
7	Preamplifier	ShwarzBeck	BBV 9718	BBV 9718	2013/10/25
8	High pass filter	Compliance Direction systems	BSU-6	34202	2013/10/25
9	Amplifer	Compliance Direction systems	PAP1-4060	120	2013/10/26
10	Loop Antenna	Rohde&Schwarz	HFH2-Z2	100020	2013/10/25
11	TURNTABLE	MATURO	TT2.0	----	N/A
12	ANTENNA MAST	MATURO	TAM-4.0-P	----	N/A
13	Horn Antenna	SCHWARZBECK	BBHA9170	25841	2013/10/27

Maximum Peak Output Power / Power Spectral Density / 6dB Bandwidth / Band Edge Compliance of RF Emission / Spurious RF Conducted Emission					
Item	Test Equipment	Manufacturer	Model No.	Serial No.	Last Cal.
1	Spectrum Analyzer	Rohde&Schwarz	FSU26	201141	2013/10/25

The Cal.Interval was one year

## 4. TEST CONDITIONS AND RESULTS

### 4.1. AC Power Conducted Emission

#### TEST CONFIGURATION

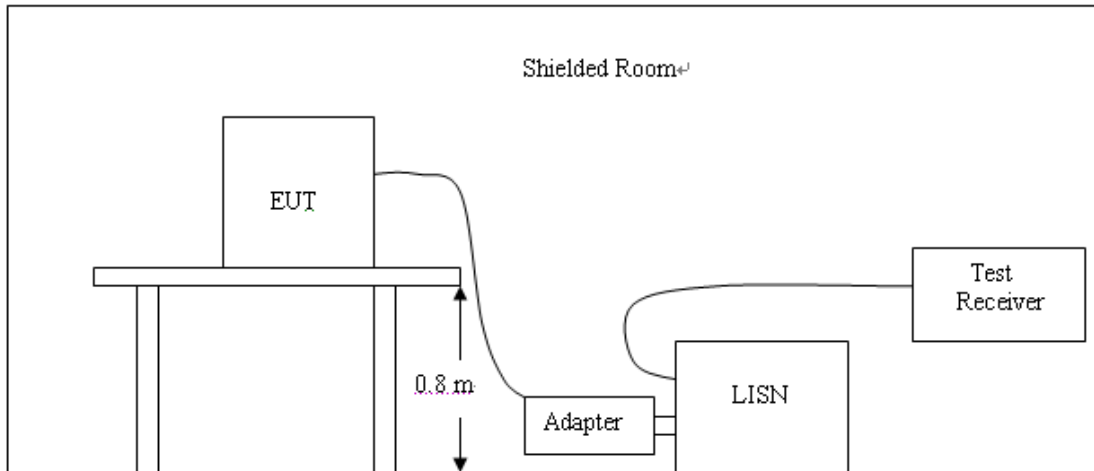

#### TEST PROCEDURE

1. The equipment was set up as per the test configuration to simulate typical actual usage per the user's manual. The EUT is a tabletop system, a wooden table with a height of 0.8 meters is used and is placed on the ground plane as per ANSI C63.10-2009.
2. Support equipment, if needed, was placed as per ANSI C63.10-2009
3. All I/O cables were positioned to simulate typical actual usage as per ANSI C63.10-2009
4. The EUT received DC5V power from the adapter, the adapter received AC120V/60Hz power through a Line Impedance Stabilization Network (LISN) which supplied power source and was grounded to the ground plane.
5. All support equipments received AC power from a second LISN, if any.
6. The EUT test program was started. Emissions were measured on each current carrying line of the EUT using a spectrum Analyzer / Receiver connected to the LISN powering the EUT. The LISN has two monitoring points: Line 1 (Hot Side) and Line 2 (Neutral Side). Two scans were taken: one with Line 1 connected to Analyzer / Receiver and Line 2 connected to a 50 ohm load; the second scan had Line 1 connected to a 50 ohm load and Line 2 connected to the Analyzer / Receiver.
7. Analyzer / Receiver scanned from 150 KHz to 30MHz for emissions in each of the test modes.
8. During the above scans, the emissions were maximized by cable manipulation.

#### AC Power Conducted Emission Limit

For intentional device, according to § 15.207(a) AC Power Conducted Emission Limits is as following :

Frequency (MHz)	Maximum RF Line Voltage (dBµV)			
	CLASS A		CLASS B	
	Q.P.	Ave.	Q.P.	Ave.
0.15 - 0.50	79	66	66-56*	56-46*
0.50 - 5.00	73	60	56	46
5.00 - 30.0	73	60	60	50

\* Decreasing linearly with the logarithm of the frequency

#### TEST RESULTS

Remark: We tested all mode and recorded worst case at GFSK mode.

**SCAN TABLE: "Voltage (9K-30M) FIN"**  
 Short Description: 150K-30M Voltage

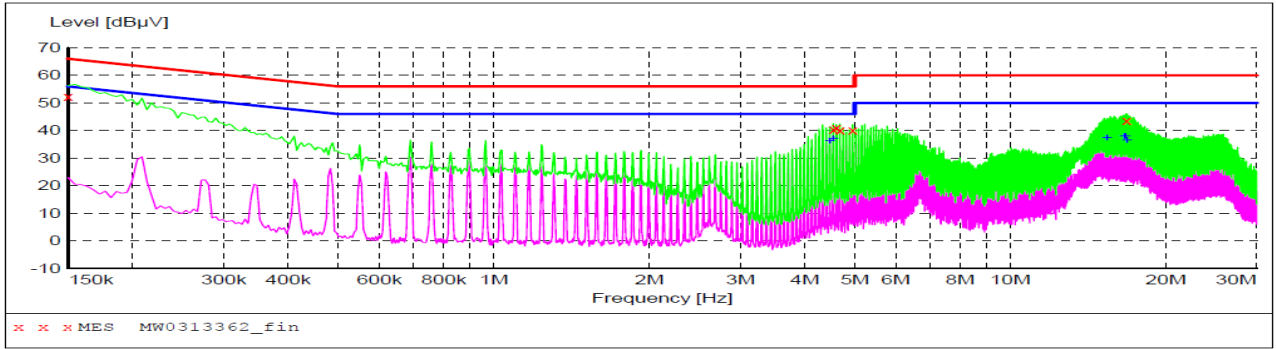

**MEASUREMENT RESULT: "MW0313362\_fin"**

3/13/2014 9:01PM

Frequency MHz	Level dBµV	Transd dB	Limit dBµV	Margin dB	Detector	Line	PE
0.150000	52.40	10.1	66	13.6	QP	N	GND
4.542000	40.40	10.2	56	15.6	QP	N	GND
4.609500	40.90	10.2	56	15.1	QP	N	GND
4.681500	40.10	10.2	56	15.9	QP	N	GND
4.956000	40.10	10.2	56	15.9	QP	N	GND
16.791000	43.50	10.7	60	16.5	QP	N	GND

**MEASUREMENT RESULT: "MW0313362\_fin2"**

3/13/2014 9:01PM

Frequency MHz	Level dBµV	Transd dB	Limit dBµV	Margin dB	Detector	Line	PE
4.474500	36.10	10.2	46	9.9	AV	N	GND
4.542000	37.00	10.2	46	9.0	AV	N	GND
15.414000	37.20	10.7	50	12.8	AV	N	GND
16.651500	37.90	10.7	50	12.1	AV	N	GND
16.719000	37.80	10.7	50	12.2	AV	N	GND
16.854000	36.50	10.7	50	13.5	AV	N	GND

**SCAN TABLE: "Voltage (9K-30M) FIN"**  
 Short Description: 150K-30M Voltage

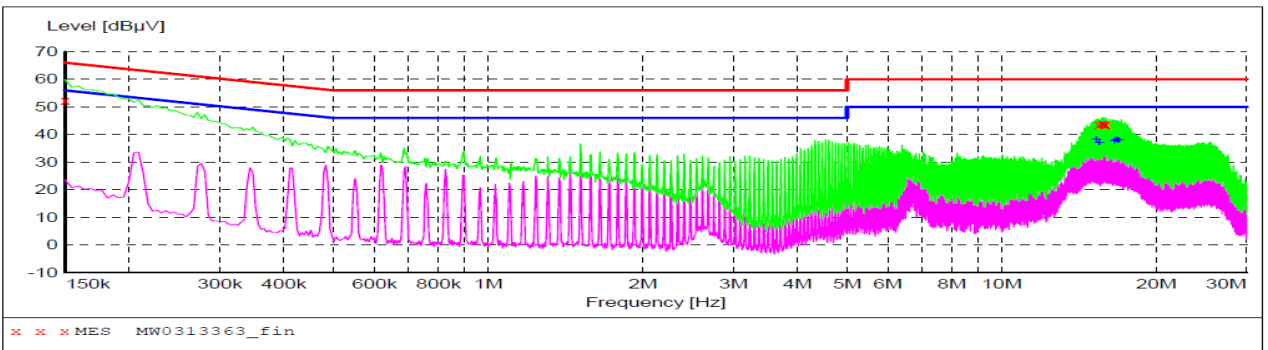

**MEASUREMENT RESULT: "MW0313363\_fin"**

3/13/2014 9:04PM

Frequency MHz	Level dBµV	Transd dB	Limit dBµV	Margin dB	Detector	Line	PE
0.150000	52.40	10.1	66	13.6	QP	L1	GND
15.477000	43.60	10.7	60	16.4	QP	L1	GND
15.684000	43.80	10.7	60	16.2	QP	L1	GND
15.756000	44.00	10.7	60	16.0	QP	L1	GND
15.891000	43.60	10.7	60	16.4	QP	L1	GND
15.963000	43.50	10.7	60	16.5	QP	L1	GND

**MEASUREMENT RESULT: "MW0313363\_fin2"**

3/13/2014 9:04PM

Frequency MHz	Level dBµV	Transd dB	Limit dBµV	Margin dB	Detector	Line	PE
15.274500	38.20	10.6	50	11.8	AV	L1	GND
15.477000	36.90	10.7	50	13.1	AV	L1	GND
16.584000	37.60	10.7	50	12.4	AV	L1	GND
16.719000	38.20	10.7	50	11.8	AV	L1	GND
16.858500	37.80	10.7	50	12.2	AV	L1	GND
16.926000	37.80	10.7	50	12.2	AV	L1	GND

## 4.2. Radiated Emission

### TEST CONFIGURATION

Radiated Emission Test Set-Up

Frequency range 9KHz – 30MHz

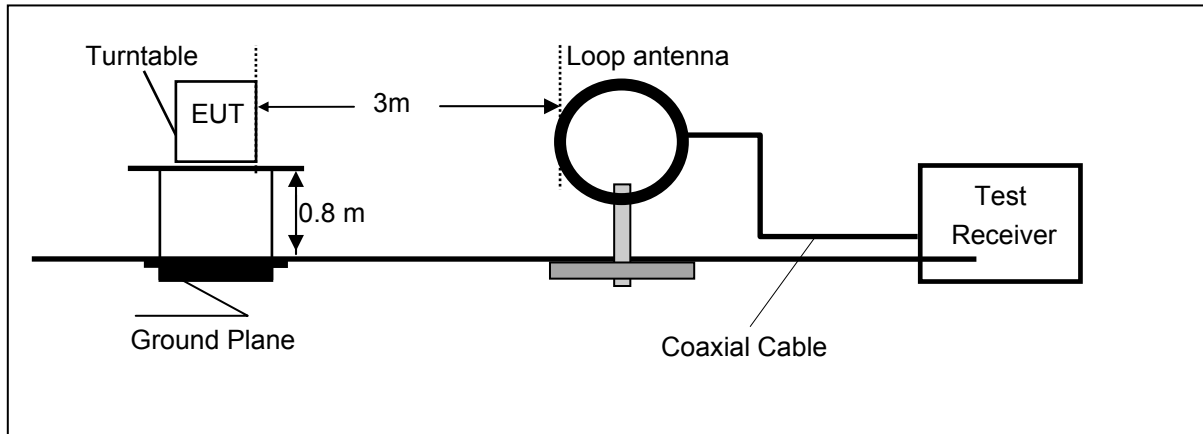

Frequency range 30MHz – 1000MHz

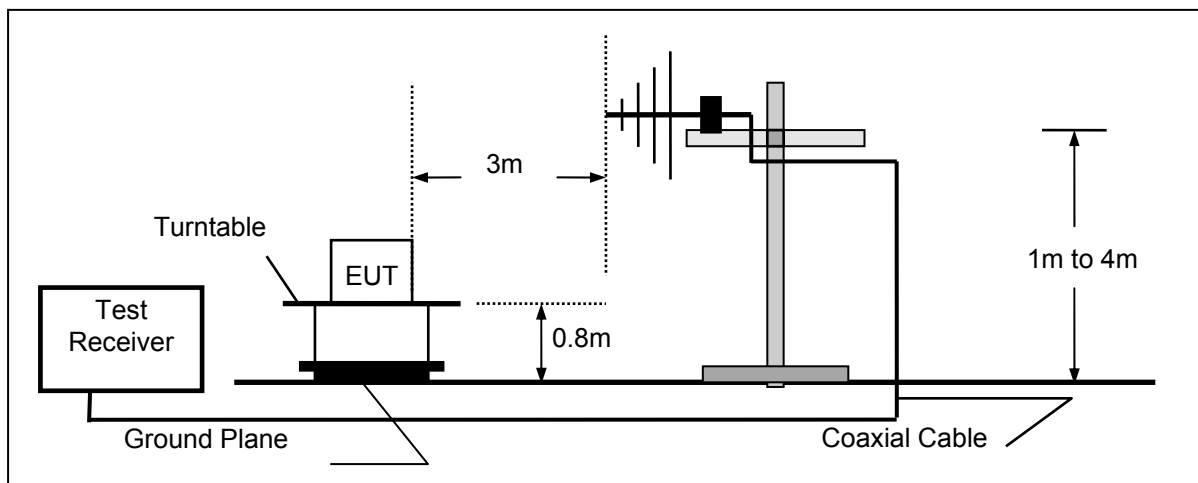

Frequency range above 1GHz-25GHz

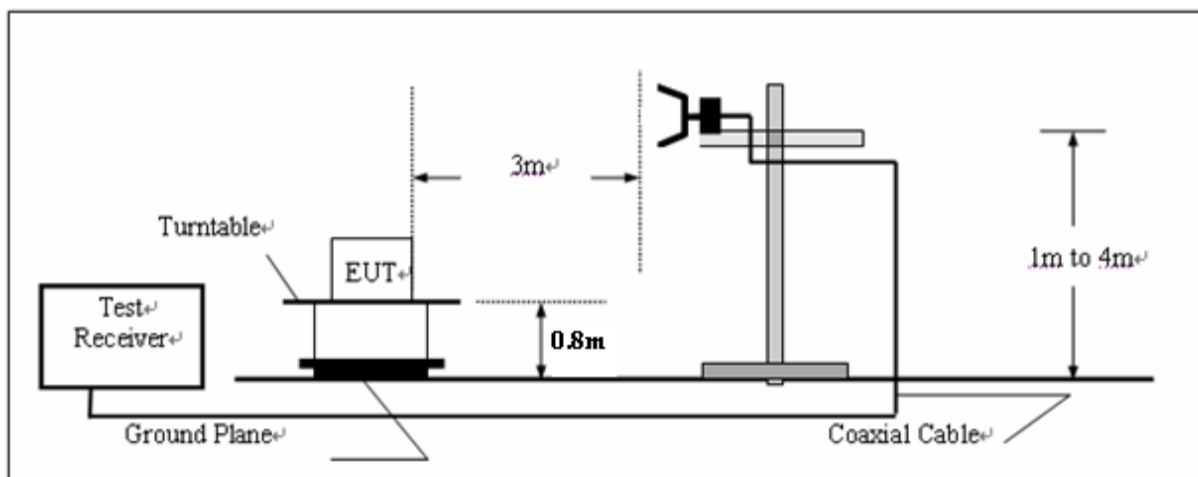

### TEST PROCEDURE

1. The EUT was placed on a turn table which is 0.8m above ground plane.

2. Maximum procedure was performed by raising the receiving antenna from 1m to 4m and rotating the turn table from 0° to 360° to acquire the highest emissions from EUT
3. And also, each emission was to be maximized by changing the polarization of receiving antenna both horizontal and vertical.
4. Repeat above procedures until all frequency measurements have been completed.
5. The EUT minimum operation frequency was 32.768kHz and maximum operation frequency was 2480MHz. so radiated emission test frequency band from 9KHz to 25GHz.

**Field Strength Calculation**

The field strength is calculated by adding the Antenna Factor and Cable Factor and subtracting the Amplifier Gain and Duty Cycle Correction Factor(if any) from the measured reading. The basic equation with a sample calculation is as follows:

$$FS = RA + AF + CL - AG$$

Where FS = Field Strength	CL = Cable Attenuation Factor (Cable Loss)
RA = Reading Amplitude	AG = Amplifier Gain
AF = Antenna Factor	

For example

Frequency (MHz)	FS (dBµV/m)	RA (dBµV/m)	AF (dB)	CL (dB)	AG (dB)	Transd (dB)
300.00	40	58.1	12.2	1.6	31.90	-18.1

$$Transd = AF + CL - AG$$

**RADIATION LIMIT**

For intentional device, according to § 15.209(a), the general requirement of field strength of radiated emission from intentional radiators at a distance of 3 meters shall not exceed the following table. According to § 15.247(d), in any 100kHz bandwidth outside the frequency band in which the EUT is operating, the radio frequency power that is produced by the intentional radiator shall be at least 20dB below that in the 100kHz bandwidth within the band that contains the highest level of desired power.

The frequency spectrum above 1 GHz for Transmitter was investigated. All emission not reported are much lower than the prescribed limits. Set the RBW=1MHz, VBW=3MHz for Peak Detector while the RBW=1MHz, VBW=10Hz for Average Detector, Readings are both peak and average values. The pre-test have done for the EUT in three axes and found the worst emission at position shown in test setup photos.

Frequency (MHz)	Distance (Meters)	Radiated (dBµV/m)	Radiated (µV/m)
30-88	3	40.0	100
88-216	3	43.5	150
216-960	3	46.0	200
Above 960	3	54.0	500

**TEST RESULTS**

Note: 1. We tested both battery powered and charging mode at three orientations, recorded worst case at charging mode.

2. We tested all modes and recorded worst case at GFSK mode.

**For 9KHz to 30MHz**

Frequency (MHz)	Corrected Reading (dBµV/m)@3m	FCC Limit (dBµV/m) @3m	Margin (dB)	Detector	Result
12.00	45.67	69.54	23.87	QP	PASS
24.00	48.23	69.54	21.31	QP	PASS

For 30MHz to 1000MHz

**SCAN TABLE: "test Field(30M-1G)OP"**

Short Description:		Field Strength(30M-1G)				
Start	Stop	Step	Detector	Meas. Time	IF Bandw.	Transducer
Frequency	Frequency	Width				
30.0 MHz	1.0 GHz	60.0 kHz	QuasiPeak	1.0 s	120 kHz	VULB9163

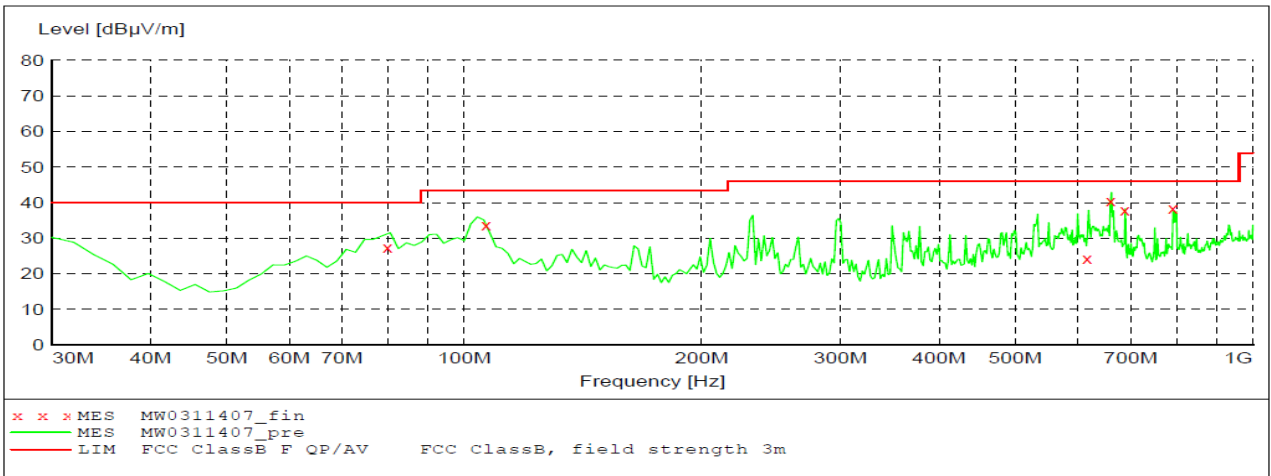

**MEASUREMENT RESULT: "MW0311407\_fin"**

3/11/2014 9:51PM

Frequency MHz	Level dBµV/m	Transd dB	Limit dBµV/m	Margin dB	Det.	Height cm	Azimuth deg	Polarization
79.920000	27.30	-22.6	40.0	12.7	QP	350.0	178.00	HORIZONTAL
106.680000	33.60	-19.2	43.5	9.9	QP	250.0	188.00	HORIZONTAL
616.620000	24.20	-12.5	46.0	21.8	QP	100.0	192.00	HORIZONTAL
660.420000	40.60	-11.0	46.0	5.4	QP	139.0	159.00	HORIZONTAL
688.080000	37.90	-10.9	46.0	8.1	QP	100.0	141.00	HORIZONTAL
792.480000	38.40	-8.7	46.0	7.6	QP	114.0	176.00	HORIZONTAL

**SCAN TABLE: "test Field(30M-1G)OP"**

Short Description:		Field Strength(30M-1G)				
Start	Stop	Step	Detector	Meas. Time	IF Bandw.	Transducer
Frequency	Frequency	Width				
30.0 MHz	1.0 GHz	60.0 kHz	QuasiPeak	1.0 s	120 kHz	VULB9163

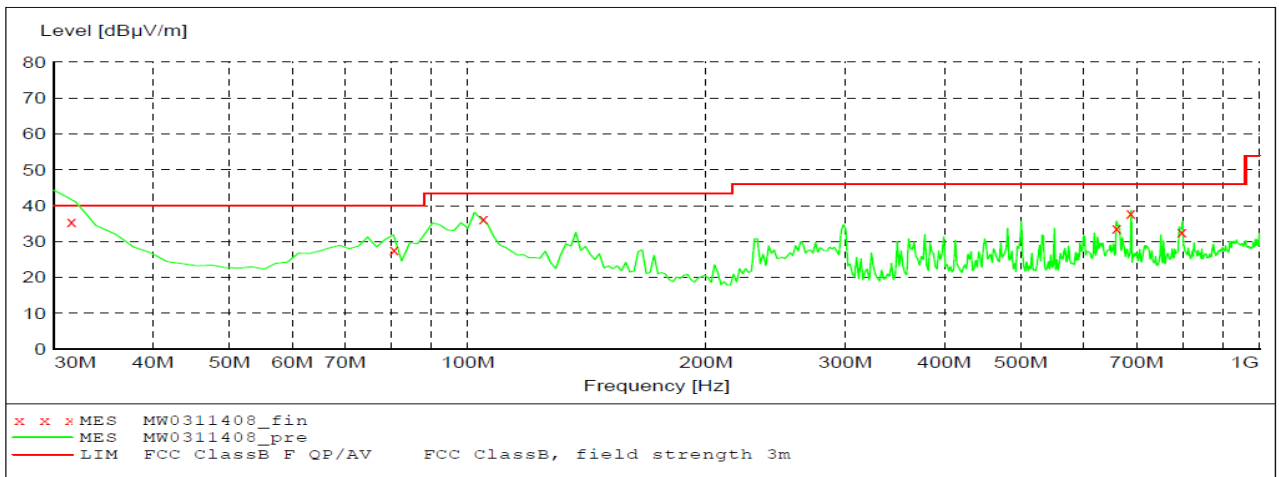

**MEASUREMENT RESULT: "MW0311408\_fin"**

3/11/2014 10:05PM

Frequency MHz	Level dBµV/m	Transd dB	Limit dBµV/m	Margin dB	Det.	Height cm	Azimuth deg	Polarization
31.560000	35.50	-11.0	40.0	4.5	QP	100.0	235.00	VERTICAL
80.760000	27.60	-22.5	40.0	12.4	QP	100.0	238.00	VERTICAL
104.700000	36.40	-19.3	43.5	7.1	QP	100.0	263.00	VERTICAL
660.420000	33.80	-11.0	46.0	12.2	QP	114.0	222.00	VERTICAL
688.080000	37.90	-10.9	46.0	8.1	QP	100.0	156.00	VERTICAL
798.900000	32.70	-8.8	46.0	13.3	QP	100.0	173.00	VERTICAL

For 1GHz to 25GHz

**Low Channel @ Channel 00 @ 2402 MHz**

ANTENNA POLARITY & TEST DISTANCE: HORIZONTAL AT 3 M												
No.	Frequency (MHz)	Emission Level (dBuV/m)		Limit (dBuV/m)	Margin (dB)	Antenna Height (m)	Table Angle (Degree)	Raw Value (dBuV)	Antenna Factor (dB/m)	Cable Factor (dB)	Pre-amplifier	Correction Factor (dB/m)
1	4804.00	58.68	PK	74.00	15.32	1.00 H	257	56.60	31.58	7.00	36.5	2.08
2	4804.00	39.67	AV	54.00	14.33	1.00 H	257	37.59	31.58	7.00	36.5	2.08
3	7206.00	50.73	PK	74.00	23.27	1.00 H	45	40.07	37.06	8.90	35.3	10.66

ANTENNA POLARITY & TEST DISTANCE: VERTICAL AT 3 M												
No.	Frequency (MHz)	Emission Level (dBuV/m)		Limit (dBuV/m)	Margin (dB)	Antenna Height (m)	Table Angle (Degree)	Raw Value (dBuV)	Antenna Factor (dB/m)	Cable Factor (dB)	Pre-amplifier	Correction Factor (dB/m)
1	4804.00	55.14	PK	74.00	18.86	1.00 V	48	53.06	31.58	7.00	36.5	2.08
2	4804.00	38.69	AV	54.00	15.31	1.00 V	48	36.61	31.58	7.00	36.5	2.08
3	7206.00	47.38	PK	74.00	26.62	1.00 V	35	36.72	37.06	8.90	35.3	10.66

**Middle Channel @ Channel 39 @ 2441 MHz**

ANTENNA POLARITY & TEST DISTANCE: HORIZONTAL AT 3 M												
No.	Frequency (MHz)	Emission Level (dBuV/m)		Limit (dBuV/m)	Margin (dB)	Antenna Height (m)	Table Angle (Degree)	Raw Value (dBuV)	Antenna Factor (dB/m)	Cable Factor (dB)	Pre-amplifier	Correction Factor (dB/m)
1	4882.00	56.31	PK	74.00	17.69	1.00 H	179	54.17	31.04	7.60	36.5	2.14
2	4882.00	37.58	AV	54.00	16.42	1.00 H	179	35.44	31.04	7.60	36.5	2.14
3	7323.00	41.73	PK	74.00	32.27	1.00 H	67	30.59	37.84	8.60	35.3	11.14

ANTENNA POLARITY & TEST DISTANCE: VERTICAL AT 3 M												
No.	Frequency (MHz)	Emission Level (dBuV/m)		Limit (dBuV/m)	Margin (dB)	Antenna Height (m)	Table Angle (Degree)	Raw Value (dBuV)	Antenna Factor (dB/m)	Cable Factor (dB)	Pre-amplifier	Correction Factor (dB/m)
1	4882.00	57.31	PK	74.00	16.69	1.00 V	180	55.17	31.04	7.60	36.5	2.14
2	4882.00	38.47	AV	54.00	15.53	1.00 V	180	36.33	31.04	7.60	36.5	2.14
3	7323.00	46.72	PK	74.00	27.28	1.00 V	67	35.58	37.84	8.60	35.3	11.14

**High Channel @ Channel 78 @ 2480 MHz**

ANTENNA POLARITY & TEST DISTANCE: HORIZONTAL AT 3 M												
No.	Frequency (MHz)	Emission Level (dBuV/m)		Limit (dBuV/m)	Margin (dB)	Antenna Height (m)	Table Angle (Degree)	Raw Value (dBuV)	Antenna Factor (dB/m)	Cable Factor (dB)	Pre-amplifier	Correction Factor (dB/m)
1	4960.00	56.79	PK	74.00	17.21	1.00 H	54	54.36	31.63	7.00	36.2	2.43
2	4960.00	38.76	AV	54.00	15.24	1.00 H	54	36.33	31.63	7.00	36.2	2.43
3	7340.00	48.45	PK	74.00	25.55	1.00 H	135	36.85	38.40	8.50	35.3	11.60

ANTENNA POLARITY & TEST DISTANCE: VERTICAL AT 3 M												
No.	Frequency (MHz)	Emission Level (dBuV/m)		Limit (dBuV/m)	Margin (dB)	Antenna Height (m)	Table Angle (Degree)	Raw Value (dBuV)	Antenna Factor (dB/m)	Cable Factor (dB)	Pre-amplifier	Correction Factor (dB/m)
1	4960.00	57.68	PK	74.00	16.32	1.00 V	57	55.25	31.63	7.00	-36.2	2.43
2	4960.00	37.72	AV	54.00	16.28	1.00 V	57	35.29	31.63	7.00	-36.2	2.43
3	7340.00	51.29	PK	74.00	22.71	1.00 V	384	39.69	38.40	8.50	-35.3	11.60

**REMARKS:**

1. Emission level (dBuV/m) = Raw Value (dBuV) + Correction Factor (dB/m)
2. Correction Factor (dB/m) = Antenna Factor (dB/m) + Cable Factor (dB) - Pre-amplifier Factor
3. The other emission levels were very low against the limit.
4. Margin value = Limit value - Emission level.
5. The average measurement was not performed when the peak measured data under the limit of average detection.



### 4.3. Maximum Peak Output Power

#### TEST CONFIGURATION

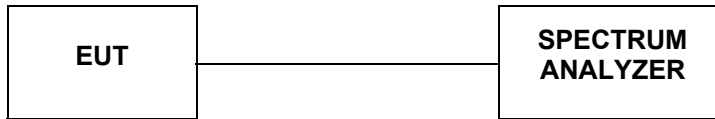

#### TEST PROCEDURE

According to ANSI C63.10:2009 Maximum peak conducted output power

1. Set the RBW =3MHz.
2. Set VBW  $\geq$  3RBW
3. Set span  $\geq$  3RBW
4. Sweep time = auto couple
5. Detector = peak
6. Trace mode = max hold
7. Allow trace to fully stabilize
8. Use peak marker function to determine the peak amplitude level

#### LIMIT

The Maximum Peak Output Power Measurement is 30dBm.

#### TEST RESULTS

##### 4.3.1 GFSK Test Mode

###### A. Test Verdict

Channel	Frequency (MHz)	Measured Output Peak Power (dBm)	Refer to Plot	Limits (dBm)	Verdict
00	2402	-0.59	Plot 4.3.1 A	30	PASS
39	2441	-0.83	Plot 4.3.1 B	30	PASS
78	2480	-0.71	Plot 4.3.1 C	30	PASS

Note: 1.The test results including the cable lose.

###### B. Test Plots



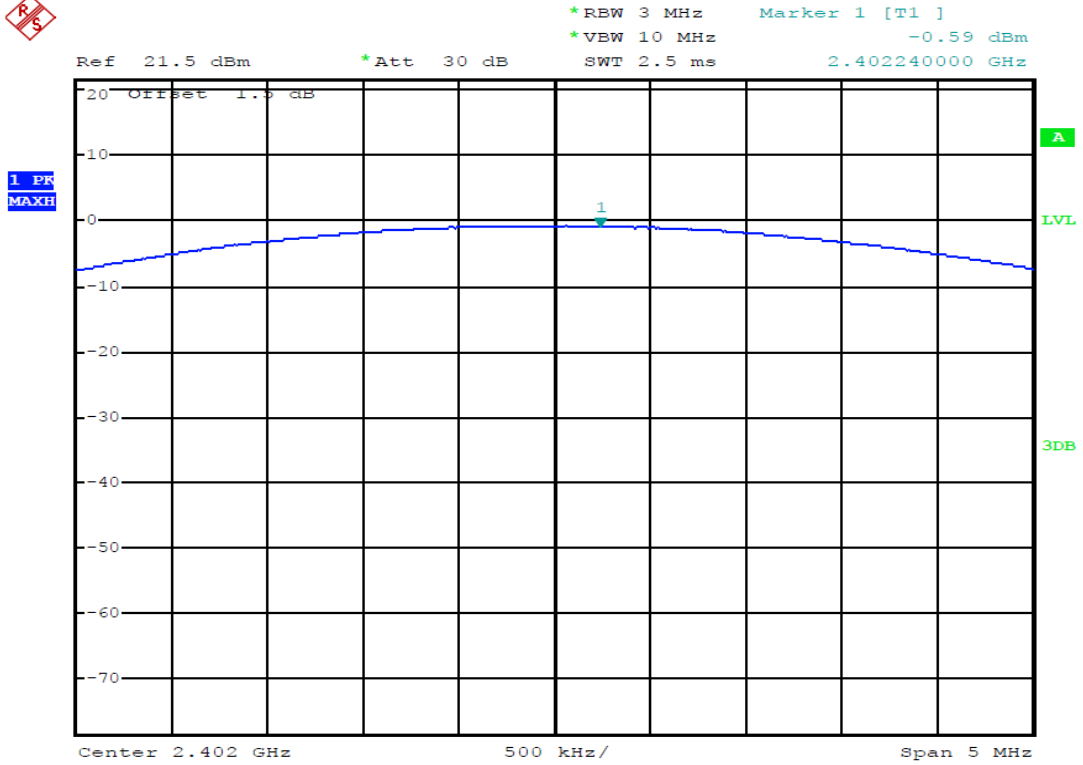

Date: 20.MAR.2014 20:51:58

(Plot 4.3.1 A: Channel 00: 2402MHz @ GFSK)

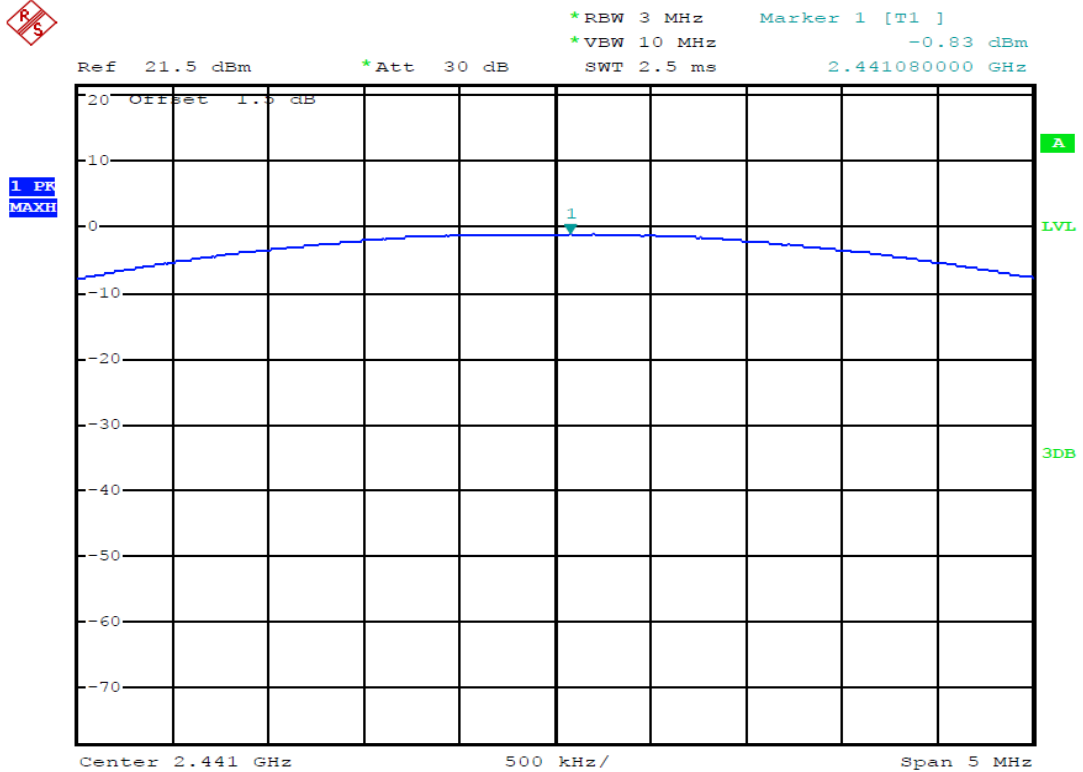

Date: 20.MAR.2014 20:52:31

(Plot 4.3.1 B: Channel 39: 2441MHz @ GFSK)

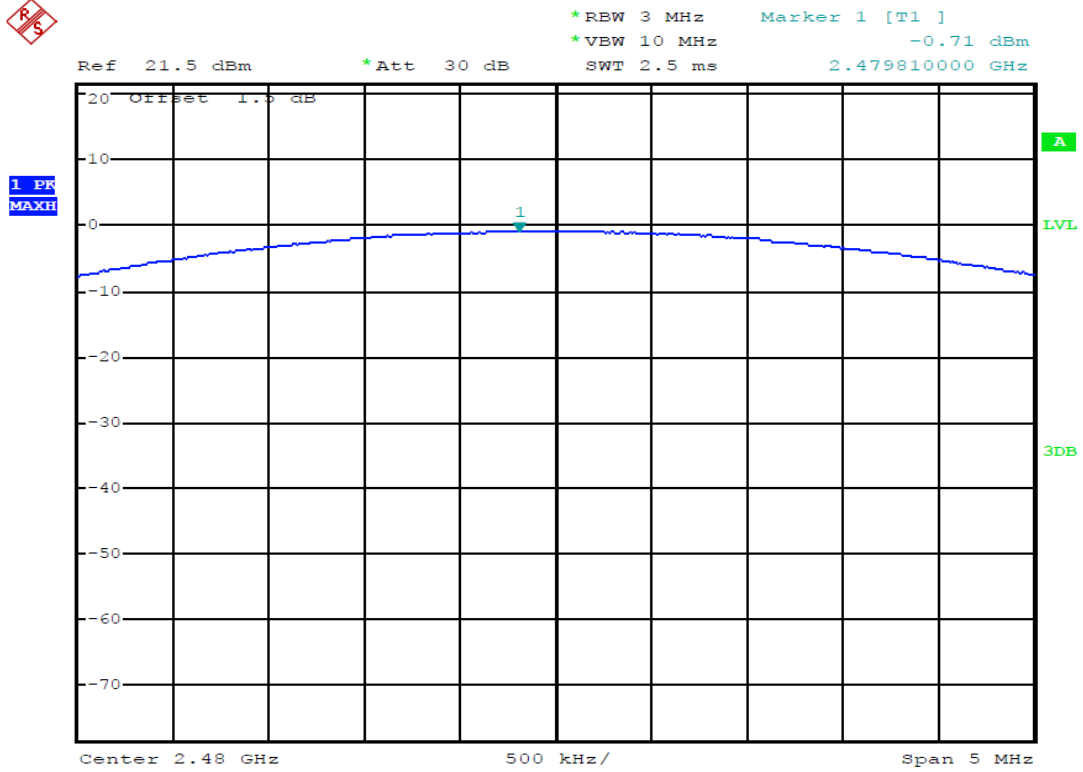

Date: 20.MAR.2014 20:54:17

(Plot 4.3.1 C: Channel 78: 2480MHz @ GFSK)

**4.3.2 8DPSK Test Mode**

A. Test Verdict

Channel	Frequency (MHz)	Measured Output Peak Power (dBm)	Refer to Plot	Limits (dBm)	Result
00	2402	-1.15	Plot 4.3.2 A	30	PASS
39	2441	-1.26	Plot 4.3.2 B	30	PASS
78	2480	-1.51	Plot 4.3.2 C	30	PASS

Note: 1.The test results including the cable lose.

B. Test Plots



Ref 21.5 dBm \*Att 30 dB \*RBW 3 MHz Marker 1 [T1 ]  
\*VBW 10 MHz -1.15 dBm  
SWT 2.5 ms 2.401880000 GHz

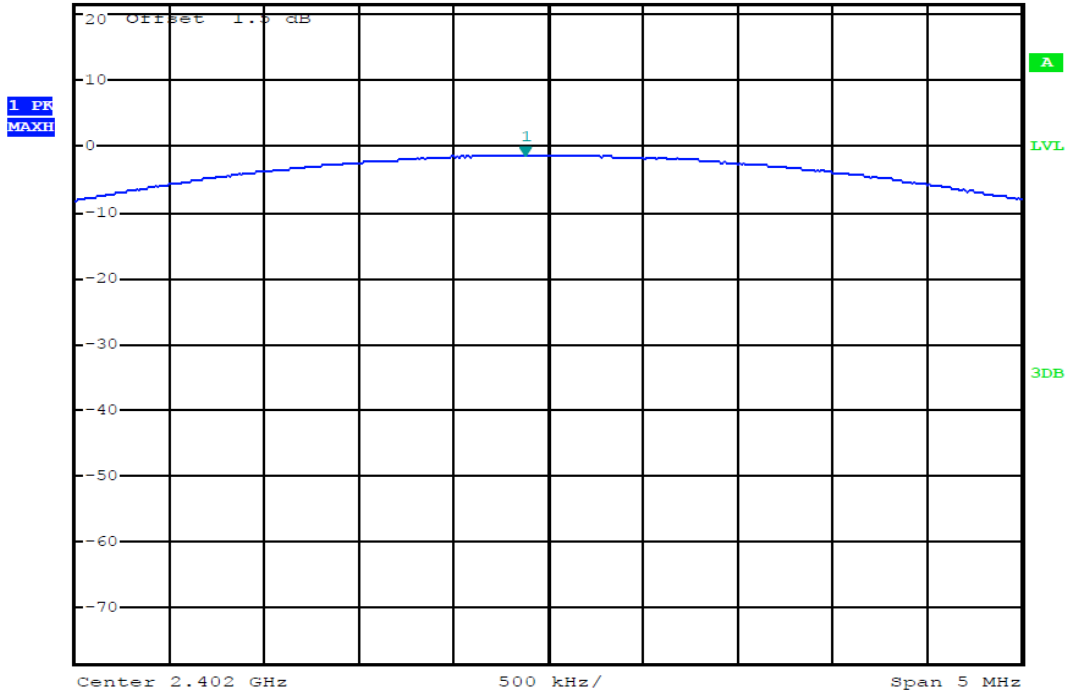

Date: 20.MAR.2014 20:54:55

(Plot 4.3.2 A: Channel 00: 2402MHz @ 8DPSK)



Ref 21.5 dBm \*Att 30 dB \*RBW 3 MHz Marker 1 [T1 ]  
\*VBW 10 MHz -1.26 dBm  
SWT 2.5 ms 2.440880000 GHz

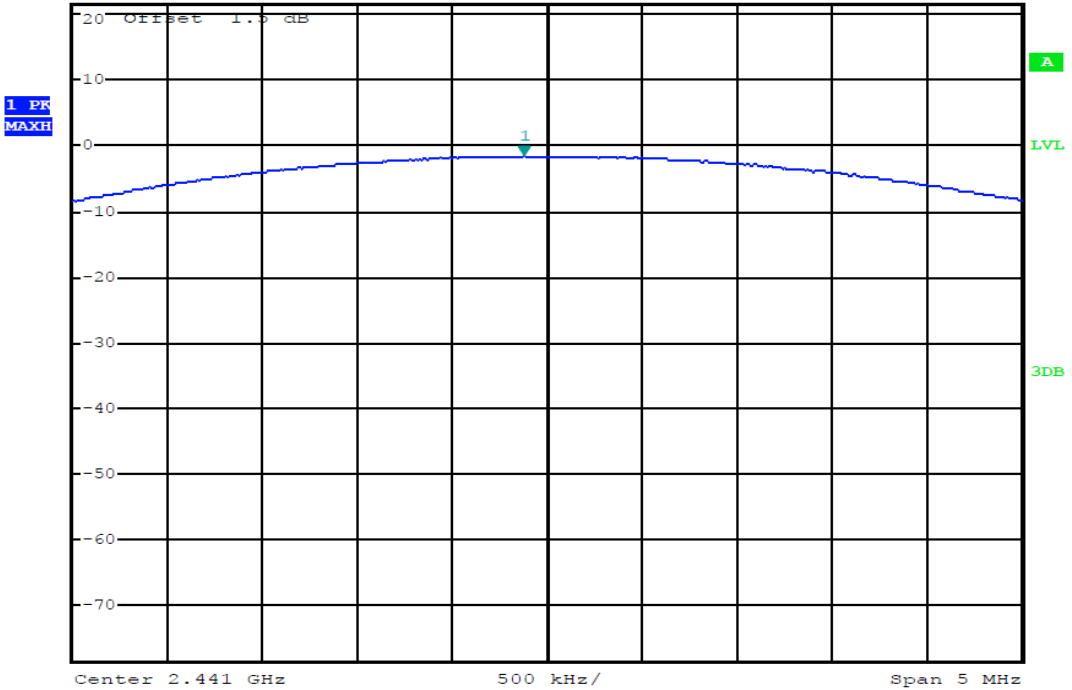

Date: 20.MAR.2014 20:55:26

(Plot 4.3.2 B: Channel 39: 2441MHz @ 8DPSK)

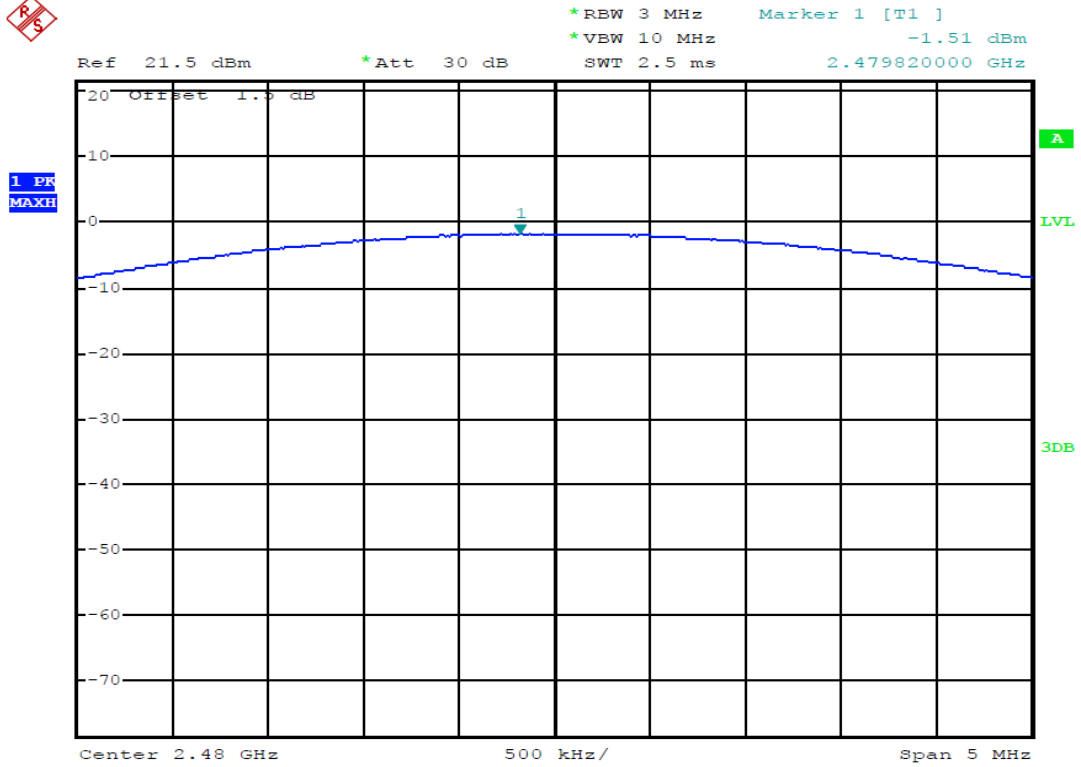

Date: 20.MAR.2014 20:56:27

(Plot 4.3.2 C: Channel 78: 2480MHz @ 8DPSK)

**4.3.3  $\pi/4$ DQPSK Test Mode**

A. Test Verdict

Channel	Frequency (MHz)	Measured Output Peak Power (dBm)	Refer to Plot	Limits (dBm)	Result
00	2402	-1.03	Plot 4.3.3 A	30	PASS
39	2441	-1.16	Plot 4.3.3 B	30	PASS
78	2480	-1.58	Plot 4.3.3 C	30	PASS

Note: 1.The test results including the cable lose.

B. Test Plots



Ref 21.5 dBm \*Att 30 dB \*RBW 3 MHz Marker 1 [T1 ]  
\*VBW 10 MHz -1.03 dBm  
SWT 2.5 ms 2.401830000 GHz

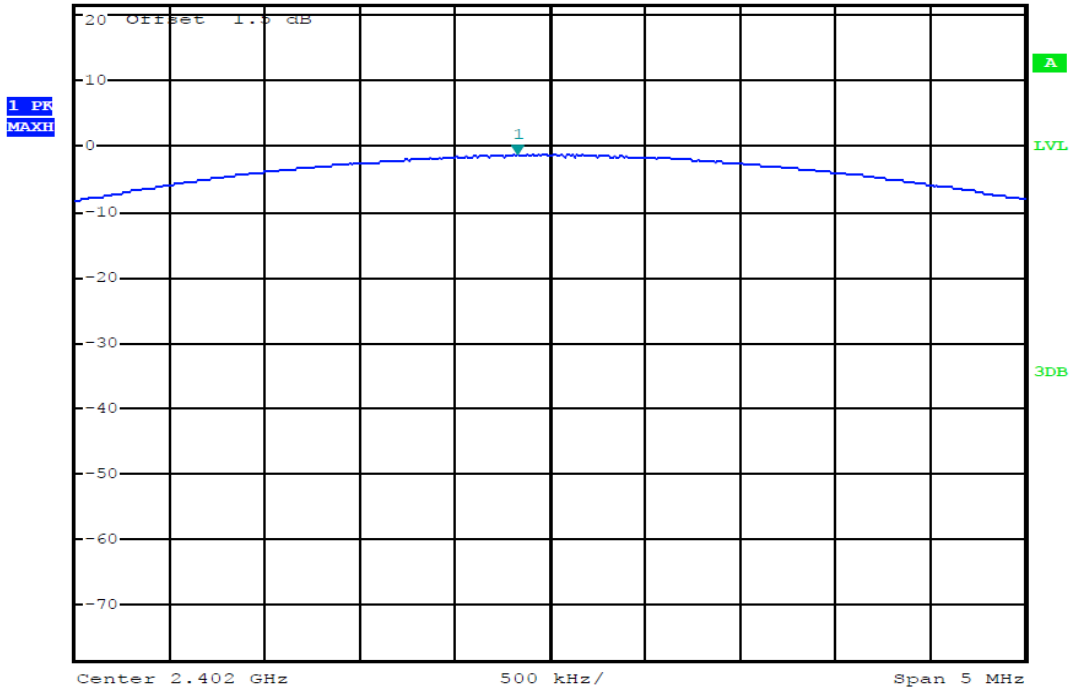

Date: 20.MAR.2014 20:57:17

(Plot 4.3.3 A: Channel 00: 2402MHz @  $\pi/4$ DQPSK)



Ref 21.5 dBm \*Att 30 dB \*RBW 3 MHz Marker 1 [T1 ]  
\*VBW 10 MHz -1.16 dBm  
SWT 2.5 ms 2.440930000 GHz

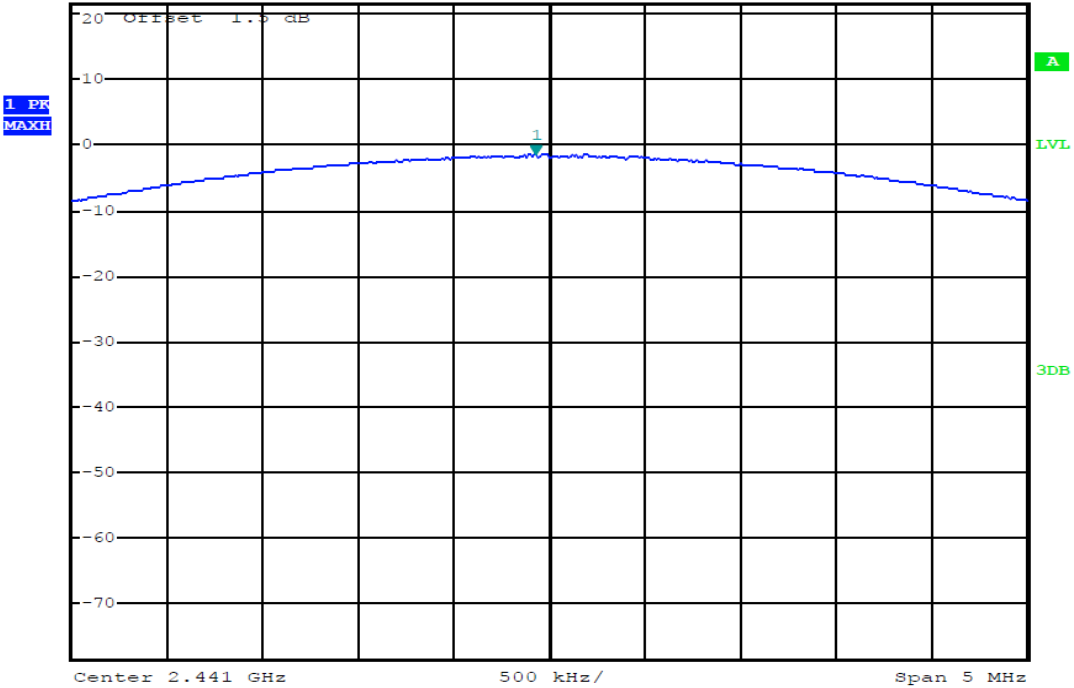

Date: 20.MAR.2014 20:57:50

(Plot 4.3.3 B: Channel 39: 2441MHz @  $\pi/4$ DQPSK)



\*RBW 3 MHz      Marker 1 [T1 ]  
\*VBW 10 MHz      -1.58 dBm  
SWT 2.5 ms      2.479880000 GHz

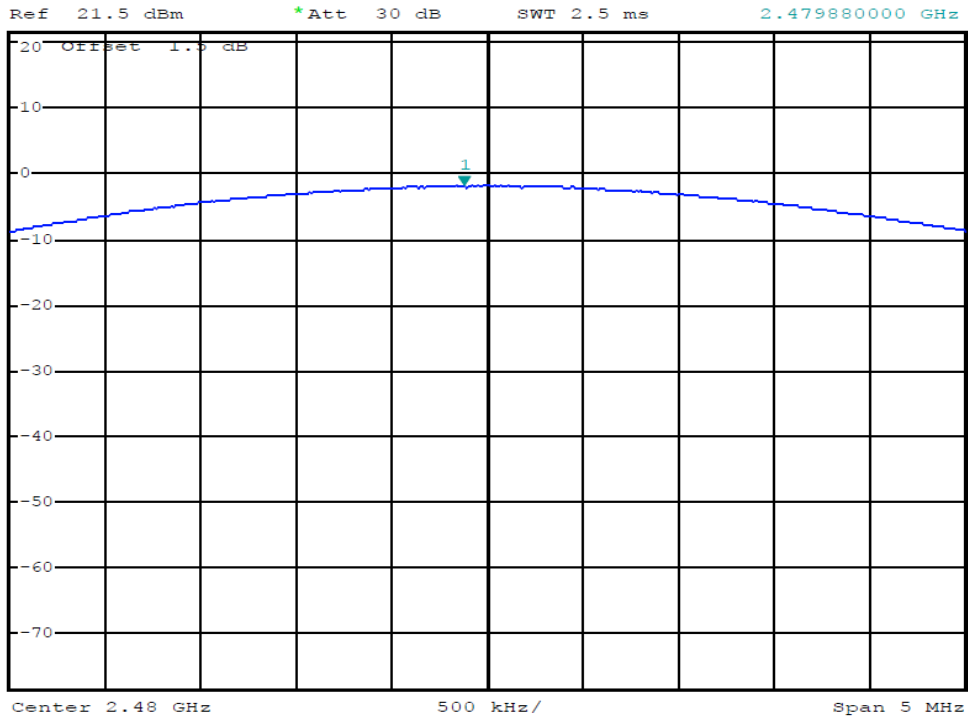

Date: 20.MAR.2014 20:58:27

(Plot 4.3.3 C: Channel 78: 2480MHz @ $\pi/4$ DQPSK)

### 4.4. 20dB Bandwidth

#### TEST CONFIGURATION

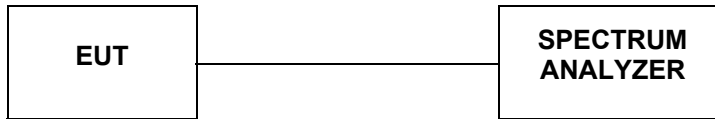

#### TEST PROCEDURE

The transmitter output was connected to the spectrum analyzer through an attenuator. The bandwidth of the fundamental frequency was measured by spectrum analyzer with RBW=30 KHz and VBW=100KHz. The 20dB bandwidth is defined as the total spectrum the power of which is higher than peak power minus 20dB.

#### LIMIT

For frequency hopping systems operating in the 2400MHz-2483.5MHz no limit for 20dB bandwidth.

#### TEST RESULTS

##### 4.4.1 GFSK Test Mode

###### A. Test Verdict

Channel	Frequency (MHz)	20dB Bandwidth (MHz)	Refer to Plot	Limits (MHz)	Verdict
00	2402	0.848	Plot 4.4.1 A	/	PASS
39	2441	0.840	Plot 4.4.1 B	/	PASS
78	2480	0.872	Plot 4.4.1 C	/	PASS

Note: 1.The test results including the cable lose.

###### B. Test Plots

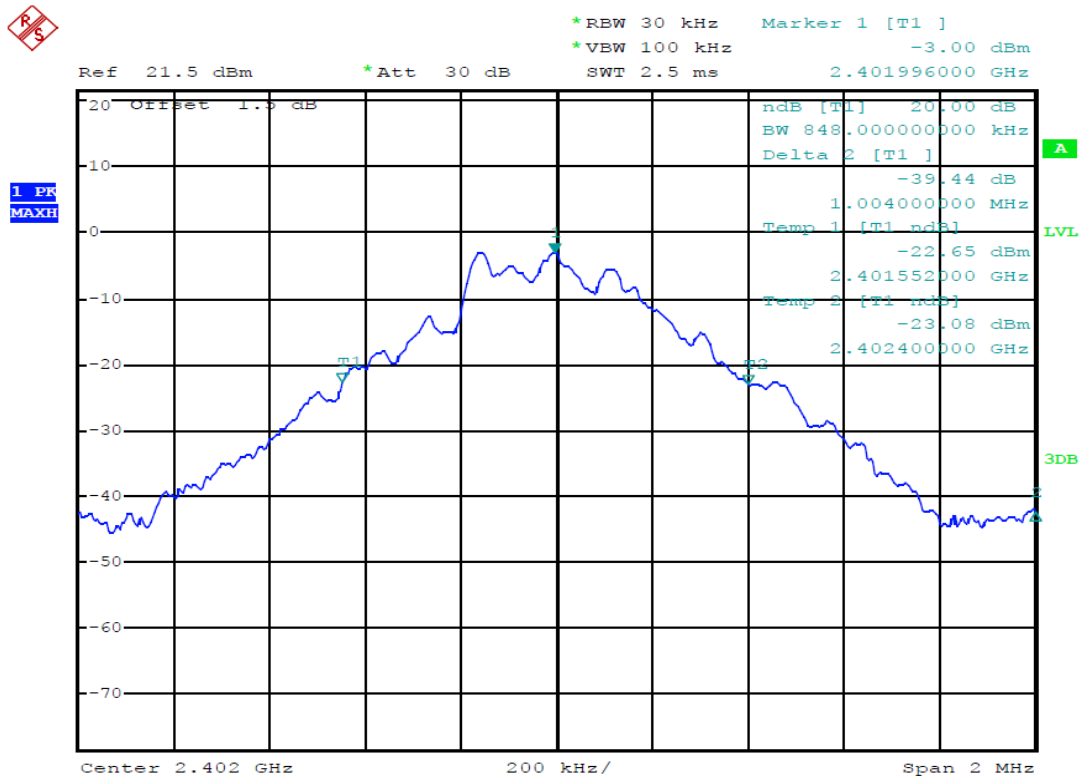

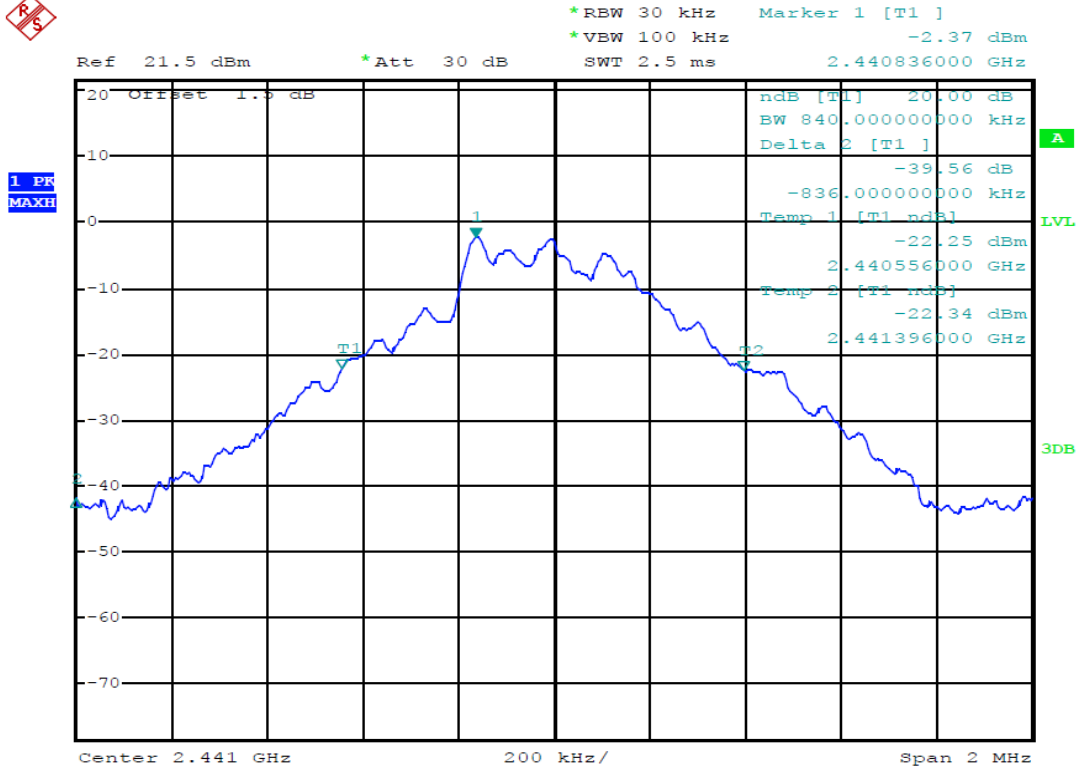

Date: 20.MAR.2014 21:08:11

(Plot 4.4.1 B: Channel 39: 2441MHz @ GFSK)

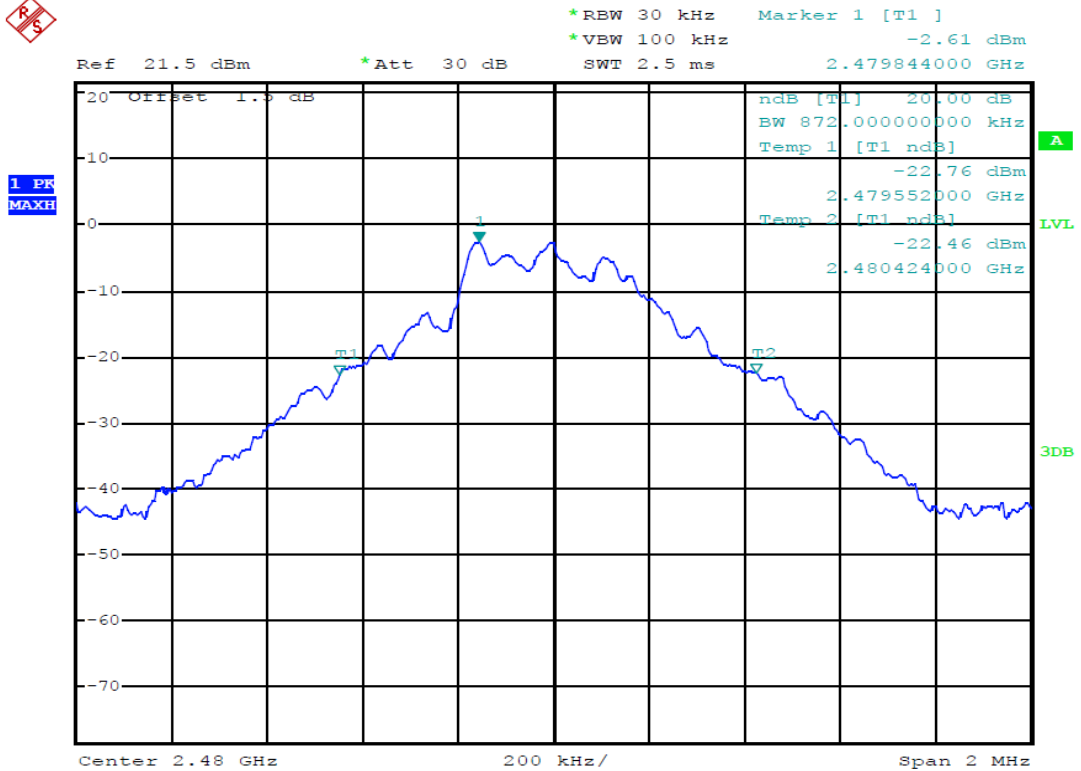

Date: 20.MAR.2014 21:09:28

(Plot 4.4.1 C: Channel 78: 2480MHz @ GFSK)



### 4.4.2 8DPSK Test Mode

#### A. Test Verdict

Channel	Frequency (MHz)	20dB Bandwidth (MHz)	Refer to Plot	Limits (MHz)	Verdict
00	2402	1.216	Plot 4.4.2 A	/	PASS
39	2441	1.216	Plot 4.4.2 B	/	PASS
78	2480	1.216	Plot 4.4.2 C	/	PASS

Note: 1.The test results including the cable lose.

#### B. Test Plots

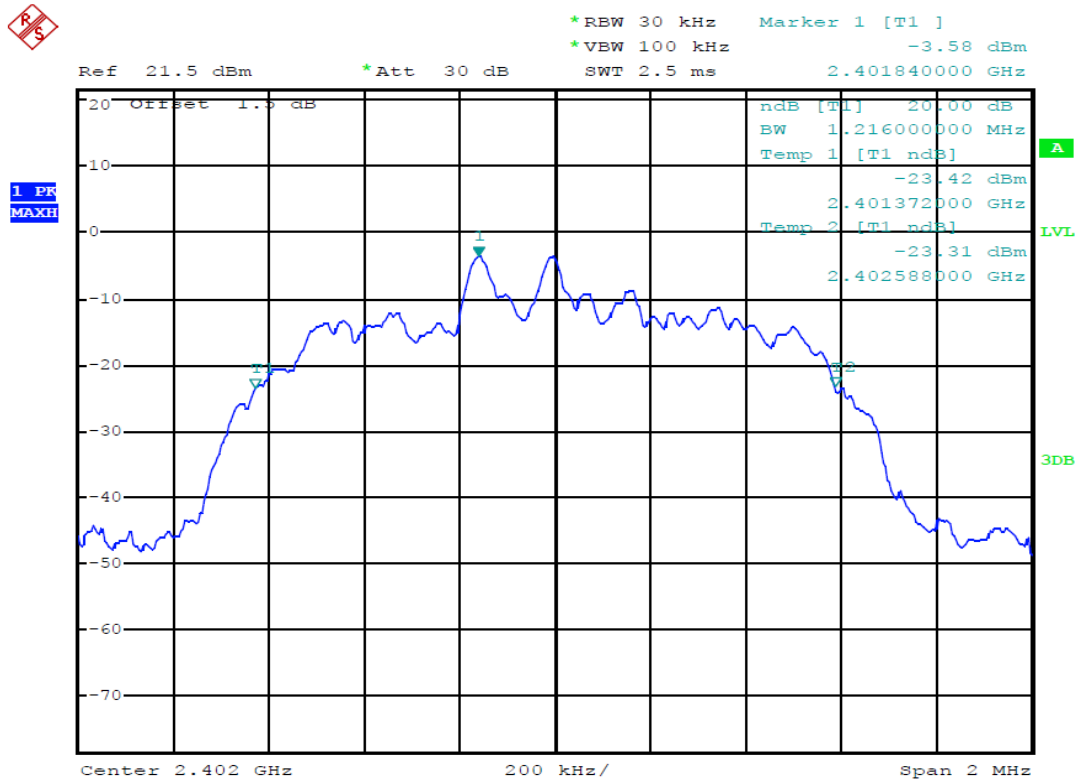

Date: MAR.20.2014 21:10:08

(Plot 4.4.2 A: Channel 00: 2402MHz @ 8DPSK)

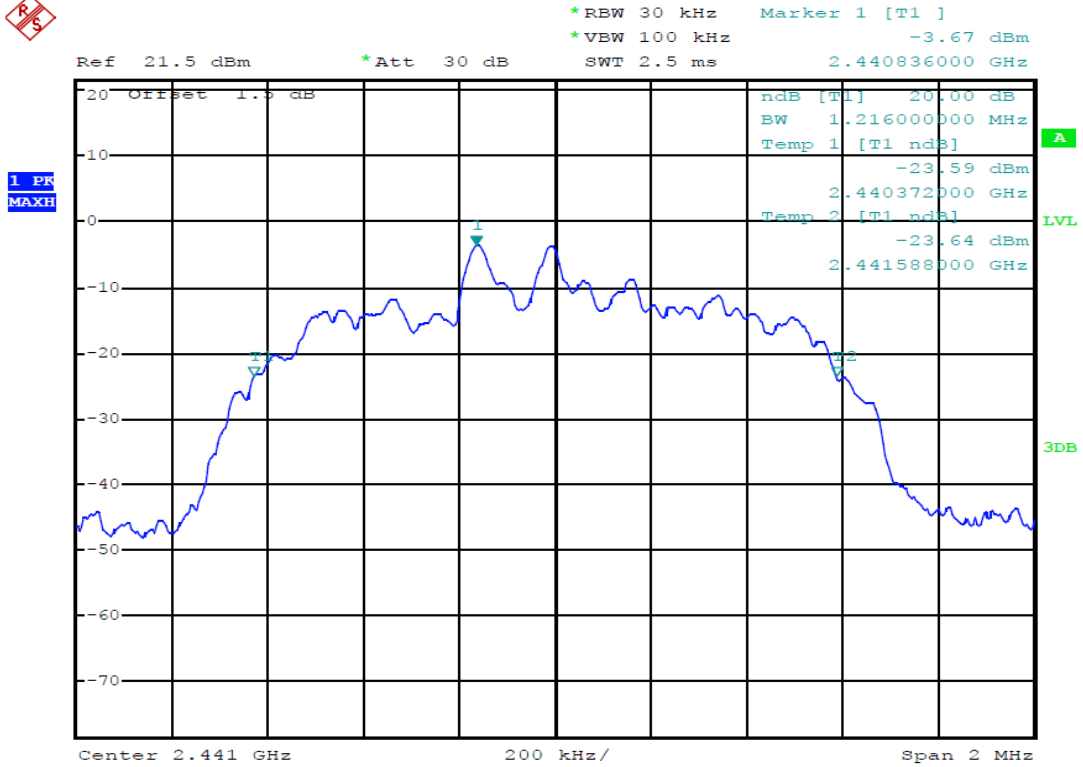

Date: 20.MAR.2014 21:10:38

(Plot 4.4.2 B: Channel 39: 2441MHz @ 8DPSK)

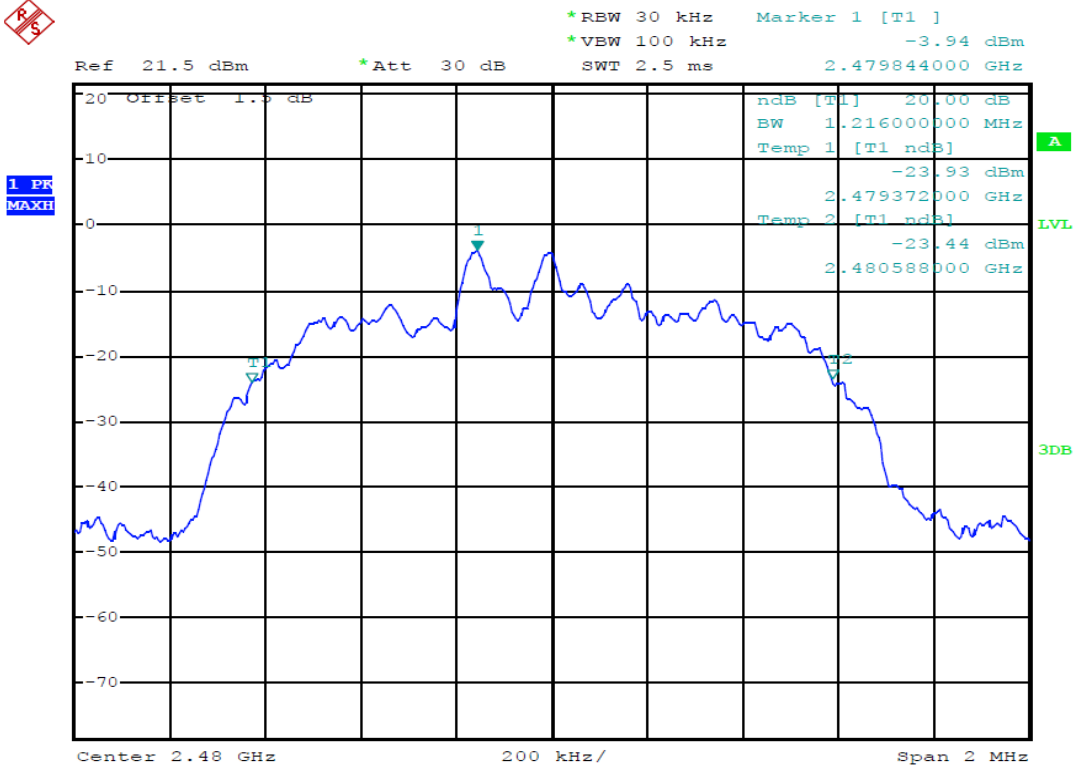

Date: 20.MAR.2014 21:11:46

(Plot 4.4.2 C: Channel 78: 2480MHz @ 8DPSK)

### 4.4.3 $\pi/4$ DQPSK Test Mode

#### A. Test Verdict

Channel	Frequency (MHz)	20dB Bandwidth (MHz)	Refer to Plot	Limits (MHz)	Verdict
00	2402	1.212	Plot 4.4.3 A	/	PASS
39	2441	1.212	Plot 4.4.3 B	/	PASS
78	2480	1.212	Plot 4.4.3 C	/	PASS

Note: 1.The test results including the cable lose.

#### B. Test Plots

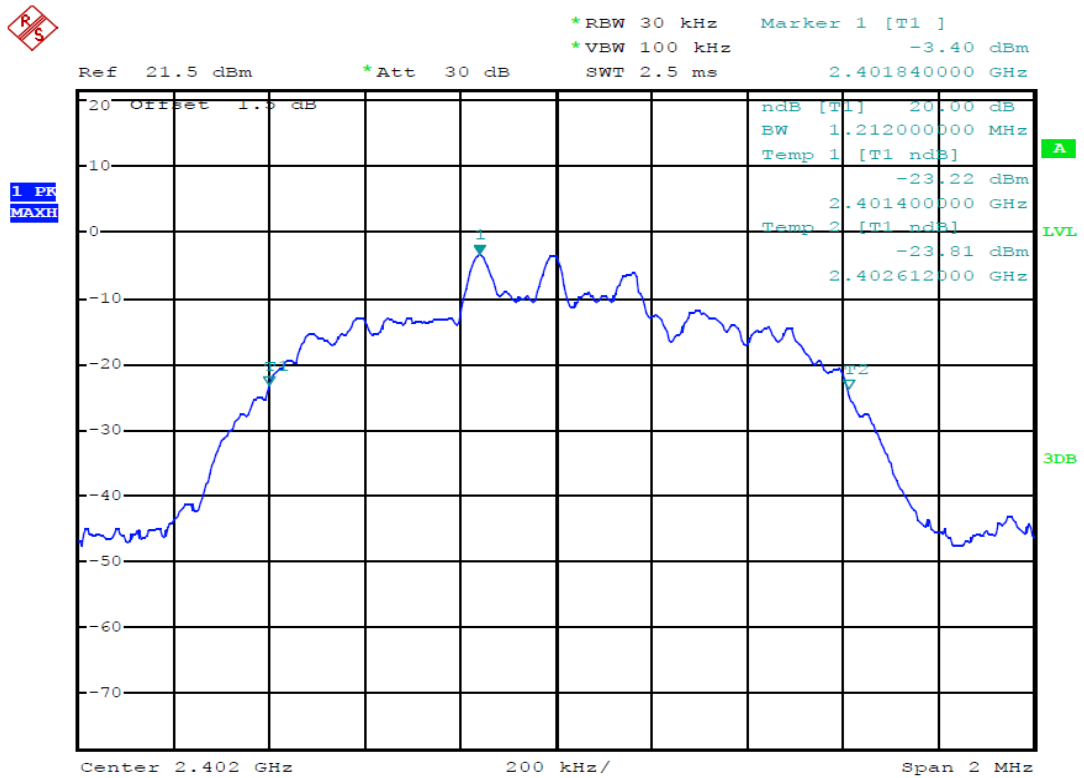

Date: 20.MAR.2014 21:12:34

(Plot 4.4.3 A: Channel 00: 2402MHz @  $\pi/4$ DQPSK)

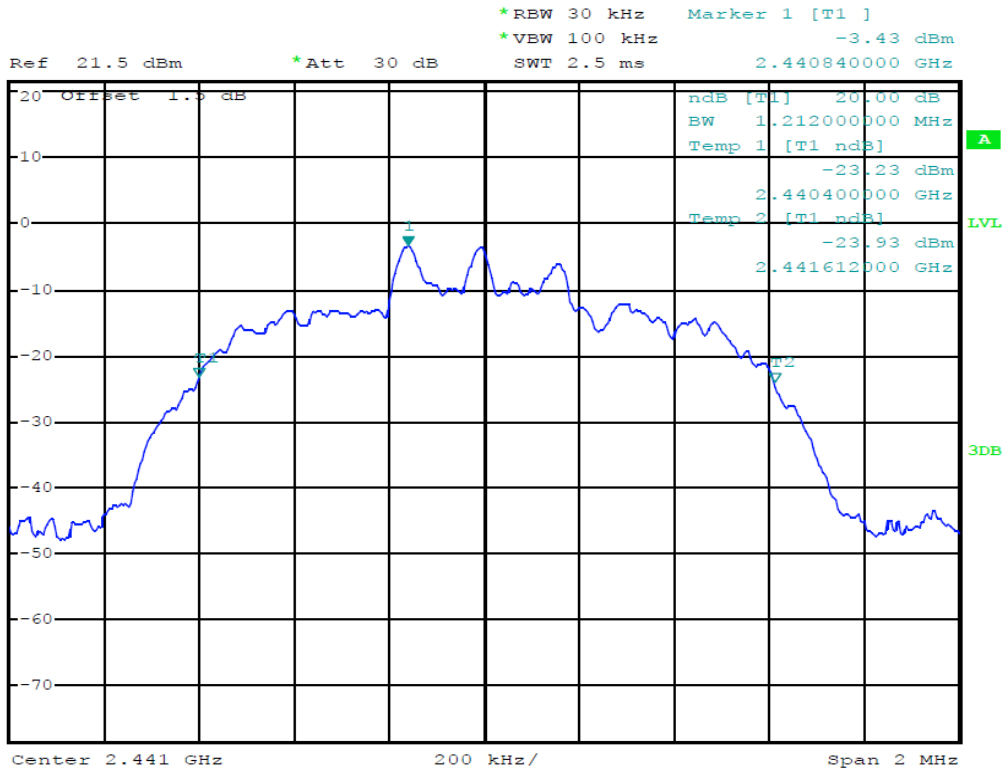

Date: 20.MAR.2014 21:13:08

(Plot 4.4.3 B: Channel 39: 2441MHz @ $\pi/4$ DQPSK)

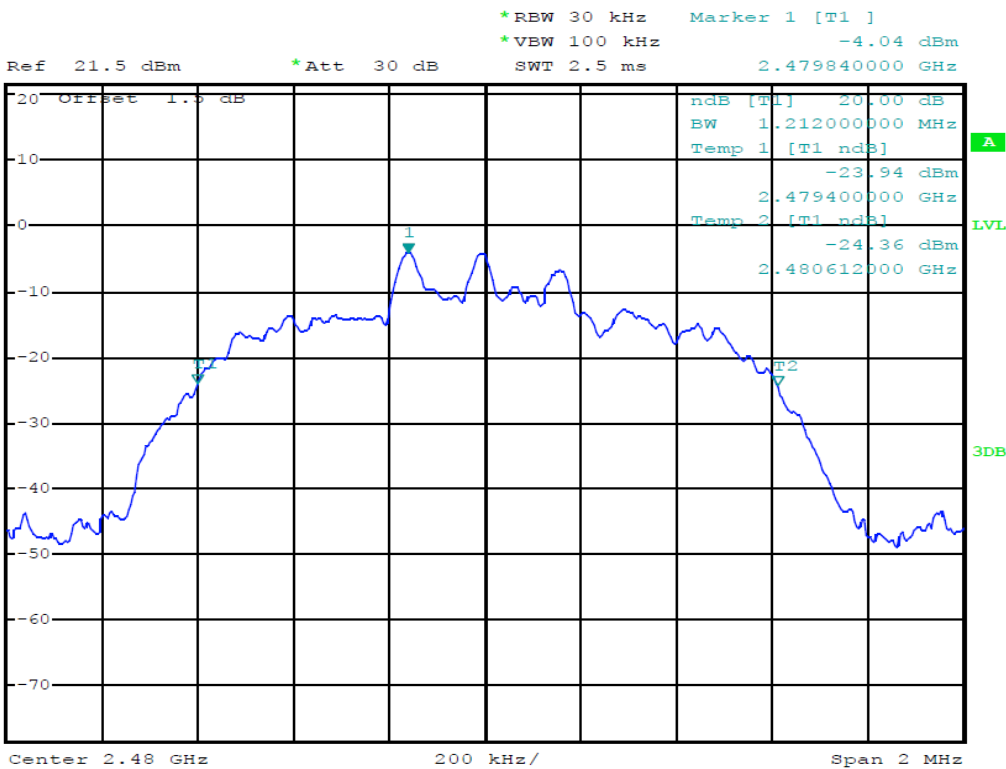

Date: 20.MAR.2014 21:13:37

(Plot 4.4.3 C: Channel 78: 2480MHz @ $\pi/4$ DQPSK)

## 4.5. Band Edge

### Applicable Standard

In any 100 kHz bandwidth outside the frequency band in which the spread spectrum or digitally modulated intentional radiator is operating, the radio frequency power that is produced by the intentional radiator shall be at least 20 dB below that in the 100 kHz bandwidth within the band that contains the highest level of the desired power, based on either an RF conducted or a radiated measurement, provided the transmitter demonstrates compliance with the peak conducted power limits. If the transmitter complies with the conducted power limits based on the use of RMS averaging over a time interval, as permitted under paragraph (b)(3) of this section, the attenuation required under this paragraph shall be 30 dB instead of 20 dB. Attenuation below the general limits specified in §15.209(a) is not required. In addition, radiated emissions which fall in the restricted bands, as defined in §15.205(a), must also comply with the radiated emission limits specified in §15.209(a) (see §15.205(c)).

### TEST PROCEDURE

1. Check the calibration of the measuring instrument using either an internal calibrator or a known signal from an external generator.
2. Remove the antenna from the EUT and then connect to a low loss RF cable from the antenna port to a EMI test receiver, then turn on the EUT and make it operate in transmitting mode. Then set it to Low Channel and High Channel within its operating range, and make sure the instrument is operated in its linear range.
3. Set both RBW and VBW of spectrum analyzer to 100 kHz with a convenient frequency span including 100kHz bandwidth from band edge, for Radiated emissions restricted band RBW=1MHz, VBW=3MHz.
4. Measure the highest amplitude appearing on spectral display and set it as a reference level. Plot the graph with marking the highest point and edge frequency.
5. Repeat above procedures until all measured frequencies were complete.

### TEST RESULTS

Remark: we measured all conditions(DH1,DH3,DH5) and recorded worst case at DH1

#### **4.5.1 For Radiated Bandedge Measurement**

Remark: we tested radiated bandedge at both hopping and no-hopping modes,recorded worst case at no-hopping mode

##### **4.5.1.1 GFSK Test Mode**

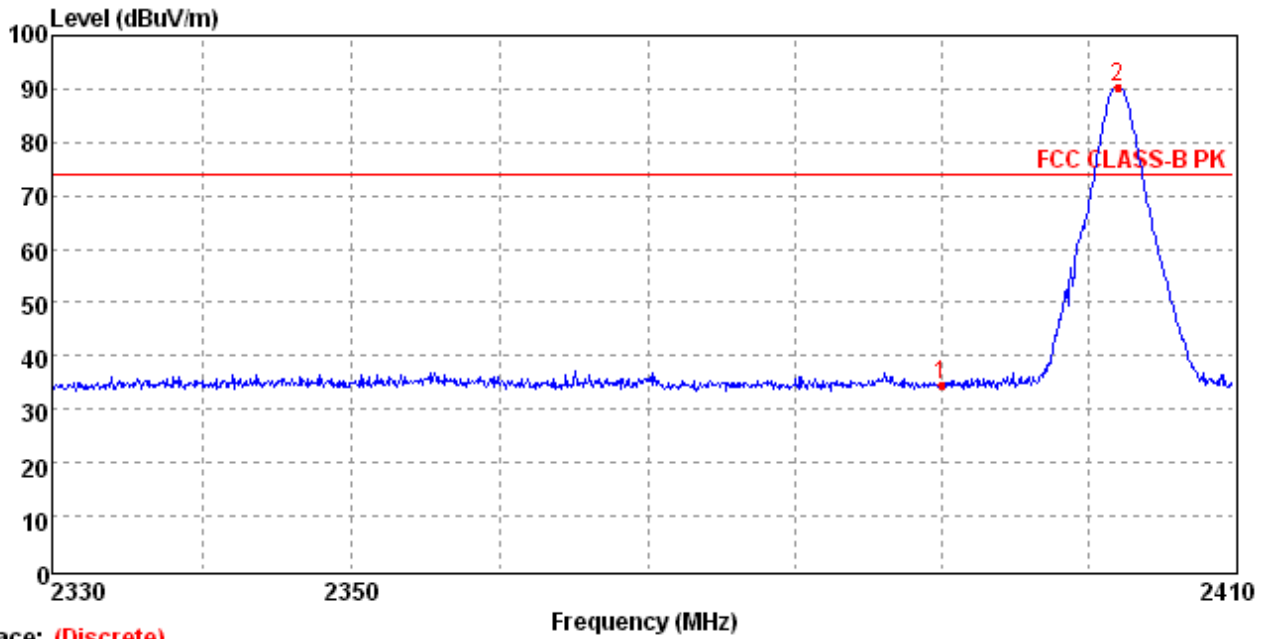

Trace: (Discrete)

Mark	Frequency (MHz)	Level (dBuV/m)	Cable Loss (dB)	Antenna Factor (dB/m)	Preamp Factor (dB)	Reading Level (dBuV/m)	Limit (dBuV/m)	Margin (dB)	Antenna Polarization	Detector
1	2390.00	34.74	3.32	27.49	36.12	40.05	74.00	39.26	Hor	Peak
2	2402.25	90.26	3.32	27.49	36.12	95.57	74.00	-16.26	Hor	Peak

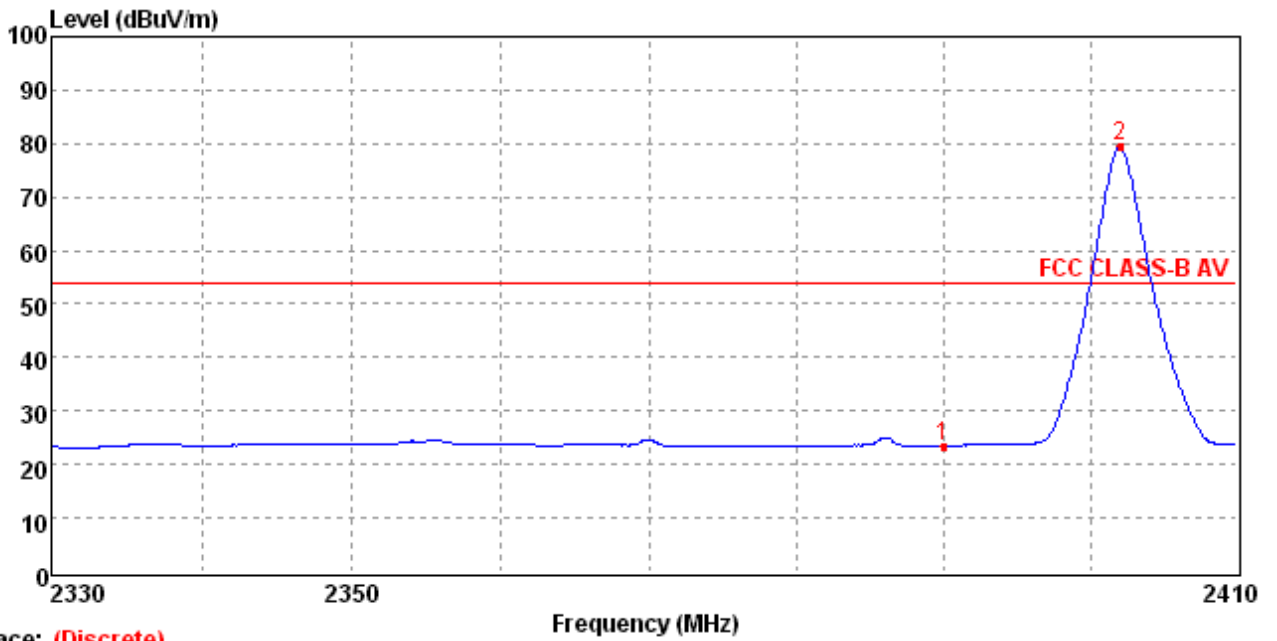

Trace: (Discrete)

Mark	Frequency (MHz)	Level (dBuV/m)	Cable Loss (dB)	Antenna Factor (dB/m)	Preamp Factor (dB)	Reading Level (dBuV/m)	Limit (dBuV/m)	Margin (dB)	Antenna Polarization	Detector
1	2390.00	23.52	3.32	27.49	36.12	28.83	54.00	30.48	Hor	Average
2	2402.25	79.64	3.32	27.49	36.12	84.95	54.00	-25.64	Hor	Average

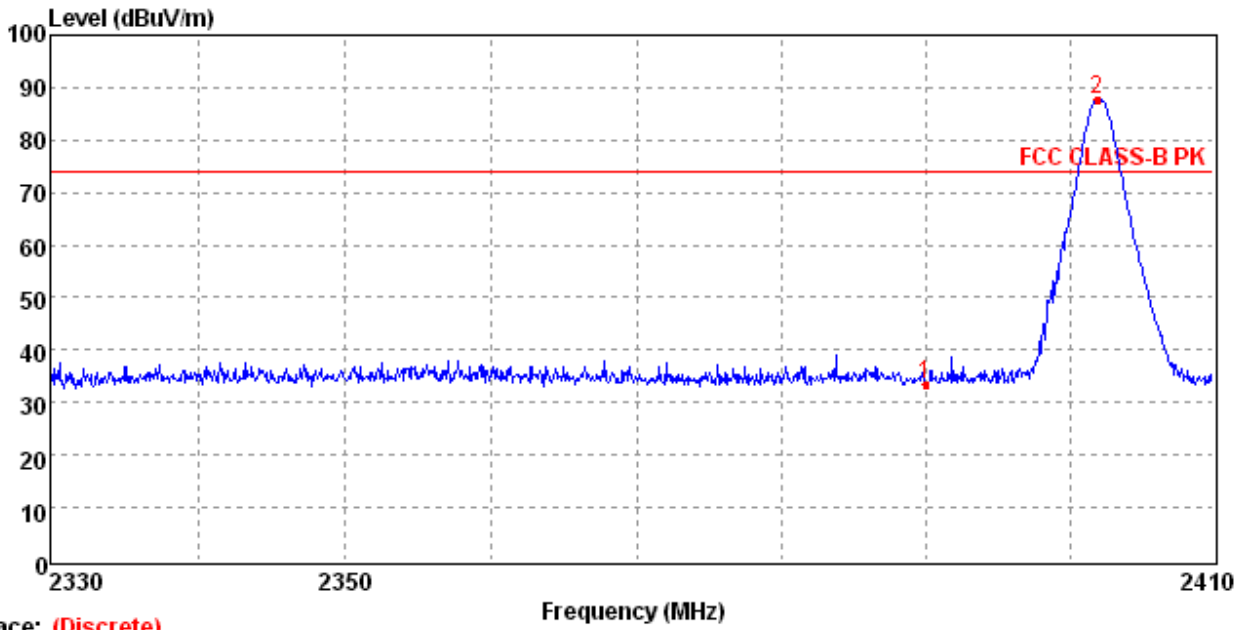

Trace: (Discrete)

Mark	Frequency (MHz)	Level (dBuV/m)	Cable Loss (dB)	Antenna Factor (dB/m)	Preamp Factor (dB)	Reading Level (dBuV/m)	Limit (dBuV/m)	Margin (dB)	Antenna Polarization	Detector
1	2390.00	33.44	3.32	27.49	36.12	38.75	74.00	40.56	Ver	Peak
2	2402.25	87.64	3.32	27.49	36.12	92.95	74.00	-13.64	Ver	Peak

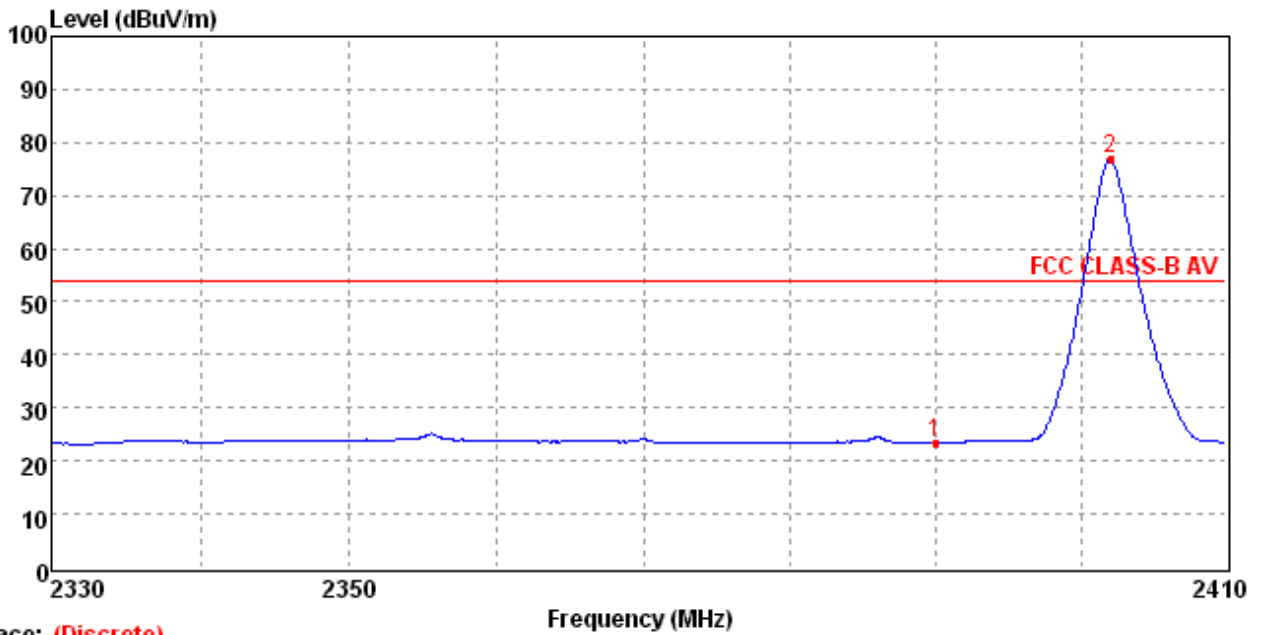

Trace: (Discrete)

Mark	Frequency (MHz)	Level (dBuV/m)	Cable Loss (dB)	Antenna Factor (dB/m)	Preamp Factor (dB)	Reading Level (dBuV/m)	Limit (dBuV/m)	Margin (dB)	Antenna Polarization	Detector
1	2390.00	23.49	3.32	27.49	36.12	28.80	54.00	30.51	Ver	Average
2	2402.25	77.00	3.32	27.49	36.12	82.31	54.00	-23.00	Ver	Average

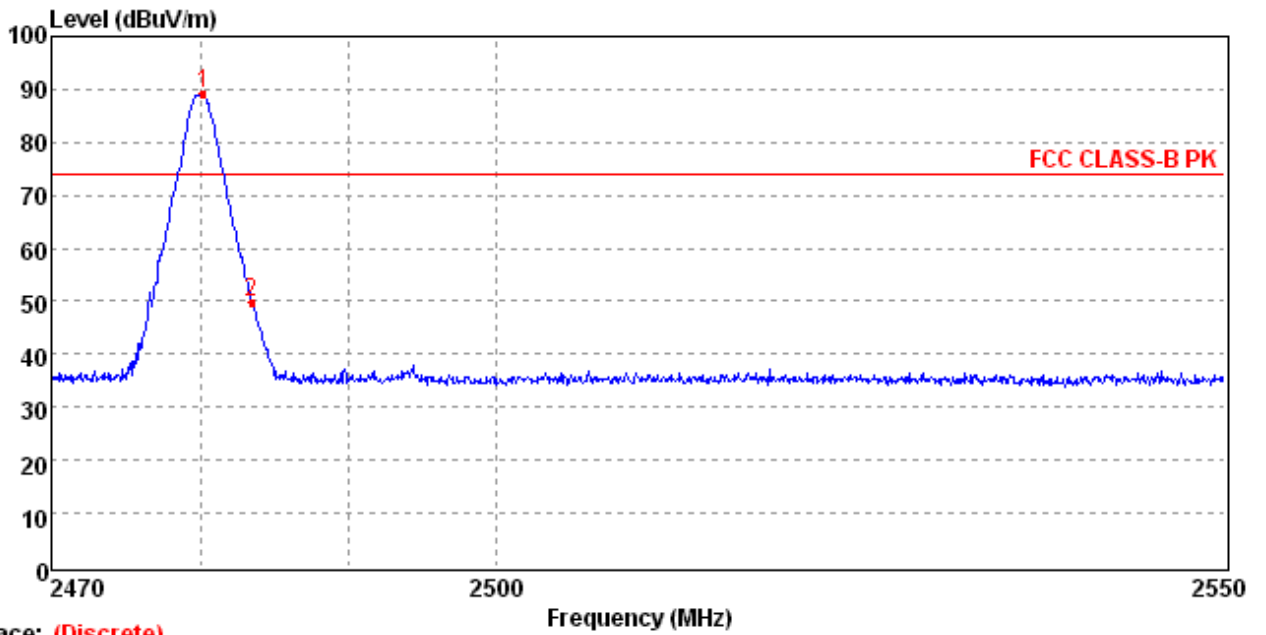

Mark	Frequency (MHz)	Level (dBuV/m)	Cable Loss (dB)	Antenna Factor (dB/m)	Preamp Factor (dB)	Reading Level (dBuV/m)	Limit (dBuV/m)	Margin (dB)	Antenna Polarization	Detector
1	2480.10	89.05	3.88	27.45	36.55	94.27	74.00	-15.05	Hor	Peak
2	2483.50	49.86	3.88	27.45	36.55	55.08	74.00	24.14	Hor	Peak

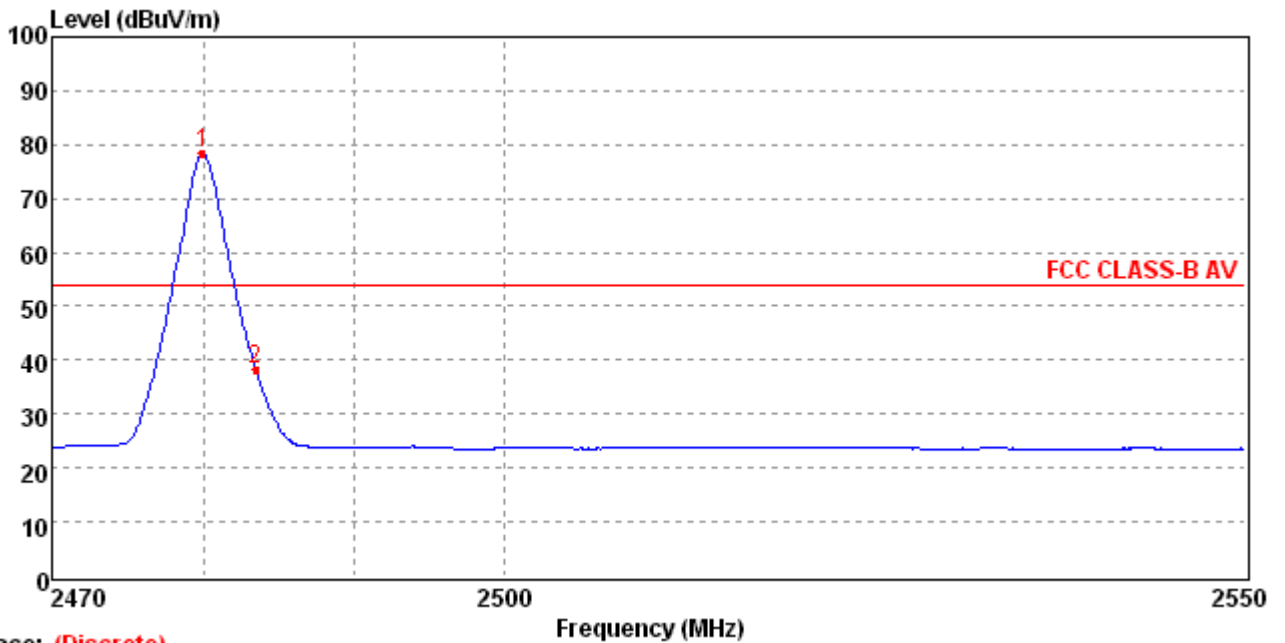

Mark	Frequency (MHz)	Level (dBuV/m)	Cable Loss (dB)	Antenna Factor (dB/m)	Preamp Factor (dB)	Reading Level (dBuV/m)	Limit (dBuV/m)	Margin (dB)	Antenna Polarization	Detector
1	2480.10	78.44	3.88	27.45	36.55	83.66	54.00	-24.44	Hor	Average
2	2483.50	38.17	3.88	27.45	36.55	43.39	54.00	15.83	Hor	Average



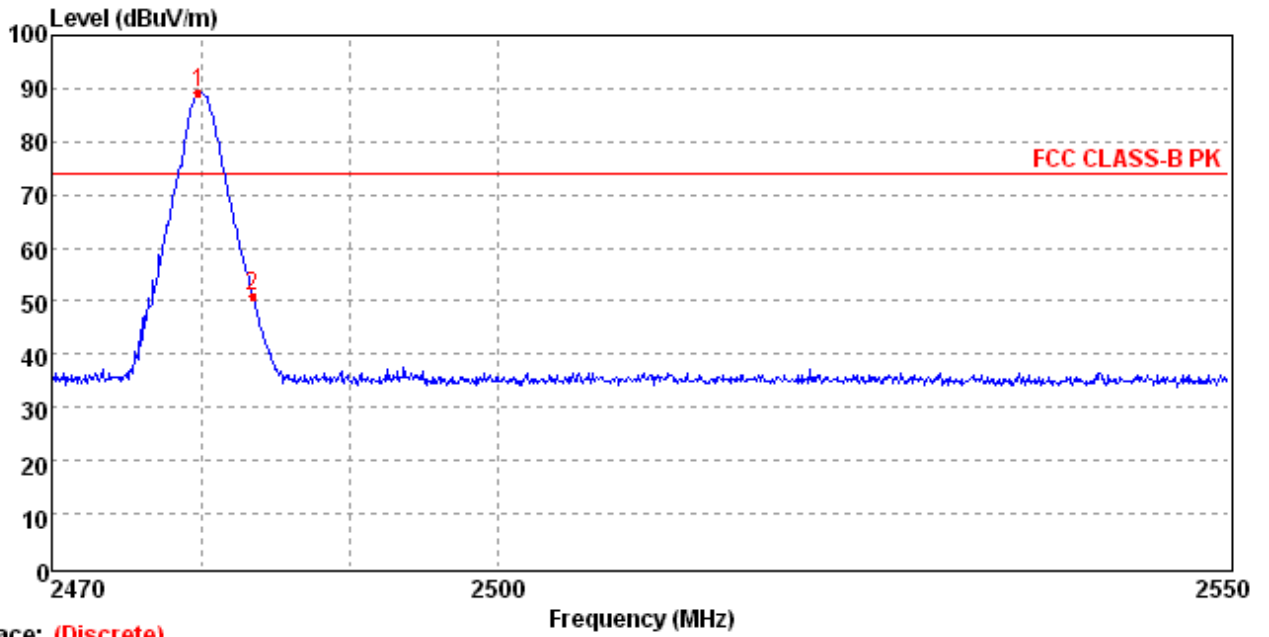

Trace: (Discrete)

Mark	Frequency (MHz)	Level (dBuV/m)	Cable Loss (dB)	Antenna Factor (dB/m)	Preamp Factor (dB)	Reading Level (dBuV/m)	Limit (dBuV/m)	Margin (dB)	Antenna Polarization	Detector
1	2479.83	89.14	3.88	27.45	36.55	94.36	74.00	-15.14	Ver	Peak
2	2483.50	50.80	3.88	27.45	36.55	56.02	74.00	23.20	Ver	Peak

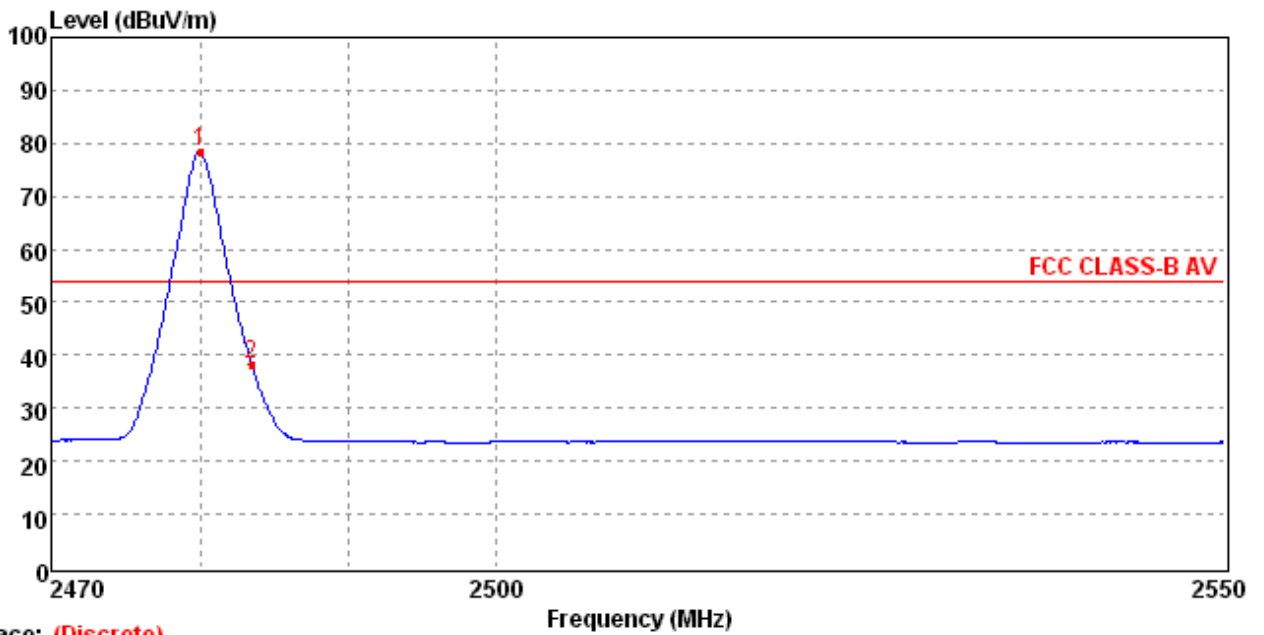

Trace: (Discrete)

Mark	Frequency (MHz)	Level (dBuV/m)	Cable Loss (dB)	Antenna Factor (dB/m)	Preamp Factor (dB)	Reading Level (dBuV/m)	Limit (dBuV/m)	Margin (dB)	Antenna Polarization	Detector
1	2480.01	78.41	3.88	27.45	36.55	83.63	54.00	-24.41	Ver	Average
2	2483.50	38.15	3.88	27.45	36.55	43.37	54.00	15.85	Ver	Average

4.5.1.2 8DPSK Test Mode

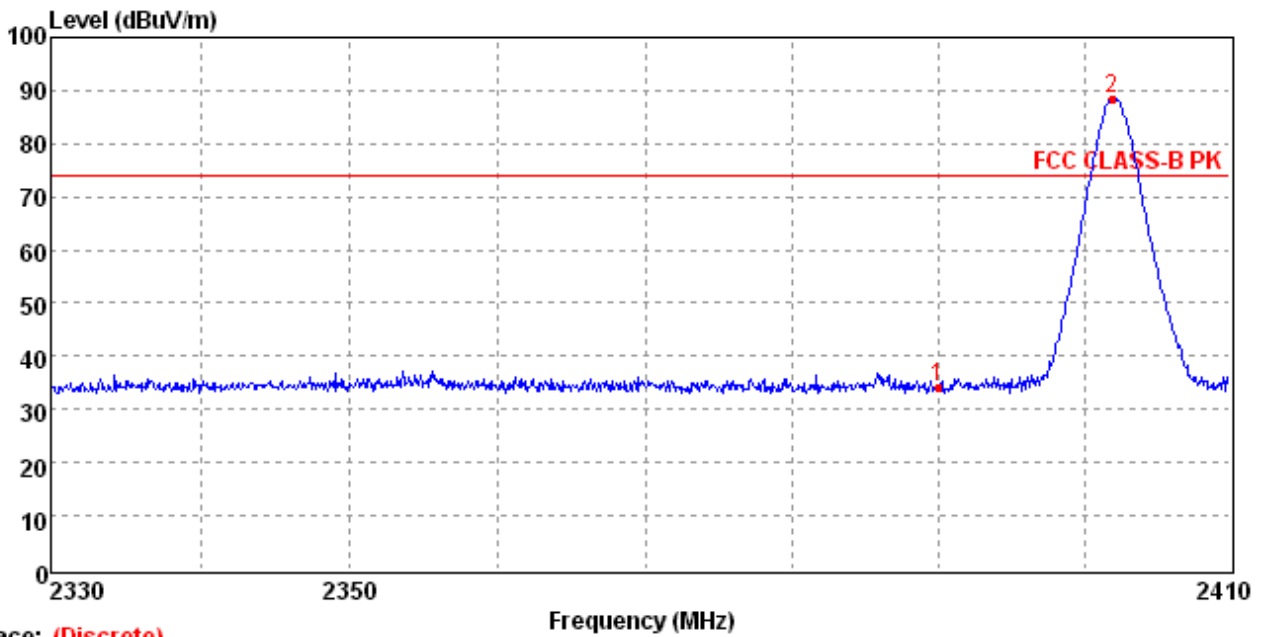

Trace: (Discrete)

Mark	Frequency (MHz)	Level (dBuV/m)	Cable Loss (dB)	Antenna Factor (dB/m)	Preamp Factor (dB)	Reading Level (dBuV/m)	Limit (dBuV/m)	Margin (dB)	Antenna Polarization	Detector
1	2390.00	34.09	3.32	27.49	36.12	39.40	74.00	39.91	Hor	Peak
2	2402.25	88.56	3.32	27.49	36.12	93.87	74.00	-14.56	Hor	Peak

Data: 25

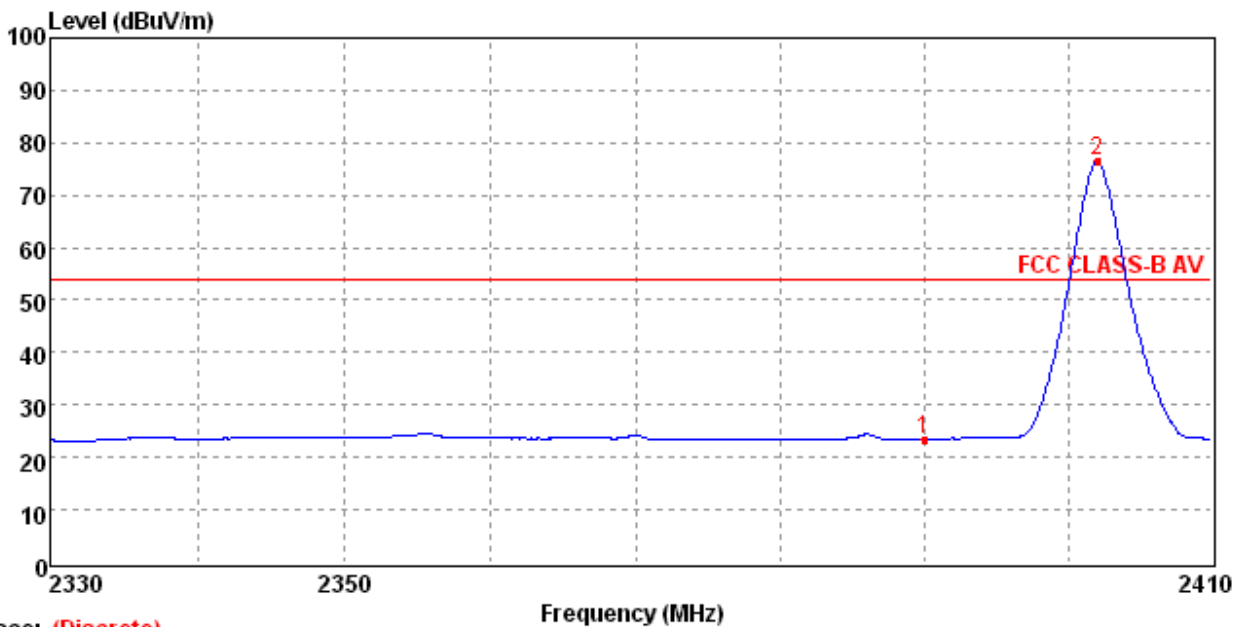

Trace: (Discrete)

Mark	Frequency (MHz)	Level (dBuV/m)	Cable Loss (dB)	Antenna Factor (dB/m)	Preamp Factor (dB)	Reading Level (dBuV/m)	Limit (dBuV/m)	Margin (dB)	Antenna Polarization	Detector
1	2390.00	23.46	3.32	27.49	36.12	28.77	54.00	30.54	Hor	Average
2	2402.25	76.46	3.32	27.49	36.12	81.77	54.00	-22.46	Hor	Average

Data: 26

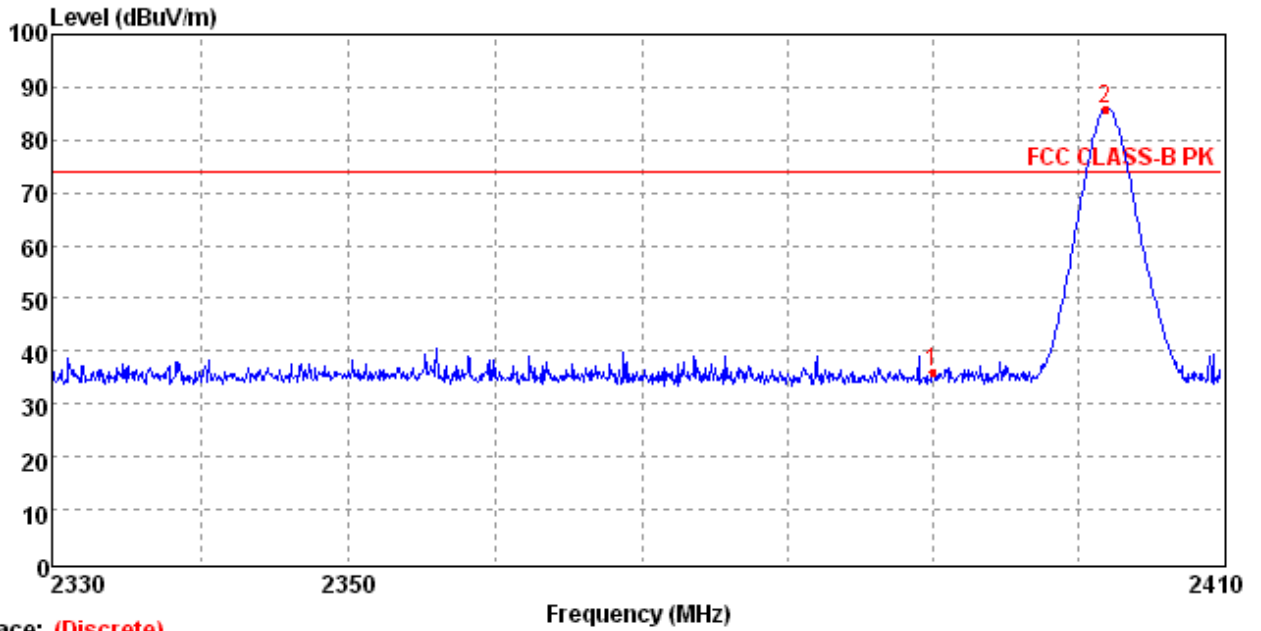

Trace: (Discrete)

Mark	Frequency (MHz)	Level (dBuV/m)	Cable Loss (dB)	Antenna Factor (dB/m)	Preamp Factor (dB)	Reading Level (dBuV/m)	Limit (dBuV/m)	Margin (dB)	Antenna Polarization	Detector
1	2390.00	36.10	3.32	27.49	36.12	41.41	74.00	37.90	Ver	Peak
2	2402.25	85.96	3.32	27.49	36.12	91.27	74.00	-11.96	Ver	Peak

Data: 27

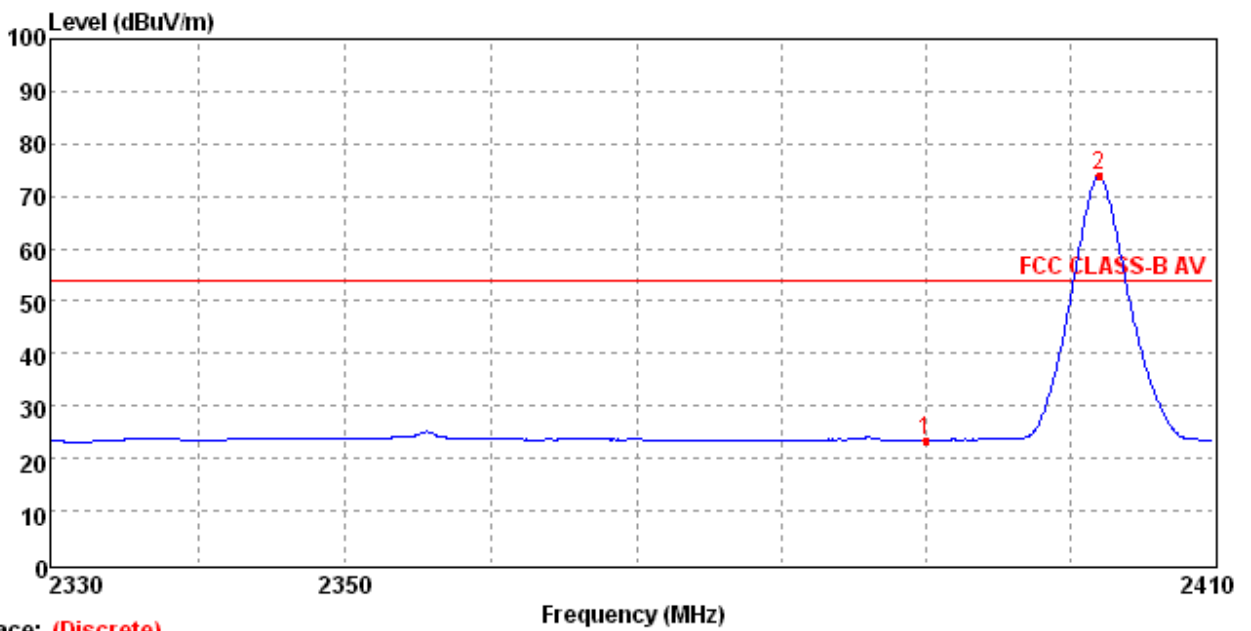

Trace: (Discrete)

Mark	Frequency (MHz)	Level (dBuV/m)	Cable Loss (dB)	Antenna Factor (dB/m)	Preamp Factor (dB)	Reading Level (dBuV/m)	Limit (dBuV/m)	Margin (dB)	Antenna Polarization	Detector
1	2390.00	23.48	3.32	27.49	36.12	28.79	54.00	30.52	Ver	Average
2	2402.25	73.86	3.32	27.49	36.12	79.17	54.00	-19.86	Ver	Average

Data: 14

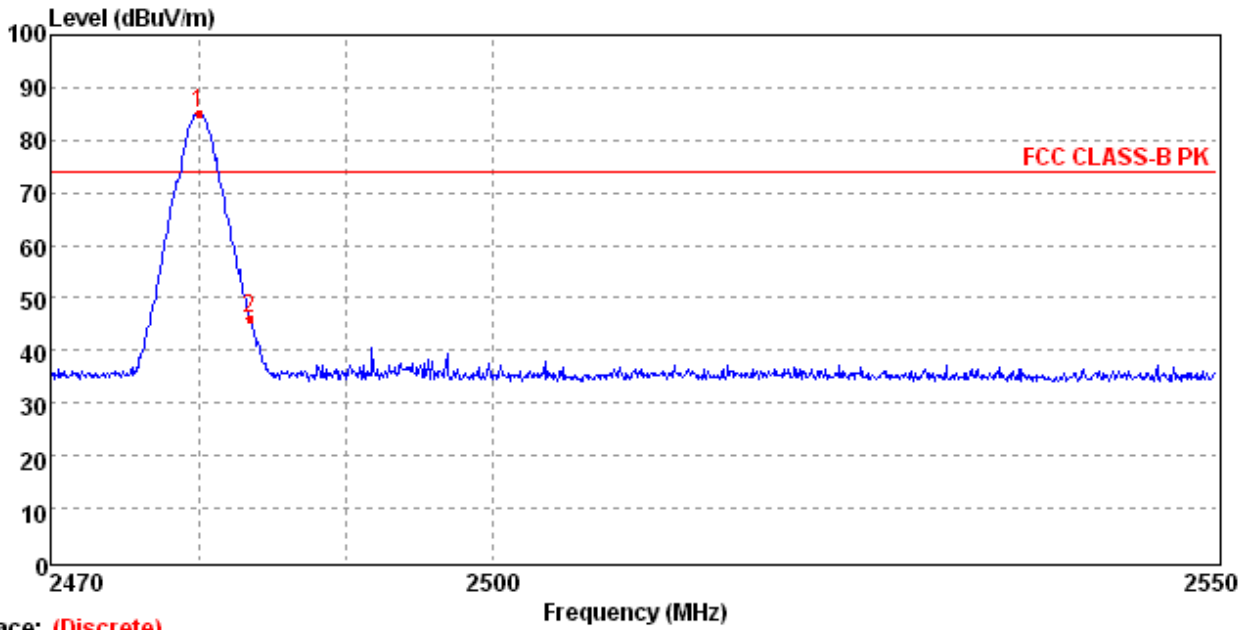

Trace: (Discrete)

Mark	Frequency (MHz)	Level (dBuV/m)	Cable Loss (dB)	Antenna Factor (dB/m)	Preamp Factor (dB)	Reading Level (dBuV/m)	Limit (dBuV/m)	Margin (dB)	Antenna Polarization	Detector
1	2479.83	85.20	3.88	27.45	36.55	90.42	74.00	-11.20	Hor	Peak
2	2483.50	45.94	3.88	27.45	36.55	51.16	74.00	28.06	Hor	Peak

Data: 15

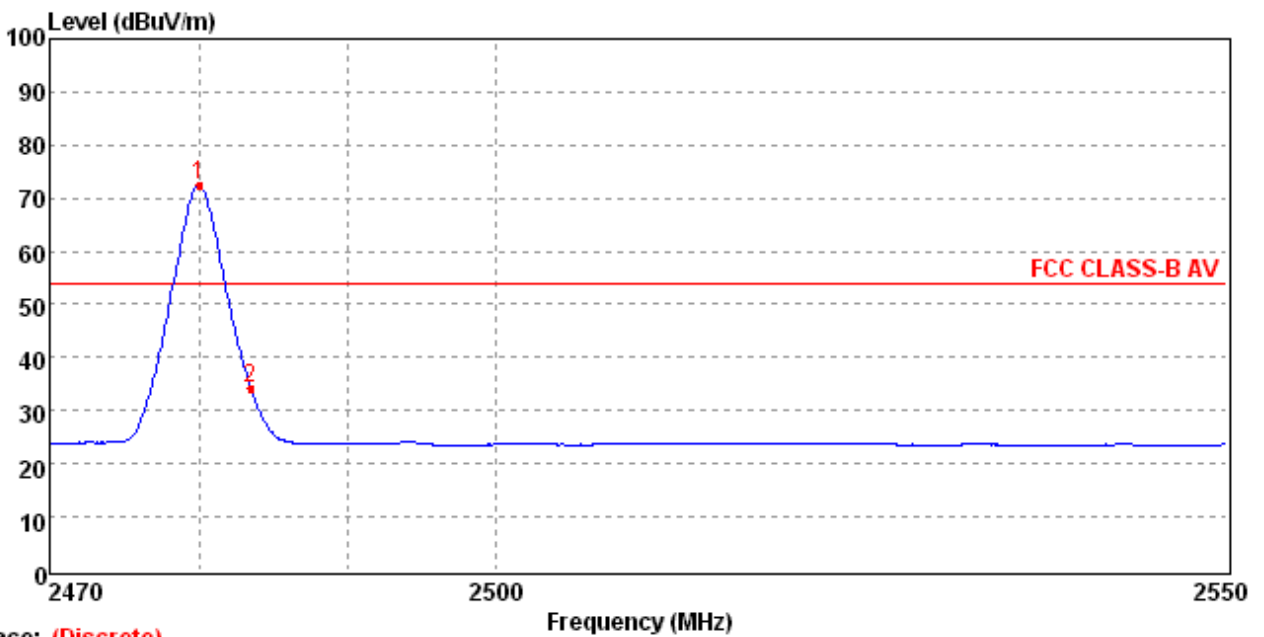

Trace: (Discrete)

Mark	Frequency (MHz)	Level (dBuV/m)	Cable Loss (dB)	Antenna Factor (dB/m)	Preamp Factor (dB)	Reading Level (dBuV/m)	Limit (dBuV/m)	Margin (dB)	Antenna Polarization	Detector
1	2480.01	72.56	3.88	27.45	36.55	77.78	54.00	-18.56	Hor	Average
2	2483.50	34.25	3.88	27.45	36.55	39.47	54.00	19.75	Hor	Average

Data: 12

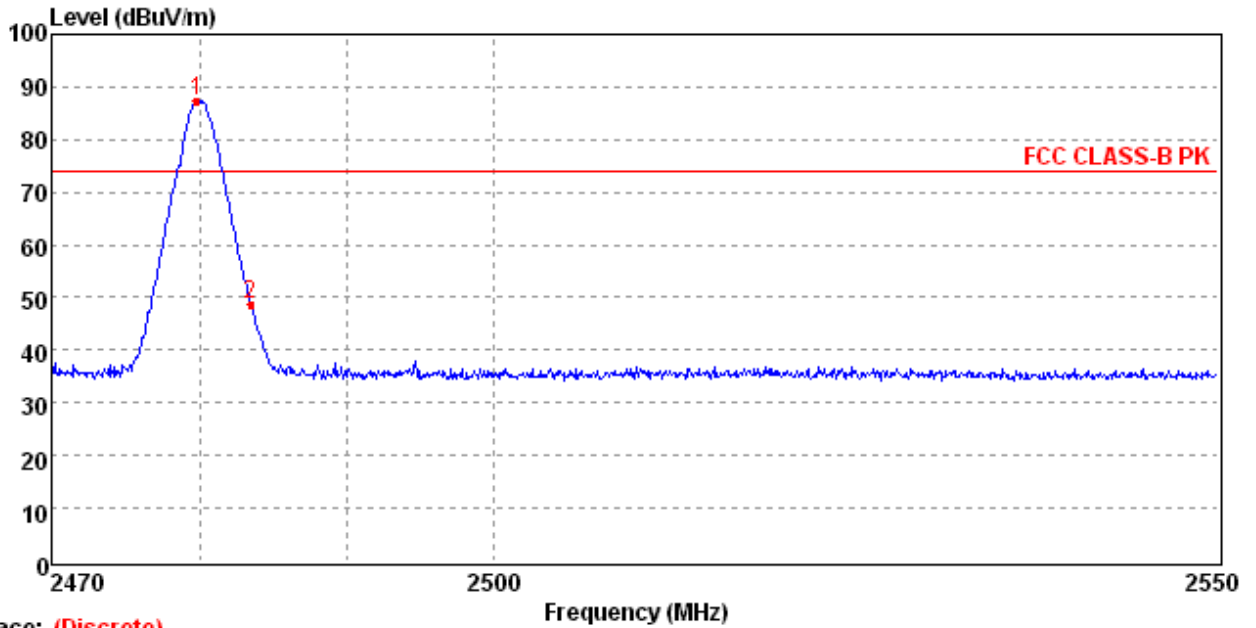

Trace: (Discrete)

Mark	Frequency (MHz)	Level (dBuV/m)	Cable Loss (dB)	Antenna Factor (dB/m)	Preamp Factor (dB)	Reading Level (dBuV/m)	Limit (dBuV/m)	Margin (dB)	Antenna Polarization	Detector
1	2480.01	87.34	3.88	27.45	36.55	92.56	74.00	-13.34	Ver	Peak
2	2483.50	48.64	3.88	27.45	36.55	53.86	74.00	25.36	Ver	Peak

Data: 13

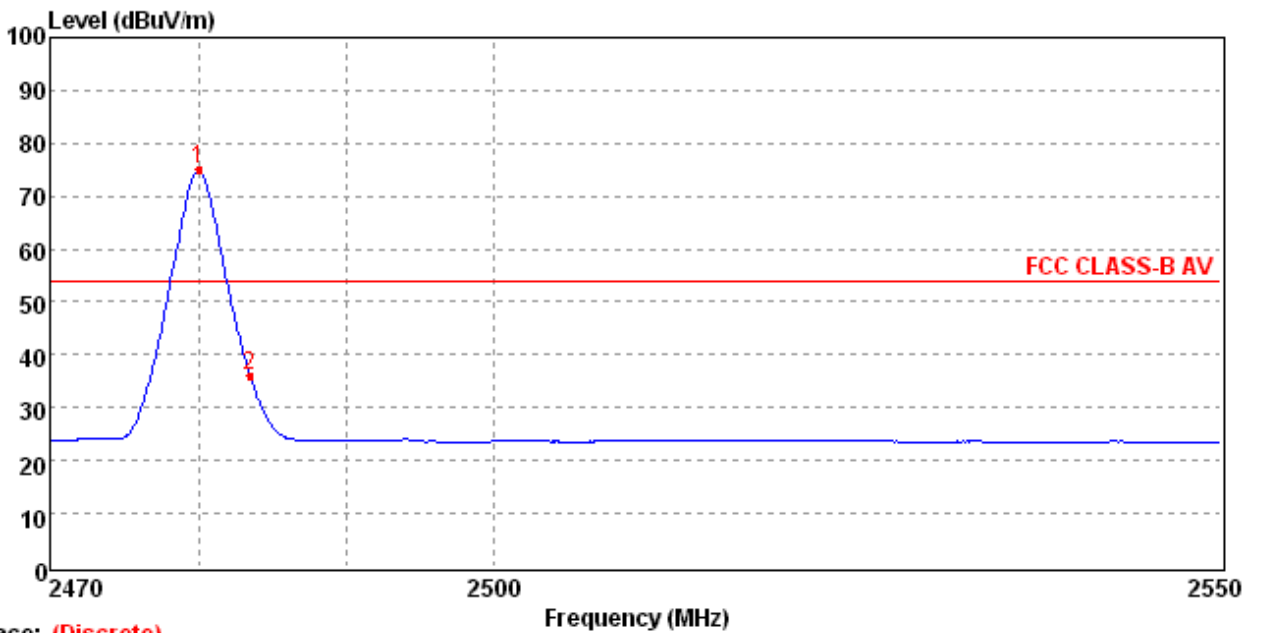

Trace: (Discrete)

Mark	Frequency (MHz)	Level (dBuV/m)	Cable Loss (dB)	Antenna Factor (dB/m)	Preamp Factor (dB)	Reading Level (dBuV/m)	Limit (dBuV/m)	Margin (dB)	Antenna Polarization	Detector
1	2480.01	74.91	3.88	27.45	36.55	80.13	54.00	-20.91	Ver	Average
2	2483.50	36.14	3.88	27.45	36.55	41.36	54.00	17.86	Ver	Average

4.5.1.3  $\pi/4$ DQPSK Test Mode

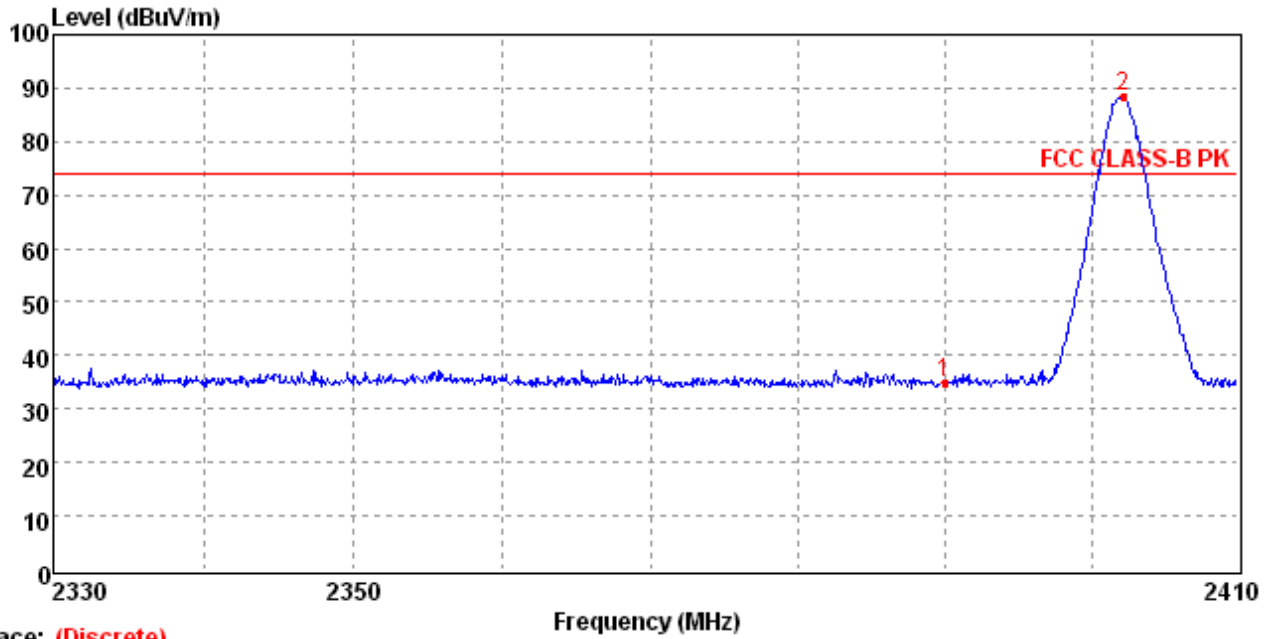

Trace: (Discrete)

Mark	Frequency (MHz)	Level (dBuV/m)	Cable Loss (dB)	Antenna Factor (dB/m)	Preamp Factor (dB)	Reading Level (dBuV/m)	Limit (dBuV/m)	Margin (dB)	Antenna Polarization	Detector
1	2390.00	34.77	3.32	27.49	36.12	40.08	74.00	39.23	Hor	Peak
2	2401.95	88.38	3.32	27.49	36.12	93.69	74.00	-14.38	Hor	Peak

Data: 23

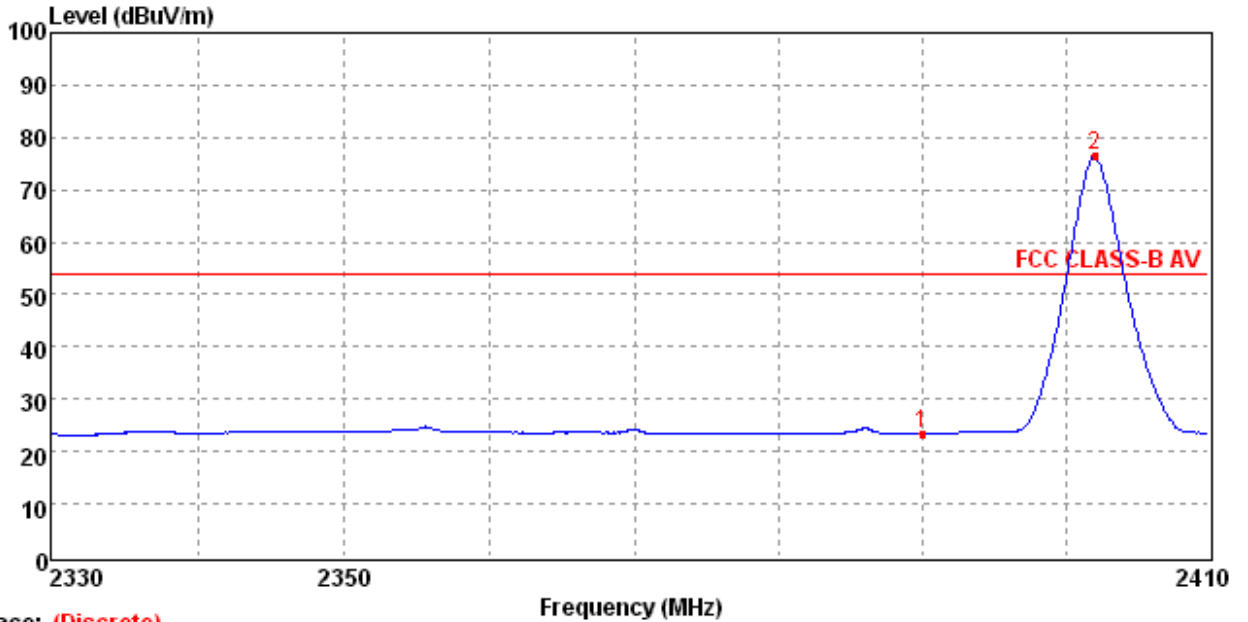

Trace: (Discrete)

Mark	Frequency (MHz)	Level (dBuV/m)	Cable Loss (dB)	Antenna Factor (dB/m)	Preamp Factor (dB)	Reading Level (dBuV/m)	Limit (dBuV/m)	Margin (dB)	Antenna Polarization	Detector
1	2390.00	23.45	3.32	27.49	36.12	28.76	54.00	30.55	Hor	Average
2	2402.15	76.47	3.32	27.49	36.12	81.78	54.00	-22.47	Hor	Average

Data: 20

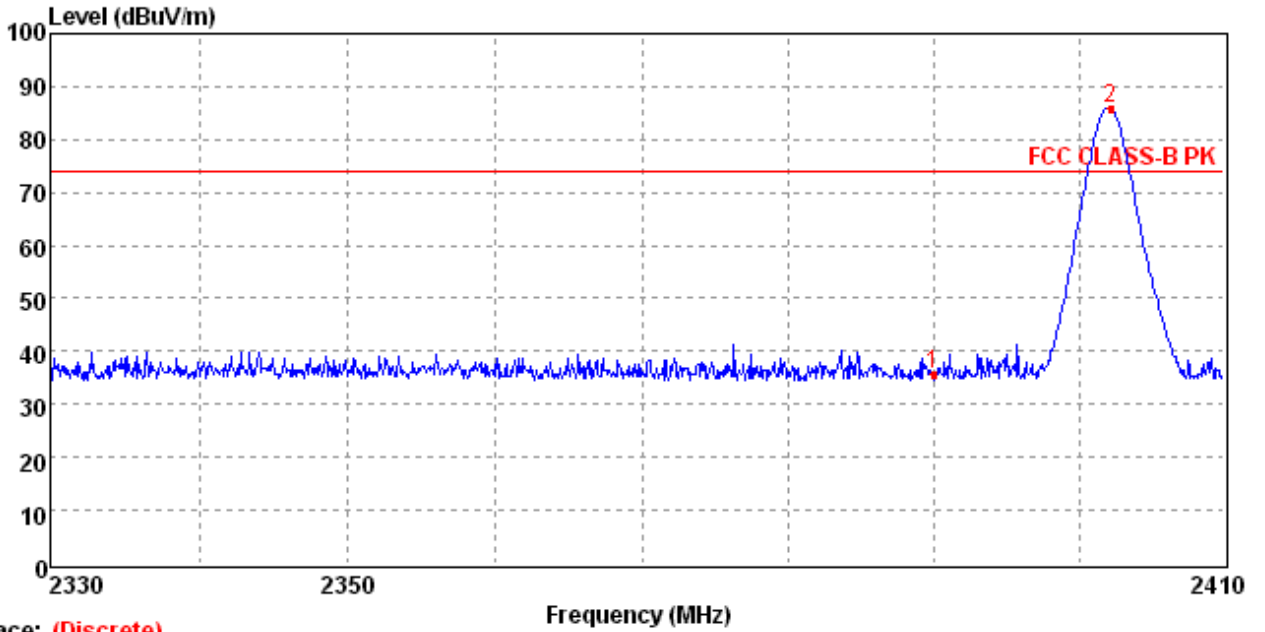

Trace: (Discrete)

Mark	Frequency (MHz)	Level (dBuV/m)	Cable Loss (dB)	Antenna Factor (dB/m)	Preamp Factor (dB)	Reading Level (dBuV/m)	Limit (dBuV/m)	Margin (dB)	Antenna Polarization	Detector
1	2390.00	35.55	3.32	27.49	36.12	40.86	74.00	38.45	Ver	Peak
2	2401.95	85.91	3.32	27.49	36.12	91.22	74.00	-11.91	Ver	Peak

Data: 21

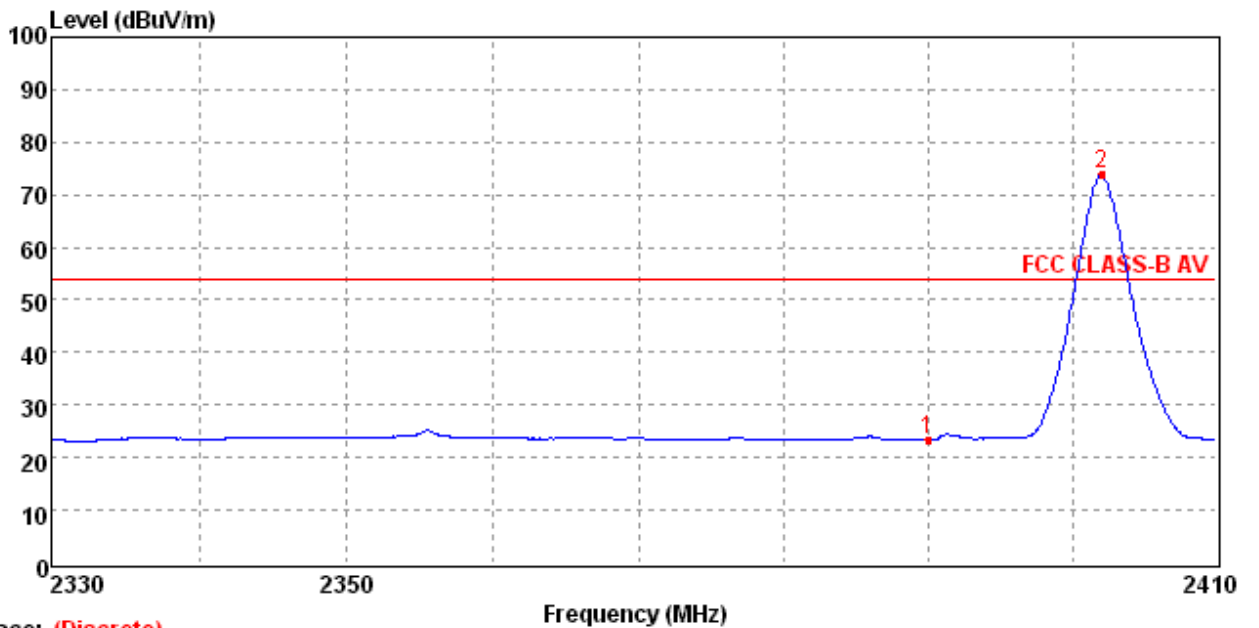

Trace: (Discrete)

Mark	Frequency (MHz)	Level (dBuV/m)	Cable Loss (dB)	Antenna Factor (dB/m)	Preamp Factor (dB)	Reading Level (dBuV/m)	Limit (dBuV/m)	Margin (dB)	Antenna Polarization	Detector
1	2390.00	23.49	3.32	27.49	36.12	28.80	54.00	30.51	Ver	Average
2	2402.15	73.85	3.32	27.49	36.12	79.16	54.00	-19.85	Ver	Average

Data: 16

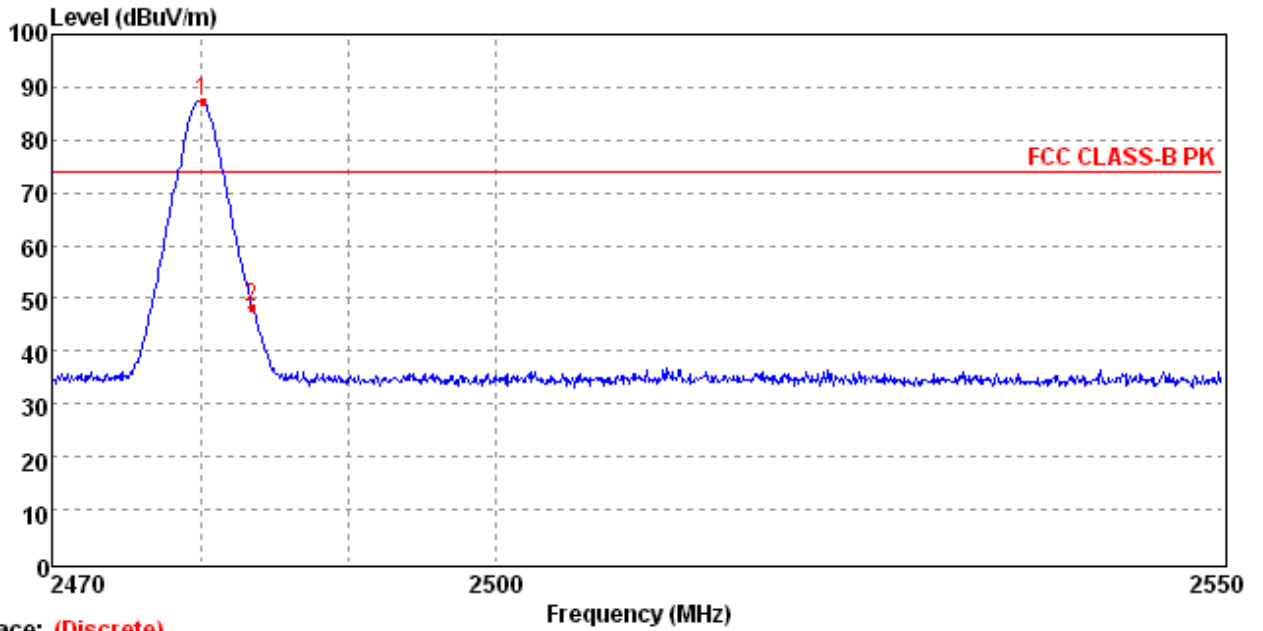

Trace: (Discrete)

Mark	Frequency (MHz)	Level (dBuV/m)	Cable Loss (dB)	Antenna Factor (dB/m)	Preamp Factor (dB)	Reading Level (dBuV/m)	Limit (dBuV/m)	Margin (dB)	Antenna Polarization	Detector
1	2479.83	87.31	3.88	27.45	36.55	92.53	74.00	-13.31	Hor	Peak
2	2483.50	48.39	3.88	27.45	36.55	53.61	74.00	25.61	Hor	Peak

Data: 17

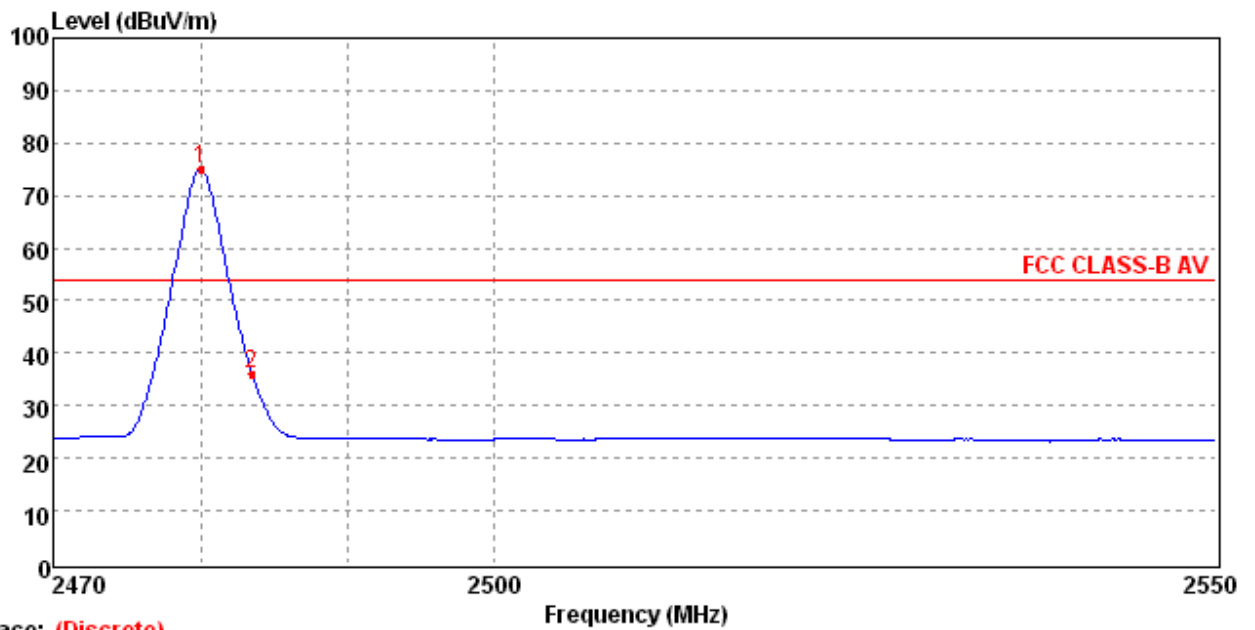

Trace: (Discrete)

Mark	Frequency (MHz)	Level (dBuV/m)	Cable Loss (dB)	Antenna Factor (dB/m)	Preamp Factor (dB)	Reading Level (dBuV/m)	Limit (dBuV/m)	Margin (dB)	Antenna Polarization	Detector
1	2480.01	75.13	3.88	27.45	36.55	80.35	54.00	-21.13	Hor	Average
2	2483.50	36.20	3.88	27.45	36.55	41.42	54.00	17.80	Hor	Average



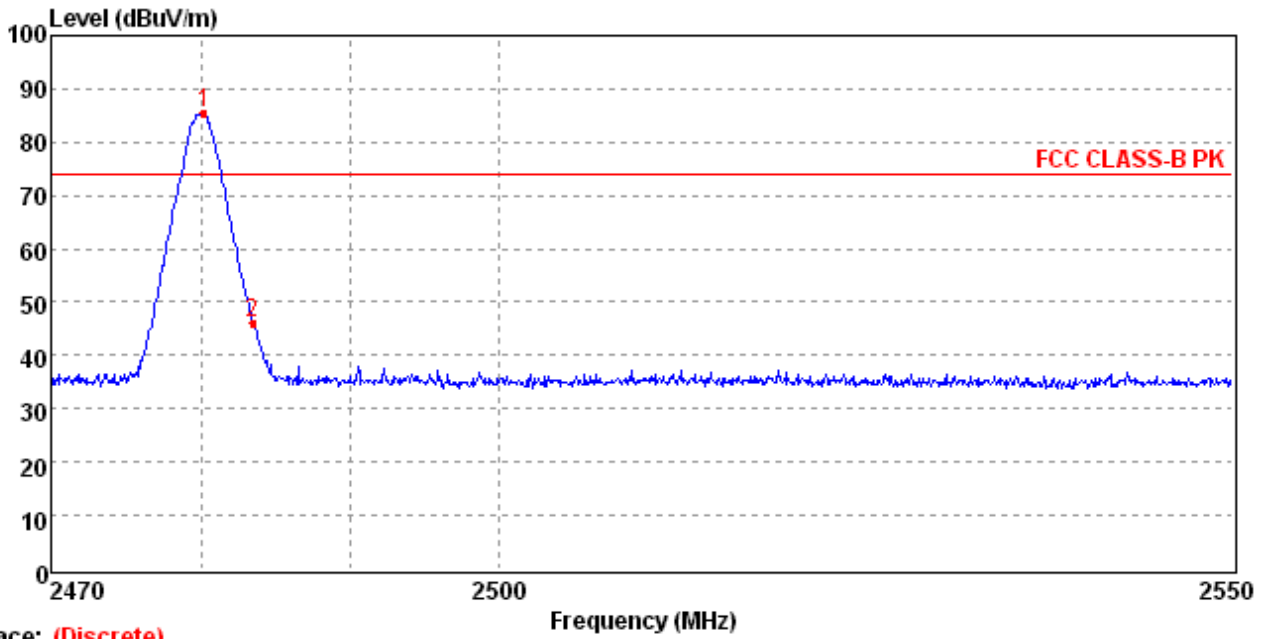

Mark	Frequency (MHz)	Level (dBuV/m)	Cable Loss (dB)	Antenna Factor (dB/m)	Preamp Factor (dB)	Reading Level (dBuV/m)	Limit (dBuV/m)	Margin (dB)	Antenna Polarization	Detector
1	2474.92	85.48	3.88	27.45	36.55	90.70	74.00	-11.48	Ver	Peak
2	2483.50	46.11	3.88	27.45	36.55	51.33	74.00	27.89	Ver	Peak

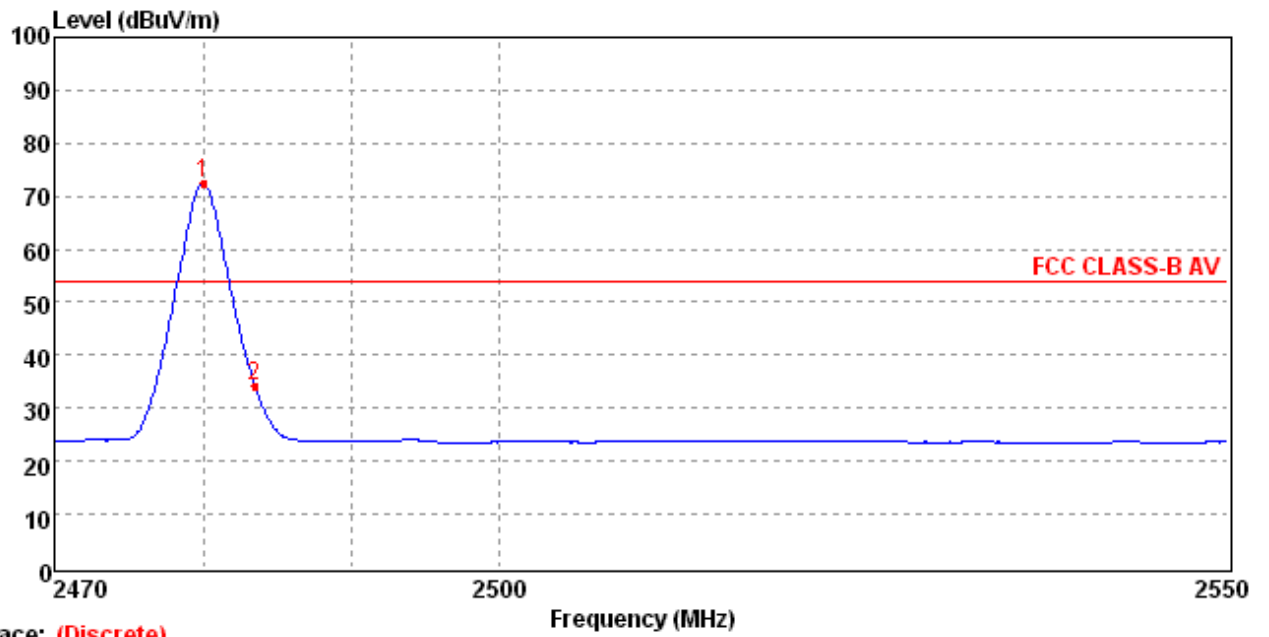

Mark	Frequency (MHz)	Level (dBuV/m)	Cable Loss (dB)	Antenna Factor (dB/m)	Preamp Factor (dB)	Reading Level (dBuV/m)	Limit (dBuV/m)	Margin (dB)	Antenna Polarization	Detector
1	2480.01	72.62	3.88	27.45	36.55	77.84	54.00	-18.62	Ver	Average
2	2483.50	34.23	3.88	27.45	36.55	39.45	54.00	19.77	Ver	Average

### 4.5.2 For Conducted Bandedge Measurement

#### 4.5.2.1 GFSK Test Mode

##### A. Test Verdict

Frequency (MHz)	Delta Peak to Band emission (dBc)	Hopping Mode	Detector	Limit (dBc)	Refer to Plot	Verdict
2400.00	44.86	OFF	Peak	20	Plot 4.5.2.1 A	PASS
2400.00	45.93	ON	Peak	20	Plot 4.5.2.1 B	PASS
2483.50	48.14	OFF	Peak	20	Plot 4.5.2.1 C	PASS
2483.50	48.06	ON	Peak	20	Plot 4.5.2.1 D	PASS

##### B. Test Plots

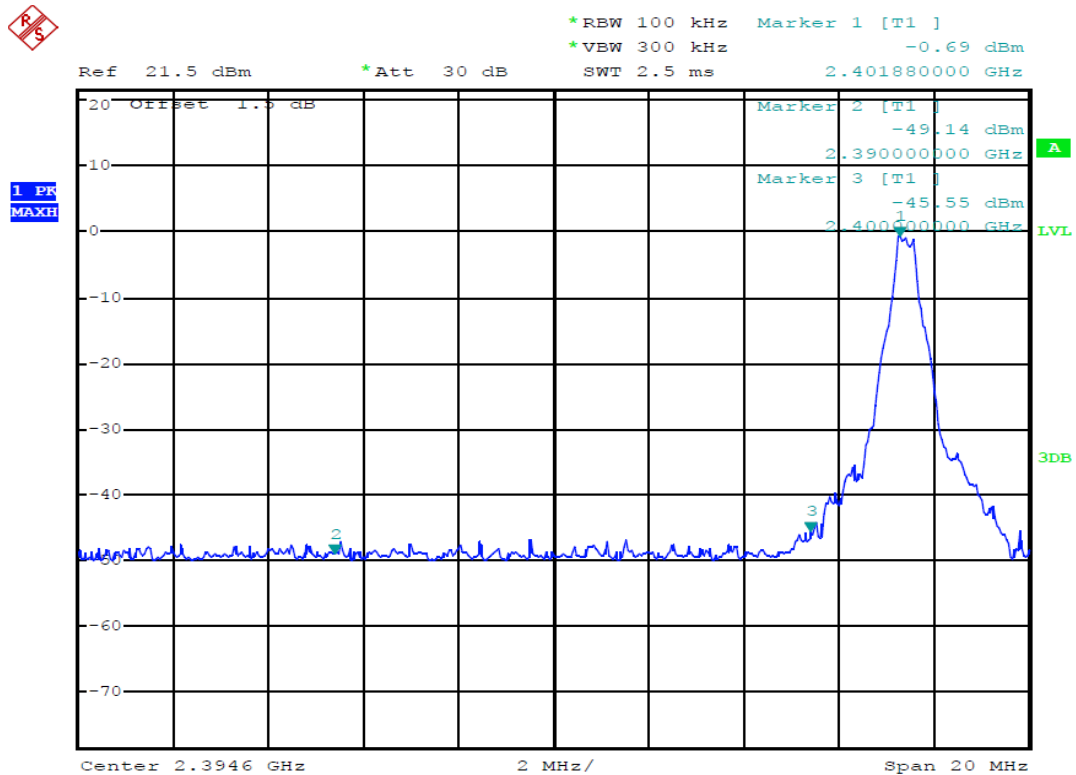

Date: 20.MAR.2014 21:35:58

(Plot 4.5.2.1 A: Channel 00: 2402MHz @ GFSK)



\*RBW 100 kHz Marker 1 [T1 ]  
\*VBW 300 kHz -1.91 dBm  
Ref 21.5 dBm \*Att 30 dB SWT 2.5 ms 2.403840000 GHz

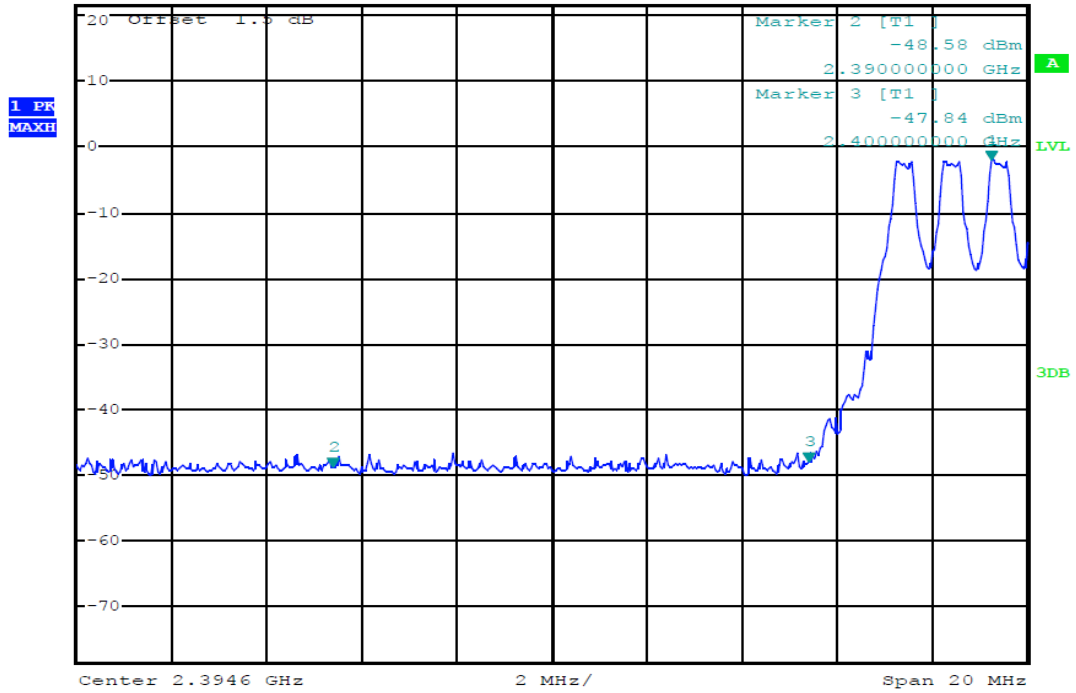

Date: 20.MAR.2014 21:37:19

(Plot 4.5.2.1 B: Hopping Mode @ GFSK)



\*RBW 100 kHz Marker 1 [T1 ]  
\*VBW 300 kHz -0.63 dBm  
Ref 21.5 dBm \*Att 30 dB SWT 5 ms 2.479800000 GHz

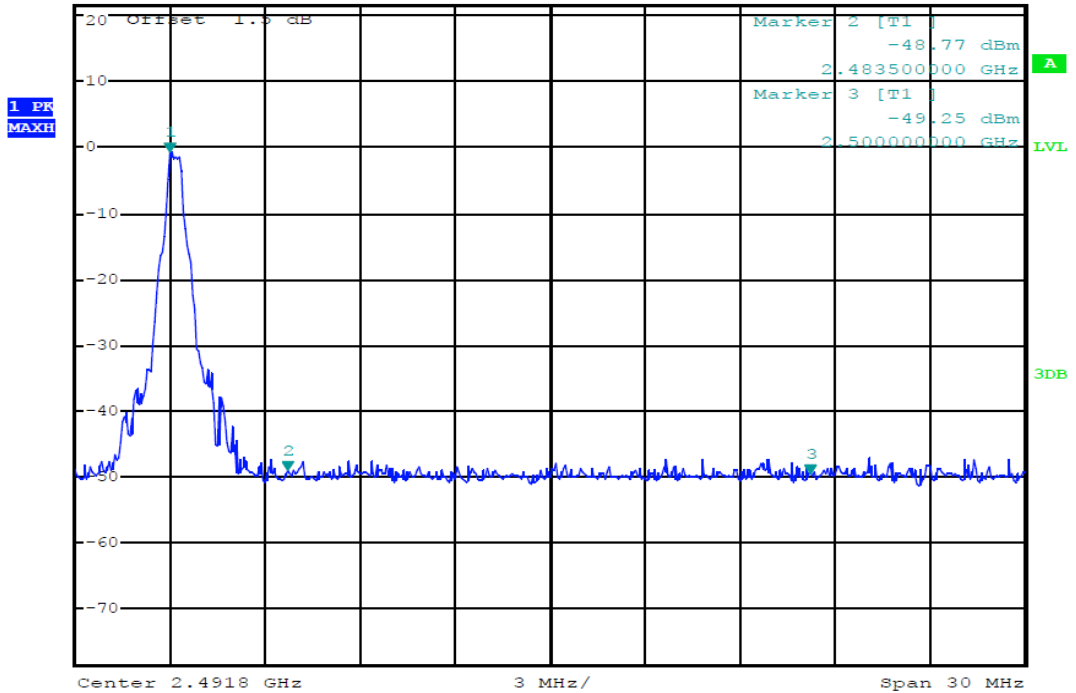

Date: 20.MAR.2014 21:45:04

(Plot 4.5.2.1 C: Channel 78: 2480MHz @ GFSK)

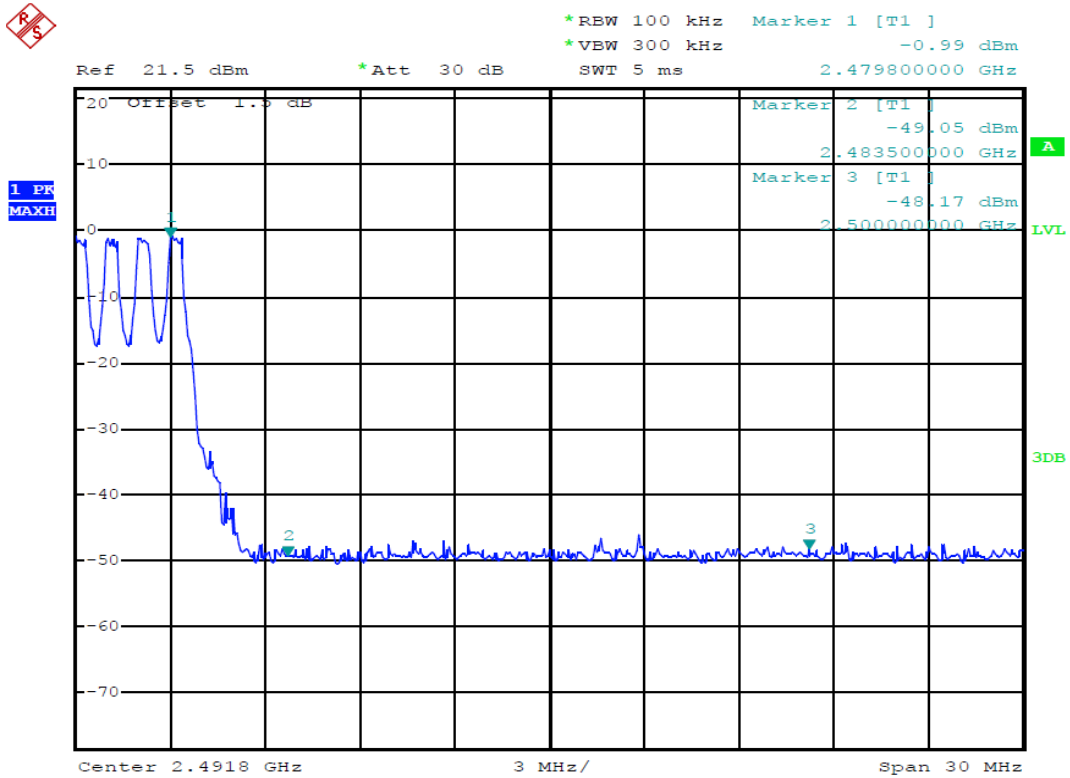

Date: 20.MAR.2014 21:45:38

(Plot 4.5.2.1 D: Hopping Mode @ GFSK)

**4.5.2.2 8DPSK Test Mode**

A. Test Verdict

Frequency (MHz)	Delta Peak to Band emission (dBc)	Hopping Mode	Detector	Limit (dBc)	Refer to Plot	Verdict
2400.00	45.97	OFF	Peak	20	Plot 4.5.2.2 A	PASS
2400.00	45.93	ON	Peak	20	Plot 4.5.2.2 B	PASS
2483.50	45.46	OFF	Peak	20	Plot 4.5.2.2 C	PASS
2483.50	46.38	ON	Peak	20	Plot 4.5.2.2 D	PASS

B. Test Plots

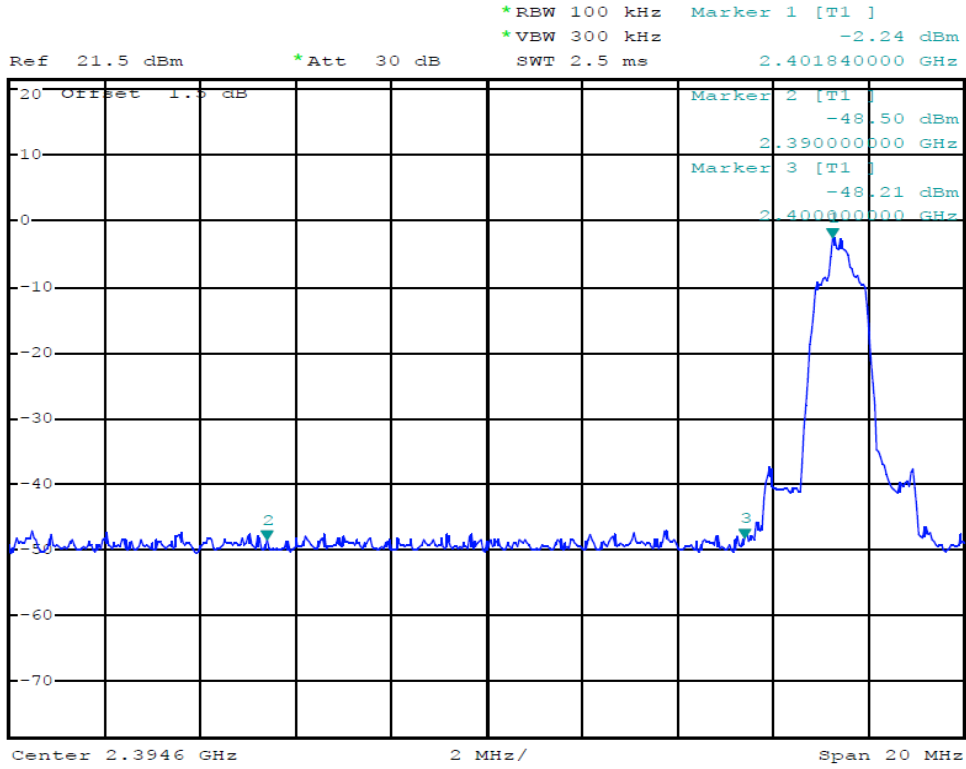

Date: 20.MAR.2014 21:38:16

(Plot 4.5.2.2 A: Channel 00: 2402MHz @ 8DPSK)

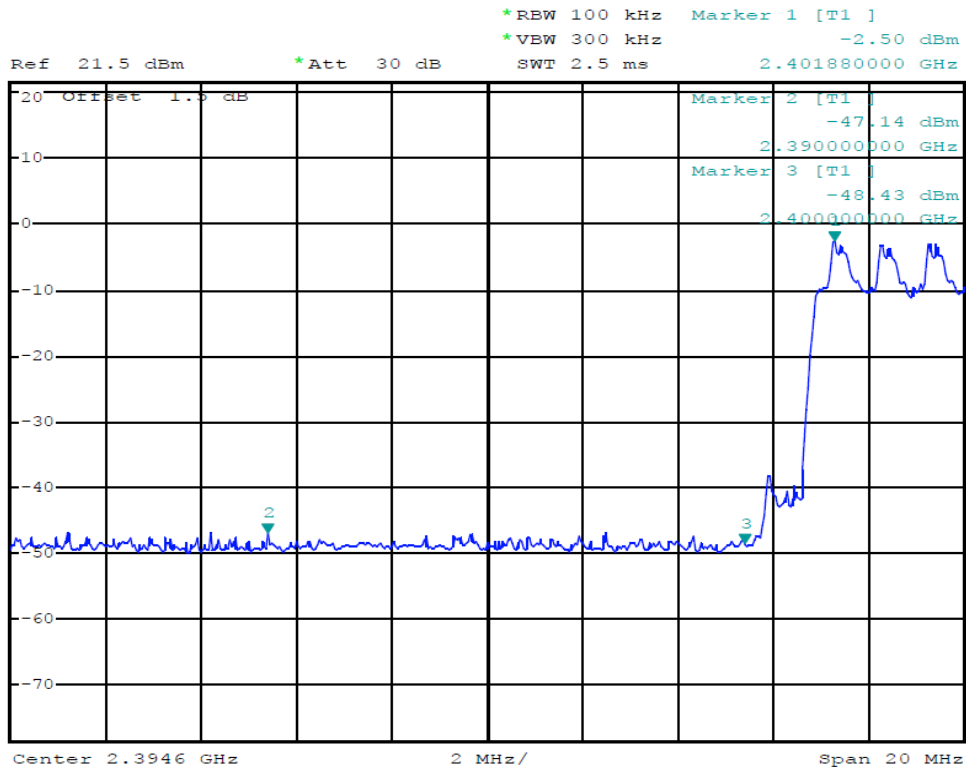

Date: 20.MAR.2014 21:39:29

(Plot 4.5.2.2 B: Hopping Mode @ 8DPSK)

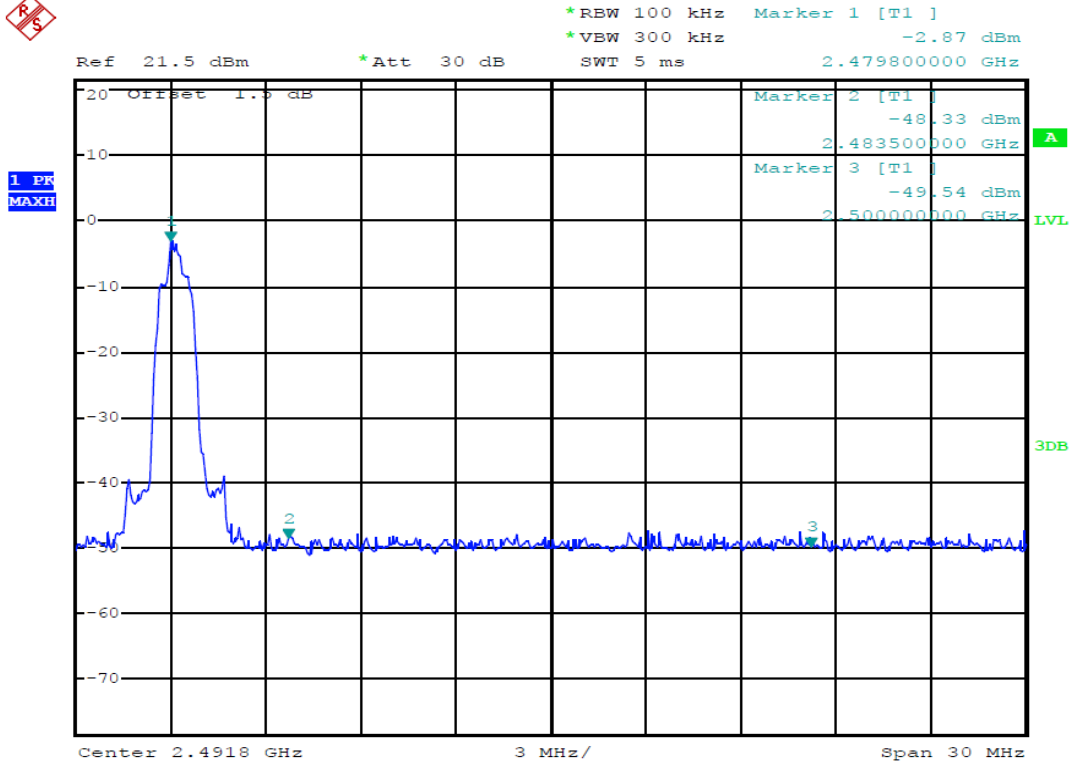

Date: 20.MAR.2014 21:46:15

(Plot 4.5.2.2 C: Channel 78: 2480MHz @ 8DPSK)

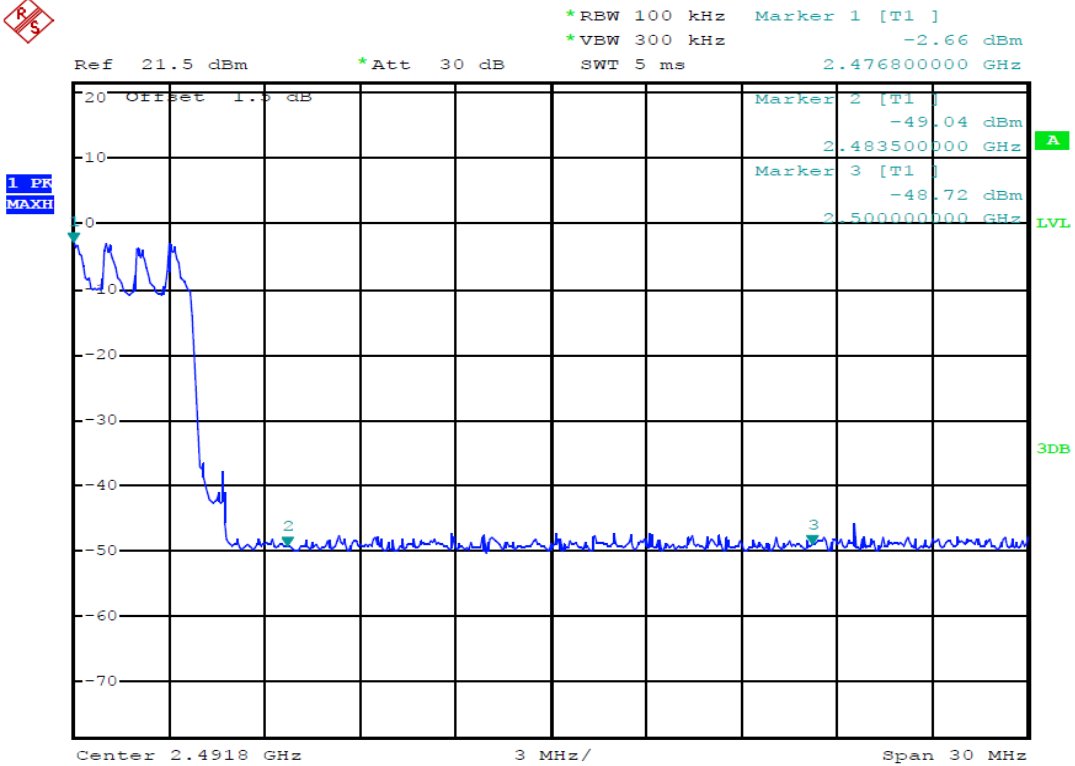

Date: 20.MAR.2014 21:46:53

(Plot 4.5.2.2 D: Hopping Mode @ 8DPSK)

4.5.2.3  $\pi/4$ DQPSK Test Mode

A. Test Verdict

Frequency (MHz)	Delta Peak to Band emission (dBc)	Hopping Mode	Detector	Limit (dBc)	Refer to Plot	Verdict
2400.00	47.49	OFF	Peak	20	Plot 4.5.2.3 A	PASS
2400.00	46.91	ON	Peak	20	Plot 4.5.2.3 B	PASS
2483.50	45.18	OFF	Peak	20	Plot 4.5.2.3 C	PASS
2483.50	45.09	ON	Peak	20	Plot 4.5.2.3 D	PASS

B. Test Plots

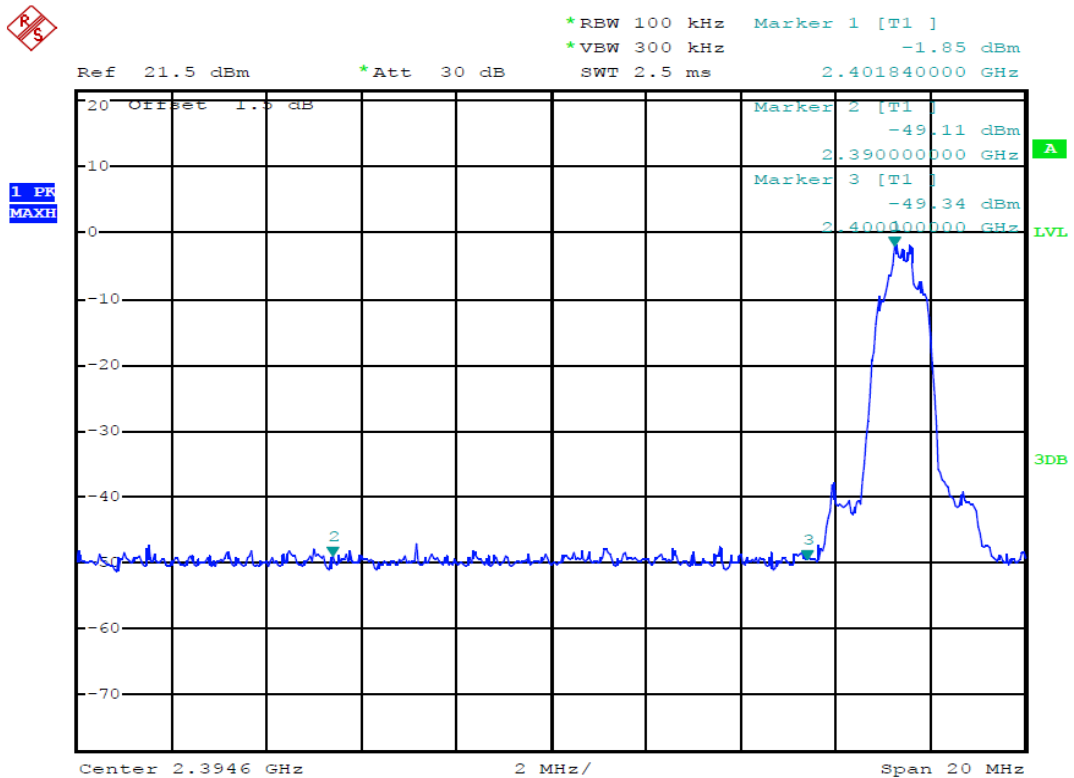

Date: 20.MAR.2014 21:39:59

(Plot 4.5.2.3 A: Channel 00: 2402MHz @  $\pi/4$ DQPSK)

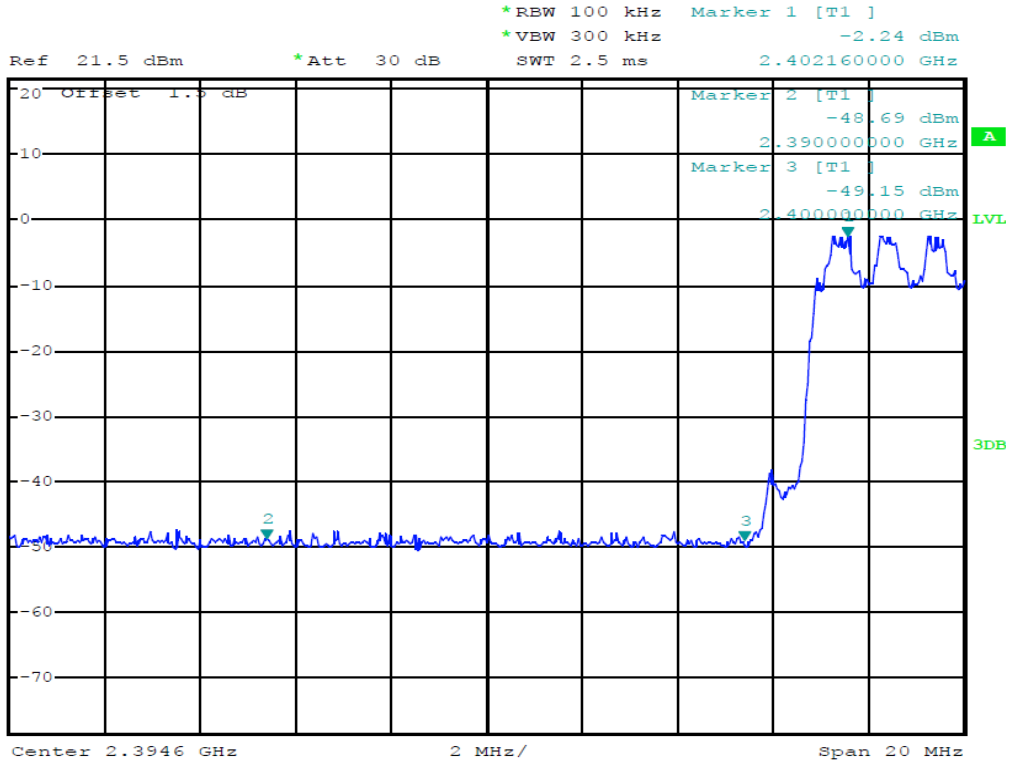

Date: 20.MAR.2014 21:40:58

(Plot 4.5.2.3 B: Hopping Mode @ $\pi/4$ DQPSK)

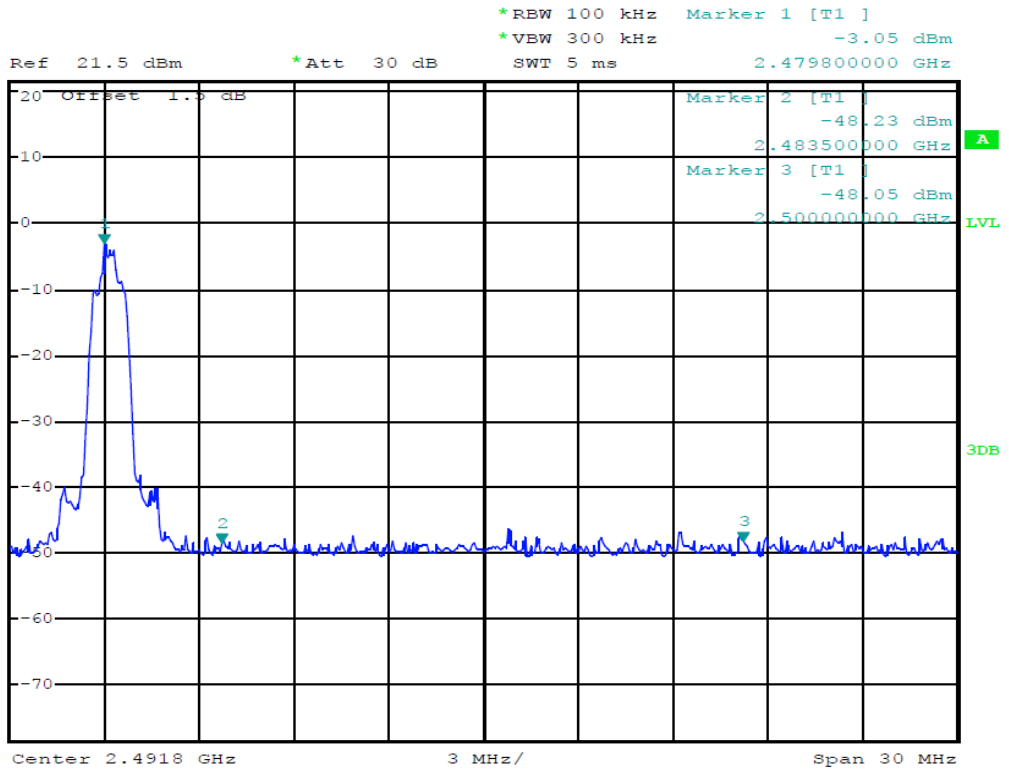

Date: 20.MAR.2014 21:43:18

(Plot 4.5.2.3 C: Channel 78: 2480MHz @  $\pi/4$ DQPSK)





Ref 21.5 dBm \*Att 30 dB SWT 5 ms  
\*RBW 100 kHz Marker 1 [T1 ] -3.11 dBm  
\*VBW 300 kHz 2.478120000 GHz

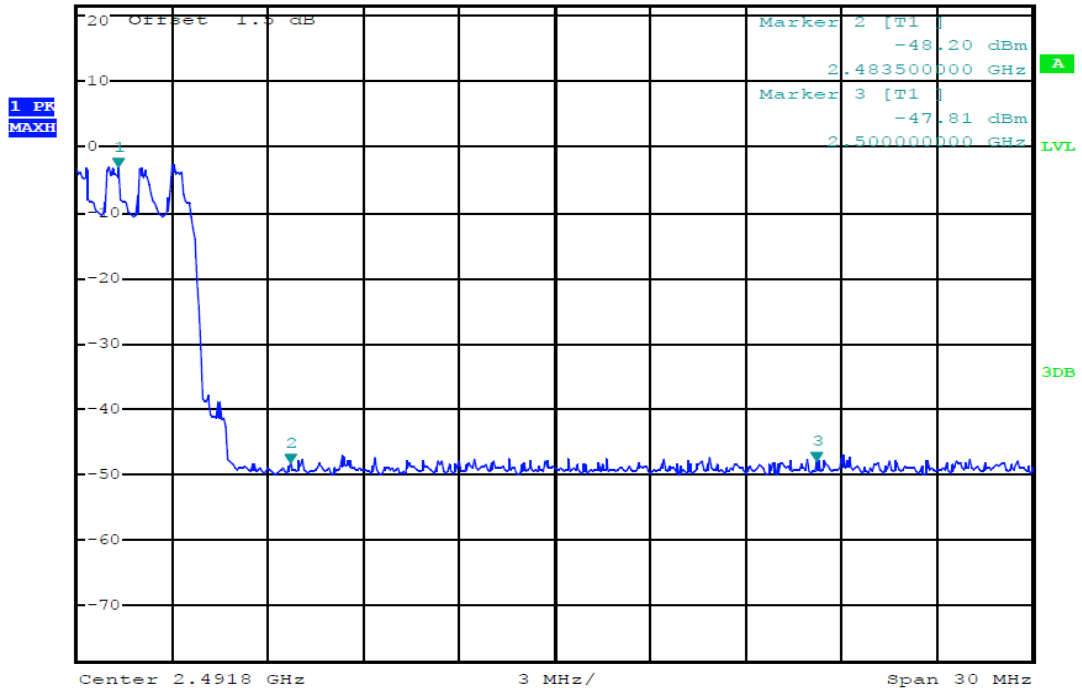

Date: 20.MAR.2014 21:44:30

(Plot 4.5.2.3 D: Hopping Mode @ $\pi/4$ DQPSK)

## 4.6. Frequency Separation

### TEST CONFIGURATION

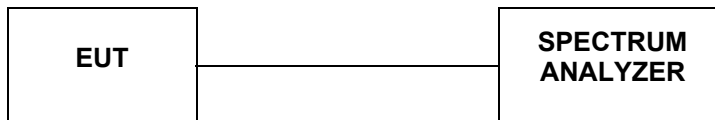

### TEST PROCEDURE

The transmitter output was connected to the spectrum analyzer through an attenuator. The bandwidth of the fundamental frequency was measured by spectrum analyzer with RBW=30 KHz and VBW=100KHz.

### LIMIT

According to 15.247(a)(1), frequency hopping systems shall have hopping channel carrier frequencies separated by minimum of 25KHz or the  $2/3 \times 20\text{dB}$  bandwidth of the hopping channel, whichever is greater.

### TEST RESULTS

#### 4.6.1 GFSK Test Mode

##### A. Test Verdict

Channel	Frequency (MHz)	Channel Separation (MHz)	Refer to Plot	Limits (KHz)	Verdict
00	2402	1.004	Plot 4.6.1 A	565.33	PASS
01	2403				
38	2440	1.004	Plot 4.6.1 B	560.00	PASS
39	2441				
77	2479	1.004	Plot 4.6.1 C	581.33	PASS
78	2480				

##### B. Test Plots



\*RBW 100 kHz Delta 1 [T1 ]  
\*VBW 300 kHz 0.01 dB  
Ref 21.5 dBm \*Att 30 dB SWT 2.5 ms 1.004000000 MHz

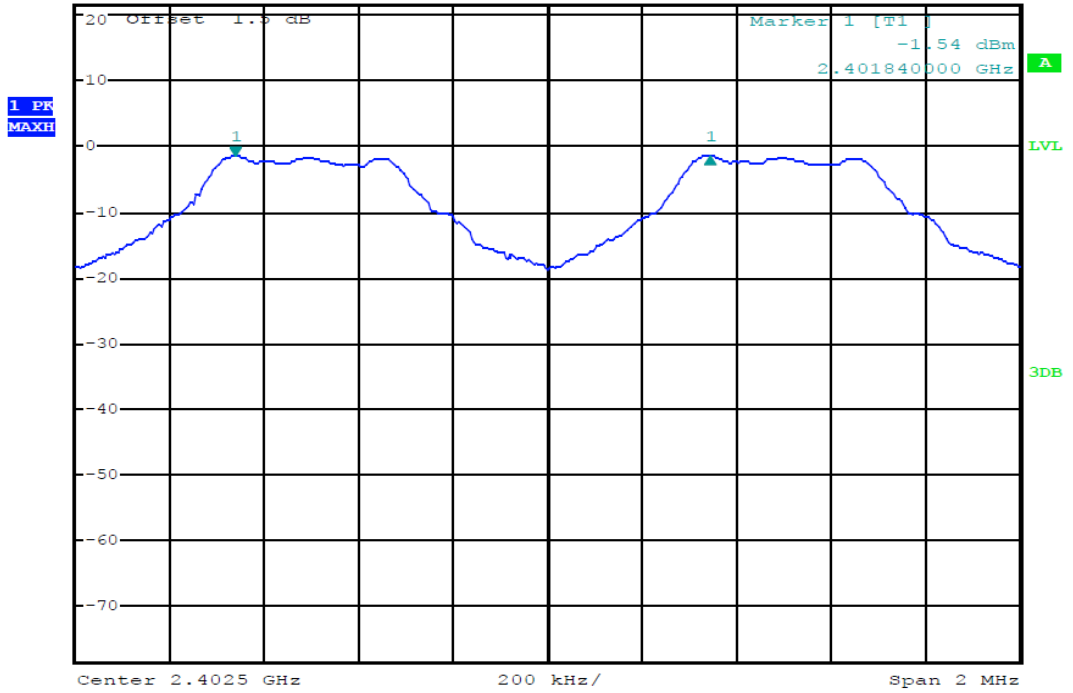

Date: 20.MAR.2014 21:48:49

(Plot 4.6.1 A: Channel 00: 2402MHz @ GFSK)



\*RBW 100 kHz Delta 1 [T1 ]  
\*VBW 300 kHz 0.07 dB  
Ref 21.5 dBm \*Att 30 dB SWT 2.5 ms 1.004000000 MHz

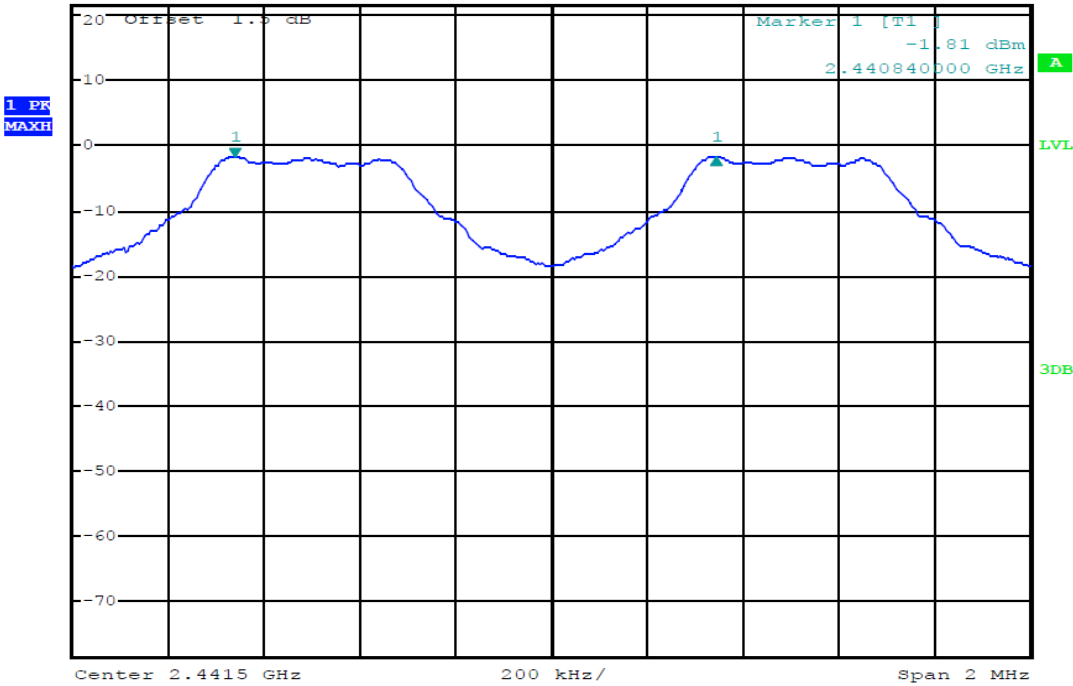

Date: 20.MAR.2014 21:49:51

(Plot 4.6.1 B: Channel 39: 2441MHz @ GFSK)

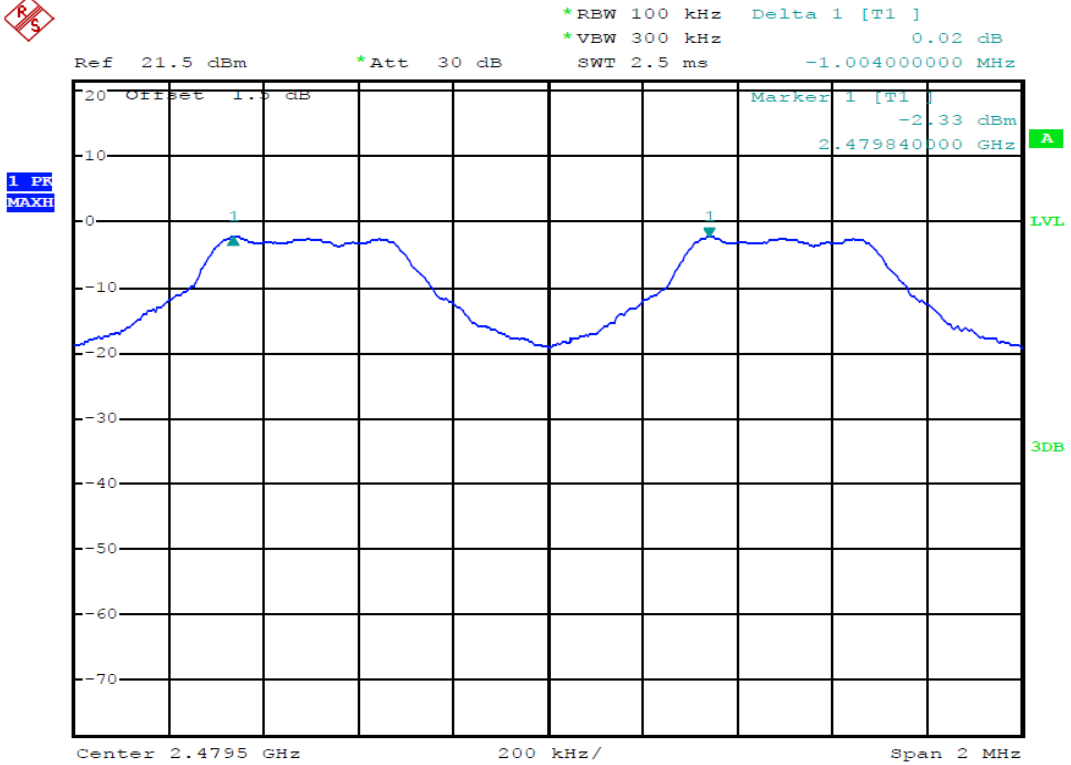

Date: 20.MAR.2014 21:50:51

(Plot 4.6.1 C: Channel 78: 2480MHz @ GFSK)

**4.6.2 8DPSK Test Mode**

A. Test Verdict

Channel	Frequency (MHz)	Channel Separation (MHz)	Refer to Plot	Limits (KHz)	Verdict
00	2402	1.004	Plot 4.6.2 A	810.67	PASS
01	2403				
38	2440	1.004	Plot 4.6.2 B	810.67	PASS
39	2441				
77	2479	1.004	Plot 4.6.2 C	810.67	PASS
78	2480				

B. Test Plots

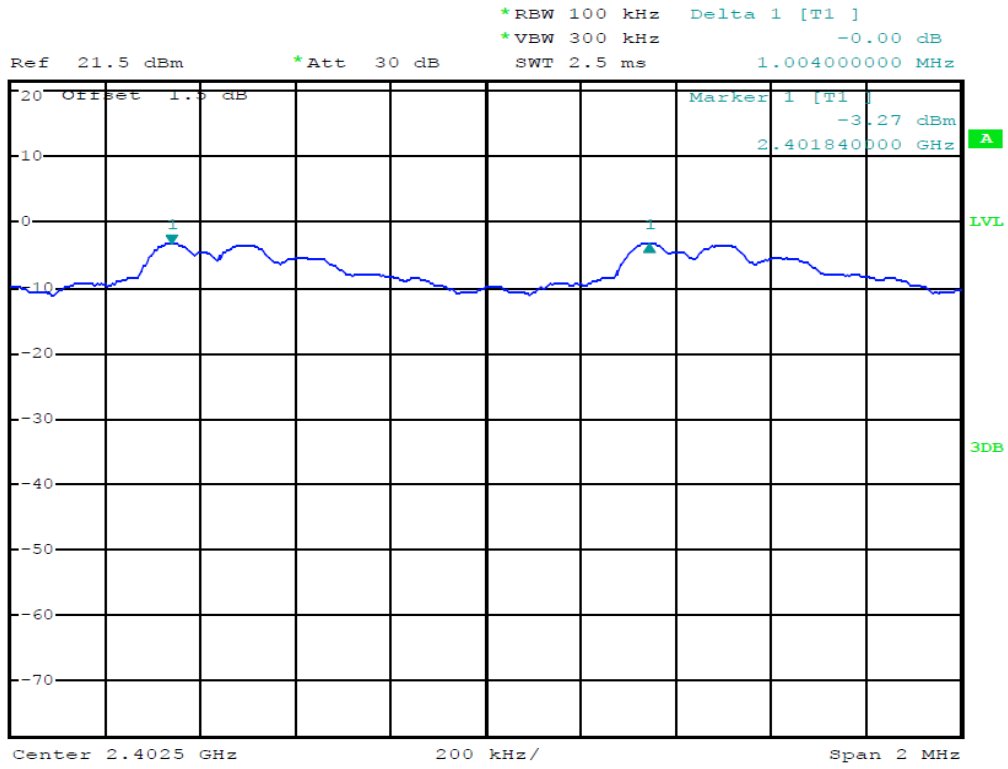

Date: 20.MAR.2014 21:52:43

(Plot 4.6.2 A: Channel 00: 2402MHz @ 8DPSK)

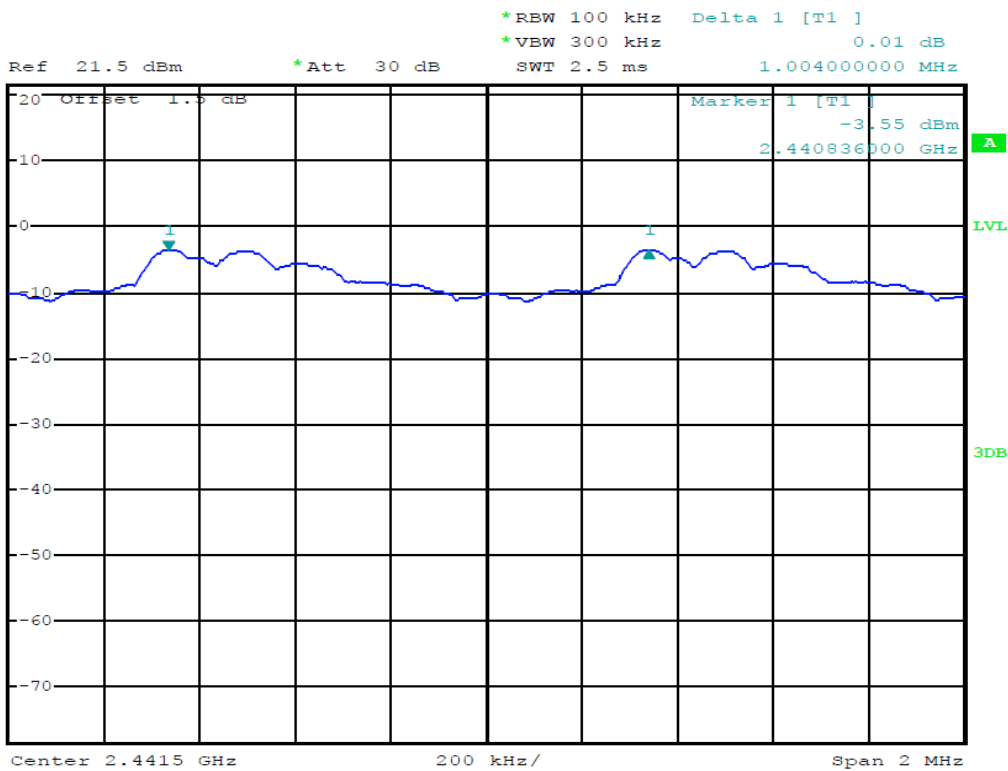

Date: 20.MAR.2014 21:53:49

(Plot 4.6.2 B: Channel 39: 2441MHz @ @ 8DPSK)

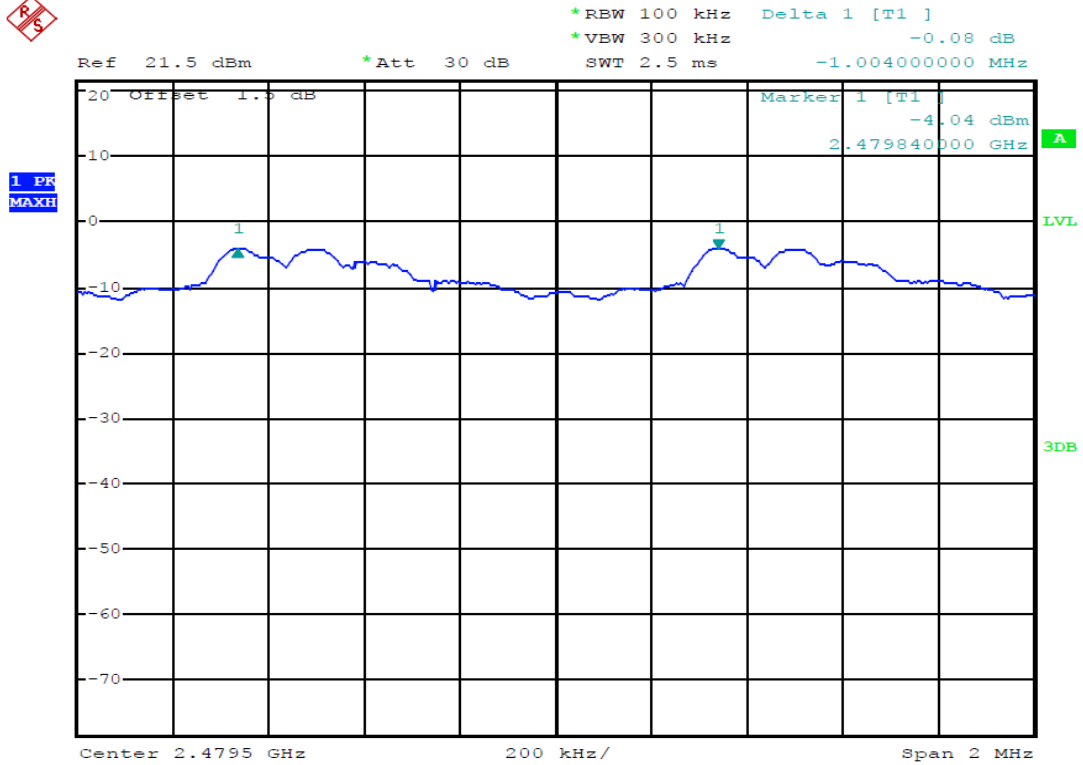

Date: 20.MAR.2014 21:51:47

(Plot 4.6.2 C: Channel 78: 2480MHz @ @ 8DPSK)

**4.6.3  $\pi/4$ DQPSK Test Mode**

A. Test Verdict

Channel	Frequency (MHz)	Channel Separation (MHz)	Refer to Plot	Limits (KHz)	Verdict
00	2402	1.004	Plot 4.6.3 A	808.00	PASS
01	2403				
38	2440	1.004	Plot 4.6.3 B	808.00	PASS
39	2441				
77	2479	1.004	Plot 4.6.3 C	808.00	PASS
78	2480				

B. Test Plots

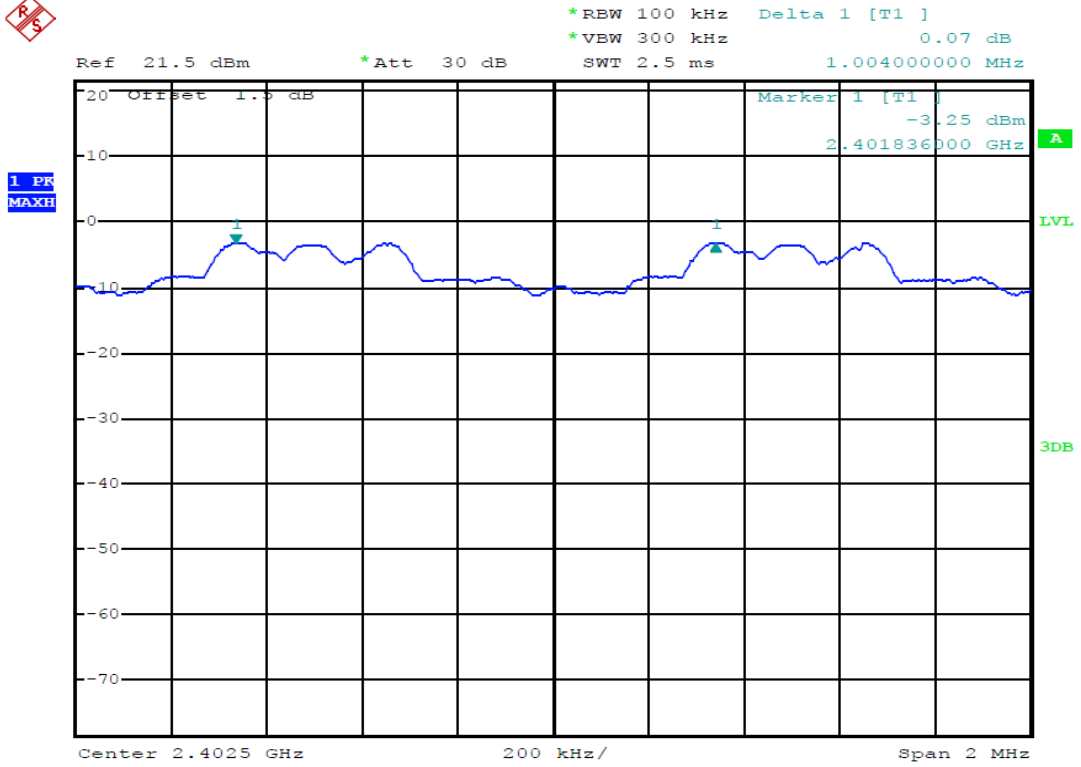

Date: 20.MAR.2014 21:55:58

(Plot 4.6.3 A: Channel 00: 2402MHz @ $\pi/4$ DQPSK)

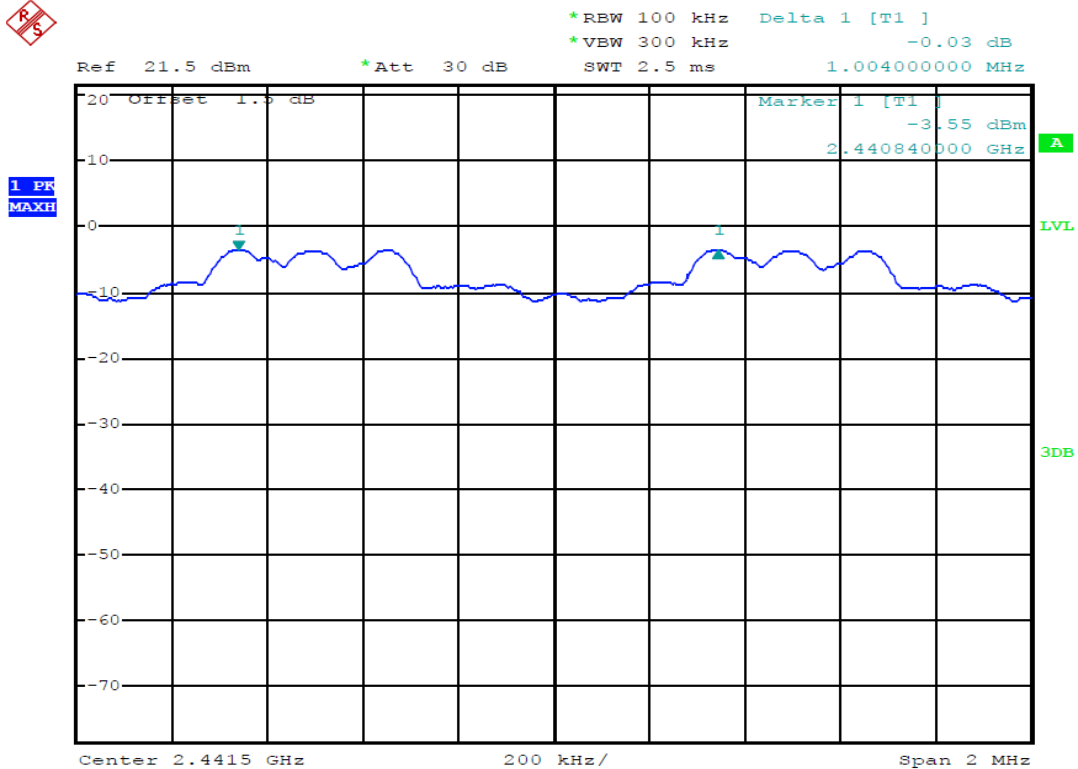

Date: 20.MAR.2014 21:54:57

(Plot 4.6.3 B: Channel 39: 2441MHz @  $\pi/4$ DQPSK)



\*RBW 100 kHz Marker 1 [T1 ]  
\*VEW 300 kHz -4.06 dBm  
SWT 2.5 ms 2.478836000 GHz

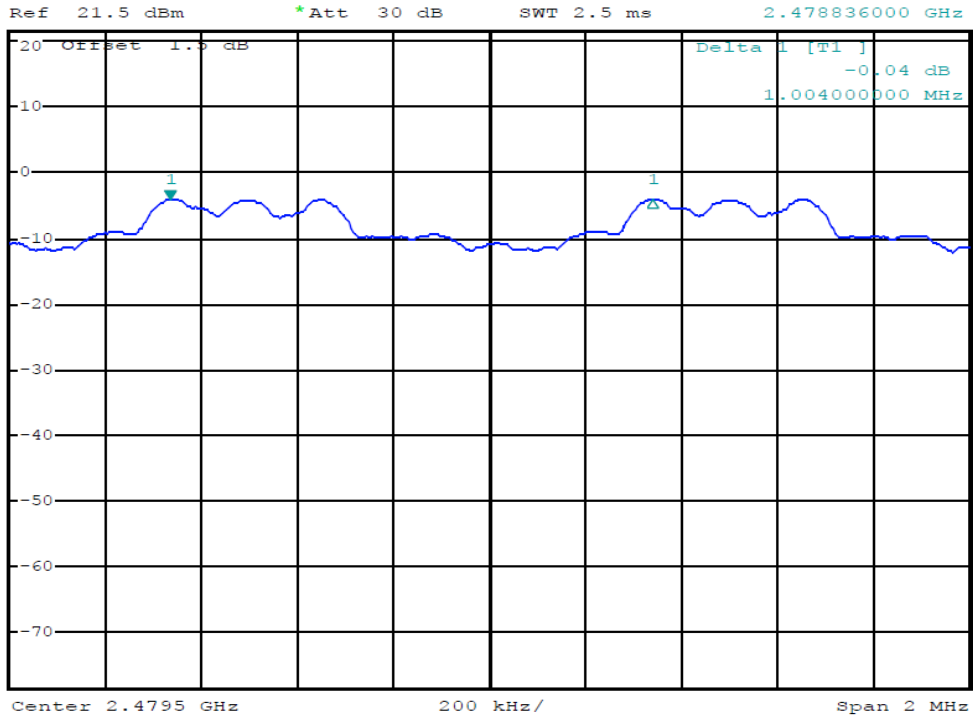

Date: 20.MAR.2014 21:57:28

(Plot 4.6.3 C: Channel 78: 2480MHz @ @π/4DQPSK)



### 4.7. Number of hopping frequency

#### TEST CONFIGURATION

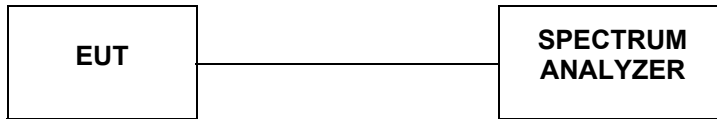

#### TEST PROCEDURE

The transmitter output was connected to the spectrum analyzer through an attenuator. Set spectrum analyzer start 2400MHz to 2483.5MHz with RBW=30 KHz and VBW=100KHz.

#### LIMIT

Frequency hopping systems in the 2400–2483.5 MHz band shall use at least 15 channels.

#### TEST RESULTS

##### 4.7.1 GFSK Test Mode

###### A. Test Verdict

Hopping Channel Frequency Range (MHz)	Number of Hopping Channel	Refer to Plot	Limit	Verdict
2400-2483.5	79	Plot 4.7.1 A	≥15	PASS

###### B. Test Plots

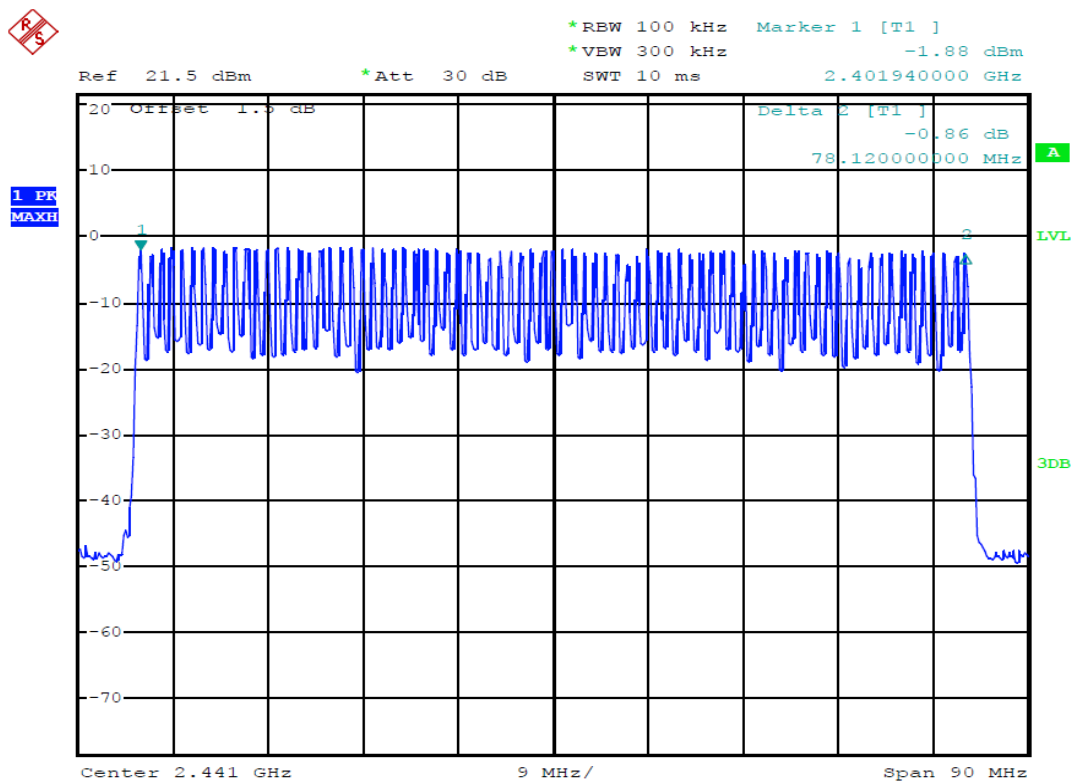

Date: 20.MAR.2014 21:06:13

(Plot 4.7.1 A: @ GFSK)

### 4.7.2 8DPSK Test Mode

#### A. Test Verdict

Hopping Channel Frequency Range (MHz)	Number of Hopping Channel	Refer to Plot	Limit	Verdict
2400-2483.5	79	Plot 4.7.2 A	≥15	PASS

#### B. Test Plots

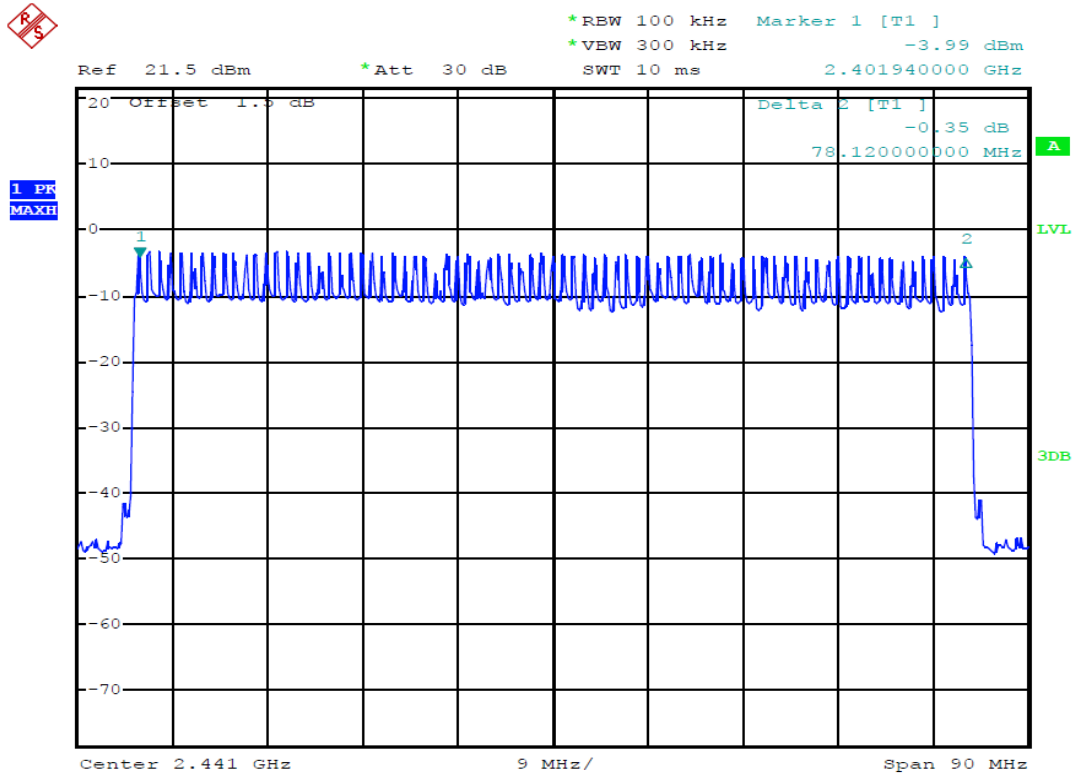

Date: 20.MAR.2014 21:04:42

(Plot 4.7.2 A: @ 8DPSK)

### 4.7.3 π/4DQPSK Test Mode

#### A. Test Verdict

Hopping Channel Frequency Range (MHz)	Number of Hopping Channel	Refer to Plot	Limit	Verdict
2400-2483.5	79	Plot 4.7.3 A	≥15	PASS

#### B. Test Plots



\*RBW 100 kHz Delta 2 [T1 ]  
\*VBW 300 kHz -0.63 dB  
SWT 10 ms 78.12000000 MHz

Ref 21.5 dBm \*Att 30 dB

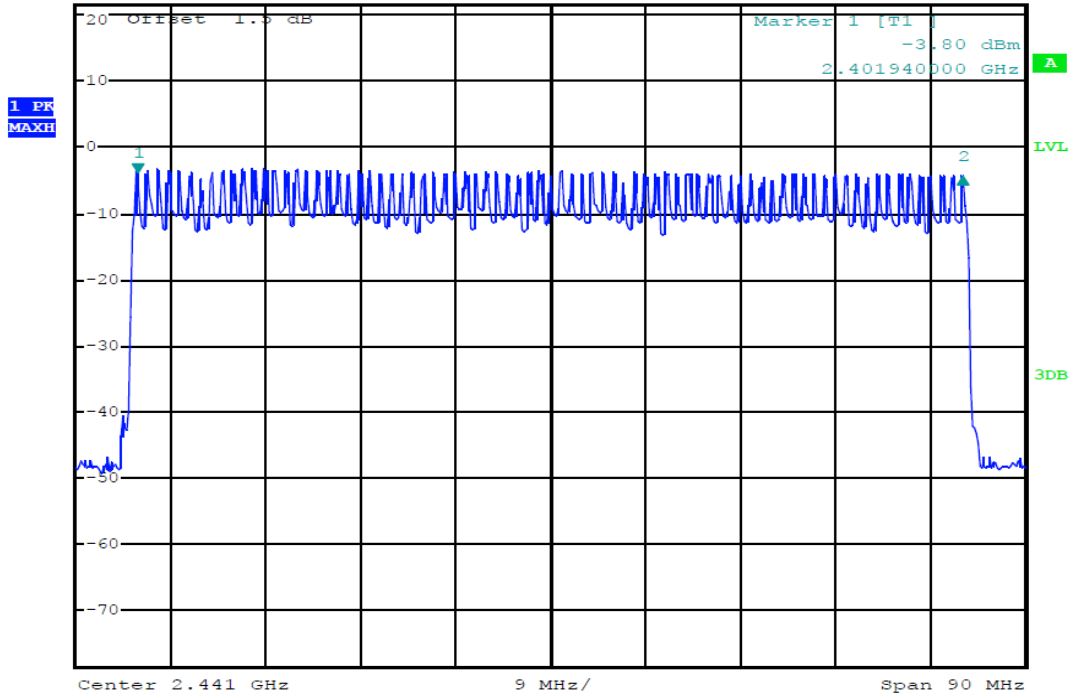

Date: 20.MAR.2014 21:02:06

(Plot 4.7.3 A: @ $\pi/4$ DQPSK)

### 4.8. Time Of Occupancy(Dwell Time)

#### TEST CONFIGURATION

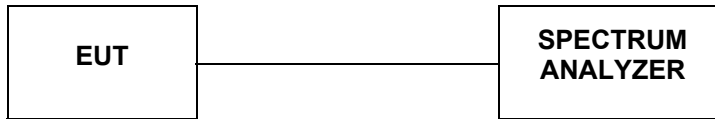

#### TEST PROCEDURE

The transmitter output was connected to the spectrum analyzer through an attenuator. Set center frequency of spectrum analyzer=operating frequency with RBW=1MHz and VBW=3MHz, Span=0Hz.

#### LIMIT

The average time of occupancy on any channel shall not be greater than 0.4 seconds within a pe-riod of 0.4 seconds multiplied by the number of hopping channels employed.

#### TEST RESULTS

##### 4.8.1 GFSK Test Mode

###### A. Test Verdict

Mode	Frequency (MHz)	Pulse Width (ms)	Dwell Time (S)	Limit (S)	Refer to Plot	Verdict
DH 1	2402	0.420	0.1344	0.4	Plot 4.8.1 A1	PASS
	2441	0.420	0.1344	0.4	Plot 4.8.1 A2	PASS
	2480	0.420	0.1344	0.4	Plot 4.8.1 A3	PASS
<b>Note:</b> Dwell time=Pulse time (ms) × (1600 ÷ 2 ÷ 79) ×31.6 Second						
DH 3	2402	1.695	0.2712	0.4	Plot 4.8.1 B1	PASS
	2441	1.695	0.2712	0.4	Plot 4.8.1 B2	PASS
	2480	1.695	0.2712	0.4	Plot 4.8.1 B3	PASS
<b>Note:</b> Dwell time=Pulse time (ms) × (1600 ÷ 4 ÷ 79) ×31.6 Second						
DH 5	2402	2.955	0.3152	0.4	Plot 4.8.1 C1	PASS
	2441	2.955	0.3152	0.4	Plot 4.8.1 C2	PASS
	2480	2.955	0.3152	0.4	Plot 4.8.1 C3	PASS
<b>Note:</b> Dwell time=Pulse Time (ms) × (1600 ÷ 6 ÷ 79) ×31.6 Second						

###### B. Test Plots

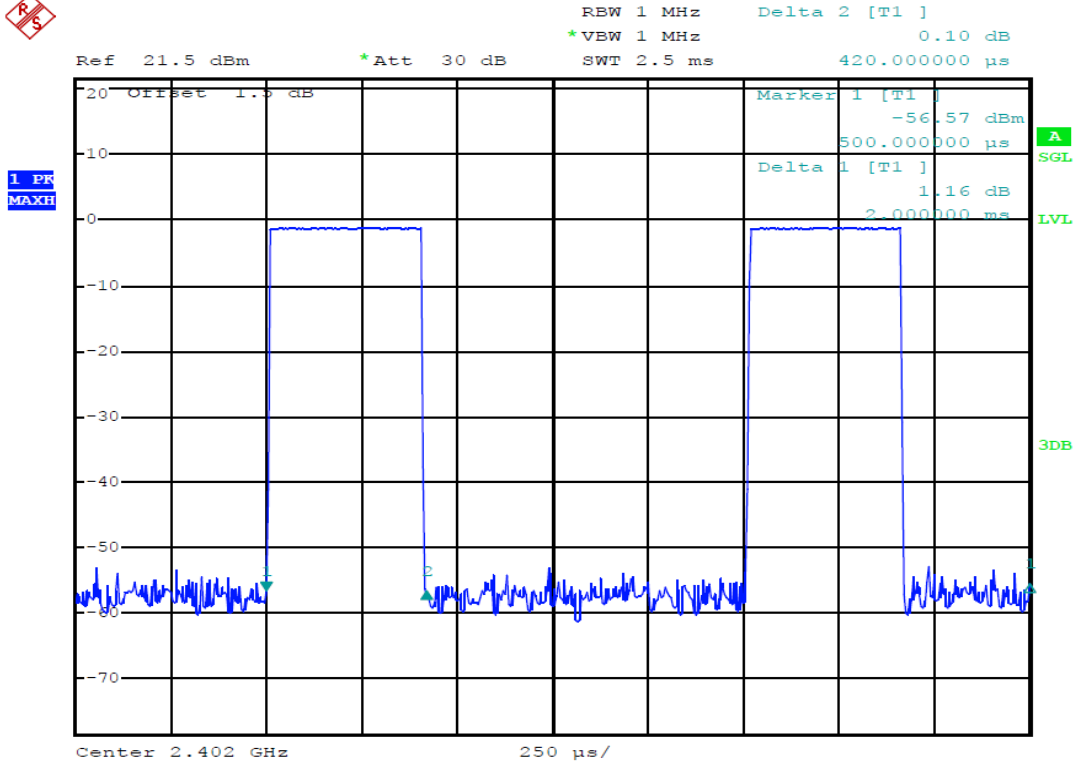

Date: 20.MAR.2014 21:59:27

(Plot 4.8.1.A1: Channel 00: 2402MHz @ GFSK @ DH1)

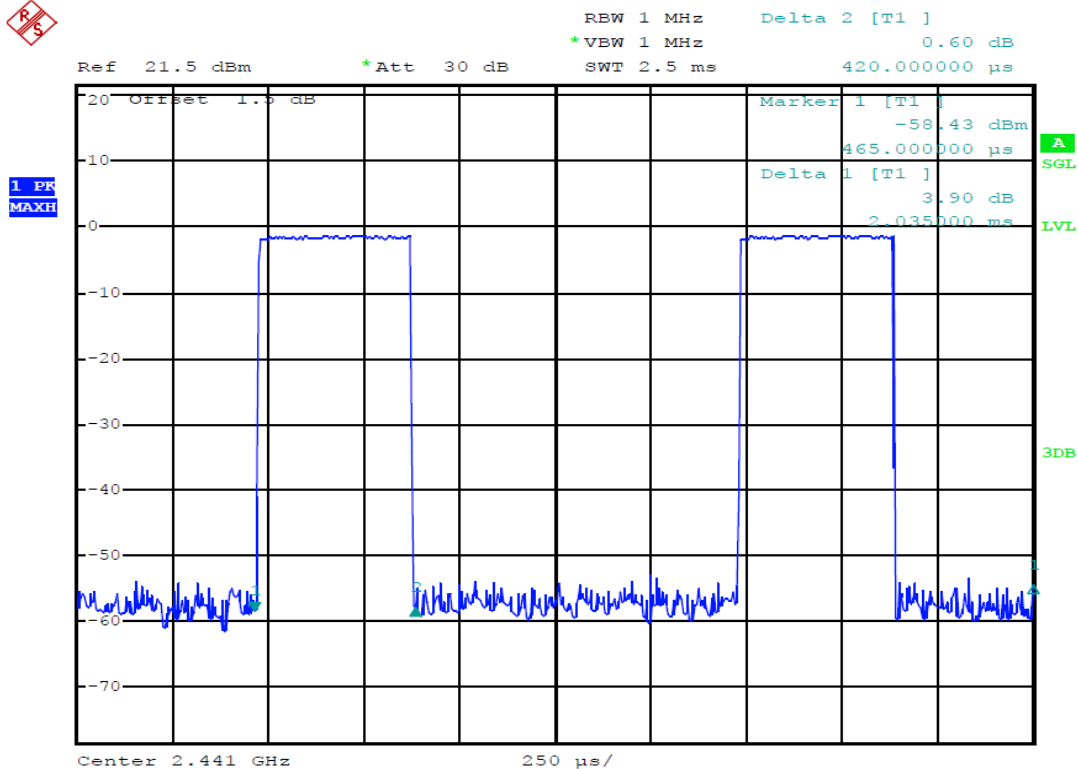

Date: 20.MAR.2014 22:01:08

(Plot 4.8.1.A2: Channel 39: 2441MHz @ GFSK @ DH1)

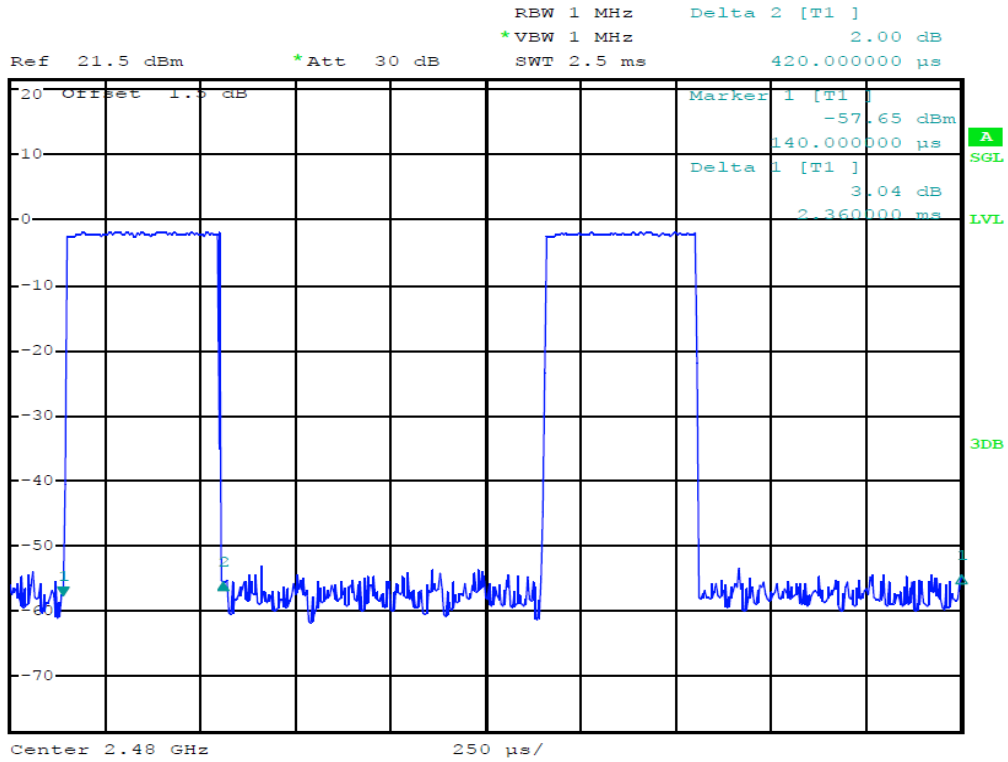

Date: 20.MAR.2014 22:02:12

(Plot 4.8.1.A3: Channel 78: 2480MHz @ GFSK @ DH1)

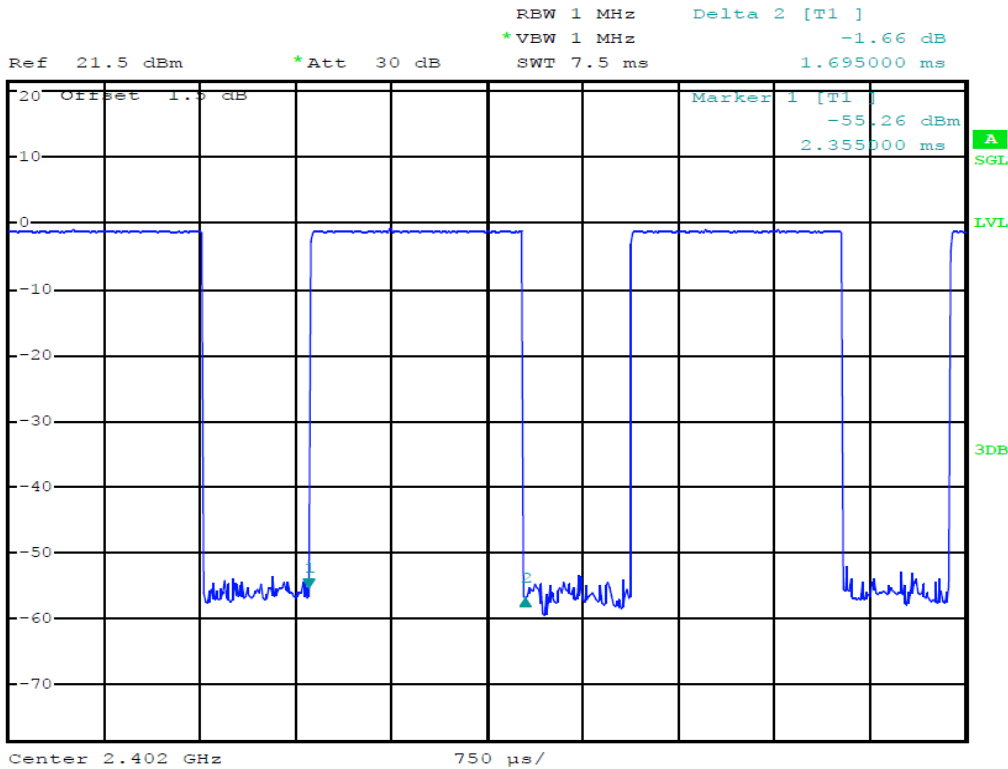

Date: 20.MAR.2014 22:08:29

(Plot 4.8.1.B1: Channel 00: 2402MHz @ GFSK @ DH3)

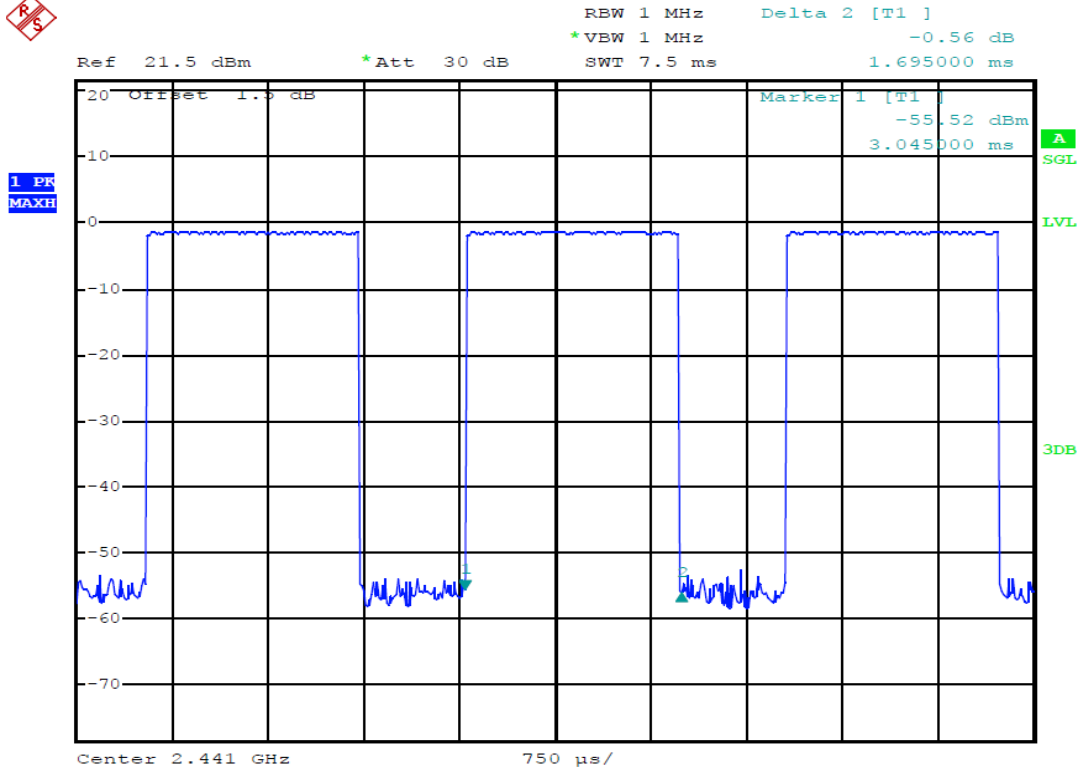

Date: 20.MAR.2014 22:08:52

(Plot 4.8.1.B2: Channel 39: 2441MHz @ GFSK @ DH3)

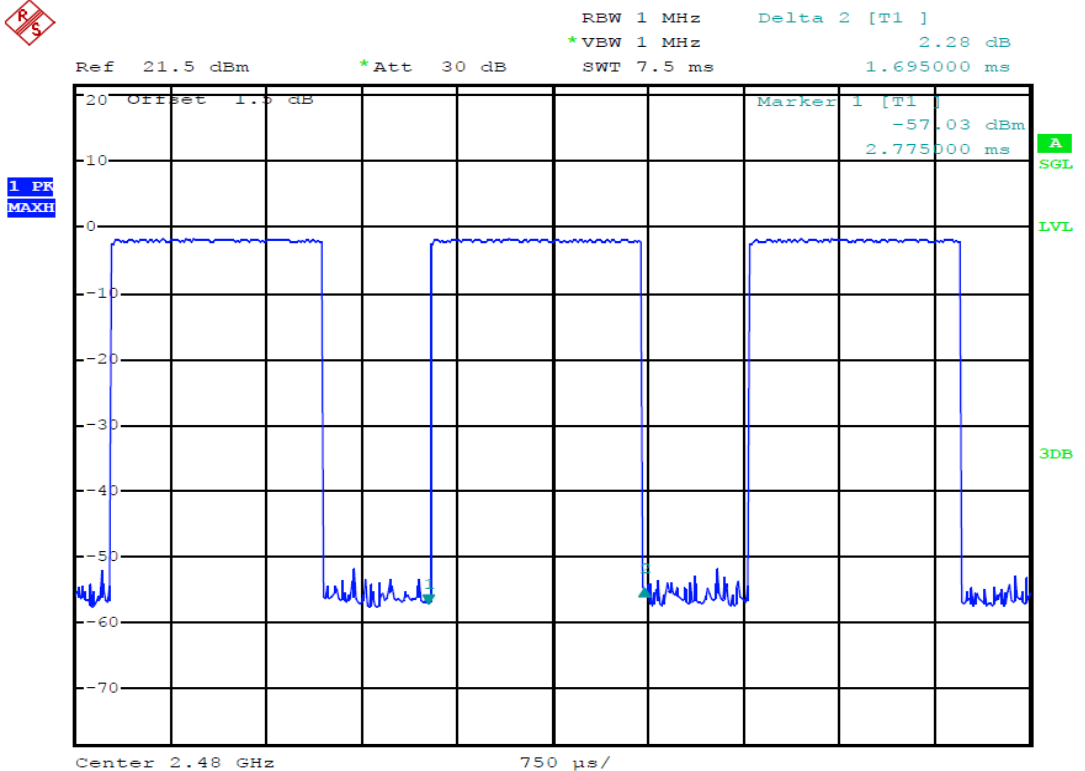

Date: 20.MAR.2014 22:09:20

(Plot 4.8.1.B3: Channel 78: 2480MHz @ GFSK @ DH3)

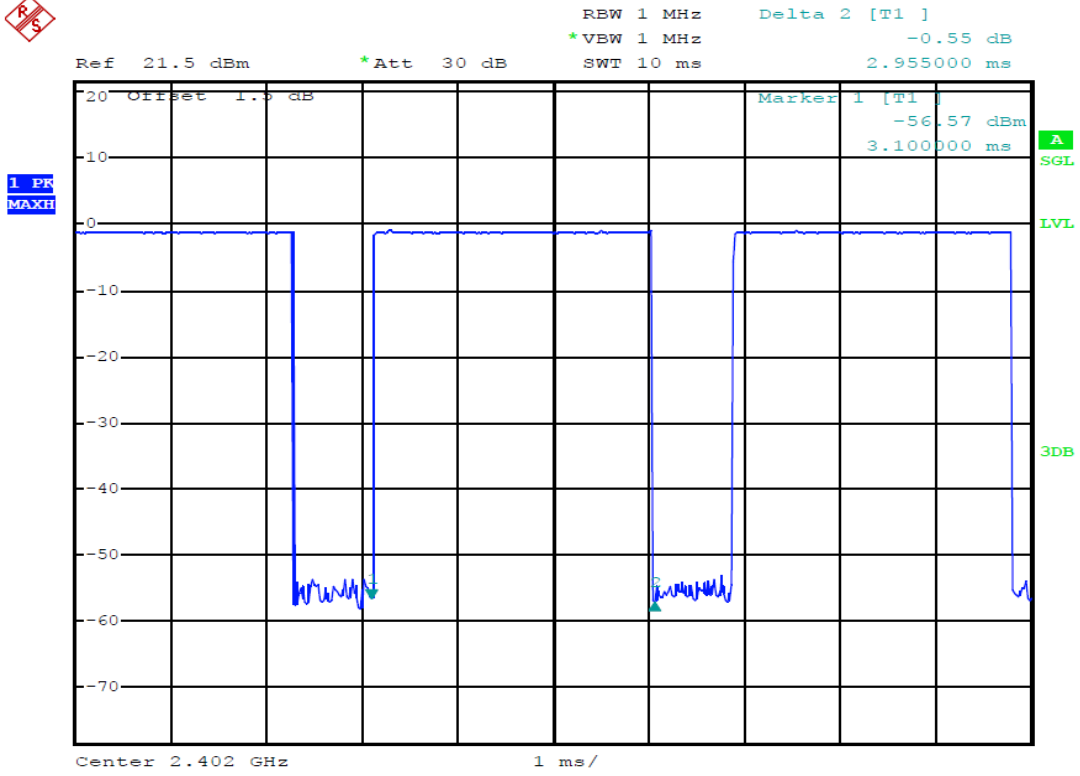

Date: 20.MAR.2014 22:15:21

(Plot 4.8.1.C1: Channel 00: 2402MHz @ GFSK @ DH5)

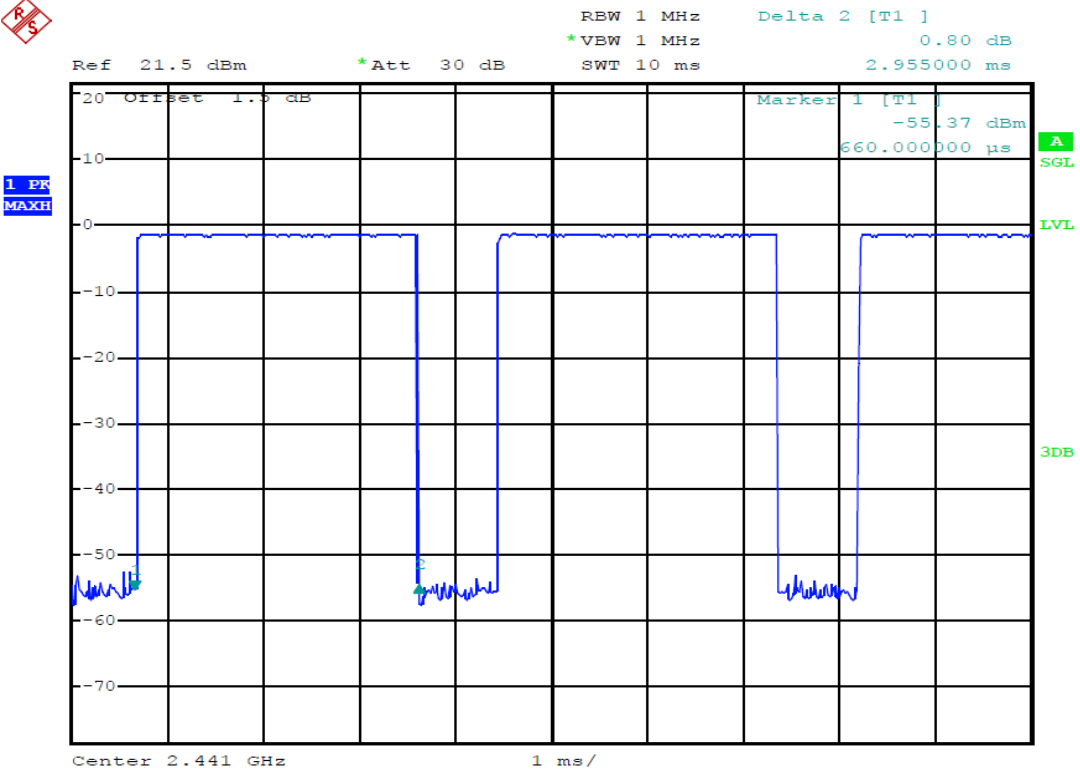

Date: 20.MAR.2014 22:15:46

(Plot 4.8.1.C2: Channel 39: 2441MHz @ GFSK @ DH5)



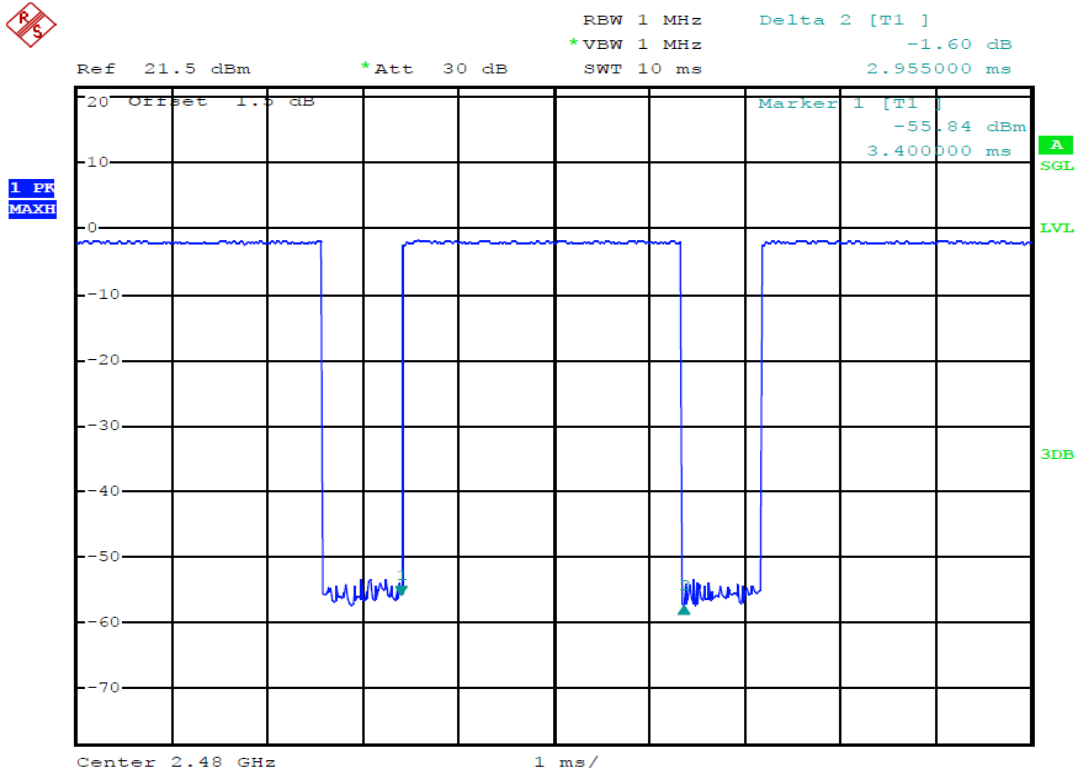

Date: 20.MAR.2014 22:16:11

(Plot 4.8.1.C3: Channel 78: 2480MHz @ GFSK @ DH5)

4.8.2 8DPSK Test Mode

A. Test Verdict

Mode	Frequency (MHz)	Pulse Width (ms)	Dwell Time (S)	Limit (S)	Refer to Plot	Verdict
DH 1	2402	0.430	0.1376	0.4	Plot 4.8.2 A1	PASS
	2441	0.435	0.1392	0.4	Plot 4.8.2 A2	PASS
	2480	0.430	0.1376	0.4	Plot 4.8.2 A3	PASS
<b>Note:</b> Dwell time=Pulse time (ms) × (1600 ÷ 2 ÷ 79) ×31.6 Second						
DH 3	2402	1.695	0.2712	0.4	Plot 4.8.2 B1	PASS
	2441	1.695	0.2712	0.4	Plot 4.8.2 B2	PASS
	2480	1.695	0.2712	0.4	Plot 4.8.2 B3	PASS
<b>Note:</b> Dwell time=Pulse time (ms) × (1600 ÷ 4 ÷ 79) ×31.6 Second						
DH 5	2402	2.955	0.3152	0.4	Plot 4.8.2 C1	PASS
	2441	2.955	0.3152	0.4	Plot 4.8.2 C2	PASS
	2480	2.955	0.3152	0.4	Plot 4.8.2 C3	PASS
<b>Note:</b> Dwell time=Pulse Time (ms) × (1600 ÷ 6 ÷ 79) ×31.6 Second						

B. Test Plots

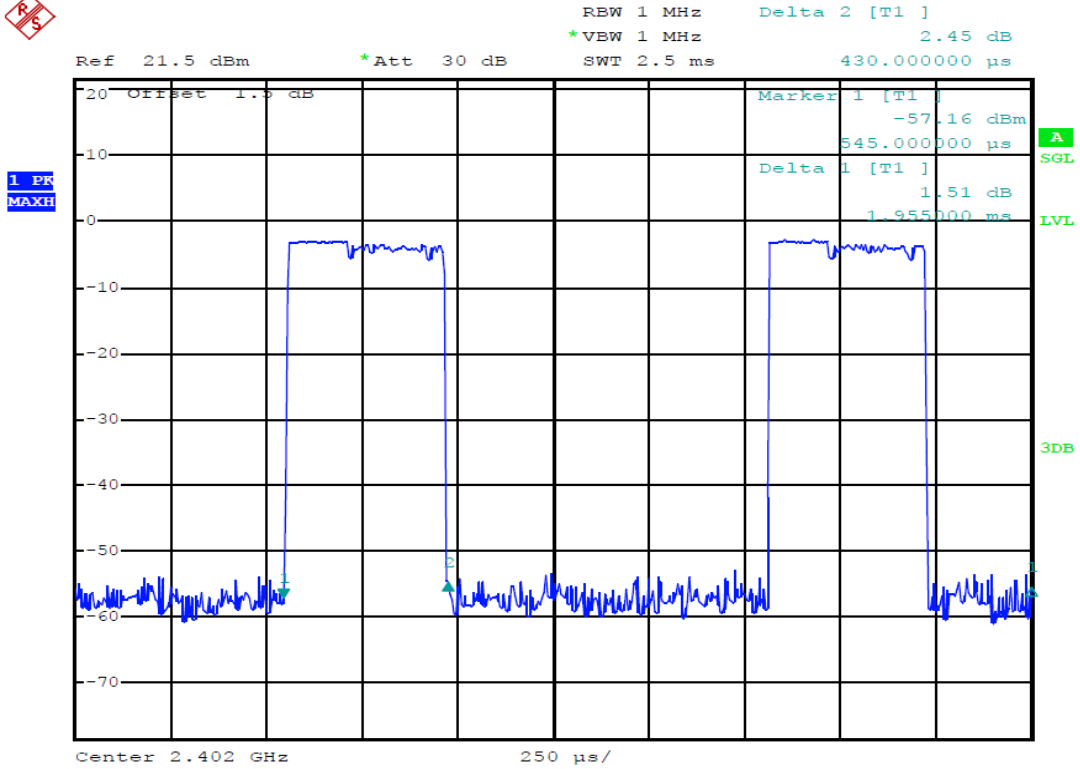

Date: 20.MAR.2014 22:03:08

(Plot 4.8.2.A1: Channel 00: 2402MHz @ 8DPSK @ DH1)

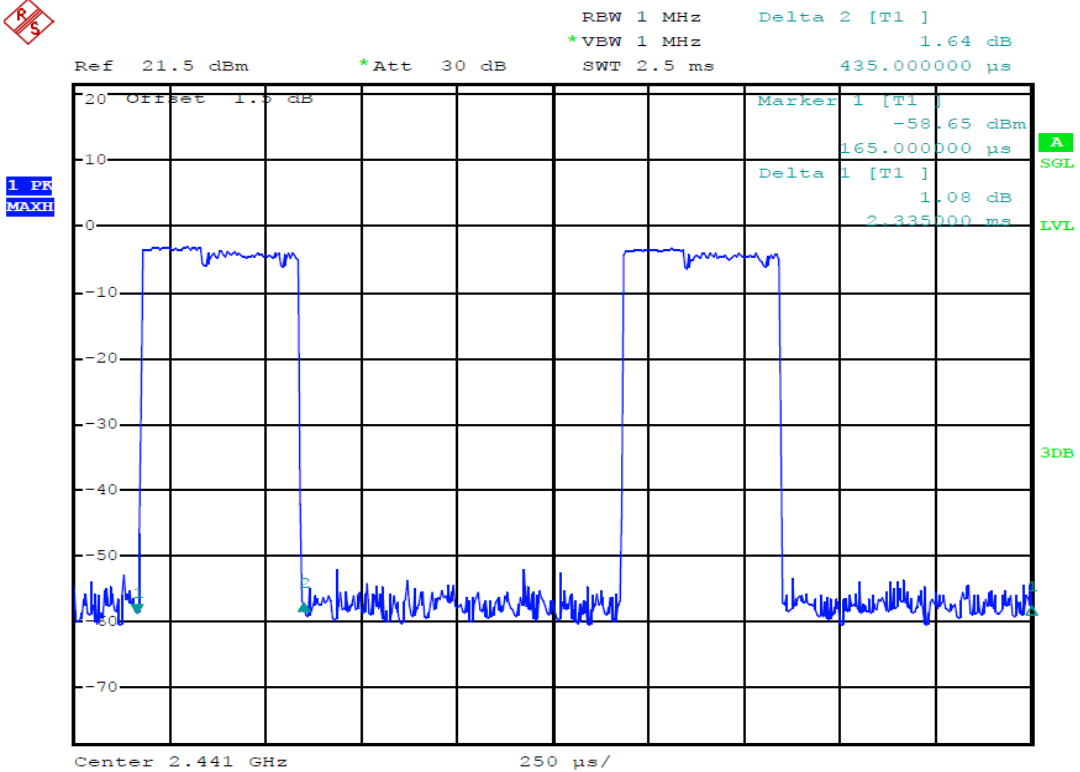

Date: 20.MAR.2014 22:04:04

(Plot 4.8.2.A2: Channel 39: 2441MHz @ 8DPSK @ DH1)

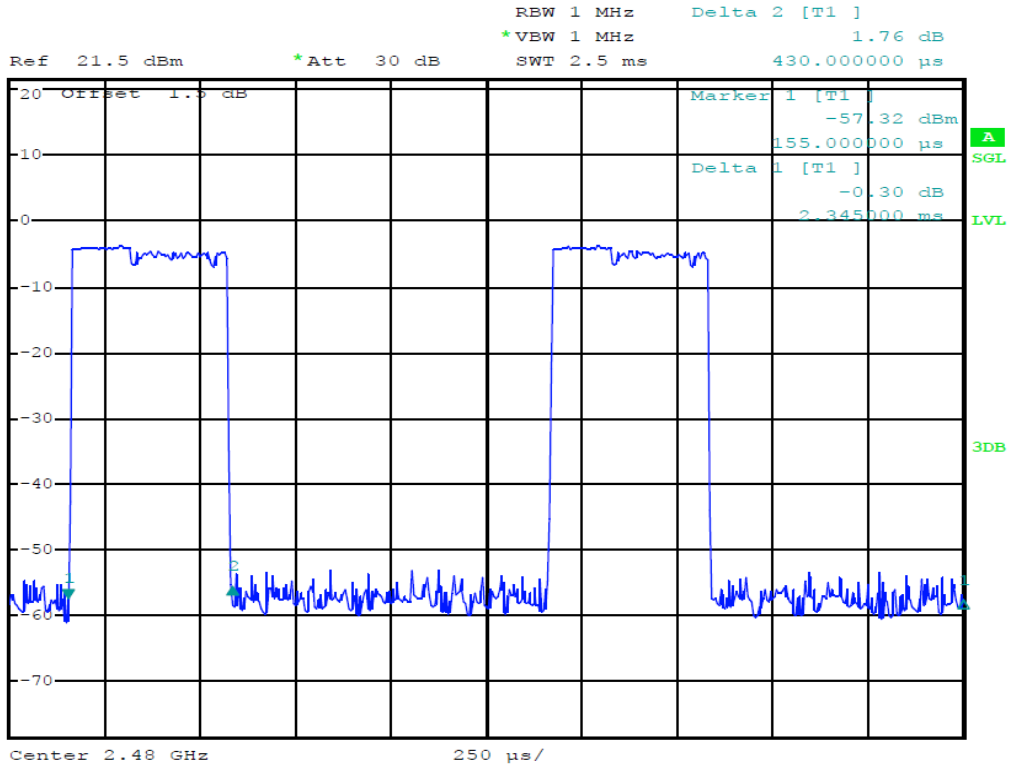

Date: 20.MAR.2014 22:04:25

(Plot 4.8.2.A3: Channel 78: 2480MHz @ 8DPSK @ DH1)

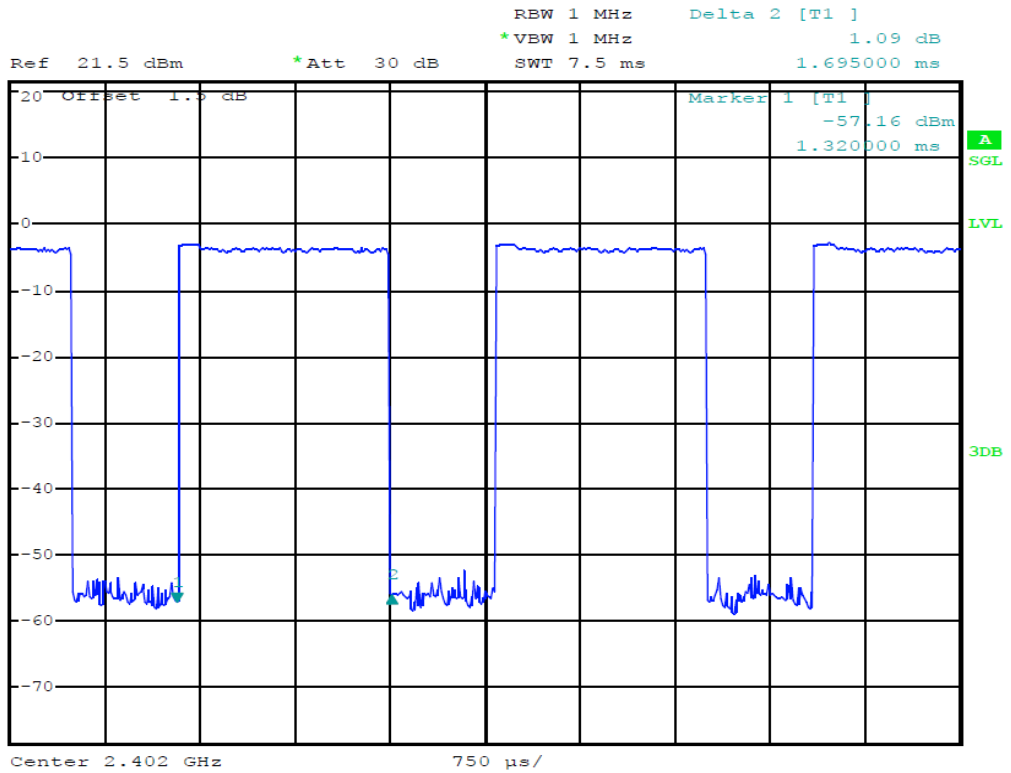

Date: 20.MAR.2014 22:10:00

(Plot 4.8.2.B1: Channel 00: 2402MHz @ 8DPSK @ DH3)

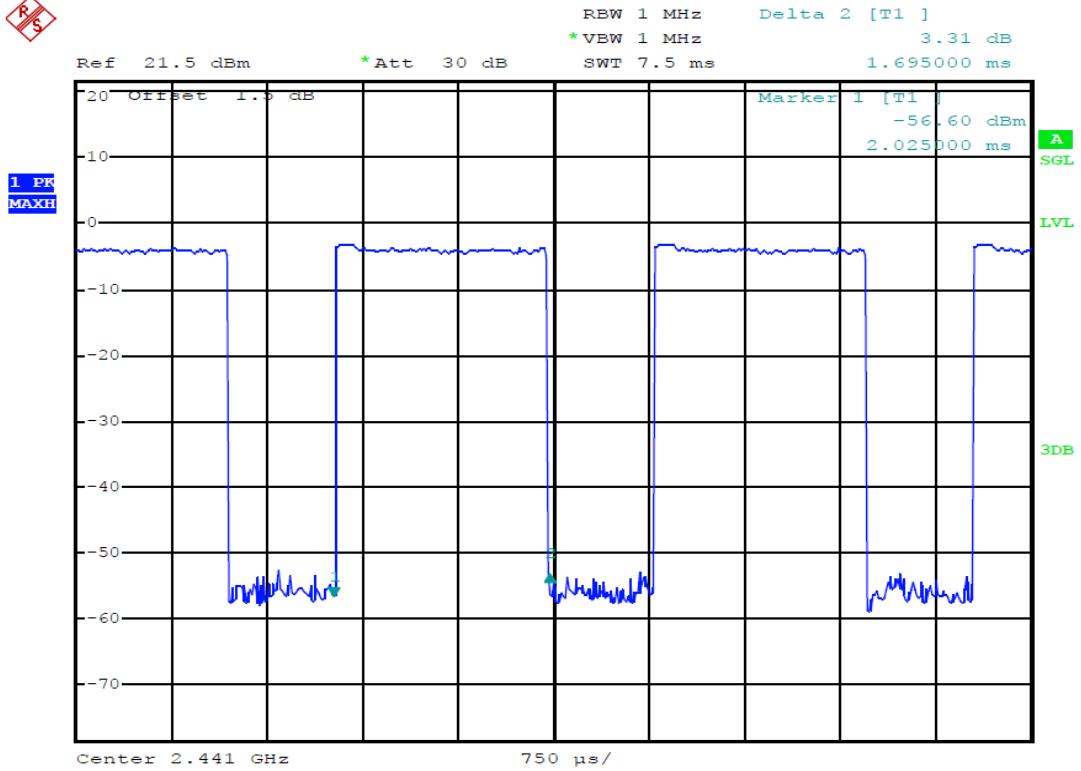

Date: 20.MAR.2014 22:10:31

(Plot 4.8.2.B2: Channel 39: 2441MHz @ 8DPSK @ DH3)

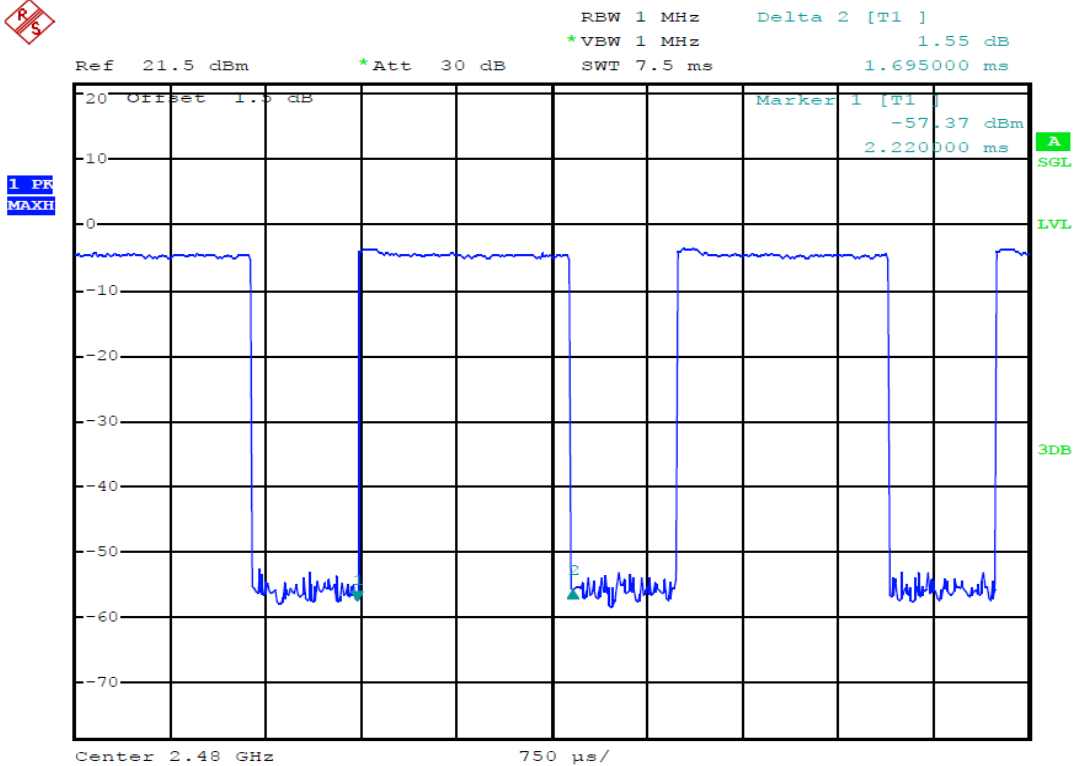

Date: 20.MAR.2014 22:10:58

(Plot 4.8.2.B3: Channel 78: 2480MHz @ 8DPSK @ DH3)

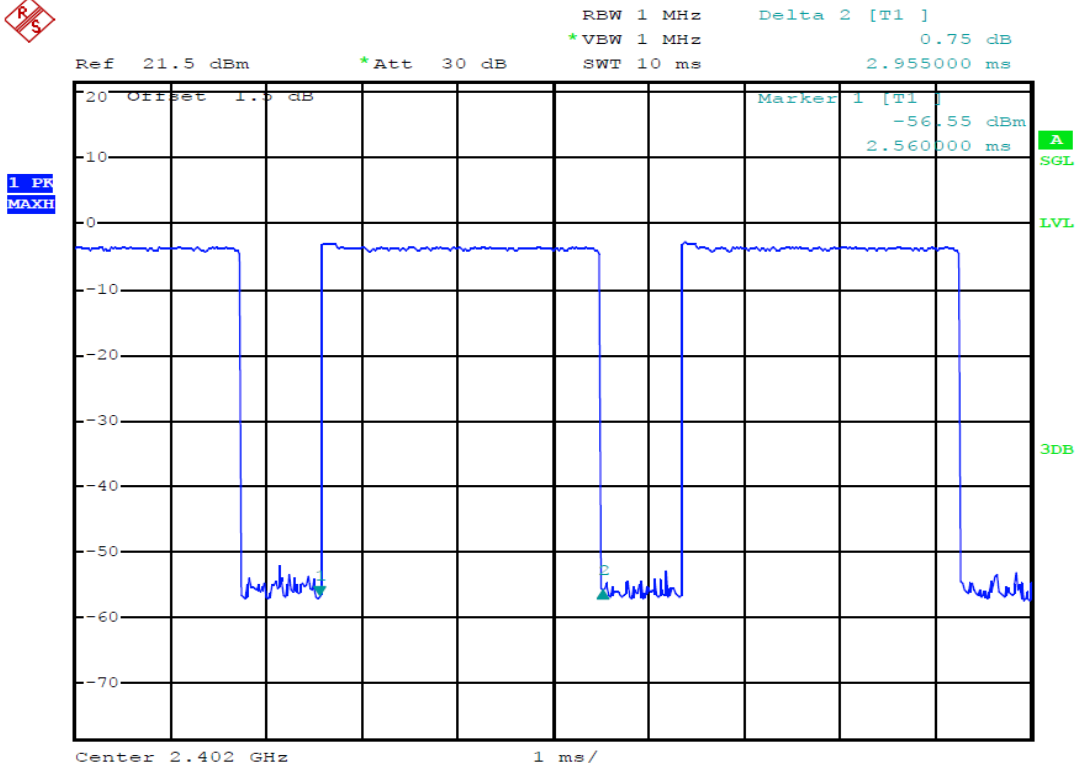

Date: 20.MAR.2014 22:11:44

(Plot 4.8.2.C1: Channel 00: 2402MHz @ 8DPSK @ DH5)

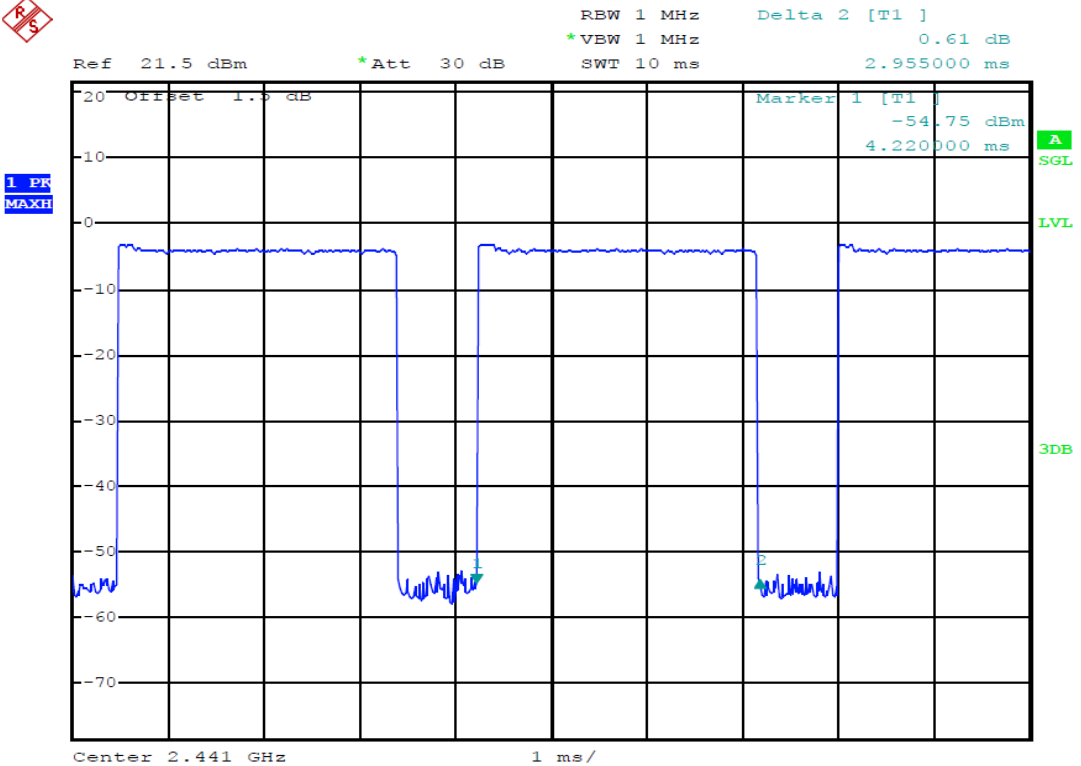

Date: 20.MAR.2014 22:12:19

(Plot 4.8.2.C2: Channel 39: 2441MHz @ 8DPSK @ DH5)

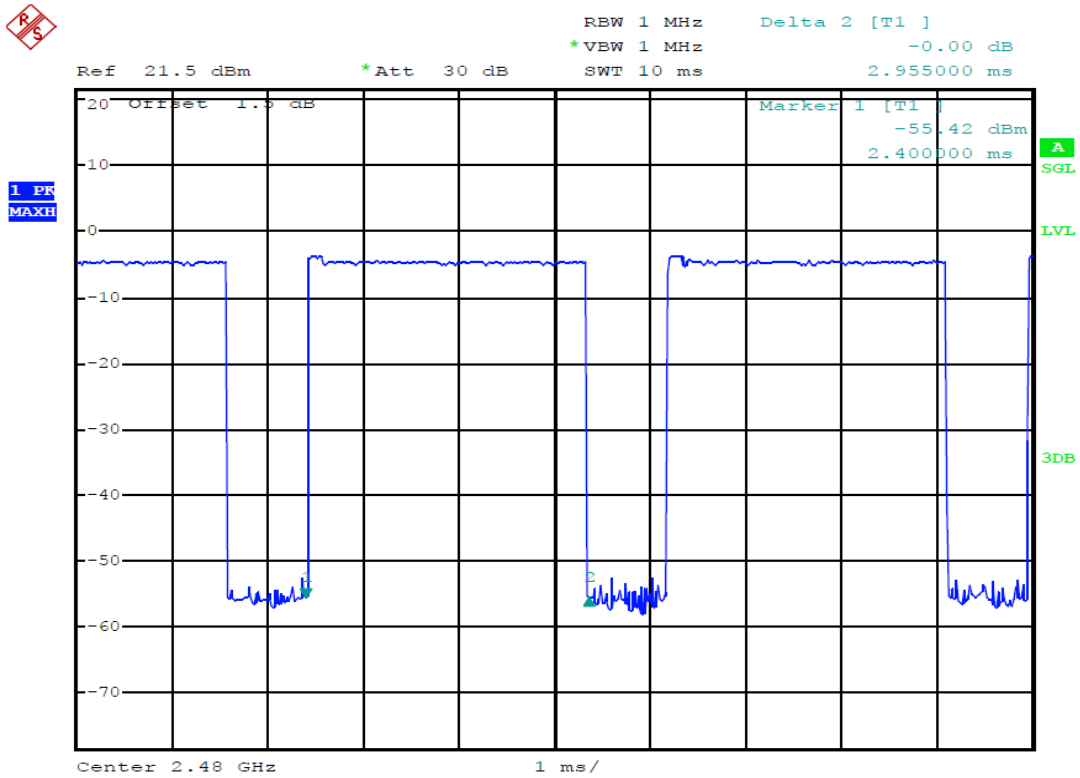

Date: 20.MAR.2014 22:12:43

(Plot 4.8.2.C3: Channel 78: 2480MHz @ 8DPSK @ DH5)

4.8.3  $\pi/4$ DQPSK Test Mode

A. Test Verdict

Mode	Frequency (MHz)	Pulse Width (ms)	Dwell Time (S)	Limit (S)	Refer to Plot	Verdict
DH 1	2402	0.435	0.139276	0.4	Plot 4.8.3 A1	PASS
	2441	0.430	0.1376	0.4	Plot 4.8.3 A2	PASS
	2480	0.430	0.1376	0.4	Plot 4.8.3 A3	PASS
<b>Note:</b> Dwell time=Pulse time (ms) × (1600 ÷ 2 ÷ 79) ×31.6 Second						
DH 3	2402	1.695	0.2712	0.4	Plot 4.8.3 B1	PASS
	2441	1.695	0.2712	0.4	Plot 4.8.3 B2	PASS
	2480	1.695	0.2712	0.4	Plot 4.8.3 B3	PASS
<b>Note:</b> Dwell time=Pulse time (ms) × (1600 ÷ 4 ÷ 79) ×31.6 Second						
DH 5	2402	2.955	0.3152	0.4	Plot 4.8.3 C1	PASS
	2441	2.955	0.3152	0.4	Plot 4.8.3 C2	PASS
	2480	2.955	0.3152	0.4	Plot 4.8.3 C3	PASS
<b>Note:</b> Dwell time=Pulse Time (ms) × (1600 ÷ 6 ÷ 79) ×31.6 Second						

B. Test Plots

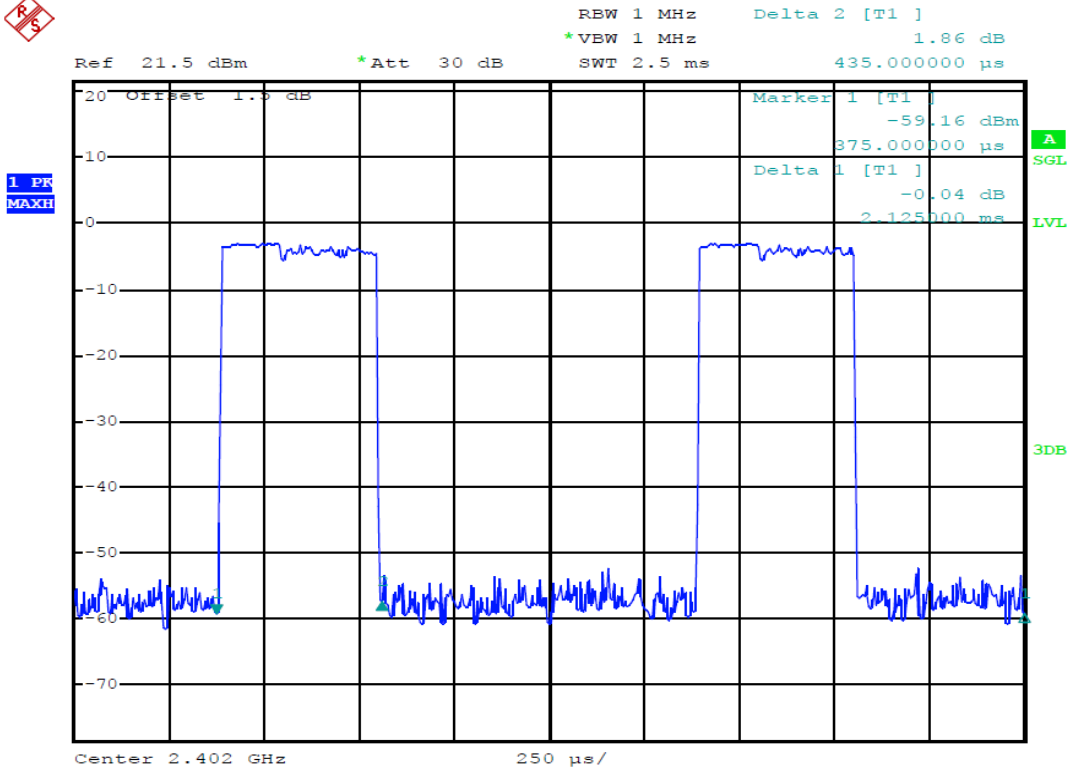

Date: 20.MAR.2014 22:04:55

(Plot 4.8.3.A1: Channel 00: 2402MHz @  $\pi/4$ DQPSK @ DH1)

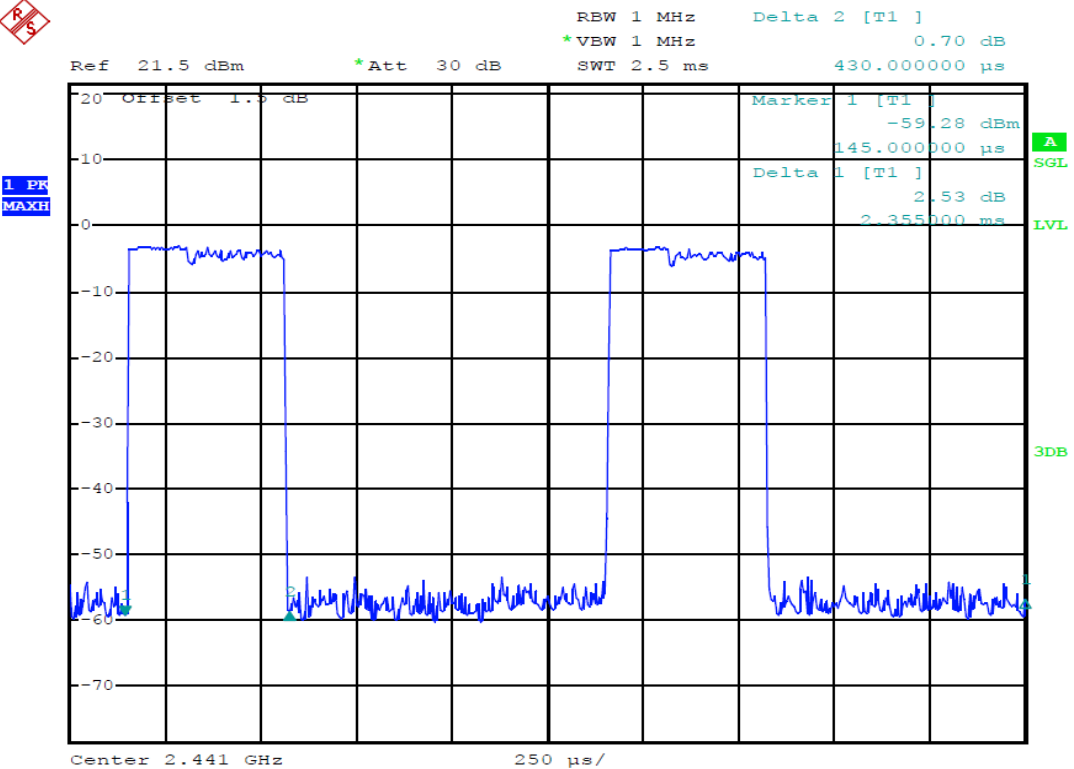

Date: 20.MAR.2014 22:05:20

(Plot 4.8.3.A2: Channel 39: 2441MHz @  $\pi/4$ DQPSK @ DH1)

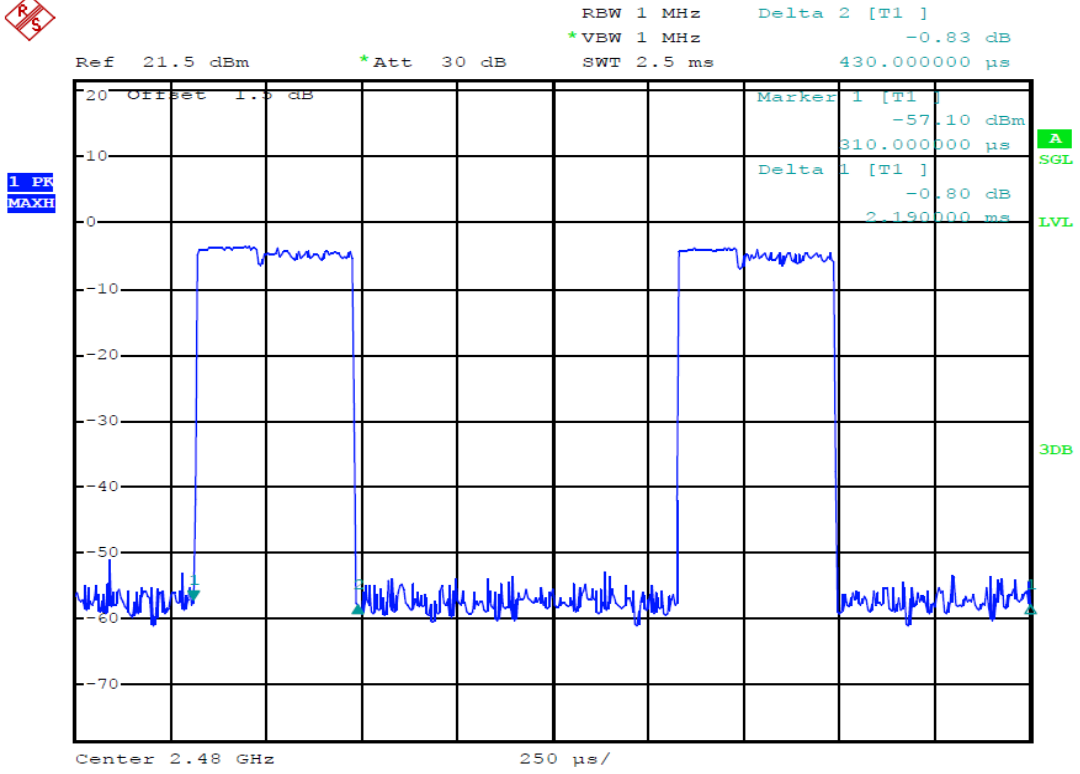

Date: 20.MAR.2014 22:05:54

(Plot 4.8.3.A3: Channel 78: 2480MHz @  $\pi/4$ DQPSK @ DH1)

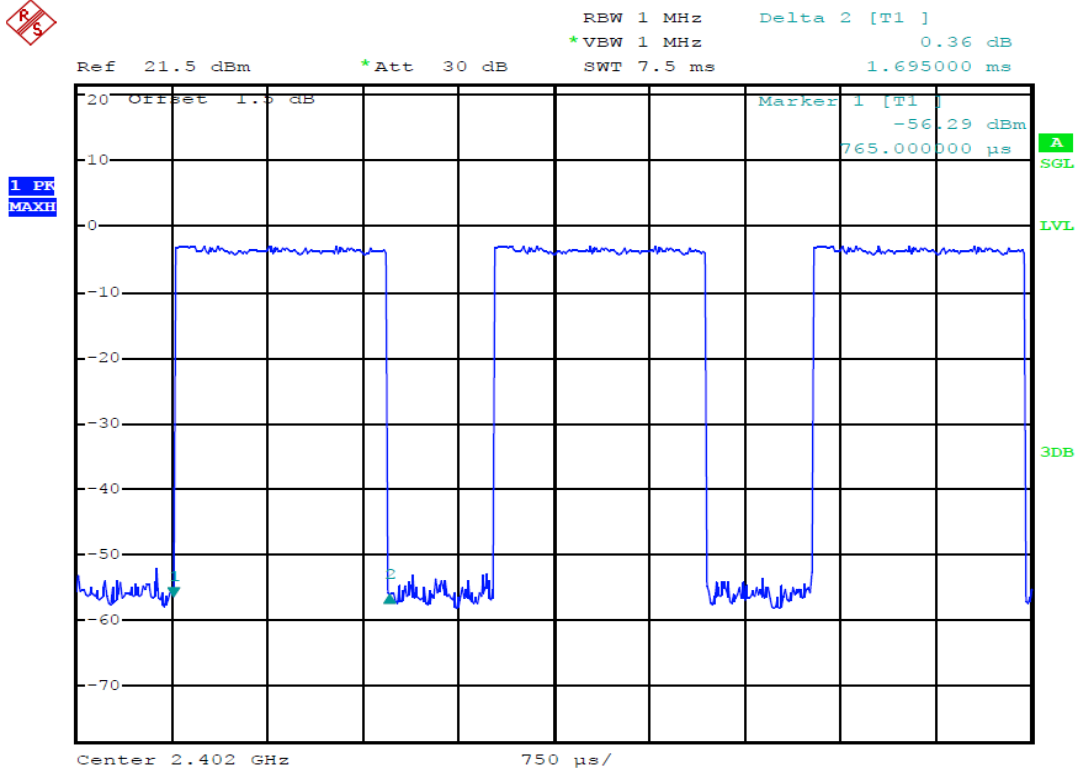

Date: 20.MAR.2014 22:07:04

(Plot 4.8.3.B1: Channel 00: 2402MHz @  $\pi/4$ DQPSK @ DH3)



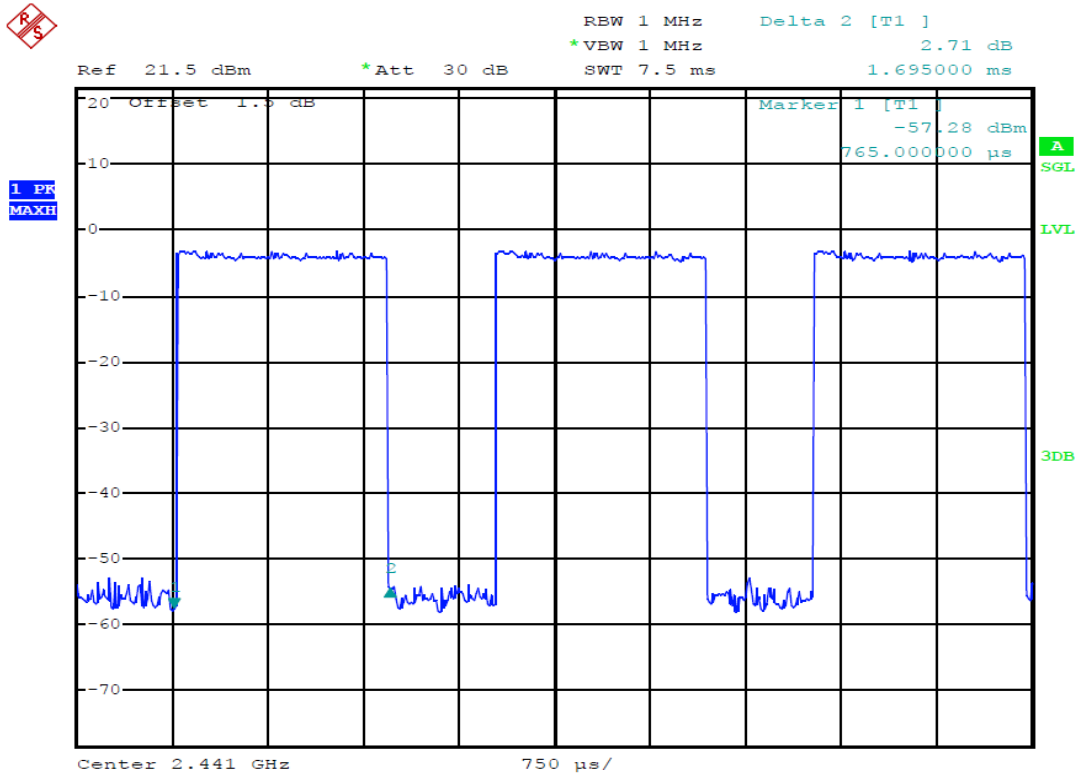

Date: 20.MAR.2014 22:07:25

(Plot 4.8.3.B2: Channel 39: 2441MHz @  $\pi/4$ DQPSK @ DH3)

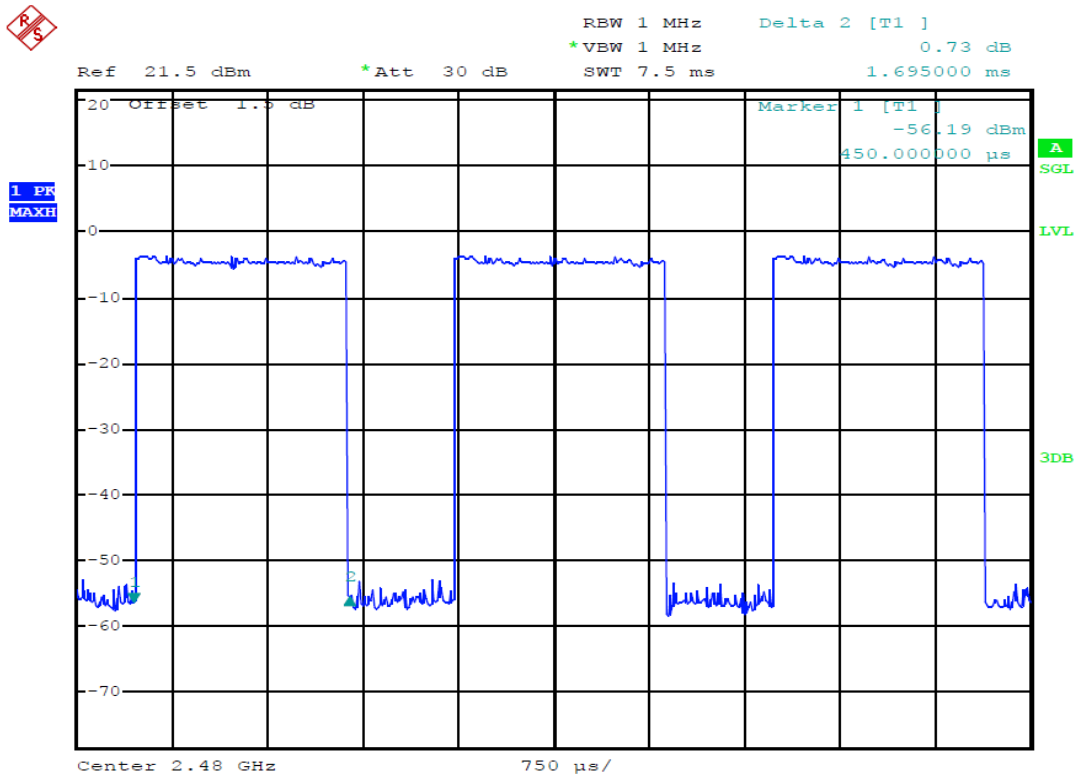

Date: 20.MAR.2014 22:07:50

(Plot 4.8.3.B3: Channel 78: 2480MHz @  $\pi/4$ DQPSK @ DH3)

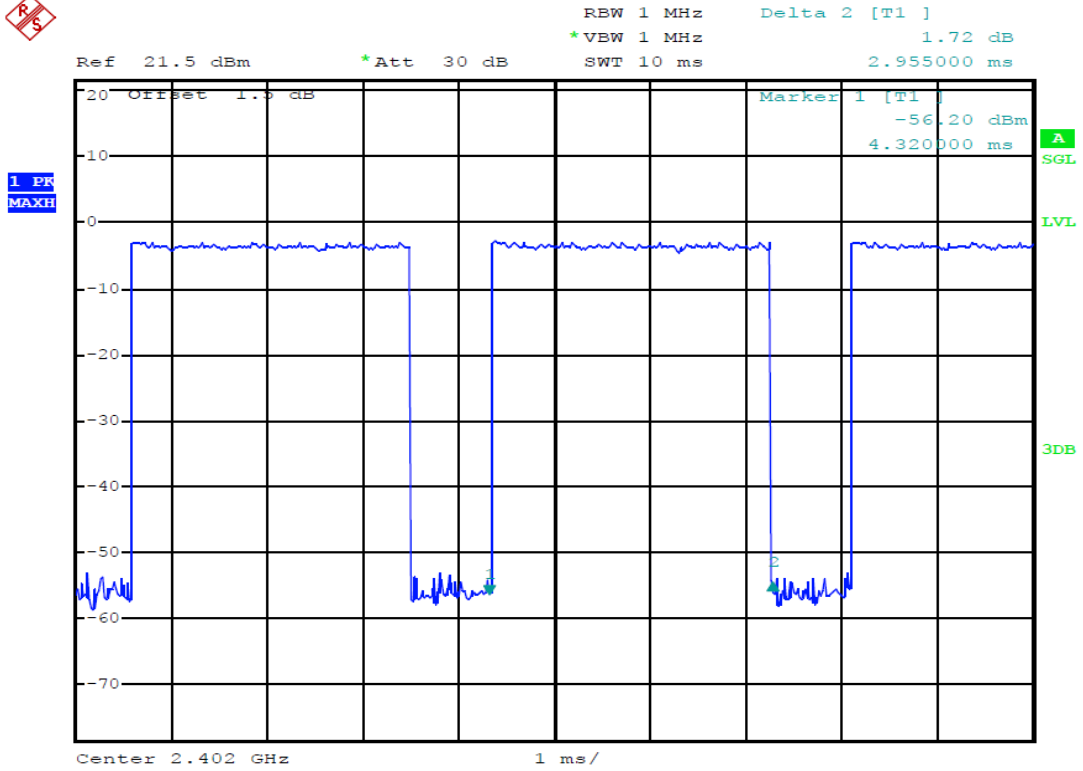

Date: 20.MAR.2014 22:14:01

(Plot 4.8.3.C1: Channel 00: 2402MHz @  $\pi/4$ DQPSK @ DH5)

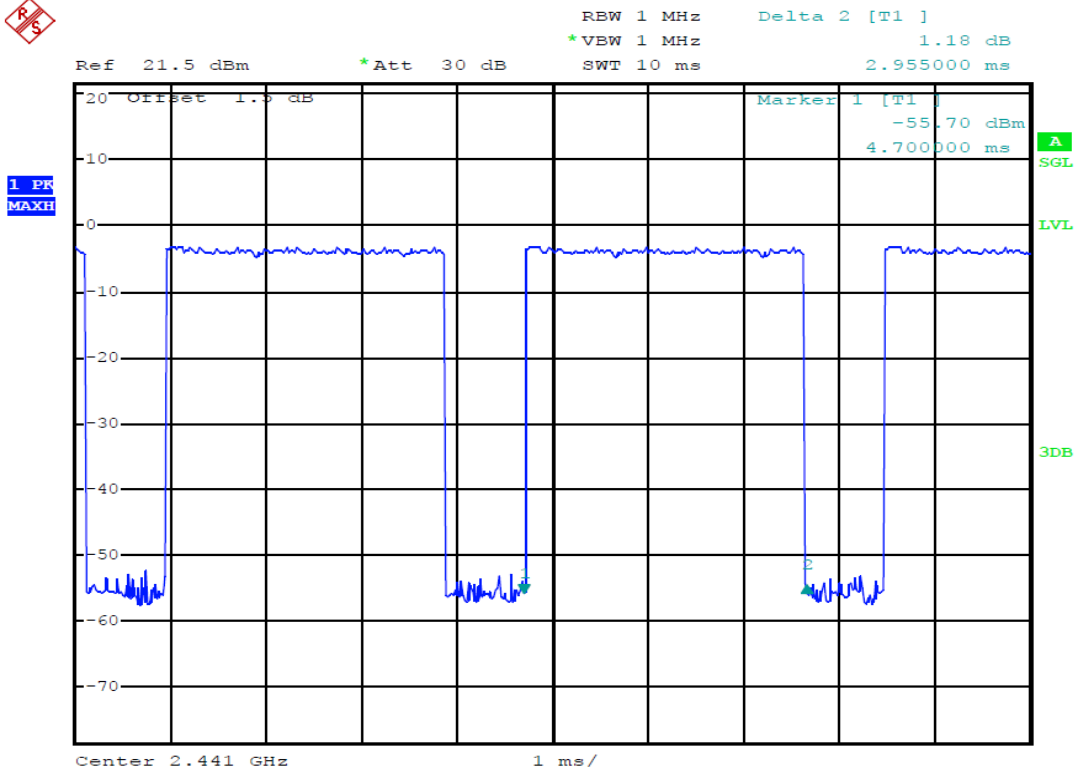

Date: 20.MAR.2014 22:14:33

(Plot 4.8.3.C2: Channel 39: 2441MHz @  $\pi/4$ DQPSK @ DH5)

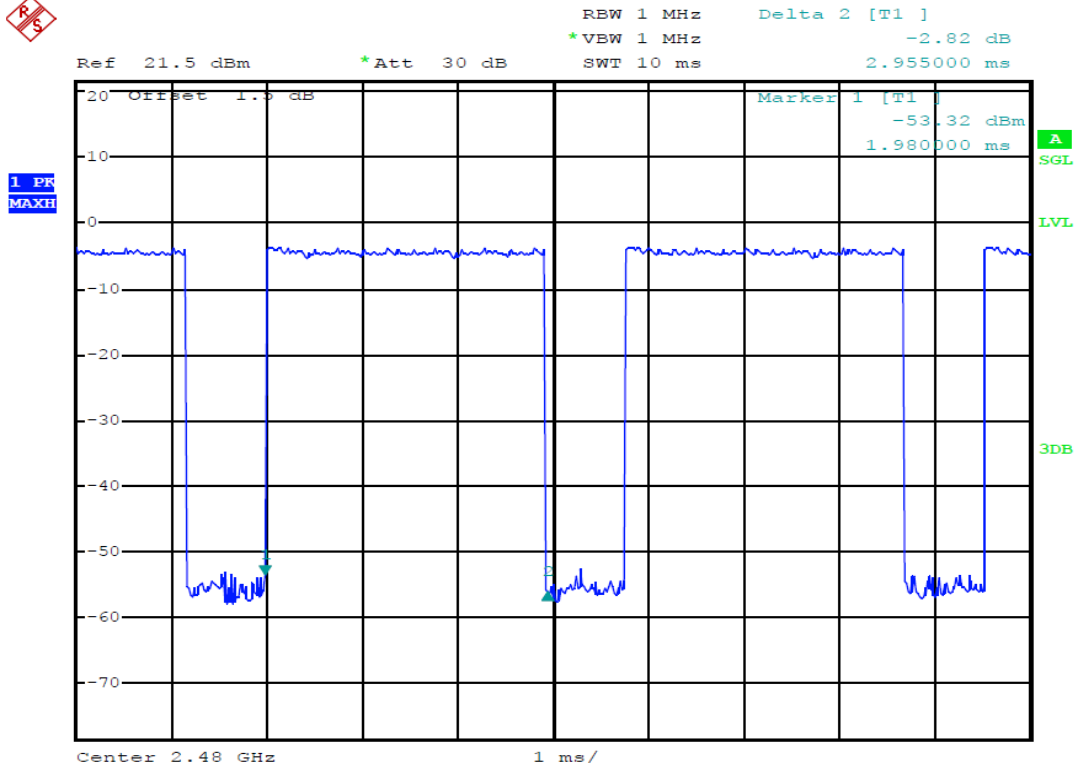

Date: 20.MAR.2014 22:13:17

(Plot 4.8.3.C3: Channel 78: 2480MHz @  $\pi/4$ DQPSK @ DH5)

### 4.9. Spurious RF Conducted Emission

#### TEST CONFIGURATION

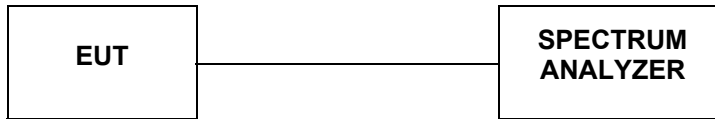

#### TEST PROCEDURE

The Spurious RF conducted emissions compliance of RF radiated emission should be measured by following the guidance in ANSI C63.10-2009 with respect to maximizing the emission by rotating the EUT, measuring the emission while the EUT is situated in three orthogonal planes (if appropriate), adjusting the measurement antenna height and polarization etc. Set RBW=100kHz and VBM= 300KHz to measure the peak field strength , and measurement frequency range from 30MHz to 26.5GHz.

#### LIMIT

1. Below -20dB of the highest emission level in operating band.
2. Fall in the restricted bands listed in section 15.205. The maximum permitted average field strength is listed in section 15.209.

#### TEST RESULTS

Remark: we measured all conditions(DH1,DH3,DH5) and recorded worst case at DH1

##### 4.9.1 GFSK Test Mode

###### A. Test Verdict

Channel	Frequency (MHz)	Frequency Range	Limit (dBc)	Refer to Plot	Verdict
00	2402	30MHz-3GHz	-20	Plot 4.9.1 A1	PASS
		3GHz-15GHz	-20	Plot 4.9.1 A2	PASS
		15GHz-25GHz	-20	Plot 4.9.1 A3	PASS
39	2441	30MHz-3GHz	-20	Plot 4.9.1 B1	PASS
		3GHz-15GHz	-20	Plot 4.9.1 B2	PASS
		15GHz-25GHz	-20	Plot 4.9.1 B3	PASS
78	2480	30MHz-3GHz	-20	Plot 4.9.1 C1	PASS
		3GHz-15GHz	-20	Plot 4.9.1 C2	PASS
		15GHz-25GHz	-20	Plot 4.9.1 C3	PASS

###### B. Test Plots

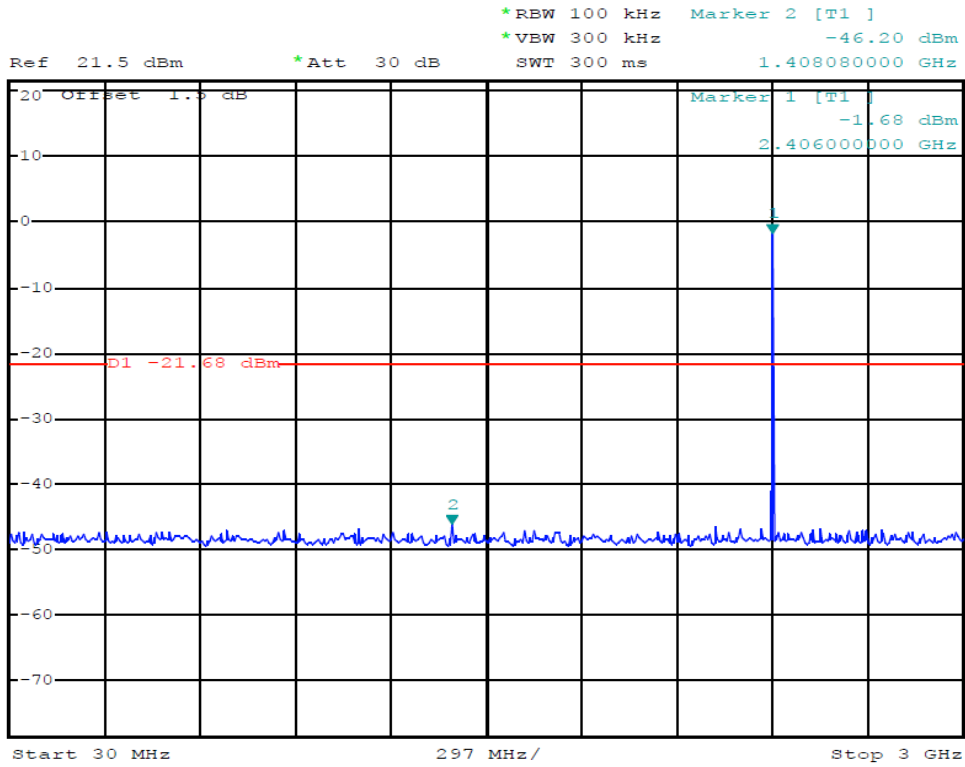

Date: 20.MAR.2014 21:24:28

(Plot 4.9.1.A1: Channel 00: 2402MHz @ GFSK)

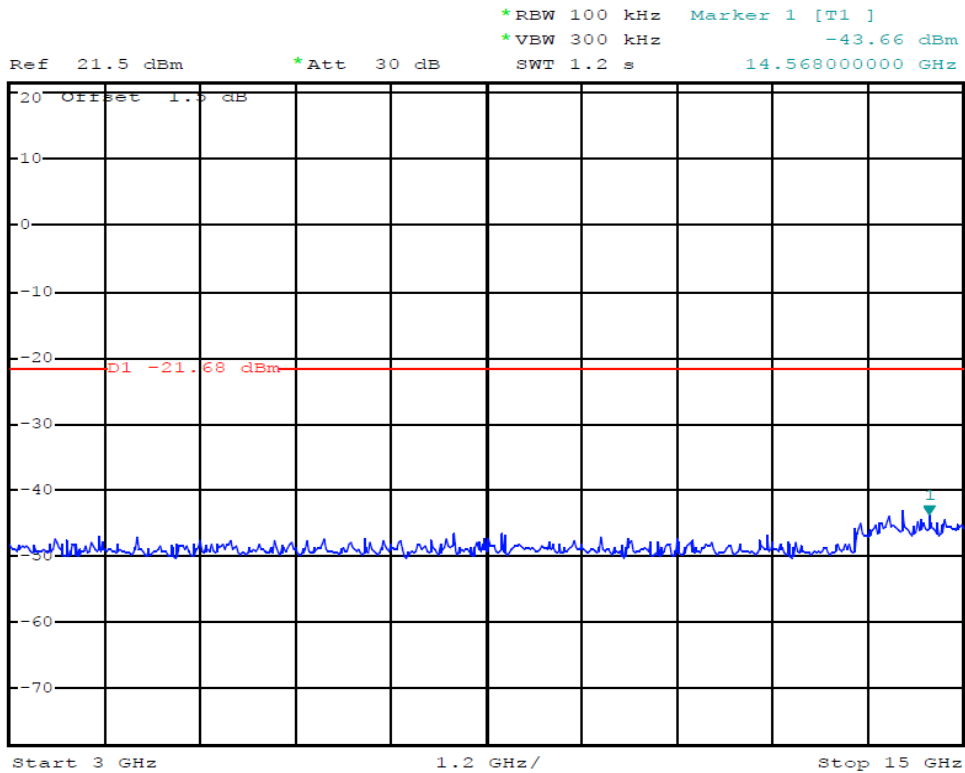

Date: 20.MAR.2014 21:24:58

(Plot 4.9.1.A2: Channel 00: 2402MHz @ GFSK)



Ref 21.5 dBm \*Att 30 dB \*RBW 100 kHz Marker 1 [T1 ]  
\*VBW 300 kHz -41.95 dBm  
SWT 1 s 25.000000000 GHz

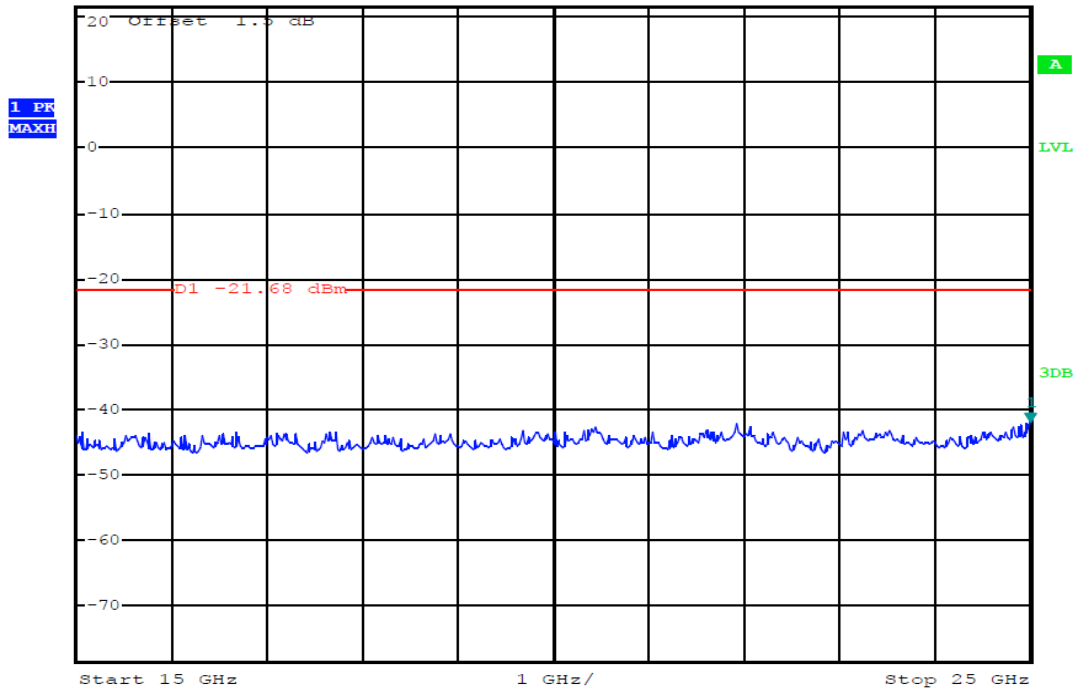

Date: 20.MAR.2014 21:25:23

(Plot 4.9.1.A3: Channel 00: 2402MHz @ GFSK)



Ref 21.5 dBm \*Att 30 dB \*RBW 100 kHz Marker 2 [T1 ]  
\*VBW 300 kHz -46.69 dBm  
SWT 300 ms 2.833680000 GHz

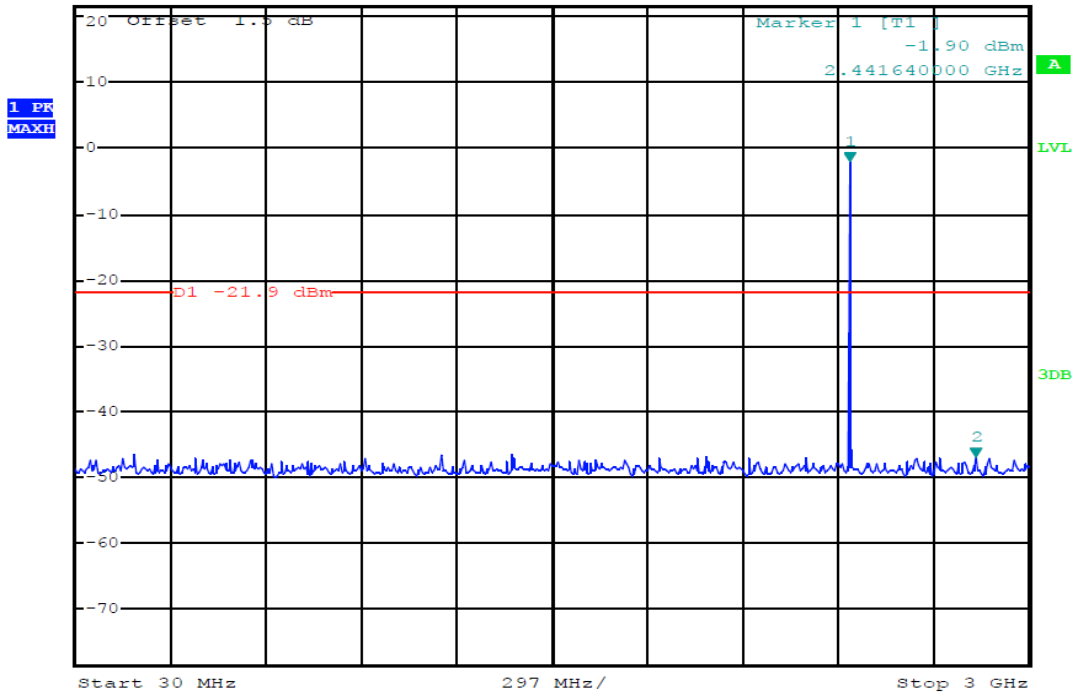

Date: 20.MAR.2014 21:26:09

(Plot 4.9.1.B1: Channel 39: 2441MHz @ GFSK)



Ref 21.5 dBm \*Att 30 dB \*RBW 100 kHz Marker 1 [T1 ]  
\*VBW 300 kHz -43.85 dBm  
SWT 1.2 s 13.800000000 GHz

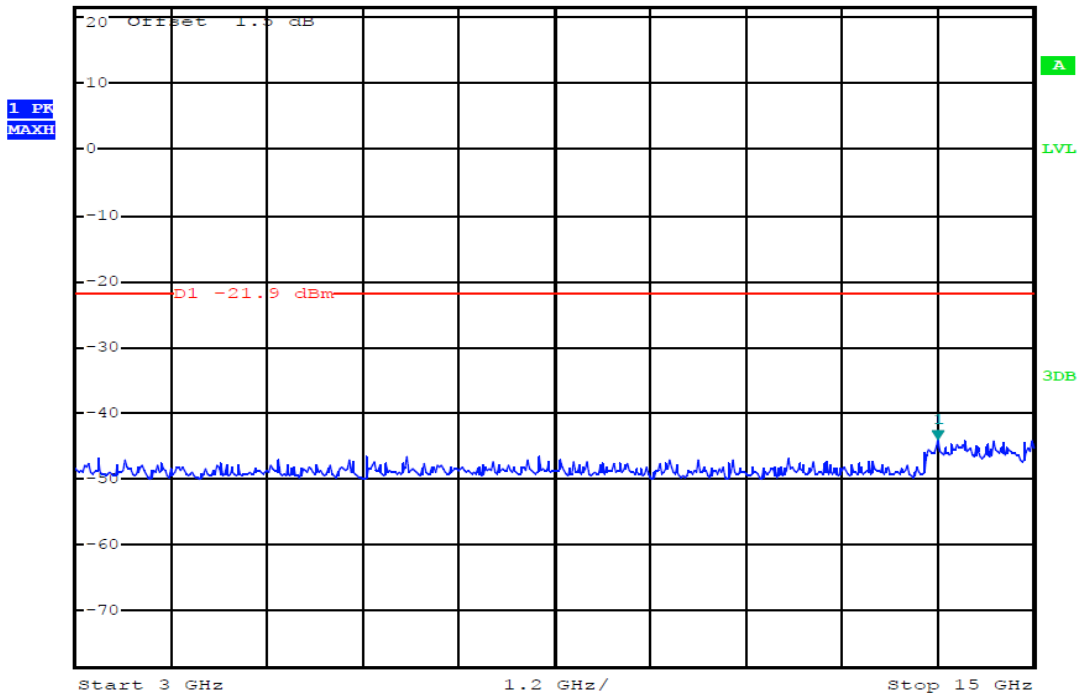

Date: 20.MAR.2014 21:26:30

(Plot 4.9.1.B2: Channel 39: 2441MHz @ GFSK)



Ref 21.5 dBm \*Att 30 dB \*RBW 100 kHz Marker 1 [T1 ]  
\*VBW 300 kHz -43.02 dBm  
SWT 1 s 17.240000000 GHz

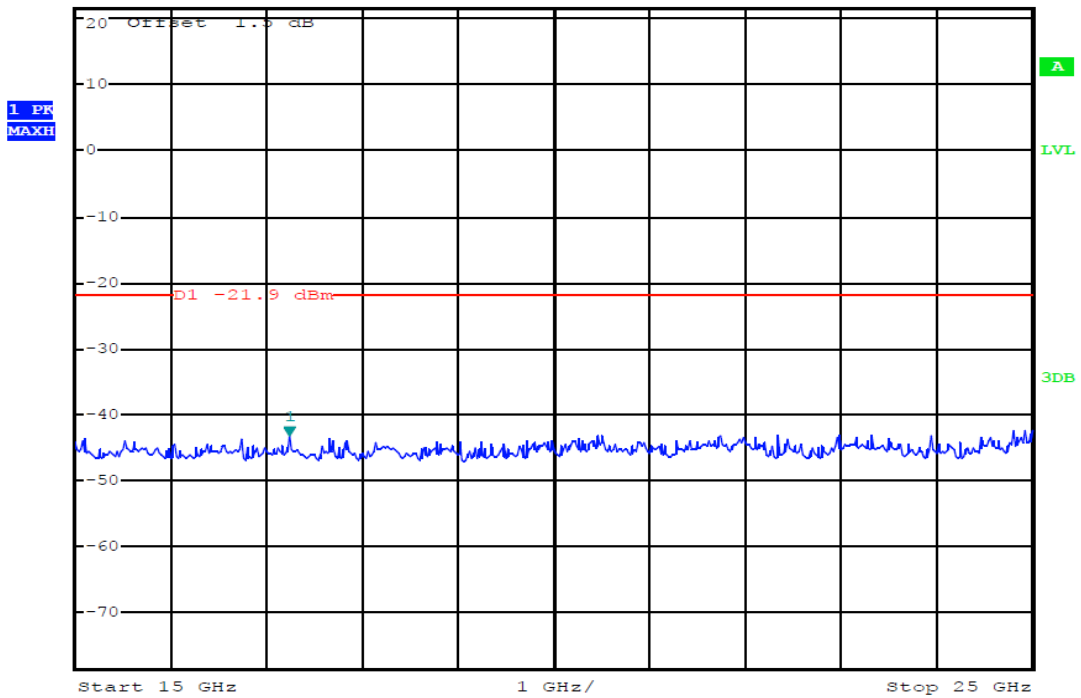

Date: 20.MAR.2014 21:26:47

(Plot 4.9.1.B3: Channel 39: 2441MHz @ GFSK)

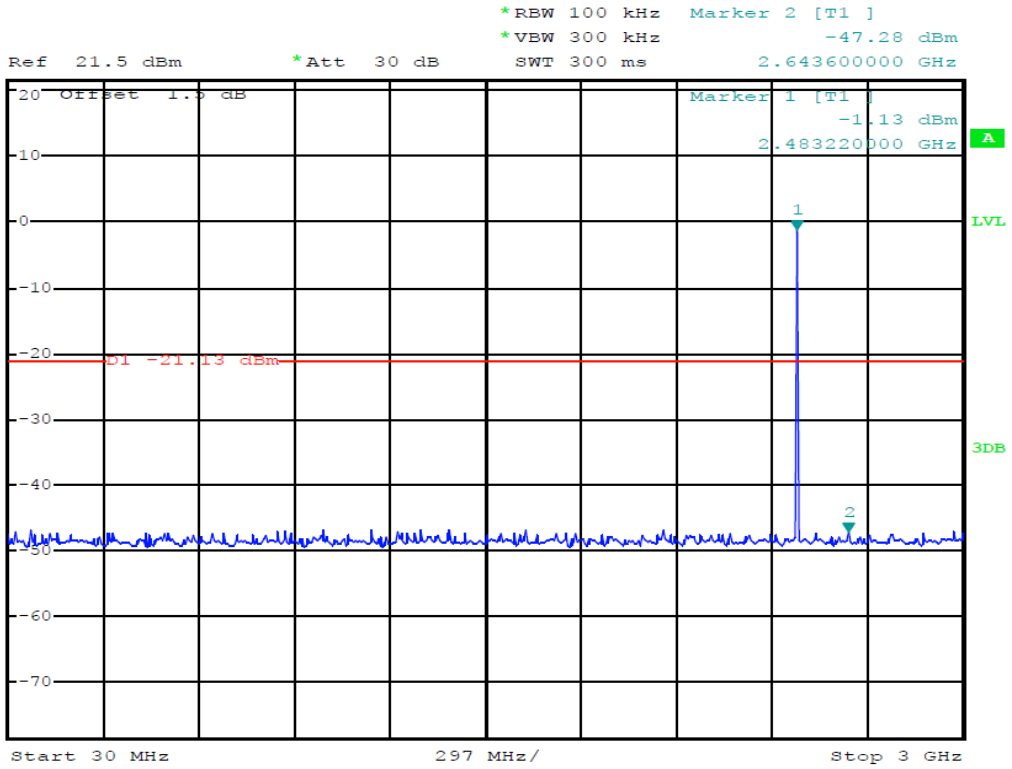

Date: 20.MAR.2014 21:27:58

(Plot 4.9.1.C1: Channel 78: 2480MHz @ GFSK)

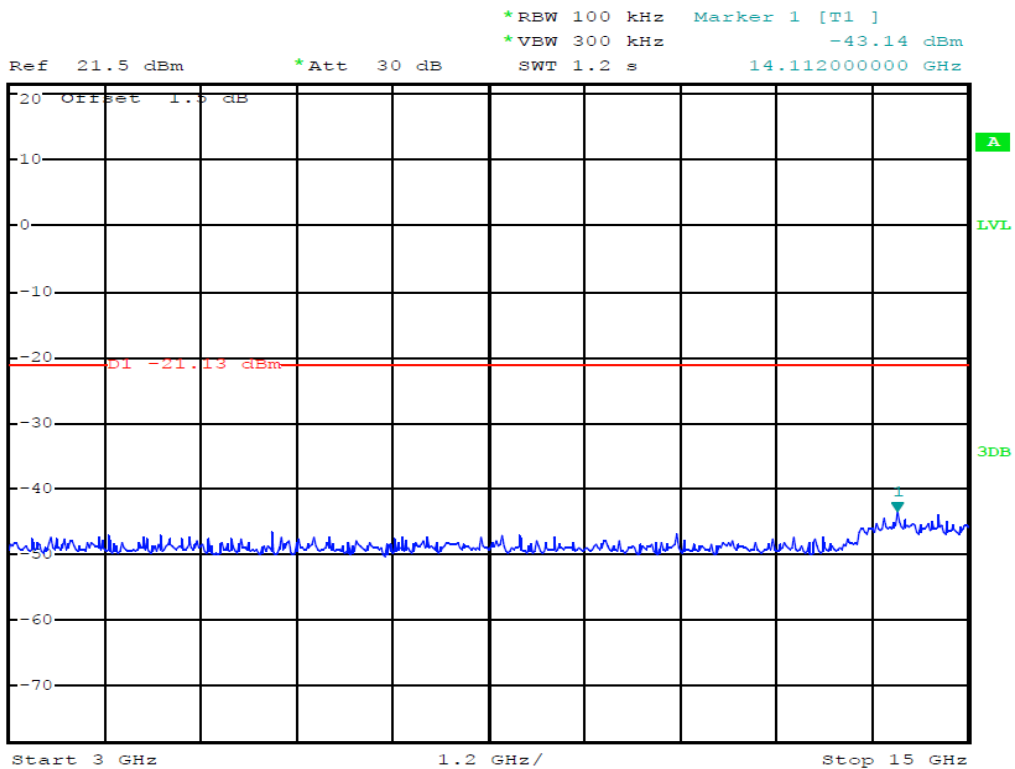

Date: 20.MAR.2014 21:28:20

(Plot 4.9.1.C2: Channel 78: 2480MHz @ GFSK)



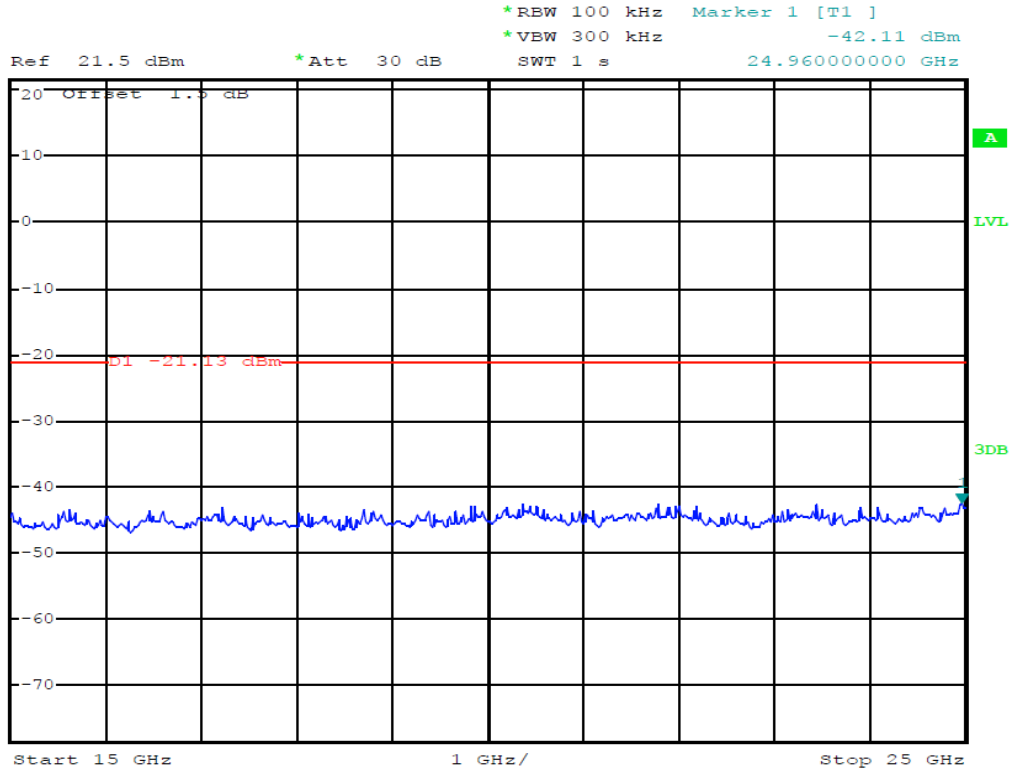

Date: 20.MAR.2014 21:28:40

(Plot 4.9.1.C3: Channel 78: 2480MHz @ GFSK)

**4.9.2 8DPSK Test Mode**

A. Test Verdict

Channel	Frequency (MHz)	Frequency Range	Limit (dBc)	Refer to Plot	Verdict
00	2402	30MHz-3GHz	-20	Plot 4.9.2 A1	PASS
		3GHz-15GHz	-20	Plot 4.9.2 A2	PASS
		15GHz-25GHz	-20	Plot 4.9.2 A3	PASS
39	2441	30MHz-3GHz	-20	Plot 4.9.2 B1	PASS
		3GHz-15GHz	-20	Plot 4.9.2 B2	PASS
		15GHz-25GHz	-20	Plot 4.9.2 B3	PASS
78	2480	30MHz-3GHz	-20	Plot 4.9.2 C1	PASS
		3GHz-15GHz	-20	Plot 4.9.2 C2	PASS
		15GHz-25GHz	-20	Plot 4.9.2 C3	PASS

B. Test Plots

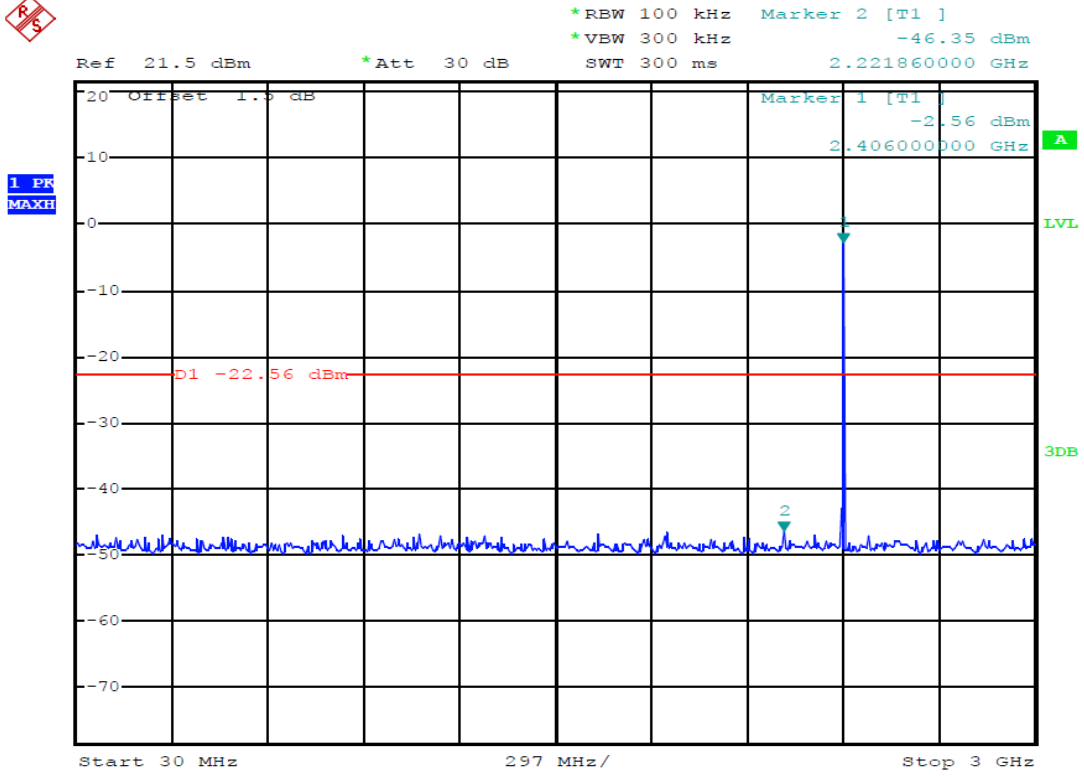

Date: 20.MAR.2014 21:29:37

(Plot 4.9.2.A1: Channel 00: 2402MHz @ 8DPSK)

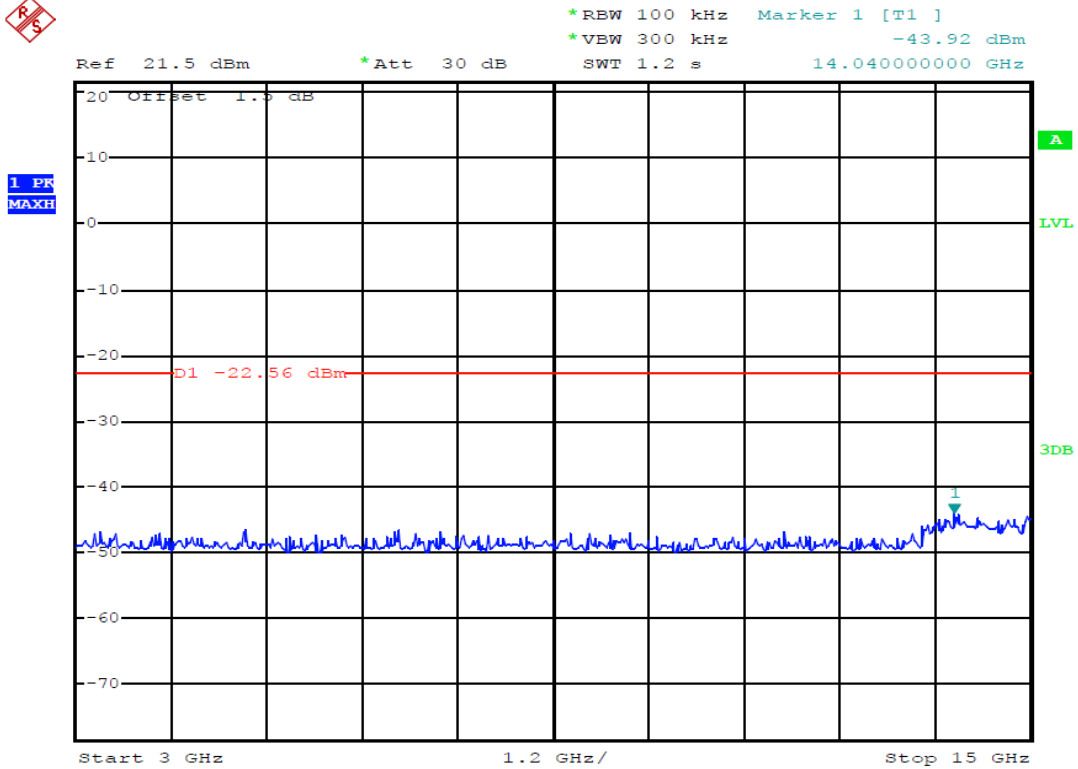

Date: 20.MAR.2014 21:29:55

(Plot 4.9.2.A2: Channel 00: 2402MHz @ 8DPSK)

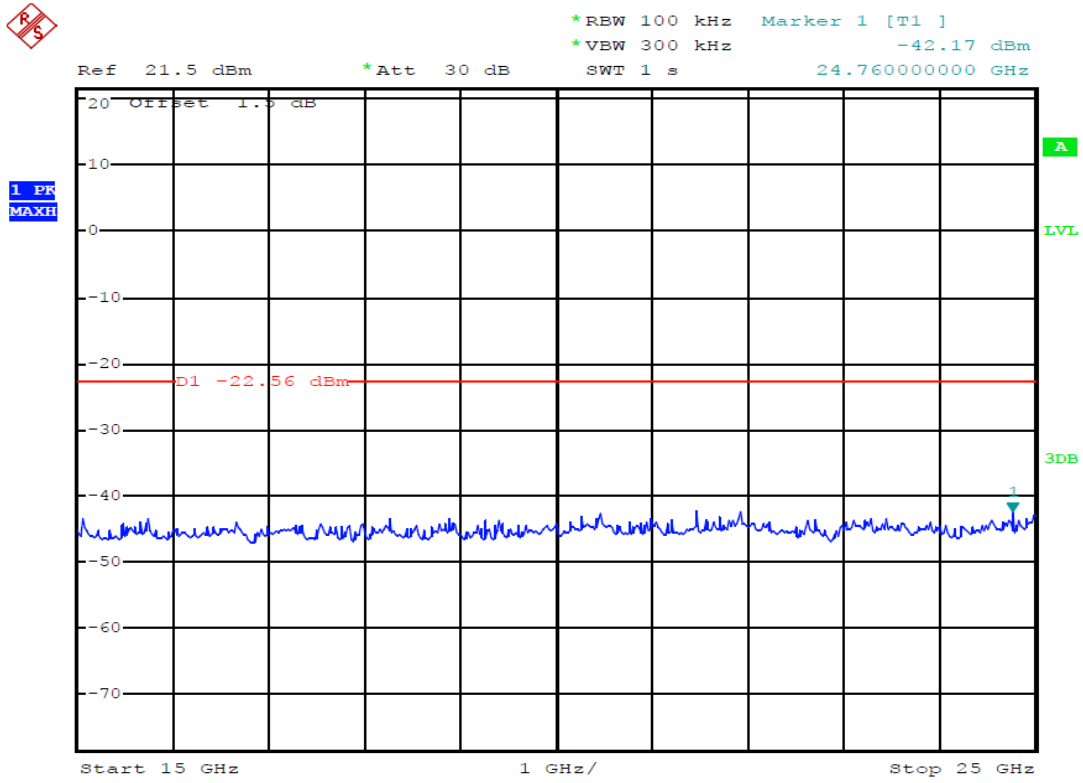

Date: 20.MAR.2014 21:30:10

(Plot 4.9.2.A3: Channel 00: 2402MHz @ 8DPSK)

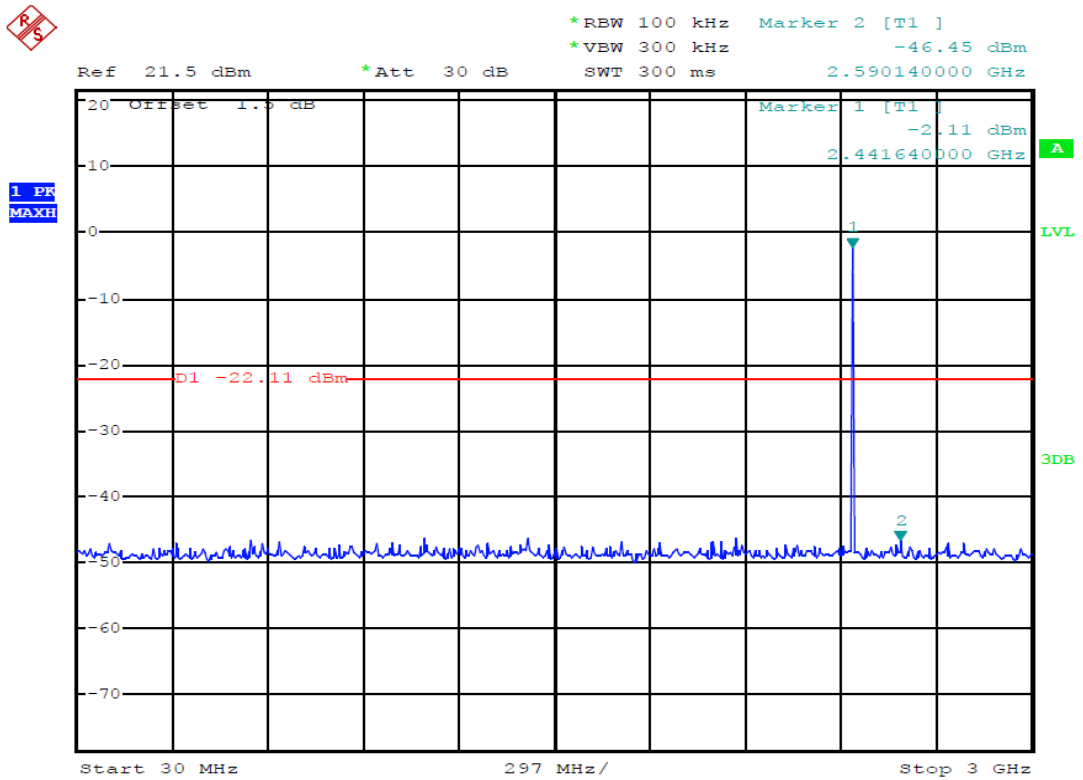

Date: 20.MAR.2014 21:30:59

(Plot 4.9.2.B1: Channel 39: 2441MHz @ 8DPSK)

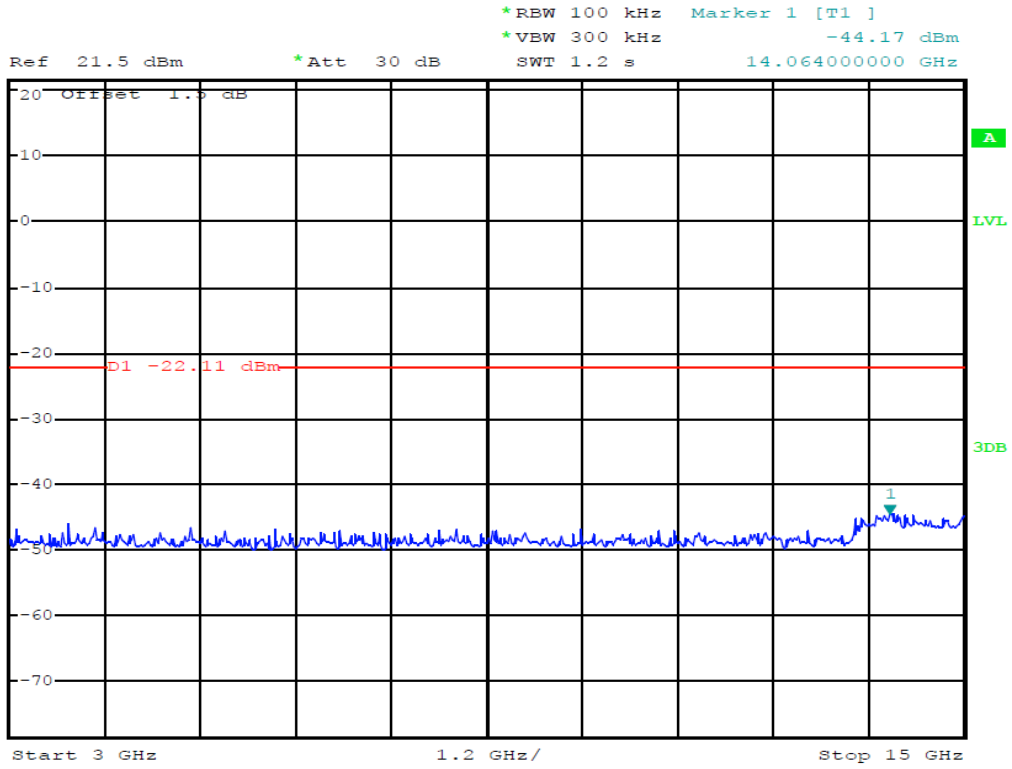

Date: 20.MAR.2014 21:31:21

(Plot 4.9.2.B2: Channel 39: 2441MHz @ 8DPSK)

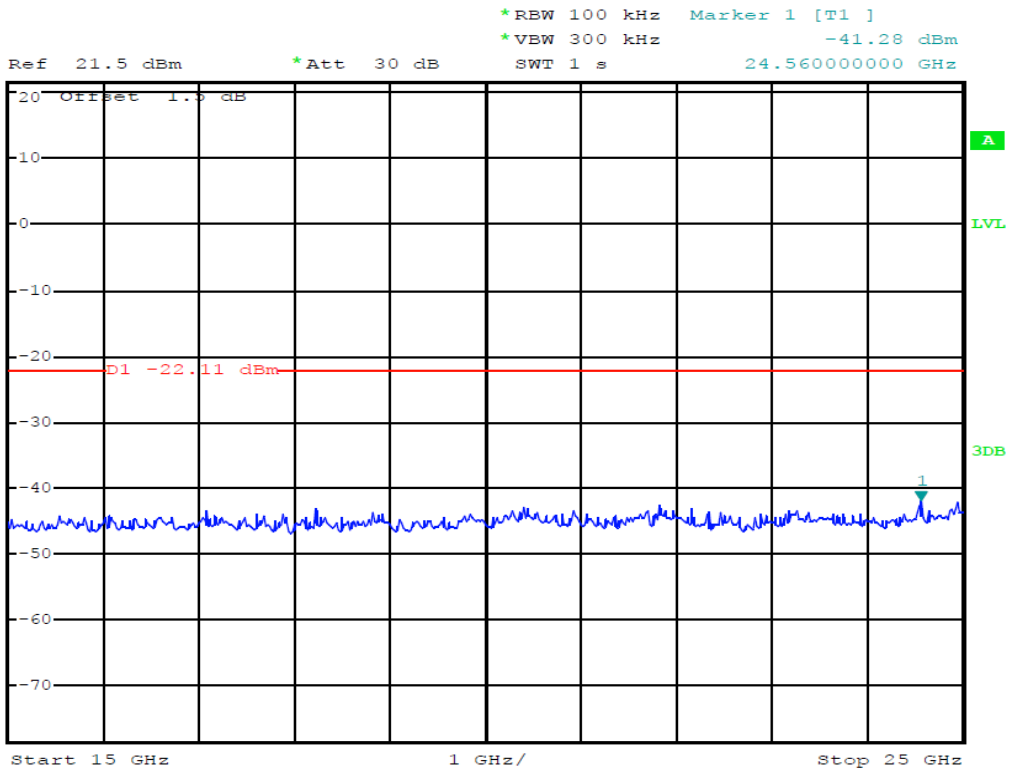

Date: 20.MAR.2014 21:31:37

(Plot 4.9.2.B3: Channel 39: 2441MHz @ 8DPSK)

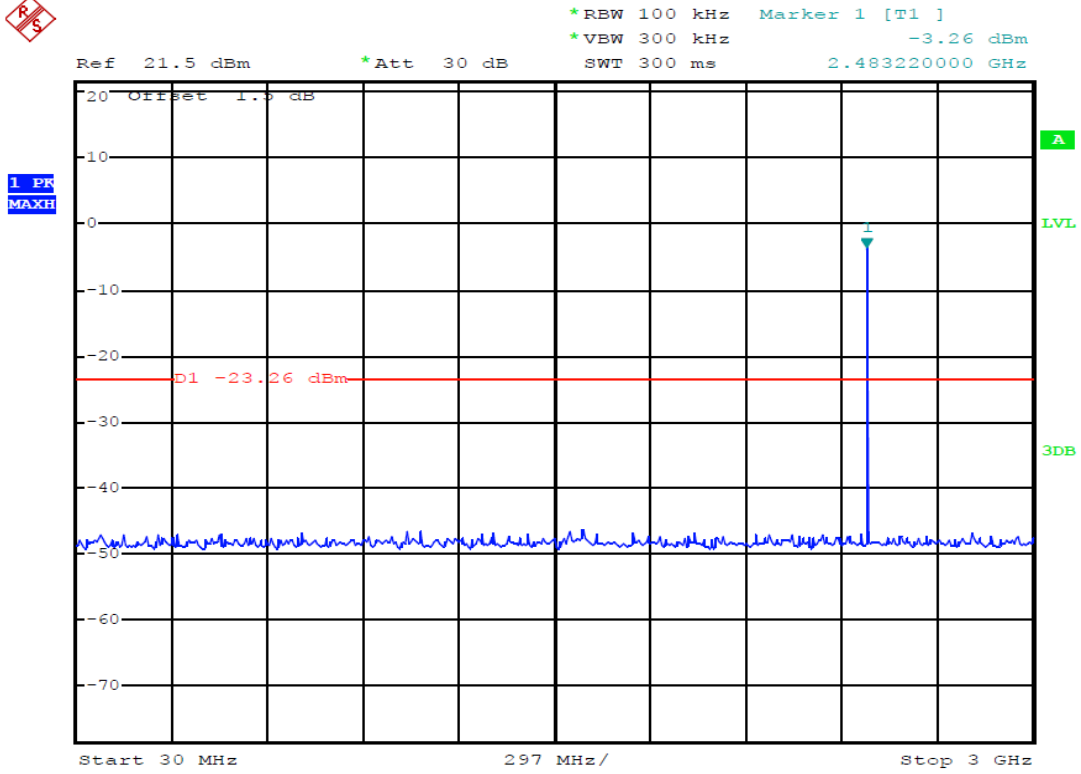

Date: 20.MAR.2014 21:33:28

(Plot 4.9.2.C1: Channel 78: 2480MHz @ 8DPSK)

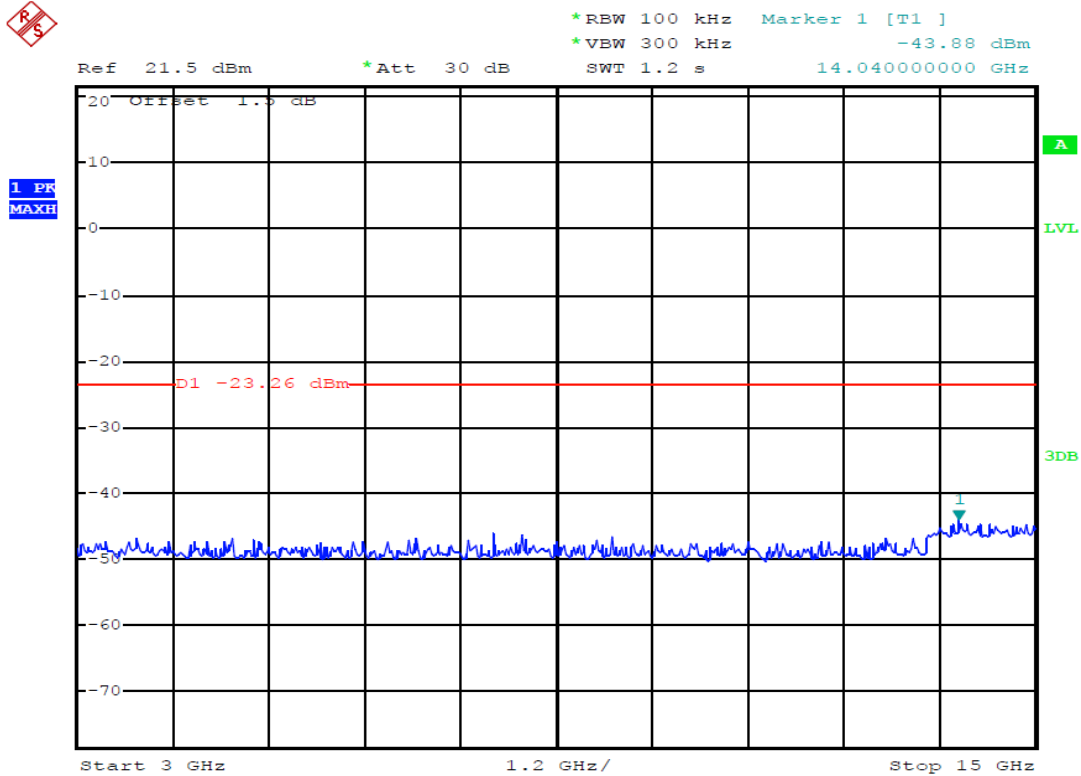

Date: 20.MAR.2014 21:33:45

(Plot 4.9.2.C2: Channel 78: 2480MHz @ 8DPSK)

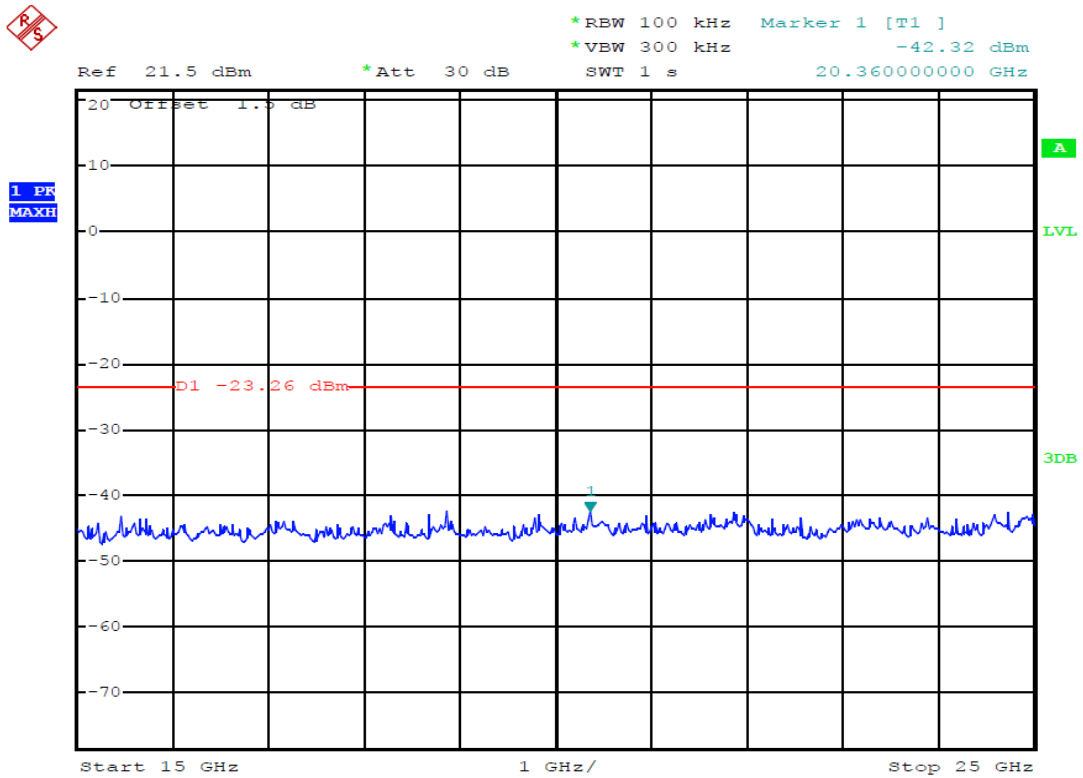

Date: 20.MAR.2014 21:33:59

(Plot 4.9.2.C3: Channel 78: 2480MHz @ 8DPSK)

**4.9.3  $\pi/4$ DQPSK Test Mode**

A. Test Verdict

Channel	Frequency (MHz)	Frequency Range	Limit (dBc)	Refer to Plot	Verdict
00	2402	30MHz-3GHz	-20	Plot 4.9.3 A1	PASS
		3GHz-15GHz	-20	Plot 4.9.3 A2	PASS
		15GHz-25GHz	-20	Plot 4.9.3 A3	PASS
39	2441	30MHz-3GHz	-20	Plot 4.9.3 B1	PASS
		3GHz-15GHz	-20	Plot 4.9.3 B2	PASS
		15GHz-25GHz	-20	Plot 4.9.3 B3	PASS
78	2480	30MHz-3GHz	-20	Plot 4.9.3 C1	PASS
		3GHz-15GHz	-20	Plot 4.9.3 C2	PASS
		15GHz-25GHz	-20	Plot 4.9.3 C3	PASS

B. Test Plots

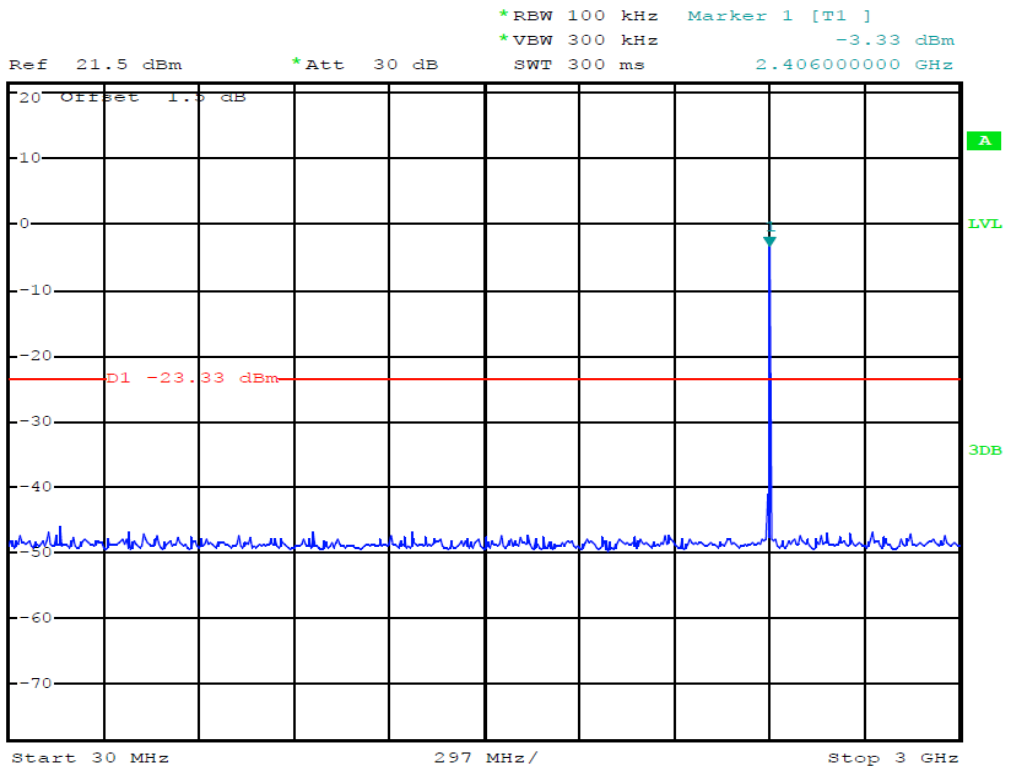

Date: 20.MAR.2014 21:20:30

(Plot 4.9.3.A1: Channel 00: 2402MHz @  $\pi/4$ DQPSK)

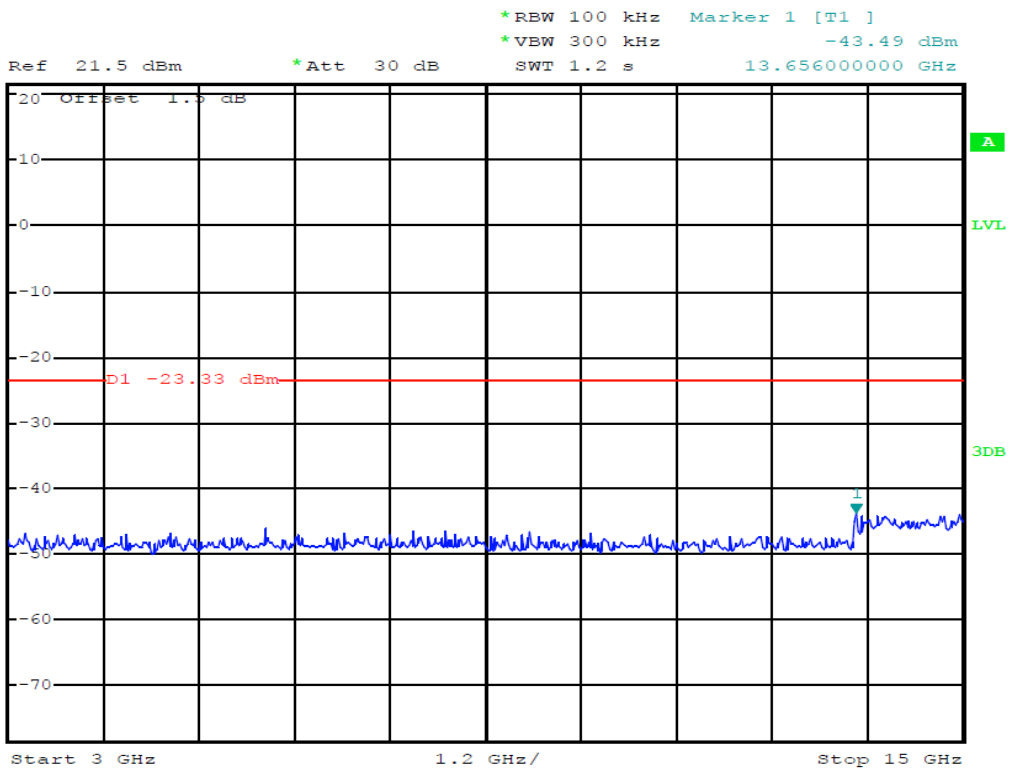

Date: 20.MAR.2014 21:20:58

(Plot 4.9.3.A2: Channel 00: 2402MHz @  $\pi/4$ DQPSK)

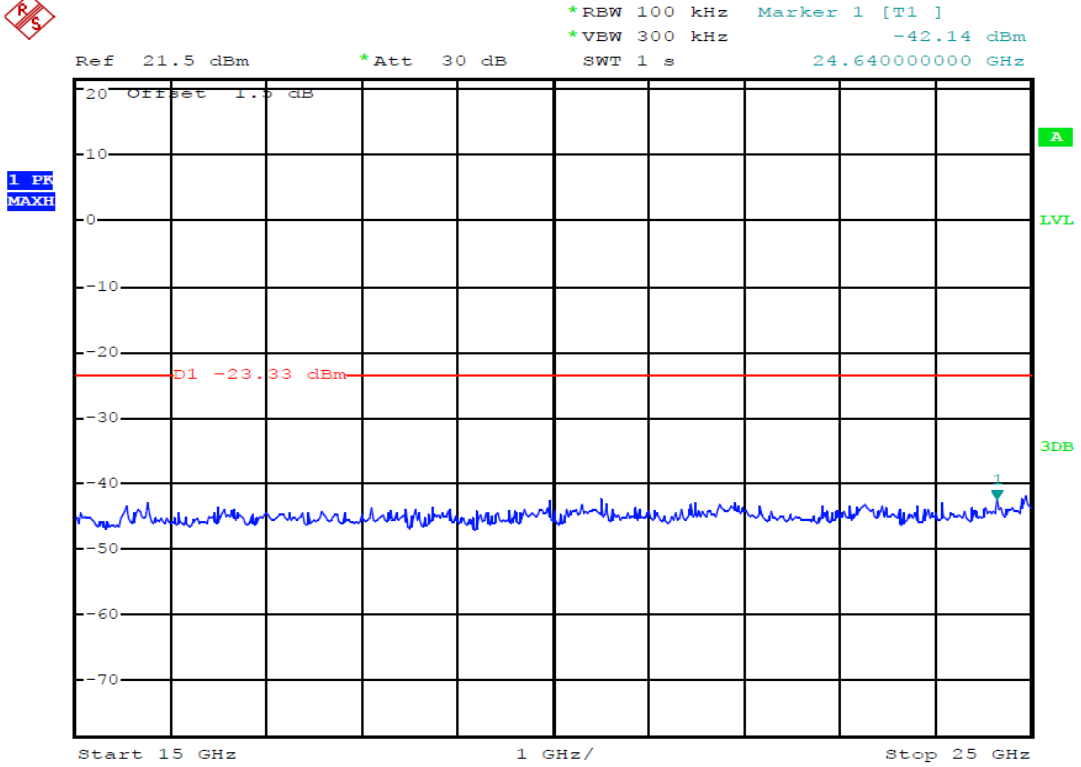

Date: 20.MAR.2014 21:21:18

(Plot 4.9.3.A3: Channel 00: 2402MHz @  $\pi/4$ DQPSK)

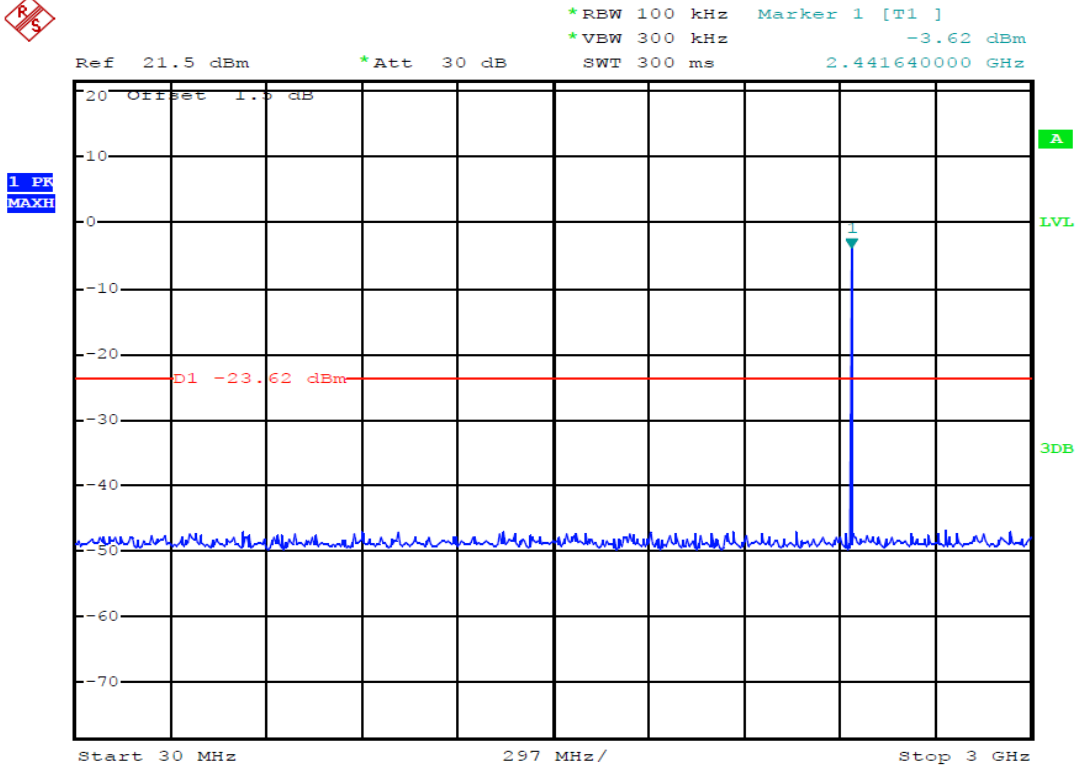

Date: 20.MAR.2014 21:22:09

(Plot 4.9.3.B1: Channel 39: 2441MHz @  $\pi/4$ DQPSK)



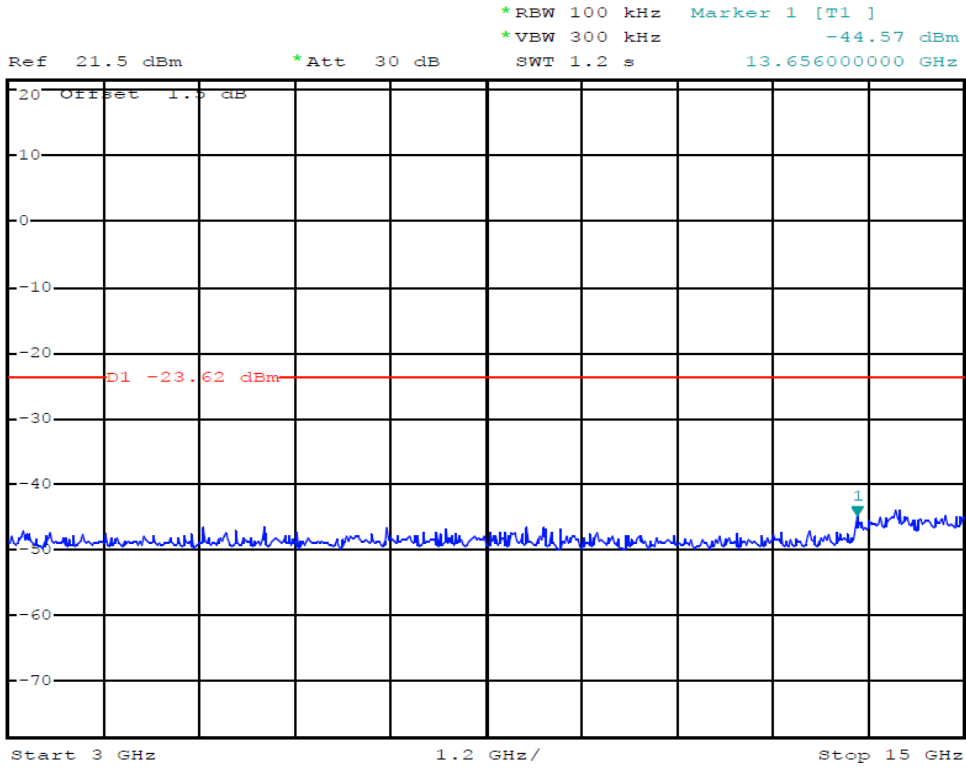

Date: 20.MAR.2014 21:22:30

(Plot 4.9.3.B2: Channel 39: 2441MHz @  $\pi/4$ DQPSK)

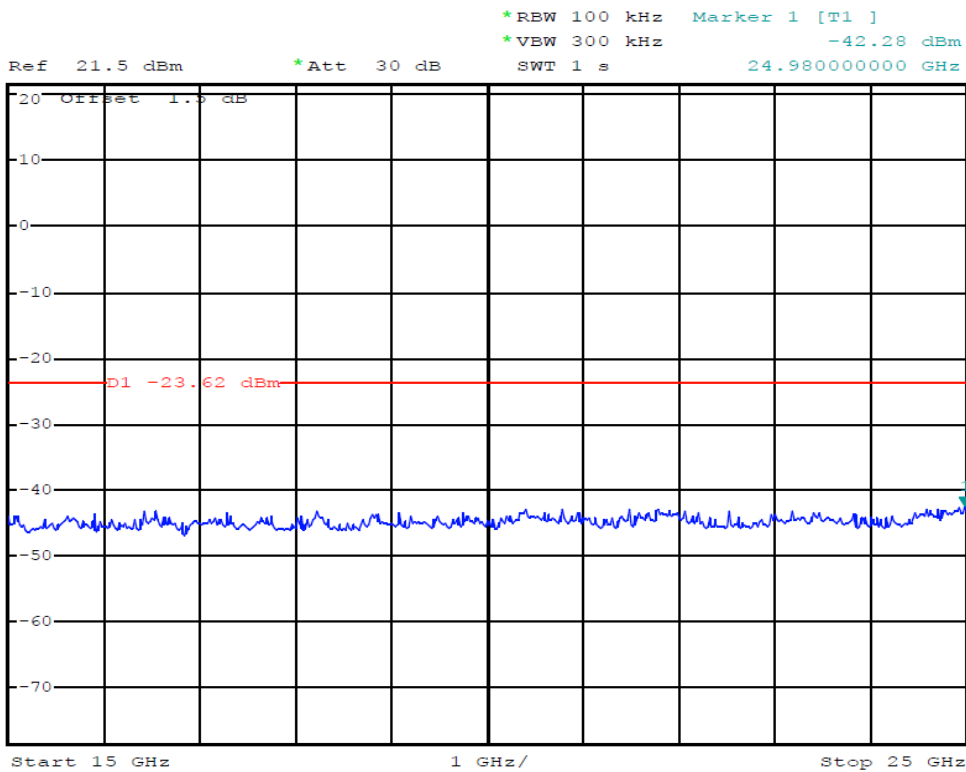

Date: 20.MAR.2014 21:23:02

(Plot 4.9.3.B3: Channel 39: 2441MHz @  $\pi/4$ DQPSK)

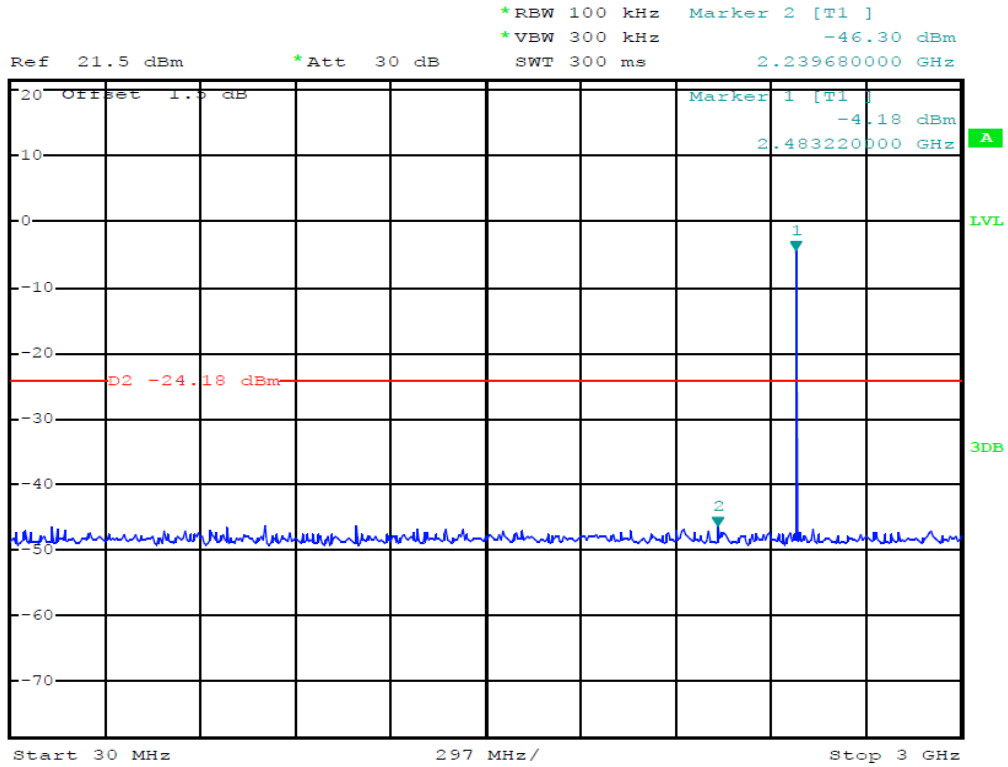

Date: 20.MAR.2014 21:17:30

(Plot 4.9.3.C1: Channel 78: 2480MHz @  $\pi/4$ DQPSK)

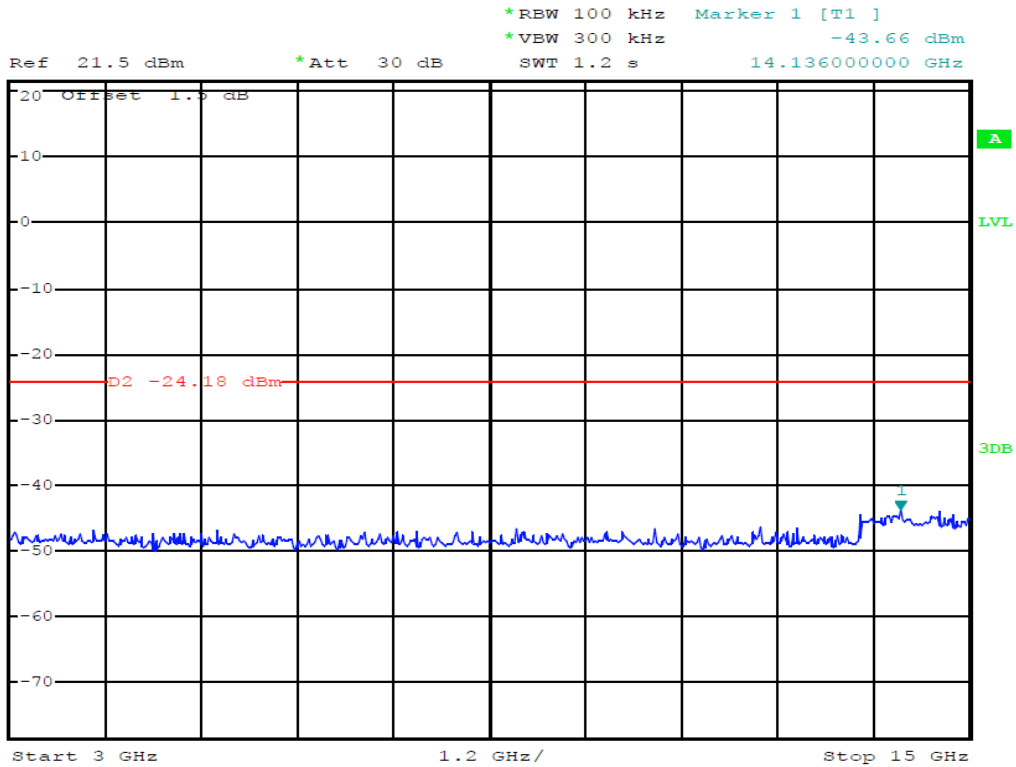

Date: 20.MAR.2014 21:18:16

(Plot 4.9.3.C2: Channel 78: 2480MHz @  $\pi/4$ DQPSK)

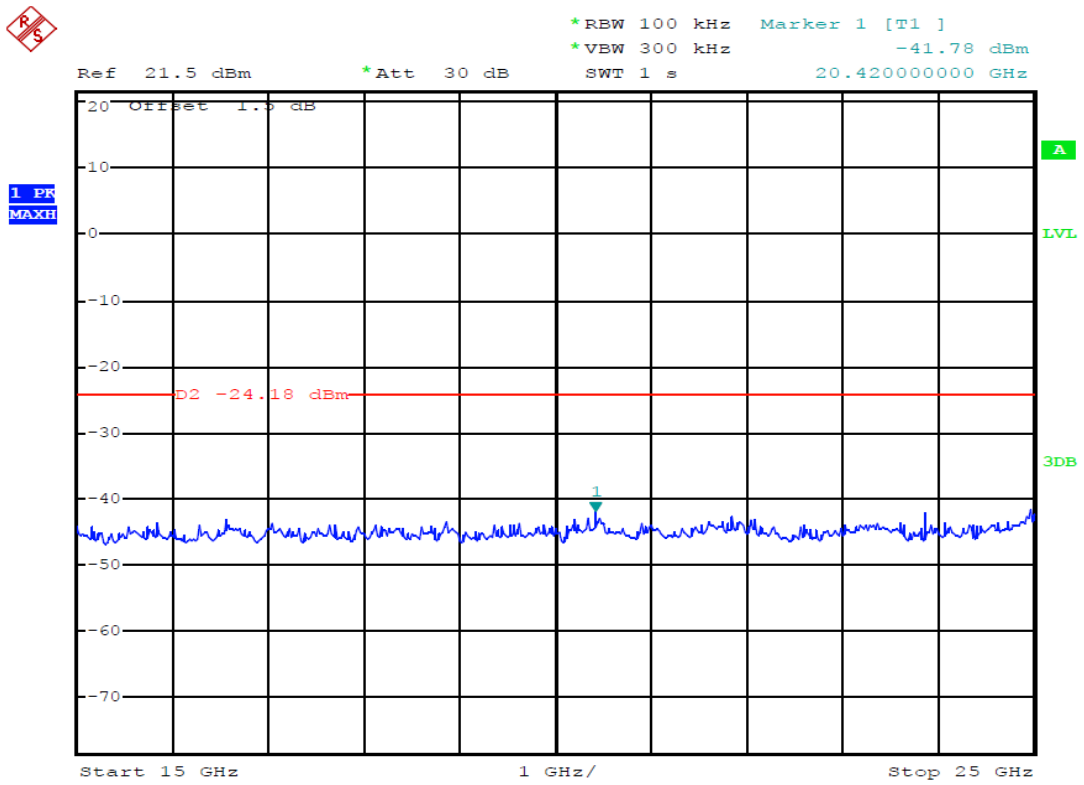

Date: 20.MAR.2014 21:18:42

(Plot 4.9.3.C3: Channel 78: 2480MHz @  $\pi/4$ DQPSK)

### 4.10. Pseudorandom Frequency Hopping Sequence

**TEST APPLICABLE**

**For 47 CFR Part 15C section 15.247 (a)(1) requirement:**

Frequency hopping systems shall have hopping channel carrier frequencies separated by a minimum of 25 kHz or the 20 dB bandwidth of the hopping channel, whichever is greater. Alternatively, frequency hopping systems operating in the 2400–2483.5 MHz band may have hopping channel carrier frequencies that are separated by 25 kHz or two-thirds of the 20 dB bandwidth of the hopping channel, whichever is greater, provided the systems operate with an output power no greater than 125 mW. The system shall hop to channel frequencies that are selected at the system hopping rate from a pseudo randomly ordered list of hopping frequencies. Each frequency must be used equally on the average by each transmitter. The system receivers shall have input bandwidths that match the hopping channel bandwidths of their corresponding transmitters and shall shift frequencies in synchronization with the transmitted signals.

**EUT Pseudorandom Frequency Hopping Sequence Requirement**

The pseudorandom frequency hopping sequence may be generated in a nine-stage shift register whose 5<sup>th</sup> and 9<sup>th</sup> stage outputs are added in a modulo-two addition stage. And the result is fed back to the input of the first stage. The sequence begins with the first one of 9 consecutive ones, for example: the shift register is initialized with nine ones.

- Number of shift register stages:9
- Length of pseudo-random sequence:29-1=511 bits
- Longest sequence of zeros:8(non-inverted signal)

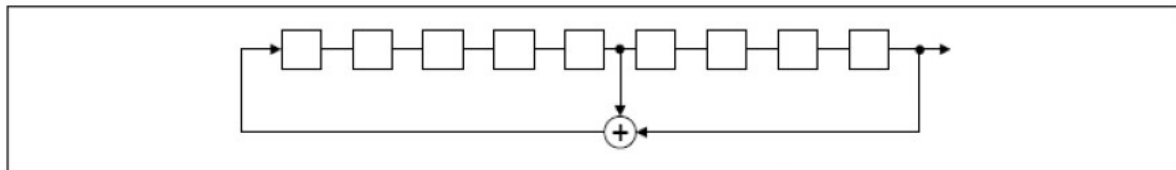

*Linear Feedback Shift Register for Generation of the PRBS sequence*

An example of pseudorandom frequency hopping sequence as follows:

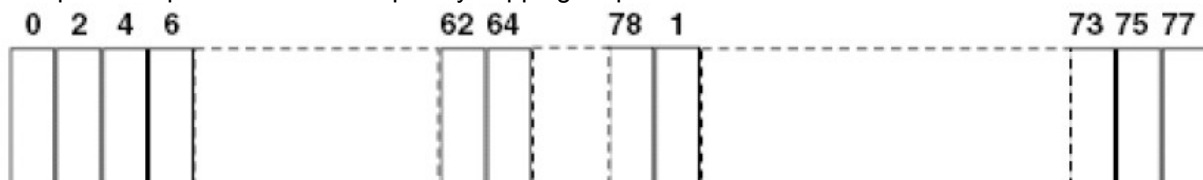

Each frequency used equally on the average by each transmitter. The system receiver have input bandwidths that match the hopping channel bandwidths of their corresponding transmitter and shift frequencies in synchronization with the transmitted signals.

## 4.11. Antenna Requirement

### Standard Applicable

For intentional device, according to FCC 47 CFR Section 15.203, an intentional radiator shall be designed to ensure that no antenna other than that furnished by the responsible party shall be used with the device.

And according to FCC 47 CFR Section 15.247 (c), if transmitting antennas of directional gain greater than 6dBi are used, the power shall be reduced by the amount in dB that the directional gain of the antenna exceeds 6dBi.

### **Refer to statement below for compliance.**

The manufacturer may design the unit so that the user can replace a broken antenna, but the use of a standard antenna jack or electrical connector is prohibited. Further, this requirement does not apply to intentional radiators that must be professionally installed.

### Antenna Connected Construction

The WLAN and Bluetooth sharing same antenna and the maximum antenna gain of BT used was 1.20 dBi.

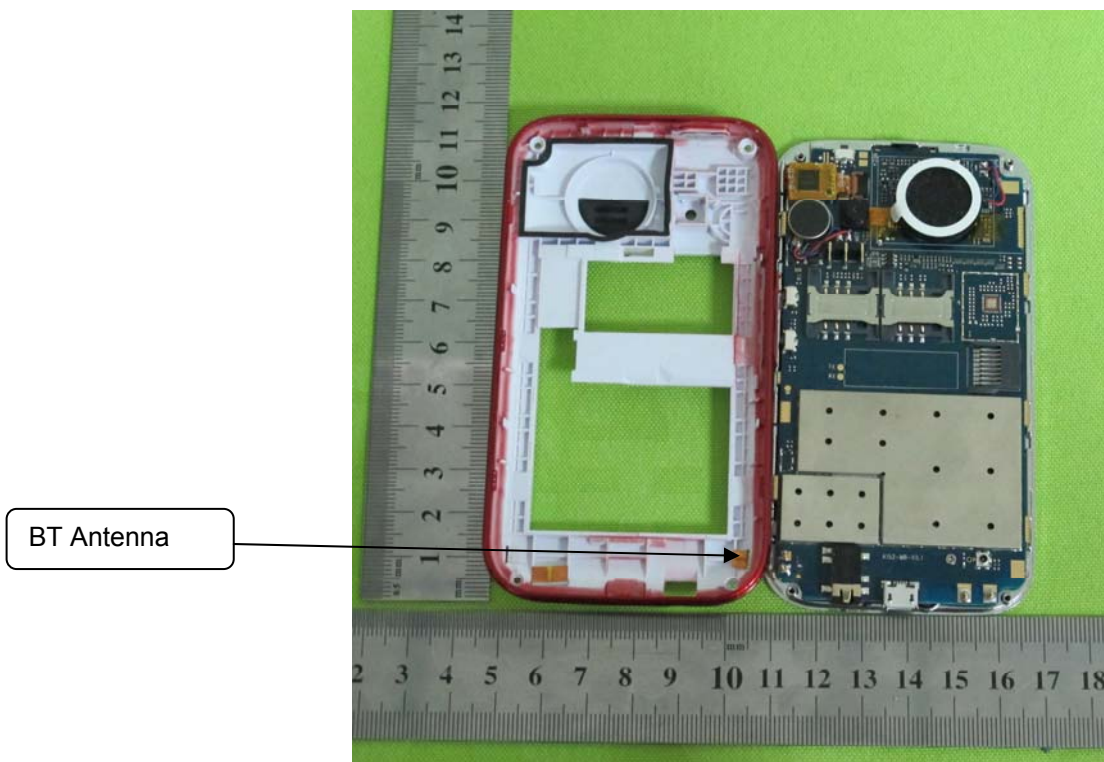

## 5. Test Setup Photos of the EUT

Radiated Emission (30MHz-1GHz)



Radiated Emission (above 1GHz)



Conducted Emission (AC Mains)



## 6. External and Internal Photos of the EUT

### External photos of the EUT













Internal photos of the EUT

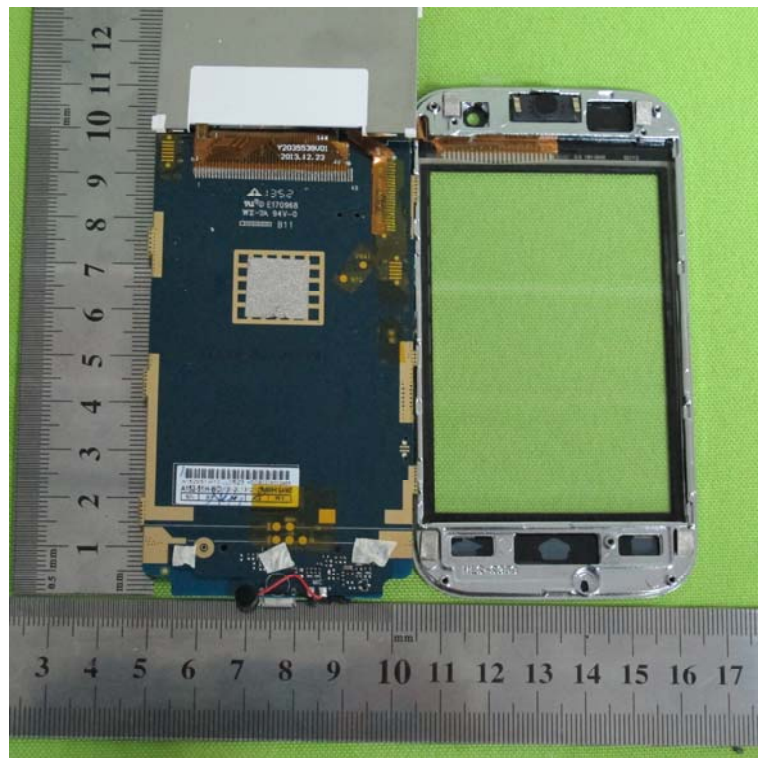
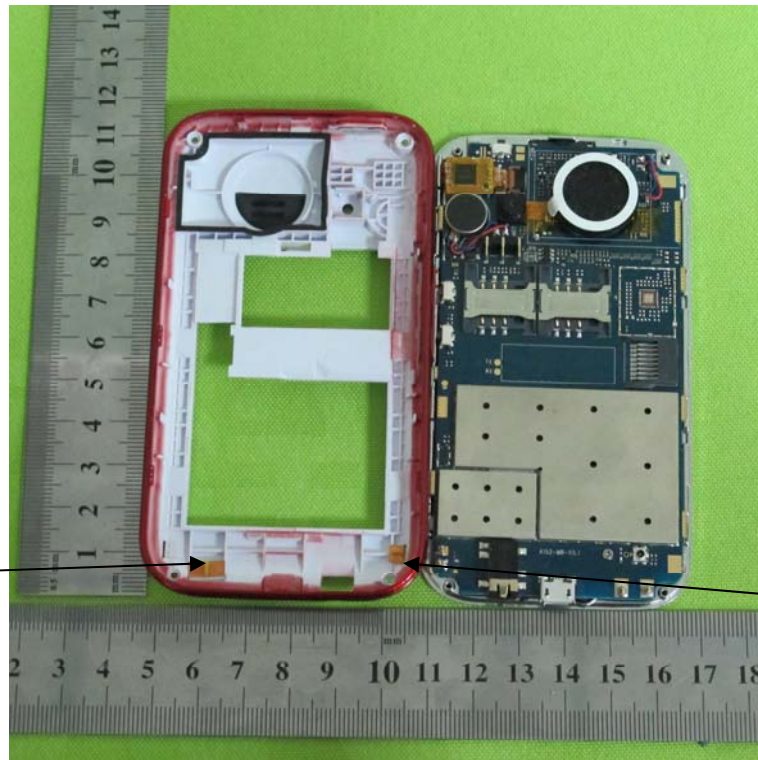

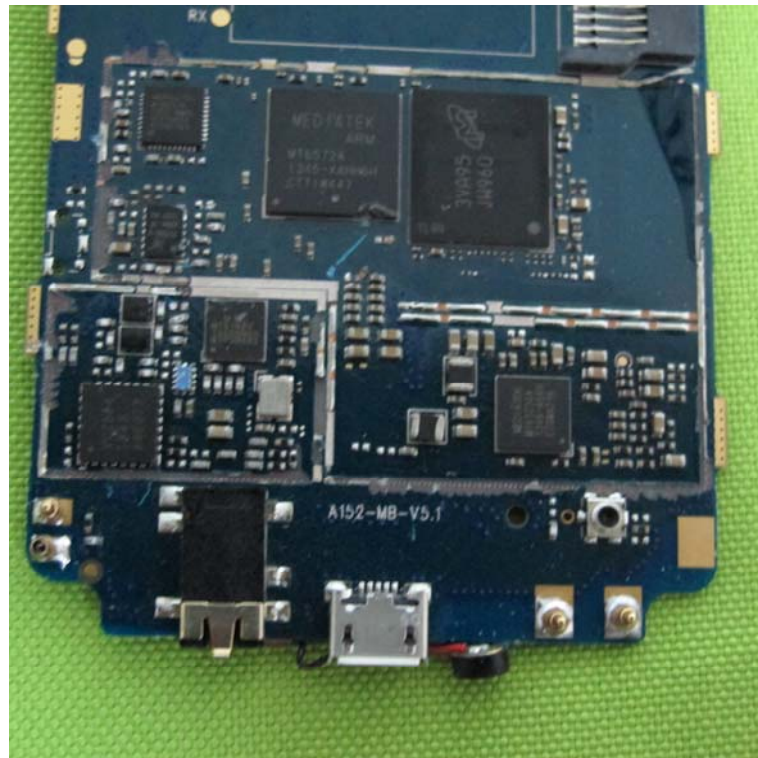
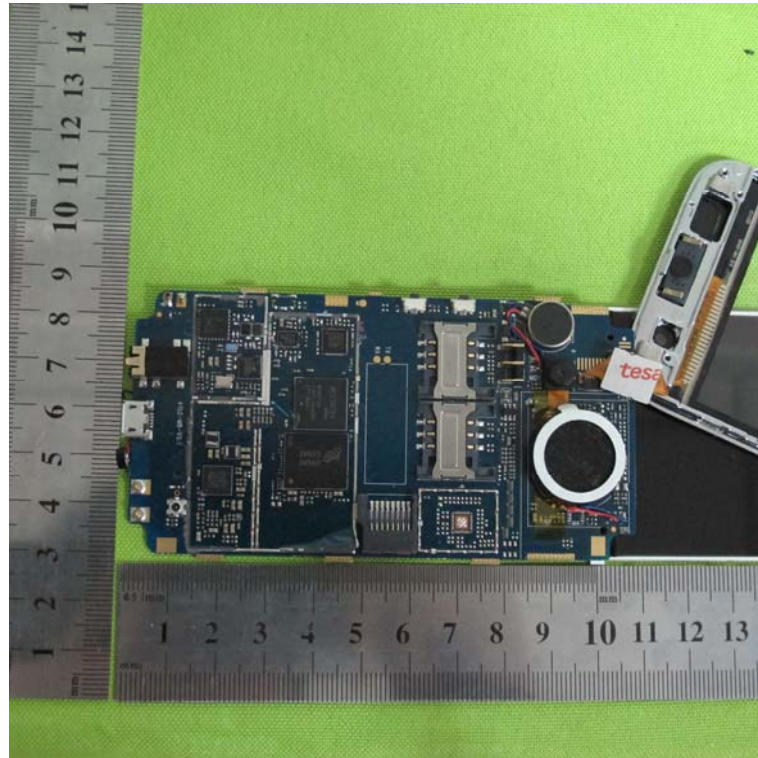



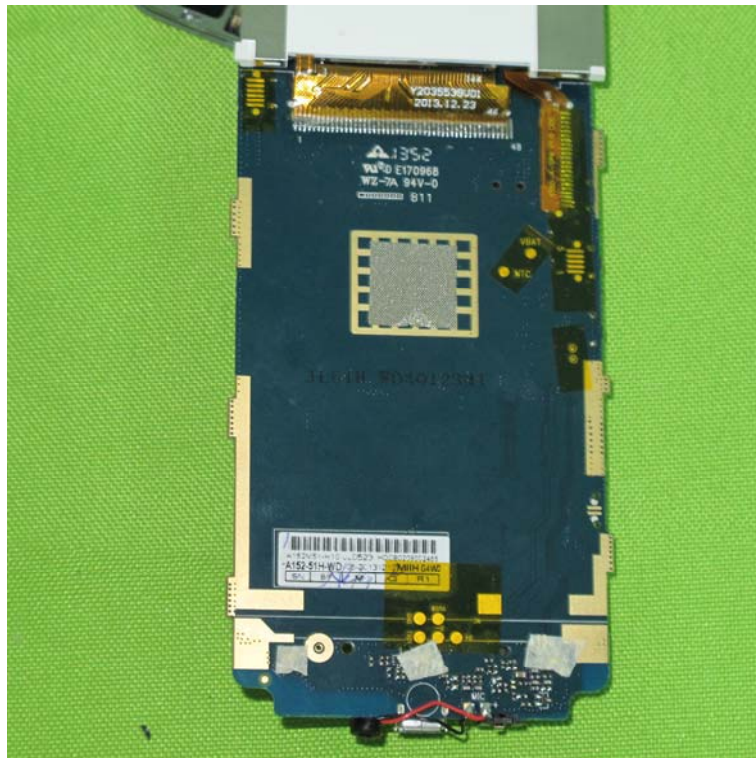
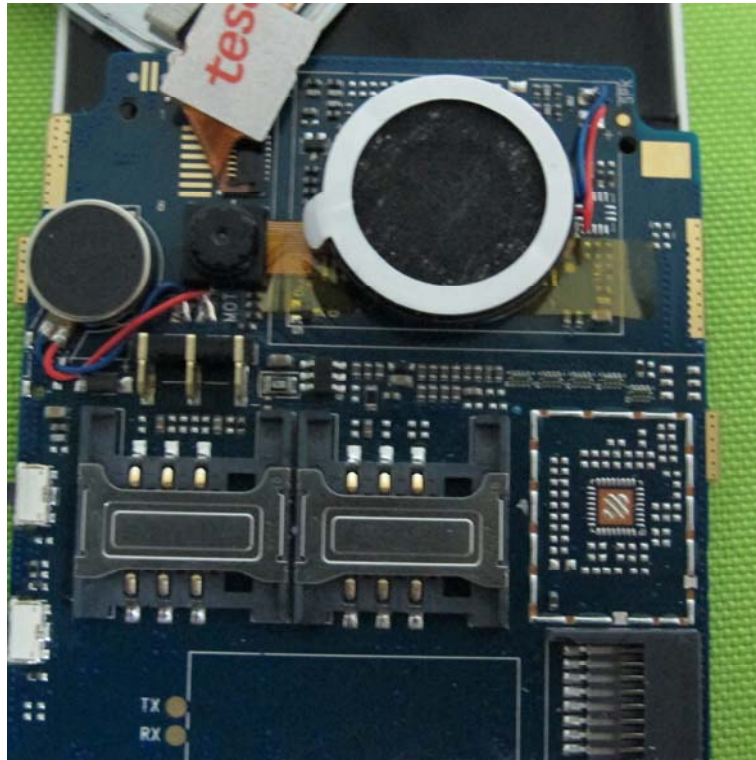

.....End of Report.....