

FCC PART 22/24 TEST REPORT

FCC Part 22 /Part 24

Report Reference No...... : **MWR1403002901**

FCC ID..... : **2ABOSSKYCOOL**

Compiled by
(position+printed name+signature)..: File administrators Martin Ao



Supervised by
(position+printed name+signature)..: Test Engineer Martin Ao

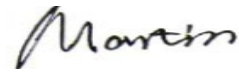

Approved by
(position+printed name+signature)..: Manager Dixon Hao

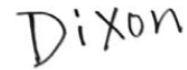

Date of issue.....: Mar 25, 2014

Representative Laboratory Name .: **Maxwell International Co., Ltd.**

Address.....: Room 509, Hongfa center building, Baoan District, Shenzhen, Guangdong, China

Testing Laboratory Name: **DTT Services Co.,Ltd**

Address.....: 1F,2 Block, Jiaquan Building, Guanlan High-tech Park, Bao'an District, Shenzhen, Guangdong, China. 518110

Applicant's name.....: **SKY PHONE LLC**

Address.....: 1348 Washington Av. Suite 350

Test specification :

Standard: **FCC Part 22: PUBLIC MOBILE SERVICES**

FCC Part 24: PERSONAL COMMUNICATIONS SERVICES

TRF Originator.....: DTT Services Co.,Ltd

Master TRF.....: Dated 2011-05

DTT Services Co.,Ltd All rights reserved.

This publication may be reproduced in whole or in part for non-commercial purposes as long as the DTT Services Co.,Ltd as copyright owner and source of the material. DTT Services Co.,Ltd takes no responsibility for and will not assume liability for damages resulting from the reader's interpretation of the reproduced material due to its placement and context.

Test item description: SKY Cool

Trade Mark: 

Manufacturer.....: **SKY PHONE LLC**

Model/Type reference.....: MG834

Listed Models: MG834xy(x:0-9,y:A-Z),MS834,MS834xy(x:0-9,y:A-Z),
PRO8340xy(x:0-9,y:A-Z), W100

Ratings.....: DC 3.70V

Modulation: GMSK for GSM/GPRS

GPRS.....: Supported

Hardware version: M152-MB-V5.1

Software version: V5.1

Frequency.....: GSM 850MHz; PCS 1900MHz;

Result.....: **PASS**

TEST REPORT

Test Report No. :	MWR1403002901	Mar 25, 2014
		Date of issue

Equipment under Test : Sky Cool

Model /Type : MG834

Listed Models : MG834xy(x:0-9,y:A-Z),MS834,MS834xy(x:0-9,y:A-Z),
PRO8340xy(x:0-9,y:A-Z), W100

Applicant : **SKY PHONE LLC**

Address : 1348 Washington Av. Suite 350

Manufacturer : **SKY PHONE LLC**

Address : 1348 Washington Av. Suite 350

Test Result:	PASS
---------------------	-------------

The test report merely corresponds to the test sample.
It is not permitted to copy extracts of these test result without the written permission of the test laboratory.

Contents

1.	<u>TEST STANDARDS.....</u>	4
2.	<u>SUMMARY</u>	5
2.1.	General Remarks	5
2.2.	Product Description	5
2.3.	Equipment under Test	5
2.4.	Short description of the Equipment under Test (EUT)	5
2.5.	Internal Identification of AE used during the test	6
2.6.	Normal Accessory setting	6
2.7.	EUT configuration	6
2.8.	Related Submittal(s) / Grant (s)	6
2.9.	Modifications	6
2.10.	Note	6
3.	<u>TEST ENVIRONMENT.....</u>	7
3.1.	Address of the test laboratory	7
3.2.	Test Facility	7
3.3.	Environmental conditions	7
3.4.	Statement of the measurement uncertainty	7
3.5.	Test Description	8
3.6.	Equipments Used during the Test	8
4.	<u>TEST CONDITIONS AND RESULTS.....</u>	10
4.1.	Conducted Emissions Test	10
4.2.	OUTPUT POWER	15
4.3.	Radiated Spurious Emssion	19
4.4.	OCCUPIED BANDWIDTH	23
4.5.	EMISSION BANDWIDTH	31
4.6.	BAND EDGE COMPLIANCE	39
4.7.	Spurious Emssion on Antenna Port	45
4.8.	Frequency Stability Test	68
5.	<u>TEST SETUP PHOTOS OF THE EUT</u>	70
6.	<u>EXTERNAL AND INTERNAL PHOTOS OF THE EUT</u>	71

1. TEST STANDARDS

The tests were performed according to following standards:

[FCC Part 22 \(10-1-12 Edition\)](#): PRIVATE LAND MOBILE RADIO SERVICES.

[FCC Part 24\(10-1-12 Edition\)](#): PUBLIC MOBILE SERVICES

[TIA/EIA 603 D June 2010](#): Land Mobile FM or PM Communications Equipment Measurement and Performance Standards.

[47 CFR FCC Part 15 Subpart B](#): - Unintentional Radiators

[FCC Part 2](#): FREQUENCY ALLOCA-TIONS AND RADIO TREATY MAT-TERS; GENERAL RULES AND REG-ULATIONS

[ANSI C63.4:2009](#): Methods of Measurement of Radio-Noise Emissions from Low-Voltage Electrical and Electronic Equipment in the Range of 9 kHz to 40 GHz

2. SUMMARY

2.1. General Remarks

Date of receipt of test sample	:	Mar 10, 2014
Testing commenced on	:	Mar 10, 2014
Testing concluded on	:	Mar 25, 2014

2.2. Product Description

The **SKY PHONE LLC**'s Model: MG384 or the "EUT" as referred to in this report; more general information as follows, for more details, refer to the user's manual of the EUT.

Name of EUT	Sky Cool
Model Number	MG834, MG834xy(x:0-9,y:A-Z),MS834,MS834xy(x:0-9,y:A-Z), PRO8340xy(x:0-9,y:A-Z), W100
FCC ID	2ABOSSKYCOOL
Modulation Type	GMSK for GSM/GPRS
Antenna Type	External
GSM/EDGE/GPRS	Supported GPRS
Extreme temp. Tolerance	-30°C to +50°C
Extreme vol. Limits	3.40VDC to 4.20VDC (nominal: 3.70VDC)
GSM Operation Frequency Band	GSM 850MHz/ PCS 1900MHz
GSM Release Version	R99
GPRS operation mode	Class B
GPRS Multislot Class	12
EGPRS Multislot Class	Not Supported

2.3. Equipment under Test

Power supply system utilised

Power supply voltage	:	<input type="radio"/> 120V / 60 Hz	<input type="radio"/> 115V / 60Hz
		<input type="radio"/> 12 V DC	<input type="radio"/> 24 V DC
		<input checked="" type="radio"/> Other (specified in blank below)	

DC 3.70V

Test frequency list

Modulation Type	Test Channel	Channel Number	Test Frequency
GSM850	Low	128	824.20 MHz
	Middle	188	836.60 MHz
	High	251	848.80 MHz
PCS1900	Low	512	1850.20 MHz
	Middle	661	1880.00 MHz
	High	810	1909.80 MHz

2.4. Short description of the Equipment under Test (EUT)

The Equipment Under Test (EUT) is a model of Sky Cool with GSM/GPRS,WiFi and Bluetooth

function and integrated antenna. Manual and specifications of the EUT were provided to fulfil the test.

Samples undergoing test were selected by the Client.

2.5. Internal Identification of AE used during the test

AE ID*	Description
AE1	Battery
AE2	Charger

AE1

Model: MG834
 Manufacturer: SKY PHONE LLC
 Capacitance: 800mAh
 Nominal Voltage: 3.70V

AE2:

Model: MG834
 Manufacturer: SKY PHONE LLC

*AE ID: is used to identify the test sample in the lab internally.

2.6. Normal Accessory setting

Fully charged battery was used during the test.

2.7. EUT configuration

The following peripheral devices and interface cables were connected during the measurement:

- supplied by the manufacturer
- supplied by the lab

<input type="radio"/>	Power Cable	Length (m) :	/
		Shield :	/
		Detachable :	/
<input type="radio"/>	Multimeter	Manufacturer :	/
		Model No. :	/

2.8. Related Submittal(s) / Grant (s)

This submittal(s) (test report) is intended for **FCC ID: 2ABOSSKYCOOL** filing to comply with FCC Part 22 and Part 24 Rules

2.9. Modifications

No modifications were implemented to meet testing criteria.

2.10. Note

- The EUT is a Sky Cool with GSM/GPRS,WiFi and Bluetooth fuction,The functions of the EUT listed as below:

	Test Standards	Reference Report
GSM/GPRS	FCC Part 22/FCC Part 24	MWR1403002901
Bluetooth	FCC Part 15 C 15.247	MWR1403002902
WiFi	FCC Part 15 C 15.247	MWR1403002903
USB Port	FCC Part 15 B	MWR1403002904
SAR	FCC Part 2 §2.1093	MWR1403002905

3. TEST ENVIRONMENT

3.1. Address of the test laboratory

DTT Services Co.,Ltd
 1F,2 Block, Jiaquan Building, Guanlan High-tech Park, Bao'an District, Shenzhen, Guangdong, China.
 518110
 The sites are constructed in conformance with the requirements of ANSI C63.7, ANSI C63.4 (2003) and CISPR Publication 22.

3.2. Test Facility

The test facility is recognized, certified, or accredited by the following organizations:

IC Registration No.: 9783A

The 3m alternate test site of DTT Services Co.,Ltd EMC Laboratory has been registered by Certification and Engineer Bureau of Industry Canada for the performance of with Registration NO.: 9783A on Aug, 2011.

FCC-Registration No.: 214666

DTT Services Co.,Ltd EMC Laboratory has been registered and fully described in a report filed with the (FCC) Federal Communications Commission. The acceptance letter from the FCC is maintained in our files. Registration 214666, Sep 19, 2011

3.3. Environmental conditions

During the measurement the environmental conditions were within the listed ranges:

Temperature:	15-35 ° C
Humidity:	30-60 %
Atmospheric pressure:	950-1050mbar

3.4. Statement of the measurement uncertainty

The data and results referenced in this document are true and accurate. The reader is cautioned that there may be errors within the calibration limits of the equipment and facilities. The measurement uncertainty was calculated for all measurements listed in this test report acc. to CISPR 16 - 4 „Specification for radio disturbance and immunity measuring apparatus and methods – Part 4: Uncertainty in EMC Measurements“ and is documented in the DTT Services Co.,Ltd quality system acc. to DIN EN ISO/IEC 17025. Furthermore, component and process variability of devices similar to that tested may result in additional deviation. The manufacturer has the sole responsibility of continued compliance of the device.

Hereafter the best measurement capability for DTT Services Co.,Ltd laboratory is reported:

Test Items	Measurement Uncertainty	Notes
Frequency stability	25 Hz	(1)
Transmitter power conducted	0.57 dB	(1)
Transmitter power Radiated	2.20 dB	(1)
Conducted spurious emission 9KHz-12.75 GHz	1.60 dB	(1)
Conducted Emission 9KHz-30MHz	3.39 dB	(1)
Radiated Emission 30~1000MHz	4.24 dB	(1)
Radiated Emissio 1~18GHz	5.16 dB	(1)
Radiated Emissio 18-40GHz	5.54 dB	(1)

(1) This uncertainty represents an expanded uncertainty expressed at approximately the 95% confidence level using a coverage factor of k=1.96.

3.5. Test Description

Test Items	Clause in FCC rules	Verdict
Conducted Emission	15.107/15.207	PASS
Output Power	22.913(a)/24.232(c)	PASS
Radiated Spurious Emission	2.1051/22.917/24.238	PASS
Frequency Stability	2.1055/24.235	PASS
Occupied Bandwidth	2.1049(h)(i)	PASS
Emission Bandwidth	22.917(b)/24.238(b)	PASS
Band Edge Compliance	22.917(b)/24.238(b)	PASS
Conducted Spurious Emission	2.1057/22.917/24.238	PASS

Remark:

1. The measurement uncertainty is not included in the test result.

3.6. Equipments Used during the Test

AC Power Conducted Emission					
No.	Equipment	Manufacturer	Model No.	Serial No.	Last Cal.
1	Artificial Mains	Rohde&Schwarz	ESH2-Z5	100028	2013/10/26
2	EMI Test Receiver	Rohde&Schwarz	ESCS 30	100038	2013/10/26
3	Pulse Limiter	Rohde&Schwarz	ESHSZ2	100044	2013/10/26
4	EMI Test Software	Rohde&Schwarz	ES-K1 V1.71	N/A	N/A
5	UNIVERSAL RADIO COMMUNICATION	Rohde&Schwarz	CMU200	112012	2013/10/26

Output Power(Conducted) & Occupied Bandwidth & Emission Bandwidth & Band Edge Compliance & Conducted Spurious Emission					
No.	Equipment	Manufacturer	Model No.	Serial No.	Last Cal.
1	UNIVERSAL RADIO COMMUNICATION	Rohde&Schwarz	CMU200	112012	2013/10/26
2	Spectrum Analyzer	Rohde&Schwarz	FSU26	201141	2013/10/25
3	Splitter	Mini-Circuit	ZAPD-4	400059	2013/10/25

Frequency Stability					
No.	Equipment	Manufacturer	Model No.	Serial No.	Last Cal.
1	UNIVERSAL RADIO COMMUNICATION	Rohde&Schwarz	CMU200	112012	2013/10/26
2	Spectrum Analyzer	Rohde&Schwarz	FSU26	201141	2013/10/25
3	Climate Chamber	ESPEC	EL-10KA	05107008	2013/10/14
4	Splitter	Mini-Circuit	ZAPD-4	400059	2013/10/25

Output Power (Radiated) & Radiated Spurious Emission					
No.	Equipment	Manufacturer	Model No.	Serial No.	Last Cal.
1	UNIVERSAL RADIO COMMUNICATION	Rohde&Schwarz	CMU200	112012	2013/10/26
2	Spectrum Analyzer	Rohde&Schwarz	FSU26	201141	2013/10/25
3	HORN ANTENNA	ShwarzBeck	9120D	1012	2013/10/27
4	HORN ANTENNA	ShwarzBeck	9120D	1011	2013/10/27
5	Ultra-Broadband Antenna	ShwarzBeck	VULB9163	538	2013/10/27
6	Ultra-Broadband Antenna	ShwarzBeck	VULB9163	539	2013/10/27
7	TURNTABLE	MATURO	TT2.0	----	N/A
8	ANTENNA MAST	MATURO	TAM-4.0-P	----	N/A
9	EMI Test Software	Audix	E3	N/A	N/A
10	EMI Test Receiver	Rohde&Schwarz	ESIB 26	100009	2013/10/25
11	RF Test Panel	Rohde&Schwarz	TS / RSP	335015/ 0017	N/A
12	High pass filter	Compliance Direction systems	BSU-6	34202	2013/10/25
13	Splitter	Mini-Circuit	ZAPD-4	400059	2013/10/25
14	Horn Antenna	SCHWARZBECK	BBHA9170	25841	2013/10/27
15	Horn Antenna	SCHWARZBECK	BBHA9170	25842	2013/10/27

16	Preamplifier	ShwarzBeck	BBV 9718	BBV 9718	2013/10/25
17	Broadband Preamplifier	ShwarzBeck	BBV743	9743-0079	2013/10/25
18	Signal Generator	Rohde&Schwarz	SMF100A	101932	2013/10/26
19	Amplifier	Compliance Direction systems	PAP1-4060	120	2013/10/26

The calibration interval was one year.

4. TEST CONDITIONS AND RESULTS

4.1. Conducted Emissions Test

TEST APPLICABLE

The EUT was tested according to ANSI C63.4 - 2009. The frequency spectrum from 0.15 MHz to 30 MHz was investigated. The LISN used was 50 ohm / 50 u Henry as specified by section 5.1 of ANSI C63.4 - 2009. Cables and peripherals were moved to find the maximum emission levels for each frequency.

TEST CONFIGURATION

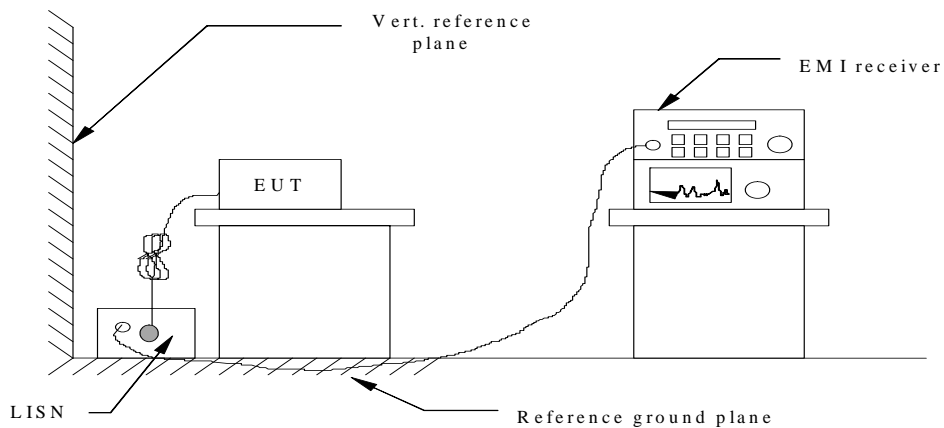

TEST PROCEDURE

- 1 The equipment was set up as per the test configuration to simulate typical actual usage per the user's manual. The EUT is a tabletop system; a wooden table with a height of 0.8 meters is used and is placed on the ground plane as per ANSI C63.4-2009.
- 2 Support equipment, if needed, was placed as per ANSI C63.4-2009.
- 3 All I/O cables were positioned to simulate typical actual usage as per ANSI C63.4-2009.
- 4 If EUT received DC power from the adapter, the adapter received AC120V/60Hz power through a Line Impedance Stabilization Network (LISN) which supplied power source and was grounded to the ground plane.
- 5 All support equipments received AC power from a second LISN, if any.
- 6 The EUT test program was started. Emissions were measured on each current carrying line of the EUT using a spectrum Analyzer / Receiver connected to the LISN powering the EUT. The LISN has two monitoring points: Line 1 (Hot Side) and Line 2 (Neutral Side). Two scans were taken: one with Line 1 connected to Analyzer / Receiver and Line 2 connected to a 50 ohm load; the second scan had Line 1 connected to a 50 ohm load and Line 2 connected to the Analyzer / Receiver.
- 7 Analyzer / Receiver scanned from 150 KHz to 30MHz for emissions in each of the test modes.
- 8 During the above scans, the emissions were maximized by cable manipulation.

Conducted Power Line Emission Limit

For unintentional device, according to § 15.107(a) Line Conducted Emission Limits is as following :

Frequency (MHz)	Maximum RF Line Voltage (dBµV)			
	CLASS A		CLASS B	
	Q.P.	Ave.	Q.P.	Ave.
0.15 - 0.50	79	66	66-56*	56-46*
0.50 - 5.00	73	60	56	46
5.00 - 30.0	73	60	60	50

* Decreasing linearly with the logarithm of the frequency

For intentional device, according to §15.207(a) Line Conducted Emission Limit is same as above table.

TEST RESULTS

GSM850MHz-AE2

SCAN TABLE: "Voltage (9K-30M) FIN"
 Short Description: 150K-30M Voltage

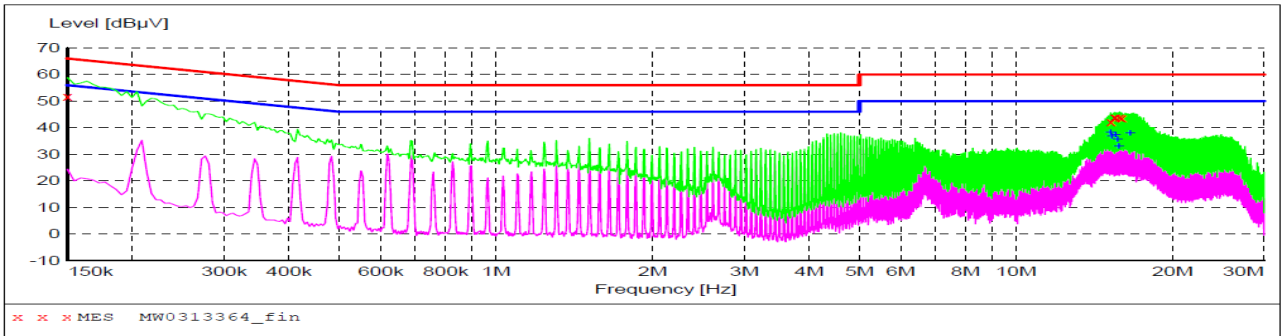

MEASUREMENT RESULT: "MW0313364_fin"

3/13/2014 9:08PM

Frequency MHz	Level dBµV	Transd dB	Limit dBµV	Margin dB	Detector	Line	PE
0.150000	51.70	10.1	66	14.3	QP	L1	GND
15.207000	42.00	10.6	60	18.0	QP	L1	GND
15.477000	44.00	10.7	60	16.0	QP	L1	GND
15.544500	44.00	10.7	60	16.0	QP	L1	GND
15.819000	43.80	10.7	60	16.2	QP	L1	GND
15.958500	43.50	10.7	60	16.5	QP	L1	GND

MEASUREMENT RESULT: "MW0313364_fin2"

3/13/2014 9:08PM

Frequency MHz	Level dBµV	Transd dB	Limit dBµV	Margin dB	Detector	Line	PE
15.202500	38.10	10.6	50	11.9	AV	L1	GND
15.274500	36.60	10.6	50	13.4	AV	L1	GND
15.549000	37.30	10.7	50	12.7	AV	L1	GND
15.688500	35.60	10.7	50	14.4	AV	L1	GND
15.760500	32.80	10.7	50	17.2	AV	L1	GND
16.575000	37.90	10.7	50	12.1	AV	L1	GND

SCAN TABLE: "Voltage (9K-30M) FIN"
 Short Description: 150K-30M Voltage

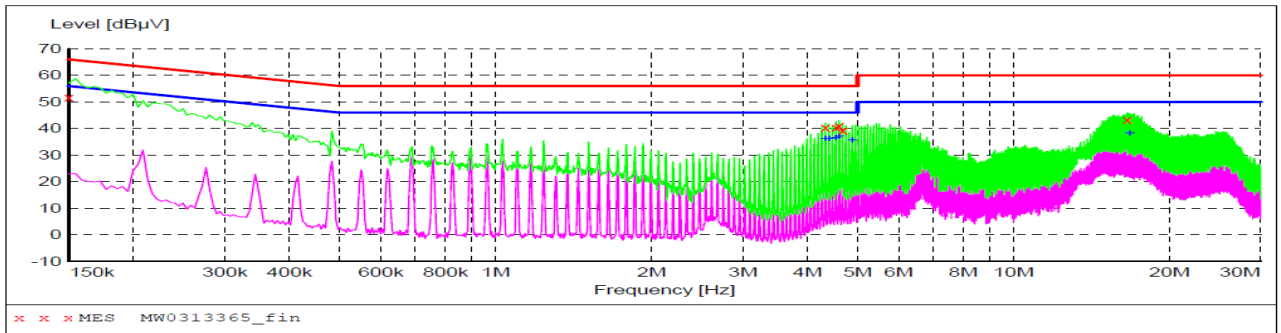

MEASUREMENT RESULT: "MW0313365_fin"

3/13/2014 9:12PM

Frequency MHz	Level dBµV	Transd dB	Limit dBµV	Margin dB	Detector	Line	PE
0.150000	51.60	10.1	66	14.4	QP	N	GND
4.335000	40.40	10.2	56	15.6	QP	N	GND
4.542000	40.40	10.2	56	15.6	QP	N	GND
4.609500	41.00	10.2	56	15.0	QP	N	GND
4.681500	39.20	10.2	56	16.8	QP	N	GND
16.579500	43.40	10.7	60	16.6	QP	N	GND

MEASUREMENT RESULT: "MW0313365_fin2"

3/13/2014 9:12PM

Frequency MHz	Level dBµV	Transd dB	Limit dBµV	Margin dB	Detector	Line	PE
4.335000	35.90	10.2	46	10.1	AV	N	GND
4.402500	36.20	10.2	46	9.8	AV	N	GND
4.542000	36.50	10.2	46	9.5	AV	N	GND
4.609500	36.90	10.2	46	9.1	AV	N	GND
4.884000	35.50	10.2	46	10.5	AV	N	GND
16.786500	38.00	10.7	50	12.0	AV	N	GND

PCS1900MHz-AE2

SCAN TABLE: "Voltage (9K-30M) FIN"
 Short Description: 150K-30M Voltage

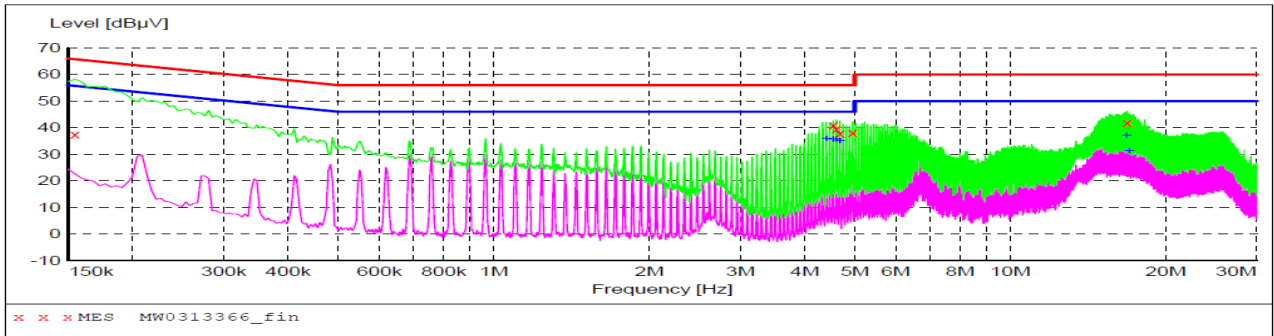

MEASUREMENT RESULT: "MW0313366_fin"

3/13/2014 9:16PM

Frequency MHz	Level dBµV	Transd dB	Limit dBµV	Margin dB	Detector	Line	PE
0.154500	37.40	10.1	66	28.4	QP	N	GND
4.542000	41.00	10.2	56	15.0	QP	N	GND
4.609500	39.40	10.2	56	16.6	QP	N	GND
4.681500	37.80	10.2	56	18.2	QP	N	GND
4.956000	38.00	10.2	56	18.0	QP	N	GND
16.858500	41.90	10.7	60	18.1	QP	N	GND

MEASUREMENT RESULT: "MW0313366_fin2"

3/13/2014 9:16PM

Frequency MHz	Level dBµV	Transd dB	Limit dBµV	Margin dB	Detector	Line	PE
4.402500	35.70	10.2	46	10.3	AV	N	GND
4.542000	35.60	10.2	46	10.4	AV	N	GND
4.609500	35.40	10.2	46	10.6	AV	N	GND
4.677000	34.80	10.2	46	11.2	AV	N	GND
16.786500	36.80	10.7	50	13.2	AV	N	GND
16.984500	31.10	10.7	50	18.9	AV	N	GND

SCAN TABLE: "Voltage (9K-30M) FIN"
 Short Description: 150K-30M Voltage

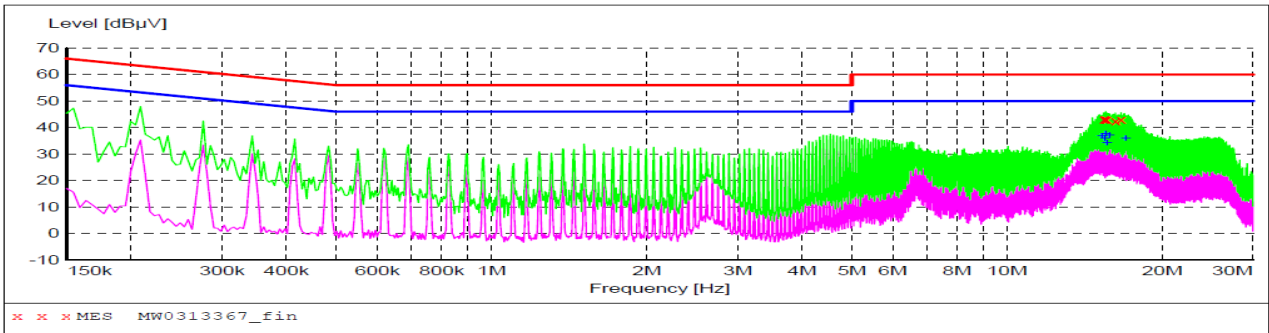

MEASUREMENT RESULT: "MW0313367_fin"

3/13/2014 9:19PM

Frequency MHz	Level dBµV	Transd dB	Limit dBµV	Margin dB	Detector	Line	PE
15.409500	43.00	10.7	60	17.0	QP	L1	GND
15.481500	43.20	10.7	60	16.8	QP	L1	GND
15.549000	42.90	10.7	60	17.1	QP	L1	GND
15.616500	43.00	10.7	60	17.0	QP	L1	GND
16.237500	42.50	10.7	60	17.5	QP	L1	GND
16.647000	42.90	10.7	60	17.1	QP	L1	GND

MEASUREMENT RESULT: "MW0313367_fin2"

3/13/2014 9:19PM

Frequency MHz	Level dBµV	Transd dB	Limit dBµV	Margin dB	Detector	Line	PE
15.274500	36.60	10.6	50	13.4	AV	L1	GND
15.481500	35.80	10.7	50	14.2	AV	L1	GND
15.544500	37.50	10.7	50	12.5	AV	L1	GND
15.621000	34.10	10.7	50	15.9	AV	L1	GND
15.823500	36.90	10.7	50	13.1	AV	L1	GND
16.993500	35.70	10.7	50	14.3	AV	L1	GND

CAMERA-AE2

SCAN TABLE: "Voltage (9K-30M) FIN"
 Short Description: 150K-30M Voltage

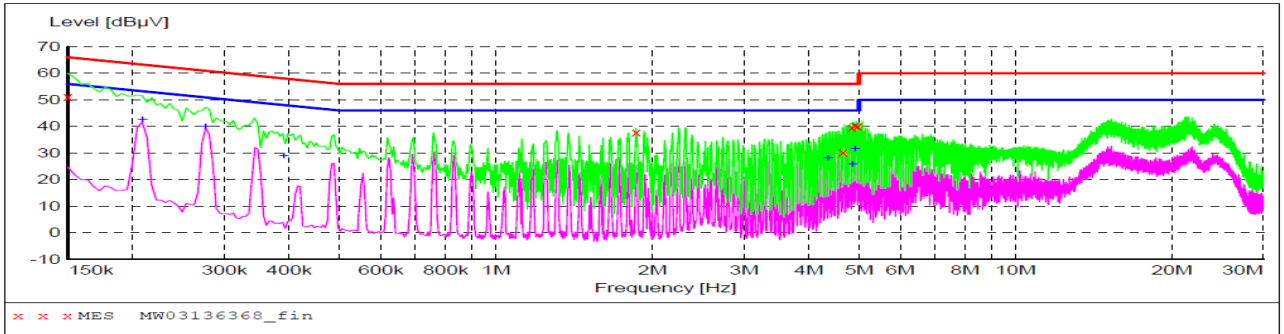

MEASUREMENT RESULT: "MW0313368_fin"

3/13/2014 9:21PM

Frequency MHz	Level dBµV	Transd dB	Limit dBµV	Margin dB	Detector	Line	PE
0.150000	52.00	10.1	66	14.0	QP	L1	GND
1.860000	37.70	10.2	56	16.3	QP	L1	GND
4.663500	30.30	10.2	56	25.7	QP	L1	GND
4.843500	39.60	10.2	56	16.4	QP	L1	GND
4.911000	40.80	10.2	56	15.2	QP	L1	GND
4.978500	40.30	10.2	56	15.7	QP	L1	GND

MEASUREMENT RESULT: "MW0313368_fin2"

3/13/2014 9:21PM

Frequency MHz	Level dBµV	Transd dB	Limit dBµV	Margin dB	Detector	Line	PE
0.208500	42.00	10.1	53	10.3	AV	L1	GND
0.276000	39.50	10.1	51	11.6	AV	L1	GND
0.390300	28.20	10.2	46	17.8	AV	L1	GND
4.353000	28.50	10.2	46	17.5	AV	L1	GND
4.852500	25.90	10.2	46	20.1	AV	L1	GND
4.911000	31.80	10.2	46	14.2	AV	L1	GND

SCAN TABLE: "Voltage (9K-30M) FIN"
 Short Description: 150K-30M Voltage

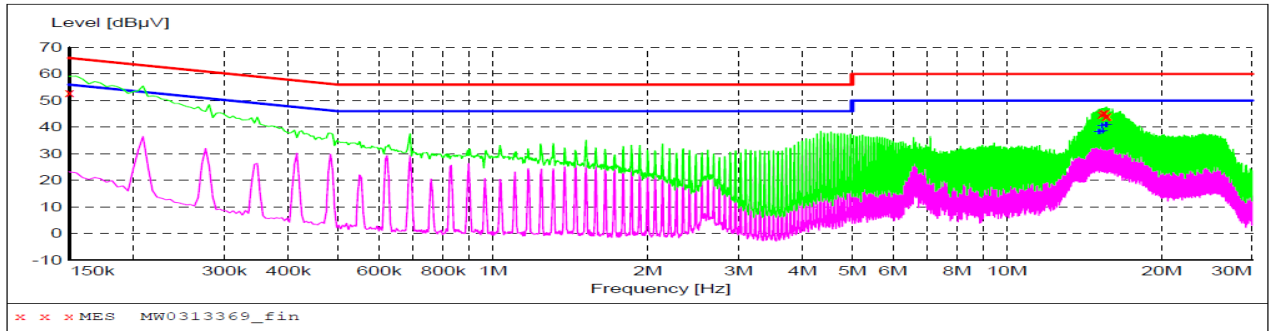

MEASUREMENT RESULT: "MW0313369_fin"

3/13/2014 9:24PM

Frequency MHz	Level dBµV	Transd dB	Limit dBµV	Margin dB	Detector	Line	PE
0.150000	52.50	10.1	66	13.5	QP	L1	GND
15.306000	44.40	10.6	60	15.6	QP	L1	GND
15.373500	45.10	10.7	60	14.9	QP	L1	GND
15.508500	45.00	10.7	60	15.0	QP	L1	GND
15.585000	43.90	10.7	60	16.1	QP	L1	GND
15.643500	44.50	10.7	60	15.5	QP	L1	GND

MEASUREMENT RESULT: "MW0313369_fin2"

3/13/2014 9:25PM

Frequency MHz	Level dBµV	Transd dB	Limit dBµV	Margin dB	Detector	Line	PE
15.094500	38.50	10.6	50	11.5	AV	L1	GND
15.171000	38.80	10.6	50	11.2	AV	L1	GND
15.306000	40.30	10.6	50	9.7	AV	L1	GND
15.378000	38.40	10.7	50	11.6	AV	L1	GND
15.580500	40.40	10.7	50	9.6	AV	L1	GND
15.648000	40.20	10.7	50	9.8	AV	L1	GND

MP3-AE2

SCAN TABLE: "Voltage (9K-30M) FIN"
 Short Description: 150K-30M Voltage

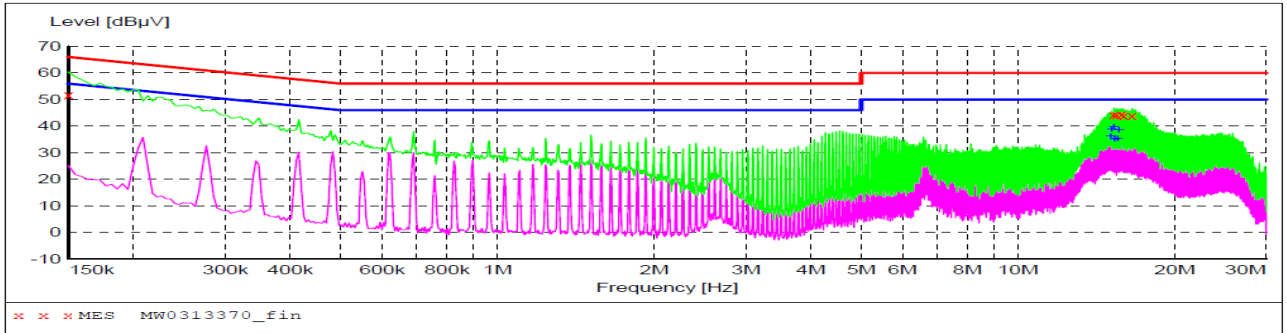

MEASUREMENT RESULT: "MW0313370_fin"

3/13/2014 9:29PM

Frequency MHz	Level dBµV	Transd dB	Limit dBµV	Margin dB	Detector	Line	PE
0.150000	51.80	10.1	66	14.2	QP	L1	GND
15.279000	44.50	10.6	60	15.5	QP	L1	GND
15.486000	44.70	10.7	60	15.3	QP	L1	GND
15.832500	44.80	10.7	60	15.2	QP	L1	GND
15.972000	44.20	10.7	60	15.8	QP	L1	GND
16.588500	43.50	10.7	60	16.5	QP	L1	GND

MEASUREMENT RESULT: "MW0313370_fin2"

3/13/2014 9:29PM

Frequency MHz	Level dBµV	Transd dB	Limit dBµV	Margin dB	Detector	Line	PE
15.072000	35.70	10.6	50	14.3	AV	L1	GND
15.144000	38.90	10.6	50	11.1	AV	L1	GND
15.283500	39.20	10.6	50	10.8	AV	L1	GND
15.346500	34.60	10.6	50	15.4	AV	L1	GND
15.553500	35.90	10.7	50	14.1	AV	L1	GND
15.625500	38.50	10.7	50	11.5	AV	L1	GND

SCAN TABLE: "Voltage (9K-30M) FIN"
 Short Description: 150K-30M Voltage

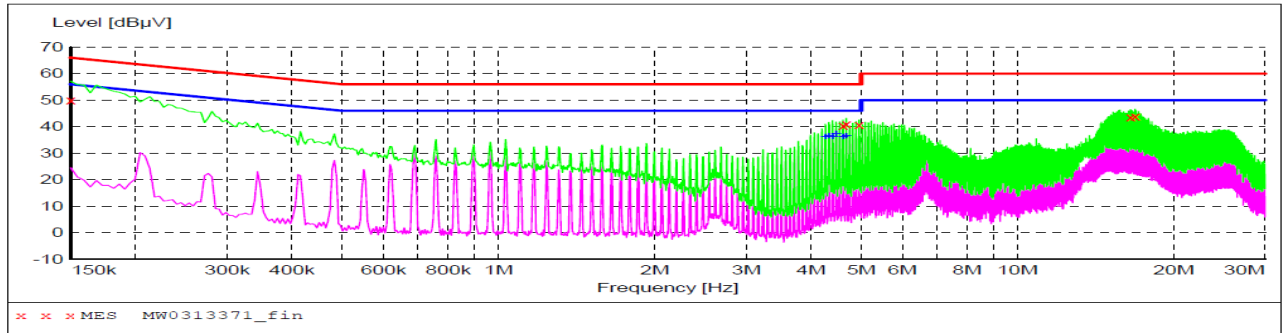

MEASUREMENT RESULT: "MW0313371_fin"

3/13/2014 9:32PM

Frequency MHz	Level dBµV	Transd dB	Limit dBµV	Margin dB	Detector	Line	PE
0.150000	49.90	10.1	66	16.1	QP	N	GND
4.614000	40.50	10.2	56	15.5	QP	N	GND
4.681500	40.40	10.2	56	15.6	QP	N	GND
4.956000	40.20	10.2	56	15.8	QP	N	GND
16.516500	43.50	10.7	60	16.5	QP	N	GND
16.863000	43.30	10.7	60	16.7	QP	N	GND

MEASUREMENT RESULT: "MW0313371_fin2"

2/13/2014 9:33PM

Frequency MHz	Level dBµV	Transd dB	Limit dBµV	Margin dB	Detector	Line	PE
4.267500	36.90	10.2	46	9.1	AV	N	GND
4.335000	36.10	10.2	46	9.9	AV	N	GND
4.407000	36.50	10.2	46	9.5	AV	N	GND
4.474500	37.20	10.2	46	8.8	AV	N	GND
4.614000	36.60	10.2	46	9.4	AV	N	GND
4.681500	36.60	10.2	46	9.4	AV	N	GND

4.2. OUTPUT POWER

TEST APPLICABLE

During the process of testing, the EUT was controlled via Rhode & Schwarz Digital Radio Communication tester (CMU200) to ensure max power transmission and proper modulation. This result contains output power and EIRP measurements for the EUT. In all cases, output power is within the specified limits.

4.2.1. Conducted Output Power

TEST CONFIGURATION

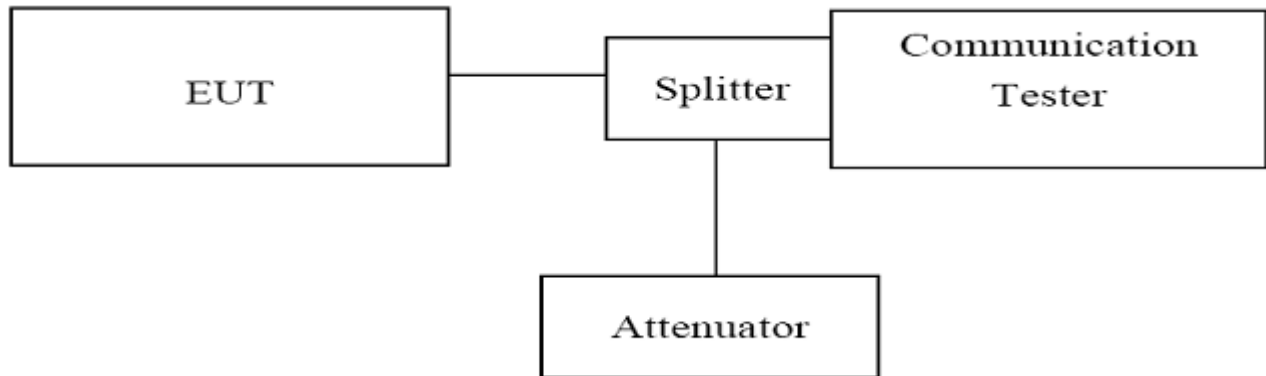

TEST PROCEDURE

1. The EUT was set up for the max output power with pseudo random data modulation.
2. The power was measured with Rhode & Schwarz Spectrum Analyzer FSU (peak)
3. These measurements were done at 3 frequencies, 1850.20 MHz, 1880.00 MHz and 1909.80 MHz for PCS1900 band; 824.20 MHz, 836.60 MHz and 848.80 MHz for GSM850 band. (bottom, middle and top of operational frequency range).

TEST CONDITION

RBW	VBW	Sweep Time	Span
1MHz	3MHz	300ms	10MHz

GSM850				
Function	Power step	Nominal Peak output power (dBm)	Power & Multislot class	Operation class
GSM	5	33dBm(2W)	4	/
GPRS	3	33dBm(2W)	12	B

PCS1900				
Function	Power step	Nominal Peak output power (dBm)	Power & Multislot class	Operation class
GSM	0	30dBm(1W)	1	/
GPRS	3	30dBm(1W)	12	B

TEST RESULTS

GSM850(GMSK)		
Frequency (MHz)	Power Step	Output Power (dBm)
824.20	5	32.18
836.60	5	32.47
848.80	5	32.56

GPRS850(GMSK,1Slot)		
Frequency (MHz)	Power Step	Output Power (dBm)
824.20	3	32.03
836.60	3	32.31
848.80	3	32.49

PCS1900(GMSK)		
Frequency (MHz)	Power Step	Output Power (dBm)
1850.20	0	29.89
1880.00	0	29.61
1909.80	0	29.05

GPRS1900(GMSK,1Slot)		
Frequency (MHz)	Power Step	Output Power (dBm)
1850.20	3	29.72
1880.00	3	29.44
1909.80	3	28.96

4.2.2. Radiated Output Power

TEST DESCRIPTION

This is the test for the maximum radiated power from the EUT. Rule Part 24.232(c) specifies, "Mobile/portable stations are limited to 2 watts e.i.r.p. Peak power" and 24.232(e) specifies that "Peak transmit power must be measured over any interval of continuous transmission using instrumentation calibrated in terms of an rms-equivalent voltage." Rule Part 22.913(a) specifies "The ERP of mobile transmitters and auxiliary test transmitters must not exceed 7 Watts."

TEST CONFIGURATION

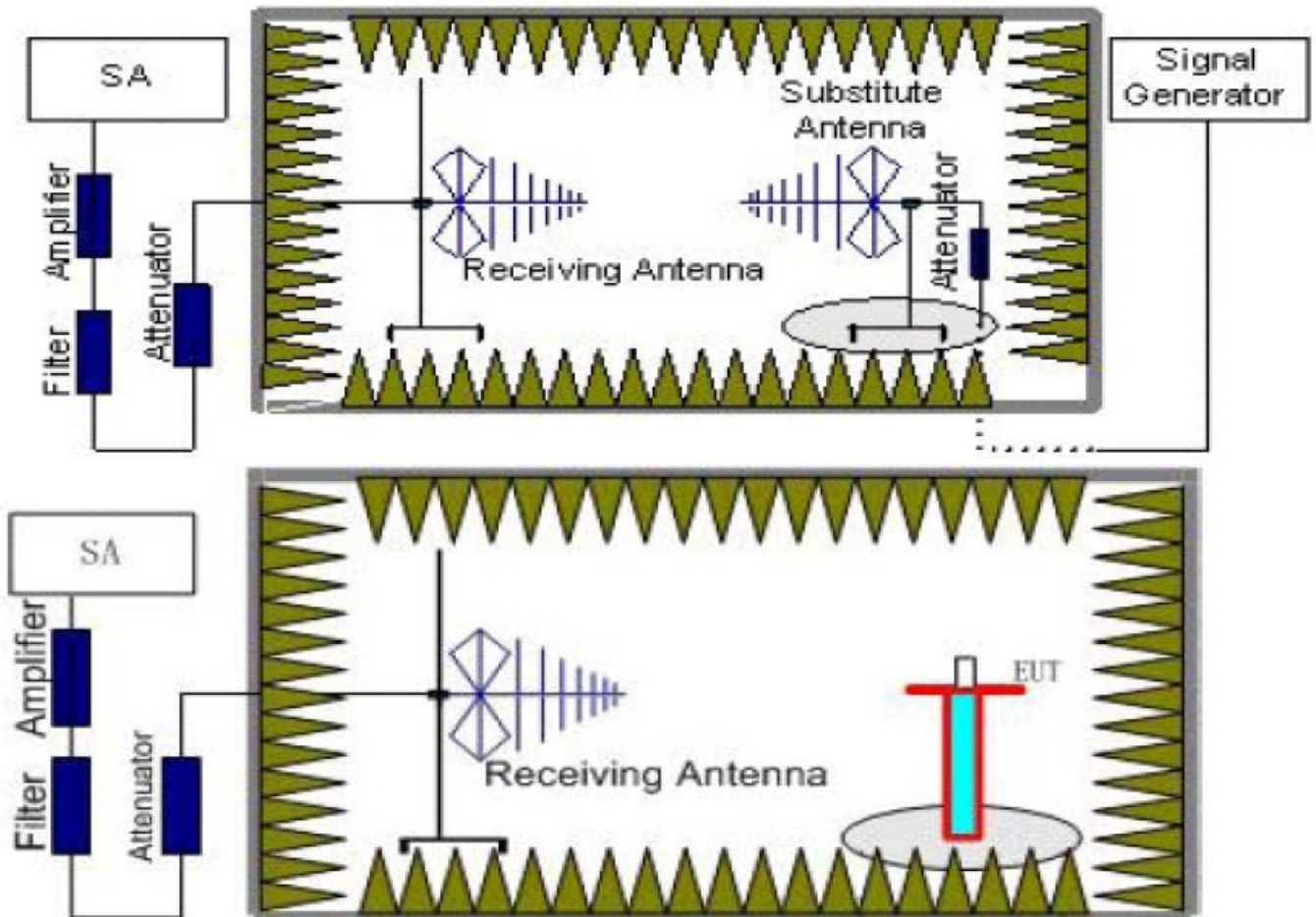

TEST PROCEDURE

1. EUT was placed on a 1.50 meter high non-conductive stand at a 3 meter test distance from the receive antenna. A receiving antenna was placed on the antenna mast 3 meters from the EUT for emission measurements. The height of receiving antenna is 1.50m. Detected emissions were maximized at each frequency by rotating the EUT through 360° and adjusting the receiving antenna polarization. The radiated emission measurements of all transmit frequencies in three channels (High, Middle, Low) were measured with peak detector.
2. A log-periodic antenna or double-ridged waveguide horn antenna shall be substituted in place of the EUT. The log-periodic antenna will be driven by a signal generator and the level will be adjusted till the same power value on the spectrum analyzer or receiver. The level of the spurious emissions can be calculated through the level of the signal generator, cable loss, the gain of the substitution antenna and the reading of the spectrum analyzer or receiver.
3. The EUT is then put into continuously transmitting mode at its maximum power level during the test. Set Test Receiver or Spectrum RBW=1MHz, VBW=3MHz, And the maximum value of the receiver should be recorded as (P_r).
4. The EUT shall be replaced by a substitution antenna. In the chamber, an substitution antenna for the frequency band of interest is placed at the reference point of the chamber. An RF Signal source for the frequency band of interest is connected to the substitution antenna with a cable that has been constructed to not interfere with the radiation pattern of the antenna. A power (P_{Mea}) is applied to the input of the substitution antenna, and adjust the level of the signal generator output until the value of the receiver reach the previously recorded (P_r). The power of signal source (P_{Mea}) is recorded. The test should be performed by rotating the test item and adjusting the receiving antenna polarization.
5. A amplifier should be connected to the Signal Source output port. And the cable should be connect between the Amplifier and the Substitution Antenna. The cable loss (P_{cl}), the Substitution Antenna Gain (G_a) and the Amplifier Gain (P_{Ag}) should be recorded after test.
The measurement results are obtained as described below:
Power(EIRP)=P_{Mea}- P_{Ag} - P_{cl} + G_a
We used SMF100A microwave signal generator which signal level can up to 33dBm,so we not used power Amplifier for substitution test; The measurement results are amend as described below:
Power(EIRP)=P_{Mea}- P_{cl} + G_a
6. This value is EIRP since the measurement is calibrated using an antenna of known gain (2.15 dBi) and known input power.
7. ERP can be calculated from EIRP by subtracting the gain of the dipole, ERP = EIRP-2.15dBi.

TEST LIMIT

According to 22.913(a) and 24.232(c), the ERP should be not exceed following table limits:

GSM850(GPRS850,EDGE850)		
Function	Power Step	Burst Peak ERP (dBm)
GSM	5	≤38.45dBm (7W)
GPRS	3	≤38.45dBm (7W)
EGPRS	3	≤38.45dBm (7W)

PCS1900(GPRS1900,EDGE1900)		
Function	Power Step	Burst Peak EIRP (dBm)
GSM	0	≤33dBm (2W)
GPRS	3	≤33dBm (2W)
EGPRS	3	≤33dBm (2W)

TEST RESULTS

GSM850						
Frequency (MHz)	P _{Mea} (dBm)	P _{cl} (dB)	G _a Antenna Gain (dB)	Correction (dB)	ERP (dBm)	Polarization
824.20	28.32	1.56	8.45	2.15	33.06	H
836.60	28.49	1.50	8.45	2.15	33.29	H
848.80	27.97	1.67	8.39	2.15	32.54	H
824.20	28.54	1.56	8.45	2.15	33.28	V
836.60	28.87	1.50	8.45	2.15	33.67	V
848.80	28.42	1.67	8.39	2.15	32.99	V

GPRS850						
Frequency (MHz)	P _{Mea} (dBm)	P _{cl} (dB)	G _a Antenna Gain (dB)	Correction (dB)	ERP (dBm)	Polarization
824.20	28.13	1.56	8.45	2.15	32.87	H
836.60	28.38	1.50	8.45	2.15	33.18	H
848.80	27.76	1.67	8.39	2.15	32.33	H
824.20	28.41	1.56	8.45	2.15	33.15	V
836.60	28.75	1.50	8.45	2.15	33.55	V
848.80	28.17	1.67	8.39	2.15	32.74	V

PCS1900						
Frequency (MHz)	P _{Mea} (dBm)	P _{cl} (dB)	G _a Antenna Gain (dB)	Correction (dB)	EIRP (dBm)	Polarization
1850.20	25.71	3.52	8.35	2.15	30.54	H
1880.00	26.19	3.61	8.29	2.15	30.87	H
1909.80	25.36	3.67	8.37	2.15	30.06	H
1850.20	26.05	3.52	8.35	2.15	30.88	V
1880.00	26.52	3.61	8.29	2.15	31.20	V
1909.80	25.73	3.67	8.37	2.15	30.43	V

GPRS1900						
Frequency (MHz)	P _{Mea} (dBm)	P _{cl} (dB)	G _a Antenna Gain (dB)	Correction (dB)	EIRP (dBm)	Polarization
1850.20	25.66	3.52	8.35	2.15	30.49	H
1880.00	26.06	3.61	8.29	2.15	30.74	H
1909.80	25.30	3.67	8.37	2.15	30.00	H
1850.20	25.94	3.52	8.35	2.15	30.77	V
1880.00	26.48	3.61	8.29	2.15	31.16	V
1909.80	25.62	3.67	8.37	2.15	30.32	V

4.3. Radiated Spurious Emission

TEST APPLICABLE

According to the TIA/EIA 603D:2010 test method, The Receiver or Spectrum was scanned from 30 MHz to the 10th harmonic of the highest frequency generated within the equipment, which is the transmitted carrier that can be as high as 1910 MHz. The resolution bandwidth is set as outlined in Part 24.238 and Part 22.917. The spectrum is scanned with the mobile station transmitting at carrier frequencies that pertain to low, mid and high channels of PCS1900 and GSM850.

TEST CONFIGURATION

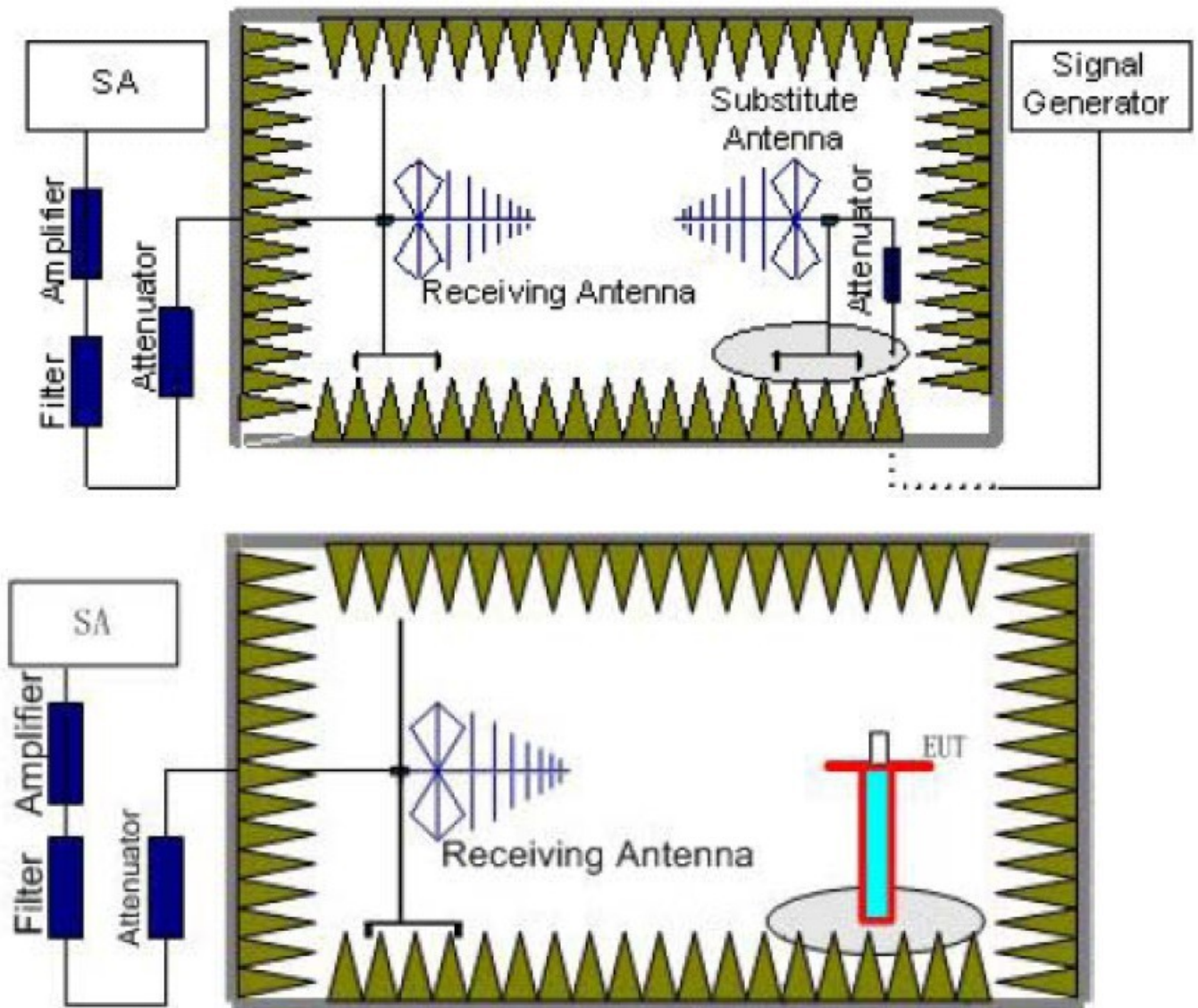

TEST PROCEDURE

1. EUT was placed on a 1.50 meter high non-conductive stand at a 3 meter test distance from the receive antenna. A receiving antenna was placed on the antenna mast 3 meters from the EUT for emission measurements. The height of receiving antenna is 1.50m. Detected emissions were maximized at each frequency by rotating the EUT through 360° and adjusting the receiving antenna polarization. The radiated emission measurements of all transmit frequencies in three channels (High, Middle, Low) were measured with peak detector.
2. A log-periodic antenna or double-ridged waveguide horn antenna shall be substituted in place of the EUT. The log-periodic antenna will be driven by a signal generator and the level will be adjusted till the same power value on the spectrum analyzer or receiver. The level of the spurious emissions can be calculated through the level of the signal generator, cable loss, the gain of the substitution antenna and the reading of the spectrum analyzer or receiver.

3. The EUT is then put into continuously transmitting mode at its maximum power level during the test. Set Test Receiver or Spectrum RBW=1MHz, VBW=3MHz, And the maximum value of the receiver should be recorded as (P_r).
4. The EUT shall be replaced by a substitution antenna. In the chamber, an substitution antenna for the frequency band of interest is placed at the reference point of the chamber. An RF Signal source for the frequency band of interest is connected to the substitution antenna with a cable that has been constructed to not interfere with the radiation pattern of the antenna. A power (P_{Mea}) is applied to the input of the substitution antenna, and adjust the level of the signal generator output until the value of the receiver reach the previously recorded (P_r). The power of signal source (P_{Mea}) is recorded. The test should be performed by rotating the test item and adjusting the receiving antenna polarization.
5. A amplifier should be connected to the Signal Source output port. And the cable should be connect between the Amplifier and the Substitution Antenna. The cable loss (P_{cl}), the Substitution Antenna Gain (G_a) and the Amplifier Gain (P_{Ag}) should be recorded after test.
The measurement results are obtained as described below:
Power(EIRP)=P_{Mea}- P_{Ag} - P_{cl} + G_a
6. This value is EIRP since the measurement is calibrated using an antenna of known gain (2.15 dBi) and known input power.
7. ERP can be calculated from EIRP by subtracting the gain of the dipole, ERP = EIRP -2.15dBi.
8. In order to make sure test results more clearly, we set frequency range and sweep time for difference frequency range as follows table:

Working Frequency	Subrange (GHz)	RBW	VBW	Sweep time (s)
850MHz	0.03~1	100KHz	300KHz	10
	1-2	1 MHz	3 MHz	2
	2~5	1 MHz	3 MHz	3
	5~8	1 MHz	3 MHz	3
	8~10	1 MHz	3 MHz	3
1900MHz	0.03~1	100KHz	300KHz	10
	1-2	1 MHz	3 MHz	2
	2~5	1 MHz	3 MHz	3
	5~8	1 MHz	3 MHz	3
	8~11	1 MHz	3 MHz	3
	11~14	1 MHz	3 MHz	3
	14~18	1 MHz	3 MHz	3
	18~20	1 MHz	3 MHz	2

TEST LIMITS

According to 24.238 and 22.917 specify that the power of any emission outside of the authorized operating frequency ranges must be attenuated below the transmitting power (P) by a factor of at least 43 + 10 log(P) dB.

The specification that emissions shall be attenuated below the transmitter power (P) by at least 43 + 10 log (P) dB, translates in the relevant power range (1 to 0.001 W) to -13 dBm. At 1 W the specified minimum attenuation becomes 43 dB and relative to a 30 dBm (1 W) carrier becomes a limit of -13 dBm. At 0.001 W (0 dBm) the minimum attenuation is 13 dB, which again yields a limit of -13 dBm. In this way a translation of the specification from relative to absolute terms is carried out.

Frequency	Channel	Frequency Range	Verdict
GSM850	Low	30MHz-10GHz	PASS
	Middle	30MHz-10GHz	PASS
	High	30MHz-10GHz	PASS
GSM1900	Low	30MHz-20GHz	PASS
	Middle	30MHz-20GHz	PASS
	High	30MHz-20GHz	PASS

GSM850							
Channel Number: 128				Test Frequency: 824.20 MHz			
Frequency (MHz)	P _{Mea} (dBm)	Path Loss	Antenna Gain	Correction (dB)	Peak ERP(dBm)	Limit (dBm)	Polarization
2472.57	-22.61	4.32	6.77	2.15	-22.31	-13.00	H
3294.35	-31.37	4.55	12.25	2.15	-25.82	-13.00	H
4942.65	-35.31	4.70	12.92	2.15	-29.24	-13.00	H
2472.57	-20.12	4.32	6.77	2.15	-19.82	-13.00	V
3294.35	-26.32	4.55	12.25	2.15	-20.77	-13.00	V
4115.67	-32.61	4.59	12.76	2.15	-26.59	-13.00	V

GSM850							
Channel Number: 190				Test Frequency: 836.60 MHz			
Frequency (MHz)	P _{Mea} (dBm)	Path Loss	Antenna Gain	Correction (dB)	Peak ERP(dBm)	Limit (dBm)	Polarization
3342.00	-26.51	4.55	12.25	2.15	-20.96	-13.00	H
4182.70	-28.59	4.59	12.76	2.15	-22.57	-13.00	H
5014.14	-30.03	4.78	12.88	2.15	-24.08	-13.00	H
3342.00	-24.01	4.55	12.25	2.15	-18.46	-13.00	V
4182.70	-25.07	4.59	12.76	2.15	-19.05	-13.00	V
5014.14	-28.21	4.78	12.88	2.15	-22.26	-13.00	V

GSM850							
Channel Number: 251				Test Frequency: 848.80 MHz			
Frequency (MHz)	P _{Mea} (dBm)	Path Loss	Antenna Gain	Correction (dB)	Peak ERP(dBm)	Limit (dBm)	Polarization
2547.01	-23.73	4.29	6.83	2.15	-23.34	-13.00	H
3390.34	-31.01	4.58	12.59	2.15	-25.15	-13.00	H
4232.20	-35.00	4.59	12.76	2.15	-28.98	-13.00	H
2547.01	-21.03	4.29	6.83	2.15	-20.64	-13.00	V
3390.34	-28.13	4.58	12.59	2.15	-22.27	-13.00	V
4232.20	-32.71	4.59	12.76	2.15	-26.69	-13.00	V

PCS1900							
Channel Number: 512				Test Frequency: 1850.20 MHz			
Frequency (MHz)	P _{Mea} (dBm)	Path Loss	Antenna Gain	Correction (dB)	Peak ERP(dBm)	Limit (dBm)	Polarization
3701.26	-28.67	4.55	12.34	2.15	-23.03	-13.00	H
5550.08	-27.19	5.05	13.53	2.15	-20.86	-13.00	H
7402.15	-31.36	4.64	11.60	2.15	-26.55	-13.00	H
3701.26	-26.42	4.55	12.34	2.15	-20.78	-13.00	V
5550.08	-24.82	5.05	13.53	2.15	-18.49	-13.00	V
7402.15	-29.95	4.64	11.60	2.15	-25.14	-13.00	V

PCS1900							
Channel Number: 661				Test Frequency: 1880.00 MHz			
Frequency (MHz)	P _{Mea} (dBm)	Path Loss	Antenna Gain	Correction (dB)	Peak ERP(dBm)	Limit (dBm)	Polarization
3761.51	-27.25	4.55	12.40	2.15	-21.55	-13.00	H
5642.28	-26.63	4.96	13.60	2.15	-20.14	-13.00	H
7521.96	-31.81	4.71	11.89	2.15	-26.78	-13.00	H
3761.51	-25.49	4.55	12.40	2.15	-19.79	-13.00	V
5642.28	-23.06	4.96	13.60	2.15	-16.57	-13.00	V
7521.96	-28.38	4.71	11.89	2.15	-23.35	-13.00	V

PCS1900							
Channel Number: 810				Test Frequency: 1909.80 MHz			
Frequency (MHz)	P _{Mea} (dBm)	Path Loss	Antenna Gain	Correction (dB)	Peak ERP(dBm)	Limit (dBm)	Polarization
3820.18	-31.13	4.51	12.43	2.15	-25.36	-13.00	H
5731.56	-30.55	4.90	13.61	2.15	-23.99	-13.00	H
7638.25	-33.78	4.78	12.00	2.15	-28.71	-13.00	H
3820.18	-28.82	4.51	12.43	2.15	-23.05	-13.00	V
5731.56	-27.68	4.90	13.61	2.15	-21.12	-13.00	V
7638.25	-30.49	4.78	12.00	2.15	-25.42	-13.00	V

Note: 1. In general, the worse case attenuation requirement shown above was applied.

3. *** means that the emission level is too low to be measured or at least 20 dB down than the limit.

4.4. OCCUPIED BANDWIDTH

TEST APPLICABLE

Similar to conducted emissions; occupied bandwidth measurements are only provided for selected frequencies in order to reduce the amount of submitted data. Data were taken at the extreme and mid frequencies of PCS1900 band and GSM850 band. The table below lists the measured 99% BW.

TEST CONFIGURATION

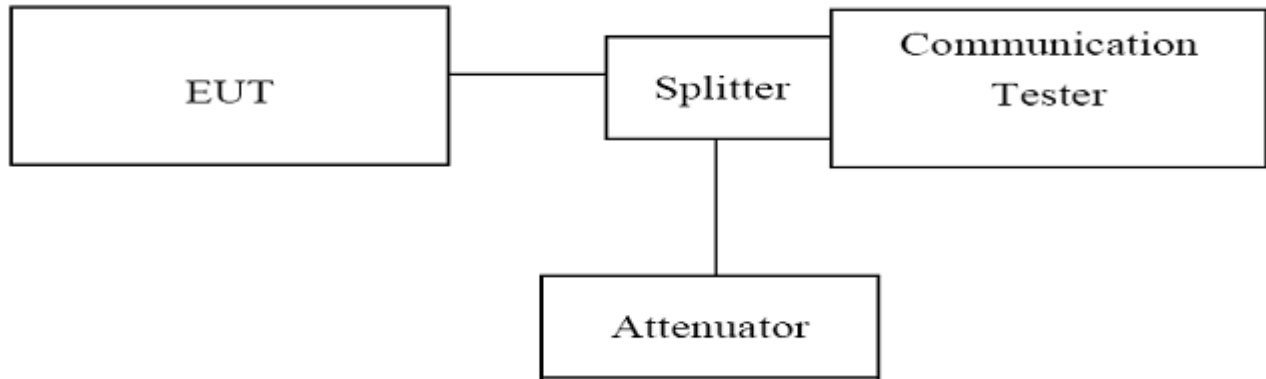

TEST PROCEDURE

1. The EUT was set up for the max output power with pseudo random data modulation;
2. The Occupied bandwidth was measured with Rhode & Schwarz Spectrum Analyzer FSU (peak);
3. Set RBW=5KHz,VBW=50KHz,Span=500KHz,SWT=20ms;
4. Set SPA Max hold. Mark peak, Set 99% Occupied Bandwidth
5. These measurements were done at 3 frequencies, 1850.20 MHz, 1880.00 MHz and 1909.80 MHz for PCS1900 band; 824.20MHz, 836.60 MHz and 848.80 MHz for GSM850 band. (bottom, middle and top of operational frequency range).

TEST RESULTS

GSM850				
Channel Number	Frequency (MHz)	Occupied Bandwidth (99% BW) (kHz)	Refer to Plot	Verdict
128	824.20	244.39	Plot 4.4.1 A	PASS
190	836.60	248.40	Plot 4.4.1 B	PASS
251	848.80	241.99	Plot 4.4.1 C	PASS

GPRS850				
Channel Number	Frequency (MHz)	Occupied Bandwidth (99% BW) (kHz)	Refer to Plot	Verdict
128	824.20	241.99	Plot 4.4.2 A	PASS
190	836.60	244.39	Plot 4.4.2 B	PASS
251	848.80	245.19	Plot 4.4.2 C	PASS

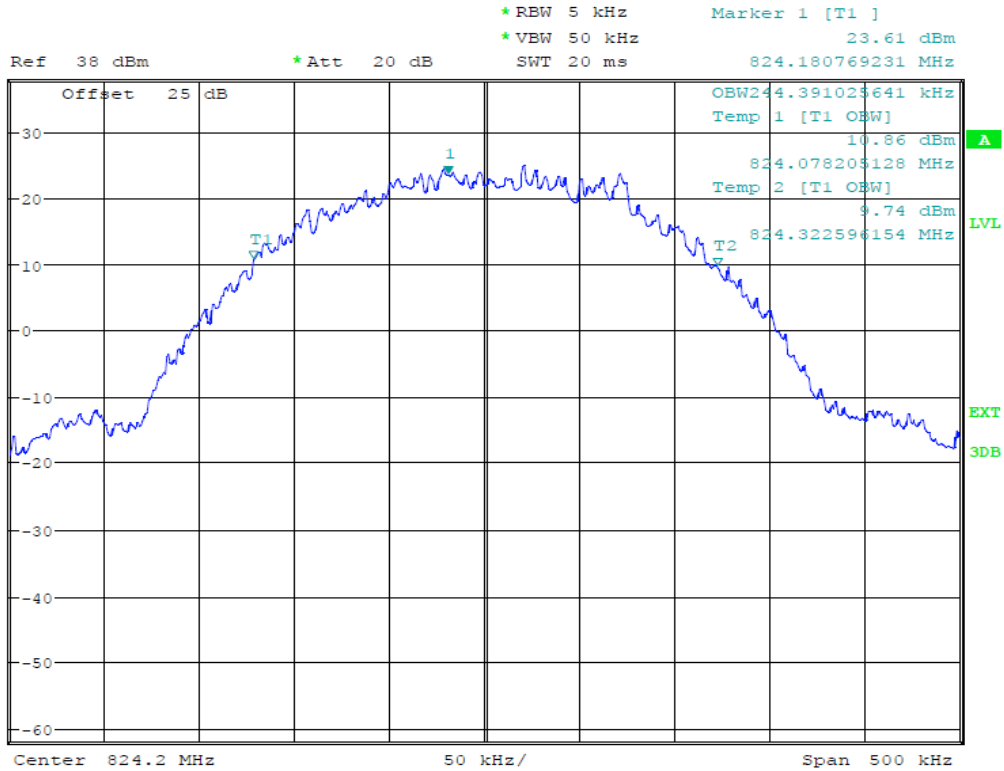

Date: 19.MAR.2014 11:46:24

(Plot 4.4.1 A: Channel 128: 824.20MHz @ GSM850)

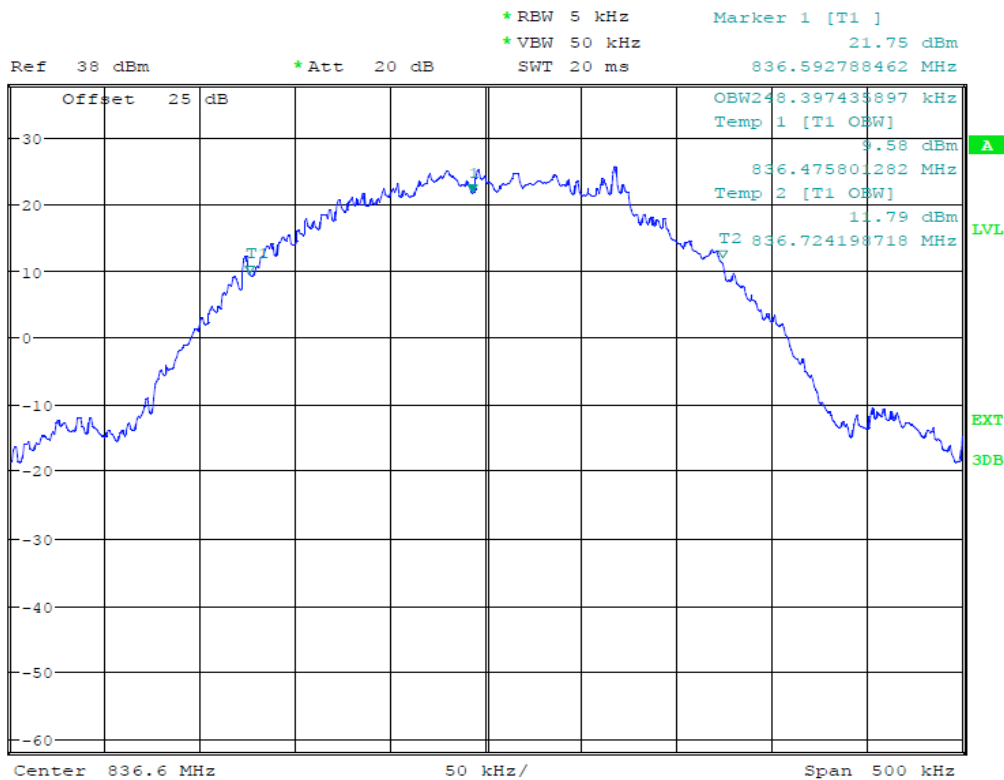

Date: 19.MAR.2014 11:47:27

(Plot 4.4.1 B: Channel 190: 836.60MHz @ GSM850)

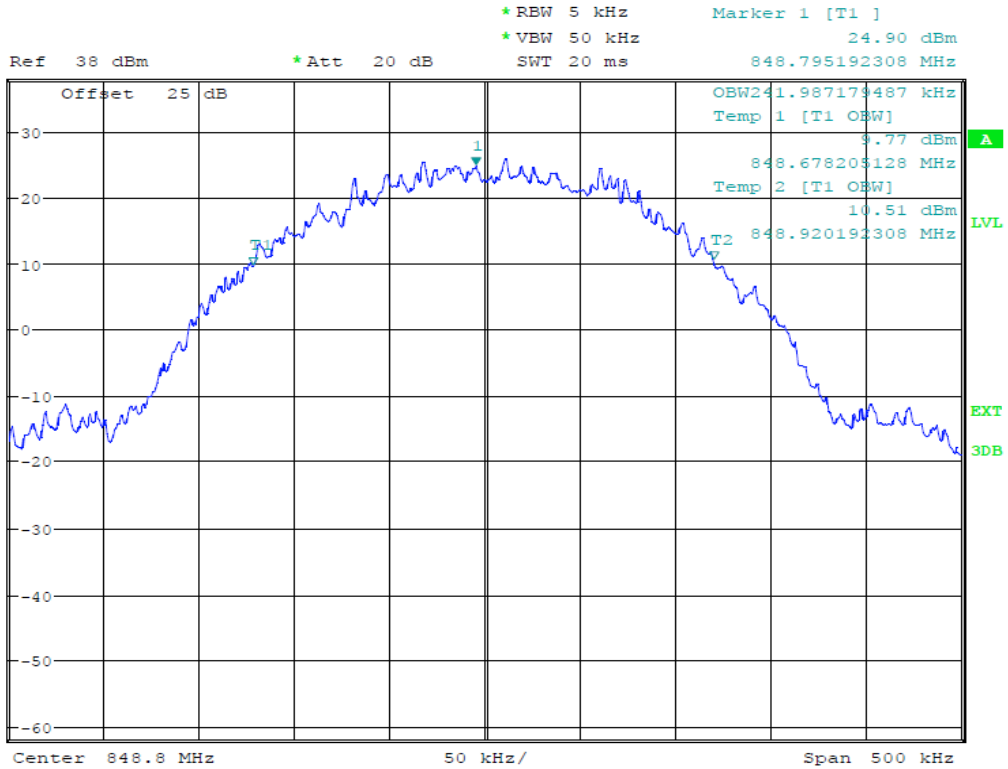

Date: 19.MAR.2014 11:48:59

(Plot 4.4.1 C: Channel 251: 848.80MHz @ GSM850)

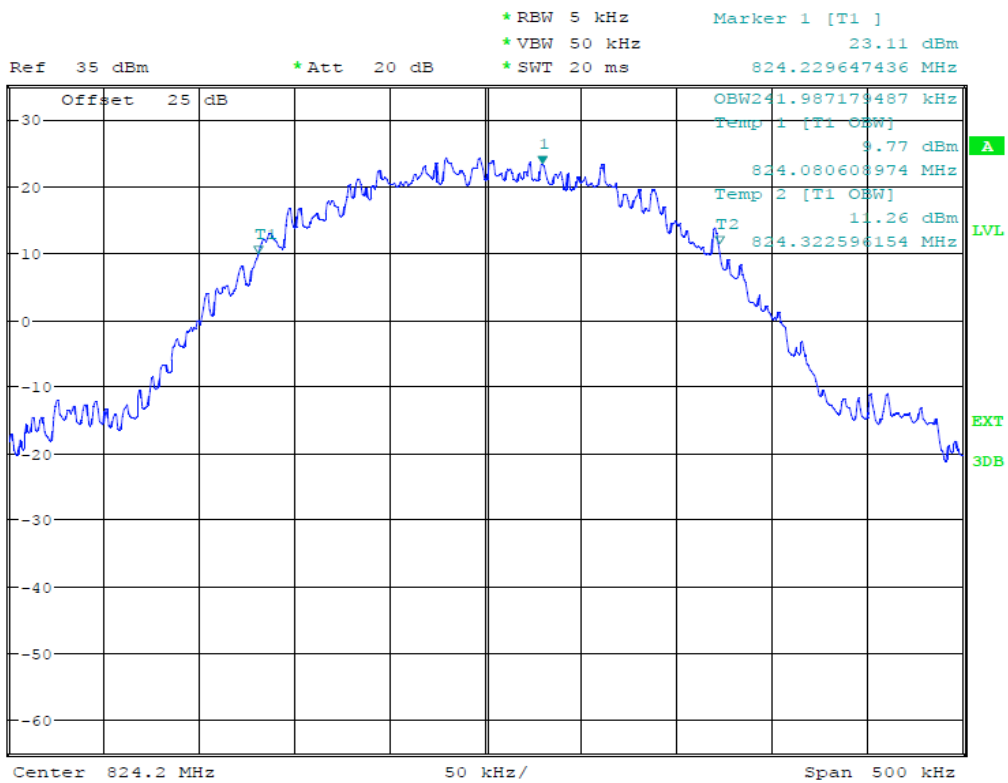

Date: 19.MAR.2014 15:16:41

(Plot 4.4.2 A: Channel 128: 824.20MHz @ GPRS850)

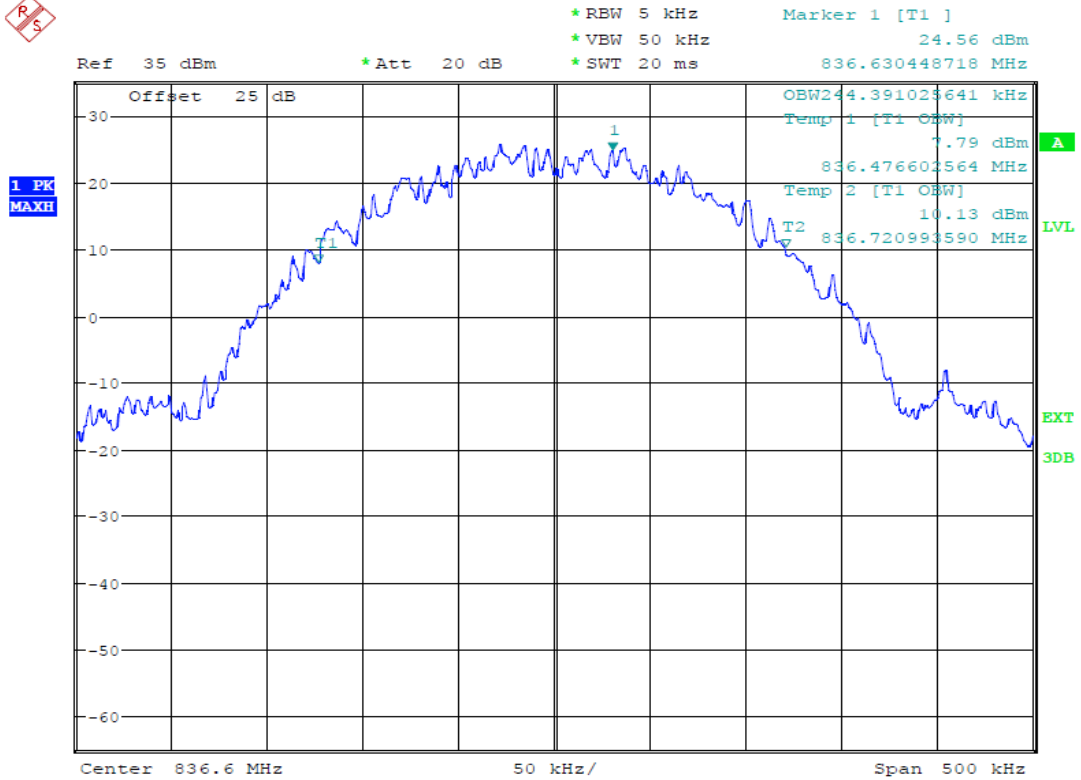

Date: 19.MAR.2014 15:15:44

(Plot 4.4.2 B: Channel 190: 836.60MHz @ GPRS850)

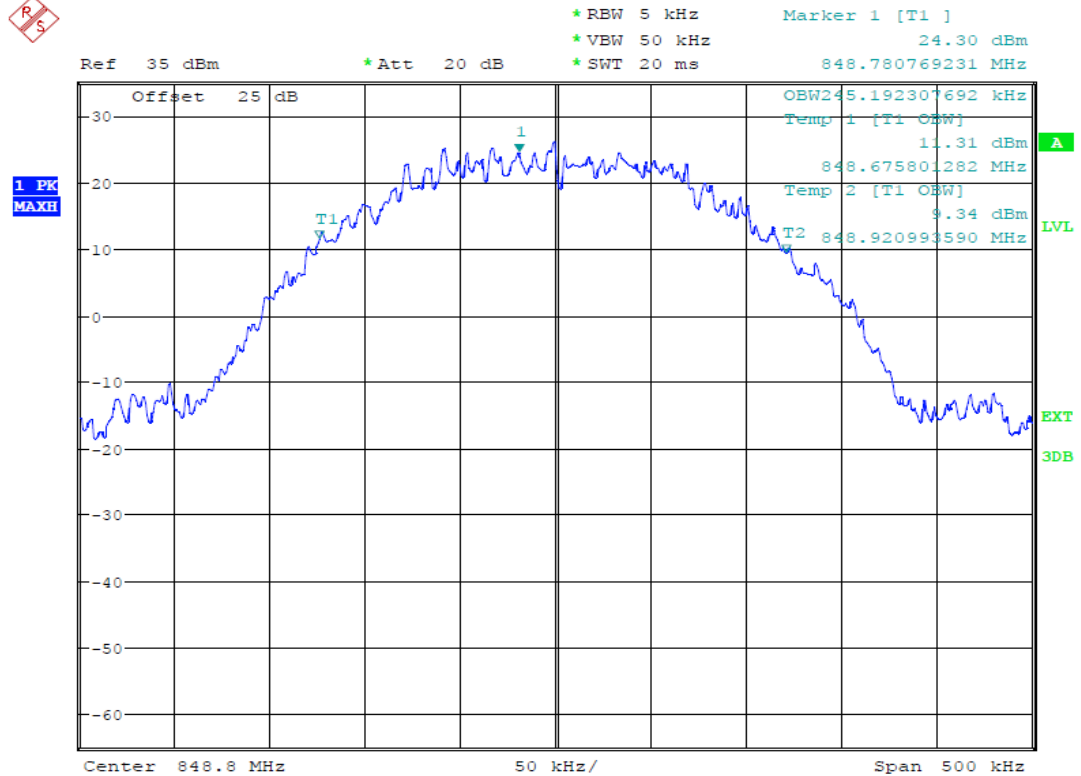

Date: 19.MAR.2014 15:15:11

(Plot 4.4.2 C: Channel 251: 848.80MHz @ GPRS850)

GSM1900				
Channel Number	Frequency (MHz)	Occupied Bandwidth (99% BW) (kHz)	Refer to Plot	Verdict
512	1850.20	245.99	Plot 4.4.3 A	PASS
661	1880.00	245.99	Plot 4.4.3 B	PASS
810	1909.80	244.39	Plot 4.4.3 C	PASS

GPRS1900				
Channel Number	Frequency (MHz)	Occupied Bandwidth (99% BW) (kHz)	Refer to Plot	Verdict
512	1850.20	243.59	Plot 4.4.4 A	PASS
661	1880.00	244.39	Plot 4.4.4 B	PASS
810	1909.80	245.19	Plot 4.4.4 C	PASS

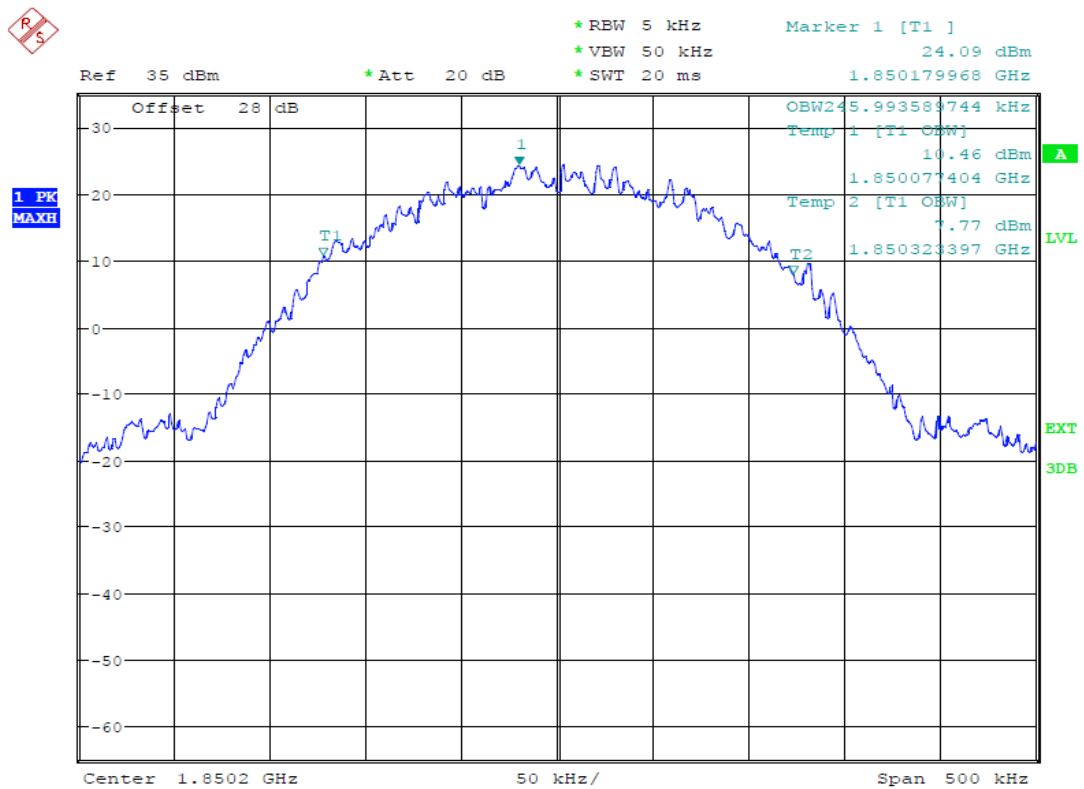

Date: 19.MAR.2014 13:24:32

(Plot 4.4.3 A: Channel 512:1820.20MHz @ PCS1900)

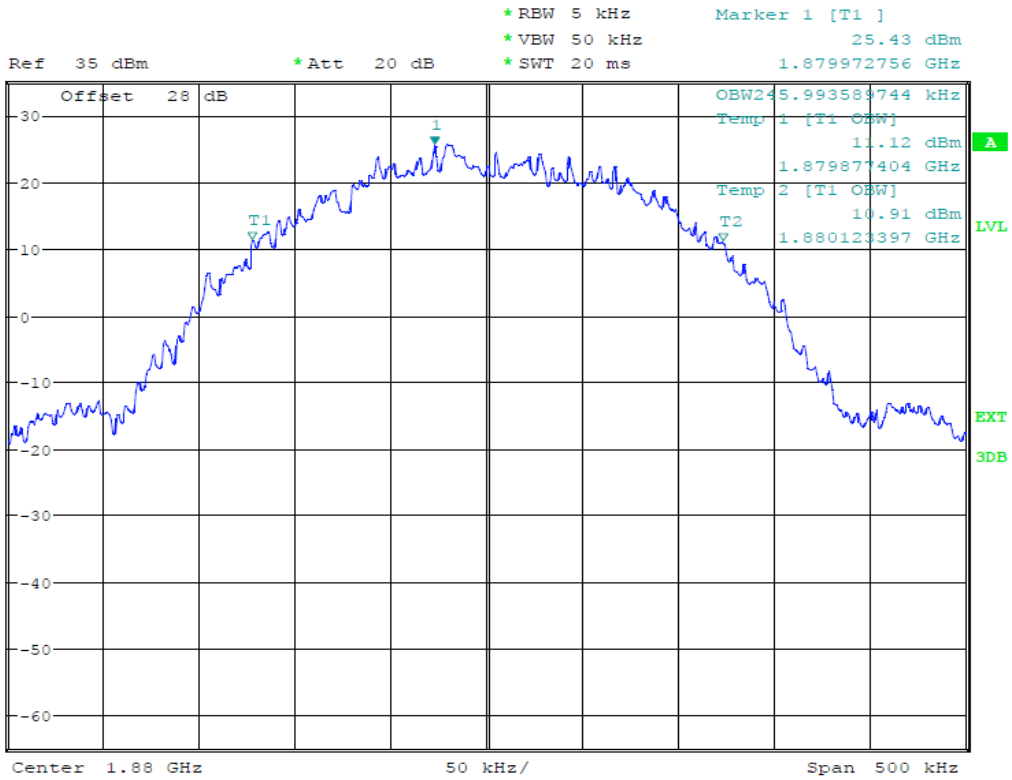

Date: 19.MAR.2014 13:26:40

(Plot 4.4.3 B: Channel 661:1880.00MHz @ PCS1900)

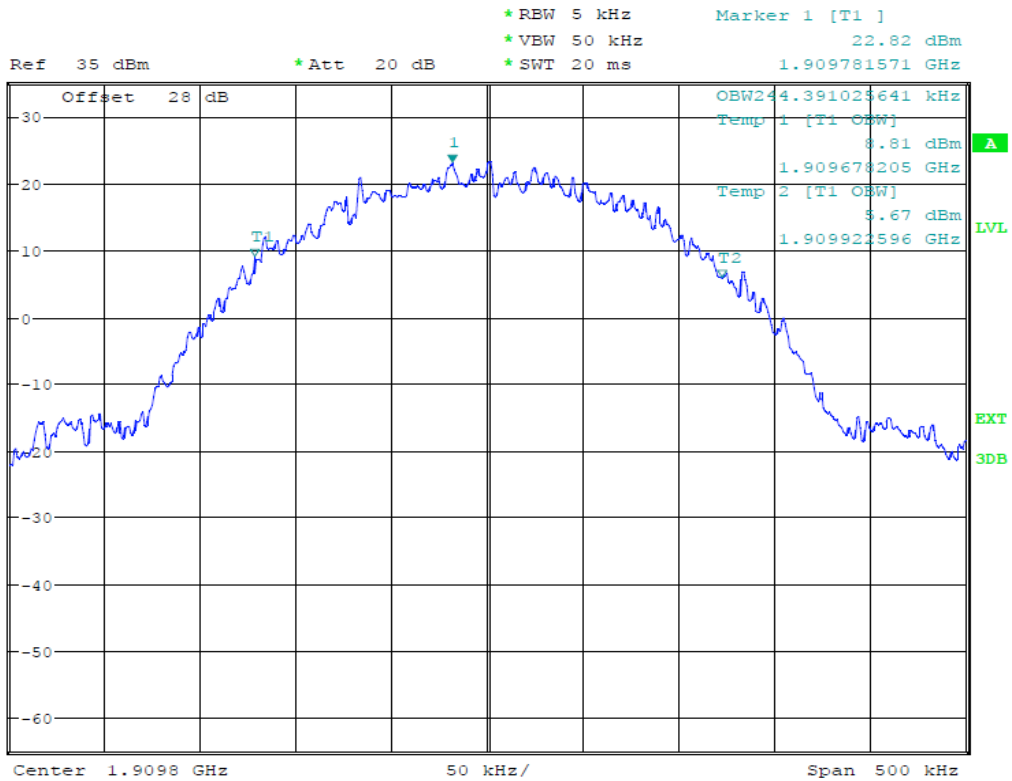

Date: 19.MAR.2014 13:29:07

(Plot 4.4.3 C: Channel 810:1909.80MHz @ PCS1900)

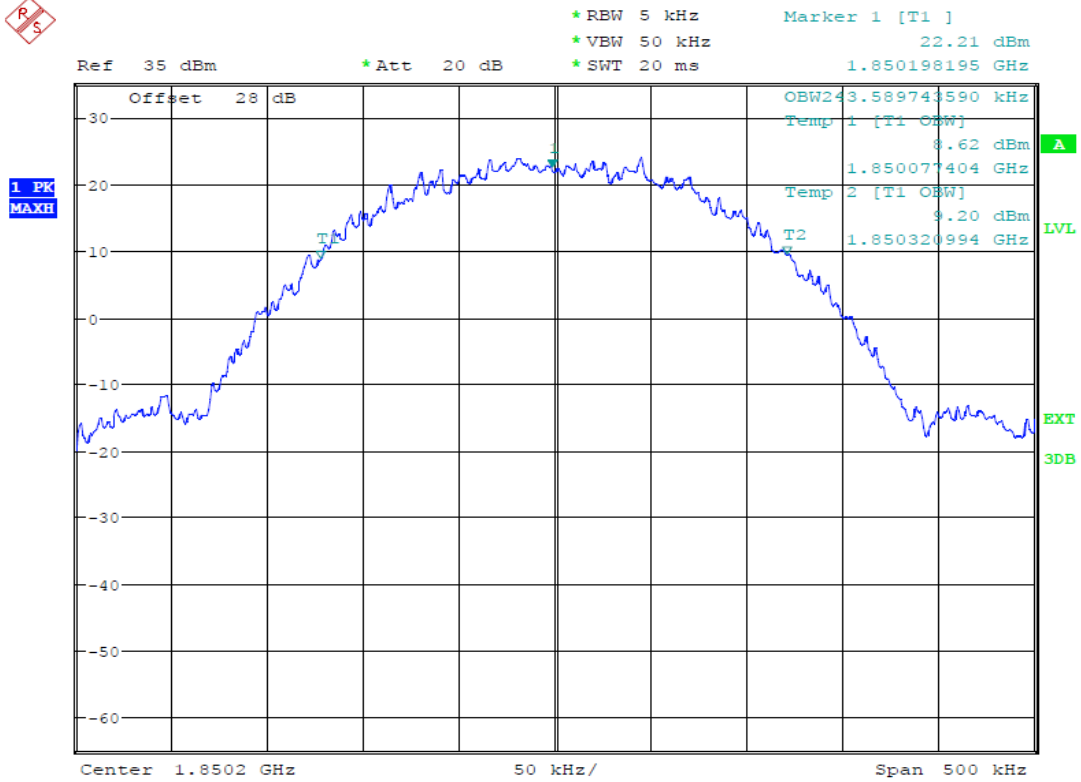

Date: 19.MAR.2014 14:50:33

(Plot 4.4.4 A: Channel 512:1820.20MHz @ GPRS1900)

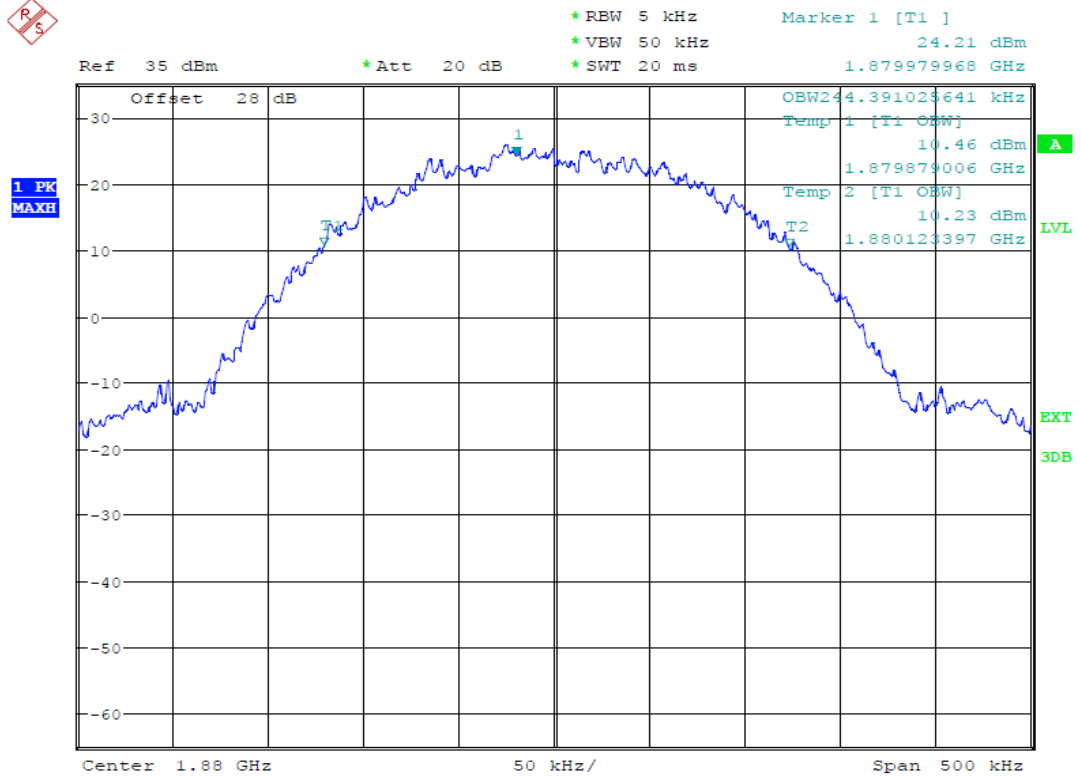

Date: 19.MAR.2014 14:48:26

(Plot 4.4.4 B: Channel 661:1880.00MHz @ GPRS1900)

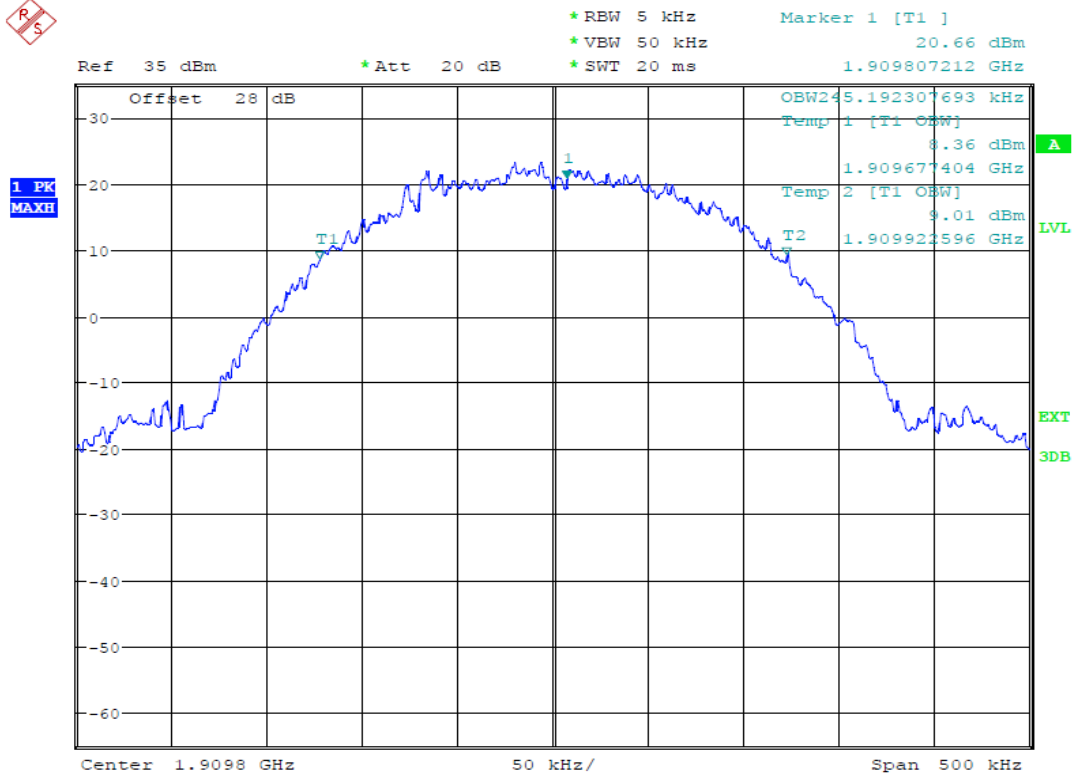

Date: 19.MAR.2014 14:46:07

(Plot 4.4.4 C: Channel 810:1909.80MHz @ GPRS1900)

4.5. EMISSION BANDWIDTH

TEST APPLICABLE

Similar to conducted emissions; occupied bandwidth measurements are only provided for selected frequencies in order to reduce the amount of submitted data. Data were taken at the extreme and mid frequencies of PCS1900 band and GSM850 band. The table below lists the measured -26dBc BW.

TEST CONFIGURATION

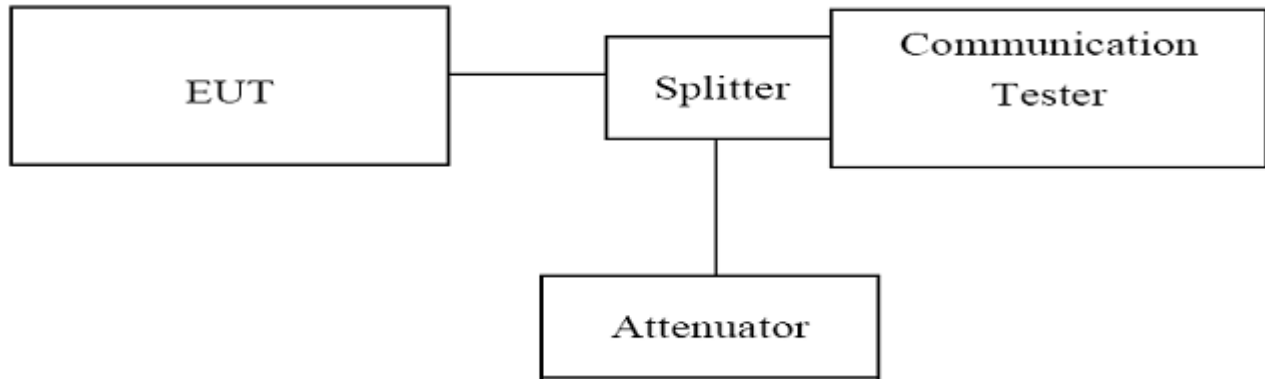

TEST PROCEDURE

1. The EUT was set up for the max output power with pseudo random data modulation;
2. The Occupied bandwidth was measured with Rhode & Schwarz Spectrum Analyzer FSU (peak);
3. Set RBW=5KHz, VBW=50KHz, Span=500KHz, SWT=20ms;
4. Set SPA Max hold. Mark peak, Set -26dBc Occupied Bandwidth
5. These measurements were done at 3 frequencies, 1850.20 MHz, 1880.00 MHz and 1909.80 MHz for PCS1900 band; 824.20MHz, 836.60 MHz and 848.80 MHz for GSM850 band. (bottom, middle and top of operational frequency range).

TEST RESULTS

GSM850				
Channel Number	Frequency (MHz)	Occupied Bandwidth (-26dBc BW) (kHz)	Refer to Plot	Verdict
128	824.20	314.10	Plot 4.5.1 A	PASS
190	836.60	309.29	Plot 4.5.1 B	PASS
251	848.80	319.71	Plot 4.5.1 C	PASS

GPRS850				
Channel Number	Frequency (MHz)	Occupied Bandwidth (-26dBc BW) (kHz)	Refer to Plot	Verdict
128	824.20	314.10	Plot 4.5.2 A	PASS
190	836.60	313.30	Plot 4.5.2 B	PASS
251	848.80	314.10	Plot 4.5.2 C	PASS

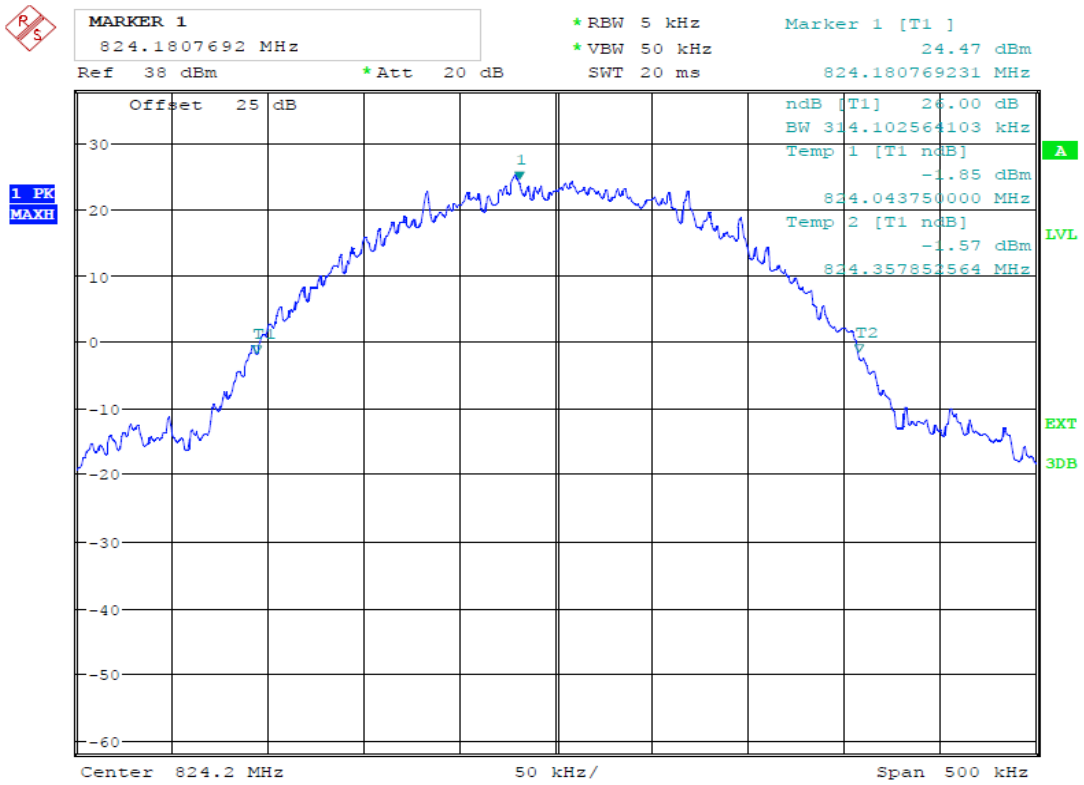

Date: 19.MAR.2014 11:51:39

(Plot 4.5.1 A: Channel 128: 824.20MHz @ GSM850)

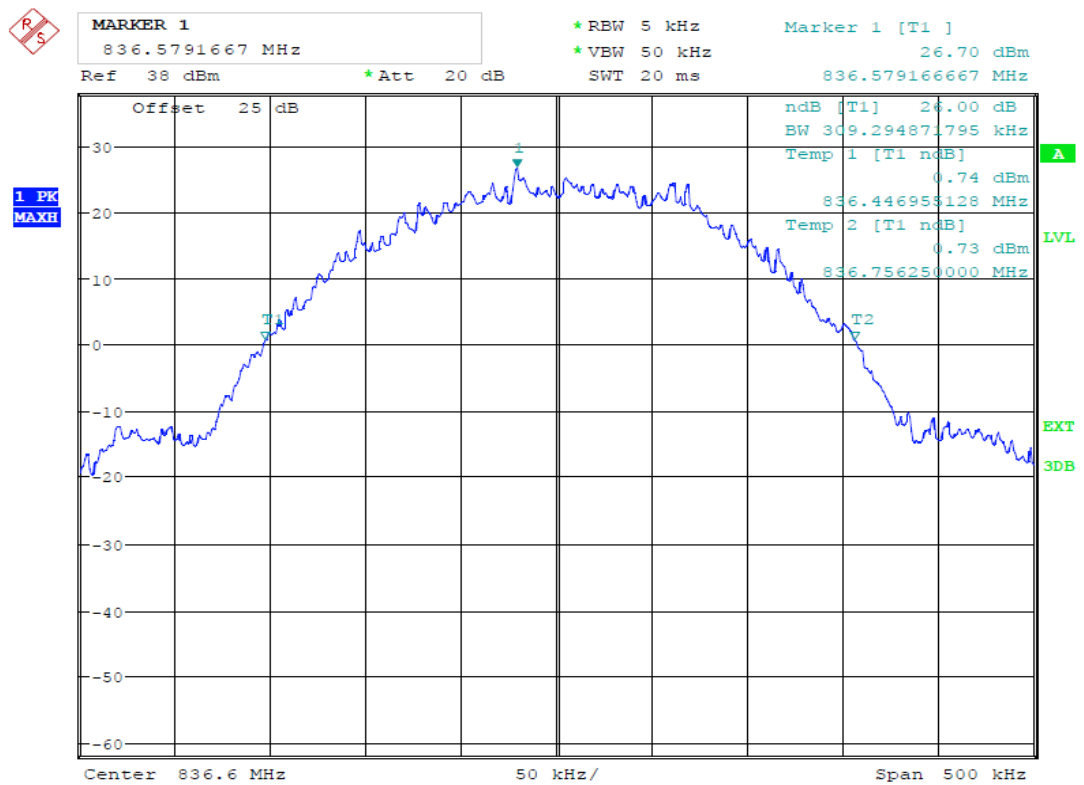

Date: 19.MAR.2014 11:50:47

(Plot 4.5.1 B: Channel 190: 836.60MHz @ GSM850)

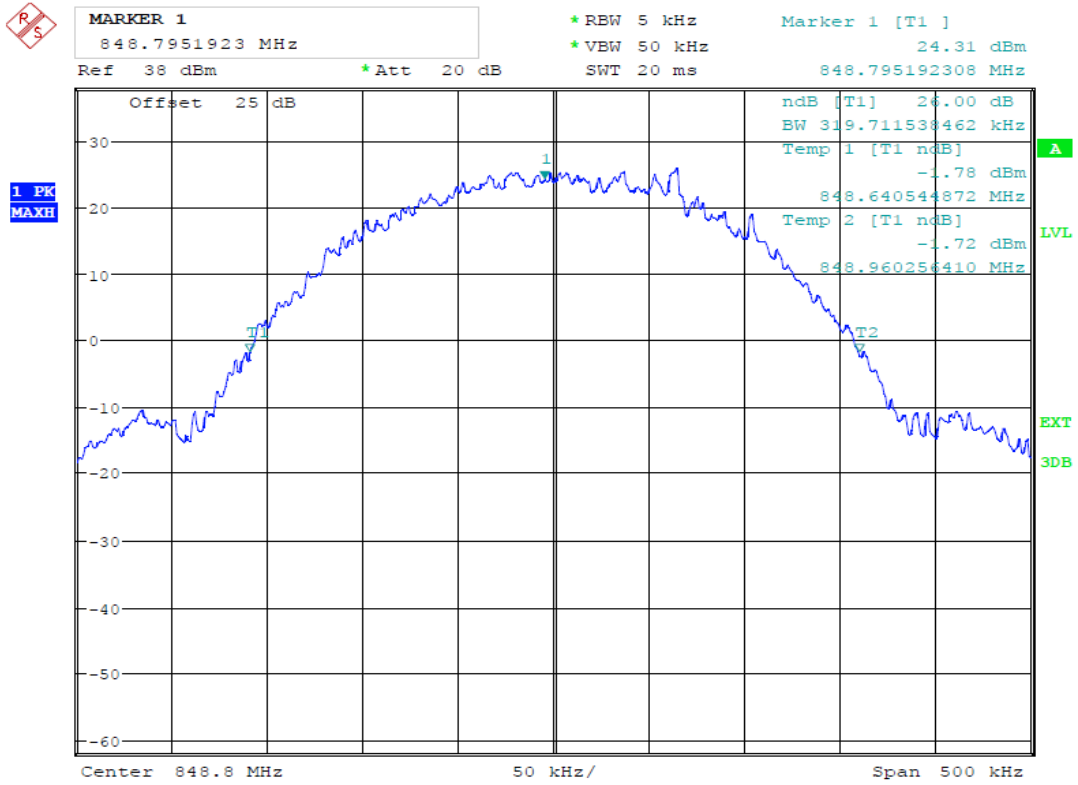

Date: 19.MAR.2014 11:49:57

(Plot 4.5.1 C: Channel 251: 848.80MHz @ GSM850)

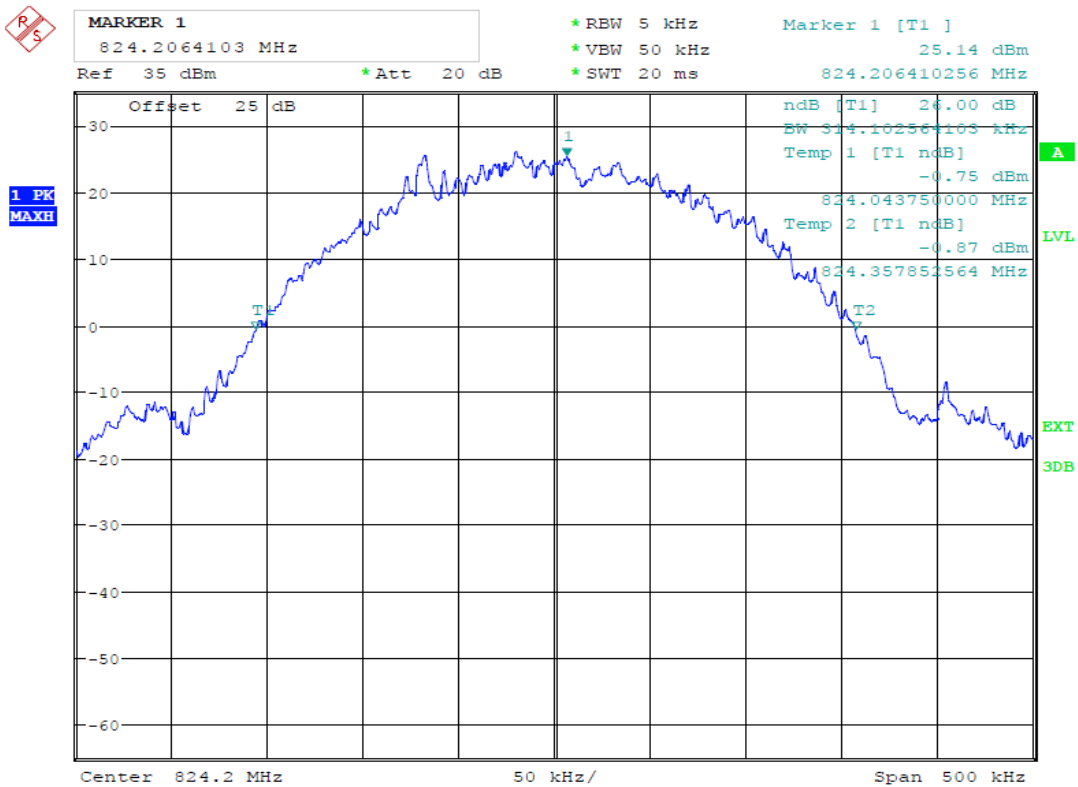

Date: 19.MAR.2014 15:17:07

(Plot 4.5.2 A: Channel 128: 824.20MHz @ GPRS850)

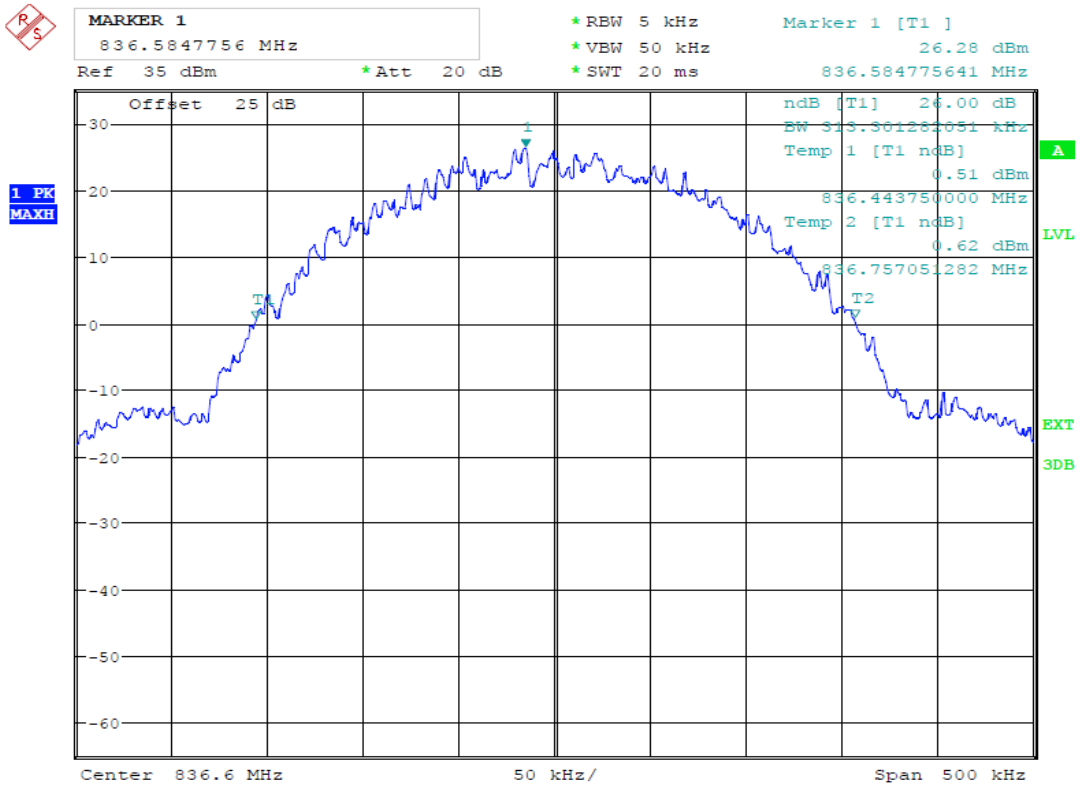

Date: 19.MAR.2014 15:17:37

(Plot 4.5.2 B: Channel 190: 836.60MHz @ GPRS850)

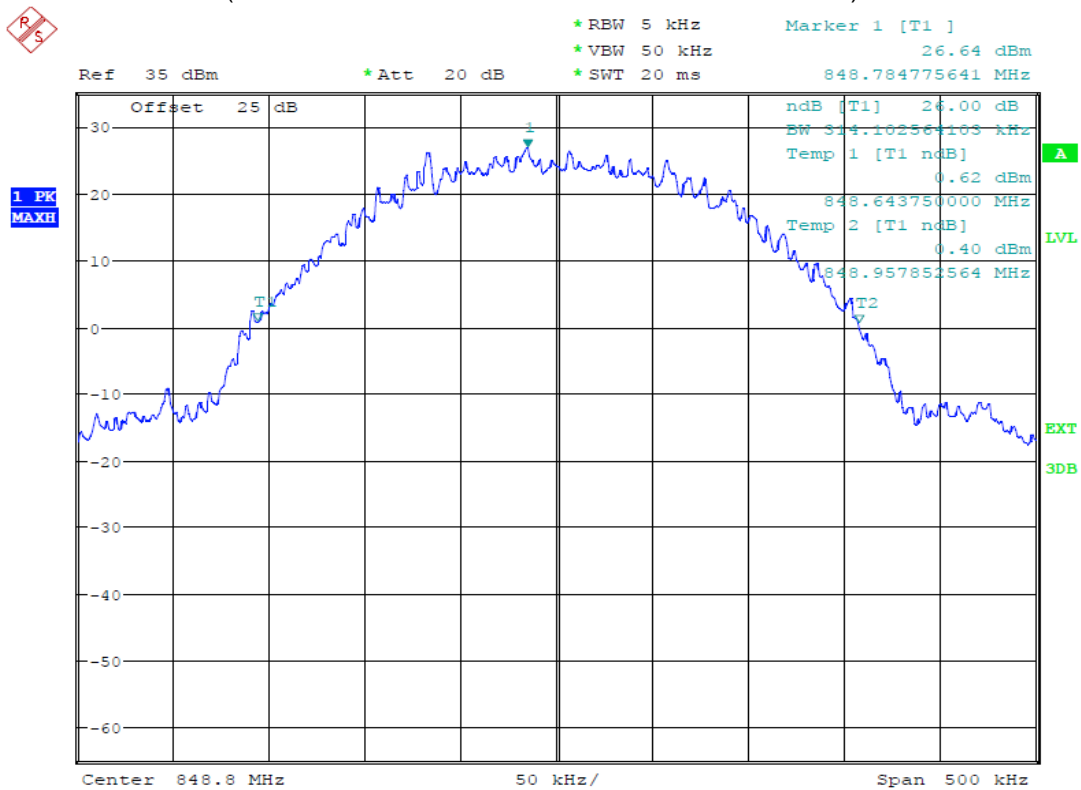

Date: 19.MAR.2014 15:18:12

(Plot 4.5.2 C: Channel 251: 848.80MHz @ GPRS850)

GSM1900				
Channel Number	Frequency (MHz)	Occupied Bandwidth (99% BW) (kHz)	Refer to Plot	Verdict
512	1850.20	319.71	Plot 4.5.3 A	PASS
661	1880.00	318.11	Plot 4.5.3 B	PASS
810	1909.80	314.90	Plot 4.5.3 C	PASS

GPRS1900				
Channel Number	Frequency (MHz)	Occupied Bandwidth (-26dBc BW) (kHz)	Refer to Plot	Verdict
512	1850.20	318.90	Plot 4.5.4 A	PASS
661	1880.00	317.31	Plot 4.5.4 B	PASS
810	1909.80	314.10	Plot 4.5.4 C	PASS

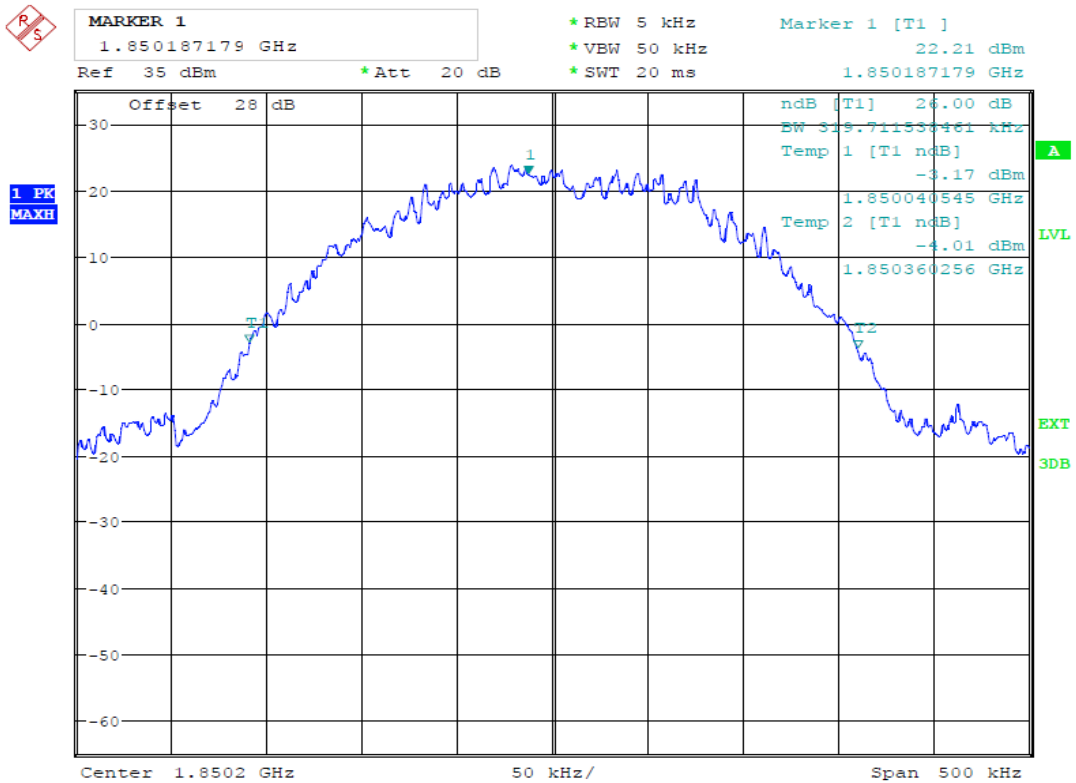

Date: 19.MAR.2014 13:09:01

(Plot 4.5.3 A: Channel 512:1820.20MHz @ PCS1900)

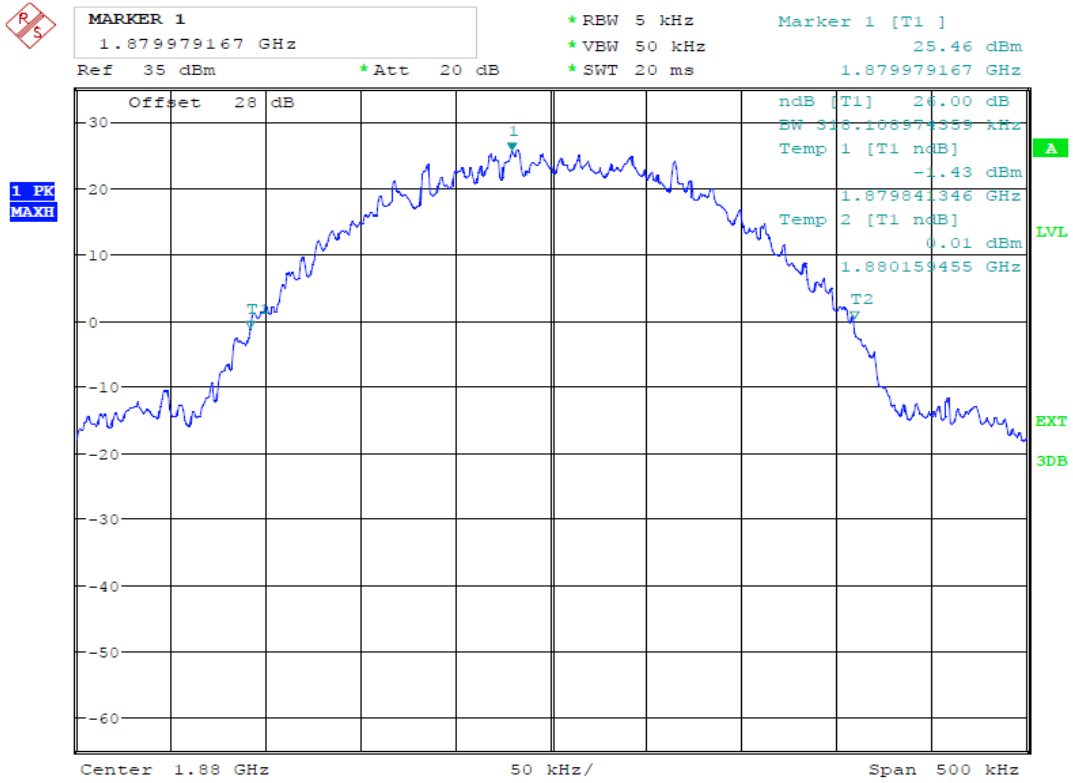

Date: 19.MAR.2014 13:12:02

(Plot 4.5.3 B: Channel 661:1880.00MHz @ PCS1900)

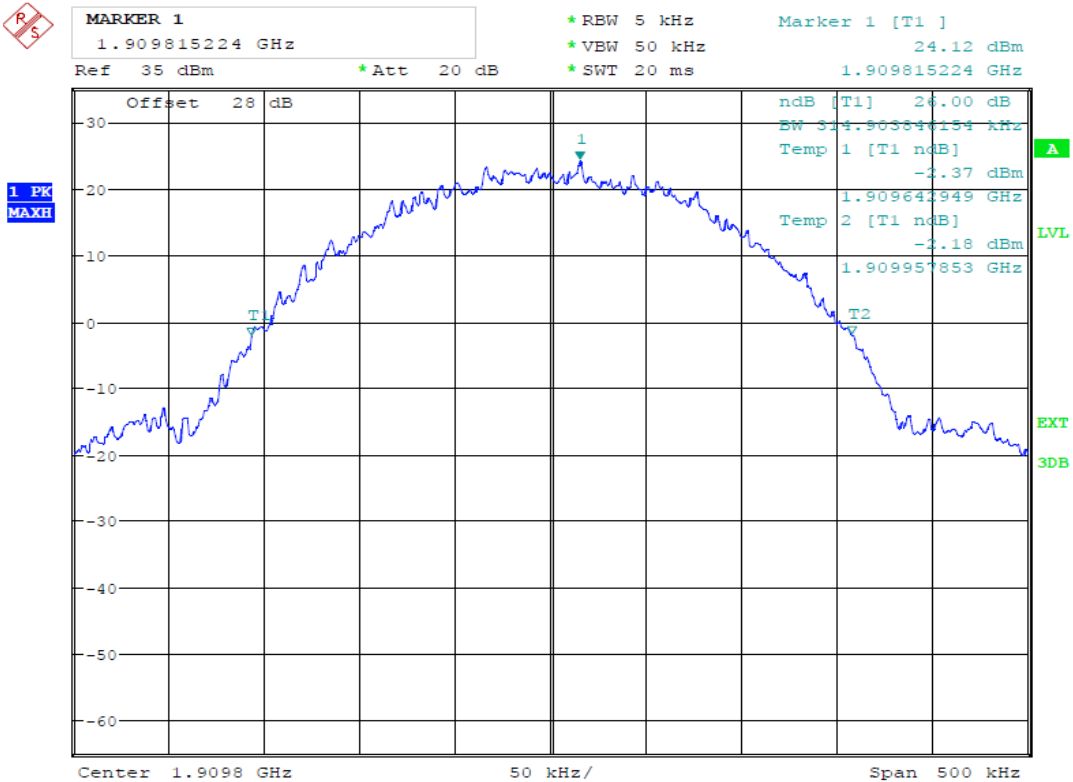

Date: 19.MAR.2014 13:11:14

(Plot 4.5.3 C: Channel 810:1909.80MHz @ PCS1900)

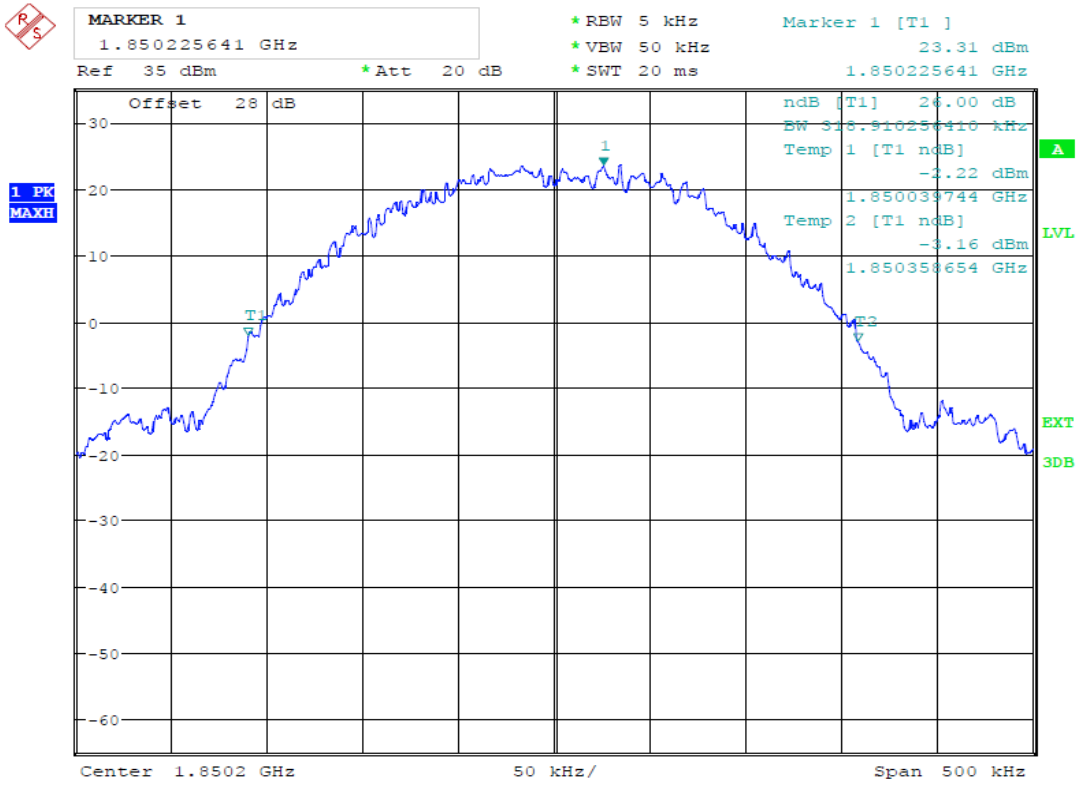

Date: 19.MAR.2014 14:51:15

(Plot 4.5.4 A: Channel 512:1820.20MHz @ GPRS1900)

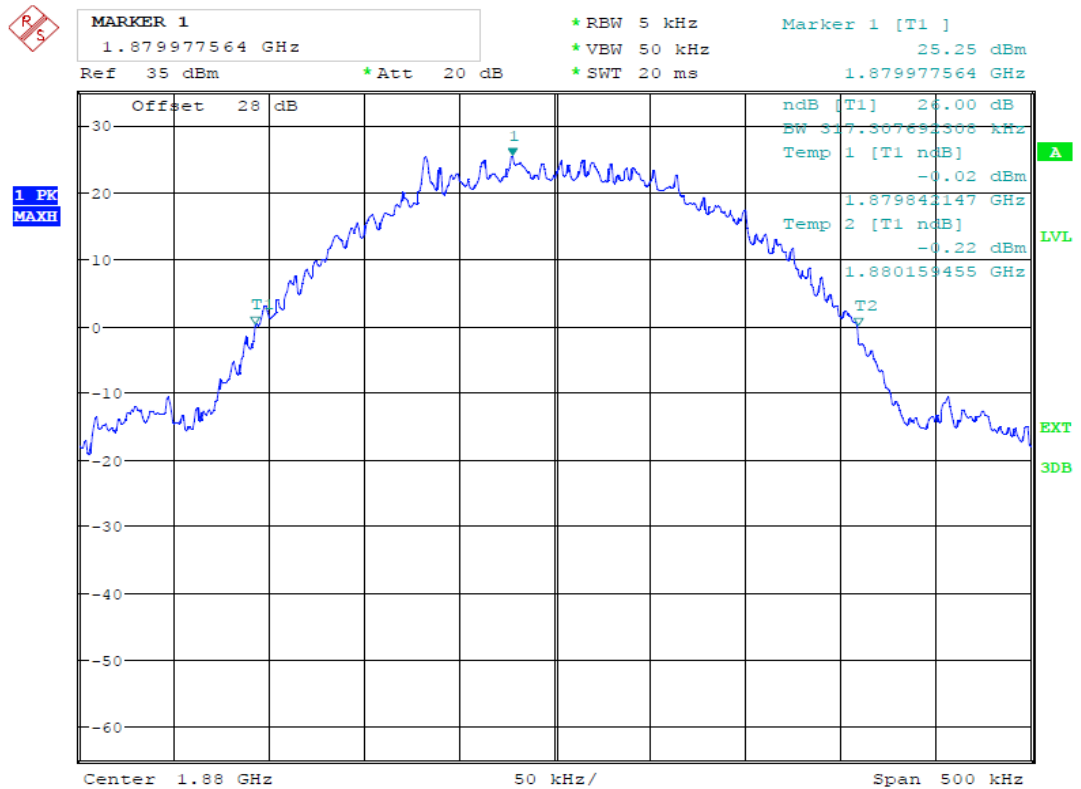

Date: 19.MAR.2014 14:51:52

(Plot 4.5.4 B: Channel 661:1880.00MHz @ GPRS1900)

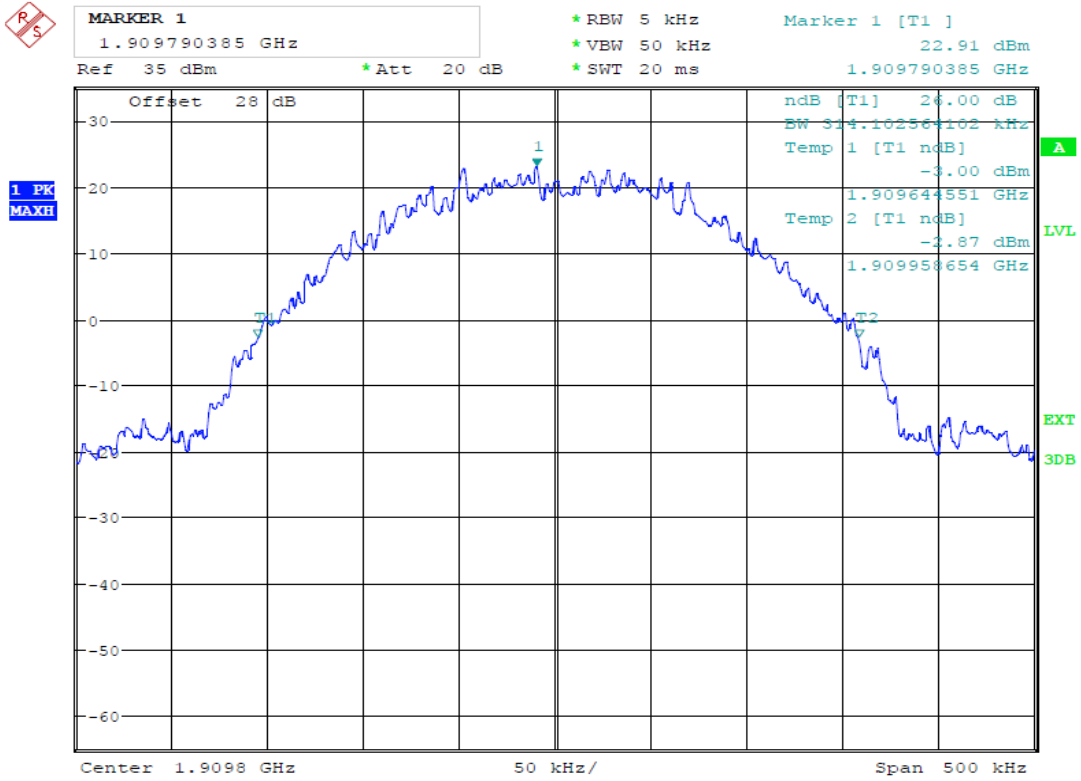

Date: 19.MAR.2014 14:52:17

(Plot 4.5.4 C: Channel 810:1909.80MHz @ GPRS1900)

4.6. BAND EDGE COMPLIANCE

TEST APPLICABLE

During the process of testing, the EUT was controlled via Rhode & Schwarz Digital Radio Communication tester (CMU200) to ensure max power transmission and proper modulation.

TEST CONFIGURATION

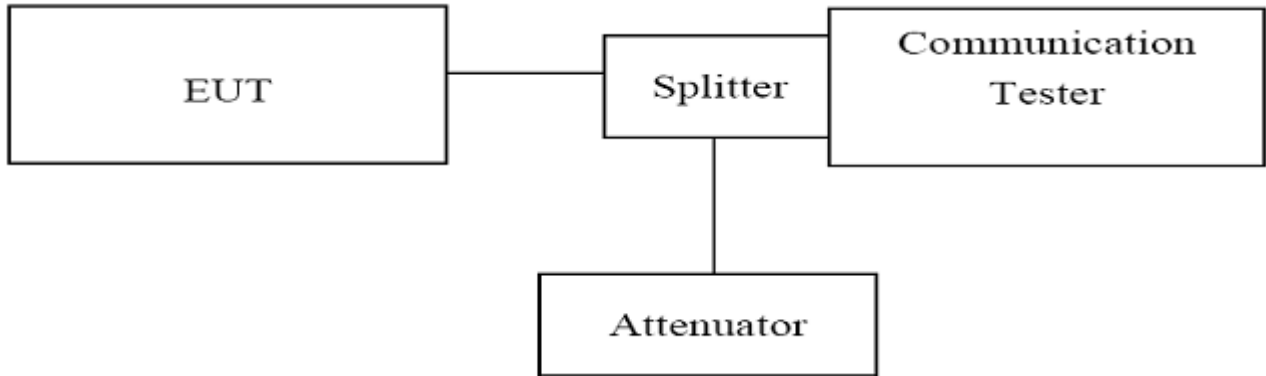

TEST PROCEDURE

1. The EUT was set up for the max output power with pseudo random data modulation;
2. The power was measured with Rhode & Schwarz Spectrum Analyzer FSU (peak);
3. Set RBW=5KHz,VBW=50KHz,Span=1MHz,SWT=300ms;
4. These measurements were done at 3 frequencies, 1850.20 MHz, 1880.00 MHz and 1909.80 MHz for PCS1900 band; 824.20 MHz, 836.60 MHz and 848.80 MHz for GSM850 band. (bottom, middle and top of operational frequency range).

TEST RESULTS

GSM850						
Channel Number	Frequency (MHz)	Measurement Results		Limit (dBm)	Refer to Plot	Verdict
		Frequency (MHz)	Values (dBm)			
128	824.20	823.99	-13.92	-13.00	Plot 4.6.1 A	PASS
251	848.80	849.02	-13.68	-13.00	Plot 4.6.1 B	PASS

GPRS850						
Channel Number	Frequency (MHz)	Measurement Results		Limit (dBm)	Refer to Plot	Verdict
		Frequency (MHz)	Values (dBm)			
128	824.20	823.97	-13.55	-13.00	Plot 4.6.2 A	PASS
251	848.80	849.02	-13.74	-13.00	Plot 4.6.2 B	PASS



*RBW 5 kHz
*VBW 50 kHz
*SWT 300 ms
Marker 1 [T1]
-13.92 dBm
823.993589744 MHz

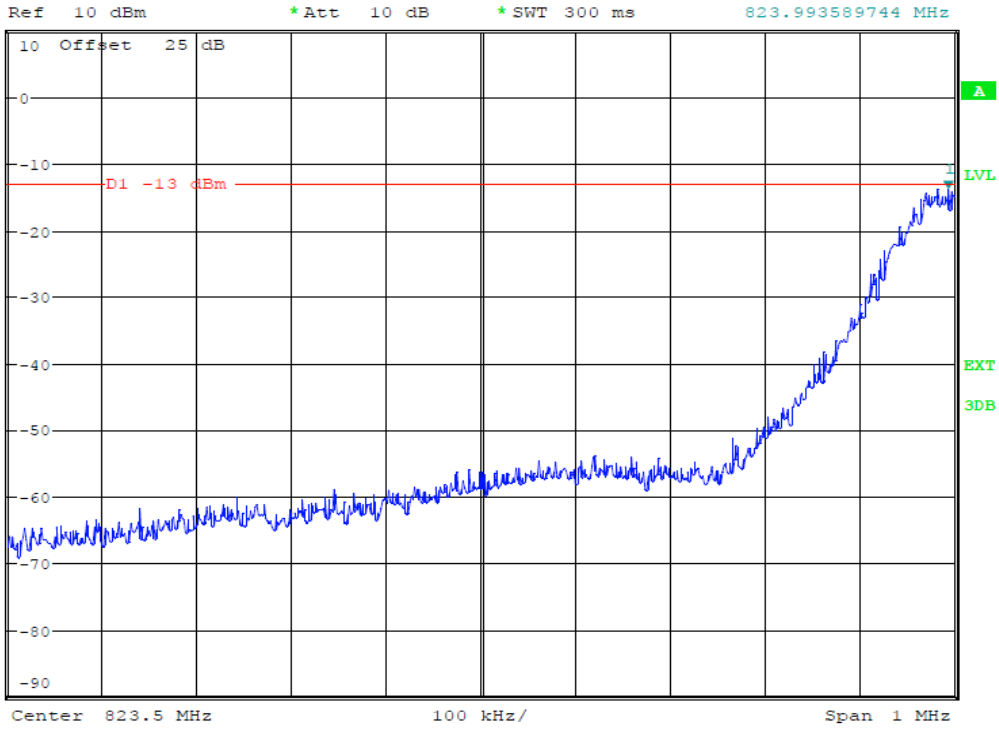

Date: 19.MAR.2014 11:56:54

(Plot 4.6.1 A: Channel 128: 824.20MHz @ GSM850)



*RBW 5 kHz
*VBW 50 kHz
*SWT 300 ms
Marker 1 [T1]
-13.68 dBm
849.022435897 MHz

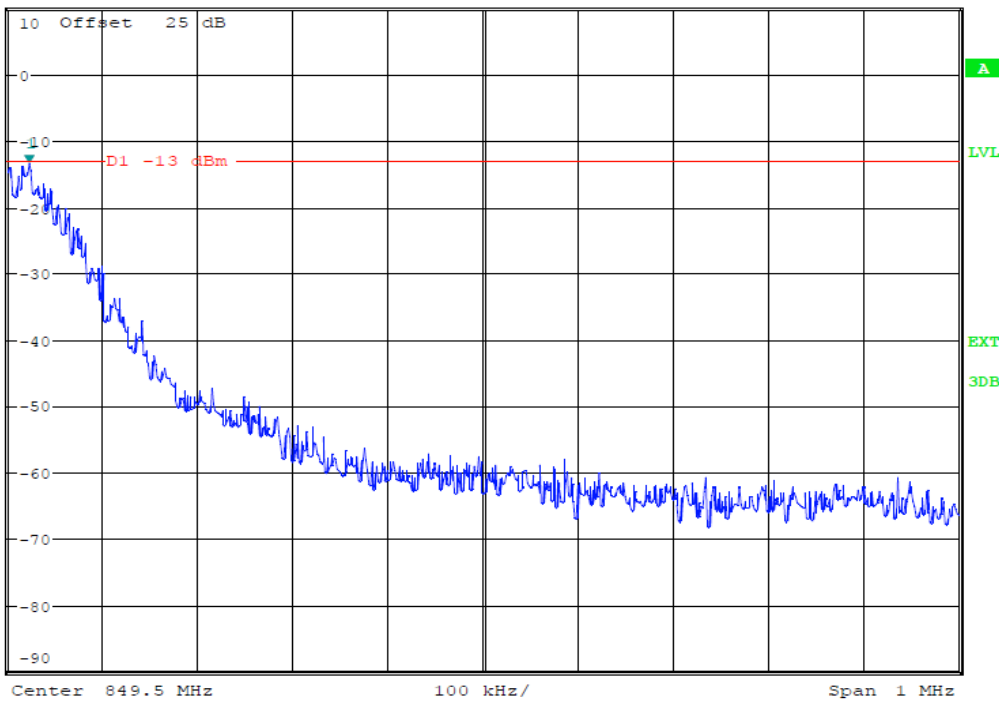

Date: 19.MAR.2014 12:00:13

(Plot 4.6.1 B: Channel 251: 848.80MHz @ GSM850)



*RBW 5 kHz
*VBW 50 kHz
*SWT 300 ms
Marker 1 [T1]
-13.55 dBm
823.971153846 MHz

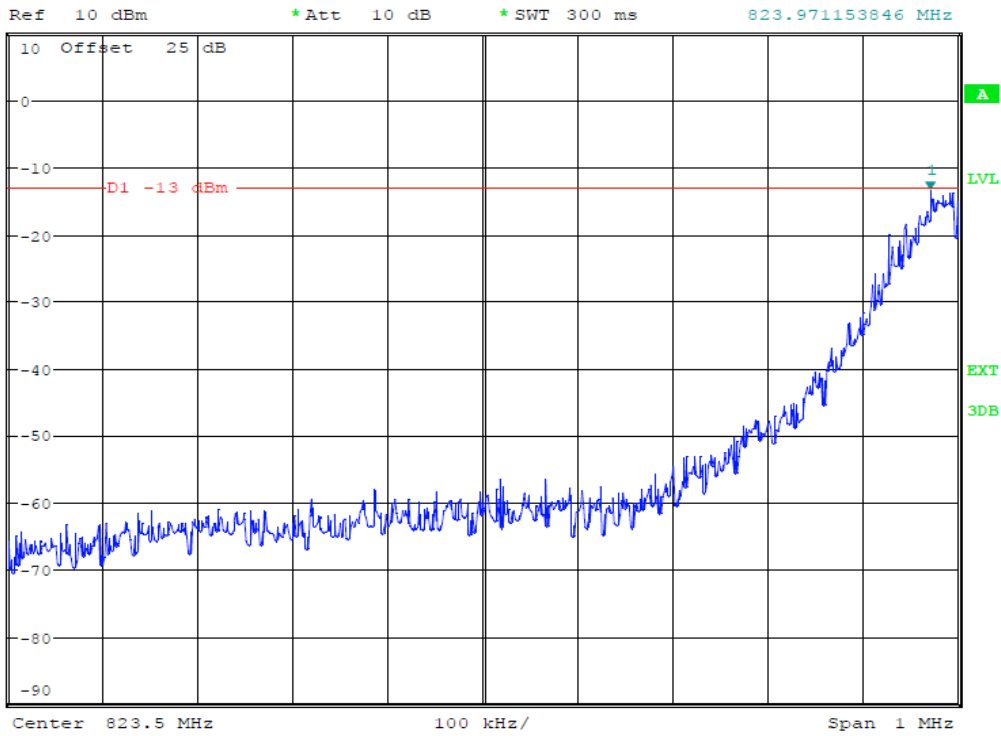

Date: 19.MAR.2014 15:23:51

(Plot 4.6.2 A: Channel 128: 824.20MHz @ GPRS850)



*RBW 5 kHz
*VBW 50 kHz
*SWT 300 ms
Marker 1 [T1]
-13.74 dBm
849.020833333 MHz

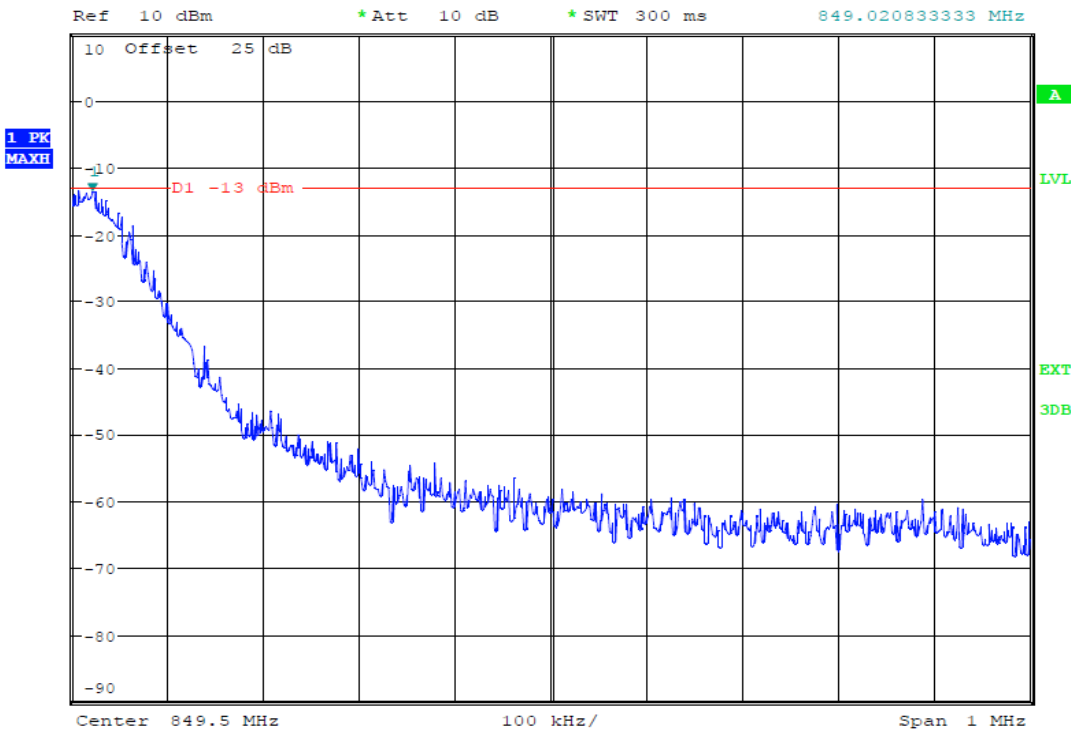

Date: 19.MAR.2014 15:22:53

(Plot 4.6.2 B: Channel 251: 848.80MHz @ GPRS850)

PCS1900						
Channel Number	Frequency (MHz)	Measurement Results		Limit (dBm)	Refer to Plot	Verdict
		Frequency (MHz)	Values (dBm)			
512	1850.20	1850.00	-13.92	-13.00	Plot 4.6.3 A	PASS
810	1909.80	1910.00	-14.26	-13.00	Plot 4.6.3 B	PASS

GPRS1900						
Channel Number	Frequency (MHz)	Measurement Results		Limit (dBm)	Refer to Plot	Verdict
		Frequency (MHz)	Values (dBm)			
512	1850.20	1850.00	-13.51	-13.00	Plot 4.6.4 A	PASS
810	1909.80	1910.00	-13.86	-13.00	Plot 4.6.4 B	PASS

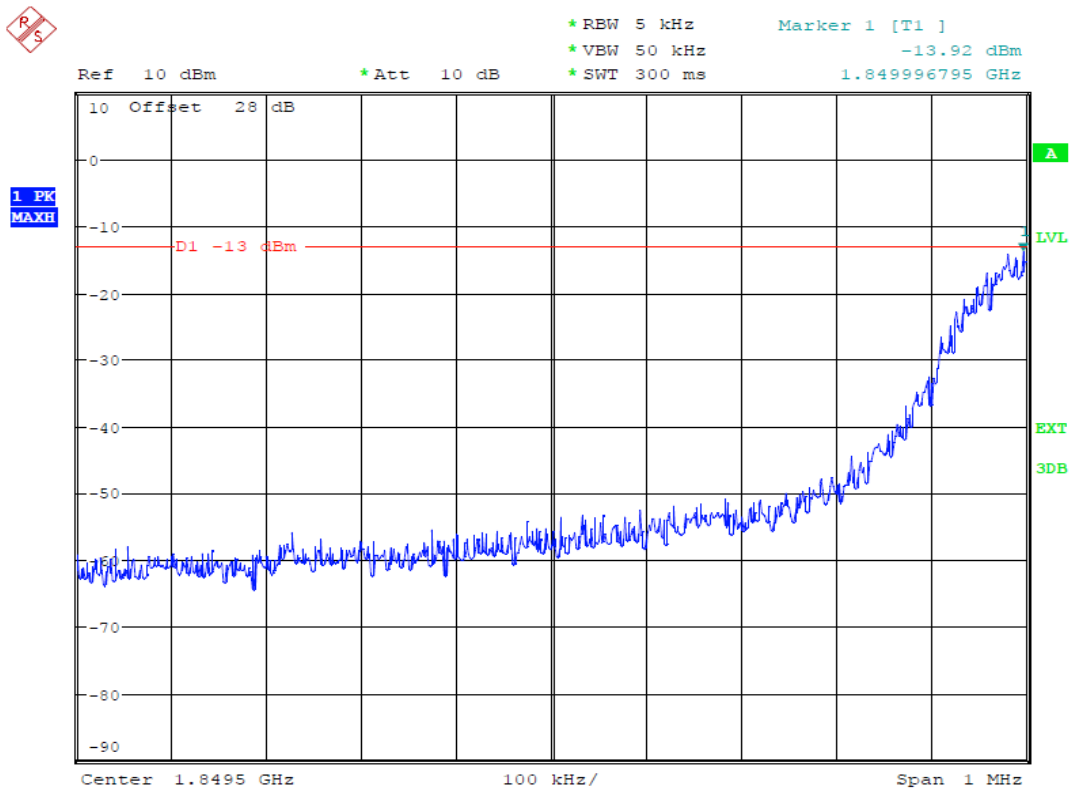

Date: 19.MAR.2014 15:37:34

(Plot 4.6.3 A: Channel 512: 1850.20MHz @ PCS1900)



*RBW 5 kHz
*VBW 50 kHz
*SWT 300 ms
Marker 1 [T1]
-14.26 dBm
1.910006410 GHz

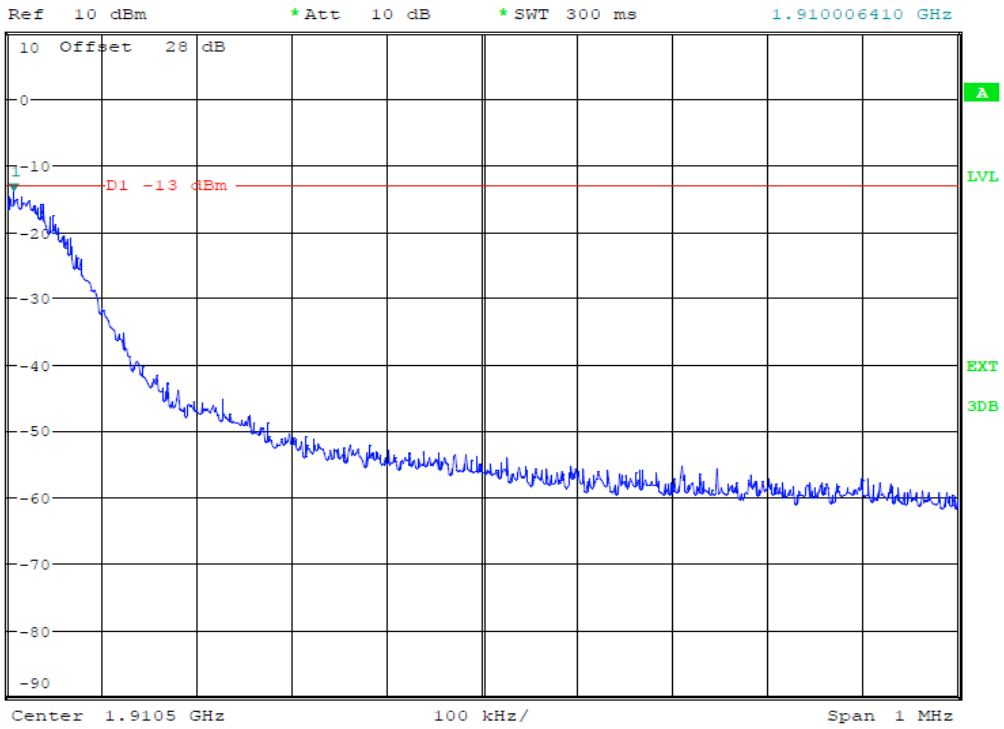

Date: 19.MAR.2014 15:39:37

(Plot 4.6.3 B: Channel 810: 1909.80MHz @ PCS1900)



*RBW 5 kHz
*VBW 50 kHz
*SWT 300 ms
Marker 1 [T1]
-13.51 dBm
1.849996795 GHz

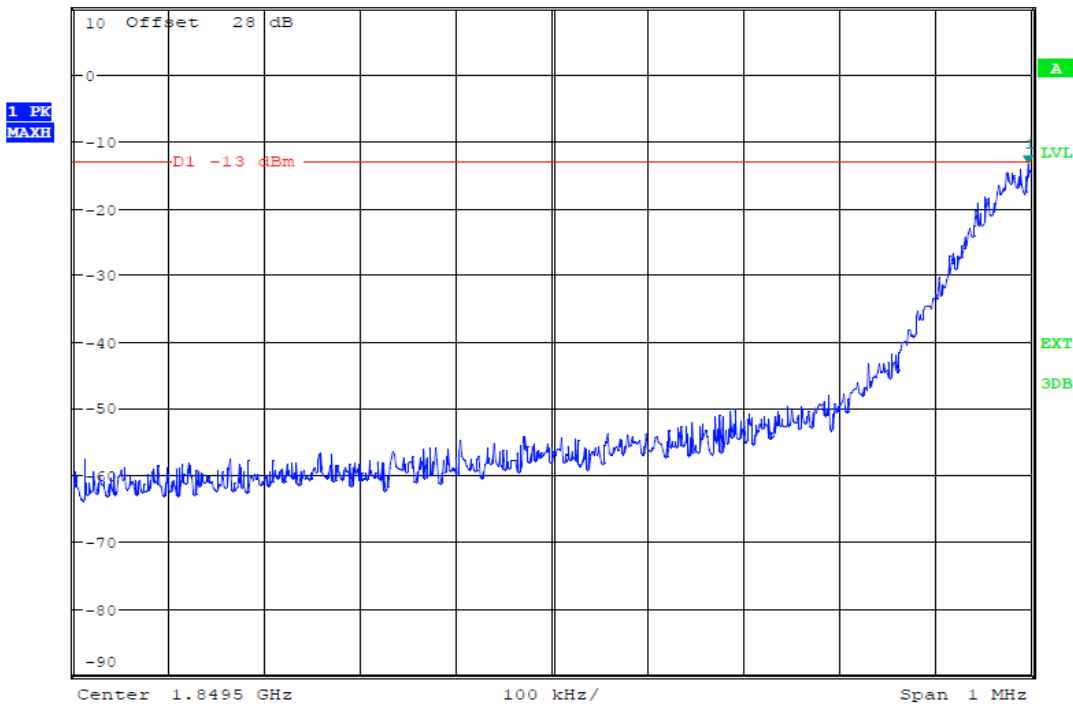

Date: 19.MAR.2014 15:35:26

(Plot 4.6.4 A: Channel 512: 1850.20MHz @ GPRS1900)



*RBW 5 kHz Marker 1 [T1]
*VBW 50 kHz -13.86 dBm
*SWT 300 ms 1.910003205 GHz

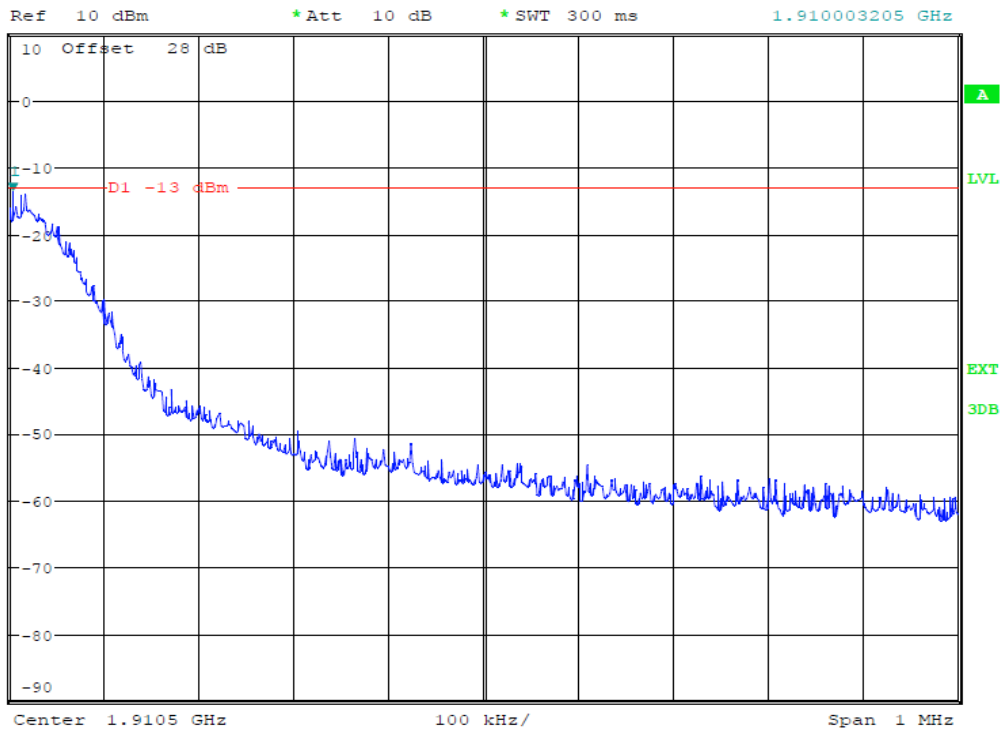

Date: 19.MAR.2014 15:34:19

(Plot 4.6.4 B: Channel 810: 1909.80MHz @ GPRS1900)

4.7. Spurious Emission on Antenna Port

TEST APPLICABLE

The following steps outline the procedure used to measure the conducted emissions from the EUT.

1. Determine frequency range for measurements: From CFR 2.1057 the spectrum should be investigated from the lowest radio frequency generated in the equipment up to at least the 10th harmonic of the carrier frequency. For the equipment of PCS1900 band, this equates to a frequency range of 30 MHz to 19.1 GHz, data taken from 30 MHz to 20 GHz. For GSM850, data taken from 30 MHz to 10 GHz.
2. The sweep time is set automatically by instrument itself. That should be the optimal sweep time for the span and the RBW. If the sweep time is too short, that is sweep is too fast, the sweep result is not accurate; if the sweep time is too long, that is sweep is too low, some frequency components may be lost. The instrument will give a optimal sweep time according the selected span and RBW.
3. The procedure to get the conducted spurious emission is as follows:
The trace mode is set to MaxHold to get the highest signal at each frequency;
Wait 25 seconds;
Get the result.
4. Determine EUT transmit frequencies: below outlines the band edge frequencies pertinent to conducted emissions testing.

TEST CONFIGURATION

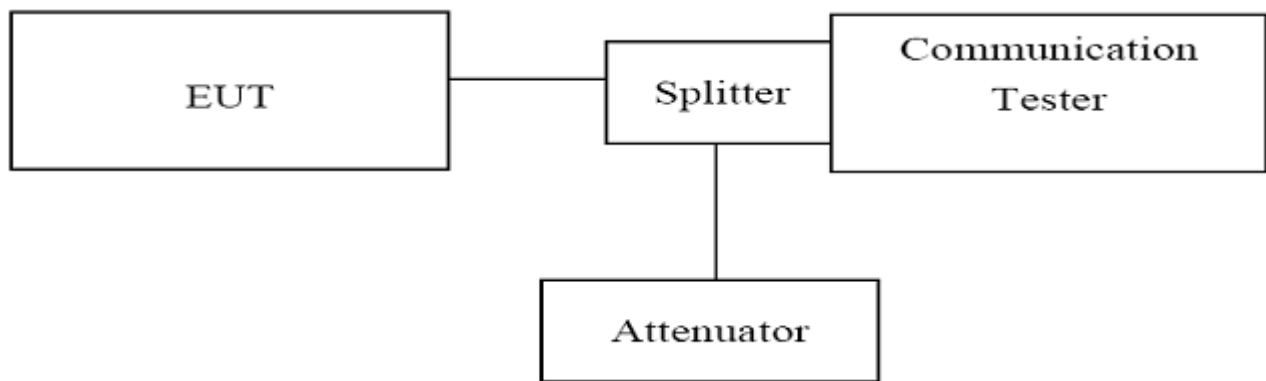

TEST PROCEDURE

1. The EUT was set up for the max output power with pseudo random data modulation;
2. The power was measured with Rhode & Schwarz Spectrum Analyzer FSU (peak);
3. These measurements were done at 3 frequencies, 1850.20 MHz, 1880.00 MHz and 1909.80 MHz for PCS1900 band; 824.20 MHz, 836.60 MHz and 848.80 MHz for GSM850 band. (bottom, middle and top of operational frequency range).

TEST LIMIT

Part 24.238 and Part 22.917 specify that the power of any emission outside of the authorized operating frequency ranges must be attenuated below the transmitting power (P) by a factor of at least $43 + 10 \log(P)$ dB.

The specification that emissions shall be attenuated below the transmitter power (P) by at least $43 + 10 \log(P)$ dB, translates in the relevant power range (1 to 0.001 W) to -13 dBm. At 1 W the specified minimum attenuation becomes 43 dB and relative to a 30 dBm (1 W) carrier becomes a limit of -13 dBm. At 0.001 W (0 dBm) the minimum attenuation is 13 dB, which again yields a limit of -13 dBm. In this way a translation of the specification from relative to absolute terms is carried out.

TEST RESULTS

GSM850						
Channel Number: 128		Test Frequency: 824.20 MHz			Test Mode: Traffic	
Start Frequency (MHz)	Stop Frequency (MHz)	Measurement Results		Limit (dBm)	Refer to Plot	Verdict
		Frequency (MHz)	Values (dBm)			
30	1000	***	***	-13.00	Plot 4.7.1 A1	PASS
1000	2500	1649.04	-31.82	-13.00	Plot 4.7.1 A2	PASS
2500	7500	3237.18	-40.56	-13.00	Plot 4.7.1 A3	PASS
7500	10000	8317.31	-40.82	-13.00	Plot 4.7.1 A4	PASS

GSM850						
Channel Number: 190		Test Frequency: 836.60 MHz			Test Mode: Traffic	
Start Frequency (MHz)	Stop Frequency (MHz)	Measurement Results		Limit (dBm)	Refer to Plot	Verdict
		Frequency (MHz)	Values (dBm)			
30	1000	***	***	-13.00	Plot 4.7.2 A1	PASS
1000	2500	1673.08	-31.92	-13.00	Plot 4.7.2 A2	PASS
2500	7500	2508.01	-29.85	-13.00	Plot 4.7.2 A3	PASS
7500	10000	8874.20	-41.06	-13.00	Plot 4.7.2 A4	PASS

GSM850						
Channel Number: 251		Test Frequency: 848.80 MHz			Test Mode: Traffic	
Start Frequency (MHz)	Stop Frequency (MHz)	Measurement Results		Limit (dBm)	Refer to Plot	Verdict
		Frequency (MHz)	Values (dBm)			
30	1000	***	***	-13.00	Plot 4.7.3 A1	PASS
1000	2500	1697.12	-33.78	-13.00	Plot 4.7.3 A2	PASS
2500	7500	2540.06	-29.26	-13.00	Plot 4.7.3 A3	PASS
7500	10000	7724.36	-40.76	-13.00	Plot 4.7.3 A4	PASS

GSM850						
Test Mode: Idle						
Start Frequency (MHz)	Stop Frequency (MHz)	Measurement Results		Limit (dBm)	Refer to Plot	Verdict
		Frequency (MHz)	Values (dBm)			
30	1000	87.52	-40.03	-13.00	Plot 4.7.4 A1	PASS
1000	2500	2478.37	-40.40	-13.00	Plot 4.7.4 A2	PASS
2500	7500	3493.59	-40.31	-13.00	Plot 4.7.4 A3	PASS
7500	10000	7764.42	-40.58	-13.00	Plot 4.7.4 A4	PASS

Note: 1. In general, the worse case attenuation requirement shown above was applied.
 2. *** means that the emission level is too low to be measured or at least 20 dB down than the limit.

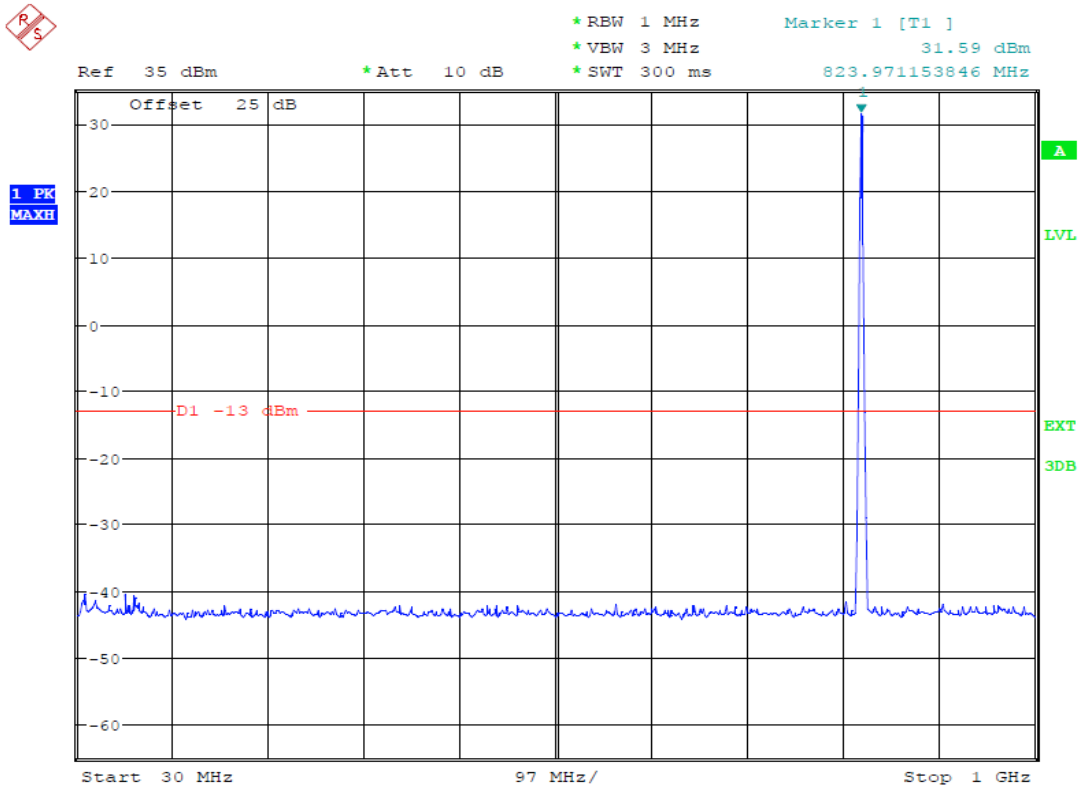

Date: 19.MAR.2014 15:25:22

(Plot 4.7.1 A1: Channel 128: 824.20MHz @ Traffic @ GSM850)

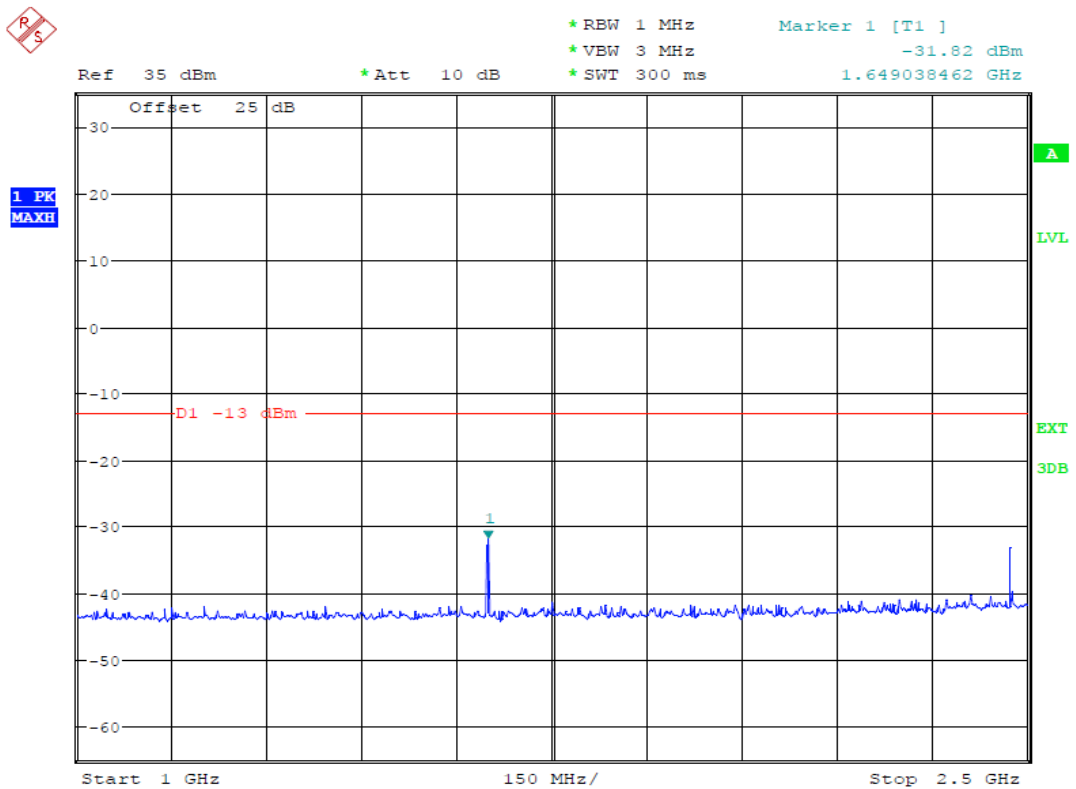

Date: 19.MAR.2014 15:25:48

(Plot 4.7.1 A2: Channel 128: 824.20MHz @ Traffic @ GSM850)



*RBW 1 MHz
*VBW 3 MHz
*SWT 300 ms
Marker 1 [T1]
-40.56 dBm
3.237179487 GHz

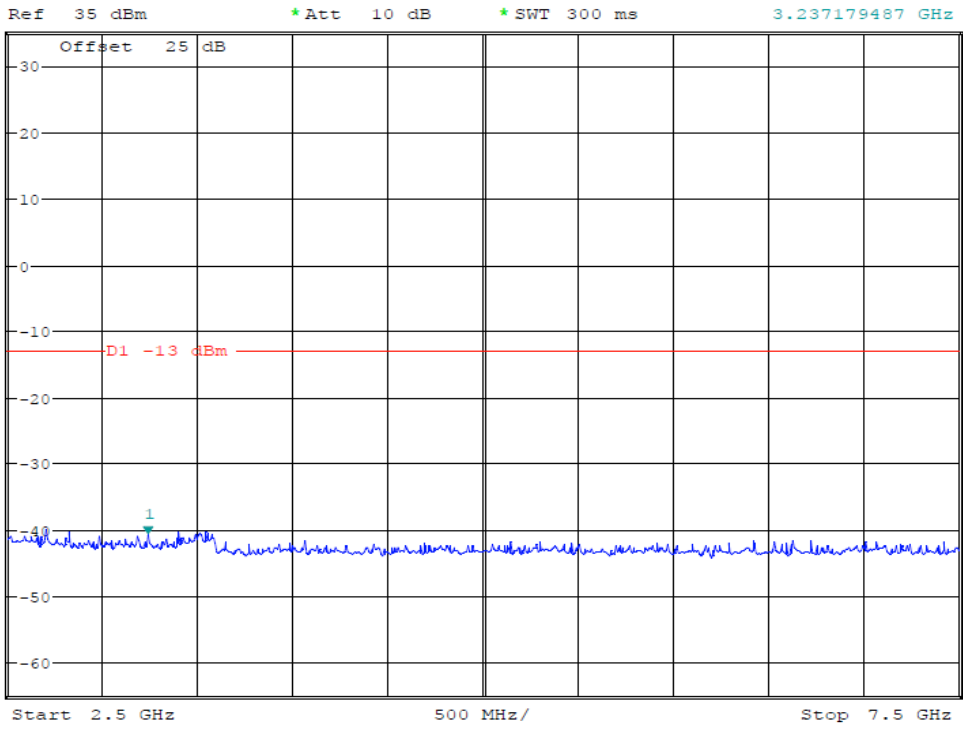

Date: 19.MAR.2014 15:26:09

(Plot 4.7.1 A3: Channel 128: 824.20MHz @ Traffic @ GSM850)



*RBW 1 MHz
*VBW 3 MHz
*SWT 300 ms
Marker 1 [T1]
-40.82 dBm
8.317307692 GHz

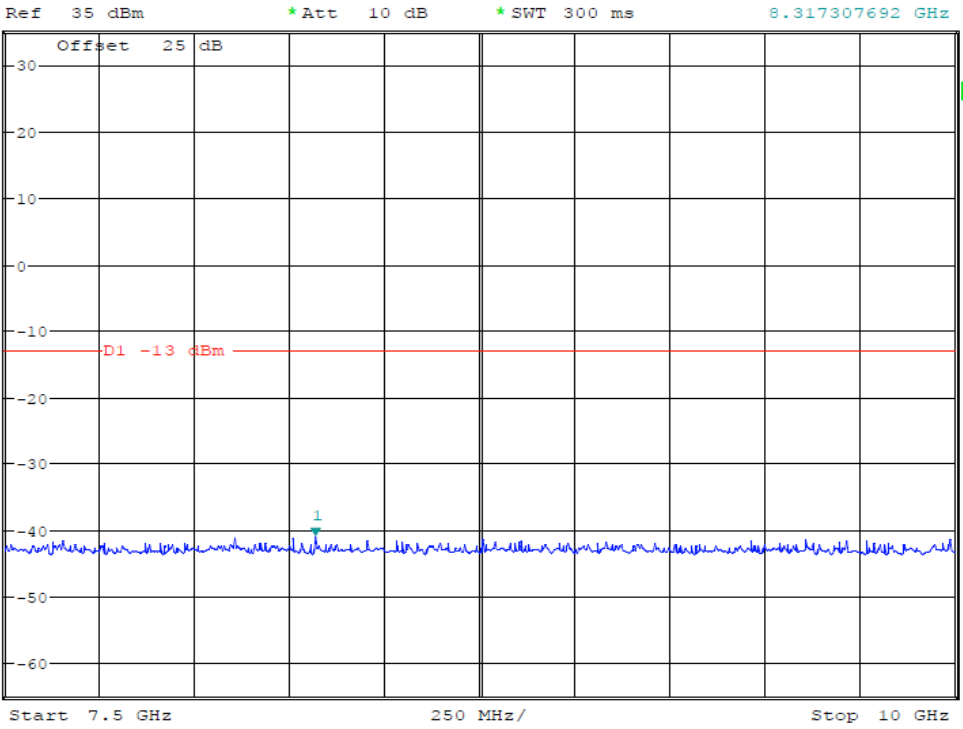

Date: 19.MAR.2014 15:26:27

(Plot 4.7.1 A4: Channel 128: 824.20MHz @ Traffic @ GSM850)

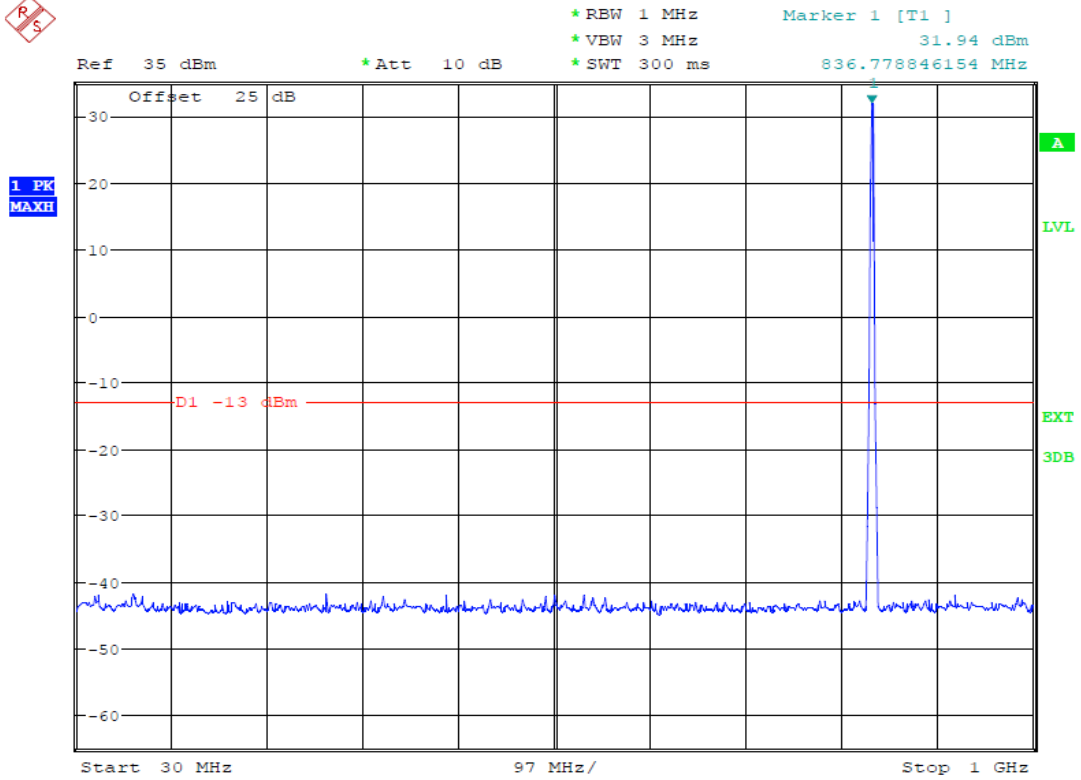

Date: 19.MAR.2014 15:26:59

(Plot 4.7.2 A1: Channel 190: 836.60MHz @ Traffic @ GSM850)

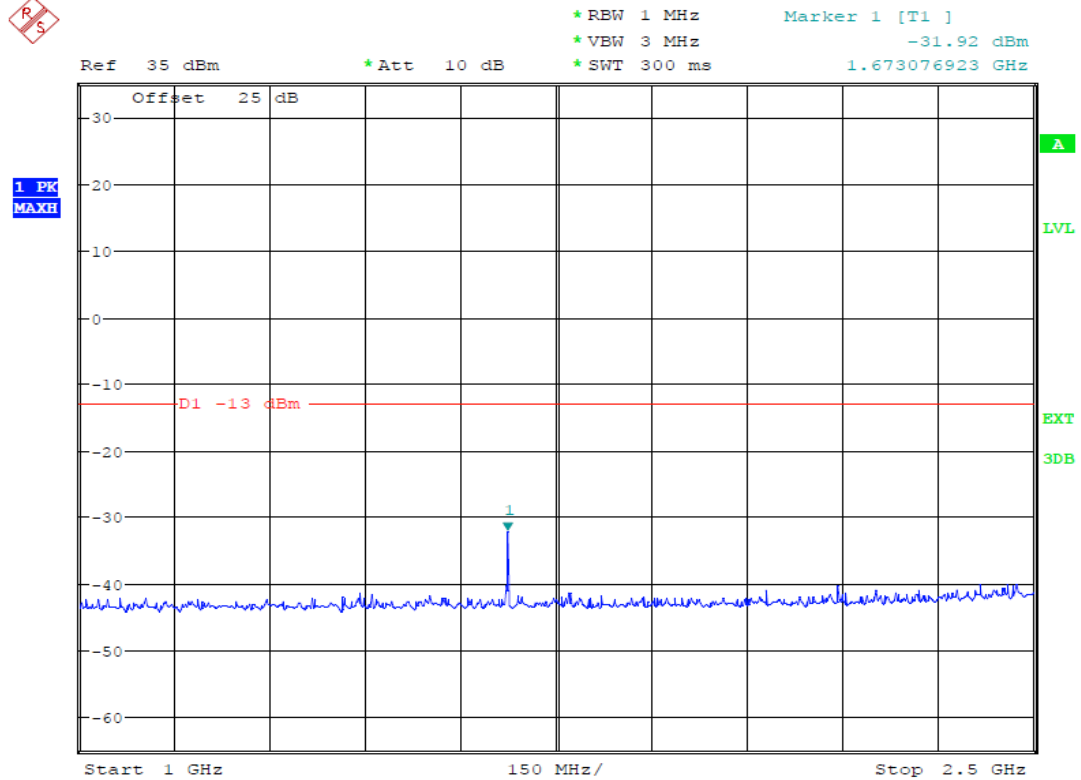

Date: 19.MAR.2014 15:27:27

(Plot 4.7.2 A2: Channel 190: 836.60MHz @ Traffic @ GSM850)

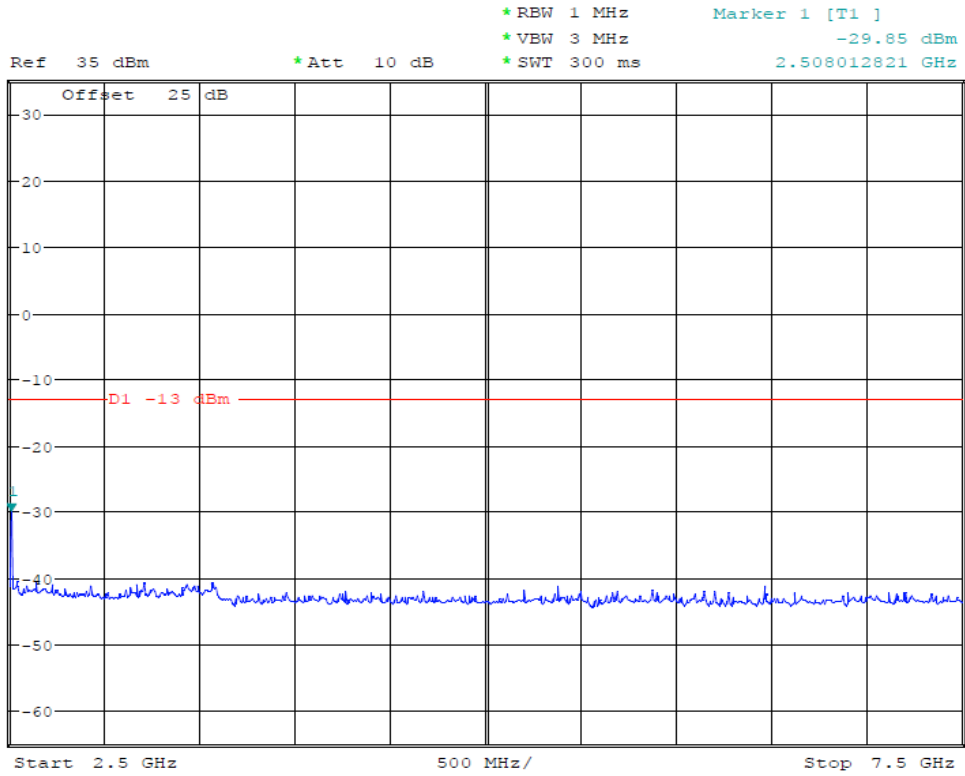

Date: 19.MAR.2014 15:27:48

(Plot 4.7.2 A3: Channel 190: 836.60MHz @ Traffic @ GSM850)

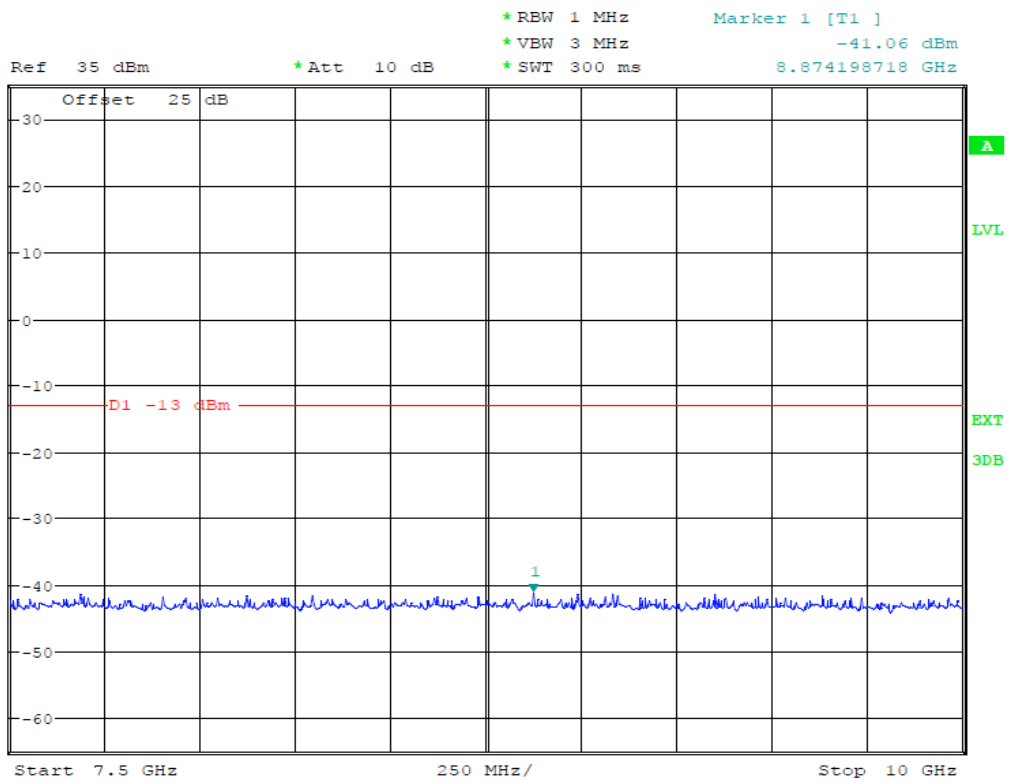

Date: 19.MAR.2014 15:28:03

(Plot 4.7.2 A4: Channel 190: 836.60MHz @ Traffic @ GSM850)

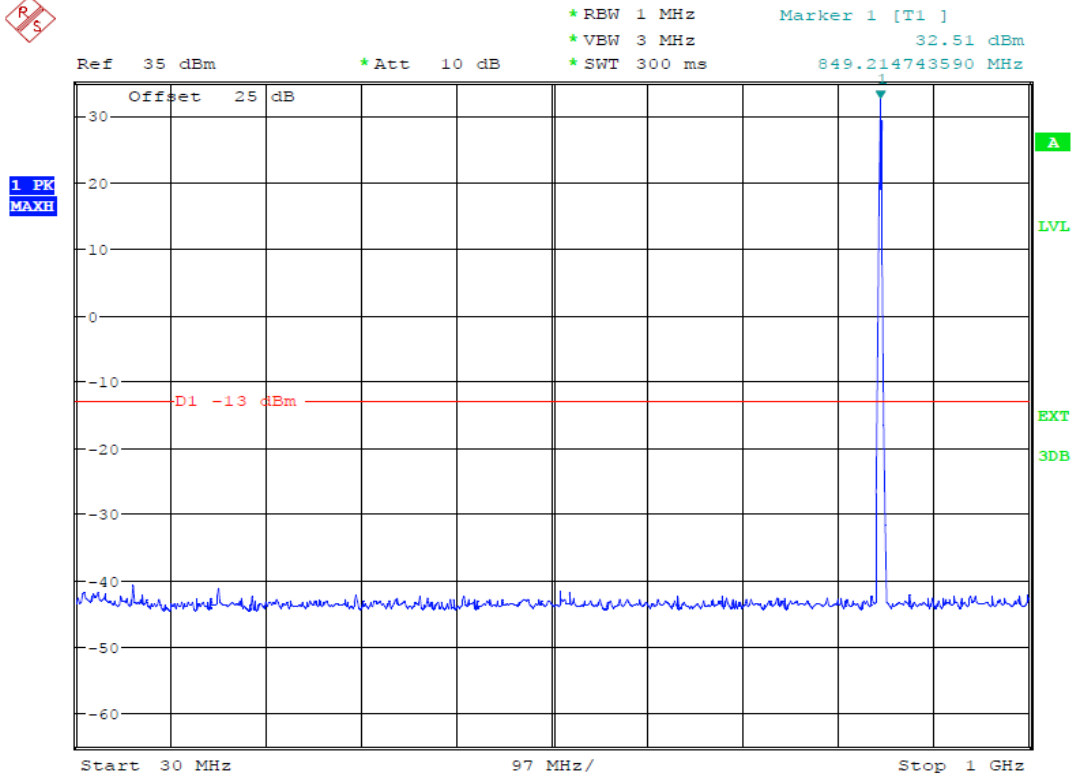

Date: 19.MAR.2014 15:28:33

(Plot 4.7.3 A1: Channel 251: 848.80MHz @ Traffic @ GSM850)

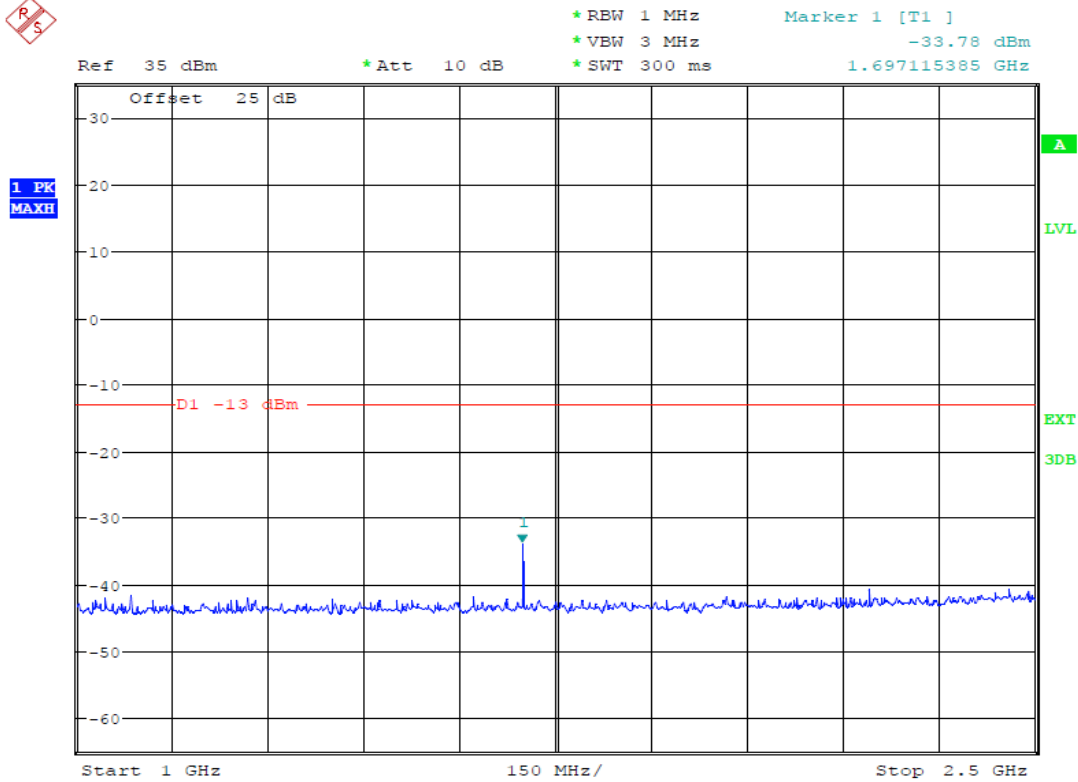

Date: 19.MAR.2014 15:28:45

(Plot 4.7.3 A2: Channel 251: 848.80MHz @ Traffic @ GSM850)

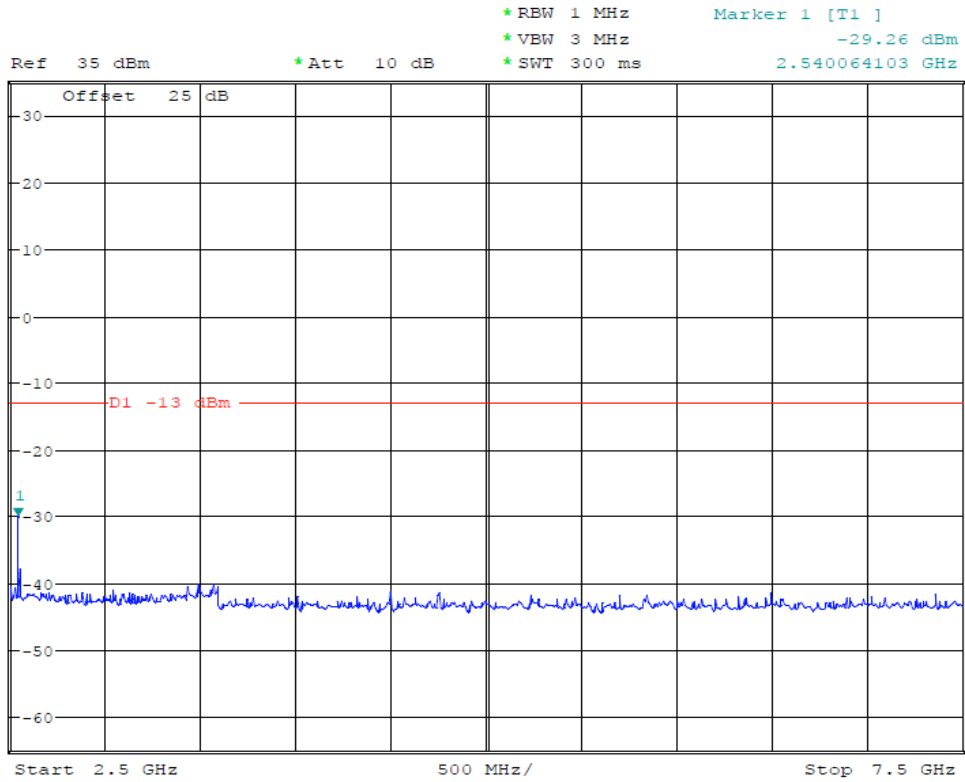

Date: 19.MAR.2014 15:29:00

(Plot 4.7.3 A3: Channel 251: 848.80MHz @ Traffic @ GSM850)

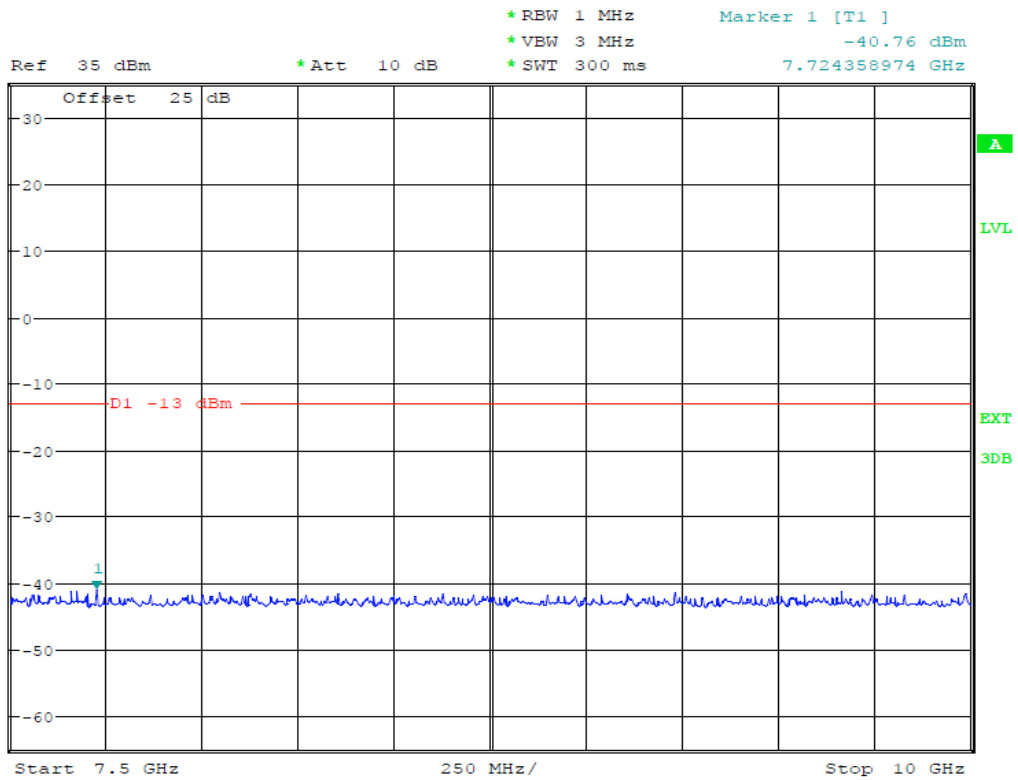

Date: 19.MAR.2014 15:29:23

(Plot 4.7.3 A4: Channel 251: 848.80MHz @ Traffic @ GSM850)

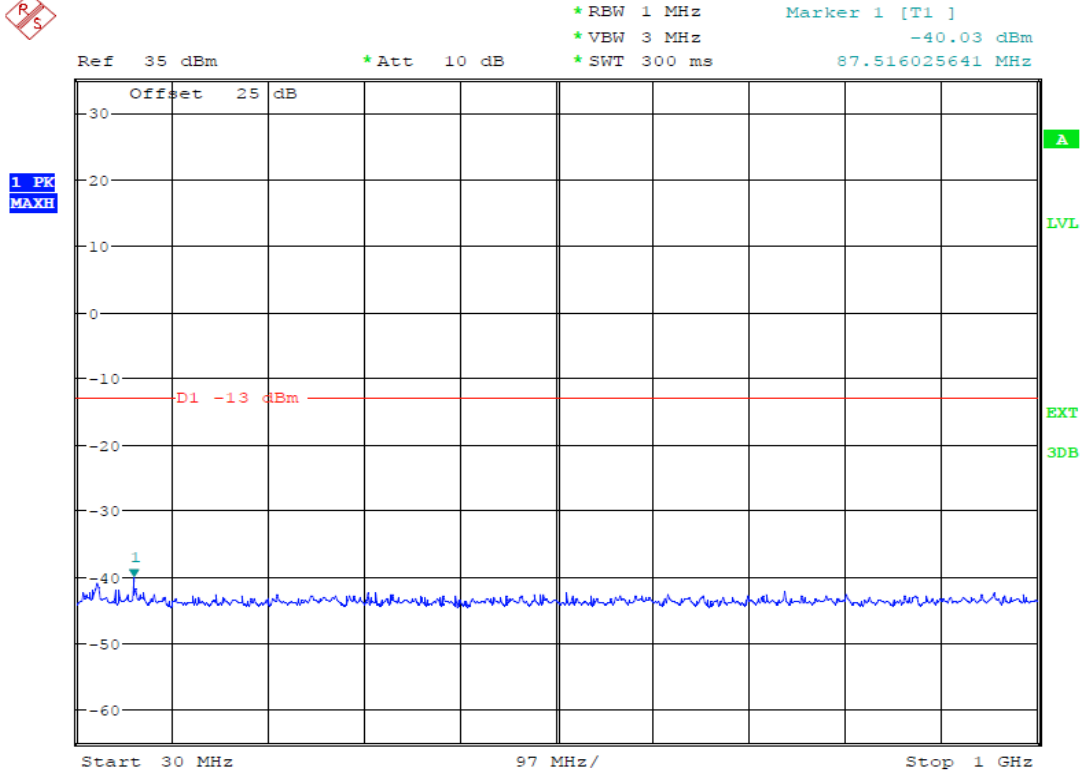

Date: 19.MAR.2014 15:29:55

(Plot 4.7.4 A1: Idle @ GSM850)

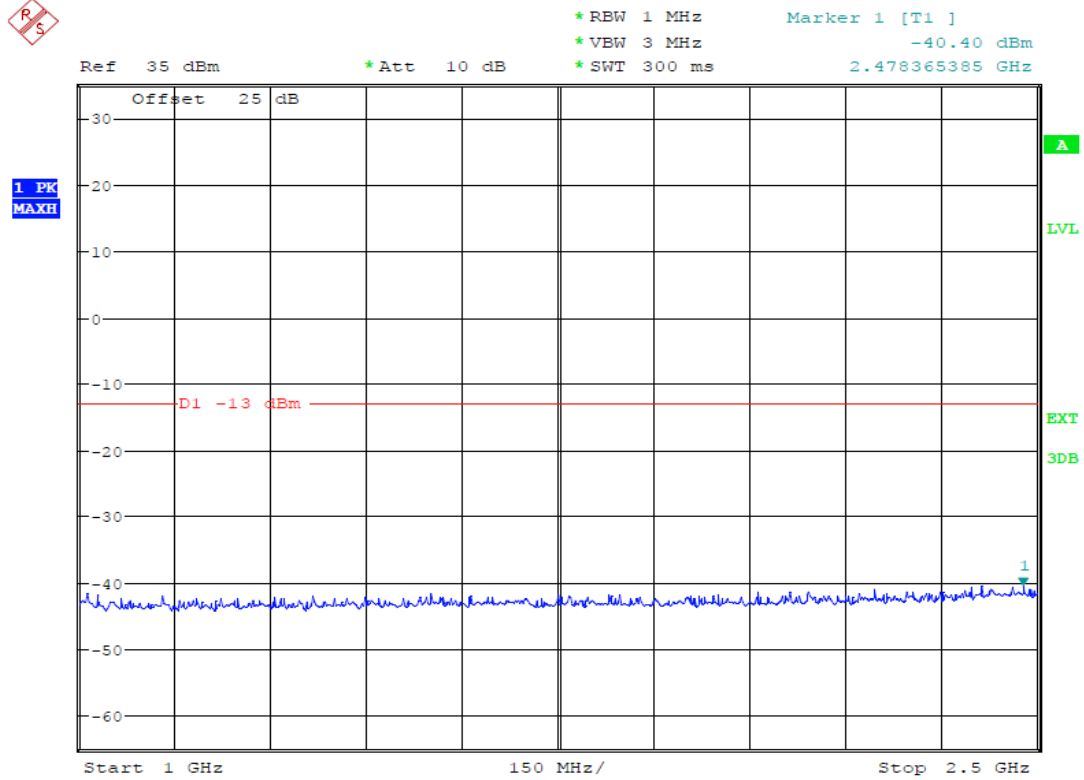

Date: 19.MAR.2014 15:30:18

(Plot 4.7.4 A2: Idle @ GSM850)

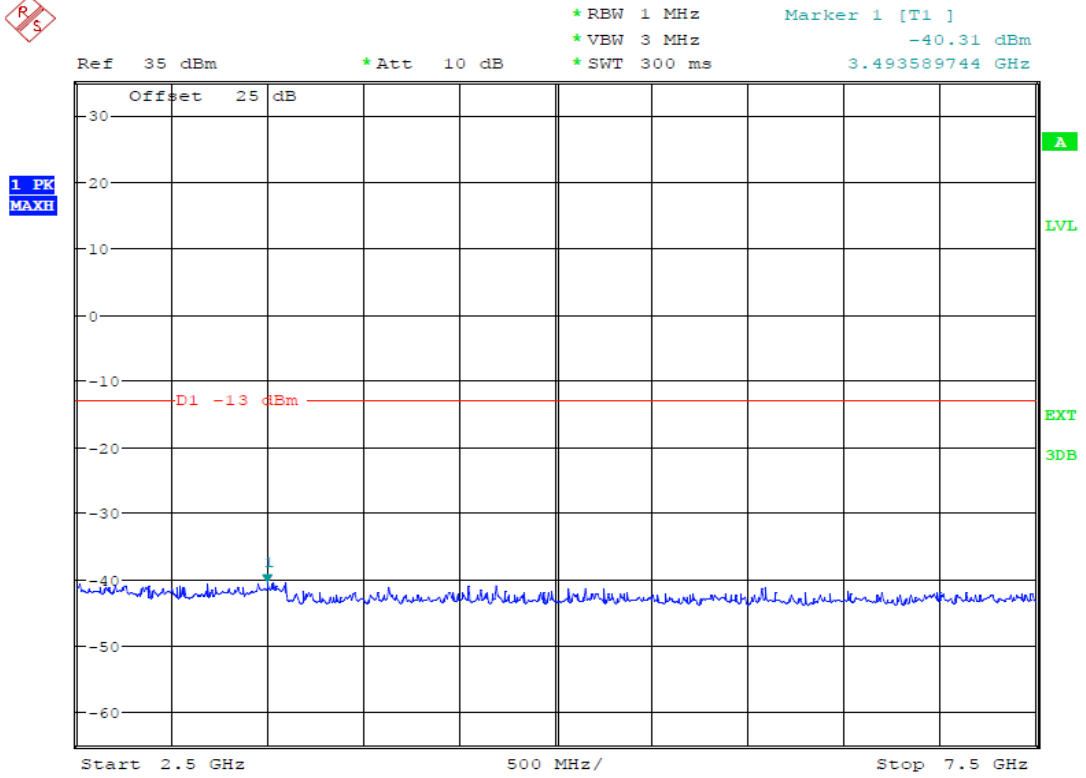

Date: 19.MAR.2014 15:30:39

(Plot 4.7.4 A3: Idle @ GSM850)

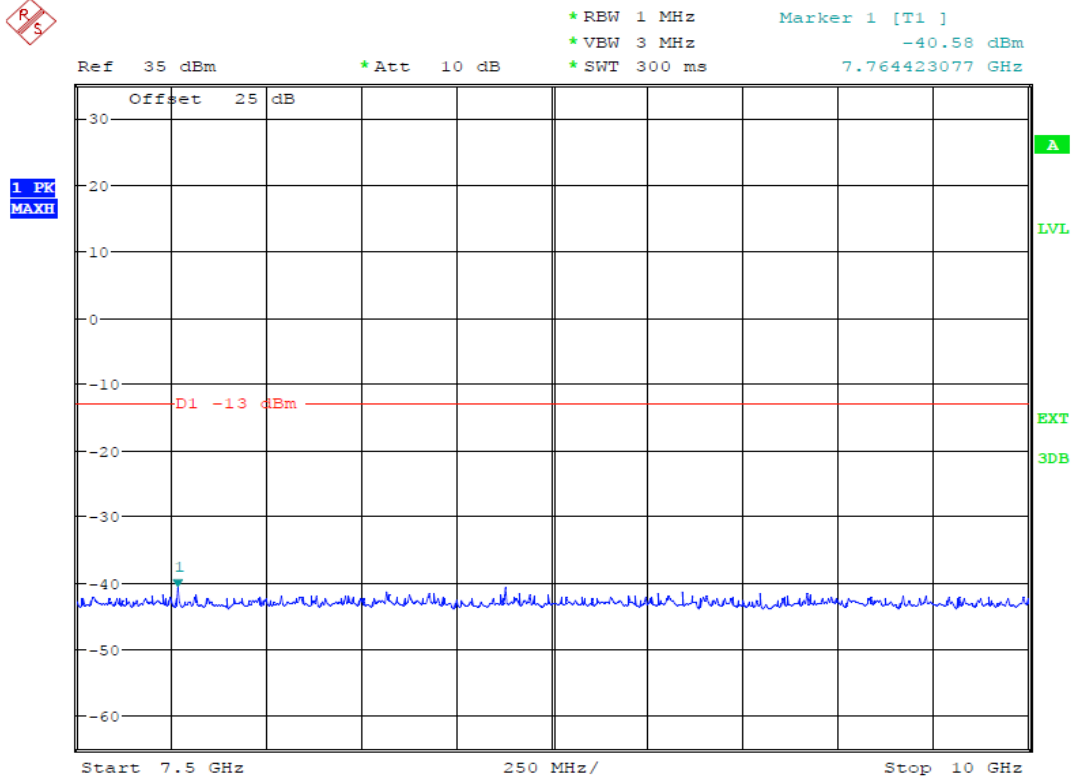

Date: 19.MAR.2014 15:30:53

(Plot 4.7.4 A4: Idle @ GSM850)

PCS1900						
Channel Number: 512		Test Frequency: 1850.20 MHz			Test Mode: Traffic	
Start Frequency (MHz)	Stop Frequency (MHz)	Measurement Results		Limit (dBm)	Refer to Plot	Verdict
		Frequency (MHz)	Values (dBm)			
30	1000	42.44	-38.23	-13.00	Plot 4.7.5 A1	PASS
1000	2500	***	***	-13.00	Plot 4.7.5 A2	PASS
2500	7500	3565.71	-37.71	-13.00	Plot 4.7.5 A3	PASS
7500	10000	7792.47	-38.82	-13.00	Plot 4.7.5 A4	PASS
10000	15000	13565.71	-38.59	-13.00	Plot 4.7.5 A5	PASS
15000	20000	15426.78	-38.34	-13.00	Plot 4.7.5 A6	PASS

PCS1900						
Channel Number: 661		Test Frequency: 1880.00 MHz			Test Mode: Traffic	
Start Frequency (MHz)	Stop Frequency (MHz)	Measurement Results		Limit (dBm)	Refer to Plot	Verdict
		Frequency (MHz)	Values (dBm)			
30	1000	39.33	-35.89	-13.00	Plot 4.7.6 A1	PASS
1000	2500	***	***	-13.00	Plot 4.7.6 A2	PASS
2500	7500	3509.62	-38.11	-13.00	Plot 4.7.6 A3	PASS
7500	10000	8553.69	-38.37	-13.00	Plot 4.7.6 A4	PASS
10000	15000	14270.83	-37.17	-13.00	Plot 4.7.6 A5	PASS
15000	20000	18092.95	-37.03	-13.00	Plot 4.7.6 A6	PASS

PCS1900						
Channel Number: 810		Test Frequency: 1909.80 MHz			Test Mode: Traffic	
Start Frequency (MHz)	Stop Frequency (MHz)	Measurement Results		Limit (dBm)	Refer to Plot	Verdict
		Frequency (MHz)	Values (dBm)			
30	1000	42.44	-38.24	-13.00	Plot 4.7.7 A1	PASS
1000	2500	***	***	-13.00	Plot 4.7.7 A2	PASS
2500	7500	3349.36	-36.75	-13.00	Plot 4.7.7 A3	PASS
7500	10000	9739.58	-36.98	-13.00	Plot 4.7.7 A4	PASS
10000	15000	14615.38	-37.08	-13.00	Plot 4.7.7 A5	PASS
15000	20000	17395.83	-36.77	-13.00	Plot 4.7.7 A6	PASS

PCS1900						
Test Mode: Idle						
Start Frequency (MHz)	Stop Frequency (MHz)	Measurement Results		Limit (dBm)	Refer to Plot	Verdict
		Frequency (MHz)	Values (dBm)			
30	1000	40.88	-38.97	-13.00	Plot 4.7.8 A1	PASS
1000	2500	2487.98	-36.82	-13.00	Plot 4.7.8 A2	PASS
2500	7500	3509.62	-37.33	-13.00	Plot 4.7.8 A3	PASS
7500	10000	8605.77	-38.01	-13.00	Plot 4.7.8 A4	PASS
10000	15000	10873.40	-37.49	-13.00	Plot 4.7.8 A5	PASS
15000	20000	16907.05	-36.68	-13.00	Plot 4.7.8 A6	PASS

Note: 1. In general, the worse case attenuation requirement shown above was applied.
 2. *** means that the emission level is too low to be measured or at least 20 dB down than the limit.

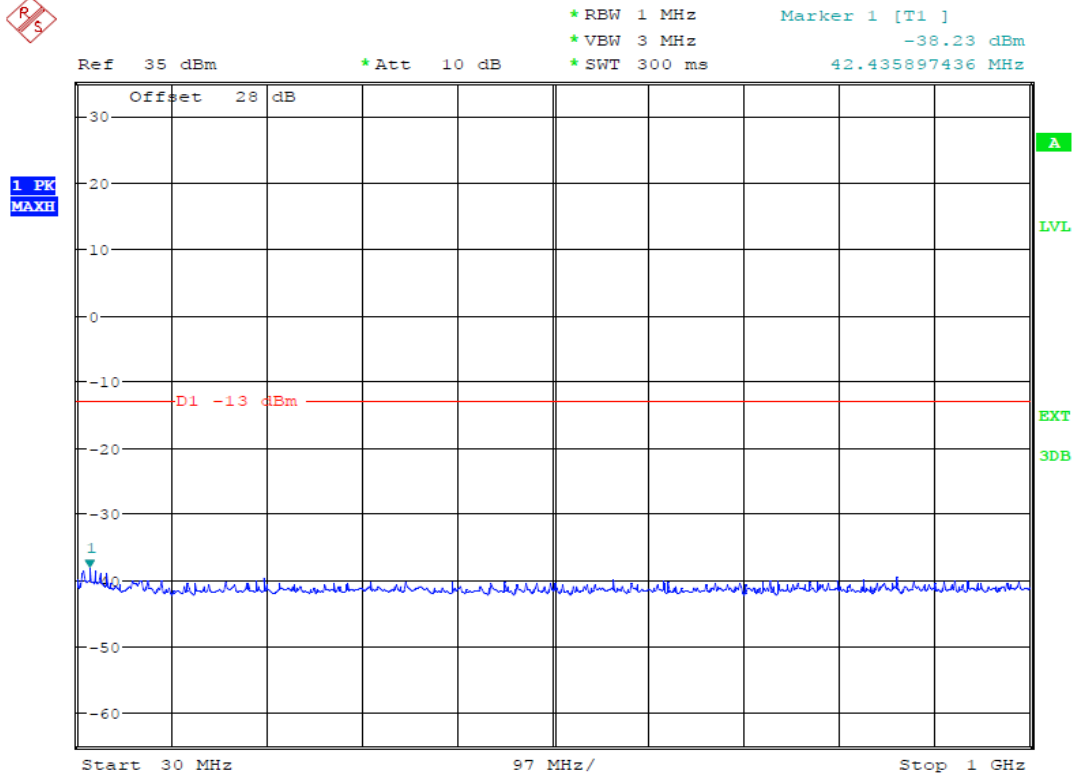

Date: 19.MAR.2014 13:34:42

(Plot 4.7.5 A1: Channel 512: 1850.20MHz @ Traffic @ PCS1900)

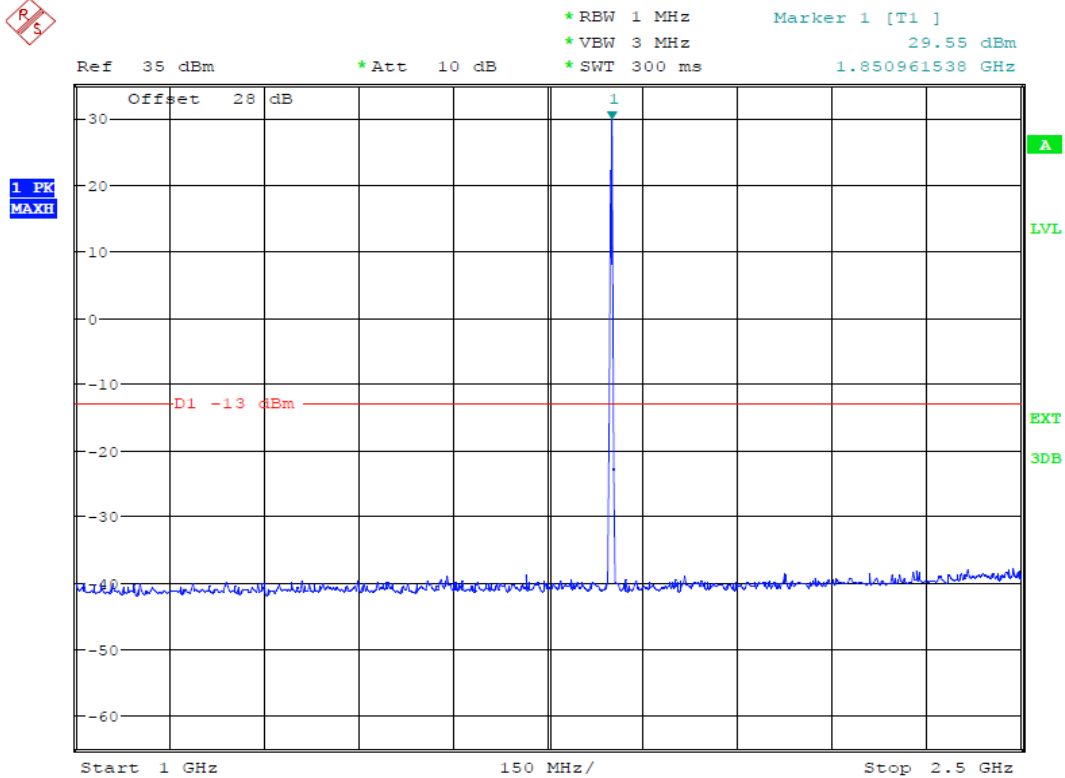

Date: 19.MAR.2014 13:35:23

(Plot 4.7.5 A2: Channel 512: 1850.20MHz @ Traffic @ PCS1900)



Ref 35 dBm *Att 10 dB *RBW 1 MHz *VBW 3 MHz *SWT 300 ms Marker 1 [T1] -37.71 dBm 3.565705128 GHz

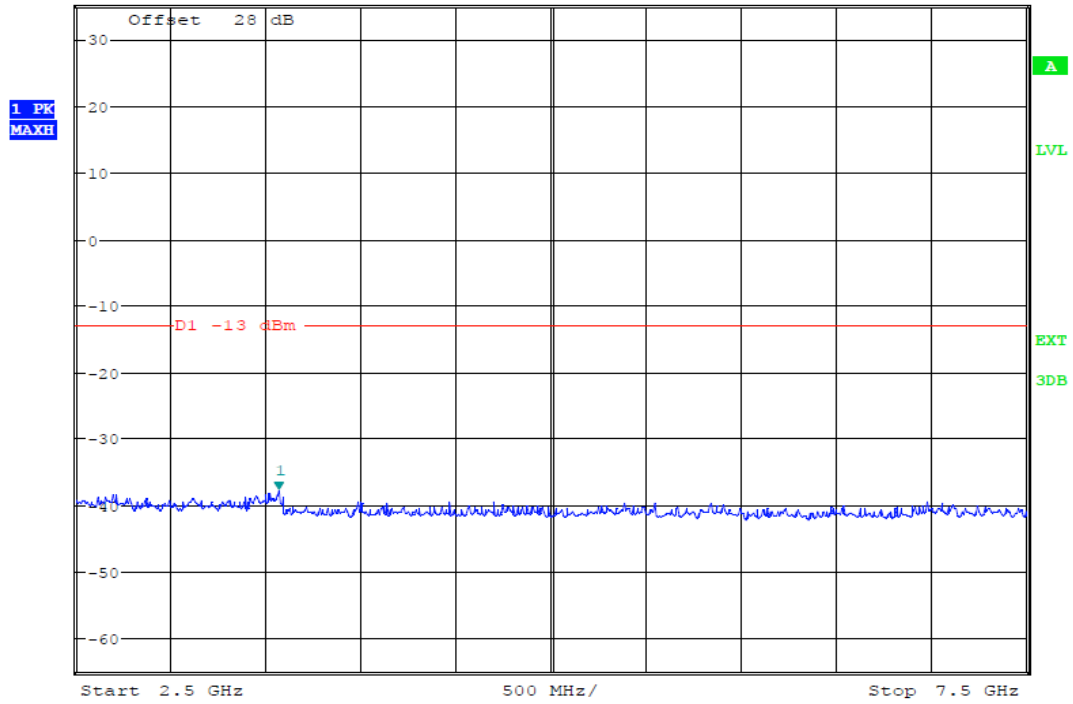

Date: 19.MAR.2014 13:35:51

(Plot 4.7.5 A3: Channel 512: 1850.20MHz @ Traffic @ PCS1900)



Ref 35 dBm *Att 10 dB *RBW 1 MHz *VBW 3 MHz *SWT 300 ms Marker 1 [T1] -38.82 dBm 7.792467949 GHz

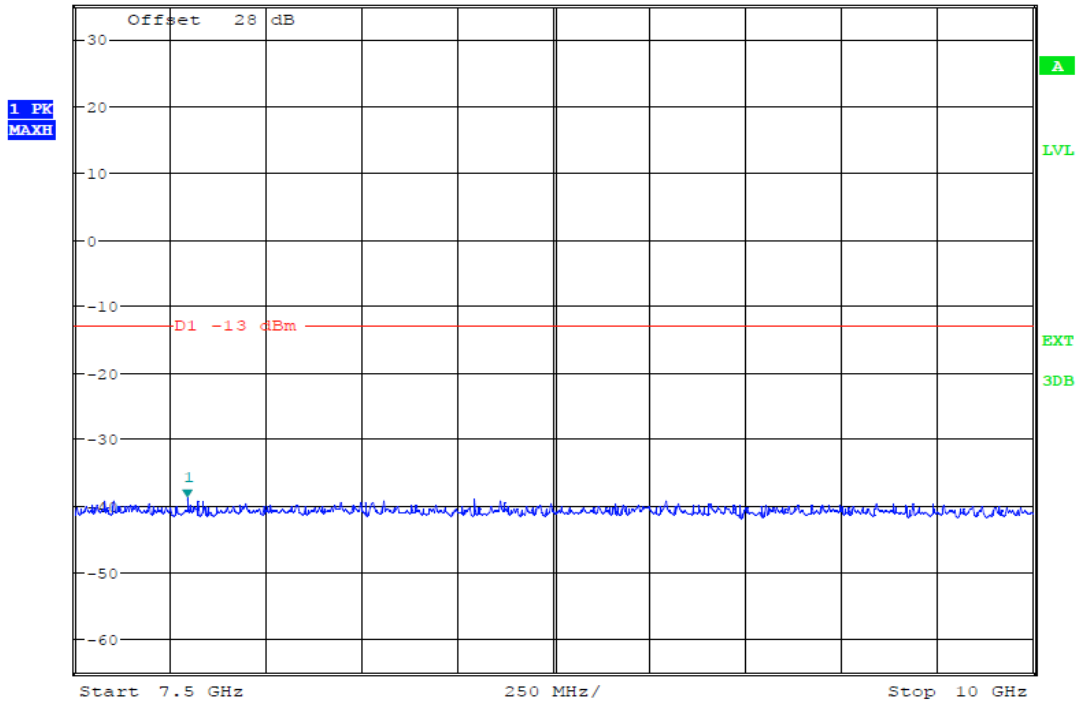

Date: 19.MAR.2014 13:36:15

(Plot 4.7.5 A4: Channel 512: 1850.20MHz @ Traffic @ PCS1900)

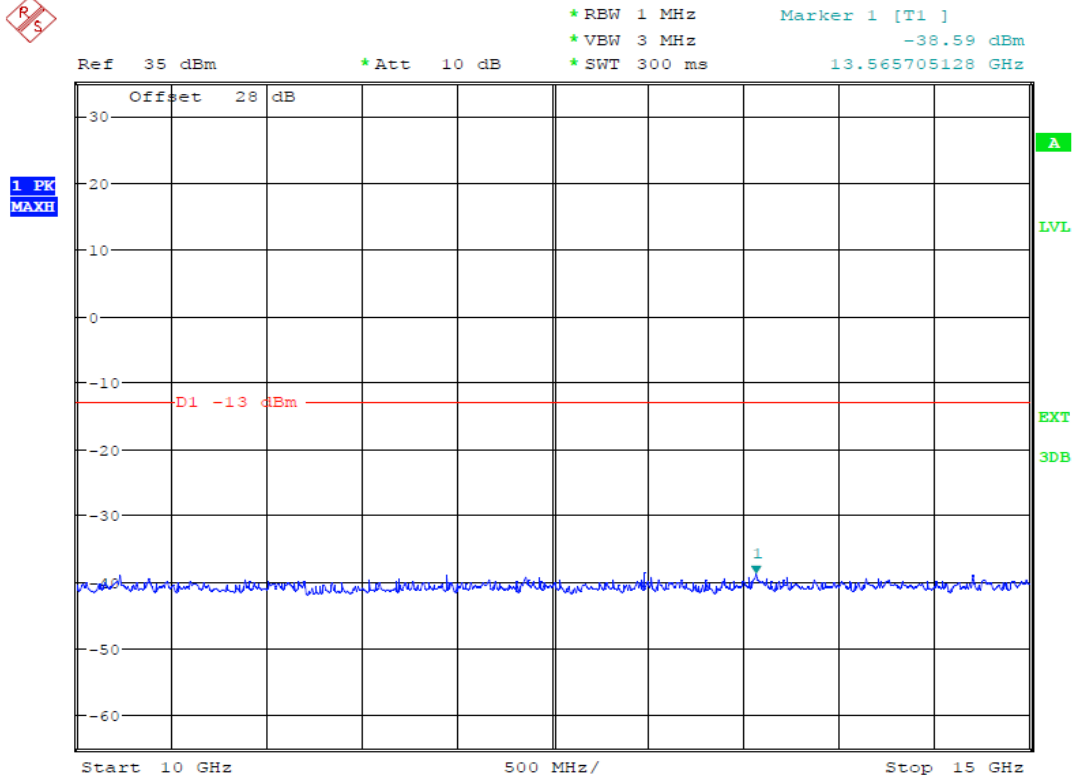

Date: 19.MAR.2014 13:37:02

(Plot 4.7.5 A5: Channel 512: 1850.20MHz @ Traffic @ PCS1900)

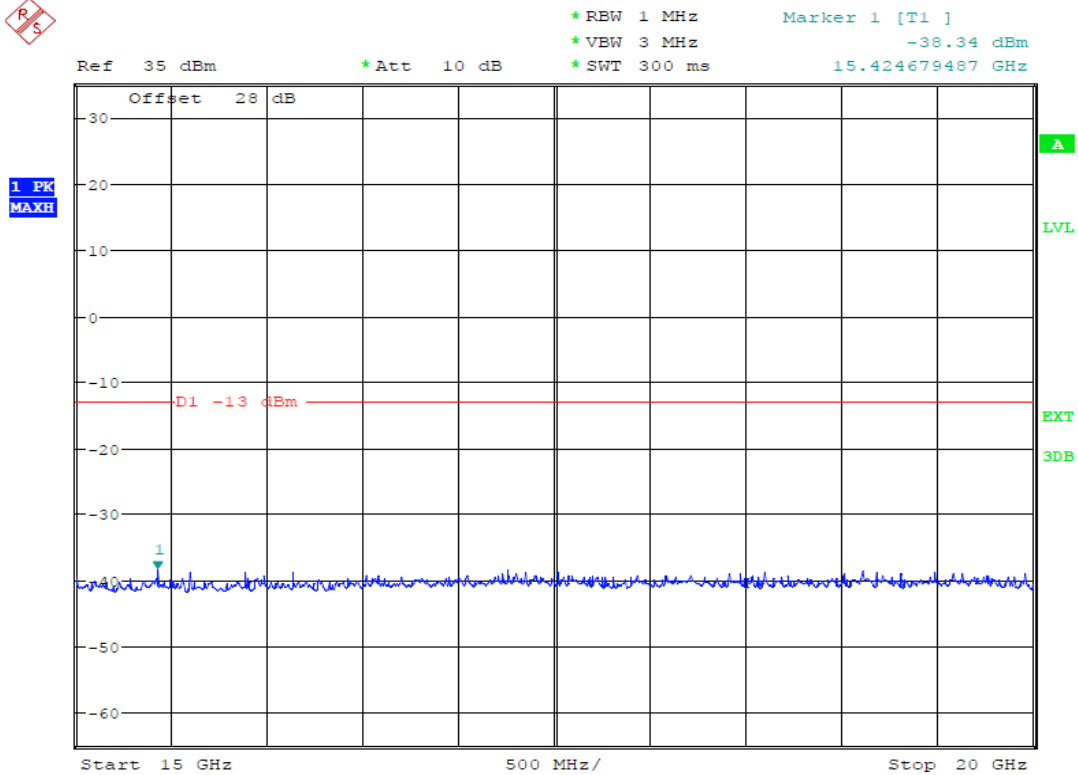

Date: 19.MAR.2014 13:37:28

(Plot 4.7.5 A6: Channel 512: 1850.20MHz @ Traffic @ PCS1900)

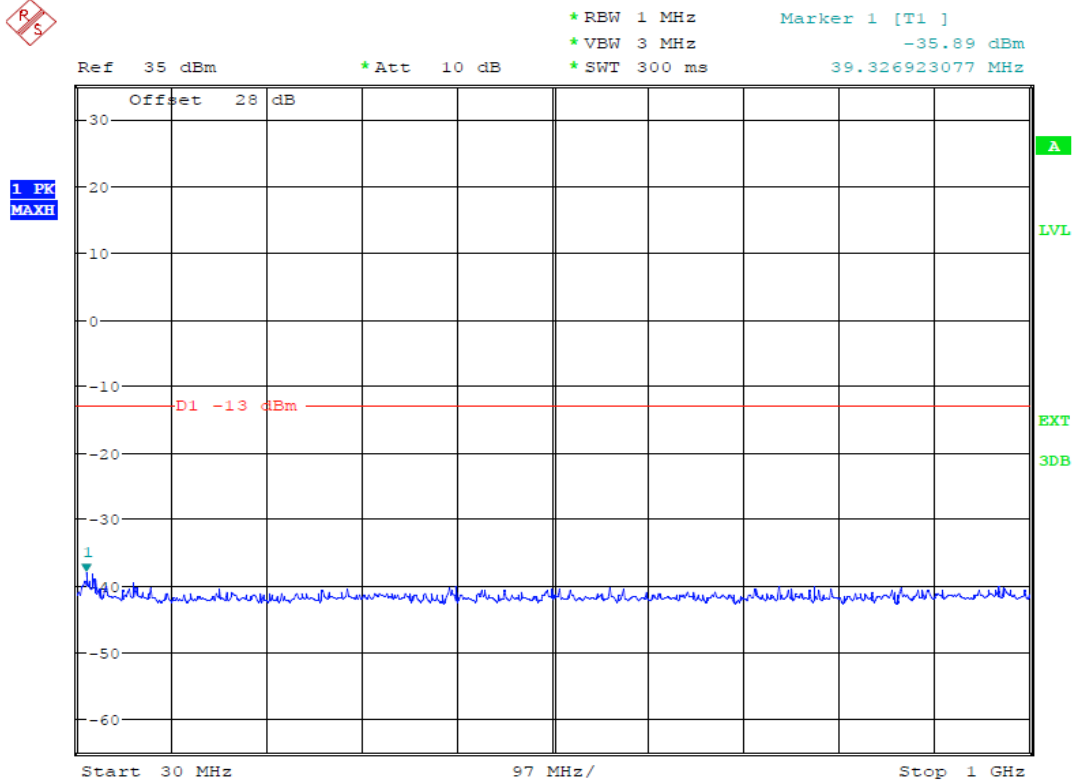

Date: 19.MAR.2014 13:37:55

(Plot 4.7.6 A1: Channel 661: 1880.00MHz @ Traffic @ PCS1900)

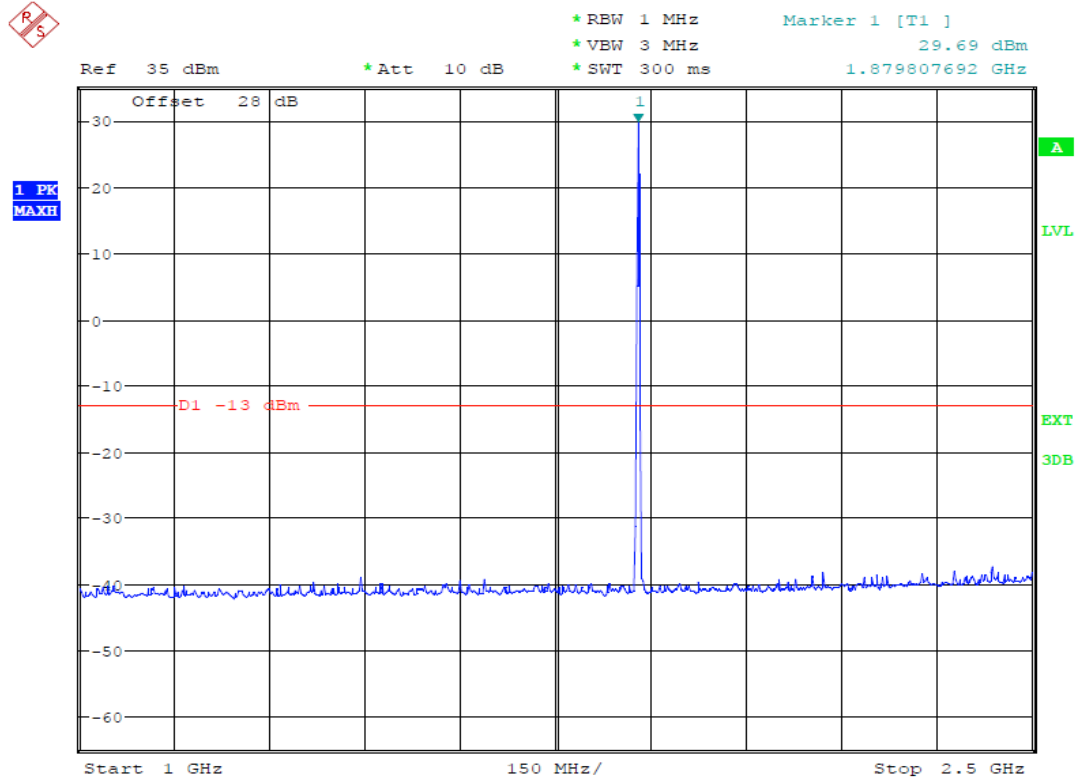

Date: 19.MAR.2014 13:38:57

(Plot 4.7.6 A2: Channel 661: 1880.00MHz @ Traffic @ PCS1900)

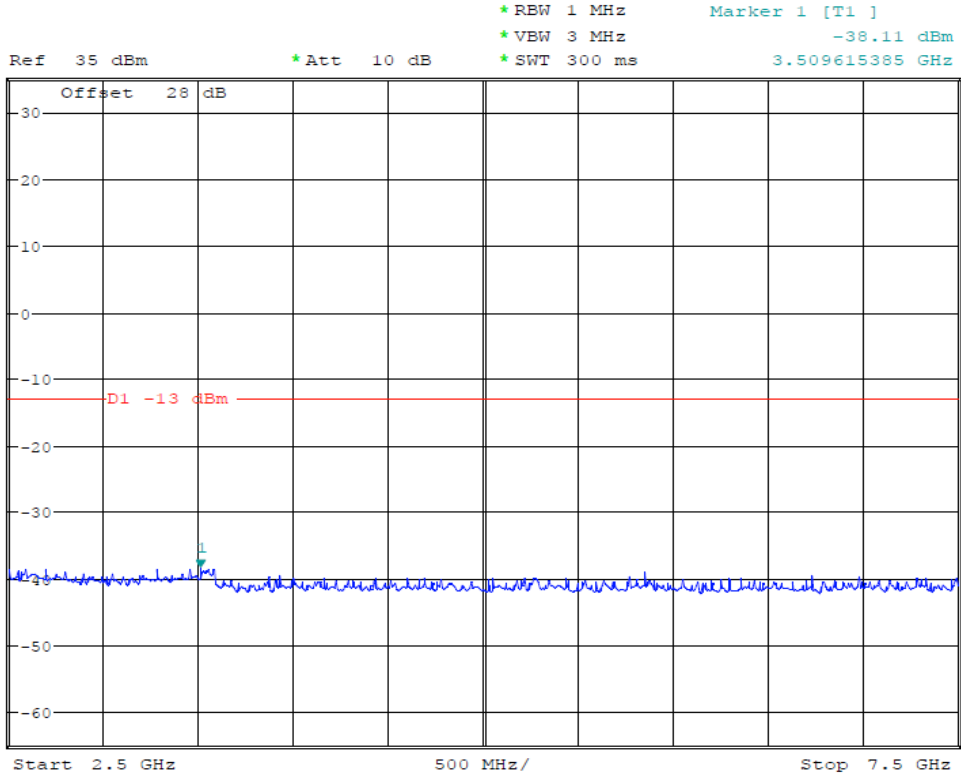

Date: 19.MAR.2014 13:39:24

(Plot 4.7.6 A3: Channel 661: 1880.00MHz @ Traffic @ PCS1900)

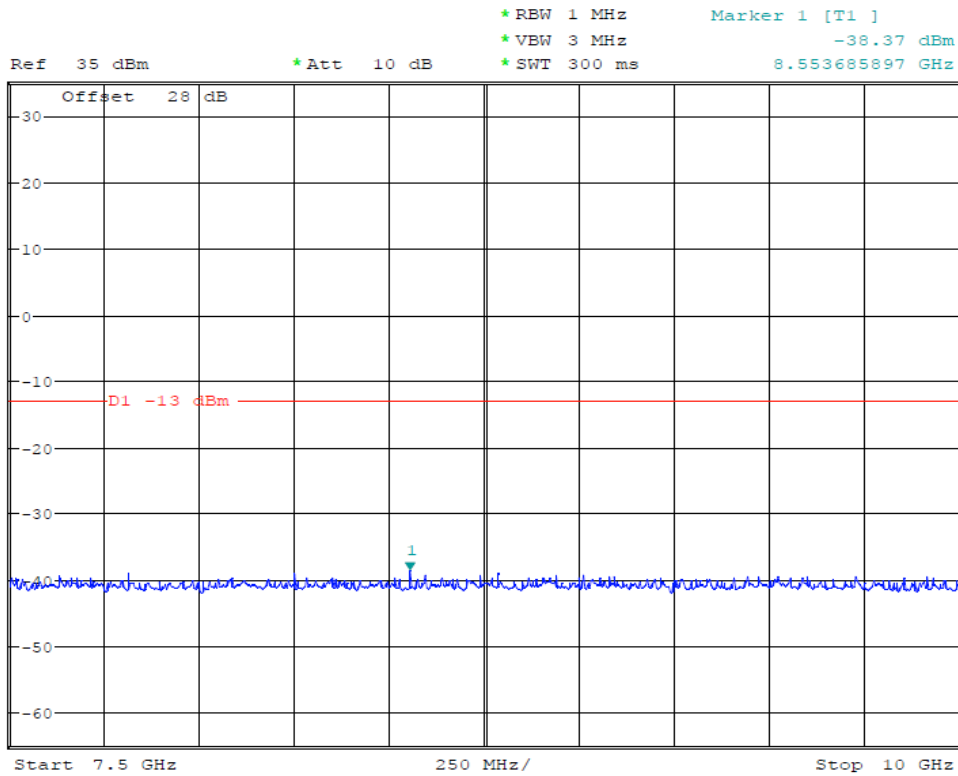

Date: 19.MAR.2014 13:39:46

(Plot 4.7.6 A4: Channel 661: 1880.00MHz @ Traffic @ PCS1900)



Ref 35 dBm *Att 10 dB *RBW 1 MHz *VSW 3 MHz *SWT 300 ms Marker 1 [T1]
-37.17 dBm
14.270833333 GHz

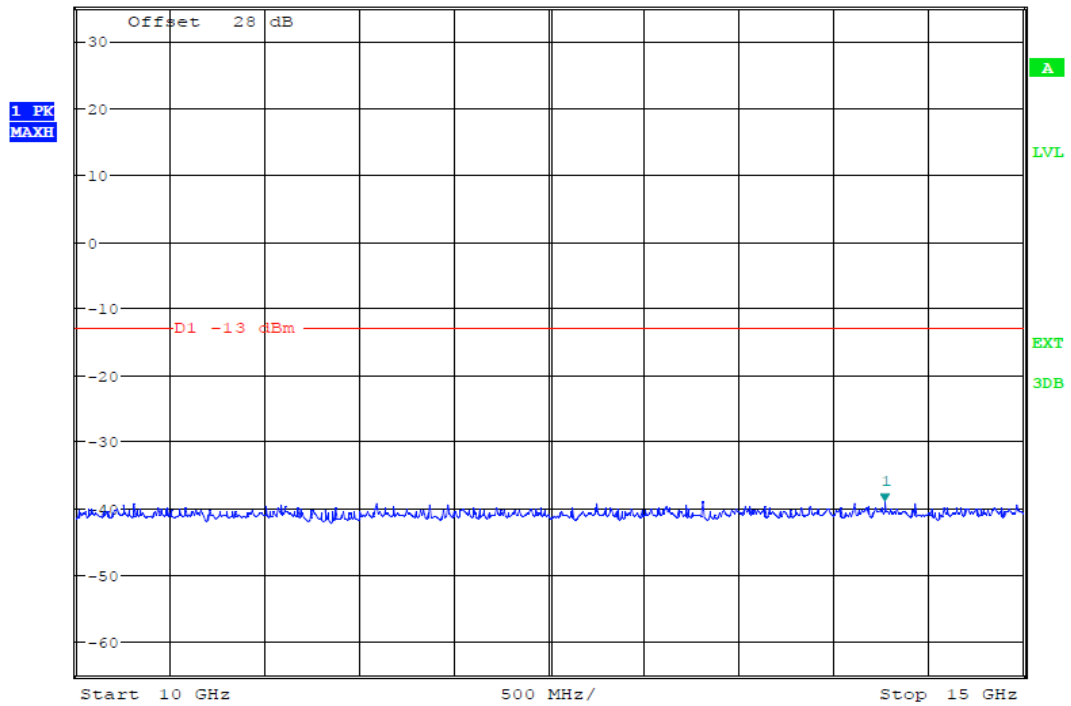

Date: 19.MAR.2014 13:40:06

(Plot 4.7.6 A5: Channel 661: 1880.00MHz @ Traffic @ PCS1900)



Ref 35 dBm *Att 10 dB *RBW 1 MHz *VSW 3 MHz *SWT 300 ms Marker 1 [T1]
-37.03 dBm
18.092948718 GHz

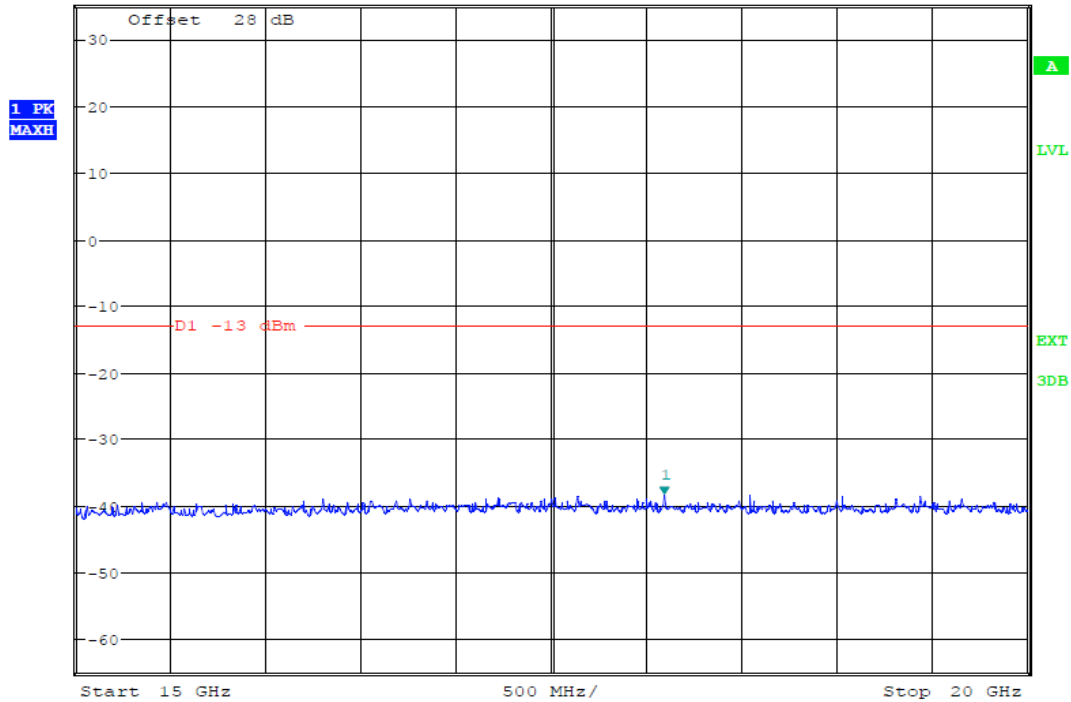

Date: 19.MAR.2014 13:40:22

(Plot 4.7.6 A6: Channel 661: 1880.00MHz @ Traffic @ PCS1900)

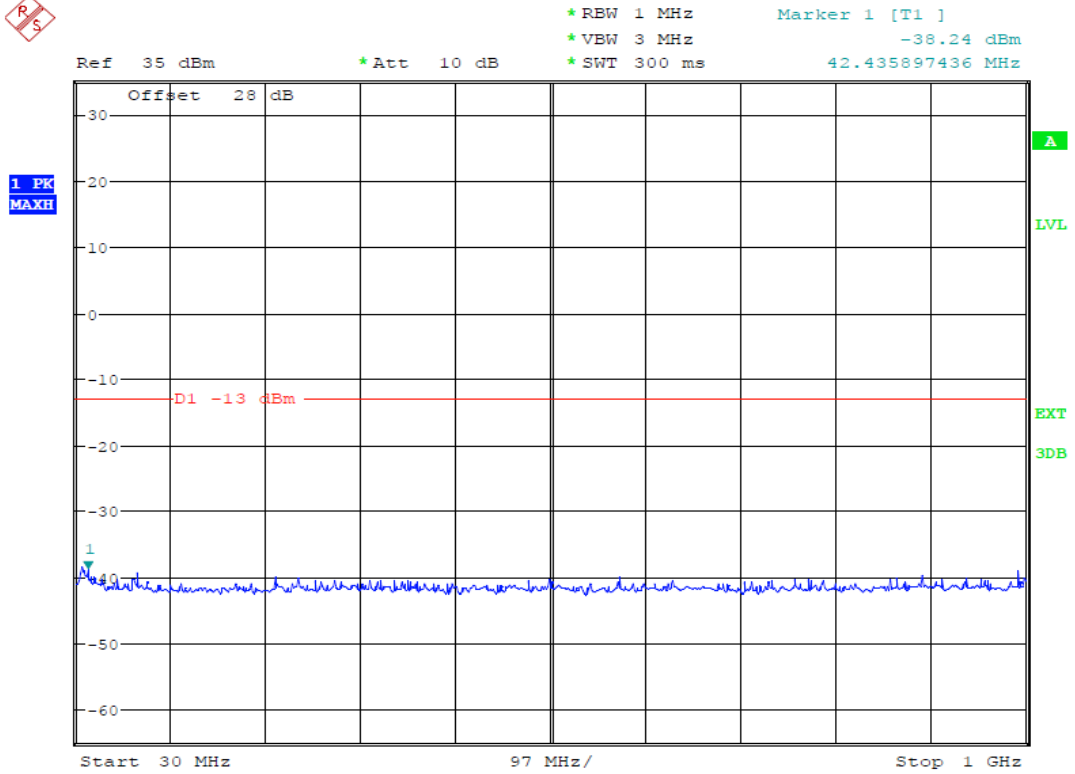

Date: 19.MAR.2014 13:40:54

(Plot 4.7.7 A1: Channel 810: 1909.80MHz @ Traffic @ PCS1900)

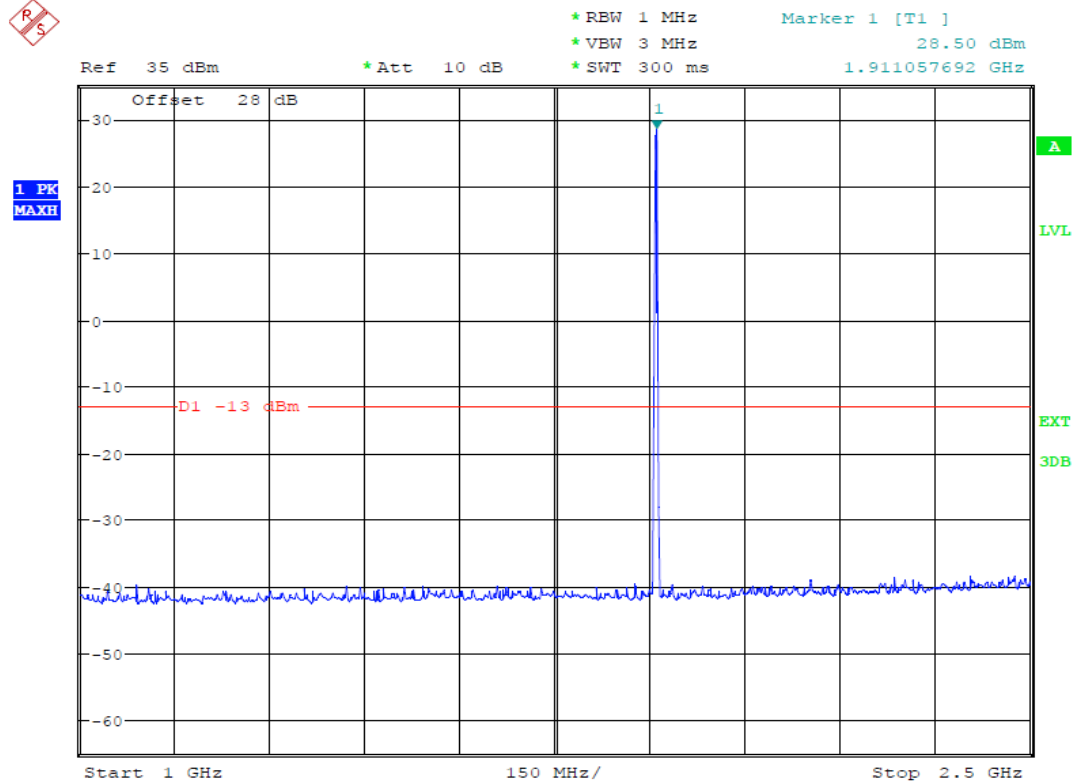

Date: 19.MAR.2014 13:41:28

(Plot 4.7.7 A2: Channel 810: 1909.80MHz @ Traffic @ PCS1900)

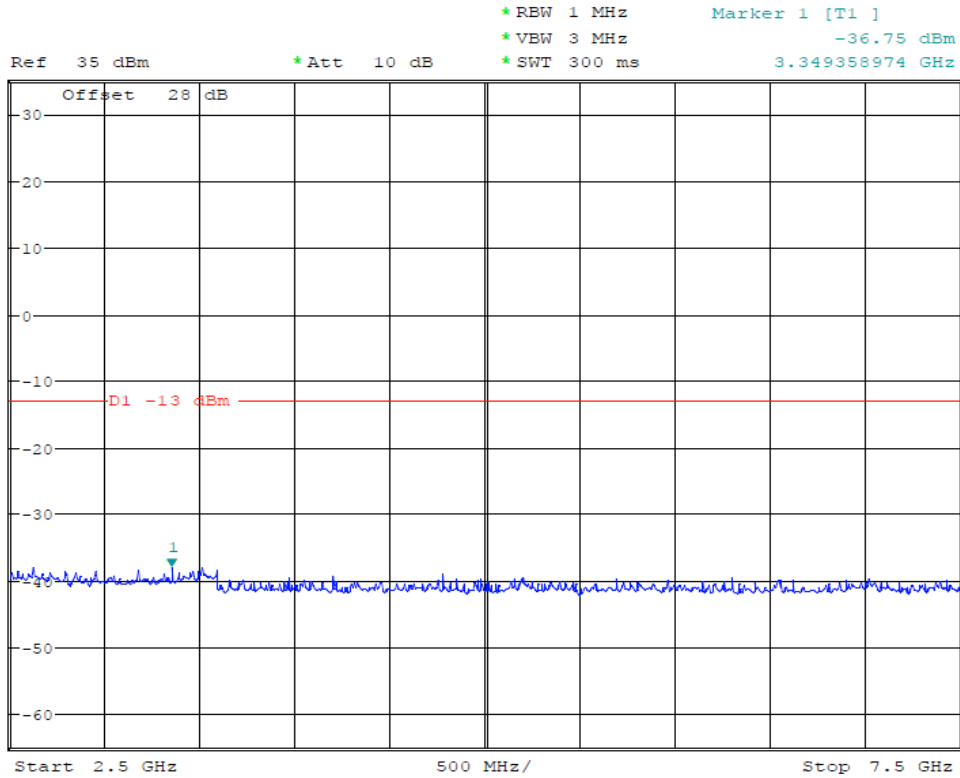

Date: 19.MAR.2014 13:41:52

(Plot 4.7.7 A3: Channel 810: 1909.80MHz @ Traffic @ PCS1900)

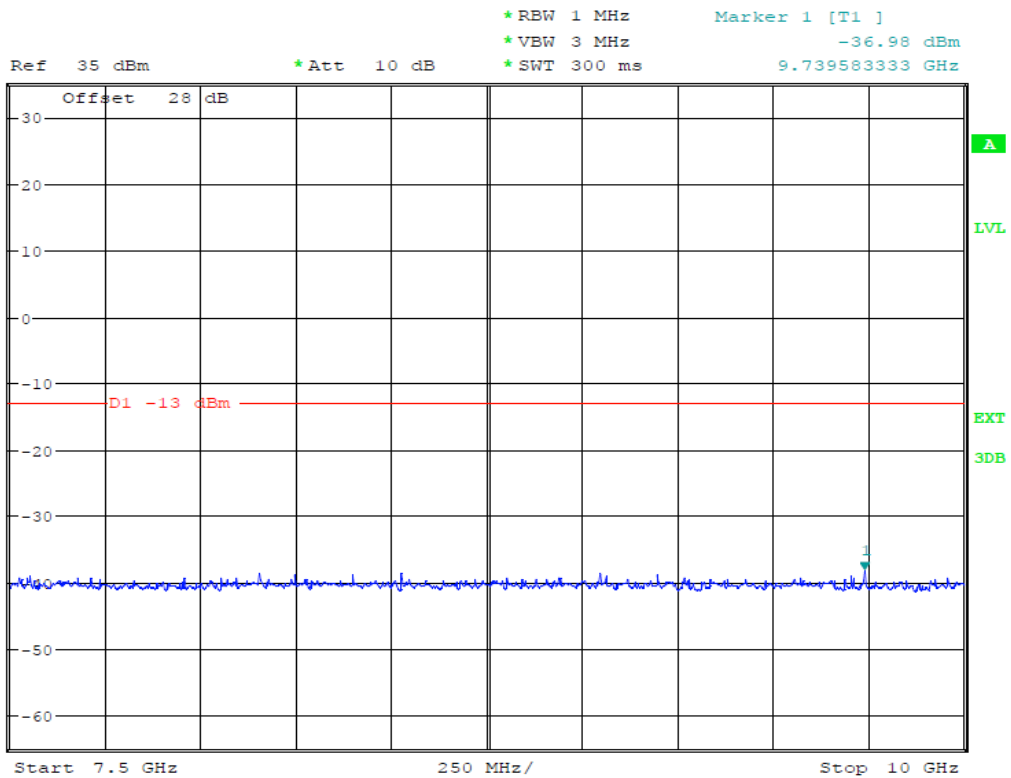

Date: 19.MAR.2014 13:42:46

(Plot 4.7.7 A4: Channel 810: 1909.80MHz @ Traffic @ PCS1900)

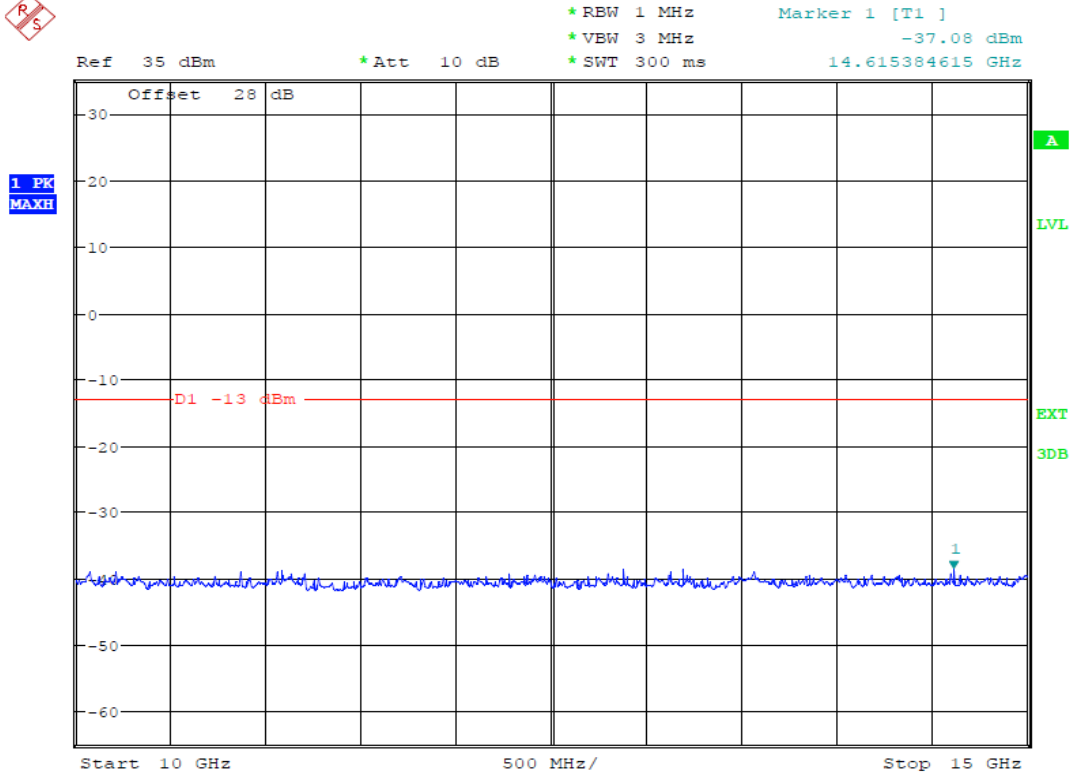

Date: 19.MAR.2014 13:43:13

(Plot 4.7.7 A5: Channel 810: 1909.80MHz @ Traffic @ PCS1900)

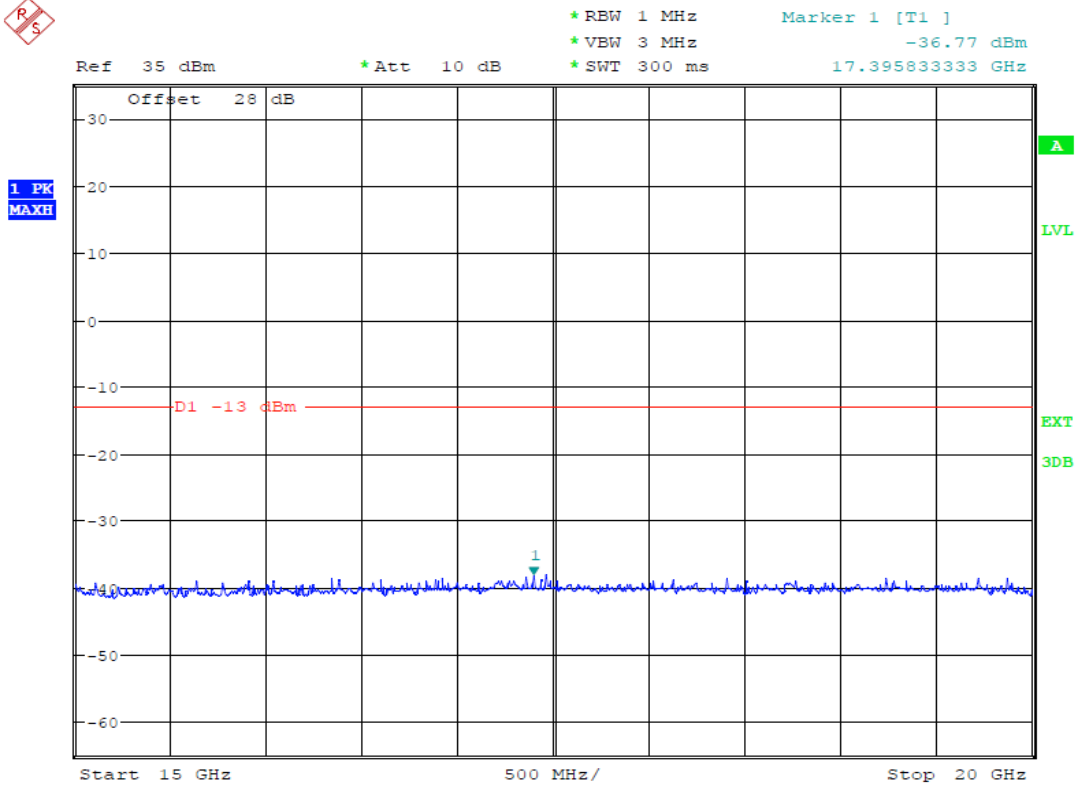

Date: 19.MAR.2014 13:43:38

(Plot 4.7.7 A6: Channel 810: 1909.80MHz @ Traffic @ PCS1900)

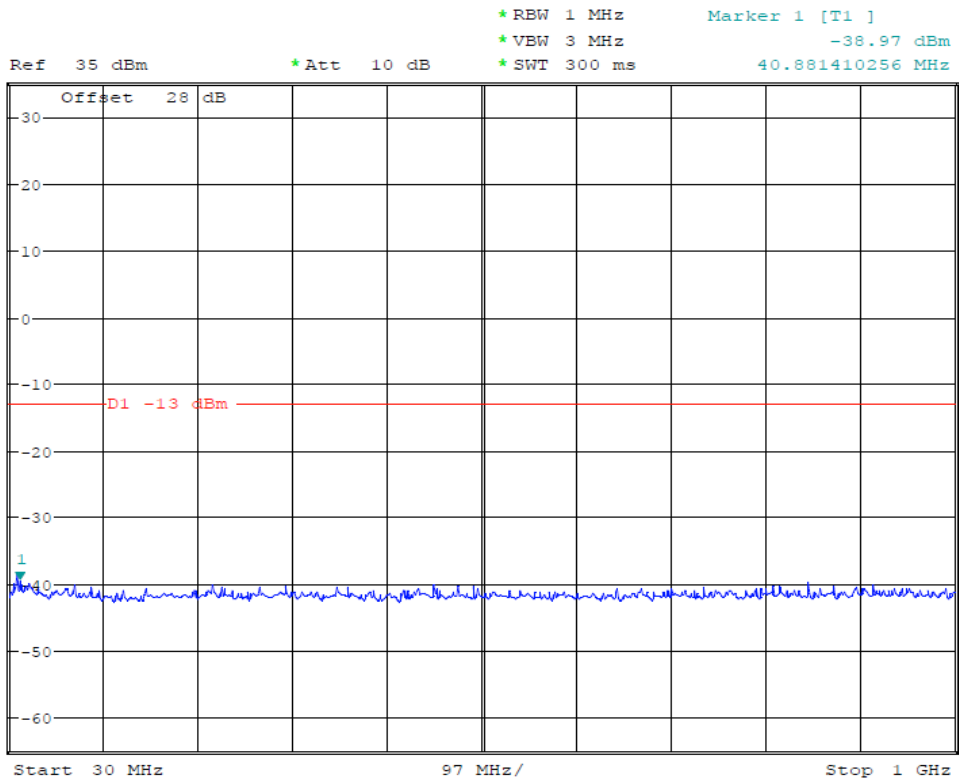

Date: 19.MAR.2014 13:45:21

(Plot 4.7.8 A1: Idle @ PCS1900)

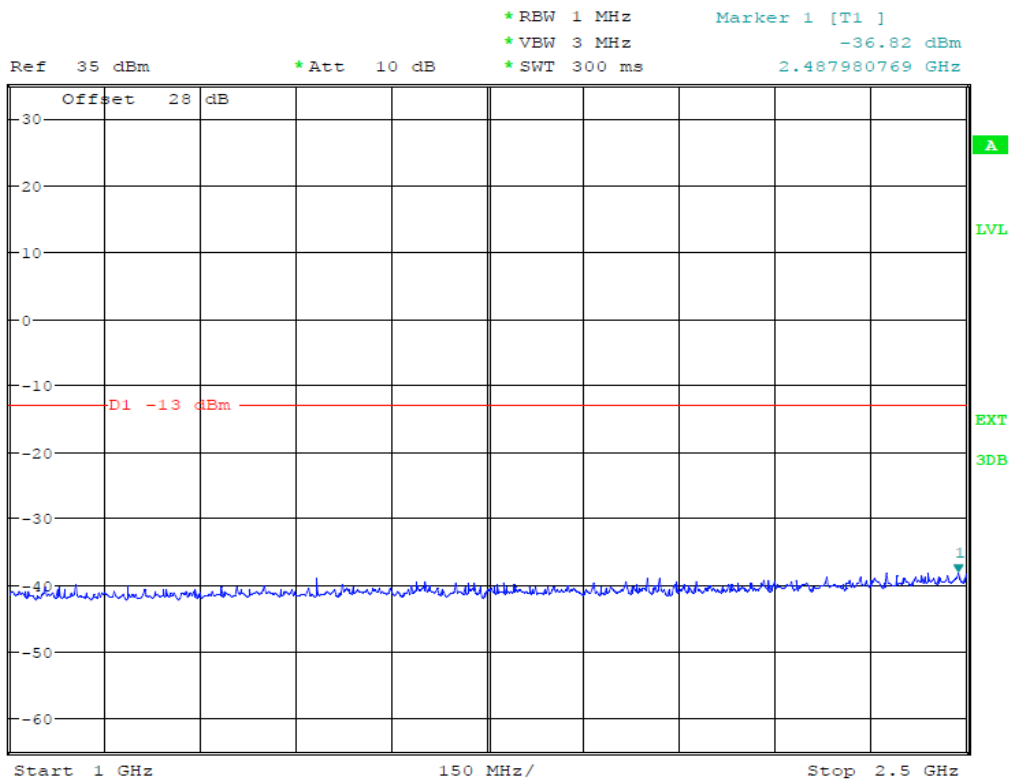

Date: 19.MAR.2014 13:45:44

(Plot 4.7.8 A2: Idle @ PCS1900)

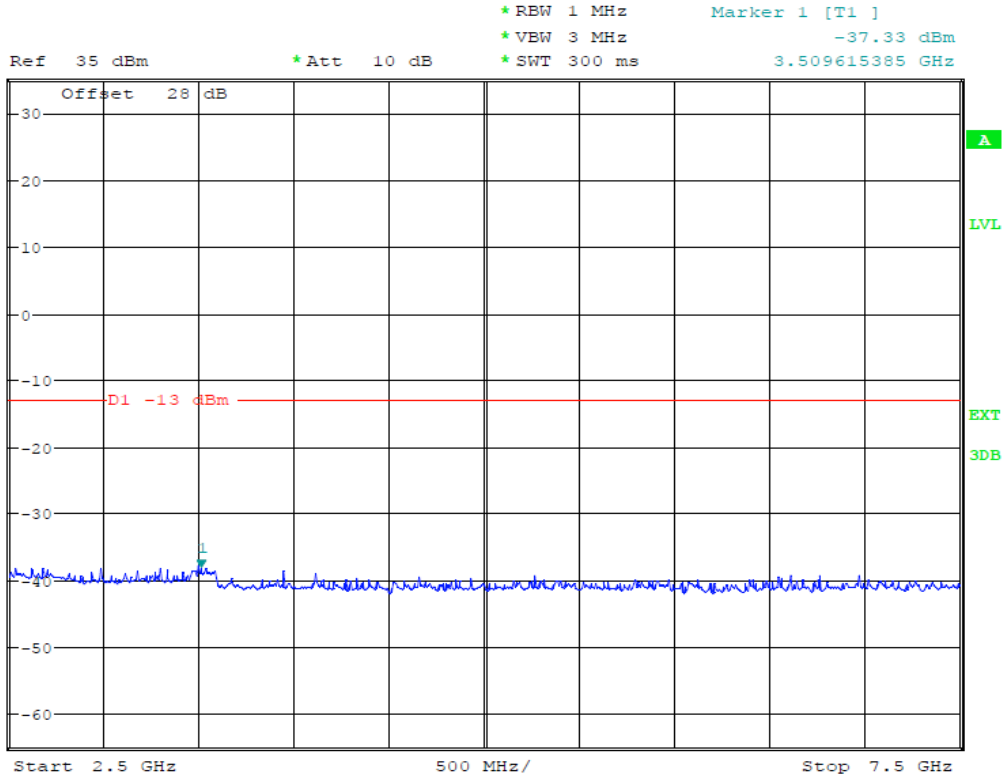

Date: 19.MAR.2014 13:46:04

(Plot 4.7.8 A3: Idle @ PCS1900)

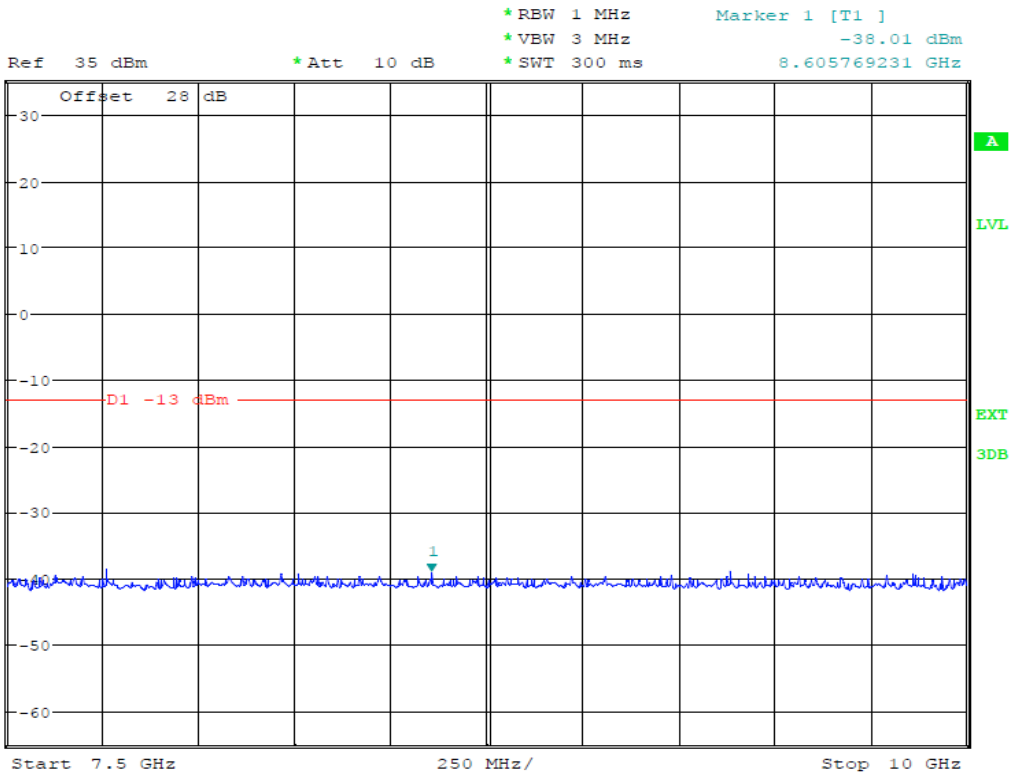

Date: 19.MAR.2014 13:46:21

(Plot 4.7.8 A4: Idle @ PCS1900)

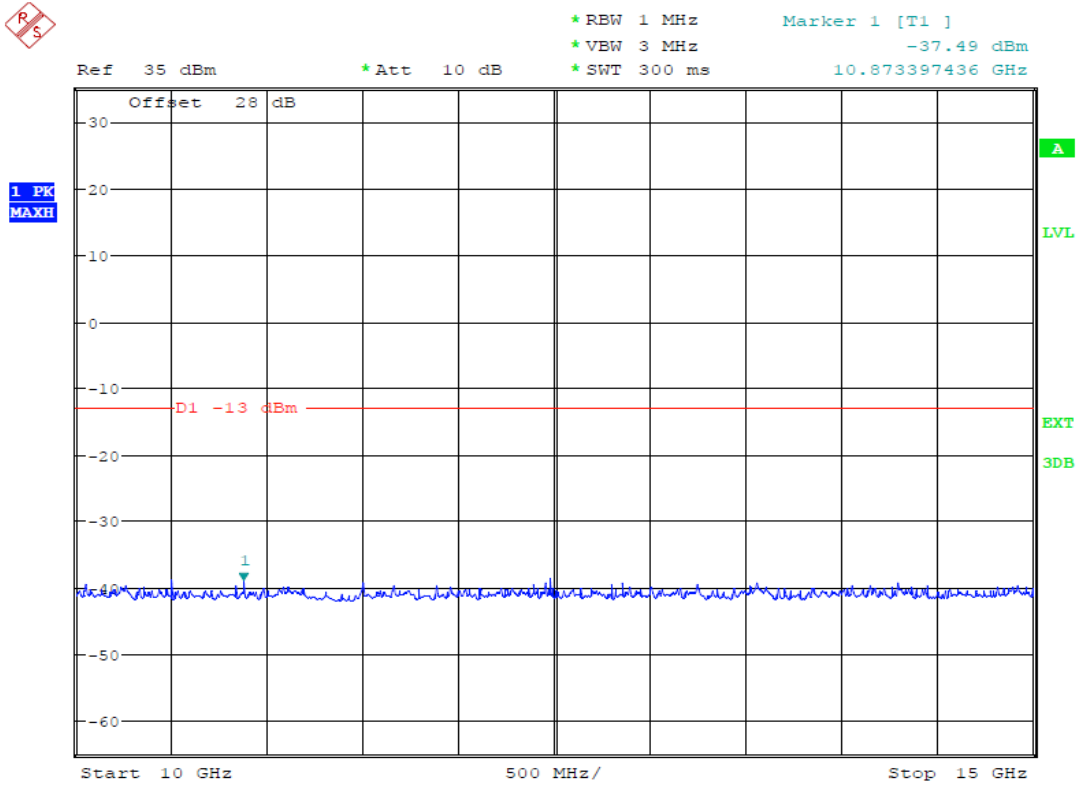

Date: 19.MAR.2014 13:46:38

(Plot 4.7.8 A5: Idle @ PCS1900)

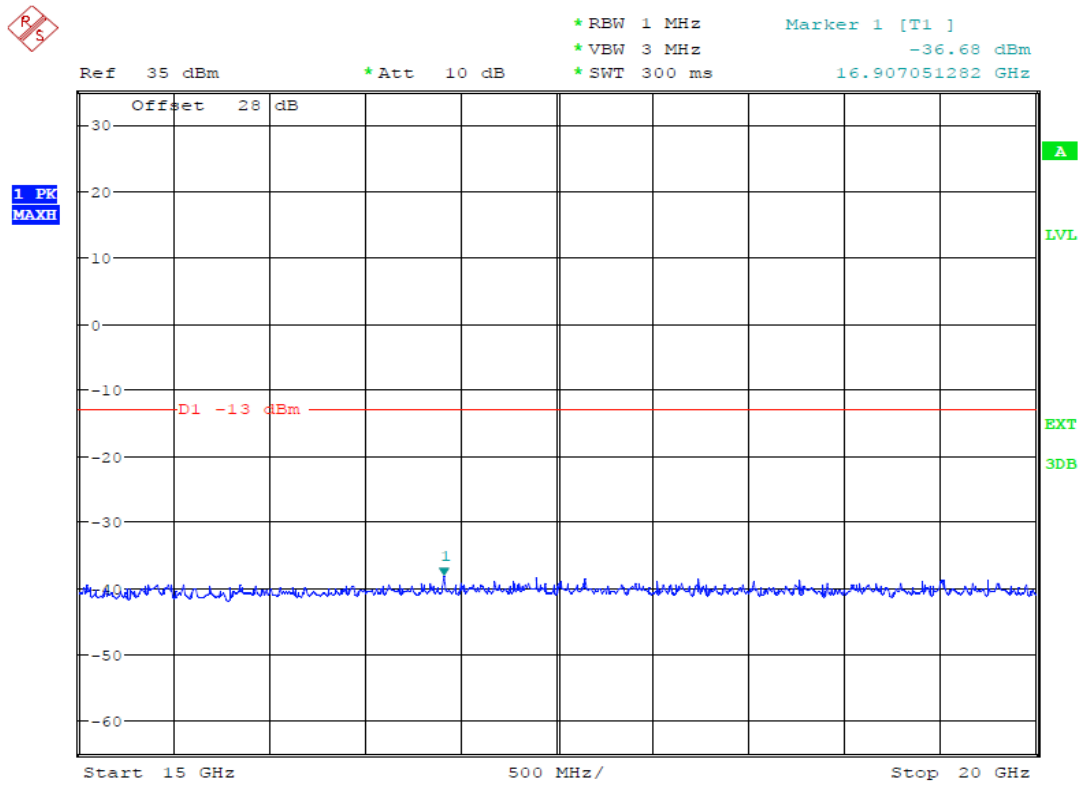

Date: 19.MAR.2014 13:46:57

(Plot 4.7.8 A6: Idle @ PCS1900)

4.8. Frequency Stability Test

TEST APPLICABLE

1. According to FCC Part 2 Section 2.1055 (a)(1), the frequency stability shall be measured with variation of ambient temperature from -30°C to +50°C centigrade.
2. According to FCC Part 2 Section 2.1055 (E) (2), for battery powered equipment, the frequency stability shall be measured with reducing primary supply voltage to the battery operating end point, which is specified by the manufacture.
3. Vary primary supply voltage from 85 to 115 percent of the nominal value for other than hand carried voltage equipment and the end voltage point was 3.40V.

TEST PROCEDURE

In order to measure the carrier frequency under the condition of AFC lock, it is necessary to make measurements with the EUT in a "call mode". This is accomplished with the use of R&S CMU200 DIGITAL RADIO COMMUNICATION TESTER.

1. Measure the carrier frequency at room temperature;
2. Subject the EUT to overnight soak at -30°C;
3. With the EUT, powered via nominal voltage, connected to the CMU200 and in a simulated call on middle channel of PCS 1900 and GSM850, measure the carrier frequency. These measurements should be made within 2 minutes of Powering up the EUT, to prevent significant self-warming;
4. Repeat the above measurements at 10°C increments from -30°C to +50°C. Allow at least 0.5 hours at each temperature, unpowered, before making measurements;
5. Remeasure carrier frequency at room temperature with nominal voltage. Vary supply voltage from minimum voltage to maximum voltage, in 0.1Volt increments remeasuring carrier frequency at each voltage. Pause at nominal voltage for 0.5 hours unpowered, to allow any self-heating to stabilize, before continuing;
6. Subject the EUT to overnight soak at +50°C;
7. With the EUT, powered via nominal voltage, connected to the CMU200 and in a simulated call on the centre channel, measure the carrier frequency. These measurements should be made within 2 minutes of Powering up the EUT, to prevent significant self-warming;
8. Repeat the above measurements at 10°C increments from +50°C to -30°C. Allow at least 0.5 hours at each temperature, unpowered, before making measurements;
9. At all temperature levels hold the temperature to +/- 0.5°C during the measurement procedure;

TEST CONFIGURATION

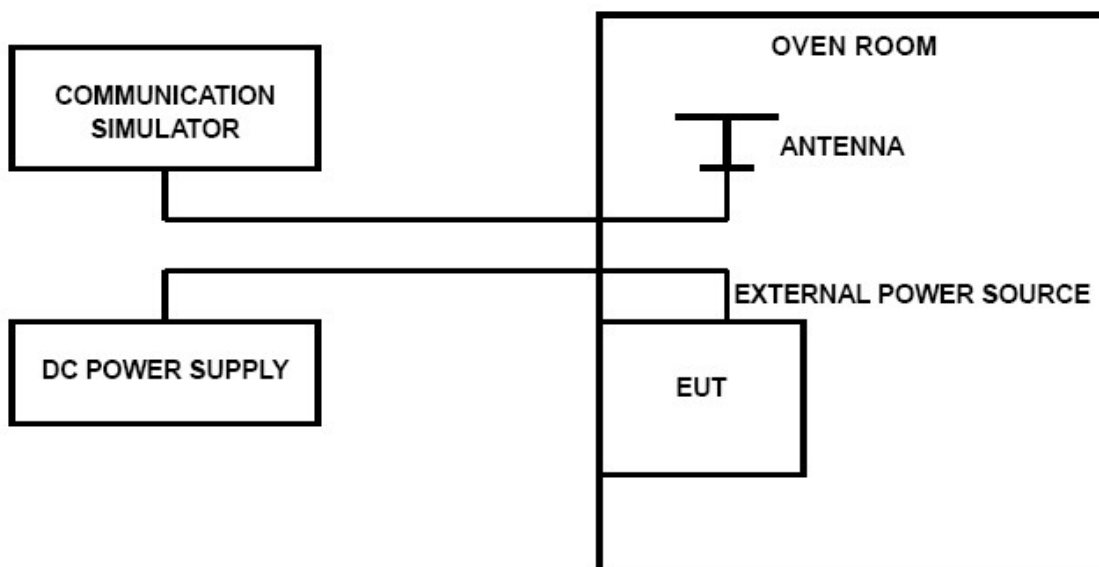

TEST LIMITS

For Hand carried battery powered equipment

According to the JTC standard the frequency stability of the carrier shall be accurate to within 0.1 ppm of the received frequency from the base station. This accuracy is sufficient to meet Sec. 24.235, Frequency Stability.

The frequency stability shall be sufficient to ensure that the fundamental emission stays within the authorized frequency block. As this transceiver is considered "Hand carried, battery powered equipment" Section 2.1055(d)(2) applies. This requires that the lower voltage for frequency stability testing be specified by the manufacturer. This transceiver is specified to operate with an input voltage of between 3.40VDC and 4.20VDC, with a nominal voltage of 3.70DC. Operation above or below these voltage limits is prohibited by transceiver software in order to prevent improper operation as well as to protect components from overstress. These voltages represent a tolerance of -10 % and +12.5 %. For the purposes of measuring frequency stability these voltage limits are to be used.

For equipment powered by primary supply voltage

According to the JTC standard the frequency stability of the carrier shall be accurate to within 0.1 ppm of the received frequency from the base station. This accuracy is sufficient to meet Sec. 24.235, Frequency Stability. The frequency stability shall be sufficient to ensure that the fundamental emission stays within the authorized frequency block. For this EUT section 2.1055(d)(1) applies. This requires varying primary supply voltage from 85 to 115 percent of the nominal value for other than hand carried battery equipment.

TEST RESULTS

Remark: We tested GSM and GPRS mode, recorded worst case at GSM mode.

GSM850					
DC Power	Temperature (°C)	Frequency error(Hz)	Frequency error(ppm)	Limit (ppm)	Verdict
3.40	25	33	0.053	0.10	PASS
3.70	25	-29	0.046	0.10	PASS
4.20	25	-23	0.043	0.10	PASS
3.70	-30	-25	0.046	0.10	PASS
3.70	-20	-22	0.038	0.10	PASS
3.70	-10	-18	0.029	0.10	PASS
3.70	0	-18	0.034	0.10	PASS
3.70	10	-23	0.033	0.10	PASS
3.70	20	-29	0.051	0.10	PASS
3.70	30	-26	0.046	0.10	PASS
3.70	40	-22	0.042	0.10	PASS
3.70	50	-18	0.049	0.10	PASS

PCS1900					
DC Power	Temperature (°C)	Frequency error(Hz)	Frequency error(ppm)	Limit (ppm)	Verdict
3.40	20	-48	0.036	0.10	PASS
3.70	20	-42	0.032	0.10	PASS
4.20	20	-48	0.029	0.10	PASS
3.70	-30	-45	0.025	0.10	PASS
3.70	-20	-41	0.039	0.10	PASS
3.70	-10	-41	0.025	0.10	PASS
3.70	0	-39	0.034	0.10	PASS
3.70	10	-34	0.033	0.10	PASS
3.70	20	-42	0.027	0.10	PASS
3.70	30	-41	0.038	0.10	PASS
3.70	40	-38	0.035	0.10	PASS
3.70	50	-38	0.029	0.10	PASS

5. Test Setup Photos of the EUT

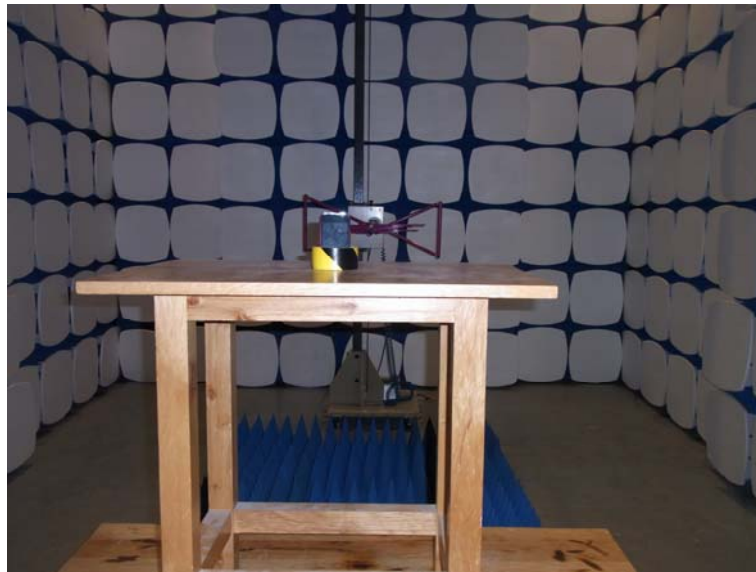

6. External and Internal Photos of the EUT

External photos of the EUT









Internal photos of the EUT

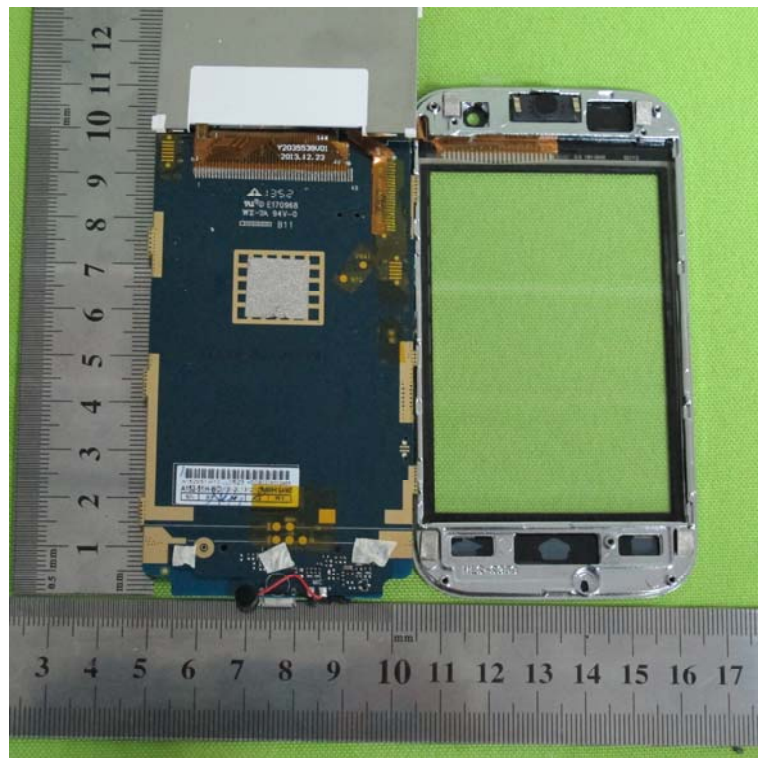
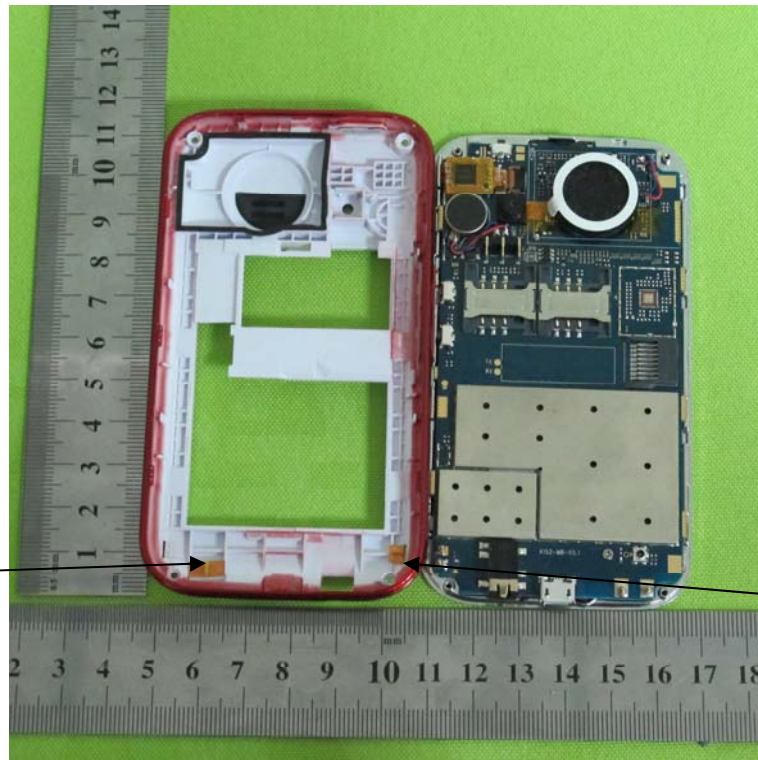

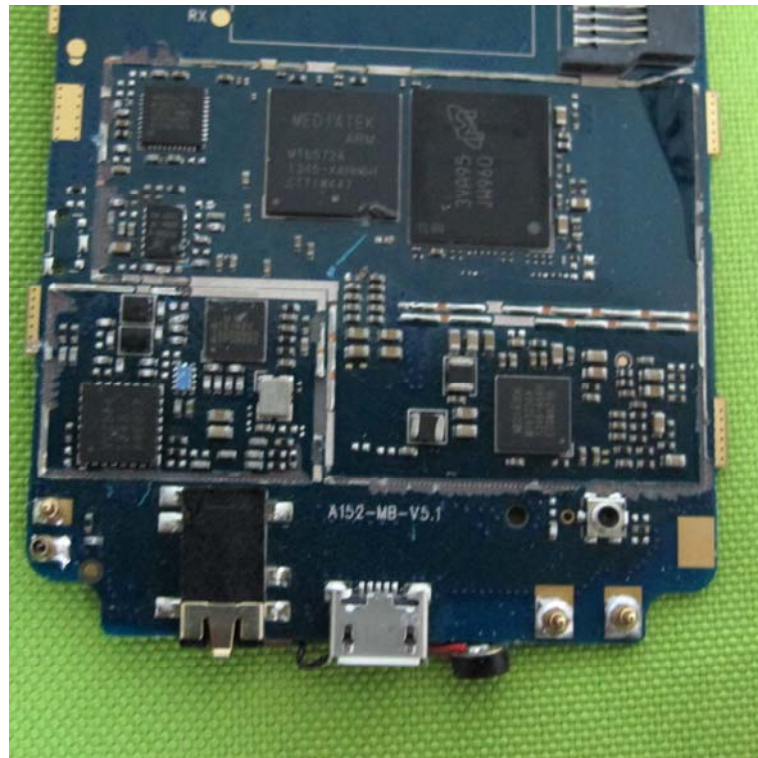
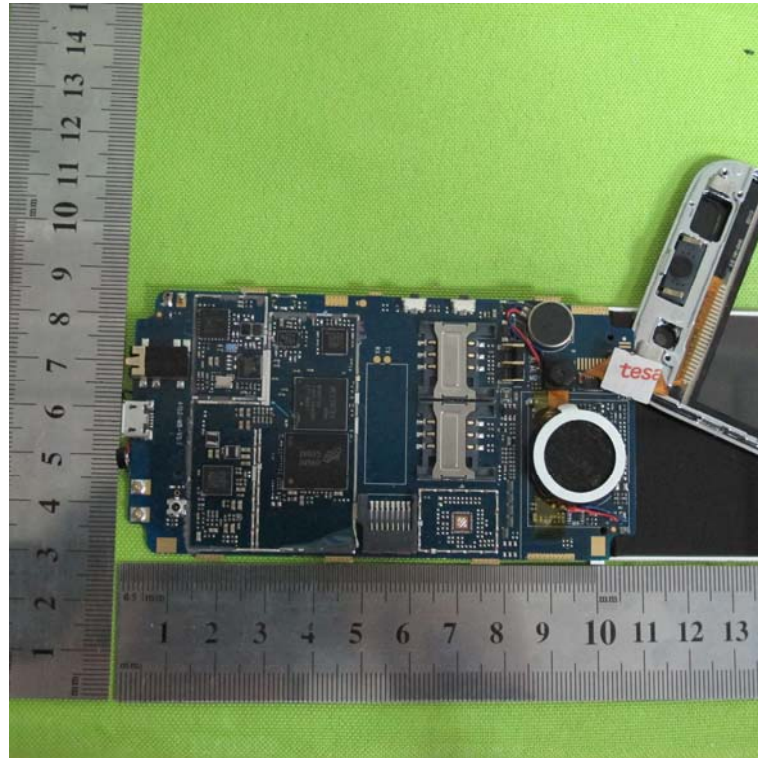

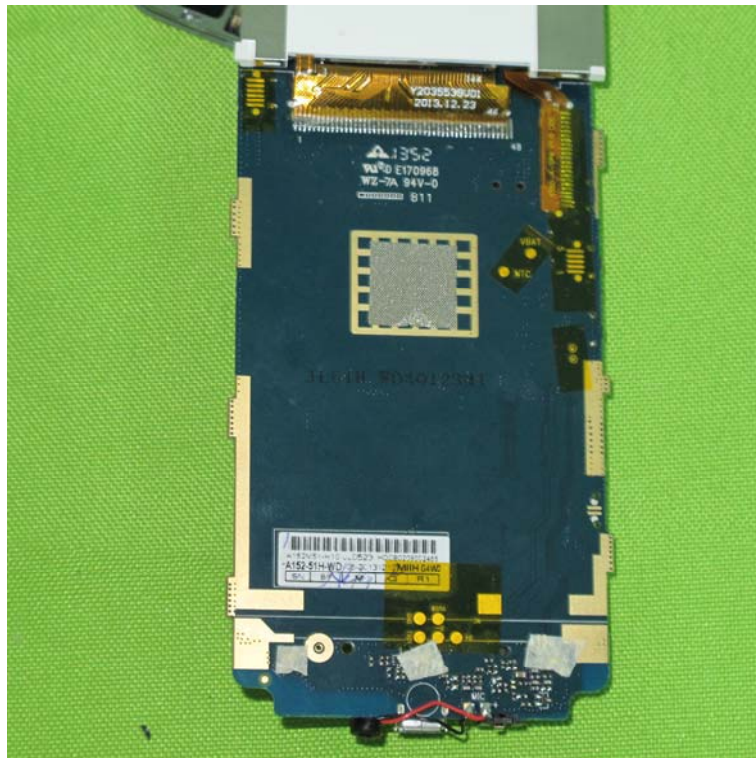
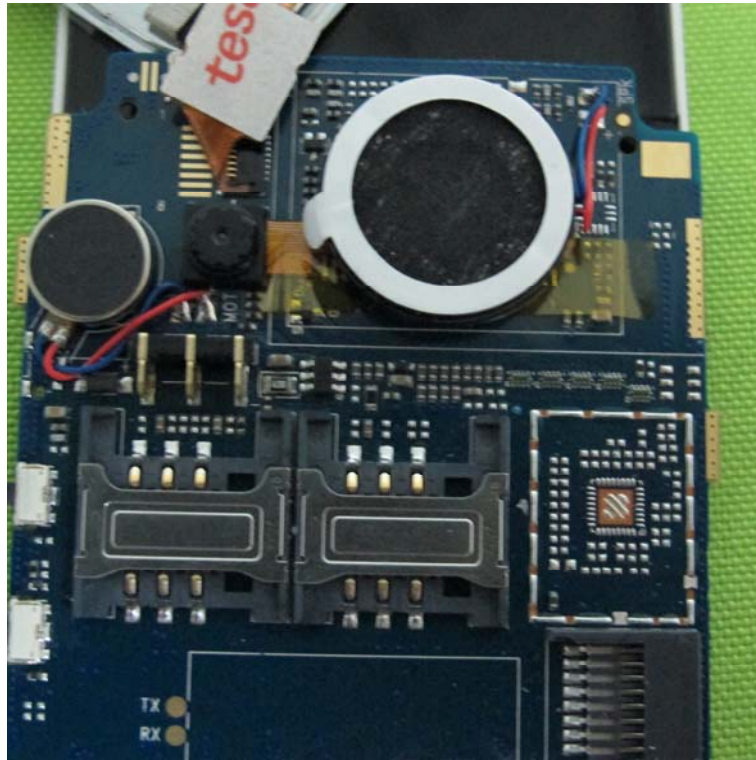

.....End of Report.....