



RADIO TEST REPORT

Report No: STS1506072F04

Issued for

Sky Phone LLC

1348 Washington Av. #350 Miami Beach FL., USA

Product Name:	Smart Phone
Brand Name:	Sky Devices
Model No.:	Sky 5.0L
Series Model:	N/A
FCC ID:	2ABOSSKY50L
Test Standard:	FCC Part 15.247

Any reproduction of this document must be done in full. No single part of this document may be reproduced without permission from STS, All Test Data Presented in this report is only applicable to presented test sample.





TEST RESULT CERTIFICATION

Applicant's name..... : Sky Phone LLC
Address..... : 1348 Washington Av. #350 Miami Beach FL., USA
Manufacture's Name : Shenzhen Konka Telecommunications Technology Co., Ltd.
Address..... : No.9008 Shennan Road,Overseas Chinese Town,ShenZhen, Guangdong,China

Product description

Product name..... : Smart Phone
Model and/or type reference : Sky 5.0L
Serial Model : N/A

Standards..... : FCC Part15.247

Test procedure.....: ANSI C63.10-2013

This device described above has been tested by STS, and the test results show that the equipment under test (EUT) is in compliance with the FCC requirements. And it is applicable only to the tested sample identified in the report.

This report shall not be reproduced except in full, without the written approval of STS, this document may be altered or revised by STS, personal only, and shall be noted in the revision of the document.

Date of Test..... :

Date (s) of performance of tests..... : 10 July. 2015 ~16 July. 2015

Date of Issue : 17 July. 2015

Test Result : **Pass**

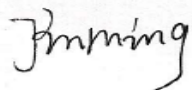
Testing Engineer : 

 (Jin Ming)

Technical Manager : 

 (Vita Li)

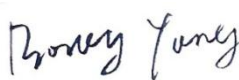
Authorized Signatory : 

 (Bovey Yang)





Table of Contents	Page
1. SUMMARY OF TEST RESULTS	6
1.1 TEST FACILITY	7
1.2 MEASUREMENT UNCERTAINTY	7
2. GENERAL INFORMATION	8
2.1 GENERAL DESCRIPTION OF EUT	8
2.2 DESCRIPTION OF TEST MODES	10
2.3 BLOCK DIGRAM SHOWING THE CONFIGURATION OF SYSTEM TEST	11
2.4 DESCRIPTION OF SUPPORT UNITS	11
2.5 EQUIPMENTS LIST FOR ALL TEST ITEMS	12
3. EMC EMISSION TEST	13
3.1 CONDUCTED EMISSION MEASUREMENT	13
3.1.1 POWER LINE CONDUCTED EMISSION LIMITS	13
3.1.2 TEST RESULT	14
3.2 RADIATED EMISSION MEASUREMENT	16
3.2.1 RADIATED EMISSION LIMITS	16
3.2.2 TEST PROCEDURE	17
3.2.3 TEST SETUP	18
3.2.4 EUT OPERATING CONDITIONS	19
3.2.5 TEST RESULT	20
4. CONDUCTED SPURIOUS EMISSIONS	26
4.1 APPLIED PROCEDURES / LIMIT	26
4.2 TEST PROCEDURE	26
4.3 DEVIATION FROM STANDARD	26
4.4 TEST SETUP	26
4.5 EUT OPERATION CONDITIONS	26
4.6 TEST RESULTS	27
5. POWER SPECTRAL DENSITY TEST	39
5.1 APPLIED PROCEDURES / LIMIT	39
5.2 TEST PROCEDURE	39
5.3 DEVIATION FROM STANDARD	39
5.4 TEST SETUP	39
5.5 EUT OPERATION CONDITIONS	39
5.6 TEST RESULTS	40
6. BANDWIDTH TEST	48



Table of Contents	Page
6.1 APPLIED PROCEDURES / LIMIT	48
6.2 TEST PROCEDURE	48
6.3 DEVIATION FROM STANDARD	48
6.4 TEST SETUP	48
6.5 EUT OPERATION CONDITIONS	48
6.6 TEST RESULTS	49
7. PEAK OUTPUT POWER TEST	57
7.1 APPLIED PROCEDURES / LIMIT	57
7.2 TEST PROCEDURE	57
7.3 DEVIATION FROM STANDARD	57
7.4 TEST SETUP	57
7.5 EUT OPERATION CONDITIONS	57
7.6 TEST RESULTS	58
8. ANTENNA REQUIREMENT	59
8.1 STANDARD REQUIREMENT	59
8.2 EUT ANTENNA	59
APPENDIX - PHOTOS OF TEST SETUP	60



Revision History

Rev.	Issue Date	Report NO.	Effect Page	Contents
00	17 July. 2015	STS1506072F04	ALL	Initial Issue





1. SUMMARY OF TEST RESULTS

Test procedures according to the technical standards:

FCC Part15 (15.247) , Subpart C			
Standard Section	Test Item	Judgment	Remark
15.207	Conducted Emission	PASS	
15.247 (a)(2)	6dB Bandwidth	PASS	
15.247 (b) (reference KDB 558074 d05 v02. /9.1.2)	Peak Output Power	PASS	
15.247 (c)	Radiated Spurious Emission	PASS	
15.247 (d)	Conducted Spurious Emission	PASS	
15.247 (e)	Power Spectral Density	PASS	
15.205	Band Edge Emission	PASS	
15.203	Antenna Requirement	PASS	

NOTE:

(1) "N/A" denotes test is not applicable in this Test Report



1.1 TEST FACILITY

Shenzhen STS Test Services Co., Ltd.

Add. : 1/F., Building B, Zhuoke Science Park, No.190,Chongqing Road,
Fuyong Street, Bao'an District, Shenzhen, Guangdong,China

CNAS Registration No.: L7649;

FCC Registration No.: 842334; IC Registration No.: 12108A-1

1.2 MEASUREMENT UNCERTAINTY

The reported uncertainty of measurement $y \pm U$, where expanded uncertainty U is based on a standard uncertainty multiplied by a coverage factor of $k=2$, providing a level of confidence of approximately 95 %.

No.	Item	Uncertainty
1	Conducted Emission (9KHz-150KHz)	$\pm 2.88\text{dB}$
2	Conducted Emission (150KHz-30MHz)	$\pm 2.67\text{dB}$
3	RF power,conducted	$\pm 0.70\text{dB}$
4	Spurious emissions,conducted	$\pm 1.19\text{dB}$
5	All emissions,radiated(<1G) 30MHz-200MHz	$\pm 2.83\text{dB}$
6	All emissions,radiated(<1G) 200MHz-1000MHz	$\pm 2.94\text{dB}$
7	All emissions,radiated(>1G)	$\pm 3.03\text{dB}$
8	Temperature	$\pm 0.5^{\circ}\text{C}$
9	Humidity	$\pm 2\%$



2. GENERAL INFORMATION

2.1 GENERAL DESCRIPTION OF EUT

Equipment	Smart Phone												
Trade Name	Sky Devices												
Model Name	Sky 5.0L												
Serial Model	N/A												
Model Difference	N/A												
Product Description	The EUT is a Smart Phone												
	<table border="1"> <tr> <td>Operation Frequency:</td> <td>802.11b/g/n 20: 2412~2462 MHz 802.11n 40: 2422~2452MHz</td> </tr> <tr> <td>Modulation Type:</td> <td>CCK/OFDM/DBPSK/DAPSK</td> </tr> <tr> <td>Bit Rate of Transmitter</td> <td>802.11b:11/5.5/2/1 Mbps 802.11g:54/48/36/24/18/12/9/6Mbps 802.11n(20/40MHz):300/150/144.44/130/117/115.56/104/86.67/78/52/6.5Mbps</td> </tr> <tr> <td>Number Of Channel</td> <td>802.11b/g/n20: 11CH 802.11n 40: 7CH</td> </tr> <tr> <td>Antenna Designation:</td> <td>Please see Note 3.</td> </tr> <tr> <td>Antenna Gain (dBi)</td> <td>0 dbi</td> </tr> </table>	Operation Frequency:	802.11b/g/n 20: 2412~2462 MHz 802.11n 40: 2422~2452MHz	Modulation Type:	CCK/OFDM/DBPSK/DAPSK	Bit Rate of Transmitter	802.11b:11/5.5/2/1 Mbps 802.11g:54/48/36/24/18/12/9/6Mbps 802.11n(20/40MHz):300/150/144.44/130/117/115.56/104/86.67/78/52/6.5Mbps	Number Of Channel	802.11b/g/n20: 11CH 802.11n 40: 7CH	Antenna Designation:	Please see Note 3.	Antenna Gain (dBi)	0 dbi
	Operation Frequency:	802.11b/g/n 20: 2412~2462 MHz 802.11n 40: 2422~2452MHz											
	Modulation Type:	CCK/OFDM/DBPSK/DAPSK											
	Bit Rate of Transmitter	802.11b:11/5.5/2/1 Mbps 802.11g:54/48/36/24/18/12/9/6Mbps 802.11n(20/40MHz):300/150/144.44/130/117/115.56/104/86.67/78/52/6.5Mbps											
	Number Of Channel	802.11b/g/n20: 11CH 802.11n 40: 7CH											
	Antenna Designation:	Please see Note 3.											
	Antenna Gain (dBi)	0 dbi											
Channel List	Please refer to the Note 2.												
Ratings	DC 3.8V from battery												
Adapter	Power supply and ADP (rating) : Input:100-240V AC,50/60Hz 200mA Output:5.0V,1000mA												
Battery	Rated Voltage: 3.8V capacity : 2000mA												
Hardware version number	V1.1												
Software versioning number	ALPS.L1.MP3.V1_KONKA6735M.35U.L												
Connecting I/O Port(s)	Please refer to the User's Manual												

Note:

- 1 For a more detailed features description, please refer to the manufacturer's specifications or the User's Manual.



2

Channel List for 802.11b/g/n(20MHz)							
Channel	Frequency (MHz)	Channel	Frequency (MHz)	Channel	Frequency (MHz)	Channel	Frequency (MHz)
01	2412	04	2427	07	2442	10	2457
02	2417	05	2432	08	2447	11	2462
03	2422	06	2437	09	2452		

Channel List for 802.11n(40MHz)							
Channel	Frequency (MHz)	Channel	Frequency (MHz)	Channel	Frequency (MHz)	Channel	Frequency (MHz)
03	2422	06	2437	09	2452		
04	2427	07	2442				
05	2432	08	2447				

3 Table for Filed Antenna

Ant.	Brand	Model Name	Antenna Type	Connector	Gain (dBi)	NOTE
A	N/A	N/A	PIFA Antenna	N/A	0	N/A



2.2 DESCRIPTION OF TEST MODES

To investigate the maximum EMI emission characteristics generates from EUT, the test system was pre-scanning tested base on the consideration of following EUT operation mode or test configuration mode which possible have effect on EMI emission level. Each of these EUT operation mode(s) or test configuration mode(s) mentioned above was evaluated respectively.

Pretest Mode	Description
Mode 1	Low
Mode 2	Middle
Mode 3	High
Mode 4	Charging + Keeping TX mode

For Conducted Emission	
Final Test Mode	Description
Mode 4	Charging + Keeping TX mode

For Radiated Emission	
Final Test Mode	Description
Mode 1	Low
Mode 2	Middle
Mode 3	High
Mode 4	Charging + Keeping TX mode

Note:

- (1) The measurements are performed at the highest, middle, lowest available channels.
- (2) The measurements are performed at all Bit Rate of Transmitter, the worst data was reported
- (3) We have be tested for all avaiable U.S. voltage and frequencies(For 120V,50/60Hz and 240V, 50/60Hz) for which the device is capable of operation.

2.3 BLOCK DIGRAM SHOWING THE CONFIGURATION OF SYSTEM TEST

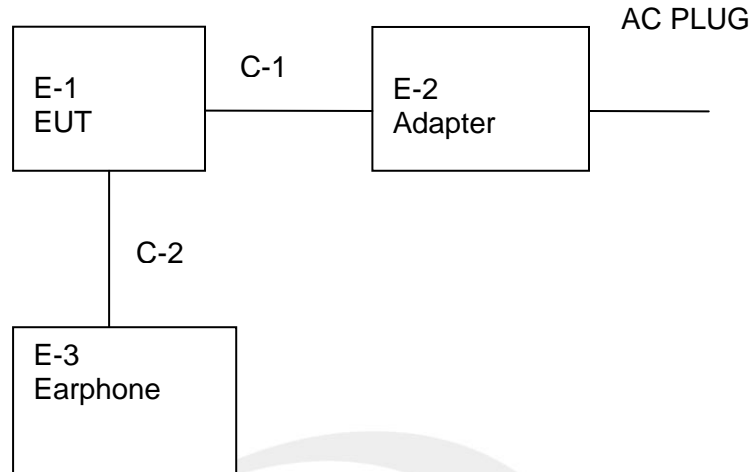

2.4 DESCRIPTION OF SUPPORT UNITS

The EUT has been tested as an independent unit together with other necessary accessories or support units. The following support units or accessories were used to form a representative test configuration during the tests.

Item	Equipment	Mfr/Brand	Model/Type No.	Series No.	Note
E-1	Smart Phone	Sky Devices	Sky 5.0L	N/A	EUT
E-2	Adapter	Sky Devices	A31-501000	N/A	EUT
E-3	Earphone	N/A	SX-3511	N/A	EUT

Item	Shielded Type	Ferrite Core	Length	Note
C-1	unshielded	NO	72.5cm	N/A
C-2	unshielded	NO	138.5cm	N/A

Note:

- (1) The support equipment was authorized by Declaration of Confirmation.
- (2) For detachable type I/O cable should be specified the length in cm in 『Length』 column.



2.5 EQUIPMENTS LIST FOR ALL TEST ITEMS

Radiation Test equipment

Kind of Equipment	Manufacturer	Type No.	Serial No.	Last calibration	Calibrated until
Spectrum Analyzer	Agilent	E4407B	MY50140340	2014.10.25	2015.10.24
Test Receiver	R&S	ESCI	101427	2014.10.25	2015.10.24
Bilog Antenna	TESEQ	CBL6111D	34678	2014.11.25	2015.11.24
Horn Antenna	Schwarzbeck	BBHA 9120D(1201)	9120D-1343	2015.03.06	2016.03.05
50Ω Coaxial Switch	Anritsu	MP59B	6200264416	2015.06.06	2016.06.05
PreAmplifier	Agilent	8449B	60538	2014.10.25	2015.10.24
Loop Antenna	ARA	PLA-1030/B	1029	2015.06.08	2016.06.07
USB RF power sensor	DARE	RPR3006W	15I00041SNO03	2014.10.25	2015.10.24

Conduction Test equipment

Kind of Equipment	Manufacturer	Type No.	Serial No.	Last calibration	Calibrated until
EMI Test Receiver	R&S	ESPI	102086	2014.11.20	2015.11.19
LISN	R&S	ENV216	101242	2014.10.25	2015.10.24



3. EMC EMISSION TEST

3.1 CONDUCTED EMISSION MEASUREMENT

3.1.1 POWER LINE CONDUCTED EMISSION LIMITS

Operating frequency band. In case the emission fall within the restricted band specified on Part 15.247&207(a) limit in the table below has to be followed.

FREQUENCY (MHz)	Class B (dBuV)		Standard
	Quasi-peak	Average	
0.15 -0.5	66 - 56 *	56 - 46 *	CISPR
0.50 -5.0	56.00	46.00	CISPR
5.0 -30.0	60.00	50.00	CISPR

0.15 -0.5	66 - 56 *	56 - 46 *	FCC
0.50 -5.0	56.00	46.00	FCC
5.0 -30.0	60.00	50.00	FCC

Note:

- (1) The tighter limit applies at the band edges.
- (2) The limit of " * " marked band means the limitation decreases linearly with the logarithm of the frequency in the range.

The following table is the setting of the receiver



3.1.2 TEST RESULT

EUT:	Smart Phone	Model Name.:	Sky 5.0L
Temperature:	26 °C	Relative Humidity:	54%
Pressure:	1010hPa	Phase:	L
Test Voltage:	DC 5V from Adapter AC120V/60Hz	Test Mode:	Mode 4

Frequency (MHz)	Reading (dBUV)	Correct Factor(dB)	Result (dBUV)	Limit (dBUV)	Margin (dB)	Remark
0.1660	31.52	10.00	41.52	65.16	-23.64	QP
0.1660	20.69	10.00	30.69	55.16	-24.47	AVG
0.6540	31.95	9.98	41.93	56.00	-14.07	QP
0.6540	18.76	9.98	28.74	46.00	-17.26	AVG
1.7580	25.01	9.98	34.99	56.00	-21.01	QP
1.7580	13.18	9.98	23.16	46.00	-22.84	AVG
2.6460	23.89	10.00	33.89	56.00	-22.11	QP
2.6460	10.60	10.00	20.60	46.00	-25.40	AVG
5.4060	23.78	10.20	33.98	60.00	-26.02	QP
5.4060	9.45	10.20	19.65	50.00	-30.35	AVG
23.1300	24.14	10.61	34.75	60.00	-25.25	QP
23.1300	18.93	10.61	29.54	50.00	-20.46	AVG

Remark:

1. Factor = Antenna Factor + Cable Loss – Pre-amplifier.

100.0 dBUV

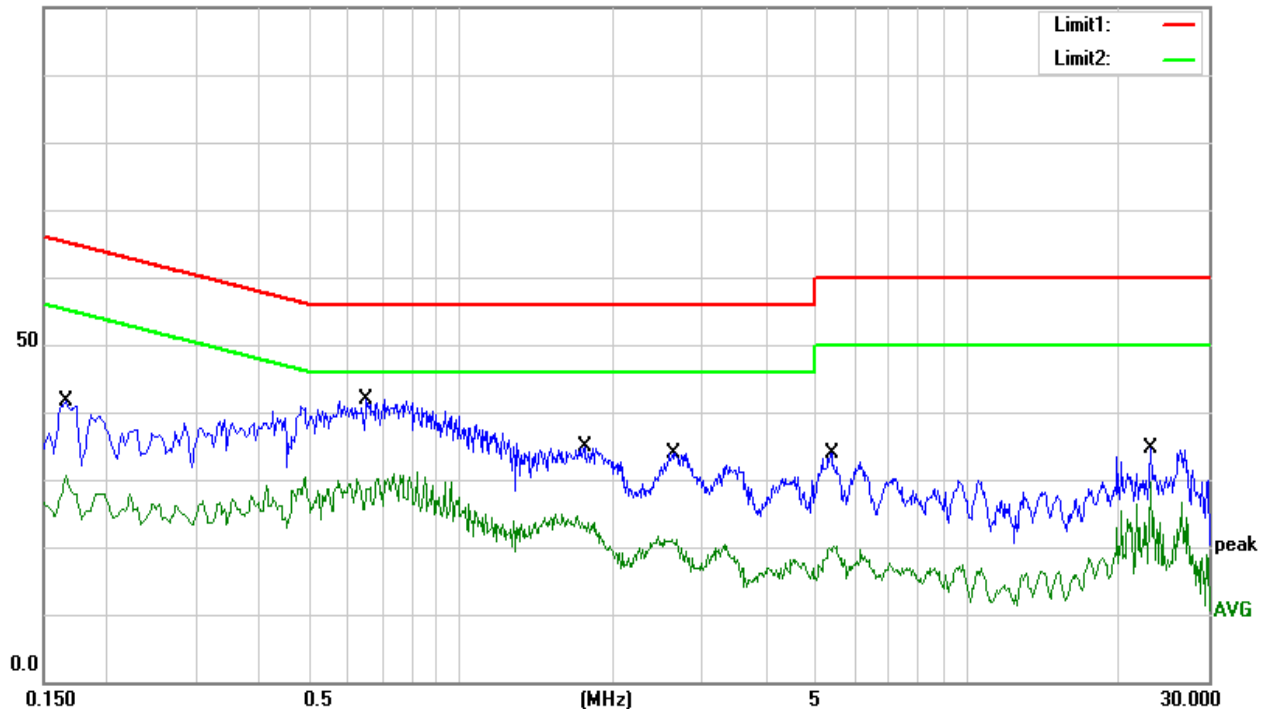



EUT:	Smart Phone	Model Name.:	Sky 5.0L
Temperature:	26 °C	Relative Humidity:	54%
Pressure:	1010hPa	Phase:	N
Test Voltage:	DC 5V from Adapter AC120V/60Hz	Test Mode:	Mode 4

Frequency (MHz)	Reading (dBUV)	Correct Factor(dB)	Result (dBUV)	Limit (dBUV)	Margin (dB)	Remark
0.4820	35.96	9.92	45.88	56.30	-10.42	QP
0.4820	19.06	9.92	28.98	46.30	-17.32	AVG
0.7020	35.95	10.00	45.95	56.00	-10.05	QP
0.7020	20.98	10.00	30.98	46.00	-15.02	AVG
1.5100	33.43	10.00	43.43	56.00	-12.57	QP
1.5100	18.36	10.00	28.36	46.00	-17.64	AVG
2.3700	27.69	10.00	37.69	56.00	-18.31	QP
2.3700	13.57	10.00	23.57	46.00	-22.43	AVG
5.5140	26.21	10.20	36.41	60.00	-23.59	QP
5.5140	11.05	10.20	21.25	50.00	-28.75	AVG
23.1300	28.27	10.66	38.93	60.00	-21.07	QP
23.1300	20.94	10.66	31.60	50.00	-18.40	AVG

Remark:

1. Factor = Antenna Factor + Cable Loss – Pre-amplifier.

100.0 dBUV

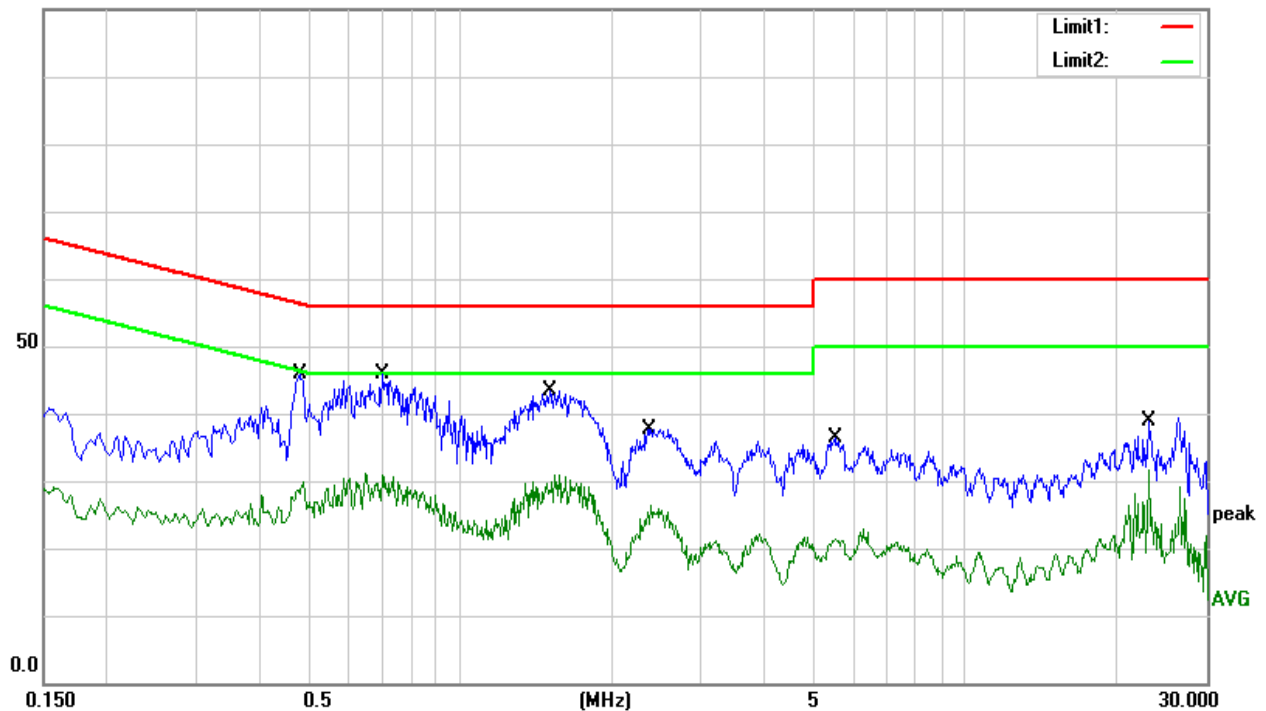



3.2 RADIATED EMISSION MEASUREMENT

3.2.1 RADIATED EMISSION LIMITS

6 dBc in any 100 kHz bandwidth outside the operating frequency band. In case the emission fall within the restricted band specified on Part 15.247&205(a), then the Part 15.247&209(a) limit in the table below has to be followed.

Frequencies (MHz)	Field Strength (micovolts/meter)	Measurement Distance (meters)
0.009~0.490	2400/F(KHz)	300
0.490~1.705	24000/F(KHz)	30
1.705~30.0	30	30
30~88	100	3
88~216	150	3
216~960	200	3
Above 960	500	3

LIMITS OF RADIATED EMISSION MEASUREMENT (Above 1000MHz)

FREQUENCY (MHz)	Class B (dBuV/m) (at 3M)	
	PEAK	AVERAGE
Above 1000	74	54

Notes:

- (1) The limit for radiated test was performed according to FCC PART 15C.
- (2) The tighter limit applies at the band edges.
- (3) Emission level (dBuV/m)=20log Emission level (uV/m).

FREQUENCY RANGE OF RADIATED MEASUREMENT (For unintentional radiators)

Highest frequency generated or Upper frequency of measurement used in the device or on which the device operates or tunes (MHz)	Range (MHz)
Below 1.705	30
1.705 – 108	1000
108 – 500	2000
500 – 1000	5000
Above 1000	5 th harmonic of the highest frequency or 40 GHz, whichever is lower



Spectrum Parameter	Setting
Attenuation	Auto
Detector	Peak
Start Frequency	1000 MHz(Peak/AV)
Stop Frequency	10 th carrier hamonic(Peak/AV)
RB / VB (emission in restricted band)	1 MHz / 1 MHz, AV=3 MHz

Receiver Parameter	Setting
Attenuation	Auto
Start ~ Stop Frequency	9kHz~150kHz / RB 200Hz for QP
Start ~ Stop Frequency	150kHz~30MHz / RB 9kHz for QP
Start ~ Stop Frequency	30MHz~1000MHz / RB 120kHz for QP

3.2.2 TEST PROCEDURE

- The measuring distance of at 3 m shall be used for measurements at frequency up to 1GHz. For frequencies above 1GHz, any suitable measuring distance may be used.
- The EUT was placed on the top of a rotating table 0.8 meters(above 1GHz is 1.5 m) above the ground at a 3 meter open area test site. The table was rotated 360 degrees to determine the position of the highest radiation.
- The height of the equipment or of the substitution antenna shall be 0.8 m(above 1GHz is 1.5 m); the height of the test antenna shall vary between 1 m to 4 m. Both horizontal and vertical polarizations of the antenna are set to make the measurement.
- The initial step in collecting conducted emission data is a spectrum analyzer peak detector mode pre-scanning the measurement frequency range. Significant peaks are then marked and then Quasi Peak detector mode re-measured.
- If the Peak Mode measured value compliance with and lower than Quasi Peak Mode Limit, the EUT shall be deemed to meet QP Limits and then no additional QP Mode measurement performed.
- For the actual test configuration, please refer to the related Item –EUT Test Photos.

Note:

Both horizontal and vertical antenna polarities were tested and performed pretest to three orthogonal axis. The worst case emissions were reported

3.2.3 TEST SETUP

(A) Radiated Emission Test-Up Frequency Below 30MHz

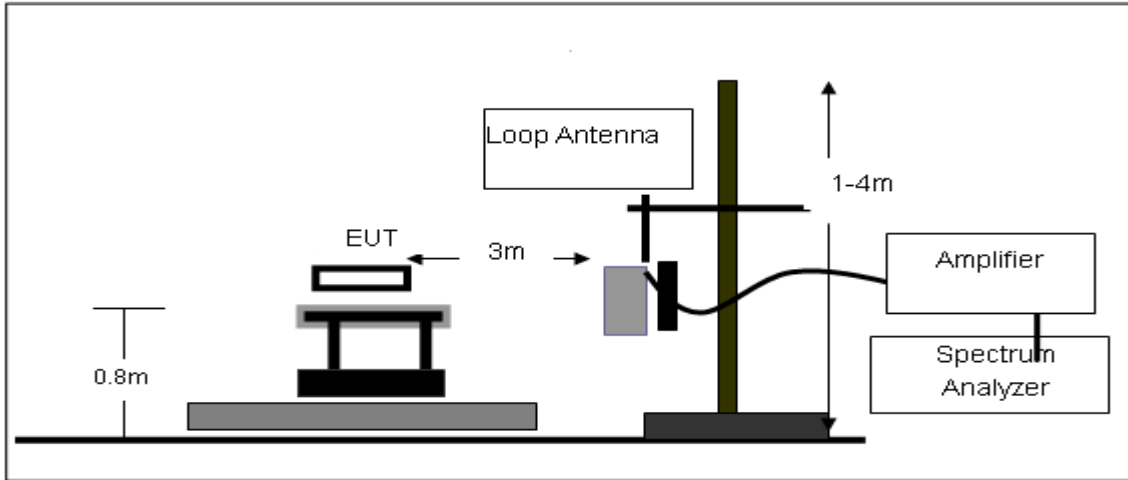

(B) Radiated Emission Test-Up Frequency 30MHz~1GHz

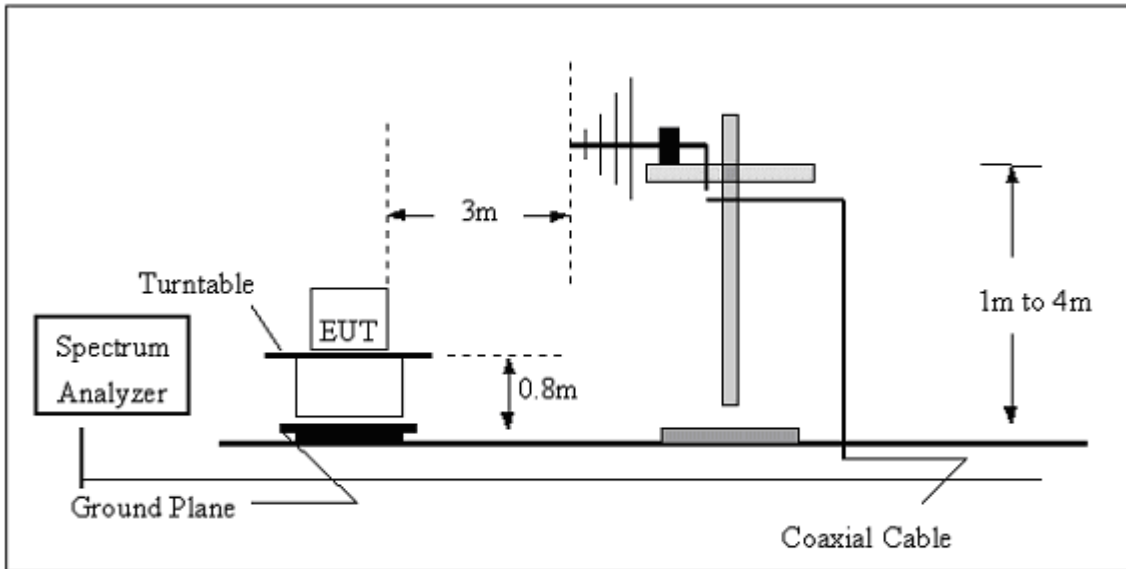

(C) Radiated Emission Test-Up Frequency Above 1GHz

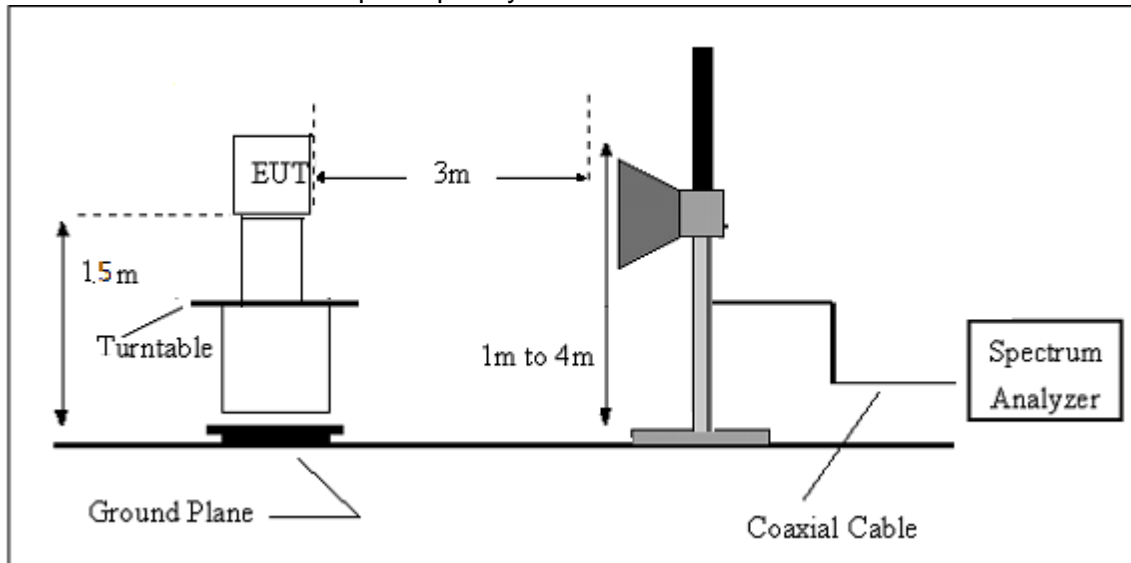

3.2.4 EUT OPERATING CONDITIONS

The EUT tested system was configured as the statements of 2.3 Unless otherwise a special operating condition is specified in the follows during the testing.



3.2.5 TEST RESULT

9KHz-30MHz

EUT:	Smart Phone	Model Name. :	Sky 5.0L
Temperature:	20 °C	Relative Humidity:	48%
Pressure:	1010 hPa	Test Voltage :	DC 5V from Adapter with AC 120V/60Hz
Test Mode :	Link mode	Polarization :	--

Freq. (MHz)	Reading (dBuV/m)	Limit (dBuV/m)	Margin (dB)	State P/F	Test Result
--	--	--	--	--	PASS
--	--	--	--	--	PASS

NOTE:

The amplitude of spurious emissions which are attenuated by more than 20dB below the permissible value has no need to be reported.

Distance extrapolation factor = $40 \log(\text{specific distance}/\text{test distance})$ (dB);

Limit line = specific limits(dBuv) + distance extrapolation factor.



30MHz - 1000MHz

EUT:	Smart Phone	Model Name. :	Sky 5.0L
Temperature:	20 °C	Relative Humidity:	48%
Pressure:	1010 hPa	Test Voltage :	DC 5V from Adapter with AC 120V/60Hz
Test Mode :	Mode 4	Polarization :	Horizontal

Frequency (MHz)	Reading (dBUV)	Correct Factor(dB/m)	Result (dBUV/m)	Limit (dBUV/m)	Margin (dB)	Remark
30.9620	4.75	18.20	22.95	40.00	-17.05	QP
59.2325	11.66	5.45	17.11	40.00	-22.89	QP
109.0286	8.98	11.27	20.25	43.50	-23.25	QP
237.4760	12.44	11.51	23.95	46.00	-22.05	QP
475.4991	12.69	19.81	32.50	46.00	-13.50	QP
842.1296	8.96	26.79	35.75	46.00	-10.25	QP

Remark:

1. Factor = Antenna Factor + Cable Loss – Pre-amplifier.

80.0 dBUV/m

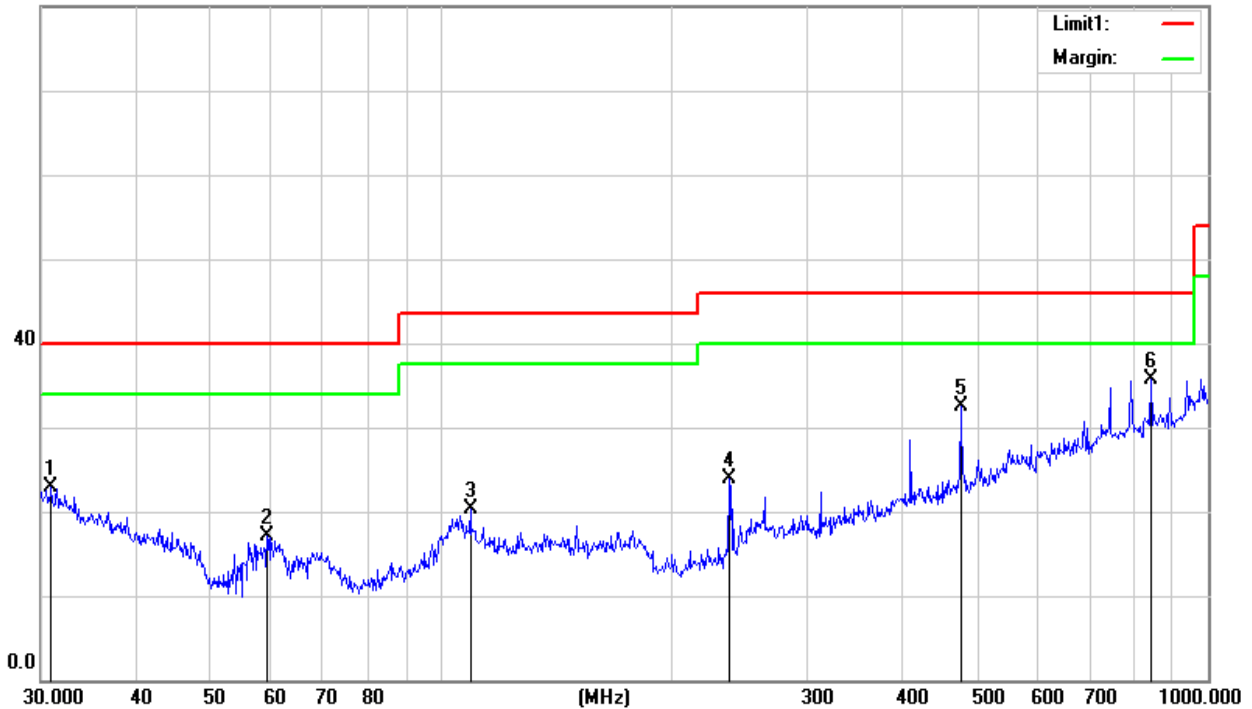



30MHz - 1000MHz

EUT:	Smart Phone	Model Name. :	Sky 5.0L
Temperature:	20 °C	Relative Humidity:	48%
Pressure:	1010 hPa	Test Voltage :	DC 5V from Adapter with AC 120V/60Hz
Test Mode :	Mode 4	Polarization :	Vertical

Frequency (MHz)	Reading (dBuV)	Correct Factor(dB/m)	Result (dBuV/m)	Limit (dBuV/m)	Margin (dB)	Remark
42.7496	19.61	11.95	31.56	40.00	-8.44	QP
64.8865	17.61	5.66	23.27	40.00	-16.73	QP
104.5361	10.33	11.19	21.52	43.50	-21.98	QP
139.8508	5.57	12.58	18.15	43.50	-25.35	QP
238.3102	9.63	11.61	21.24	46.00	-24.76	QP
649.6597	5.61	23.00	28.61	46.00	-17.39	QP

Remark:

1. Factor = Antenna Factor + Cable Loss – Pre-amplifier.

80.0 dBuV/m

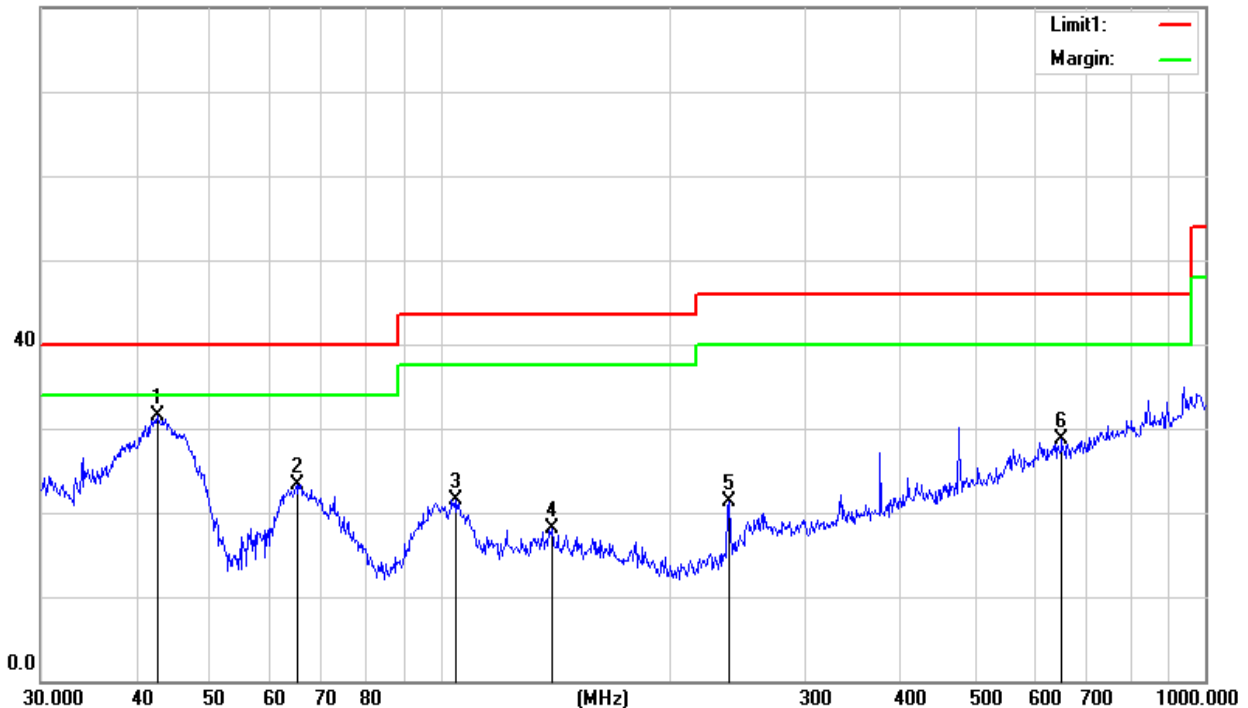



Above 1000MHz

EUT :	Smart Phone	Model Name :	Sky 5.0L
Temperature :	20 °C	Relative Humidity :	48%
Pressure :	1010 hPa	Test Voltage :	DC 5V from Adapter with AC 120V/60Hz

Frequency (MHz)	Reading (dBuV)	Factor (dB)	Emission Level (dBuV/m)	Limit (dBuV/m)	Margin (dB)	Detector	Comment
Low Channel (802.11b/2412 MHz)							
4824.20	66.45	-3.58	62.87	74	-11.13	PK	Vertical
4824.22	47.49	-3.58	43.91	54	-10.09	AV	Vertical
7236.13	62.21	-0.8	61.41	74	-12.59	PK	Vertical
7236.12	41.58	-0.8	40.78	54	-13.22	AV	Vertical
4824.20	61.88	-3.58	58.3	74	-15.7	PK	Horizontal
4824.22	44.36	-3.58	40.78	54	-13.22	AV	Horizontal
Mid Channel (802.11b/2437 MHz)							
4874.09	65.46	-3.56	61.9	74	-12.1	PK	Vertical
4874.07	49.12	-3.56	45.56	54	-8.44	AV	Vertical
7311.22	61.41	-0.78	60.63	74	-13.37	PK	Vertical
7311.21	44.00	-0.78	43.22	54	-10.78	AV	Vertical
4874.18	61.63	-3.56	58.07	74	-15.93	PK	Horizontal
4874.15	45.57	-3.56	42.01	54	-11.99	AV	Horizontal
High Channel (802.11b/2462 MHz)							
4944.26	61.41	-3.54	57.87	74	-16.13	PK	Vertical
4944.30	45.62	-3.54	42.08	54	-11.92	AV	Vertical
7416.33	61.04	-0.75	60.29	74	-13.71	PK	Vertical
7416.30	45.26	-0.75	44.51	54	-9.49	AV	Vertical
4944.26	60.94	-3.54	57.4	74	-16.6	PK	Horizontal
4944.30	45.58	-3.54	42.04	54	-11.96	AV	Horizontal

Remark:

- Factor = Antenna Factor + Cable Loss – Pre-amplifier.
- Scan with 802.11b, 802.11g, 802.11n (HT-20), 802.11n (HT-40), the worst case is 802.11b.



3.2.6 TEST RESULTS (Band edge)

EUT :	Smart Phone	Model Name :	Sky 5.0L
Temperature :	20 °C	Relative Humidity :	48%
Pressure :	1010 hPa	Test Voltage :	DC 5V from Adapter with AC 120V/60Hz

Frequency (MHz)	Reading (dBuV)	Factor (dB)	Emission Level (dBµV/m)	Limit (dBuV/m)	Margin (dB)	Detector	Comment
802.11 b							
2399.9	68.43	-12.99	55.44	74	-18.56	PK	Vertical
2399.9	54.16	-12.99	41.17	54	-12.83	AV	Vertical
2399.9	69.17	-12.99	56.18	74	-17.82	PK	Horizontal
2399.9	53.03	-12.99	40.04	54	-13.96	AV	Horizontal
2483.6	69.87	-12.78	57.09	74	-16.91	PK	Vertical
2483.6	53.07	-12.78	40.29	54	-13.71	AV	Vertical
2483.6	70.12	-12.78	57.34	74	-16.66	PK	Horizontal
2483.6	53.07	-12.78	40.29	54	-13.71	AV	Horizontal
802.11 g							
2399.9	68.31	-12.99	55.32	74	-18.68	PK	Vertical
2399.9	54.28	-12.99	41.29	54	-12.71	AV	Vertical
2399.9	69.41	-12.99	56.42	74	-17.58	PK	Horizontal
2399.9	52.87	-12.99	39.88	54	-14.12	AV	Horizontal
2483.6	70.35	-12.78	57.57	74	-16.43	PK	Vertical
2483.6	53.29	-12.78	40.51	54	-13.49	AV	Vertical
2483.6	70.28	-12.78	57.5	74	-16.5	PK	Horizontal
2483.6	53.17	-12.78	40.39	54	-13.61	AV	Horizontal



802.11 n20							
2399.9	68.43	-12.99	55.44	74	-18.56	PK	Vertical
2399.9	53.87	-12.99	40.88	54	-13.12	AV	Vertical
2399.9	69.24	-12.99	56.25	74	-17.75	PK	Horizontal
2399.9	52.97	-12.99	39.98	54	-14.02	AV	Horizontal
2483.6	70.45	-12.78	57.67	74	-16.33	PK	Vertical
2483.6	52.93	-12.78	40.15	54	-13.85	AV	Vertical
2483.6	70.29	-12.78	57.51	74	-16.49	PK	Horizontal
2483.6	52.89	-12.78	40.11	54	-13.89	AV	Horizontal
802.11 n40							
2399.9	67.98	-12.99	54.99	74	-19.01	PK	Vertical
2399.9	54.69	-12.99	41.7	54	-12.3	AV	Vertical
2399.9	69.27	-12.99	56.28	74	-17.72	PK	Horizontal
2399.9	53.19	-12.99	40.2	54	-13.8	AV	Horizontal
2483.6	70.28	-12.78	57.5	74	-16.5	PK	Vertical
2483.6	53.01	-12.78	40.23	54	-13.77	AV	Vertical
2483.6	70.25	-12.78	57.47	74	-16.53	PK	Horizontal
2483.6	53.34	-12.78	40.56	54	-13.44	AV	Horizontal
<p>Remark: Factor = Antenna Factor + Cable Loss – Pre-amplifier.</p> <p>Low measurement frequencies is range from 2310 to 2400 MHz, high measurement frequencies is range from 2483.5 to 2500 MHz. Only show the worst point data of the emissions in the frequency 2310-2400 MHz and 2483.5-2500 MHz.</p>							

4. CONDUCTED SPURIOUS EMISSIONS

4.1 APPLIED PROCEDURES / LIMIT

In any 100 kHz bandwidth outside the frequency band in which the spread spectrum or digitally modulated intentional radiator is operating, the radio frequency power that is produced by the intentional radiator shall be at least 20 dB below that in the 100 kHz bandwidth within the band that contains the highest level of the desired power, based on either an RF conducted or a radiated measurement. Attenuation below the general limits specified in Section 15.209(a) is not required. In addition, radiated emissions which fall in the restricted bands, as defined in §15.205(a), must also comply with the radiated emission limits specified in §15.209(a) (see §15.205(c)).

4.2 TEST PROCEDURE

Spectrum Parameter	Setting
Detector	Peak
Start/Stop Frequency	30 MHz to 10th carrier harmonic
RB / VB (emission in restricted band)	100 KHz/300 KHz
Trace-Mode:	Max hold

For Band edge

Spectrum Parameter	Setting
Detector	Peak
Start/Stop Frequency	Lower Band Edge: 2300 to 2430 MHz Upper Band Edge: 2450 to 2500 MHz
RB / VB (emission in restricted band)	100 KHz/300 KHz
Trace-Mode:	Max hold

4.3 DEVIATION FROM STANDARD

No deviation.

4.4 TEST SETUP

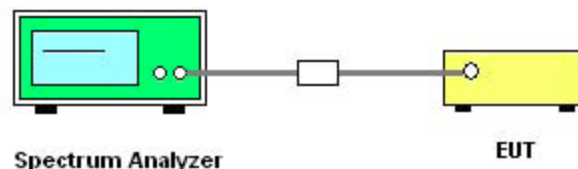

The EUT which is powered by the Battery, is coupled to the Spectrum Analyzer; the RF load attached to the EUT antenna terminal is 50Ohm; the path loss as the factor is calibrated to correct the reading. Make the measurement with the spectrum analyzer's resolution bandwidth (RBW) = 100 kHz. In order to make an accurate measurement, set the span greater than RBW.

4.5 EUT OPERATION CONDITIONS

The EUT tested system was configured as the statements of 2.3 Unless otherwise a special operating condition is specified in the follows during the testing.



4.6 TEST RESULTS

EUT :	Smart Phone	Model Name :	Sky 5.0L
Temperature :	25 °C	Relative Humidity :	60%
Pressure :	1015 hPa	Test Voltage :	DC 3.8V
Test Mode :	TX b Mode /CH01, CH06, CH11		

CH 01

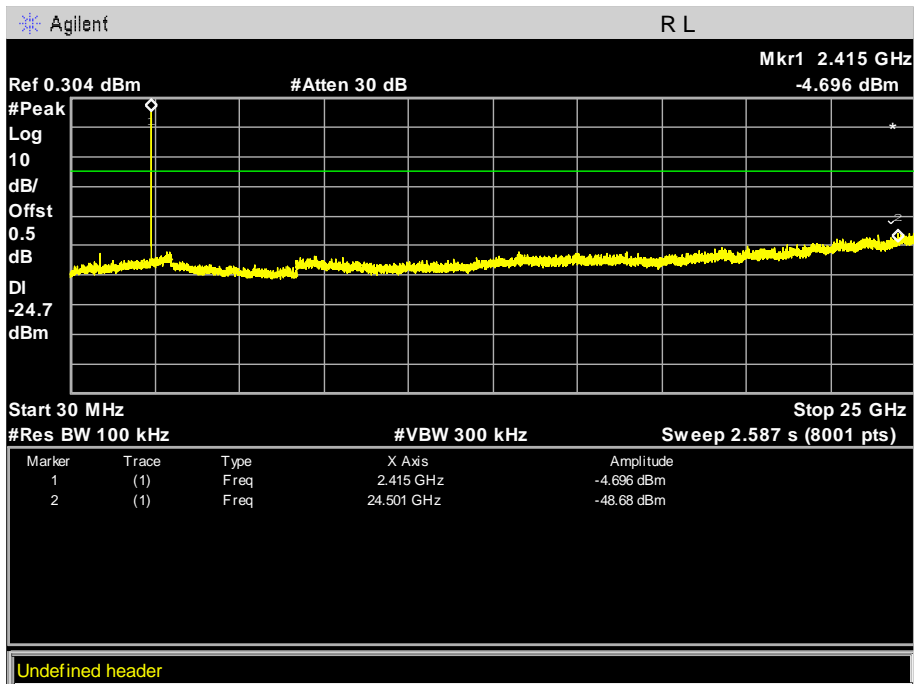



CH 06

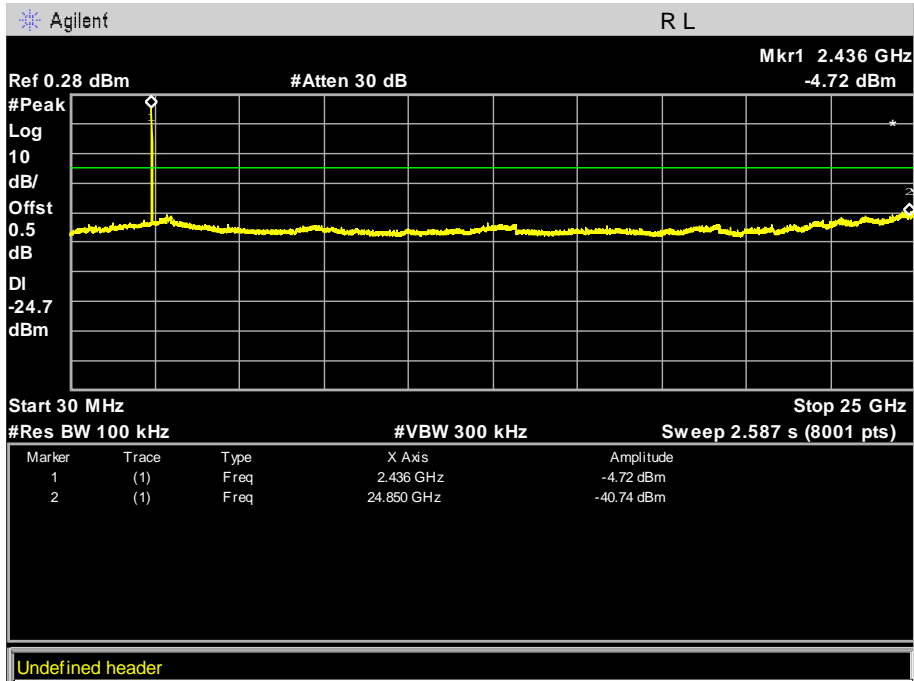

CH 11

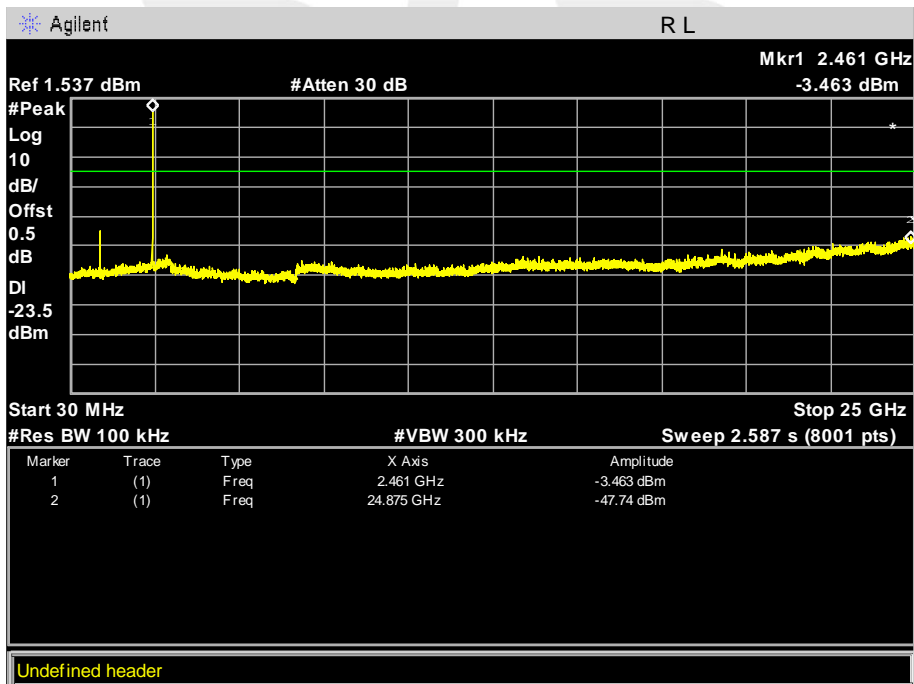



Band edge

CH 01

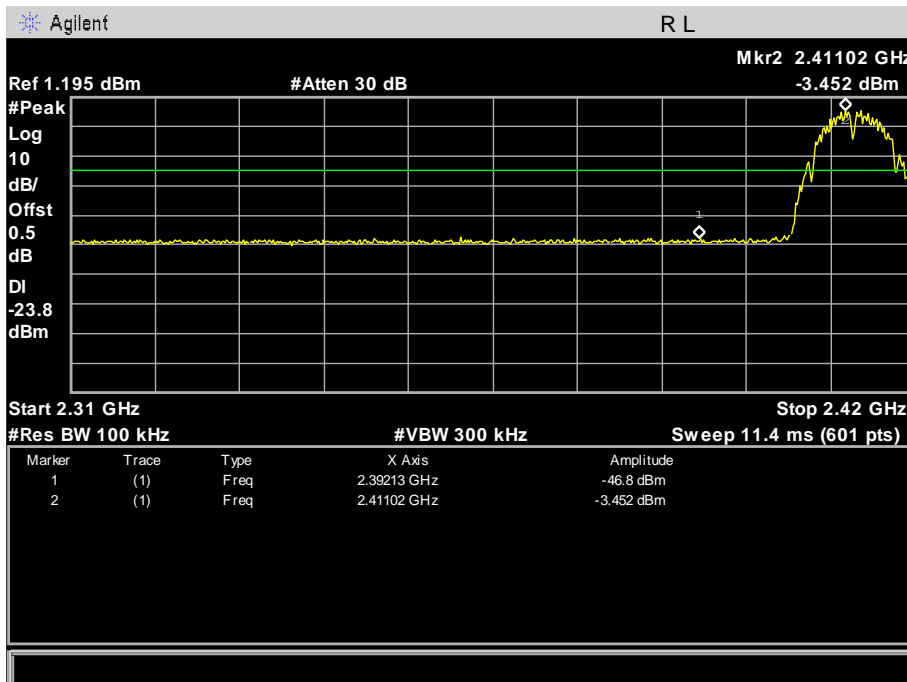

CH 11

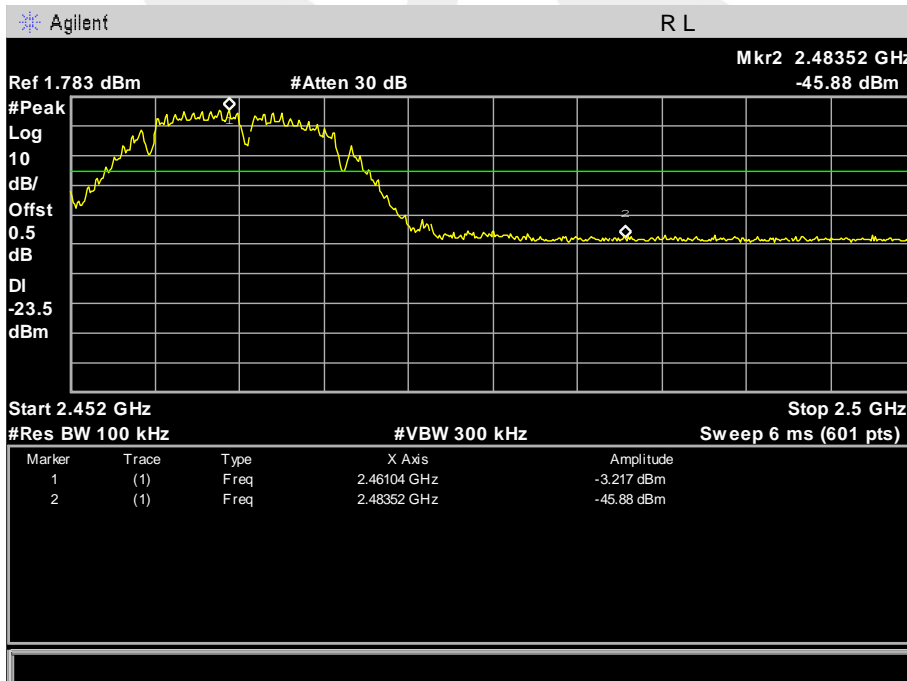



EUT :	Smart Phone	Model Name :	Sky 5.0L
Temperature :	25 °C	Relative Humidity :	60%
Pressure :	1015 hPa	Test Voltage :	DC 3.8V
Test Mode :	TX g Mode /CH01, CH06, CH11		

CH 01

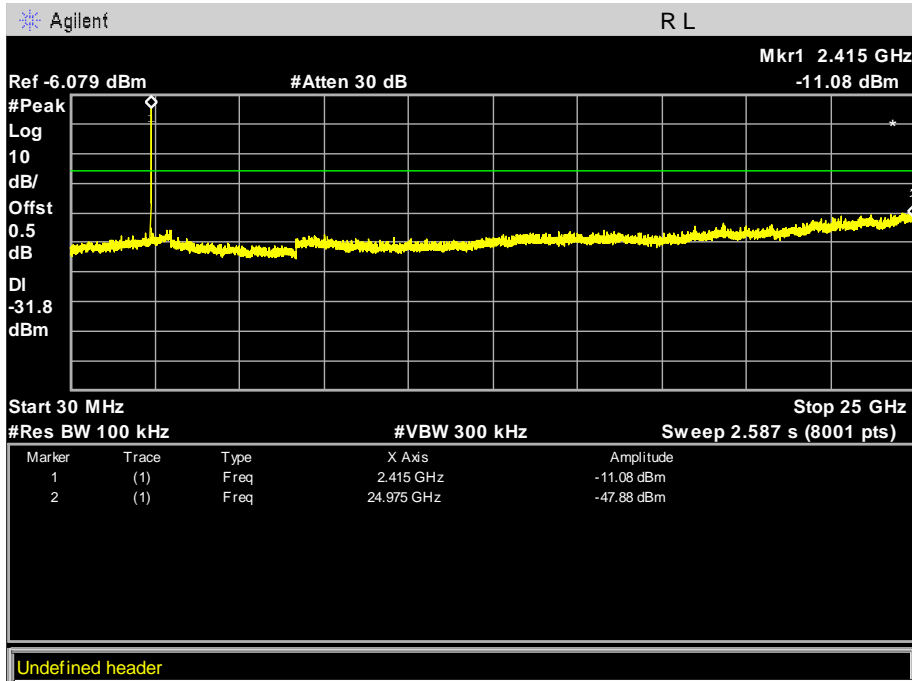

CH06

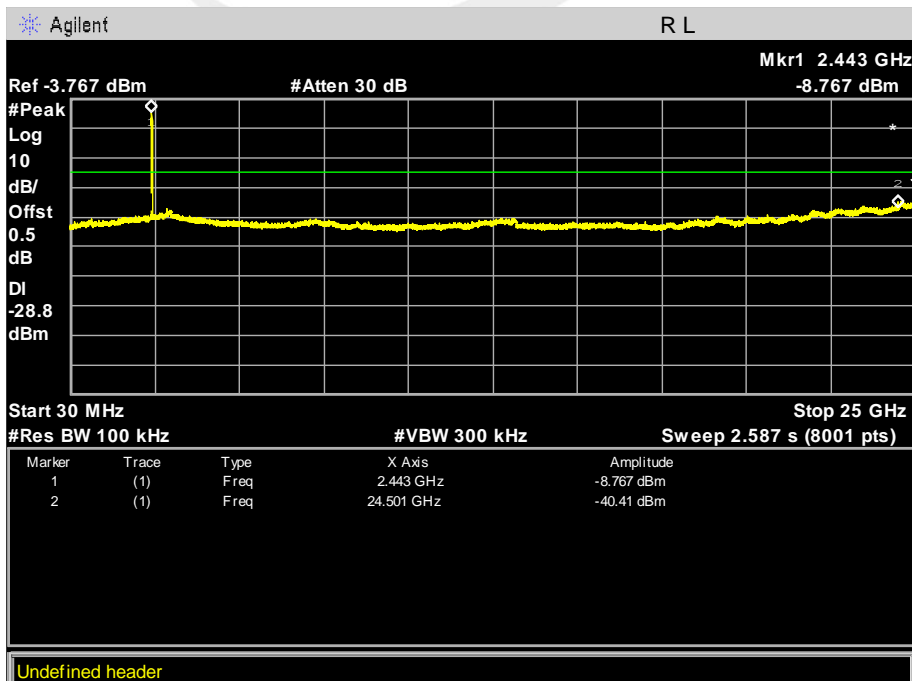



CH 11

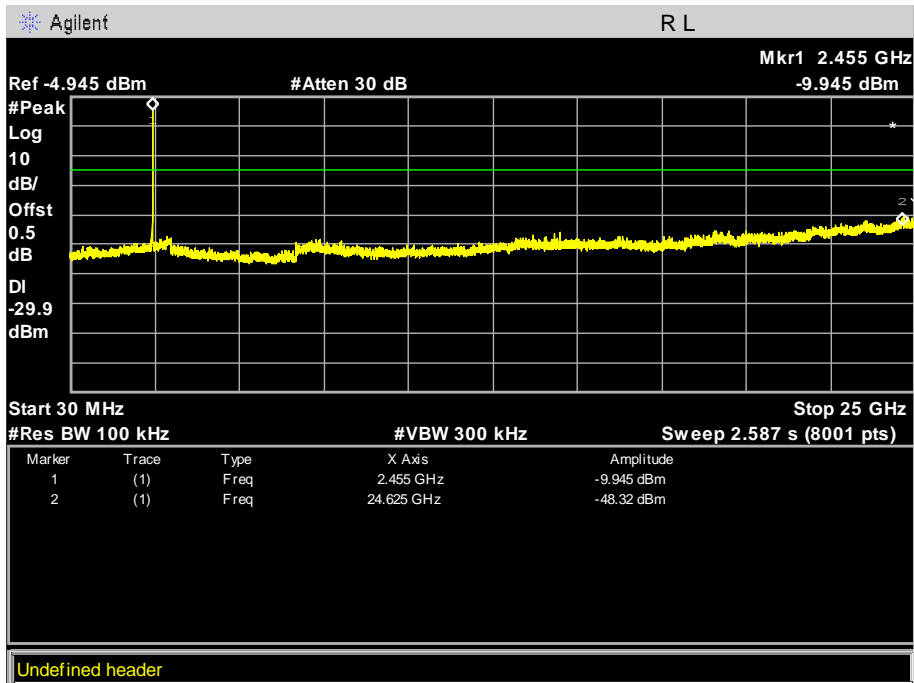



Band edge

CH 01

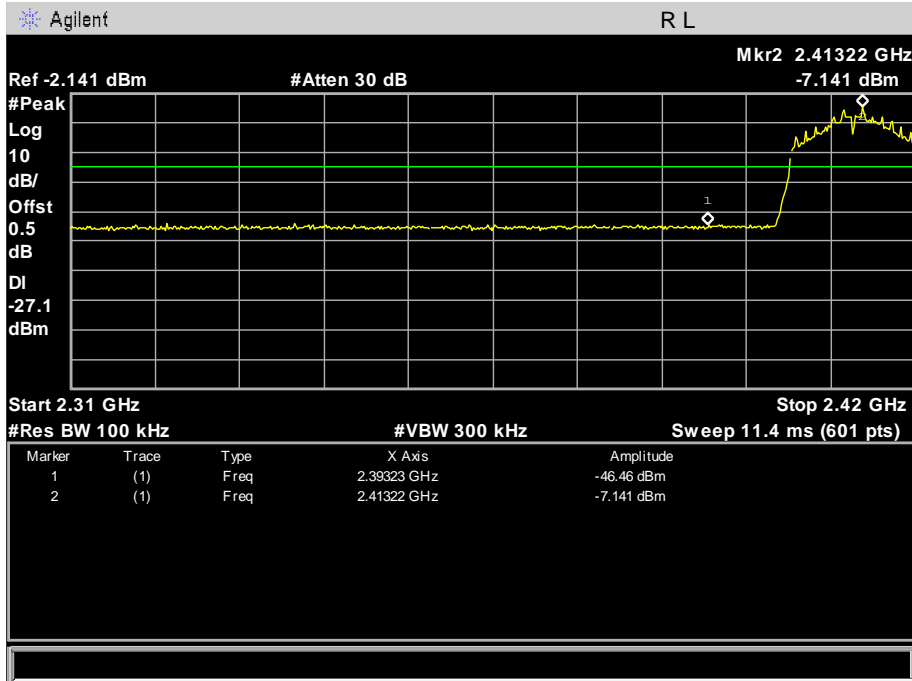

CH11

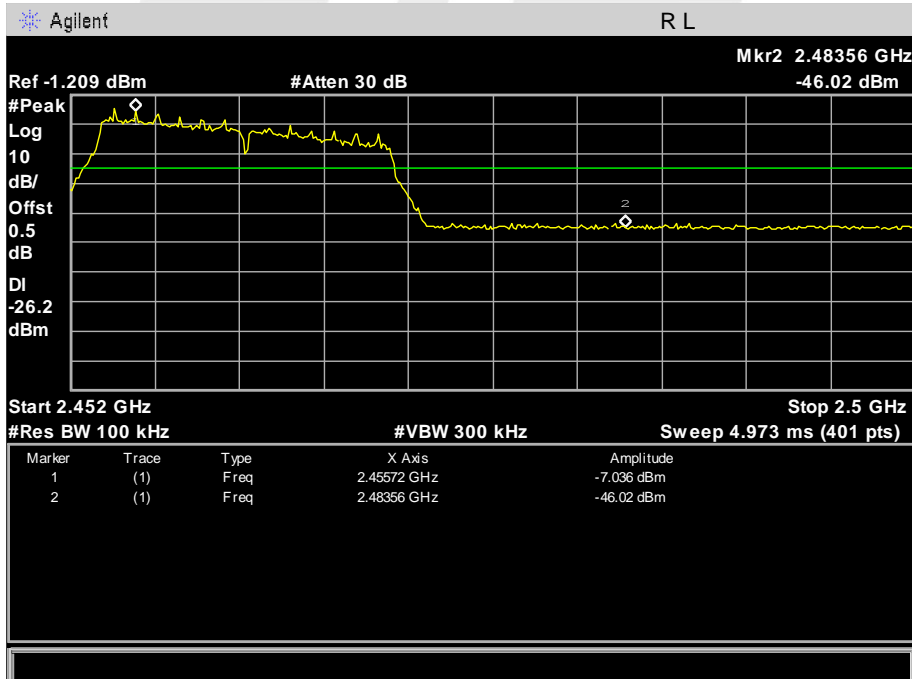



EUT :	Smart Phone	Model Name :	Sky 5.0L
Temperature :	25 °C	Relative Humidity :	60%
Pressure :	1015 hPa	Test Voltage :	DC 3.8V
Test Mode :	TX n Mode(20M) /CH01, CH06, CH11		

CH 01

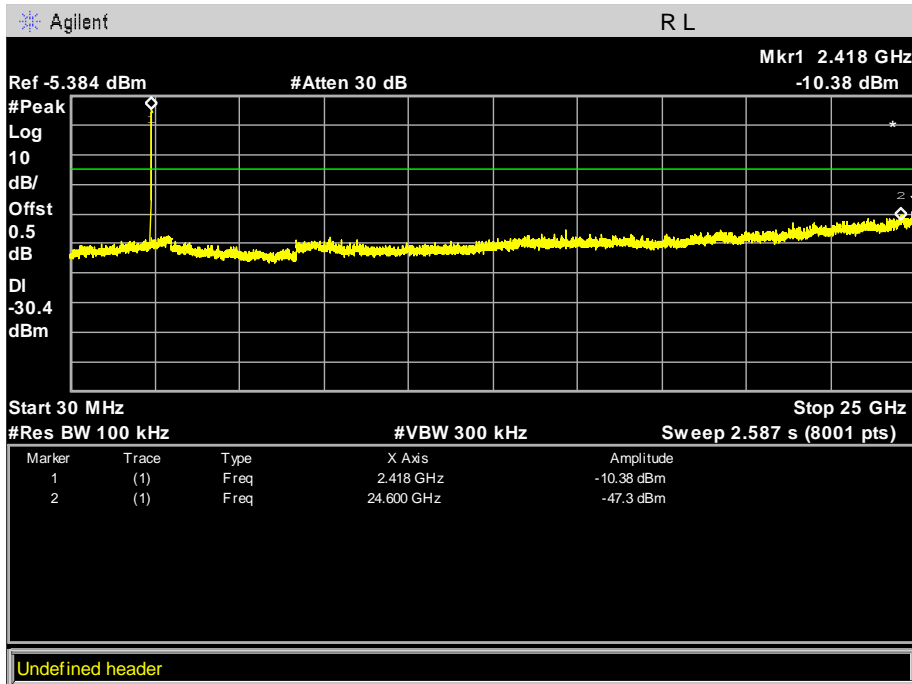

CH 06

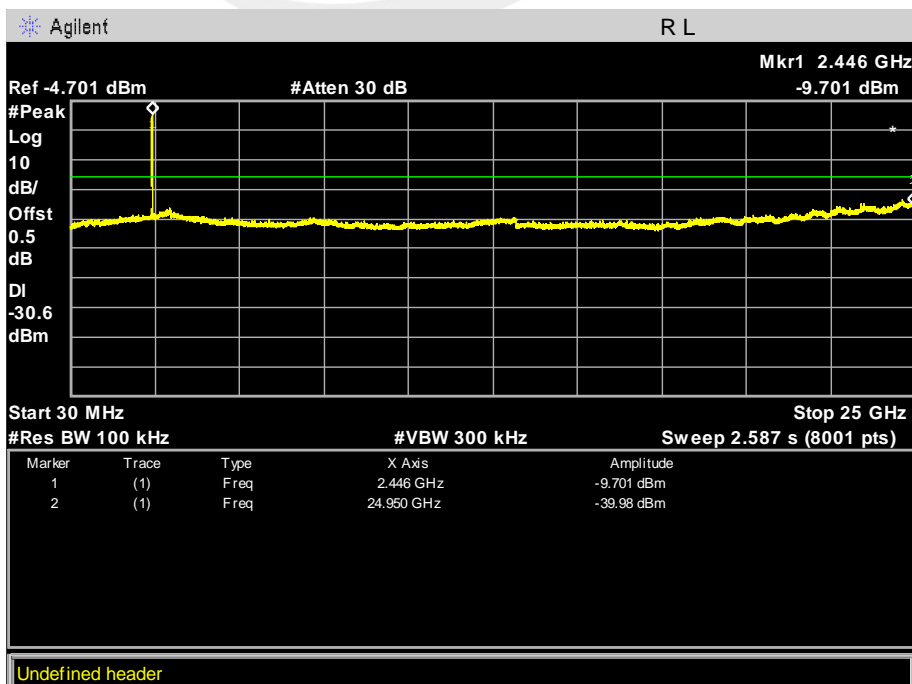



CH 11

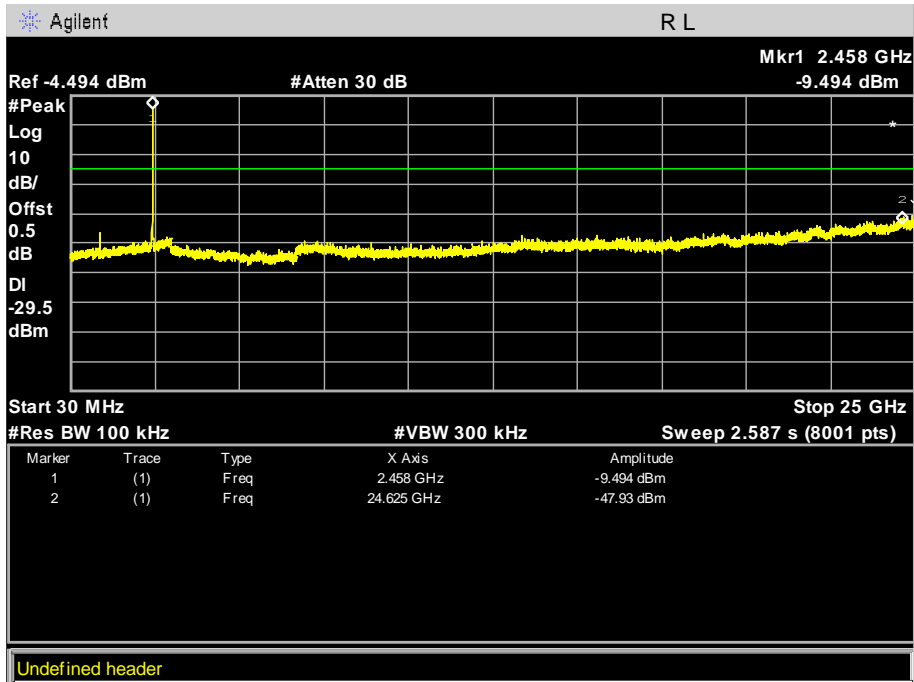



Band edge

CH 01

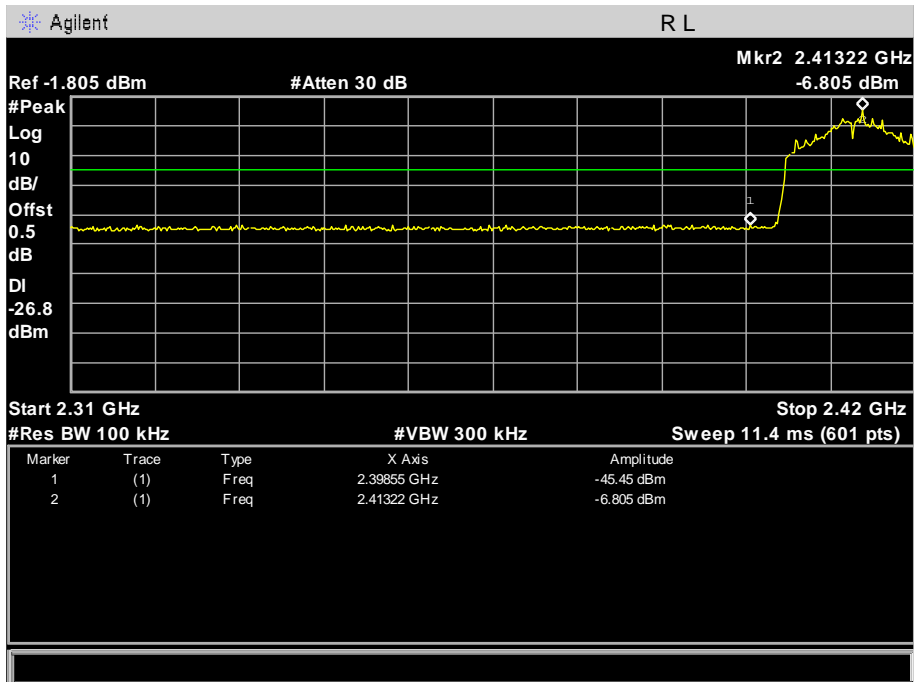

CH 11

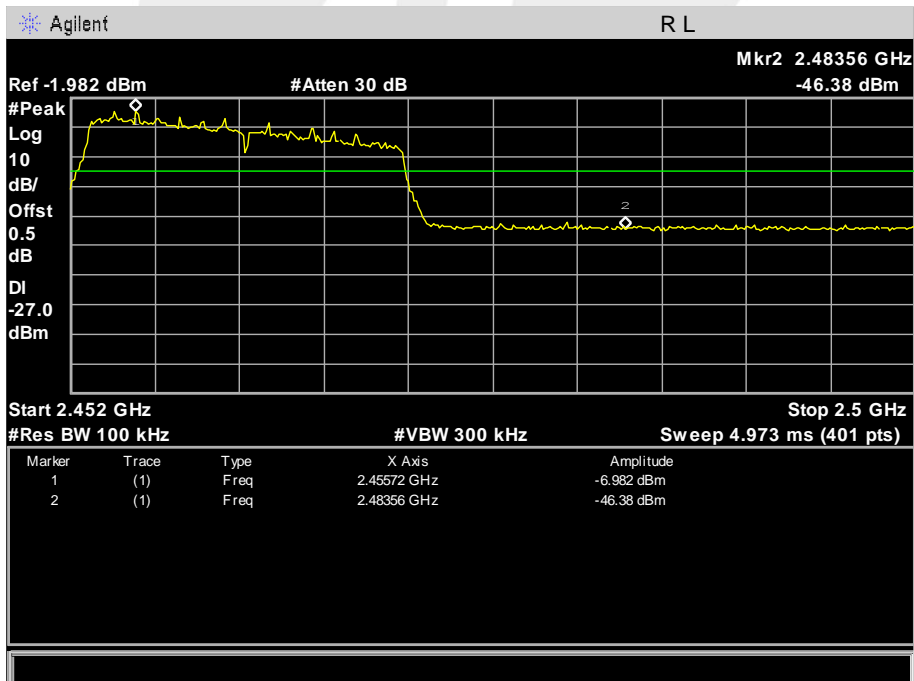



EUT :	Smart Phone	Model Name :	Sky 5.0L
Temperature :	25 °C	Relative Humidity :	60%
Pressure :	1015 hPa	Test Voltage :	DC 3.8V
Test Mode :	TX n Mode(40M) /CH03, CH06, CH09		

CH 03

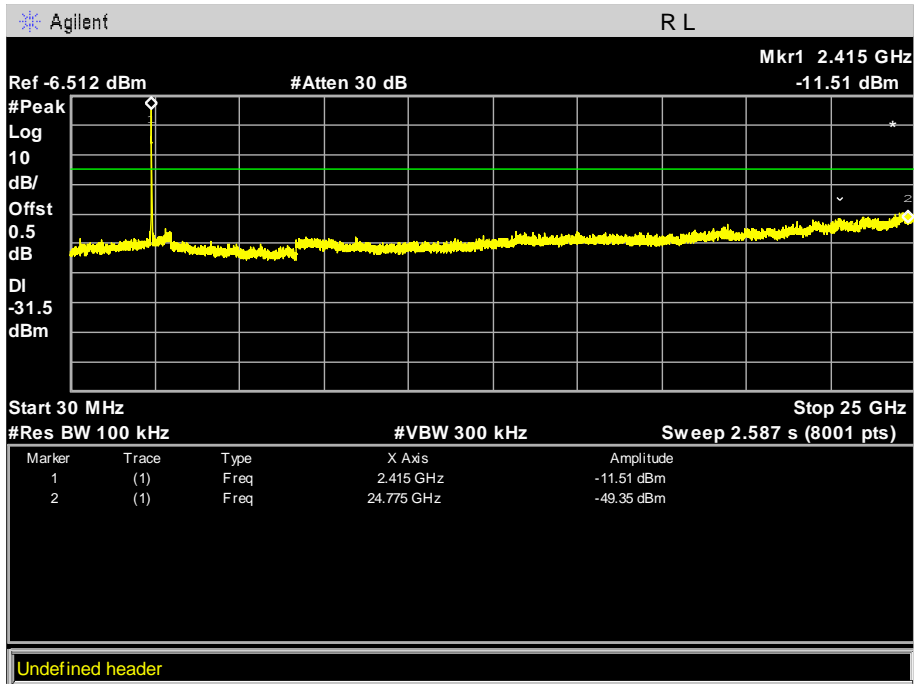



CH06

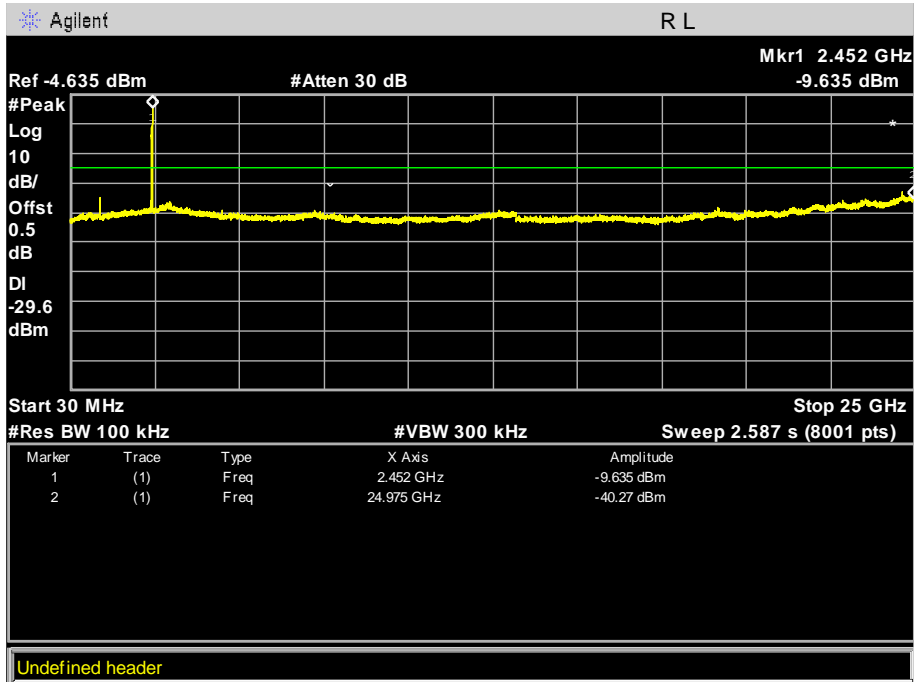

CH09

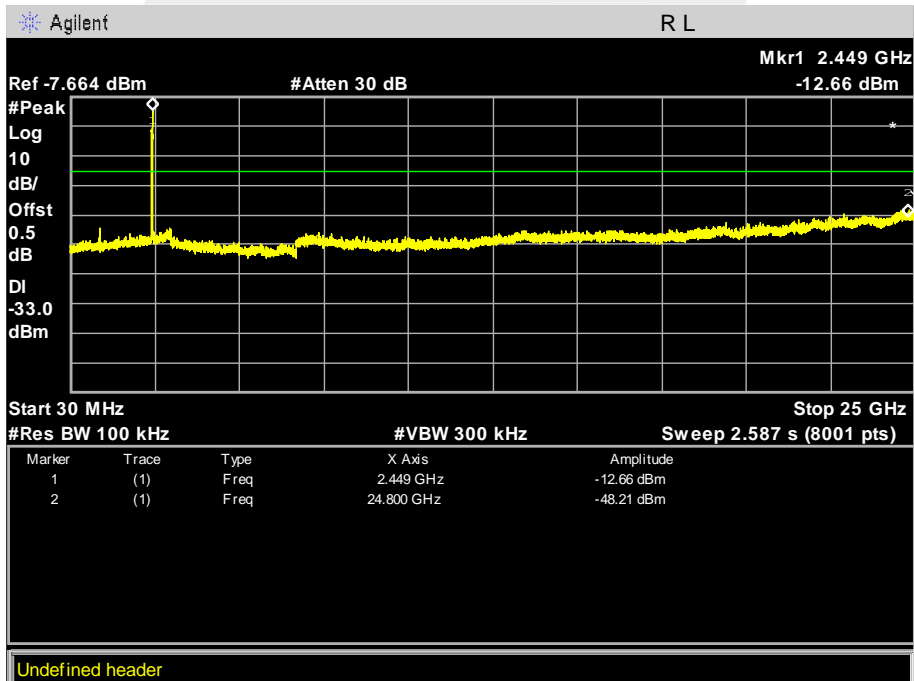



Band edge

CH03

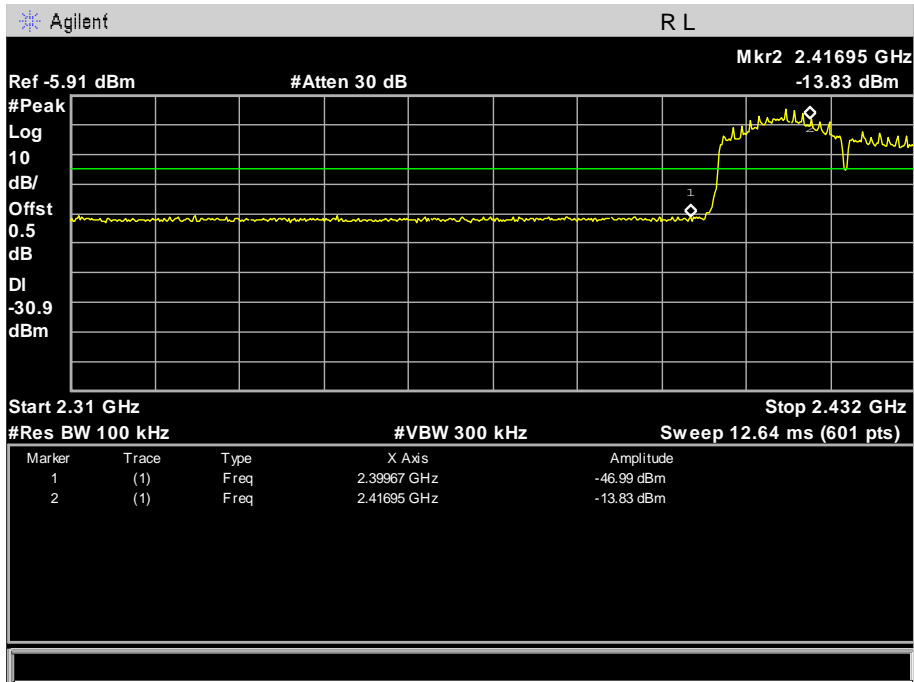

CH 09

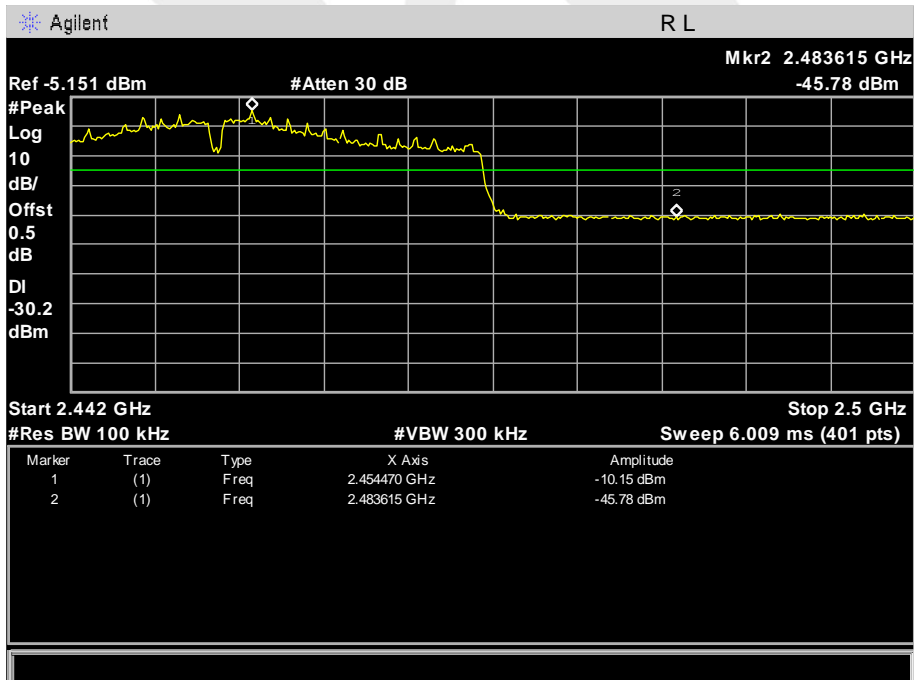



5. POWER SPECTRAL DENSITY TEST

5.1 APPLIED PROCEDURES / LIMIT

FCC Part15 (15.247) , Subpart C				
Section	Test Item	Limit	Frequency Range (MHz)	Result
15.247	Power Spectral Density	8 dBm (in any 3KHz)	2400-2483.5	PASS

5.2 TEST PROCEDURE

1. Set analyzer center frequency to DTS channel center frequency.
2. Set the span to 1.5 times the DTS channel bandwidth.
3. Set the RBW \geq 3 kHz.
4. Set the VBW \geq 3 x RBW.
5. Detector = peak.
6. Sweep time = auto couple.
7. Trace mode = max hold.
8. Allow trace to fully stabilize.
9. Use the peak marker function to determine the maximum amplitude level.
10. If measured value exceeds limit, reduce RBW (no less than 3 kHz) and repeat.

5.3 DEVIATION FROM STANDARD

No deviation.

5.4 TEST SETUP

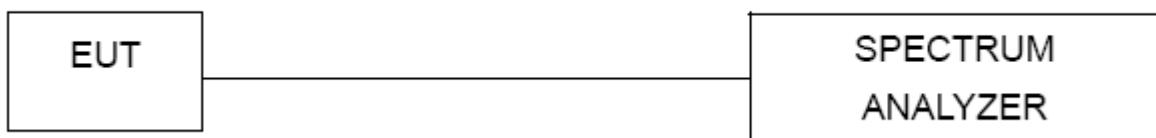

5.5 EUT OPERATION CONDITIONS

The EUT tested system was configured as the statements of 2.3 Unless otherwise a special operating condition is specified in the follows during the testing.



5.6 TEST RESULTS

EUT :	Smart Phone	Model Name :	Sky 5.0L
Temperature :	25 °C	Relative Humidity :	60%
Pressure :	1015 hPa	Test Voltage :	DC 3.8V
Test Mode :	TX b Mode /CH01, CH06, CH11		

Frequency	Power Density (dBm)	Limit (dBm)	Result
2412 MHz	-16.38	8	PASS
2437 MHz	-17.91	8	PASS
2462 MHz	-16.42	8	PASS

TX CH01

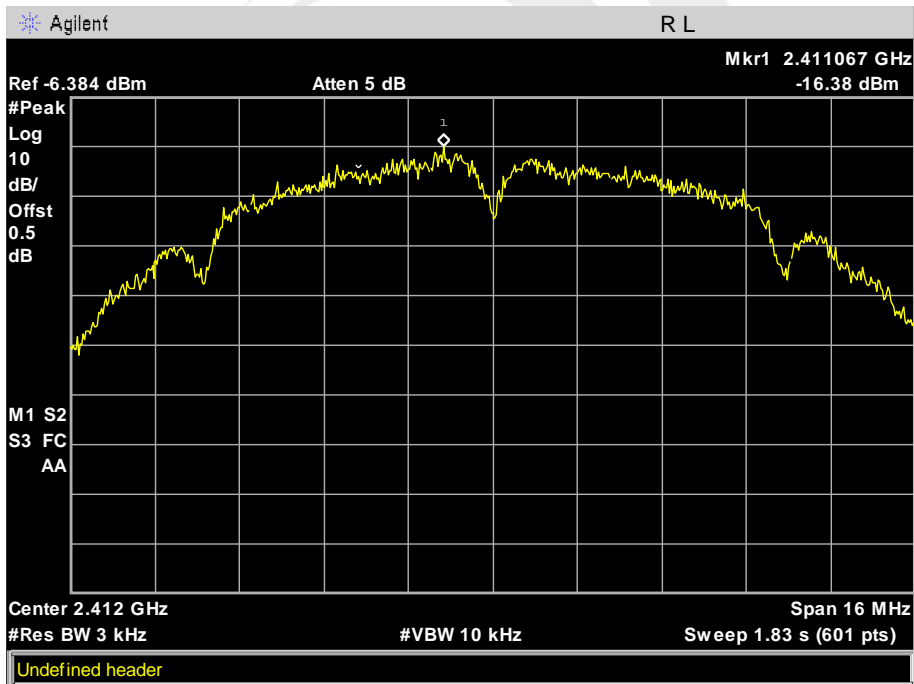



TX CH06

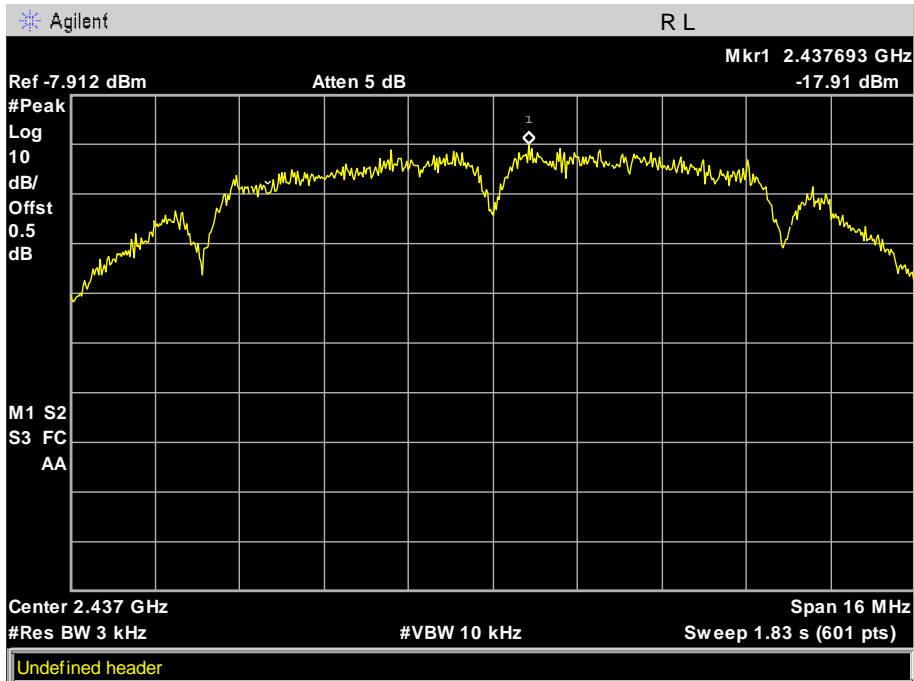

TX CH11

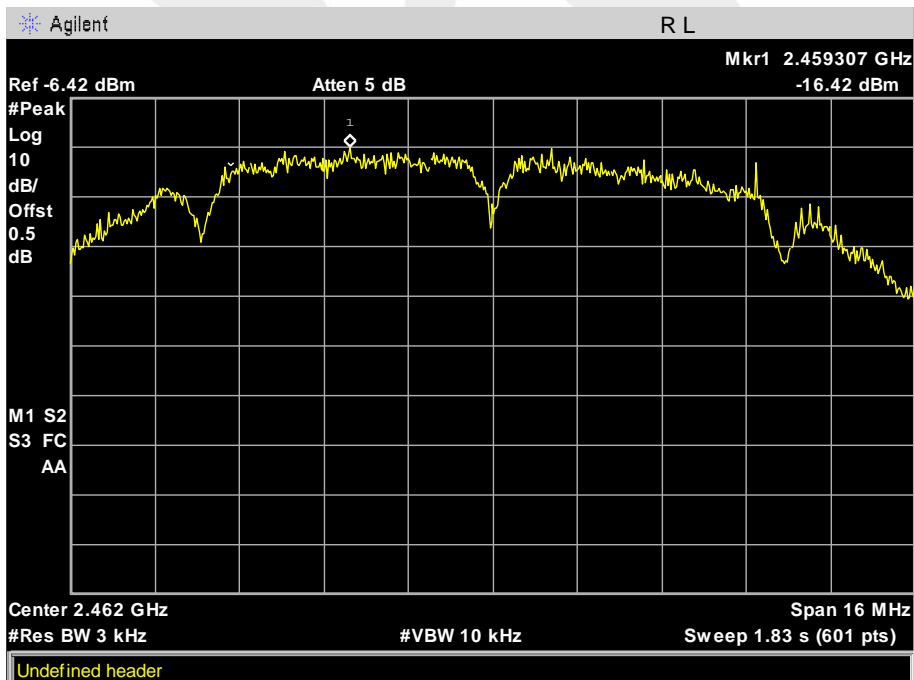



EUT :	Smart Phone	Model Name :	Sky 5.0L
Temperature :	25 °C	Relative Humidity :	60%
Pressure :	1015 hPa	Test Voltage :	DC 3.8V
Test Mode :	TX g Mode /CH01, CH06, CH11		

Frequency	Power Density (dBm)	Limit (dBm)	Result
2412 MHz	-20.23	8	PASS
2437 MHz	-21.28	8	PASS
2462 MHz	-20.66	8	PASS

TX CH01

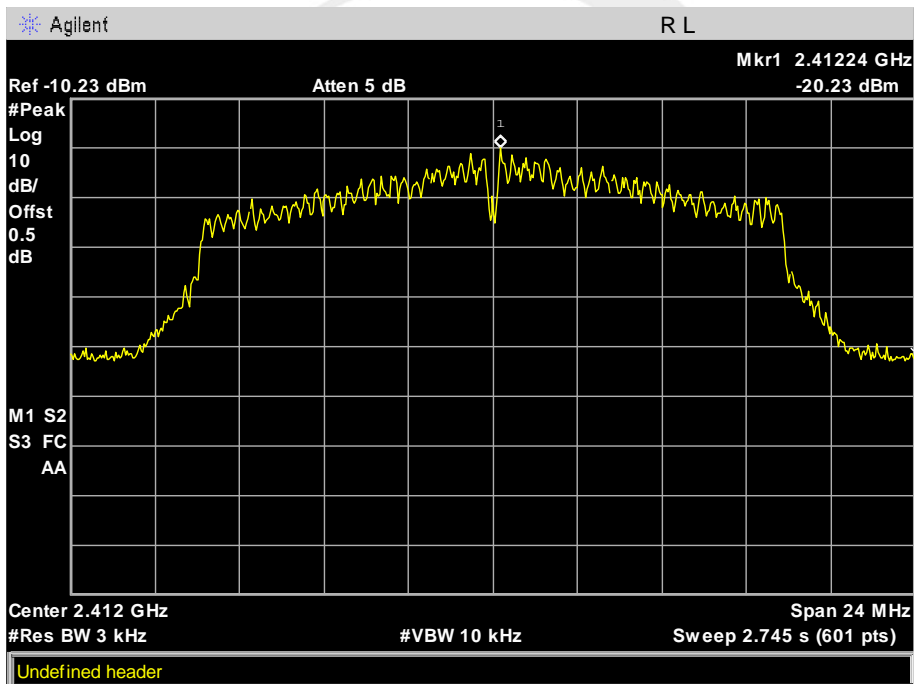



TX CH06

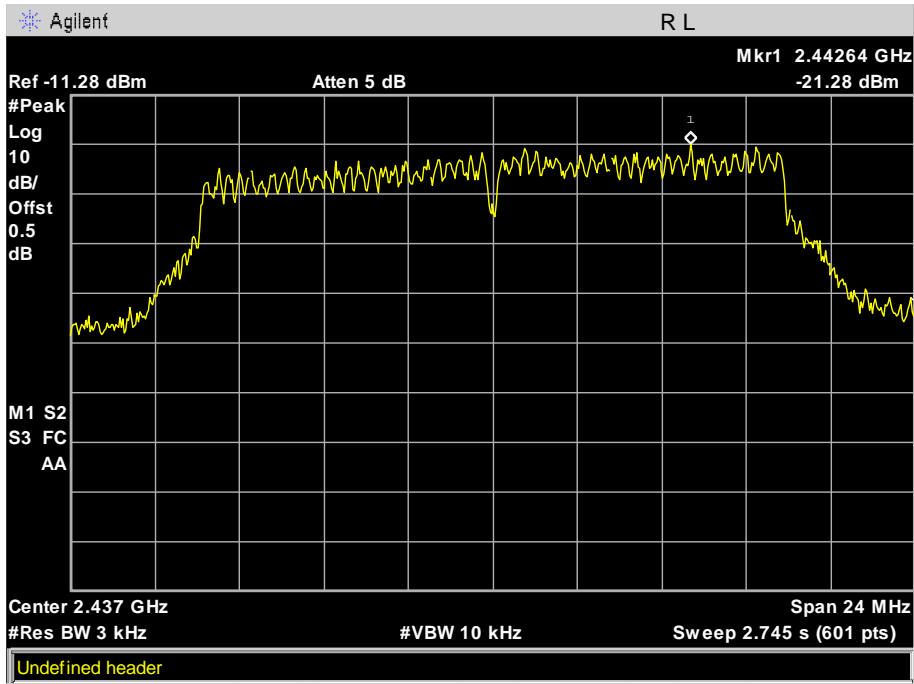

TX CH11

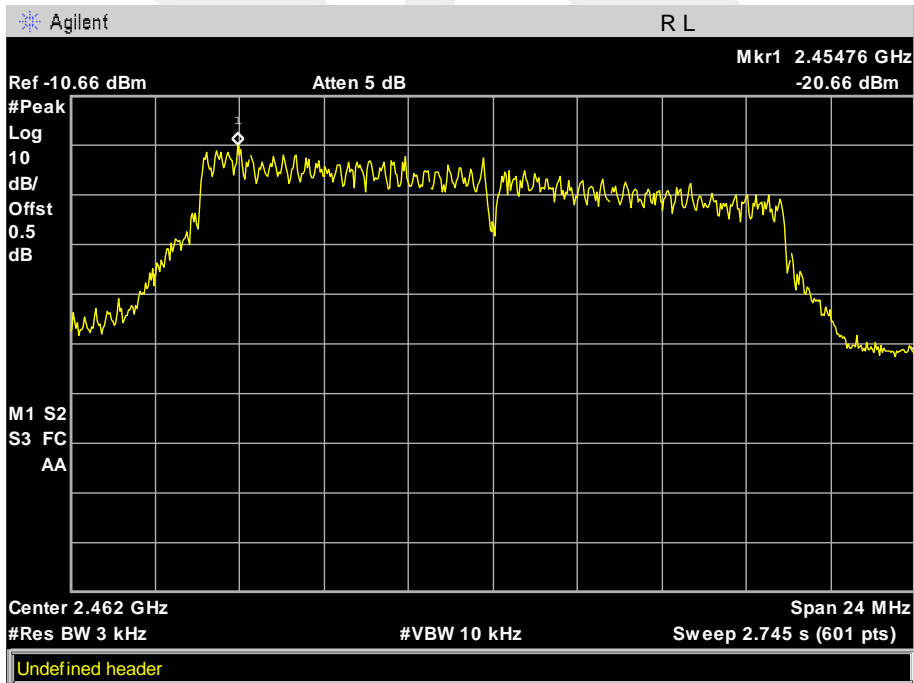



EUT :	Smart Phone	Model Name :	Sky 5.0L
Temperature :	25 °C	Relative Humidity :	60%
Pressure :	1015 hPa	Test Voltage :	DC 3.8V
Test Mode :	TX n Mode(20M) /CH01, CH06, CH11		

Frequency	Power Density (dBm)	Limit (dBm)	Result
2412 MHz	-22.35	8	PASS
2437 MHz	-21.45	8	PASS
2462 MHz	-20.54	8	PASS

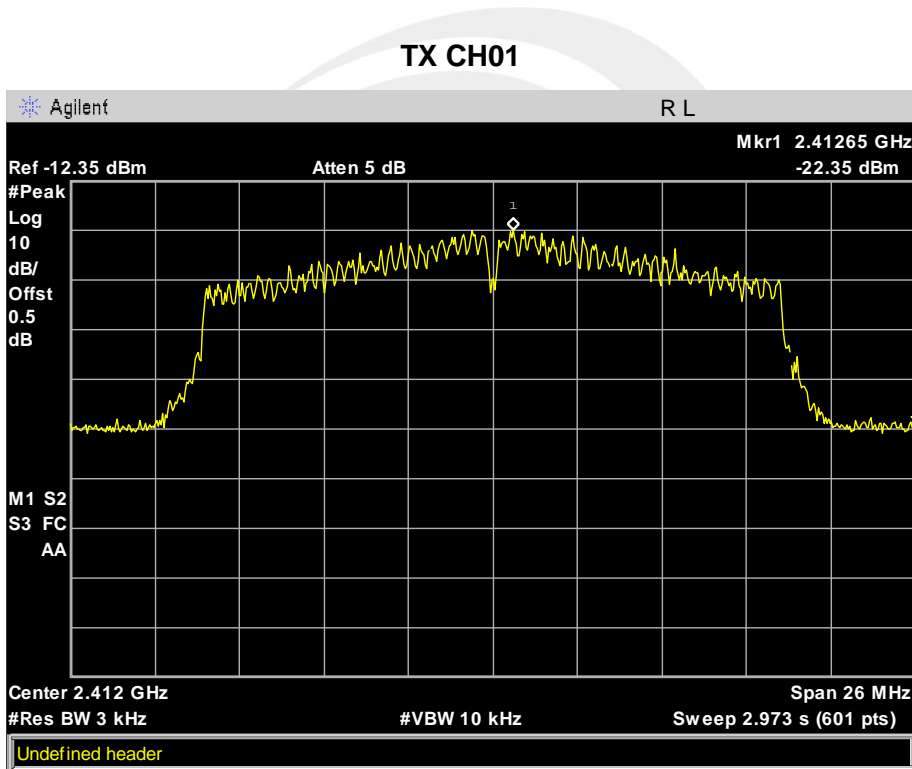



TX CH06

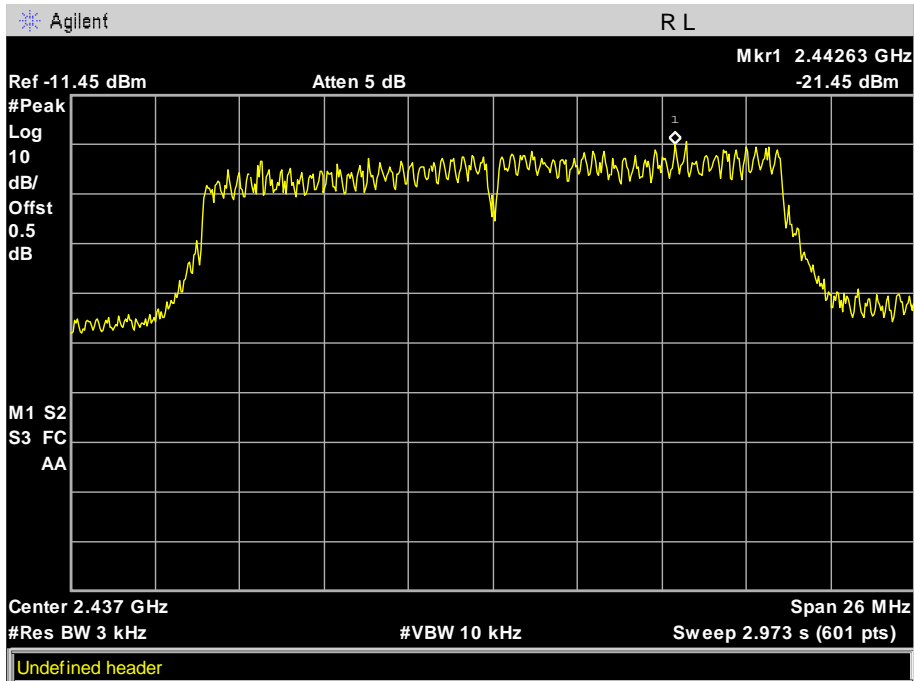

TX CH11

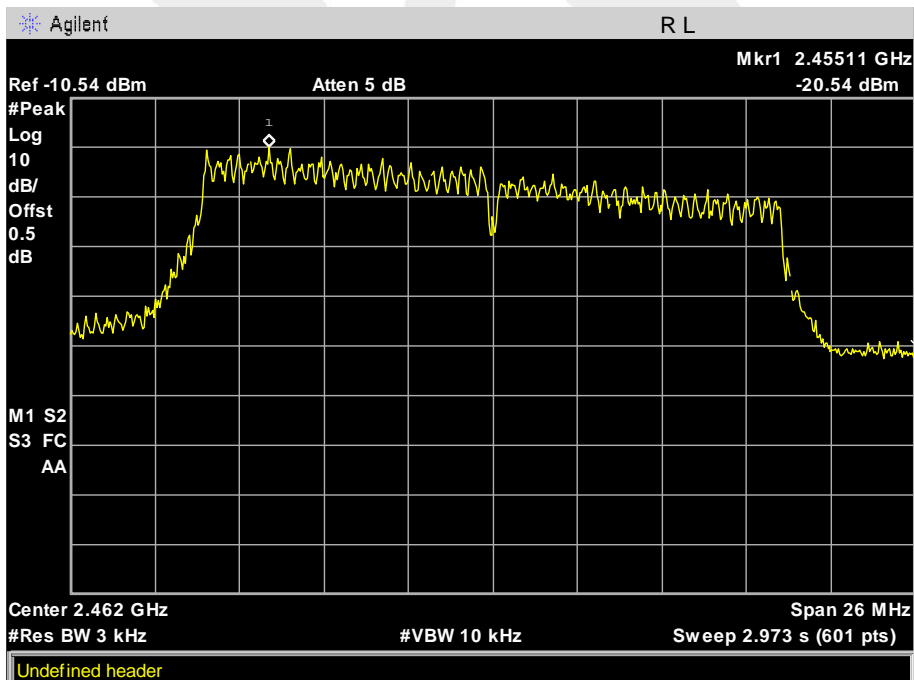



EUT :	Smart Phone	Model Name :	Sky 5.0L
Temperature :	25 °C	Relative Humidity :	60%
Pressure :	1015 hPa	Test Voltage :	DC 3.8V
Test Mode :	TX n Mode(40M) /CH03, CH06, CH09		

Frequency	Power Density (dBm)	Limit (dBm)	Result
2422 MHz	-26.98	8	PASS
2437 MHz	-23.35	8	PASS
2452 MHz	-24.56	8	PASS

TX CH03

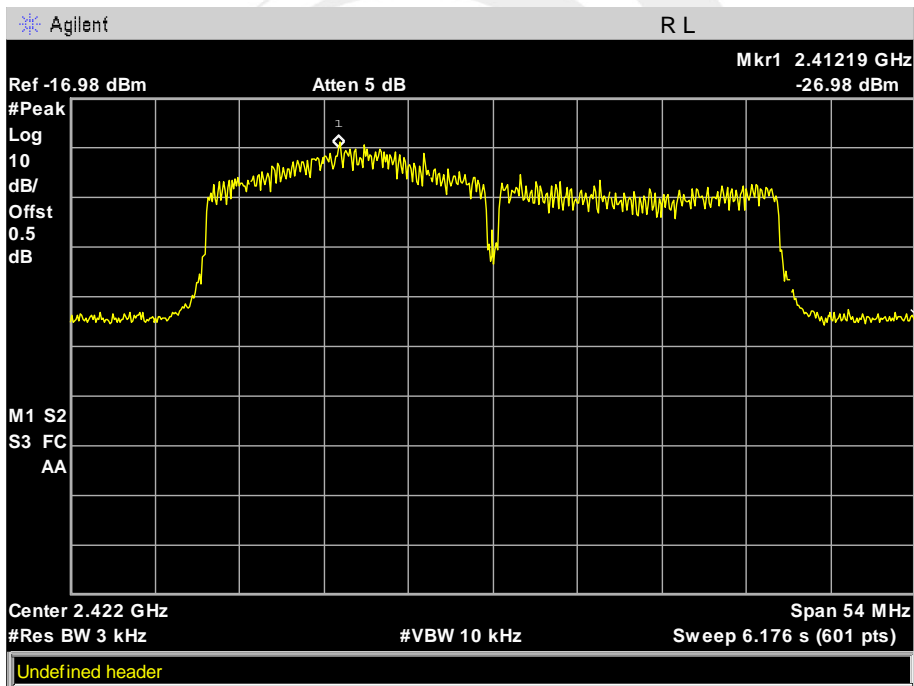



TX CH06

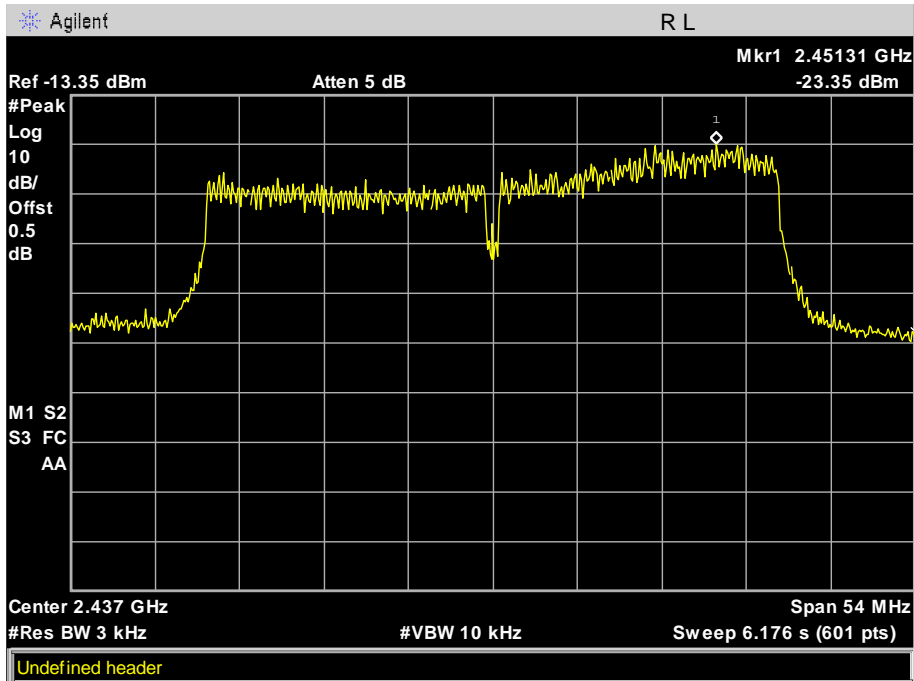

TX CH09

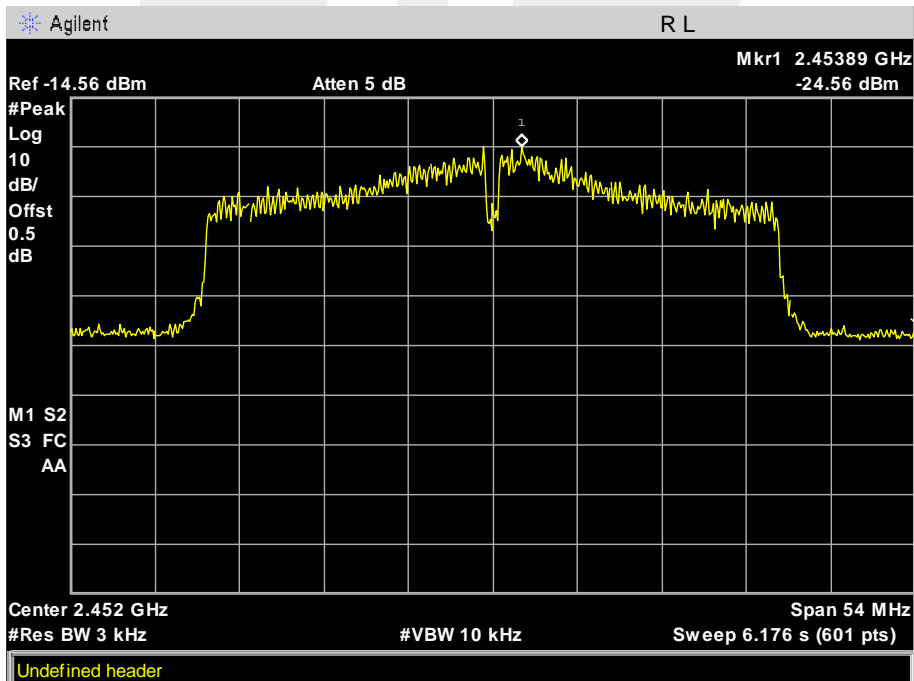



6. BANDWIDTH TEST

6.1 APPLIED PROCEDURES / LIMIT

FCC Part15 (15.247) , Subpart C				
Section	Test Item	Limit	Frequency Range (MHz)	Result
15.247(a)(2)	Bandwidth	$\geq 500\text{KHz}$ (6dB bandwidth)	2400-2483.5	PASS

6.2 TEST PROCEDURE

1. Set RBW = 100 kHz.
2. Set the video bandwidth (VBW) ≥ 3 RBW.
3. Detector = Peak.
4. Trace mode = max hold.
5. Sweep = auto couple.
6. Allow the trace to stabilize.
7. Measure the maximum width of the emission that is constrained by the frequencies associated with the two outermost amplitude points (upper and lower frequencies) that are attenuated by 6 dB relative to the maximum level measured in the fundamental emission.

6.3 DEVIATION FROM STANDARD

No deviation.

6.4 TEST SETUP



6.5 EUT OPERATION CONDITIONS

The EUT tested system was configured as the statements of 2.3 Unless otherwise a special operating condition is specified in the follows during the testing.



6.6 TEST RESULTS

EUT :	Smart Phone	Model Name :	Sky 5.0L
Temperature :	25 °C	Relative Humidity :	60%
Pressure :	1012 hPa	Test Voltage :	DC 3.8V
Test Mode :	TX b Mode /CH01, CH06, CH11		

Frequency	6dB Bandwidth (MHz)	Channel Separation (KHz)	Result
2412 MHz	8.014	>=500KHz	PASS
2437 MHz	9.050	>=500KHz	PASS
2462 MHz	9.123	>=500KHz	PASS

TX CH 01

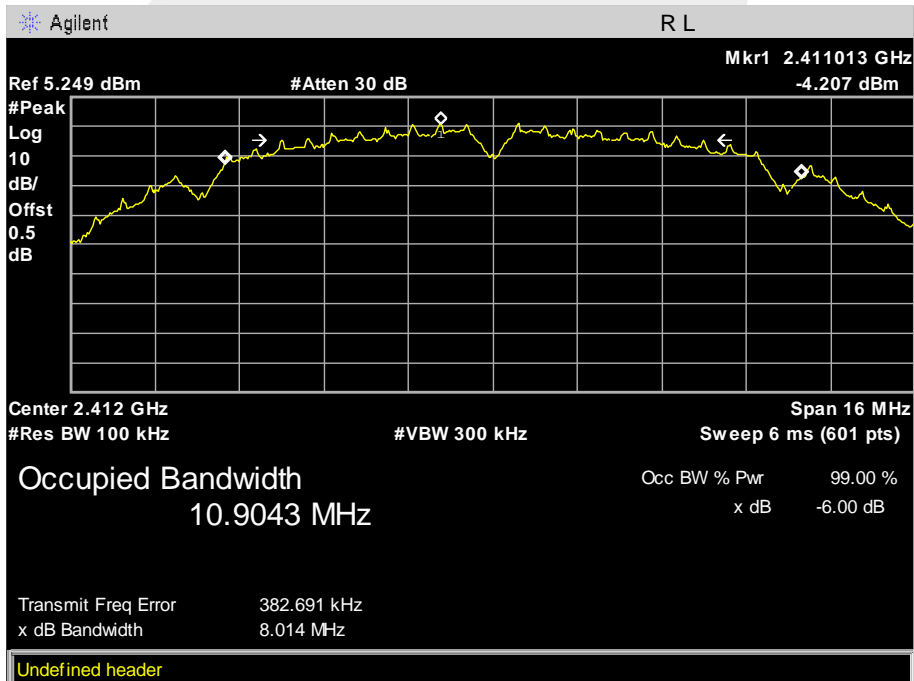



TX CH 06

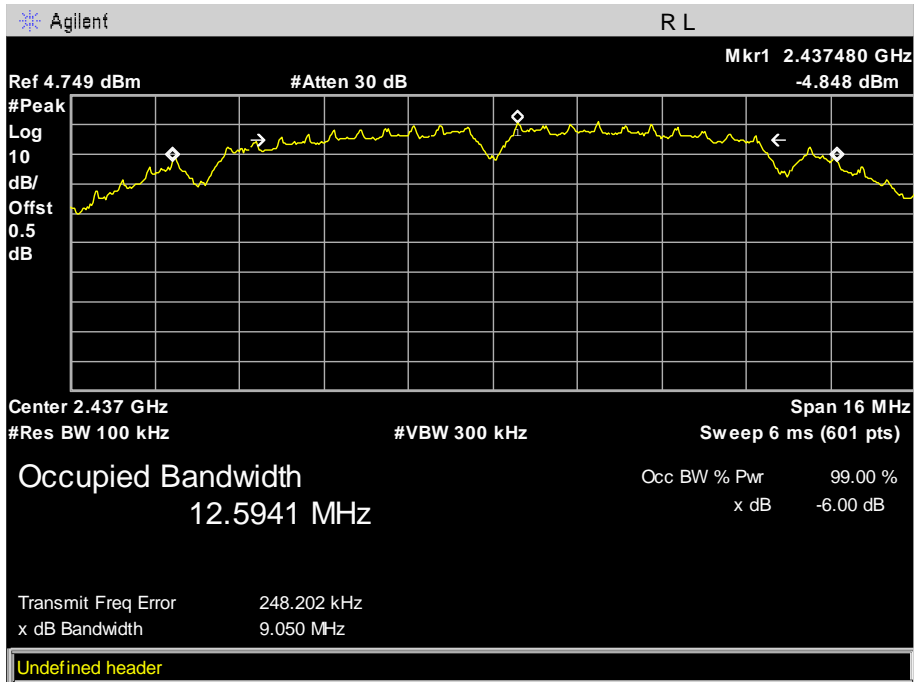

TX CH 11

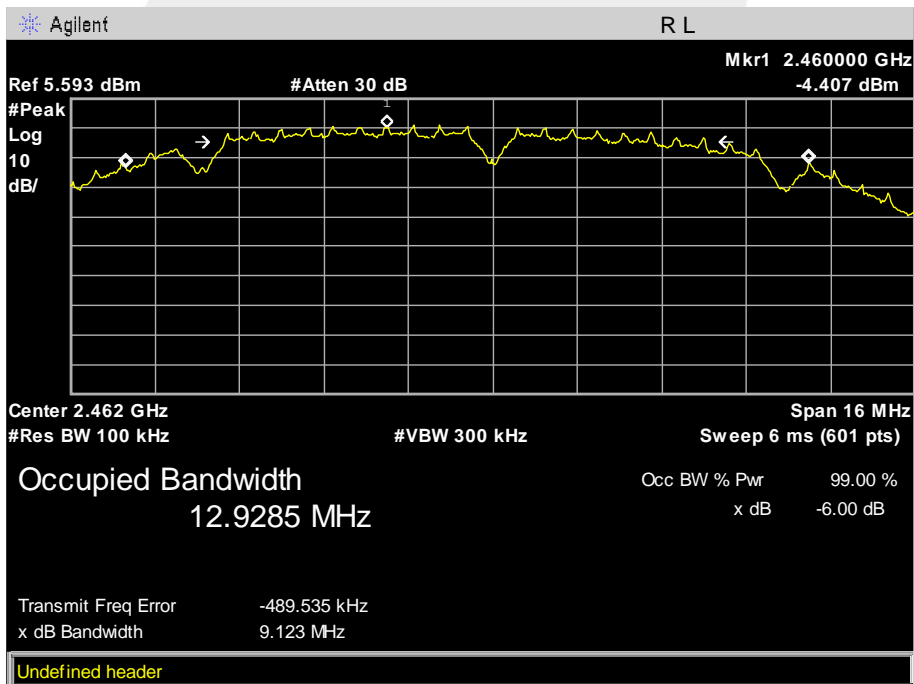



EUT :	Smart Phone	Model Name :	Sky 5.0L
Temperature :	25 °C	Relative Humidity :	60%
Pressure :	1012 hPa	Test Voltage :	DC 3.8V
Test Mode :	TX g Mode /CH01, CH06, CH11		

Frequency	6dB Bandwidth (MHz)	Channel Separation (KHz)	Result
2412 MHz	10.071	>=500KHz	PASS
2437 MHz	14.505	>=500KHz	PASS
2462 MHz	10.717	>=500KHz	PASS

TX CH 01

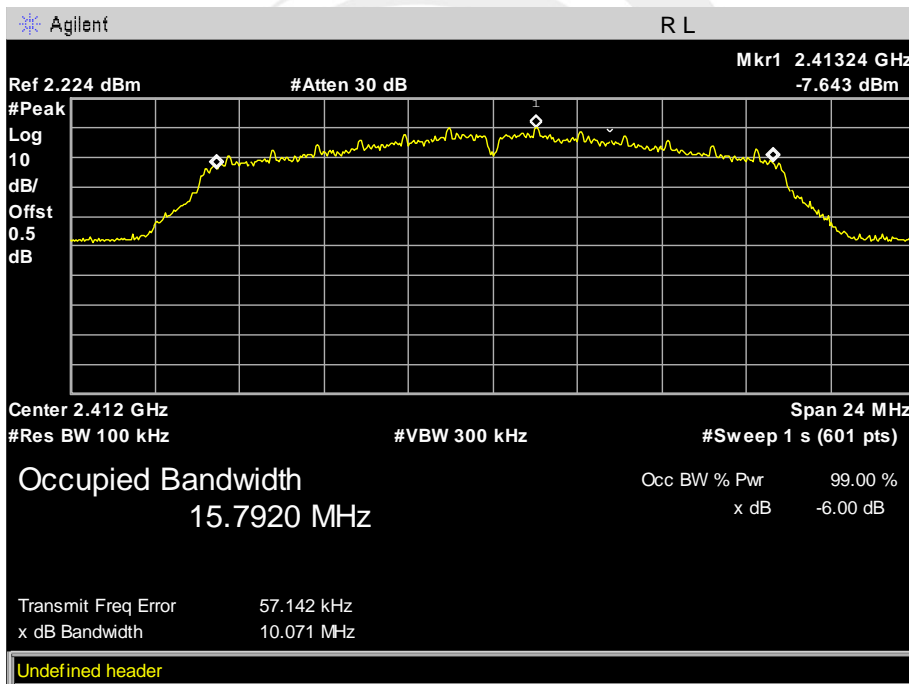



TX CH 06

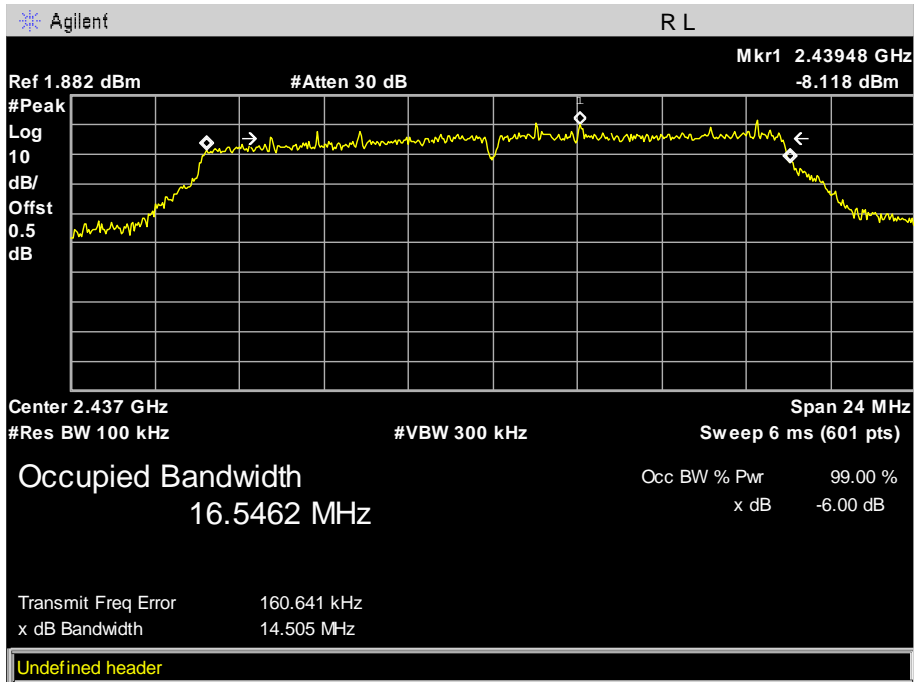

TX CH 11

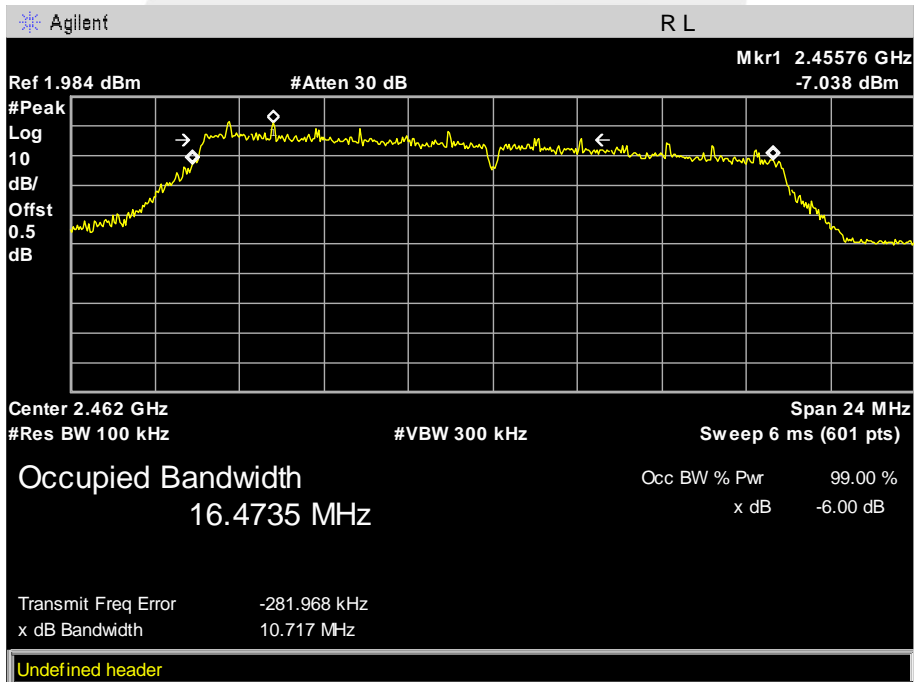



EUT :	Smart Phone	Model Name :	Sky 5.0L
Temperature :	25 °C	Relative Humidity :	60%
Pressure :	1012 hPa	Test Voltage :	DC 3.8V
Test Mode :	TX n Mode(20M) /CH01, CH06, CH11		

Frequency	6dB Bandwidth (MHz)	Channel Separation (KHz)	Result
2412 MHz	10.041	>=500KHz	PASS
2437 MHz	15.156	>=500KHz	PASS
2462 MHz	11.358	>=500KHz	PASS

TX CH 01

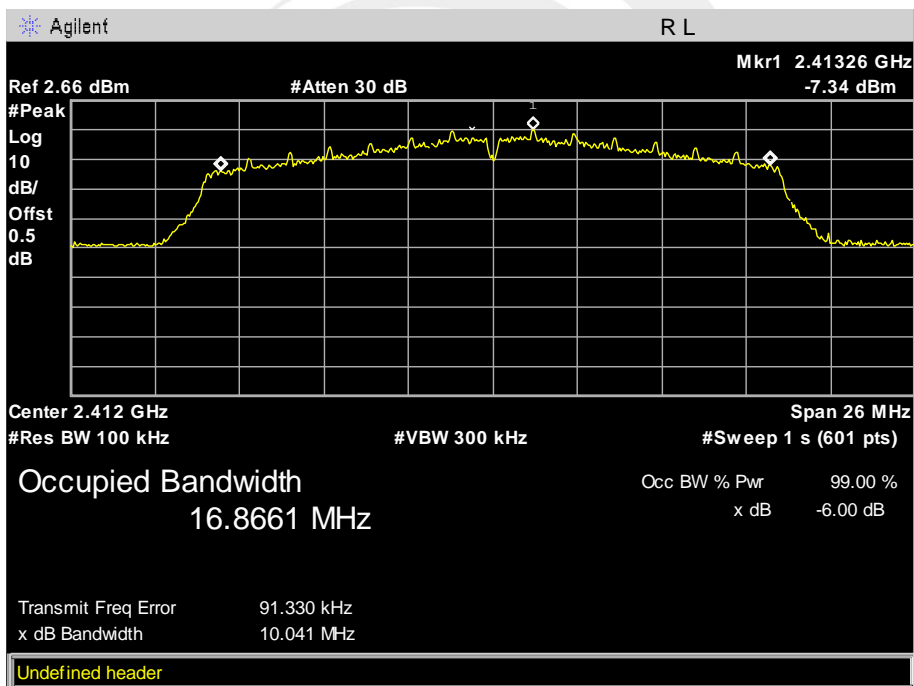



TX CH 06

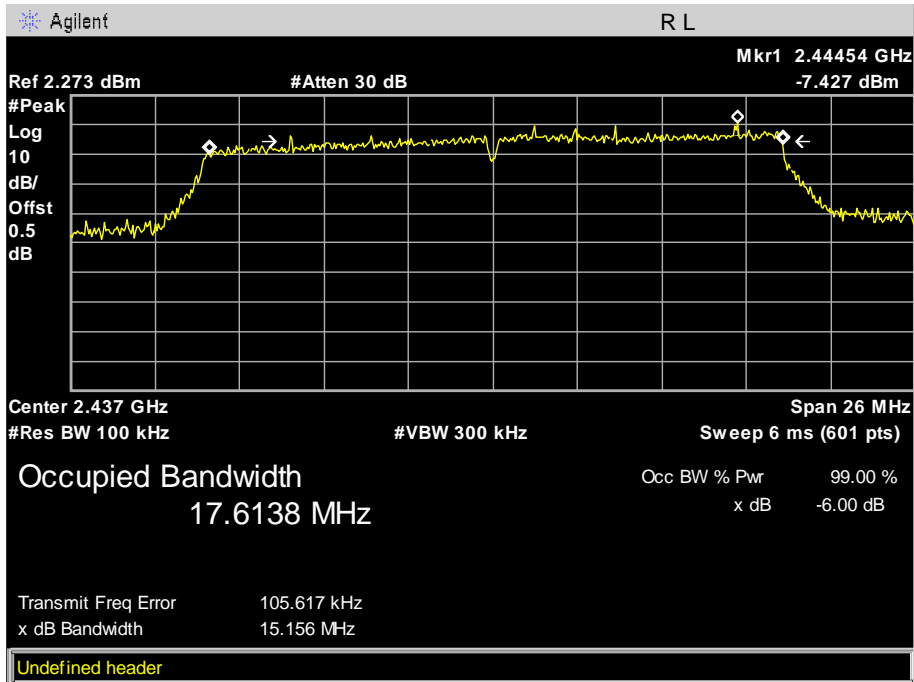

TX CH 11

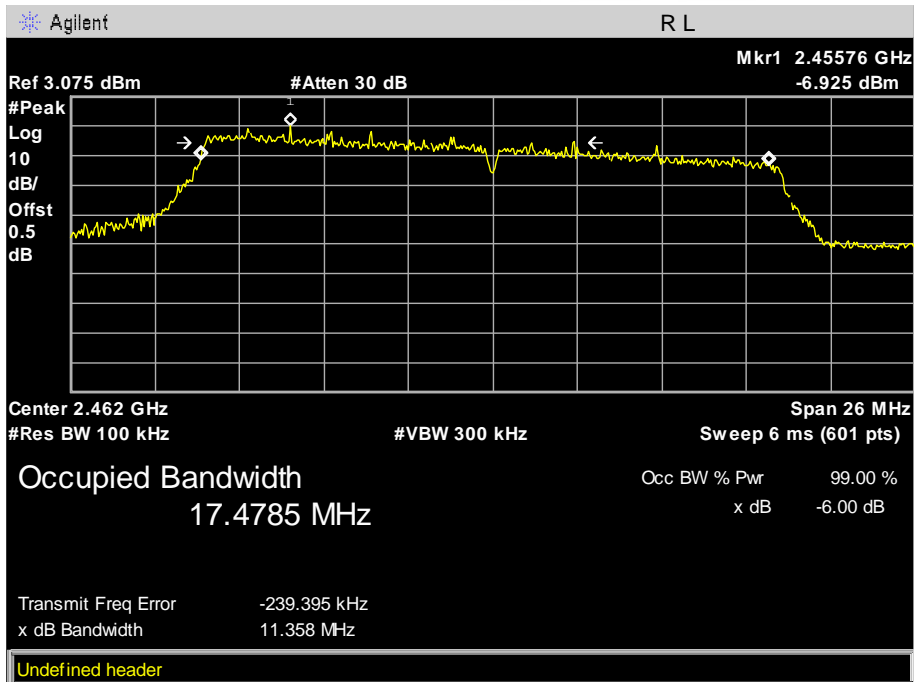



EUT :	Smart Phone	Model Name :	Sky 5.0L
Temperature :	25 °C	Relative Humidity :	60%
Pressure :	1012 hPa	Test Voltage :	DC 3.8V
Test Mode :	TX n Mode(40M) /CH03, CH06, CH09		

Frequency	6dB Bandwidth (MHz)	Channel Separation (KHz)	Result
2422 MHz	12.664	>=500KHz	PASS
2437 MHz	10.114	>=500KHz	PASS
2452 MHz	15.067	>=500KHz	PASS

TX CH 03

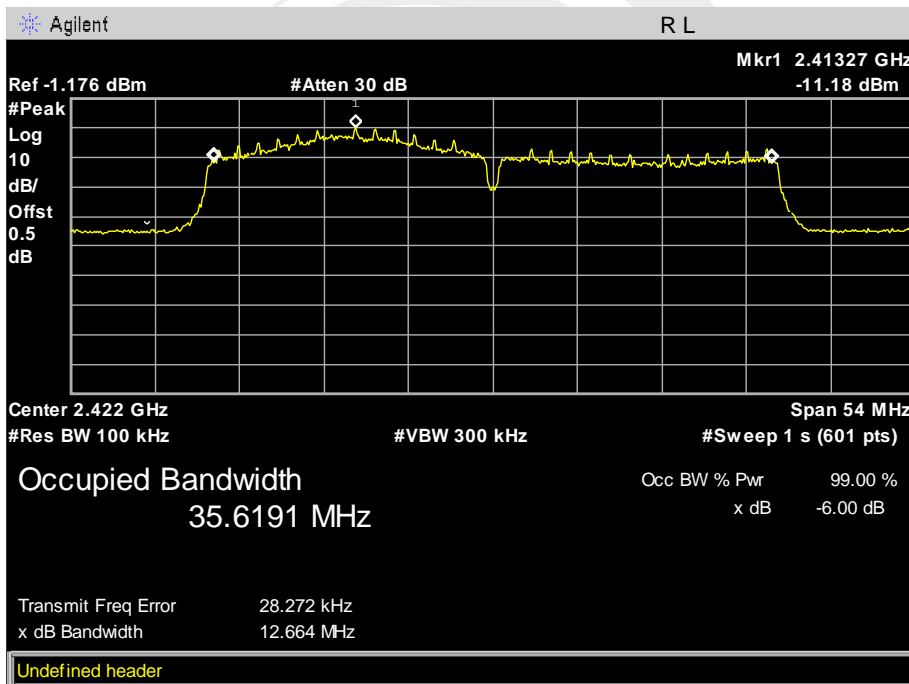



TX CH 06

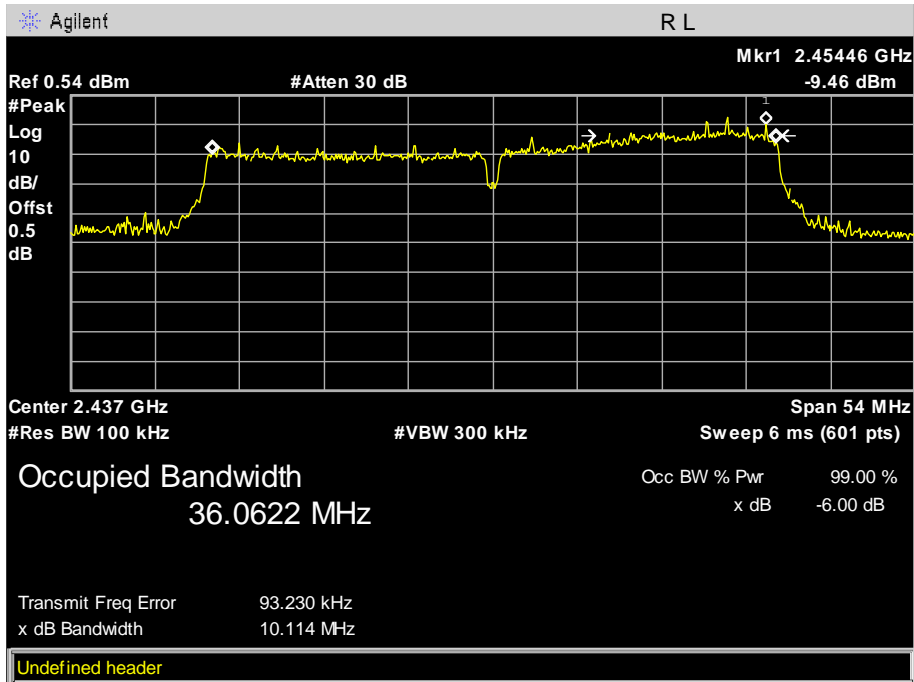

TX CH 09

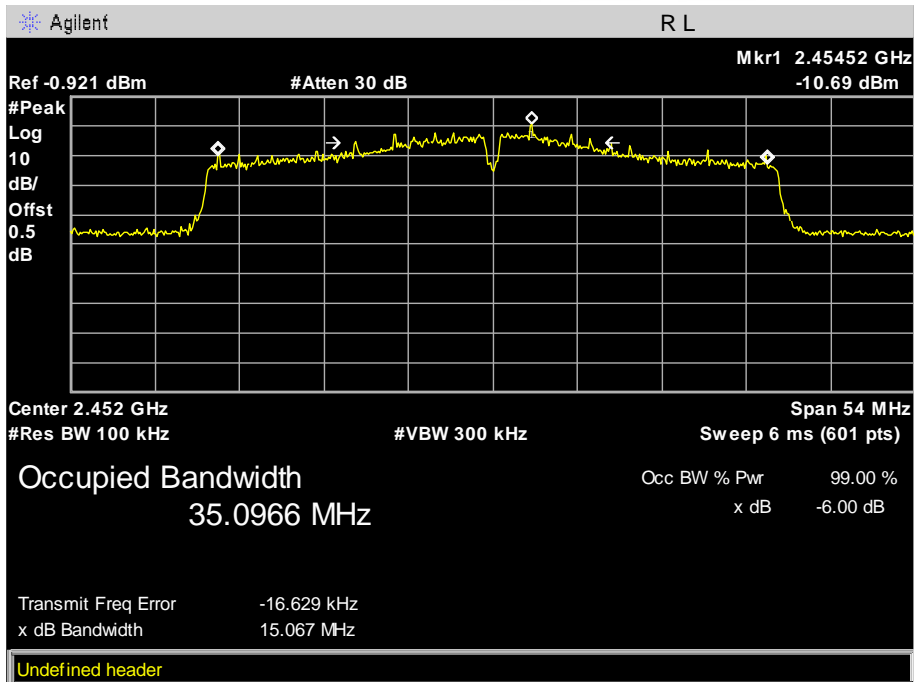



7. PEAK OUTPUT POWER TEST

7.1 APPLIED PROCEDURES / LIMIT

FCC Part15 (15.247) , Subpart C				
Section	Test Item	Limit	Frequency Range (MHz)	Result
15.247(b)(3)	Peak Output Power	1 watt or 30dBm	2400-2483.5	PASS

7.2 TEST PROCEDURE

- a. The EUT was directly connected to the Power Sensor&Power meter

7.3 DEVIATION FROM STANDARD

No deviation.

7.4 TEST SETUP



7.5 EUT OPERATION CONDITIONS

The EUT tested system was configured as the statements of 2.3 Unless otherwise a special operating condition is specified in the follows during the testing.



7.6 TEST RESULTS

EUT :	Smart Phone	Model Name :	Sky 5.0L
Temperature :	25 °C	Relative Humidity :	60%
Pressure :	1012 hPa	Test Voltage :	DC 3.8V
Test Mode :	TX b/g/n(20M,40M) Mode /CH01, CH06, CH11		

TX 802.11b Mode			
Test Channe	Frequency	Peak Conducted Output Power	LIMIT
	(MHz)	(dBm)	dBm
CH01	2412	7.08	30
CH06	2437	7.97	30
CH11	2462	8.91	30

TX 802.11g Mode			
Test Channe	Frequency	Peak Conducted Output Power	LIMIT
	(MHz)	(dBm)	dBm
CH01	2412	9.90	30
CH06	2437	9.58	30
CH11	2462	9.67	30

TX 802.11n20 Mode			
Test Channe	Frequency	Peak Conducted Output Power	LIMIT
	(MHz)	(dBm)	dBm
CH01	2412	5.64	30
CH06	2437	5.66	30
CH11	2462	6.26	30

TX 802.11n40 Mode			
Test Channe	Frequency	Peak Conducted Output Power	LIMIT
	(MHz)	(dBm)	dBm
CH03	2422	2.96	30
CH06	2437	3.48	30
CH09	2452	3.37	30



8. ANTENNA REQUIREMENT

8.1 STANDARD REQUIREMENT

15.203 requirement: For intentional device, according to 15.203: an intentional radiator shall be designed to ensure that no antenna other than that furnished by the responsible party shall be used with the device.

8.2 EUT ANTENNA

The EUT antenna is permanent attach Antenna. It comply with the standard requirement.



APPENDIX - PHOTOS OF TEST SETUP

Radiated Measurement Photos

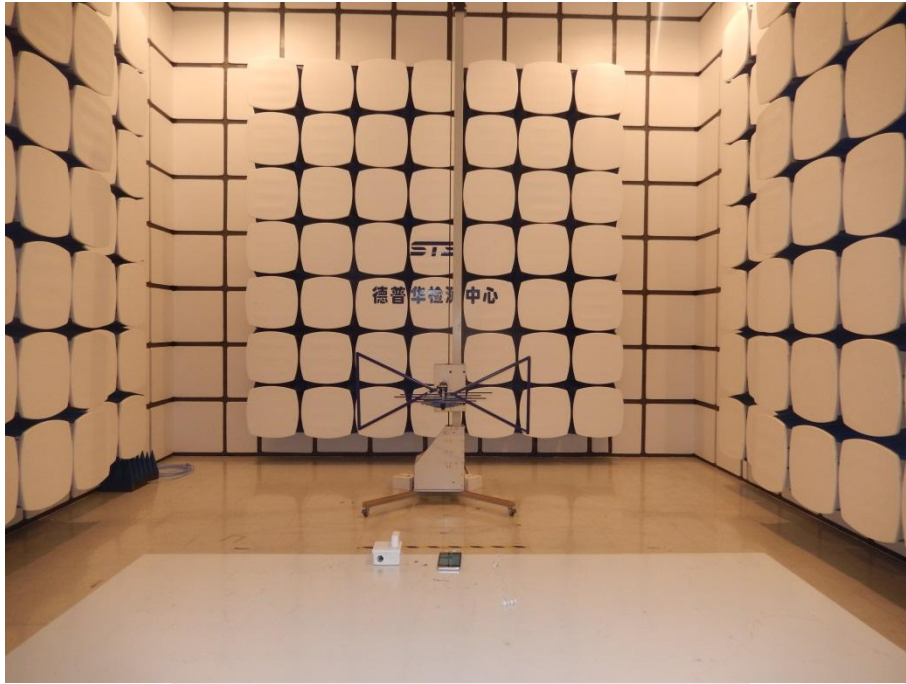

Conducted Measurement Photos



*****END OF THE REPORT*****