



RADIO TEST REPORT

Report No: STS1506072F02

Issued for
Sky Phone LLC

1348 Washington Av. #350 Miami Beach FL., USA

Product Name:	Smart Phone
Brand Name:	Sky Devices
Model No.:	Sky 5.0L
Series Model:	N/A
FCC ID:	2ABOSSKY50L
Test Standard:	FCC Part 15.247

Any reproduction of this document must be done in full. No single part of this document may be reproduced without permission from STS, All Test Data Presented in this report is only applicable to presented Test sample.





TEST RESULT CERTIFICATION

Applicant's name: Sky Phone LLC

Address: 1348 Washington Av. #350 Miami Beach FL., USA

Manufacture's Name: Shenzhen Konka Telecommunications Technology Co., Ltd.

Address: No.9008 Shennan Road,Overseas Chinese Town, ShenZhen, Guangdong,China

Product description

Product name.....: Smart Phone

Model and/or type reference : Sky 5.0L

Serial Model: N/A

Standards: FCC Part15.247

Test procedure ANSI C63.10-2013

This device described above has been tested by STS, and the test results show that the equipment under test (EUT) is in compliance with the FCC requirements. And it is applicable only to the tested sample identified in the report.

This report shall not be reproduced except in full, without the written approval of STS, thidocument may be altered or revised by STS, personal only, and shall be noted in the revision of the document.

Date of Test:

Date (s) of performance of tests: 10 July. 2015 ~16 July. 2015

Date of Issue.....: 17 July. 2015

Test Result.....: **Pass**

Testing Engineer : Jin Ming
(Jin Ming)

Technical Manager : Vita Li
(Vita Li)

Authorized Signatory : Bovey Yang
(Bovey Yang)





Table of Contents	Page
1. SUMMARY OF TEST RESULTS	5
1.1 TEST FACILITY	5
1.2 MEASUREMENT UNCERTAINTY	5
2. GENERAL INFORMATION	6
2.1 GENERAL DESCRIPTION OF EUT	6
2.2 DESCRIPTION OF TEST MODES	8
2.3 BLOCK DIGRAM SHOWING THE CONFIGURATION OF SYSTEM TESTED	9
2.4 DESCRIPTION OF SUPPORT UNITS(CONDUCTED MODE)	10
2.5 EQUIPMENTS LIST FOR ALL TEST ITEMS	11
3. EMC EMISSION TEST	12
3.1 CONDUCTED EMISSION MEASUREMENT	12
3.2 TEST PROCEDURE	13
3.3 TEST SETUP	13
3.4 EUT OPERATING CONDITIONS	13
3.5 TEST RESULTS	14
4. RADIATED EMISSION MEASUREMENT	16
4.1 RADIATED EMISSION LIMITS	16
4.2 TEST PROCEDURE	17
4.3 TEST SETUP	18
4.4 EUT OPERATING CONDITIONS	19
4.5 TEST RESULTS	19
4.6 TEST RESULTS (RESTRICTED BANDS REQUIREMENTS)	23
5. CONDUCTED SPURIOUS EMISSIONS	24
5.1 REQUIREMENT	24
5.2 TEST PROCEDURE	24
5.3 TEST SETUP	24
5.4 EUT OPERATION CONDITIONS	24
5.5 TEST RESULTS	25
6. POWER SPECTRAL DENSITY TEST	28
6.1 APPLIED PROCEDURES / LIMIT	28
6.2 TEST PROCEDURE	28
6.3 TEST SETUP	28



Table of Contents	Page
6.4 EUT OPERATION CONDITIONS	28
6.5 TEST RESULTS	29
7. BANDWIDTH TEST	31
7.1 APPLIED PROCEDURES / LIMIT	31
7.2 TEST PROCEDURE	31
7.3 TEST SETUP	31
7.4 EUT OPERATION CONDITIONS	31
7.5 TEST RESULTS	32
8. PEAK OUTPUT POWER TEST	34
8.1 APPLIED PROCEDURES / LIMIT	34
8.2 TEST PROCEDURE	34
8.3 TEST SETUP	34
8.4 EUT OPERATION CONDITIONS	34
8.5 TEST RESULTS	35
9. ANTENNA REQUIREMENT	36
9.1 STANDARD REQUIREMENT	36
9.2 EUT ANTENNA	36
10. EUT TEST PHOTO	37



1. SUMMARY OF TEST RESULTS

Test procedures according to the technical standards:

FCC Part15 (15.247) , Subpart C			
Standard Section	Test Item	Judgment	Remark
15.207	Conducted Emission	PASS	--
15.247 (a)(2)	6dB Bandwidth	PASS	--
15.247 (b)	Peak Output Power	PASS	--
15.247 (c)	Radiated Spurious Emission	PASS	--
15.247 (d)	Power Spectral Density	PASS	--
15.205	Band Edge Emission	PASS	--
15.203	Antenna Requirement	PASS	--

NOTE:

(1) "N/A" denotes test is not applicable in this Test Report

1.1 TEST FACILITY

Shenzhen STS Test Services Co., Ltd.

Add. : 1/F., Building B, Zhuoke Science Park, No.190,Chongqing Road,
Fuyong Street, Bao'an District, Shenzhen, Guangdong,China
CNAS Registration No.: L7649;

FCC Registration No.: 842334; IC Registration No.: 12108A-1

1.2 MEASUREMENT UNCERTAINTY

The reported uncertainty of measurement $y \pm U$, where expanded uncertainty U is based on a standard uncertainty multiplied by a coverage factor of $k=2$, providing a level of confidence of approximately 95 %.

No.	Item	Uncertainty
1	Conducted Emission (9KHz-150KHz)	$\pm 2.88\text{dB}$
2	Conducted Emission (150KHz-30MHz)	$\pm 2.67\text{dB}$
3	RF power,conducted	$\pm 0.70\text{dB}$
4	Spurious emissions,conducted	$\pm 1.19\text{dB}$
5	All emissions,radiated(<1G) 30MHz-200MHz	$\pm 2.83\text{dB}$
6	All emissions,radiated(<1G) 200MHz-1000MHz	$\pm 2.94\text{dB}$
7	All emissions,radiated(>1G)	$\pm 3.03\text{dB}$
8	Temperature	$\pm 0.5^{\circ}\text{C}$
9	Humidity	$\pm 2\%$



2. GENERAL INFORMATION

2.1 GENERAL DESCRIPTION OF EUT

Equipment	Smart Phone	
Trade Name	Sky Devices	
Model Name	Sky 5.0L	
Serial Model	N/A	
Model Difference	N/A	
Product Description	The EUT is a Smart Phone	
	Operation Frequency:	2402~2480 MHz
	Modulation Type:	GFSK
	Radio Technology	BLE
	Number Of Channel	40
	Antenna Designation:	Please see Note 3.
	Antenna Gain (dBi)	0 dBi
Channel List	Please refer to the Note 2.	
Adapter	Input:AC 100-240V,50/60Hz,200mA Output:DC 5V,1000mA	
Battery	Rated Voltage: 3.8V capacity :2000mAh	
Hardware version number	V1.1	
Software versioning number	ALPS.L1.MP3.V1_KONKA6735M.35U.L	
Connecting I/O Port(s)	Please refer to the User's Manual	

Note:

1. For a more detailed features description, please refer to the manufacturer's specifications or the User's Manual.



2.

Channel List							
Channel	Frequency (MHz)	Channel	Frequency (MHz)	Channel	Frequency (MHz)	Channel	Frequency (MHz)
01	2402	11	2422	21	2442	31	2462
02	2404	12	2424	22	2444	32	2464
03	2406	13	2426	23	2446	33	2466
04	2408	14	2428	24	2448	34	2468
05	2410	15	2430	25	2450	35	2470
06	2412	16	2432	26	2452	36	2472
07	2414	17	2434	27	2454	37	2474
08	2416	18	2436	28	2456	38	2476
09	2418	19	2438	29	2458	39	2478
10	2420	20	2440	30	2460	40	2480

3.

Table for Filed Antenna

Ant.	Brand	Model Name	Antenna Type	Connector	Gain (dBi)	NOTE
A	N/A	N/A	PIFA Antenna	N/A	0	BT 4.0 ANT





2.2 DESCRIPTION OF TEST MODES

To investigate the maximum EMI emission characteristics generates from EUT, the test system was pre-scanning tested base on the consideration of following EUT operation mode or test configuration mode which possible have effect on EMI emission level. Each of these EUT operation mode(s) or test configuration mode(s) mentioned above was evaluated respectively.

Pretest Mode	Description
Mode 1	TX CH1/CH20/CH40
Mode 2	Keeping TX mode

For Conducted Emission	
Final Test Mode	Description
Mode 2	Keeping TX mode

For Radiated Emission	
Final Test Mode	Description
Mode 1	TX CH1/CH20/CH40
Mode 2	Keeping TX mode

Note:

- (1) The measurements are performed at the highest, middle, lowest available channels.
- (2) The measurements are performed at all Bit Rate of Transmitter, the worst data was reported
- (3) We have be tested for all avaiable U.S. voltage and frequencies(For 120V,50/60Hz and 240V, 50/60Hz) for which the device is capable of operation.



2.3 BLOCK DIGRAM SHOWING THE CONFIGURATION OF SYSTEM TESTED

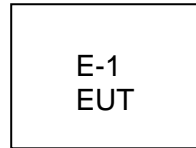



2.4 DESCRIPTION OF SUPPORT UNITS(CONDUCTED MODE)

The EUT has been tested as an independent unit together with other necessary accessories or support units. The following support units or accessories were used to form a representative test configuration during the tests.

Item	Equipment	Mfr/Brand	Model/Type No.	Series No.	Note
E-1	Smart Phone	Sky Devices	Sky 5.0L	N/A	EUT

Item	Shielded Type	Ferrite Core	Length	Note
N/A	N/A	N/A	N/A	N/A

Note:

- (1) The support equipment was authorized by Declaration of Confirmation.
- (2) For detachable type I/O cable should be specified the length in cm in 『Length』 column.



2.5 EQUIPMENTS LIST FOR ALL TEST ITEMS

Radiation Test equipment

Kind of Equipment	Manufacturer	Type No.	Serial No.	Last calibration	Calibrated until
Spectrum Analyzer	Agilent	E4407B	MY50140340	2014.10.25	2015.10.24
Test Receiver	R&S	ESCI	101427	2014.10.25	2015.10.24
Bilog Antenna	TESEQ	CBL6111D	34678	2014.11.25	2015.11.24
Horn Antenna	Schwarzbeck	BBHA 9120D(1201)	9120D-1343	2015.03.06	2016.03.05
50Ω Coaxial Switch	Anritsu	MP59B	6200264416	2015.06.06	2016.06.05
PreAmplifier	Agilent	8449B	60538	2014.10.25	2015.10.24
Loop Antenna	ARA	PLA-1030/B	1029	2015.06.08	2016.06.07
USB RF power sensor	DARE	RPR3006W	15I00041SNO03	2014.10.25	2015.10.24

Conduction Test equipment

Kind of Equipment	Manufacturer	Type No.	Serial No.	Last calibration	Calibrated until
EMI Test Receiver	R&S	ESPI	102086	2014.11.20	2015.11.19
LISN	R&S	ENV216	101242	2014.10.25	2015.10.24



3. EMC EMISSION TEST

3.1 CONDUCTED EMISSION MEASUREMENT

3.1.1 POWER LINE CONDUCTED EMISSION LIMITS

operating frequency band. In case the emission fall within the restricted band specified on Part 15.247&207(a) limit in the table below has to be followed.

FREQUENCY (MHz)	Class B (dBuV)		Standard
	Quasi-peak	Average	
0.15 -0.5	66 - 56 *	56 - 46 *	CISPR
0.50 -5.0	56.00	46.00	CISPR
5.0 -30.0	60.00	50.00	CISPR

0.15 -0.5	66 - 56 *	56 - 46 *	FCC
0.50 -5.0	56.00	46.00	FCC
5.0 -30.0	60.00	50.00	FCC

Note:

- (1) The tighter limit applies at the band edges.
- (2) The limit of " * " marked band means the limitation decreases linearly with the logarithm of the frequency in the range.

The following table is the setting of the receiver

Receiver Parameters	Setting
Attenuation	10 dB
Start Frequency	0.15 MHz
Stop Frequency	30 MHz
IF Bandwidth	9 kHz

3.2 TEST PROCEDURE

- a. The EUT was placed 0.4 meters from the horizontal ground plane with EUT being connected to the power mains through a line impedance stabilization network (LISN). All other support equipments powered from additional LISN(s). The LISN provide 50 Ohm/ 50uH of coupling impedance for the measuring instrument.
- b. Interconnecting cables that hang closer than 40 cm to the ground plane shall be folded back and forth in the center forming a bundle 30 to 40 cm long.
- c. I/O cables that are not connected to a peripheral shall be bundled in the center. The end of the cable may be terminated, if required, using the correct terminating impedance. The overall length shall not exceed 1 m.
- d. LISN at least 80 cm from nearest part of EUT chassis.
- e. For the actual test configuration, please refer to the related Item –EUT Test Photos.

3.3 TEST SETUP

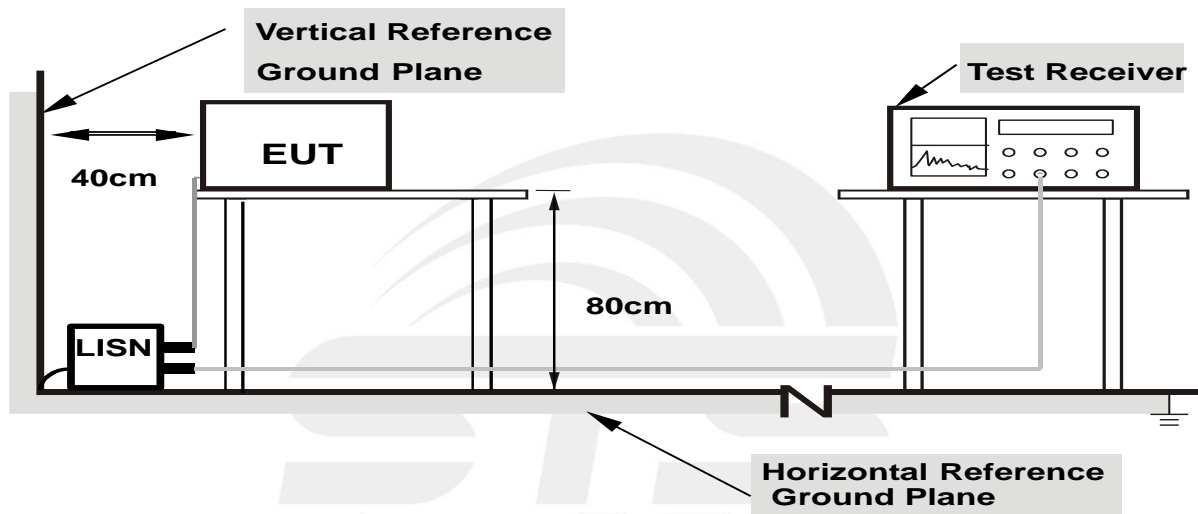

**Note: 1.Support units were connected to second LISN.
 2.Both of LISNs (AMN) are 80 cm from EUT and at least 80 from other units and other metal planes**

3.4 EUT OPERATING CONDITIONS

The EUT was configured for testing in a typical fashion (as a customer would normally use it). The EUT has been programmed to continuously transmit during test. This operating condition was tested and used to collect the included data.



3.5 TEST RESULTS

EUT :	Smart Phone	Model Name. :	Sky 5.0L
Temperature :	26 °C	Relative Humidity :	54%
Pressure :	1010hPa	Phase :	L
Test Voltage :	DC 5V from Adapter AC120V/60Hz	Test Mode :	Mode 2

Frequency (MHz)	Reading (dBuV)	Correct Factor(dB)	Result (dBuV)	Limit (dBuV)	Margin (dB)	Remark
0.1660	31.52	10.00	41.52	65.16	-23.64	QP
0.1660	20.69	10.00	30.69	55.16	-24.47	AVG
0.6540	31.95	9.98	41.93	56.00	-14.07	QP
0.6540	18.76	9.98	28.74	46.00	-17.26	AVG
1.7580	25.01	9.98	34.99	56.00	-21.01	QP
1.7580	13.18	9.98	23.16	46.00	-22.84	AVG
2.6460	23.89	10.00	33.89	56.00	-22.11	QP
2.6460	10.60	10.00	20.60	46.00	-25.40	AVG
5.4060	23.78	10.20	33.98	60.00	-26.02	QP
5.4060	9.45	10.20	19.65	50.00	-30.35	AVG
23.1300	24.14	10.61	34.75	60.00	-25.25	QP
23.1300	18.93	10.61	29.54	50.00	-20.46	AVG

Remark:

1. Factor = Antenna Factor + Cable Loss – Pre-amplifier.

100.0 dBuV

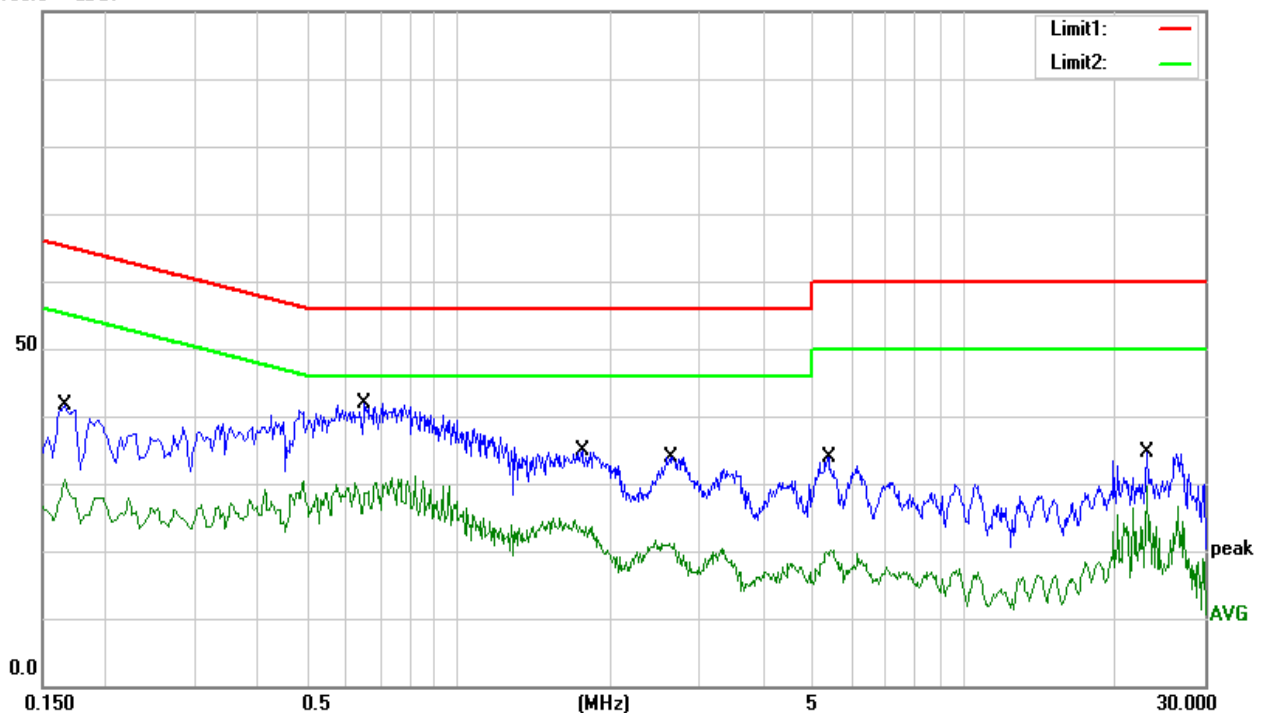



EUT :	Smart Phone	Model Name. :	Sky 5.0L
Temperature :	26 °C	Relative Humidity :	54%
Pressure :	1010hPa	Phase :	N
Test Voltage :	DC 5V from Adapter AC120V/60Hz	Test Mode :	Mode 2

Frequency (MHz)	Reading (dBuV)	Correct Factor(dB)	Result (dBuV)	Limit (dBuV)	Margin (dB)	Remark
0.4820	35.96	9.92	45.88	56.30	-10.42	QP
0.4820	19.06	9.92	28.98	46.30	-17.32	AVG
0.7020	35.95	10.00	45.95	56.00	-10.05	QP
0.7020	20.98	10.00	30.98	46.00	-15.02	AVG
1.5100	33.43	10.00	43.43	56.00	-12.57	QP
1.5100	18.36	10.00	28.36	46.00	-17.64	AVG
2.3700	27.69	10.00	37.69	56.00	-18.31	QP
2.3700	13.57	10.00	23.57	46.00	-22.43	AVG
5.5140	26.21	10.20	36.41	60.00	-23.59	QP
5.5140	11.05	10.20	21.25	50.00	-28.75	AVG
23.1300	28.27	10.66	38.93	60.00	-21.07	QP
23.1300	20.94	10.66	31.60	50.00	-18.40	AVG

Remark:

- Factor = Antenna Factor + Cable Loss – Pre-amplifier.

100.0 dBuV

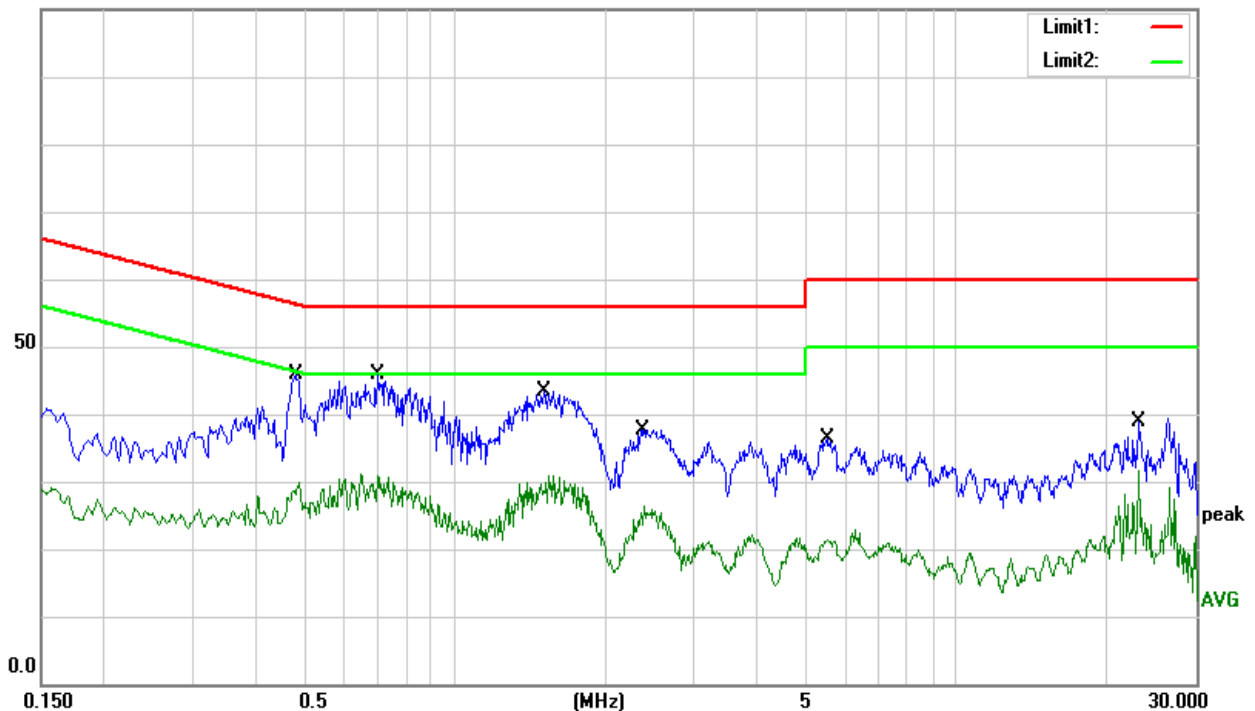



4. RADIATED EMISSION MEASUREMENT

4.1 RADIATED EMISSION LIMITS

6dBc in any 100 kHz bandwidth outside the operating frequency band. In case the emission fall within the restricted band specified on Part 15.247&205(a), then the Part15.247&209(a) limit in the table below has to be followed.

LIMITS OF RADIATED EMISSION MEASUREMENT (Frequency Range 9kHz-1000MHz)

Frequencies (MHz)	Field Strength (micorvolts/meter)	Measurement Distance (meters)
0.009~0.490	2400/F(KHz)	300
0.490~1.705	24000/F(KHz)	30
1.705~30.0	30	30
30~88	100	3
88~216	150	3
216~960	200	3
Above 960	500	3

LIMITS OF RADIATED EMISSION MEASUREMENT (Above 1000MHz)

FREQUENCY (MHz)	Class B (dBuV/m) (at 3M)	
	PEAK	AVERAGE
Above 1000	74	54

Notes:

- (1) The limit for radiated test was performed according to FCC PART 15C.
- (2) The tighter limit applies at the band edges.
- (3) Emission level (dBuV/m)=20log Emission level (uV/m).

Spectrum Parameter	Setting
Attenuation	Auto
Detector	Peak
Start Frequency	1000 MHz(Peak/AV)
Stop Frequency	10th carrier harmonic(Peak/AV)
RB / VB (emission in restricted band)	1 MHz / 1 MHz, AV=1 MHz / 10Hz

Receiver Parameter	Setting
Attenuation	Auto
Start ~ Stop Frequency	9kHz~150kHz / RB 200Hz for QP
Start ~ Stop Frequency	150kHz~30MHz / RB 9kHz for QP
Start ~ Stop Frequency	30MHz~1000MHz / RB 120kHz for QP



4.2 TEST PROCEDURE

- a. The measuring distance of at 3 m shall be used for measurements at frequency up to 1GHz. For frequencies above 1GHz, any suitable measuring distance may be used.
- b. The EUT was placed on the top of a rotating table 0.8 meters(above 1GHz is 1.5 m) above the ground at a 3 meter open area test site. The table was rotated 360 degrees to determine the position of the highest radiation.
- c. The height of the equipment or of the substitution antenna shall be 0.8 m(above 1GHz is 1.5 m); the height of the test antenna shall vary between 1 m to 4 m. Both horizontal and vertical polarizations of the antenna are set to make the measurement.
- d. The initial step in collecting conducted emission data is a spectrum analyzer peak detector mode pre-scanning the measurement frequency range. Significant peaks are then marked and then Quasi Peak detector mode re-measured.
- e. If the Peak Mode measured value compliance with and lower than Quasi Peak Mode Limit, the EUT shall be deemed to meet QP Limits and then no additional QP Mode measurement performed.
- f. For the actual test configuration, please refer to the related Item –EUT Test Photos.

Note:

Both horizontal and vertical antenna polarities were tested and performed pretest to three orthogonal axis. The worst case emissions were reported

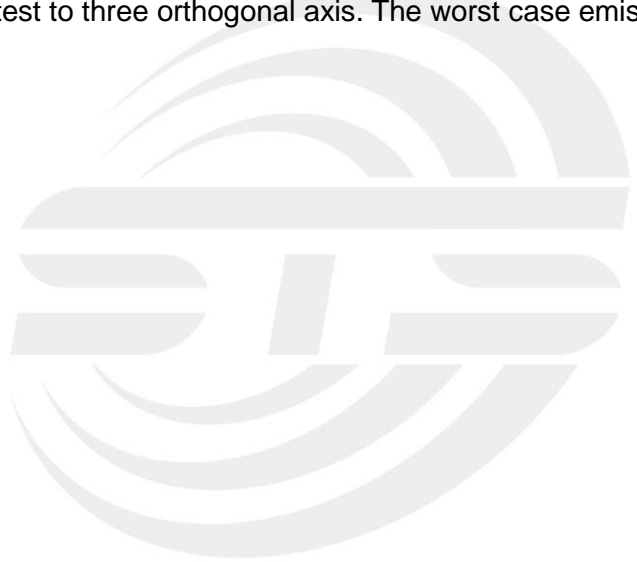

4.3 TEST SETUP

(A) Radiated Emission Test-Up Frequency Below 30MHz

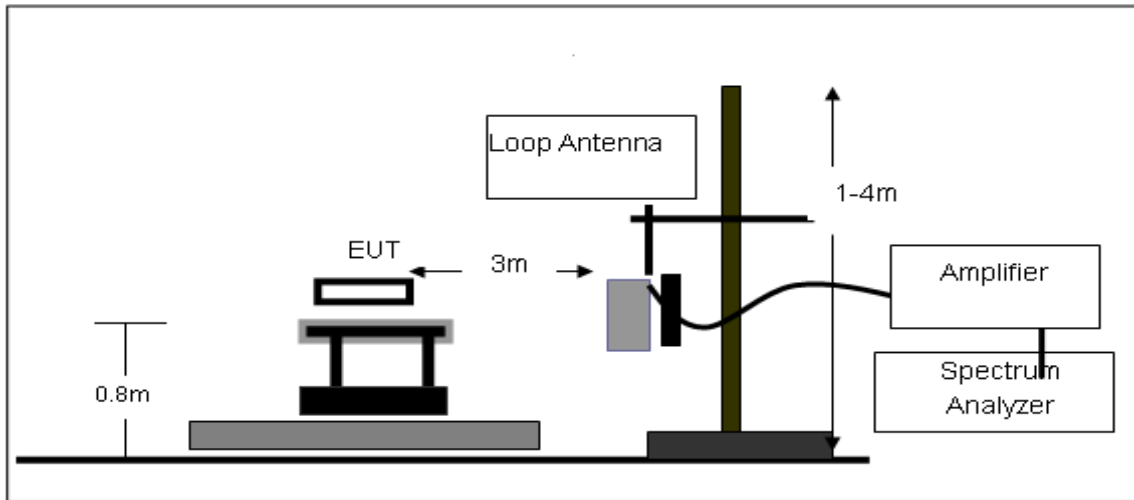

(B) Radiated Emission Test-Up Frequency 30MHz~1GHz

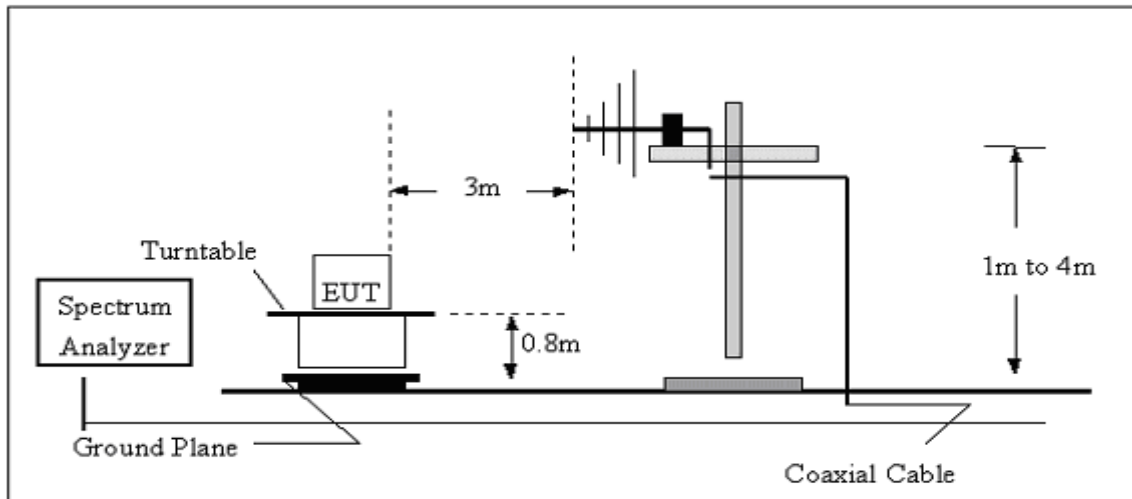

(C) Radiated Emission Test-Up Frequency Above 1GHz

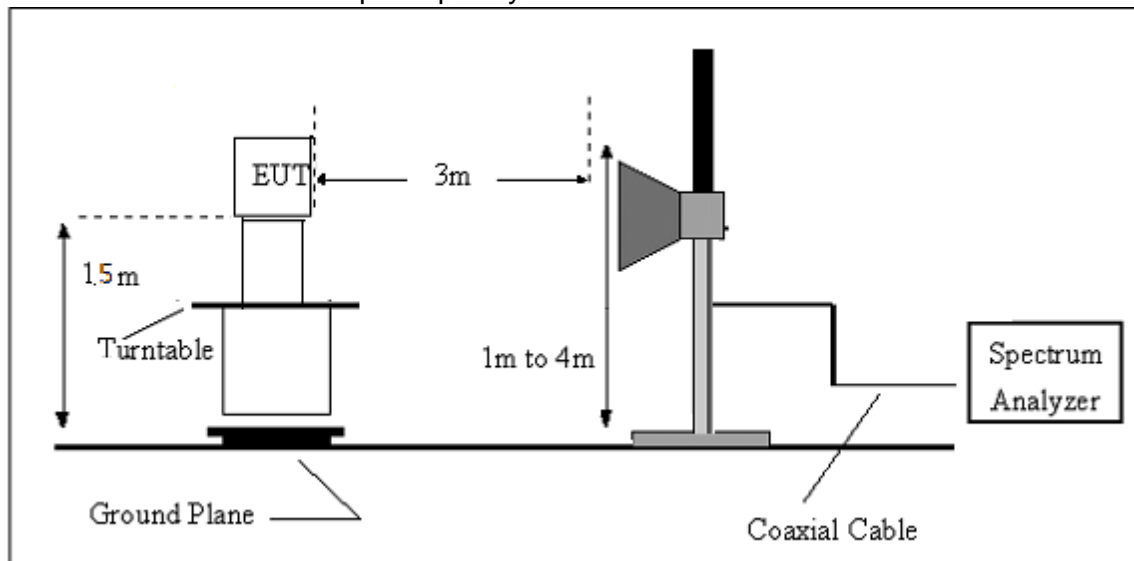



4.4 EUT OPERATING CONDITIONS

The EUT tested system was configured as the statements of 2.3 Unless otherwise a special operating condition is specified in the follows during the testing.

4.5 TEST RESULTS

(Between 9KHz – 30 MHz)

EUT:	Smart Phone	Model Name. :	Sky 5.0L
Temperature:	20 °C	Relative Humidity:	48%
Pressure:	1010 hPa	Test Voltage :	DC 5V from Adapter AC120V/60Hz
Test Mode :	Link mode	Polarization :	--

Freq. (MHz)	Reading (dBuV/m)	Limit (dBuV/m)	Margin (dB)	State P/F
--	--	--	--	PASS
--	--	--	--	PASS

NOTE:

The amplitude of spurious emissions which are attenuated by more than 20dB below the permissible value has no need to be reported.

Distance extrapolation factor = $40 \log(\text{specific distance}/\text{test distance})$ (dB);

Limit line = specific limits(dBuv) + distance extrapolation factor.



Between 30-1000MHz

EUT :	Smart Phone	Model Name. :	Sky 5.0L
Temperature :	26 °C	Relative Humidity :	54%
Pressure :	1010hPa	Phase :	Horizontal
Test Voltage :	DC 5V from Adapter AC120V/60Hz	Test Mode :	Mode 2

Frequency (MHz)	Reading (dBuV)	Correct Factor(dB/m)	Result (dBuV/m)	Limit (dBuV/m)	Margin (dB)	Remark
30.9618	4.82	18.21	23.03	40.00	-16.97	QP
43.0504	7.92	11.82	19.74	40.00	-20.26	QP
60.0690	13.41	5.33	18.74	40.00	-21.26	QP
104.1701	12.01	11.15	23.16	43.50	-20.34	QP
234.9910	16.33	11.22	27.55	46.00	-18.45	QP
470.5231	21.86	19.69	41.55	46.00	-4.45	QP

Remark:

1. Factor = Antenna Factor + Cable Loss – Pre-amplifier.

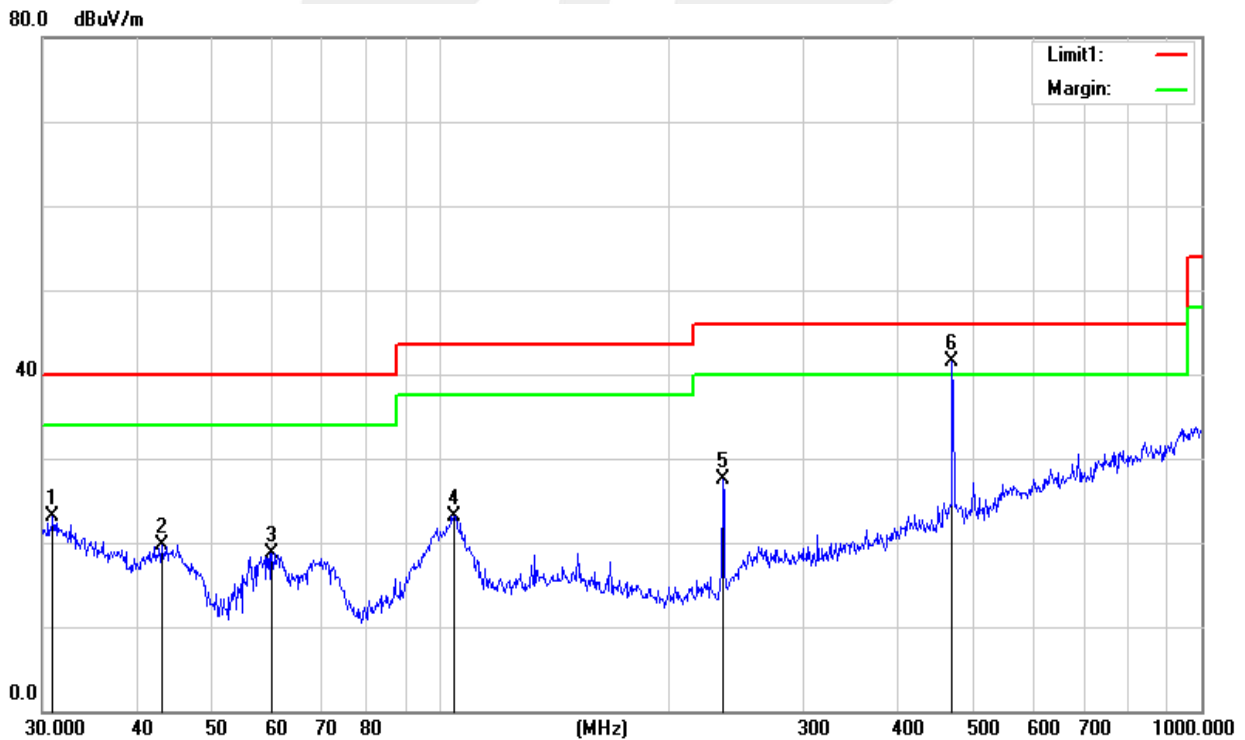



EUT :	Smart Phone	Model Name. :	Sky 5.0L
Temperature :	26 °C	Relative Humidity :	54%
Pressure :	1010hPa	Phase :	Vertical
Test Voltage :	DC 5V from Adapter AC120V/60Hz	Test Mode :	Mode 2

Frequency (MHz)	Reading (dBuV)	Correct Factor(dB/m)	Result (dBuV/m)	Limit (dBuV/m)	Margin (dB)	Remark
41.7130	20.21	12.50	32.71	40.00	-7.29	QP
63.3132	17.85	5.51	23.36	40.00	-16.64	QP
103.4421	11.62	11.07	22.69	43.50	-20.81	QP
133.1511	5.79	12.49	18.28	43.50	-25.22	QP
234.9910	14.14	11.22	25.36	46.00	-20.64	QP
470.5232	13.09	19.69	32.78	46.00	-13.22	QP

Remark:

- Factor = Antenna Factor + Cable Loss – Pre-amplifier.

80.0 dBuV/m

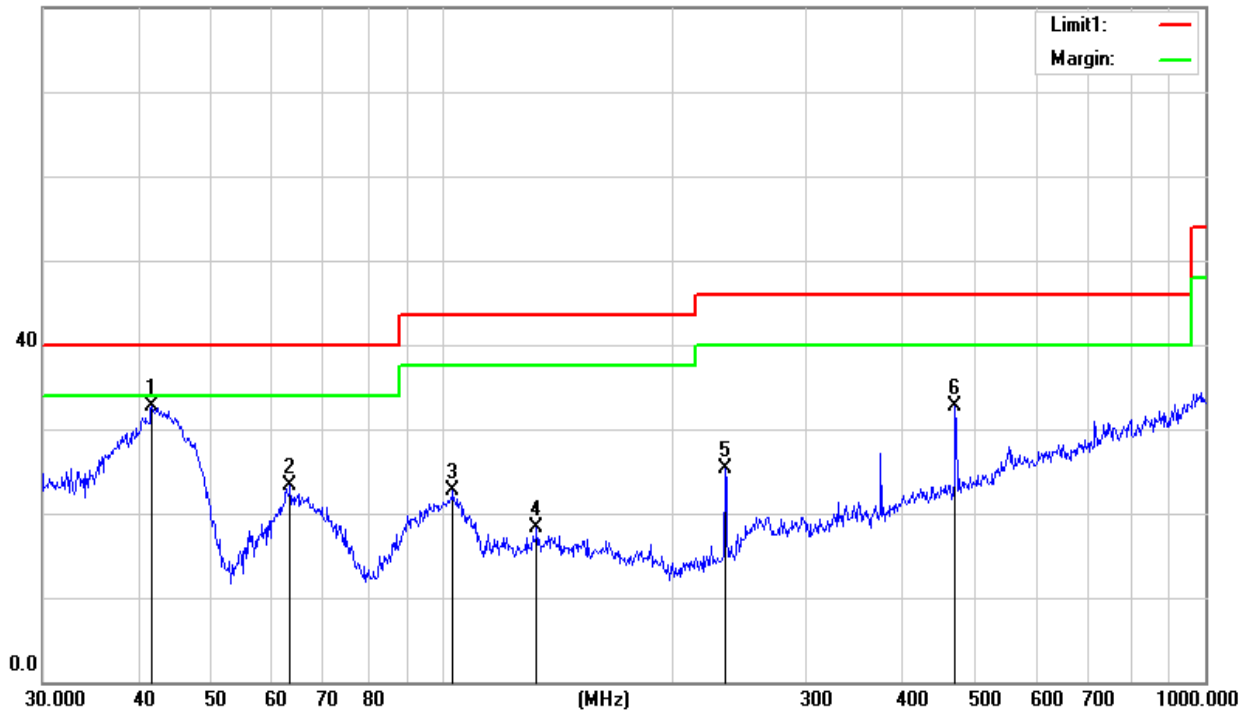



Above 1000 MHz

EUT :	Smart Phone	Model Name :	Sky 5.0L
Temperature :	20 °C	Relative Humidity :	48%
Pressure :	1010 hPa	Test Voltage :	DC 3.8V

Frequency (MHz)	Reading (dBuV)	Factor (dB)	Emission Level (dB μ V/m)	Limit (dBuV/m)	Margin (dB)	Detector	Comment
Low Channel (GFSK/2402 MHz)							
4804.20	66.17	-3.62	62.55	74	-11.45	PK	Vertical
4804.21	47.21	-3.62	43.59	54	-10.41	AV	Vertical
7206.13	62.60	-0.9	61.7	74	-12.3	PK	Vertical
7206.12	41.83	-0.9	40.93	54	-13.07	AV	Vertical
4804.00	61.94	-3.65	58.29	74	-15.71	PK	Horizontal
4803.99	44.26	-3.65	40.61	54	-13.39	AV	Horizontal
Mid Channel (GFSK/2440 MHz)							
4882.08	65.40	-3.65	61.75	74	-12.25	PK	Vertical
4882.07	49.08	-3.65	45.43	54	-8.57	AV	Vertical
7320.21	61.23	-0.83	60.4	74	-13.6	PK	Vertical
7320.21	44.57	-0.83	43.74	54	-10.26	AV	Vertical
4882.18	61.46	-3.68	57.78	74	-16.22	PK	Horizontal
4882.15	45.59	-3.68	41.91	54	-12.09	AV	Horizontal
High Channel (GFSK/2480 MHz)							
4960.26	60.99	-3.59	57.4	74	-16.6	PK	Vertical
4960.30	45.77	-3.59	42.18	54	-11.82	AV	Vertical
7440.26	61.46	-0.73	60.73	74	-13.27	PK	Vertical
7440.31	45.46	-0.73	44.73	54	-9.27	AV	Vertical
4960.32	61.02	-3.59	57.43	74	-16.57	PK	Horizontal
4960.31	45.37	-3.59	41.78	54	-12.22	AV	Horizontal
Remark: 1. Factor = Antenna Factor + Cable Loss – Pre-amplifier.							



4.6 TEST RESULTS (RESTRICTED BANDS REQUIREMENTS)

EUT :	Smart Phone	Model Name :	Sky 5.0L
Temperature :	20 °C	Relative Humidity :	48%
Pressure :	1010 hPa	Test Voltage :	DC 3.8V

Frequency (MHz)	Reading (dBuV)	Factor (dB)	Emission Level (dBuV/m)	Limit (dBuV/m)	Margin (dB)	Detector	Comment
GFSK							
2399.9	68.13	-12.99	55.14	74	-18.86	PK	Vertical
2399.9	54.05	-12.99	41.06	54	-12.94	AV	Vertical
2399.9	69.36	-12.99	56.37	74	-17.63	PK	Horizontal
2399.9	52.96	-12.99	39.97	54	-14.03	AV	Horizontal
2483.6	70.10	-12.78	57.32	74	-16.68	PK	Vertical
2483.6	53.06	-12.78	40.28	54	-13.72	AV	Vertical
2483.6	70.38	-12.78	57.6	74	-16.4	PK	Horizontal
2483.6	53.11	-12.78	40.33	54	-13.67	AV	Horizontal
Remark: 1. Factor = Antenna Factor + Cable Loss – Pre-amplifier.							
Low measurement frequencies is range from 2310 to 2400 MHz, high measurement frequencies is range from 2483.5 to 2500 MHz. Only show the worst point data of the emissions in the frequency 2310-2400 MHz and 2483.5-2500 MHz.							

5. CONDUCTED SPURIOUS EMISSIONS

5.1 REQUIREMENT

According to FCC section 15.247(d), in any 100kHz bandwidth outside the frequency band in which the spread spectrum or digitally modulated intentional radiator is operating, the radio frequency power that is produced by the intentional radiator shall be at least 20dB below that in the 100kHz bandwidth within the band that contains the highest level of the desired power, based on either an RF conducted or a radiated measurement.

5.2 TEST PROCEDURE

According to FCC section 15.247(d), in any 100kHz bandwidth outside the frequency band in which the spread spectrum or digitally modulated intentional radiator is operating, the radio frequency power that is produced by the intentional radiator shall be at least 20dB below that in the 100kHz bandwidth within the band that contains the highest level of the desired power, based on either an RF conducted or a radiated measurement.

Spectrum Parameter	Setting
Detector	Peak
Start/Stop Frequency	30 MHz to 10th carrier harmonic
RB / VB (emission in restricted band)	100 KHz/300 KHz
Trace-Mode:	Max hold

For Band edge

Spectrum Parameter	Setting
Detector	Peak
Start/Stop Frequency	Lower Band Edge: 2310 – 2404 MHz Upper Band Edge: 2478 – 2500 MHz
RB / VB (emission in restricted band)	100 KHz/300 KHz
Trace-Mode:	Max hold

5.3 TEST SETUP

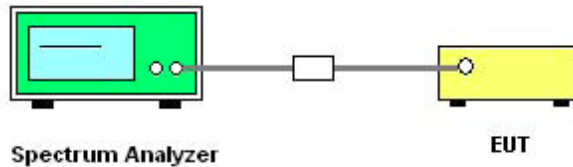

The EUT which is powered by the Battery, is coupled to the Spectrum Analyzer; the RF load attached to the EUT antenna terminal is 50Ohm; the path loss as the factor is calibrated to correct the reading. Make the measurement with the spectrum analyzer's resolution bandwidth(RBW) = 100 kHz. In order to make an accurate measurement, set the span greater than RBW.

5.4 EUT OPERATION CONDITIONS

The EUT tested system was configured as the statements of 2.3 Unless otherwise a special operating condition is specified in the follows during the testing.



5.5 TEST RESULTS

EUT :	Smart Phone	Model Name :	Sky 5.0L
Temperature :	25 °C	Relative Humidity :	50%
Pressure :	1012 hPa	Test Voltage :	DC 3.8V
Test Mode :	TX Mode /CH01, CH20, CH40		

01 CH

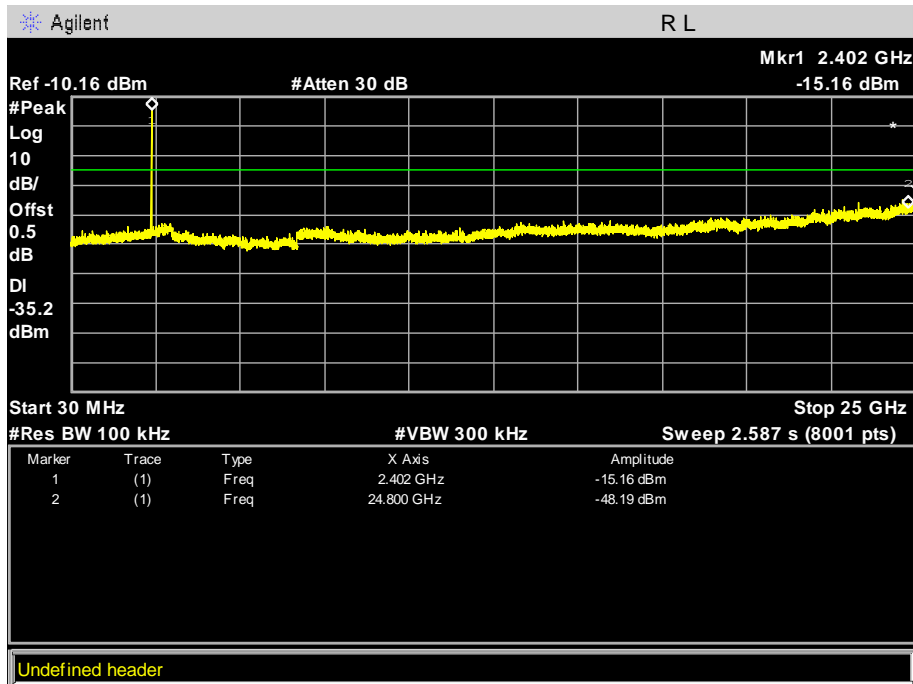



20 CH

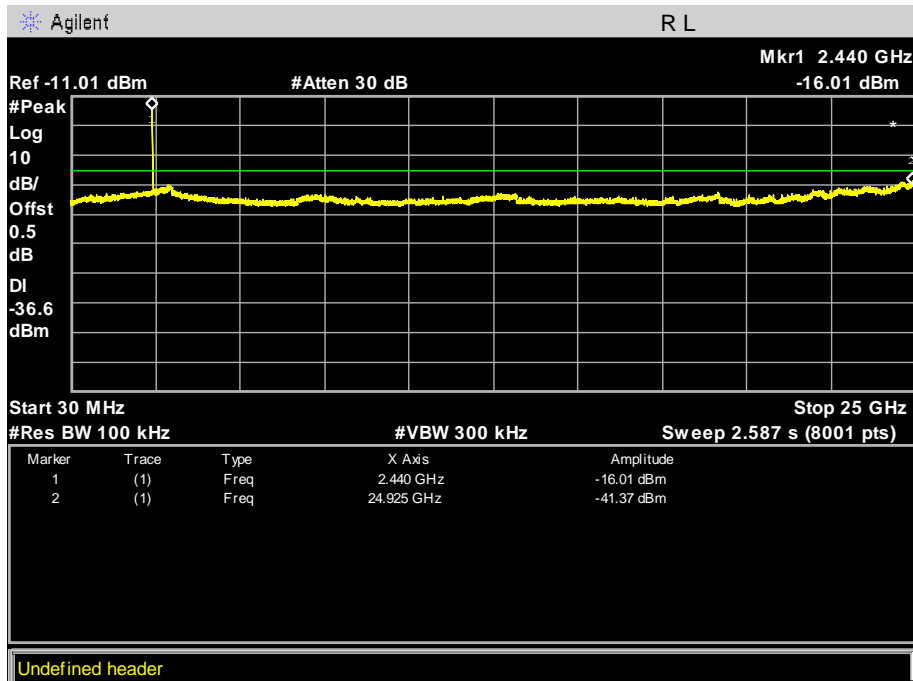

40 CH

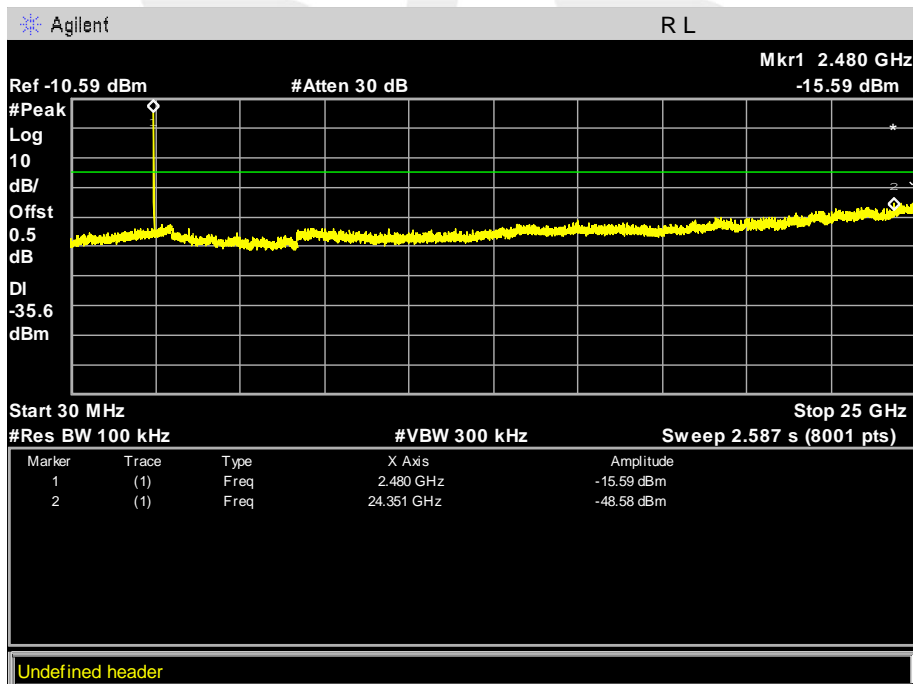



For Band edge

01 CH

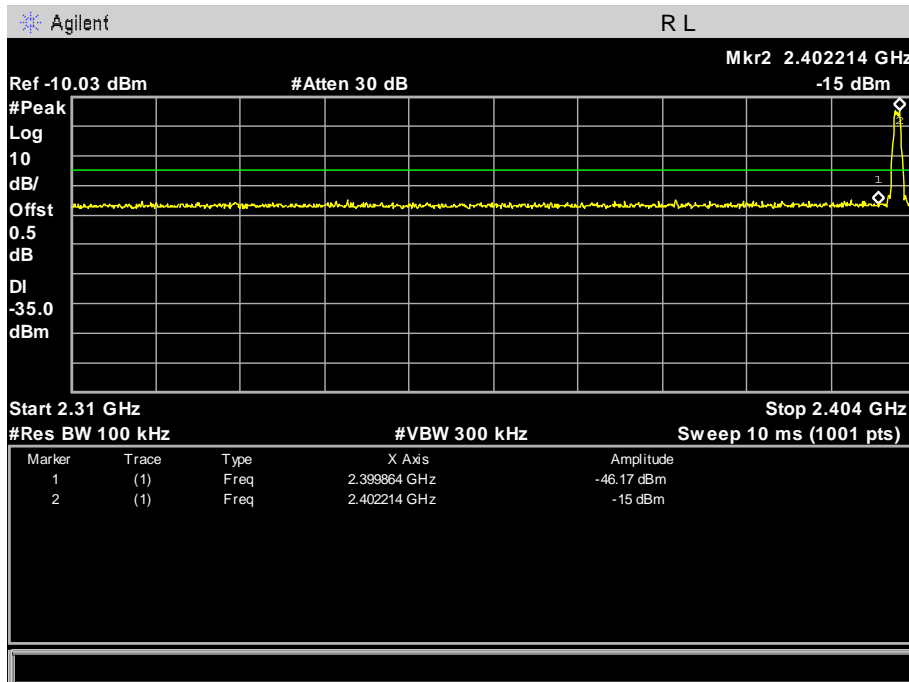

40 CH

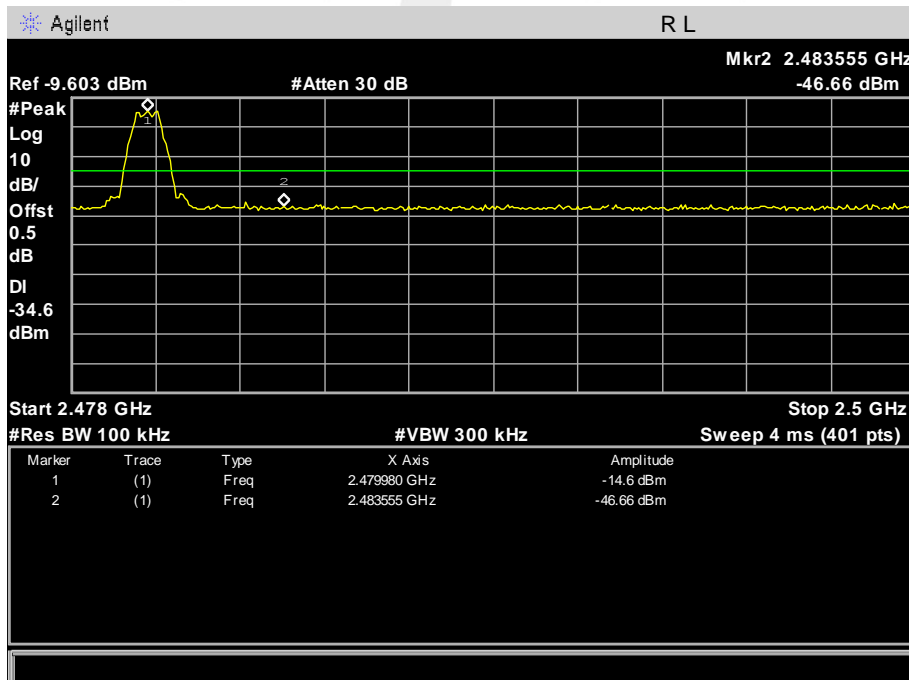



6. POWER SPECTRAL DENSITY TEST

6.1 APPLIED PROCEDURES / LIMIT

FCC Part15 (15.247) , Subpart C				
Section	Test Item	Limit	Frequency Range (MHz)	Result
15.247	Power Spectral Density	8 dBm (in any 3KHz)	2400-2483.5	PASS

6.2 TEST PROCEDURE

1. Set analyzer center frequency to DTS channel center frequency.
2. Set the span to 1.5 times the DTS channel bandwidth.
3. Set the RBW \geq 3 kHz.
4. Set the VBW \geq 3 x RBW.
5. Detector = peak.
6. Sweep time = auto couple.
7. Trace mode = max hold.
8. Allow trace to fully stabilize.
9. Use the peak marker function to determine the maximum amplitude level.
10. If measured value exceeds limit, reduce RBW (no less than 3 kHz) and repeat.

6.3 TEST SETUP



6.4 EUT OPERATION CONDITIONS

The EUT tested system was configured as the statements of 2.3 Unless otherwise a special operating condition is specified in the follows during the testing.



6.5 TEST RESULTS

EUT :	Smart Phone	Model Name :	Sky 5.0L
Temperature :	25 °C	Relative Humidity :	60%
Pressure :	1015 hPa	Test Voltage :	DC 3.8V
Test Mode :	TX Mode /CH01, CH20, CH40		

Frequency	Power Density (dBm)	Limit (dBm)	Result
2402 MHz	-29.16	8	PASS
2440 MHz	-28.69	8	PASS
2480 MHz	-28.61	8	PASS

TX CH01

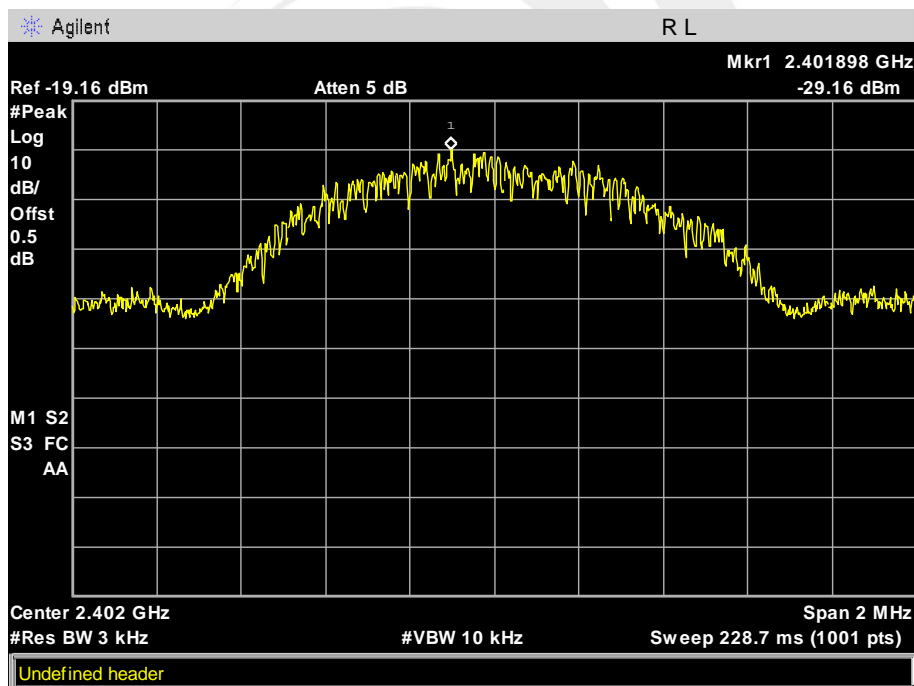



TX CH20

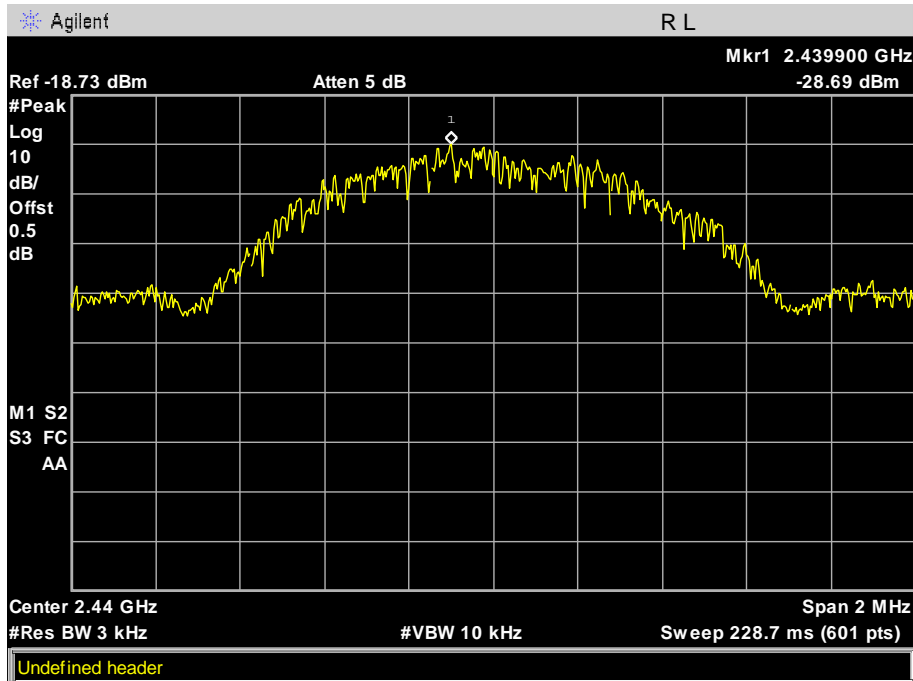

TX CH40

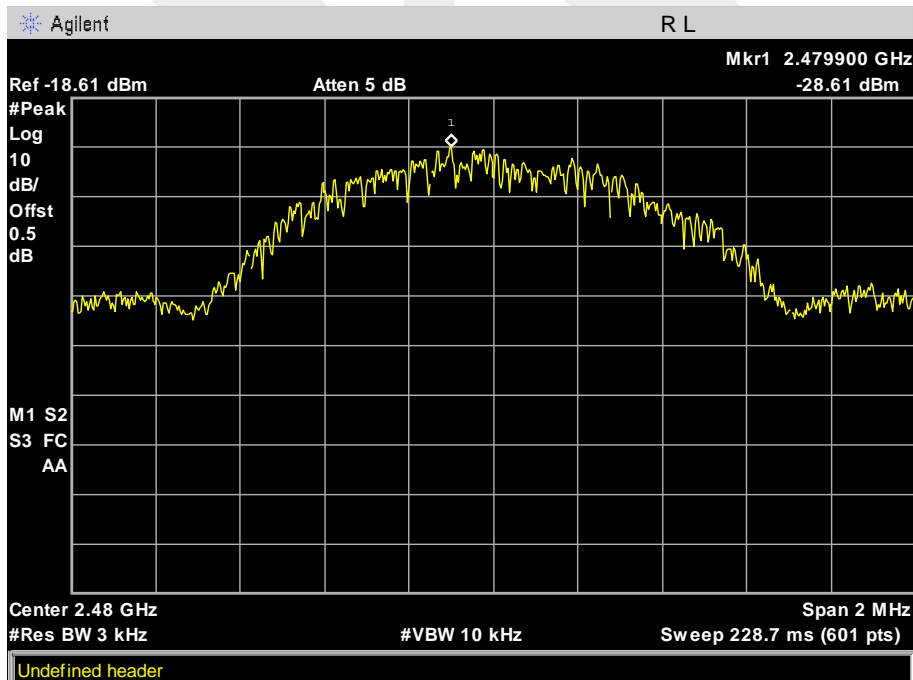



7. BANDWIDTH TEST

7.1 APPLIED PROCEDURES / LIMIT

FCC Part15 (15.247) , Subpart C				
Section	Test Item	Limit	Frequency Range (MHz)	Result
15.247(a)(2)	Bandwidth	$\geq 500\text{KHz}$ (6dB bandwidth)	2400-2483.5	PASS

7.2 TEST PROCEDURE

1. Set RBW = 100 kHz.
2. Set the video bandwidth (VBW) ≥ 3 RBW.
3. Detector = Peak.
4. Trace mode = max hold.
5. Sweep = auto couple.
6. Allow the trace to stabilize.
7. Measure the maximum width of the emission that is constrained by the frequencies associated with the two outermost amplitude points (upper and lower frequencies) that are attenuated by 6 dB relative to the maximum level measured in the fundamental emission.

7.3 TEST SETUP



7.4 EUT OPERATION CONDITIONS

The EUT tested system was configured as the statements of 2.3 Unless otherwise a special operating condition is specified in the follows during the testing.



7.5 TEST RESULTS

EUT :	Smart Phone	Model Name :	Sky 5.0L
Temperature :	25 °C	Relative Humidity :	60%
Pressure :	1012 hPa	Test Voltage :	DC 3.8V
Test Mode :	TX Mode /CH01, CH20, CH40		

Frequency	6dB Bandwidth (MHz)	Channel Separation (MHz)	Result
2402 MHz	0.715	>=500KHz	PASS
2440 MHz	0.724	>=500KHz	PASS
2480 MHz	0.718	>=500KHz	PASS

TX CH 01

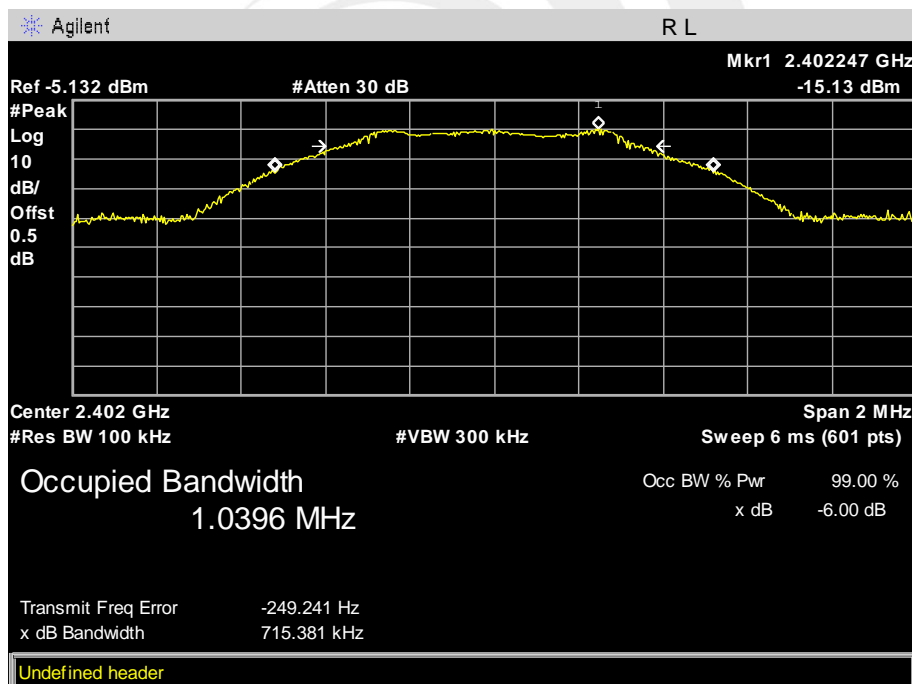



TX CH 20

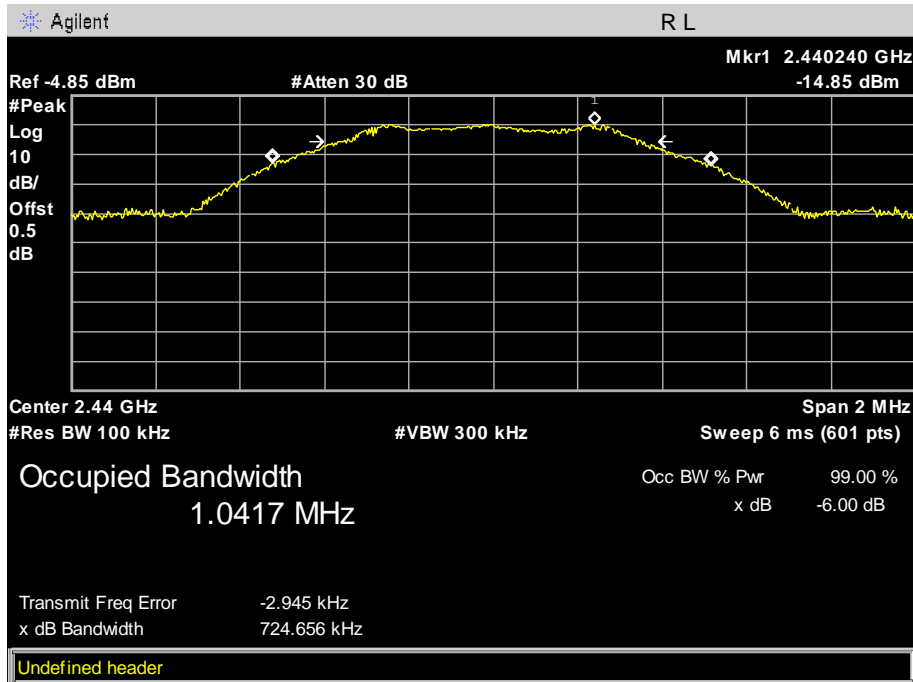

TX CH 40

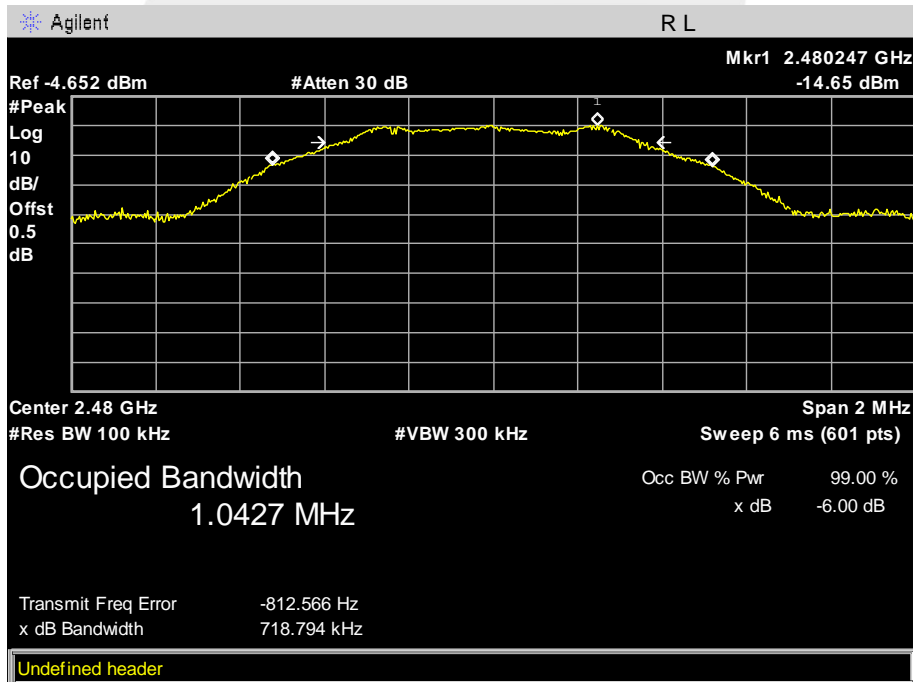



8. PEAK OUTPUT POWER TEST

8.1 APPLIED PROCEDURES / LIMIT

FCC Part15 (15.247) , Subpart C				
Section	Test Item	Limit	Frequency Range (MHz)	Result
15.247(b)(3)	Peak Output Power	1 watt or 30dBm	2400-2483.5	PASS

8.2 TEST PROCEDURE

- a. The EUT was directly connected to the Power Sensor&Power meter

8.3 TEST SETUP



8.4 EUT OPERATION CONDITIONS

The EUT tested system was configured as the statements of 2.3 Unless otherwise a special operating condition is specified in the follows during the testing.



8.5 TEST RESULTS

EUT :	Smart Phone	Model Name :	Sky 5.0L
Temperature :	25 °C	Relative Humidity :	60%
Pressure :	1012 hPa	Test Voltage :	DC 3.8V
Test Mode :	TX Mode /CH01, CH20, CH40		

TX Mode			
Test Channe	Frequency	Peak Conducted Output Power	LIMIT
	(MHz)	(dBm)	dBm
CH01	2402	-14.19	30
CH20	2440	-13.89	30
CH40	2480	-14.01	30



9. ANTENNA REQUIREMENT

9.1 STANDARD REQUIREMENT

15.203 requirement: For intentional device, according to 15.203: an intentional radiator shall be designed to ensure that no antenna other than that furnished by the responsible party shall be used with the device.

9.2 EUT ANTENNA

The EUT antenna is permanent attach Antenna. It comply with the standard requirement.



10. EUT TEST PHOTO

Radiated Measurement Photos

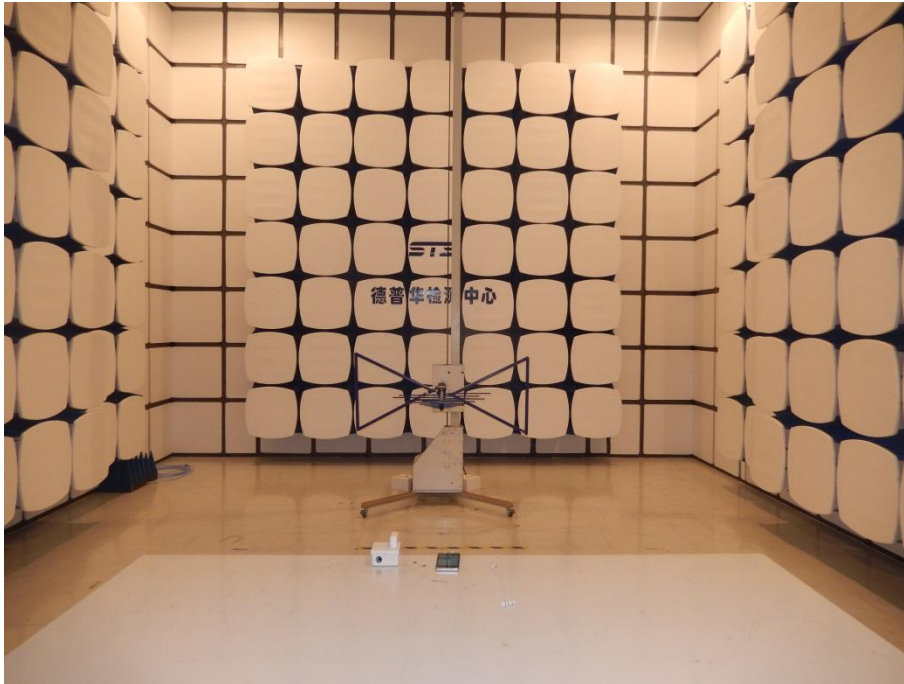



Conducted Measurement Photos



※※※※END OF THE REPORT※※※※