FCC Test Report

Report No.: AGC00364160701FE03

FCC ID : 2ABOSPLAT40
APPLICATION PURPOSE : Original Equipment
PRODUCT DESIGNATION : Smart Phone
BRAND NAME : SKY
MODEL NAME : Platinum 4.0
CLIENT : Sky Phone LLC.
DATE OF ISSUE : Aug. 19, 2016
STANDARD(S) : FCC Part 15 Rules
TEST PROCEDURE(S) : DA 00-705
REPORT VERSION : V1.0

Attestation of Global Compliance (Shenzhen) Co., Ltd



CAUTION:

This report shall not be reproduced except in full without the written permission of the test laboratory and shall not be quoted out of context.



Report Revise Record

Report Version	Revise Time	Issued Date	Valid Version	Notes
V1.0	/	Aug. 19, 2016	Valid	Original Report

TABLE OF CONTENTS

1. VERIFICATION OF CONFORMITY	5
2. GENERAL INFORMATION	6
2.1. PRODUCT DESCRIPTION.....	6
2.2. TABLE OF CARRIER FREQUENCYS.....	6
2.3. RECEIVER INPUT BANDWIDTH.....	7
2.4. EXAMPLE OF A HOPPING SEQUENCY IN DATA MODE	7
2.5. EQUALLY AVERAGE USE OF FREQUENCIES AND BEHAVIOUR	7
2.6. RELATED SUBMITTAL(S) / GRANT (S).....	8
2.7. TEST METHODOLOGY.....	8
2.8. SPECIAL ACCESSORIES	8
2.9. EQUIPMENT MODIFICATIONS	8
3. MEASUREMENT UNCERTAINTY.....	9
4. DESCRIPTION OF TEST MODES.....	9
5. SYSTEM TEST CONFIGURATION	10
5.1. CONFIGURATION OF EUT SYSTEM	10
5.2. EQUIPMENT USED IN EUT SYSTEM	10
5.3. SUMMARY OF TEST RESULTS	10
6. TEST FACILITY	11
7. PEAK OUTPUT POWER	13
7.1. MEASUREMENT PROCEDURE	13
7.2. TEST SET-UP (BLOCK DIAGRAM OF CONFIGURATION).....	13
7.3. LIMITS AND MEASUREMENT RESULT	14
8. 20DB BANDWIDTH.....	20
8.1. MEASUREMENT PROCEDURE	20
8.2. TEST SET-UP (BLOCK DIAGRAM OF CONFIGURATION).....	20
8.3. LIMITS AND MEASUREMENT RESULTS.....	20
9. CONDUCTED SPURIOUS EMISSION	21
9.1. MEASUREMENT PROCEDURE	26
9.2. TEST SET-UP (BLOCK DIAGRAM OF CONFIGURATION).....	26
9.3. MEASUREMENT EQUIPMENT USED.....	26
9.4. LIMITS AND MEASUREMENT RESULT	26
10. RADIATED EMISSION	54
10.1. MEASUREMENT PROCEDURE	54
10.2. TEST SETUP.....	56

10.3. TEST RESULT	57
11. BAND EDGE EMISSION	64
11.1. MEASUREMENT PROCEDURE	64
11.2. TEST SET-UP	64
11.3. Radiated TEST RESULT	65
11.4 Conducted TEST RESULT	66
12. NUMBER OF HOPPING FREQUENCY.....	71
12.1. MEASUREMENT PROCEDURE	71
12.2. TEST SETUP (BLOCK DIAGRAM OF CONFIGURATION).....	71
12.3. MEASUREMENT EQUIPMENT USED	71
12.4. LIMITS AND MEASUREMENT RESULT	71
13. TIME OF OCCUPANCY (DWELL TIME).....	72
13.1. MEASUREMENT PROCEDURE	72
13.2. TEST SETUP (BLOCK DIAGRAM OF CONFIGURATION).....	72
13.3. MEASUREMENT EQUIPMENT USED	72
13.4. LIMITS AND MEASUREMENT RESULT	72
14. FREQUENCY SEPARATION	74
14.1. MEASUREMENT PROCEDURE	74
14.2. TEST SETUP (BLOCK DIAGRAM OF CONFIGURATION).....	74
14.3. MEASUREMENT EQUIPMENT USED	74
14.4. LIMITS AND MEASUREMENT RESULT	74
15. FCC LINE CONDUCTED EMISSION TEST	75
15.1. LIMITS OF LINE CONDUCTED EMISSION TEST	75
15.2. BLOCK DIAGRAM OF LINE CONDUCTED EMISSION TEST	76
15.3. PRELIMINARY PROCEDURE OF LINE CONDUCTED EMISSION TEST	77
15.4. FINAL PROCEDURE OF LINE CONDUCTED EMISSION TEST	77
15.5. TEST RESULT OF LINE CONDUCTED EMISSION TEST	78
APPENDIX A: PHOTOGRAPHS OF TEST SETUP	80
APPENDIX B: PHOTOGRAPHS OF EUT	82

1. VERIFICATION OF CONFORMITY

Applicant	Sky Phone LLC.
Address	1348 Washington Av. #350, Miami Beach FL. 33139
Manufacturer	DongGuan Tenexon Communication Technology Co., Ltd.
Address	L1-L3, Block A, Building B, KeYuan 9th Road No.1, Tang Xia Town, Dongguan City, Guangdong China.
Product Designation	Smart Phone
Brand Name	SKY
Test Model	Platinum 4.0
Date of test	July 25, 2016~Aug. 10, 2016
Deviation	None
Condition of Test Sample	Normal
Report Template	AGCRT-US-BR/RF

We hereby certify that:

The above equipment was tested by Dongguan Precise Testing Service Co., Ltd. The test data, data evaluation, test procedures, and equipment configurations shown in this report were made in accordance with the procedures given in ANSI C63.10 (2013) and the energy emitted by the sample EUT tested as described in this report is in compliance with radiated emission limits of FCC Rules Part 15.247.

Tested By *Dota Zhang*
Dota Zhang(Zhang Jianfeng) Aug. 19, 2016

Reviewed By *Bart Xie*
Bart Xie(Xie Xiaobin) Aug. 19, 2016

Approved By *Solger Zhang*
Solger Zhang(Zhang Hongyi)
Authorized Officer Aug. 19, 2016

2. GENERAL INFORMATION

2.1. PRODUCT DESCRIPTION

The EUT is “Smart Phone” designed as a “Communication Device”. It is designed by way of utilizing the FHSS technology to achieve the system operation.

A major technical description of EUT is described as following

Operation Frequency	2.402 GHz to 2.480GHz
RF Output Power	3.90dBm(Max)
Bluetooth Version	V 3.0
Modulation	GFSK, π /4-DQPSK, 8DPSK
Number of channels	79(For BR/EDR)
Hardware Version	S71MA0RB1_C390_BOM07_V2.05
Software Version	SC7731C_C390_TRX_071_V1.1_20160713
Antenna Designation	Integral Antenna
Antenna Gain	-1.6dBi
Power Supply	DC3.7V by Battery

2.2. TABLE OF CARRIER FREQUENCIES

Frequency Band	Channel Number	Frequency
2400~2483.5MHZ	0	2402MHZ
	1	2403MHZ
	:	:
	38	2440 MHZ
	39	2441 MHZ
	40	2442 MHZ
	:	:
	77	2479 MHZ
	78	2480 MHZ

2.3. RECEIVER INPUT BANDWIDTH

The input bandwidth of the receiver is 1.3MHz. In every connection one Bluetooth device is the master and the other one is slave. The master determines the hopping sequence. The slave follows this sequence. Both devices shift between RX and TX time slot according to the clock of the master. Additionally the type of connection (e.g. single or multislotted packet) is set up at the beginning of the connection. The master adapts its hopping frequency and its TX/RX timing according to the packet type of the connection. Also the slave of the connection will use these settings.

Repeating of a packet has no influence on the hopping sequence. The hopping sequence generated by the master of the connection will be followed in any case. That means, a repeated packet will not be sent on the same frequency, it is sent on the next frequency of the hopping sequence.

2.4. EXAMPLE OF A HOPPING SEQUENCE IN DATA MODE

Example of a 79 hopping sequence in data mode:

40,21,44,23,42,53,46,55,48,33,52,35,50,65,54,67
56,37,60,39,58,69,62,71,64,25,68,27,66,57,70,59
72,29,76,31,74,61,78,63,01,41,05,43,03,73,07,75
09,45,13,47,11,77,15,00,64,49,66,53,68,02,70,06
01, 51, 03, 55, 05, 04

2.5. EQUALLY AVERAGE USE OF FREQUENCIES AND BEHAVIOUR

The generation of the hopping sequence in connection mode depends essentially on two input values:

1. LAP/UAP of the master of the connection.
2. Internal master clock

The LAP (lower address part) are the 24 LSB's of the 48 BD_ADDRESS. The BD_ADDRESS is an unambiguous number of every Bluetooth unit. The UAP (upper address part) are the 24 MSB's of the 48BD_ADDRESS

The internal clock of a Bluetooth unit is derived from a free running clock which is never adjusted and is never turned off. For synchronization with other units only offsets are used. It has no relation to the time of the day. Its resolution is at least half the RX/TX slot length of 312.5us. The clock has a cycle of about one day (23h30). In most cases it is implemented as a 28-bit counter. For the deriving of the hopping sequence the entire LAP (24 bits), 4 LSB's (4 bits) (Input 1) and the 27 MSB's of the clock (Input 2) are used. With these input values different mathematical procedures (permutations, additions, XOR-operations) are performed to generate the sequence. This will be done at the beginning of every new transmission.

Regarding short transmissions the Bluetooth system has the following behavior:

The first connection between the two devices is established, a hopping sequence was generated. For transmitting the wanted data the complete hopping sequence was not used. The connection ended.

The second connection will be established. A new hopping sequence is generated. Due to the fact the Bluetooth clock has a different value, because the period between the two transmissions is longer (and it cannot be shorter) than the minimum resolution of the clock (312.5us). The hopping sequence will always differ from the first one.

2.6. RELATED SUBMITTAL(S) / GRANT (S)

This submittal(s) (test report) is intended for **FCC ID: 2ABOSPLAT40** filing to comply with Section 15.247 of the FCC Part 15, Subpart C Rules.

2.7. TEST METHODOLOGY

Both conducted and radiated testing was performed according to the procedures in FCC DA 00-705. Radiated testing was performed at an antenna to EUT distance 3 meters.

2.8. SPECIAL ACCESSORIES

Refer to section 5.2.

2.9. EQUIPMENT MODIFICATIONS

Not available for this EUT intended for grant.

3. MEASUREMENT UNCERTAINTY

Conducted measurement: +/- 2.75dB

Radiated measurement: +/- 3.2dB

4. DESCRIPTION OF TEST MODES

NO.	TEST MODE DESCRIPTION
1	Low channel GFSK
2	Middle channel GFSK
3	High channel GFSK
4	Low channel $\pi/4$ -DQPSK
5	Middle channel $\pi/4$ -DQPSK
6	High channel $\pi/4$ -DQPSK
7	Low channel 8DPSK
8	Middle channel 8DPSK
9	High channel 8DPSK
10	Normal Hopping

Note:

1. All the test modes can be supply by Built-in Li-ion battery, only the result of the worst case was recorded in the report, if no other cases.
2. For Radiated Emission, 3axis were chosen for testing for each applicable mode.

5. SYSTEM TEST CONFIGURATION

5.1. CONFIGURATION OF EUT SYSTEM

Configuration:

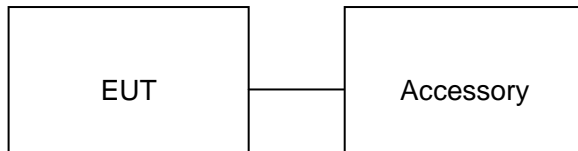

5.2. EQUIPMENT USED IN EUT SYSTEM

Item	Equipment	Model No.	ID or Specification	Remark
1	Smart Phone	Platinum 4.0	2ABOSPLAT40	EUT
2	Battery	Platinum 4.0	DC3.7V/1400mAh	Accessory
3	Adapter	Platinum 4.0	DC5V/500mA	Accessory

5.3. SUMMARY OF TEST RESULTS

FCC RULES	DESCRIPTION OF TEST	RESULT
§15.247	Peak Output Power	Compliant
§15.247	20 dB Bandwidth	Compliant
§15.247	Spurious Emission	Compliant
§15.209	Radiated Emission	Compliant
§15.247	Band Edges	Compliant
§15.207	Conduction Emission	Compliant
§15.247	Number of Hopping Frequency	Compliant
§15.247	Time of Occupancy	Compliant
§15.247	Frequency Separation	Compliant

6. TEST FACILITY

Site	Dongguan Precise Testing Service Co., Ltd.
Location	Building D,Baoding Technology Park,Guangming Road2,Dongcheng District, Dongguan, Guangdong, China,
FCC Registration No.	371540
Description	The test site is constructed and calibrated to meet the FCC requirements in documents ANSI C63.10:2013.

ALL TEST EQUIPMENT LIST

FOR RADIATED EMISSION TEST (BELOW 1GHZ)

Radiated Emission Test Site					
Name of Equipment	Manufacturer	Model Number	Serial Number	Last Calibration	Due Calibration
EMI Test Receiver	Rohde & Schwarz	ESCI	101417	July 3, 2016	July 2, 2017
Trilog Broadband Antenna (25M-1GHz)	SCHWARZBECK	VULB9160	9160-3355	July 3, 2016	July 2, 2017
Signal Amplifier	SCHWARZBECK	BBV 9475	9745-0013	July 3, 2016	July 2, 2017
RF Cable	SCHWARZBECK	AK9515E	96221	July 3, 2016	July 2, 2017
3m Anechoic Chamber	CHENGYU	966	PTS-001	June 5, 2016	June 4, 2017
MULTI-DEVICE Positioning Controller	Max-Full	MF-7802	MF780208339	N/A	N/A
Active loop antenna (9K-30MHz)	Schwarzbeck	FMZB1519	1519-038	June 5, 2016	June 4, 2017
Spectrum analyzer	Agilent	E4407B	MY46185649	June 5, 2016	June 4, 2017
Power Probe	R&S	NRP-Z23	100323	July 24,2016	July 23,2017
RF attenuator	N/A	RFA20db	68	N/A	N/A

FOR RADIATED EMISSION TEST (1GHZ ABOVE)

Radiated Emission Test Site					
Name of Equipment	Manufacturer	Model Number	Serial Number	Last Calibration	Due Calibration
EMI Test Receiver	Rohde & Schwarz	ESCI	101417	July 3, 2016	July 2, 2017
Horn Antenna (1G-18GHz)	SCHWARZBECK	BBHA9120D	9120D-1246	July 10, 2016	July 9, 2017
Spectrum Analyzer	Agilent	E4411B	MY4511453	July 3, 2016	July 2, 2017
Signal Amplifier	SCHWARZBECK	BBV 9718	9718-269	July 6, 2016	July 5, 2017
RF Cable	SCHWARZBECK	AK9515H	96220	July 7, 2016	July 6, 2017
3m Anechoic Chamber	CHENGYU	966	PTS-001	June 5, 2016	June 4, 2017
MULTI-DEVICE Positioning Controller	Max-Full	MF-7802	MF780208339	N/A	N/A

Horn Ant (18G-40GHz)	Schwarzbeck	BBHA 9170	9170-181	June 5, 2016	June 4, 2017
Power Probe	R&S	NRP-Z23	100323	July 24,2016	July 23,2017
RF attenuator	N/A	RFA20db	68	N/A	N/A
Conducted Emission Test Site					
Name of Equipment	Manufacturer	Model Number	Serial Number	Last Calibration	Due Calibration
EMI Test Receiver	Rohde & Schwarz	ESCI	101417	July 3, 2016	July 2, 2017
Artificial Mains Network	Narda	L2-16B	000WX31025	July 7, 2016	July 6, 2017
Artificial Mains Network (AUX)	Narda	L2-16B	000WX31026	July 7, 2016	July 6, 2017
RF Cable	SCHWARZBECK	AK9515E	96222	July 3, 2016	July 2, 2017
Shielded Room	CHENGYU	843	PTS-002	June 5,2016	June 4,2017

7. PEAK OUTPUT POWER

7.1. MEASUREMENT PROCEDURE

For peak power test:

1. Connect EUT RF output port to the Spectrum Analyzer through an RF attenuator
2. Set the EUT Work on the top, middle and the bottom operation frequency individually.
3. $RBW >$ the 20 dB bandwidth of the emission being measured, $VBW \geq RBW$.
4. Record the maximum power from the Spectrum Analyzer.

For average power test:

1. Connect EUT RF output port to power probe through an RF attenuator.
2. Connect the power probe to the PC.
3. Set the EUT Work on the top, the middle and the bottom operation frequency individually.
4. Record the maximum power from the software.
5. The maximum peak power shall be less 125mW (21dBm).

Note : The EUT was tested according to DA000705 for compliance to FCC 47CFR 15.247 requirements.

7.2. TEST SET-UP (BLOCK DIAGRAM OF CONFIGURATION)

PEAK POWER TEST SETUP

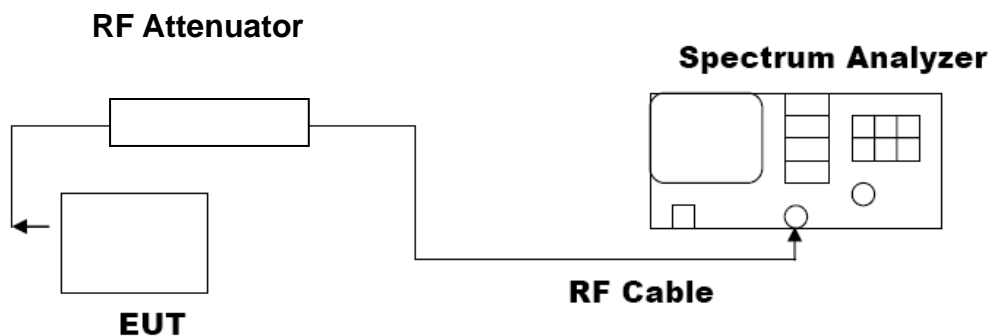

AVERAGE POWER SETUP

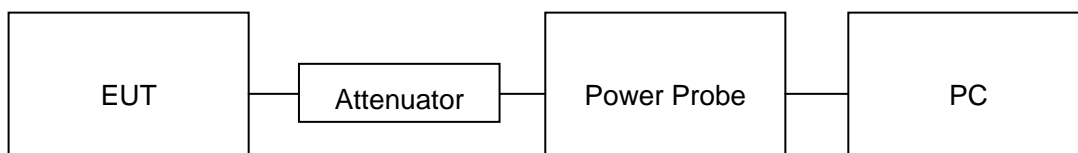

7.3. LIMITS AND MEASUREMENT RESULT

PEAK OUTPUT POWER MEASUREMENT RESULT FOR GFSK MODULATION				
Frequency (GHz)	Average Power (dBm)	Peak Power (dBm)	Applicable Limits (dBm)	Pass or Fail
2.402	0.79	2.75	21	Pass
2.441	1.14	3.16	21	Pass
2.480	1.83	3.90	21	Pass

PEAK OUTPUT POWER MEASUREMENT RESULT FOR $\pi/4$-DQPSK MODULATION				
Frequency (GHz)	Average Power (dBm)	Peak Power (dBm)	Applicable Limits (dBm)	Pass or Fail
2.402	-1.24	0.63	21	Pass
2.441	-0.86	1.10	21	Pass
2.480	-0.25	1.69	21	Pass

PEAK OUTPUT POWER MEASUREMENT RESULT FOR 8-DPSK MODULATION				
Frequency (GHz)	Average Power (dBm)	Peak Power (dBm)	Applicable Limits (dBm)	Pass or Fail
2.402	-1.28	0.75	21	Pass
2.441	-0.79	1.23	21	Pass
2.480	-0.12	1.92	21	Pass

Test Graph

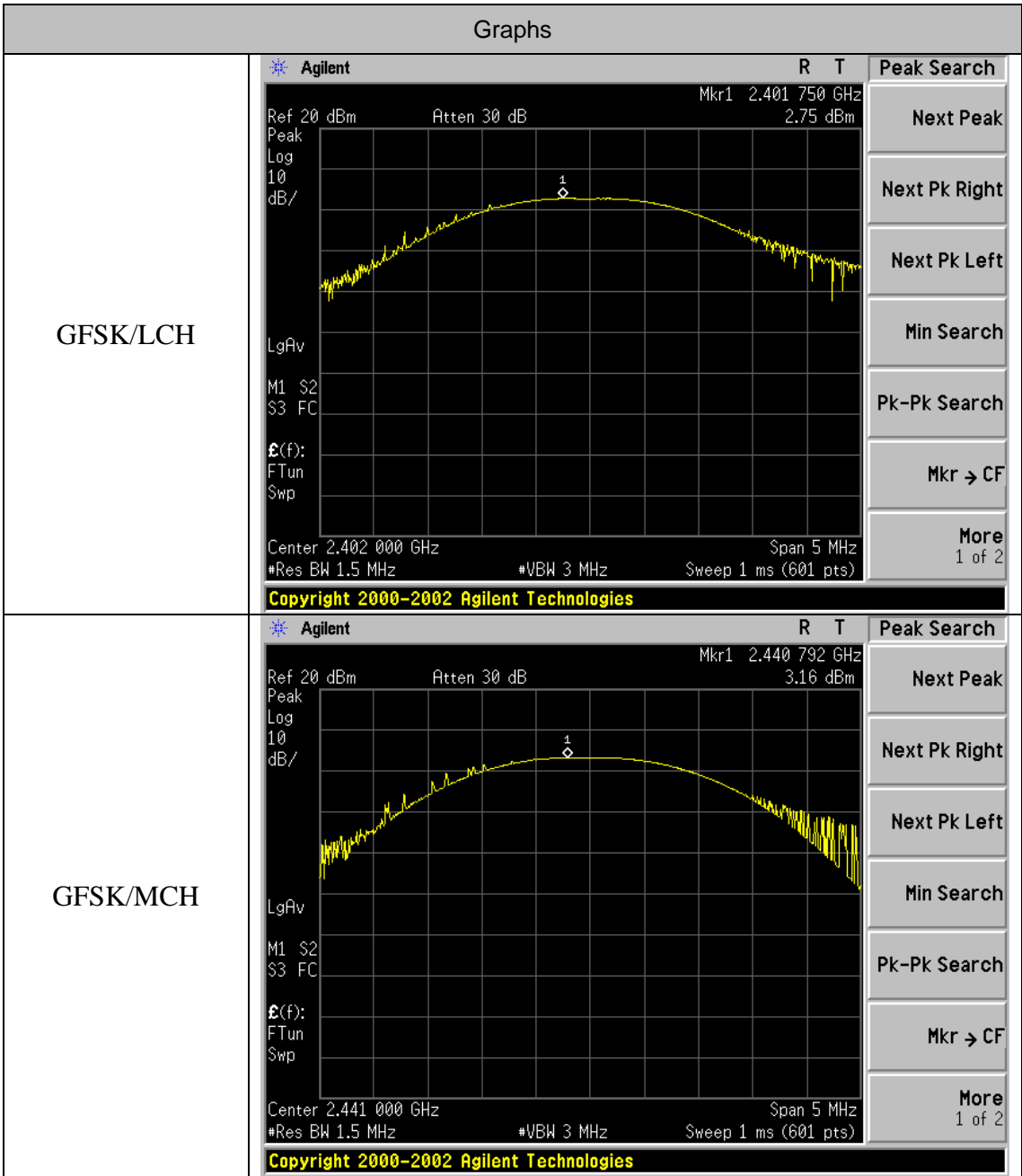

<p>GFSK/HCH</p>	<p>Agilent R T Peak Search Mkr1 2.479 792 GHz 3.90 dBm Ref 20 dBm Atten 30 dB Peak Log 10 dB/ LgAv M1 S2 S3 FC $\mathcal{E}(f)$: FTun Swp Center 2.480 000 GHz Span 5 MHz #Res BW 1.5 MHz #VBW 3 MHz Sweep 1 ms (601 pts) Copyright 2000-2002 Agilent Technologies</p>
<p>π /4DQPSK/LCH</p>	<p>Agilent R T Peak Search Mkr1 2.402 117 GHz 0.63 dBm Ref 20 dBm Atten 30 dB Peak Log 10 dB/ LgAv M1 S2 S3 FC $\mathcal{E}(f)$: FTun Swp Center 2.402 000 GHz Span 5 MHz #Res BW 1.5 MHz #VBW 3 MHz Sweep 1 ms (601 pts) Copyright 2000-2002 Agilent Technologies</p>

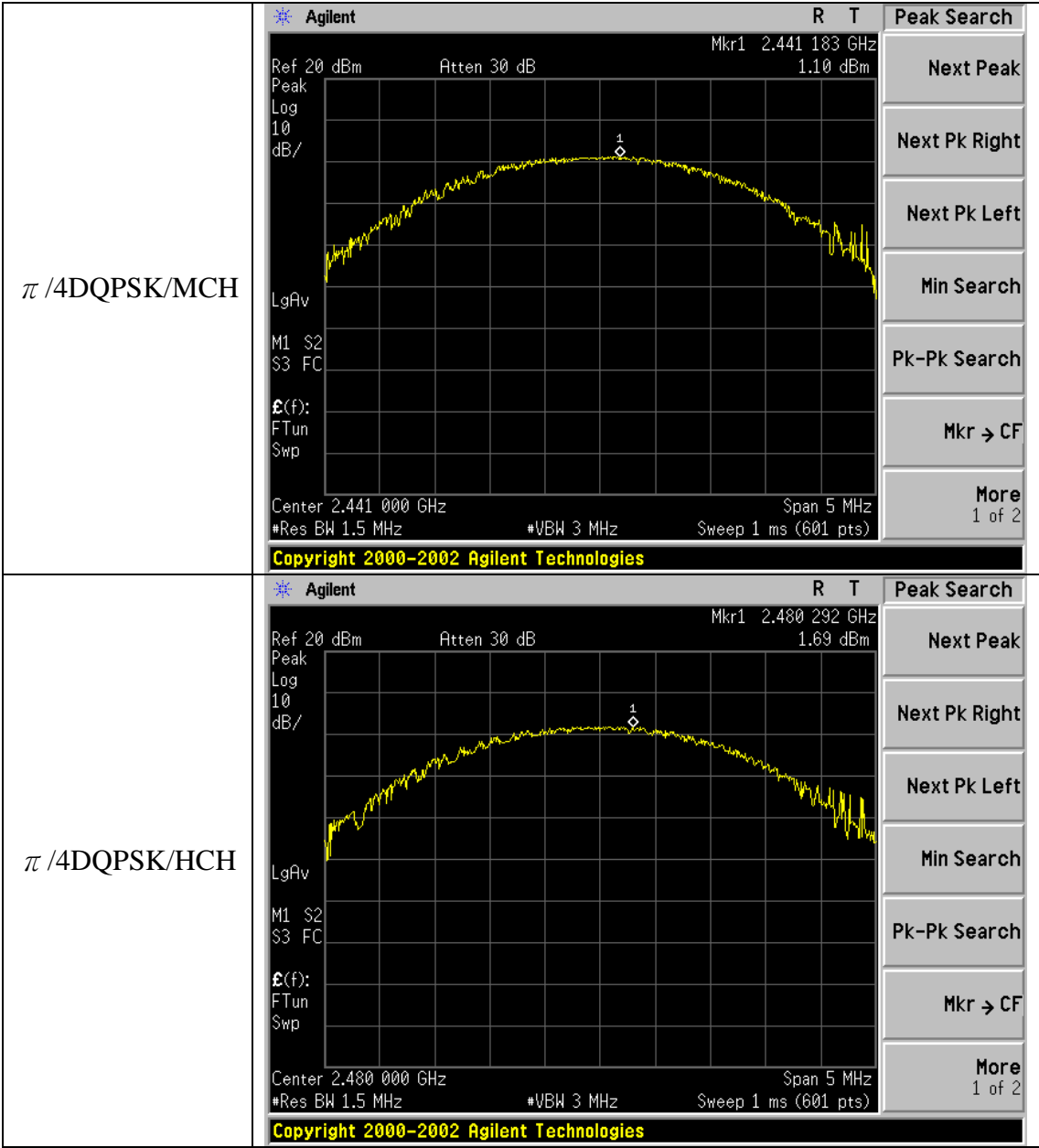

<p>8DPSK/LCH</p>	
<p>8DPSK/MCH</p>	

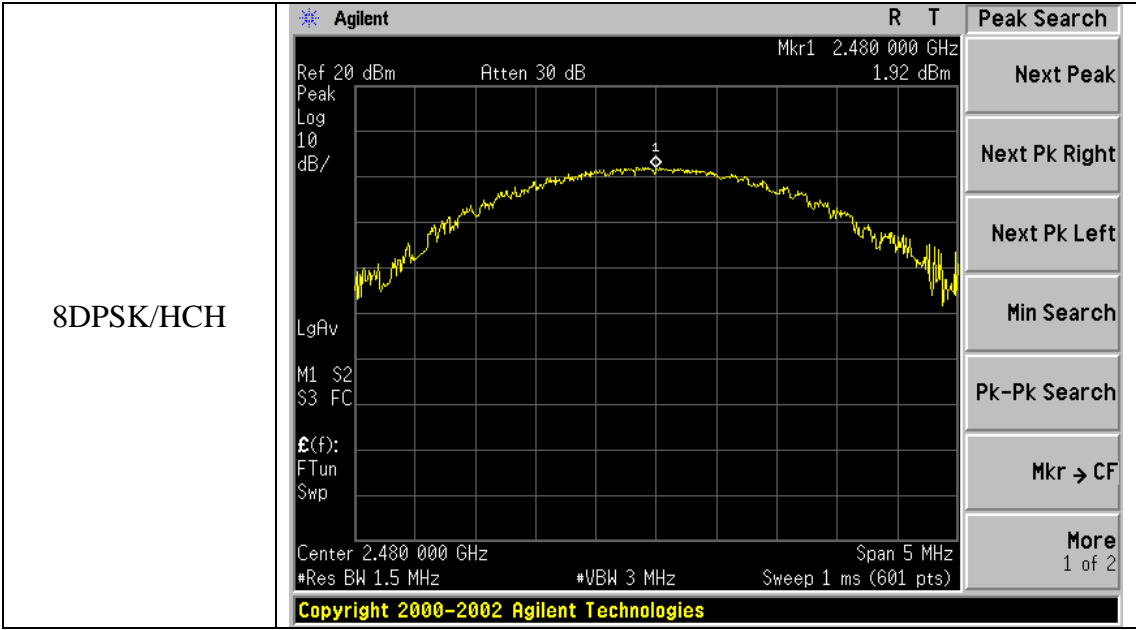

8. 20DB BANDWIDTH

8.1. MEASUREMENT PROCEDURE

1. Connect EUT RF output port to the Spectrum Analyzer through an RF attenuator
2. Set the EUT Work on the top, the middle and the bottom operation frequency individually.
3. Set Span = approximately 2 to 3 times the 20 dB bandwidth, centered on a hoping channel
RBW \geq 1% of the 20 dB bandwidth, VBW \geq RBW; Sweep = auto; Detector function = peak
4. Set SPA Trace 1 Max hold, then View.

8.2. TEST SET-UP (BLOCK DIAGRAM OF CONFIGURATION)

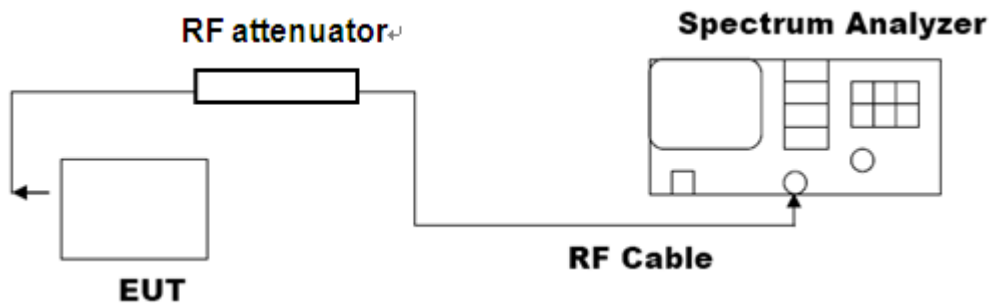

8.3. LIMITS AND MEASUREMENT RESULTS

Mode	Channel.	EBW [MHz]	OBW [MHz]	Verdict
GFSK	LCH	0.8198	0.8147	PASS
GFSK	MCH	0.8260	0.8118	PASS
GFSK	HCH	0.8270	0.8044	PASS
$\pi/4$ DQPSK	LCH	1.156	1.0927	PASS
$\pi/4$ DQPSK	MCH	1.153	1.0801	PASS
$\pi/4$ DQPSK	HCH	1.113	1.0818	PASS
8DPSK	LCH	1.157	1.0889	PASS
8DPSK	MCH	1.079	1.0565	PASS
8DPSK	HCH	1.162	1.0987	PASS

Test Graph

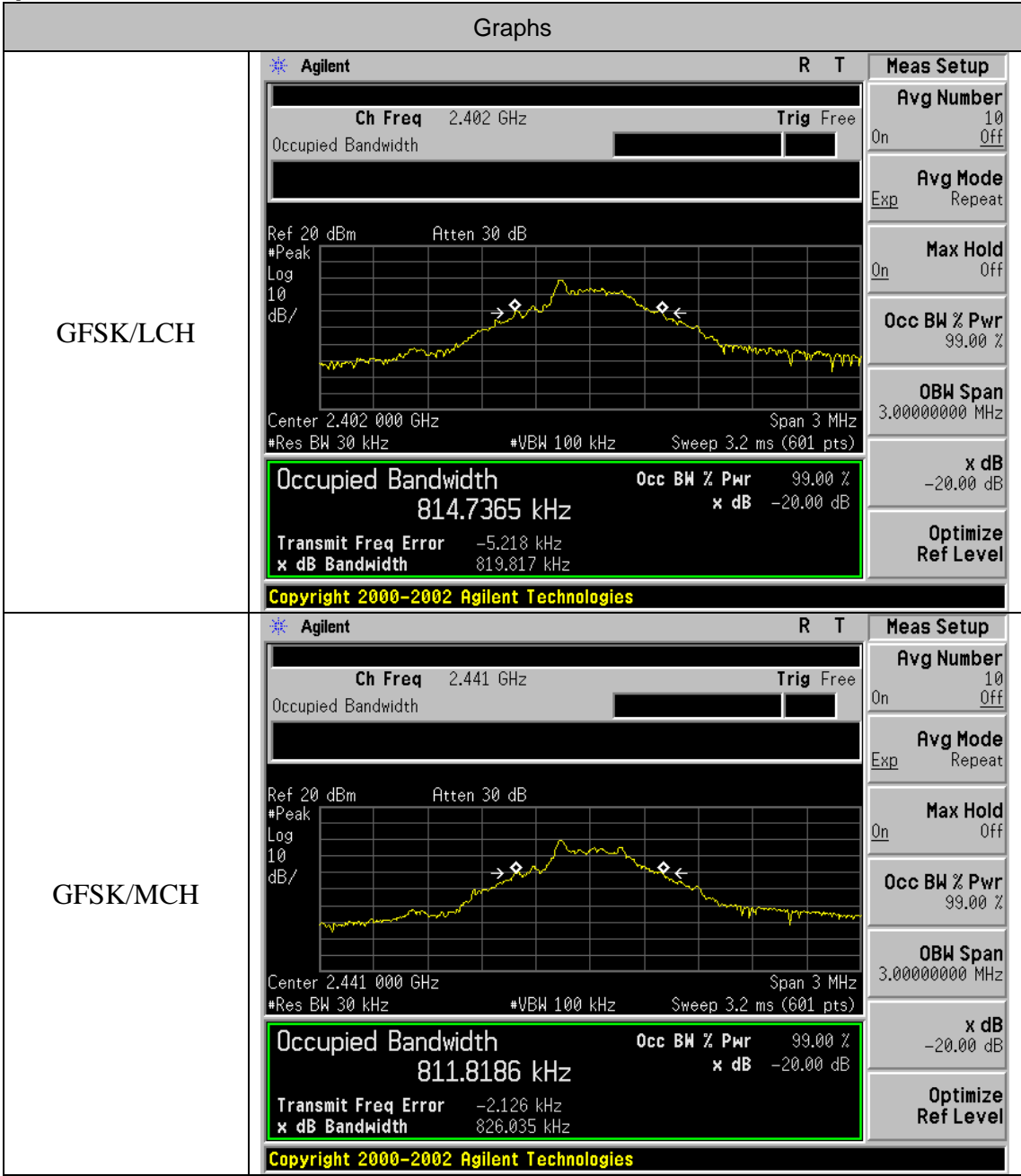

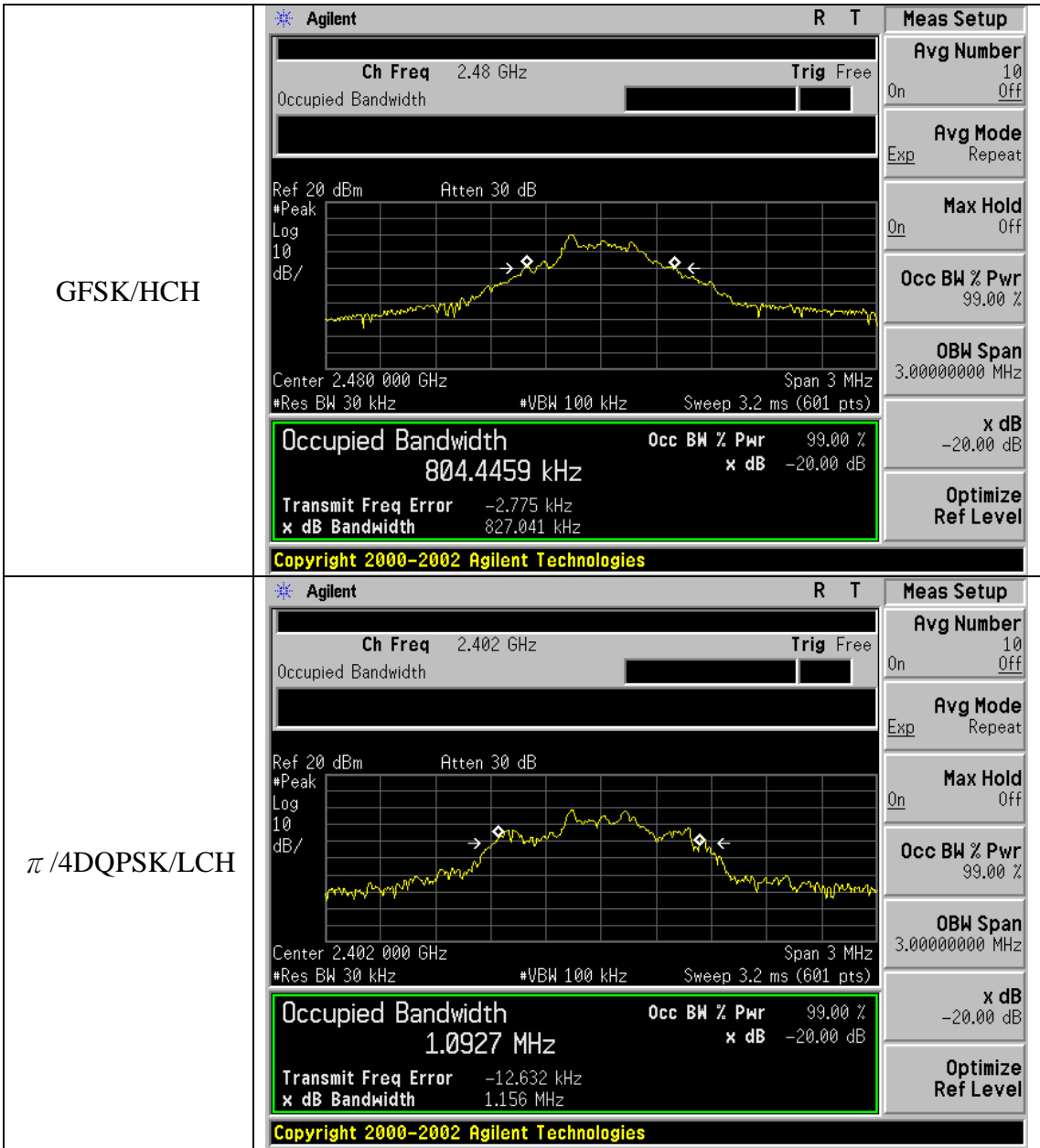

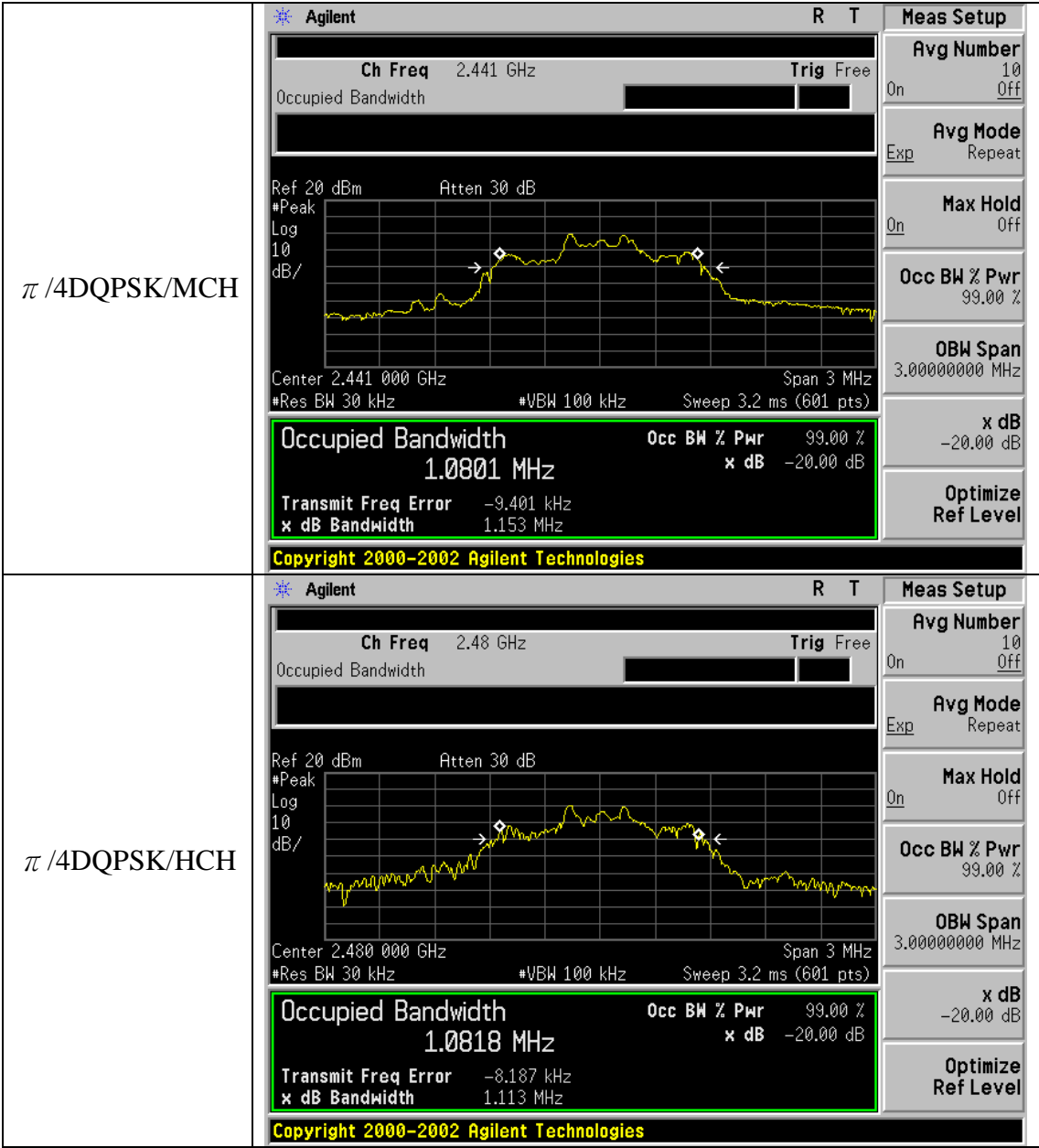

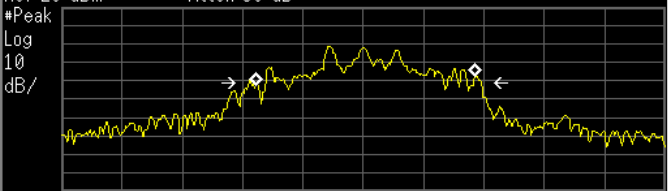
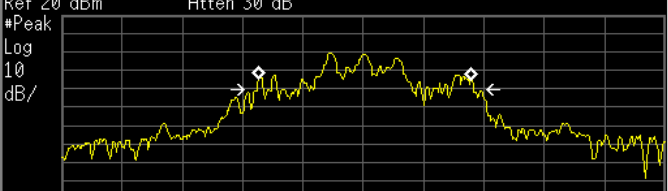
<p>8DPSK/LCH</p>	<div style="border: 1px solid black; padding: 5px;"> <p>Agilent R T</p> <hr/> <p>Ch Freq 2.402 GHz Trig Free</p> <p>Occupied Bandwidth █</p> <hr/> <p>Ref 20 dBm Atten 30 dB</p> <p>#Peak Log 10 dB/</p>  <p>Center 2.402 000 GHz Span 3 MHz</p> <p>#Res BW 30 kHz #VBW 100 kHz Sweep 3.2 ms (601 pts)</p> <div style="border: 2px solid green; padding: 2px; margin-top: 5px;"> <p>Occupied Bandwidth Occ BW % Pwr 99.00 %</p> <p style="font-size: 1.2em;">1.0889 MHz x dB -20.00 dB</p> <p>Transmit Freq Error 9.051 kHz</p> <p>x dB Bandwidth 1.157 MHz</p> </div> <p style="font-size: 0.8em; color: yellow;">Copyright 2000-2002 Agilent Technologies</p> </div>
<p>8DPSK/MCH</p>	<div style="border: 1px solid black; padding: 5px;"> <p>Agilent R T</p> <hr/> <p>Ch Freq 2.441 GHz Trig Free</p> <p>Occupied Bandwidth █</p> <hr/> <p>Ref 20 dBm Atten 30 dB</p> <p>#Peak Log 10 dB/</p>  <p>Center 2.441 000 GHz Span 3 MHz</p> <p>#Res BW 30 kHz #VBW 100 kHz Sweep 3.2 ms (601 pts)</p> <div style="border: 2px solid green; padding: 2px; margin-top: 5px;"> <p>Occupied Bandwidth Occ BW % Pwr 99.00 %</p> <p style="font-size: 1.2em;">1.0565 MHz x dB -20.00 dB</p> <p>Transmit Freq Error 7.281 kHz</p> <p>x dB Bandwidth 1.079 MHz</p> </div> <p style="font-size: 0.8em; color: yellow;">Copyright 2000-2002 Agilent Technologies</p> </div>

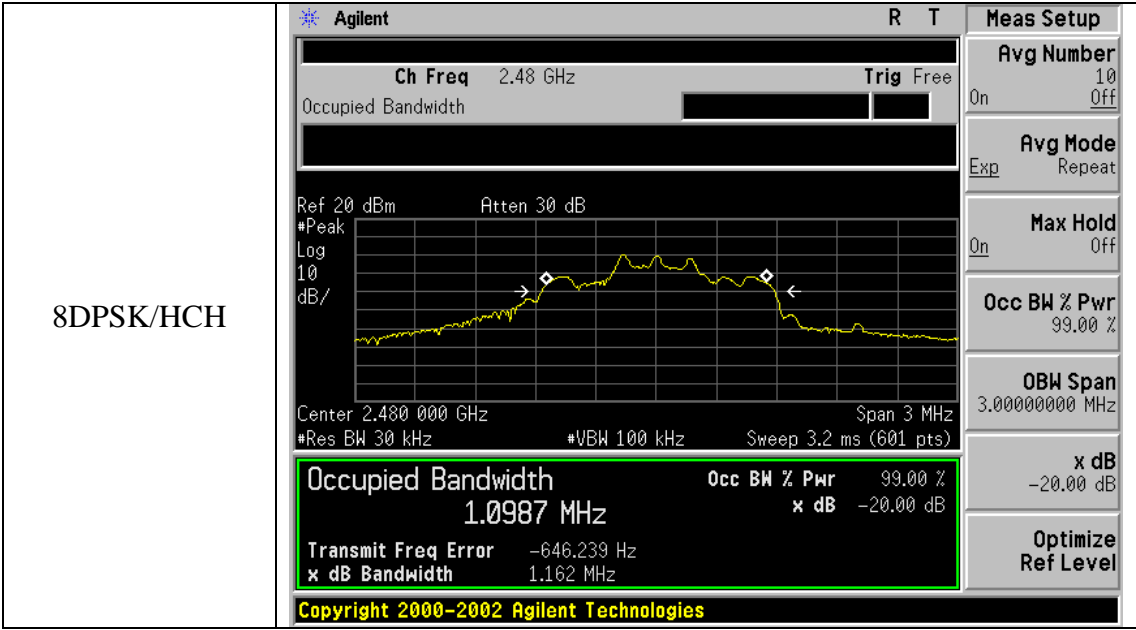

9. CONDUCTED SPURIOUS EMISSION

9.1. MEASUREMENT PROCEDURE

1. Connect EUT RF output port to the Spectrum Analyzer through an RF attenuator
2. Set the EUT Work on the top, the Middle and the bottom operation frequency individually.
3. Set the Span = wide enough to capture the peak level of the in-band emission and all spurious emissions from the lowest frequency generated in the EUT up through the 10th harmonic.
RBW = 100 kHz; VBW \geq RBW; Sweep = auto; Detector function = peak.
4. Set SPA Trace 1 Max hold, then View.

Note: The EUT was tested according to DA000705 for compliance to FCC 47CFR 15.247 requirements. Owing to satisfy the requirements of the number of measurement points, we set the RBW=1MHz, VBW > RBW, scan up through 10th harmonic, and consider the tested results as the worst case, if the tested results conform to the requirement, we can deem that the real tested results(set the RBW=100KHz, VBW > RBW) are conform to the requirement.

9.2. TEST SET-UP (BLOCK DIAGRAM OF CONFIGURATION)

The same as described in section 8.2

9.3. MEASUREMENT EQUIPMENT USED

The same as described in section 6

9.4. LIMITS AND MEASUREMENT RESULT

LIMITS AND MEASUREMENT RESULT		
Applicable Limits	Measurement Result	
	Test Data	Criteria
In any 100 KHz Bandwidth Outside the frequency band in which the spread spectrum intentional radiator is operating, the radio frequency power that is produce by the intentional radiator shall be at least 20 dB below that in 100KHz bandwidth within the band that contains the highest level of the desired power. In addition, radiation emissions which fall in the restricted bands, as defined in §15.205(a), must also comply with the radiated emission limits specified in§15.209(a))	At least -20dBc than the limit Specified on the BOTTOM Channel	PASS
	At least -20dBc than the limit Specified on the TOP Channel	PASS

Test Graph

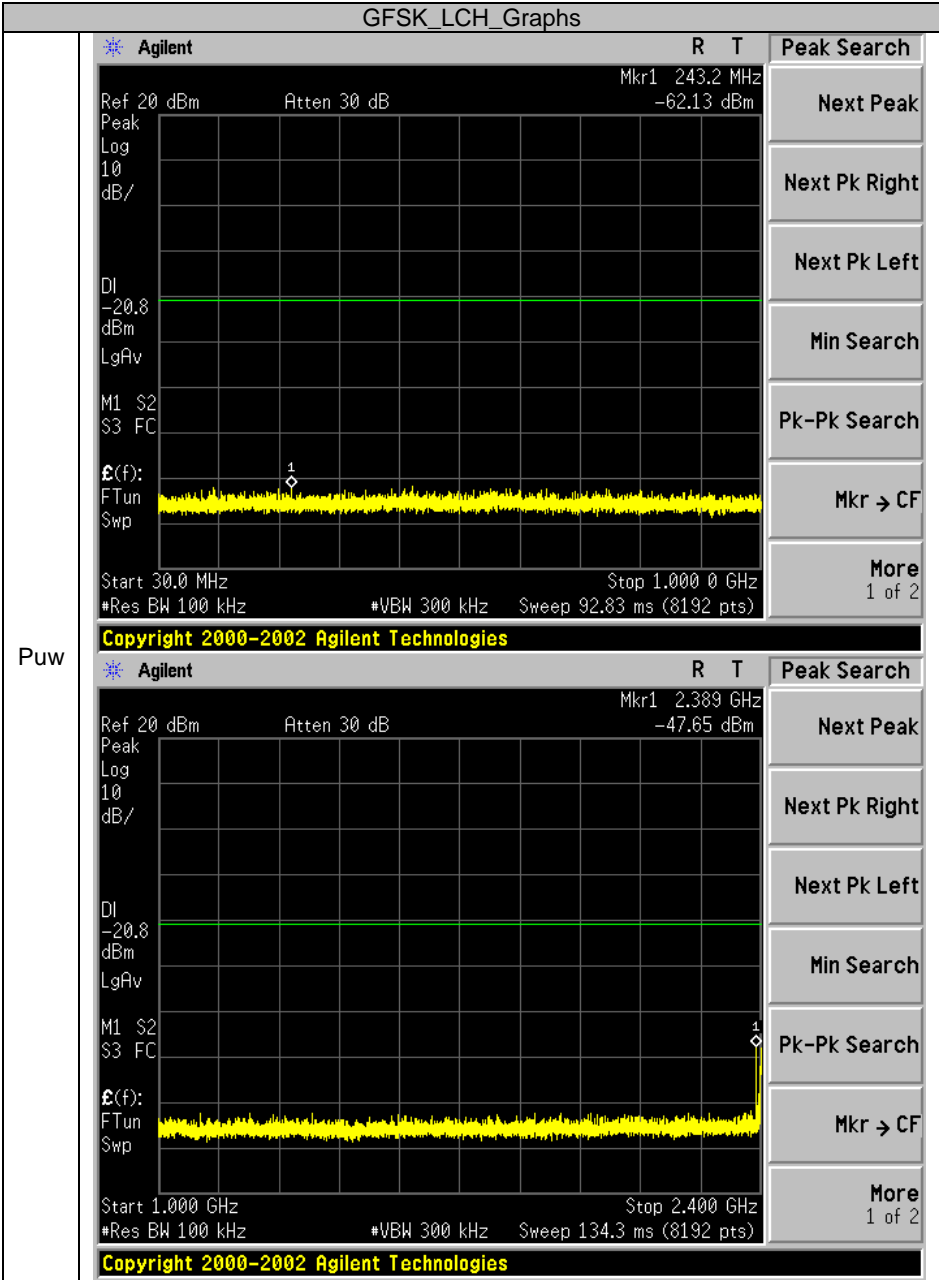

Puw

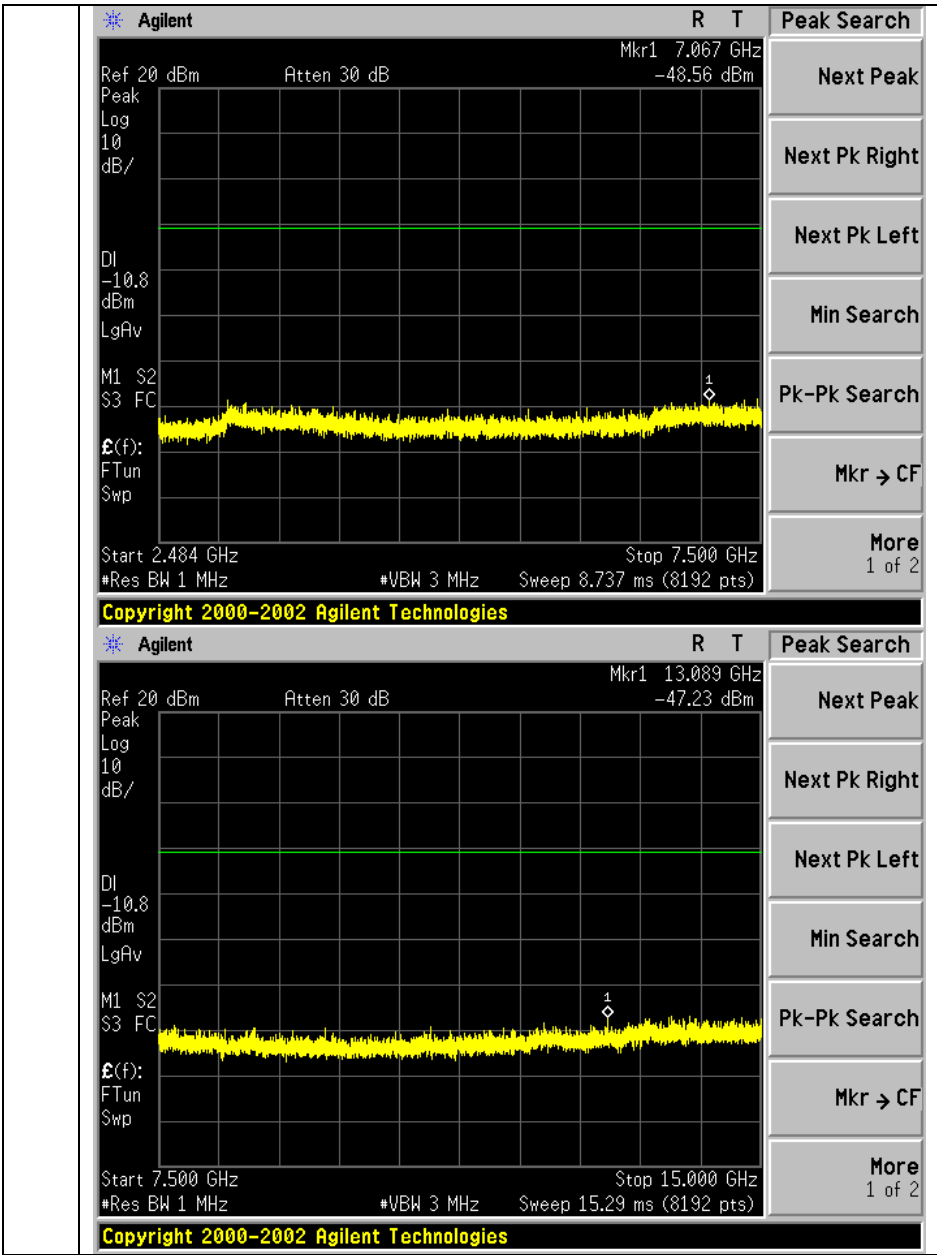

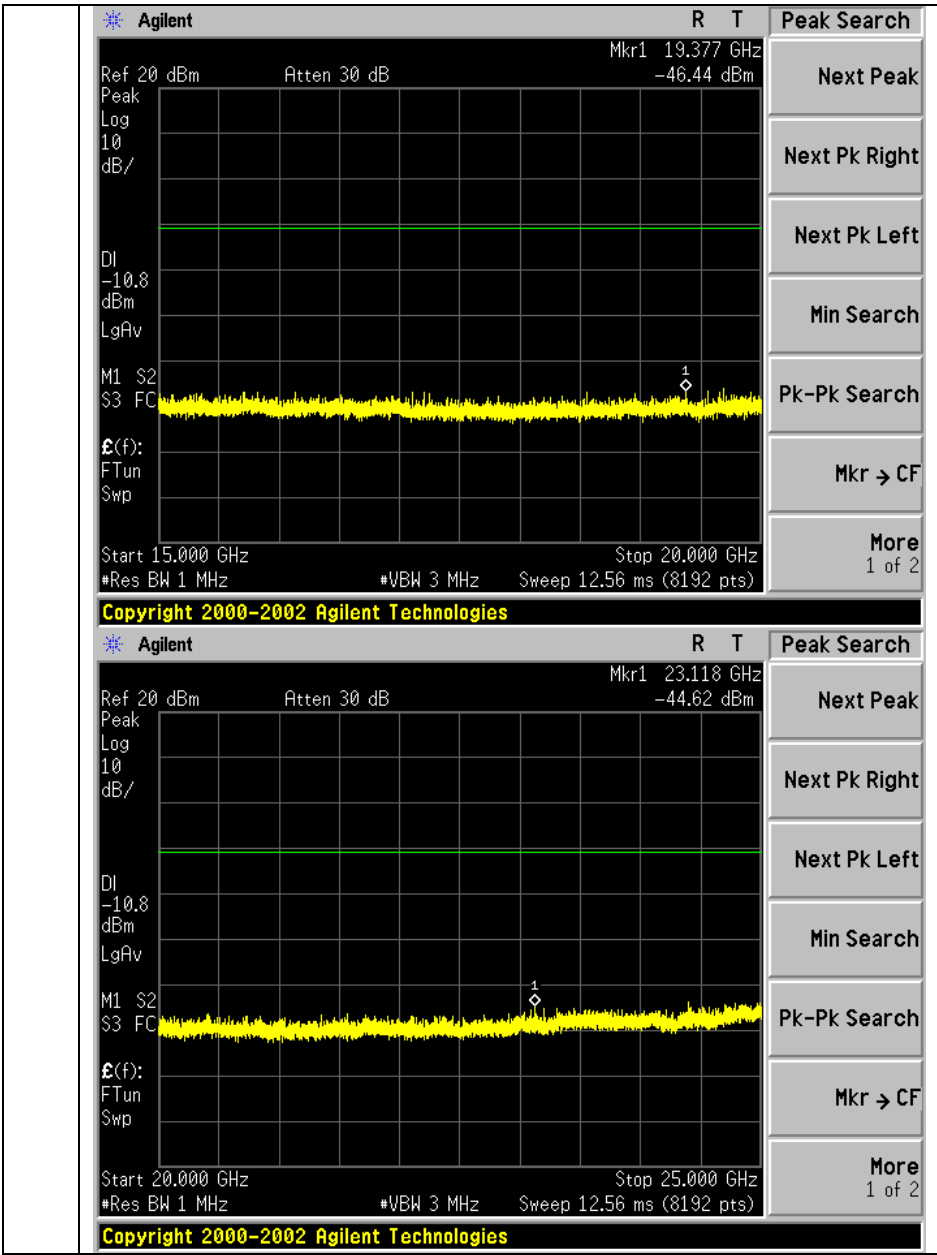

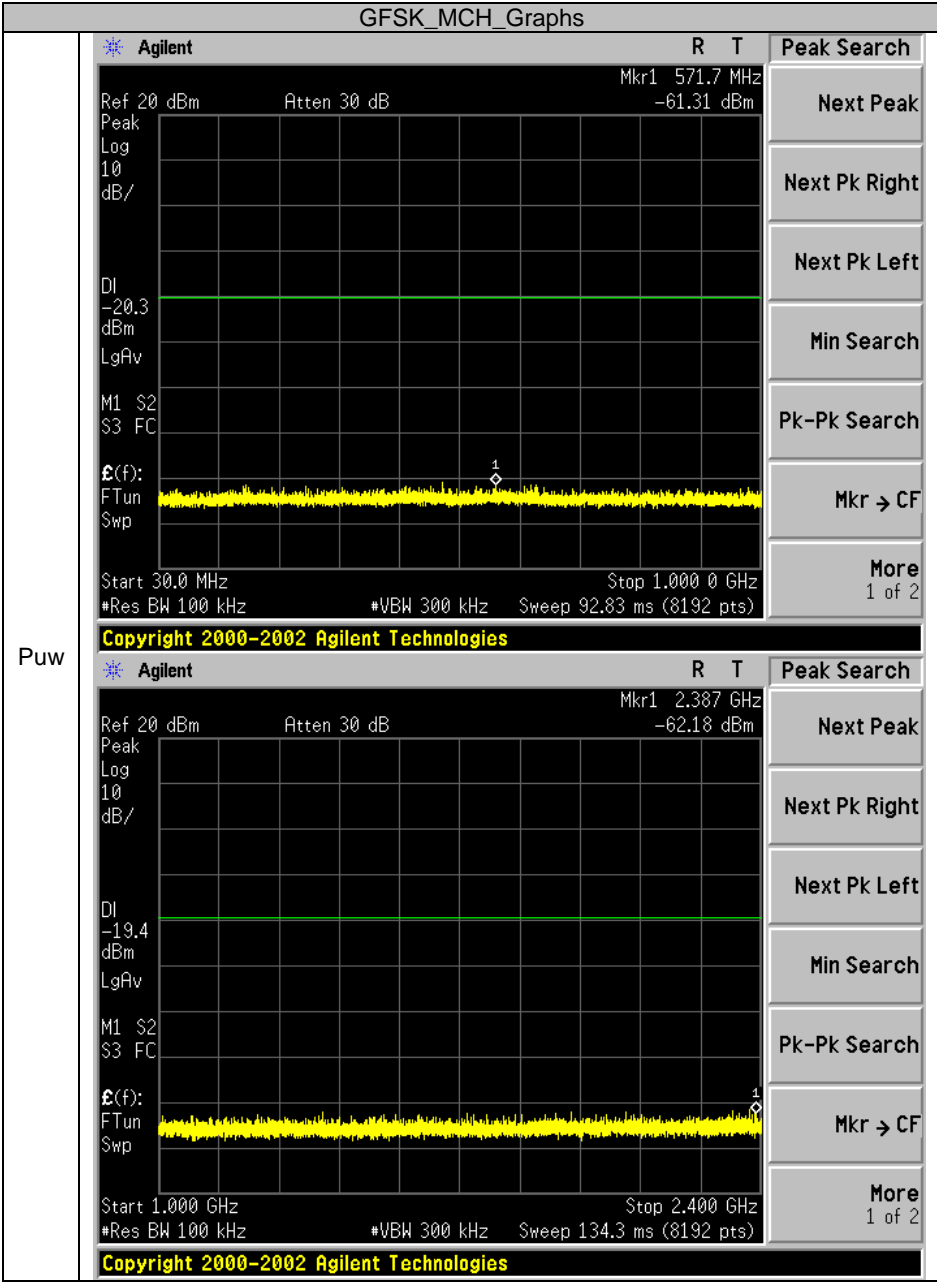

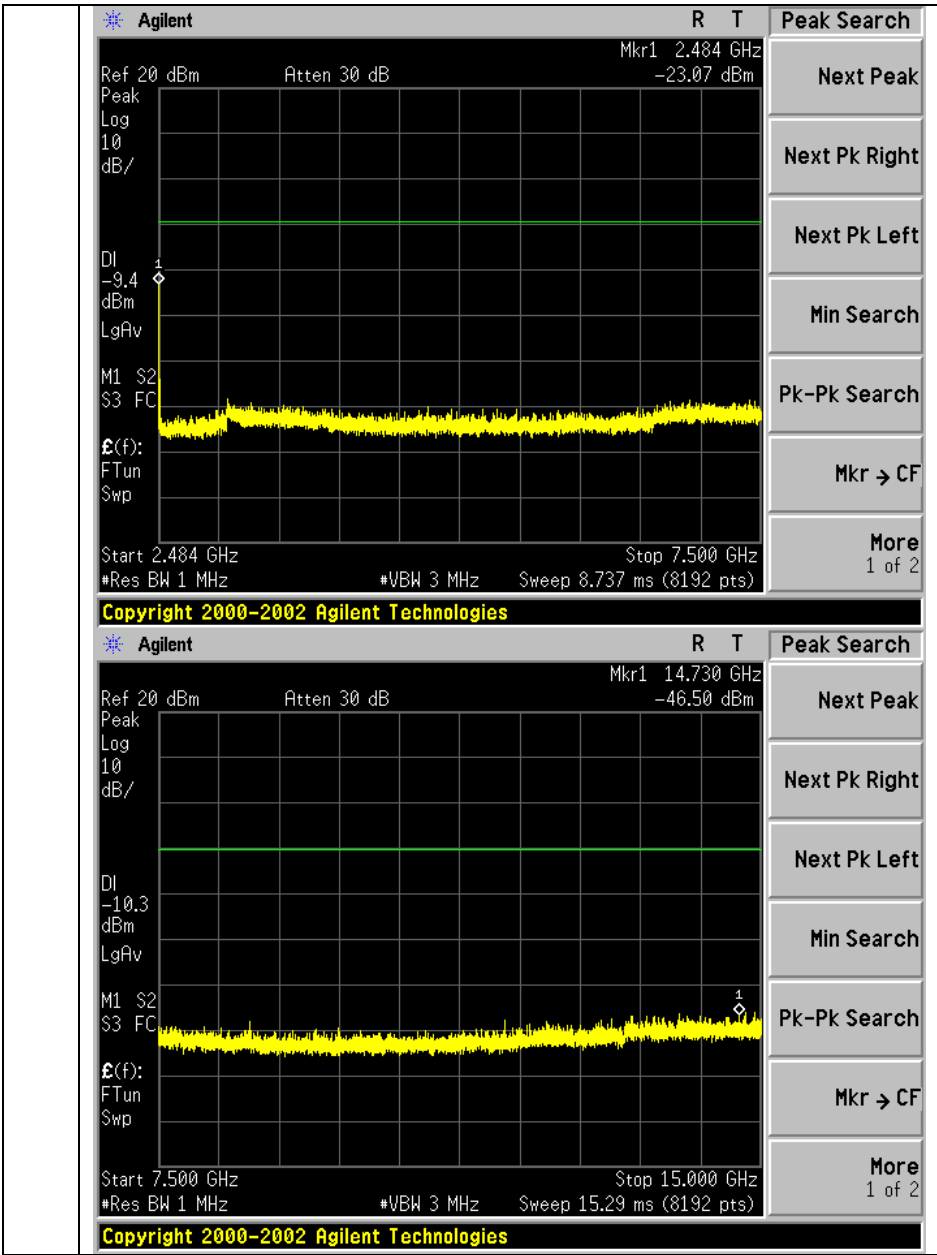

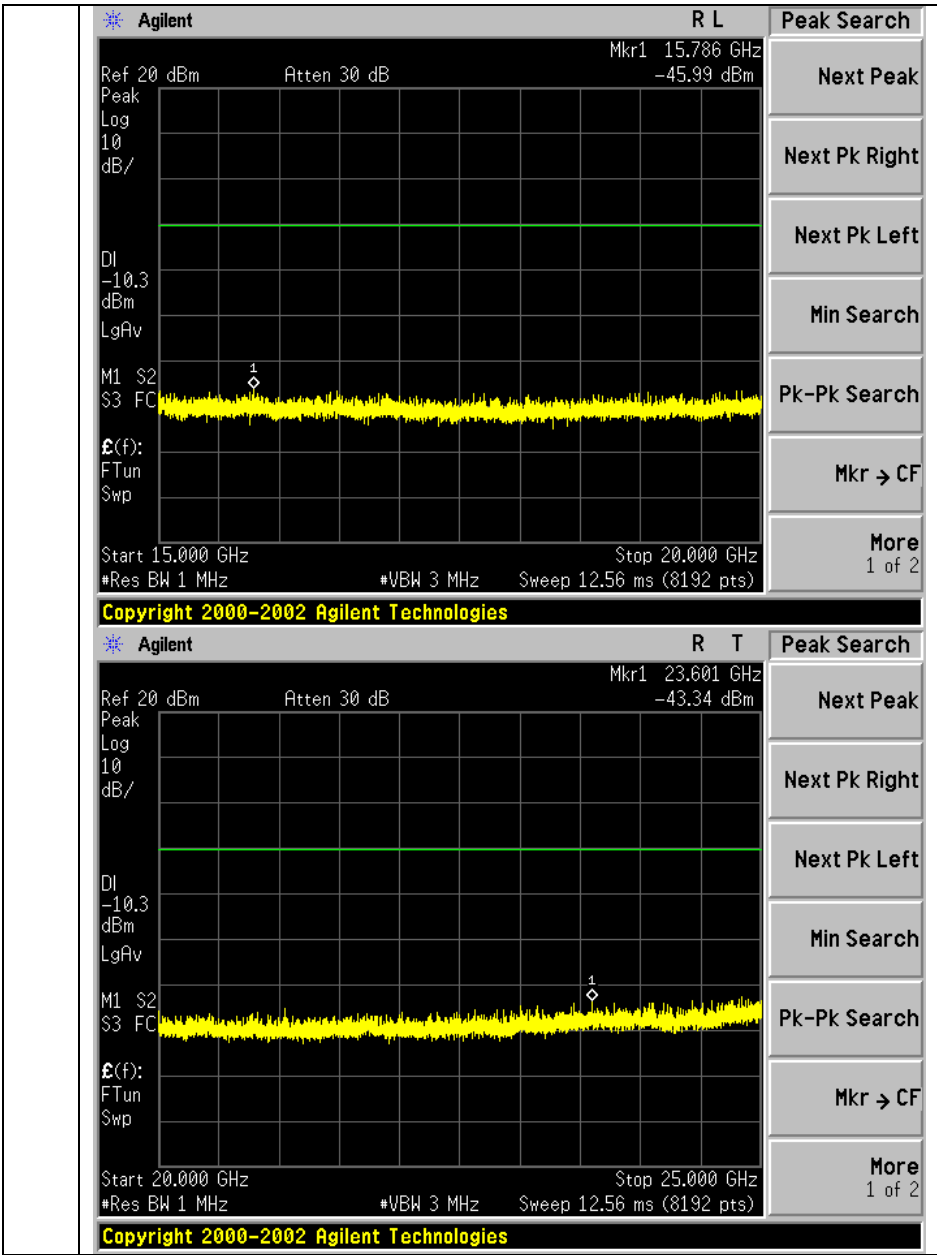

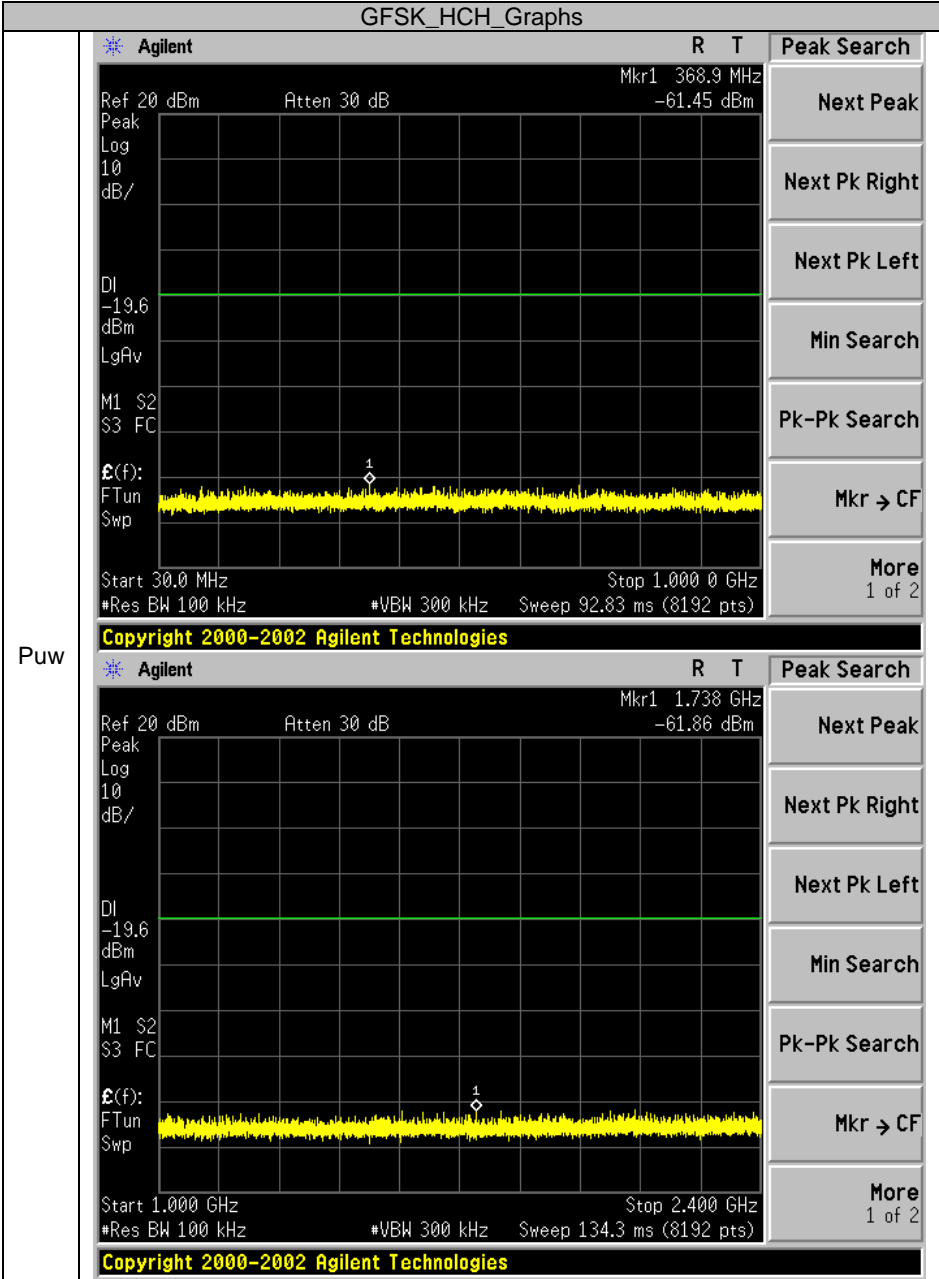

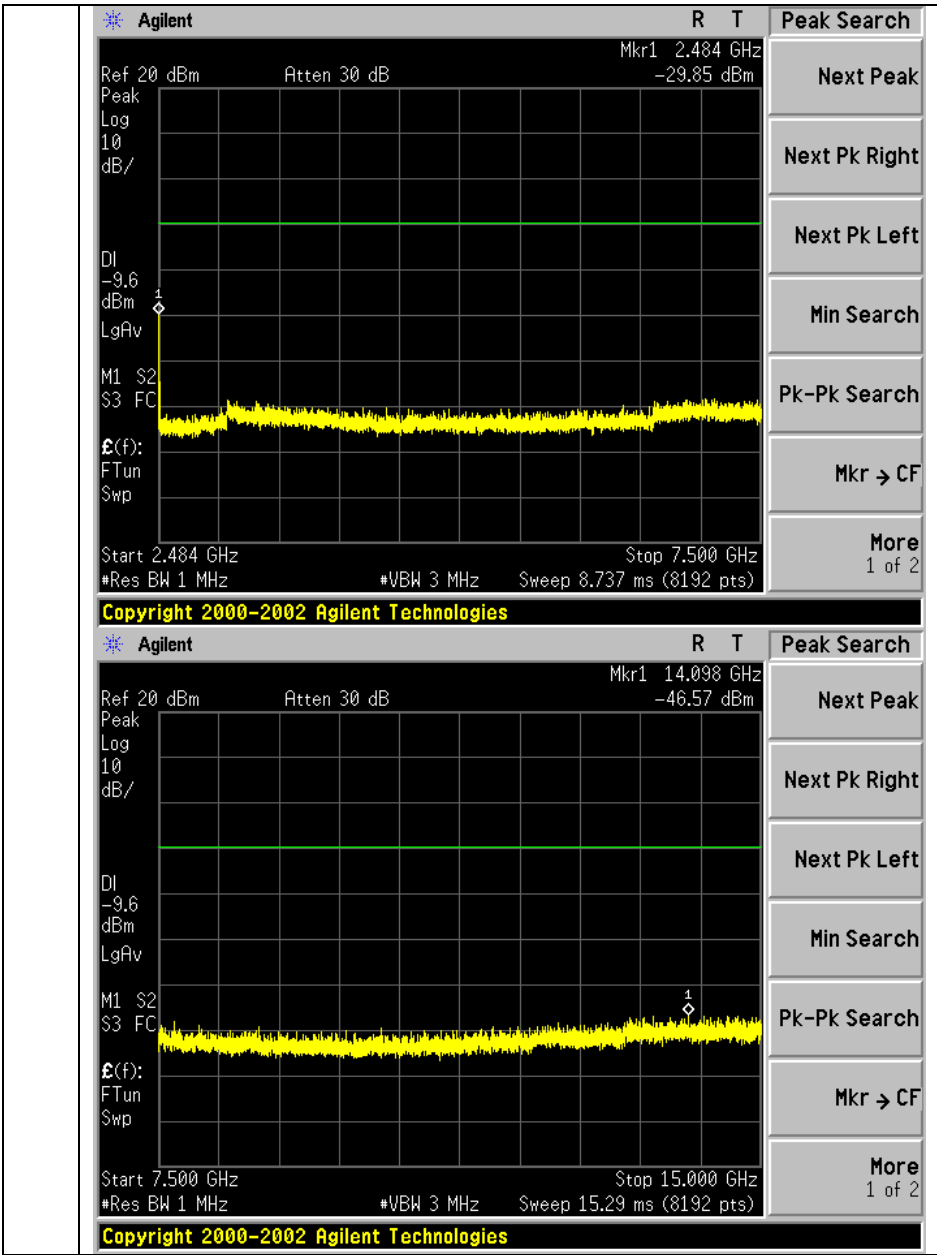

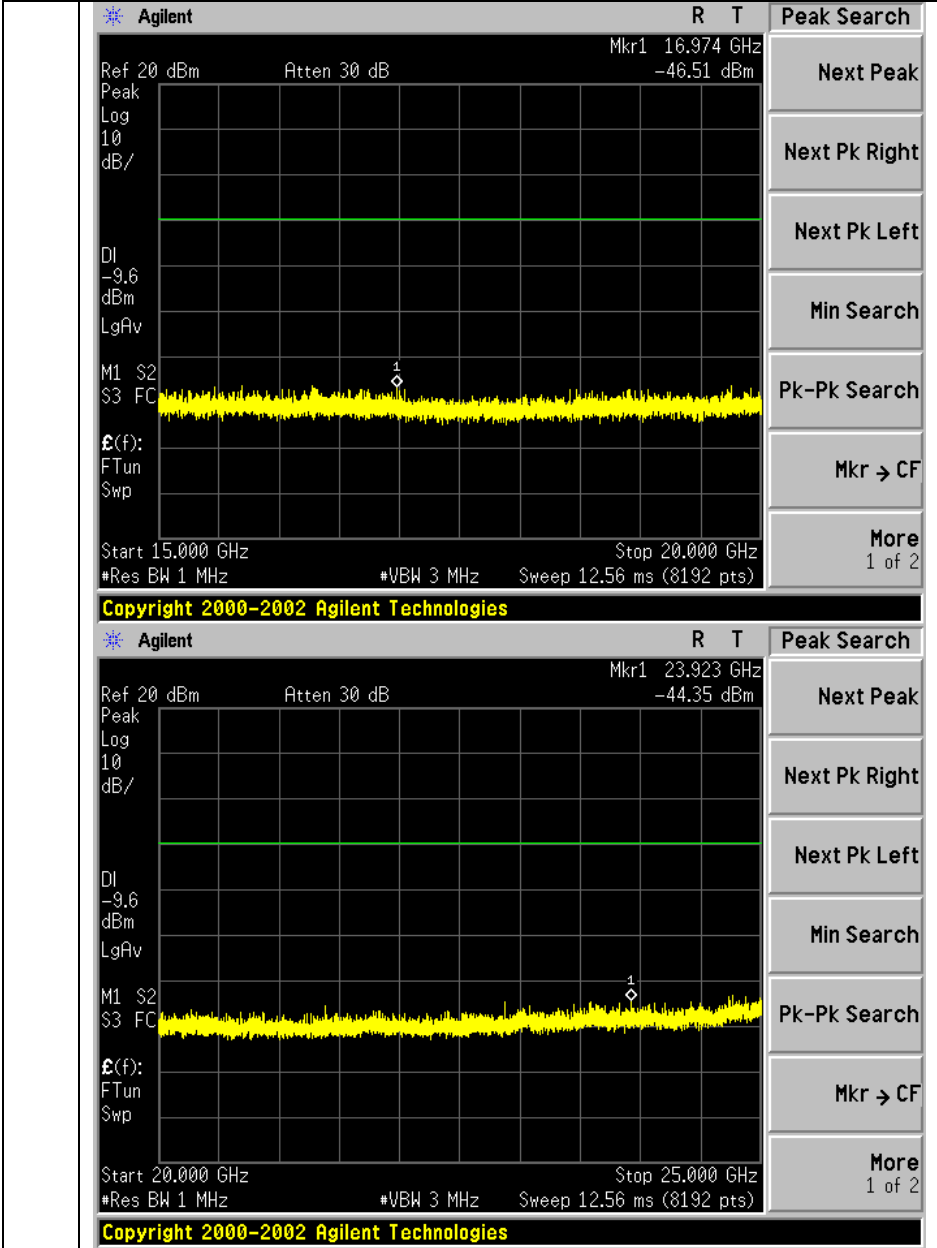

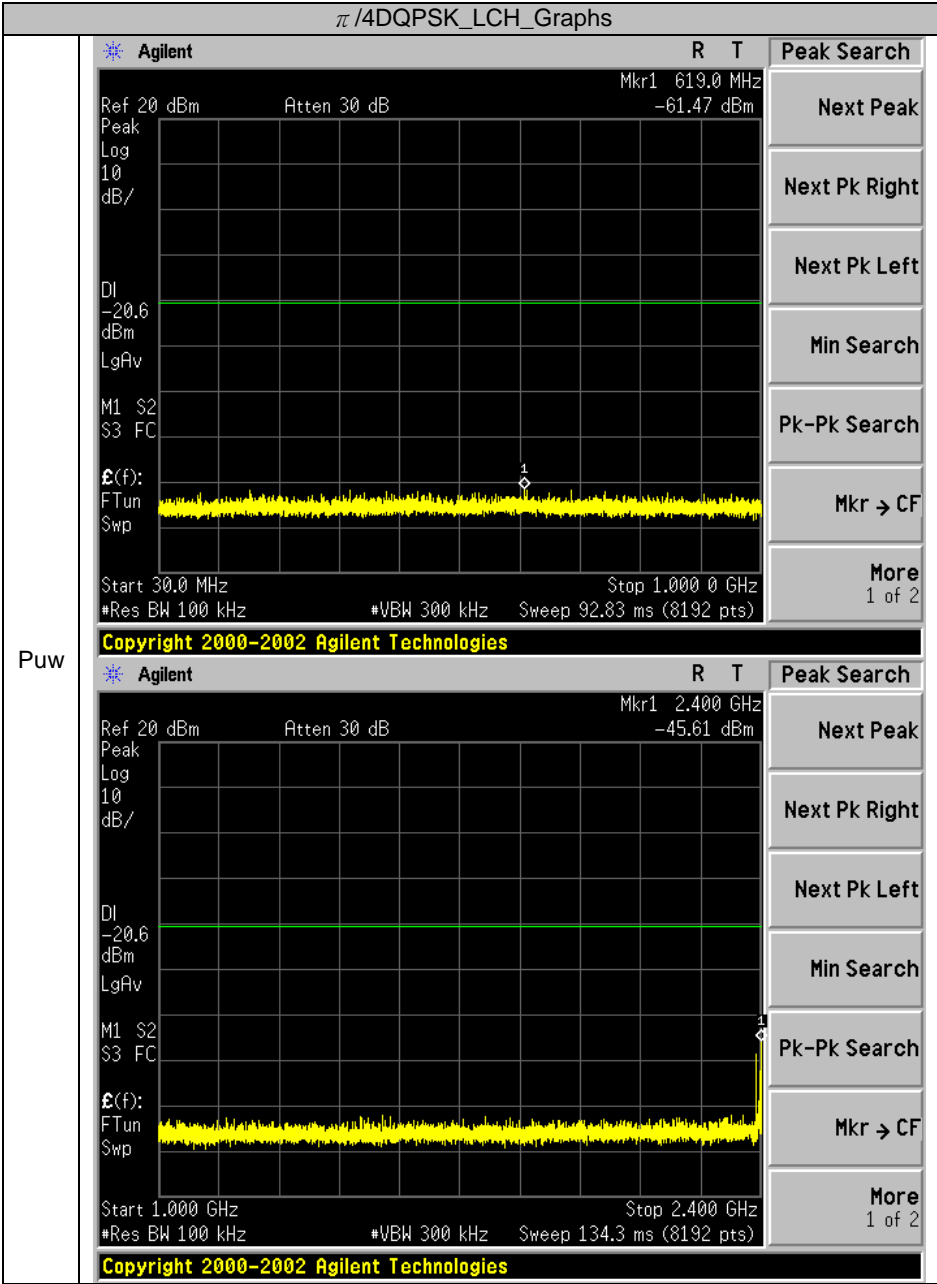

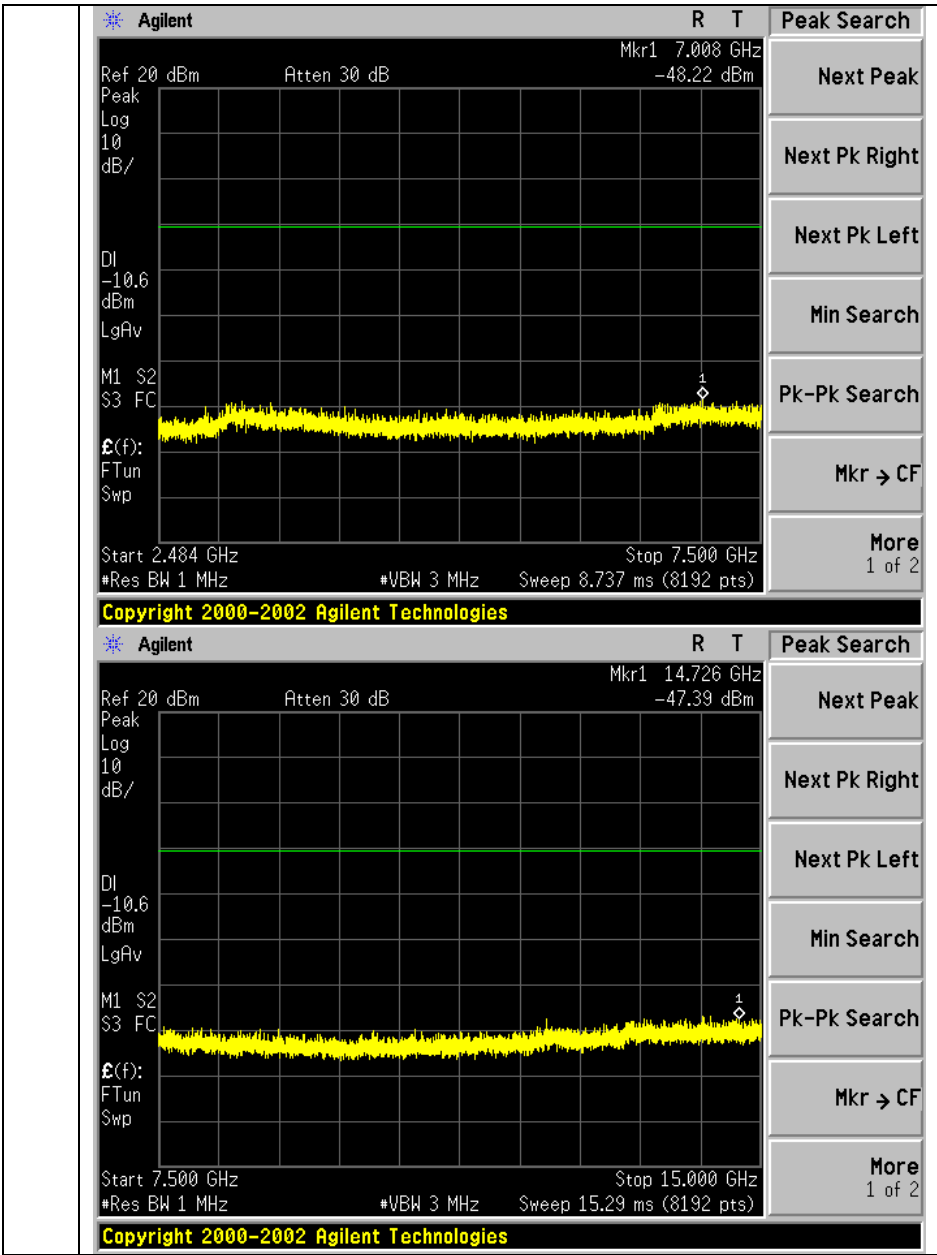

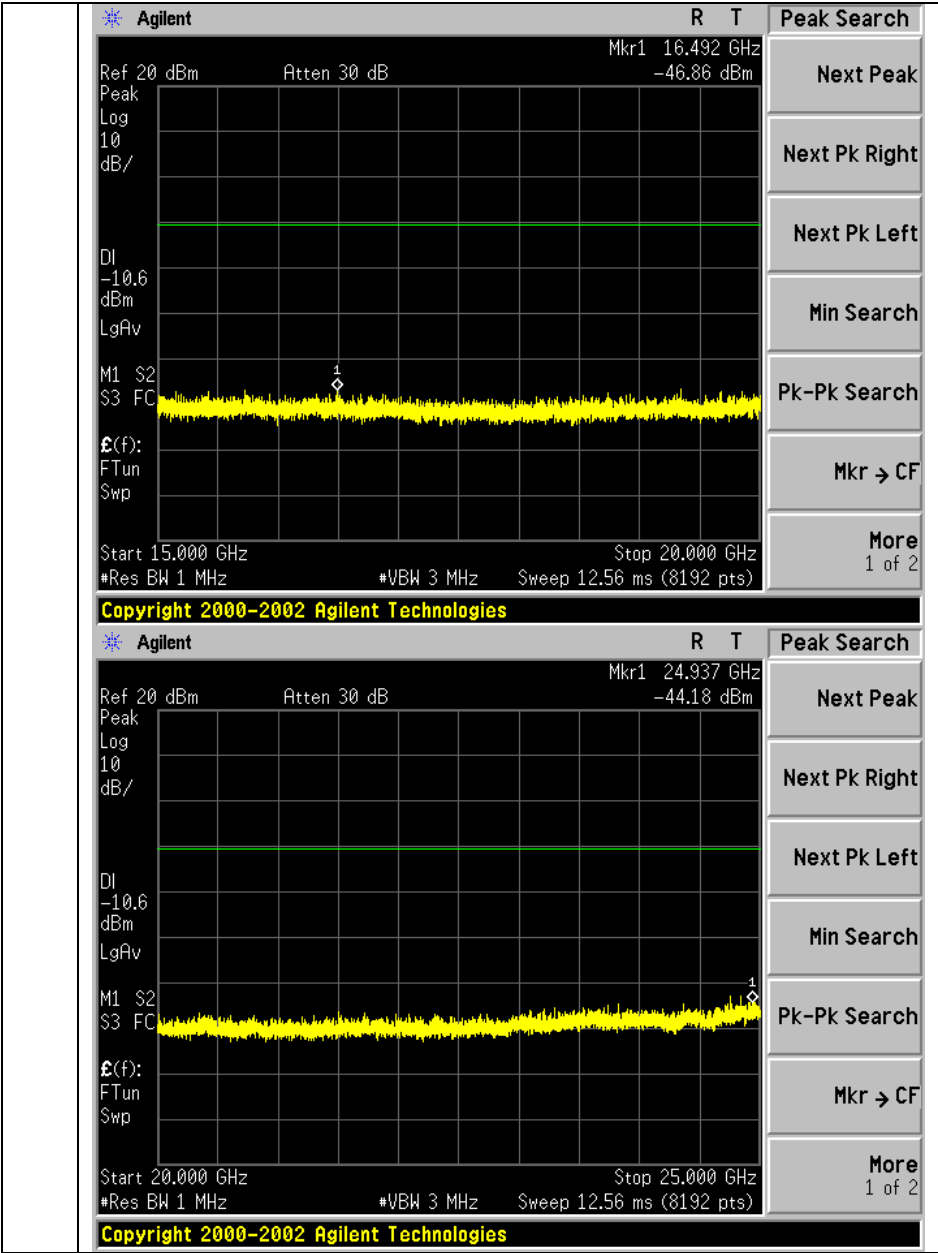

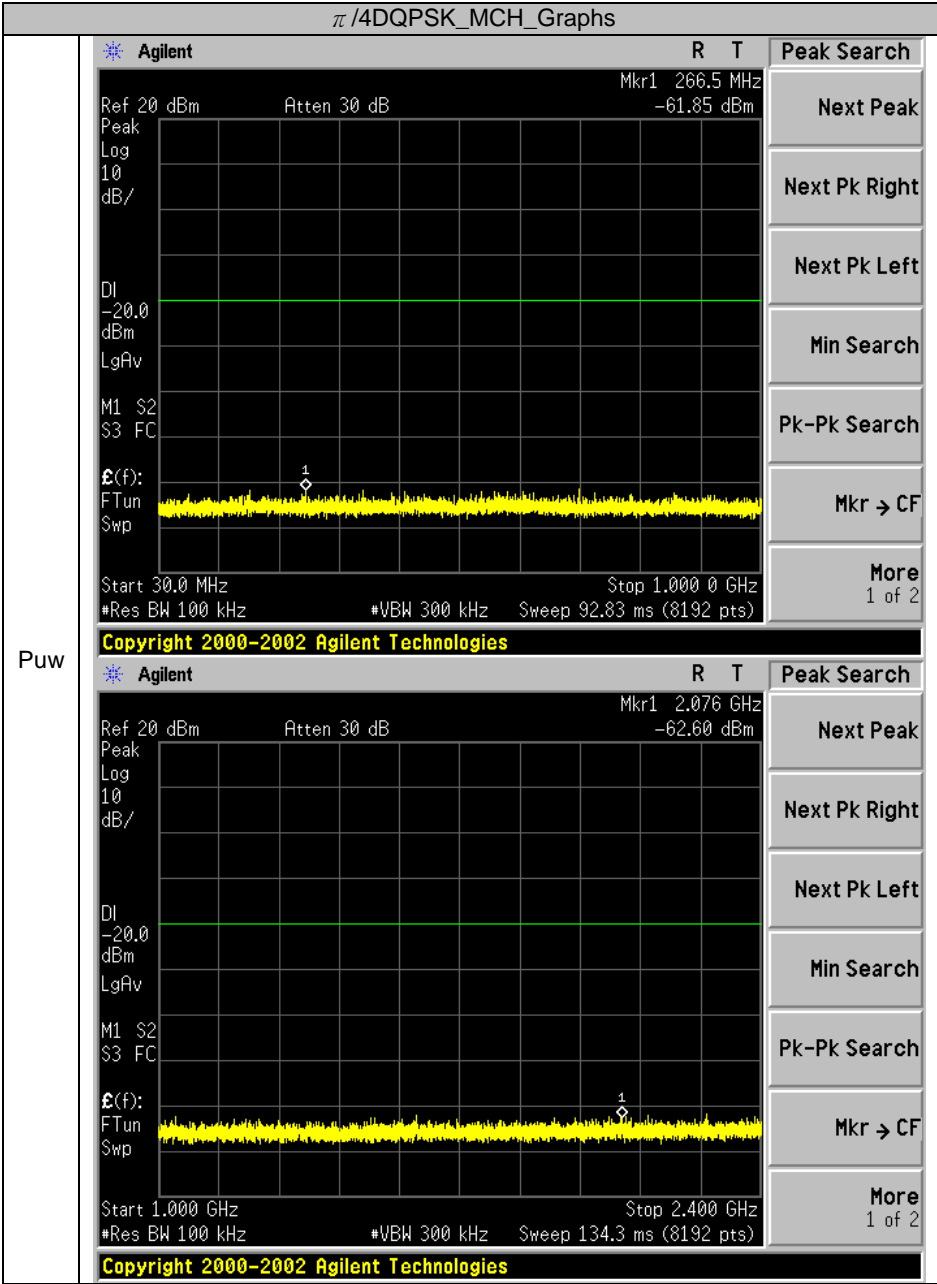

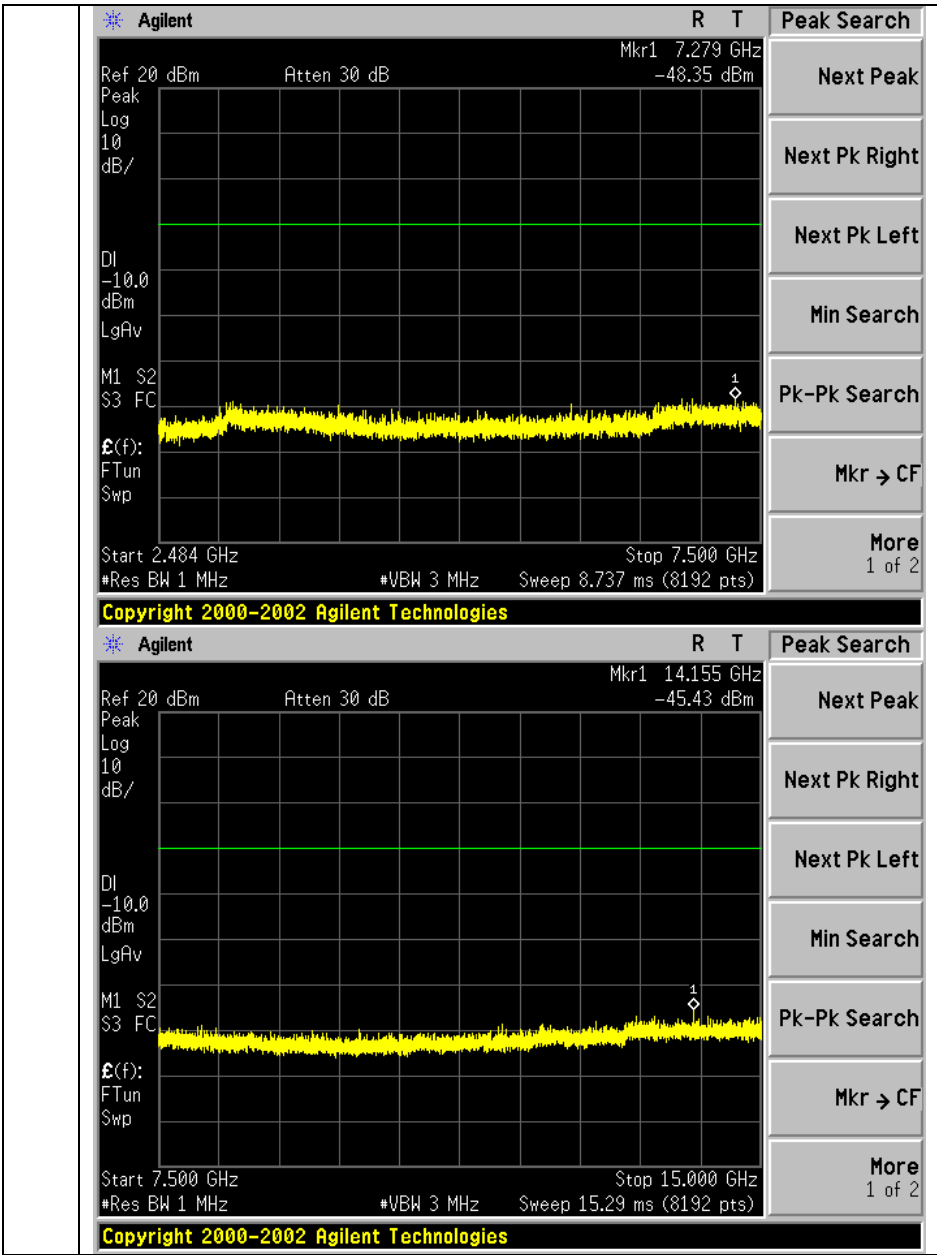

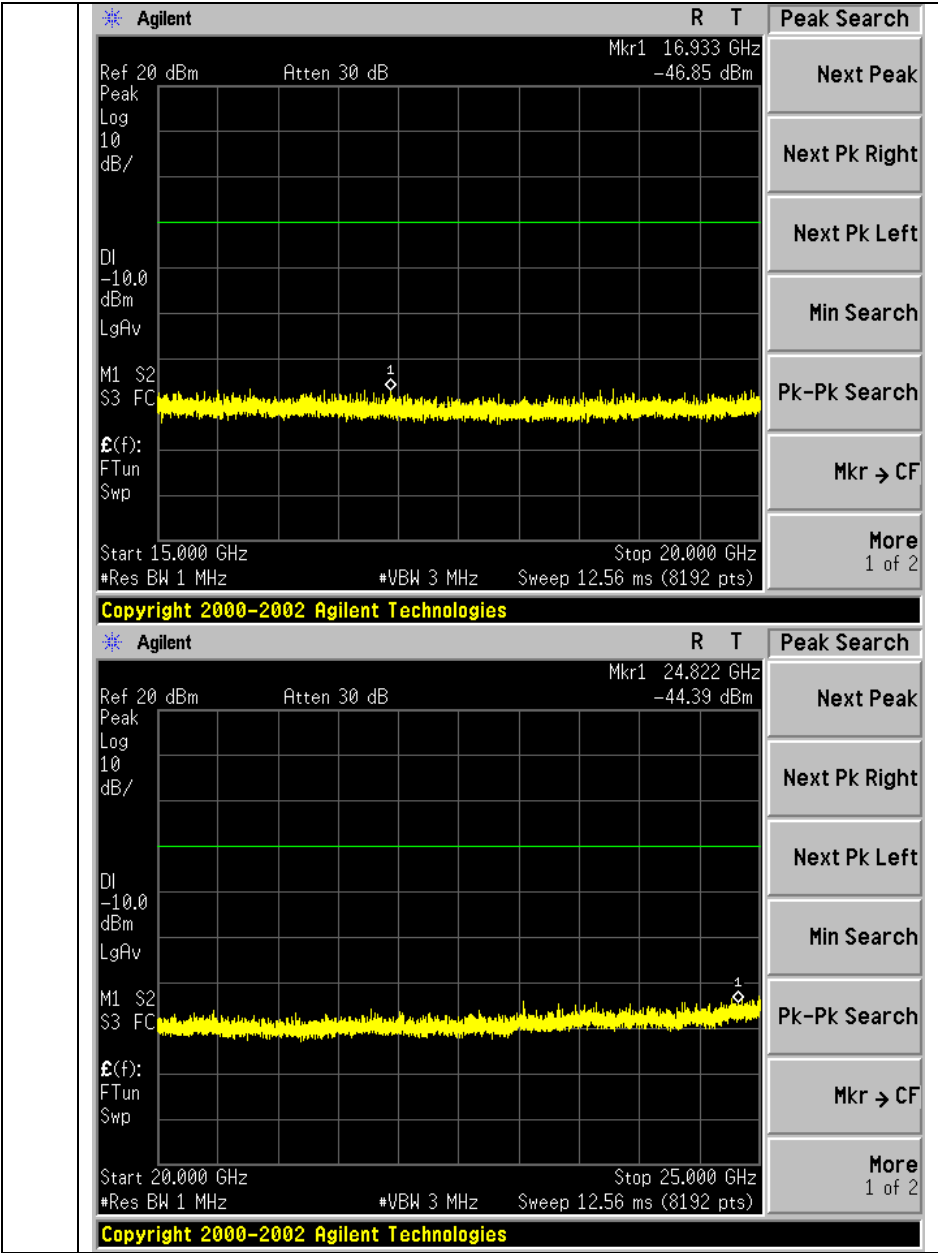

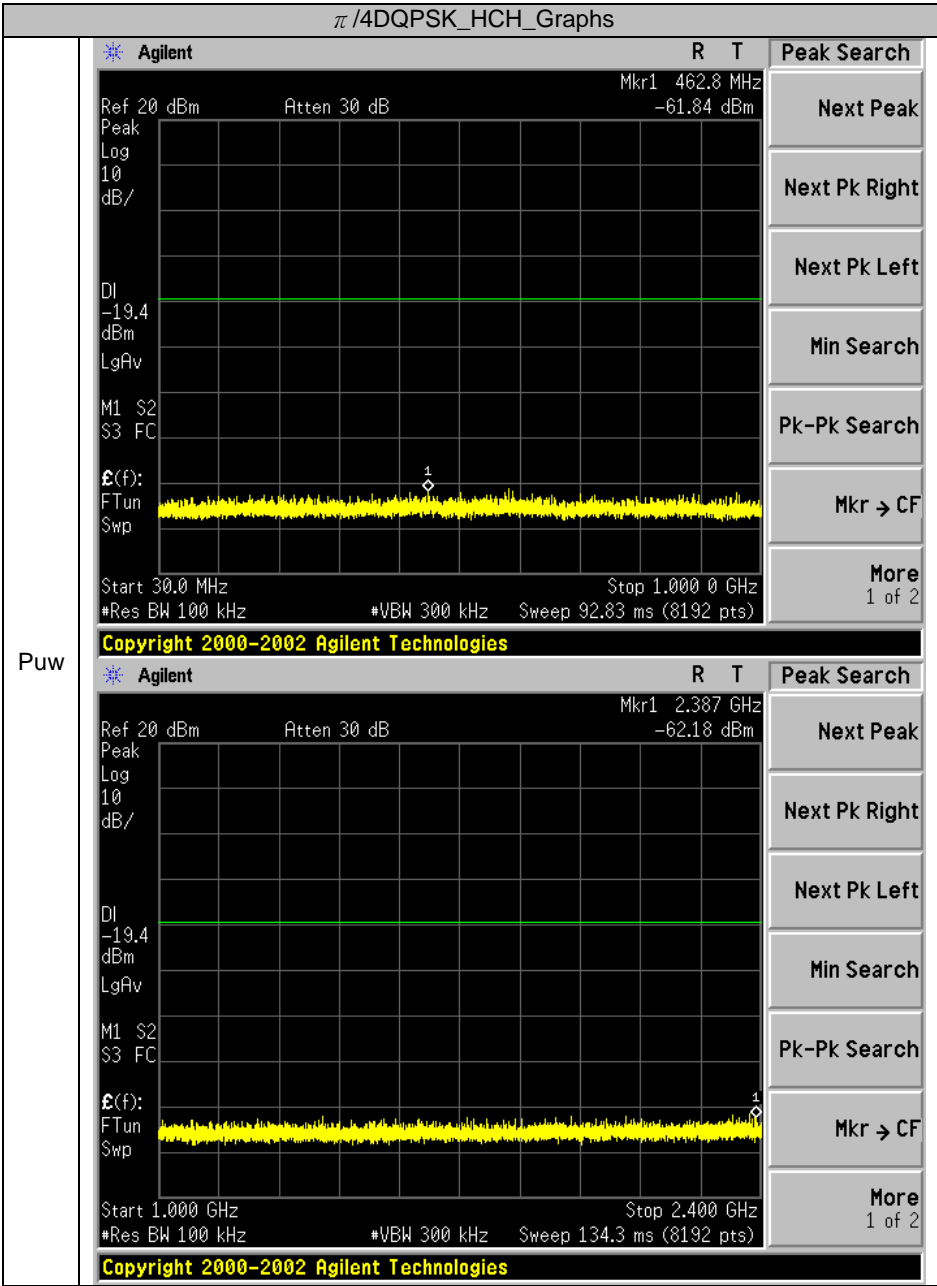

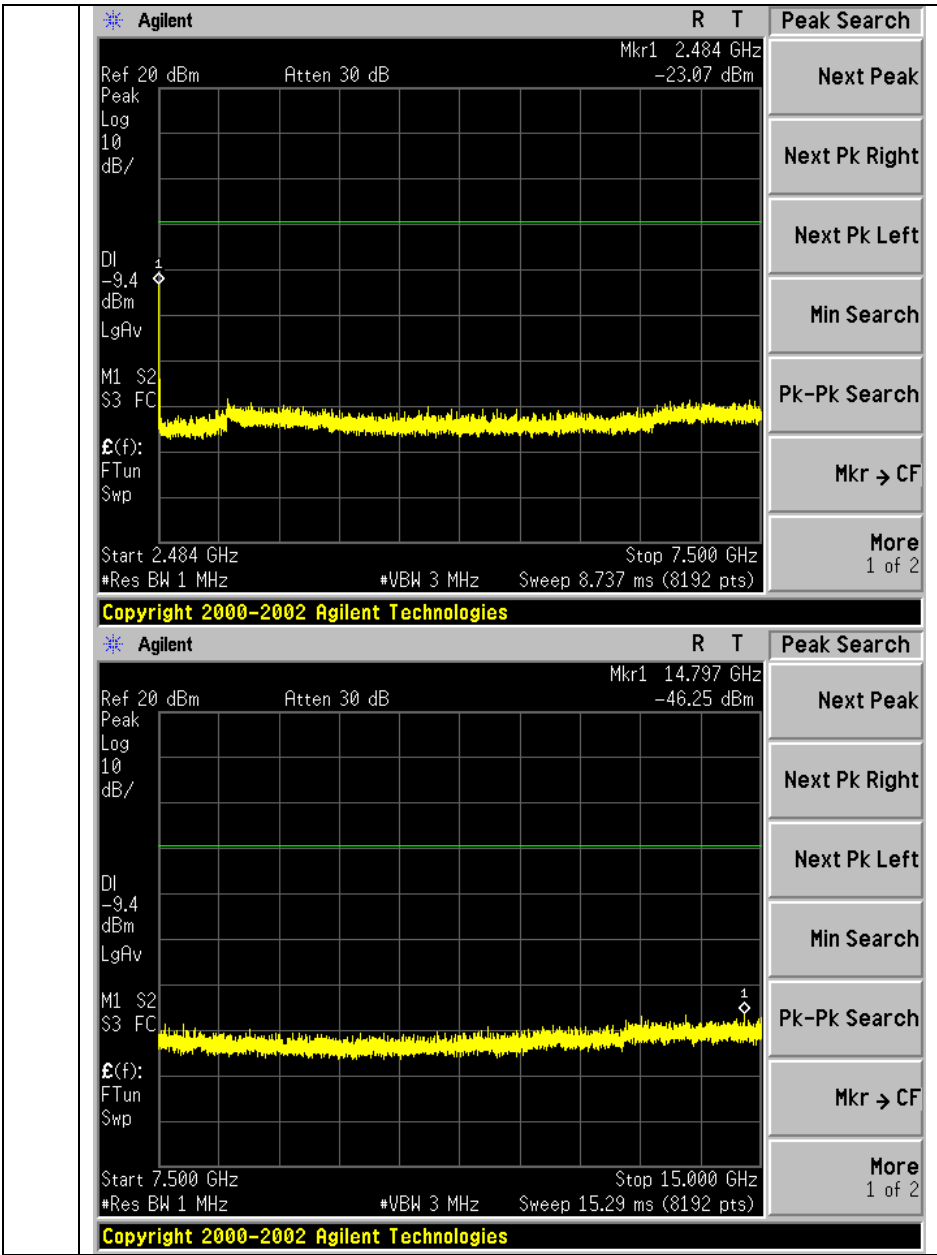

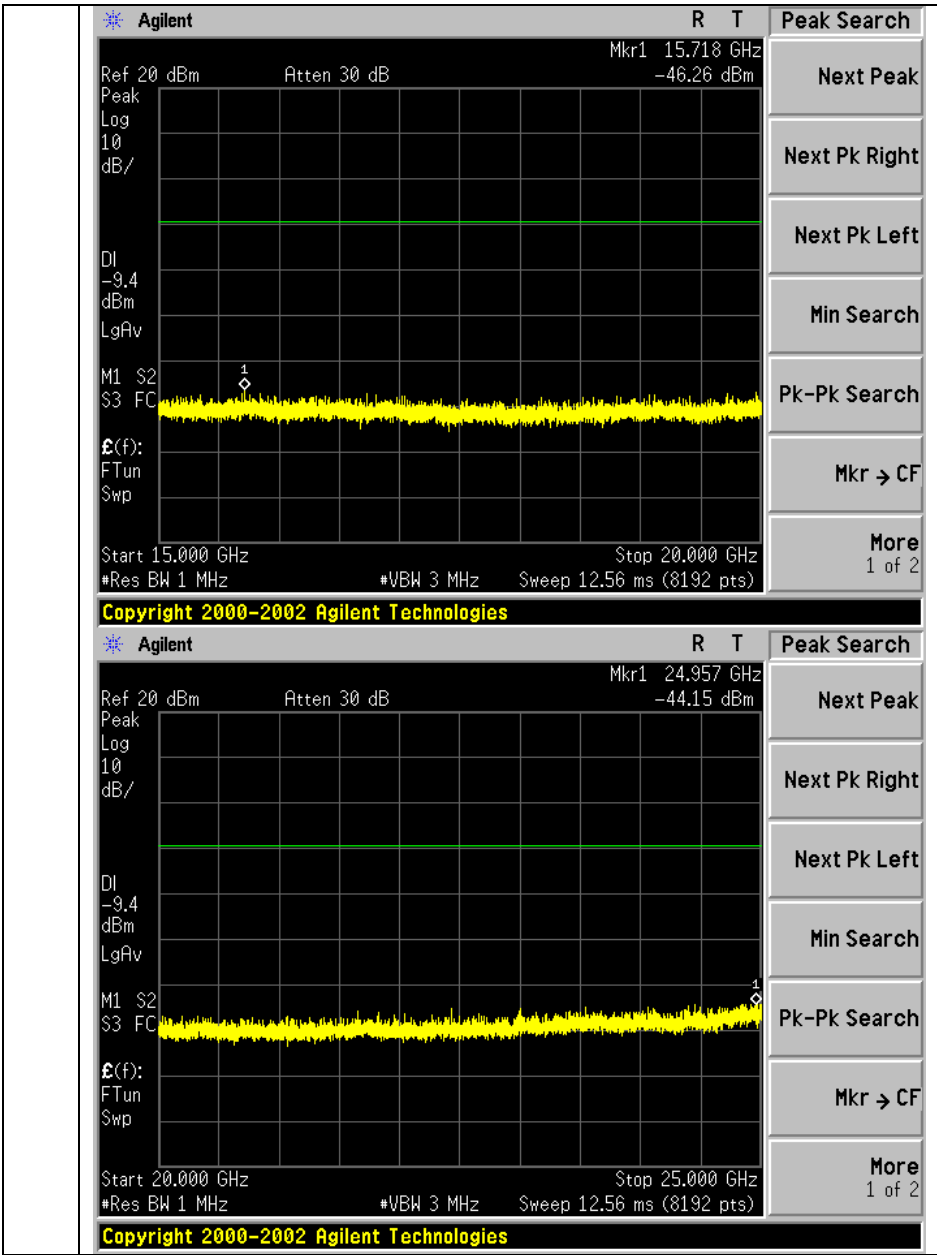

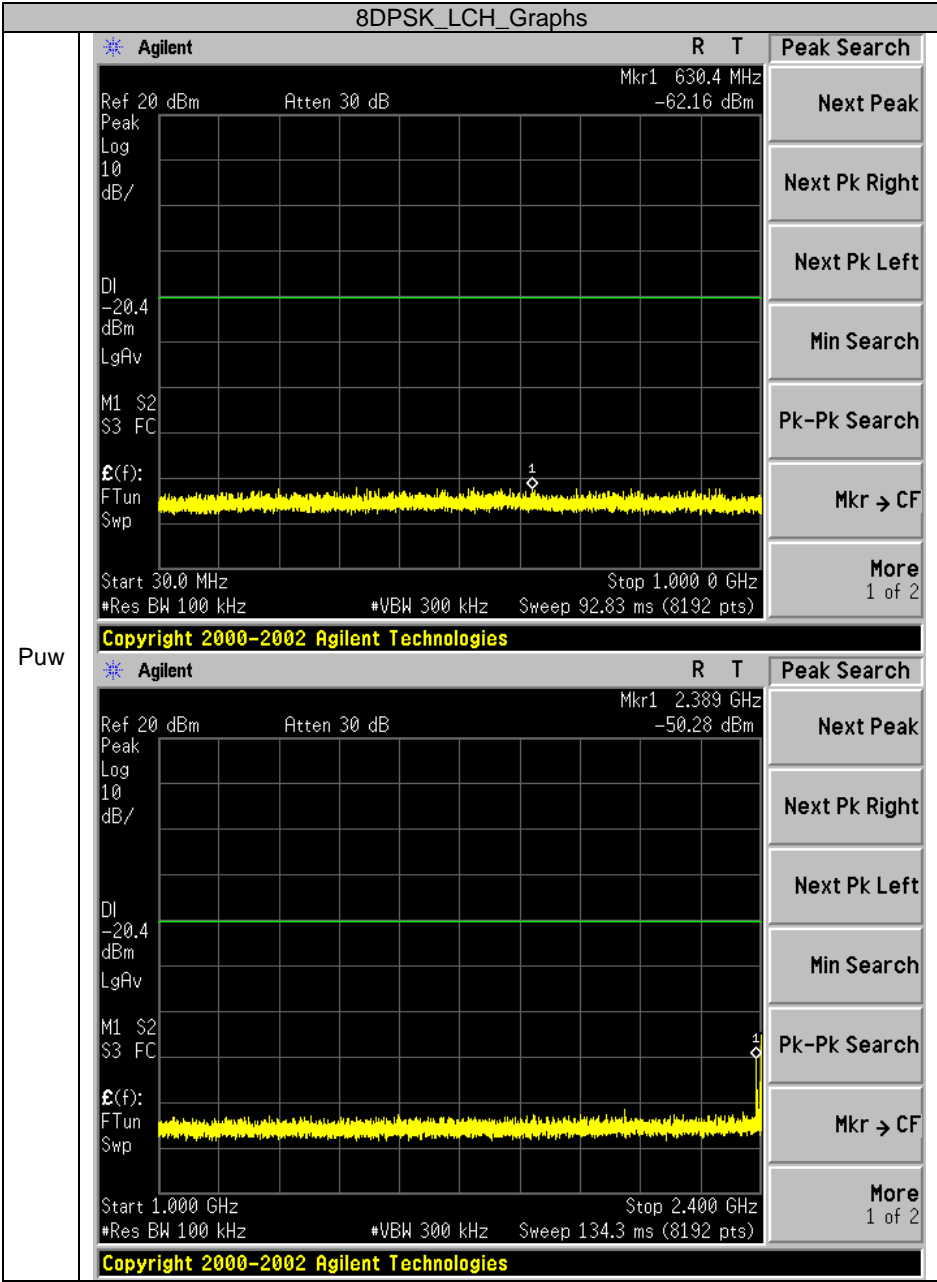

Puw

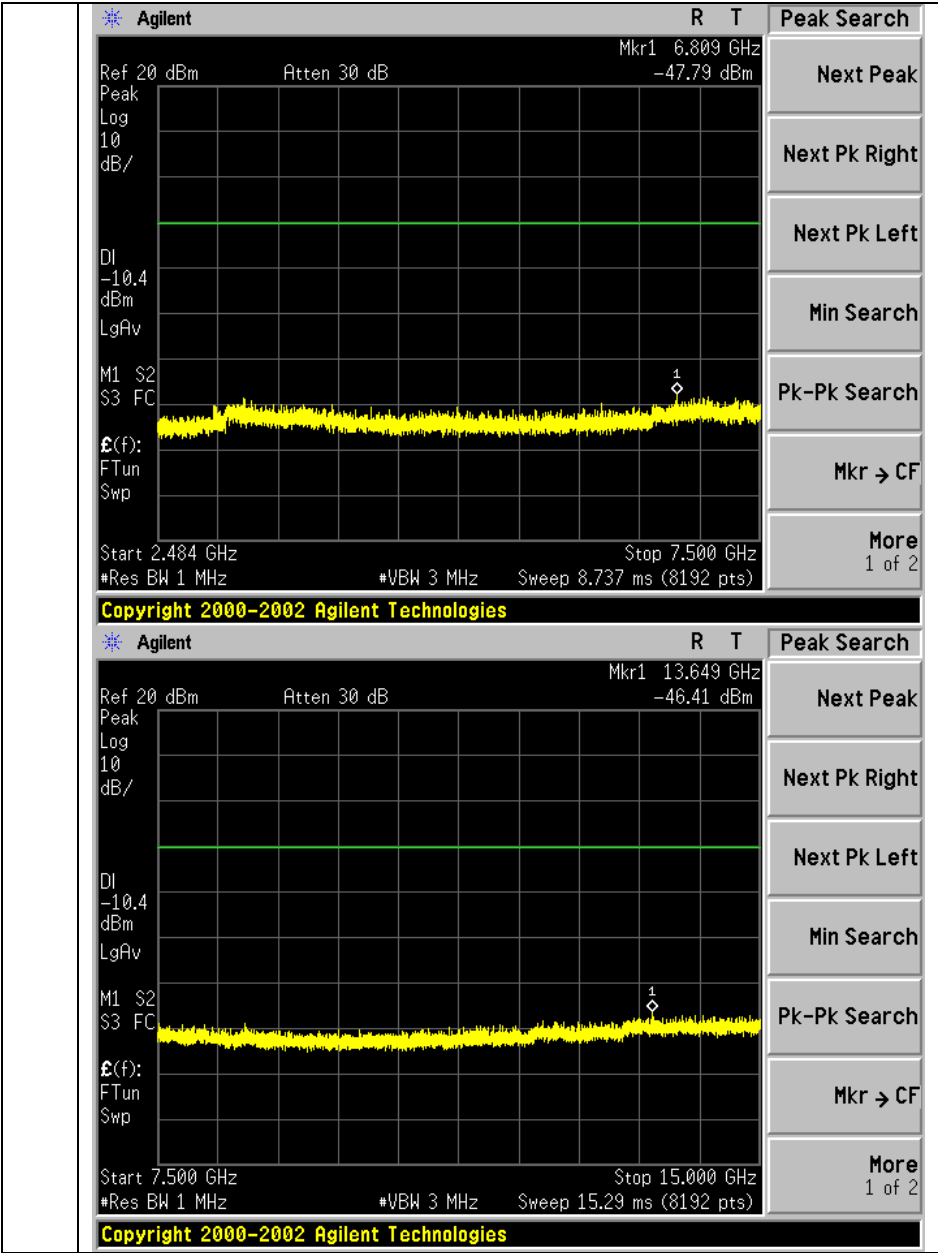

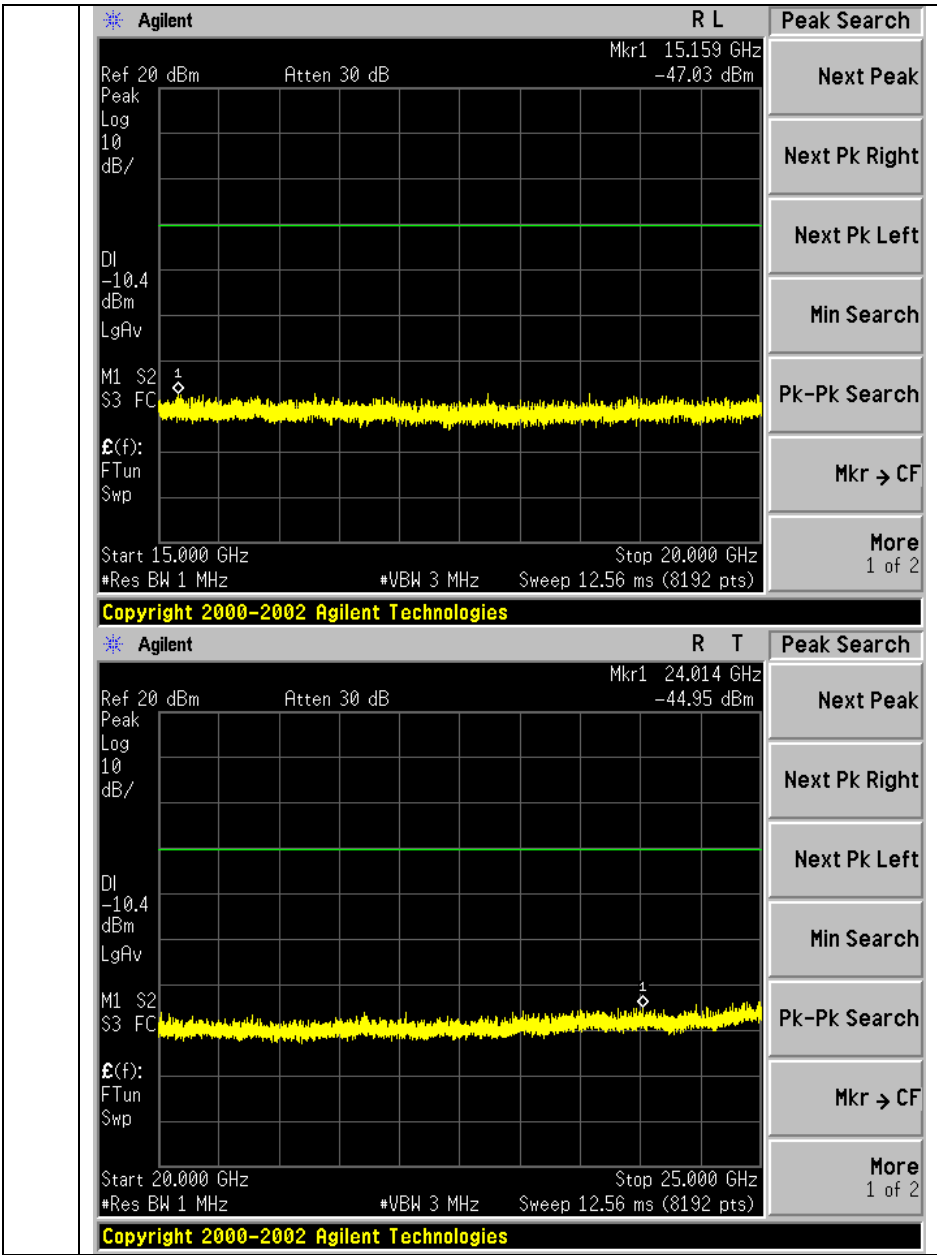

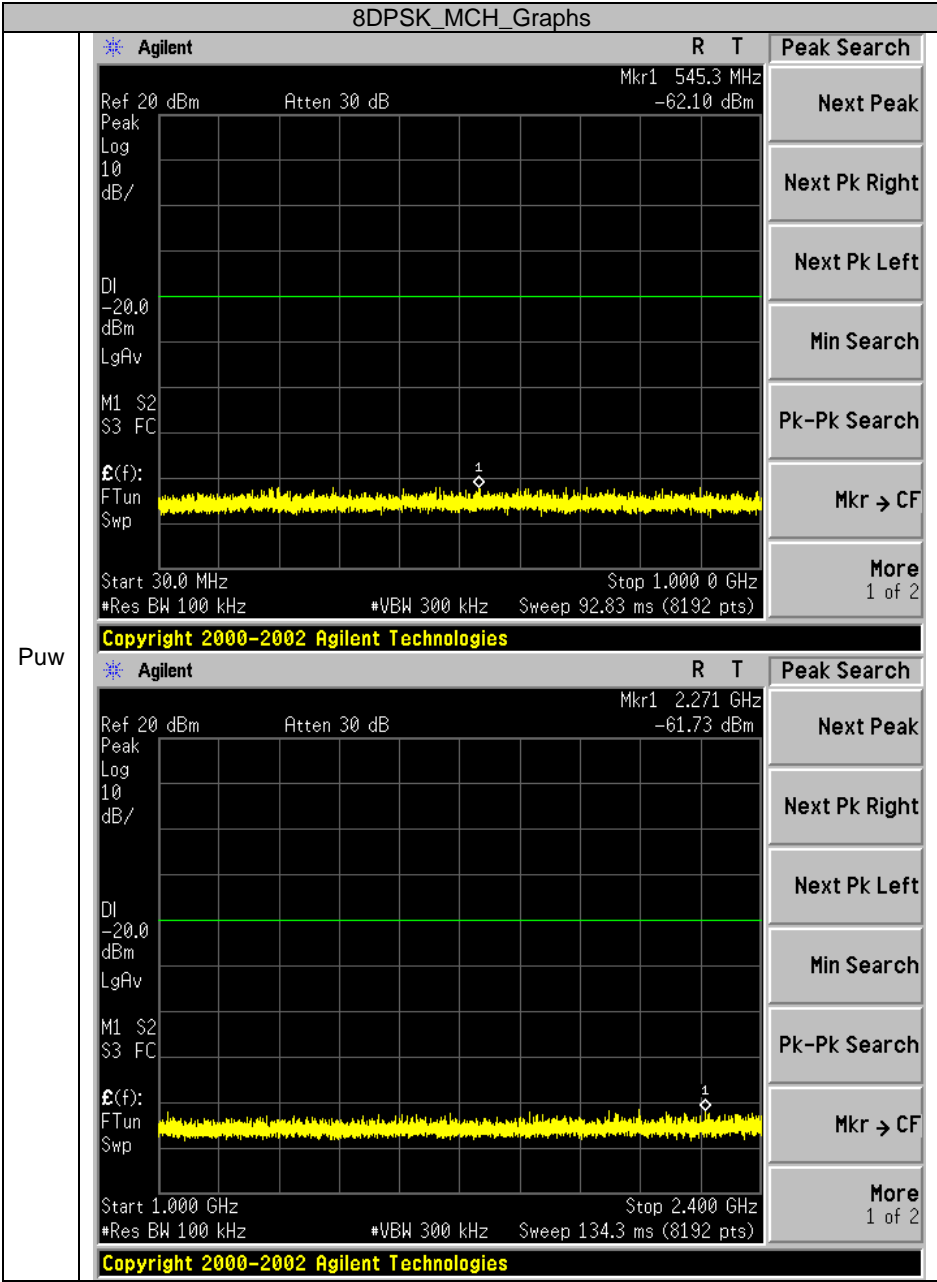

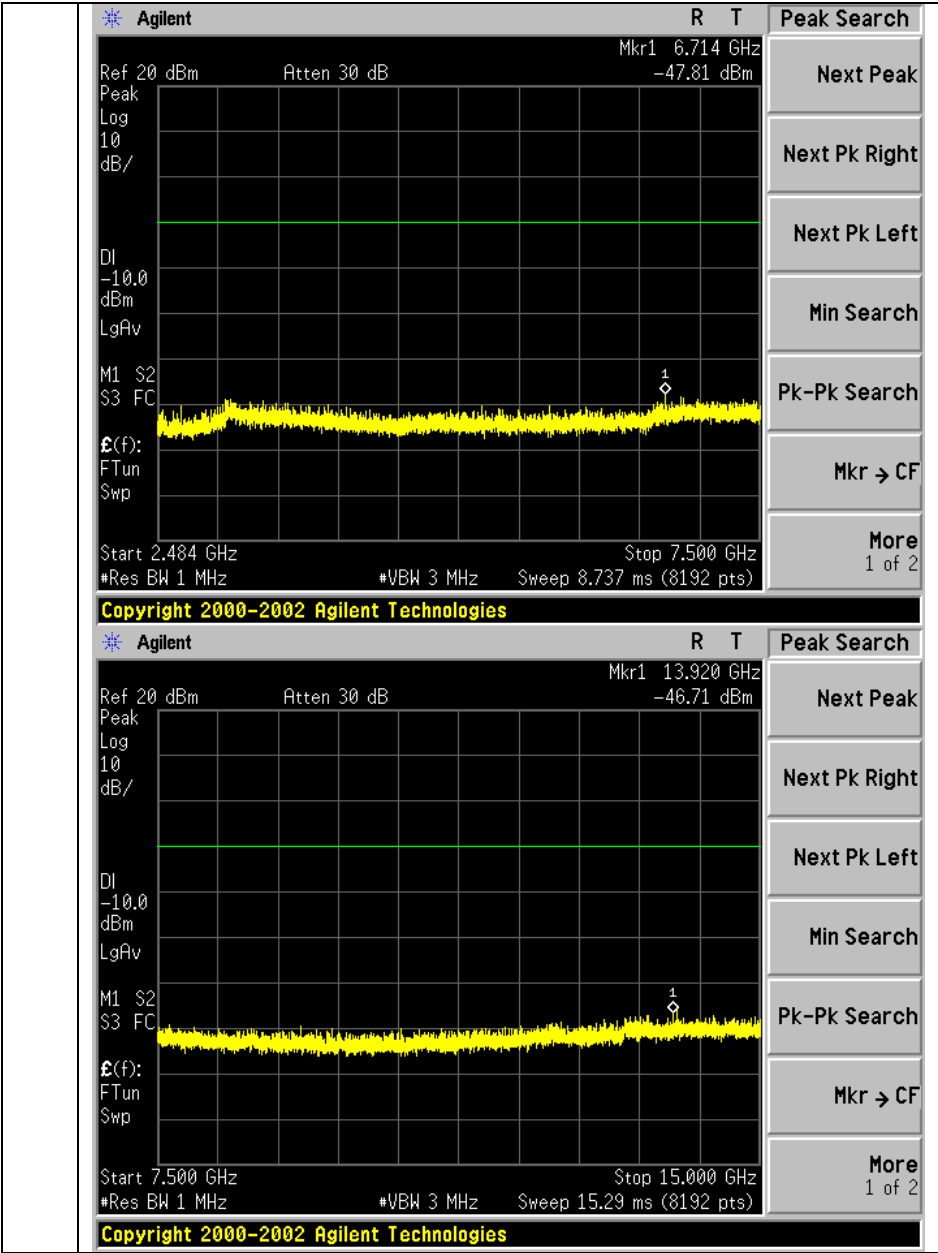

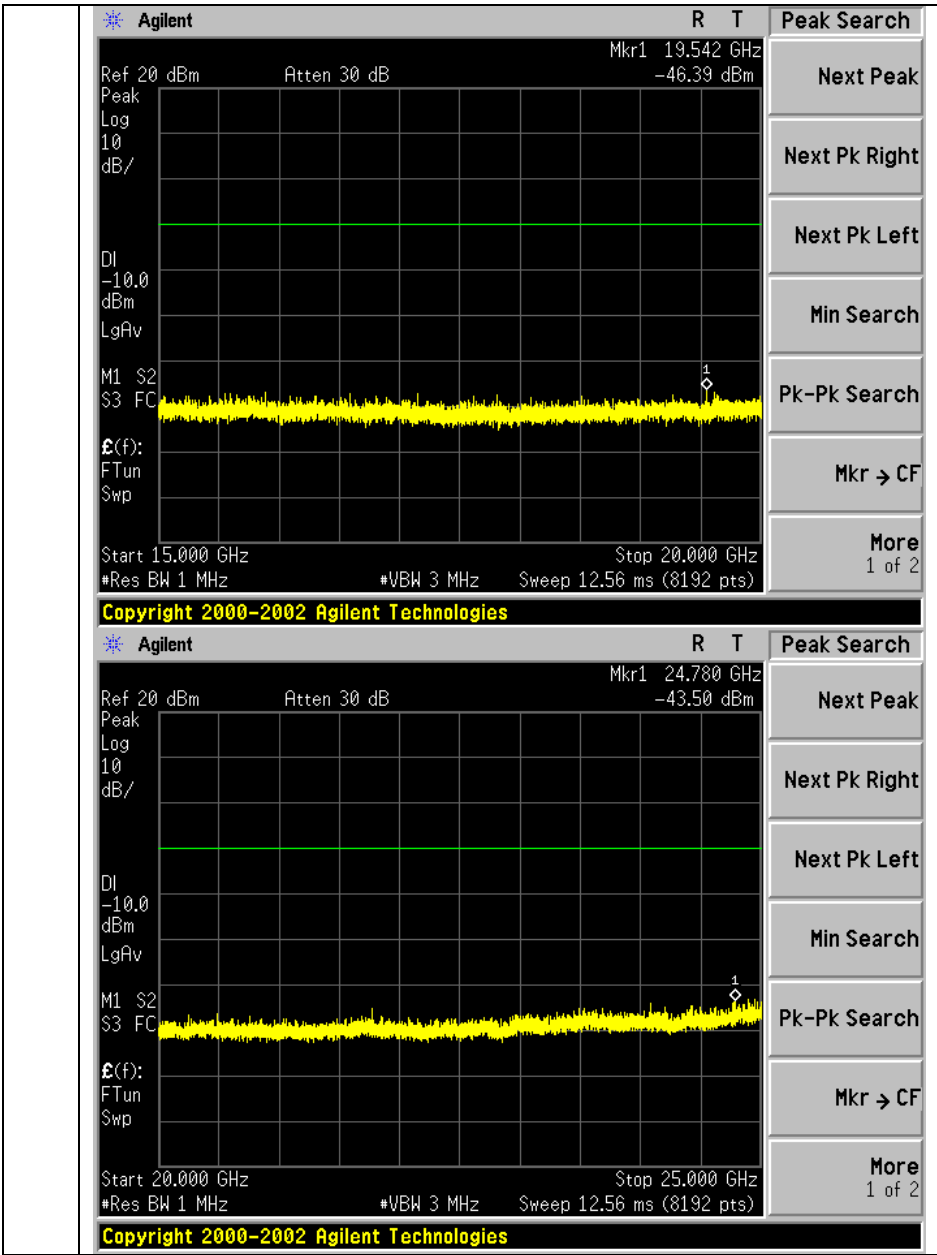

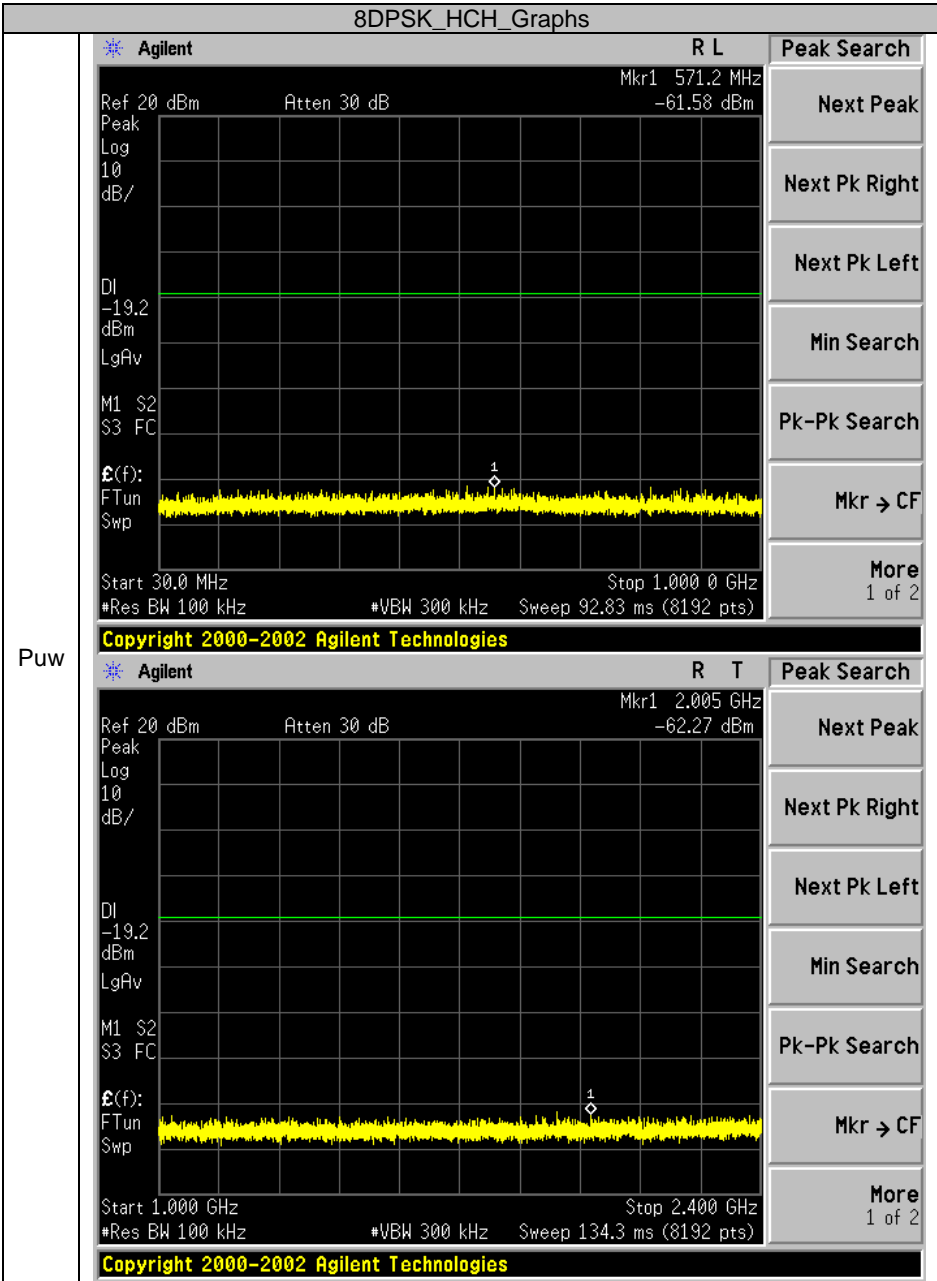

Puw

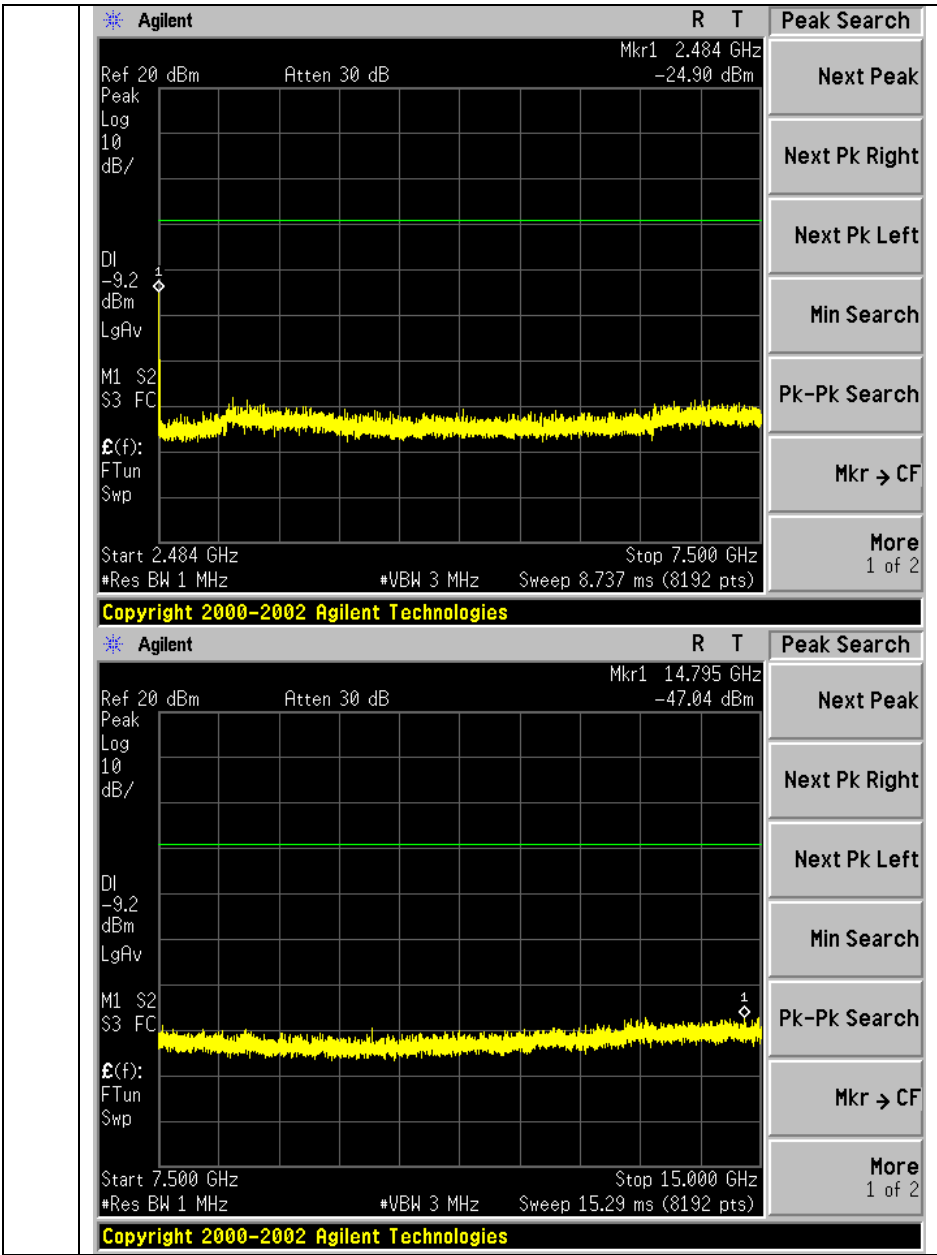

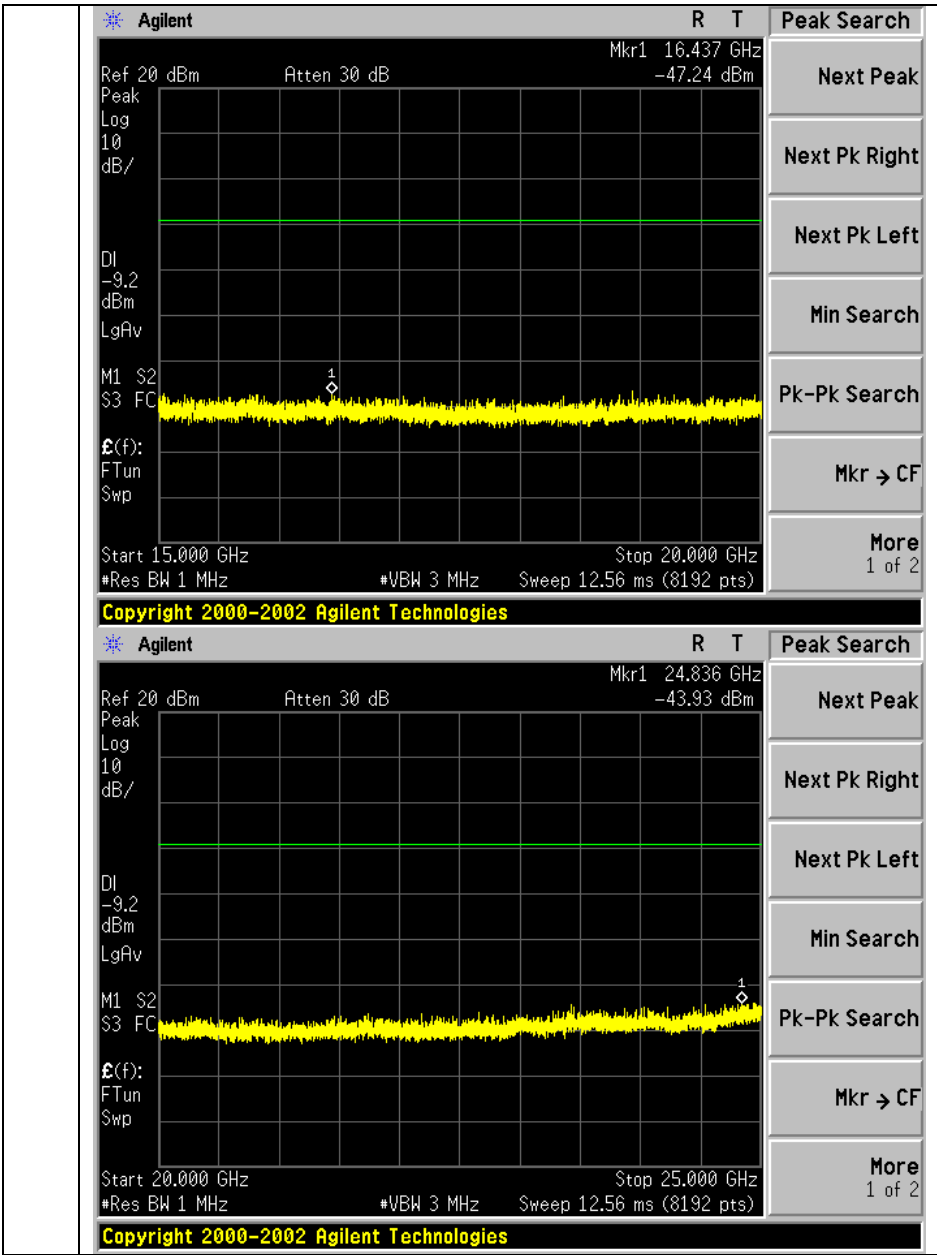

10. RADIATED EMISSION

10.1. MEASUREMENT PROCEDURE

1. Configure the EUT according to ANSI C63.10. The EUT was placed on the top of the turntable 0.8 meter above ground. The phase center of the receiving antenna mounted on the top of a height-variable antenna tower was placed 3 meters far away from the turntable.
2. Power on the EUT and all the supporting units. The turntable was rotated by 360 degrees to determine the position of the highest radiation.
3. The height of the broadband receiving antenna was varied between one meter and four meters above ground to find the maximum emissions field strength of both horizontal and vertical polarization.
4. For each suspected emissions, the antenna tower was scan (from 1 M to 4 M) and then the turntable was rotated (from 0 degree to 360 degrees) to find the maximum reading.
5. Set the test-receiver system to Peak or CISPR quasi-peak Detect Function with specified bandwidth under Maximum Hold Mode.
6. For emissions above 1GHz, use 1MHz VBW and RBW for peak reading. Then 1MHz RBW and 10Hz VBW for average reading in spectrum analyzer. The EUT was placed on the top of the turntable 1.5 meter above ground. The phase center of the receiving antenna mounted on the top of a height-variable antenna tower was placed 3 meters far away from the turntable.
7. When the radiated emissions limits are expressed in terms of the average value of the emissions, and pulsed operation is employed, the measurement field strength shall be determined by averaging over one complete pulse train, including blanking intervals, as long as the pulse train does not exceed 0.1 seconds. As an alternative (provided the transmitter operates for longer than 0.1 seconds) or in cases where the pulse train exceeds 0.1 seconds, the measured field strength shall be determined from the average absolute voltage during a 0.1 second interval during which the field strength is at its maximum values.
8. If the emissions level of the EUT in peak mode was 3 dB lower than the average limit specified, then testing will be stopped and peak values of EUT will be reported, otherwise, the emissions which do not have 3 dB margin will be repeated one by one using the quasi-peak method for below 1GHz.
9. For testing above 1GHz, the emissions level of the EUT in peak mode was lower than average limit (that means the emissions level in peak mode also complies with the limit in average mode), then testing will be stopped and peak values of EUT will be reported, otherwise, the emissions will be measured in average mode again and reported.
10. In case the emission is lower than 30MHz, loop antenna has to be used for measurement and the recorded data should be QP measured by receiver. High - Low scan is not required in this case.

The following table is the setting of spectrum analyzer and receiver.

Spectrum Parameter	Setting
Start ~Stop Frequency	9KHz~150KHz/RB 200Hz for QP
Start ~Stop Frequency	150KHz~30MHz/RB 9KHz for QP
Start ~Stop Frequency	30MHz~1000MHz/RB 120KHz for QP
Start ~Stop Frequency	1GHz~26.5GHz 1MHz/1MHz for Peak, 1MHz/10Hz for Average

Receiver Parameter	Setting
Start ~Stop Frequency	9KHz~150KHz/RB 200Hz for QP
Start ~Stop Frequency	150KHz~30MHz/RB 9KHz for QP
Start ~Stop Frequency	30MHz~1000MHz/RB 120KHz for QP

10.2. TEST SETUP

RADIATED EMISSION TEST SETUP 30MHz-1000MHz

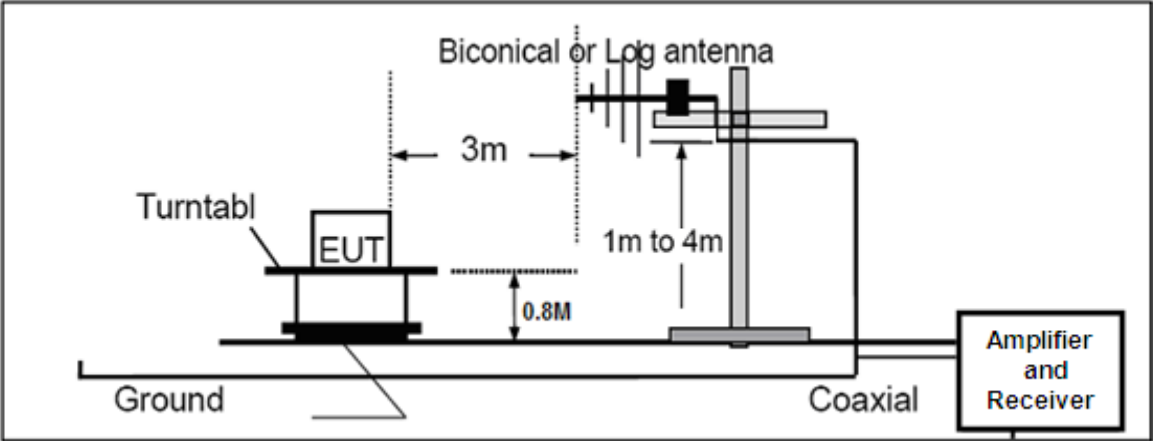

RADIATED EMISSION TEST SETUP ABOVE 1000MHz

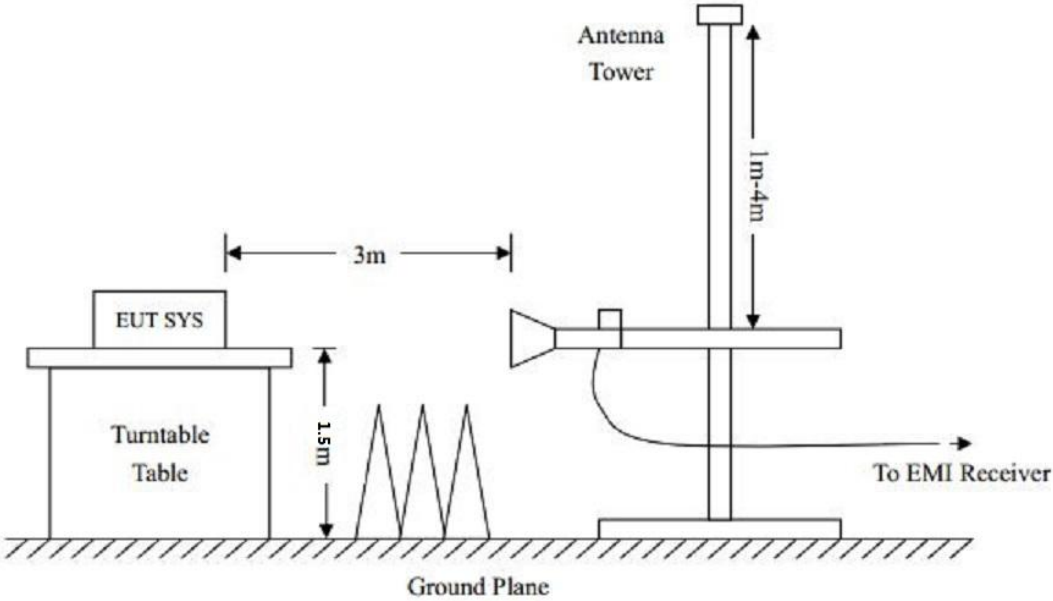

10.3. TEST RESULT

RADIATED EMISSION BELOW 30MHZ

No emission found between lowest internal used/generated frequencies to 30MHz.

RADIATED EMISSION BELOW 1GHZ

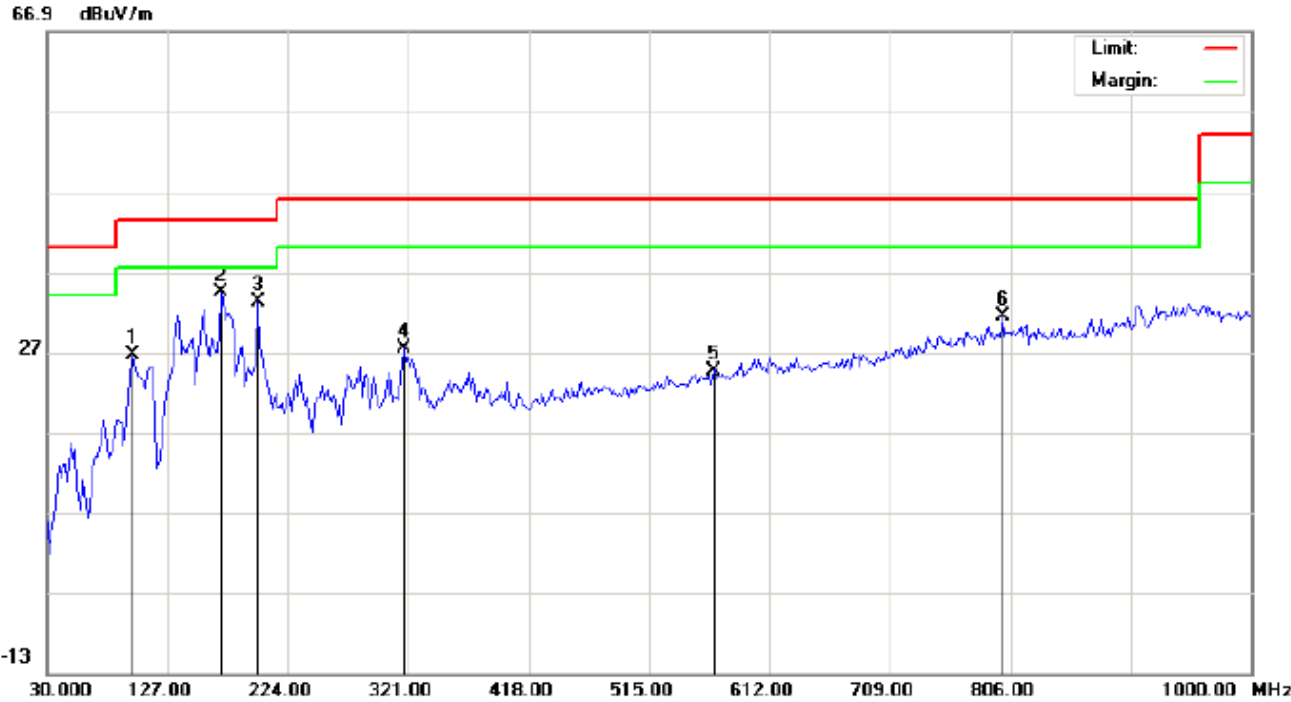

Site: site #1
Limit: FCC Class B 3M Radiation
EUT: Smart Phone
M/N: Platinum 4.0
Mode: Low channel TX
Note:

Polarization: *Horizontal*
Power: AC 120V/60Hz
Distance: 3m

Temperature: 22.8
Humidity: 56.1 %

No.	Mk	Freq.	Reading	Factor	Measurement	Limit	Over	Detector	Antenna Height	Table Degree	Comment
		MHz	dBuV	dB/m	dBuV/m	dBuV/m	dB		cm	degree	
1		99.5167	16.62	10.00	26.62	43.50	-16.88	peak			
2	*	170.6500	23.66	10.72	34.38	43.50	-9.12	peak			
3		199.7500	21.14	11.99	33.13	43.50	-10.37	peak			
4		317.7667	10.77	16.59	27.36	46.00	-18.64	peak			
5		566.7333	1.80	22.90	24.70	46.00	-21.30	peak			
6		799.5333	4.05	27.31	31.36	46.00	-14.64	peak			

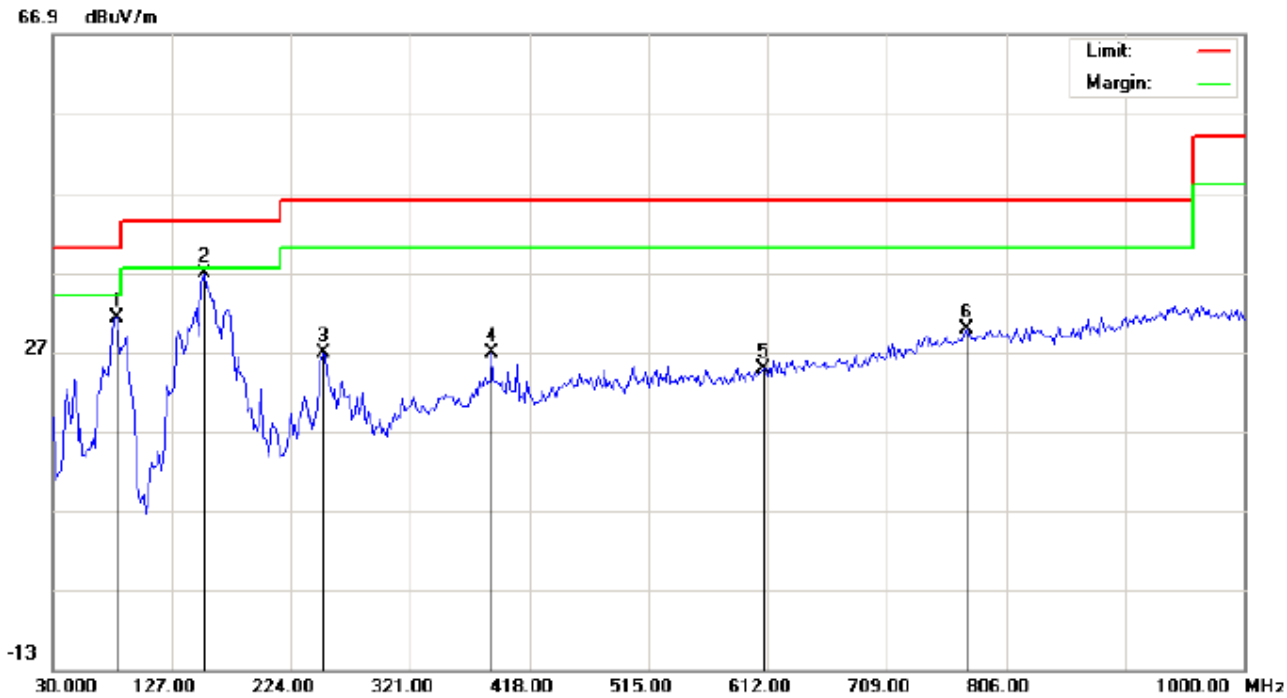

Site: site #1
 Limit: FCC Class B 3M Radiation
 EUT: Smart Phone
 M/N: Platinum 4.0
 Mode: Low channel TX
 Note:

Polarization: *Vertical*
 Power: AC 120V/60Hz
 Distance: 3m

Temperature: 22.8
 Humidity: 56.1 %

No.	Mk	Freq.	Reading	Factor	Measurement	Limit	Over	Detector	Antenna Height	Table Degree	Comment
		MHz	dBuV	dB/m	dBuV/m	dBuV/m	dB		cm	degree	
1		81.7333	28.77	2.42	31.19	40.00	-8.81	peak			
2	*	152.8667	21.62	15.28	36.90	43.50	-6.60	peak			
3		249.8667	12.90	13.89	26.79	46.00	-19.21	peak			
4		387.2833	7.76	18.99	26.75	46.00	-19.25	peak			
5		608.7667	1.97	22.93	24.90	46.00	-21.10	peak			
6		773.6667	2.78	26.96	29.74	46.00	-16.26	peak			

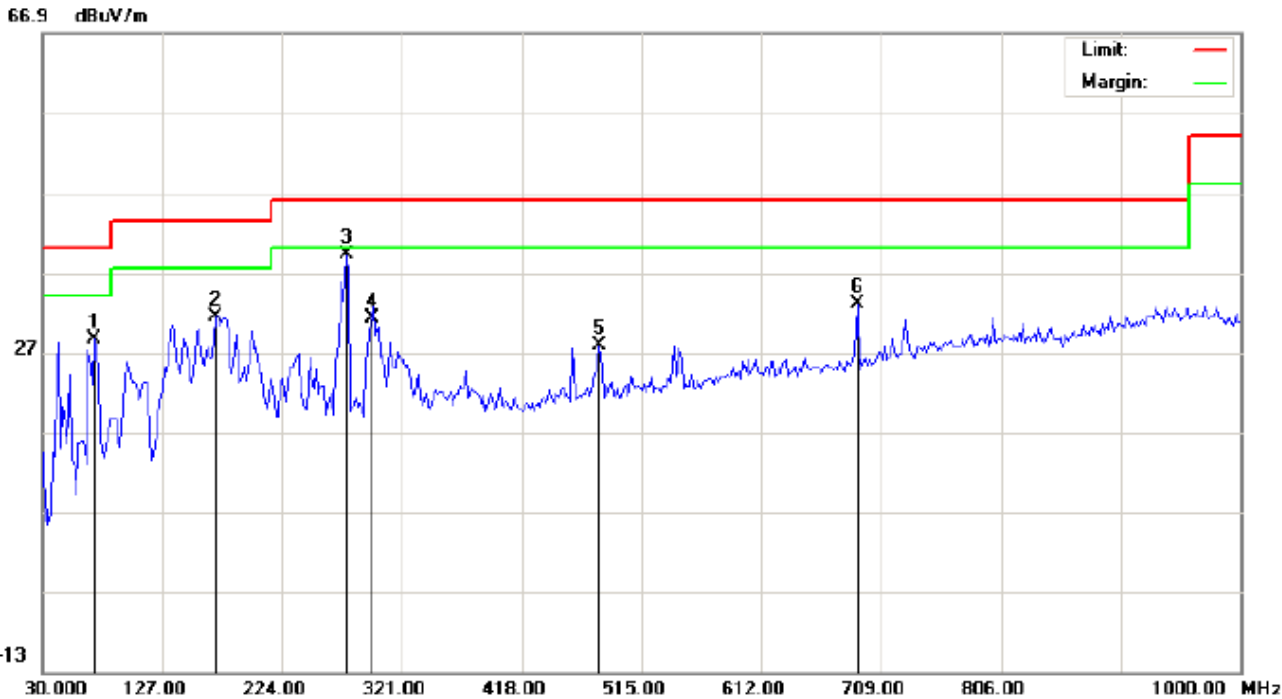

Site: site #1
 Limit: FCC Class B 3M Radiation
 EUT: Smart Phone
 M/N: Platinum 4.0
 Mode: Middle channel TX
 Note:

Polarization: *Horizontal*
 Power: AC 120V/60Hz
 Distance: 3m

Temperature: 22.8
 Humidity: 56.1 %

No.	Mk	Freq.	Reading	Factor	Measurement	Limit	Over	Detector	Antenna Height	Table Degree	Comment
		MHz	dBuV	dB/m	dBuV/m	dBuV/m	dB		cm	degree	
1		72.0333	20.33	8.28	28.61	40.00	-11.39	peak			
2		170.6500	20.65	10.72	31.37	43.50	-12.13	peak			
3	*	275.7333	27.90	11.28	39.18	46.00	-6.82	peak			
4		296.7500	16.29	14.86	31.15	46.00	-14.85	peak			
5		481.0500	6.86	20.93	27.79	46.00	-18.21	peak			
6		689.6000	8.18	24.91	33.09	46.00	-12.91	peak			

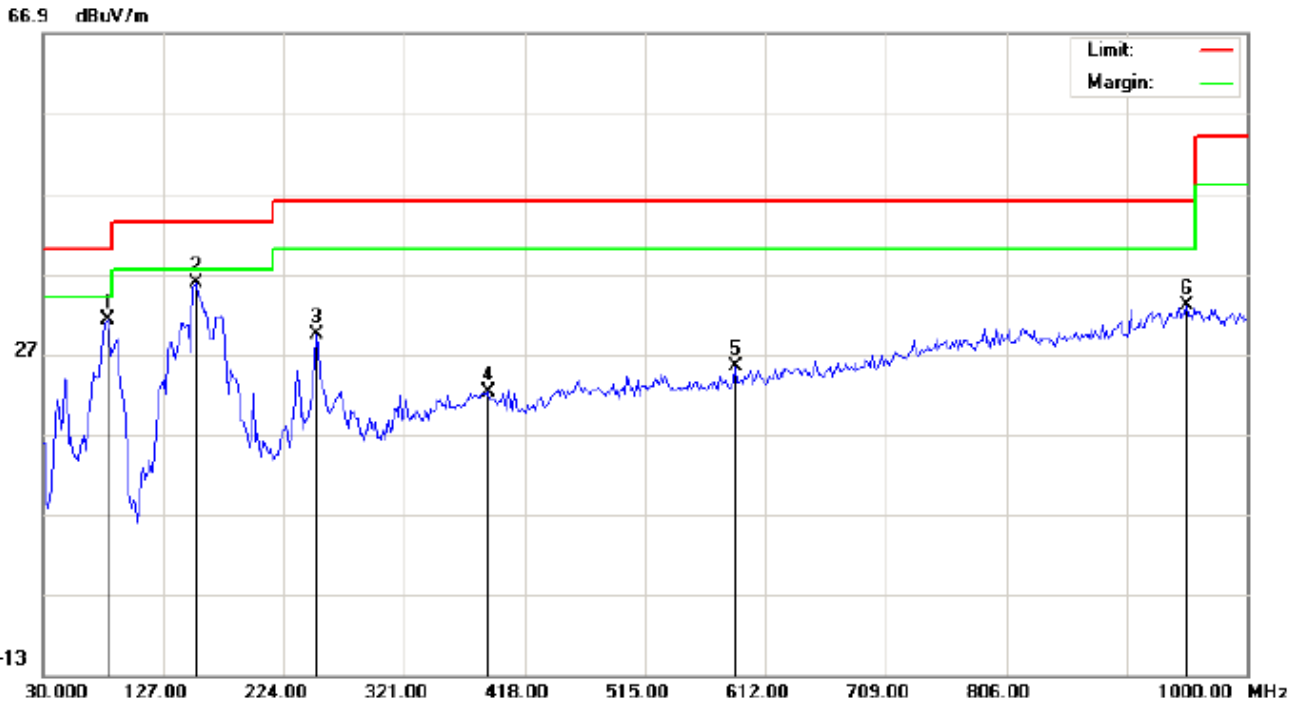

Site: site #1
 Limit: FCC Class B 3M Radiation
 EUT: Smart Phone
 M/N: Platinum 4.0
 Mode: Middle channel TX
 Note:

Polarization: *Vertical*
 Power: AC 120V/60Hz
 Distance: 3m

Temperature: 22.8
 Humidity: 56.1 %

No.	Mk	Freq.	Reading	Factor	Measurement	Limit	Over	Detector	Antenna	Table	Comment
		MHz	dBuV	dB/m	dBuV/m	dBuV/m	dB		Height	Degree	
									cm	degree	
1		81.7333	28.82	2.42	31.24	40.00	-8.76	peak			
2	*	152.8667	20.47	15.28	35.75	43.50	-7.75	peak			
3		249.8667	15.53	13.89	29.42	46.00	-16.58	peak			
4		388.9000	3.30	19.00	22.30	46.00	-23.70	peak			
5		587.7500	2.64	22.67	25.31	46.00	-20.69	peak			
6		951.5000	3.11	29.99	33.10	46.00	-12.90	peak			

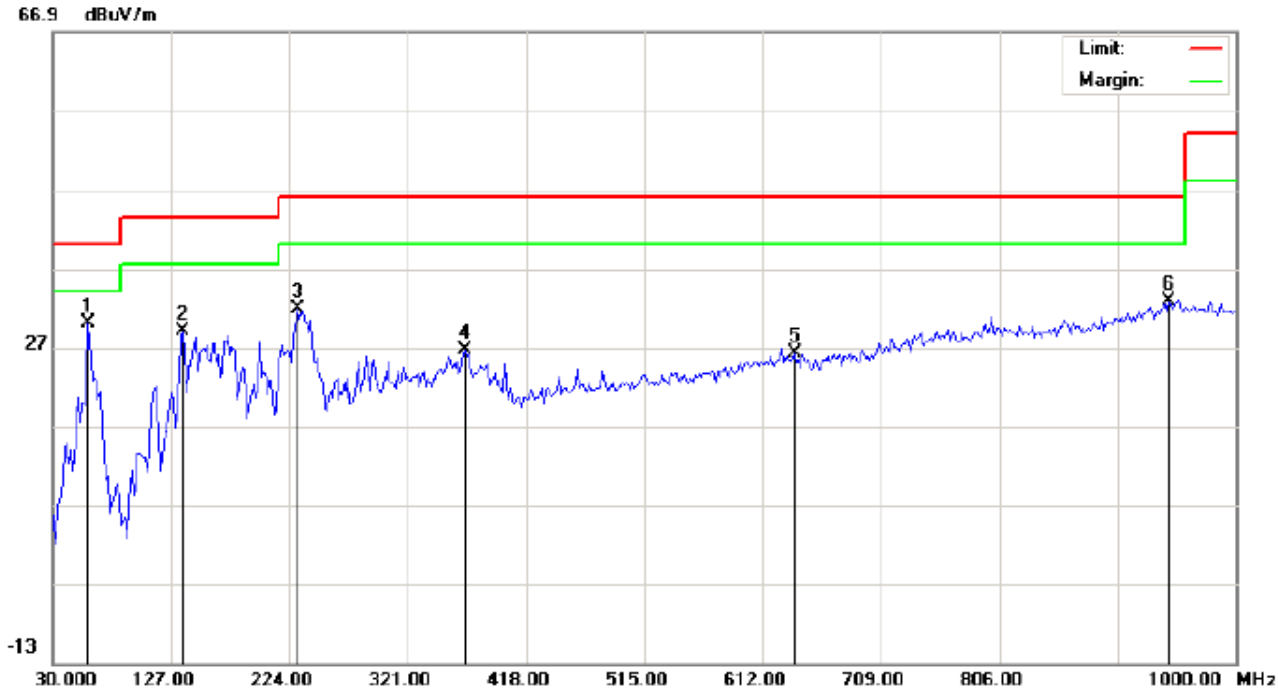

Site: site #1
 Limit: FCC Class B 3M Radiation
 EUT: Smart Phone
 M/N: Platinum 4.0
 Mode: High channel TX
 Note:

Polarization: *Horizontal*
 Power: AC 120V/60Hz
 Distance: 3m

Temperature: 22.8
 Humidity: 56.1 %

No.	Mk	Freq.	Reading	Factor	Measurement	Limit	Over	Detector	Antenna Height	Table Degree	Comment
		MHz	dBuV	dB/m	dBuV/m	dBuV/m	dB		cm	degree	
1	*	59.1000	28.53	1.47	30.00	40.00	-10.00	peak			
2		136.7000	15.37	13.66	29.03	43.50	-14.47	peak			
3		230.4667	23.00	8.89	31.89	46.00	-14.11	peak			
4		367.8833	7.84	18.86	26.70	46.00	-19.30	peak			
5		637.8667	2.45	23.82	26.27	46.00	-19.73	peak			
6		945.0333	3.03	29.86	32.89	46.00	-13.11	peak			

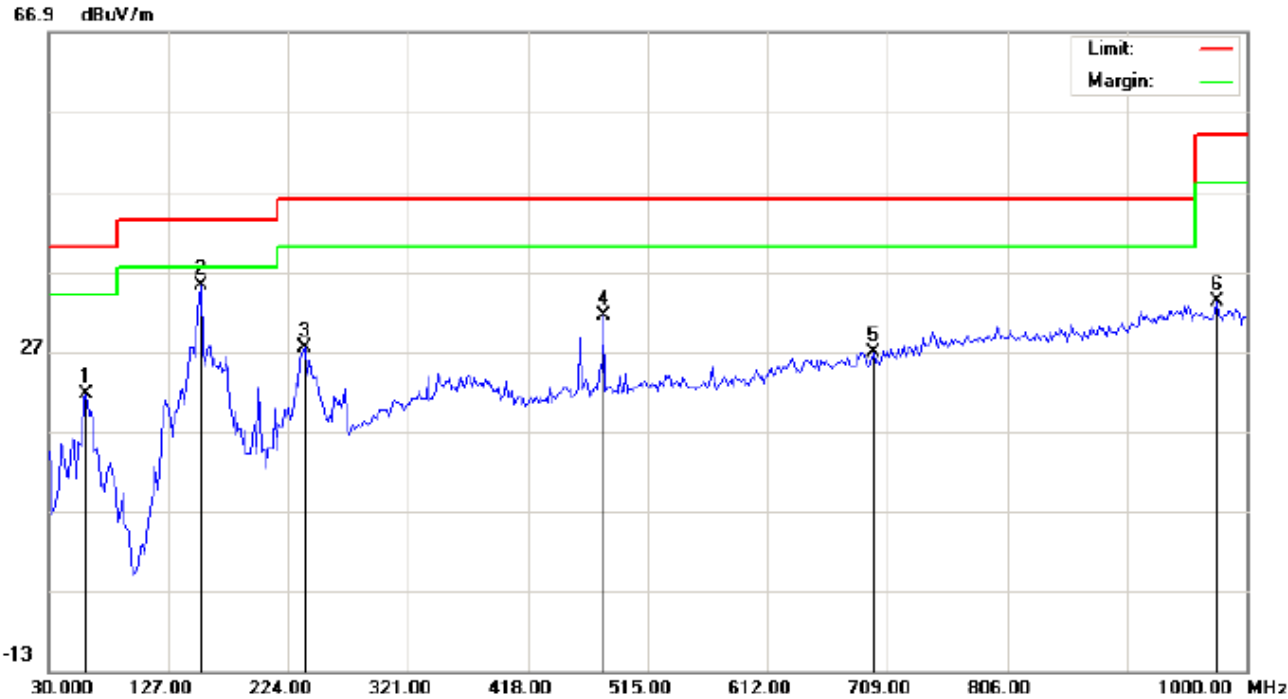

Site: site #1
 Limit: FCC Class B 3M Radiation
 EUT: Smart Phone
 M/N: Platinum 4.0
 Mode: High channel TX
 Note:

Polarization: **Vertical**
 Power: AC 120V/60Hz
 Distance: 3m

Temperature: 22.8
 Humidity: 56.1 %

No.	Mk	Freq.	Reading	Factor	Measurement	Limit	Over	Detector	Antenna Height	Table Degree	Comment
		MHz	dBuV	dB/m	dBuV/m	dBuV/m	dB		cm	degree	
1		60.7167	13.79	7.87	21.66	40.00	-18.34	peak			
2	*	152.8667	19.93	15.28	35.21	43.50	-8.29	peak			
3		236.9333	14.85	12.62	27.47	46.00	-18.53	peak			
4		479.4333	10.51	20.91	31.42	46.00	-14.58	peak			
5		697.6833	1.73	25.13	26.86	46.00	-19.14	peak			
6		975.7500	3.40	29.75	33.15	54.00	-20.85	peak			

RESULT: PASS

Note: 1. Factor=Antenna Factor + Cable loss, Margin=Measurement-Limit.

2. The "Factor" value can be calculated automatically by software of measurement system.

RADIATED EMISSION TEST- (ABOVE 1GHZ)

Frequency (MHz)	Meter Reading (dB μ V)	Factor (dB)	Emission Level (dB μ V/m)	Limits (dB μ V/m)	Margin (dB)	Detector Type	Comment
Low Channel (2402 MHz)							
4804.264	64.11	-3.62	60.49	74	-13.51	Pk	Vertical
4804.272	42.04	-3.62	38.42	54	-15.58	AV	Vertical
7206.138	63.42	-0.9	62.52	74	-11.48	pk	Vertical
7206.156	42.08	-0.9	41.18	54	-12.82	AV	Vertical
4803.959	63.78	-3.64	60.14	74	-13.86	Pk	Horizontal
4803.964	45.06	-3.64	41.42	54	-12.58	AV	Horizontal
Mid Channel (2441 MHz)							
4882.128	62.18	-3.65	58.53	74	-15.47	Pk	Vertical
4882.094	43.46	-3.65	39.81	54	-14.19	AV	Vertical
7323.228	65.28	-0.82	64.46	74	-9.54	Pk	Vertical
7323.220	46.31	-0.82	45.49	54	-8.51	AV	Vertical
4882.096	64.19	-3.68	60.51	74	-13.49	Pk	Horizontal
4882.171	41.55	-3.68	37.87	54	-16.13	AV	Horizontal
High Channel (2480 MHz)							
4960.260	65.68	-3.59	62.09	74	-11.91	pk	Vertical
4960.325	44.11	-3.59	40.52	54	-13.48	AV	Vertical
4960.190	62.17	-3.59	58.58	74	-15.42	pk	Horizontal
4960.157	43.89	-3.59	40.3	54	-13.7	AV	Horizontal

Note:

1) 30MHz~25GHz:(Scan with GFSK, $\pi/4$ -DQPSK,8DPSK, the worst casw is GFSK Mode)

2) Factor = Antenna Factor + Cable Loss – Pre-amplifier.

Emission Level = Meter Reading + Factor

Margin = Emission Leve - Limit

RESULT: PASS

11. BAND EDGE EMISSION

11.1. MEASUREMENT PROCEDURE

1. The transmitter output is connected to a spectrum analyzer. The resolution bandwidth is set to 100kHz. The video bandwidth is set to 300kHz.
2. Transmitter set to the normal hopping mode at 2.4 and 2.4835 GHz.

11.2. TEST SET-UP

Radiated same as 10.2

Conducted set up

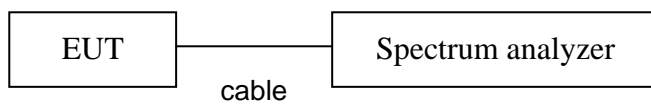

11.3. Radiated TEST RESULT

Frequency	Meter Reading	Factor	Emission Level	Limits	Margin	Detector	Comment
(MHz)	(dB μ V)	(dB)	(dB μ V/m)	(dB μ V/m)	(dB)	Type	
GFSK							
2399.9	65.38	-12.99	52.39	74	-21.61	peak	Vertical
2399.9	54.03	-12.99	41.04	54	-12.96	AVG	Vertical
2399.9	71.09	-12.99	58.1	74	-15.9	peak	Horizontal
2399.9	55.27	-12.99	42.28	54	-11.72	AVG	Horizontal
2483.6	76.13	-12.78	63.35	74	-10.65	peak	Vertical
2483.6	52.02	-12.78	39.24	54	-14.76	AVG	Vertical
2483.6	73.41	-12.78	60.63	74	-13.37	peak	Horizontal
2483.6	51.08	-12.78	38.3	54	-15.7	AVG	Horizontal
$\pi/4$-DQPSK							
2399.9	73.46	-12.99	60.47	74	-13.53	peak	Vertical
2399.9	55.24	-12.99	42.25	54	-11.75	AVG	Vertical
2399.9	73.79	-12.99	60.8	74	-13.2	peak	Horizontal
2399.9	51.14	-12.99	38.15	54	-15.85	AVG	Horizontal
2483.6	73.49	-12.78	60.71	74	-13.29	peak	Vertical
2483.6	51.47	-12.78	38.69	54	-15.31	AVG	Vertical
2483.6	75.46	-12.78	62.68	74	-11.32	peak	Horizontal
2483.6	52.38	-12.78	39.6	54	-14.4	AVG	Horizontal
8DPSK							
2399.9	75.04	-12.99	62.05	74	-11.95	peak	Vertical
2399.9	51.03	-12.99	38.04	54	-15.96	AVG	Vertical
2399.9	73.58	-12.99	60.59	74	-13.41	peak	Horizontal
2399.9	52.07	-12.99	39.08	54	-14.92	AVG	Horizontal
2483.6	73.17	-12.78	60.39	74	-13.61	peak	Vertical
2483.6	55.47	-12.78	42.69	54	-11.31	AVG	Vertical
2483.6	73.47	-12.78	60.69	74	-13.31	peak	Horizontal
2483.6	51.04	-12.78	38.26	54	-15.74	AVG	Horizontal

RESULT: PASS

Note: The other modes radiation emission have enough 20dB margin.

Factor=Antenna Factor + Cable loss - Amplifier gain, Over=Measure-Limit.

The "Factor" value can be calculated automatically by software of measurement system.

11.4 Conducted TEST RESULT

Mode	Channel	Carrier Frequency [MHz]	Frequency Hopping	Max Spurious Level [dBm]	Verdict
GFSK	LCH	2402	Off	-45.69	PASS
			On	-47.88	PASS
GFSK	HCH	2480	Off	-45.04	PASS
			On	-41.46	PASS
$\pi/4$ DQPSK	LCH	2402	Off	-42.33	PASS
$\pi/4$ DQPSK	HCH	2480	Off	-42.80	PASS
8DPSK	LCH	2402	Off	-48.62	PASS
8DPSK	HCH	2480	Off	-43.97	PASS

Note: All modes were tested, only the worst case record in the report.

Test Graph

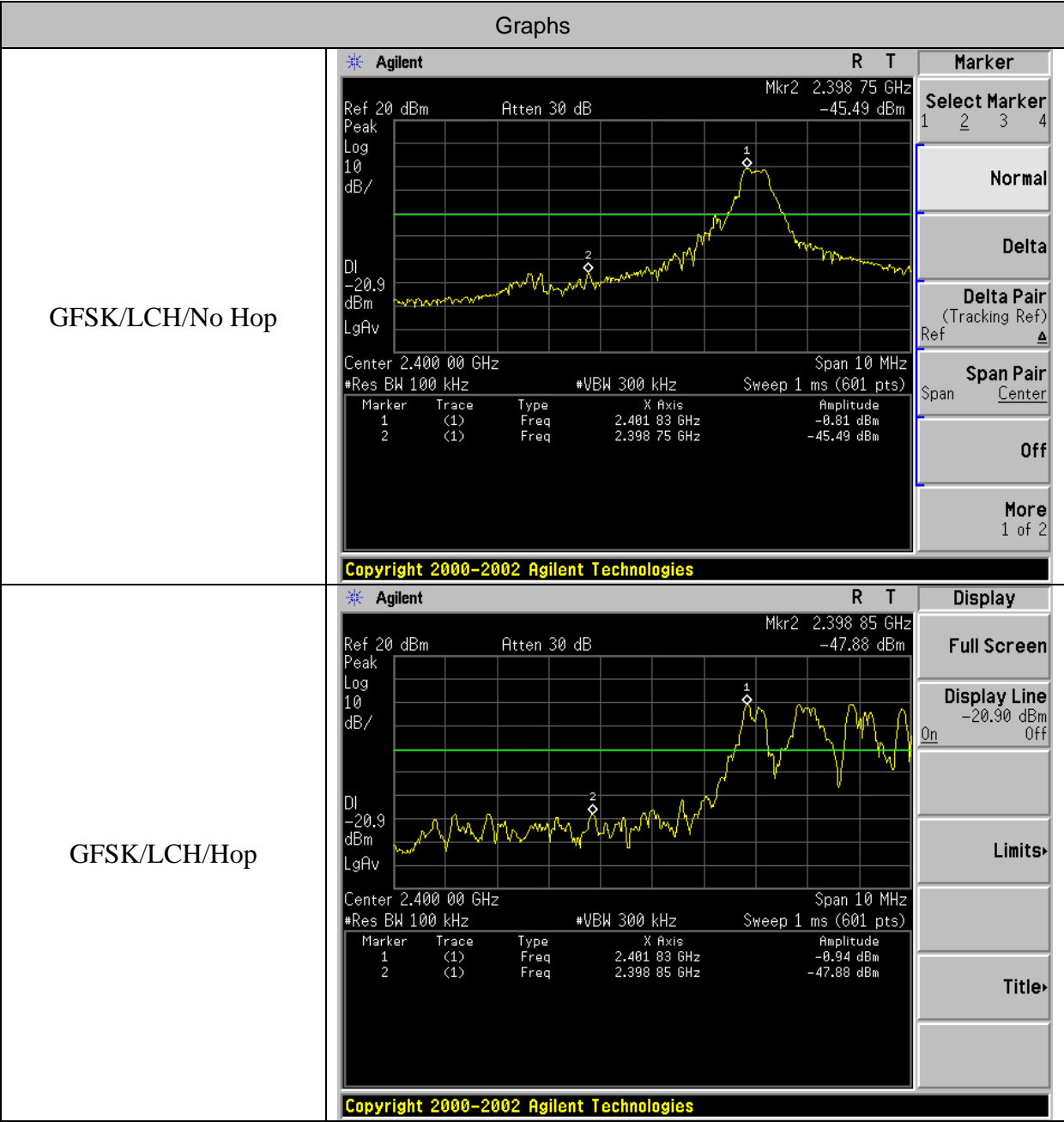

Marker

Select Marker
1 2 3 4

Normal

Delta

Delta Pair
(Tracking Ref)
Ref ▲

Span Pair
Span Center

Off

More
1 of 2

Display

Full Screen

Display Line
-20.90 dBm
On Off

Limits

Title

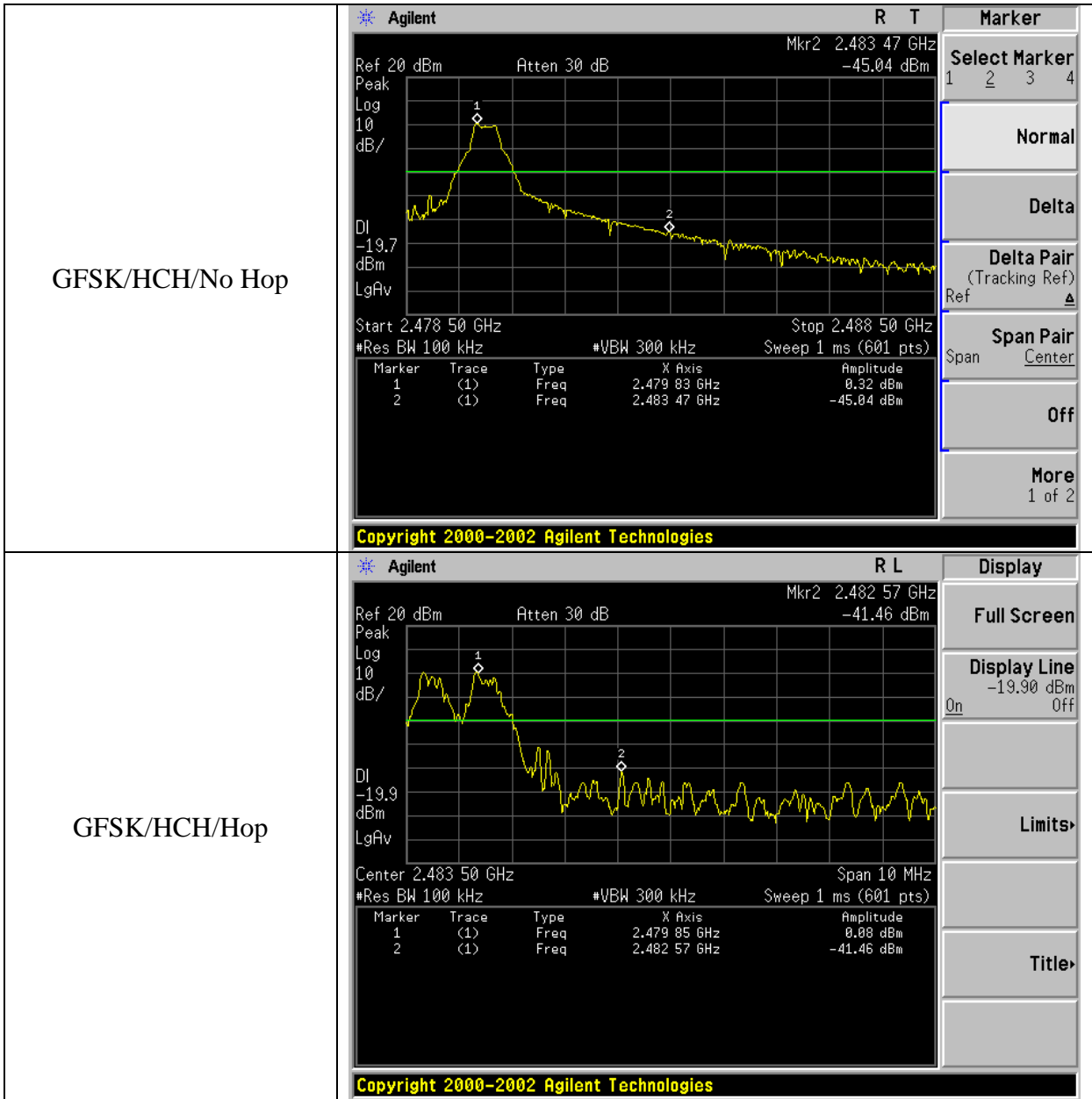

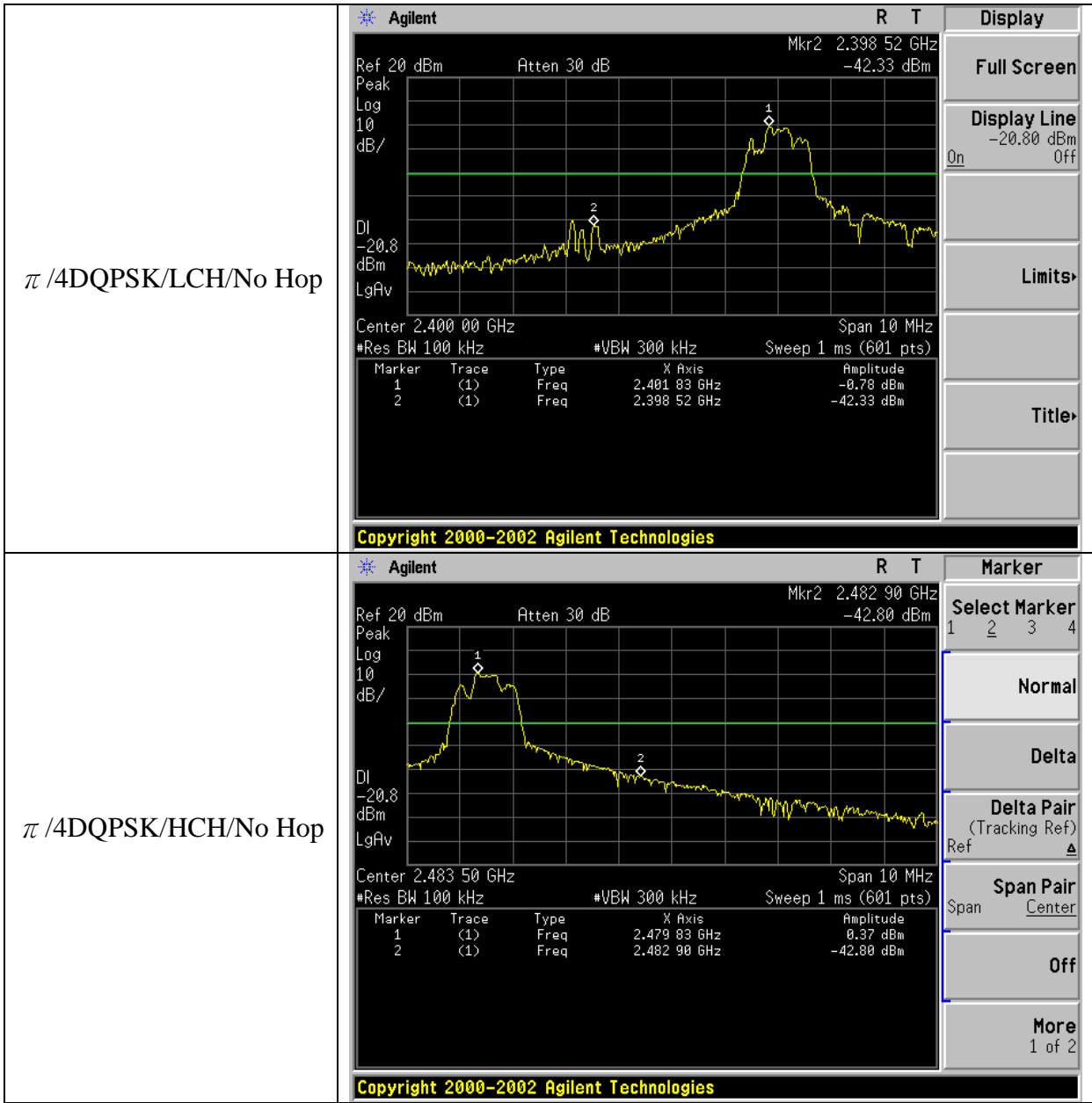

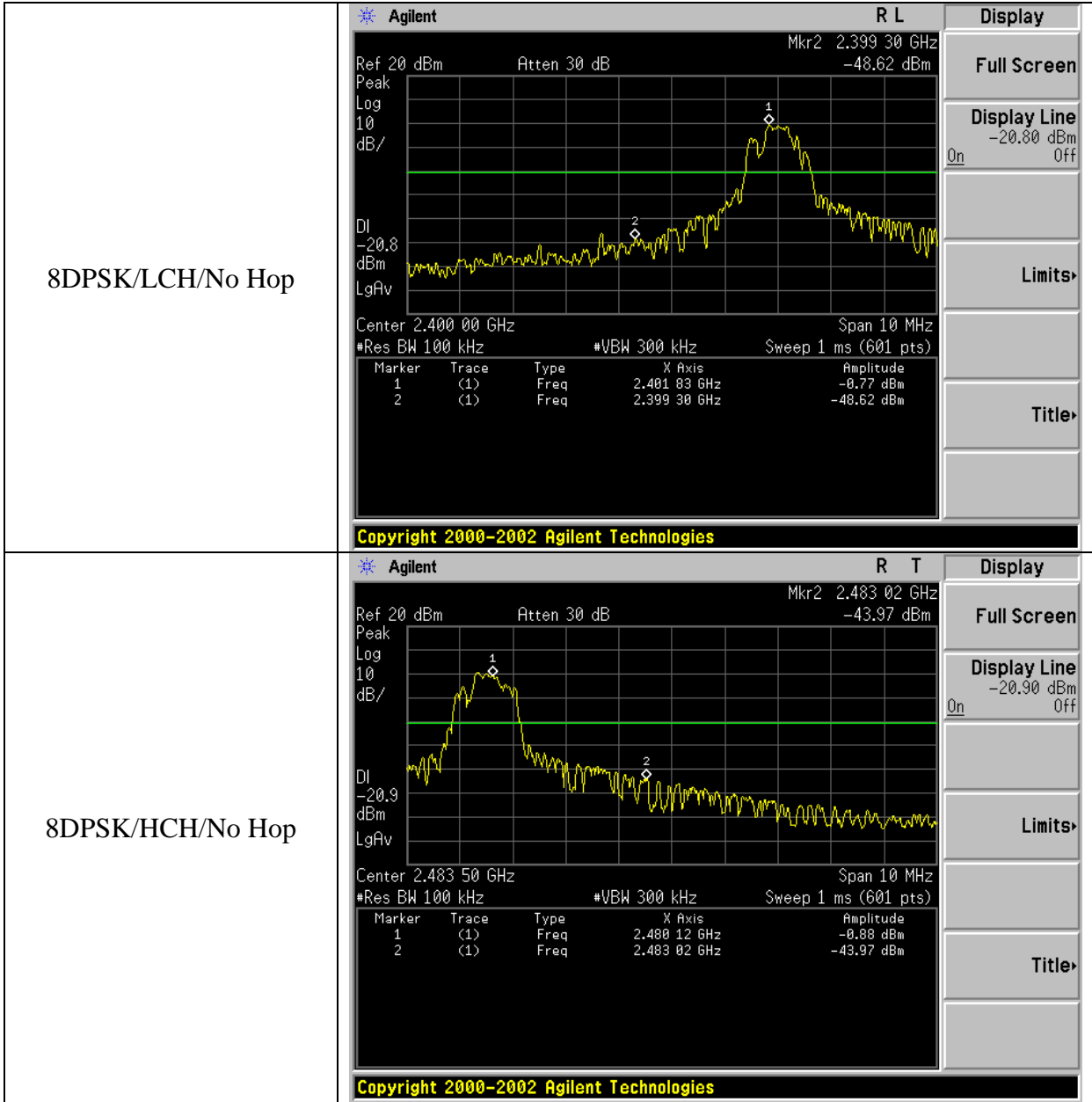

12. NUMBER OF HOPPING FREQUENCY

12.1. MEASUREMENT PROCEDURE

1. Place the EUT on the table and set it in transmitting mode.
2. Remove the antenna from the EUT and then connect a low RF cable from the antenna port to the spectrum analyzer.
3. Set the spectrum analyzer Start = 2.4GHz Stop = 2.4835GHz
4. Set the Spectrum Analyzer as RBW>=1%span, VBW>=RBW.

12.2. TEST SETUP (BLOCK DIAGRAM OF CONFIGURATION)

Same as described in section 8.2

12.3. MEASUREMENT EQUIPMENT USED

The same as described in section 6

12.4. LIMITS AND MEASUREMENT RESULT

Mode	Channel.	Number of Hopping Channel	Verdict
GFSK	Hop	79	PASS

Note: All modes were tested, only the worst case record in the report.

Test Graph

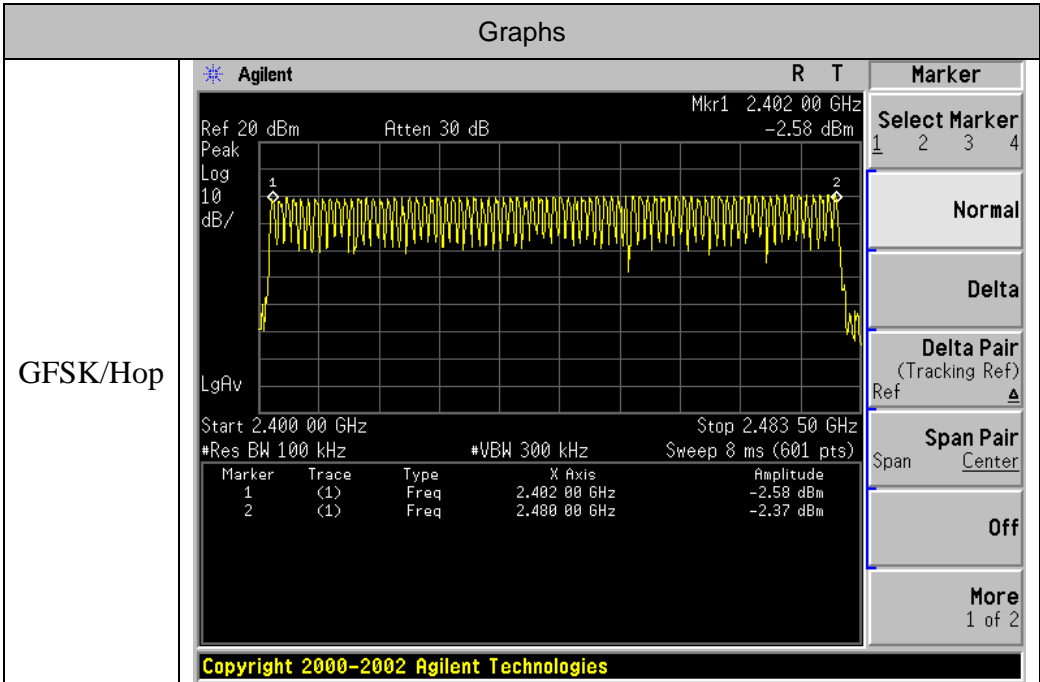

13. TIME OF OCCUPANCY (DWELL TIME)

13.1. MEASUREMENT PROCEDURE

1. Place the EUT on the table and set it in transmitting mode
2. Remove the antenna from the EUT and then connect a low RF cable from the antenna port to the spectrum analyzer.
3. Set Span = zero span, centered on a hopping channel
4. Set the spectrum analyzer as RBW=1MHz, VBW>=RBW, Span = 0 Hz

13.2. TEST SETUP (BLOCK DIAGRAM OF CONFIGURATION)

Same as described in section 8.2

13.3. MEASUREMENT EQUIPMENT USED

The same as described in section 6

13.4. LIMITS AND MEASUREMENT RESULT

The Dwell Time=Burst Width*Total Hops. The detailed calculations are showed as follows:

- The duration for dwell time calculation: $0.4[s]*\text{hopping number}=0.4[s]*79[\text{ch}]=31.6[s*\text{ch}]$;
- The burst width [ms/hop/ch], which is directly measured, refers to the duration on one channel hop.
- The hops per second for all channels: The selected EUT Conf uses a slot type of 5-Tx&1-Rx and a hopping rate of 1600 [ch*hop/s] for all channels. So the final hopping rate for all channels is $1600/6=266.67$ [ch*hop/s]
- The hops per second on one channel: 266.67 [ch*hops/s]/ 79 [ch]= 3.38 [hop/s];
- The total hops for all channels within the dwell time calculation duration: 3.38 [hop/s]* $31.6[s*\text{ch}]=106.67$ [hop*ch];
- The dwell time for all channels hopping: 106.67 [hop*ch]*Burst Width [ms/hop/ch].

Mode	Channel.	Burst Width [ms/hop/ch]	Total Hops[hop*ch]	Dwell Time[ms]	Verdict	Limit (ms)
GFSK	LCH	2.907	106.67	310.09	PASS	400
GFSK	MCH	2.918	106.67	311.26	PASS	400
GFSK	HCH	2.916	106.67	311.05	PASS	400

Test Graph

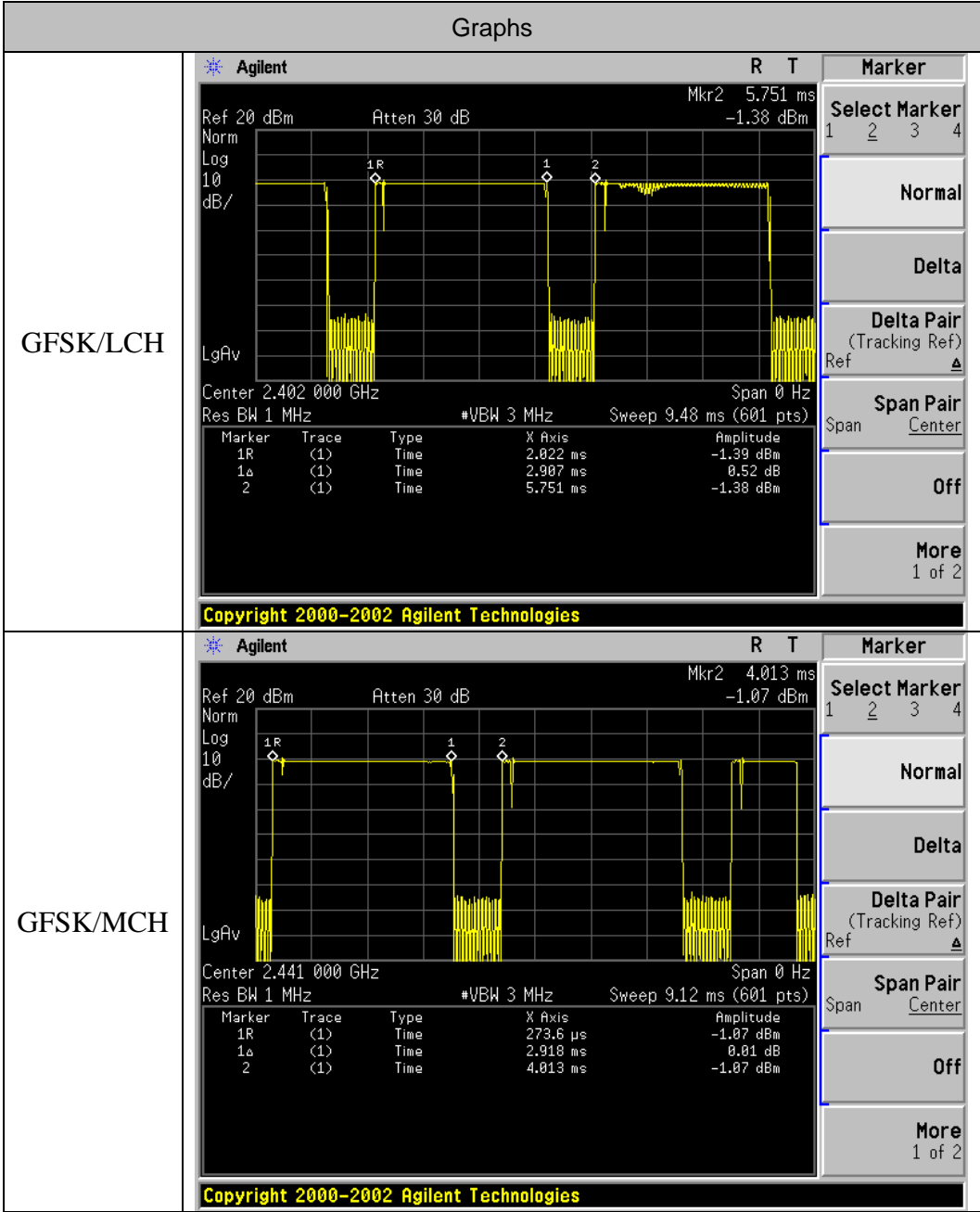

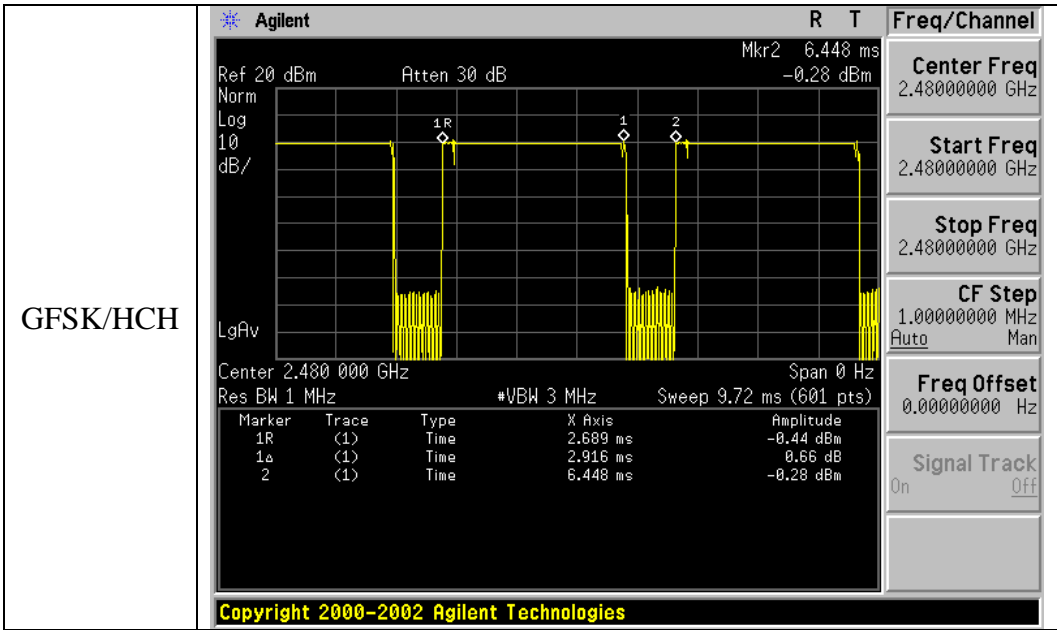

GFSK/HCH

14. FREQUENCY SEPARATION

14.1. MEASUREMENT PROCEDURE

1. Place the EUT on the table and set it in transmitting mode
2. Remove the antenna from the EUT and then connect a low RF cable from the antenna port to the spectrum analyzer
3. Set Span = wide enough to capture the peaks of two adjacent channels Resolution (or IF) Bandwidth (RBW) ≥ 1% of the span Video (or Average) Bandwidth (VBW) ≥ RBW; Sweep = auto; Detector function = peak; Trace = max hold

14.2. TEST SETUP (BLOCK DIAGRAM OF CONFIGURATION)

Same as described in section 6.2

14.3. MEASUREMENT EQUIPMENT USED

The same as described in section 6.3

14.4. LIMITS AND MEASUREMENT RESULT

Mode	Channel.	Carrier Frequency Separation [MHz]	Verdict
8DPSK	Hop	1.002	PASS

Note: All modes were tested, only the worst case record in the report.

Test Graph

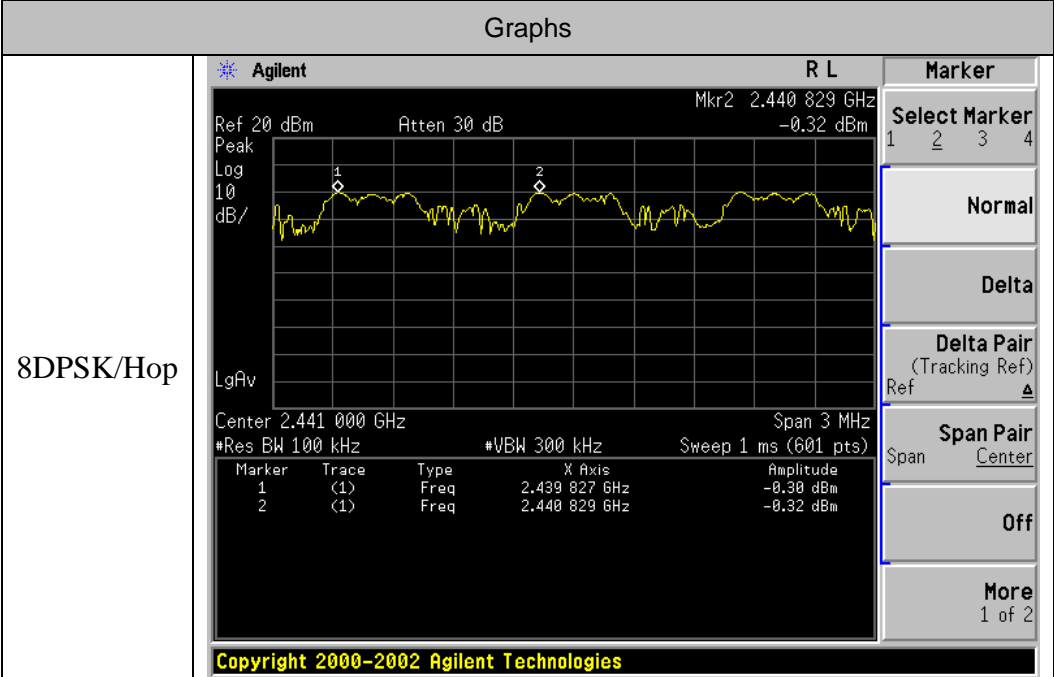

15. FCC LINE CONDUCTED EMISSION TEST

15.1. LIMITS OF LINE CONDUCTED EMISSION TEST

Frequency	Maximum RF Line Voltage	
	Q.P.(dBuV)	Average(dBuV)
150kHz~500kHz	66-56	56-46
500kHz~5MHz	56	46
5MHz~30MHz	60	50

Note:

1. The lower limit shall apply at the transition frequency.
2. The limit decreases linearly with the logarithm of the frequency in the range 0.15 MHz to 0.50 MHz.

15.2. BLOCK DIAGRAM OF LINE CONDUCTED EMISSION TEST

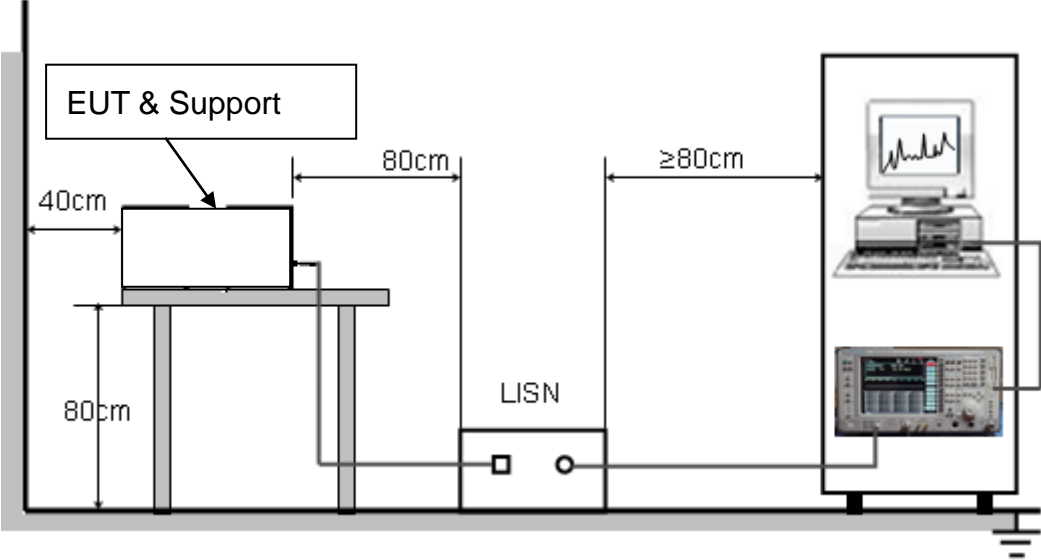

15.3. PRELIMINARY PROCEDURE OF LINE CONDUCTED EMISSION TEST

1. The equipment was set up as per the test configuration to simulate typical actual usage per the user's manual. When the EUT is a tabletop system, a wooden table with a height of 0.8 meters is used and is placed on the ground plane as per ANSI C63.10 (see Test Facility for the dimensions of the ground plane used). When the EUT is a floor-standing equipment, it is placed on the ground plane which has a 3-12 mm non-conductive covering to insulate the EUT from the ground plane.
2. Support equipment, if needed, was placed as per ANSI C63.10.
3. All I/O cables were positioned to simulate typical actual usage as per ANSI C63.10.
4. All support equipments received AC120V/60Hz power from a LISN, if any.
5. The EUT received DC charging voltage by adapter which received 120V/60Hz power by a LISN..
6. The test program was started. Emissions were measured on each current carrying line of the EUT using a spectrum Analyzer / Receiver connected to the LISN powering the EUT. The LISN has two monitoring points: Line 1 (Hot Side) and Line 2 (Neutral Side). Two scans were taken: one with Line 1 connected to Analyzer / Receiver and Line 2 connected to a 50 ohm load; the second scan had Line 1 connected to a 50 ohm load and Line 2 connected to the Analyzer / Receiver.
7. Analyzer / Receiver scanned from 150 kHz to 30MHz for emissions in each of the test modes.
8. During the above scans, the emissions were maximized by cable manipulation.
9. The test mode(s) were scanned during the preliminary test.

Then, the EUT configuration and cable configuration of the above highest emission level were recorded for reference of final testing.

15.4. FINAL PROCEDURE OF LINE CONDUCTED EMISSION TEST

1. EUT and support equipment was set up on the test bench as per step 2 of the preliminary test.
2. A scan was taken on both power lines, Line 1 and Line 2, recording at least the six highest emissions. Emission frequency and amplitude were recorded into a computer in which correction factors were used to calculate the emission level and compare reading to the applicable limit. If EUT emission level was less -2dB to the A.V. limit in Peak mode, then the emission signal was re-checked using Q.P and Average detector.
3. The test data of the worst case condition(s) was reported on the Summary Data page.

15.5. TEST RESULT OF LINE CONDUCTED EMISSION TEST

Line Conducted Emission Test Line 1-L

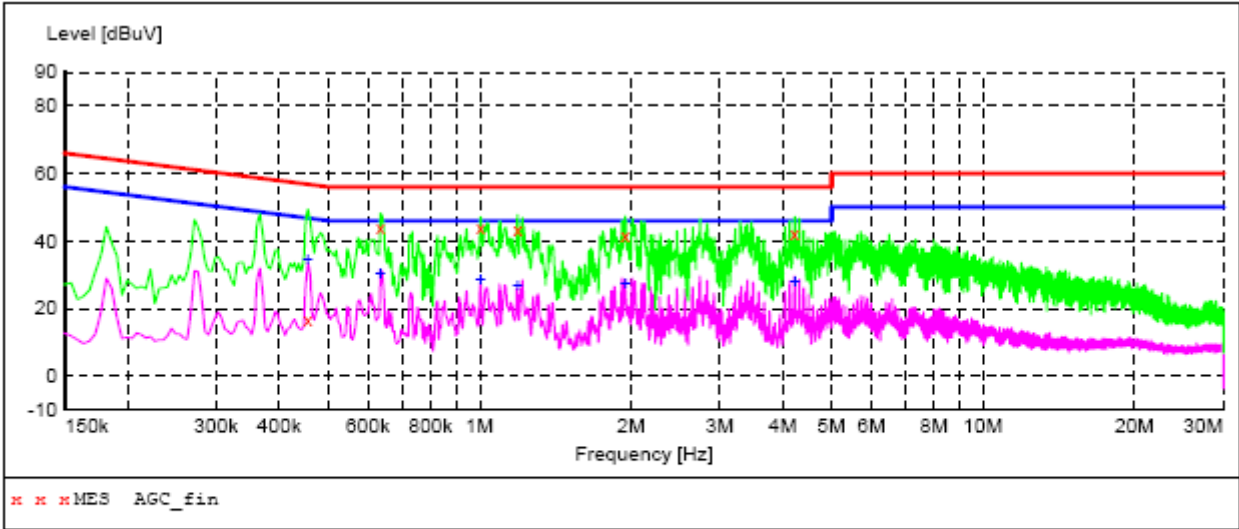

MEASUREMENT RESULT: "AGC_fin"

2016/7/26 14:39

Frequency	Level	Transd	Limit	Margin	Detector	Line	PE	AUX STATE
MHz	dBuV	dB	dBuV	dB				
0.456000	16.60	10.3	57	40.2	QP	L1	FLO	ON
0.636000	44.00	10.3	56	12.0	QP	L1	FLO	ON
1.005000	43.90	10.4	56	12.1	QP	L1	FLO	ON
1.189500	43.40	10.4	56	12.6	QP	L1	FLO	ON
1.945500	41.70	10.4	56	14.3	QP	L1	FLO	ON
4.227000	42.00	10.5	56	14.0	QP	L1	FLO	ON

MEASUREMENT RESULT: "AGC_fin2"

2016/7/26 14:39

Frequency	Level	Transd	Limit	Margin	Detector	Line	PE	AUX STATE
MHz	dBuV	dB	dBuV	dB				
0.456000	34.50	10.3	47	12.3	AV	L1	FLO	ON
0.636000	30.20	10.3	46	15.8	AV	L1	FLO	ON
1.005000	28.60	10.4	46	17.4	AV	L1	FLO	ON
1.189500	26.80	10.4	46	19.2	AV	L1	FLO	ON
1.945500	27.30	10.4	46	18.7	AV	L1	FLO	ON
4.227000	28.00	10.5	46	18.0	AV	L1	FLO	ON

Line Conducted Emission Test Line 2-N

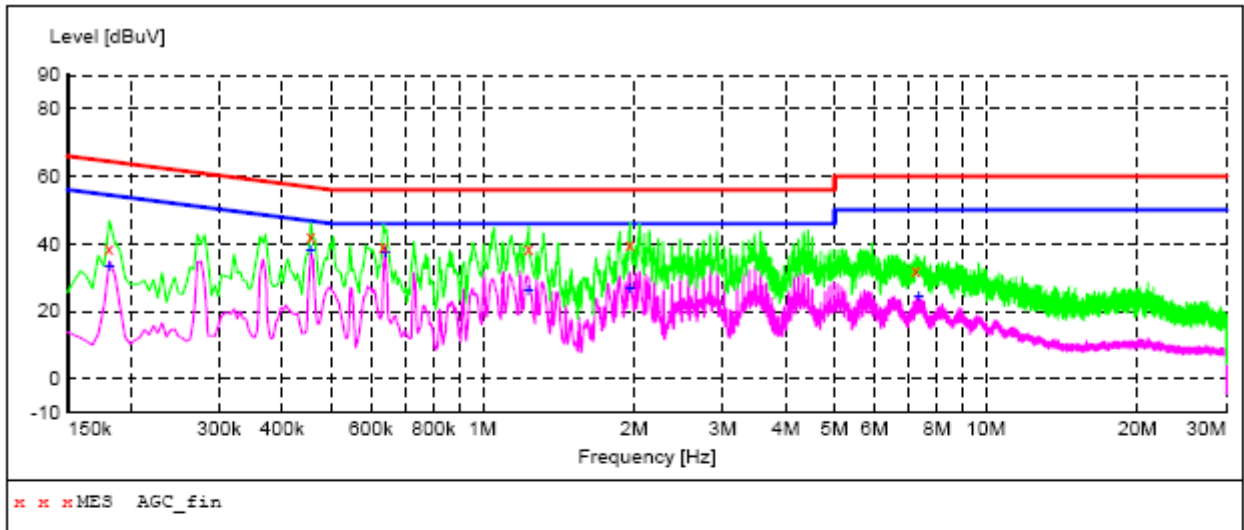

MEASUREMENT RESULT: "AGC_fin"

2016/7/26 14:26

Frequency	Level	Transd	Limit	Margin	Detector	Line	PE	AUX STATE
MHz	dBuV	dB	dBuV	dB				
0.181500	38.40	10.3	64	26.0	QP	N	FLO	ON
0.456000	42.10	10.3	57	14.7	QP	N	FLO	ON
0.636000	39.50	10.3	56	16.5	QP	N	FLO	ON
1.234500	38.60	10.4	56	17.4	QP	N	FLO	ON
1.963500	39.80	10.4	56	16.2	QP	N	FLO	ON
7.251000	32.20	10.7	60	27.8	QP	N	FLO	ON

MEASUREMENT RESULT: "AGC_fin2"

2016/7/26 14:26

Frequency	Level	Transd	Limit	Margin	Detector	Line	PE	AUX STATE
MHz	dBuV	dB	dBuV	dB				
0.181500	33.10	10.3	54	21.3	AV	N	FLO	ON
0.456000	38.00	10.3	47	8.8	AV	N	FLO	ON
0.640500	37.20	10.3	46	8.8	AV	N	FLO	ON
1.234500	26.20	10.4	46	19.8	AV	N	FLO	ON
1.963500	26.90	10.4	46	19.1	AV	N	FLO	ON
7.345500	24.50	10.7	50	25.5	AV	N	FLO	ON

APPENDIX A: PHOTOGRAPHS OF TEST SETUP
FCC LINE CONDUCTED EMISSION TEST SETUP



FCC RADIATED EMISSION TEST SETUP





APPENDIX B: PHOTOGRAPHS OF EUT
TOTAL VIEW OF EUT



THE LABEL OF ADAPTER



THE LABEL OF BATTERY



TOP VIEW OF EUT



BOTTOM VIEW OF EUT



FRONT VIEW OF EUT



BACK VIEW OF EUT



LEFT VIEW OF EUT



RIGHT VIEW OF EUT

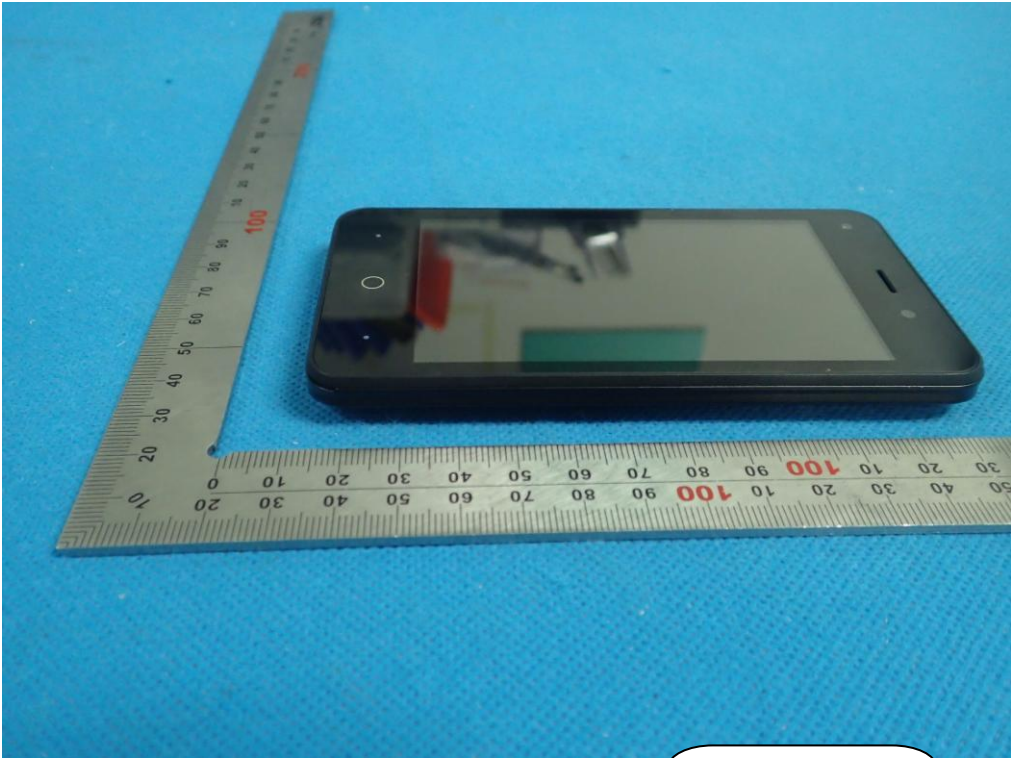

OPEN VIEW OF EUT-1

GPS/BT/WIFI
Antenna

GSM/WCDMA
Antenna



OPEN VIEW OF EUT-2



OPEN VIEW OF EUT-3



INTERNAL VIEW OF EUT-1

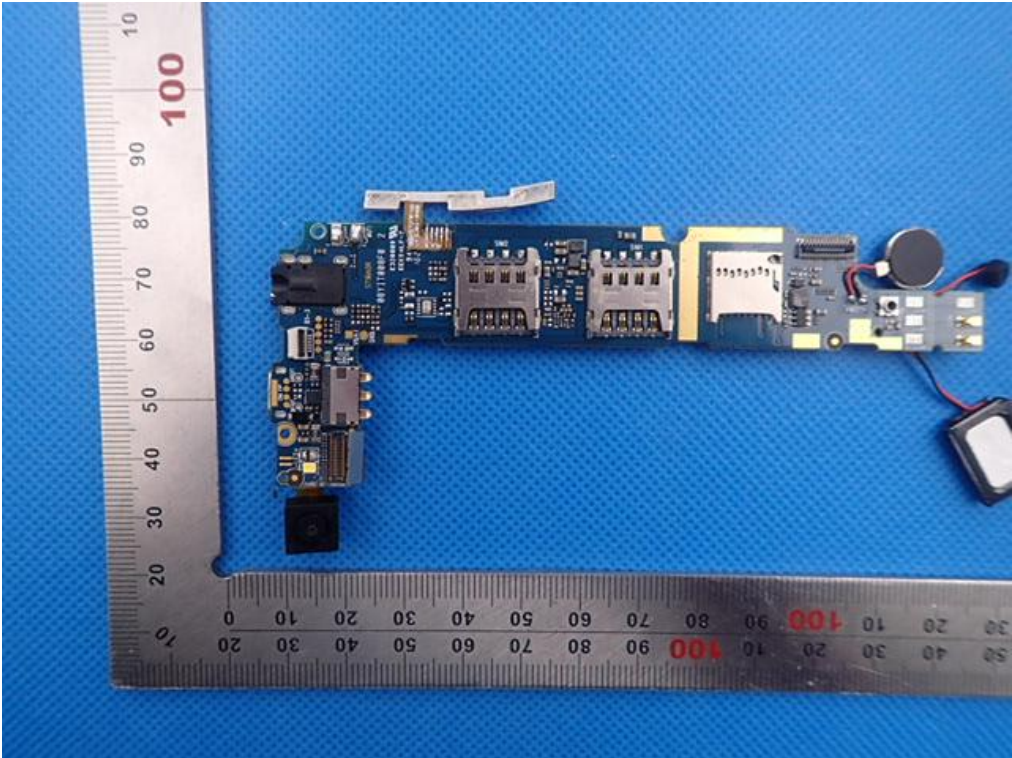

INTERNAL VIEW OF EUT-2

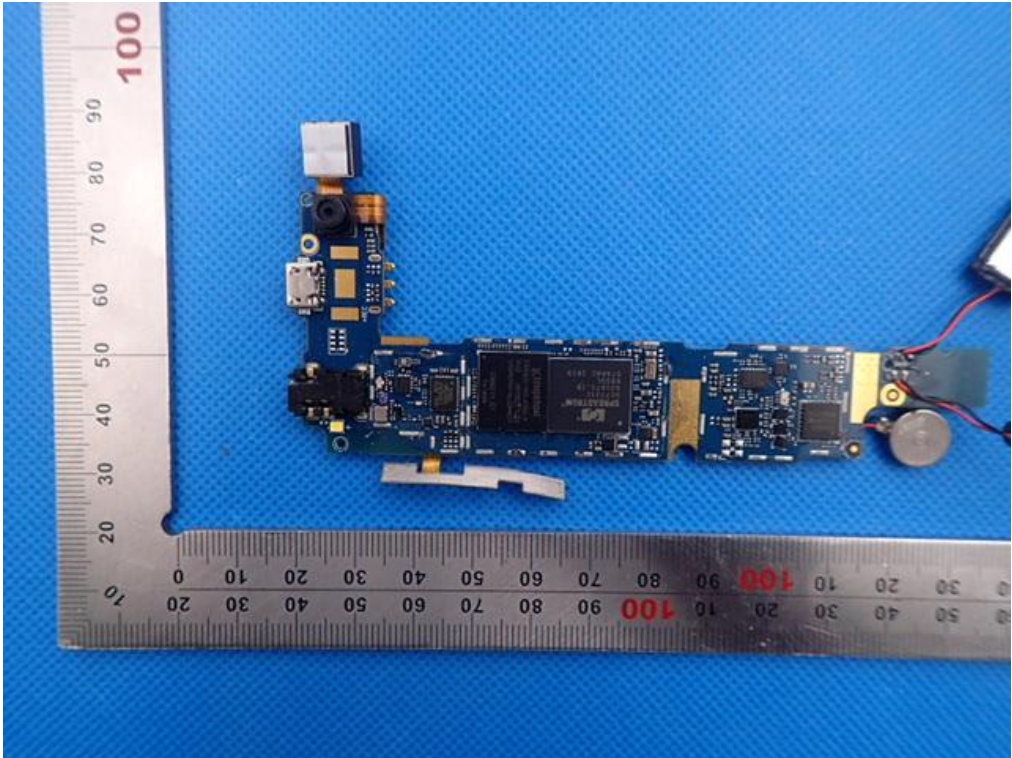

----END OF REPORT----