



TEST REPORT

Report Reference No...... : **TRE1511007603** R/C.....: 46077
FCC ID..... : **2ABOSGCSKYFUEGO50D**
Applicant's name..... : **Sky Phone LLC**
 Address..... : 1348 Washington Av. #350, Miami Beach FL. 33139
 Manufacturer..... : DongGuan Tenexon Communication Technology Co., Ltd.
 Address..... : L1 - L3, Block A, Building B, KeYuan 9th Road No. 1, Tangxia Town, Dongguan City ,Guangdong China.
Test item description : **Smart Phone**
 Trade Mark : SKY
 Model/Type reference..... : Fuego 5.0D
 Listed Model(s)..... : W509
Standard : **FCC CFR Title 47 Part 15 Subpart C Section 15.247**
 Date of receipt of test sample..... : Nov. 16, 2015
 Date of testing..... : Nov. 17, 2015 ~ Nov. 27, 2015
 Date of issue..... : Nov. 28, 2015
Result..... : **PASS**

Compiled by
 (position+printedname+signature)....: File administrators Candy Liu

Candy Liu

Supervised by
 (position+printedname+signature)....: Project Engineer Lion Cai

Lion Cai

Approved by
 (position+printedname+signature)....: RF Manager Hans Hu

Hans Hu

Testing Laboratory Name : **Shenzhen Huatongwei International Inspection Co., Ltd**
 Address..... : 1/F, Bldg 3, Hongfa Hi-tech Industrial Park, Genyu Road, Tianliao, Gongming, Shenzhen, China

Shenzhen Huatongwei International Inspection Co., Ltd. All rights reserved.

This publication may be reproduced in whole or in part for non-commercial purposes as long as the Shenzhen Huatongwei International Inspection Co., Ltd is acknowledged as copyright owner and source of the material. Shenzhen Huatongwei International Inspection Co., Ltd takes no responsibility for and will not assume liability for damages resulting from the reader's interpretation of the reproduced material due to its placement and context.

Contents

1.	<u>TEST STANDARDS AND TEST DESCRIPTION</u>	3
1.1.	Test Standards	3
1.2.	Test Description	3
2.	<u>SUMMARY</u>	4
2.1.	Client Information	4
2.2.	Product Description	4
2.3.	Operation state	5
2.4.	EUT configuration	5
2.5.	Modifications	5
3.	<u>TEST ENVIRONMENT</u>	6
3.1.	Address of the test laboratory	6
3.2.	Test Facility	6
3.3.	Environmental conditions	7
3.4.	Statement of the measurement uncertainty	7
3.5.	Equipments Used during the Test	8
4.	<u>TEST CONDITIONS AND RESULTS</u>	9
4.1.	Antenna requirement	9
4.2.	Conducted Emission (AC Main)	10
4.3.	Conducted Peak Output Power	15
4.4.	20dB Emission Bandwidth	18
4.5.	Carrier Frequencies Separation	21
4.6.	Hopping Channel Number	23
4.7.	Dwell Time	25
4.8.	Pseudorandom Frequency Hopping Sequence	28
4.9.	Restricted band (radiated)	29
4.10.	Bandedge and Spurious Emission (conducted)	31
4.11.	Spurious Emission (radiated)	41
5.	<u>TEST SETUP PHOTOS OF THE EUT</u>	47
6.	<u>EXTERNAL AND INTERNAL PHOTOS OF THE EUT</u>	49

1. TEST STANDARDS AND TEST DESCRIPTION

1.1. Test Standards

The tests were performed according to following standards:

[FCC Rules Part 15.247](#): Frequency Hopping, Direct Spread Spectrum and Hybrid Systems that are in operation within the bands of 902-928 MHz, 2400-2483.5 MHz, and 5725-5850 MHz.

[ANSI C63.10-2013](#): American National Standard for Testing Unlicensed Wireless Devices

1.2. Test Description

ReportSection	Test Item	Section in CFR 47	Result
4.1	Antenna Requirement	15.203/15.247 (c)	Pass
4.2	AC Power Line Conducted Emission	15.207	Pass
4.3	Conducted Peak Output Power	15.247 (b)(1)	Pass
4.4	20dB Occupied Bandwidth	15.247 (a)(1)	Pass
4.5	Carrier Frequencies Separation	15.247 (a)(1)	Pass
4.6	Hopping Channel Number	15.247 (a)(1)	Pass
4.7	Dwell Time	15.247 (a)(1)	Pass
4.8	Pseudorandom Frequency Hopping Sequence	15.247(b)(4)&TCB Exclusion List (7 July 2002)	Pass
4.9	Restricted band	15.247(d)/15.205	Pass
4.10/4.11	Radiated Emission	15.247(d)/15.209	Pass

Remark: The measurement uncertainty is not included in the test result.

2. SUMMARY

2.1. Client Information

Applicant:	Sky Phone LLC
Address:	1348 Washington Av. #350, Miami Beach FL. 33139
Manufacturer:	DongGuan Tenexon Communication Technology Co., Ltd.
Address:	L1 - L3, Block A, Building B, KeYuan 9th Road No. 1, Tangxia Town, Dongguan City ,Guangdong China.

2.2. Product Description

Name of EUT	Smart Phone
Trade Mark:	SKY
Model No.:	Fuego 5.0D
Listed Model(s):	W509
IMEI1:	358228054952654
IMEI2:	358228054958748
Power supply:	DC 3.8V From internal battery
Adapter information:	Model:Fuego 5.0D Input:AC 100-240V 50/60Hz 0.2A Output: 5Vd.c., 1.0A
Bluetooth	
Version:	Supported BT3.0+EDR
Modulation:	GFSK, $\pi/4$ DQPSK, 8DPSK
Operation frequency:	2402MHz~2480MHz
Channel number:	79
Channel separation:	1MHz
Antenna type:	Internal Antenna
Antenna gain:	1.0 dBi

Remark:Test model and list model are not different,except model name.

2.3. Operation state

◆ Test frequency list

According to section 15.31(m), regards to the operating frequency range over 10 MHz, must select three channel which were tested. the Lowest frequency, the middle frequency, and the highest frequency of channel were selected to perform the test, please see the above gray bottom.

Channel	Frequency (MHz)
0	2402
1	2403
⋮	⋮
39	2441
⋮	⋮
77	2479
78	2480

◆ Test mode

For RF test items:

the engineering test program was provided and enabled to make EUT continuous transmit/receive.

For AC power line conducted emissions:

the EUT was set to connect with the Bluetooth under large package sizes transmission.

2.4. EUT configuration

The following peripheral devices and interface cables were connected during the measurement:

● - supplied by the manufacturer

○ - supplied by the lab

<input type="radio"/>	Power Cable	Length (m) :	/
		Shield :	/
		Detachable :	/
<input type="radio"/>	Multimeter	Manufacturer :	/
		Model No. :	/

2.5. Modifications

No modifications were implemented to meet testing criteria.

3. TEST ENVIRONMENT

3.1. Address of the test laboratory

Laboratory: Shenzhen Huatongwei International Inspection Co., Ltd.

Address: 1/F, Bldg 3, Hongfa Hi-tech Industrial Park, Genyu Road, Tianliao, Gongming, Shenzhen, China

Phone: 86-755-26748019 Fax: 86-755-26748089

3.2. Test Facility

The test facility is recognized, certified, or accredited by the following organizations:

CNAS-Lab Code: L1225

Shenzhen Huatongwei International Inspection Co., Ltd. has been assessed and proved to be in compliance with CNAS-CL01 Accreditation Criteria for Testing and Calibration Laboratories (identical to ISO/IEC17025: 2005 General Requirements) for the Competence of Testing and Calibration Laboratories, Date of Registration: February 28, 2015. Valid time is until February 27, 2018.

A2LA-Lab Cert. No. 3902.01

Shenzhen Huatongwei International Inspection Co., Ltd. EMC Laboratory has been accredited by A2LA for technical competence in the field of electrical testing, and proved to be in compliance with ISO/IEC 17025: 2005 General Requirements for the Competence of Testing and Calibration Laboratories and any additional program requirements in the identified field of testing. Valid time is until December 31, 2016.

FCC-Registration No.: 317478

Shenzhen Huatongwei International Inspection Co., Ltd. EMC Laboratory has been registered and fully described in a report filed with the FCC (Federal Communications Commission). The acceptance letter from the FCC is maintained in our files. Registration 317478, Renewal date Jul. 18, 2014, valid time is until Jul. 18, 2017.

IC-Registration No.: 5377A&5377B

The 3m Alternate Test Site of Shenzhen Huatongwei International Inspection Co., Ltd. has been registered by Certification and Engineering Bureau of Industry Canada for the performance of radiated measurements with Registration No. 5377A on Dec. 31, 2013, valid time is until Dec. 31, 2016.

Two 3m Alternate Test Site of Shenzhen Huatongwei International Inspection Co., Ltd. has been registered by Certification and Engineering Bureau of Industry Canada for the performance of radiated measurements with Registration No. 5377B on Dec.03, 2014, valid time is until Dec.03, 2017.

ACA

Shenzhen Huatongwei International Inspection Co., Ltd. EMC Laboratory can also perform testing for the Australian C-Tick mark as a result of our A2LA accreditation.

VCCI

The 3m Semi-

anechoic chamber (12.2m×7.95m×6.7m) of Shenzhen Huatongwei International Inspection Co., Ltd.

has been registered in accordance with the Regulations for Voluntary Control Measures with Registration No.: R-2484. Date of Registration: Dec. 20, 2012. Valid time is until Dec. 29, 2015.

Radiated disturbance above 1GHz measurement of Shenzhen Huatongwei International Inspection Co., Ltd. has been registered in accordance with the Regulations for Voluntary Control Measures with Registration No.: G-292. Date of Registration: Dec. 24, 2013. Valid time is until Dec. 23, 2016.

Main Ports Conducted Interference Measurement of Shenzhen Huatongwei International Inspection Co., Ltd. has been registered in accordance with the Regulations for Voluntary Control Measures with Registration No.: C-2726. Date of Registration: Dec. 20, 2012. Valid time is until Dec. 19, 2015.

Telecommunication Ports Conducted Interference Measurement of Shenzhen Huatongwei International Inspection Co., Ltd. has been registered in accordance with the Regulations for Voluntary Control Measures with Registration No.: T-1837. Date of Registration: May 07, 2013. Valid time is until May 06, 2016.

DNV

Shenzhen Huatongwei International Inspection Co., Ltd. has been found to comply with the requirements of DNV towards subcontractor of EMC and safety testing services in conjunction with the EMC and Low voltage Directives and in the voluntary field. The acceptance is based on a formal quality Audit and follow-ups according to relevant parts of ISO/IEC Guide 17025 (2005), in accordance with the requirements of the DNV Laboratory Quality Manual towards subcontractors. Valid time is until Aug. 24, 2016.

3.3. Environmental conditions

During the measurement the environmental conditions were within the listed ranges:

Temperature:	15~35°C
Relative Humidity:	30~60 %
Air Pressure:	950~1050mba

3.4. Statement of the measurement uncertainty

The data and results referenced in this document are true and accurate. The reader is cautioned that there may be errors within the calibration limits of the equipment and facilities. The measurement uncertainty was calculated for all measurements listed in this test report acc. to TR-100028-01 "Electromagnetic compatibility and Radio spectrum Matters (ERM); Uncertainties in the measurement of mobile radio equipment characteristics; Part 1" and TR-100028-02 "Electromagnetic compatibility and Radio spectrum Matters (ERM); Uncertainties in the measurement of mobile radio equipment characteristics; Part 2" and is documented in the Shenzhen Huatongwei International Inspection Co., Ltd quality system acc. to DIN EN ISO/IEC 17025. Furthermore, component and process variability of devices similar to that tested may result in additional deviation. The manufacturer has the sole responsibility of continued compliance of the device.

Hereafter the best measurement capability for Shenzhen Huatongwei laboratory is reported:

Test Items	Measurement Uncertainty	Notes
Transmitter power conducted	0.57 dB	(1)
Transmitter power Radiated	2.20 dB	(1)
Conducted spurious emission 9KHz-40 GHz	1.60 dB	(1)
Radiated spurious emission 9KHz-40 GHz	2.20 dB	(1)
Conducted Emission 9KHz-30MHz	3.39 dB	(1)
Radiated Emission 30~1000MHz	4.24 dB	(1)
Radiated Emission 1~18GHz	5.16 dB	(1)
Radiated Emission 18-40GHz	5.54 dB	(1)
Occupied Bandwidth	-----	(1)

(1) This uncertainty represents an expanded uncertainty expressed at approximately the 95% confidence level using a coverage factor of $k=1.96$.

3.5. Equipments Used during the Test

Conducted Emission (AC Main)					
Item	Test Equipment	Manufacturer	Model No.	Serial No.	Last Cal
1	Artificial Mains	Rohde&Schwarz	ESH2-Z5	100028	2015/11/02
2	EMI Test Receiver	Rohde&Schwarz	ESCI3	100038	2015/11/02
3	Pulse Limiter	Rohde&Schwarz	ESHSZ2	100044	2015/11/02
4	EMI Test Software	Rohde&Schwarz	ES-K1 V1.71	N/A	N/A

Radiated Emission					
Item	Test Equipment	Manufacturer	Model No.	Serial No.	Last Cal
1	Ultra-Broadband Antenna	ShwarzBeck	VULB9163	538	2015/11/02
2	EMI TEST RECEIVER	Rohde&Schwarz	ESI 26	100009	2015/11/02
3	EMI TEST Software	Audix	E3	N/A	N/A
4	TURNTABLE	ETS	2088	2149	N/A
5	ANTENNA MAST	ETS	2075	2346	N/A
6	EMI TEST Software	Rohde&Schwarz	ESK1	N/A	N/A
7	HORNANTENNA	ShwarzBeck	9120D	1011	2015/11/02
8	Amplifer	Sonoma	310N	E009-13	2015/11/02
9	JS amplifier	Rohde&Schwarz	JS4-00101800-28-5A	F201504	2015/11/02
10	High pass filter	Compliance Direction systems	BSU-6	34202	2015/11/02
11	HORNANTENNA	ShwarzBeck	9120D	1012	2015/11/02
12	Amplifer	Compliance Direction systems	PAP1-4060	120	2015/11/02
13	Loop Antenna	Rohde&Schwarz	HFH2-Z2	100020	2015/11/02
14	TURNTABLE	MATURO	TT2.0	----	N/A
15	ANTENNA MAST	MATURO	TAM-4.0-P	----	N/A
16	Horn Antenna	SCHWARZBECK	BBHA9170	25841	2015/11/02
17	ULTRA-BROADBAND ANTENNA	Rohde&Schwarz	HL562	100015	2015/11/02

Maximum Peak Output Power / Power Spectral Density / 6dB Bandwidth / Band Edge Compliance of RF Emission / Spurious RF Conducted Emission					
Item	Test Equipment	Manufacturer	Model No.	Serial No.	Last Cal
1	Spectrum Analyzer	Rohde&Schwarz	FSP	1164.4391.40	2015/11/02

The Cal.Interval was one year

4. TEST CONDITIONS AND RESULTS

4.1. Antenna requirement

Requirement

FCC CFR Title 47 Part 15 Subpart C Section 15.203:

An intentional radiator shall be designed to ensure that no antenna other than that furnished by the responsible party shall be used with the device. The use of a permanently attached antenna or of an antenna that uses a unique coupling to the intentional radiator, the manufacturer may design the unit so that a broken antenna can be replaced by the user, but the use of a standard antenna jack or electrical connector is prohibited.

FCC CFR Title 47 Part 15 Subpart C Section 15.247(c) (1)(i):

(i) Systems operating in the 2400-2483.5 MHz band that is used exclusively for fixed. Point-to-point operations may employ transmitting antennas with directional gain greater than 6dBi provided the maximum conducted output power of the intentional radiator is reduced by 1 dB for every 3 dB that the directional gain of the antenna exceeds 6dBi.

Test Result:

The antenna is integral antenna, the best case gain of the antenna is 1.0dBi

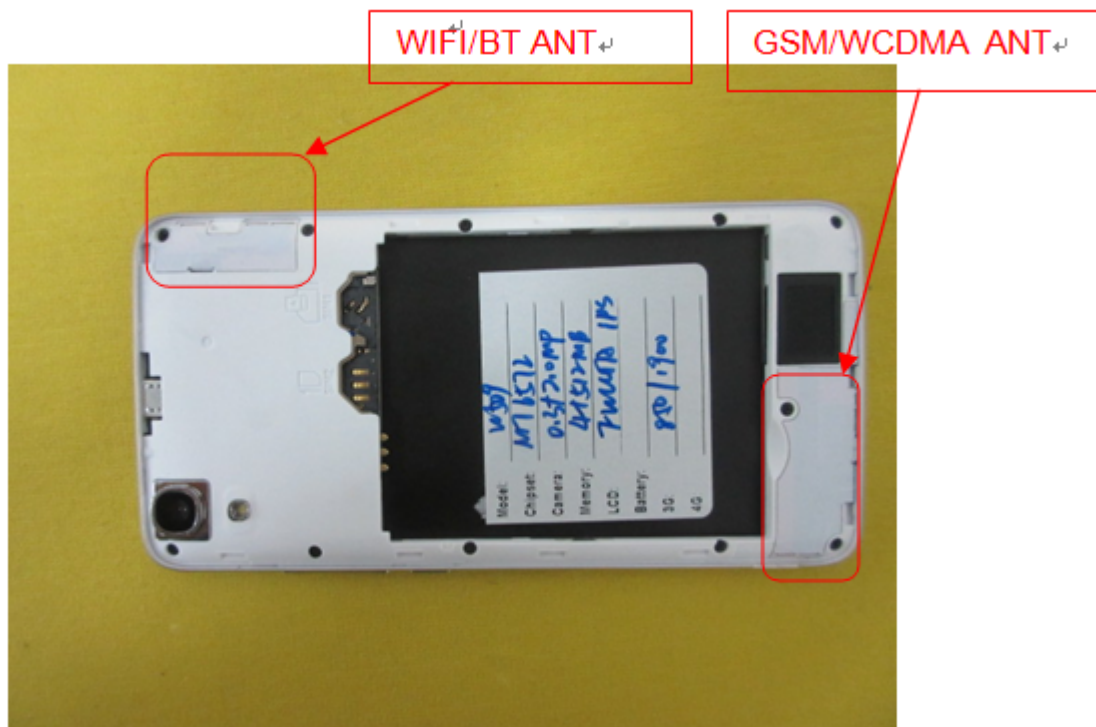

4.2. Conducted Emission (AC Main)

LIMIT

FCC CFR Title 47 Part 15 Subpart C Section 15.207

Frequency range (MHz)	Limit (dBuV)	
	Quasi-peak	Average
0.15-0.5	66 to 56*	56 to 46*
0.5-5	56	46
5-30	60	50

* Decreases with the logarithm of the frequency.

TEST CONFIGURATION

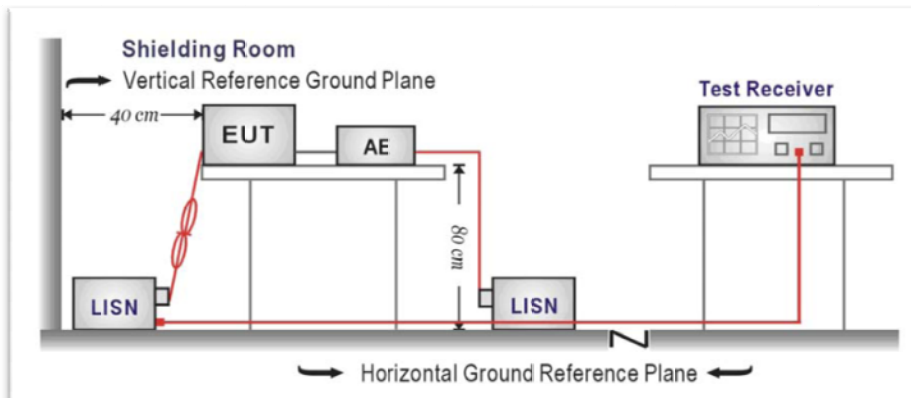

TEST PROCEDURE

1. The EUT was setup and tested according to ANSI C63.10:2013 for compliance to FCC 47CFR 15.247 requirements.
2. The EUT was placed on a platform of nominal size, 1 m by 1.5 m, raised 80 cm above the conducting ground plane. The vertical conducting plane was located 40 cm to the rear of the EUT. All other surfaces of EUT were at least 80 cm from any other grounded conducting surface.
3. The EUT and simulators are connected to the main power through a line impedance stabilization network (LISN). The LISN provides a 50 ohm /50uH coupling impedance for the measuring equipment.
4. The peripheral devices are also connected to the main power through a LISN. (Please refer to the block diagram of the test setup and photographs)
5. Each current-carrying conductor of the EUT power cord, except the ground (safety) conductor, was individually connected through a LISN to the input power source.
6. The excess length of the power cord between the EUT and the LISN receptacle were folded back and forth at the center of the lead to form a bundle not exceeding 40 cm in length.
7. Conducted emissions were investigated over the frequency range from 0.15MHz to 30MHz using a receiver bandwidth of 9 kHz.

TEST RESULTS

Test mode:AC 120V	BT	Polarization	L
-------------------	----	--------------	---

SCAN TABLE: "Voltage (9K-30M)FIN"

Short Description: 150K-30M Voltage

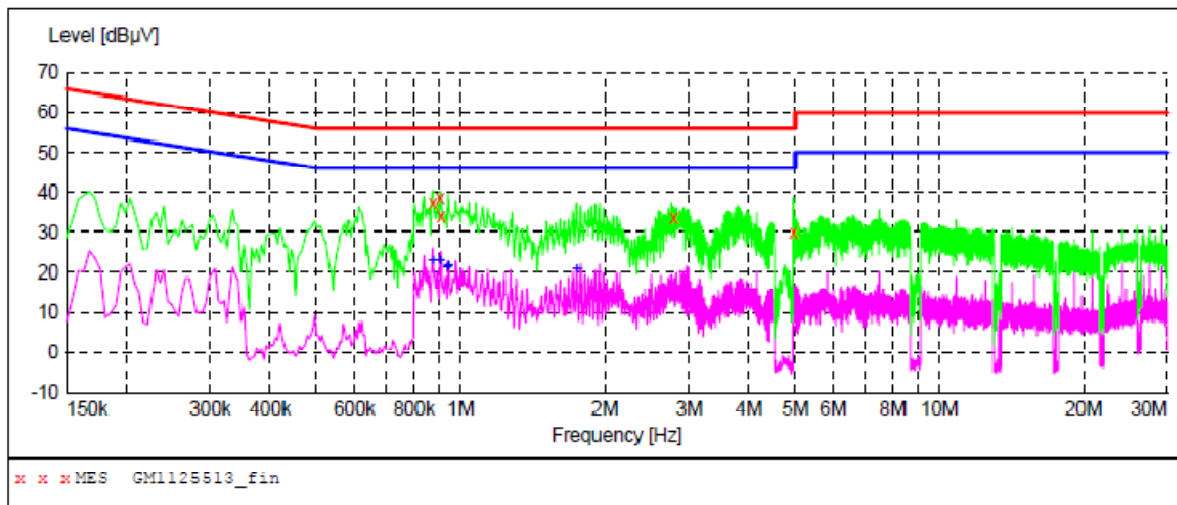

MEASUREMENT RESULT: "GM1125513_fin"

11/25/2015 1:49PM

Frequency MHz	Level dBµV	Transd dB	Limit dBµV	Margin dB	Detector	Line	PE
0.874500	37.30	10.2	56	18.7	QP	L1	GND
0.906000	38.50	10.2	56	17.5	QP	L1	GND
0.910500	34.10	10.2	56	21.9	QP	L1	GND
2.787000	33.80	10.3	56	22.2	QP	L1	GND
4.956000	30.00	10.4	56	26.0	QP	L1	GND

MEASUREMENT RESULT: "GM1125513_fin2"

11/25/2015 1:49PM

Frequency MHz	Level dBµV	Transd dB	Limit dBµV	Margin dB	Detector	Line	PE
0.874500	22.90	10.2	46	23.1	AV	L1	GND
0.906000	22.90	10.2	46	23.1	AV	L1	GND
0.937500	21.30	10.2	46	24.7	AV	L1	GND
0.942000	21.70	10.2	46	24.3	AV	L1	GND
1.747500	20.60	10.2	46	25.4	AV	L1	GND

Test mode: AC 120V	BT	Polarization	N
--------------------	----	--------------	---

SCAN TABLE: "Voltage (9K-30M) FIN"

Short Description: 150K-30M Voltage

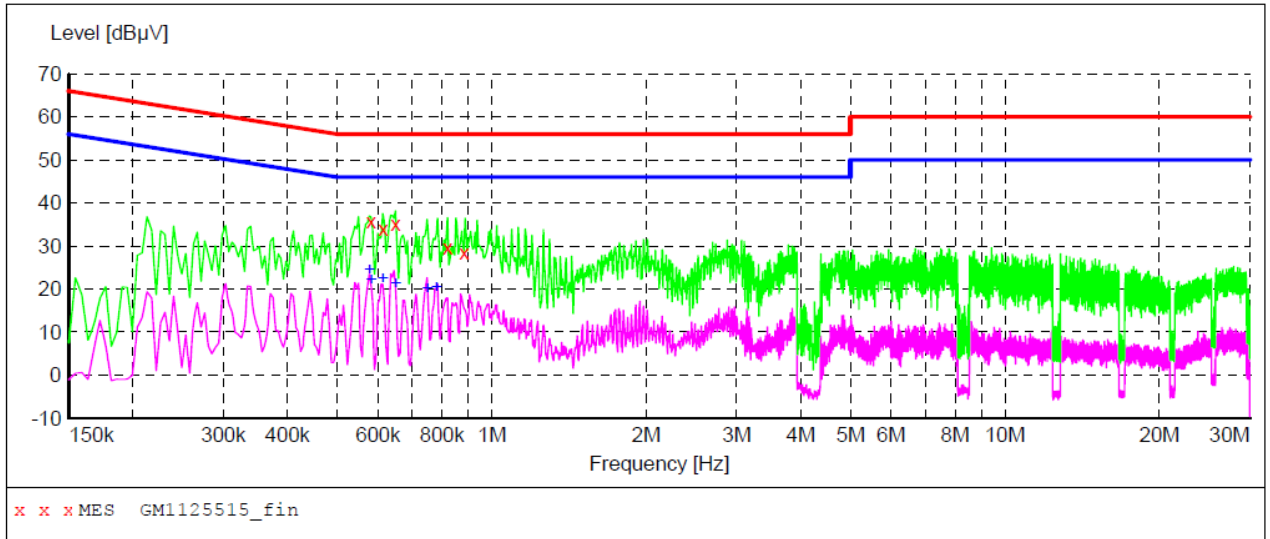

MEASUREMENT RESULT: "GM1125515_fin"

11/25/2015 1:58PM

Frequency MHz	Level dBµV	Transd dB	Limit dBµV	Margin dB	Detector	Line	PE
0.582000	35.70	10.2	56	20.3	QP	N	GND
0.613500	34.00	10.2	56	22.0	QP	N	GND
0.649500	35.00	10.2	56	21.0	QP	N	GND
0.820500	29.60	10.2	56	26.4	QP	N	GND
0.883500	28.50	10.2	56	27.5	QP	N	GND

MEASUREMENT RESULT: "GM1125515_fin2"

11/25/2015 1:58PM

Frequency MHz	Level dBµV	Transd dB	Limit dBµV	Margin dB	Detector	Line	PE
0.577500	24.30	10.2	46	21.7	AV	N	GND
0.582000	21.90	10.2	46	24.1	AV	N	GND
0.613500	22.30	10.2	46	23.7	AV	N	GND
0.649500	21.30	10.2	46	24.7	AV	N	GND
0.748500	20.10	10.2	46	25.9	AV	N	GND
0.780000	20.40	10.2	46	25.6	AV	N	GND

Test mode:AC 240V	BT	Polarization	L
-------------------	----	--------------	---

SCAN TABLE: "Voltage (9K-30M)FIN"
 Short Description: 150K-30M Voltage

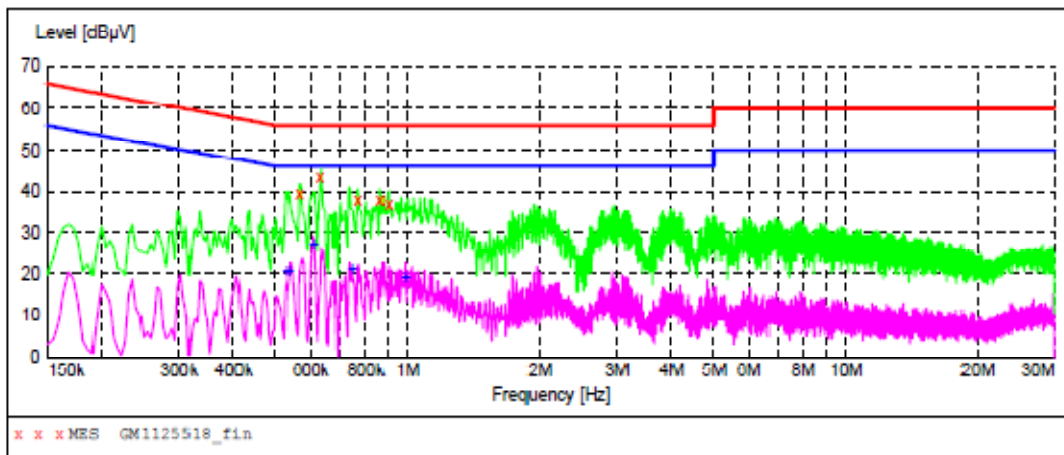

MEASUREMENT RESULT: "GM1125518_fin"

11/25/2015 2:11PM

Frequency MHz	Level dBuV	Transd dB	Limit dBuV	Margin dB	Detector	Line	PE
0.564000	39.70	10.2	56	16.3	QP	L1	GND
0.631500	43.50	10.2	56	12.5	QP	L1	GND
0.766800	39.40	10.2	56	17.6	QP	L1	GND
0.865500	38.00	10.2	56	18.0	QP	L1	GND
0.901500	37.30	10.2	56	18.7	QP	L1	GND

MEASUREMENT RESULT: "GM1125518_fin2"

11/25/2015 2:11PM

Frequency MHz	Level dBuV	Transd dB	Limit dBuV	Margin dB	Detector	Line	PE
0.532500	21.00	10.2	46	25.0	AV	L1	GND
0.609000	27.50	10.2	46	18.5	AV	L1	GND
0.744000	21.10	10.2	46	24.9	AV	L1	GND
0.987000	19.10	10.2	46	26.9	AV	L1	GND

Test mode: AC 240V	BT	Polarization	N
--------------------	----	--------------	---

SCAN TABLE: "Voltage (9K-30M) FIN"

Short Description: 150K-30M Voltage

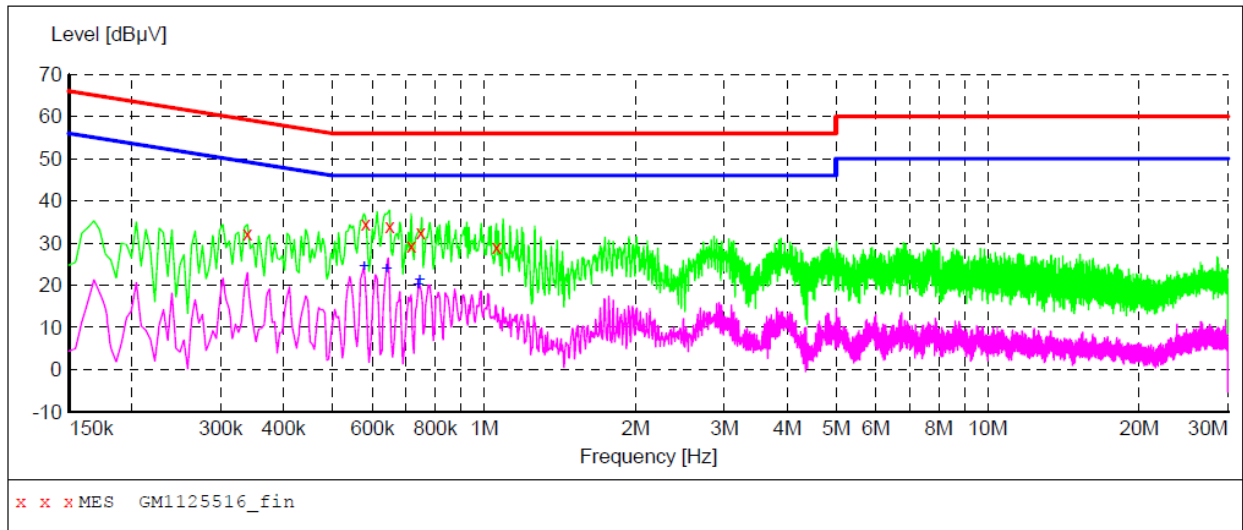

MEASUREMENT RESULT: "GM1125516_fin"

11/25/2015 2:03PM

Frequency MHz	Level dBµV	Transd dB	Limit dBµV	Margin dB	Detector	Line	PE
0.339000	32.30	10.2	59	26.9	QP	N	GND
0.582000	34.50	10.2	56	21.5	QP	N	GND
0.649500	33.80	10.2	56	22.2	QP	N	GND
0.717000	29.40	10.2	56	26.6	QP	N	GND
0.748500	32.60	10.2	56	23.4	QP	N	GND
1.059000	28.90	10.2	56	27.1	QP	N	GND

MEASUREMENT RESULT: "GM1125516_fin2"

11/25/2015 2:03PM

Frequency MHz	Level dBµV	Transd dB	Limit dBµV	Margin dB	Detector	Line	PE
0.577500	24.50	10.2	46	21.5	AV	N	GND
0.640500	23.80	10.2	46	22.2	AV	N	GND
0.739500	20.00	10.2	46	26.0	AV	N	GND
0.744000	21.20	10.2	46	24.8	AV	N	GND

4.3. Conducted Peak Output Power

LIMIT

FCC CFR Title 47 Part 15 Subpart C Section 15.247 (b)(3): **30dBm**

TEST CONFIGURATION

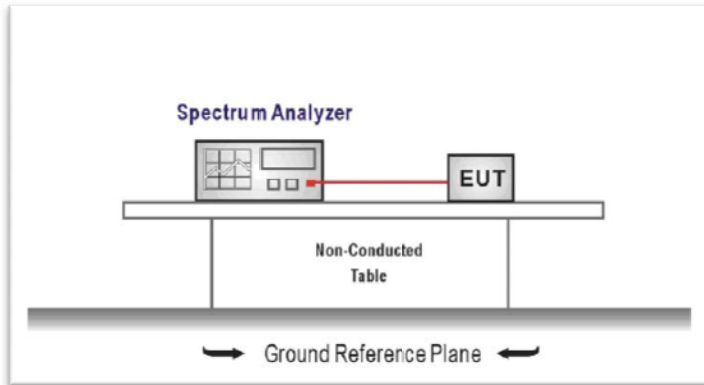

TEST PROCEDURE

Remove the antenna from the EUT and then connect a low loss RF cable from the antenna port to the spectrum.

TEST RESULTS

Modulation type	Channel	Output power (dBm)	Limit (dBm)	Result
GFSK	00	3.51	30.00	Pass
	39	4.04		
	78	3.98		
π/4DQPSK	00	2.88	21.00	Pass
	39	3.28		
	78	3.22		
8DPSK	00	2.86	21.00	Pass
	39	3.23		
	78	3.09		

Test plot as follows:

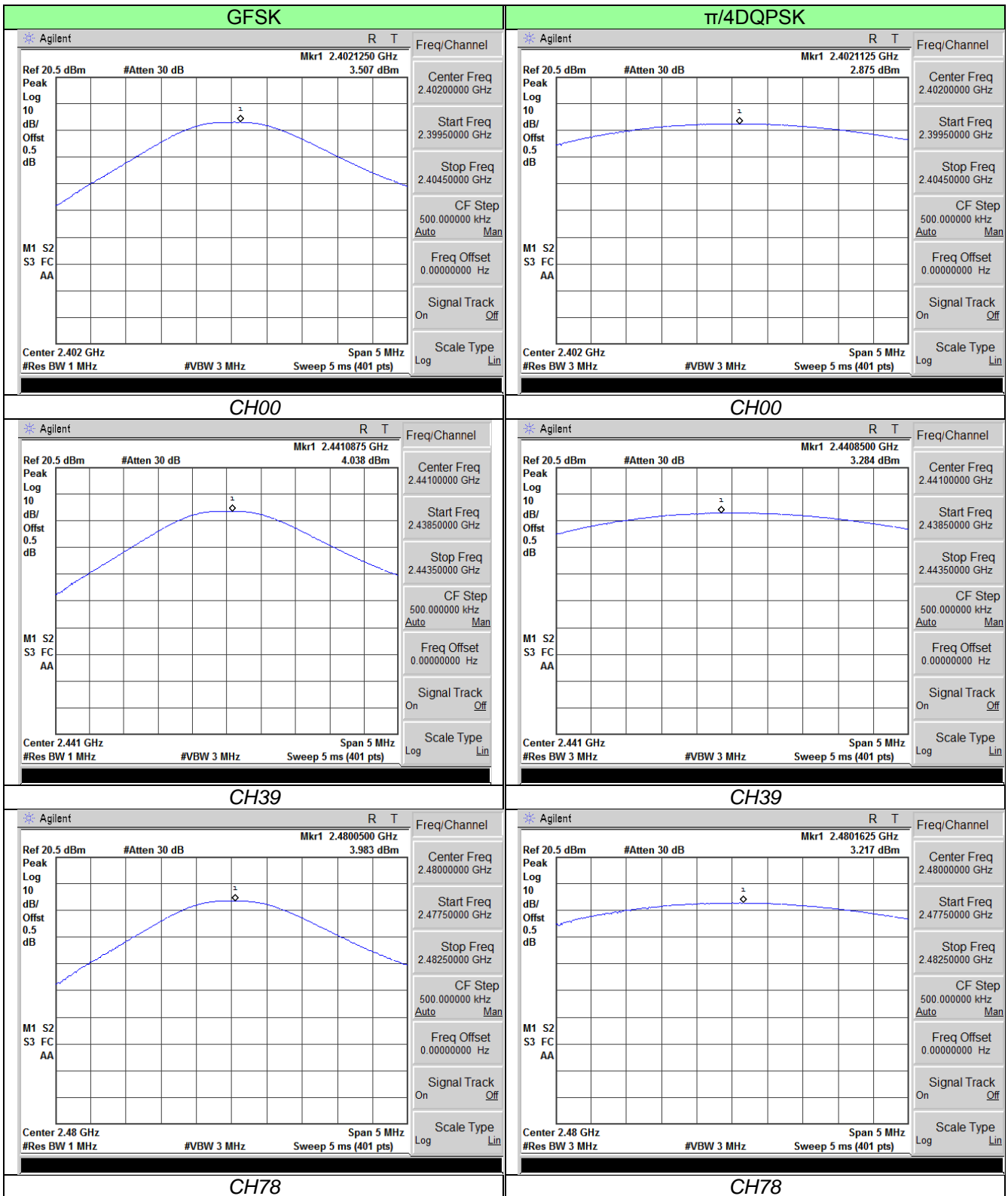

8DPSK

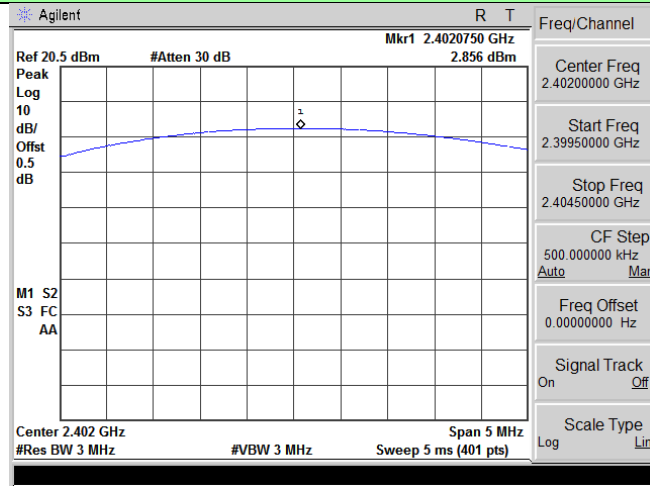

CH00

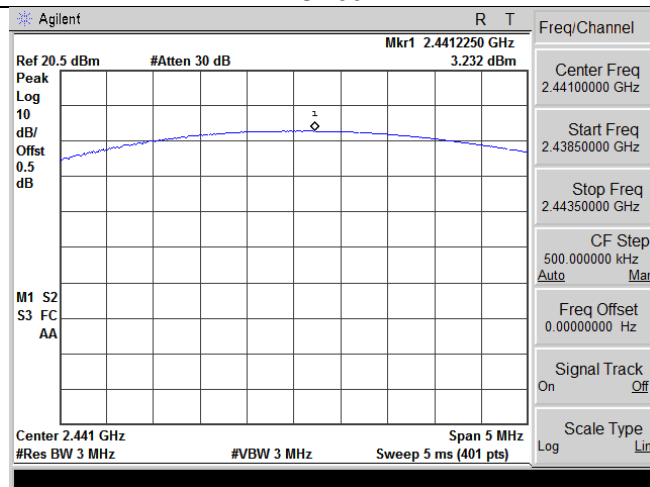

CH39

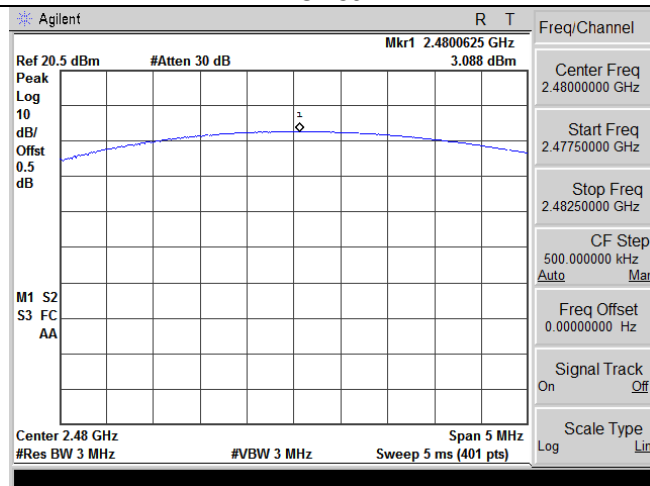

CH78

4.4. 20dB Emission Bandwidth

LIMIT

N/A

TEST CONFIGURATION

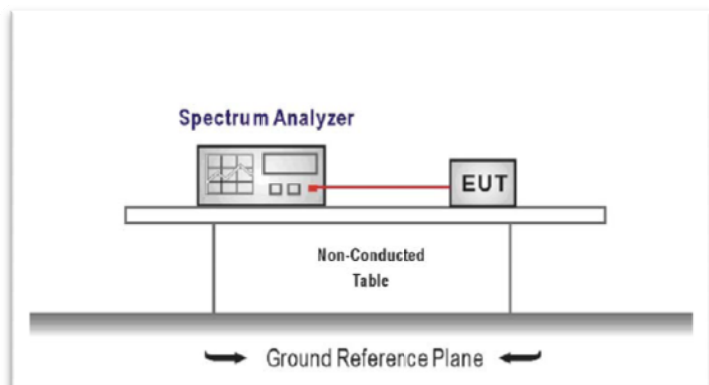

TEST PROCEDURE

1. The transmitter output was connected to the spectrum analyzer through an attenuator.
2. The bandwidth of the fundamental frequency was measured by spectrum analyzer with $RBW \geq 1\%$ of the 20 dB bandwidth and $VBW \geq RBW$.
3. The 20dB bandwidth is defined as the total spectrum the power of which is higher than peak power minus 20dB.

TEST RESULTS

Modulation type	Channel	20dB Bandwidth (MHz)	Limit (MHz)	Result
GFSK	00	0.810	/	Pass
	39	0.806		
	78	0.813		
$\pi/4$ DQPSK	00	1.143	/	Pass
	39	1.139		
	78	1.140		
8DPSK	00	1.161	/	Pass
	39	1.166		
	78	1.161		

Test plot as follows:

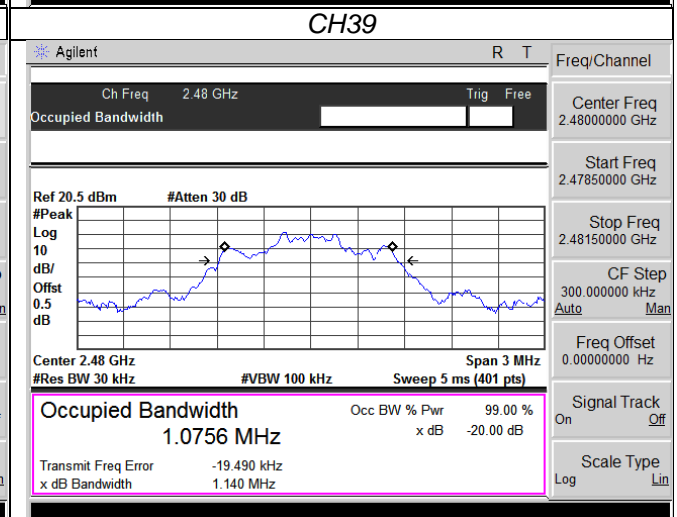
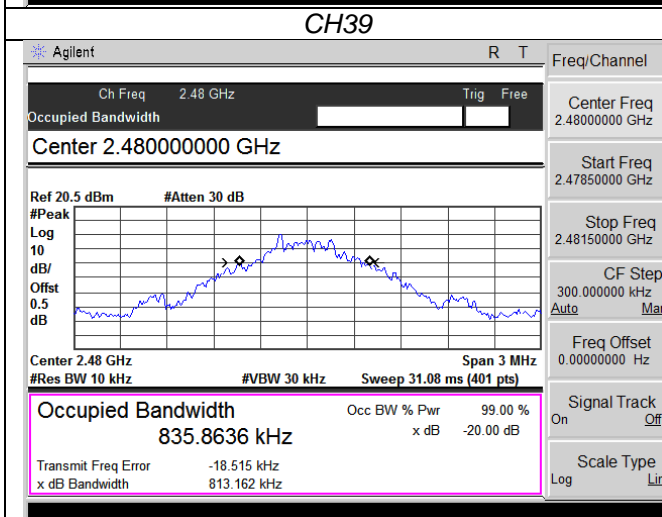
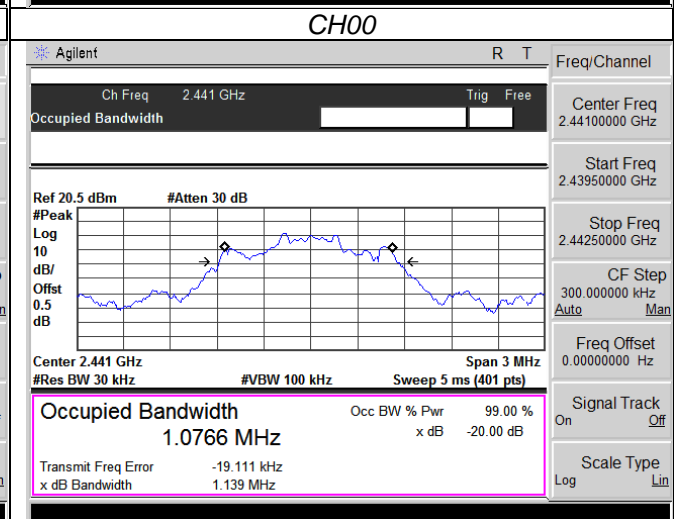
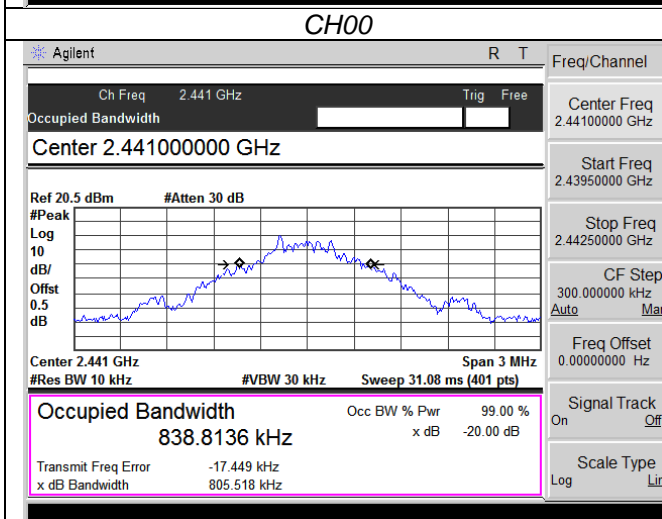
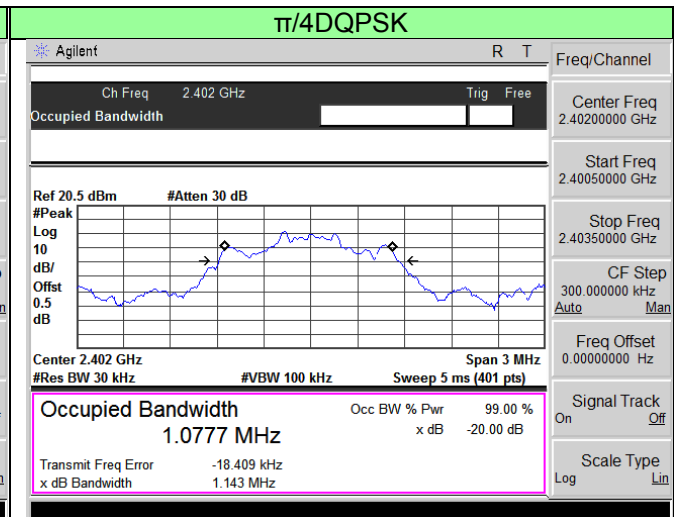
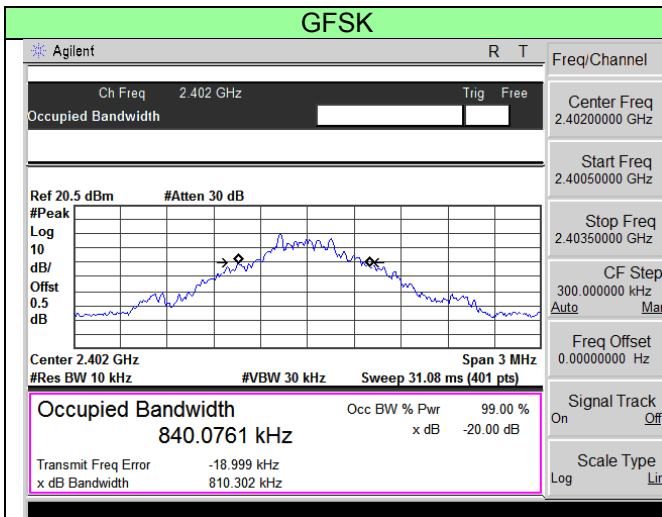

CH78

CH78

8DPSK

Agilent
R T

Ch Freq 2.402 GHz Trig Free
 Occupied Bandwidth [] []

Ref 20.5 dBm #Atten 30 dB

Center 2.402 GHz Span 3 MHz
 #Res BW 30 kHz #VBW 100 kHz Sweep 5 ms (401 pts)

Freq/Channel

Center Freq 2.40200000 GHz

Start Freq 2.40050000 GHz

Stop Freq 2.40350000 GHz

CF Step 300.000000 kHz
Auto Man

Freq Offset 0.00000000 Hz

Signal Track On Off

Scale Type Log Lin

Occupied Bandwidth Occ BW % Pwr 99.00 %
 1.0834 MHz x dB -20.00 dB

Transmit Freq Error -13.191 kHz
 x dB Bandwidth 1.161 MHz

CH00

Agilent
R T

Ch Freq 2.441 GHz Trig Free
 Occupied Bandwidth [] []

Ref 20.5 dBm #Atten 30 dB

Center 2.441 GHz Span 3 MHz
 #Res BW 30 kHz #VBW 100 kHz Sweep 5 ms (401 pts)

Freq/Channel

Center Freq 2.44100000 GHz

Start Freq 2.43950000 GHz

Stop Freq 2.44250000 GHz

CF Step 300.000000 kHz
Auto Man

Freq Offset 0.00000000 Hz

Signal Track On Off

Scale Type Log Lin

Occupied Bandwidth Occ BW % Pwr 99.00 %
 1.0836 MHz x dB -20.00 dB

Transmit Freq Error -13.195 kHz
 x dB Bandwidth 1.166 MHz

CH39

Agilent
R T

Ch Freq 2.48 GHz Trig Free
 Occupied Bandwidth [] []

Ref 20.5 dBm #Atten 30 dB

Center 2.48 GHz Span 3 MHz
 #Res BW 30 kHz #VBW 100 kHz Sweep 5 ms (401 pts)

Trace/View

Trace 1 2 3

Clear Write

Max Hold

Min Hold

View

Blank

More 1 of 2

Occupied Bandwidth Occ BW % Pwr 99.00 %
 1.0830 MHz x dB -20.00 dB

Transmit Freq Error -12.223 kHz
 x dB Bandwidth 1.161 MHz

CH78

4.5. Carrier Frequencies Separation

LIMIT

FCC CFR Title 47 Part 15 Subpart C Section 15.247 (a)(1):
 frequency hopping systems shall have hopping channel carrier frequencies separated by minimum of 25KHz or the $2/3 \cdot 20\text{dB}$ bandwidth of the hopping channel, whichever is greater.

TEST CONFIGURATION

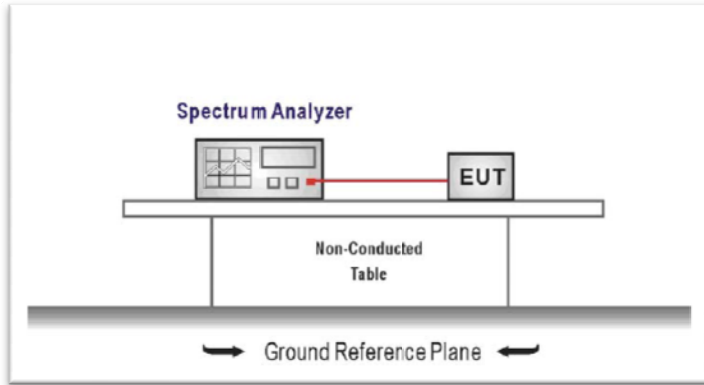

TEST PROCEDURE

1. The transmitter output was connected to the spectrum analyzer through an attenuator.
2. The bandwidth of the fundamental frequency was measured by spectrum analyzer with RBW=30 KHz and VBW=100KHz.

TEST RESULTS

Modulation type	Channel	Carrier Frequencies Separation (MHz)	Limit (MHz)	Result
GFSK	39	1.005	0.880	Pass
$\pi/4$ DQPSK	39	1.000	0.760	Pass
8DPSK	39	1.005	0.774	Pass

Test plot as follows:

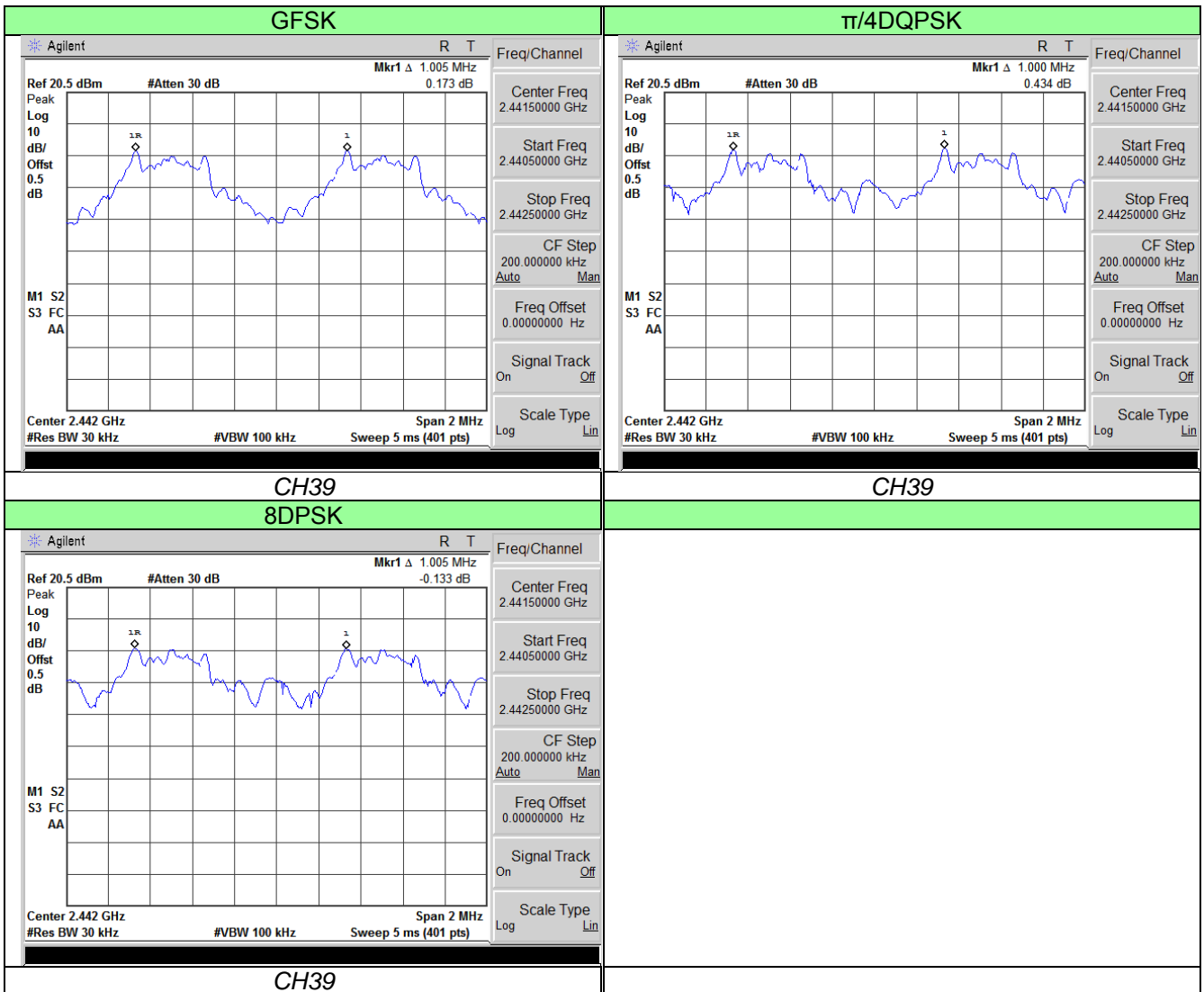

4.6. Hopping Channel Number

LIMIT

FCC CFR Title 47 Part 15 Subpart C Section 15.247 (a)(1):
 Frequency hopping systems in the 2400–2483.5 MHz band shall use at least **15** channels.

TEST CONFIGURATION

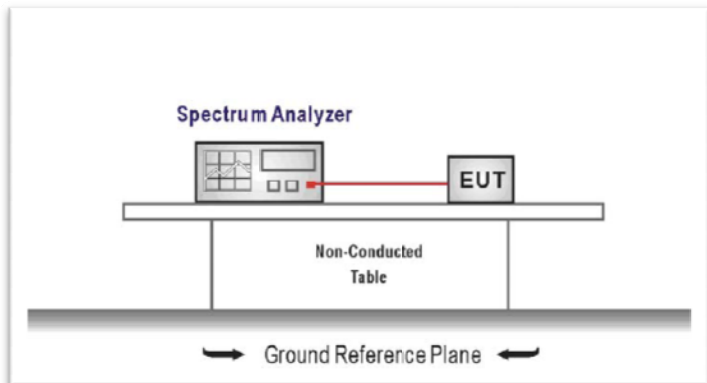

TEST PROCEDURE

1. The transmitter output was connected to the spectrum analyzer through an attenuator.
2. The bandwidth of the fundamental frequency was measured by spectrum analyzer with RBW=1MHz and VBW=3MHz.

TEST RESULTS

Modulation type	Channel number	Limit (MHz)	Result
GFSK	79	15	Pass
$\pi/4$ DQPSK	79		
8DPSK	79		

Test plot as follows:

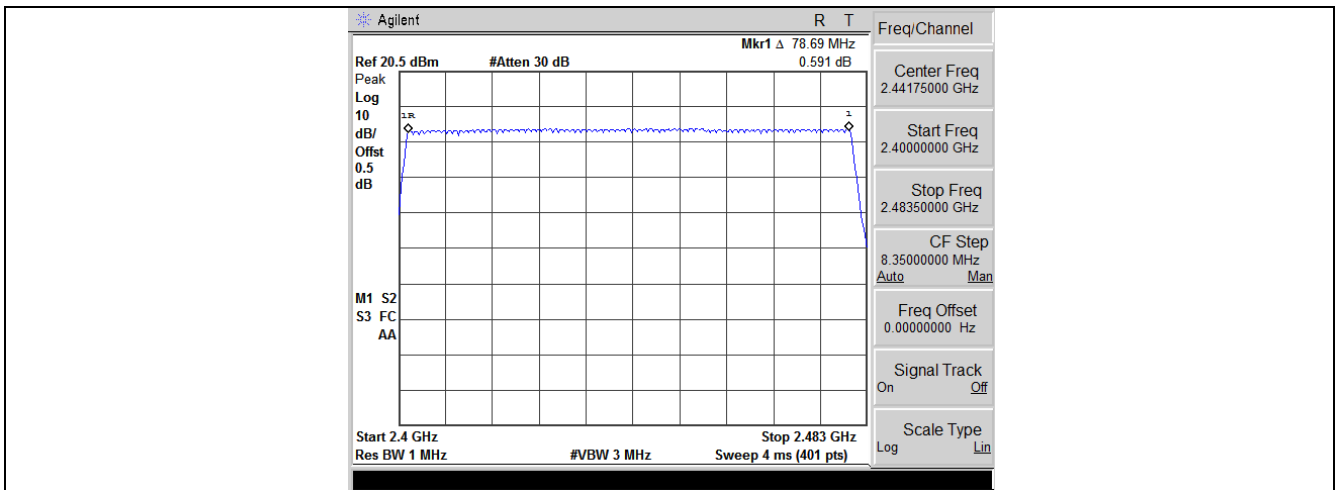

GFSK

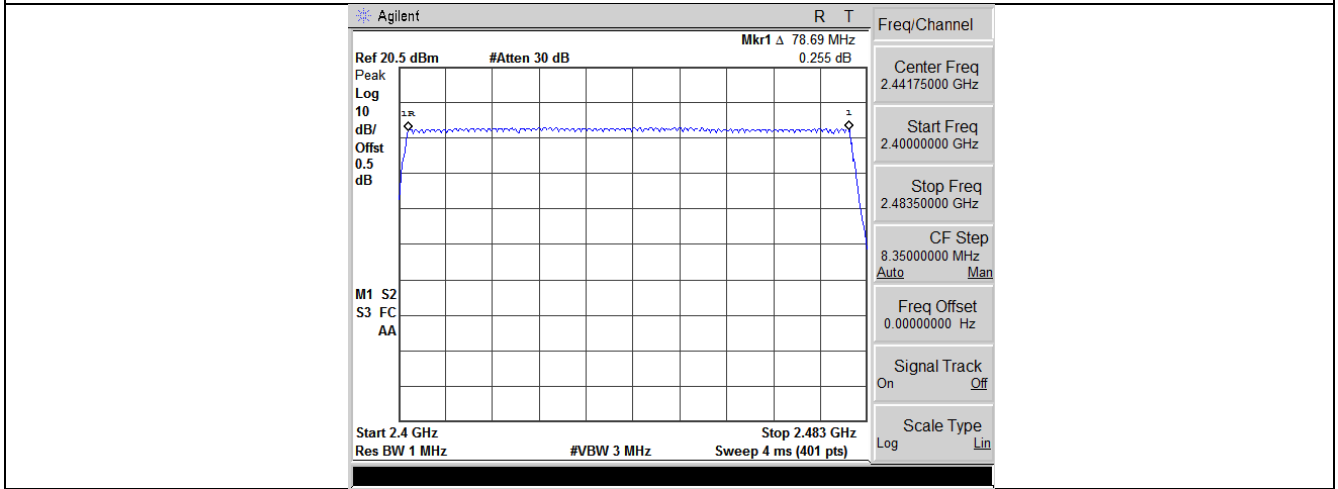

$\pi/4$ DQPSK

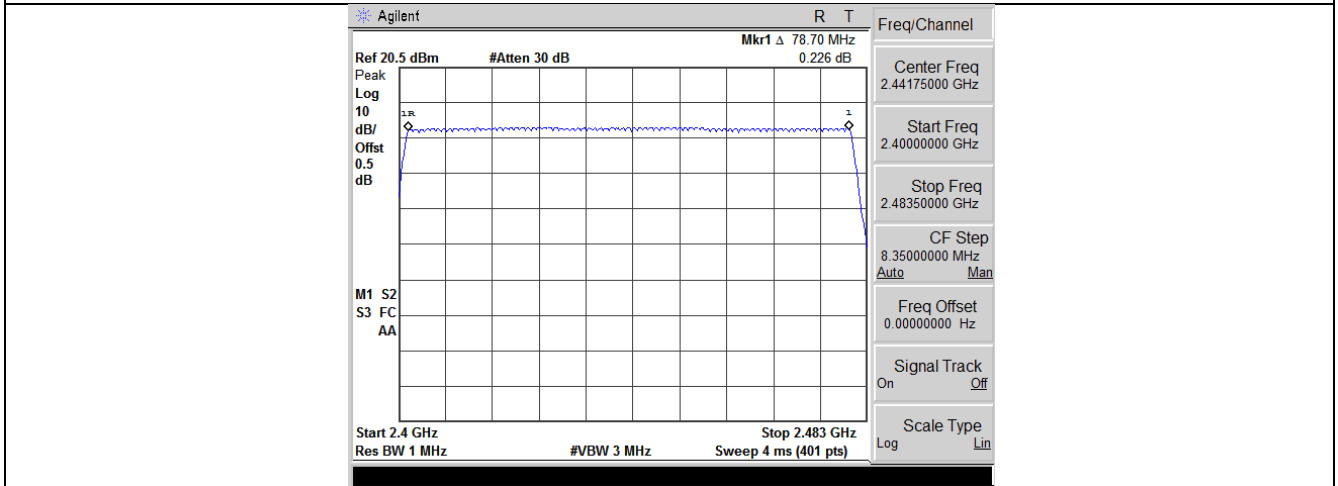

8DPSK

4.7. Dwell Time

LIMIT

FCC CFR Title 47 Part 15 Subpart C Section 15.247 (a)(1):

The average time of occupancy on any channel shall not be greater than 0.4 seconds within a pe-riod of 0.4 seconds multiplied by the number of hopping channels employed.

TEST CONFIGURATION

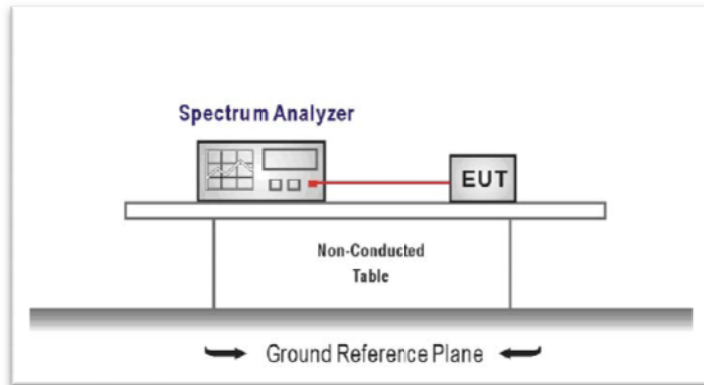

TEST PROCEDURE

1. The transmitter output was connected to the spectrum analyzer through an attenuator.
2. Set center frequency of spectrum analyzer=operating frequency with RBW=1MHz and VBW=1MHz,Span=0Hz.

TEST RESULTS

Modulation type	Channel	Dwell time (Second)	Limit (Second)	Result
GFSK	DH1	0.124	0.40	Pass
	DH3	0.260		
	DH5	0.310		
π/4DQPSK	2-DH1	0.124	0.40	Pass
	2-DH3	0.266		
	2-DH5	0.310		
8DPSK	3-DH1	0.128	0.40	Pass
	3-DH3	0.266		
	3-DH5	0.286		

Note:

1. We have tested all mode at high,middle and low channel,and recoreded worst case at middle channel.
2. Dwell time=Pulse time (ms) × (1600 ÷ 2 ÷ 79) ×31.6 Second for DH1, 2-DH1, 3-DH1
 Dwell time=Pulse time (ms) × (1600 ÷ 4 ÷ 79) ×31.6 Second for DH3, 2-DH3, 3-DH3
 Dwell time=Pulse time (ms) × (1600 ÷ 6 ÷ 79) ×31.6 Second for DH5, 2-DH5, 3-DH5

Test plot as follows:

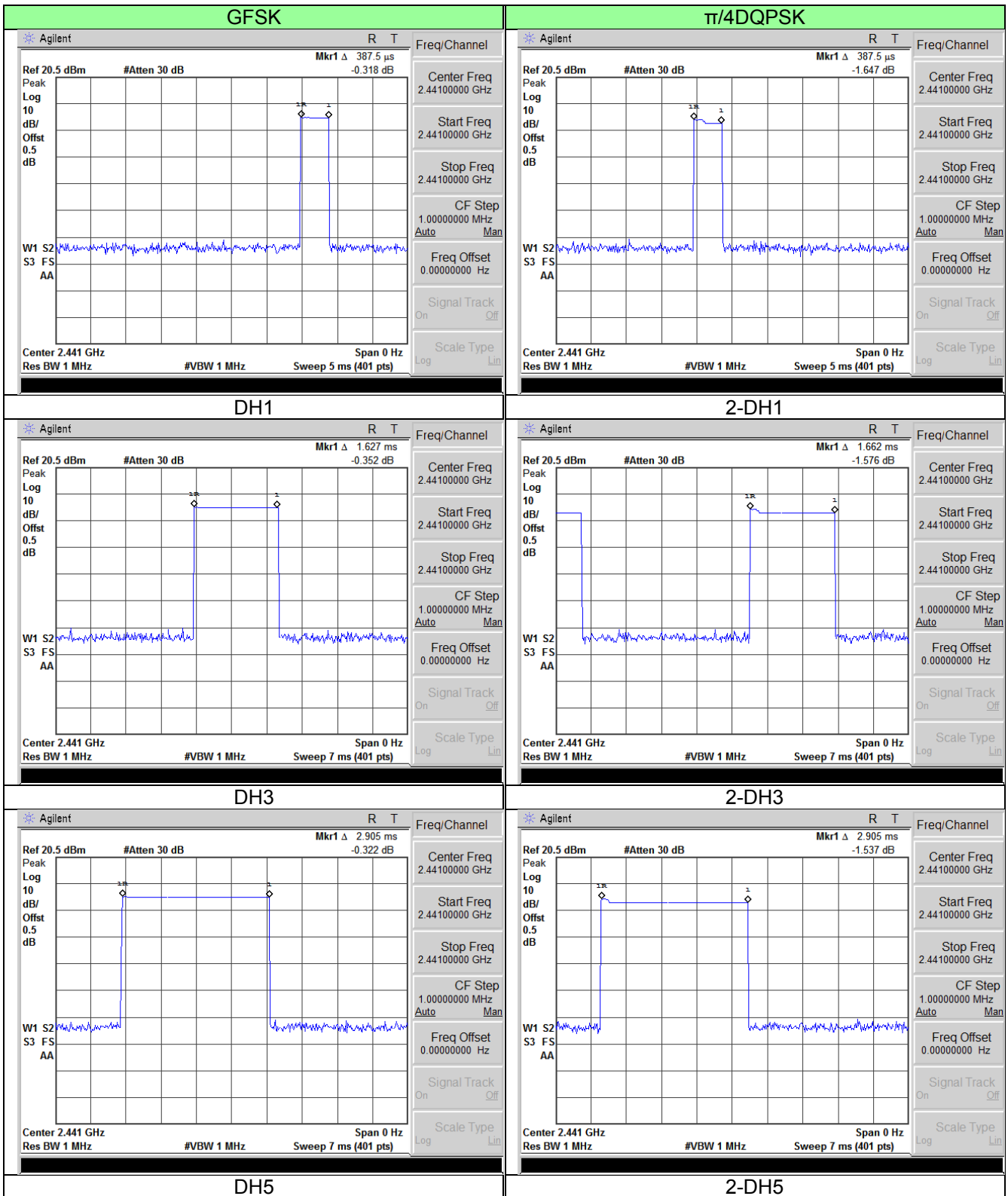

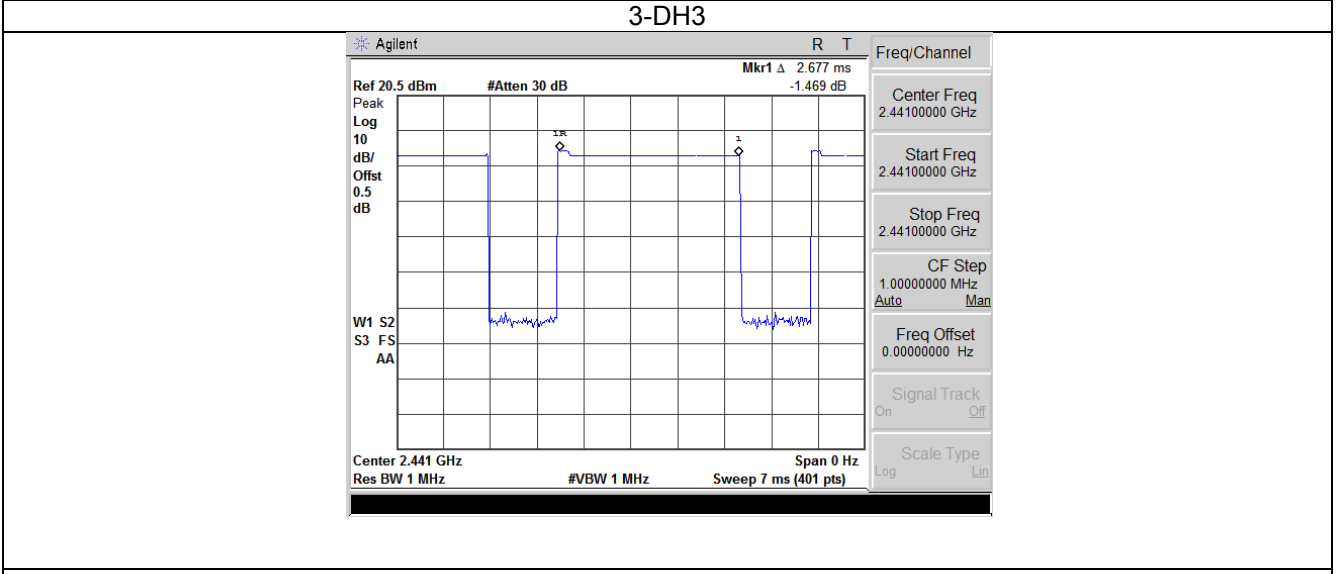
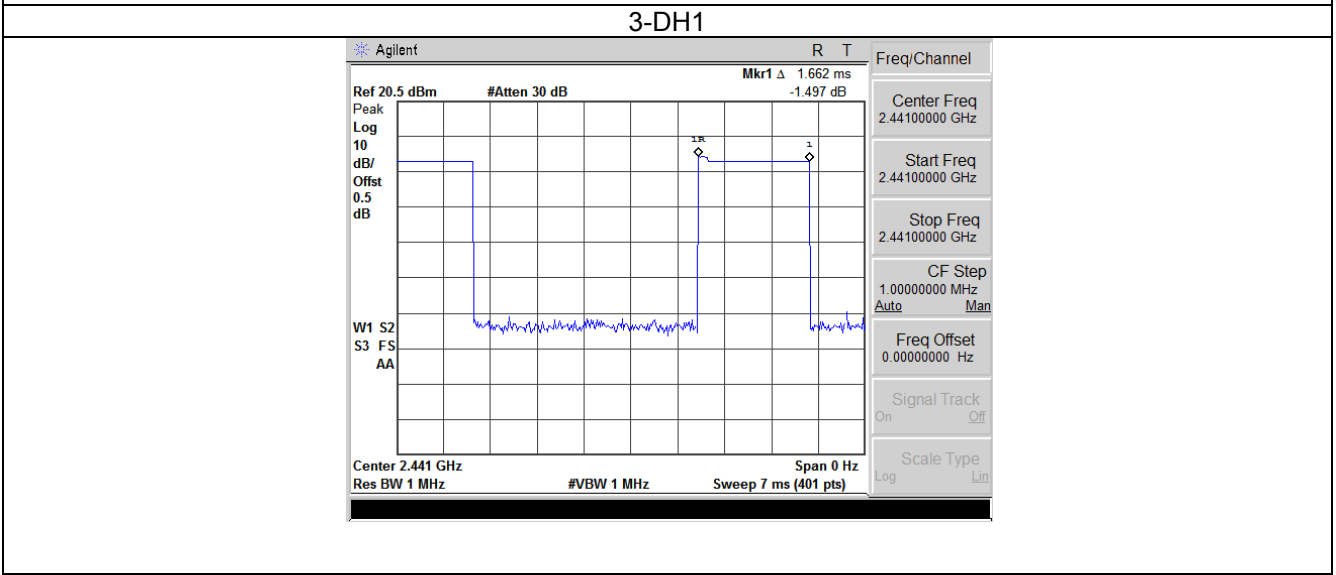
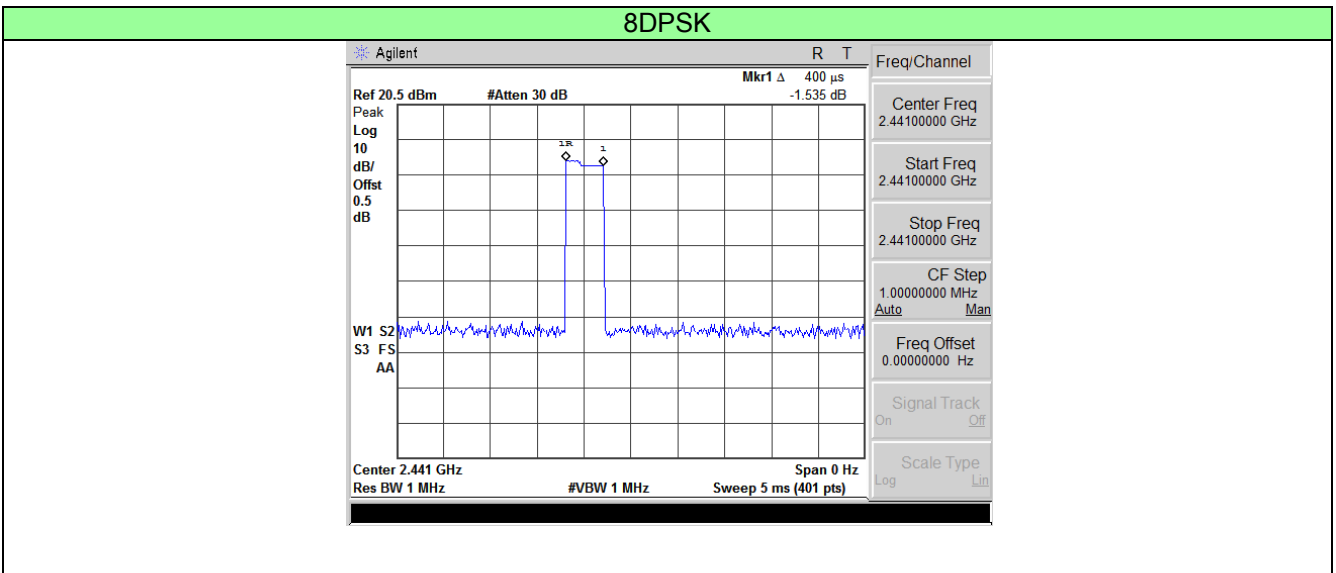

3-DH5

4.8. Pseudorandom Frequency Hopping Sequence

LIMIT

FCC CFR Title 47 Part 15 Subpart C Section 15.247 (a)(1):

Frequency hopping systems shall have hopping channel carrier frequencies separated by a minimum of 25 kHz or the 20 dB bandwidth of the hopping channel, whichever is greater. Alternatively, frequency hopping systems operating in the 2400–2483.5 MHz band may have hopping channel carrier frequencies that are separated by 25 kHz or two-thirds of the 20 dB bandwidth of the hopping channel, whichever is greater, provided the systems operate with an output power no greater than 125 mW. The system shall hop to channel frequencies that are selected at the system hopping rate from a pseudo randomly ordered list of hopping frequencies. Each frequency must be used equally on the average by each transmitter. The system receivers shall have input bandwidths that match the hopping channel bandwidths of their corresponding transmitters and shall shift frequencies in synchronization with the transmitted signals.

TEST RESULTS

The pseudorandom frequency hopping sequence may be generated in a nine-stage shift register whose 5th and 9th stage outputs are added in a modulo-two addition stage. And the result is fed back to the input of the first stage. The sequence begins with the first one of 9 consecutive ones, for example: the shift register is initialized with nine ones.

- Number of shift register stages:9
- Length of pseudo-random sequence:2⁹-1=511 bits
- Longest sequence of zeros:8(non-inverted signal)

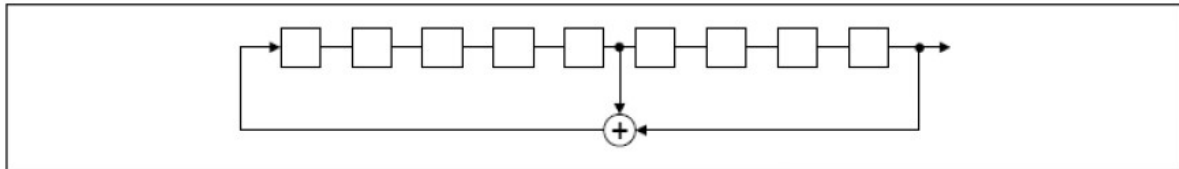

Linear Feedback Shift Register for Generation of the PRBS sequence

An example of pseudorandom frequency hopping sequence as follows:

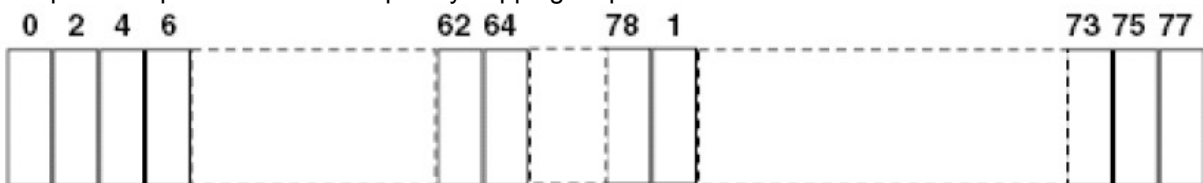

Each frequency used equally on the average by each transmitter. The system receiver has input bandwidths that match the hopping channel bandwidths of their corresponding transmitter and shifts frequencies in synchronization with the transmitted signals.

4.9. Restricted band (radiated)

LIMIT

FCC CFR Title 47 Part 15 Subpart C Section 15.209

Frequency	Limit (dBuV/m @3m)	Value
Above 1GHz	54.00	Average
	74.00	Peak

TEST CONFIGURATION

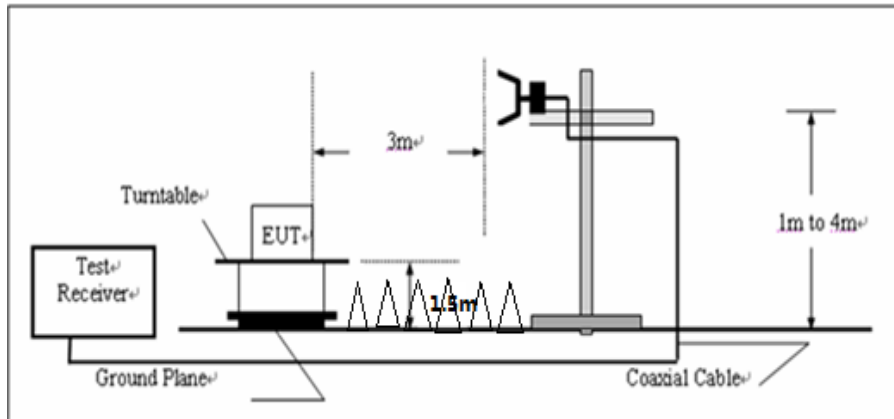

TEST PROCEDURE

1. The EUT was setup and tested according to ANSI C63.10:2013 for compliance to FCC 47CFR 15.247 requirements.
2. The EUT is placed on a turn table which is 1.5 meter above ground. The turn table is rotated 360 degrees to determine the position of the maximum emission level.
3. The EUT was positioned such that the distance from antenna to the EUT was 3 meters.
4. The antenna is scanned from 1 meter to 4 meters to find out the maximum emission level. This is repeated for both horizontal and vertical polarization of the antenna. In order to find the maximum emission, all of the interface cables were manipulated according to ANSI C63.10:2013 on radiated measurement.
5. The receiver set as follow:
 RBW=1MHz, VBW=3MHz for Peak value
 RBW=1MHz, VBW=10Hz for Average value.
6. The frequency range from 2310MHz to 2483.5MHz harmonic is checked.

TEST RESULTS

Test channel:	Lowest channel
---------------	----------------

Peak value:

Frequency (MHz)	Read Level (dBuV)	Antenna Factor (dB/m)	Cable Loss (dB)	Preamp Factor (dB)	Level (dBuV/m)	Limit Line (dBuV/m)	Over Limit (dB)	Polarization
2358.41	39.69	27.43	6.77	37.55	36.34	74	-37.66	Horizontal
2390.03	39.14	27.53	6.81	37.57	35.91	74	-38.09	Horizontal
2351.8	38.94	27.41	6.75	37.55	36.26	74	-38.45	Vertical
2390.03	38.04	27.53	6.81	37.57	35.81	74	-38.19	Vertical

Average value:

Frequency (MHz)	Read Level (dBuV)	Antenna Factor (dB/m)	Cable Loss (dB)	Preamp Factor (dB)	Level (dBuV/m)	Limit Line (dBuV/m)	Over Limit (dB)	Polarization
2350	25.33	27.41	6.74	37.55	21.93	54	-32.07	Horizontal
2390.026	26.01	27.53	6.81	37.57	22.78	54	-31.22	Horizontal
2350	25.33	27.41	6.74	37.55	21.93	54	-32.07	Vertical
2390.026	26	27.53	6.81	37.57	22.77	54	-31.23	Vertical

Test channel:	Highest channel
---------------	-----------------

Peak value:

Frequency (MHz)	Read Level (dBuV)	Antenna Factor (dB/m)	Cable Loss (dB)	Preamp Factor (dB)	Level (dBuV/m)	Limit Line (dBuV/m)	Over Limit (dB)	Polarization
2483.5	62.45	27.85	6.96	6.96	59.61	74	-14.39	Horizontal
2495.01	42.85	27.88	6.97	6.97	40.05	74	-33.95	Horizontal
2483.5	57.42	27.85	6.96	37.65	54.58	74	-19.42	Vertical
2497.16	40.95	27.9	6.97	37.66	38.16	74	-35.84	Vertical

Average value:

Frequency (MHz)	Read Level (dBuV)	Antenna Factor (dB/m)	Cable Loss (dB)	Preamp Factor (dB)	Level (dBuV/m)	Limit Line (dBuV/m)	Over Limit (dB)	Polarization
2483.5	29.76	27.85	6.96	37.65	26.92	54	-27.08	Horizontal
2500	26.02	27.9	6.98	37.66	23.24	54	-30.76	Horizontal
2483.5	29.49	27.85	6.96	37.65	26.65	54	-27.35	Vertical
2500	25.86	27.9	6.98	37.66	23.08	54	-30.92	Vertical

Note: Have pre-scan all modulation mode, found the GFSK modulation which it was worst case, so only the worst case's data on the test report.

4.10. Bandedge and Spurious Emission (conducted)

LIMIT

FCC CFR Title 47 Part 15 Subpart C Section 15.247 (d):

In any 100 kHz bandwidth outside the frequency band in which the spread spectrum intentional radiator is operating, the radio frequency power that is produced by the intentional radiator shall be at least 20 dB below that in the 100 kHz bandwidth within the band that contains the highest level of the desired power, based on either an RF conducted or a radiated measurement.

TEST CONFIGURATION

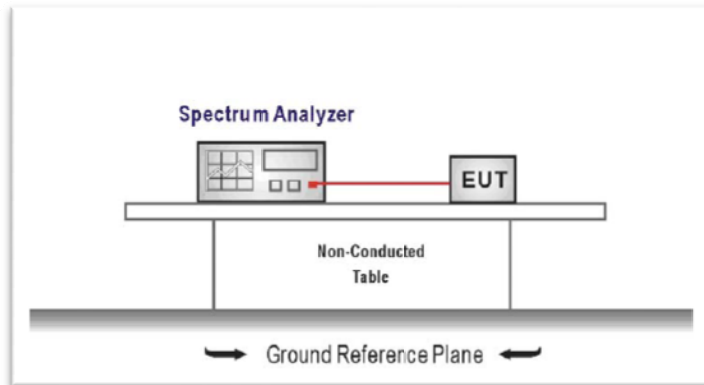

TEST PROCEDURE

1. The transmitter output was connected to the spectrum analyzer through an attenuator.
2. Conducted spurious emission the bandwidth of the fundamental frequency was measured by spectrum analyzer with RBW=100 KHz and VBW=300KHz.
3. Below -20dB of the highest emission level in operating band.

TEST RESULTS

Test plot as follows:

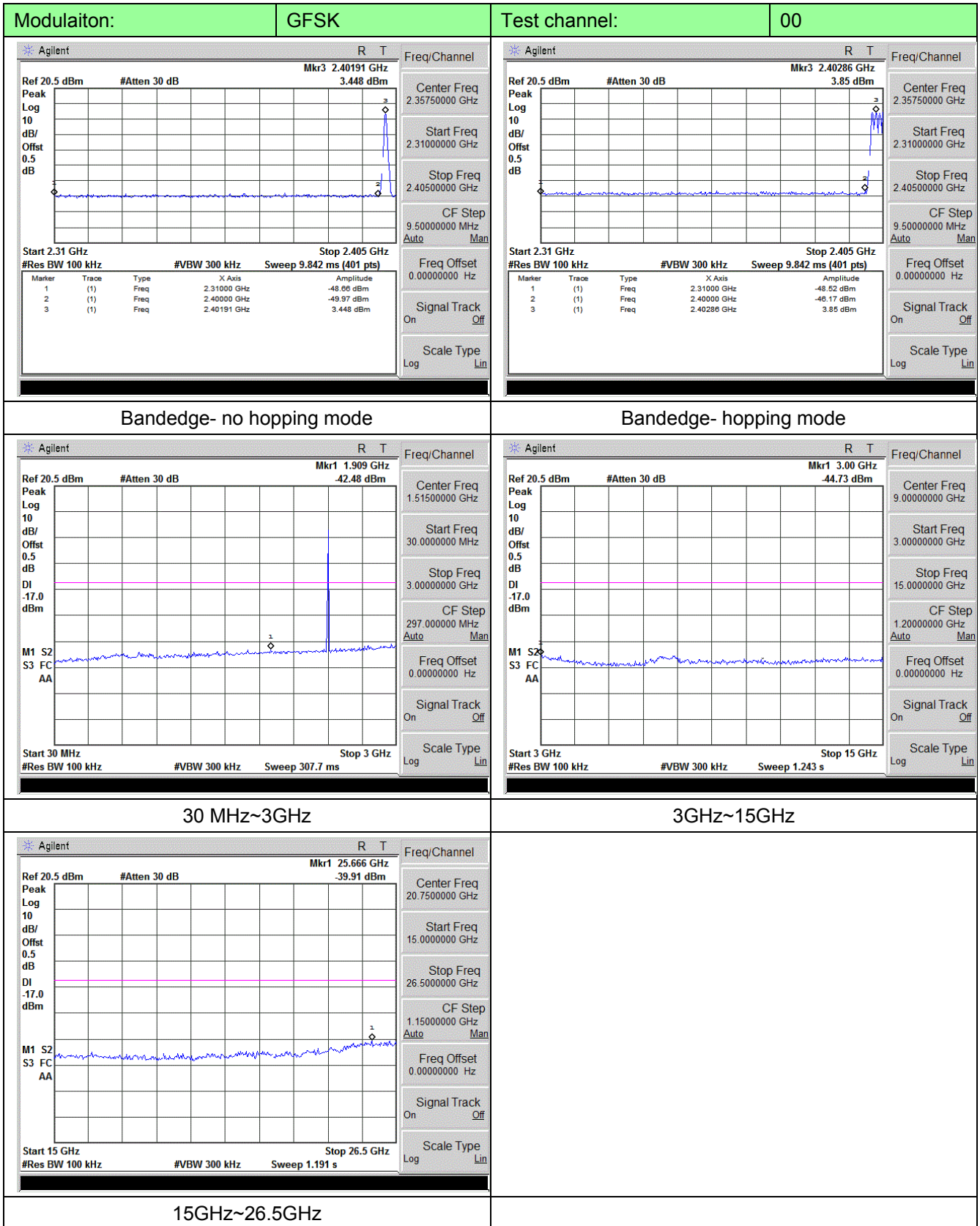

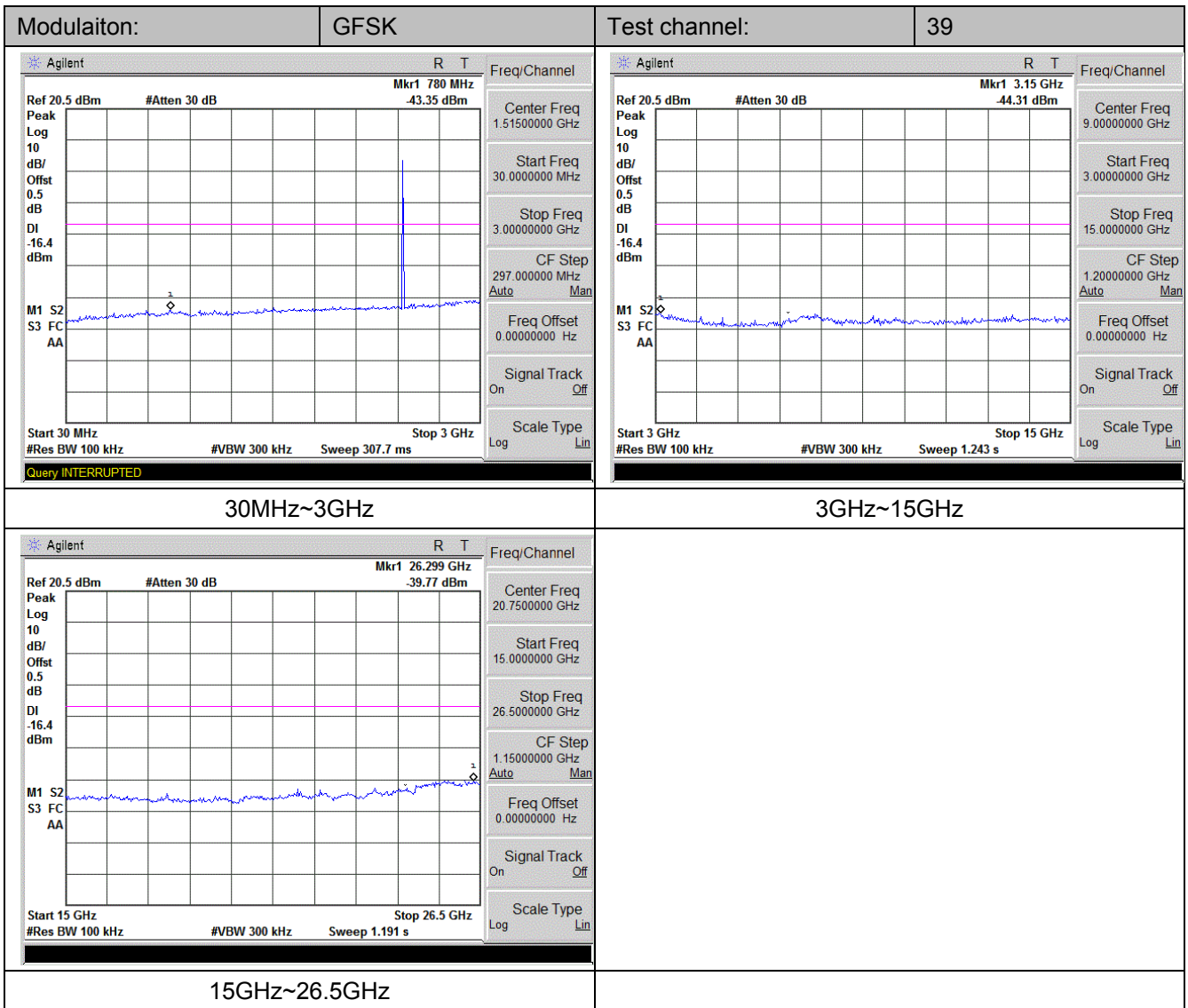

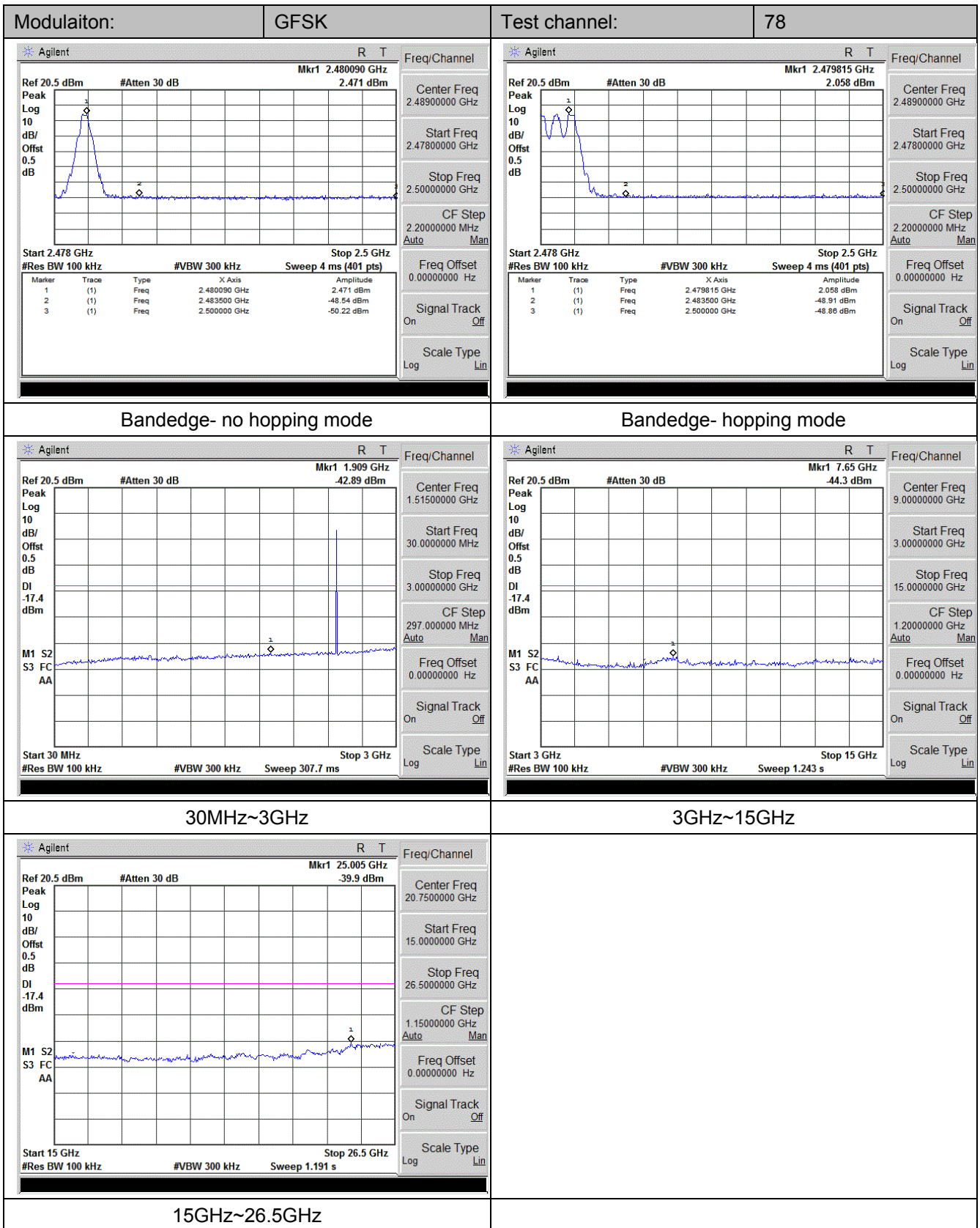

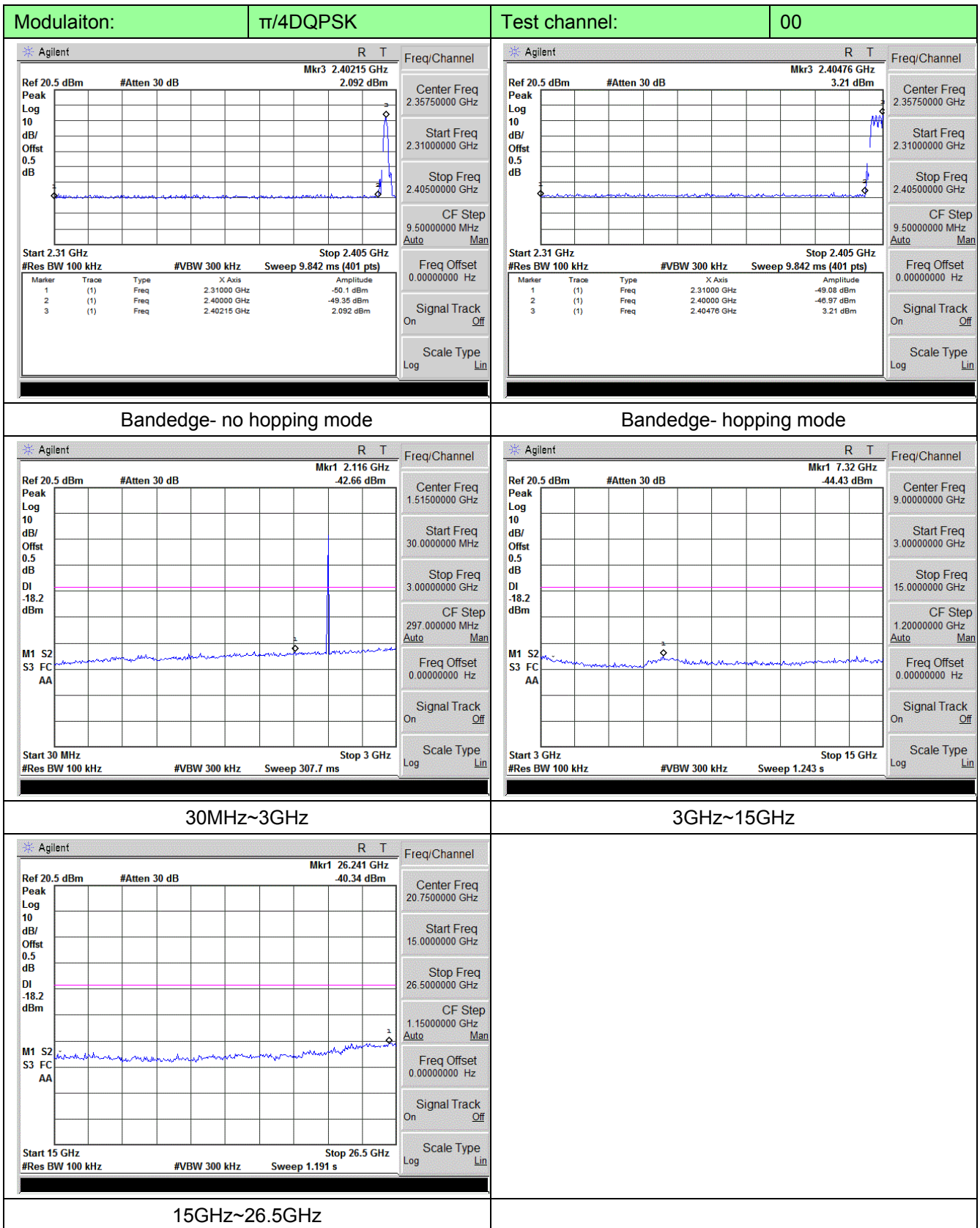

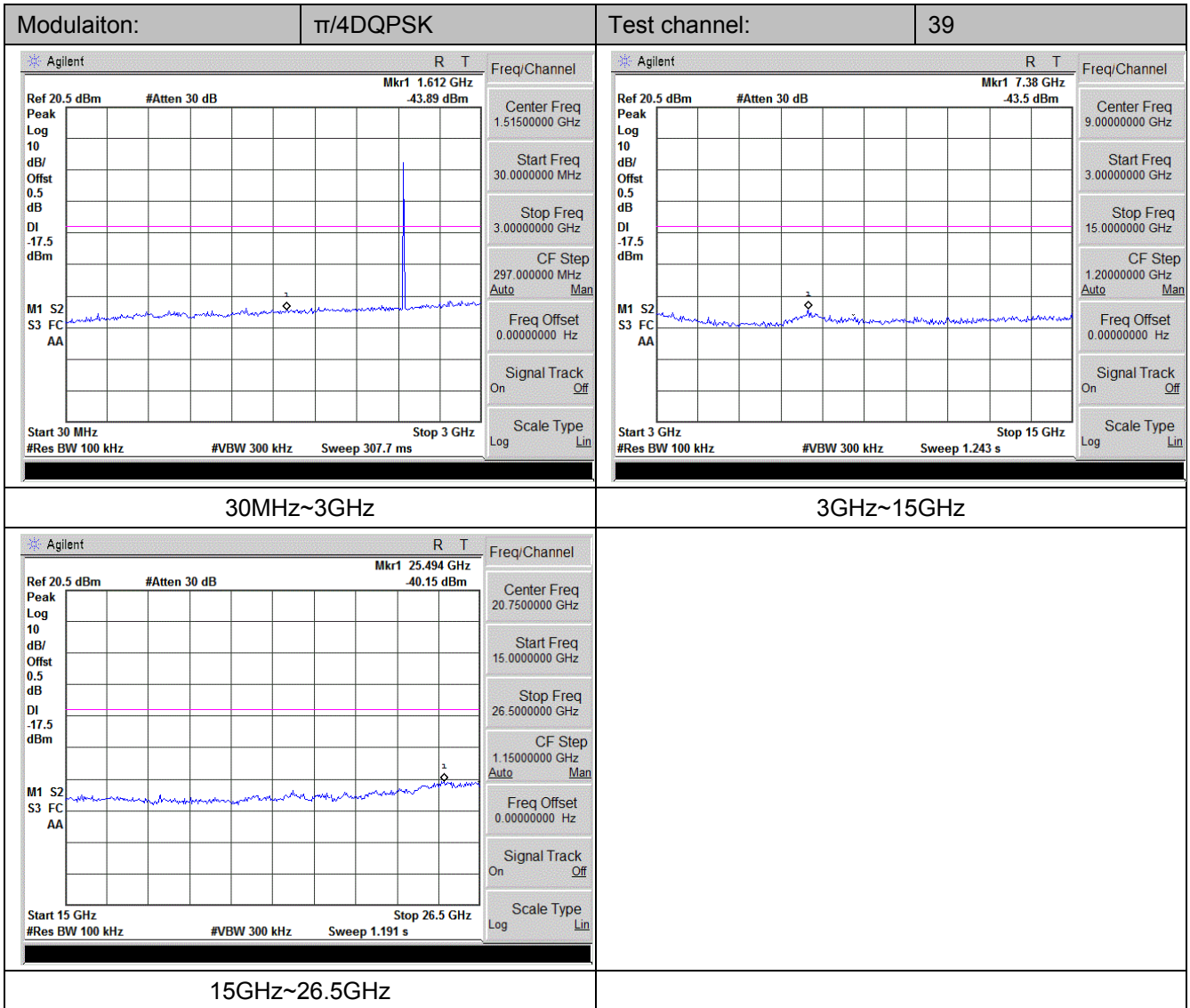

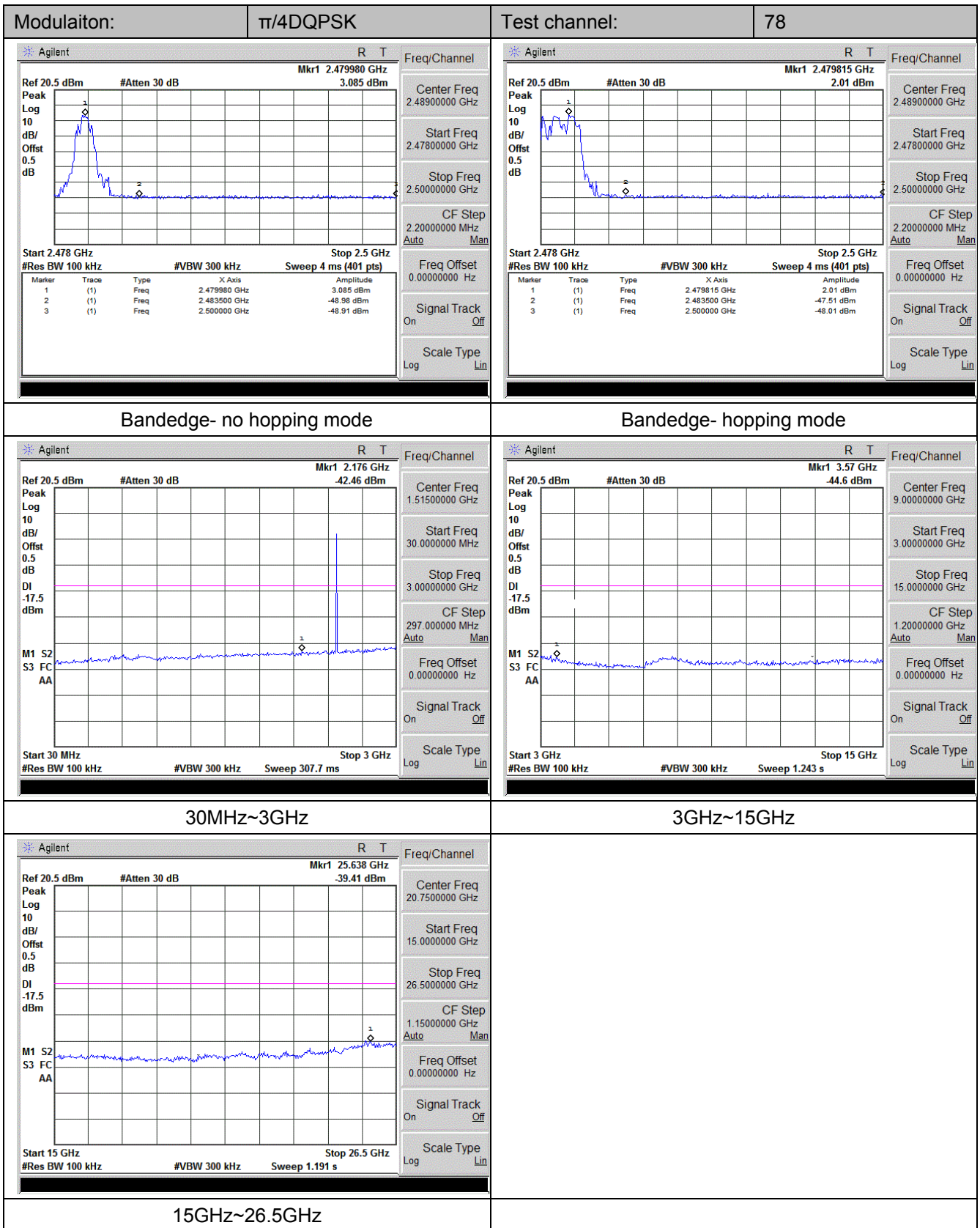

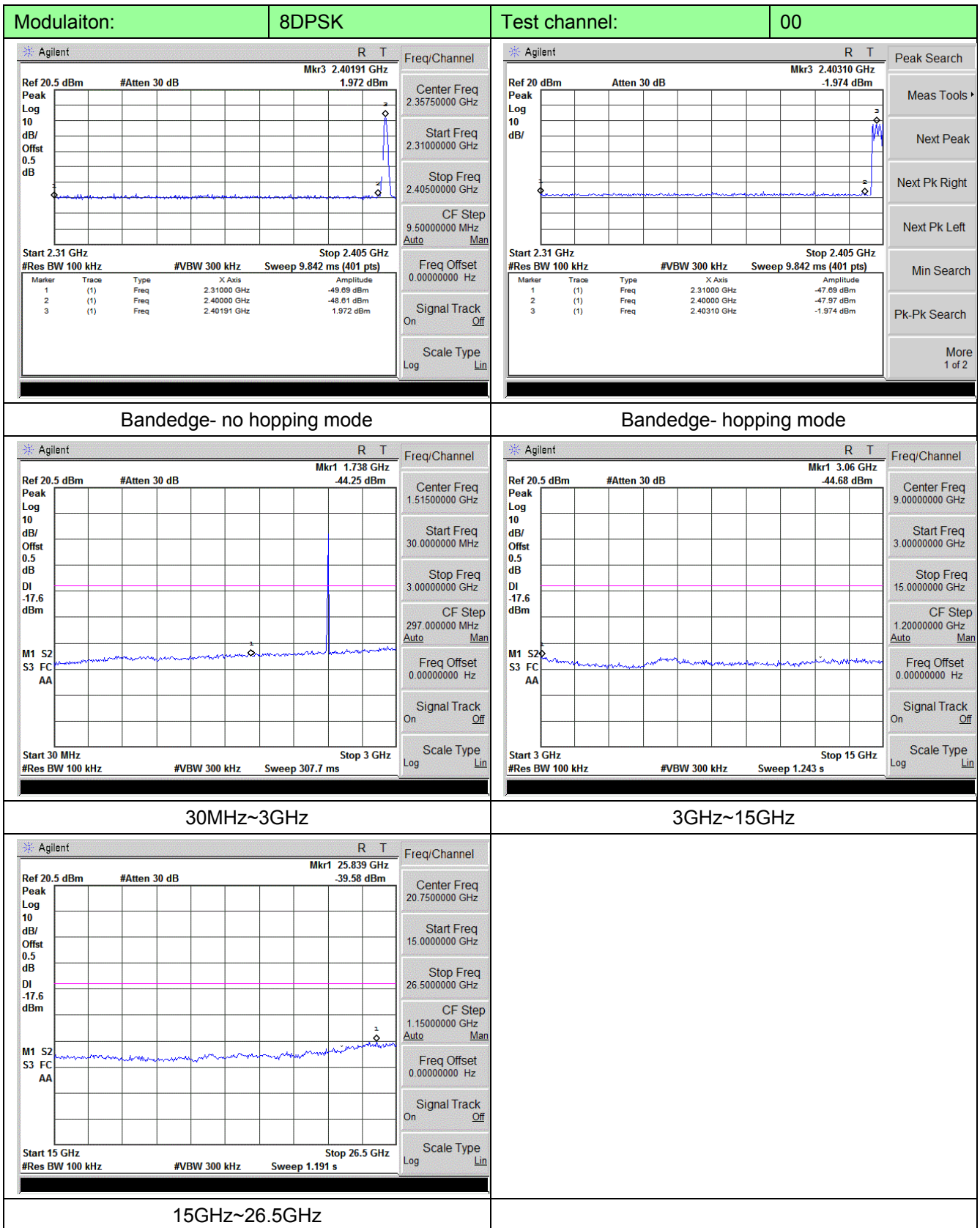

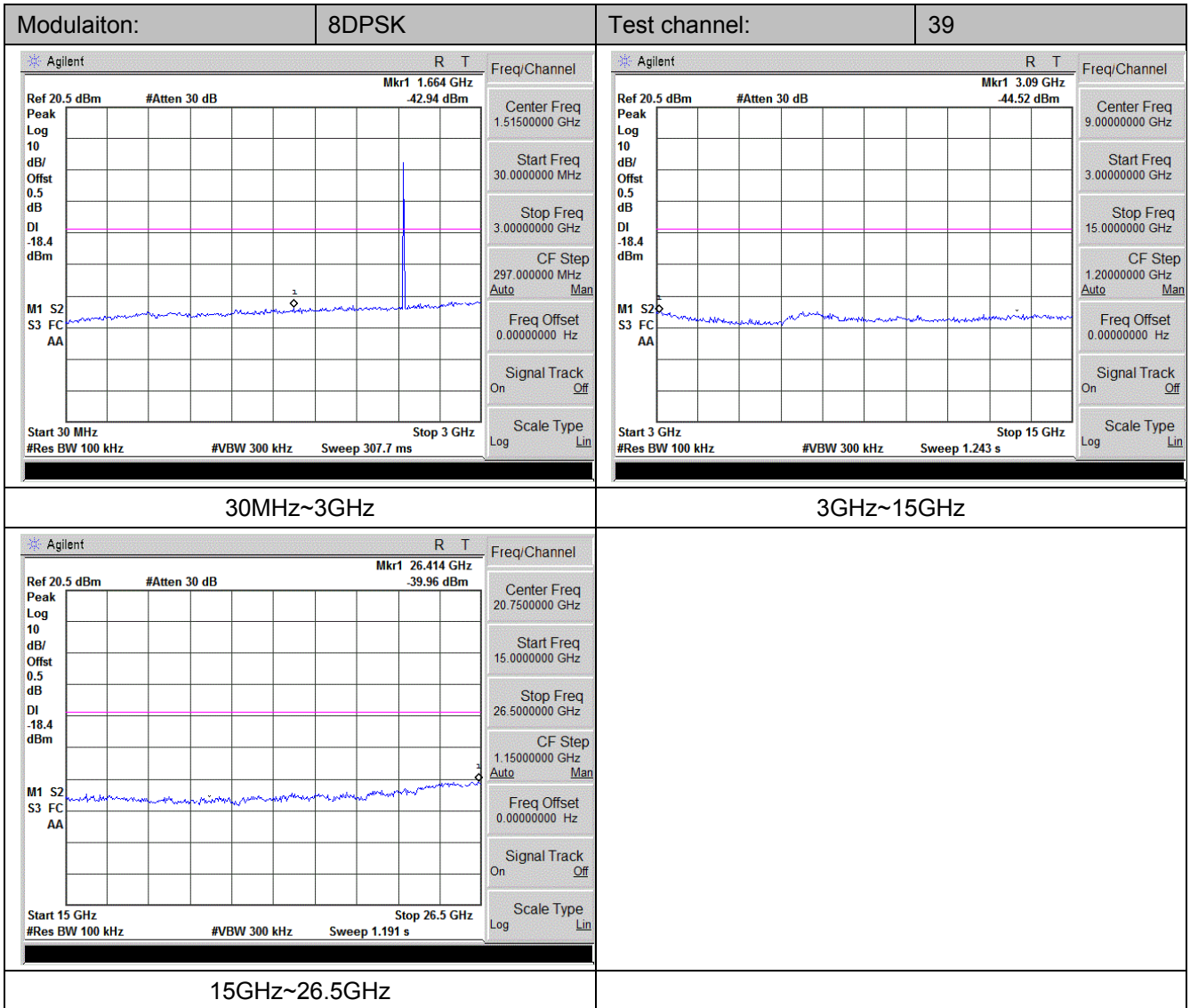

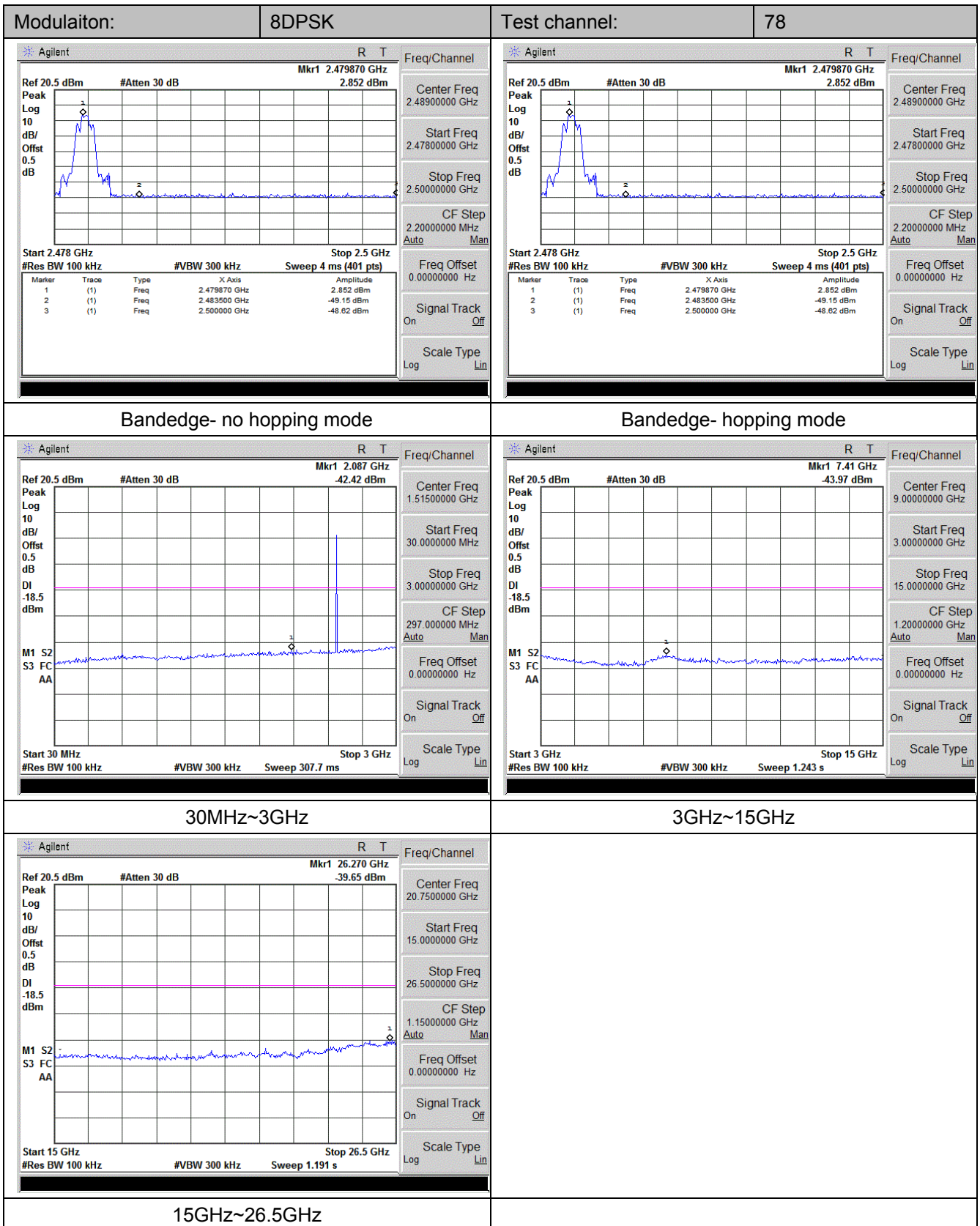

4.11. Spurious Emission (radiated)

LIMIT

FCC CFR Title 47 Part 15 Subpart C Section 15.209

Frequency	Limit (dBuV/m @3m)	Value
30MHz-88MHz	40.00	Quasi-peak
88MHz-216MHz	43.50	Quasi-peak
216MHz-960MHz	46.00	Quasi-peak
960MHz-1GHz	54.00	Quasi-peak
Above 1GHz	54.00	Average
	74.00	Peak

TEST CONFIGURATION

- ◆ Below 30MHz

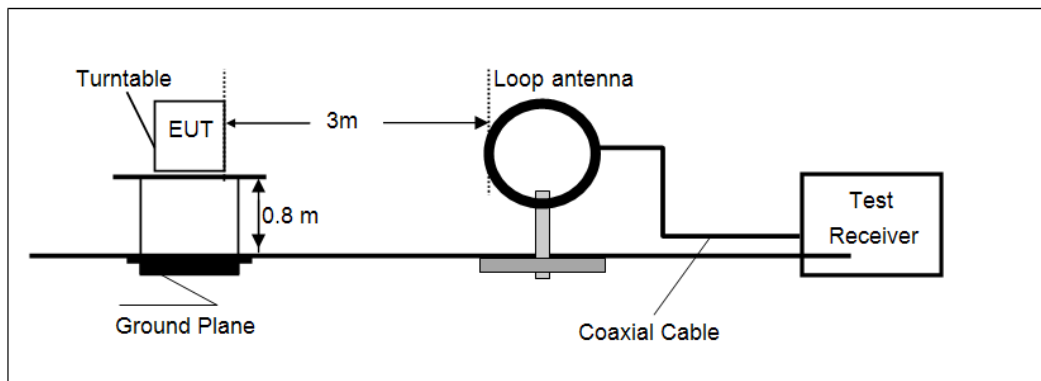

- ◆ 30MHz~1000MHz

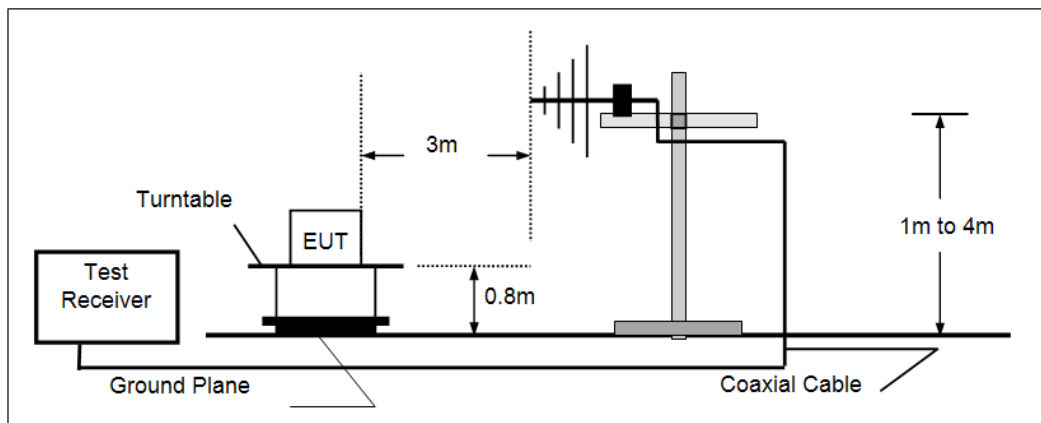

- ◆ Above 1GHz

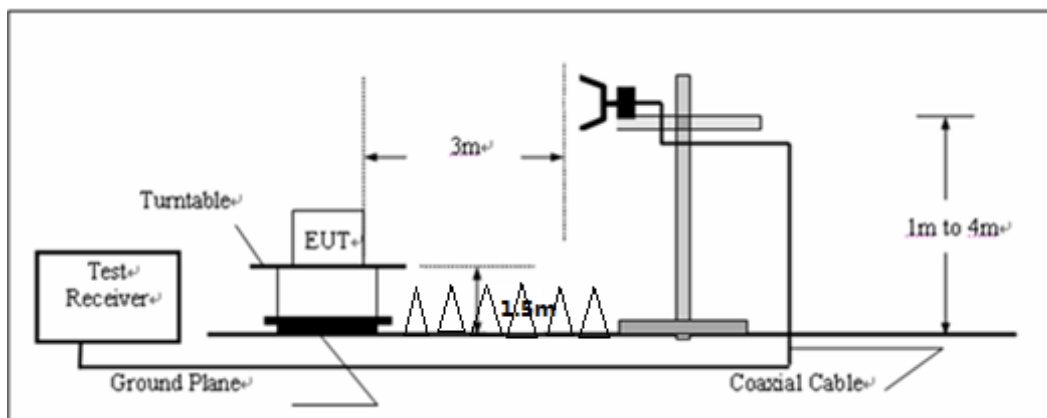

TEST PROCEDURE

1. Below 1GHz, the EUT was placed on the top of a rotating table 0.8 meters above the ground, Above 1GHz, the EUT was placed on the top of a rotating table 1.5 meters above the ground.
2. The table was rotated 360 degrees to determine the position of the highest radiation.
3. The EUT was set 3 meters away from the interference-receiving antenna, which was mounted on the top of a variable-height antenna tower.
4. The antenna height is varied from one meter to four meters above the ground to determine the maximum value of the field strength. Both horizontal and vertical polarizations of the antenna are set to make the measurement.
5. For each suspected emission, the EUT was arranged to its worst case and then the antenna was tuned to heights from 1 meter to 4 meters and the rotating table was turned from 0 degrees to 360 degrees to find the maximum reading.
6. Use the following spectrum analyzer settings
 - a) Span shall be wide enough to fully capture the emission being measured;
 - b) Below 1GHz, RBW=120KHz, VBW=300KHz, Sweep=auto, Detector function=peak, Trace=max hold; *If the emission level of the EUT measured by the peak detector is 3 dB lower than the applicable limit, the peak emission level will be reported. Otherwise, the emission measurement will be repeated using the quasi-peak detector and reported.*
 - c) Above 1GHz, RBW=1MHz, VBW=3MHz for Peak value
RBW=1MHz, VBW=10Hz for Average value.

TEST RESULTS

Noted:

Have pre-scan all modulation mode, found the GFSK modulation which it was worst case, so only the worst case's data on the test report.

Measurement data:

■ **9kHz ~ 30MHz**

The low frequency, which started from 9 kHz to 30MHz, was pre-scanned and the result which was 20dB lower than the limit line per 15.31(o) was not reported.

■ **30MHz ~ 1GHz**

SWEEP TABLE: "test (30M-1G)"

Short Description:		Field Strength			
Start	Stop	Detector	Meas. Time	IF Bandw.	Transducer
30.0 MHz	1.2 GHz	MaxPeak	Coupled	120 kHz	VULB9163 2014

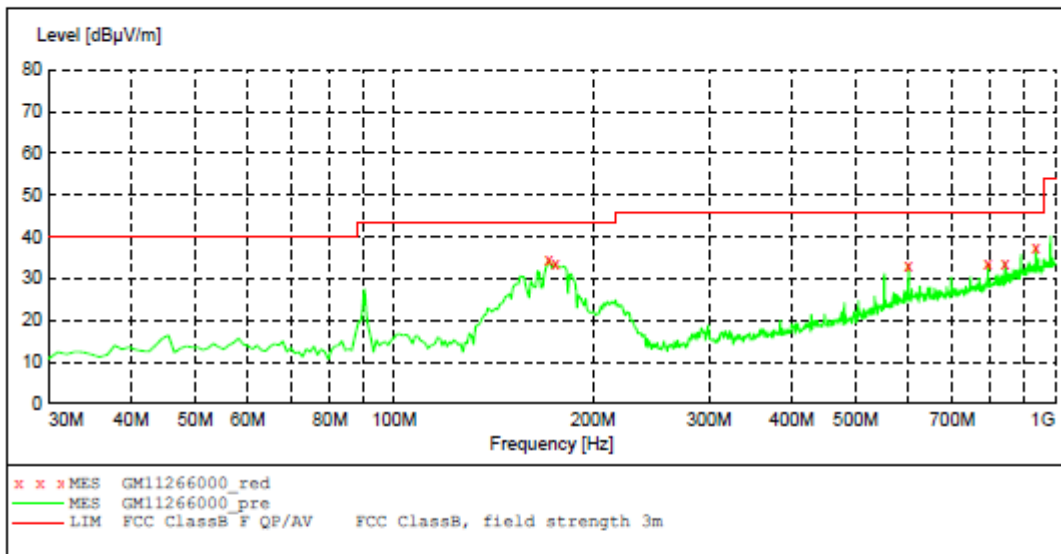

MEASUREMENT RESULT: "GM11266000_red"

11/25/2015 9:45AM

Frequency MHz	Level dBµV/m	Transd dB	Limit dBµV/m	Margin dB	Det.	Height cm	Azimuth deg	Polarization
171.620000	34.30	-16.4	43.5	9.2	QP	300.0	132.00	HORIZONTAL
175.500000	33.40	-16.1	43.5	10.1	QP	100.0	141.00	HORIZONTAL
600.360000	33.30	-2.7	46.0	12.7	QP	100.0	330.00	HORIZONTAL
792.420000	33.40	0.2	46.0	12.6	QP	100.0	355.00	HORIZONTAL
840.920000	33.80	1.3	46.0	12.2	QP	100.0	0.00	HORIZONTAL
935.980000	37.50	3.4	46.0	8.5	QP	100.0	141.00	HORIZONTAL

SWEEP TABLE: "test (30M-1G)"

Short Description:		Field Strength			
Start	Stop	Detector	Meas. Time	IF Bandw.	Transducer
Frequency	Frequency				
30.0 MHz	1.2 GHz	MaxPeak	Coupled	120 kHz	VULB9163 2014

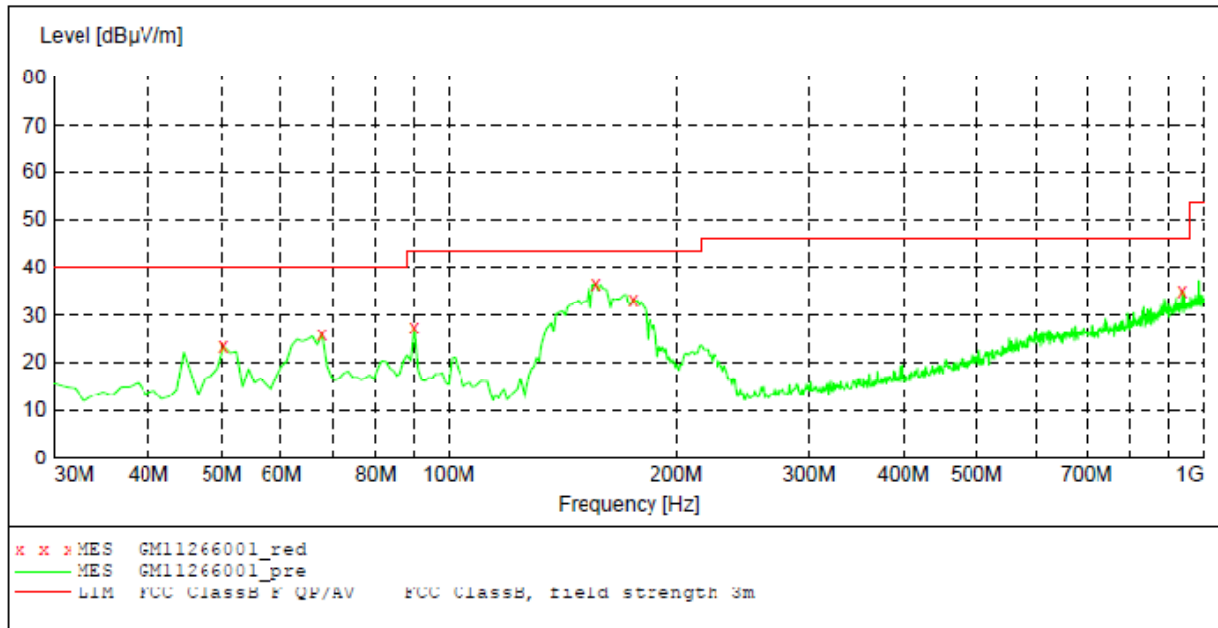

MEASUREMENT RESULT: "GM11266001_red"

11/25/2015 9:49AM

Frequency MHz	Level dBµV/m	Transd dB	Limit dBµV/m	Margin dB	Det.	Height cm	Azimuth deg	Polarization
50.370000	23.20	-14.3	40.0	16.8	QP	100.0	352.00	VERTICAL
67.830000	25.80	-16.5	40.0	14.2	QP	100.0	208.00	VERTICAL
90.140000	27.20	-16.2	43.5	16.3	QP	100.0	281.00	VERTICAL
157.070000	36.50	-17.4	43.5	7.0	QP	100.0	89.00	VERTICAL
175.500000	33.20	-16.1	43.5	10.3	QP	100.0	295.00	VERTICAL
936.950000	34.90	3.4	46.0	11.1	OP	100.0	266.00	VERTICAL

■ Above 1GHz

CH00 for GFSK									
Frequency (MHz)	Read Level (dBuV)	Antenna Factor (dB/m)	Cable Loss (dB)	Preamp Factor (dB)	Level (dBuV/m)	Limit Line (dBuV/m)	Margin Limit (dB)	Polarization	Test value
4804.00	38.02	31.28	5.66	35.29	39.67	74.00	-34.33	Vertical	Peak
7206.00	34.82	36.22	6.87	35.15	42.76	74.00	-31.24	Vertical	
9608.00	37.64	37.85	8.80	35.55	48.74	74.00	-25.26	Vertical	
12010.00	*							Vertical	
4804.00	38.14	31.28	5.66	35.29	39.79	74.00	-34.21	Horizontal	
7206.00	34.64	36.22	6.87	35.15	42.58	74.00	-31.42	Horizontal	
9608.00	36.22	37.85	8.80	35.55	47.32	74.00	-26.68	Horizontal	
12010.00	*							Horizontal	
4804.00	32.71	31.28	5.66	35.29	34.36	54.00	-19.64	Vertical	Average
7206.00	28.81	36.22	6.87	35.15	36.75	54.00	-17.25	Vertical	
9608.00	27.87	37.85	8.80	35.55	38.97	54.00	-15.03	Vertical	
12010.00	*							Vertical	
4804.00	32.70	31.28	5.66	35.29	34.35	54.00	-19.65	Horizontal	
7206.00	28.93	36.22	6.87	35.15	36.87	54.00	-17.13	Horizontal	
9608.00	27.84	37.85	8.80	35.55	38.94	54.00	-15.06	Horizontal	
12010.00	*							Horizontal	
CH39 for GFSK									
Frequency (MHz)	Read Level (dBuV)	Antenna Factor (dB/m)	Cable Loss (dB)	Preamp Factor (dB)	Level (dBuV/m)	Limit Line (dBuV/m)	Margin Limit (dB)	Polarization	Test value
4882.00	39.32	30.88	5.70	35.27	40.63	74.00	-33.37	Vertical	Peak
7323.00	35.07	35.82	6.91	35.13	42.67	74.00	-31.33	Vertical	
9764.00	36.99	37.45	8.84	35.53	47.75	74.00	-26.25	Vertical	
12205.00	*							Vertical	
4882.00	38.55	30.88	5.70	35.27	39.86	74.00	-34.14	Horizontal	
7323.00	35.14	35.82	6.91	35.13	42.74	74.00	-31.26	Horizontal	
9764.00	36.59	37.45	8.84	35.53	47.35	74.00	-26.65	Horizontal	
12205.00	*							Horizontal	
4882.00	32.77	30.88	5.70	35.27	34.08	54.00	-19.92	Vertical	Average
7323.00	28.77	35.82	6.91	35.13	36.37	54.00	-17.63	Vertical	
9764.00	27.78	37.45	8.84	35.53	38.54	54.00	-15.46	Vertical	
12205.00	*							Vertical	
4882.00	32.95	30.88	5.70	35.27	34.26	54.00	-19.74	Horizontal	
7323.00	28.75	35.82	6.91	35.13	36.35	54.00	-17.65	Horizontal	
9764.00	27.93	37.45	8.84	35.53	38.69	54.00	-15.31	Horizontal	
12205.00	*							Horizontal	

Remark:

1. Final Level = Receiver Read level + Antenna Factor + Cable Loss – Pre-amplifier Factor
2. “*”, means this data is too weak instrument of signal is unable to test.
3. The emission levels of other frequencies are very lower than the limit and not show in test report.

CH78 for GFSK									
Frequency (MHz)	Read Level (dBuV)	Antenna Factor (dB/m)	Cable Loss (dB)	Preamp Factor (dB)	Level (dBuV/m)	Limit Line (dBuV/m)	Margin Limit (dB)	Polarization	Test value
4960.00	37.93	30.98	5.73	35.32	39.32	74.00	-34.68	Vertical	Peak
7440.00	34.47	35.92	6.94	35.18	42.15	74.00	-31.85	Vertical	
9920.00	37.92	37.55	8.87	35.58	48.76	74.00	-25.24	Vertical	
12400.00	*							Vertical	
4960.00	38.55	30.98	5.73	35.32	39.94	74.00	-34.06	Horizontal	
7440.00	34.90	35.92	6.94	35.18	42.58	74.00	-31.42	Horizontal	
9920.00	36.42	37.55	8.87	35.58	47.26	74.00	-26.74	Horizontal	
12400.00	*							Horizontal	
4960.00	33.46	30.98	5.73	35.32	34.85	54.00	-19.15	Vertical	Average
7440.00	29.28	35.92	6.94	35.18	36.96	54.00	-17.04	Vertical	
9920.00	27.24	37.55	8.87	35.58	38.08	54.00	-15.92	Vertical	
12400.00	*							Vertical	
4960.00	32.83	30.98	5.73	35.32	34.22	54.00	-19.78	Horizontal	
7440.00	28.46	35.92	6.94	35.18	36.14	54.00	-17.86	Horizontal	
9920.00	28.11	37.55	8.87	35.58	38.95	54.00	-15.05	Horizontal	
12400.00	*							Horizontal	

Remark:

1. Final Level = Receiver Read level + Antenna Factor + Cable Loss – Pre-amplifier Factor
2. “*”, means this data is too weak instrument of signal is unable to test.
3. The emission levels of other frequencies are very lower than the limit and not show in test report.

5. Test Setup Photos of the EUT

Radiated Emission



Conducted Emission (AC Mains)



6. External and Internal Photos of the EUT

Reference to Test Report TRE1511007601

.....End of Report.....