

THIS DOCUMENT CONTAINS INFORMATION PROPRIETARY TO AEON CORPORATION. ANY USE OR DISCLOSURE WITHOUT THE WRITTEN PERMISSION OF AN OFFICER OF AEON IS EXPRESSLY FORBIDDEN.

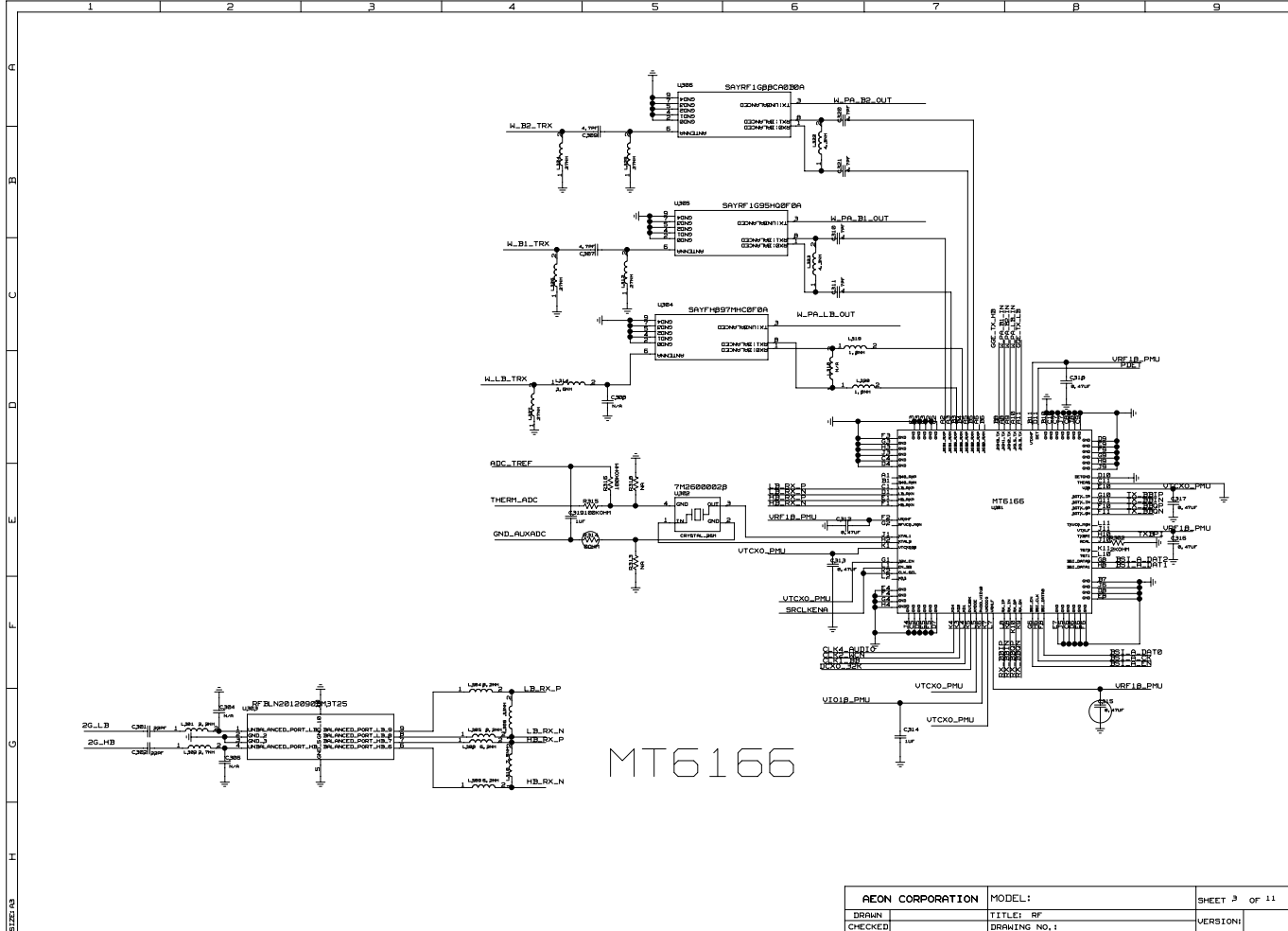

AEON CORPORATION		MODEL:1	SHEET 3 OF 11	
DRAWN		TITLE: RF	VERSION:	
CHECKED		DRAWING NO.1		

THIS DOCUMENT CONTAINS INFORMATION PROPRIETARY TO AEON CORPORATION. ANY USE OR DISCLOSURE WITHOUT THE WRITTEN PERMISSION OF AN OFFICER OF AEON IS EXPRESSLY FORBIDDEN.

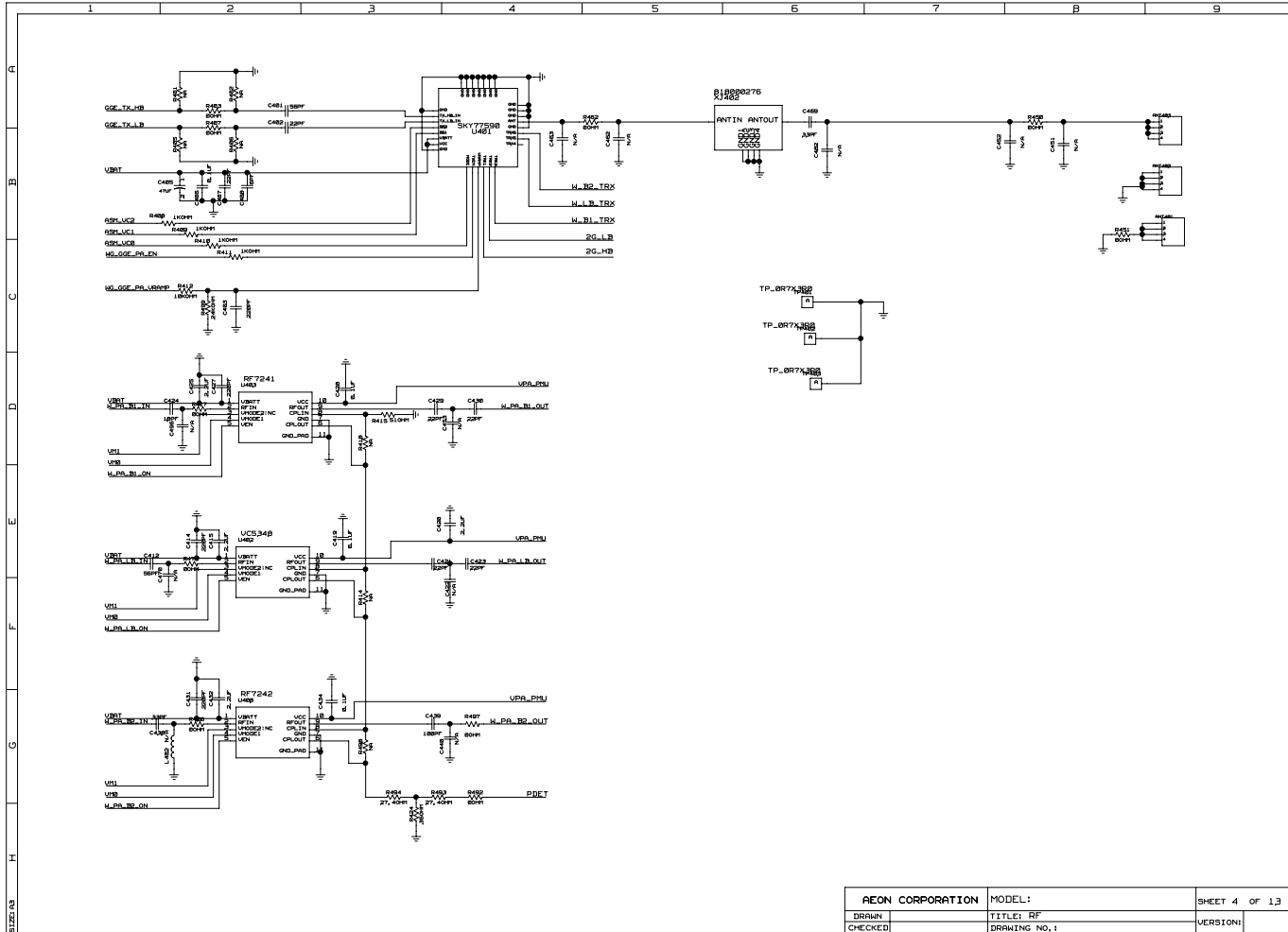

AEON CORPORATION		MODEL: 1	SHEET 4 OF 13	
DRAWN		TITLE: RF	VERSION:	
CHECKED		DRAWING NO. 1		

THIS DOCUMENT CONTAINS INFORMATION PROPRIETARY TO AECN CORPORATION. AECN, USE OR DISCLOSURE WITHOUT THE WRITTEN PERMISSION OF AN OFFICER OF AECN IS EXPRESSLY FORBIDDEN.

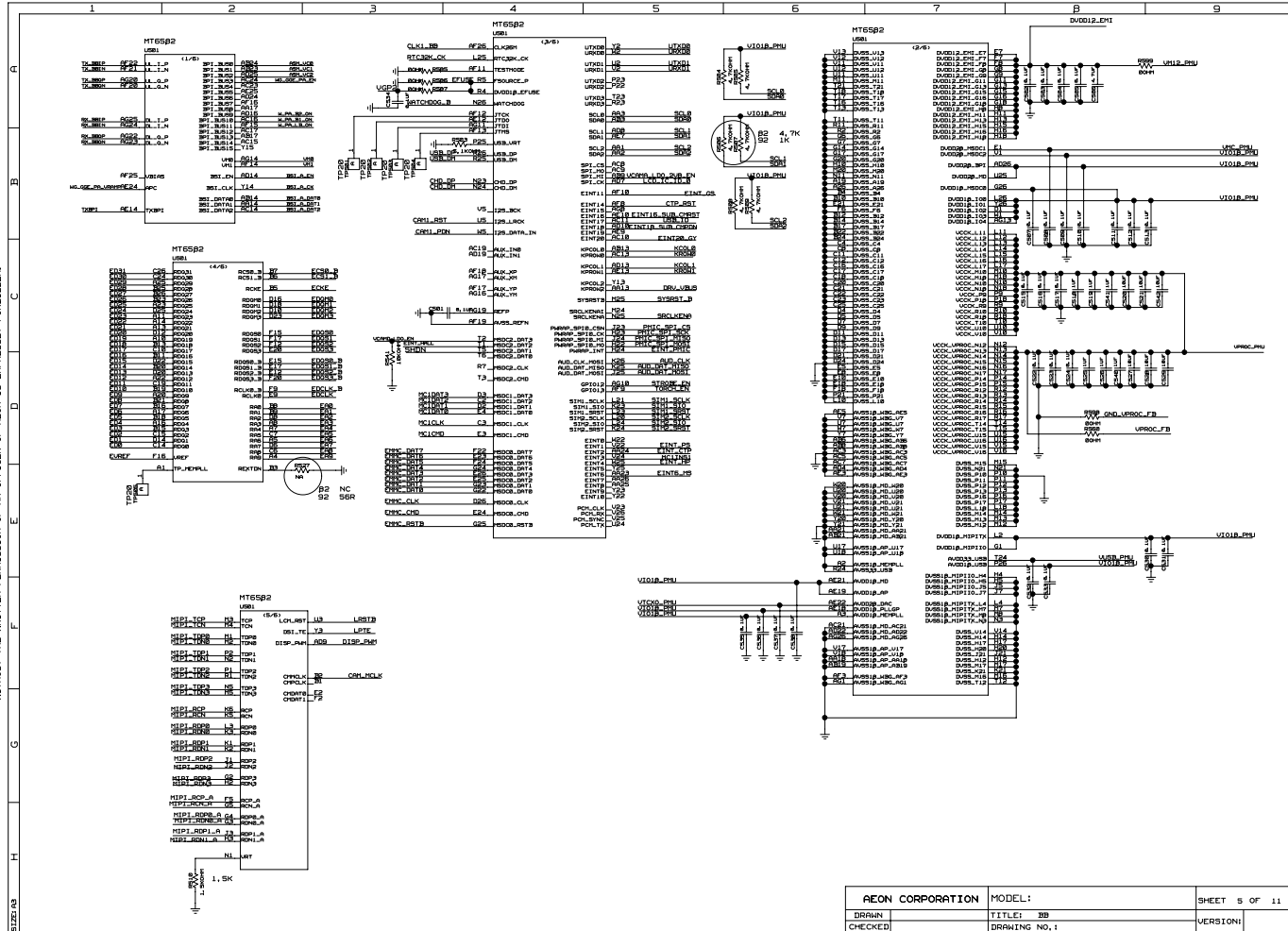

THIS DOCUMENT CONTAINS INFORMATION PROPRIETARY TO AION CORPORATION. AION'S USE OR DISCLOSURE WITHOUT THE WRITTEN PERMISSION OF AN OFFICER OF AION IS EXPRESSLY FORBIDDEN.

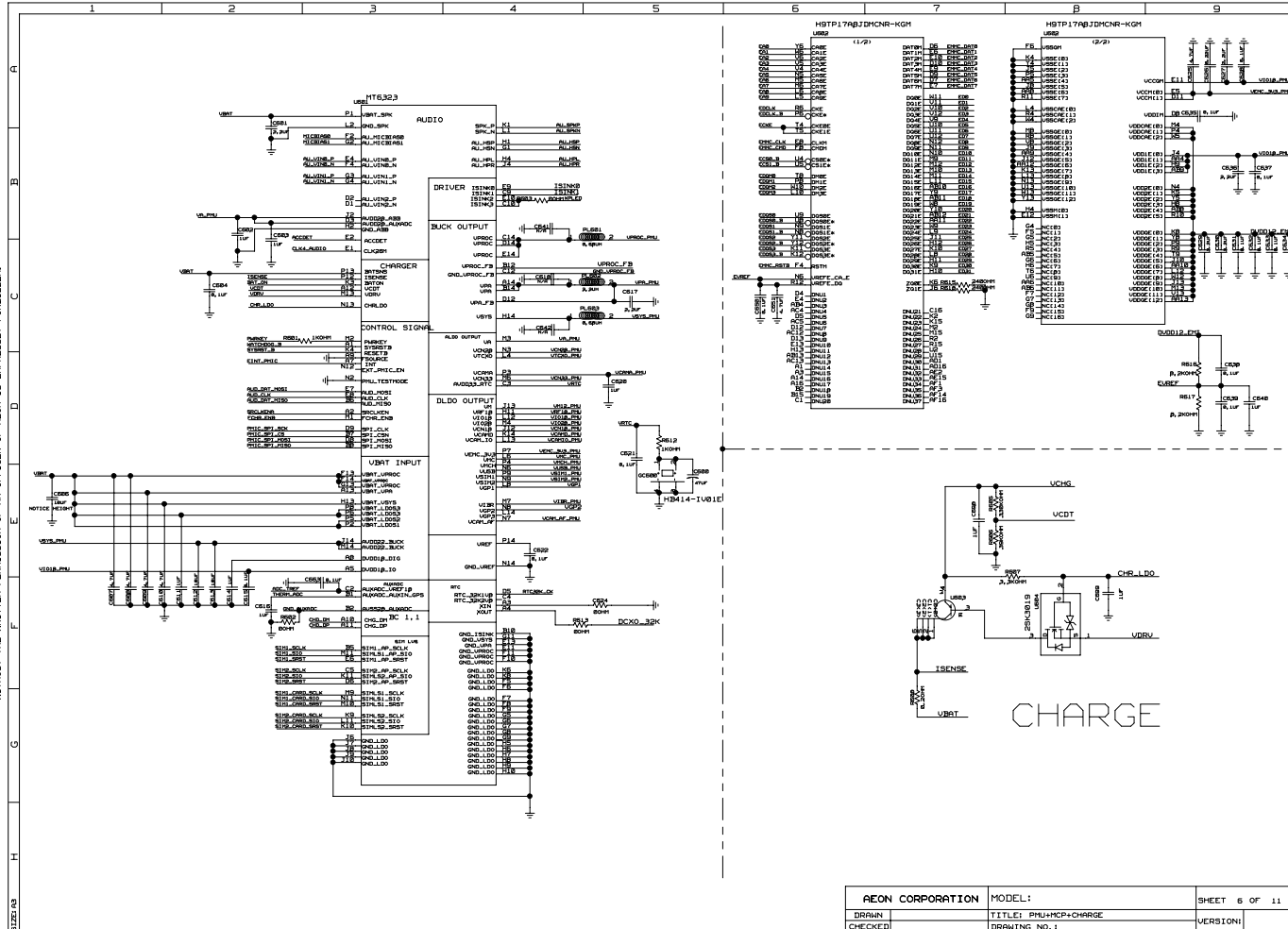

THIS DOCUMENT CONTAINS INFORMATION PROPRIETARY TO AECN CORPORATION. AECN, USE OR DISCLOSURE WITHOUT THE WRITTEN PERMISSION OF AN OFFICER OF AECN IS EXPRESSLY FORBIDDEN.

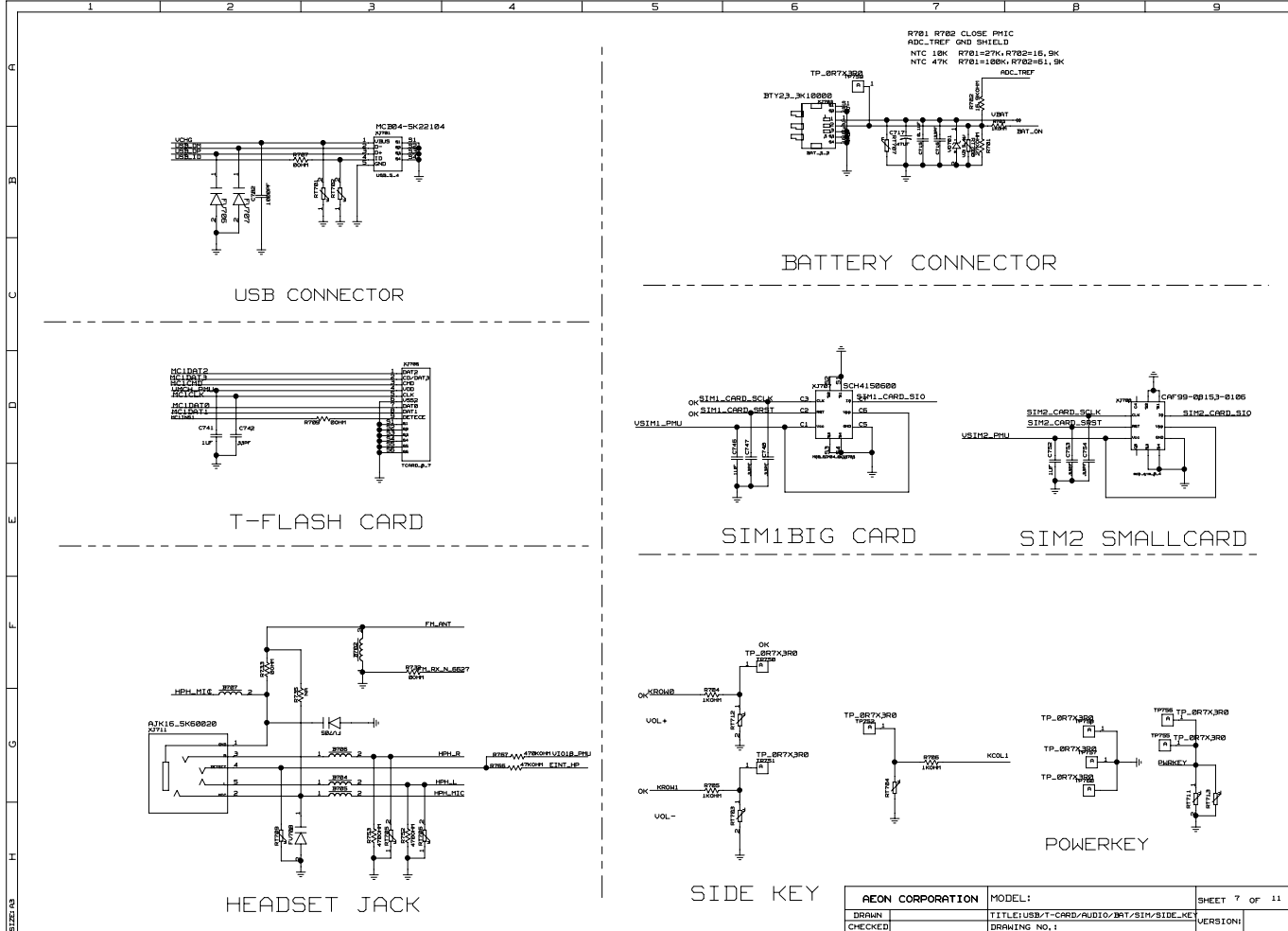

AECN CORPORATION		MODEL:1	SHEET 7 OF 11	
DRAWN	TITLE:USB/T-CARD/AUDIO/BAT/SIM/SIDE_KEY		VERSION:	
CHECKED	DRAWING NO.1			

THIS DOCUMENT CONTAINS INFORMATION PROPRIETARY TO AECN CORPORATION. AECN, USE OR DISCLOSURE WITHOUT THE WRITTEN PERMISSION OF AN OFFICER OF AECN IS EXPRESSLY FORBIDDEN.

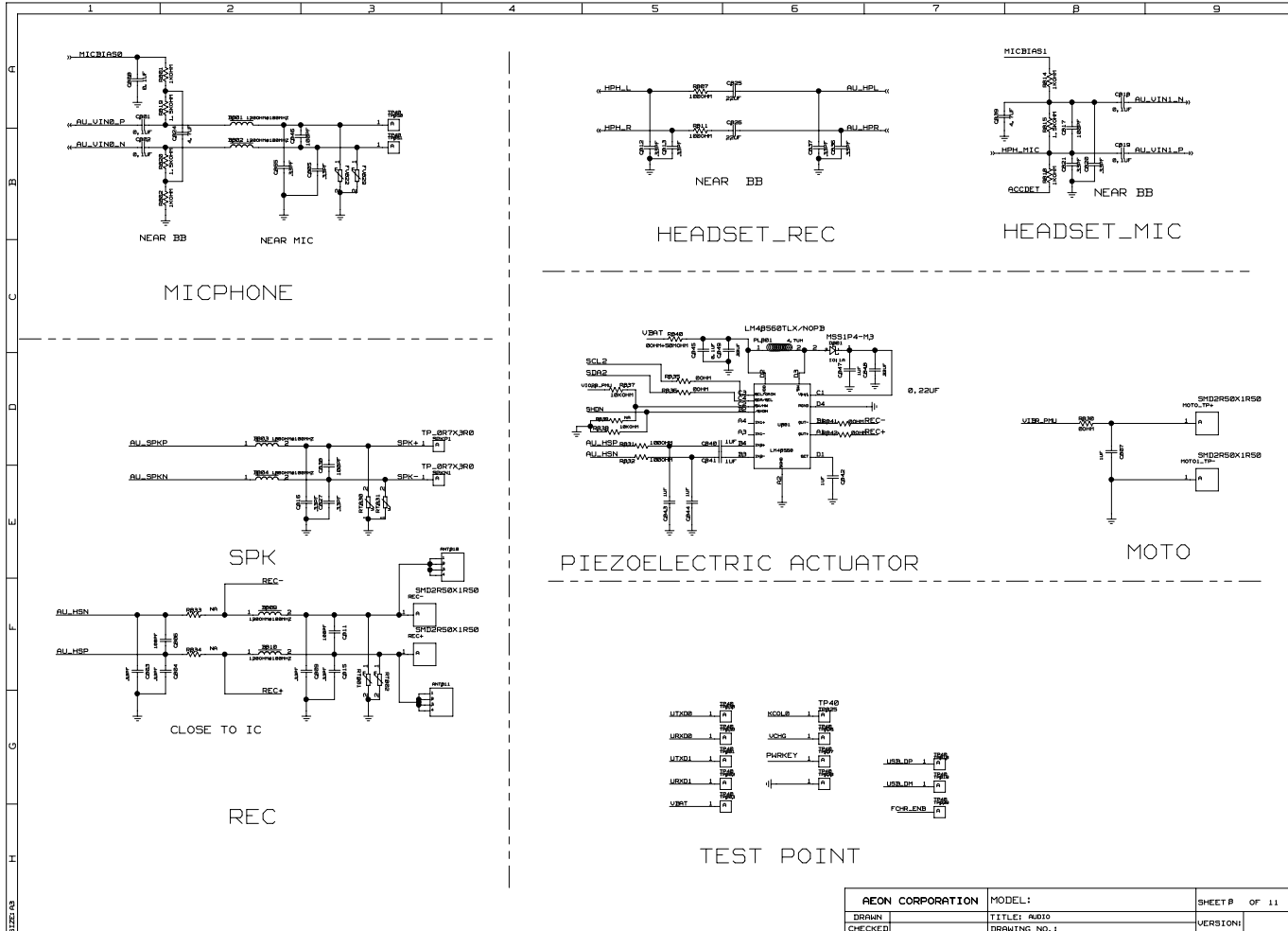

AECN CORPORATION		MODEL:	SHEET 8 OF 11	
DRAWN		TITLE: A010	VERSION:	
CHECKED		DRAWING NO.:		

THIS DOCUMENT CONTAINS INFORMATION PROPRIETARY TO AECI CORPORATION. AECI'S USE OR DISCLOSURE WITHOUT THE WRITTEN PERMISSION OF AN OFFICER OF AECI IS EXPRESSLY FORBIDDEN.

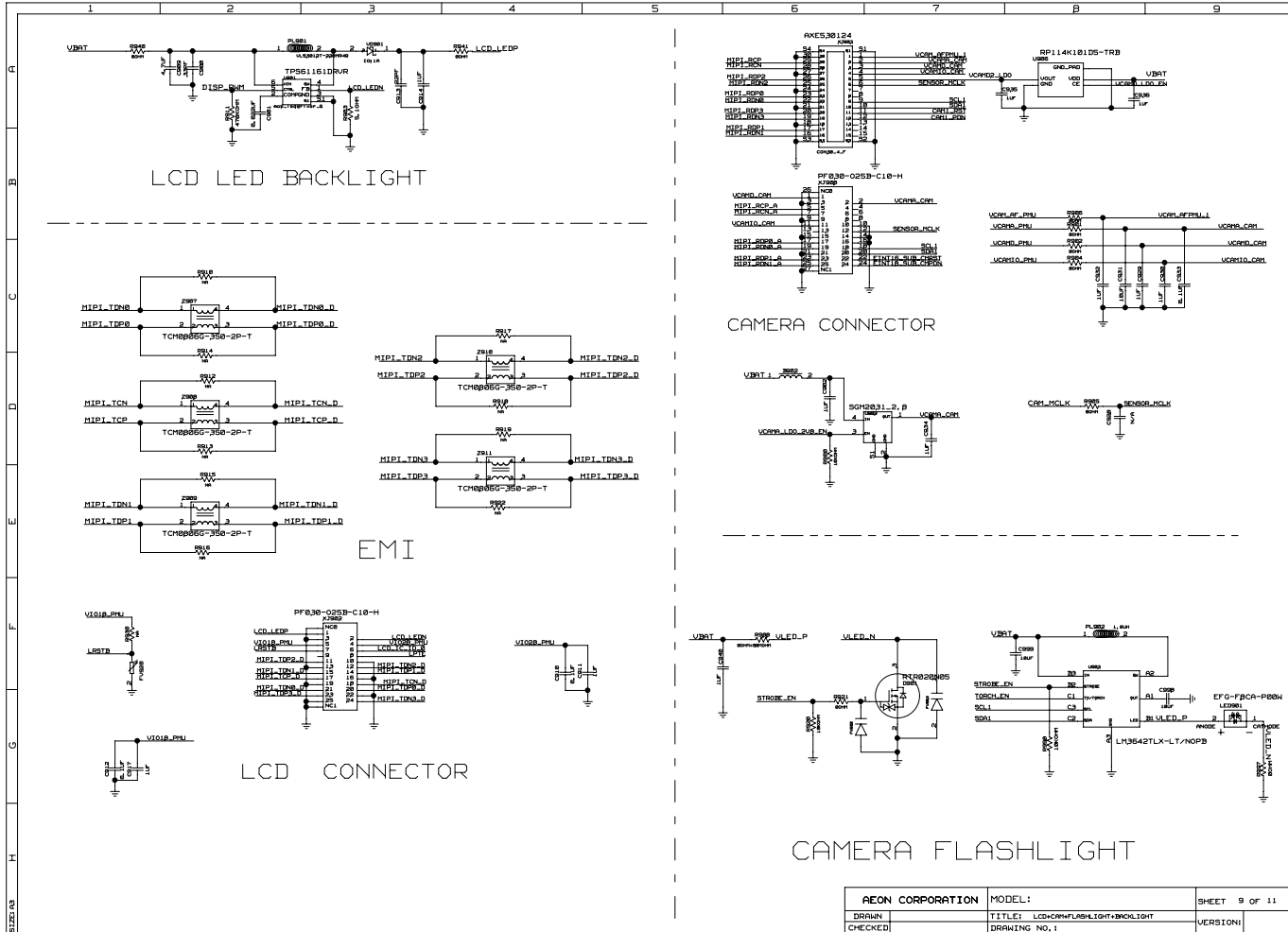

AECI CORPORATION		MODEL:	SHEET 9 OF 11
DRAWN	TITLE: LCD+CAM+FLASHLIGHT+BACKLIGHT		VERSION:
CHECKED	DRAWING NO.:		

THIS DOCUMENT CONTAINS INFORMATION PROPRIETARY TO AECN CORPORATION. AECN, USE OR DISCLOSURE WITHOUT THE WRITTEN PERMISSION OF AN OFFICER OF AECN IS EXPRESSLY FORBIDDEN.

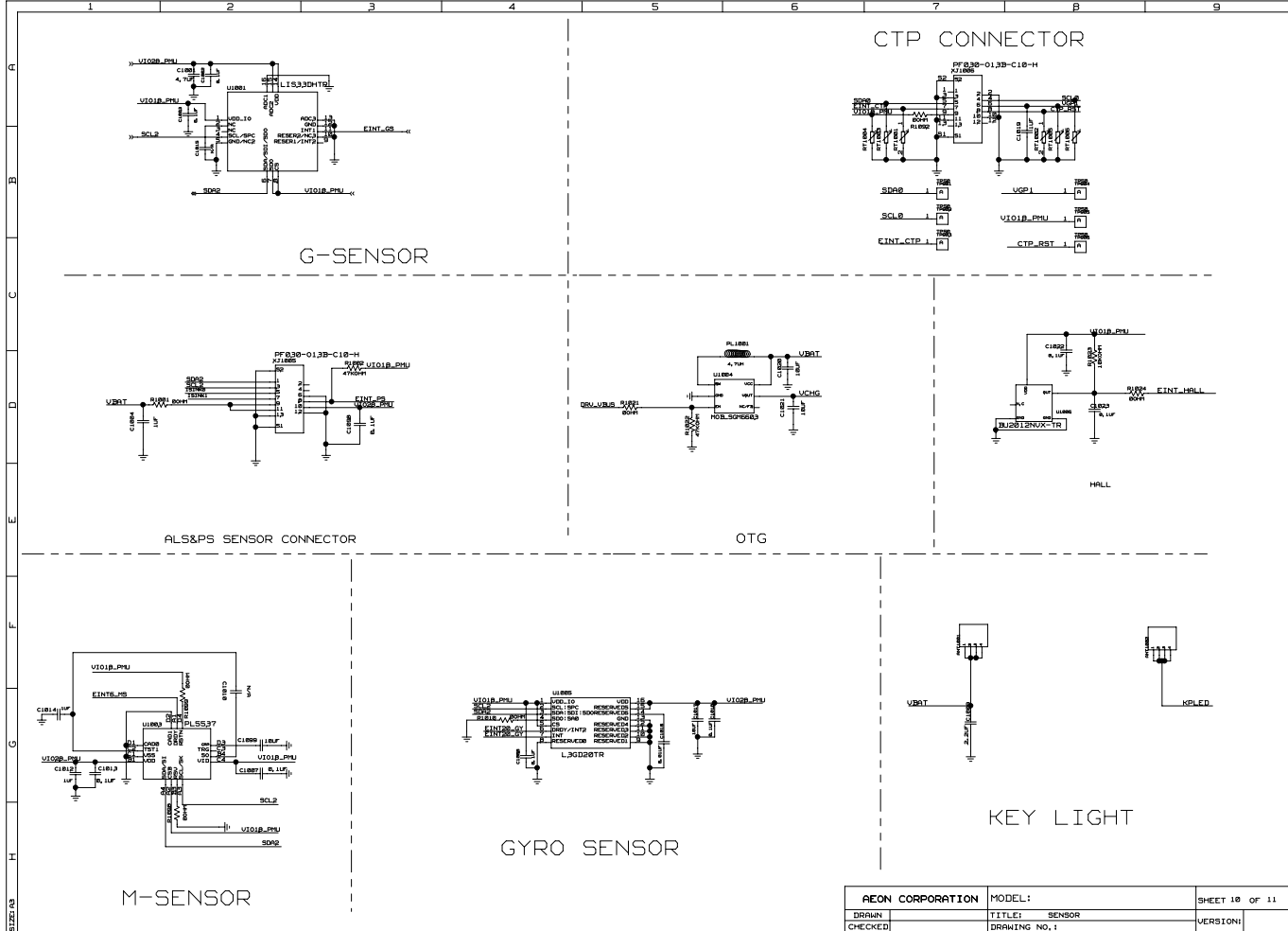

AECN CORPORATION		MODEL: 1	SHEET 10 OF 11	
DRAWN		TITLE: SENSOR		
CHECKED		DRAWING NO. 1	VERSION:	

