



# FCC RF Test Report

**Product Name: WCDMA Mobile Phone**

**Model Number: SKY 5.0S**

**Report No: 1408FR18**

**FCCID: 2ABOSGCSKY50S**

Issue by

**A Test Lab Techno Corp.**

No. 140-1, Changan Street, Bade City,

Taoyuan County 334, Taiwan R.O.C.

Tel : +886-3-2710188 / Fax : +886-3-2710190



Taiwan Accreditation Foundation accreditation number: 1330

**Note:** This report shall not be reproduced except in full, without the written approval of A Test Lab Techno Corp. This document may be altered or revised by A Test Lab Techno Corp. personnel only, and shall be noted in the revision section of the document. The client should not use it to claim product endorsement by TAF, or any government agencies. The test results in the report only apply to the tested sample.

---

## **Laboratory Accreditation and Relationship to Customer**

The testing report were performed by the Shenzhen Academy of Metrology and quality Inspection EMC Laboratory (Guangdong EMC compliance testing center), in their facilities located at Bldg. of Metrology & Quality Inspection, Longzhu Road, Nanshan District, Shenzhen, Guangdong, China. At the time of testing, Laboratory is accredited by the following organizations:

China National Accreditation Service for Conformity Assessment (CNAS) accredits the Laboratory for conformance to FCC standards, EMC international standards and EN standards. The Registration Number is CNAS L0579. The Laboratory is listed in the United States of American Federal Communications Commission (FCC), and the registration number are 446246 806614 994606(semi anechoic chamber).

The Laboratory is listed in Voluntary Control Council for Interference by Information Technology Equipment (VCCI), and the registration number are R-1974(open area test site), R-1966(semi anechoic chamber), C-2117(mains ports conducted interference measurement) and T-180(telecommunication ports conducted interference measurement).

The Laboratory is registered to perform emission tests with Industry Canada (IC), and the registration number is 11177A-1 11177A-2.

TUV Rhineland accredits the Laboratory for conformance to IEC and EN standards, the registration number is E2024086Z02.

**Applicant:** Sky Phone LLC  
**Address:** 1348 Washington Av., Miami Beach

**Date of Receipt Sample:** 2014-07-23  
**Start Date of Test:** 2014-07-23  
**End Date of Test:** 2014-08-23  
**Issue Date:** 2014-08-23

**Test Result:** Pass

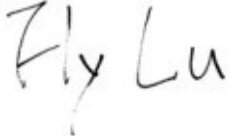
Approved By :  (Manager)      Reviewed By :  (Testing Engineer)      (FlyLv)

(Murphy Wang)      (Testing Engineer)



---

## Revision History

Rev.	Issue Date	Revisions	Revised By
00	23 Aug, 2014	Initial Issue	



---

## CONTENT

1	GeneralInformation.....	6
1.1	Applied Standard.....	6
1.2	Test Location.....	6
1.3	Test Environment Condition.....	6
2	TestSummary.....	7
2.1	CellularBand(824-849MHzpairedwith869-894MHz).....	7
2.2	PCS Band(1850-1915MHzpairedwith1930-1995 MHz).....	8
3	DescriptionoftheEquipmentunder Test(EUT).....	10
3.1	GeneralDescription.....	10
3.2	EUTIdentity.....	10
3.3	TechnicalSpecification.....	11
4	GeneralTestConditions / Configurations.....	12
4.1	TestModes.....	12
4.2	TestEnvironment.....	12
4.3	TestFrequency.....	13
4.4	DESCRIPTIONOFTESTS.....	15
4.5	TestSetups.....	18
4.6	TestConditions.....	20
5	MainTestInstruments.....	22
6	MeasurementUncertainty.....	23



## 1 General Information

### 1.1 **Applied Standard**

Applied Rules: 47CFRFCC Part02:2013  
47CFRFCC Part22:2013  
47CFR FCC Part24:2013  
47CFR FCC Part27:2013

Test Method: FCCKDB971168D01 Power Meas License Digital Systems  
TIA/EIA 603D: 010

### 1.2 **Test Location**

TestLocation1: Shenzhen Academy of Metrology and quality Inspection  
Address: No.4 Tongfa Road, Xili Town, Nanshan District, Shenzhen, Guangdong, China

### 1.3 **Test Environment Condition**

Ambient Temperature: 19.5 to 25°C  
Ambient Relative Humidity: 40 to 55%  
Atmospheric Pressure: Not applicable

## 2 Test Summary

### 2.1 Cellular Band (824-849MHz paired with 869-894MHz)

Test Item	FCC Rule No.	Requirements	Verdict
Effective(Isotropic) Radiated Power Output Data	§2.1046, §22.913	FCC: ERP ≤ 7W.	Pass
Modulation Characteristics	§2.1047	Digital modulation	N/A
Bandwidth	§2.1049	OBW: No limit. EBW: No limit.	Pass
Band Edges Compliance	§2.1051, §22.917	≤-13dBm/1%*EBW, in 1MHz bands immediately outside and adjacent to The frequency block.	Pass
Spurious Emission at Antenna Terminals	§2.1051, §22.917	FCC: ≤ -13dBm/100kHz, From 9kHz to 10th harmonics but outside authorized operating frequency ranges.	Pass
Field Strength of Spurious Radiation	§2.1053, §22.917	FCC: ≤ -13dBm/100kHz.	Pass
Frequency Stability	§2.1055, §22.355	≤ ±2.5ppm.	Pass

NOTE 1: For the verdict, the "N/A" denotes "not applicable", the "N/T" de notes "not tested".

### 2.2 PCS Band (1850-1915MHz paired with 1930-1995MHz)

Test Item	FCC Rule No.	Requirements	Verdict
Effective (Isotropic) Radiated Power Output Data	§2.1046, §24.232	EIRP ≤ 2W	Pass
Peak-Average Ratio	§2.1046, §24.232	FCC:Limit≤13dB	N/A
Modulation Characteristics	§2.1047	Digital modulation	N/A
Bandwidth	§2.1049	OBW: No limit. EBW: No limit.	Pass
Band Edges Compliance	§2.1051, §24.238	≤ -13dBm/1%*EBW, In 1MHz bands immediately outside and adjacent to The frequency block.	Pass
Spurious Emission at Antenna Terminals	§2.1051, §24.238	≤-13dBm/1MHz, from 9kHz to10th harmonics but outside authorized Operating frequency ranges.	Pass
Field Strength of Spurious Radiation	§2.1053, §24.238	≤ -13dBm/1MHz.	Pass
Frequency Stability	§2.1055, §24.235	FCC: within authorized frequency block.	Pass

NOTE 1: For the verdict, the "N/A" denotes "not applicable", the "N/T" de notes "not tested".

**2.3 AWS Band (1710-1755MHz paired with 2110-2155MHz)**

Test Item	FCC Rule No.	Requirements	Verdict
Effective (Isotropic) Radiated Power Output Data	§2.1046, §27.50(d)	EIRP ≤ 2W	Pass
Peak-Average Ratio	§2.1046, §27.50(d)	FCC:Limit≤13dB	N/A
Modulation Characteristics	§2.1047	Digital modulation	N/A
Bandwidth	§2.1049	OBW: No limit. EBW: No limit.	Pass
Band Edges Compliance	§2.1051, §27.53(h)	≤ -13dBm/1%*EBW, In 1MHz bands immediately outside and adjacent to The frequency block.	Pass
Spurious Emission at Antenna Terminals	§2.1051, §27.53(h)	≤-13dBm/1MHz, from 9kHz to10th harmonics but outside authorized Operating frequency ranges.	Pass
Field Strength of Spurious Radiation	§2.1053, §27.53(h)	≤ -13dBm/1MHz.	Pass
Frequency Stability	§2.1055, §27.54	FCC: within authorized frequency block.	Pass
NOTE 1: For the verdict, the "N/A" denotes "not applicable", the "N/T" de notes "not tested".			

**3 Description of the Equipment under Test (EUT)**
**3.1 General Description**

SKY 5.0S is subscriber equipment in the WCDMA/GSM system. The HSPA/UMTS frequency band is Band II, Band IV, and Band V, The GSM/GPRS/EDGE (EDGE downlink only) frequency band includes GSM850 and GSM900 and DCS1800 and PCS1900, but only Band IV and Band II and Band V and GSM850 and PCS1900 bands test data included in this report. The Mobile Phone implements such functions as RF signal receiving/transmitting, HSPA/UMTS and GSM/GPRS/EDGE protocol processing, voice, video MMS service, GPS, AGPS and WIFI etc. Externally it provides micro SD card interface, earphone port (to provide voice service) and SIM card interface. It also provides Bluetooth module to synchronize data between a PC and the phone, or to use the built-in modem of the phone to access the Internet with a PC, or to exchange data with other Bluetooth devices.

**3.2 EUT Identity**

IMEI No.	
SIM 1	883772029997780
SIM 2	863772029998101

NOTE: Unless otherwise noted in the report, the functional boards installed in the units shall be selected from the below list, but not means all the functional boards listed below shall be installed in one unit.



### 3.3 Technical Specification

Characteristics	Description	
Radio System Type	<input checked="" type="checkbox"/> GSM/ <input checked="" type="checkbox"/> UMTS	
Supported Frequency Range	GSM850/WCDMA850	Transmission(TX): 824 to 849MHz
		Receiving(RX): 869 to 894MHz
	GSM1900/WCDMA1900	Transmission(TX): 1850 to 1910MHz
		Receiving(RX): 1930 to 1990MHz
WCDMA1700	Transmission(TX): 1710to1755MHz	
	Receiving(RX): 2110to2155MHz	
TX and RX Antenna Ports	TX& RX port:	1
	TX-only port:	0
	RX-only port:	1
Supported Channel Bandwidth Designation of Emissions (Note: the necessary bandwidth of which is the worst value from the measured occupied bandwidths for each type of channel bandwidth configuration.)	GSM system:	200 kHz
	UMTS system:	5 MHz
	GSM850:	245KGXW
	GSM1900:	248KGXW
	UMTS 850:	4M16F9W
	UMTS 1900:	4M16F9W
	UMTS1700:	4M15F9W

## 4 General Test Conditions/Configurations

### 4.2 Test Modes

NOTE: The test mode(s) are selected according to relevant radio technology specifications.

Test Mode	Test Modes Description
GSM/TM1	GSM system, GSM,GMSK modulation
GSM/TM2	GSM system, GPRS, GMSK modulation
UMTS/TM1	WCDMA system, QPSK modulation
UMTS/TM2	HSDPA system, QPSK modulation
UMTS/TM3	HSUPA system, QPSK modulation

Note: This EUT owns two SIM cards, after we perform the pretest for these two SIM cards; we found the SIM 1 is the worst case, so its result is recorded in this report.

### 4.3 Test Environment

Environment Parameter	Selected Values During Tests	
Relative Humidity	Ambient	
Temperature	TN	Ambient
Voltage	VL	3.5V
	VN	3.7V
	VH	4.2V

NOTE: VL=lower extreme test voltage VN=nominal voltage  
VH=upper extreme test voltage TN=normal temperature

**4.4 Test Frequency**

Test Mode	TX/RX	RF Channel		
		Low(L)	Middle (M)	High (H)
GSM850	TX	Channel 128	Channel 190	Channel 251
		824.2 MHz	836.6 MHz	848.8 MHz
	RX	Channel 128	Channel 190	Channel 251
		869.2 MHz	881.6 MHz	893.8 MHz
Test Mode	TX/RX	RF Channel		
		Low(L)	Middle (M)	High (H)
GSM1900	TX	Channel 512	Channel 661	Channel 810
		1850.2 MHz	1880.0 MHz	1909.8 MHz
	RX	Channel 512	Channel 661	Channel 810
		1930.2 MHz	1960.0 MHz	1989.8 MHz
Test Mode	TX/RX	RF Channel		
		Low(L)	Middle (M)	High (H)
WCDMA850	TX	Channel 4132	Channel 4182	Channel 4233
		826.4 MHz	836.4 MHz	846.6 MHz
	RX	Channel 4357	Channel 4407	Channel 4458
		871.4 MHz	881.4 MHz	891.6 MHz
Test Mode	TX/RX	RF Channel		
		Low(L)	Middle (M)	High (H)
WCDMA1900	TX	Channel 9262	Channel 9400	Channel 9538
		1852.4 MHz	1880.0 MHz	1907.6 MHz
	RX	Channel 9662	Channel 9800	Channel 9938
		1932.4 MHz	1960.0 MHz	1987.6 MHz
Test Mode	TX/RX	RF Channel		
		Low(L)	Middle (M)	High (H)
WCDMA1700	TX	Channel 1312	Channel 1413	Channel 1513
		1712.4 MHz	1732.6 MHz	1752.6 MHz
	RX	Channel 1537	Channel 1638	Channel 1738
		2112.4 MHz	2132.6 MHz	2152.6 MHz

**4.5 Main Test Instruments**

<b>Output Power(Conducted) &amp; Occupied Bandwidth &amp; Emission Bandwidth &amp; Band Edge Compliance &amp; Conducted Spurious Emission &amp; Frequency Stability</b>					
Equipment Name	Manufacturer	Model	Serial Number	Cal Date	Cal Period
Universal Radio Communication Tester	R & S	CMU200	109369	08/07/2013	1 year
MXA Signal Analyzer	Agilent	N9020A	MY53420615	05/12/2014	1 year
2Way Divider	WOKEN	N/A	0120A02056002D	03/19/2014	2 year

<b>Output Power (Radiated) &amp; Radiated Spurious Emission</b>					
Equipment Name	Manufacturer	Model	Serial Number	Cal Date	Cal Period
Universal Radio Communication Tester	R & S	CMU200	SB8501/11	01/20/2014	1 year
EMI Test Receiver	R & S	ESU40	SB8501/09	03/16/2014	1 year
Bilog Antenna	Schwarzbeck	VULB9163	SB8501/05	01/20/2014	1 year
Bilog Antenna	Schwarzbeck	VULB9163	SB8501/04	01/20/2014	1 year
Horn Antenna	R&S	HF906	SB3435	01/20/2014	1 year
Horn Antenna	R&S	HF906	SB3436	01/20/2014	1 year
Horn Antenna	AR	AT4560	SB5392/02	01/20/2014	1 year
Amplifier	R&S	Amplifier(1-18GHz)	SB3435/01	03/16/2014	1 year
Amplifier	R&S	Amplifier(18-40GHz)	SB3435/02	03/16/2014	1 year
Test Software	R&S	EMC32	N/A	N/A	N/A
Signal Generator	Rohde&Schwarz	SMF100A	SB3438	03/16/2014	1 year
Loop Antenna	Schwarzbeck	FMZB1516	SB3345	01/22/2014	1 year

**4.6 Measurement Uncertainty**

For a 95% confidence level ( $k = 2$ ), the measurement expanded uncertainties for defined systems, in accordance with their commendations of ISO 17025 as following:

Test Item		Extended Uncertainty
Transmit Output Power Data	Power [dBm]	U = 1.2dB
Bandwidth	Magnitude[%]	U = 0.2%
Band Edge Compliance	Disturbance Power[dBm]	U = 1.2dB
Spurious Emissions, Conducted	Disturbance Power[dBm]	U = 1.2dB
Field Strength of Spurious Radiation	ERP [dBm]	For 3mChamber: U = 4.6dB (30MHzto1GHz) U = 3.0dB (above1GHz) For10mChamber: U = 4.6dB (30MHzto1GHz) U = 3.0dB (above1GHz)
Frequency Stability	Frequency Accuracy [ppm]	U = 0.21ppm

## 5.1 OUTPUT POWER

### TEST APPLICABLE

During the process of testing, the EUT was controlled via Rhode & Schwarz Digital Radio Communication tester (CMU-200) to ensure max power transmission and proper modulation. This result contains output power and EIRP measurements for the EUT. In all cases, output power is within the specified limits.

#### 5.1.1. Conducted Output Power

### TEST CONFIGURATION

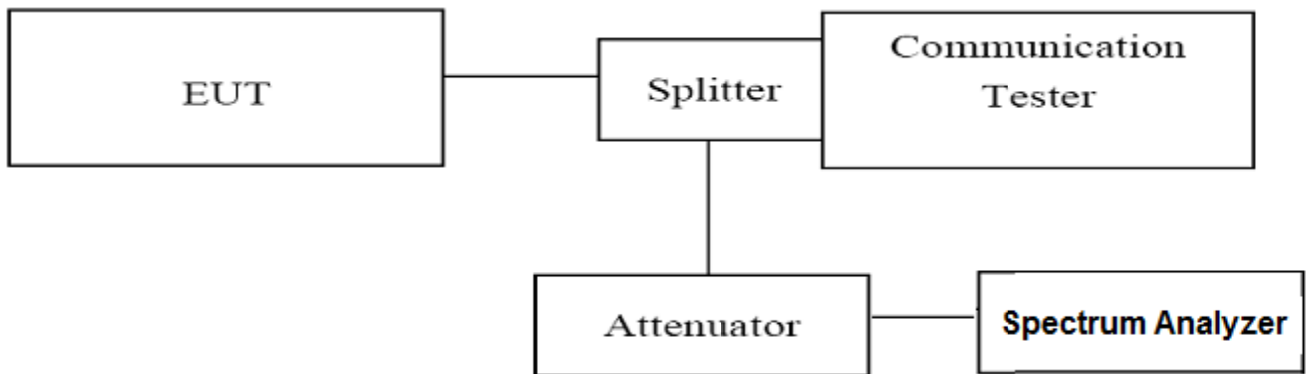

### TEST PROCEDURE

1. The EUT was set up for the max output power with pseudo random data modulation.
2. The power was measured with Agilent Spectrum Analyzer N9020A (peak)
3. These measurements were done at 3 frequencies, 1850.20 MHz, 1880.00 MHz and 1907.60 MHz for WCDMA band II; 1712.4 MHz, 1732.6 MHz and 1752.6 MHz for WCDMA band IV, 826.40 MHz, 836.60 MHz and 846.60 MHz for WCDMA band V. (low, middle and high of operational frequency range).

### TEST CONDITION

RBW	VBW	Sweep Time	Span
10MHz	10MHz	800ms	50MHz

### TEST RESULTS

UMTS/TM1/WCDMA V		
Channel	Frequency (MHz)	Output Power(dBm)
4132	826.40	23.46
4183	836.60	23.20
4233	846.60	23.12

UMTS/TM1/WCDMA II		
Channel	Frequency (MHz)	Output Power(dBm)
9262	1852.40	23.32
9400	1880.00	23.78
9538	1907.60	23.19

UMTS/TM1/WCDMA IV		
Channel	Frequency (MHz)	Output Power(dBm)
1312	1712.40	23.32
1413	1732.60	23.78
1513	1752.60	23.19

**5.1.2. Radiated Output Power**

**TEST DESCRIPTION**

This is the test for the maximum radiated power from the EUT.  
 Rule Part 24.232(c) specifies, "Mobile/portable stations are limited to 2 watts e.i.r.p. Peak power" and 24.232(e) specifies that "Peak transmit power must be measured over any interval of continuous transmission using instrumentation calibrated in terms of an rms-equivalent voltage." Rule Part 22.913(a) specifies "The ERP of mobile transmitters and auxiliary test transmitters must not exceed 7 Watts."

**TEST CONFIGURATION**

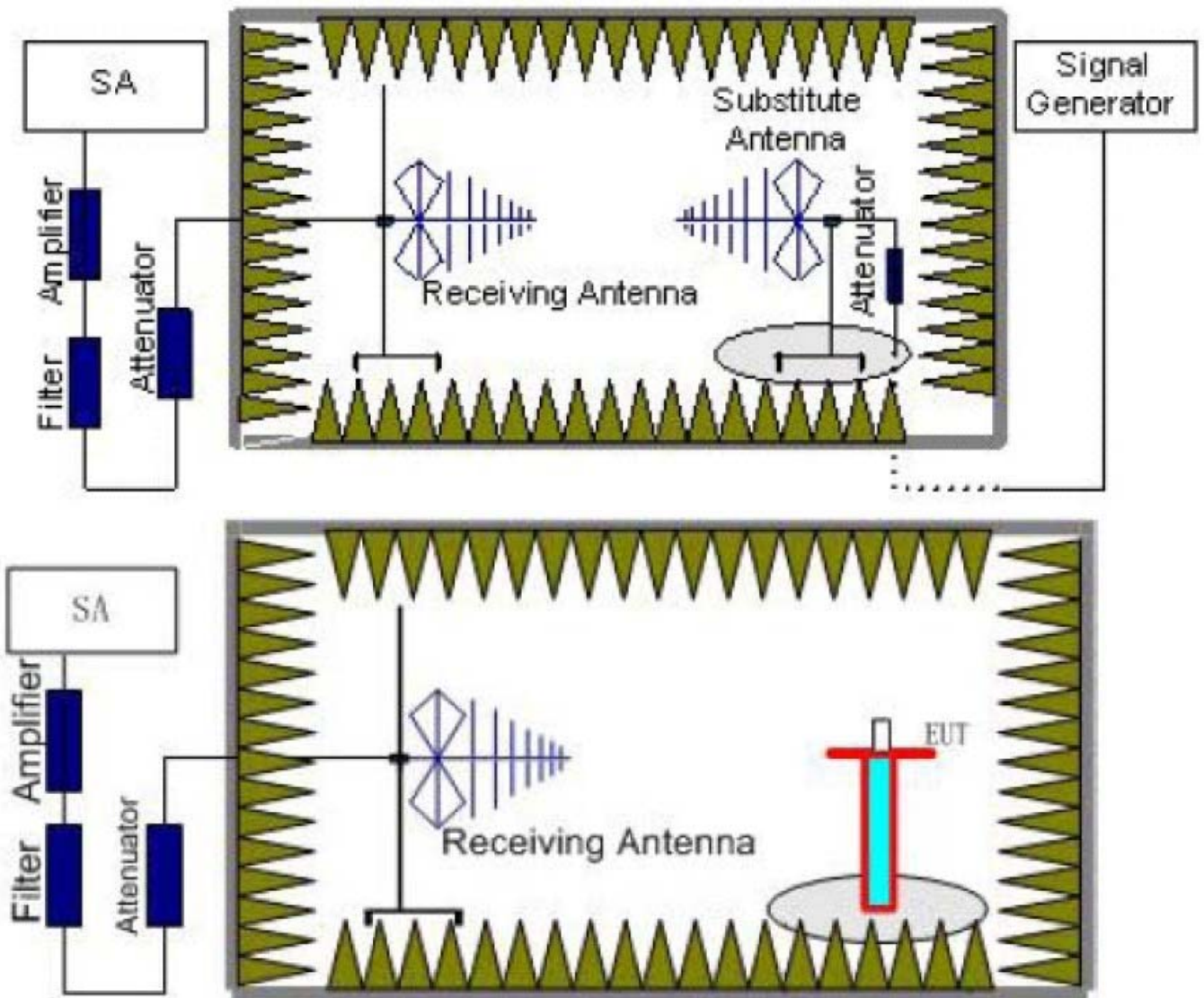



## TEST PROCEDURE

1. EUT was placed on a 1.50 meter high non-conductive stand at a 3 meter test distance from the receive antenna. A receiving antenna was placed on the antenna mast 3 meters from the EUT for emission measurements. The height of receiving antenna is 1.50m. Detected emissions were maximized at each frequency by rotating the EUT through 360° and adjusting the receiving antenna polarization. The radiated emission measurements of all transmit frequencies in three channels (High, Middle, Low) were measured with peak detector.
2. A log-periodic antenna or double-ridged waveguide horn antenna shall be substituted in place of the EUT. The log-periodic antenna will be driven by a signal generator and the level will be adjusted till the same power value on the spectrum analyzer or receiver. The level of the spurious emissions can be calculated through the level of the signal generator, cable loss, the gain of the substitution antenna and the reading of the spectrum analyzer or receiver.
3. The EUT is then put into continuously transmitting mode at its maximum power level during the test. Set Test Receiver or Spectrum RBW=10MHz, VBW=10MHz, and the maximum value of the receiver should be recorded as (P<sub>r</sub>).
4. The EUT shall be replaced by a substitution antenna. In the chamber, a substitution antenna for the frequency band of interest is placed at the reference point of the chamber. An RF Signal source for the frequency band of interest is connected to the substitution antenna with a cable that has been constructed to not interfere with the radiation pattern of the antenna. A power (P<sub>Mea</sub>) is applied to the input of the substitution antenna, and adjusts the level of the signal generator output until the value of the receiver reach the previously recorded (P<sub>r</sub>). The power of signal source (P<sub>Mea</sub>) is recorded. The test should be performed by rotating the test item and adjusting the receiving antenna polarization.
5. An amplifier should be connected to the Signal Source output port. And the cable should be connecting between the Amplifier and the Substitution Antenna. The cable loss (P<sub>cl</sub>), the Substitution Antenna Gain (G<sub>a</sub>) and the Amplifier Gain (P<sub>Ag</sub>) should be recorded after test.  
The measurement results are obtained as described below:  
Power (EIRP) = P<sub>Mea</sub> - P<sub>Ag</sub> - P<sub>cl</sub> + G<sub>a</sub>  
We used SMF100A microwave signal generator which signal level can up to 33dBm, so we not used power Amplifier for substitution test; the measurement results are amend as described below:  
Power (EIRP) = P<sub>Mea</sub> - P<sub>cl</sub> + G<sub>a</sub>
6. This value is EIRP since the measurement is calibrated using an antenna of known gain (2.15 dBi) and known input power.
7. ERP can be calculated from EIRP by subtracting the gain of the dipole, ERP = EIRP-2.15dBi.

## TEST LIMIT

According to 22.913(a) and 24.232(c), the ERP should be not exceeding following table limits:

	<b>Burst Peak EIRP</b>
WCDMA Band II	33dBm (2W)
	<b>Burst Peak EIRP</b>
WCDMA Band IV	33dBm (2W)
	<b>Burst Peak ERP</b>
WCDMA Band V	38.45dBm (7W)



## TEST RESULTS

UMTS/TM1/WCDMA Band II						
Frequency (MHz)	P <sub>Mea</sub> (dBm)	P <sub>cl</sub> (dB)	G <sub>a</sub> Antenna Gain (dB)	Correction (dB)	EIRP (dBm)	Polarization
1852.4	13.00	0.97	8.92	2.15	20.95	V
1880.0	13.89	0.97	8.92	2.15	21.84	V
1907.6	12.42	0.97	8.92	2.15	20.37	V

UMTS/TM1/ WCDMA Band IV						
Frequency (MHz)	P <sub>Mea</sub> (dBm)	P <sub>cl</sub> (dB)	G <sub>a</sub> Antenna Gain (dB)	Correction (dB)	EIRP (dBm)	Polarization
1712.40	12.34	0.91	8.88	2.15	20.31	V
1732.60	12.62	0.91	8.88	2.15	20.59	V
1752.60	12.21	0.91	8.88	2.15	20.18	V

UMTS/TM1/ WCDMA Band V						
Frequency (MHz)	P <sub>Mea</sub> (dBm)	P <sub>cl</sub> (dB)	G <sub>a</sub> Antenna Gain (dB)	Correction (dB)	ERP (dBm)	Polarization
826.40	15.91	0.5	5.28	2.15	18.54	V
836.60	16.60	0.5	5.28	2.15	19.23	V
846.60	17.22	0.5	5.28	2.15	19.85	V



## 5.2 Radiated Spurious Emission

### TEST APPLICABLE

According to the TIA/EIA 603D:2010 test method, The Receiver or Spectrum was scanned from 9 KHz to the 10th harmonic of the highest frequency generated within the equipment, which is the transmitted carrier that can be as high as 1910 MHz The resolution bandwidth is set as outlined in Part 24.238 and Part 22.917. The spectrum is scanned with the mobile station transmitting at carrier frequencies that pertain to low, mid and high channels of WCDMA Band II, WCDMA Band IV and WCDMA Band V.

### TEST CONFIGURATION

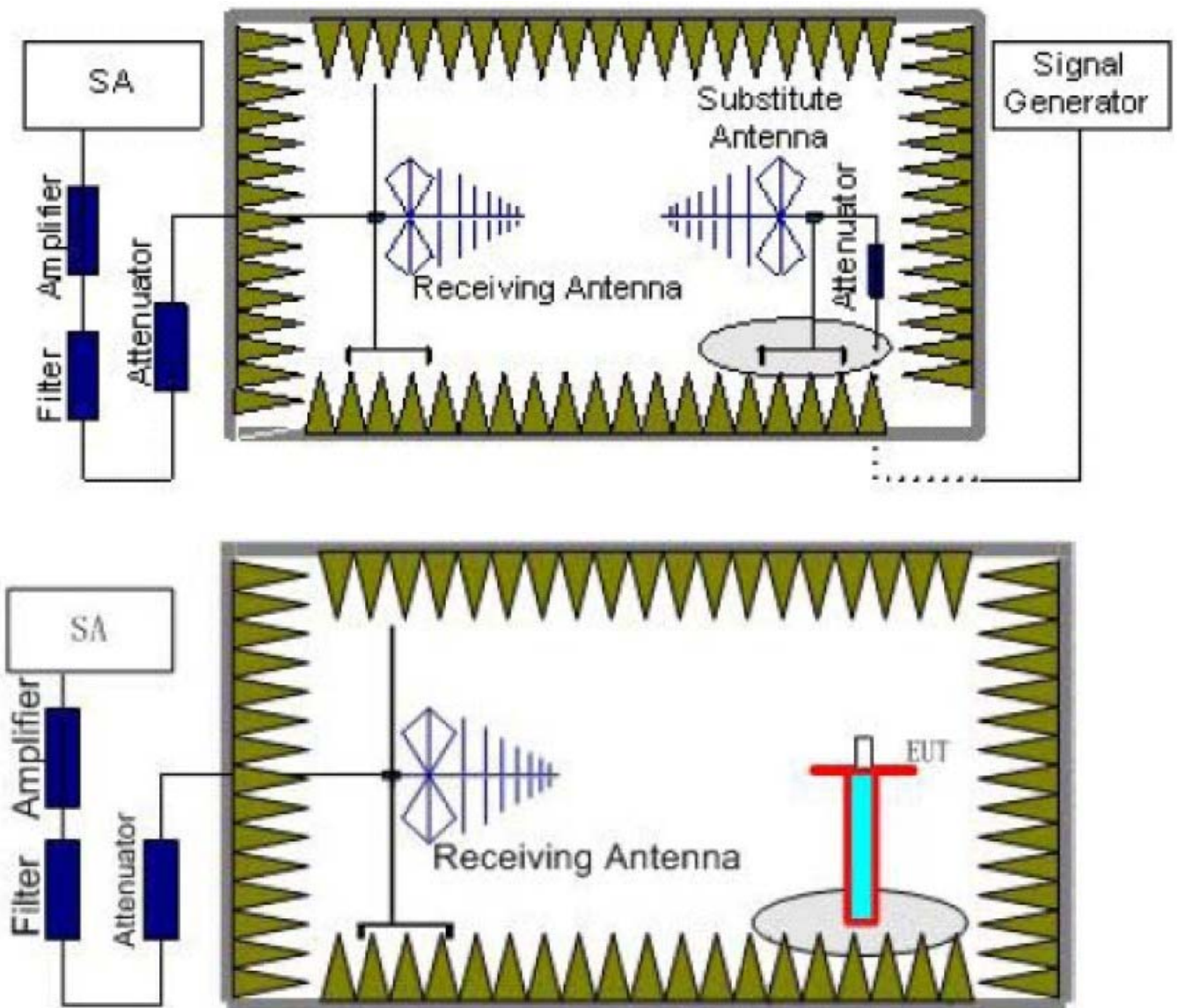

### TEST PROCEDURE

1. EUT was placed on a 1.50 meter high non-conductive stand at a 3 meter test distance from the receive antenna. A receiving antenna was placed on the antenna mast 3 meters from the EUT for emission measurements. The height of receiving antenna is 1.50m. Detected emissions were maximized at each

frequency by rotating the EUT through 360° and adjusting the receiving antenna polarization. The radiated emission measurements of all transmit frequencies in three channels (High, Middle, Low) were measured with peak detector.

2. A log-periodic antenna or double-ridged waveguide horn antenna shall be substituted in place of the EUT. The log-periodic antenna will be driven by a signal generator and the level will be adjusted till the same power value on the spectrum analyzer or receiver. The level of the spurious emissions can be calculated through the level of the signal generator, cable loss, the gain of the substitution antenna and the reading of the spectrum analyzer or receiver.
3. The EUT is then put into continuously transmitting mode at its maximum power level during the test. Set Test Receiver or Spectrum RBW=1MHz, VBW=3MHz, and the maximum value of the receiver should be recorded as ( $P_r$ ).
4. The EUT shall be replaced by a substitution antenna. In the chamber, a substitution antenna for the frequency band of interest is placed at the reference point of the chamber. An RF Signal source for the frequency band of interest is connected to the substitution antenna with a cable that has been constructed to not interfere with the radiation pattern of the antenna. Powers ( $P_{Mea}$ ) is applied to the input of the substitution antenna, and adjusts the level of the signal generator output until the value of the receiver reach the previously recorded ( $P_r$ ). The power of signal source ( $P_{Mea}$ ) is recorded. The test should be performed by rotating the test item and adjusting the receiving antenna polarization.
5. An amplifier should be connected to the Signal Source output port. And the cable should be connecting between the Amplifier and the Substitution Antenna. The cable loss ( $P_{cl}$ ), the Substitution Antenna Gain ( $G_a$ ) and the Amplifier Gain ( $P_{Ag}$ ) should be recorded after test.

The measurement results are obtained as described below:

$$\text{Power (EIRP)} = P_{Mea} - P_{Ag} - P_{cl} + G_a$$

6. This value is EIRP since the measurement is calibrated using an antenna of known gain (2.15 dBi) and known input power.
7. ERP can be calculated from EIRP by subtracting the gain of the dipole,  $ERP = EIRP - 2.15\text{dBi}$ .
8. In order to make sure test results more clearly, we set frequency range and sweep time for difference frequency range as follows table:

Working Frequency	Subrange (GHz)	RBW	VBW	Sweep time (s)
UMTS/TM1/ WCDMA Band V	0.00009~0.15	1KHz	3KHz	30
	0.00015~0.03	10KHz	30KHz	10
	0.03~1	100KHz	300KHz	10
	1~2	1 MHz	3 MHz	2
	2~5	1 MHz	3 MHz	3
	5~8	1 MHz	3 MHz	3
	8~10	1 MHz	3 MHz	3
UMTS/TM1/ WCDMA Band II	0.00009~0.15	1KHz	3KHz	30
	0.00015~0.03	10KHz	30KHz	10
	0.03~1	100KHz	300KHz	10
	1~2	1 MHz	3 MHz	2
	2~5	1 MHz	3 MHz	3
	5~8	1 MHz	3 MHz	3
	8~11	1 MHz	3 MHz	3
	11~14	1 MHz	3 MHz	3
	14~18	1 MHz	3 MHz	3
18~20	1 MHz	3 MHz	2	
UMTS/TM1/ WCDMA Band IV	0.00009~0.15	1KHz	3KHz	30
	0.00015~0.03	10KHz	30KHz	10
	0.03~1	100KHz	300KHz	10

	1~2	1 MHz	3 MHz	2
	2~5	1 MHz	3 MHz	3
	5~8	1 MHz	3 MHz	3
	8~11	1 MHz	3 MHz	3
	11~14	1 MHz	3 MHz	3
	14~18	1 MHz	3 MHz	3

**TEST LIMITS**

According to 24.238 and 22.917 specify that the power of any emission outside of the authorized operating frequency ranges must be attenuated below the transmitting power (P) by a factor of at least  $43 + 10 \log(P)$  dB.

The specification that emissions shall be attenuated below the transmitter power (P) by at least  $43 + 10 \log(P)$  dB, translates in the relevant power range (1 to 0.001 W) to -13 dBm. At 1 W the specified minimum attenuation becomes 43 dB and relative to a 30 dBm (1 W) carrier becomes a limit of -13 dBm. At 0.001 W (0 dBm) the minimum attenuation is 13 dB, which again yields a limit of -13 dBm. In this way a translation of the specification from relative to absolute terms is carried out.

Frequency	Channel	Frequency Range	Verdict
UMTS/TM1/ WCDMA Band V	Low	9KHz-10GHz	PASS
	Middle	9KHz -10GHz	PASS
	High	9KHz -10GHz	PASS
UMTS/TM1/ WCDMA Band IV	Low	9KHz-18GHz	PASS
	Middle	9KHz -18GHz	PASS
	High	9KHz -18GHz	PASS
UMTS/TM1/ WCDMA Band II	Low	9KHz -20GHz	PASS
	Middle	9KHz -20GHz	PASS
	High	9KHz -20GHz	PASS

UMTS/TM1/ WCDMA Band II							
Channel Number: 9262				Test Frequency: 1852.40 MHz			
Frequency (MHz)	P <sub>Mea</sub> (dBm)	Path Loss	Antenna Gain	Correction (dB)	Peak ERP(dBm)	Limit (dBm)	Polarization
3704.80	-41.75	4.60	9.53	2.15	-46.68	-13.00	H
5557.20	---			2.15	---	-13.00	H
3704.80	-39.02	4.60	9.53	2.15	-43.95	-13.00	V
5557.20	---			2.15	---	-13.00	V

UMTS/TM1/ WCDMA Band II							
Channel Number: 9400				Test Frequency: 1880.00 MHz			
Frequency (MHz)	P <sub>Mea</sub> (dBm)	Path Loss	Antenna Gain	Correction (dB)	Peak ERP(dBm)	Limit (dBm)	Polarization
3760.00	-41.83	4.60	9.53	2.15	-46.76	-13.00	H
5640.00	---			2.15	---	-13.00	H
3760.00	-40.25	4.60	9.53	2.15	-45.18	-13.00	V
5640.00	---			2.15	---	-13.00	V



UMTS/TM1/ WCDMA Band II							
Channel Number: 9538				Test Frequency: 1907.60 MHz			
Frequency (MHz)	P <sub>Mea</sub> (dBm)	Path Loss	Antenna Gain	Correction (dB)	Peak ERP(dBm)	Limit (dBm)	Polarization
3815.20	-42.42	4.60	9.53	2.15	-47.35	-13.00	H
5722.80	---			2.15	---	-13.00	H
3815.20	-39.90	4.60	9.53	2.15	-44.83	-13.00	V
5722.80	---			2.15	---	-13.00	V

UMTS/TM1/ WCDMA Band V							
Channel Number: 4132				Test Frequency: 826.40 MHz			
Frequency (MHz)	P <sub>Mea</sub> (dBm)	Path Loss	Antenna Gain	Correction (dB)	Peak ERP(dBm)	Limit (dBm)	Polarization
1652.80	-42.50	0.90	6.77	2.15	-48.37	-13.00	H
2479.20	---			2.15	---	-13.00	H
1652.80	-40.32	0.90	6.77	2.15	-46.19	-13.00	V
2479.20	---			2.15	---	-13.00	V

UMTS/TM1/ WCDMA Band V							
Channel Number: 4183				Test Frequency: 836.60 MHz			
Frequency (MHz)	P <sub>Mea</sub> (dBm)	Path Loss	Antenna Gain	Correction (dB)	Peak ERP(dBm)	Limit (dBm)	Polarization
1673.20	-41.87	0.90	6.77	2.15	-47.74	-13.00	H
2509.80	---			2.15	---	-13.00	H
1673.20	-39.34	0.90	6.77	2.15	-45.21	-13.00	V
2509.80	---			2.15	---	-13.00	V

UMTS/TM1/ WCDMA Band V							
Channel Number: 4233				Test Frequency: 846.60 MHz			
Frequency (MHz)	P <sub>Mea</sub> (dBm)	Path Loss	Antenna Gain	Correction (dB)	Peak ERP(dBm)	Limit (dBm)	Polarization
1693.20	-41.50	0.90	6.77	2.15	-47.37	-13.00	H
2539.80	---			2.15	---	-13.00	H
1693.20	-39.09	0.90	6.77	2.15	-44.96	-13.00	V
2539.80	---			2.15	---	-13.00	V

UMTS/TM1/ WCDMA Band IV							
Channel Number: 1312				Test Frequency: 1712.40 MHz			
Frequency (MHz)	P <sub>Mea</sub> (dBm)	Path Loss	Antenna Gain	Correction (dB)	Peak ERP(dBm)	Limit (dBm)	Polarization
3424.80	-43.25	4.10	9.48	2.15	-48.63	-13.00	H
5137.20	---			2.15	---	-13.00	H
3424.80	-39.94	4.10	9.48	2.15	-45.32	-13.00	V
5137.20	---			2.15	---	-13.00	V

UMTS/TM1/ WCDMA Band IV							
Channel Number: 1413				Test Frequency: 1732.60 MHz			
Frequency (MHz)	P <sub>Mea</sub> (dBm)	Path Loss	Antenna Gain	Correction (dB)	Peak ERP(dBm)	Limit (dBm)	Polarization
3465.20	-38.88	4.10	9.48	2.15	-44.26	-13.00	H
5197.80	---			2.15	---	-13.00	H
3465.20	-38.51	4.10	9.48	2.15	-43.89	-13.00	V
5197.80	---			2.15	---	-13.00	V

UMTS/TM1/ WCDMA Band IV							
Channel Number: 1513				Test Frequency: 1752.60 MHz			
Frequency (MHz)	P <sub>Mea</sub> (dBm)	Path Loss	Antenna Gain	Correction (dB)	Peak ERP(dBm)	Limit (dBm)	Polarization
3505.20	-42.36	4.10	9.48	2.15	-47.74	-13.00	H
5257.80	---			2.15	---	-13.00	H
3505.20	-39.27	4.10	9.48	2.15	-44.65	-13.00	V
5257.80	---			2.15	---	-13.00	V

Note: 1. In general, the worse case attenuation requirement shown above was applied.

2. "----" means that the emission level is too low to be measured or at least 20 dB down than the limit.

### 5.3 Occupied Bandwidth and Emission Bandwidth

#### TEST APPLICABLE

Similar to conducted emissions; occupied bandwidth measurements are only provided for selected frequencies in order to reduce the amount of submitted data. Data were taken at the extreme and mid frequencies of WCDMA Band II, WCDMA Band IV and WCDMA band V. The table below lists the measured 99% BW and 26dBc BW.

#### TEST CONFIGURATION

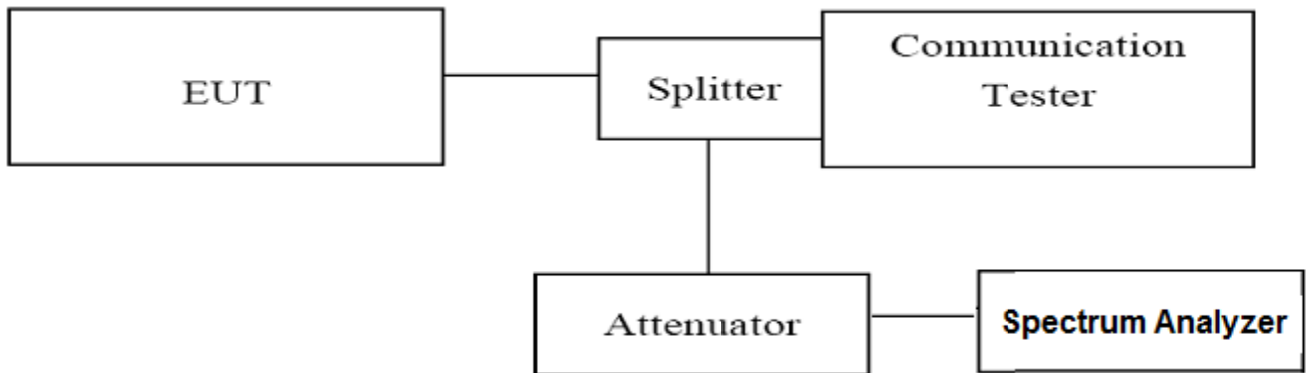

#### TEST PROCEDURE

1. The EUT was set up for the max output power with pseudo random data modulation;
2. The Occupied bandwidth was measured with Agilent Spectrum Analyzer N9020A (peak);
3. Set RBW=100KHz,VBW=300KHz,Span=10MHz,SWT=Auto;
4. Stet SPA Max hold. Mark peak, Set 99% Occupied Bandwidth and 26dBc Emission Bandwidth.
5. These measurements were done at 3 frequencies, 1850.20 MHz, 1880.00 MHz and 1709.80 MHz for WCDMA band II; 1712.40 MHz, 1732.06 MHz and 1752.60 MHz for WCDMA band IV; 826.40 MHz, 836.60 MHz and 846.60 MHz for WCDMA band V. (low, middle and high of operational frequency range).

#### TEST RESULTS

UMTS/TM1/ WCDMA Band II					
Channel Number	Frequency (MHz)	Occupied Bandwidth (99% BW) ( kHz)	Emission Bandwidth (26 dBc BW) ( kHz)	Refer to Plot	Verdict
9262	1852.4	4163.40	4711.00	Plot 5.3.1 A	PASS
9400	1880.0	4152.60	4677.00	Plot 5.3.1 B	PASS
9538	1907.6	4154.70	4687.00	Plot 5.3.1 C	PASS

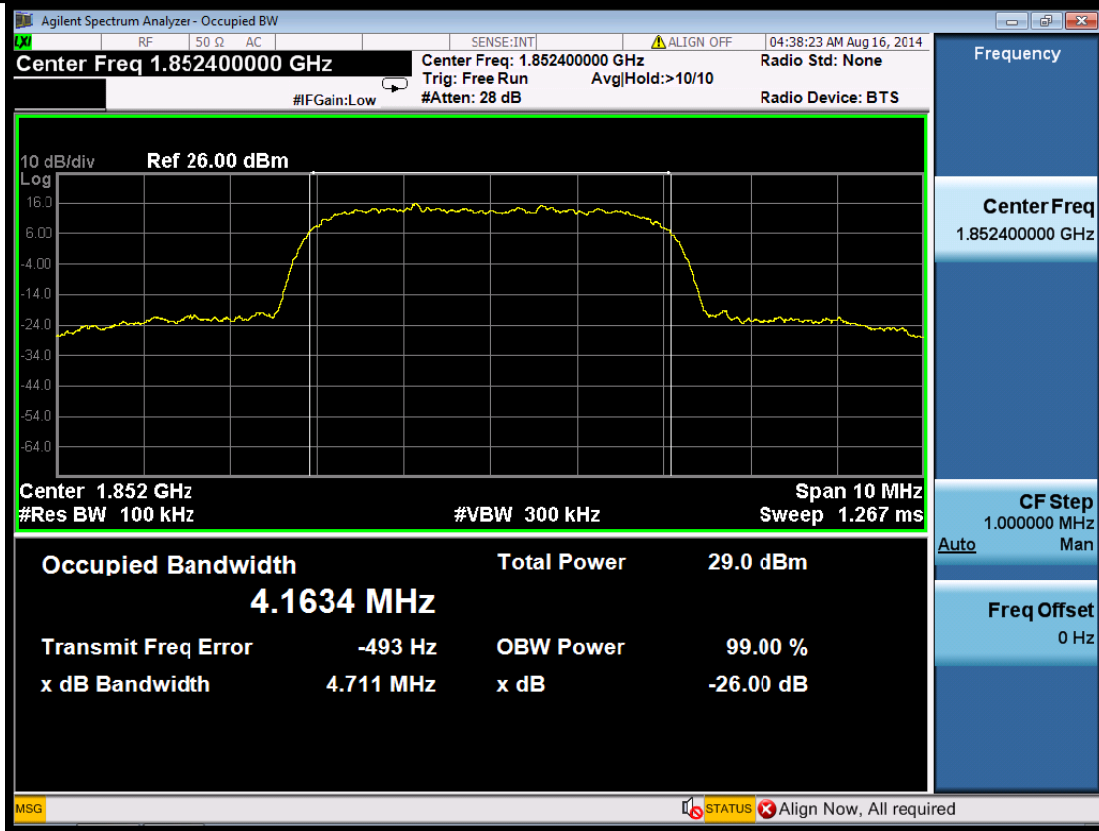

(Plot 5.3.1 A: Channel 9262: 1852.4MHz WCDMA Band II)

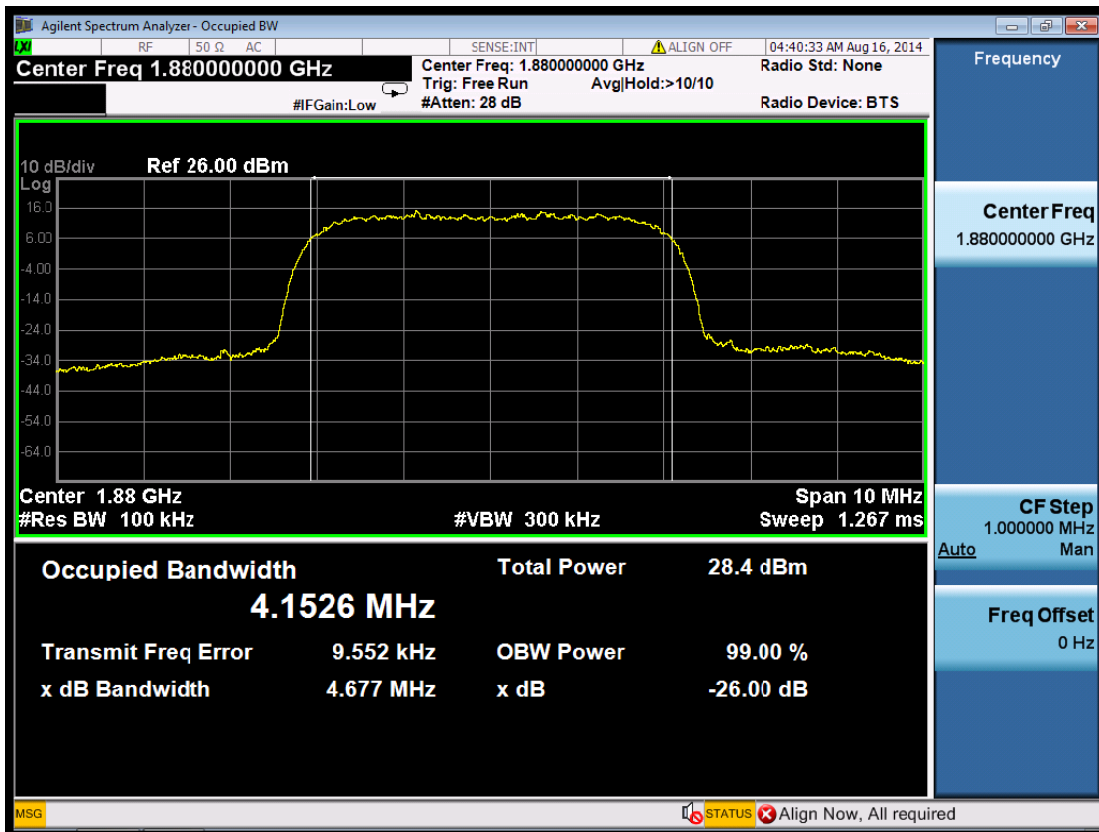

(Plot 5.3.1 B: Channel 9400: 1880.0MHz WCDMA Band II)



(Plot 5.3.1 C: Channel 9538: 1907.6MHz WCDMA Band II)

UMTS/TM1/ WCDMA Band IV					
Channel Number	Frequency (MHz)	Occupied Bandwidth (99% BW) ( kHz)	Emission Bandwidth (26 dBc BW) ( kHz)	Refer to Plot	Verdict
1312	1712.40	4150.50	4683.00	Plot 5.3.2 A	PASS
1413	1732.60	4153.30	4680.00	Plot 5.3.2 B	PASS
1513	1752.60	4153.30	4683.00	Plot 5.3.2 C	PASS



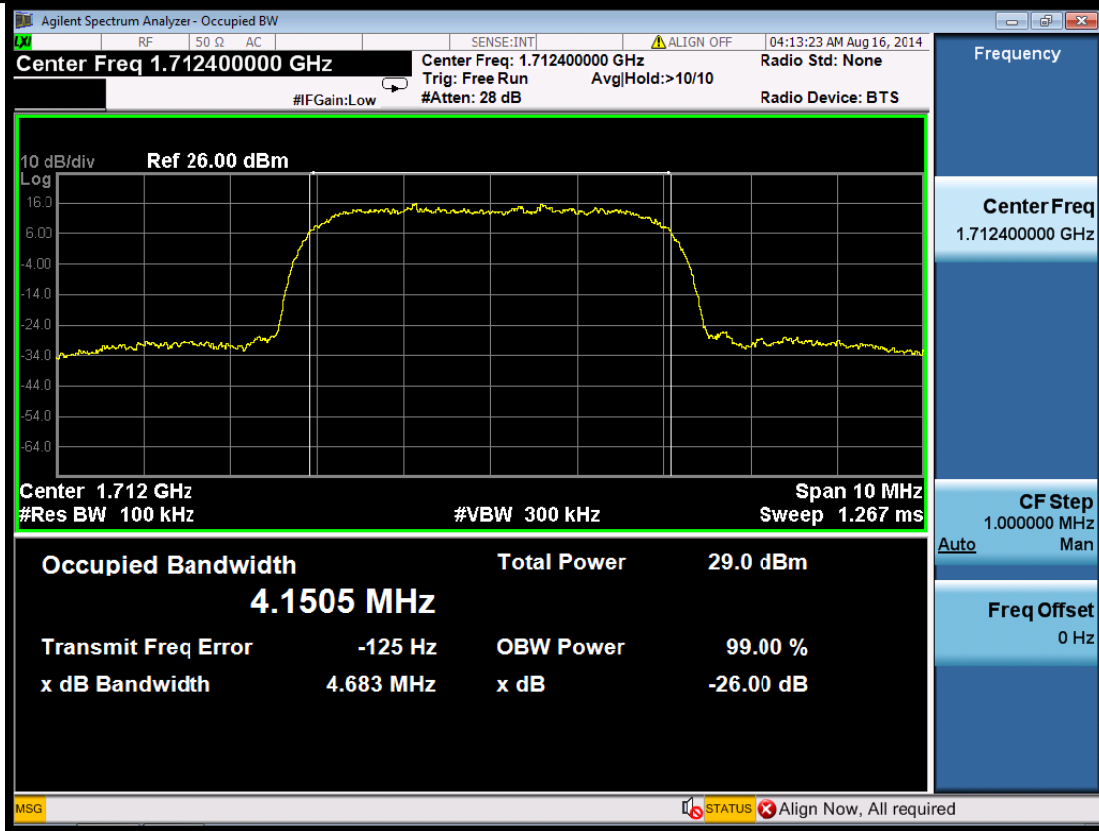

(Plot 5.3.2 A: Channel 1312: 1712.4MHz WCDMA Band IV)

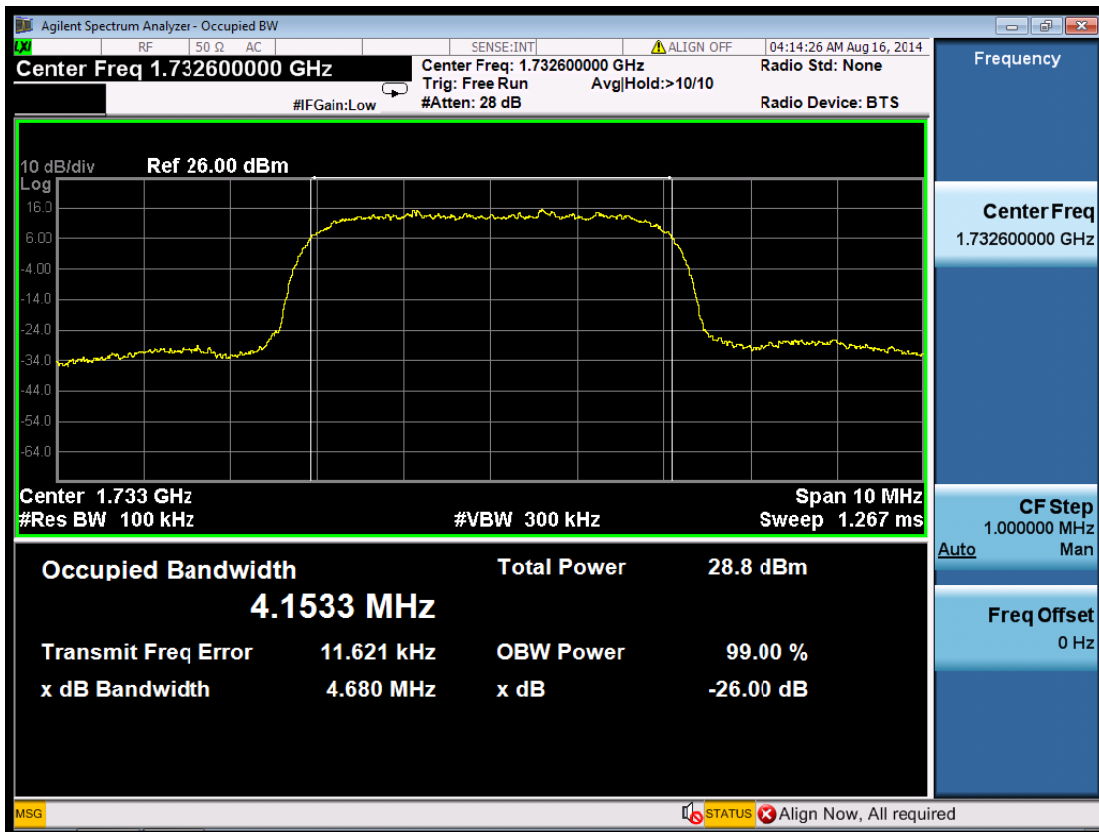

(Plot 5.3.2 B: Channel 1413: 1732.6MHz WCDMA Band IV)

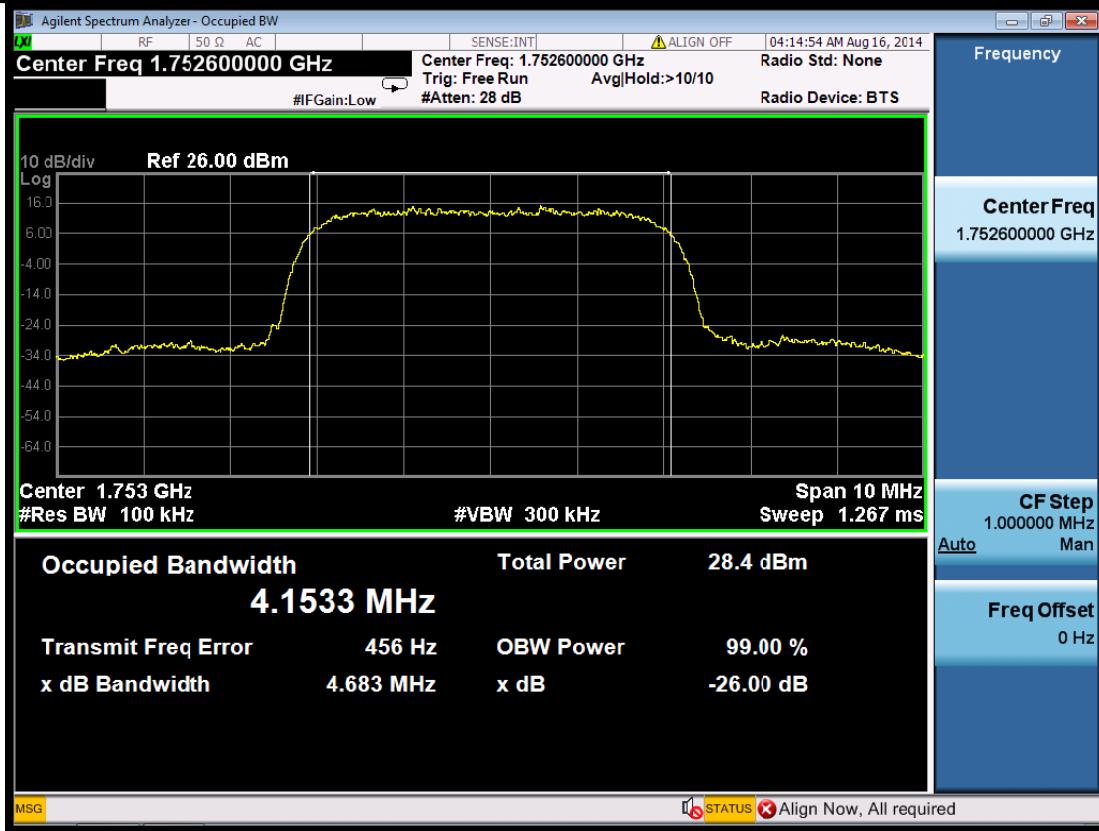

(Plot 5.3.2 C: Channel 1513: 1752.6MHz WCDMA Band IV)

UMTS/TM1/ WCDMA Band V					
Channel Number	Frequency (MHz)	Occupied Bandwidth (99% BW) (kHz)	Emission Bandwidth (26 dBc BW) (kHz)	Refer to Plot	Verdict
4132	826.40	4146.30	4679.00	Plot 5.3.3 A	PASS
4183	836.60	4156.50	4693.00	Plot 5.3.3 B	PASS
4233	846.60	4156.00	4691.00	Plot 5.3.3 C	PASS

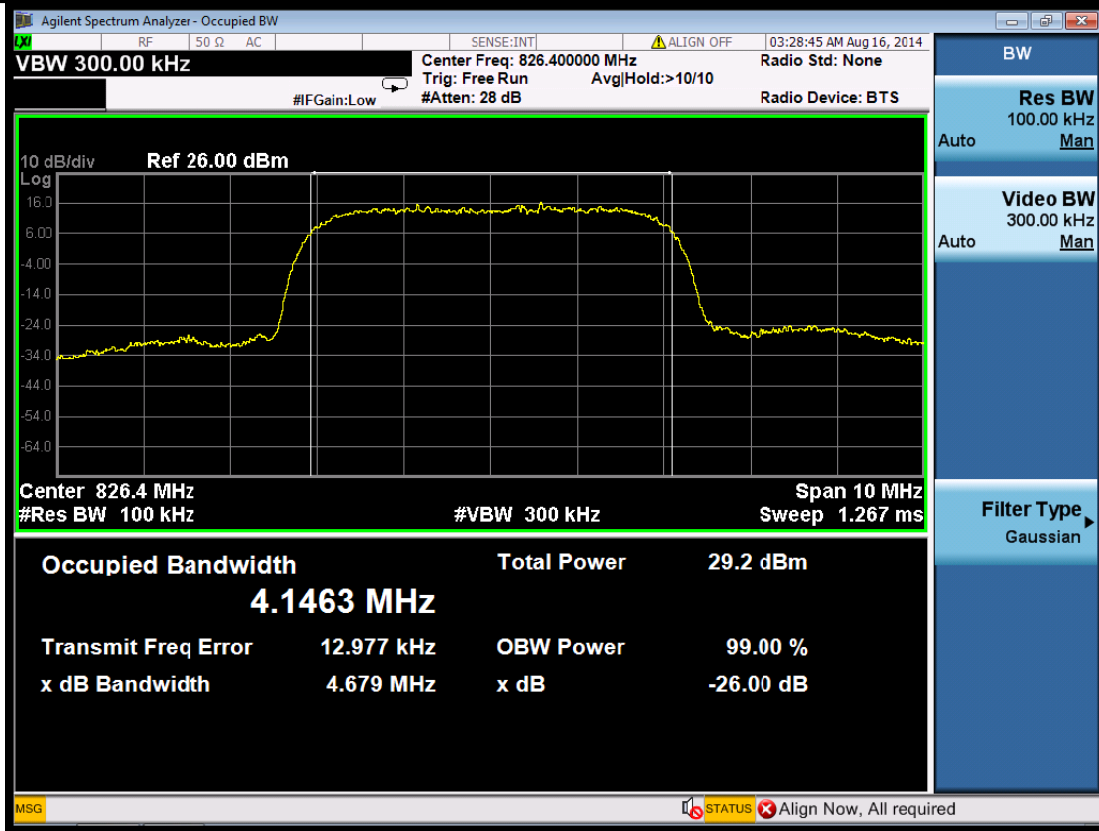

(Plot 5.3.3 A: Channel 4132:826.4MHz @ WCDMA Band V)

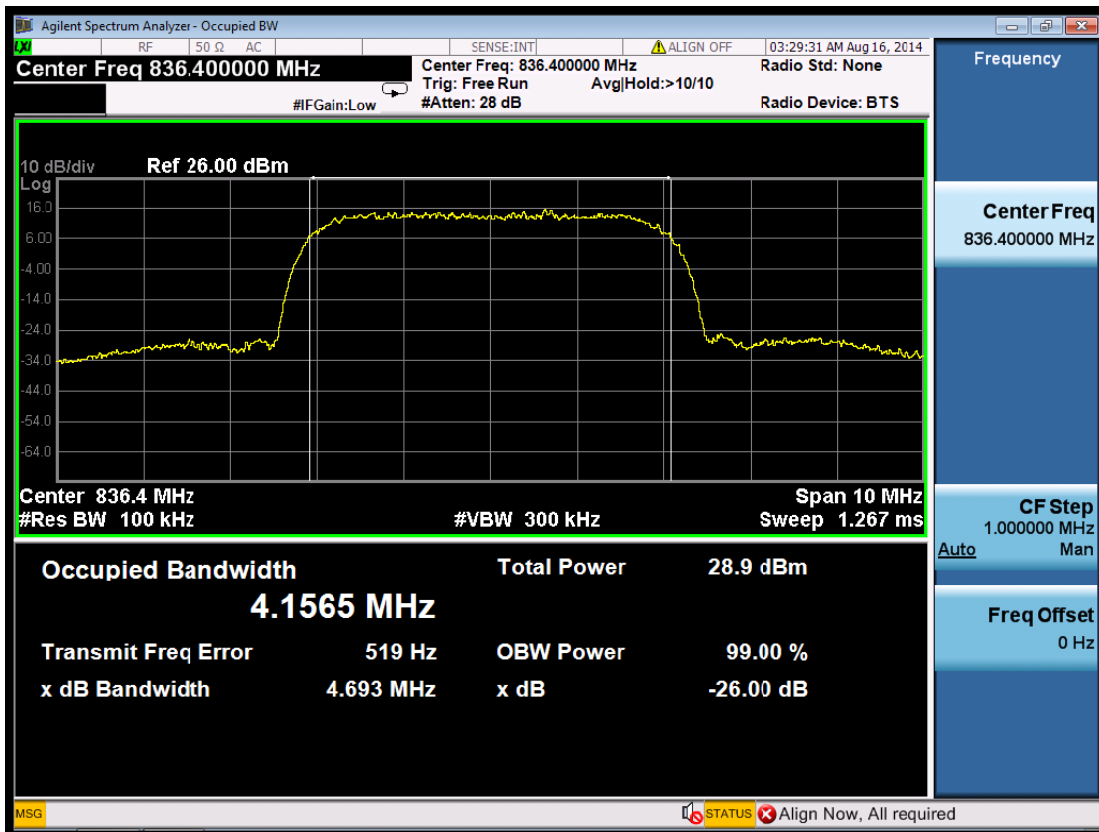

(Plot 5.3.3 B: Channel 4183:836.6MHz @ WCDMA Band V)

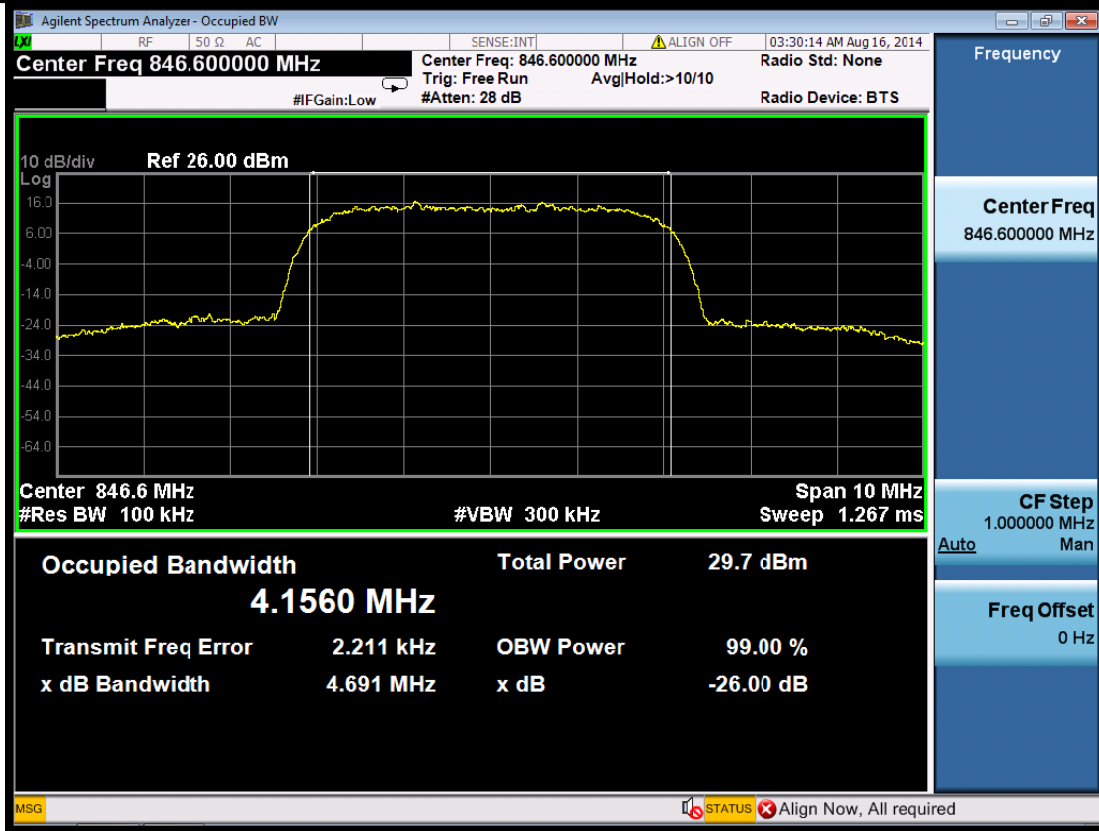

(Plot 5.3.3 C: Channel 4233:846.6MHz @ WCDMA Band V)

## 5.4 BAND EDGE COMPLIANCE

### TEST APPLICABLE

During the process of testing, the EUT was controlled via Rhode & Schwarz Digital Radio Communication tester (CMU-200) to ensure max power transmission and proper modulation.

### TEST CONFIGURATION

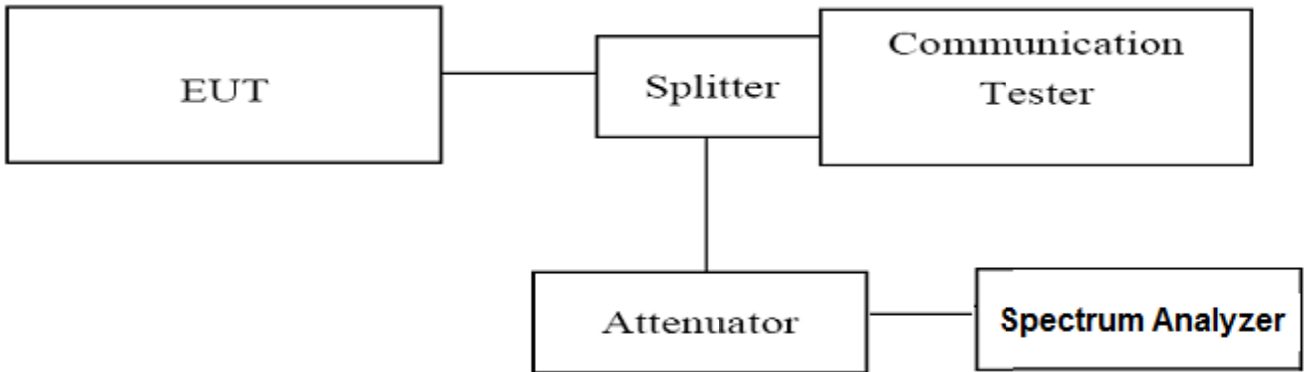

### TEST PROCEDURE

1. The EUT was set up for the max output power with pseudo random data modulation;
2. The power was measured with Rhode & Schwarz Spectrum Analyzer FSU (peak);
3. Set RBW=51KHz,VBW=150KHz,Span=10MHz,SWT=300ms;
4. These measurements were done at 2 frequencies, 1850.20 MHz and 1709.80 MHz for WCDMA band II; 1712.40 MHz and 1752.60 MHz for WCDMA band IV; 826.40 MHz and 846.60 MHz for WCDMA band V. (low and high of operational frequency range).

### TEST RESULTS

UMTS/TM1/WCDMA Band II						
Channel Number	Frequency (MHz)	Measurement Results		Limit (dBm)	Refer to Plot	Verdict
		Frequency (MHz)	Values (dBm)			
9262	1852.4	1850.00	-20.692	-13.00	Plot 5.4.1 A	PASS
9538	1907.6	1910.00	-21.193	-13.00	Plot 5.4.1 B	PASS

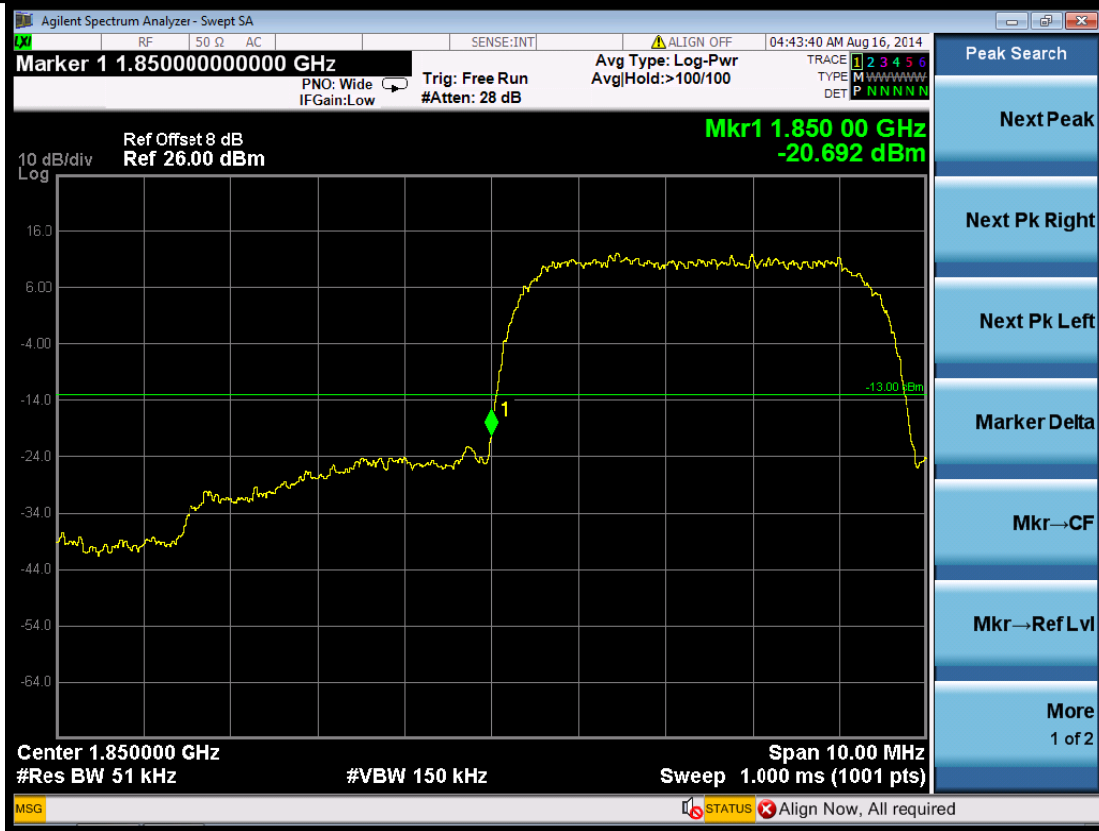

(Plot 5.4.1 A: Channel 9262: 1852.4MHz WCDMA Band II)



(Plot 5.4.1 B: Channel 9538: 1907.6MHz WCDMA Band II)



UMTS/TM1/WCDMA Band IV						
Channel Number	Frequency (MHz)	Measurement Results		Limit (dBm)	Refer to Plot	Verdict
		Frequency (MHz)	Values (dBm)			
1312	1712.40	1710.00	-25.795	-13.00	Plot 5.4.2 A	PASS
1513	1752.60	1755.00	-22.174	-13.00	Plot 5.4.2 B	PASS

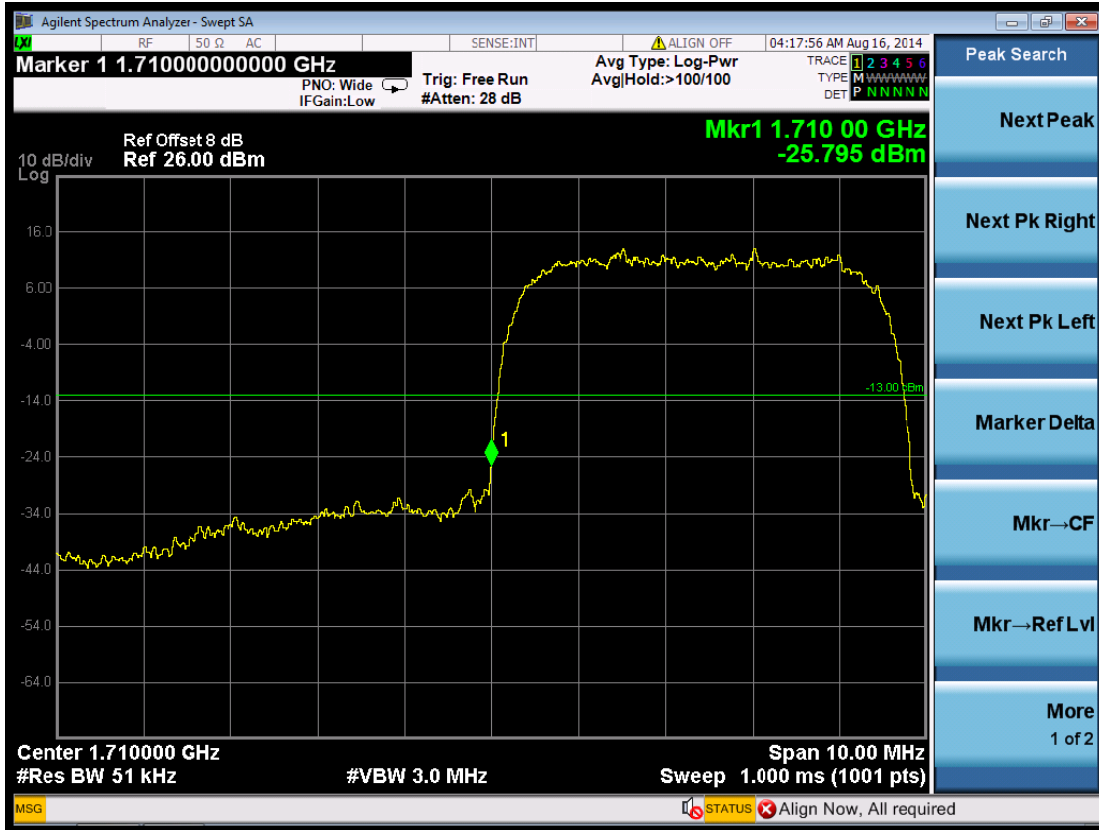

(Plot 5.4.2 A: Channel 1312: 1712.4MHz WCDMA Band IV)



(Plot 5.4.2 B: Channel 1513: 1752.6MHz WCDMA Band IV)

UMTS/TM1/WCDMA Band V						
Channel Number	Frequency (MHz)	Measurement Results		Limit (dBm)	Refer to Plot	Verdict
		Frequency (MHz)	Values (dBm)			
4132	826.40	823.95	-29.757	-13.00	Plot 5.4.3 A	PASS
4233	846.60	849.27	-24.517	-13.00	Plot 5.4.3 B	PASS



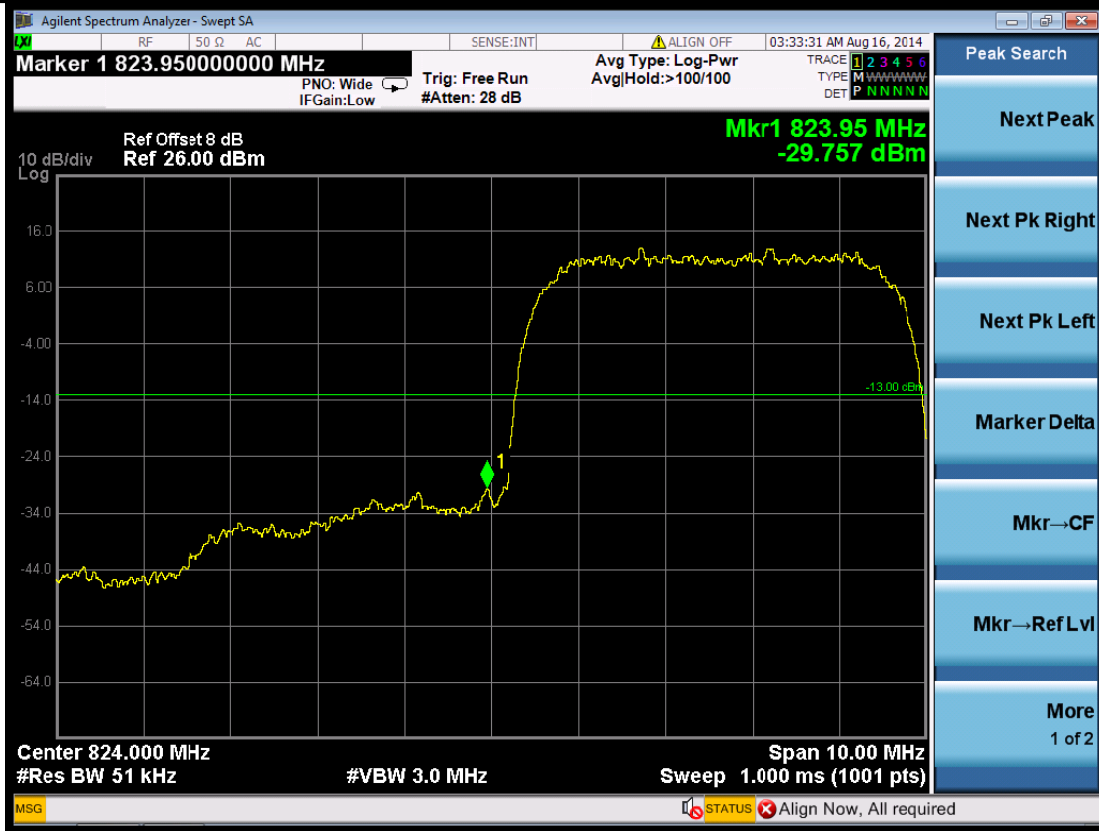

(Plot 5.4.3 A: Channel 4132: 826.4MHz @ WCDMA Band V)



(Plot 5.4.3 B: Channel 4233: 846.6MHz @ WCDMA Band V)

## 5.5 Spurious Emissions on Antenna Port

### TEST APPLICABLE

The following steps outline the procedure used to measure the conducted emissions from the EUT.

1. Determine frequency range for measurements: From CFR 2.1057 the spectrum should be investigated from the lowest radio frequency generated in the equipment up to at least the 10th harmonic of the carrier frequency. For the equipment of WCDMA band II, this equates to a frequency range of 9 KHz to 20GHz, data taken from 9 KHz to 20 GHz. For WCDMA Band IV, data taken from 9 KHz to 18 GHz. For WCDMA Band V, data taken from 9 KHz to 10 GHz.
2. The sweep time is set automatically by instrument itself. That should be the optimal sweep time for the span and the RBW. If the sweep time is too short, that is sweep is too fast, the sweep result is not accurate; if the sweep time is too long, that is sweep is too low, some frequency components may be lost. The instrument will give a optimal sweep time according the selected span and RBW.
3. The procedure to get the conducted spurious emission is as follows:  
The trace mode is set to MaxHold to get the highest signal at each frequency;  
Wait 25 seconds;  
Get the result.
4. Determine EUT transmit frequencies: below outlines the band edge frequencies pertinent to conducted emissions testing.

### TEST CONFIGURATION

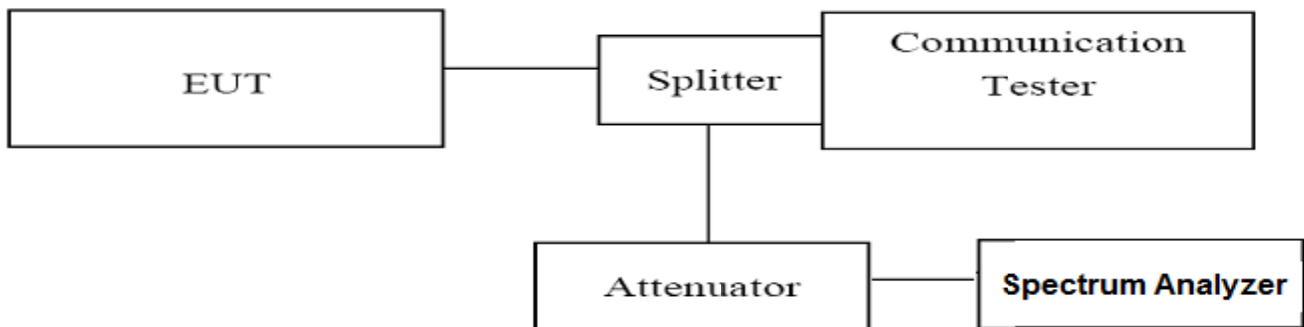

### TEST PROCEDURE

1. The EUT was set up for the max output power with pseudo random data modulation;
2. The power was measured with Agilent Spectrum Analyzer N9020A (peak);
3. These measurements were done at 3 frequencies, 1850.20 MHz, 1880.00 MHz and 1709.80 MHz for WCDMA band II; 1712.40 MHz, 1732.06 MHz and 1752.60 MHz for WCDMA band IV; 826.40 MHz, 836.60 MHz and 846.60 MHz for WCDMA band V. (low, middle and high of operational frequency range).

### TEST LIMIT

Part 24.238 and Part 22.917 specify that the power of any emission outside of the authorized operating frequency ranges must be attenuated below the transmitting power (P) by a factor of at least  $43 + 10 \log (P)$  dB.

The specification that emissions shall be attenuated below the transmitter power (P) by at least  $43 + 10 \log (P)$  dB, translates in the relevant power range (1 to 0.001 W) to -13 dBm. At 1 W the specified minimum attenuation becomes 43 dB and relative to a 30 dBm (1 W) carrier becomes a limit of -13 dBm. At 0.001 W (0 dBm) the minimum attenuation is 13 dB, which again yields a limit of -13 dBm. In this way a translation of the specification from relative to absolute terms is carried out.

**TEST RESULTS**
**5.5.1 For WCDMA Band II Test Results**

## A. Test Verdict

Test Mode/ Channel	Frequency (MHz)	Frequency Range	Refer to Plot	Limit (dBm)	Verdict
UMTS/TM1/WCDMA Band II/9262	1852.40	9KHz-150KHz	Plot 5.5.1 A1	-13.00	PASS
		150KHz-30MHz	Plot 5.5.1 A2	-13.00	PASS
		30MHz-1GHz	Plot 5.5.1 A3	-13.00	PASS
		1GHz-2.5GHz	Plot 5.5.1 A4	-13.00	PASS
		2.5GHz-7.5GHz	Plot 5.5.1 A5	-13.00	PASS
		7.5GHz-10GHz	Plot 5.5.1 A6	-13.00	PASS
		10GHz-15GHz	Plot 5.5.1 A7	-13.00	PASS
		15GHz-20GHz	Plot 5.5.1 A8	-13.00	PASS
UMTS/TM1/WCDMA Band II/9400	1880.00	9KHz-150KHz	Plot 5.5.1 B1	-13.00	PASS
		150KHz-30MHz	Plot 5.5.1 B2	-13.00	PASS
		30MHz-1GHz	Plot 5.5.1 B3	-13.00	PASS
		1GHz-2.5GHz	Plot 5.5.1 B4	-13.00	PASS
		2.5GHz-7.5GHz	Plot 5.5.1 B5	-13.00	PASS
		7.5GHz-10GHz	Plot 5.5.1 B6	-13.00	PASS
		10GHz-15GHz	Plot 5.5.1 B7	-13.00	PASS
		15GHz-20GHz	Plot 5.5.1 B8	-13.00	PASS
UMTS/TM1/WCDMA Band II/9538	1907.60	9KHz-150KHz	Plot 5.5.1 C1	-13.00	PASS
		150KHz-30MHz	Plot 5.5.1 C2	-13.00	PASS
		30MHz-1GHz	Plot 5.5.1 C3	-13.00	PASS
		1GHz-2.5GHz	Plot 5.5.1 C4	-13.00	PASS
		2.5GHz-7.5GHz	Plot 5.5.1 C5	-13.00	PASS
		7.5GHz-10GHz	Plot 5.5.1 C6	-13.00	PASS
		10GHz-15GHz	Plot 5.5.1 C7	-13.00	PASS
		15GHz-20GHz	Plot 5.5.1 C8	-13.00	PASS
UMTS/TM1/WCDMA Band II/Idle	N/A	9KHz-150KHz	Plot 5.5.1 D1	-13.00	PASS
		150KHz-30MHz	Plot 5.5.1 D2	-13.00	PASS
		30MHz-1GHz	Plot 5.5.1 D3	-13.00	PASS
		1GHz-2.5GHz	Plot 5.5.1 D4	-13.00	PASS
		2.5GHz-7.5GHz	Plot 5.5.1 D5	-13.00	PASS
		7.5GHz-10GHz	Plot 5.5.1 D6	-13.00	PASS
		10GHz-15GHz	Plot 5.5.1 D7	-13.00	PASS
		15GHz-20GHz	Plot 5.5.1 D8	-13.00	PASS

Note: 1. In general, the worse case attenuation requirement shown above was applied.

2. \*\*\* means that the emission level is too low to be measured or at least 20 dB down than the limit.

## B. Test Plots

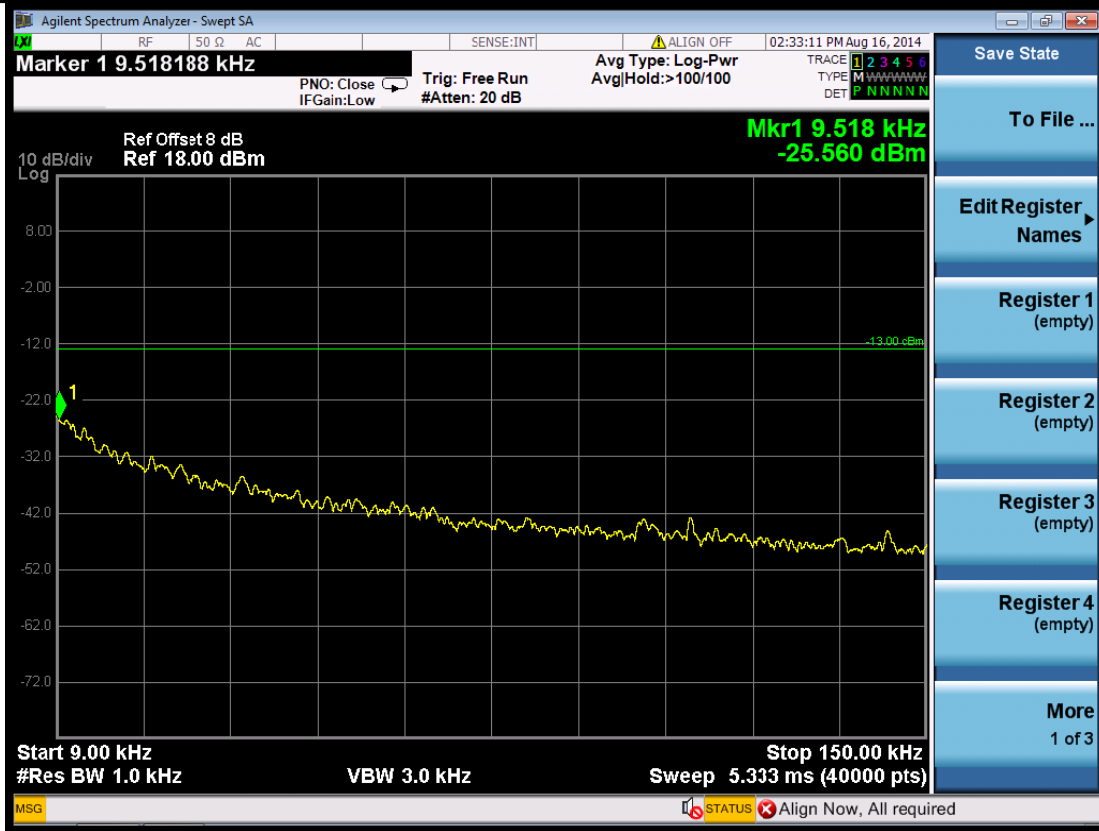

(Plot 5.5.1 A1: Channel 9262: 1852.4MHz @ Traffic WCDMA Band II)

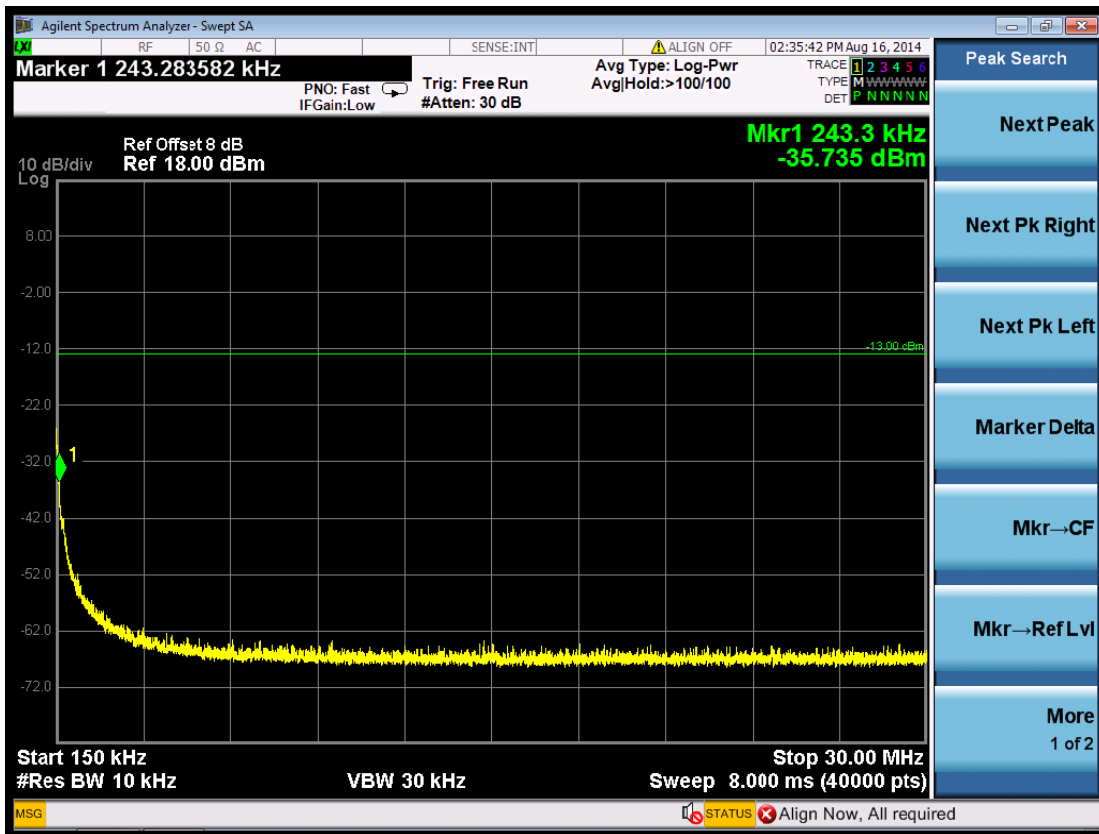

(Plot 5.5.1 A2: Channel 9262: 1852.4MHz @ Traffic WCDMA Band II)

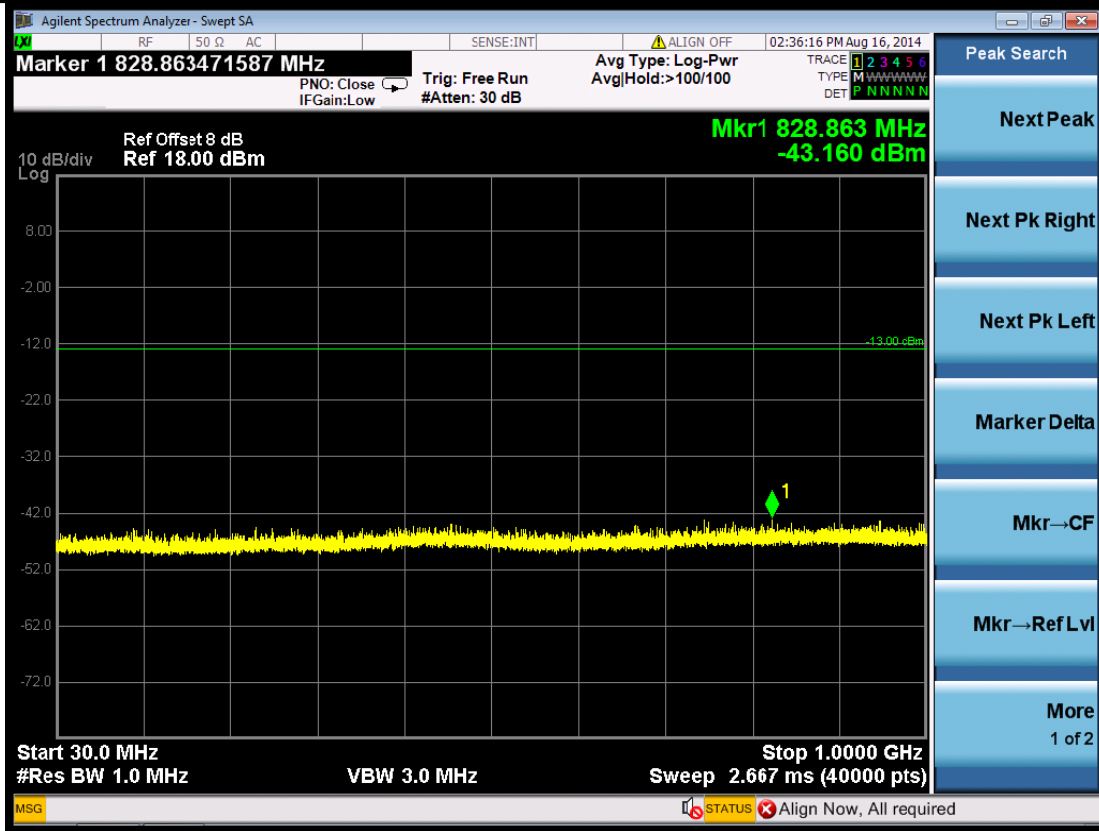

(Plot 5.5.1 A3: Channel 9262: 1852.4MHz @ Traffic WCDMA Band II)

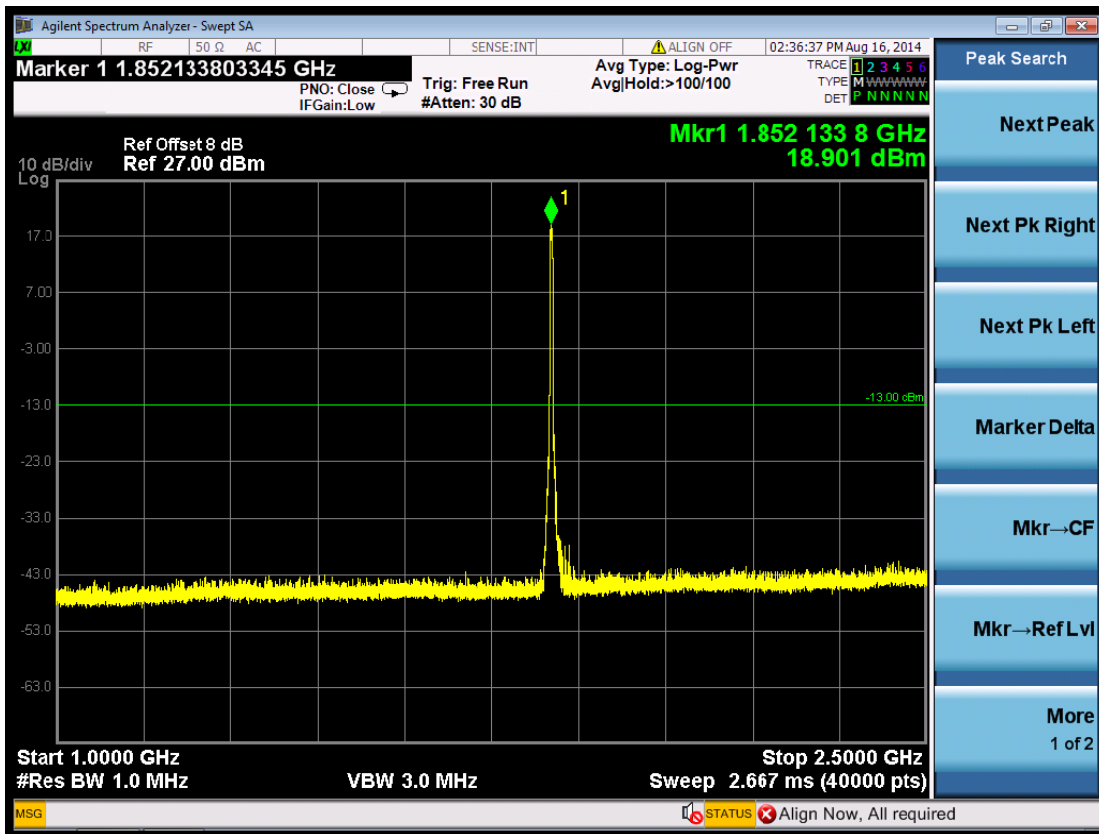

(Plot 5.5.1 A4: Channel 9262: 1852.4MHz @ Traffic WCDMA Band II)

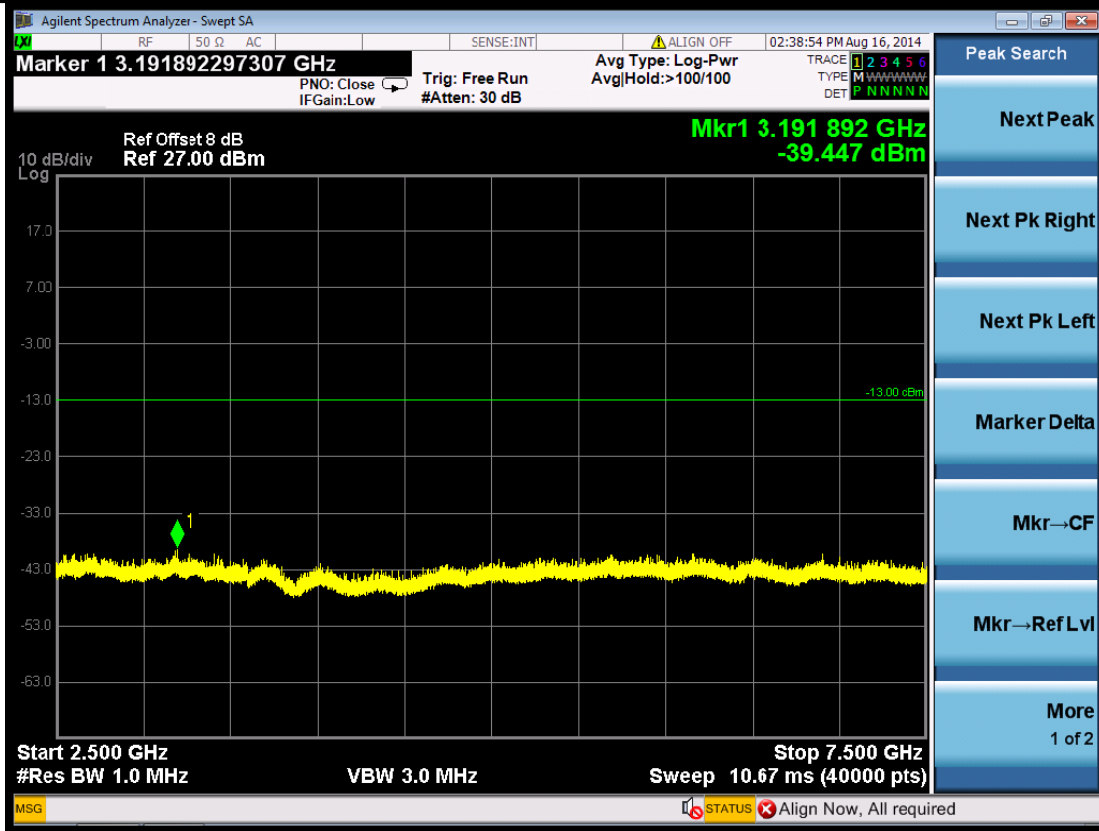

(Plot 5.5.1 A5: Channel 9262: 1852.4MHz @ Traffic WCDMA Band II)

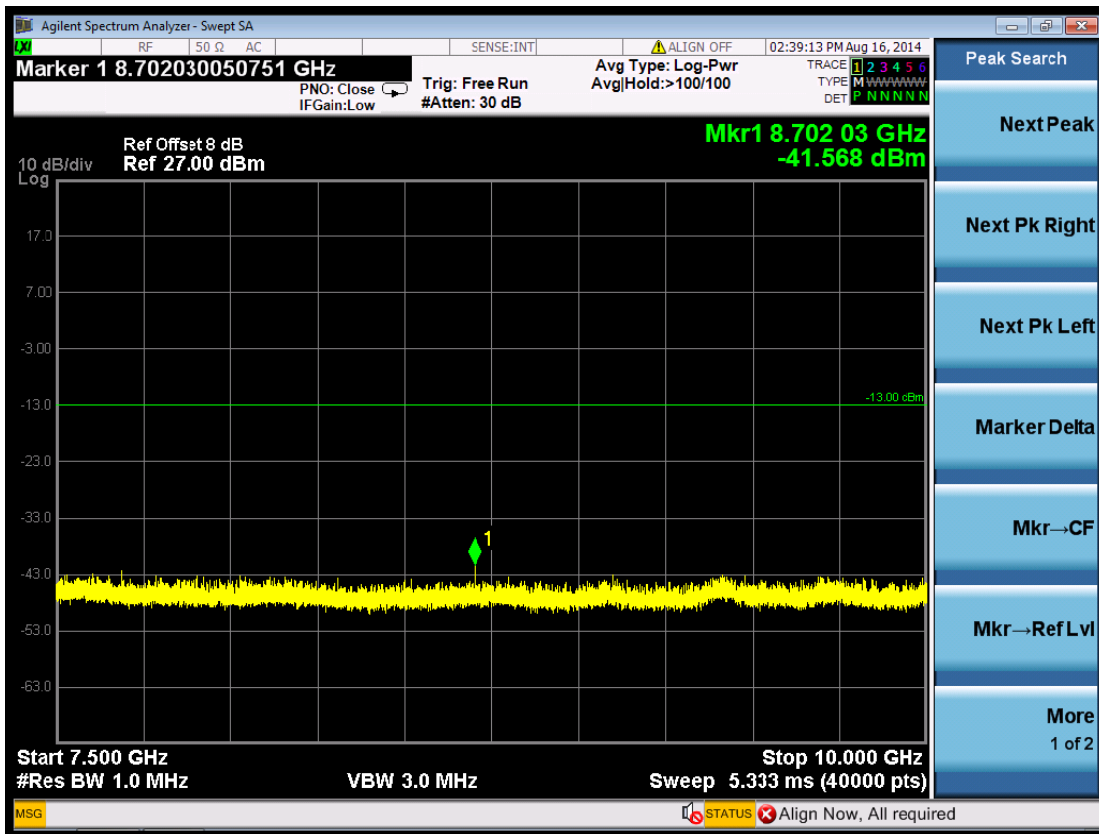

(Plot 5.5.1 A6: Channel 9262: 1852.4MHz @ Traffic WCDMA Band II)

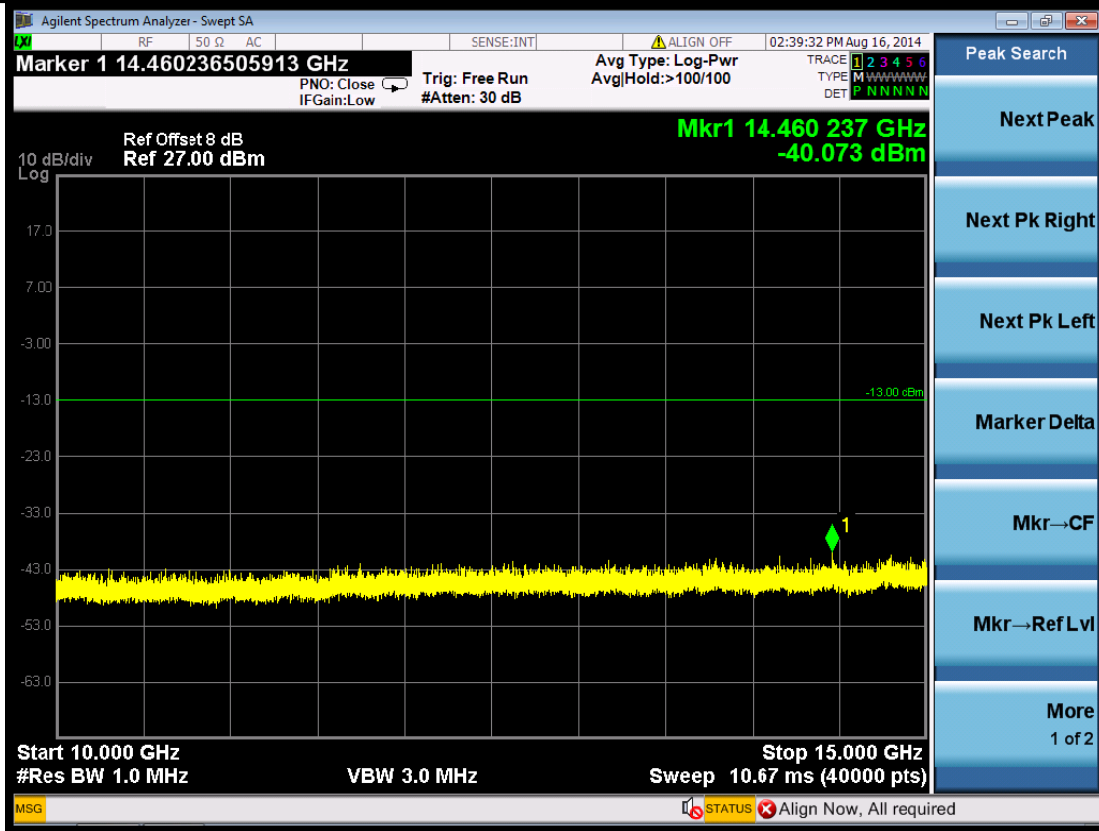

(Plot 5.5.1 A7: Channel 9262: 1852.4MHz @ Traffic WCDMA Band II)

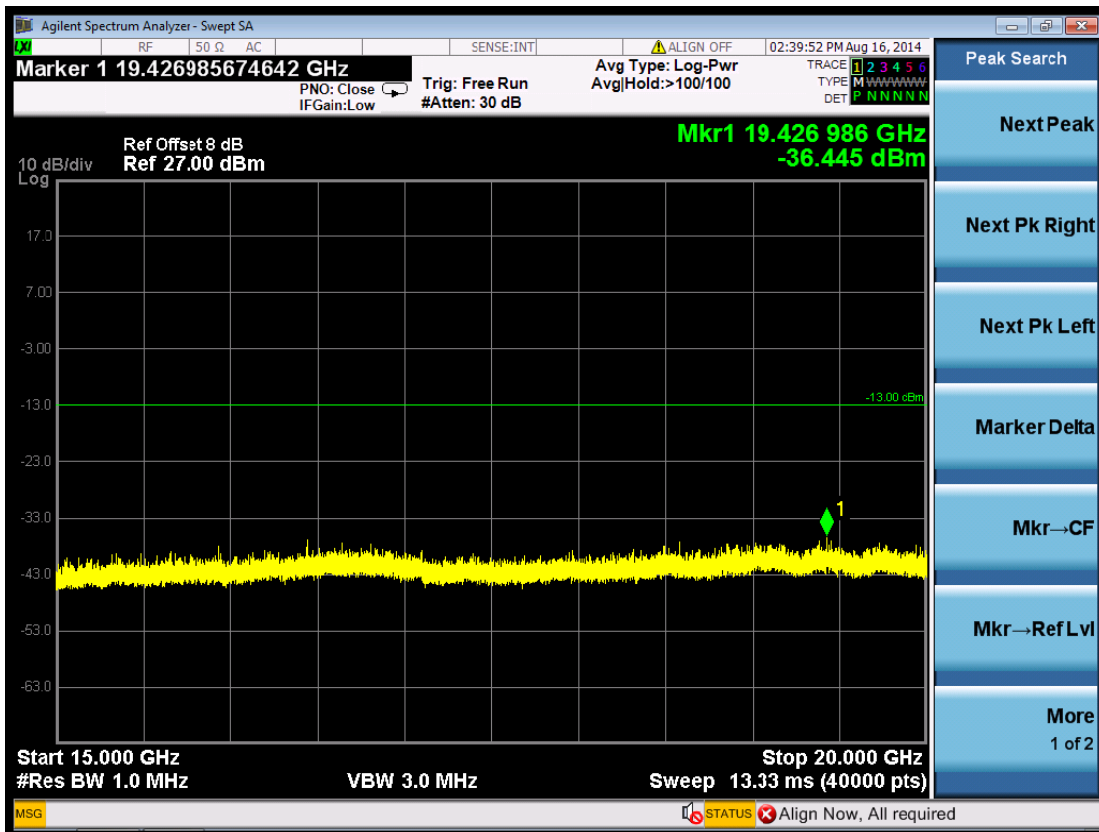

(Plot 5.5.1 A8: Channel 9262: 1852.4MHz @ Traffic WCDMA Band II)

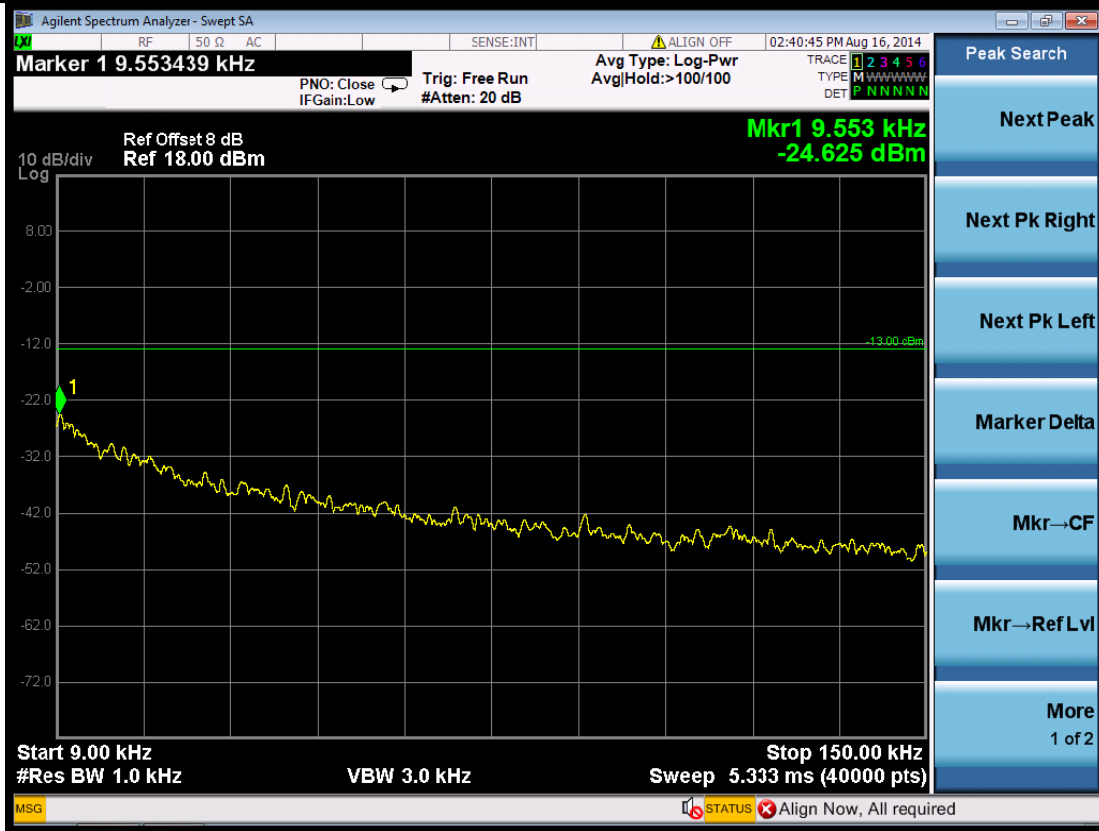

(Plot 5.5.1 B1: Channel 9400: 1880.0MHz @ Traffic WCDMA Band II)

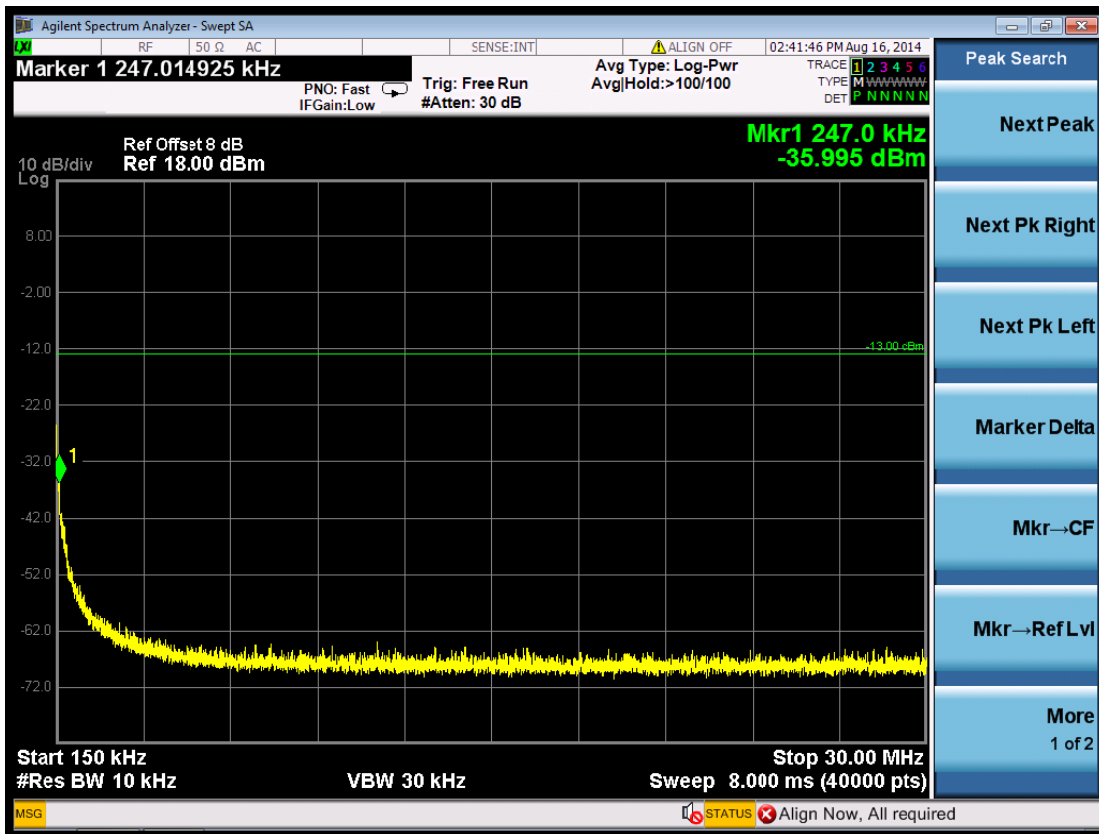

(Plot 5.5.1 B2: Channel 9400: 1880.0MHz @ Traffic WCDMA Band II)



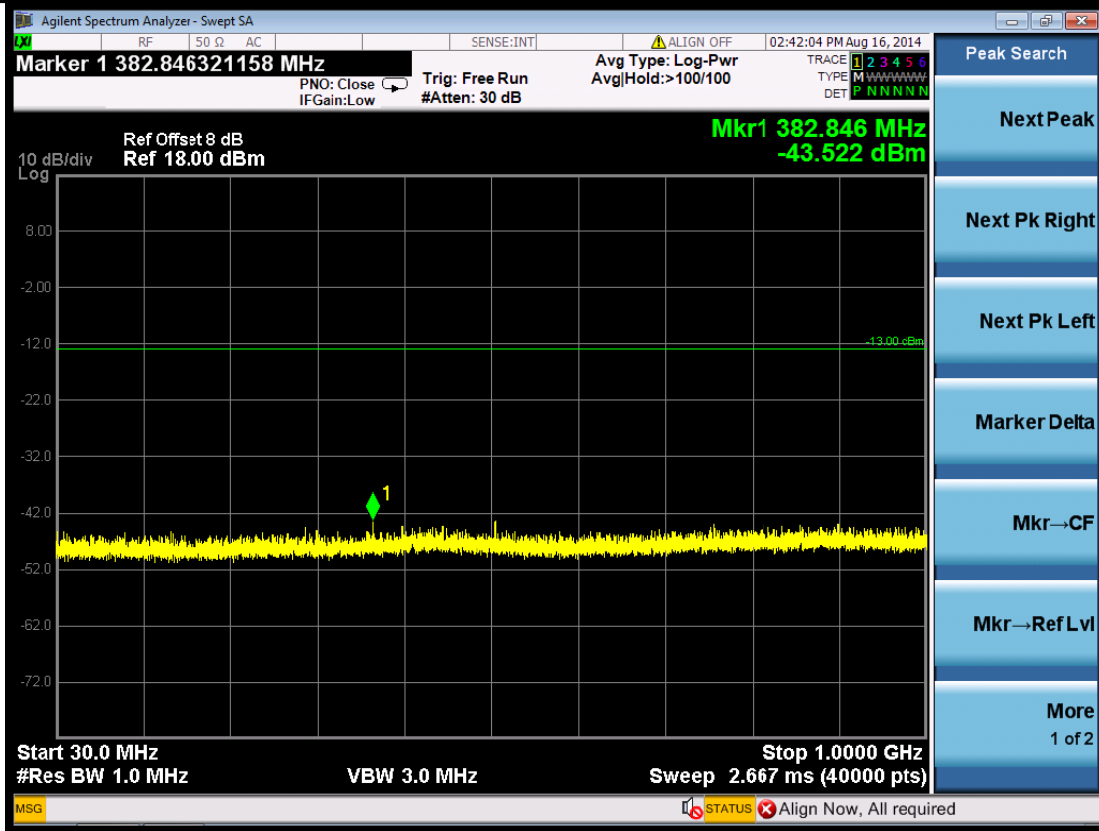

(Plot 5.5.1 B3: Channel 9400: 1880.0MHz @ Traffic WCDMA Band II)

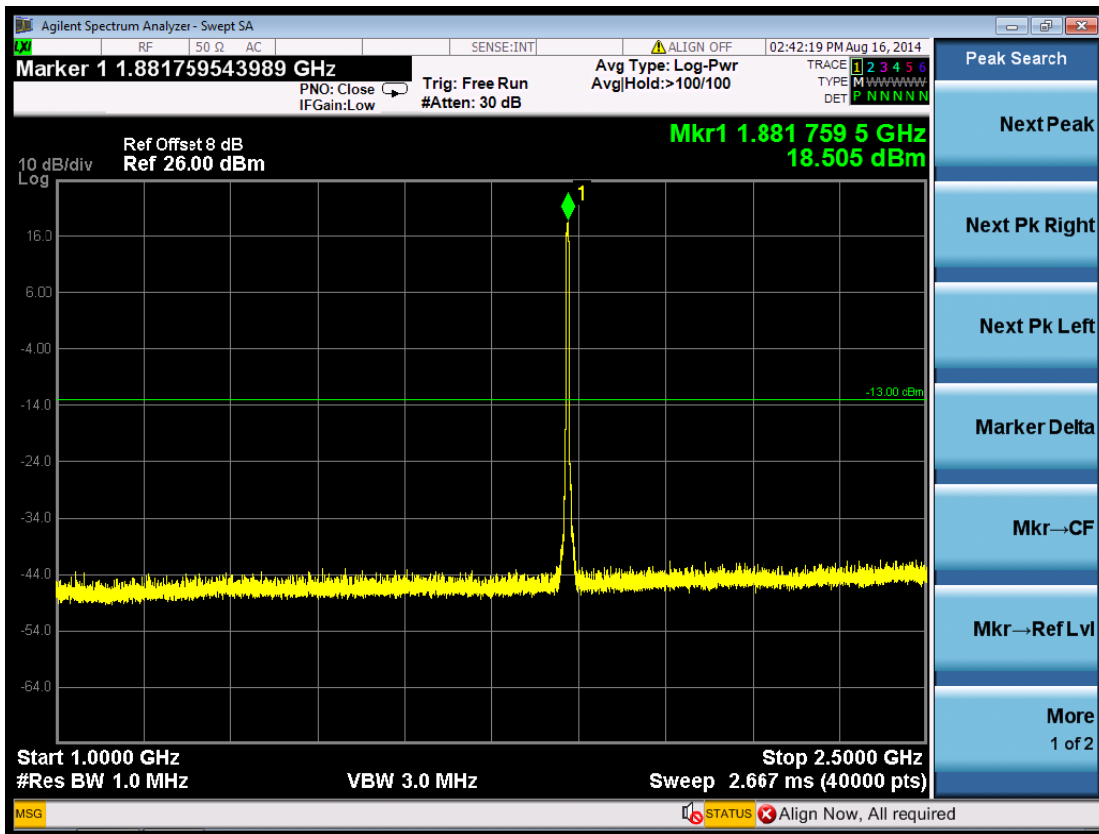

(Plot 5.5.1 B4: Channel 9400: 1880.0MHz @ Traffic WCDMA Band II)

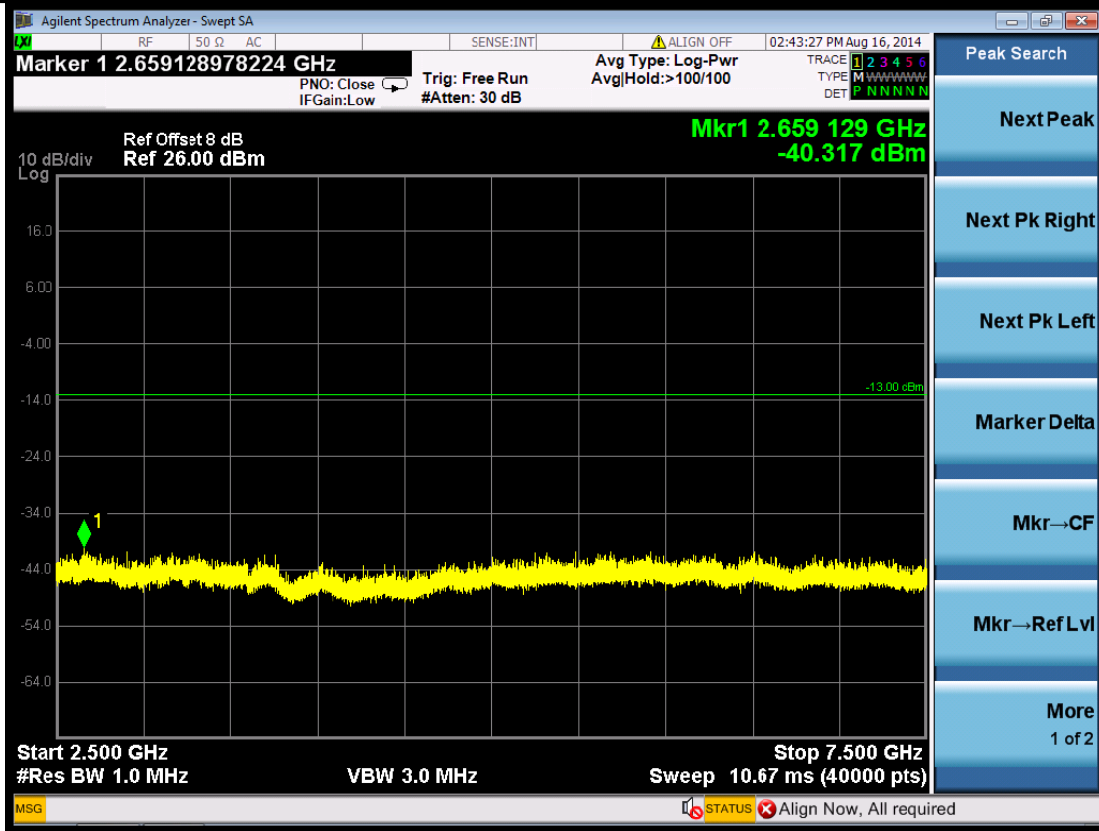

(Plot 5.5.1 B5: Channel 9400: 1880.0MHz @ Traffic WCDMA Band II)

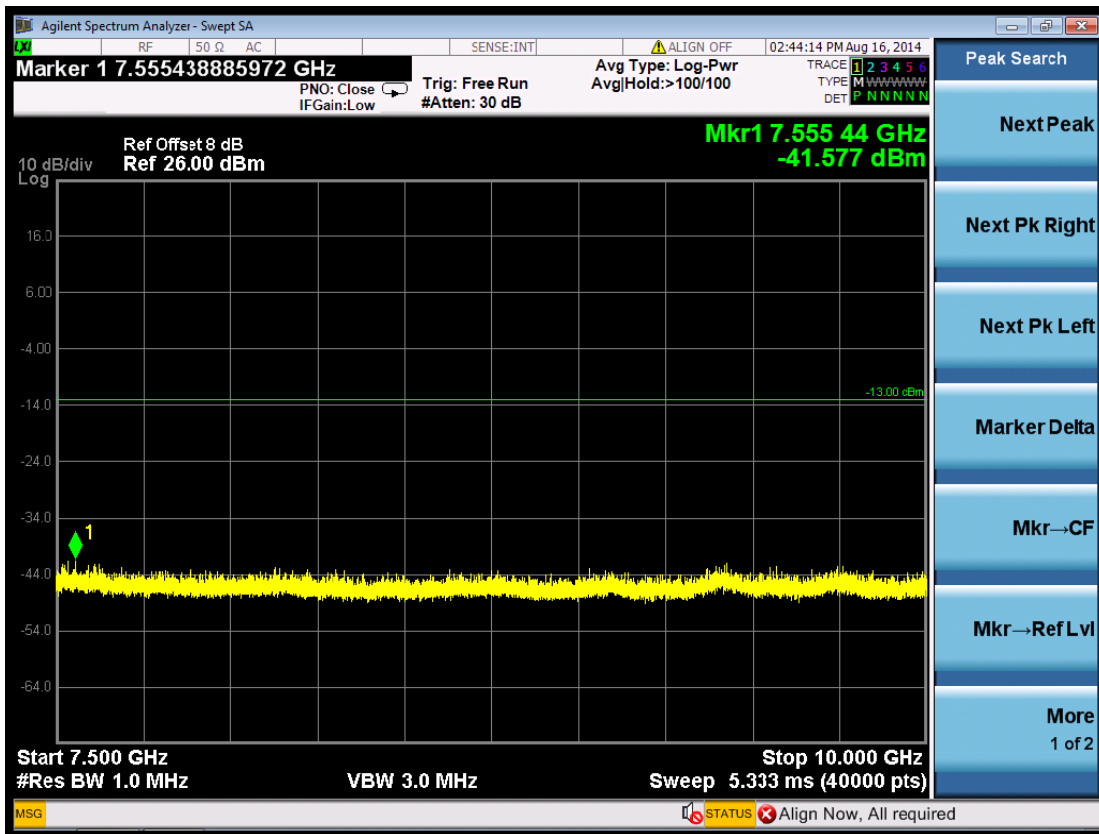

(Plot 5.5.1 B6: Channel 9400: 1880.0MHz @ Traffic WCDMA Band II)

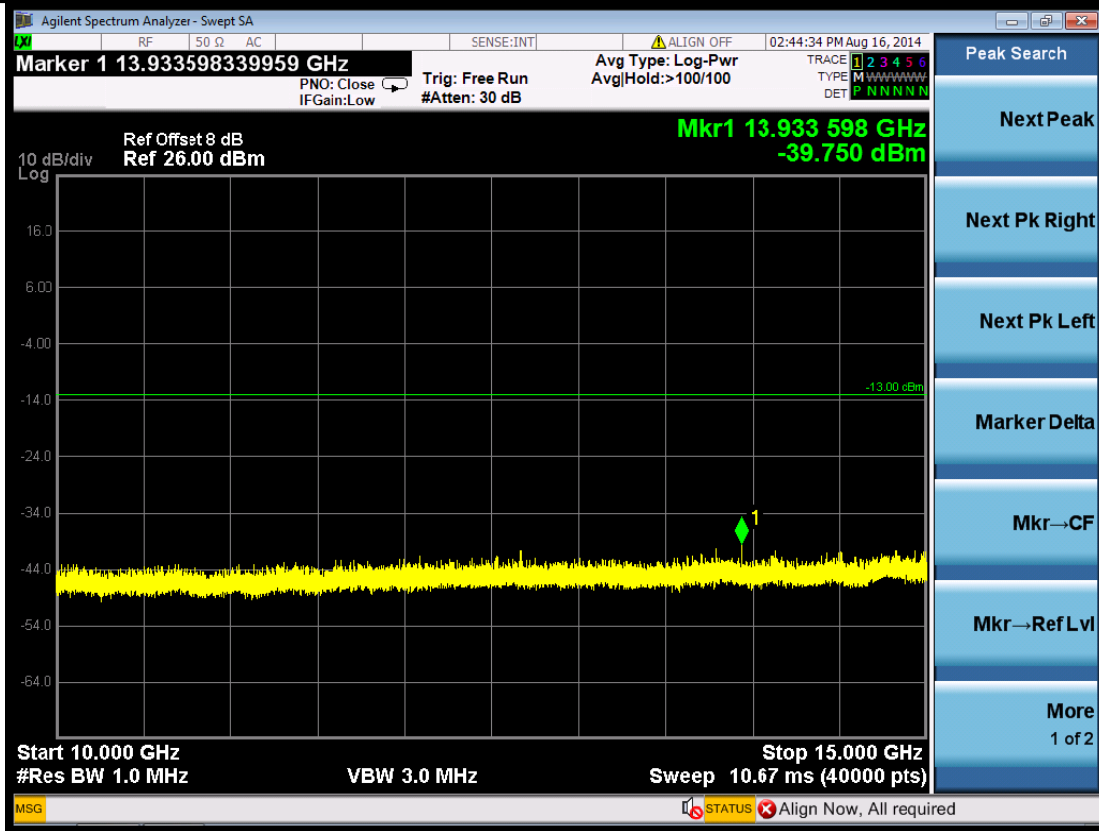

(Plot 5.5.1 B7: Channel 9400: 1880.0MHz @ Traffic WCDMA Band II)

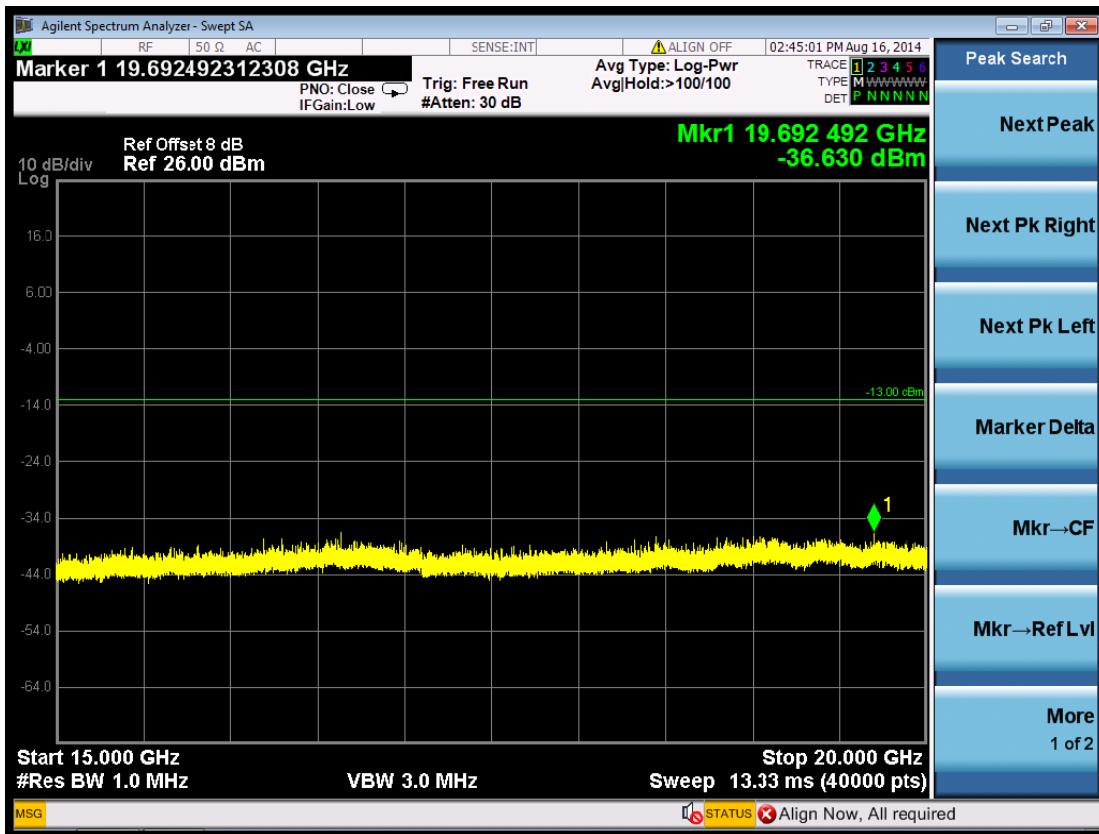

(Plot 5.5.1 B8: Channel 9400: 1880.0MHz @ Traffic WCDMA Band II)

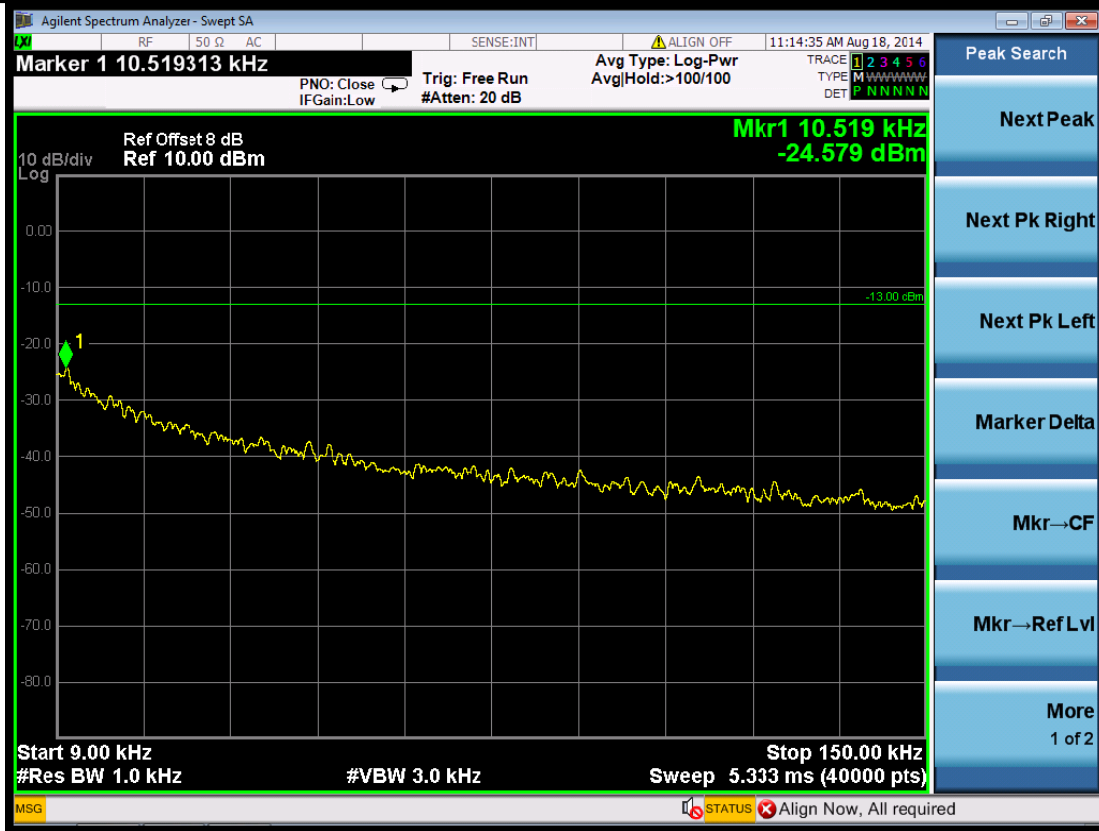

(Plot 5.5.1 C1: Channel 9538: 1907.6MHz @ Traffic WCDMA Band II)

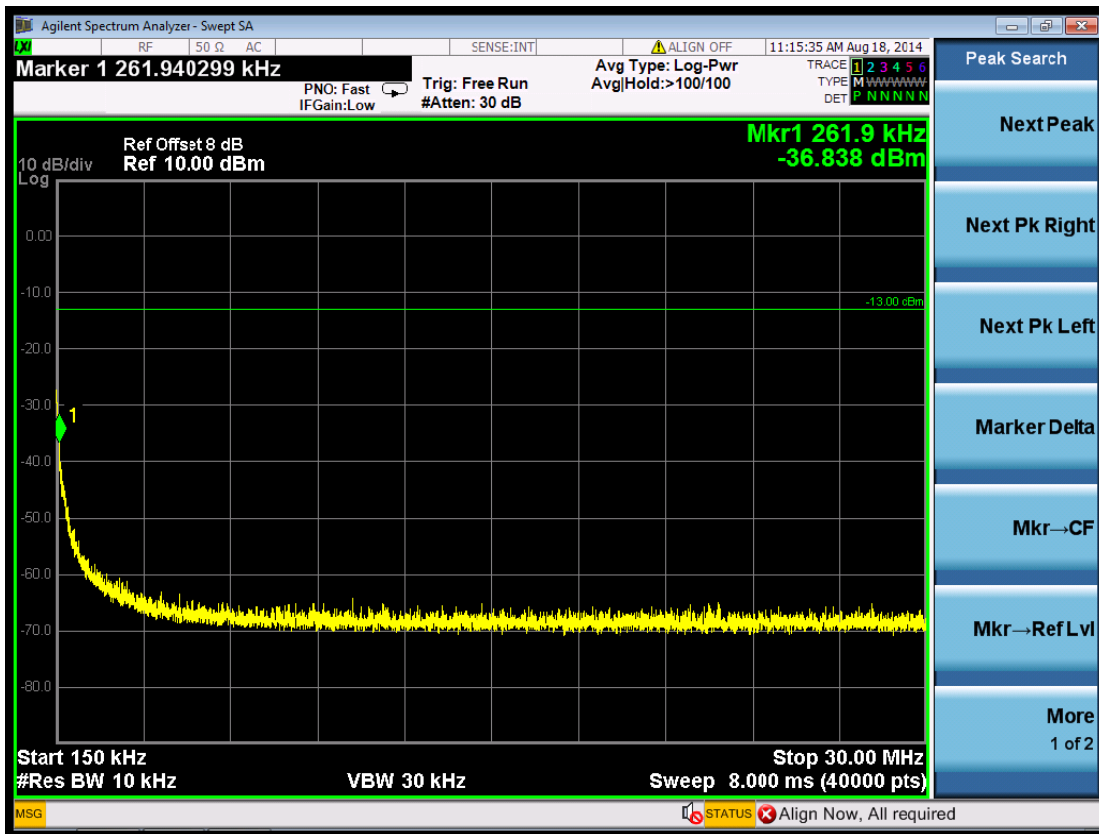

(Plot 5.5.1 C2: Channel 9538: 1907.6MHz @ Traffic WCDMA Band II)

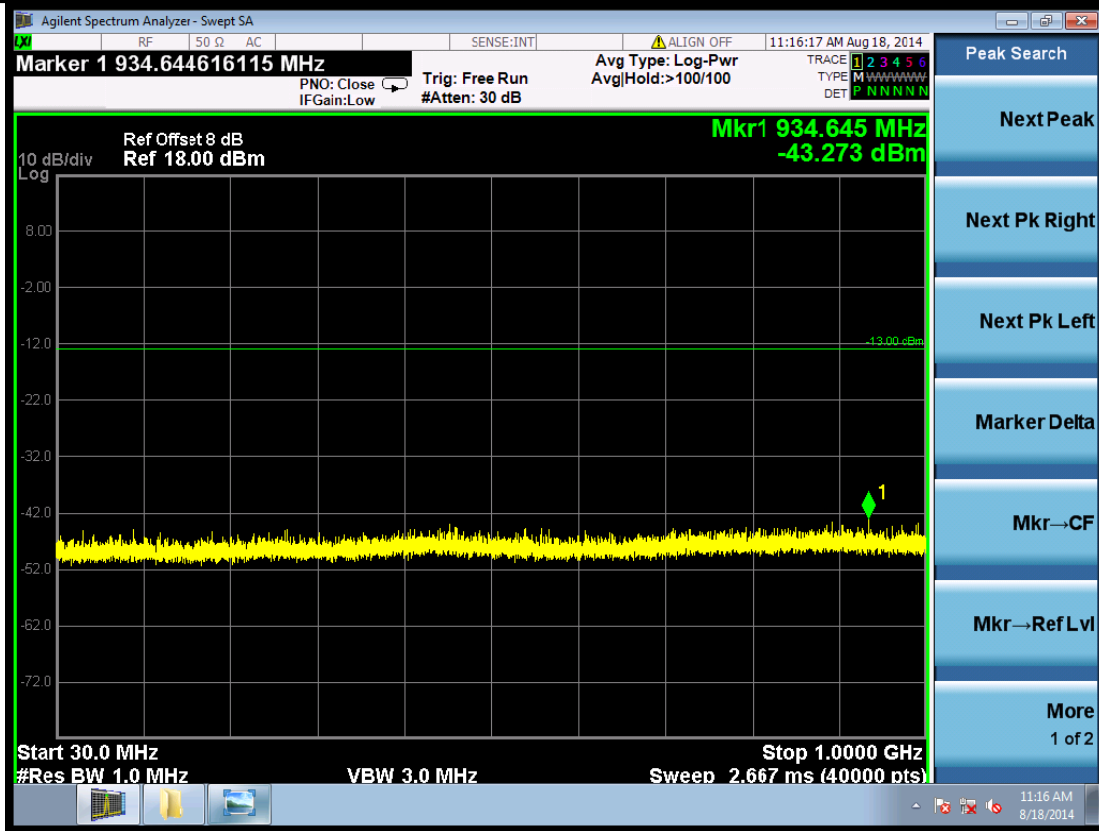

(Plot 5.5.1 C3: Channel 9538: 1907.6MHz @ Traffic WCDMA Band II)

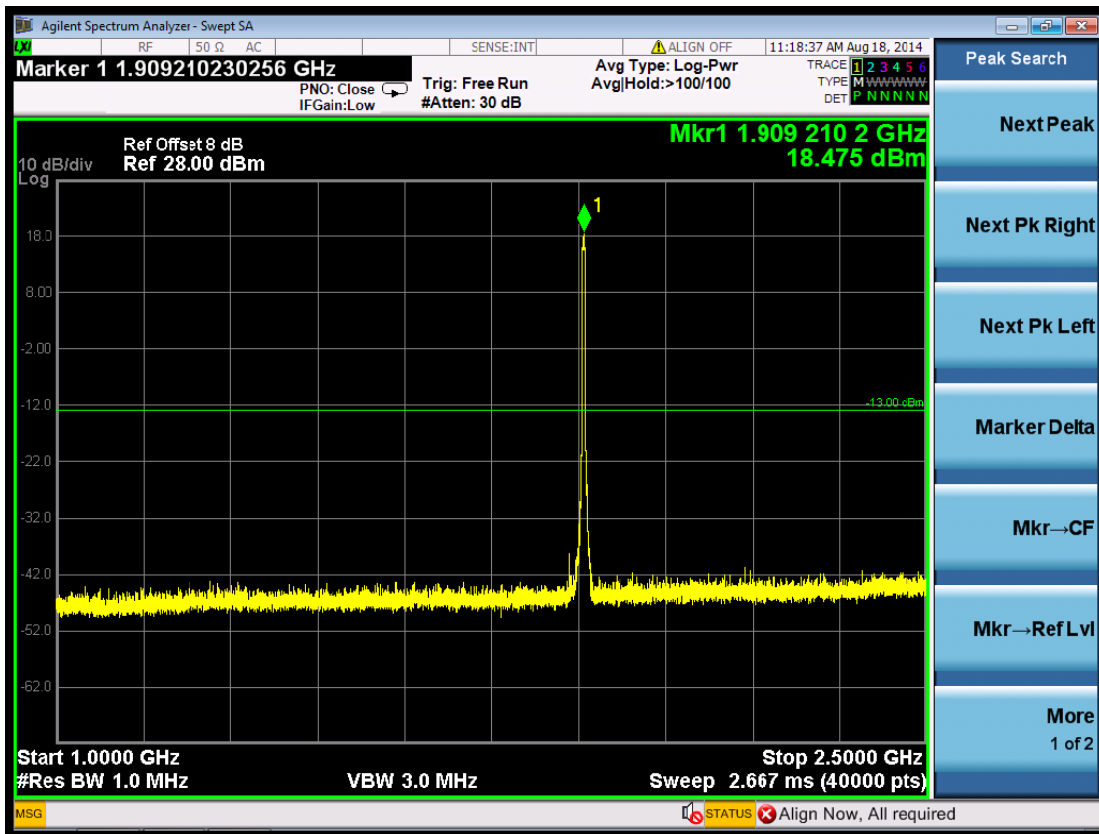

(Plot 5.5.1 C4: Channel 9538: 1907.6MHz @ Traffic WCDMA Band II)

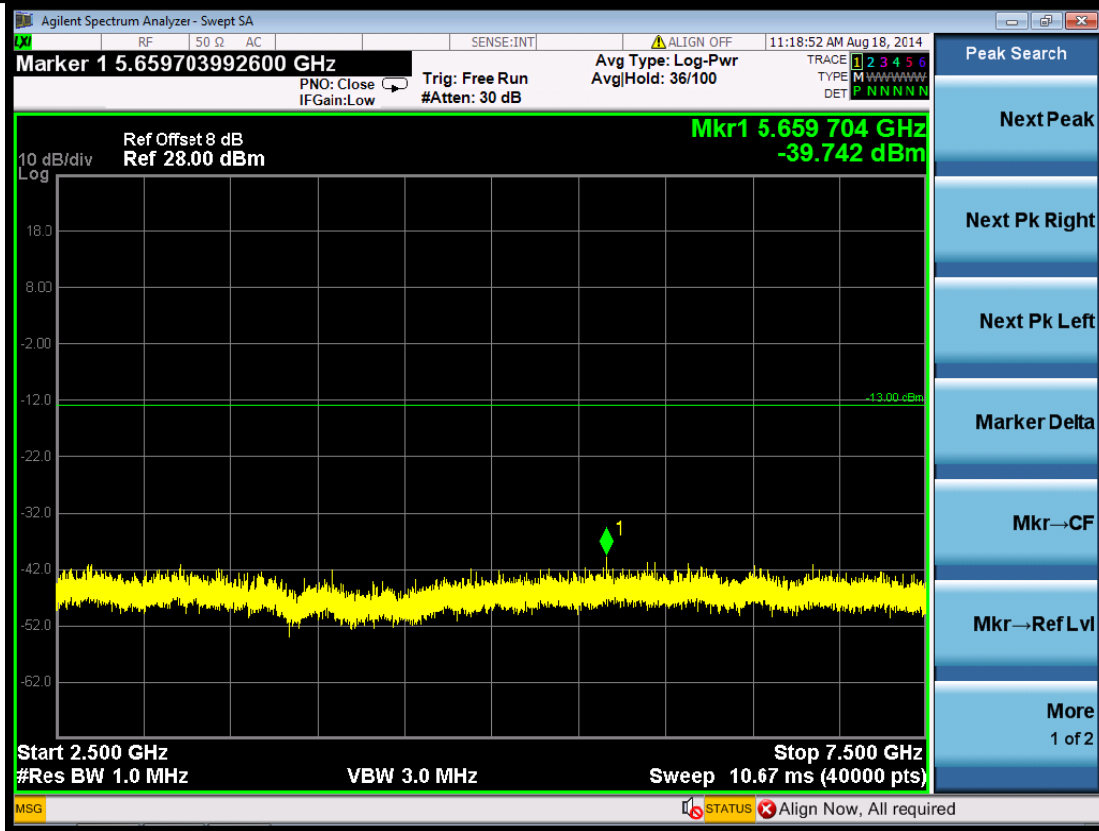

(Plot 5.5.1 C5: Channel 9538: 1907.6MHz @ Traffic WCDMA Band II)

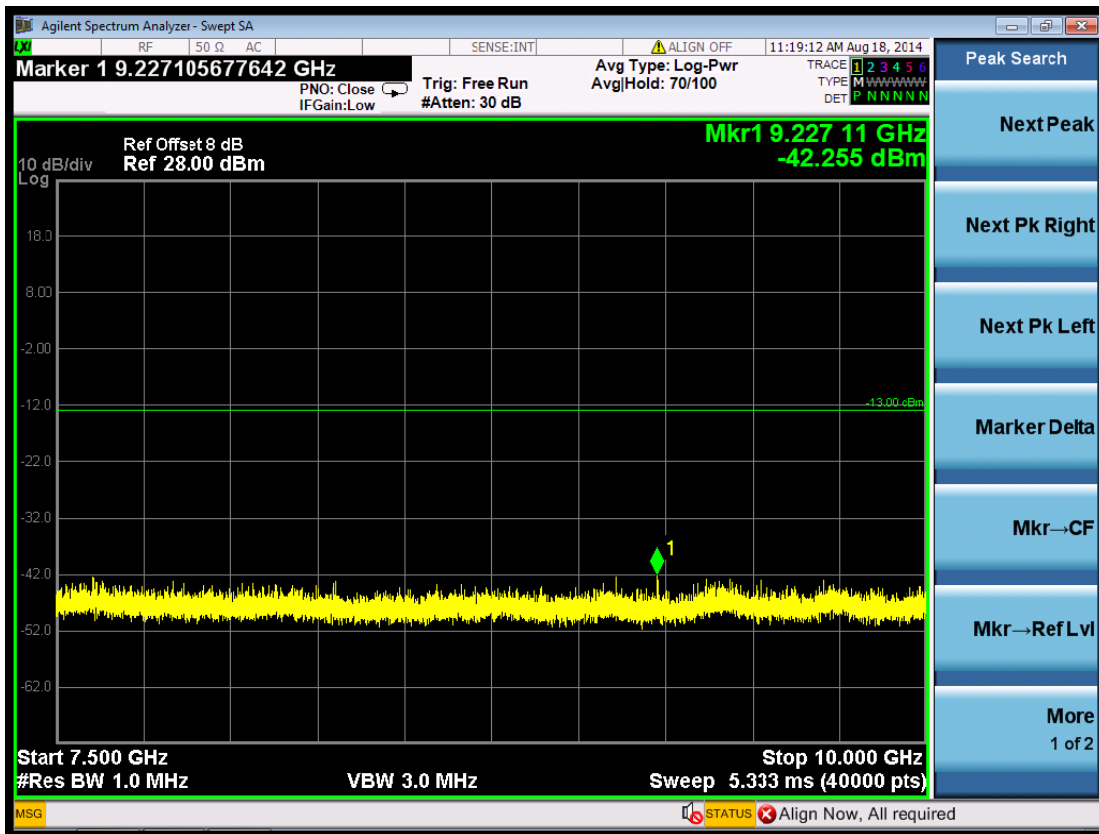

(Plot 5.5.1 C6: Channel 9538: 1907.6MHz @ Traffic WCDMA Band II)

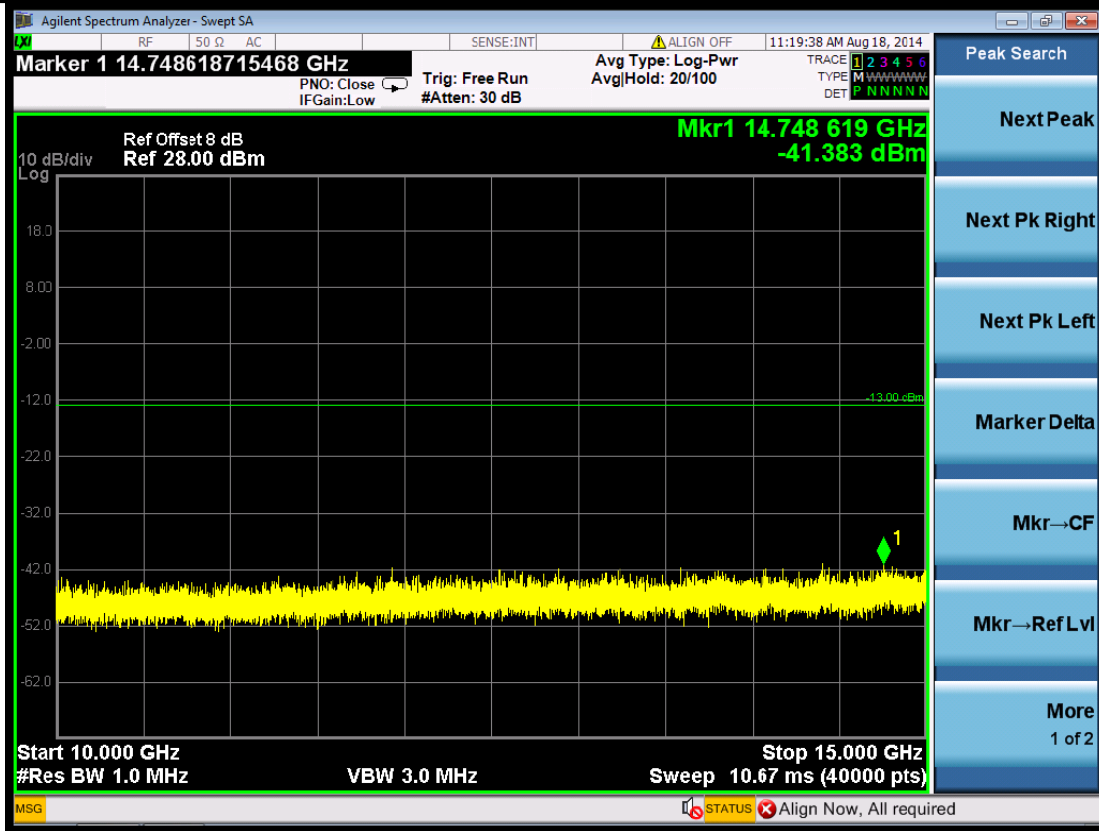

(Plot 5.5.1 C7: Channel 9538: 1907.6MHz @ Traffic WCDMA Band II)

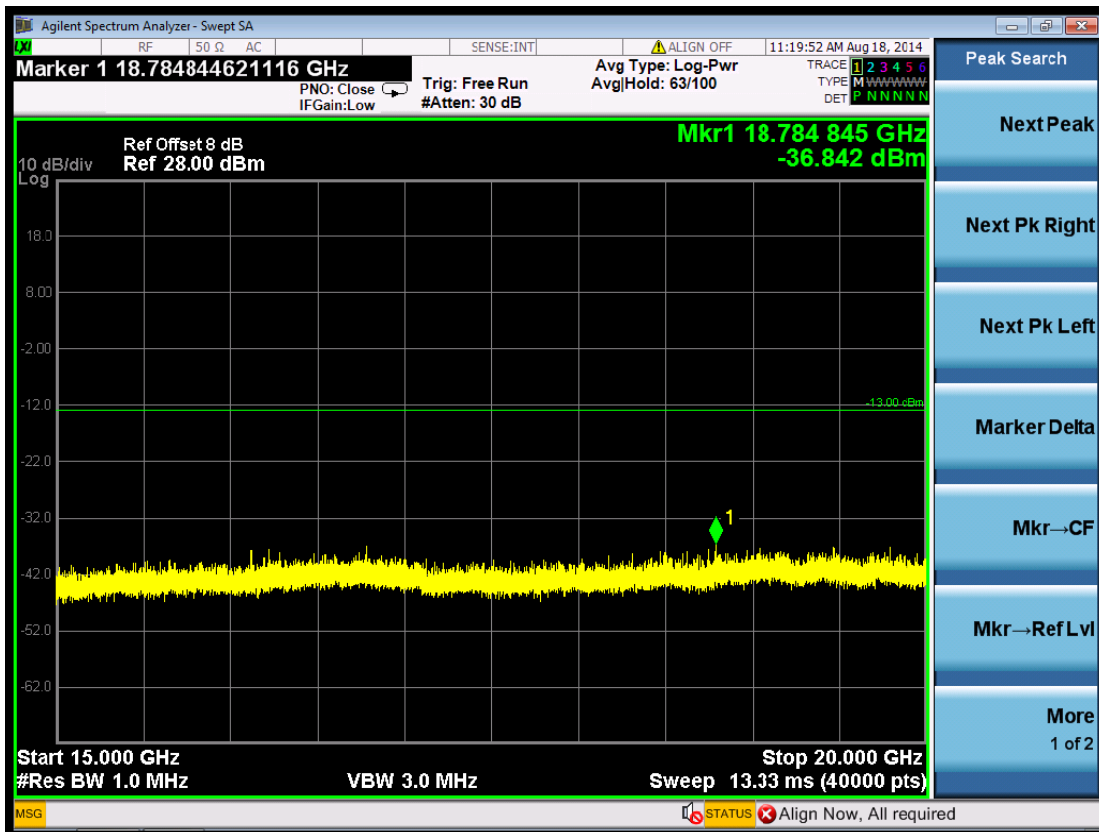

(Plot 5.5.1 C8: Channel 9538: 1907.6MHz @ Traffic WCDMA Band II)

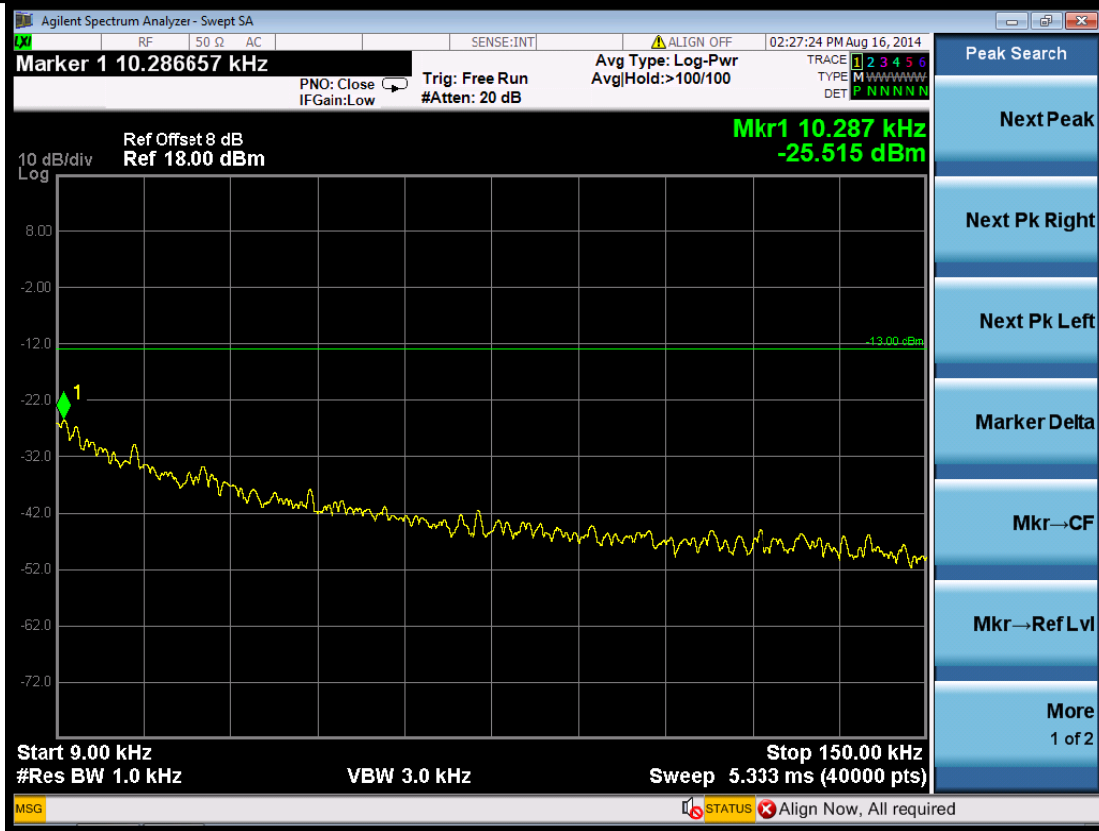

(Plot 5.5.1 D1: Idle WCDMA Band II)

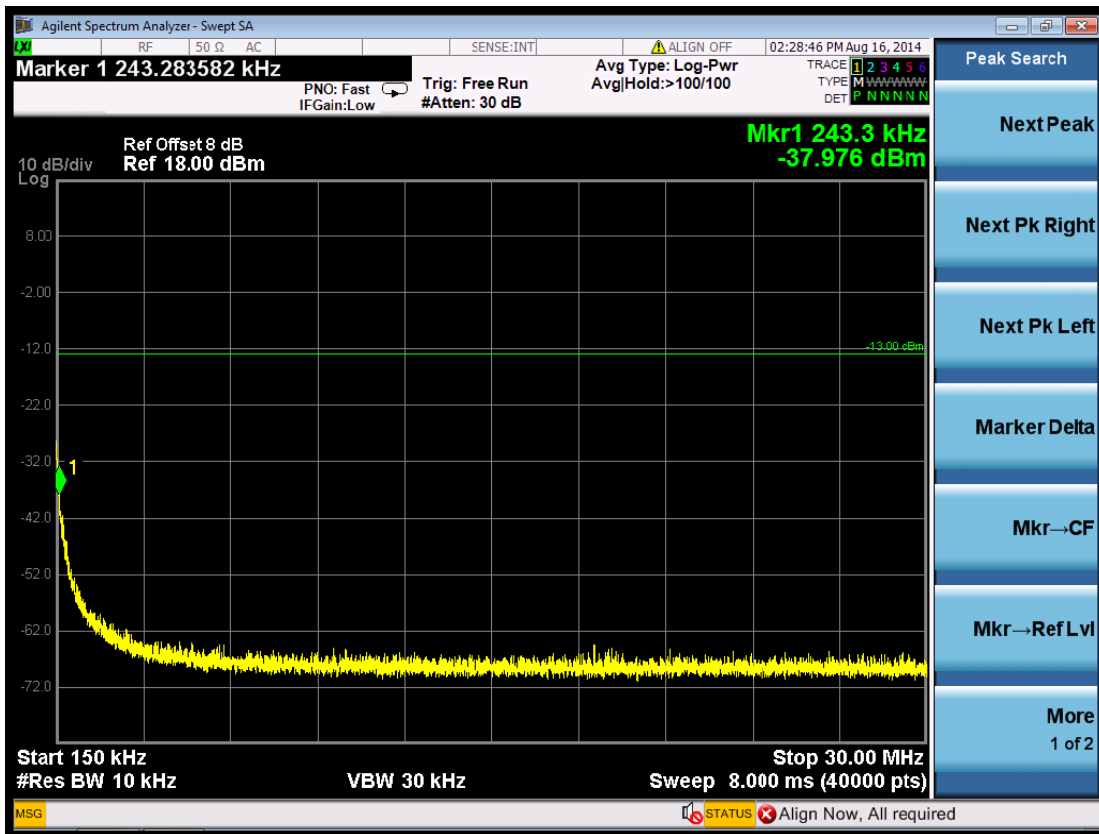

(Plot 5.5.1 D2: Idle WCDMA Band II)



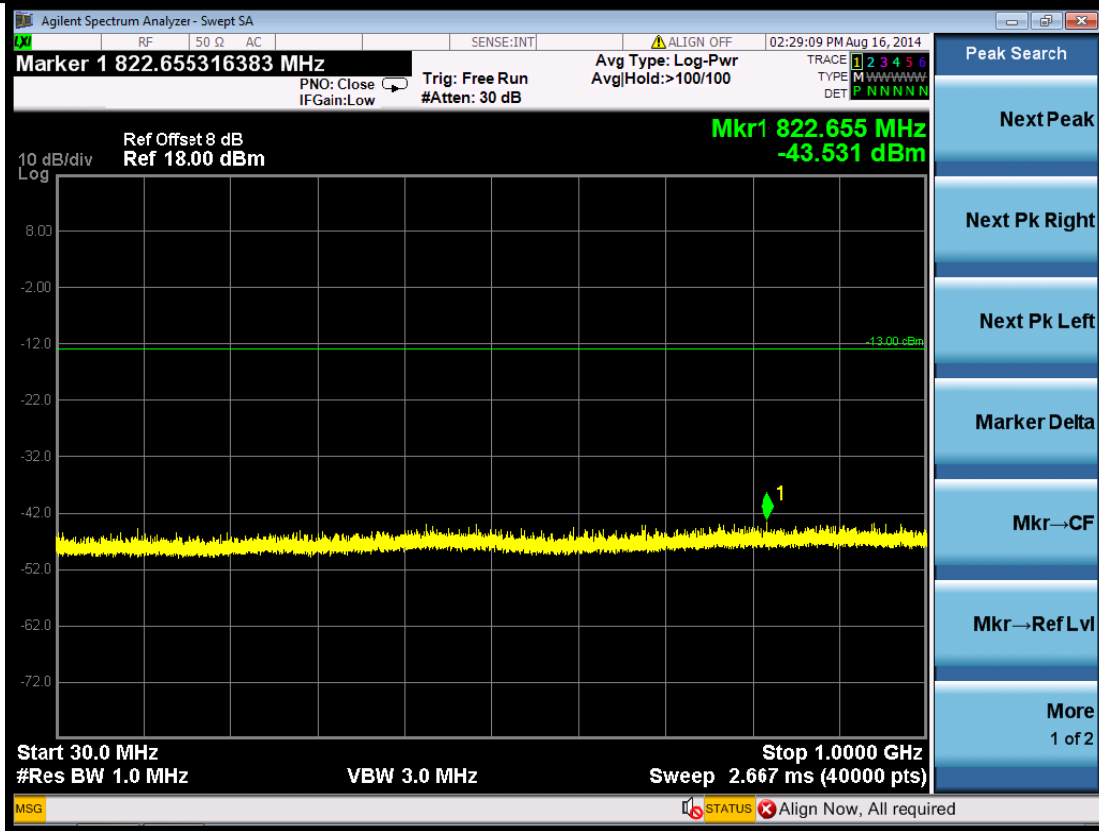

(Plot 4.5.1 D3: Idle WCDMA Band II)

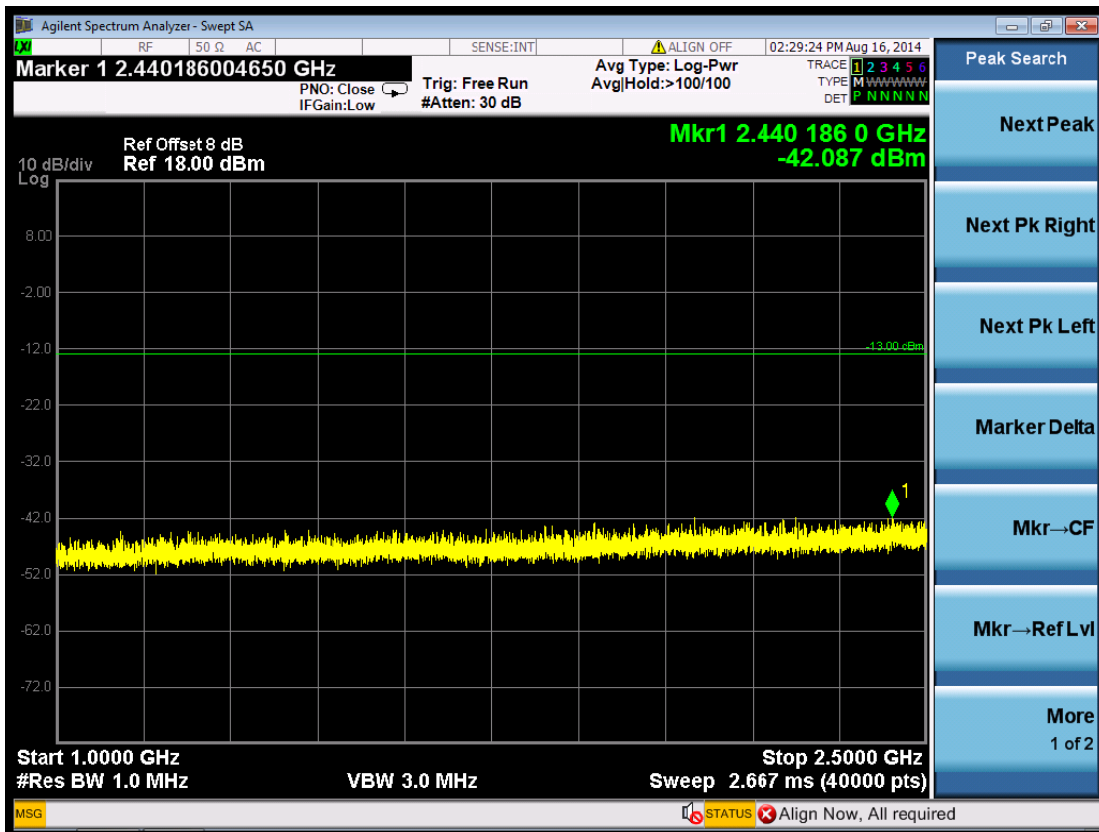

(Plot 5.5.1 D4: Idle WCDMA Band II)

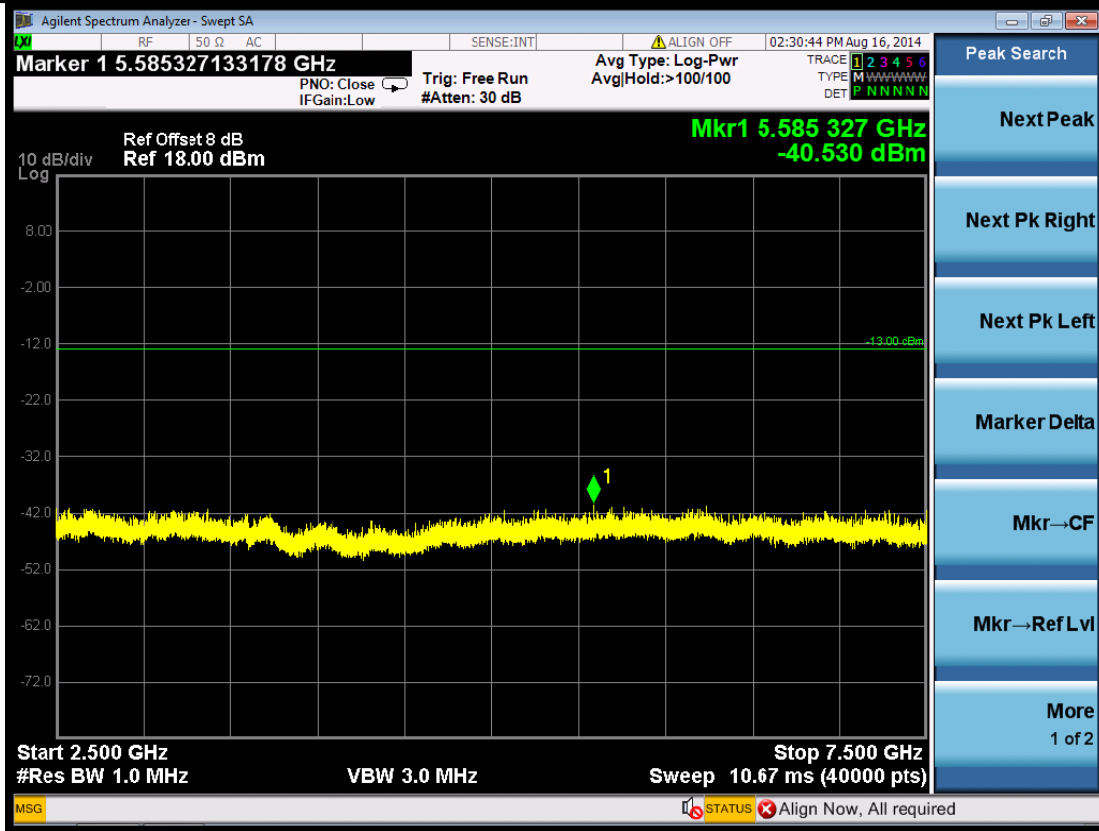

(Plot 5.5.1 D5: Idle WCDMA Band II)

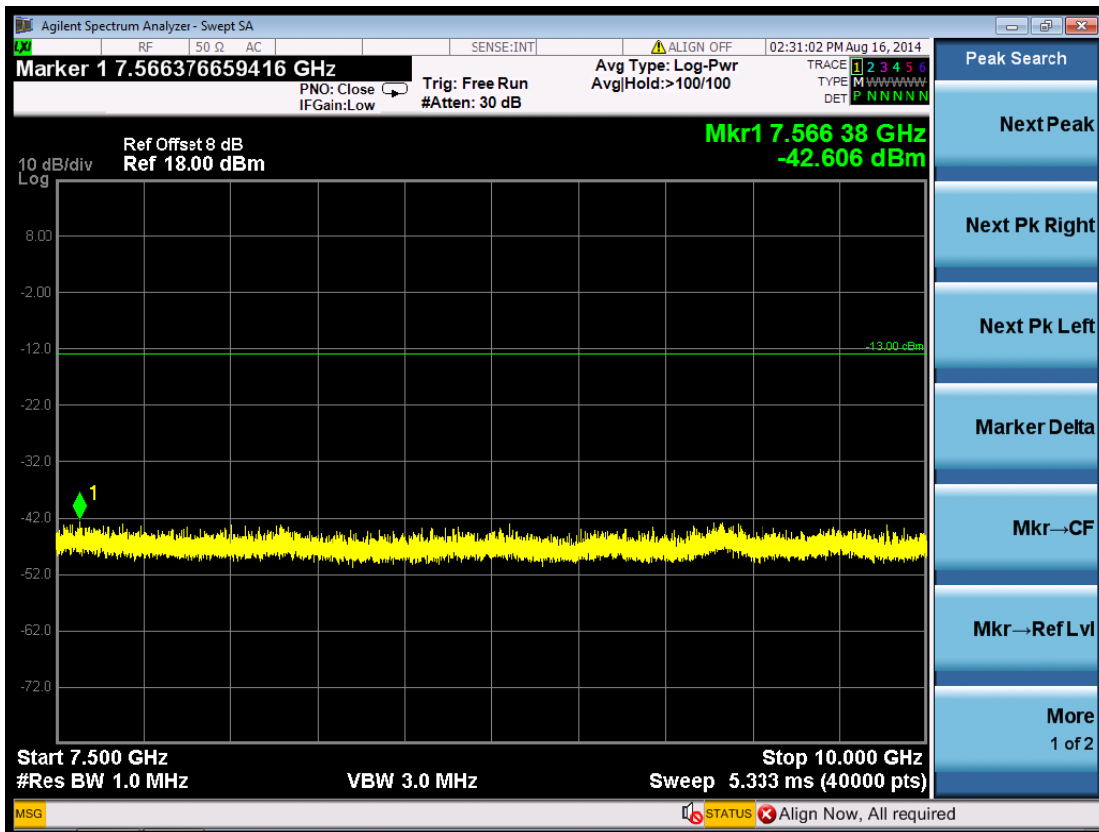

(Plot 5.5.1 D6: Idle WCDMA Band II)

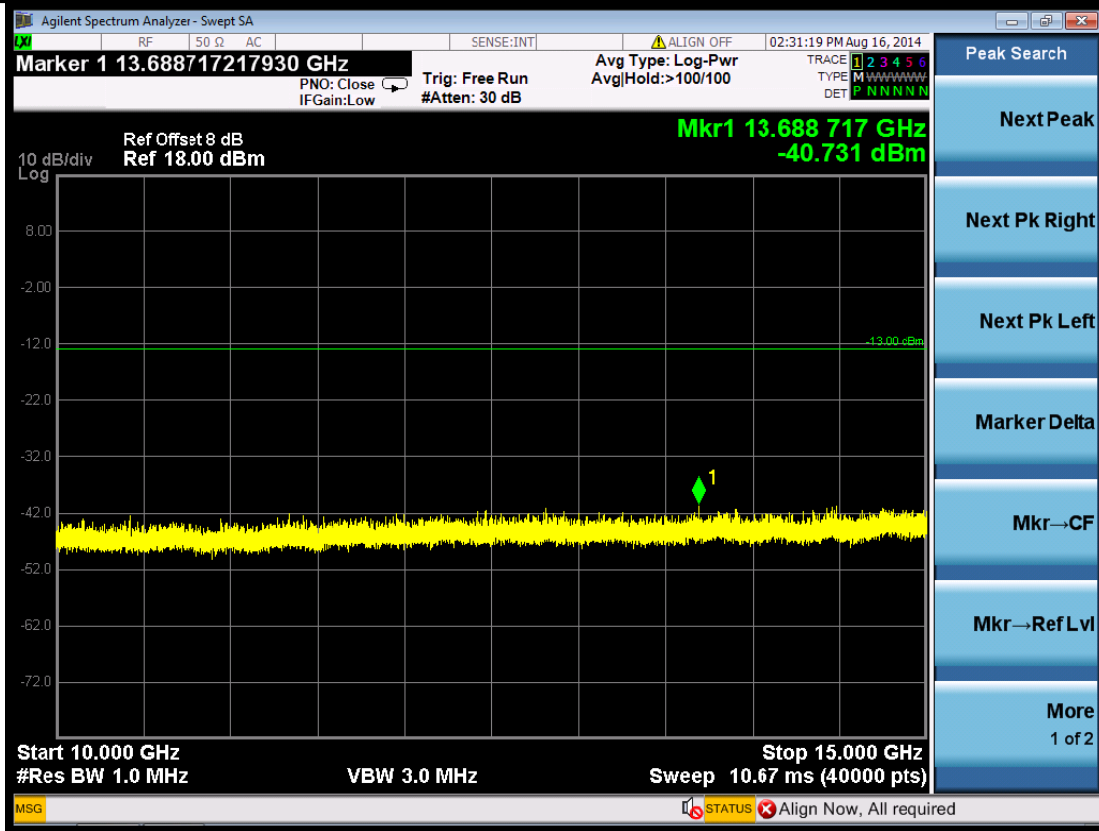

(Plot 5.5.1 D7: Idle WCDMA Band II)

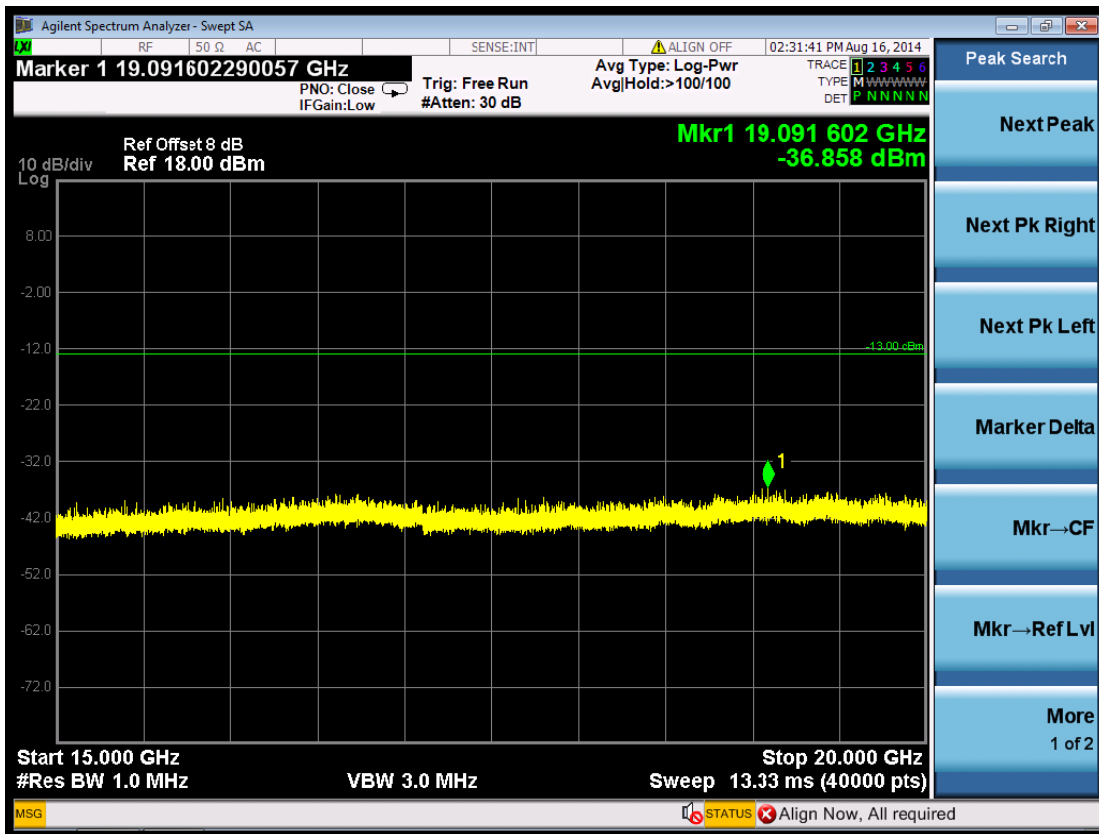

(Plot 5.5.1 D8: Idle WCDMA Band II)

**5.5.2 For WCDMA Band V Test Results**
**A. Test Verdict**

Test Mode/ Channel	Frequency (MHz)	Frequency Range	Refer to Plot	Limit (dBm)	Verdict
UMTS/TM1/WCDMA Band V/4132	826.40	9KHz-150KHz	Plot 5.5.2 A1	-13.00	PASS
		150KHz-30MHz	Plot 5.5.2 A2	-13.00	PASS
		30MHz-1GHz	Plot 5.5.2 A3	-13.00	PASS
		1GHz-2.5GHz	Plot 5.5.2 A4	-13.00	PASS
		2.5GHz-7.5GHz	Plot 5.5.2 A5	-13.00	PASS
		7.5GHz-10GHz	Plot 5.5.2 A6	-13.00	PASS
UMTS/TM1/WCDMA Band V/4183	836.60	9KHz-150KHz	Plot 5.5.2 B1	-13.00	PASS
		150KHz-30MHz	Plot 5.5.2 B2	-13.00	PASS
		30MHz-1GHz	Plot 5.5.2 B3	-13.00	PASS
		1GHz-2.5GHz	Plot 5.5.2 B4	-13.00	PASS
		2.5GHz-7.5GHz	Plot 5.5.2 B5	-13.00	PASS
		7.5GHz-10GHz	Plot 5.5.2 B6	-13.00	PASS
UMTS/TM1/WCDMA Band V/4233	846.60	9KHz-150KHz	Plot 5.5.2 C1	-13.00	PASS
		150KHz-30MHz	Plot 5.5.2 C2	-13.00	PASS
		30MHz-1GHz	Plot 5.5.2 C3	-13.00	PASS
		1GHz-2.5GHz	Plot 5.5.2 C4	-13.00	PASS
		2.5GHz-7.5GHz	Plot 5.5.2 C5	-13.00	PASS
		7.5GHz-10GHz	Plot 5.5.2 C6	-13.00	PASS
UMTS/TM1/WCDMA Band V/Idle	N/A	9KHz-150KHz	Plot 5.5.2 D1	-13.00	PASS
		150KHz-30MHz	Plot 5.5.2 D2	-13.00	PASS
		30MHz-1GHz	Plot 5.5.2 D3	-13.00	PASS
		1GHz-2.5GHz	Plot 5.5.2 D4	-13.00	PASS
		2.5GHz-7.5GHz	Plot 5.5.2 D5	-13.00	PASS
		7.5GHz-10GHz	Plot 5.5.2 D6	-13.00	PASS

Note: 1. In general, the worse case attenuation requirement shown above was applied.

2."---" means that the emission level is too low to be measured or at least 20 dB down than the limit.

**B. Test Plots**

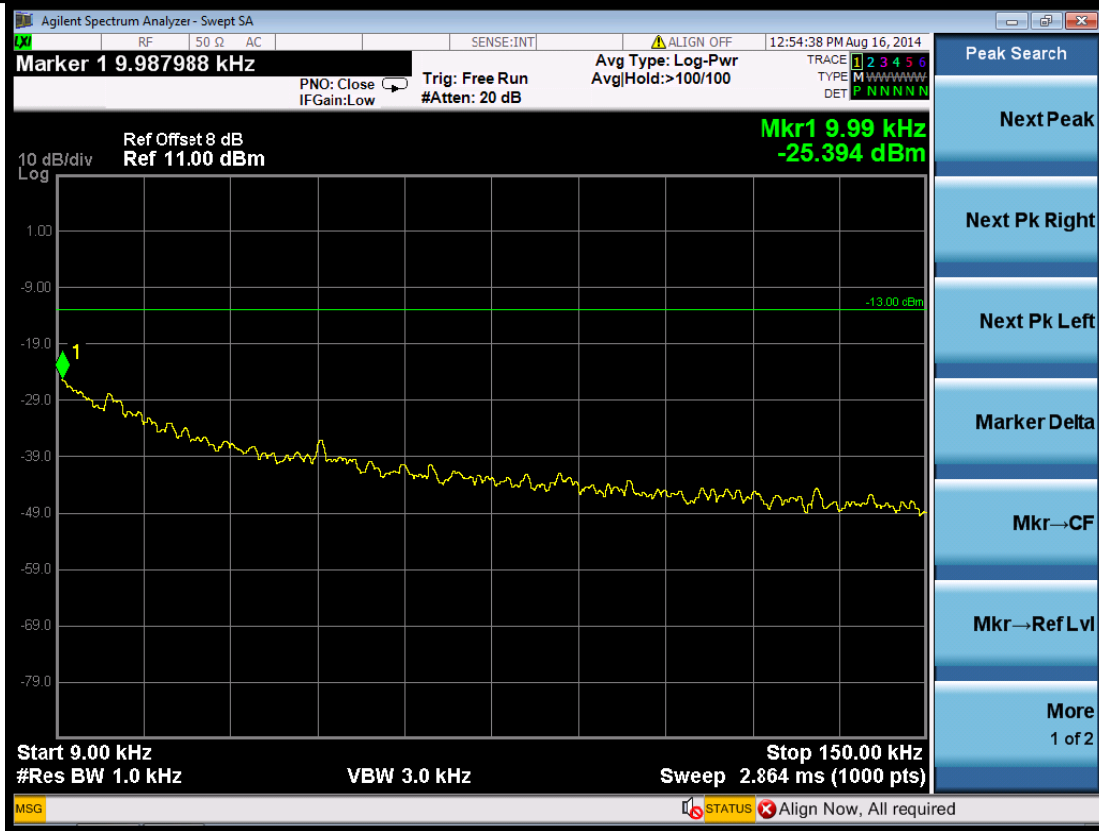

(Plot 5.5.2 A1: Channel 4132: 826.40 MHz @ WCDMA Band V)

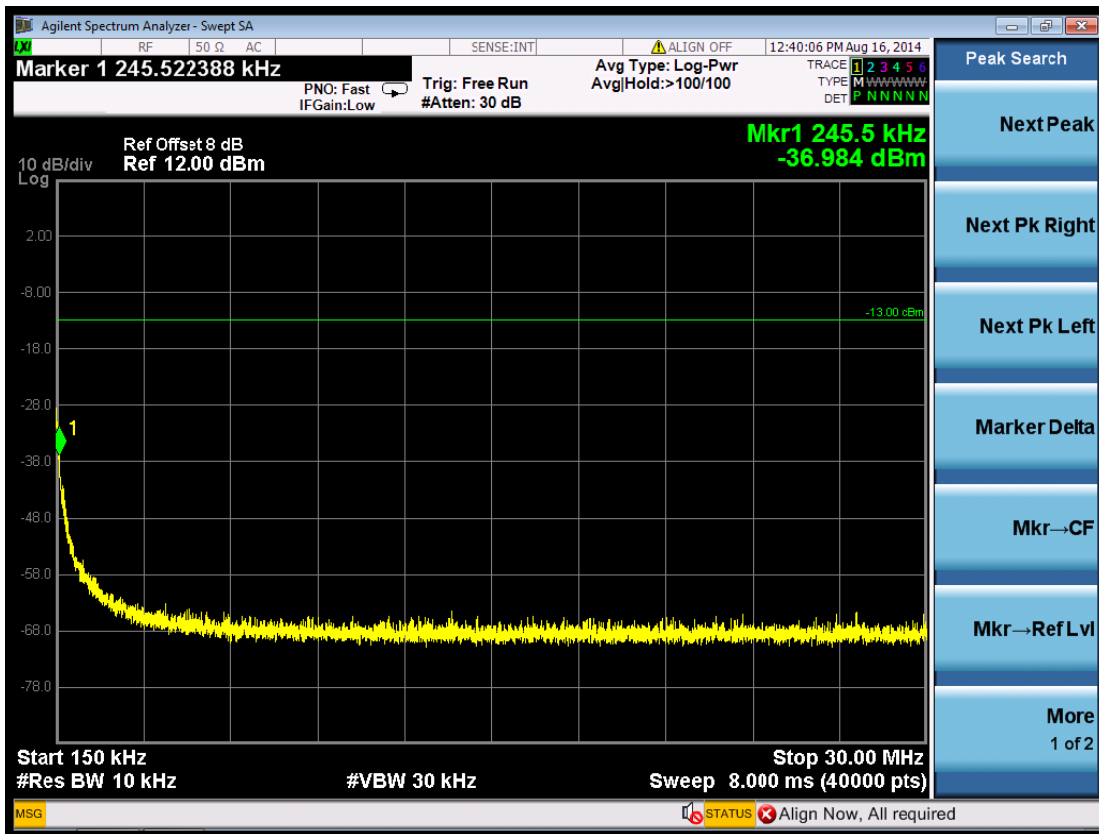

(Plot 5.5.2 A2: Channel 4132: 826.40 MHz @ WCDMA Band V)

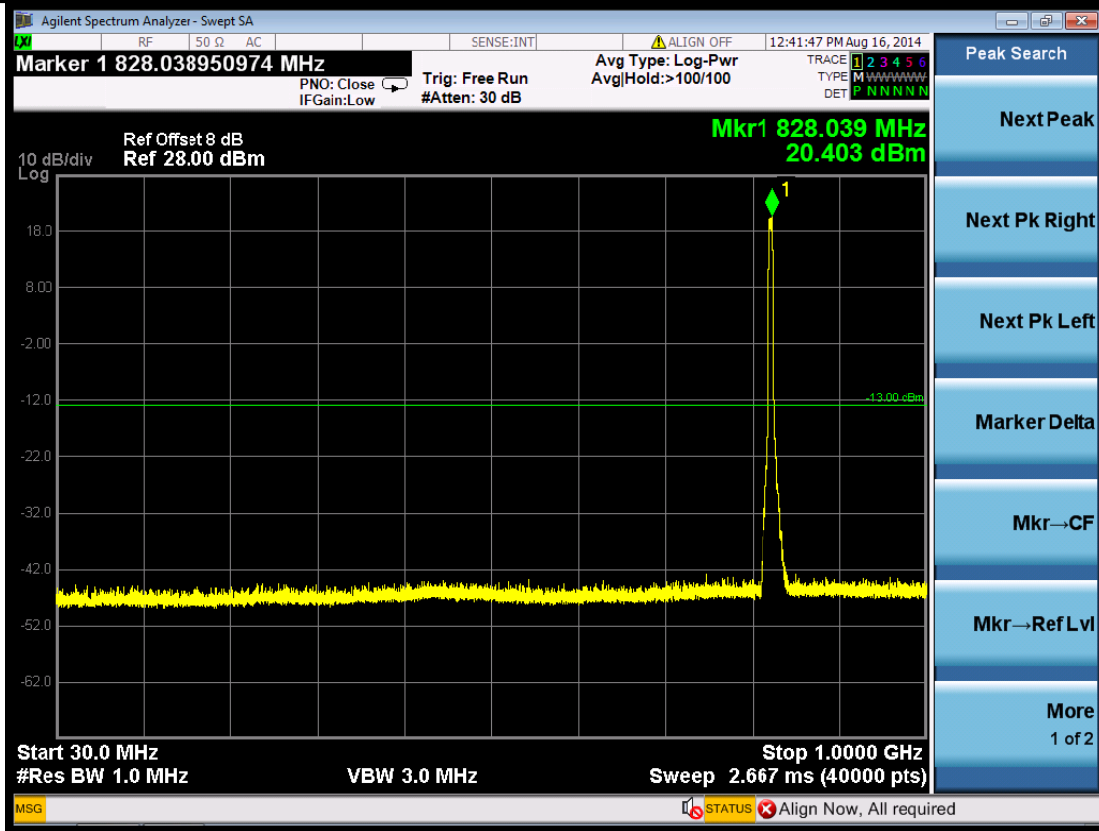

(Plot 5.5.2 A3: Channel 4132: 826.40 MHz @ WCDMA Band V)

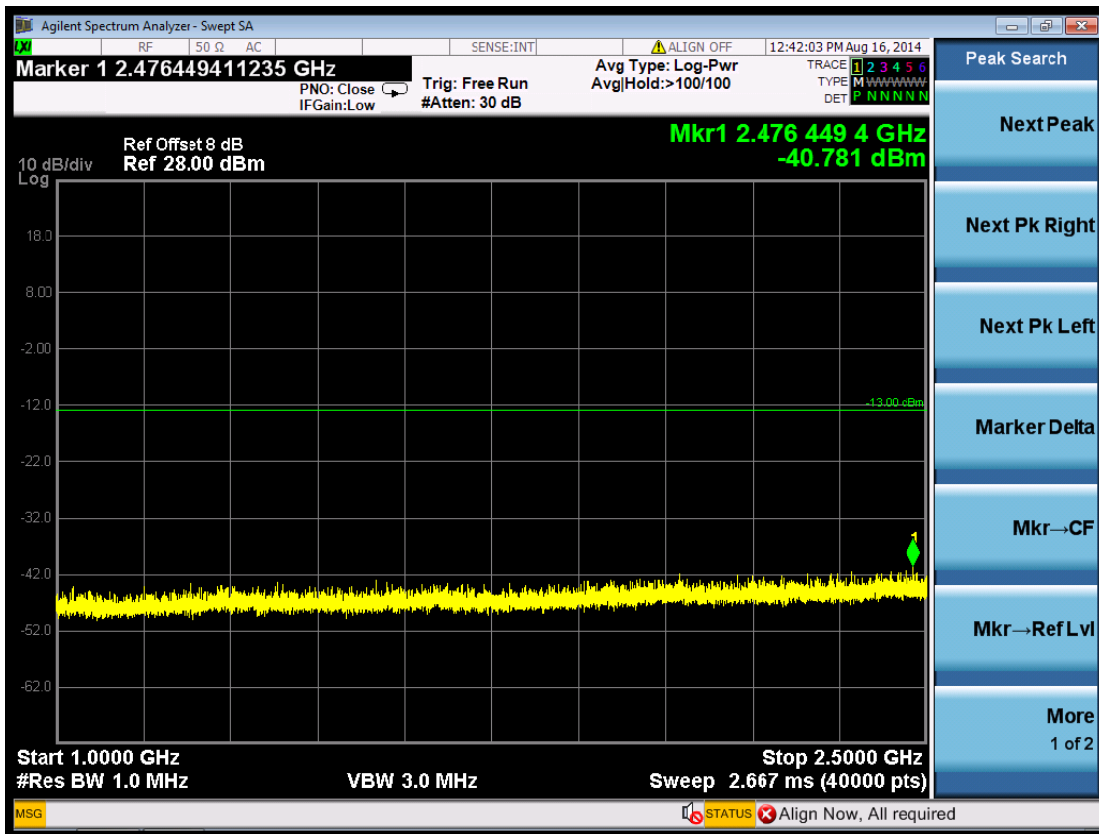

(Plot 5.5.2 A4: Channel 4132: 826.40 MHz @ WCDMA Band V)

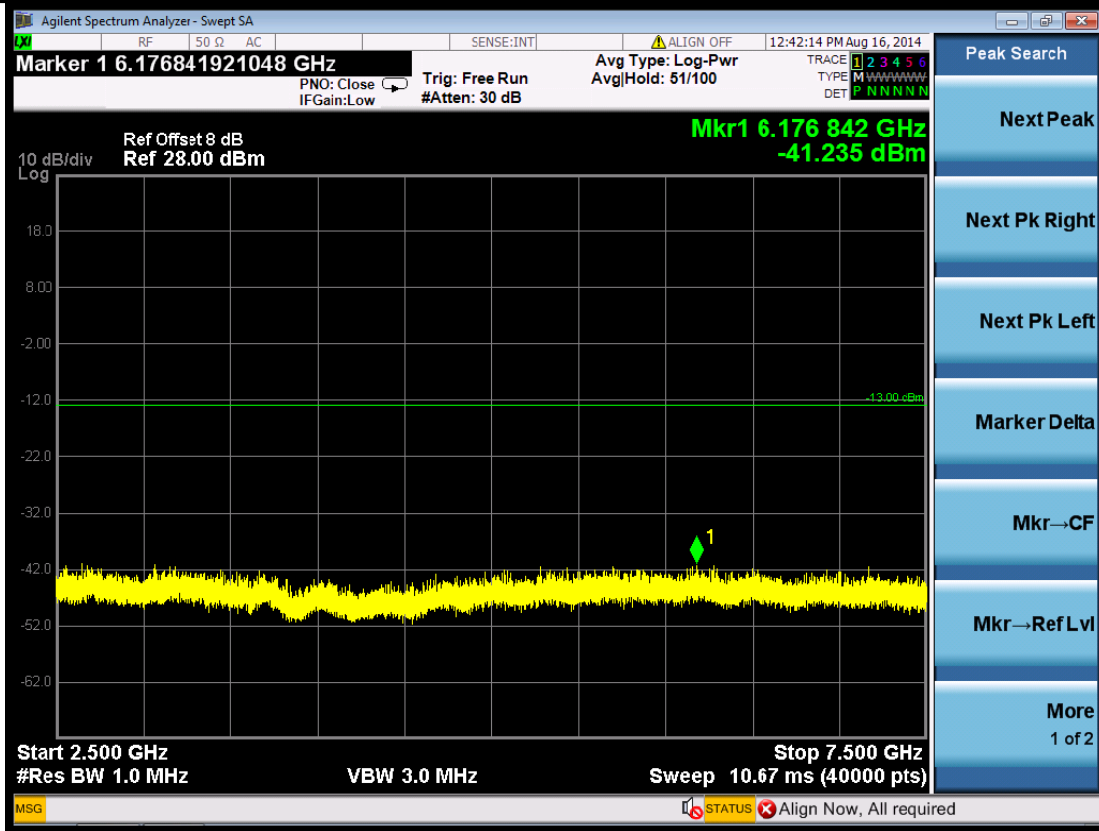

(Plot 5.5.2 A5: Channel 4132: 826.40 MHz @ WCDMA Band V)

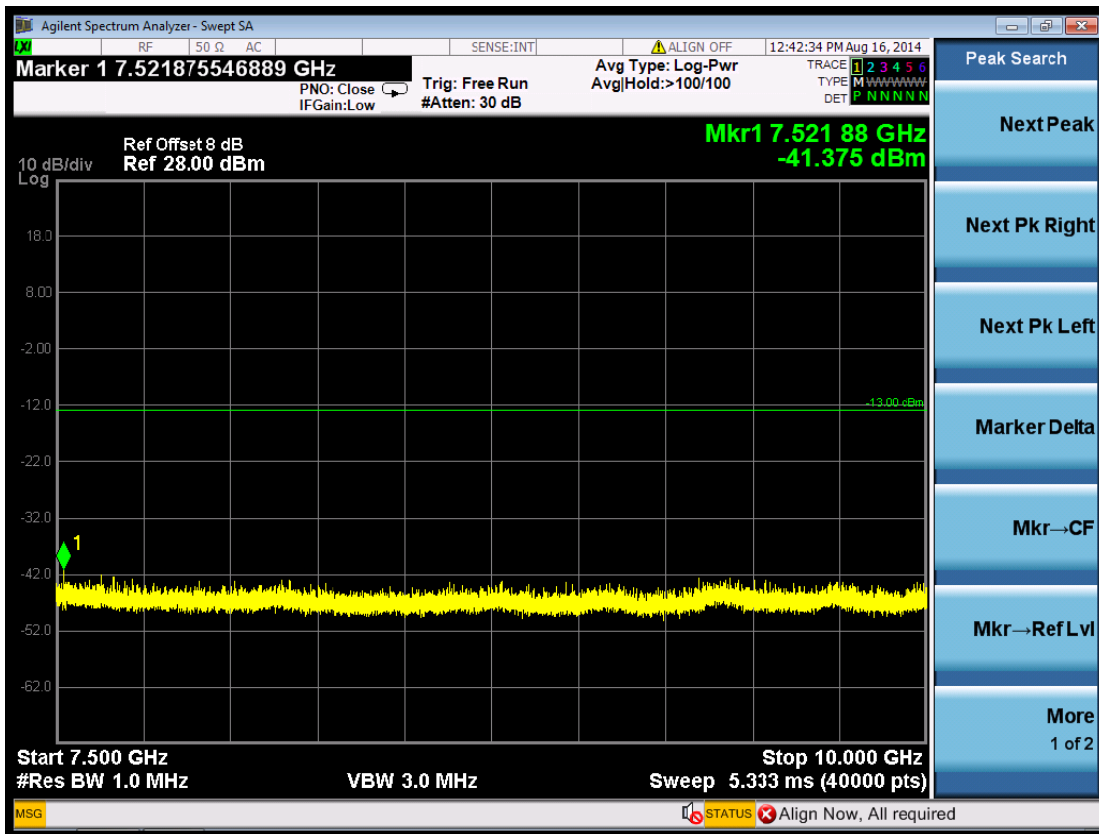

(Plot 5.5.2 A6: Channel 4132: 826.40 MHz @ WCDMA Band V)

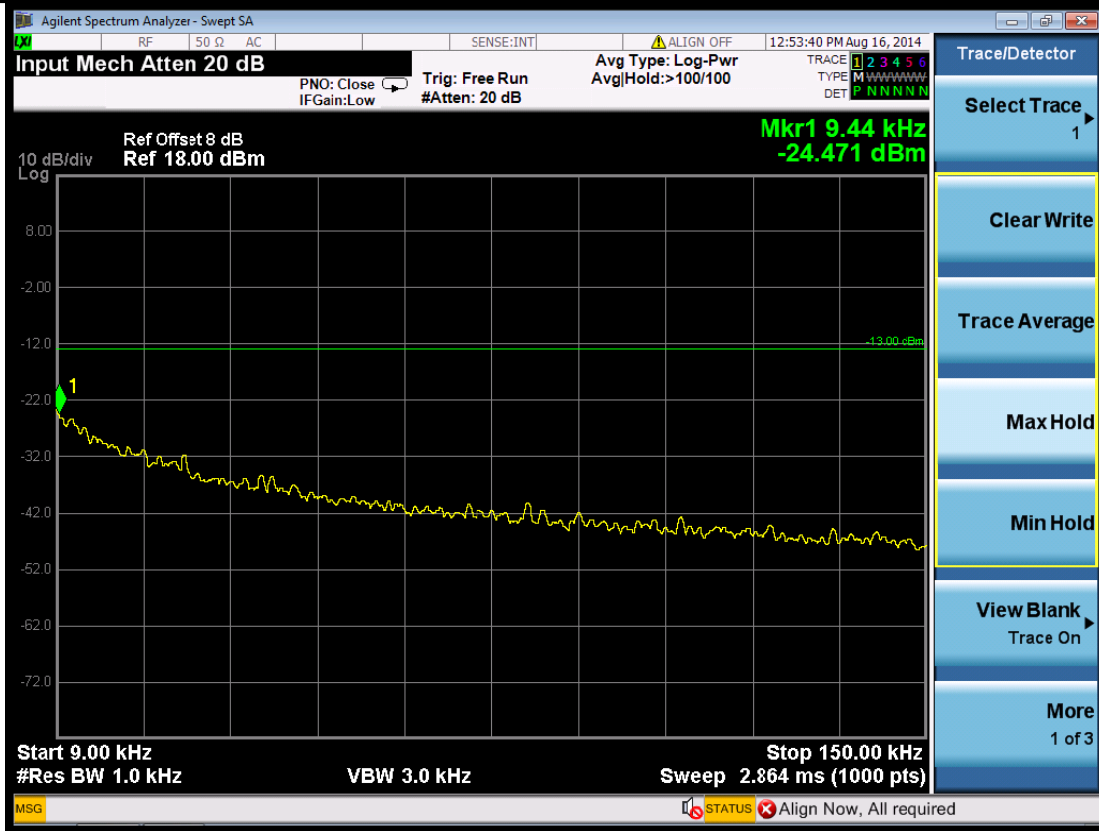

(Plot 5.5.2 B1: Channel 4183: 836.60 MHz @ WCDMA Band V)

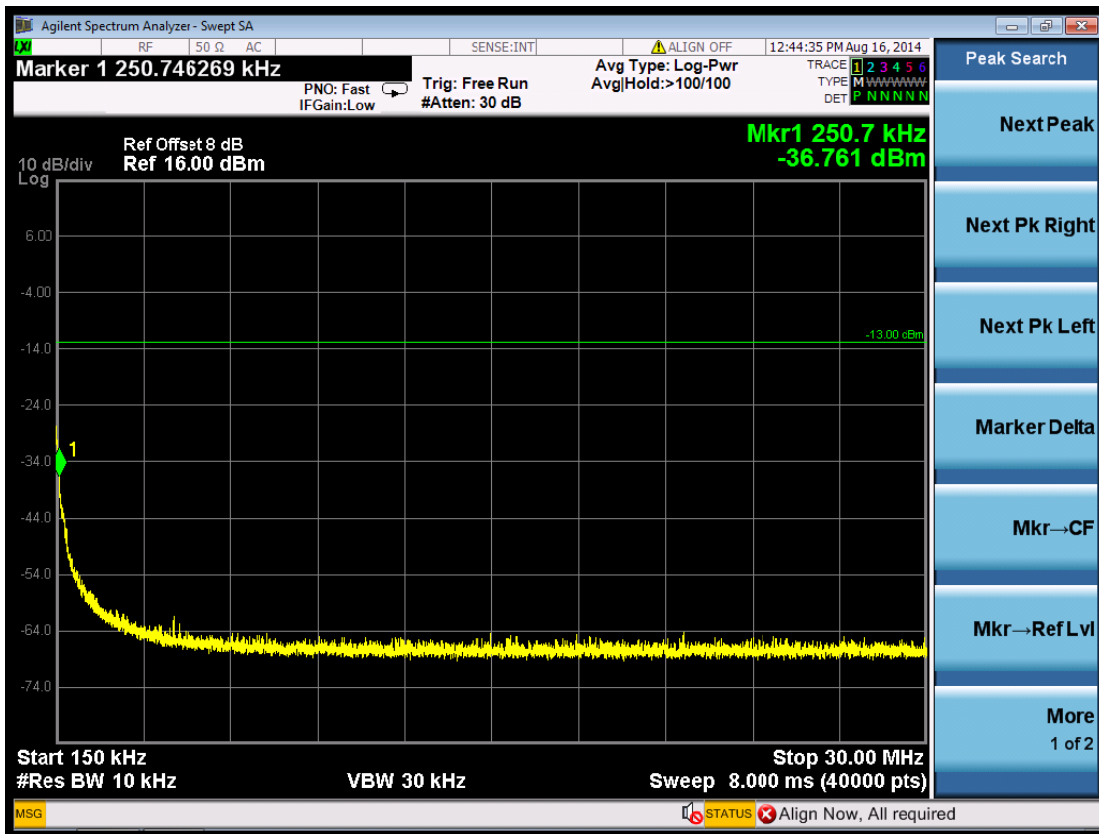

(Plot 5.5.2 B2: Channel 4183: 836.60 MHz @ WCDMA Band V)



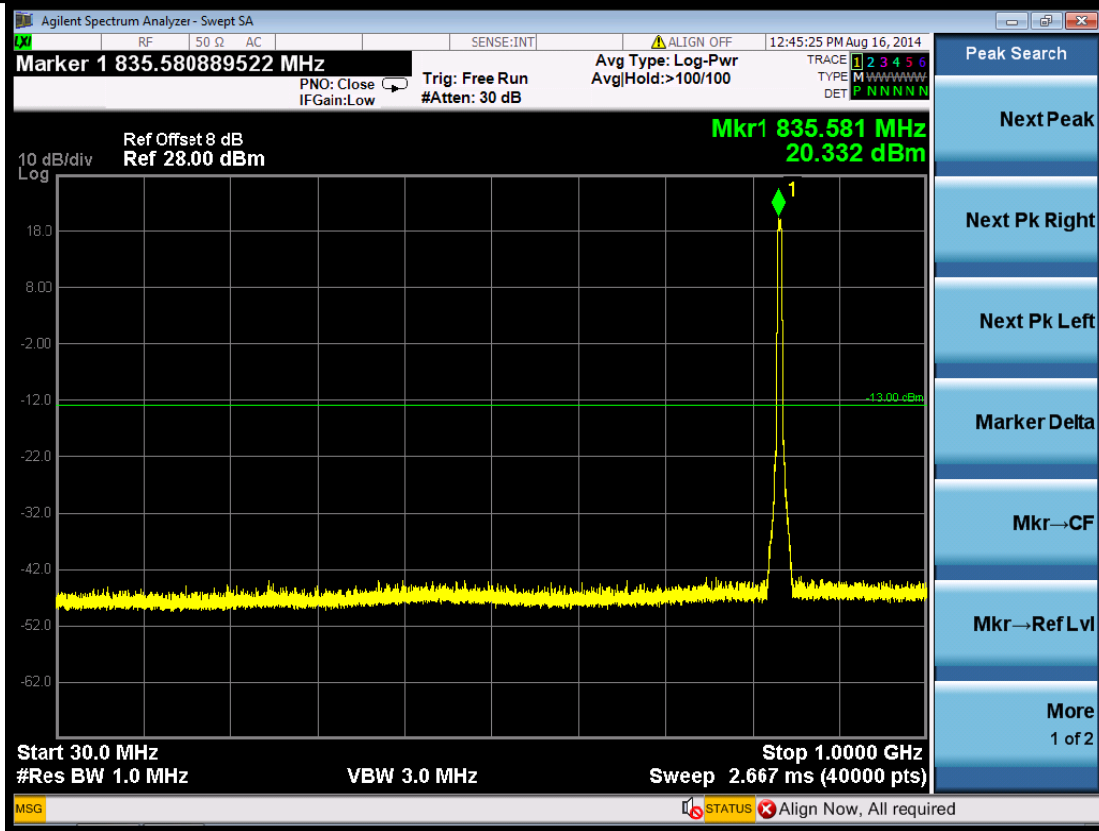

(Plot 5.5.2 B3: Channel 4183: 836.60 MHz @ WCDMA Band V)

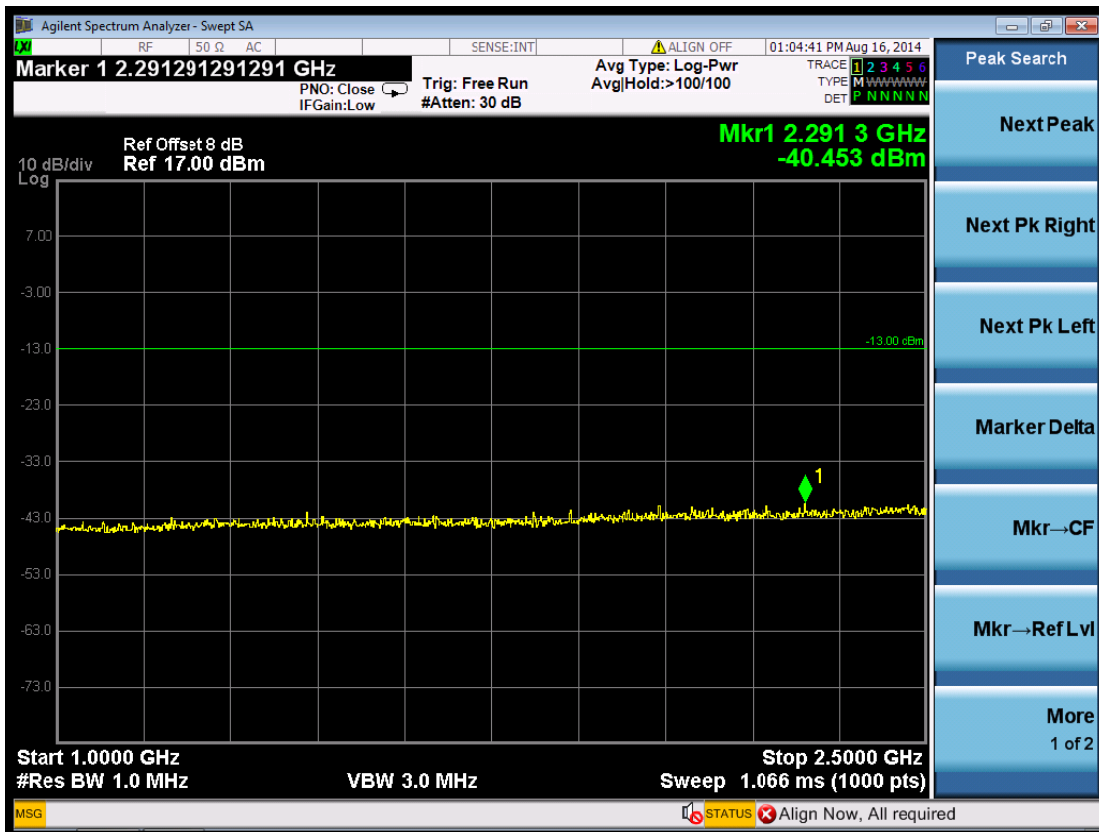

(Plot 5.5.2 B4: Channel 4183: 836.60 MHz @ WCDMA Band V)

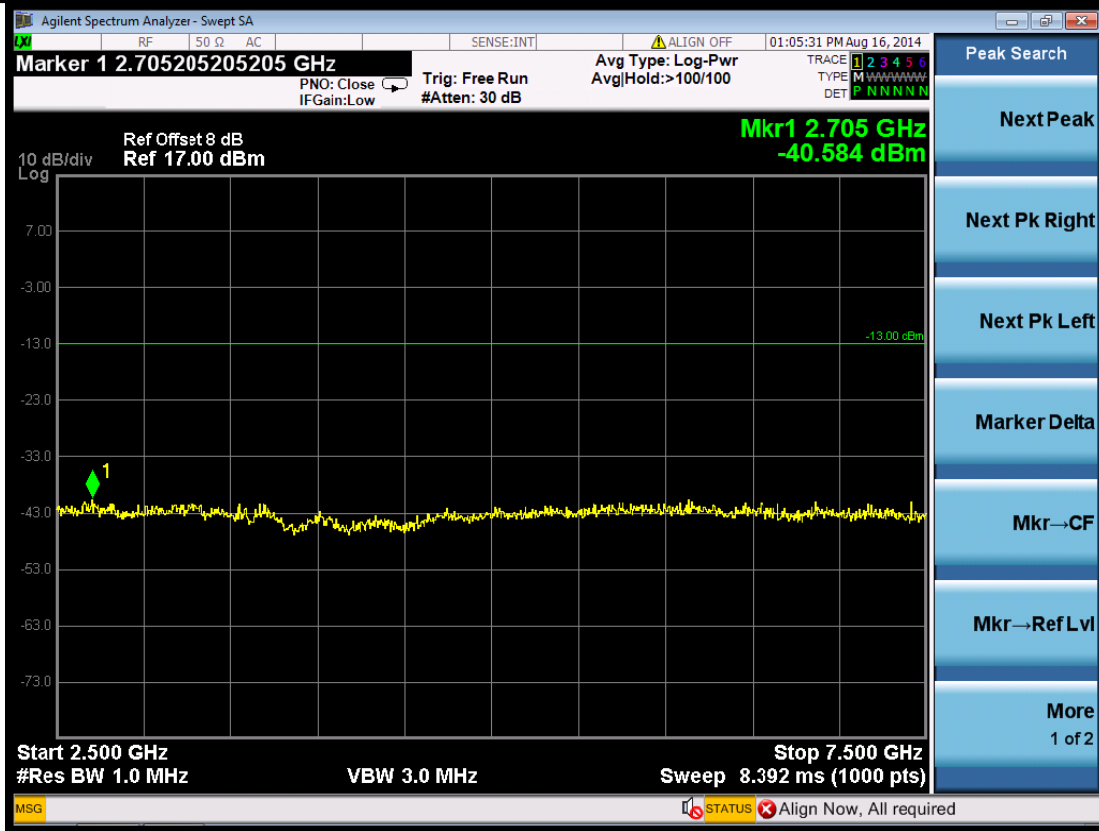

(Plot 5.5.2 B5: Channel 4183: 836.60 MHz @ WCDMA Band V)

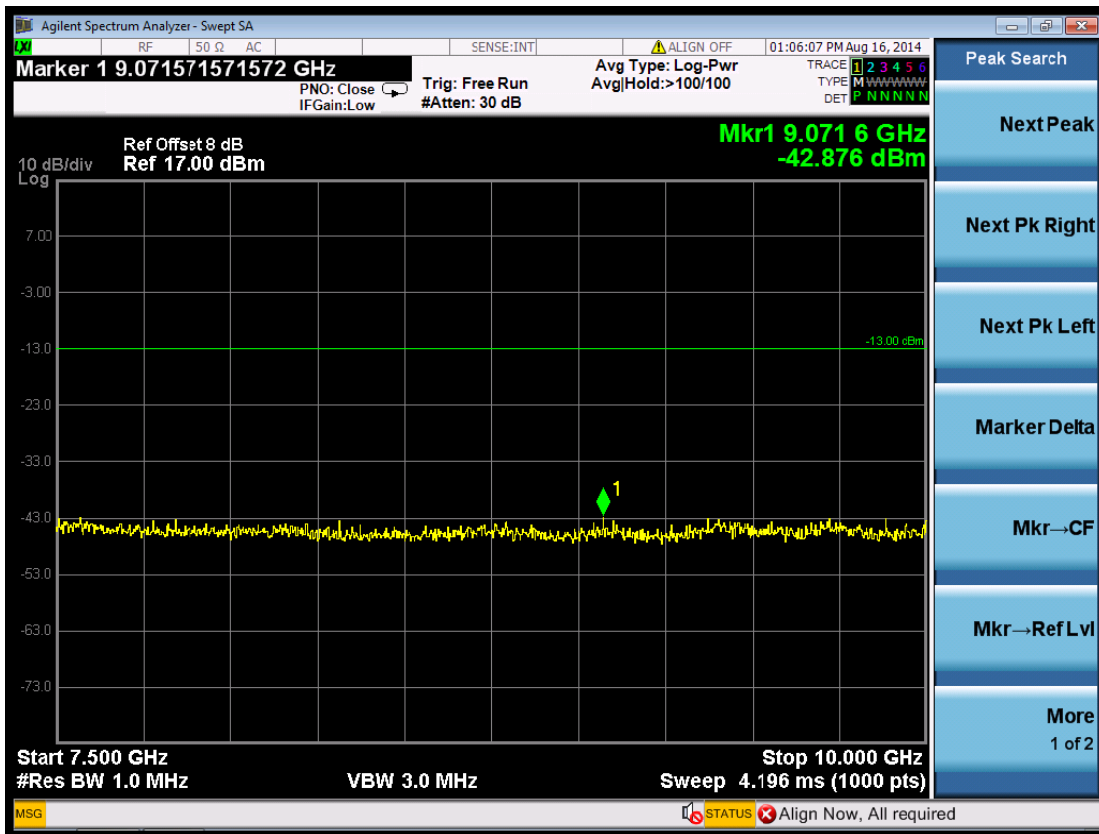

(Plot 5.5.2 B6: Channel 4183: 836.60 MHz @ WCDMA Band V)

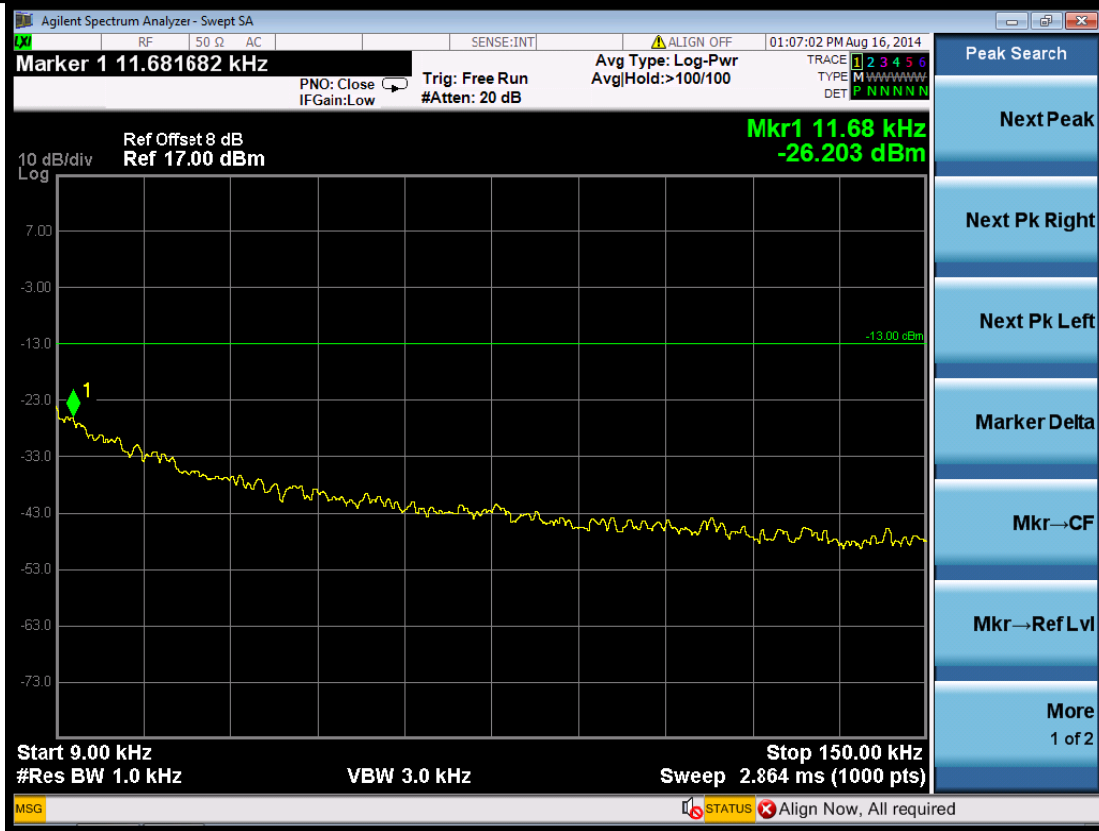

(Plot 5.5.2 C1: Channel 4233: 846.60 MHz @ WCDMA Band V)

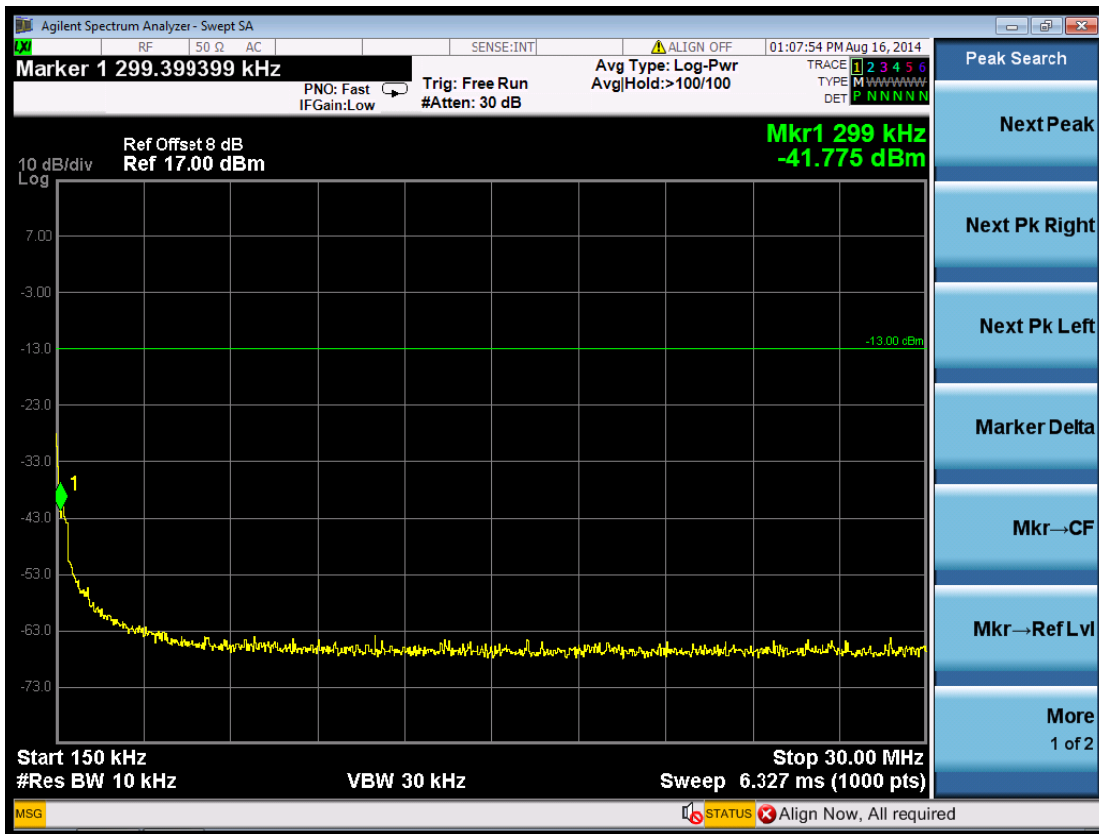

(Plot 5.5.2 C2: Channel 4233: 846.60 MHz @ WCDMA Band V)

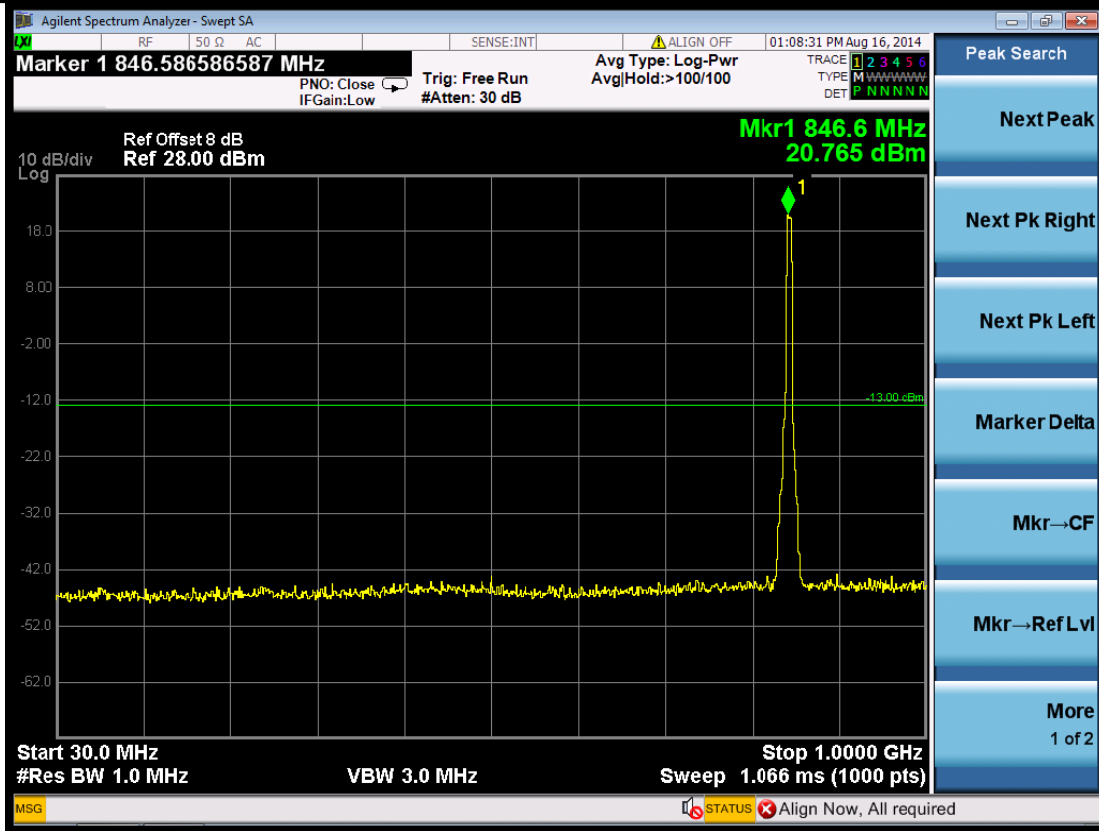

(Plot 5.5.2 C3: Channel 4233: 846.60 MHz @ WCDMA Band V)

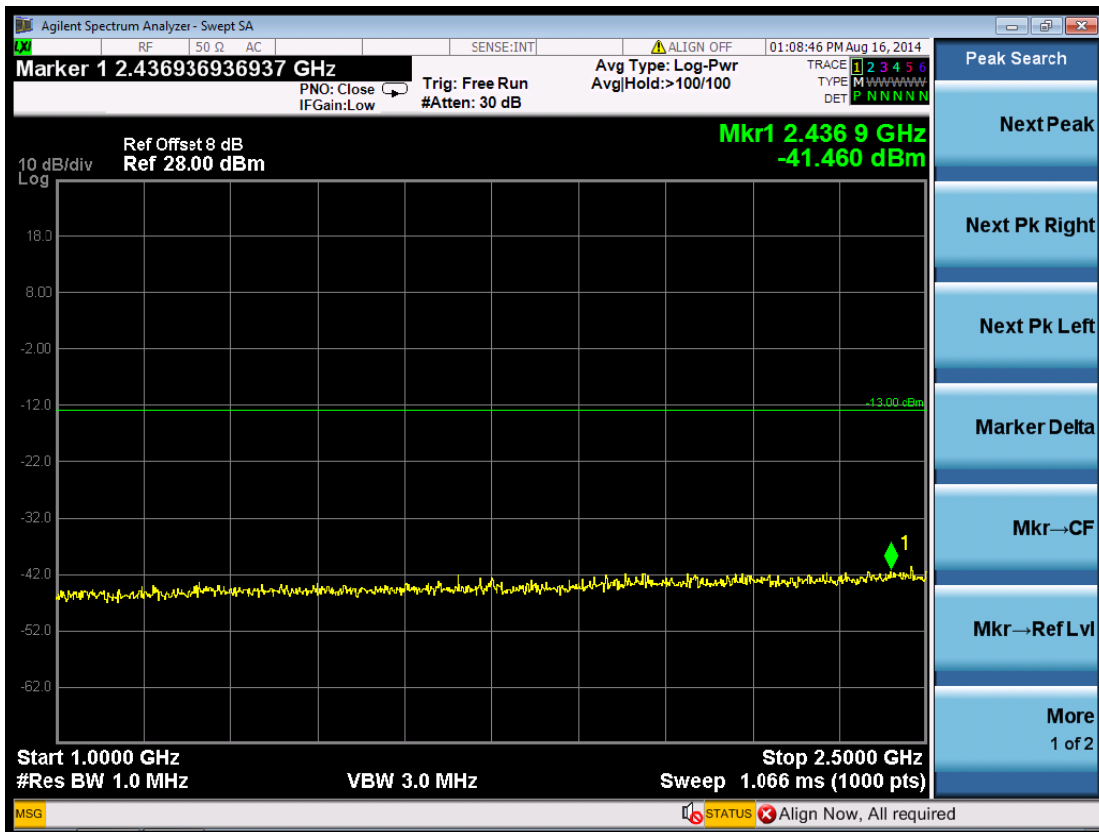

(Plot 5.5.2 C4: Channel 4233: 846.60 MHz @ WCDMA Band V)

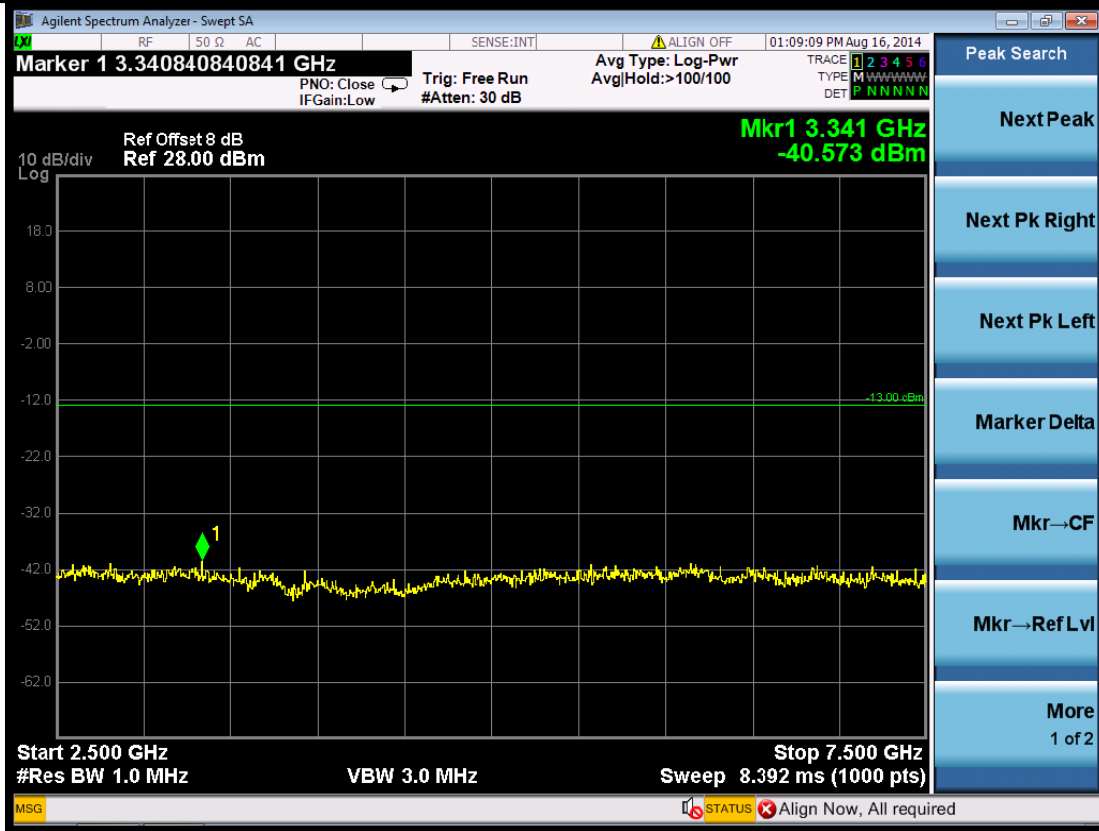

(Plot 5.5.2 C5: Channel 4233: 846.60 MHz @ WCDMA Band V)

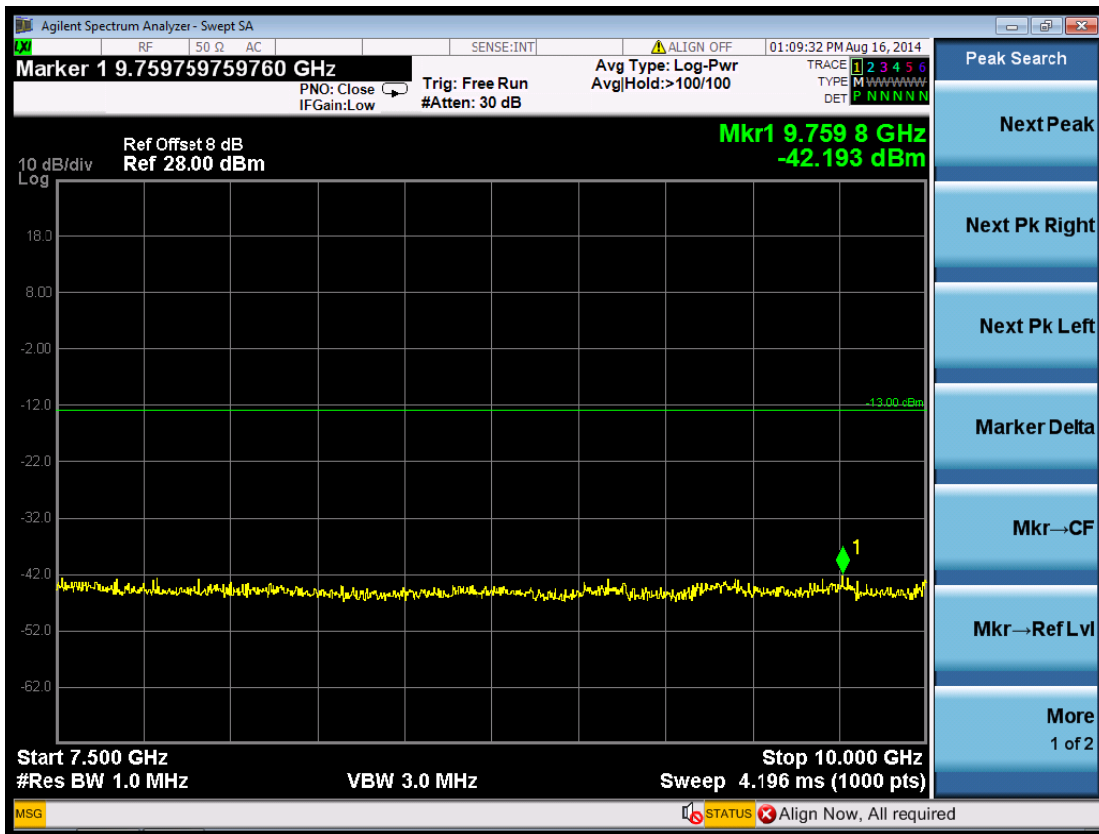

(Plot 5.5.2 C6: Channel 4233: 846.60 MHz @ WCDMA Band V)

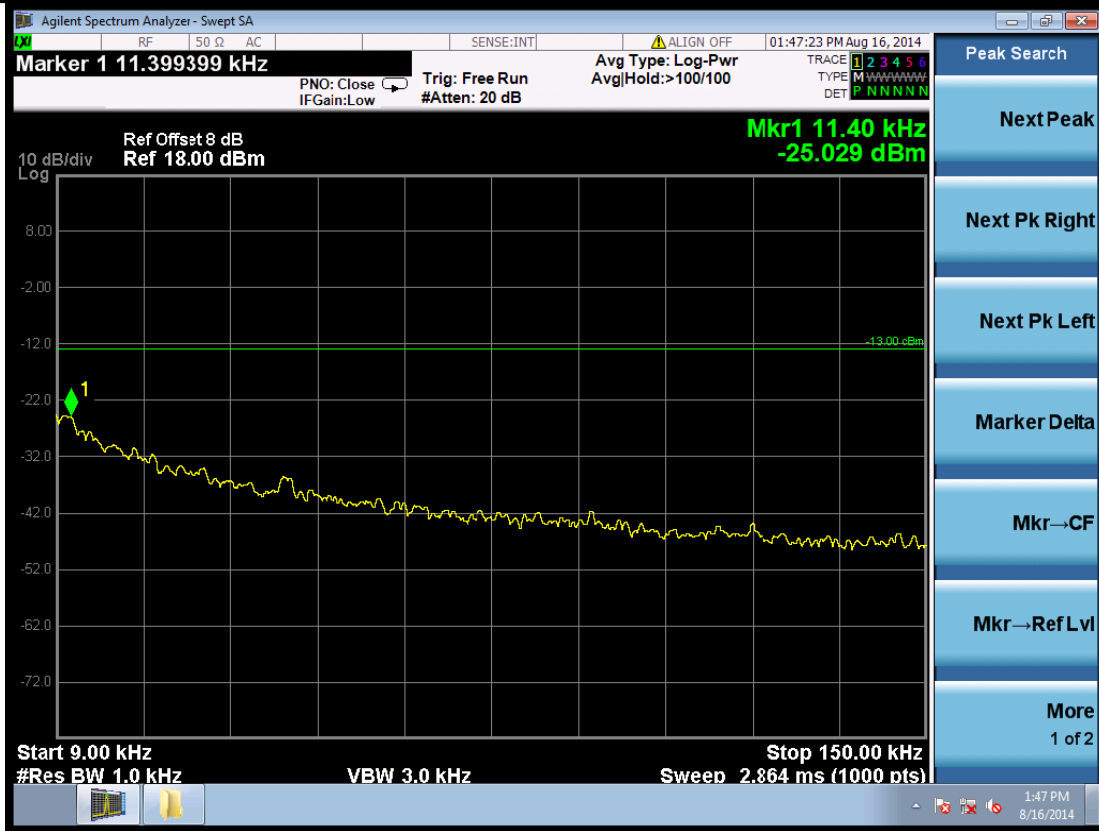

(Plot 5.5.2 D1: Idle @ WCDMA Band V)

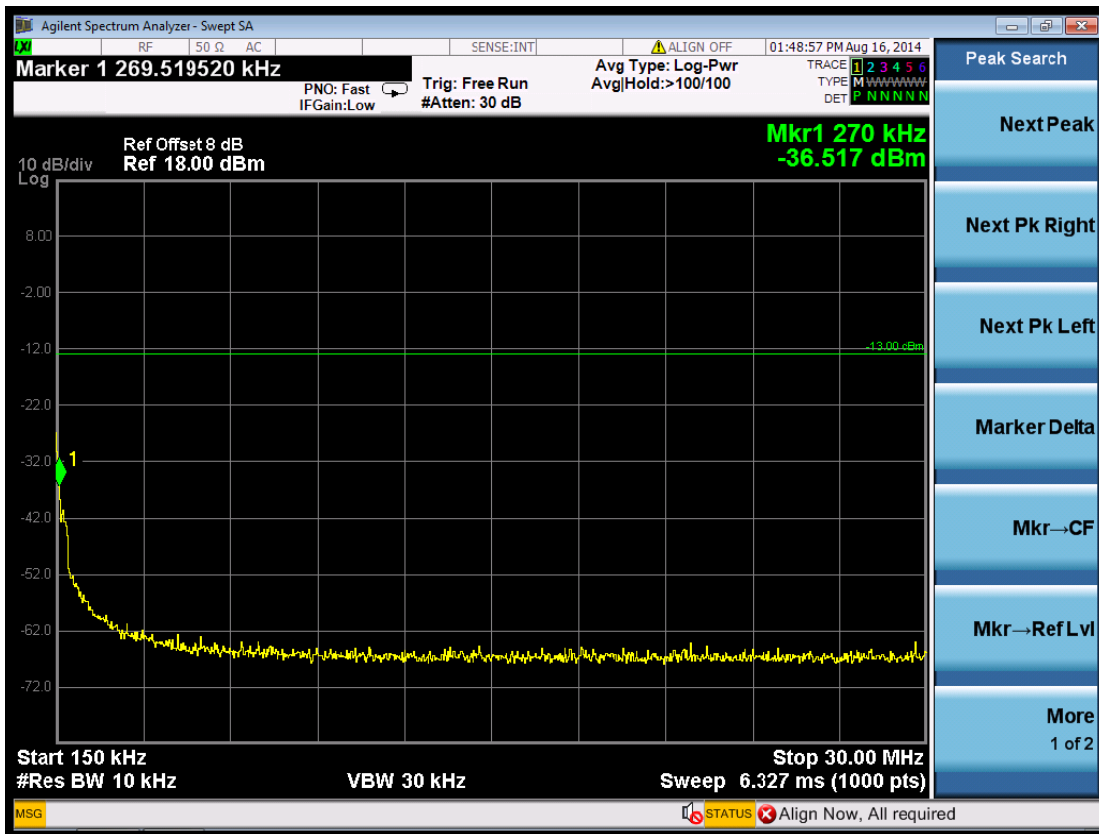

(Plot 5.5.2 D2: Idle @ WCDMA Band V)

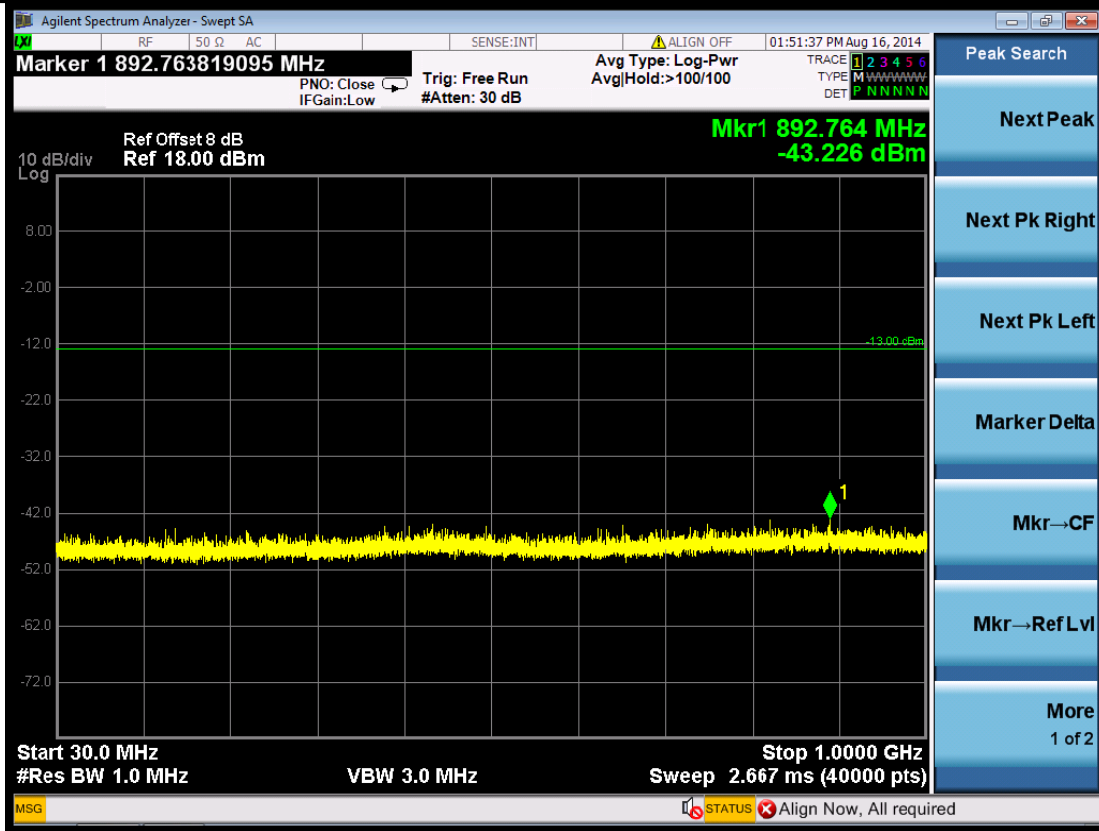

(Plot 5.5.2 D3: Idle @ WCDMA Band V)

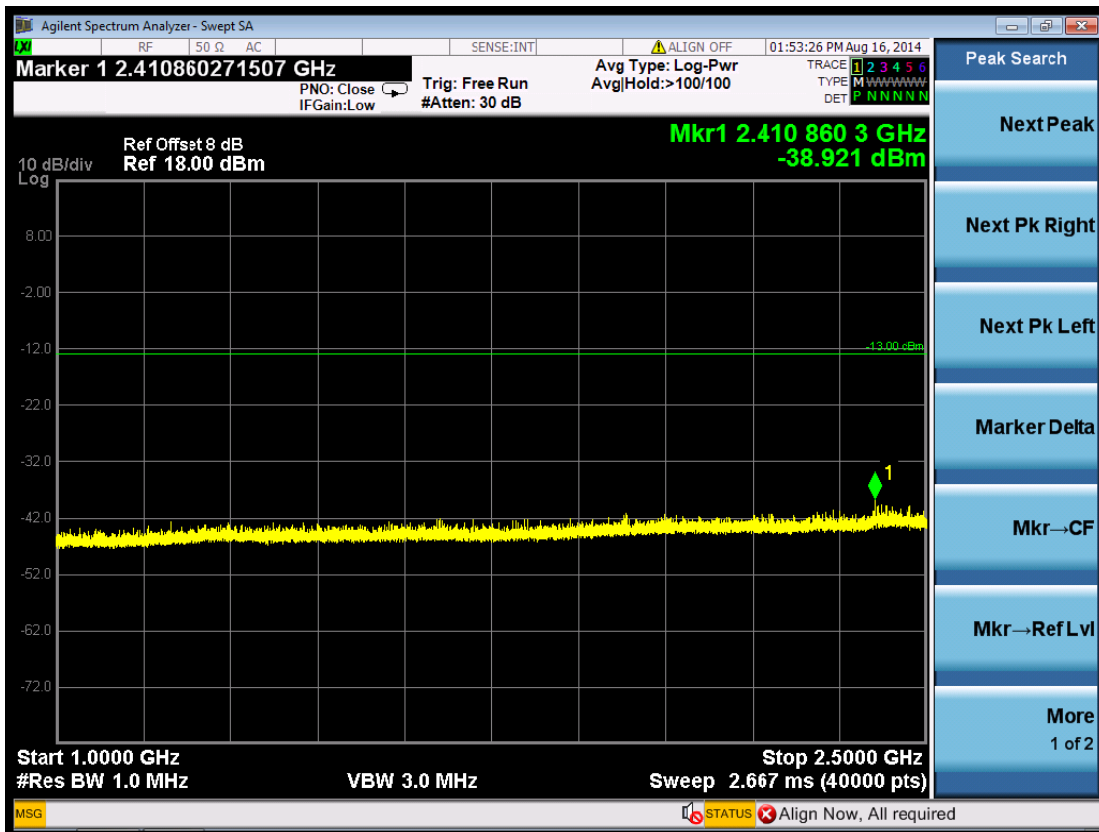

(Plot 5.5.2 D4: Idle @ WCDMA Band V)

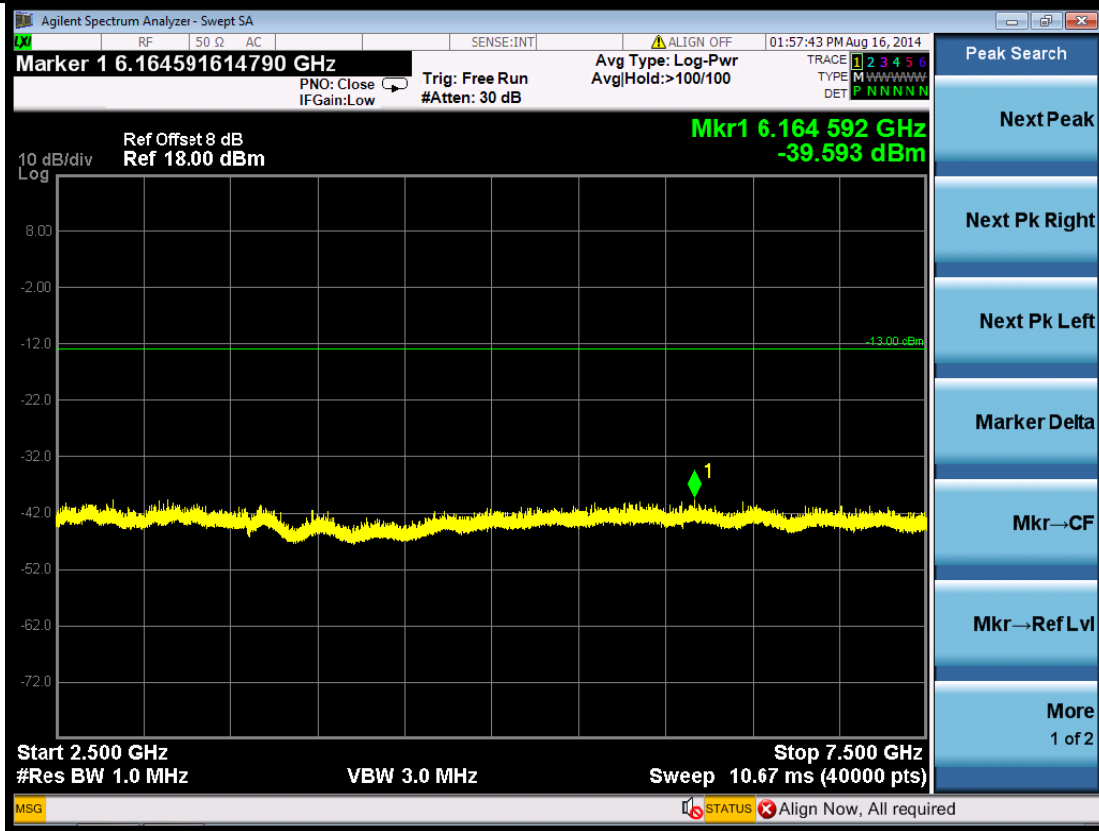

(Plot 5.5.2 D5: Idle @ WCDMA Band V)

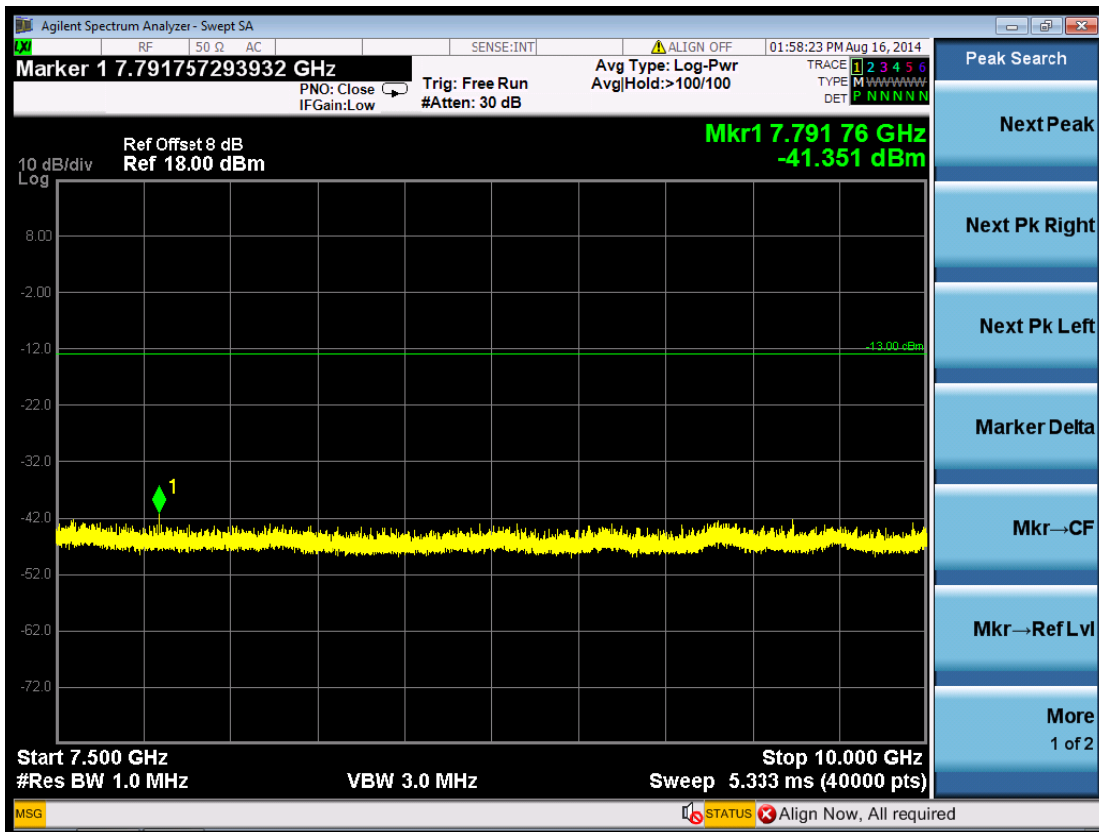

(Plot 5.5.2 D6: Idle @ WCDMA Band V)



**5.5.3 For GSM1900 Test Results**
**A. Test Verdict**

Test Mode/ Channel	Frequency (MHz)	Frequency Range	Refer to Plot	Limit (dBm)	Verdict
UMTS/TM1/WCDMA Band IV/1312	1712.40	9KHz-150KHz	Plot 5.5.3 A1	-13.00	PASS
		150KHz-30MHz	Plot 5.5.3 A2	-13.00	PASS
		30MHz-1GHz	Plot 5.5.3 A3	-13.00	PASS
		1GHz-2.5GHz	Plot 5.5.3 A4	-13.00	PASS
		2.5GHz-7.5GHz	Plot 5.5.3 A5	-13.00	PASS
		7.5GHz-10GHz	Plot 5.5.3 A6	-13.00	PASS
		10GHz-15GHz	Plot 5.5.3 A7	-13.00	PASS
		15GHz-18GHz	Plot 5.5.3 A8	-13.00	PASS
UMTS/TM1/WCDMA Band IV/1413	1732.60	9KHz-150KHz	Plot 5.5.3 B1	-13.00	PASS
		150KHz-30MHz	Plot 5.5.3 B2	-13.00	PASS
		30MHz-1GHz	Plot 5.5.3 B3	-13.00	PASS
		1GHz-2.5GHz	Plot 5.5.3 B4	-13.00	PASS
		2.5GHz-7.5GHz	Plot 5.5.3 B5	-13.00	PASS
		7.5GHz-10GHz	Plot 5.5.3 B6	-13.00	PASS
		10GHz-15GHz	Plot 5.5.3 B7	-13.00	PASS
		15GHz-18GHz	Plot 5.5.3 B8	-13.00	PASS
UMTS/TM1/WCDMA Band IV/1513	1752.60	9KHz-150KHz	Plot 5.5.3 C1	-13.00	PASS
		150KHz-30MHz	Plot 5.5.3 C2	-13.00	PASS
		30MHz-1GHz	Plot 5.5.3 C3	-13.00	PASS
		1GHz-2.5GHz	Plot 5.5.3 C4	-13.00	PASS
		2.5GHz-7.5GHz	Plot 5.5.3 C5	-13.00	PASS
		7.5GHz-10GHz	Plot 5.5.3 C6	-13.00	PASS
		10GHz-15GHz	Plot 5.5.3 C7	-13.00	PASS
		15GHz-18GHz	Plot 5.5.3 C8	-13.00	PASS
UMTS/TM1/WCDMA Band IV/Idle	N/A	9KHz-150KHz	Plot 5.5.3 D1	-13.00	PASS
		150KHz-30MHz	Plot 5.5.3 D2	-13.00	PASS
		30MHz-1GHz	Plot 5.5.3 D3	-13.00	PASS
		1GHz-2.5GHz	Plot 5.5.3 D4	-13.00	PASS
		2.5GHz-7.5GHz	Plot 5.5.3 D5	-13.00	PASS
		7.5GHz-10GHz	Plot 5.5.3 D6	-13.00	PASS
		10GHz-15GHz	Plot 5.5.3 D7	-13.00	PASS
		15GHz-18GHz	Plot 5.5.3 D8	-13.00	PASS

Note: 1. In general, the worse case attenuation requirement shown above was applied.

2."---" means that the emission level is too low to be measured or at least 20 dB down than the limit.

**B. Test Plots**

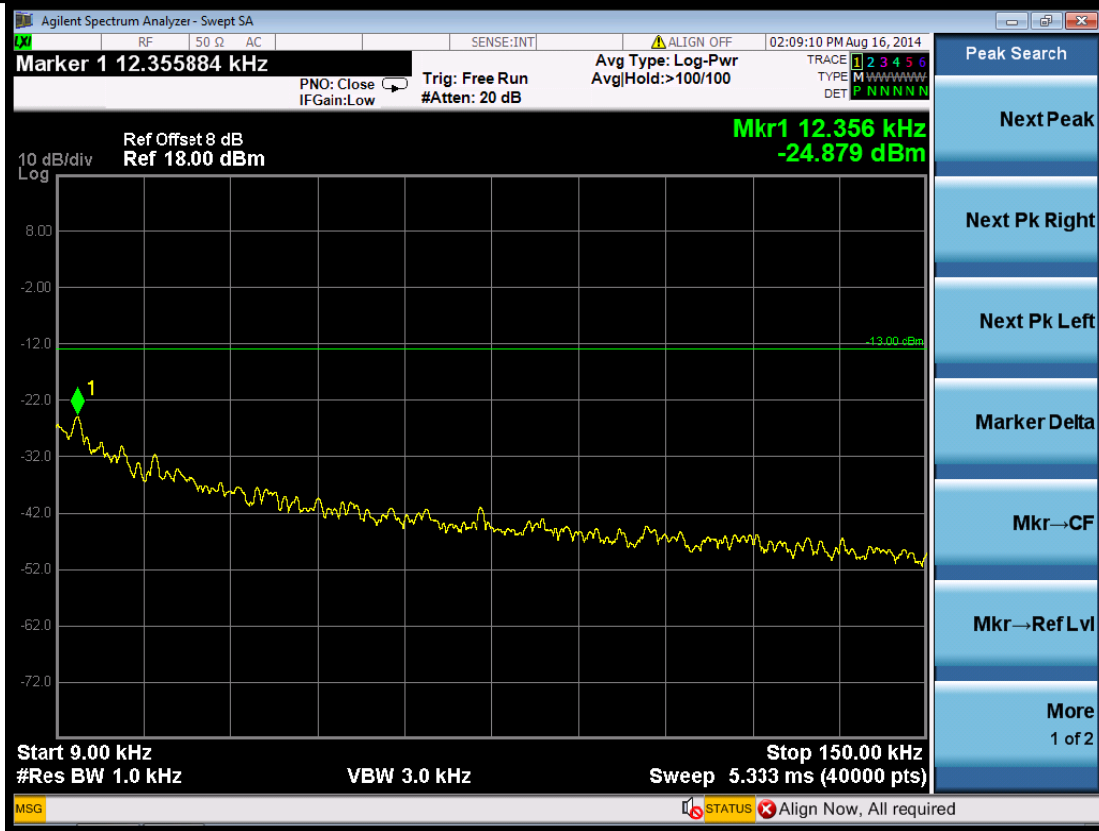

(Plot 5.5.3 A1: Channel 1312: 1712.4MHz @ Traffic WCDMA Band IV)

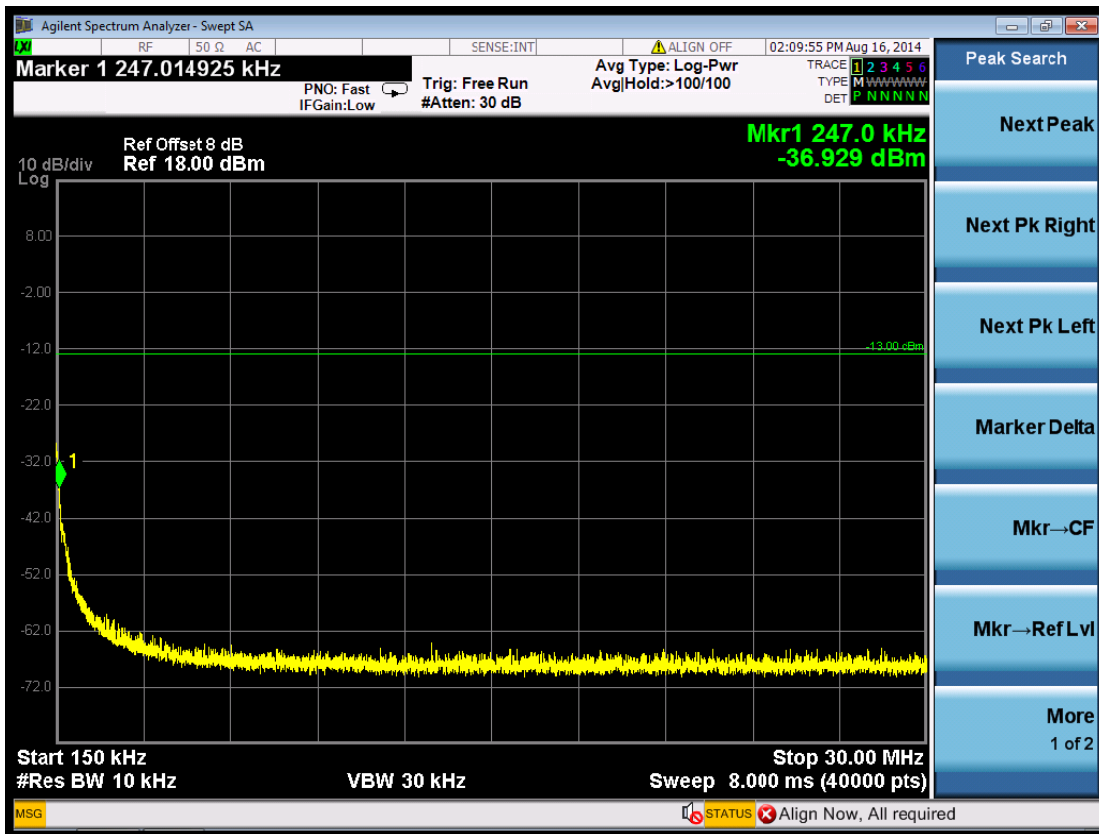

(Plot 5.5.3 A2: Channel 1312: 1712.4MHz @ Traffic WCDMA Band IV)

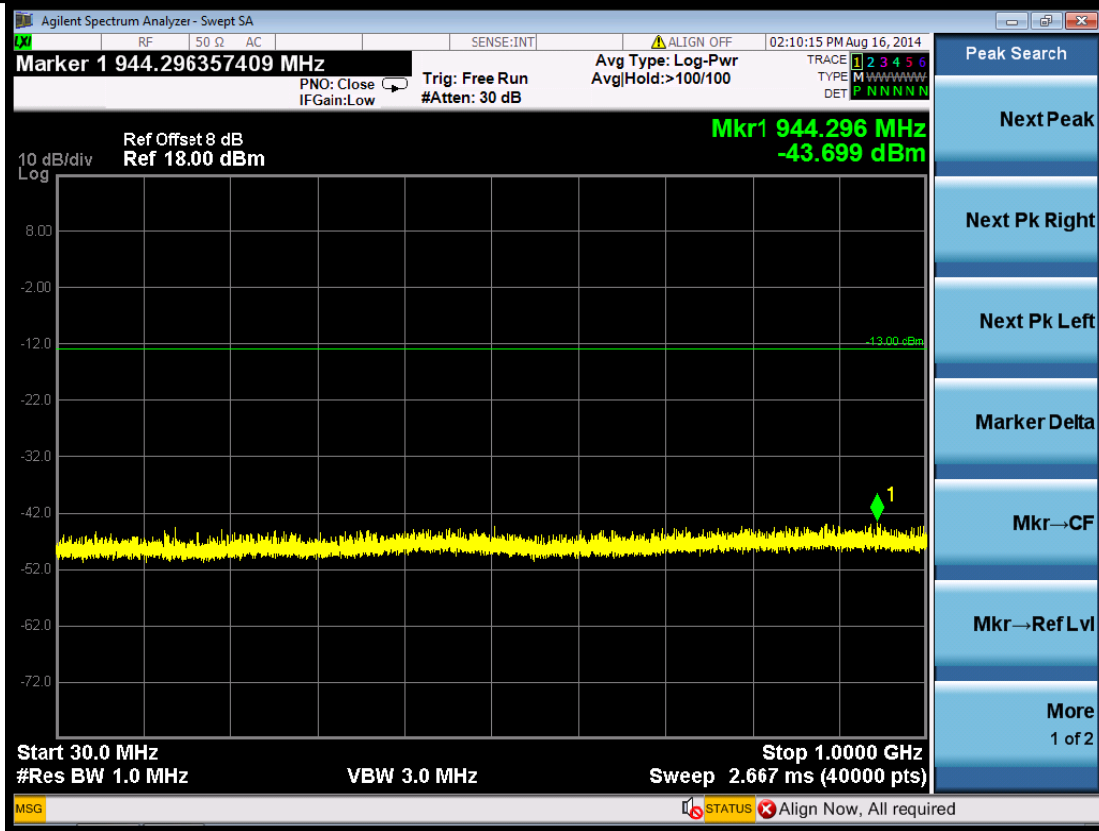

(Plot 5.5.3 A3: Channel 1312: 1712.4MHz @ Traffic WCDMA Band IV)

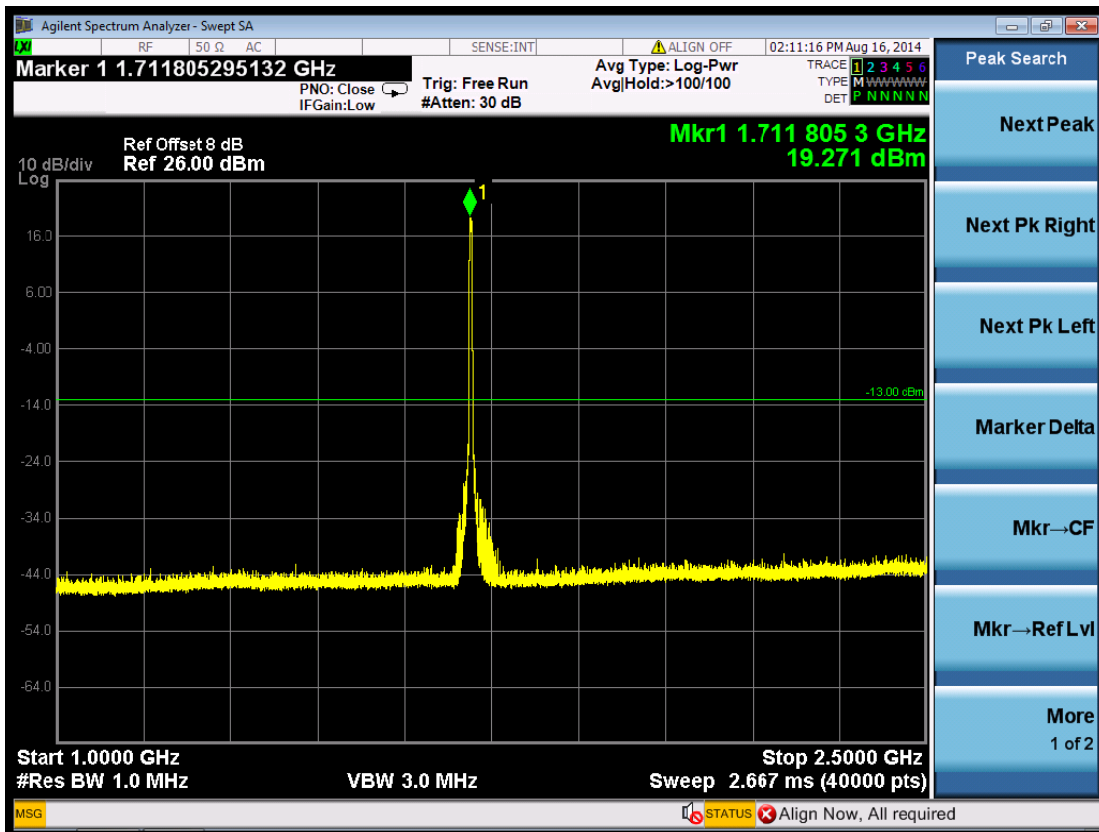

(Plot 5.5.3 A4: Channel 1312: 1712.4MHz @ Traffic WCDMA Band IV)

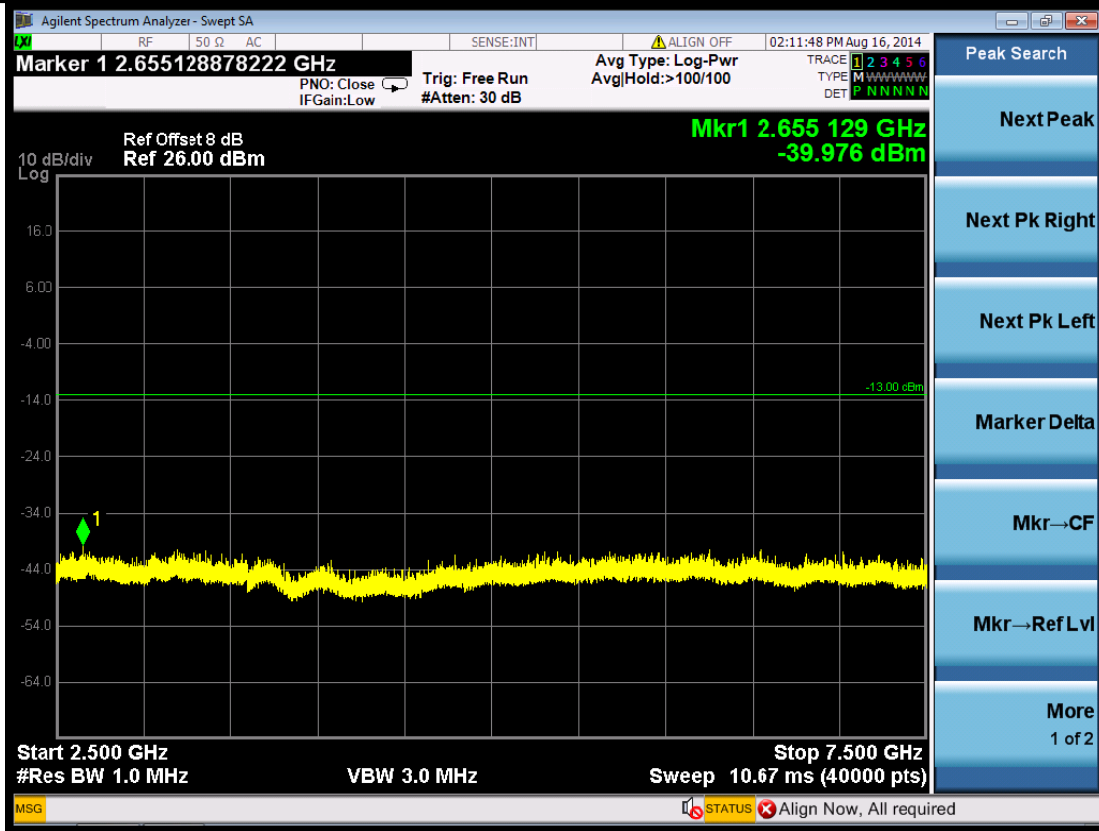

(Plot 5.5.9 A5: Channel 1312: 1712.4MHz @ Traffic WCDMA Band IV)

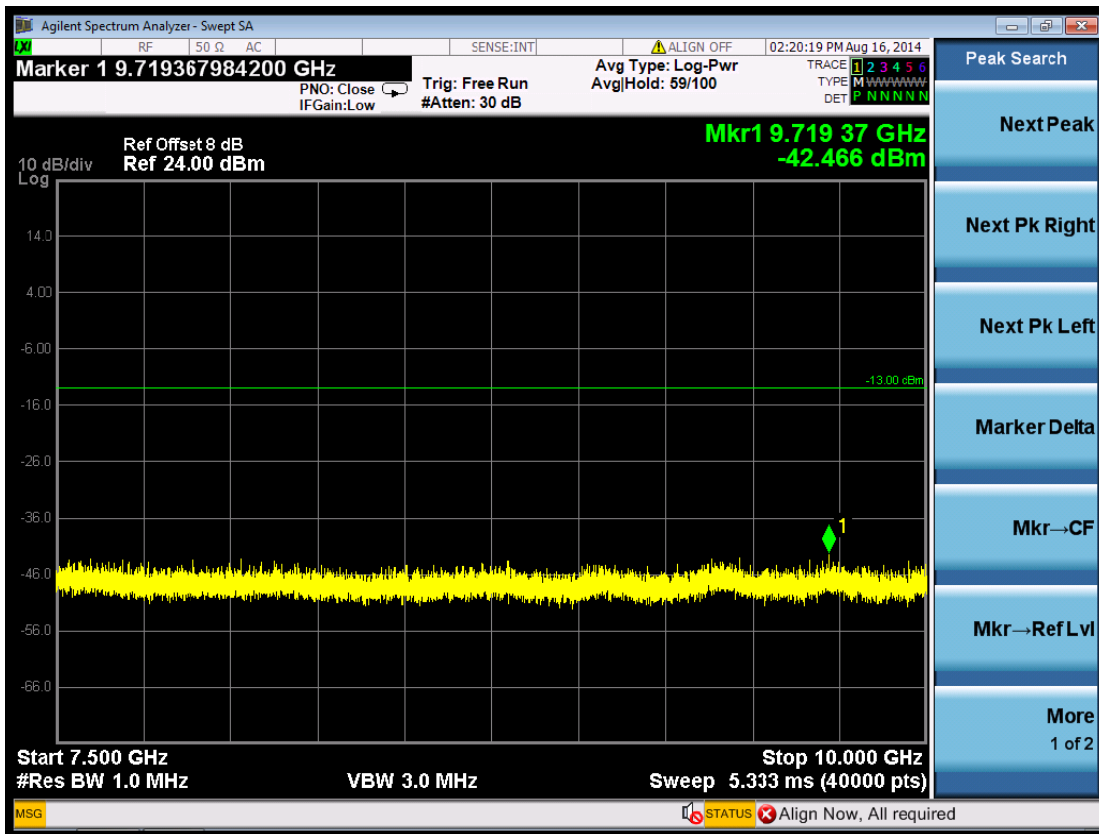

(Plot 5.5.3 A6: Channel 1312: 1712.4MHz @ Traffic WCDMA Band IV)

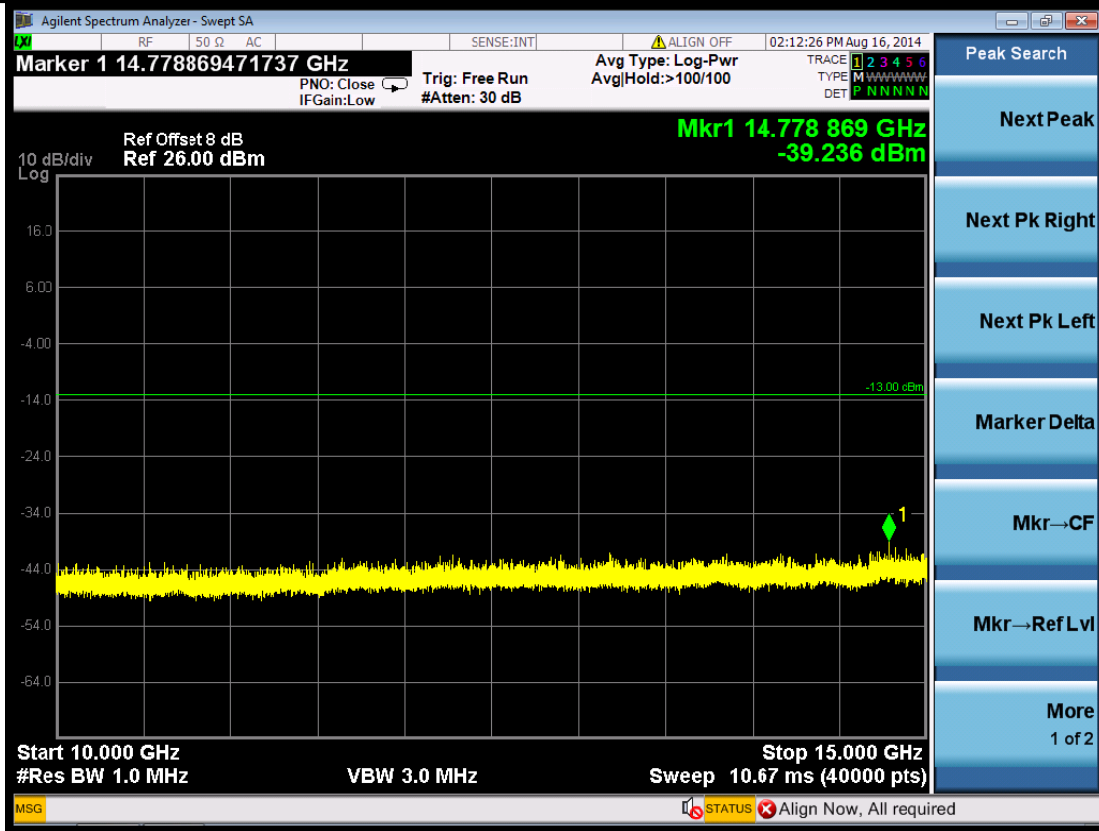

(Plot 5.5.3 A7: Channel 1312: 1712.4MHz @ Traffic WCDMA Band IV)

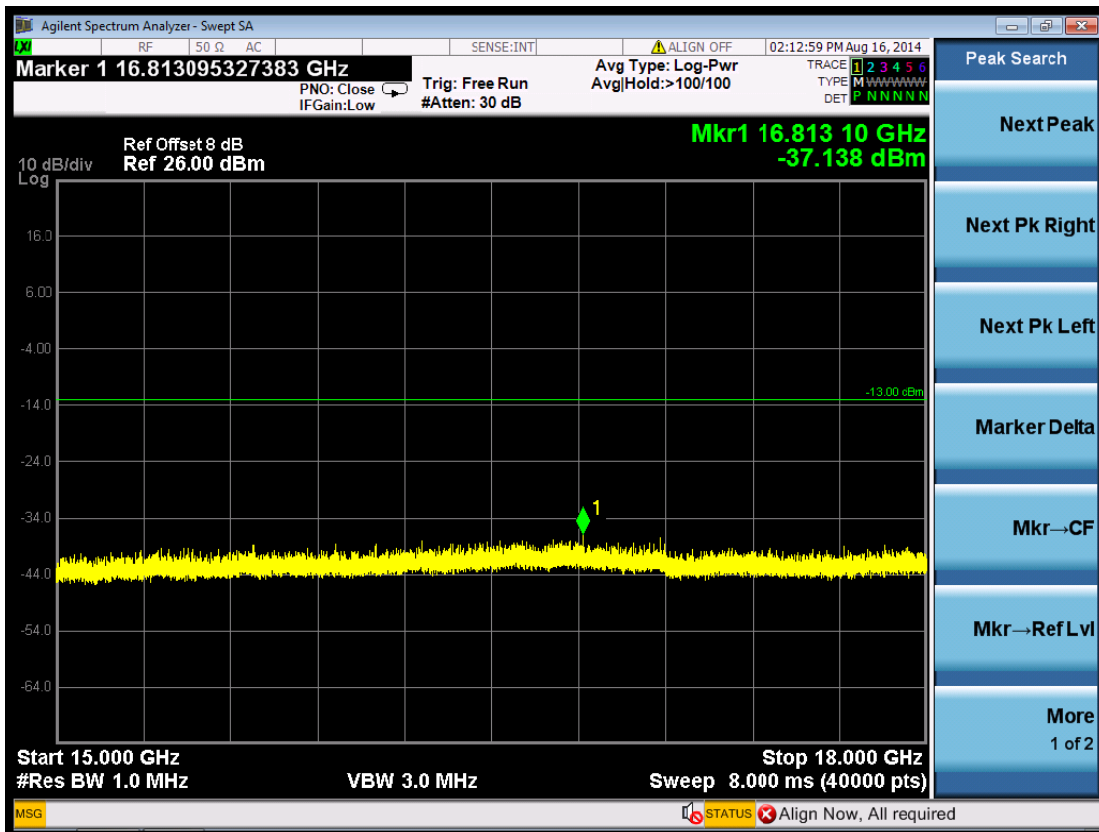

(Plot 5.5.3 A8: Channel 1312: 1712.4MHz @ Traffic WCDMA Band IV)

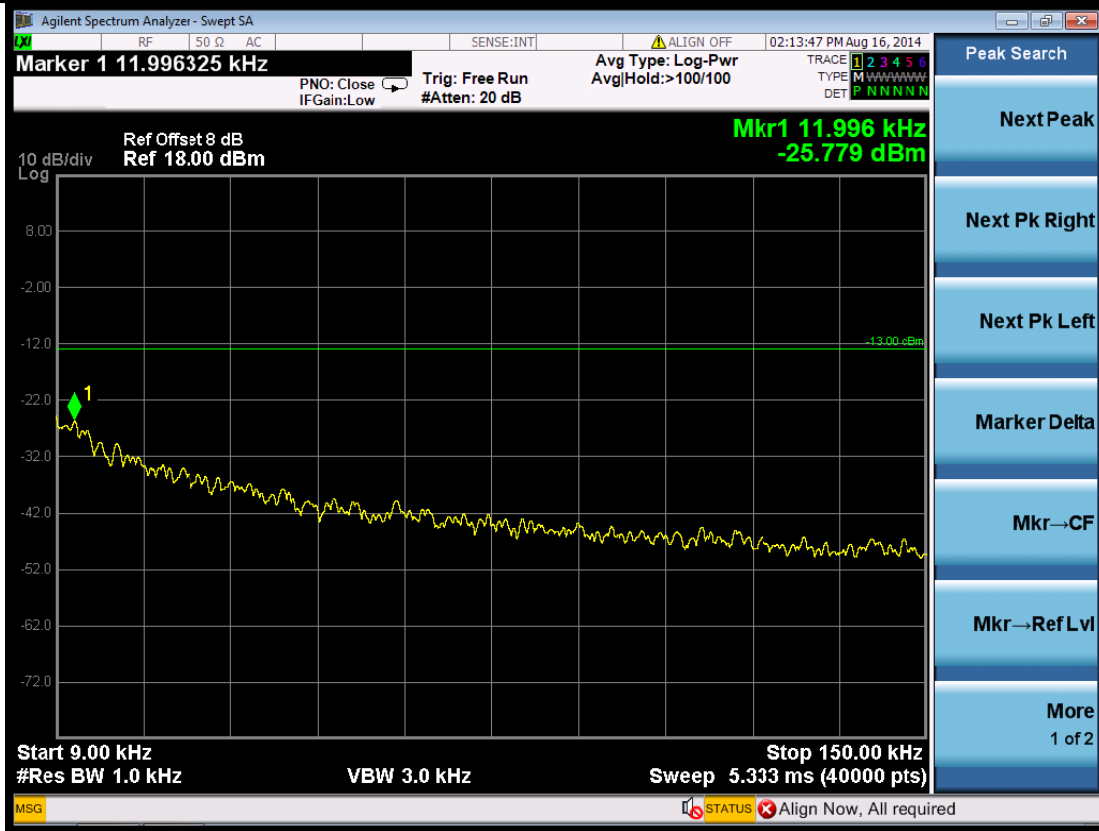

(Plot 5.5.3 B1: Channel 1413: 1732.6MHz @ Traffic WCDMA Band IV)

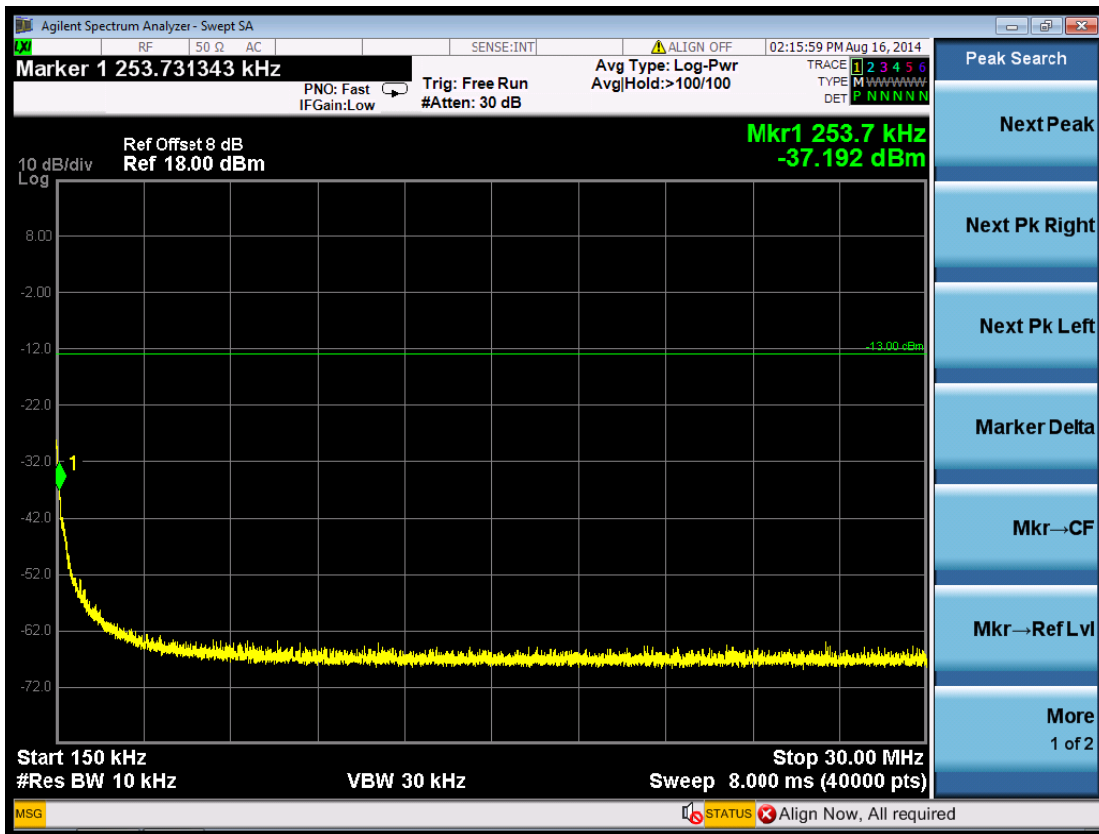

(Plot 5.5.3 B2: Channel 1413: 1732.6MHz @ Traffic WCDMA Band IV)

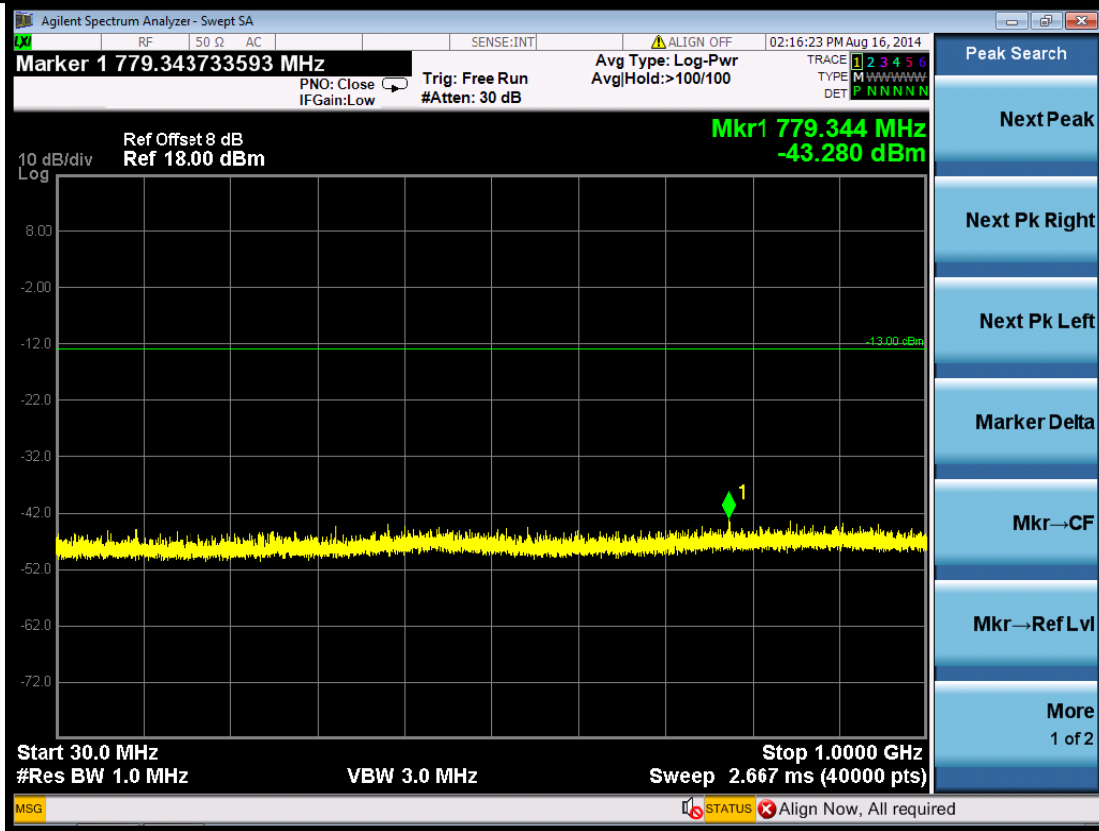

(Plot 5.5.3 B3: Channel 1413: 1732.6MHz @ Traffic WCDMA Band IV)

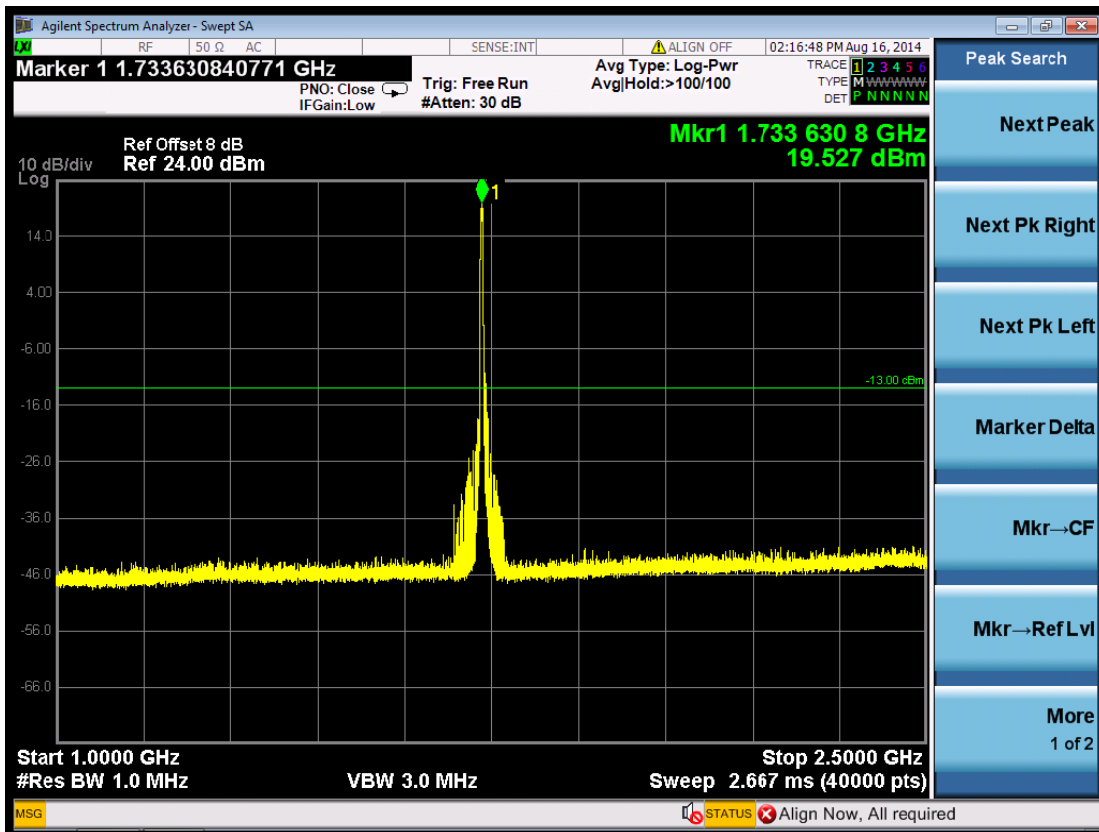

(Plot 5.5.3 B4: Channel 1413: 1732.6MHz @ Traffic WCDMA Band IV)

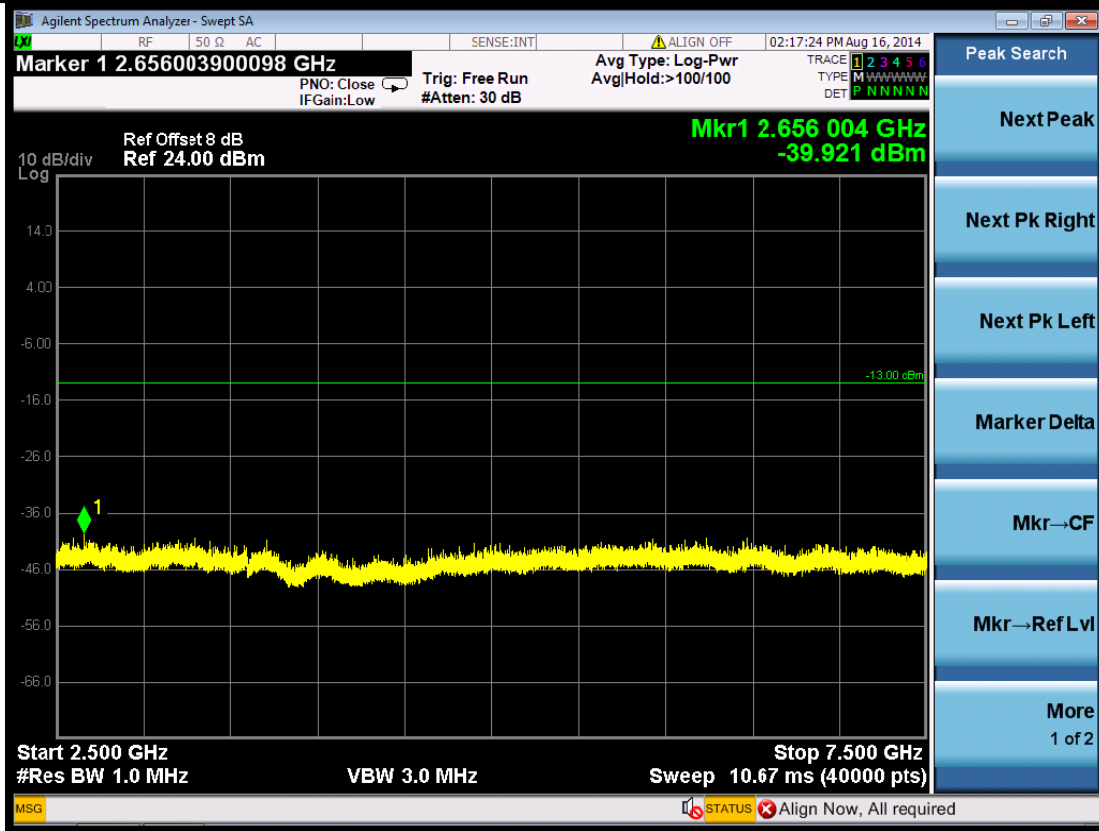

(Plot 5.5.3 B5: Channel 1413: 1732.6MHz @ Traffic WCDMA Band IV)

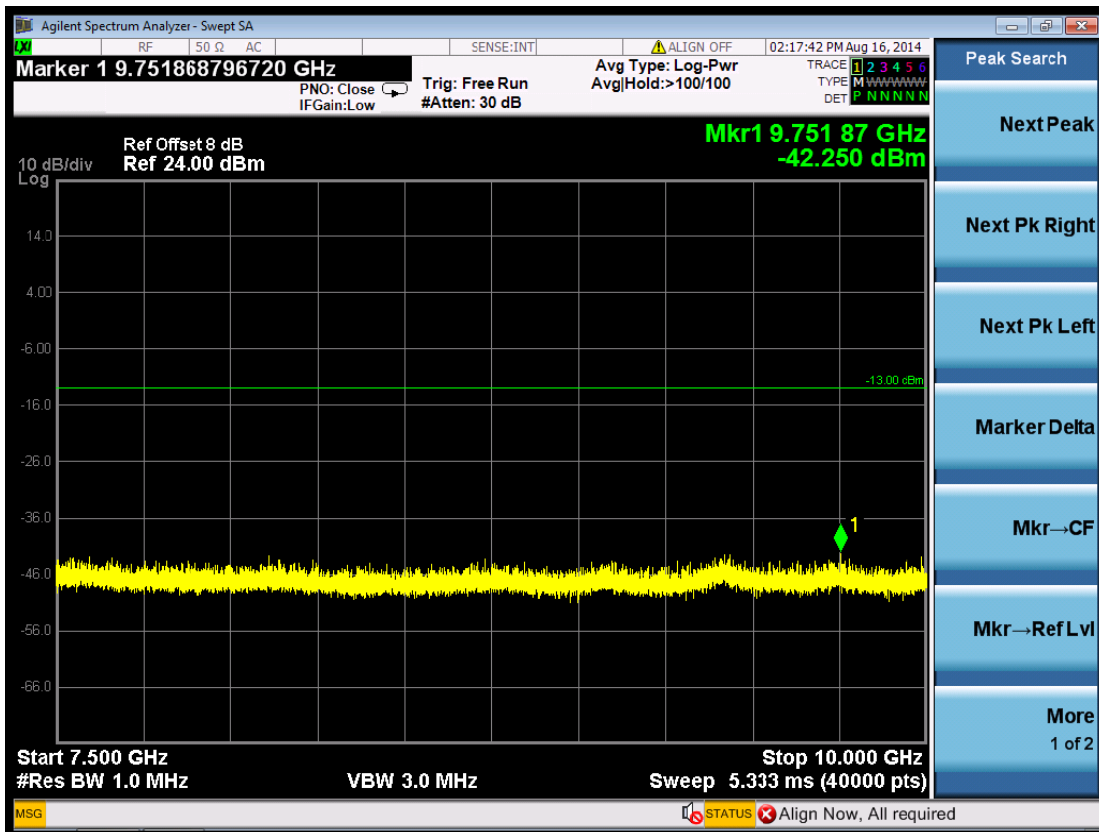

(Plot 5.5.3 B6: Channel 1413: 1732.6MHz @ Traffic WCDMA Band IV)



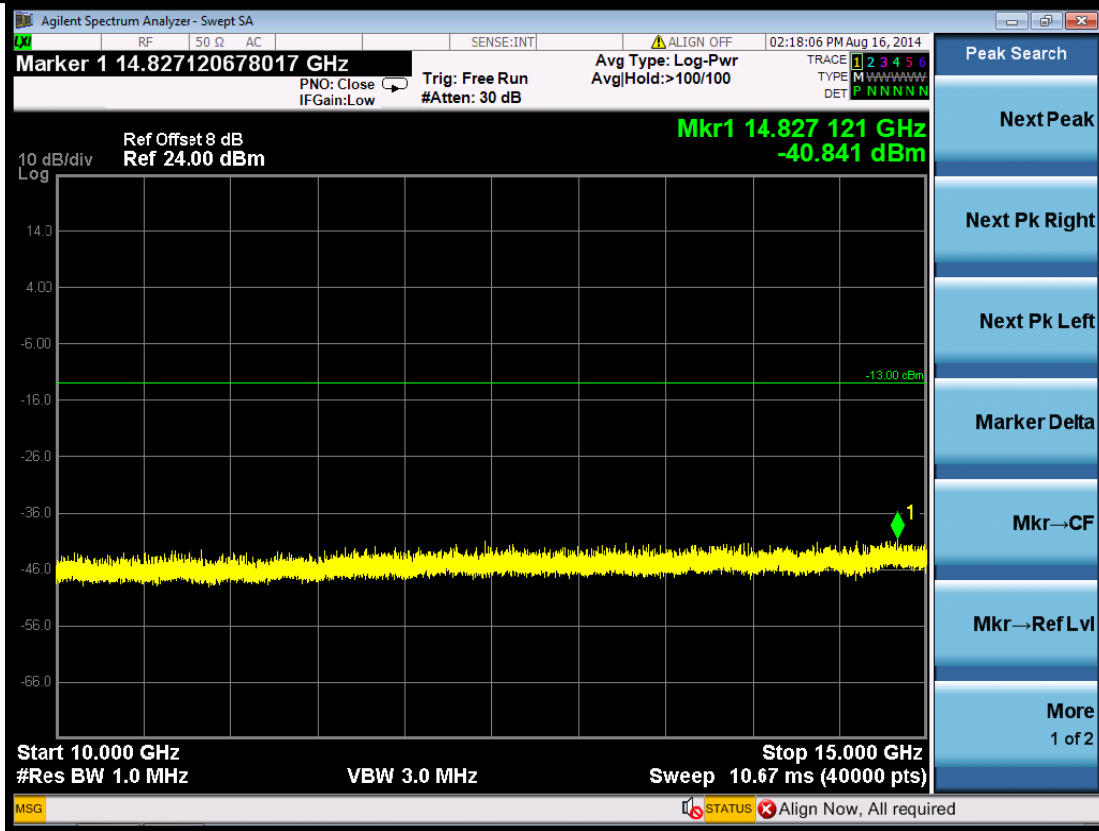

(Plot 5.5.3 B7: Channel 1413: 1732.6MHz @ Traffic WCDMA Band IV)

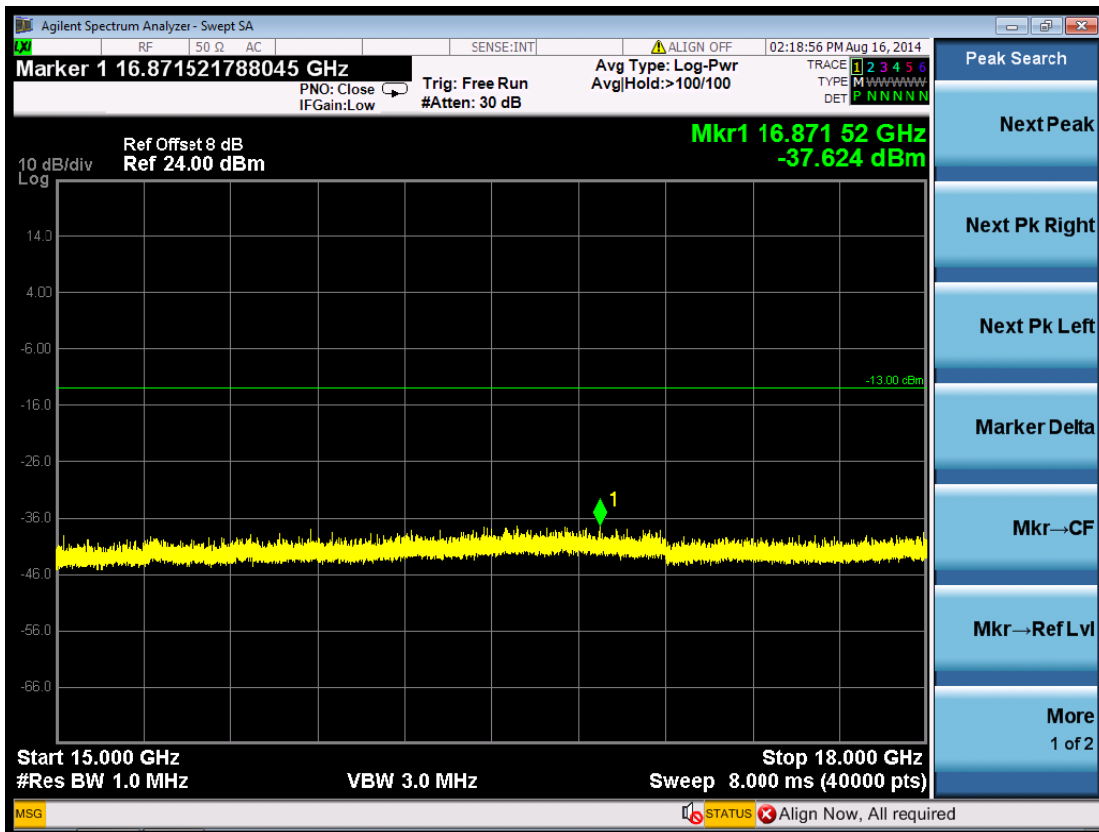

(Plot 5.5.3 B8: Channel 1413: 1732.6MHz @ Traffic WCDMA Band IV)

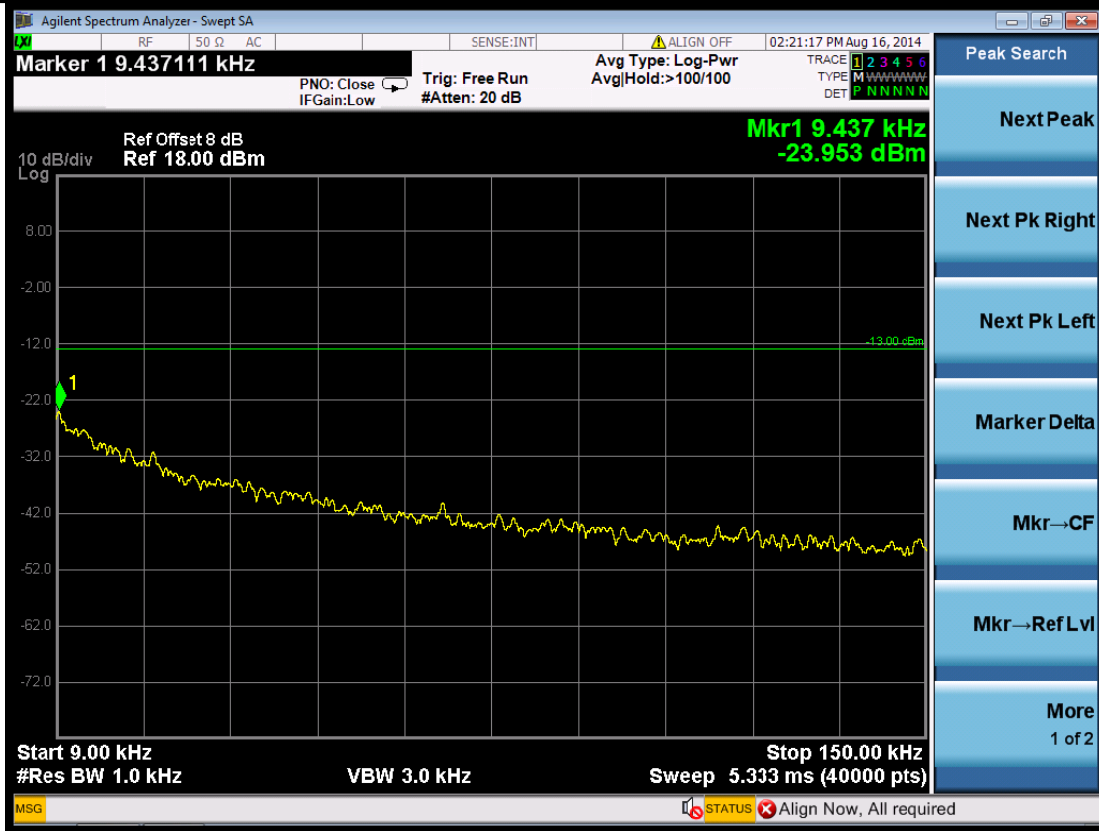

(Plot 5.5.3 C1: Channel 1513: 1752.6MHz @ Traffic WCDMA Band IV)

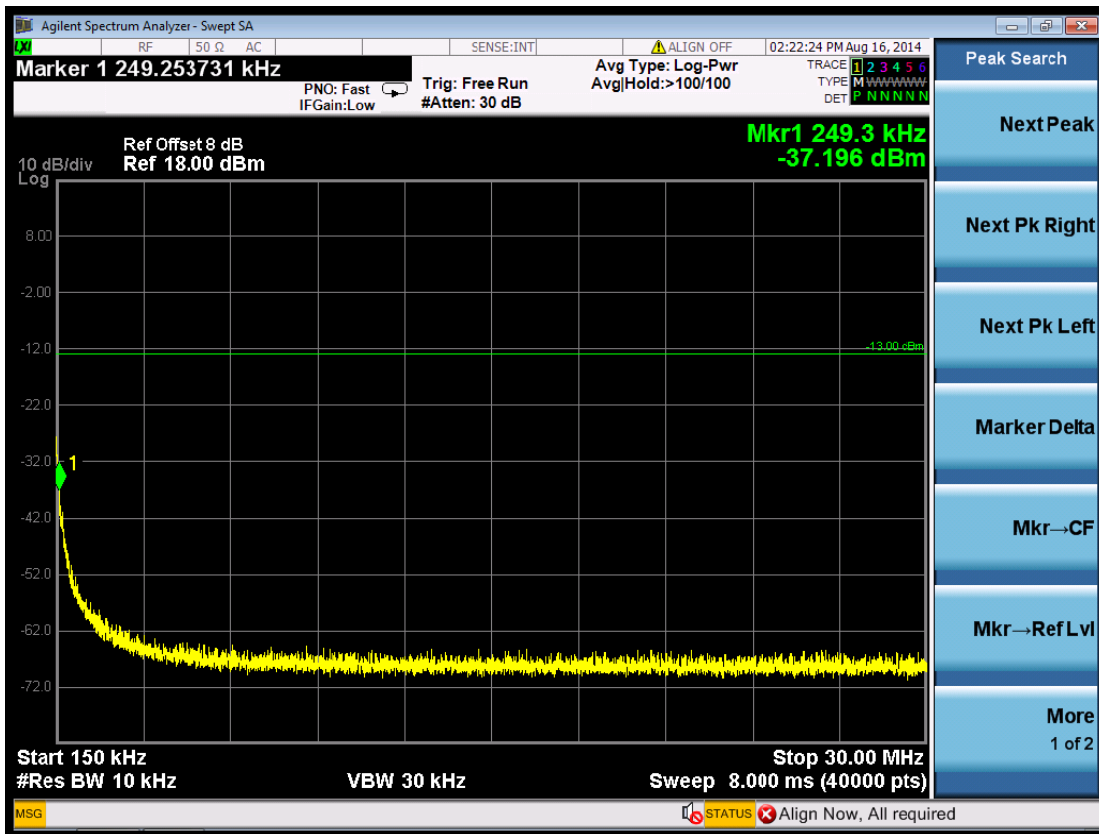

(Plot 5.5.3 C2: Channel 1513: 1752.6MHz @ Traffic WCDMA Band IV)

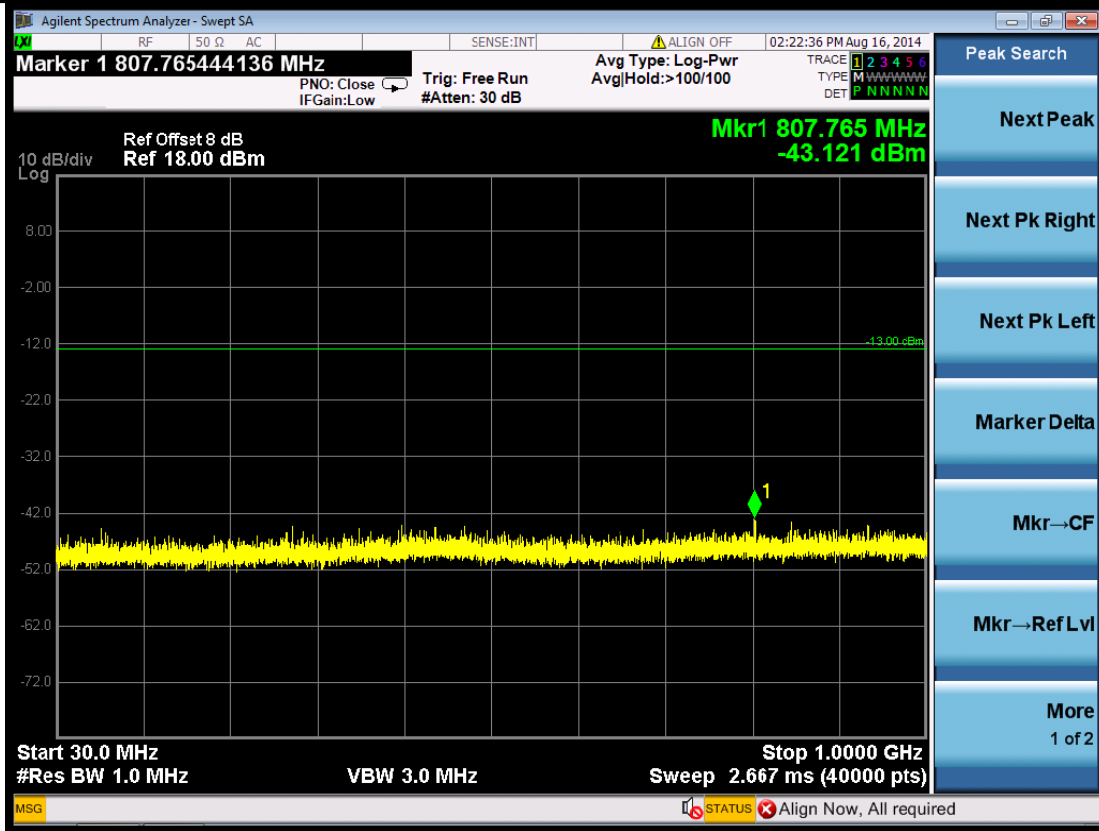

(Plot 5.5.3 C3: Channel 1513: 1752.6MHz @ Traffic WCDMA Band IV)

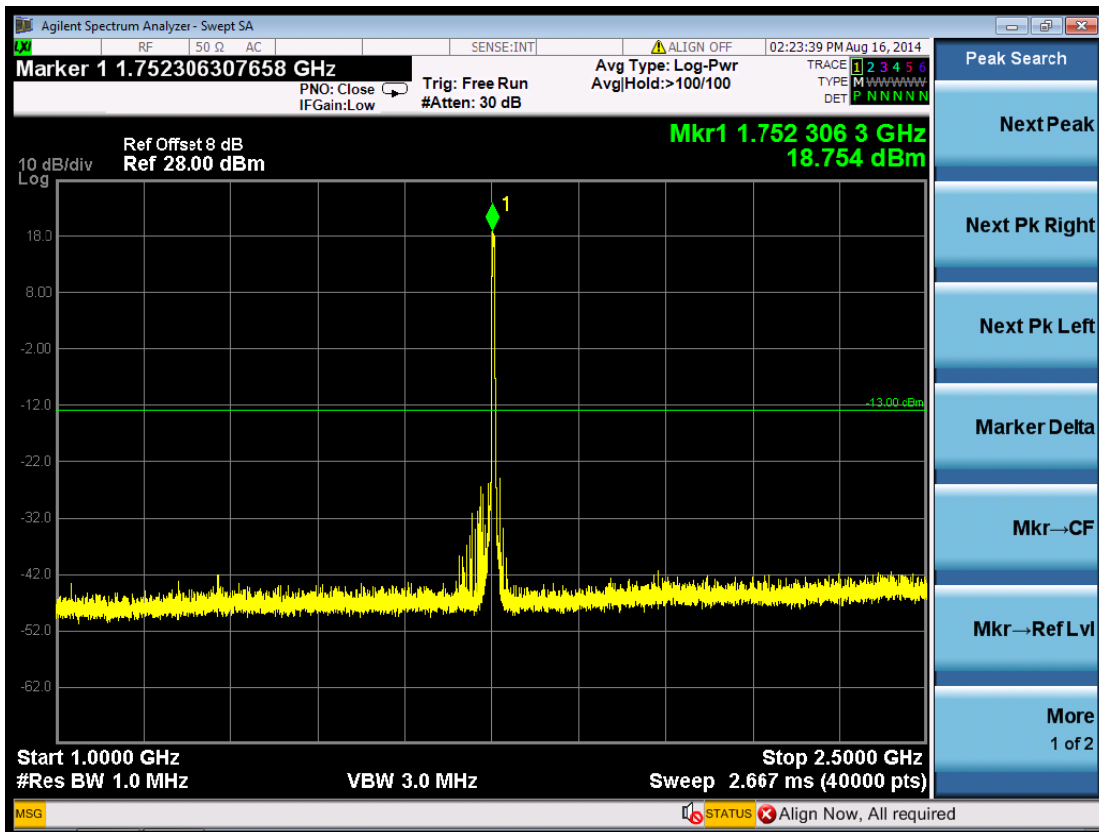

(Plot 5.5.3 C4: Channel 1513: 1752.6MHz @ Traffic WCDMA Band IV)

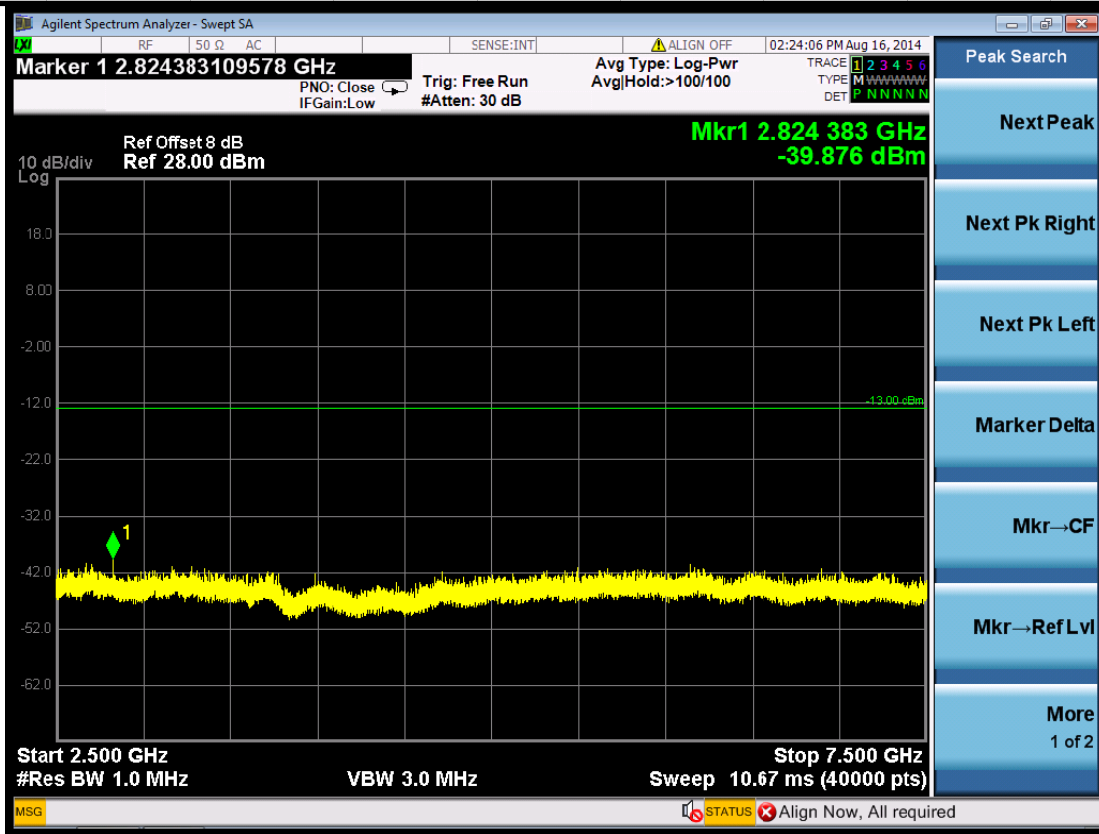

(Plot 5.5.3 C5: Channel 1513: 1752.6MHz @ Traffic WCDMA Band IV)

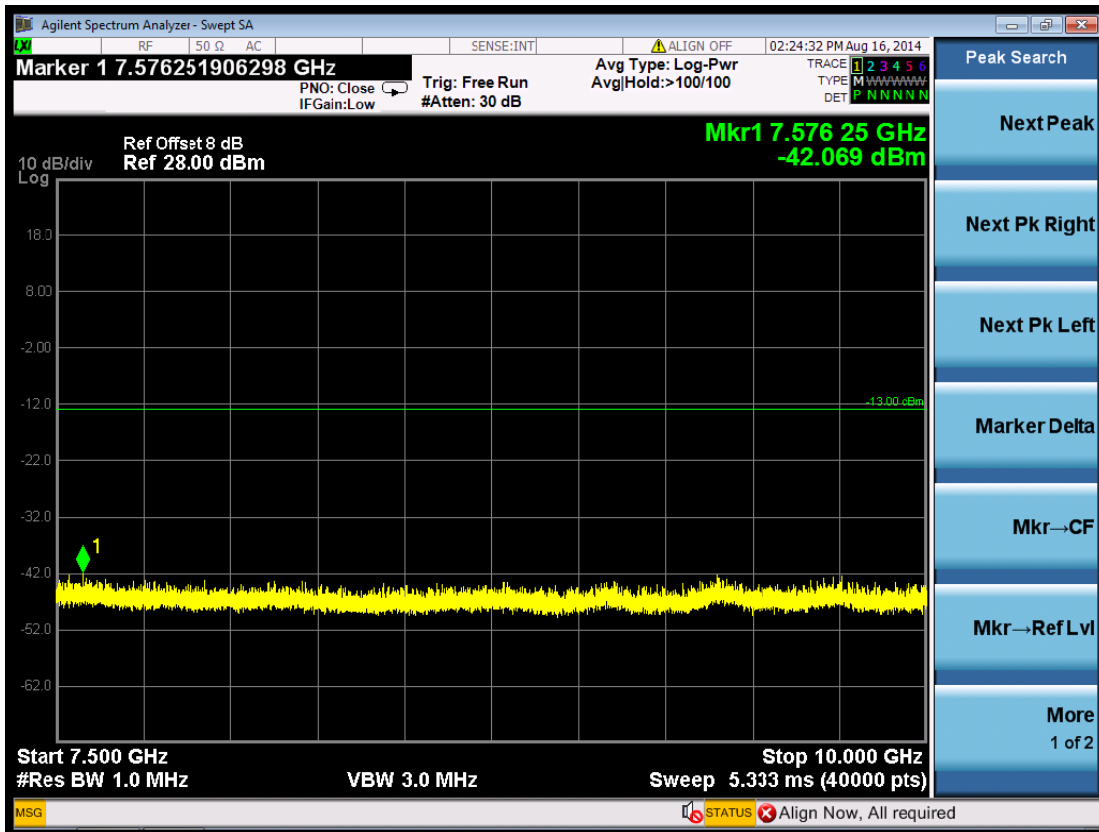

(Plot 5.5.3 C6: Channel 1513: 1752.6MHz @ Traffic WCDMA Band IV)

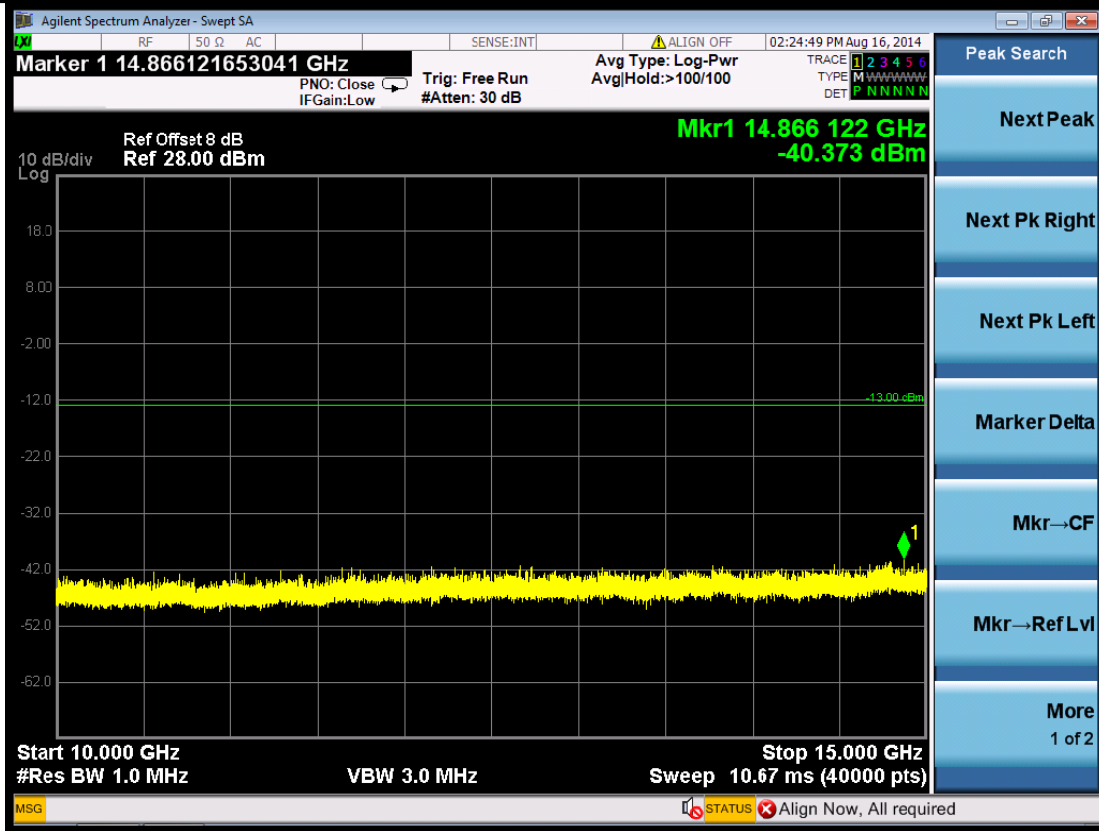

(Plot 5.5.3 C7: Channel 1513: 1752.6MHz @ Traffic WCDMA Band IV)

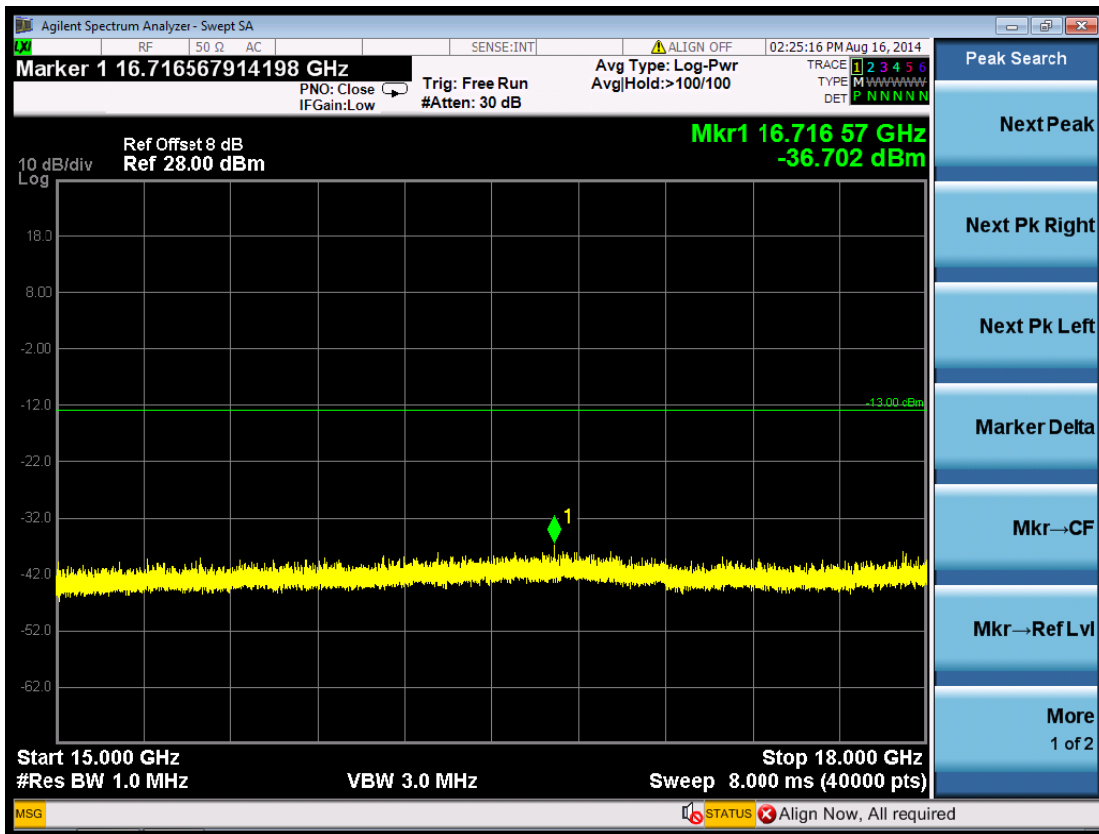

(Plot 5.5.3 C8: Channel 1513: 1752.6MHz @ Traffic WCDMA Band IV)

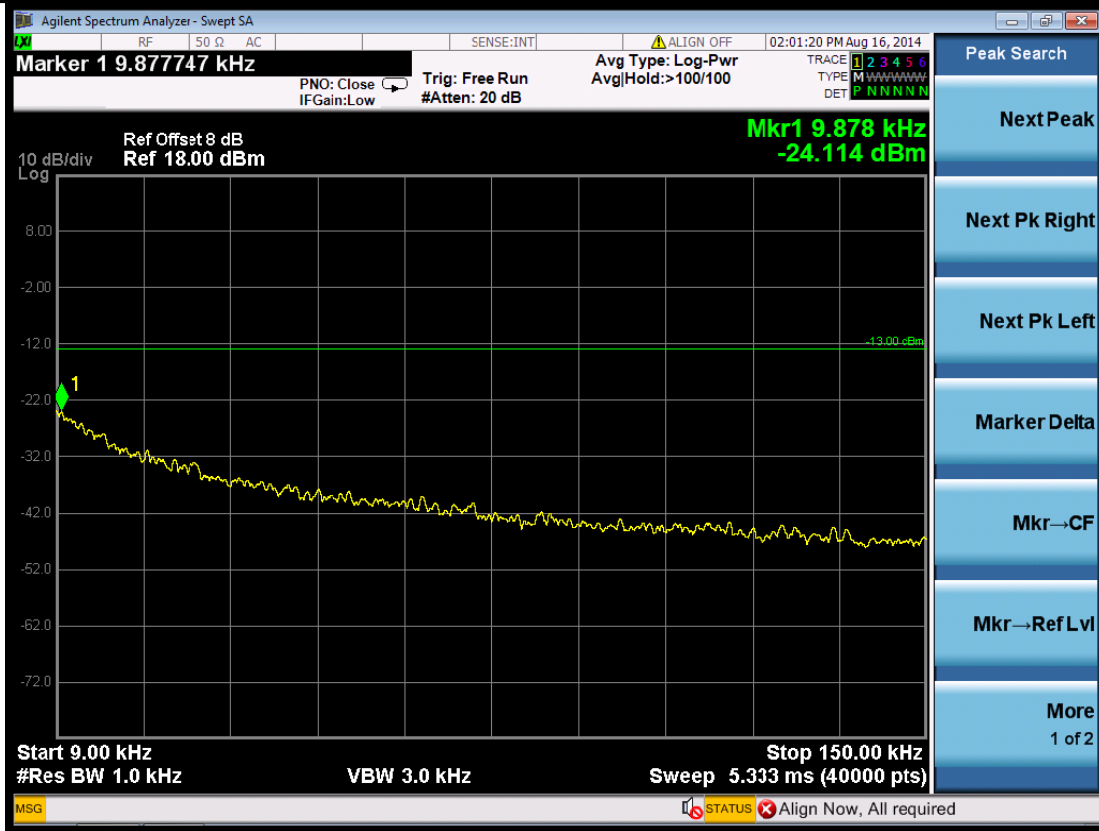

(Plot 5.5.3 D1: Idle WCDMA Band IV)

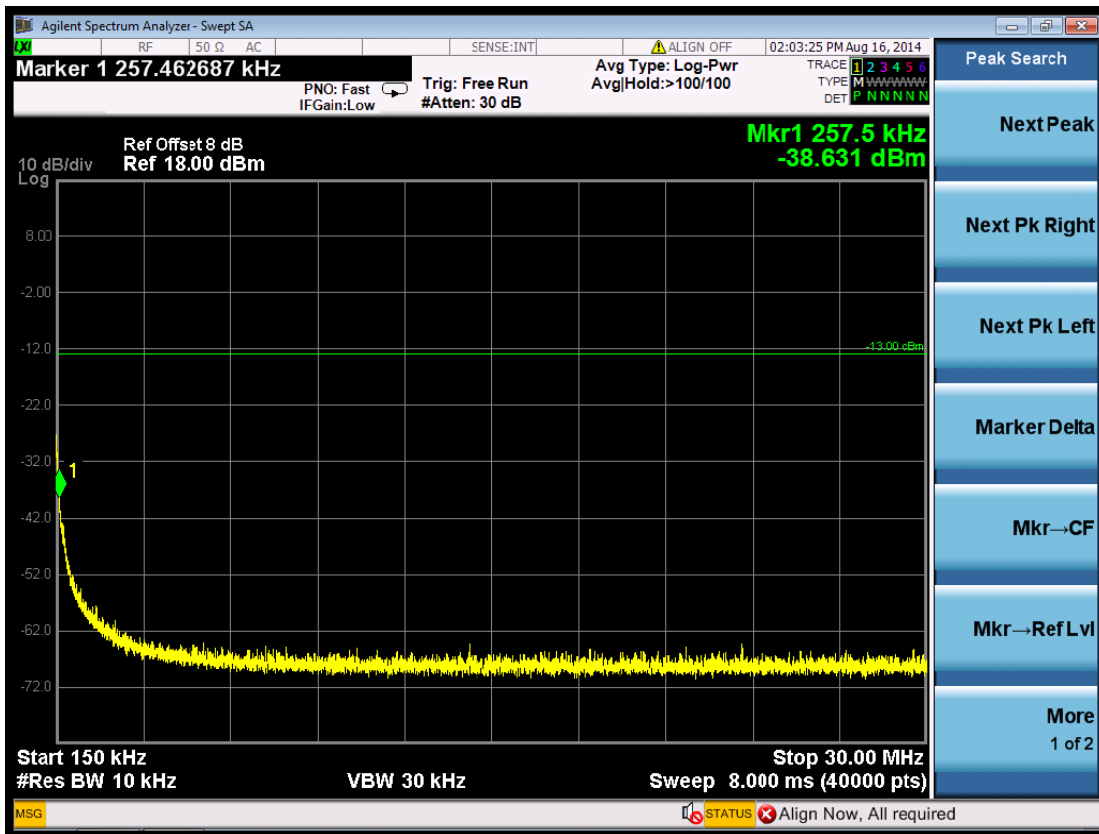

(Plot 5.5.3 D2: Idle WCDMA Band IV)

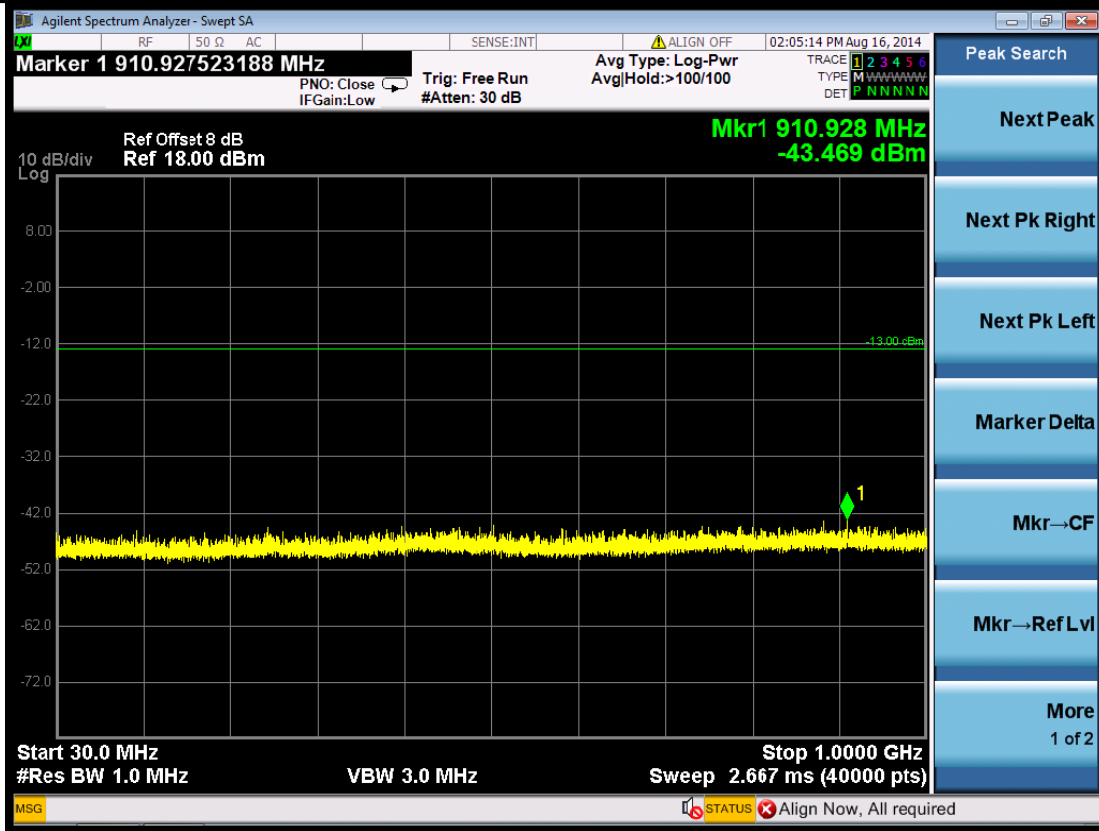

(Plot 5.5.3 D3: Idle WCDMA Band IV)

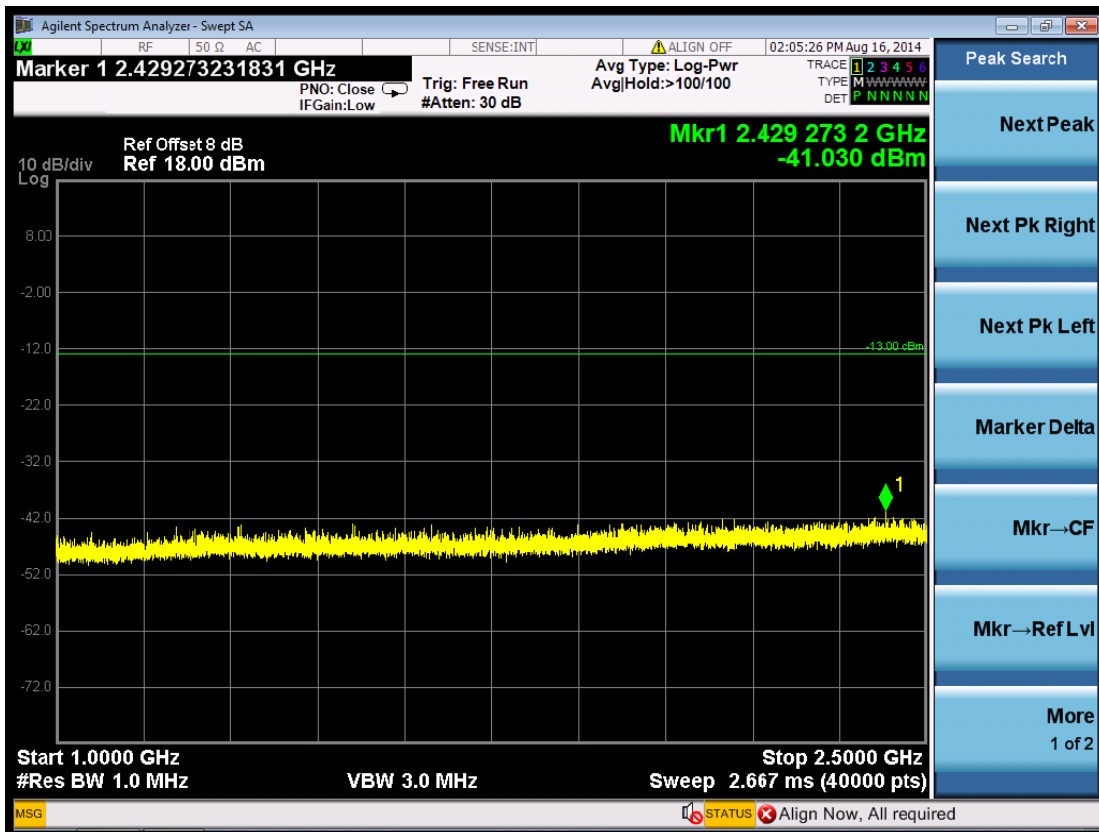

(Plot 5.5.3 D4: Idle WCDMA Band IV)

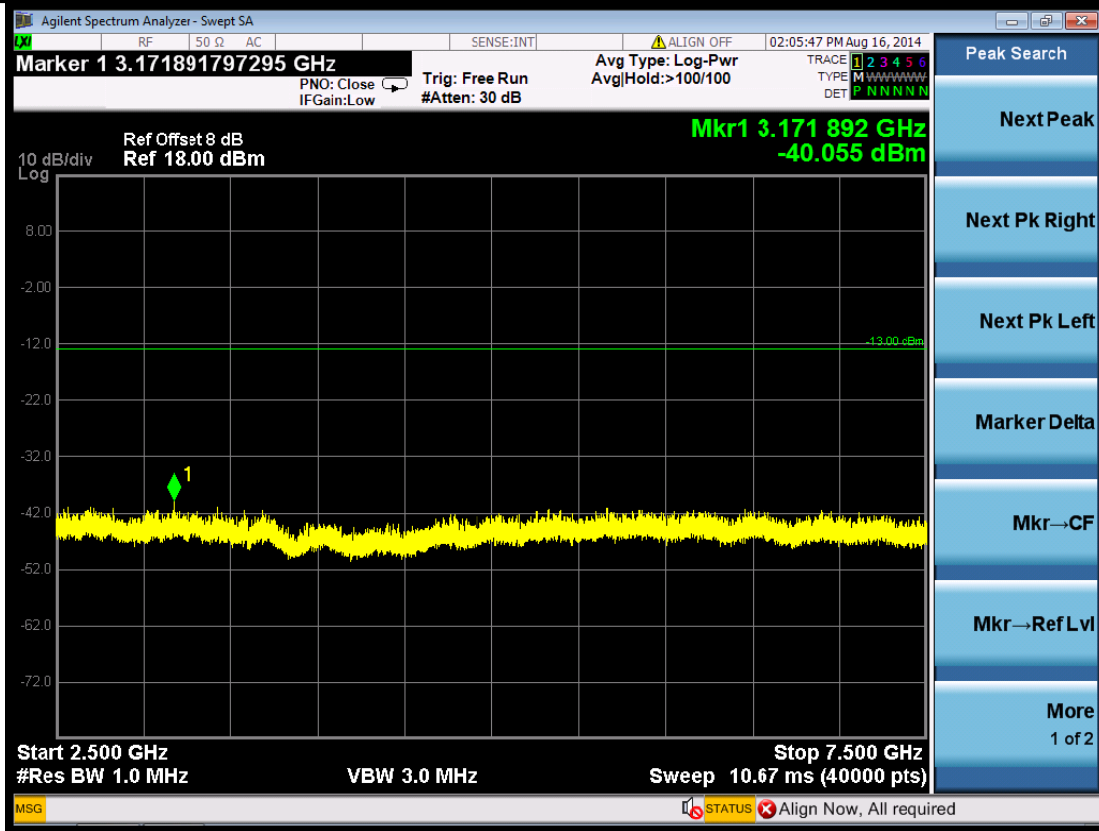

(Plot 5.5.3 D5: Idle WCDMA Band IV)

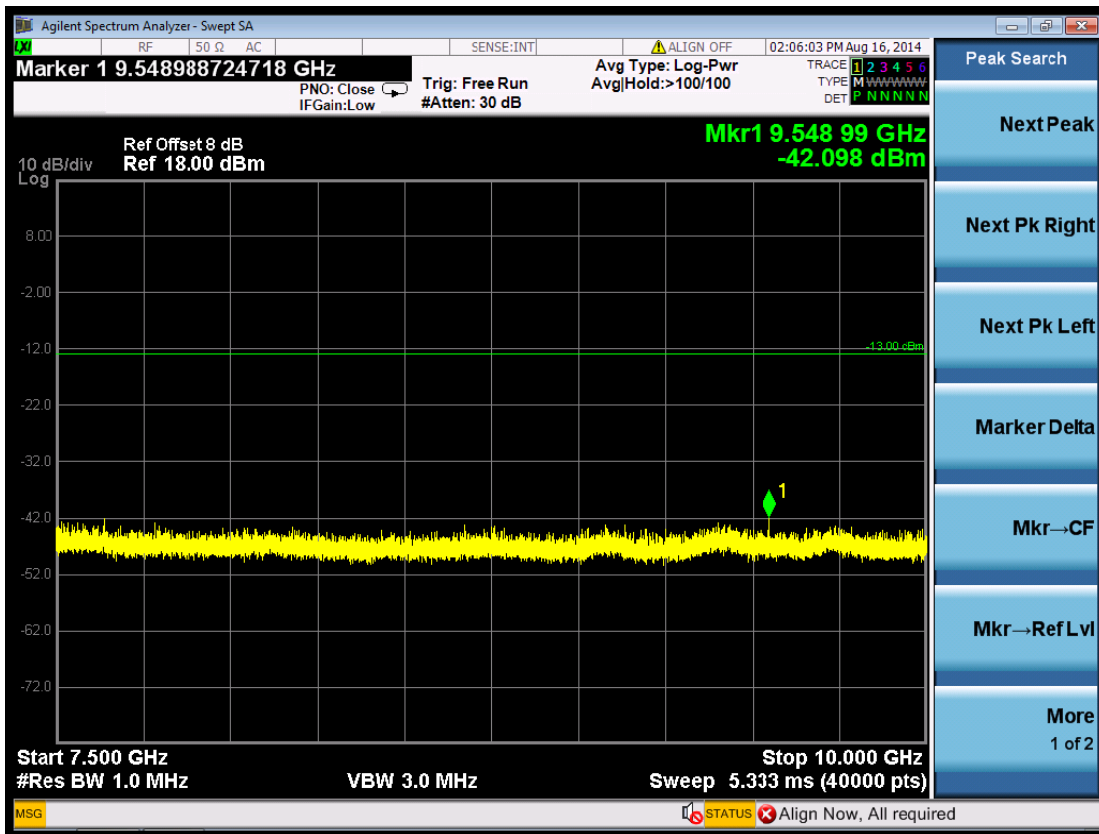

(Plot 5.5.3 D6: Idle WCDMA Band IV)



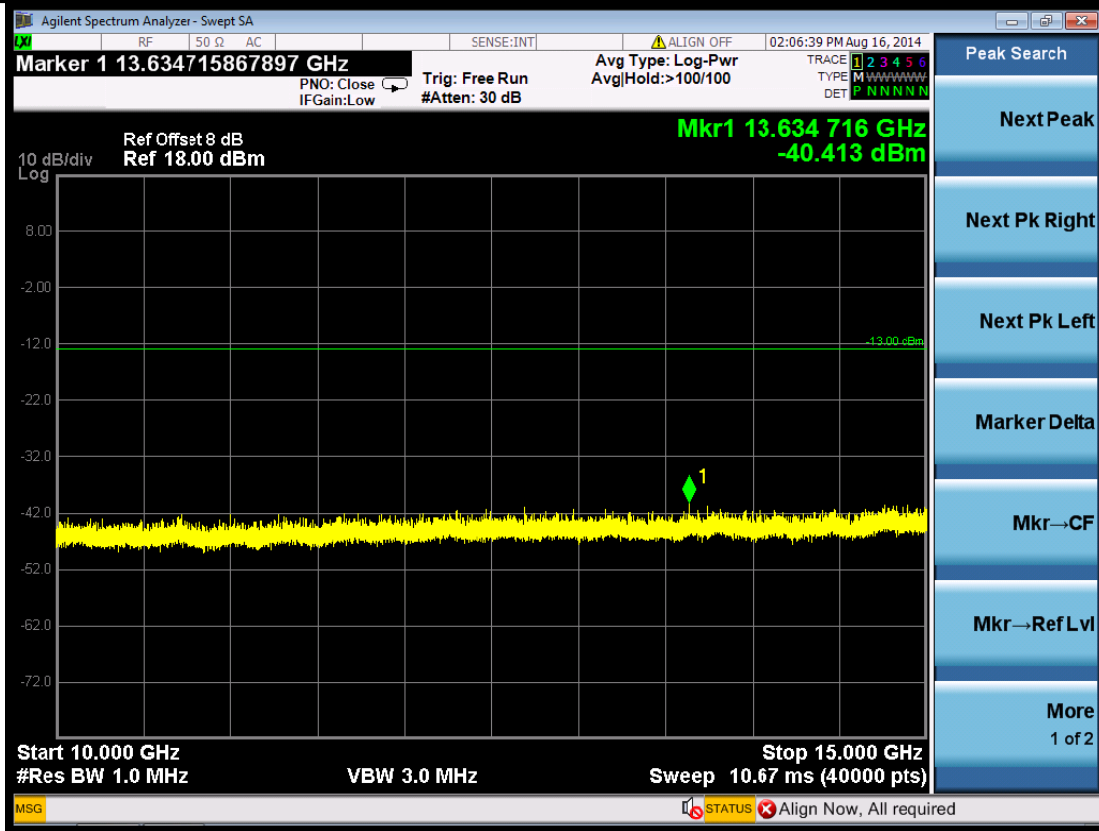

(Plot 5.5.3 D7: Idle WCDMA Band IV)

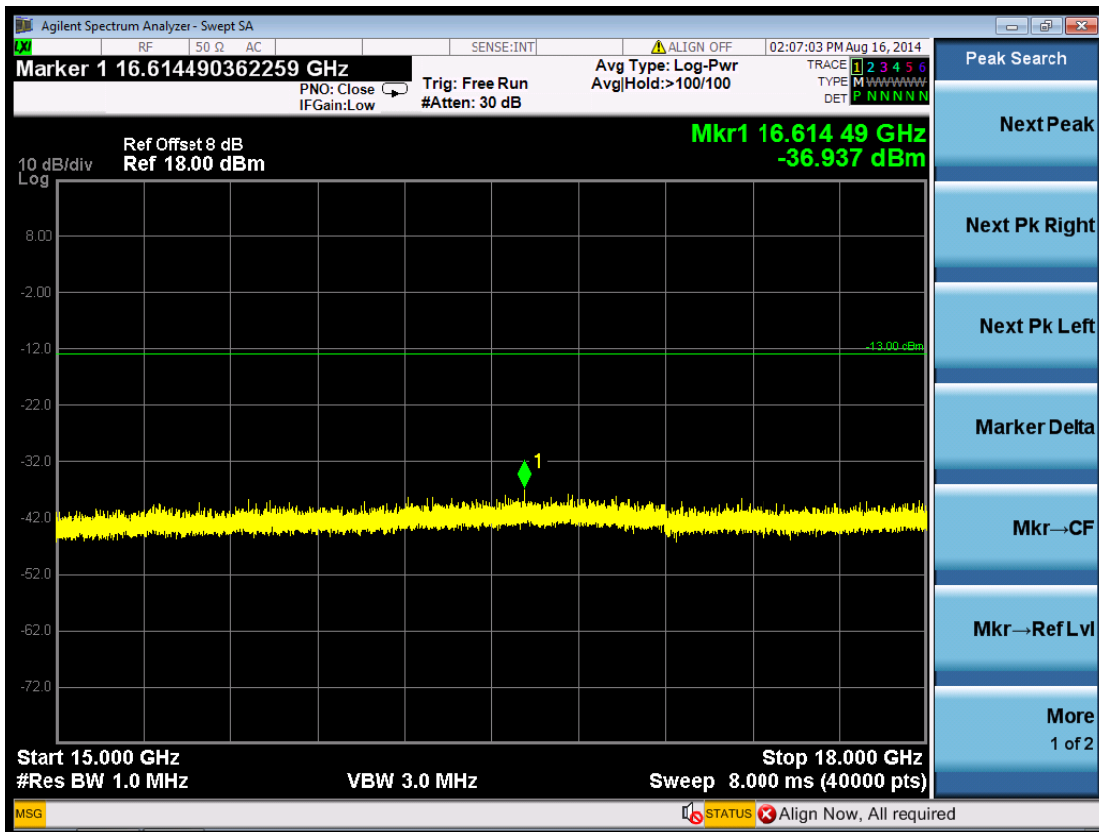

(Plot 5.5.3 D8: Idle WCDMA Band IV)

## 5.6 Frequency Stability Test

### TEST APPLICABLE

1. According to FCC Part 2 Section 2.1055 (a) (1), the frequency stability shall be measured with variation of ambient temperature from -30°C to +50°C centigrade.
2. According to FCC Part 2 Section 2.1055 (a) (2), for battery powered equipment, the frequency stability shall be measured with reducing primary supply voltage to the battery operating end point, which is specified by the manufacture.
3. Vary primary supply voltage from 85 to 115 percent of the nominal value for other than hand carried voltage equipment.

### TEST PROCEDURE

In order to measure the carrier frequency under the condition of AFC lock, it is necessary to make measurements with the EUT in a "call mode". This is accomplished with the use of R&S CMU200 DIGITAL RADIO COMMUNICATION TESTER.

1. Measure the carrier frequency at room temperature;
2. Subject the EUT to overnight soak at -30°C;
3. With the EUT, powered via nominal voltage, connected to the CMU200 and in a simulated call on middle channel of WCDMA Band II, Band IV and Band V, measure the carrier frequency. These measurements should be made within 2 minutes of Powering up the EUT, to prevent significant self-warming;
4. Repeat the above measurements at 10°C increments from -30°C to +50°C. Allow at least 0.5 hours at each temperature, unpowered, before making measurements;
5. Premeasured carrier frequency at room temperature with nominal voltage. Vary supply voltage from minimum voltage to maximum voltage, in 0.1Volt increments remeasuring carrier frequency at each voltage. Pause at nominal voltage for 0.5 hours unpowered, to allow any self-heating to stabilize, before continuing;
6. Subject the EUT to overnight soak at +50°C;
7. With the EUT, powered via nominal voltage, connected to the CMU200 and in a simulated call on the centre channel, measure the carrier frequency. These measurements should be made within 2 minutes of Powering up the EUT, to prevent significant self-warming;
8. Repeat the above measurements at 10°C increments from +50°C to -30°C. Allow at least 0.5 hours at each temperature, unpowered, before making measurements;
9. At all temperature levels hold the temperature to +/- 0.5°C during the measurement procedure;

### TEST CONFIGURATION

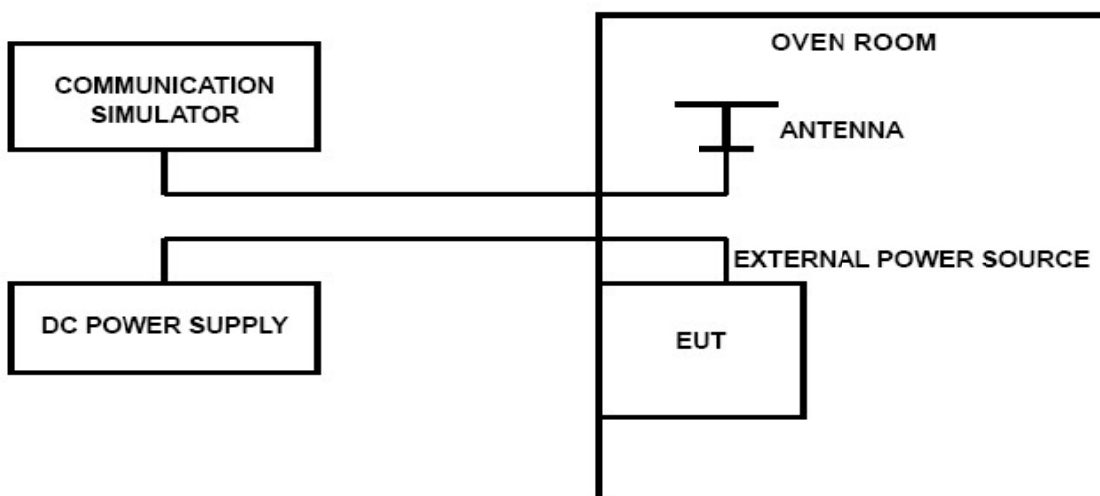

**TEST LIMITS**
***For Hand carried battery powered equipment***

According to the JTC standard the frequency stability of the carrier shall be accurate to within 2.5 ppm of the received frequency from the base station. This accuracy is sufficient to meet Sec. 24.235, Frequency Stability. The frequency stability shall be sufficient to ensure that the fundamental emission stays within the authorized frequency block. As this transceiver is considered "Hand carried, battery powered equipment" Section 2.1055(d) (2) applies. This requires that the lower voltage for frequency stability testing be specified by the manufacturer. This transceiver is specified to operate with an input voltage of between 3.50VDC and 4.20VDC, with a nominal voltage of 3.70VDC. Operation above or below these voltage limits is prohibited by transceiver software in order to prevent improper operation as well as to protect components from overstress. These voltages represent a tolerance of -10 % and +12.5 %. For the purposes of measuring frequency stability these voltage limits are to be used.

***For equipment powered by primary supply voltage***

According to the JTC standard the frequency stability of the carrier shall be accurate to within 0.1 ppm of the received frequency from the base station. This accuracy is sufficient to meet Sec. 24.235, Frequency Stability. The frequency stability shall be sufficient to ensure that the fundamental emission stays within the authorized frequency block. For this EUT section 2.1055(d) (1) applies. This requires varying primary supply voltage from 85 to 115 percent of the nominal value for other than hand carried battery equipment.

**TEST RESULTS**

UMTS/TM1/WCDMA Band II					
DC Power	Temperature (°C)	Frequency error(Hz)	Frequency error(ppm)	Limit (ppm)	Verdict
3.50	25	-11.53	0.01	2.50	PASS
3.70	25	-10.01	0.01	2.50	PASS
4.20	25	-12.67	0.01	2.50	PASS
3.70	-30	-15.53	0.01	2.50	PASS
3.70	-20	-15.15	0.01	2.50	PASS
3.70	-10	-12.77	0.01	2.50	PASS
3.70	0	-14.11	0.01	2.50	PASS
3.70	10	-17.00	0.01	2.50	PASS
3.70	20	-14.97	0.01	2.50	PASS
3.70	30	-12.62	0.01	2.50	PASS
3.70	40	-13.26	0.01	2.50	PASS
3.70	50	-13.25	0.01	2.50	PASS



UMTS/TM1/WCDMA Band IV					
DC Power	Temperature (°C)	Frequency error(Hz)	Frequency error(ppm)	Limit (ppm)	Verdict
3.50	20	-36.98	0.02	2.50	PASS
3.70	20	-35.85	0.02	2.50	PASS
4.20	20	-34.16	0.02	2.50	PASS
3.70	-30	-29.18	0.02	2.50	PASS
3.70	-20	-28.11	0.02	2.50	PASS
3.70	-10	-27.57	0.02	2.50	PASS
3.70	0	-25.50	0.01	2.50	PASS
3.70	10	-25.15	0.01	2.50	PASS
3.70	20	-26.59	0.02	2.50	PASS
3.70	30	-25.49	0.01	2.50	PASS
3.70	40	-23.74	0.01	2.50	PASS
3.70	50	-22.81	0.01	2.50	PASS

UMTS/TM1/WCDMA Band V					
DC Power	Temperature (°C)	Frequency error(Hz)	Frequency error(ppm)	Limit (ppm)	Verdict
3.50	20	-2.31	0.00	2.50	PASS
3.70	20	-2.32	0.00	2.50	PASS
4.20	20	-2.51	0.00	2.50	PASS
3.70	-30	-2.96	0.00	2.50	PASS
3.70	-20	-2.58	0.00	2.50	PASS
3.70	-10	-3.64	0.00	2.50	PASS
3.70	0	-3.98	0.00	2.50	PASS
3.70	10	-1.61	0.00	2.50	PASS
3.70	20	-1.63	0.00	2.50	PASS
3.70	30	-2.95	0.00	2.50	PASS
3.70	40	-1.42	0.00	2.50	PASS
3.70	50	0.57	0.00	2.50	PASS

END