

SAR EVALUATION REPORT

For

Sky Phone LLC

1348 Washington Av., Suite 350, Miami Beach, Florida, United States

FCC ID: 2ABOSGCSKY50LM

Report Type: Revised Report	Product Type: Smart Phone
Prepared By: Terry XiaHou	<i>Terry XiaHou</i>
Report Number: RSZ150915007-20 Rev	
Report Date: 2016-11-08	
Reviewed By: Wilson Chen	<i>Wilson Chen</i>
Prepared By: Bay Area Compliance Laboratories Corp. (Shenzhen) 6/F, the 3rd Phase of WanLi Industrial Building, ShiHua Road, FuTian Free Trade Zone Shenzhen, Guangdong, China Tel: +86-755-33320018 Fax: +86-755-33320008 www.baclcorp.com.cn	

Attestation of Test Results		
EUT Information	Company Name	Sky Phone LLC
	EUT Description	3G/4G Smart Phone
	FCC ID	2ABOSGCSKY50LM
	Model Number	SKY 5.0LM
	Test Date	2016-10-10, 2016-10-11, 2016-10-12, 2016-10-13 and 2016-11-08
Frequency	Max. SAR Level(s) Reported	Limit(W/Kg)
GSM 850	0.513 W/kg 1g Head SAR 1.043 W/kg 1g Body SAR	1.6
PCS 1900	0.220 W/kg 1g Head SAR 0.327 W/kg 1g Body SAR	
WCDMA 850	0.272 W/kg 1g Head SAR 0.395 W/kg 1g Body SAR	
WCDMA 1700	0.402 W/kg 1g Head SAR 0.644 W/kg 1g Body SAR	
WCDMA 1900	0.298 W/kg 1g Head SAR 0.642 W/kg 1g Body SAR	
LTE Band 2	0.337 W/kg 1g Head SAR 0.668 W/kg 1g Body SAR	
LTE Band 4	0.580 W/kg 1g Head SAR 0.925 W/kg 1g Body SAR	
LTE Band 5	0.218 W/kg 1g Head SAR 0.429 W/kg 1g Body SAR	
LTE Band 7	0.562 W/kg 1g Head SAR 1.002 W/kg 1g Body SAR	
Simultaneous	0.980 W/kg 1g Head SAR 1.243 W/kg 1g Body SAR	
Hotspot	1.243 W/kg 1g Body SAR	
Applicable Standards	FCC 47 CFR part 2.1093 Radiofrequency radiation exposure evaluation: portable devices	
	IEEE1528:2013 IEEE Recommended Practice for Determining the Peak Spatial-Average Specific Absorption Rate (SAR) in the Human Head from Wireless Communications Devices: Measurement Techniques	
	IEC 62209-2:2010 Human exposure to radio frequency fields from hand-held and body-mounted wireless communication devices-Human models, instrumentation, and procedures-Part 2: Procedure to determine the specific absorption rate (SAR) for wireless communication devices used in close proximity to the human body (frequency range of 30 MHz to 6 GHz)	
	KDB procedures KDB 447498 D01 General RF Exposure Guidance v06. KDB 648474 D04 Handset SAR v01r03. KDB 865664 D01 SAR measurement 100 MHz to 6 GHz v01r04 KDB 865664 D02 RF Exposure Reporting v01r02 KDB 941225 D01 3G SAR Procedures v03r01 KDB 941225 D05 SAR for LTE Devices v02r03 KDB 941225 D06 Hotspot Mode v02r01	
Note: This wireless device has been shown to be capable of compliance for localized specific absorption rate (SAR) for General Population/Uncontrolled Exposure limits specified in ANSI/IEEE Standards and has been tested in accordance with the measurement procedures specified in IEEE 1528-2013 and RF exposure KDB procedures. The results and statements contained in this report pertain only to the device(s) evaluated.		

TABLE OF CONTENTS

DOCUMENT REVISION HISTORY	4
EUT DESCRIPTION	5
TECHNICAL SPECIFICATION	5
REFERENCE, STANDARDS, AND GUIDELINES	6
SAR LIMITS	7
FACILITIES.....	8
POWER REFERENCE MEASUREMENT.....	9
AREA SCAN	9
ZOOM SCAN	10
POWER DRIFT MEASUREMENT	10
Z-SCAN.....	10
EQUIPMENT LIST AND CALIBRATION	20
EQUIPMENTS LIST & CALIBRATION INFORMATION	20
SAR MEASUREMENT SYSTEM VERIFICATION	21
LIQUID VERIFICATION	21
SYSTEM ACCURACY VERIFICATION.....	23
SAR SYSTEM VALIDATION DATA.....	24
EUT TEST STRATEGY AND METHODOLOGY	34
TEST POSITIONS FOR DEVICE OPERATING NEXT TO A PERSON’S EAR.....	34
CHEEK/TOUCH POSITION	35
EAR/TILT POSITION	35
TEST POSITIONS FOR BODY-WORN AND OTHER CONFIGURATIONS.....	36
SAR EVALUATION PROCEDURE.....	37
TEST METHODOLOGY	37
CONDUCTED OUTPUT POWER MEASUREMENT	38
PROVISION APPLICABLE	38
TEST PROCEDURE	38
SAR MEASUREMENT RESULTS	57
SAR TEST DATA.....	57
SAR SIMULTANEOUS TRANSMISSION DESCRIPTION	70
APPENDIX A MEASUREMENT UNCERTAINTY	201
APPENDIX F INFORMATIVE REFERENCES	204

DOCUMENT REVISION HISTORY

Revision Number	Report Number	Description of Revision	Date of Revision
0	RSZ150915007-20	Original Report	2015-10-13
1	RSZ150915007-20 Rev	Revised Report	2016-11-08

EUT DESCRIPTION

This report has been prepared on behalf of Sky Phone LLC and their product, FCC ID: 2ABOSGCSKY50LM, Model: SKY 5.0LM or the EUT (Equipment under Test) as referred to in the rest of this report.

Technical Specification

Product Type	Portable
Exposure Category:	Population / Uncontrolled
Antenna Type(s):	Internal Antenna
Body-Worn Accessories:	Headset
Face-Head Accessories:	None
Multi-slot Class:	Class12
Operation Mode :	GSM Voice, EGPRS/GPRS Data, WCDMA (R99 (Voice+Data), HSUPA Rel 6,HSDPA Rel 6), LTE, Wi-Fi and Bluetooth
Frequency Band:	GSM 850 : 824-849 MHz(TX) ; 869-894 MHz(RX) PCS 1900: 1850-1910 MHz(TX) ; 1930-1990 MHz(RX) WCDMA 850 : 824-849 MHz(TX) ; 869-894 MHz(RX) WCDMA 1700: 1710-1755MHz(TX); 2110-2155MHz(RX) WCDMA 1900 : 1850-1910 MHz(TX) ; 1930-1990 MHz(RX) LTE Band 2: 1850-1910MHz(TX) ; 1930-1990MHz(RX) LTE Band 4: 1710-1755MHz(TX) ; 2110-2155MHz(RX) LTE Band 5: 824-849MHz(TX) ; 869-894MHz(RX) LTE Band 7: 2500-2570MHz(TX) ; 2620-2690MHz(RX) Wi-Fi(802.11b/g/n20): 2412MHz-2472MHz Wi-Fi(802.11n40): 2422MHz-2462MHz Bluetooth3.0 : 2402MHz-2480MHz BLE:2402MHz-2480MHz
Conducted RF Power:	GSM 850 : 31.87 dBm PCS 1900: 28.91 dBm WCDMA 850: 22.31 dBm WCDMA 1700: 22.72 dBm WCDMA 1900: 22.66 dBm LTE Band 2: 22.43 dBm LTE Band 4: 21.59 dBm LTE Band 5: 21.97 dBm LTE Band 7: 22.19 dBm Wi-Fi: 9.79 dBm Bluetooth3.0: 0.05 dBm BLE: -5.61 dBm
Dimensions (L*W*H):	145 mm (L) × 72 mm (W) × 9 mm (H)
Power Source:	3.7 V _{DC} Rechargeable Battery
Normal Operation:	Head and Body-worn

REFERENCE, STANDARDS, AND GUIDELINES

FCC:

The Report and Order requires routine SAR evaluation prior to equipment authorization of portable transmitter devices, including portable telephones. For portable devices, the RF radiation exposure evaluation requirement was provided in part 2.1093. According to KDB447498 D01 “General RF Exposure Guidance”, the device should be evaluated at maximum output power (radiated from the antenna) under “worst-case” conditions for normal or intended use, incorporating normal antenna operating positions, device peak performance frequencies and positions for maximum RF energy coupling.

This report describes the methodology and results of experiments performed on wireless data terminal. The objective was to determine if there is RF radiation and if radiation is found, what is the extent of radiation with respect to safety limits. SAR (Specific Absorption Rate) is the measure of RF exposure determined by the amount of RF energy absorbed by human body (or its parts) – to determine how the RF energy couples to the body or head which is a primary health concern for body worn devices.

CE:

The order requires routine SAR evaluation prior to equipment authorization of portable transmitter devices, including portable telephones. For portable devices, the limitation of exposure of the general public to electromagnetic fields was recommended on Council Recommendation 1999/519/EC. According to the Standard IEC62209-1/2, the device should be evaluated at maximum output power (radiated from the antenna) under “worst-case” conditions for normal or intended use, incorporating normal antenna operating positions, device peak performance frequencies and positions for maximum RF energy coupling.

This report describes the methodology and results of experiments performed on wireless data terminal. The objective was to determine if there is RF radiation and if radiation is found, what is the extent of radiation with respect to safety limits. SAR (Specific Absorption Rate) is the measure of RF exposure determined by the amount of RF energy absorbed by human body (or its parts) – to determine how the RF energy couples to the body or head which is a primary health concern for body portable devices.

The test configurations were laid out on a specially designed test fixture to ensure the reproducibility of measurements. Each configuration was scanned for SAR. Analysis of each scan was carried out to characterize the above effects in the device.

SAR Limits

FCC Limit (1g Tissue)

EXPOSURE LIMITS	SAR (W/kg)	
	(General Population / Uncontrolled Exposure Environment)	(Occupational / Controlled Exposure Environment)
Spatial Average (averaged over the whole body)	0.08	0.4
Spatial Peak (averaged over any 1 g of tissue)	1.60	8.0
Spatial Peak (hands/wrists/feet/ankles averaged over 10 g)	4.0	20.0

CE Limit (10g Tissue)

EXPOSURE LIMITS	SAR (W/kg)	
	(General Population / Uncontrolled Exposure Environment)	(Occupational / Controlled Exposure Environment)
Spatial Average (averaged over the whole body)	0.08	0.4
Spatial Peak (averaged over any 10 g of tissue)	2.0	10
Spatial Peak (hands/wrists/feet/ankles averaged over 10 g)	4.0	20.0

Population/Uncontrolled Environments are defined as locations where there is the exposure of individual who have no knowledge or control of their exposure.

Occupational/Controlled Environments are defined as locations where there is exposure that may be incurred by people who are aware of the potential for exposure (i.e. as a result of employment or occupation).

General Population/Uncontrolled environments Spatial Peak limit 1.6W/kg (FCC) & 2 W/kg (CE) applied to the EUT.

FACILITIES

The test site used by Bay Area Compliance Laboratories Corp. (Shenzhen) to collect data is located at 6/F, the 3rd Phase of WanLi Industrial Building, Shi Hua Road, Fu Tian Free Trade Zone, Shenzhen, Guangdong, P.R. of China

DASY4 SAR Evaluation Procedure

Power Reference Measurement

The Power Reference Measurement and Power Drift Measurement jobs are useful jobs for monitoring the power drift of the device under test in the batch process. Both jobs measure the field at a specified reference position, at a selectable distance from the phantom surface. The reference position can be either the selected section's grid reference point or a user point in this section. The reference job projects the selected point onto the phantom surface, orients the probe perpendicularly to the surface, and approaches the surface using the selected detection method. The Minimum distance of probe sensors to surface determines the closest measurement point to phantom surface. By default, the Minimum distance of probe sensors to surface is 4mm. This distance can be modified by the user, but cannot be smaller than the Distance of sensor calibration points to probe tip as defined in the probe properties (for example, 2.7mm for an ES3DV3 probe type).

Area Scan

The Area Scan is used as a fast scan in two dimensions to find the area of high field values, before doing a finer measurement around the hot spot. The sophisticated interpolation routines implemented in DASY4 software can find the maximum locations even in relatively coarse grids.

The scanning area is defined by an editable grid. This grid is anchored at the grid reference point of the selected section in the phantom. When the Area Scan's property sheet is brought-up, grid settings can be edited by a user.

When an Area Scan has measured all reachable points, it computes the field maxima found in the scanned area, within a range of the global maximum. The range (in dB) is specified in the standards for compliance testing. For example, a 2 dB range is required in IEEE 1528-2013, IEC 62209-1:2006 and IEC 62209-2:2010 standards, whereby 3 dB is a requirement when compliance is assessed in accordance with the ARIB standard (Japan). If only one Zoom Scan follows the Area Scan, then only the absolute maximum will be taken as reference. For cases where multiple maximums are detected, the number of Zoom Scans has to be increased accordingly.

After measurement is completed, all maxima and their coordinates are listed in the Results property page. The maximum selected in the list is highlighted in the 3-D view. For the secondary maxima returned from an Area Scan, the user can specify a lower limit (peak SAR value), in addition to the Find secondary maxima within x dB condition. Only the primary maximum and any secondary maxima within x dB from the primary maximum and above this limit will be measured.

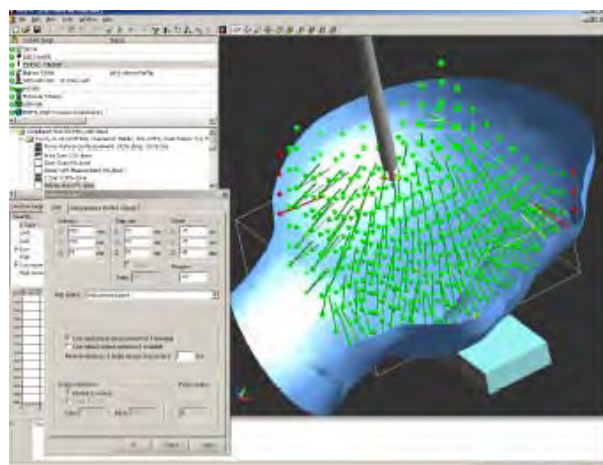
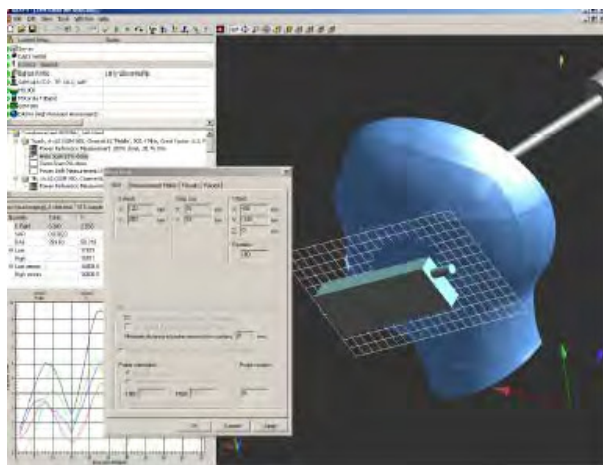

Zoom Scan

Zoom Scans are used to assess the peak spatial SAR values within a cubic averaging volume containing 1 g and 10 g of simulated tissue. The default Zoom Scan measures 5 x 5 x 7 points within a cube whose base faces are centered around the maxima found in a preceding area scan job within the same procedure. When the measurement is done, the Zoom Scan evaluates the averaged SAR for 1 g and 10 g and displays these values next to the job's label.

Power drift measurement

The Power Drift Measurement job measures the field at the same location as the most recent power reference measurement job within the same procedure, and with the same settings. The Power Drift Measurement gives the field difference in dB from the reading conducted within the last Power Reference Measurement. Several drift measurements are possible for one reference measurement. This allows a user to monitor the power drift of the device under test within a batch process. The measurement procedure is the same as Step 1.

Z-Scan

The Z Scan job measures points along a vertical straight line. The line runs along the Z axis of a one-dimensional grid. A user can anchor the grid to the section reference point, to any defined user point or to the current probe location. As with any other grids, the local Z axis of the anchor location establishes the Z axis of the grid.

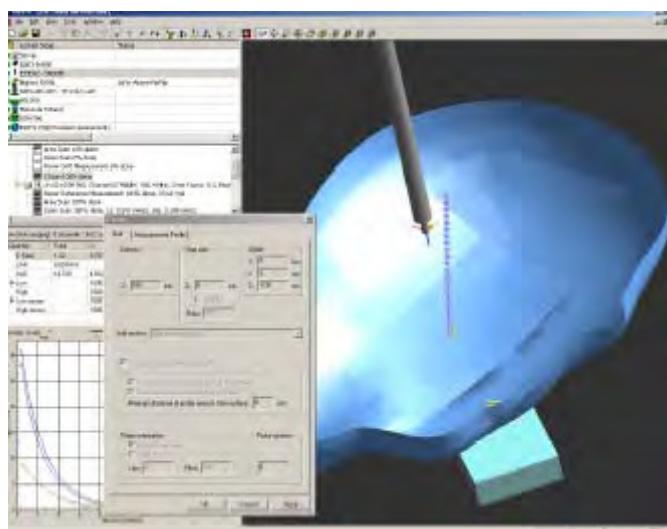

Description of Test System

These measurements were performed with the automated near-field scanning system DASY4 from Schmid & Partner Engineering AG (SPEAG) which is the fourth generation of the system shown in the figure hereinafter:



The system is based on a high precision robot (working range greater than 0.9m), which positions the probes with a positional repeatability of better than $\pm 0.02\text{mm}$. Special E- and H-field probes have been developed for measurements close to material discontinuity, the sensors of which are directly loaded with a Schottky diode and connected via highly resistive lines to the data acquisition unit.

The SAR measurements were conducted with the dosimetric probe ES3DV3 SN: 3036 (manufactured by SPEAG), designed in the classical triangular configuration and optimized for dosimetric evaluation. The probe has been calibrated according to the procedure with accuracy of better than $\pm 10\%$. The spherical isotropy was evaluated with the procedure and found to be better than $\pm 0.25\text{dB}$.

Measurement System Diagram

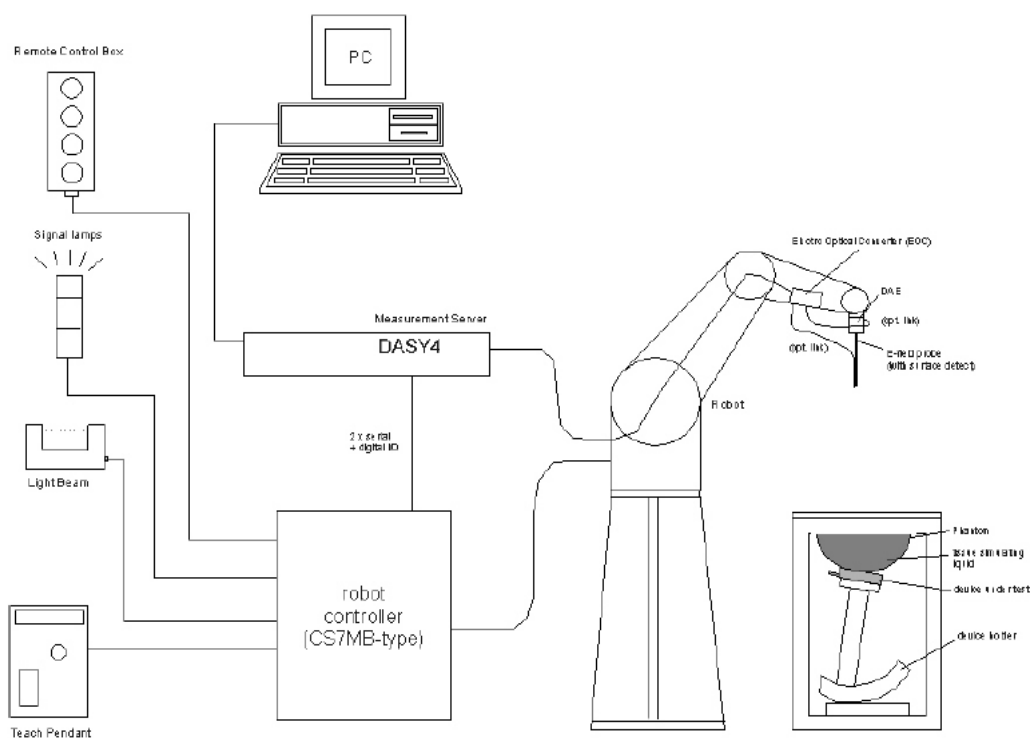

- A standard high precision 6-axis robot (Stäubli RX family) with controller, teach pendant and software. An arm extension for accommodating the data acquisition electronics (DAE).
- A dosimetric probe, i.e., an isotropic E-field probe optimized and calibrated for usage in tissue simulating liquid. The probe is equipped with an optical surface detector system.
- A data acquisition electronics (DAE) which performs the signal amplification, signal multiplexing, AD-conversion, offset measurements, mechanical surface detection, collision detection, etc. The unit is battery powered with standard or rechargeable batteries. The signal is optically transmitted to the EOC.
- The Electro-optical converter (EOC) performs the conversion between optical and electrical of the signals for the digital communication to the DAE and for the analog signal from the optical surface detection. The EOC is connected to the measurement server.
- The function of the measurement server is to perform the time critical tasks such as signal filtering, control of the robot operation and fast movement interrupts.
- A probe alignment unit which improves the (absolute) accuracy of the probe positioning.
- A computer operating Windows 2000 or Windows XP.
- DASY4 software.
- Remote control with teach pendant and additional circuitry for robot safety such as warning lamps, etc.
- The SAM twin phantom enabling testing left-hand and right-hand usage.
- The device holder for handheld smart phones.
- Tissue simulating liquid mixed according to the given recipes.
- Validation dipole kits allowing system validation.

System Components

- DASY4 Measurement Server
- Data Acquisition Electronics
- Probes
- Light Beam Unit
- Medium
- SAM Twin Phantom
- Device Holder for SAM Twin Phantom
- System Validation Kits
- Robot

DASY4 Measurement Server

The DASY4 measurement server is based on a PC/104 CPU board with a 166MHz low-power Pentium, 32MB chip disk and 64MB RAM. The necessary circuits for communication with either the DAE4 (or DAE3) electronic box as well as the 16-bit AD-converter system for optical detection and digital I/O interface are contained on the DASY4 I/O-board, which is directly connected to the PC/104 bus of the CPU board.



The measurement server performs all real-time data evaluation for field measurements and surface detection, controls robot movements and handles safety operation. The PC-operating system cannot interfere with these time critical processes. All connections are supervised by a watchdog, and disconnection of any of the cables to the measurement server will automatically disarm the robot and disable all program-controlled robot movements. Furthermore, the measurement server is equipped with two expansion slots which are reserved for future applications. Please note that the expansion slots do not have a standardized pin out and therefore only the expansion cards provided by SPEAG can be inserted. Expansion cards from any other supplier could seriously damage the measurement server.

Data Acquisition Electronics

The data acquisition electronics DAE3 consists of a highly sensitive electrometer grade preamplifier with auto-zeroing, a channel and gain-switching multiplexer, a fast 16 bit AD-converter and a command decoder and control logic unit. Transmission to the measurement server is accomplished through an optical downlink for data and status information as well as an optical uplink for commands and the clock.



Probes

The DASY system can support many different probe types.

Dosimetric Probes: These probes are specially designed and calibrated for use in liquids with high permittivities. They should not be used in air, since the spherical isotropy in air is poor (± 2 dB). The dosimetric probes have special calibrations in various liquids at different frequencies.

Free Space Probes: These are electric and magnetic field probes specially designed for measurements in free space. The z-sensor is aligned to the probe axis and the rotation angle of the x-sensor is specified. This allows the DASY system to automatically align the probe to the measurement grid for field component measurement. The free space probes are generally not calibrated in liquid. (The H-field probes can be used in liquids without any change of parameters.)

Temperature Probes: Small and sensitive temperature probes for general use. They use a completely different parameter set and different evaluation procedures. Temperature rise features allow direct SAR evaluations with these probes.

ES3DV3 Probe Specification

Construction Symmetrical design with triangular core
 Built-in optical fiber for surface detection System
 Built-in shielding against static charges
 Calibration In air from 150 MHz to 3.7 GHz
 In brain and muscle simulating tissue at
 Frequencies of 450 MHz, 900 MHz and
 1.8 GHz (accuracy $\pm 8\%$)
 Frequency 10 MHz to > 6 GHz; Linearity: ± 0.2 dB
 (30 MHz to 3 GHz)
 Directivity ± 0.2 dB in brain tissue (rotation around
 probe axis)
 ± 0.4 dB in brain tissue (rotation normal probe axis)
 Dynamic 5 mW/g to > 100 mW/g;
 Range Linearity: ± 0.2 dB
 Surface ± 0.2 mm repeatability in air and clear liquids
 Detection over diffuse reflecting surfaces.
 Dimensions Overall length: 330 mm
 Tip length: 16 mm
 Body diameter: 12 mm
 Tip diameter: 6.8 mm
 Distance from probe tip to dipole centers: 2.7 mm
 Application General dosimetric up to 3 GHz

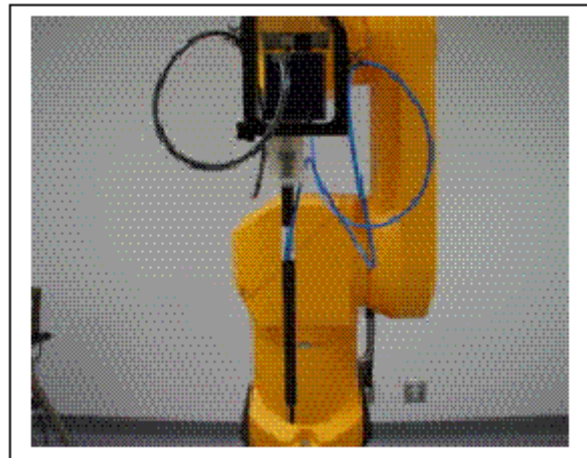

Photograph of the probe

EX3DV4 Probe Specification

Construction Symmetrical design with triangular core Built-in optical
 fiber for surface detection System
 Built-in shielding against static charges Calibration In air from 750
 MHz to 5.8 GHz In brain and muscle simulating tissue at Frequencies
 of 750 MHz, 900 MHz, 1750 MHz, 1900 MHz, 2450 MHz, 2600 MHz,
 5250 MHz, 5.6 GHz and 5.8 GHz (accuracy $\pm 8\%$) Frequency 10 MHz
 to > 6 GHz; Linearity: ± 0.2 dB
 (30 MHz to 3 GHz) Directivity ± 0.2 dB in brain tissue (rotation
 around probe axis) ± 0.4 dB in brain tissue (rotation normal probe axis)
 Dynamic 5 mW/g to > 100 mW/g; Range Linearity: ± 0.2 dB Surface
 ± 0.2 mm repeatability in air and clear liquids Detection over diffuse
 reflecting surfaces. Dimensions Overall length: 337 mm
 Tip length: 20 mm
 Body diameter: 12 mm
 Tip diameter: 2.5 mm
 Distance from probe tip to dipole centers: 1 mm
 Application General dosimetric up to 6 GHz

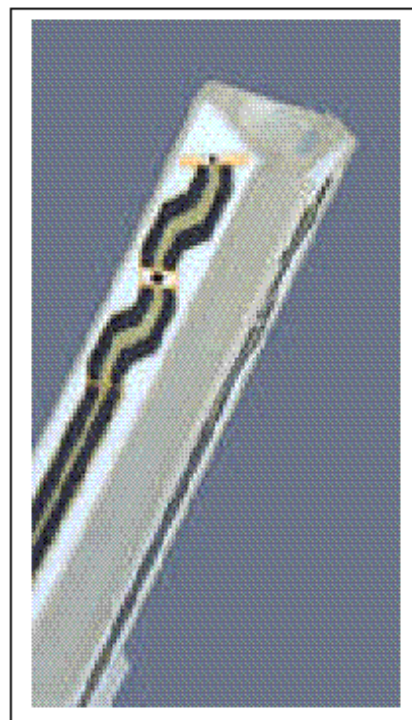

Inside view of E-field Probe

Compliance tests of smart phones Fast automatic scanning in arbitrary phantoms, The SAR measurements were conducted with the dosimetric probe designed in the classical triangular configuration and optimized for dosimetric evaluation. The probe is constructed using the thick film technique; with printed resistive lines on ceramic substrates. The probe is equipped with an optical multi-fiber line ending at the front of the probe tip. It is connected to the EOC box on the robot arm and provides an automatic detection of the phantom surface. Half of the fibers are connected to a pulsed infrared transmitter, the other half to a synchronized receiver. As the probe approaches the surface, the reflection from the surface produces a coupling from the transmitting to the receiving fibers. This reflection increases first during the approach, reaches maximum and then decreases. If the probe is flatly touching the surface, the coupling is zero. The distance of the coupling maximum to the surface is independent of the surface reflectivity and largely independent of the surface to probe angle. The DASY3 software reads the reflection during a software approach and looks for the maximum using a 2nd order fitting. The approach is stopped when

E-Field Probe Calibration Process

Each probe is calibrated according to a dosimetric assessment procedure described in [6] with accuracy better than +/- 10%. The spherical isotropy was evaluated with the procedure described in [7] and found to be better than +/-0.25dB. The sensitivity parameters (NormX, NormY, NormZ), the diode compression parameter (DCP) and the conversion factor (ConvF) of the probe are tested.

The free space E-field from amplified probe outputs is determined in a test chamber. This is performed in a TEM cell for frequencies below 1 GHz, and in a waveguide above 1 GHz for free space. For the free space calibration, the probe is placed in the volumetric center of the cavity and at the proper orientation with the field. The probe is then rotated 360 degrees.

E-field temperature correlation calibration is performed in a flat phantom filled with the appropriate simulated brain tissue. The measured free space E-field in the medium correlates to temperature rise in dielectric medium. For temperature correlation calibration a RF transparent thermistor-based temperature probe is used in conjunction with the E-field probe.

Data Evaluation

The DASY4 post-processing software (SEMCAD) automatically executes the following procedures to calculate the field units from the microvolt readings at the probe connector. The parameters used in the evaluation are stored in the configuration modules of the software:

Probe parameters:	- Sensitivity	Normi, ai0, ai1, ai2
	- Conversion factor	ConvFi
	- Diode compression point	dcp _i
Device parameters:	- Frequency	f
	- Crest factor	cf
Media parameters:	- Conductivity	σ
	- Density	ρ

These parameters must be set correctly in the software. They can be found in the component documents or they can be imported into the software from the configuration files issued for the DASY components. In the direct measuring mode of the multimeter option, the parameters of the actual system setup are used. In the scan visualization and export modes, the parameters stored in the corresponding document files are used. The first step of the evaluation is a linearization of the filtered input signal to account for the compression characteristics of the detector diode. The compensation depends on the input signal, the diode type and the DC-transmission factor from the diode to the evaluation electronics. If the exciting field is pulsed, the crest factor of the signal must be known to correctly compensate for peak power. The formula for each channel can be given as:

$$V_i = U_i + U_i^2 \cdot \frac{cf}{dcp_i}$$

With	V _i	= compensated signal of channel i (i =x, y, z)
	U _i	= input signal of channel i (i =x, y, z)
	cf	= crest factor of exciting field (DASY parameter)
	dcp _i	= diode compression point (DASY parameter)

From the compensated input signals the primary field data for each channel can be evaluated:

$$\text{E - fieldprobes : } E_i = \sqrt{\frac{V_i}{\text{Norm}_i \cdot \text{ConVF}}}$$

$$\text{H - fieldprobes : } H_i = \sqrt{V_i} \cdot \frac{a_{i0} + a_{i1}f + a_{i2}f^2}{f}$$

With	V_i	= compensated signal of channel i (i =x, y, z)
	Norm_i	= sensor sensitivity of channel i (i =x, y, z) $\mu\text{V}/(\text{V}/\text{m})^2$ for E-field probes
	ConF	= sensitivity enhancement in solution
	a_{ij}	= sensor sensitivity factors for H-field probes
	f	= carrier frequency [GHz]
	E_i	= electric field strenggy of channel i in V/m
	H_i	= diode compression point (DASY parameter)

The RSS value of the field components gives the total field strength (Hermitian magnitude):

$$E_{tot} = \sqrt{E_x^2 + E_y^2 + E_z^2}$$

The primary field data are used to calculate the derived field units.

$$SAR = E_{tot}^2 \cdot \frac{\sigma}{\rho \cdot 1'000}$$

With	SAR	= local specific absorption rate in mW/g
	E_{tot}	= total field strength in V/m
	σ	= conductivity in [mho/meter] or [Siemens/meter]
	ρ	= equivalent tissue density in g/cm^3

Note that the density is normally set to 1, to account for actual brain density rather than the density of the simulation liquid.

Light Beam Unit

The light beam switch allows automatic “tooling” of the probe. During the process, the actual position of the probe tip with respect to the robot arm is measured, as well as the probe length and the horizontal probe offset. The software then corrects all movements, so that the robot coordinates are valid for the probe tip. The repeatability of this process is better than 0.1 mm. If a position has been taught with an aligned probe, the same position will be reached with another aligned probe within 0.1 mm, even if the other probe has different dimensions. During probe rotations, the probe tip will keep its actual position.

Medium

Parameters

The parameters of the tissue simulating liquid strongly influence the SAR in the liquid. The parameters for the different frequencies are defined in the corresponding compliance standards (e.g., IEC 62209-1:2005, IEC62209-2:2010, IEEE 1528-2013).

IEEE SCC-34/SC-2 P1528 Recommended Tissue Dielectric Parameters

Frequency (MHz)	Head Tissue		Body Tissue	
	ϵ_r	σ (S/m)	ϵ_r	σ (S/m)
150	52.3	0.76	61.9	0.80
300	45.3	0.87	58.2	0.92
450	43.5	0.87	56.7	0.94
835	41.5	0.90	55.2	0.97
900	41.5	0.97	55.0	1.05
915	41.5	0.98	55.0	1.06
1450	40.5	1.20	54.0	1.30
1610	40.3	1.29	53.8	1.40
1800-2000	40.0	1.40	53.3	1.52
2450	39.2	1.80	52.7	1.95
3000	38.5	2.40	52.0	2.73
5800	35.3	5.27	48.2	6.00

Parameter measurements

Several measurement systems are available for measuring the dielectric parameters of liquids:

- The open coax test method (e.g., HP85070 dielectric probe kit) is easy to use, but has only moderate accuracy. It is calibrated with open, short, and deionized water and the calibrations a critical process.
- The transmission line method (e.g., model 1500T from DAMASKOS, INC.) measures the transmission and reflection in a liquid filled high precision line. It needs standard two port calibration and is probably more accurate than the open coax method.
- The reflection line method measures the reflection in a liquid filled shorted precision lined. The method is not suitable for these liquids because of its low sensitivity.
- The slotted line method scans the field magnitude and phase along a liquid filled line. The evaluation is straight forward and only needs a simple response calibration. The method is very accurate, but can only be used in high loss liquids and at frequencies above 100 to 200MHz. Cleaning the line can be tedious.

SAM Twin Phantom

The SAM twin phantom is a fiberglass shell phantom with 2mm shell thickness (except the ear region where shell thickness increases to 6mm). It has three measurement areas:

- Left hand
- Right hand
- Flat phantom

The phantom table comes in two sizes: A 100 x 50 x 85 cm (L x W x H) table for use with free standing robots (DASY4 professional system option) or as a second phantom and a 100 x 75 x 85 cm (L x W x H) table with reinforcements for table mounted robots (DASY4 compact system option).

The bottom plate contains three pair of bolts for locking the device holder. The device holder positions are adjusted to the standard measurement positions in the three sections. Only one device holder is necessary if two phantoms are used (e.g., for different liquids) A white cover is provided to tap the phantom during o_-periods to prevent water evaporation and changes in the liquid parameters. Free space scans of devices on the cover are possible. On the phantom top, three reference markers are provided to identify the phantom position with respect to the robot.

The phantom can be used with the following tissue simulating liquids:

- Water-sugar based liquids can be left permanently in the phantom. Always cover the liquid if the system is not used, otherwise the parameters will change due to water evaporation.
- Glycol based liquids should be used with care. As glycol is a softener for most plastics, the liquid should be taken out of the phantom and the phantom should be dried when the system is not used (desirable at least once a week).
- Do not use other organic solvents without previously testing the phantom's compatibility.

Device Holder for SAM Twin Phantom

The SAR in the phantom is approximately inversely proportional to the square of the distance between the source and the liquid surface. For a source in 5mm distance, a positioning uncertainty of $\pm 0.5\text{mm}$ would produce a SAR uncertainty of $\pm 20\%$. An accurate device positioning is therefore crucial for accurate and repeatable measurements. The positions, in which the devices must be measured, are defined by the standards.

The DASY device holder is designed to cope with different positions given in the standard. It has two scales for the device rotation (with respect to the body axis) and the device inclination (with respect to the line between the ear reference points). The rotation centers for both scales is the ear reference point (ERP). Thus the device needs no repositioning when changing the angles.



The DASY device holder has been made out of low-loss POM material having the following dielectric parameters: relative permittivity $\epsilon=3$ and loss tangent $\tan \delta=0.02$. The amount of dielectric material has been reduced in the closest vicinity of the device, since measurements have suggested that the influence of the clamp on the test results could thus be lowered.

System Validation Kits

Each DASY system is equipped with one or more system validation kits. These units, together with the predefined measurement procedures within the DASY software, enable the user to conduct the system performance check and system validation. For that purpose a well-defined SAR distribution in the flat section of the SAM twin phantom is produced.

System validation kit includes a dipole, tripod holder to fix it underneath the flat phantom and a corresponding distance holder. Dipoles are available for the variety of frequencies between 300MHz and 6 GHz (dipoles for other frequencies or media and other calibration conditions are available upon request).

The dipoles are highly symmetric and matched at the center frequency for the specified liquid and distance to the flat phantom (or flat section of the SAM-twin phantom). The accurate distance between the liquid surface and the dipole center is achieved with a distance holder that snaps on the dipole.

Robot

The DASY4 system uses the high precision industrial robots RX60L, RX90 and RX90L, as well as the RX60BL and RX90BL types out of the newer series from Stäubli SA (France). The RX robot series offers many features that are important for our application:

- High precision (repeatability 0.02mm)
- High reliability (industrial design)
- Low maintenance costs (virtually maintenance-free due to direct drive gears; no belt drives)
- Jerk-free straight movements (brushless synchronous motors; no stepper motors)
- Low ELF interference (the closed metallic construction shields against motor control fields)

For the newly delivered DASY4 systems as well as for the older DASY3 systems delivered since 1999, the CS7MB robot controller version from Stäubli is used. Previously delivered systems have either a CS7 or CS7M controller; the differences to the CS7MB are mainly in the hardware, but some procedures in the robot software from Stäubli are also not completely the same. The following descriptions about robot hard- and software correspond to CS7MB controller with software version 13.1 (edit S5). The actual commands, procedures and configurations, also including details in hardware, might differ if an older robot controller is in use. In this case please also refer to the Stäubli manuals for further information.



EQUIPMENT LIST AND CALIBRATION

Equipments List & Calibration Information

Equipment	Model	Calibration Date	Calibration Due Date	S/N
Robot	RX60BL	N/A	N/A	F02/5S01A1/A/01
Robot Controller	CS7MBs&p RX60BL	N/A	N/A	F02/5S01A1/C/01
DASY4 Test Software	DASY4, V4.5 Build 19	N/A	N/A	N/A
Data Acquisition Electronics	DAE3	2016-09-16	2017-09-16	456
E-Field Probe	ES3DV3	2016-09-12	2017-09-12	3036
E-Field Probe	EX3DV4	2016-10-04	2017-10-03	7431
Dipole, 835MHz	ALS-D-835-S-2	2014-10-08	2017-10-08	180-00558
Dipole, 1750MHz	ALS-D-1750-S-2	2016-10-04	2019-10-04	198-00304
Dipole, 1900MHz	ALS-D-1900-S-2	2014-10-09	2017-10-09	210-00710
Dipole, 2600 MHz	D2600V2	2013/12/09	2016/12/08	1073
Dipole Spacer	ALS-DS-U	N/A	N/A	250-00907
Device holder/Positioner	MD4HHTV5	N/A	N/A	SD 000 H01 KA
SPEAG SAM Twin Phantom	Twin SAM	N/A	N/A	Tp-1218
Simulated Tissue 835 MHz Head	ALS-TS-835-H	Each Time	/	270-01002
Simulated Tissue 835 MHz Body	ALS-TS-835-B	Each Time	/	270-02101
Simulated Tissue 1750 MHz Head	ALS-TS-1750-H	Each Time	/	295-01103
Simulated Tissue 1750 MHz Body	ALS-TS-1750-B	Each Time	/	295-02102
Simulated Tissue 1900 MHz Head	ALS-TS-1900-H	Each Time	/	295-01103
Simulated Tissue 1900 MHz Body	ALS-TS-1900-B	Each Time	/	295-02102
Simulated Tissue 2600 MHz Head	ALS-TS-2600-H	Each Time	/	292-01110
Simulated Tissue 2600 MHz Body	ALS-TS-2600-B	Each Time	/	292-01111
Directional couple	DC6180A	N/A	N/A	0325849
Power Amplifier	5SIG4	N/A	N/A	71377
Attenuator	3dB	N/A	N/A	5402
Dielectric probe kit	HP85070B	2016-06-13	2017-06-13	US33020324
Network analyzer	8752C	2016-06-03	2017-06-03	3410A02356
Synthesized Sweeper	HP 8341B	2016-06-03	2017-06-03	2624A00116
UNIVERSAL RADIO COMMUNICATION TESTER	CMU200	2015-11-23	2016-11-23	106891
WIDEBAND RADIO COMMUNICATION TESTER	CMW500	2016-04-19	2017-04-19	114772
EMI Test Receiver	ESCI	2016-06-13	2017-06-13	101746

SAR MEASUREMENT SYSTEM VERIFICATION

Liquid Verification

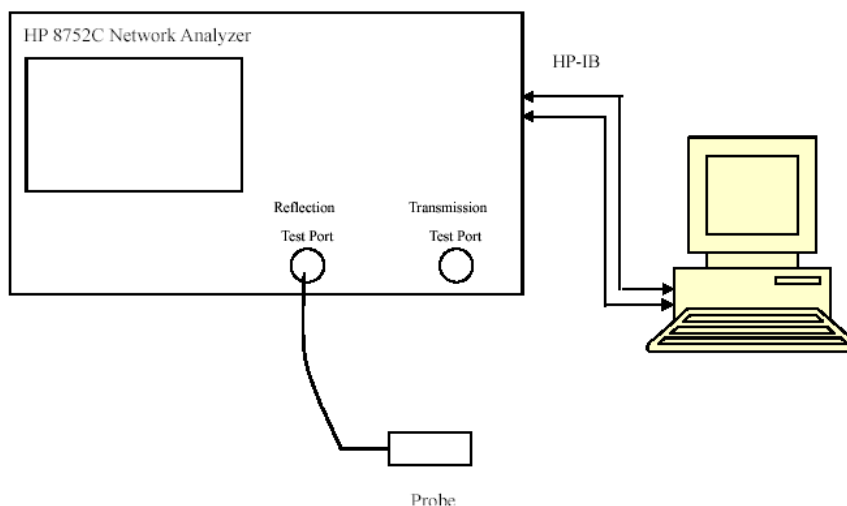

Liquid Verification Setup Block Diagram

Liquid Verification Results

Frequency	Liquid Type	Liquid Parameter		Target Value		Delta (%)		Tolerance (%)
		ϵ_r	σ (S/m)	ϵ_r	σ (S/m)	$\Delta\epsilon_r$	$\Delta\sigma$ (S/m)	
824.2	Head	40.05	0.87	41.5	0.90	-3.494	-3.333	±5
	Body	53.31	0.94	55.2	0.97	-3.424	-3.093	±5
826.4	Head	40.13	0.88	41.5	0.90	-3.301	-2.222	±5
	Body	53.42	0.95	55.2	0.97	-3.225	-2.062	±5
829.0	Head	40.18	0.89	41.5	0.90	-3.181	-1.111	±5
	Body	53.57	0.96	55.2	0.97	-2.953	-1.031	±5
836.5	Head	40.25	0.90	41.5	0.90	-3.012	0.000	±5
	Body	53.62	0.97	55.2	0.97	-2.862	0.000	±5
836.6	Head	40.25	0.90	41.5	0.90	-3.012	0.000	±5
	Body	53.62	0.97	55.2	0.97	-2.862	0.000	±5
844.0	Head	40.39	0.91	41.5	0.90	-2.675	1.111	±5
	Body	53.71	0.98	55.2	0.97	-2.699	1.031	±5
846.6	Head	40.49	0.92	41.5	0.90	-2.434	2.222	±5
	Body	53.84	0.99	55.2	0.97	-2.464	2.062	±5
848.8	Head	40.57	0.93	41.5	0.90	-2.241	3.333	±5
	Body	53.92	1.00	55.2	0.97	-2.319	3.093	±5

*Liquid Verification was performed on 2016-10-10 and 2016-10-11.

Frequency	Liquid Type	Liquid Parameter		Target Value		Delta (%)		Tolerance (%)
		ϵ_r	σ (S/m)	ϵ_r	σ (S/m)	$\Delta\epsilon_r$	$\Delta\sigma$ (S/m)	
1850.2	Head	39.42	1.36	40.0	1.40	-1.450	-2.857	±5
	Body	52.18	1.47	53.3	1.52	-2.101	-3.289	±5
1852.4	Head	39.57	1.37	40.0	1.40	-1.075	-2.143	±5
	Body	52.26	1.48	53.3	1.52	-1.951	-2.632	±5
1880.0	Head	39.72	1.39	40.0	1.40	-0.700	-0.714	±5
	Body	52.46	1.50	53.3	1.52	-1.576	-1.316	±5
1900.0	Head	39.86	1.40	40.0	1.40	-0.350	0.000	±5
	Body	52.59	1.51	53.3	1.52	-1.332	-0.658	±5
1907.6	Head	39.97	1.41	40.0	1.40	-0.075	0.714	±5
	Body	52.68	1.52	53.3	1.52	-1.163	0.000	±5
1909.8	Head	40.12	1.42	40.0	1.40	0.300	1.429	±5
	Body	52.82	1.53	53.3	1.52	-0.901	0.658	±5

*Liquid Verification was performed on 2016-10-10 and 2016-10-11.

Frequency	Liquid Type	Liquid Parameter		Target Value		Delta (%)		Tolerance (%)
		ϵ_r	σ (S/m)	ϵ_r	σ (S/m)	$\Delta\epsilon_r$	$\Delta\sigma$ (S/m)	
1860.0	Head	39.67	1.38	40.0	1.40	-0.825	-1.429	±5
	Body	52.34	1.49	53.3	1.52	-1.801	-1.974	±5
1880.0	Head	39.72	1.39	40.0	1.40	-0.700	-0.714	±5
	Body	52.46	1.50	53.3	1.52	-1.576	-1.316	±5
1900.0	Head	39.88	1.41	40.0	1.40	-0.300	0.714	±5
	Body	52.48	1.50	53.3	1.52	-1.538	-1.316	±5

*Liquid Verification was performed on 2016-10-12

Frequency	Liquid Type	Liquid Parameter		Target Value		Delta (%)		Tolerance (%)
		ϵ_r	σ (S/m)	ϵ_r	σ (S/m)	$\Delta\epsilon_r$	$\Delta\sigma$ (S/m)	
1712.4	Head	39.53	1.34	40.08	1.37	-1.372	-2.190	±5
	Body	52.17	1.44	53.43	1.49	-2.358	-3.356	±5
1720.0	Head	39.58	1.35	40.08	1.37	-1.248	-1.460	±5
	Body	52.23	1.45	53.43	1.49	-2.246	-2.685	±5
1732.5	Head	39.64	1.36	40.08	1.37	-1.098	-0.730	±5
	Body	52.36	1.46	53.43	1.49	-2.003	-2.013	±5
1732.6	Head	39.72	1.37	40.08	1.37	-0.898	0.000	±5
	Body	52.42	1.47	53.43	1.49	-1.890	-1.342	±5
1745.0	Head	39.89	1.38	40.08	1.37	-0.474	0.730	±5
	Body	52.59	1.48	53.43	1.49	-1.572	-0.671	±5
1752.6	Head	39.98	1.39	40.08	1.37	-0.250	1.460	±5
	Body	52.67	1.49	53.43	1.49	-1.422	0.000	±5

*Liquid Verification was performed on 2016-10-13.

Frequency	Liquid Type	Liquid Parameter		Target Value		Delta (%)		Tolerance (%)
		ϵ_r	σ (S/m)	ϵ_r	σ (S/m)	$\Delta\epsilon_r$	$\Delta\sigma$ (S/m)	
2510	Head	39.72	1.85	39.12	1.87	1.534	-1.070	±5
	Body	53.93	2.02	52.62	2.04	2.490	-0.980	±5
2535	Head	39.71	1.86	39.09	1.89	1.586	-1.587	±5
	Body	53.86	2.04	52.59	2.07	2.415	-1.449	±5
2560	Head	39.89	1.89	39.06	1.92	2.125	-1.563	±5
	Body	53.88	2.05	52.56	2.11	2.511	-2.844	±5

*Liquid Verification was performed on 2016-11-08.

System Accuracy Verification

Prior to the assessment, the system validation kit was used to test whether the system was operating within its specifications of $\pm 10\%$. The validation results are tabulated below. And also the corresponding SAR plot is attached as well in the SAR plots files.

System Verification Setup Block Diagram

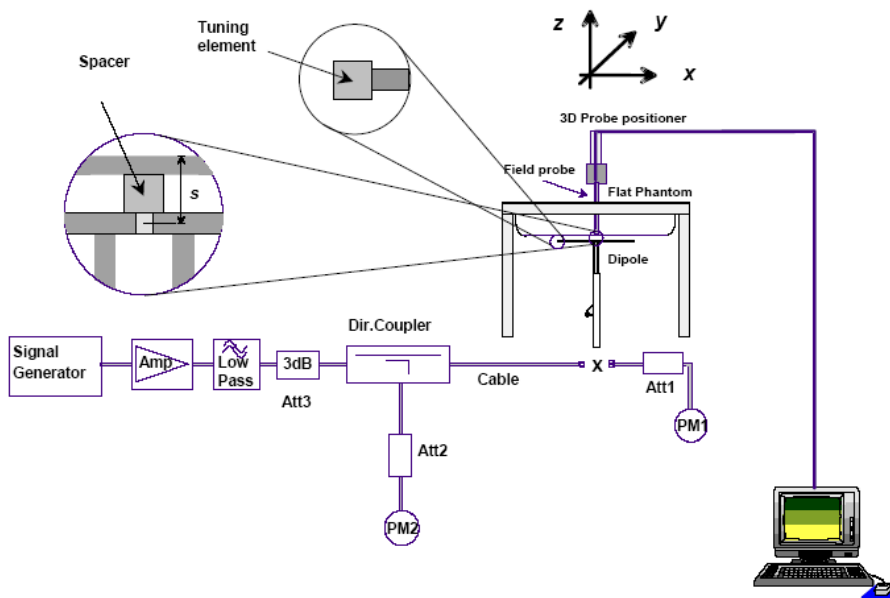

System Accuracy Check Results

Date	Frequency Band	Liquid Type	Measured SAR (W/Kg)	Target Value (W/Kg)	Delta (%)	Tolerance (%)	
2016-10-10	835	Head	1g	9.37	9.773	-4.124	± 10
	1900	Head	1g	39.5	39.481	0.048	± 10
2016-10-11	835	Body	1g	9.79	9.736	0.555	± 10
	1900	Body	1g	39.7	39.715	-0.038	± 10
2016-10-12	1900	Head	1g	38.9	39.481	-1.472	± 10
		Body	1g	39.0	39.715	-1.800	± 10
2016-10-13	1750	Head	1g	35.8	36.85	-2.849	± 10
		Body	1g	36.2	35.78	1.174	± 10
2016-11-08	2600	Head	1g	56.2	57.4	-2.091	± 10
		Body	1g	55.1	55.4	-0.542	± 10

Note:

The power inputted to dipole is 0.1Watt; the SAR values are normalized to 1 Watt forward power by multiplying 10 times.

SAR SYSTEM VALIDATION DATA

Performed on 2016-10-10:

Test Laboratory: Bay Area Compliance Labs Corp.(Shenzhen)

DUT: Dipole 835 MHz; Type: ALS-D-835-S-2; S/N: 180-00558

Program Name: 835 MHz Head

Communication System: CW; Frequency: 835 MHz; Duty Cycle: 1:1

Medium parameters used: $f = 835$ MHz; $\sigma = 0.90$ S/m; $\epsilon_r = 40.21$; $\rho = 1000$ kg/m³

Phantom section: Flat Section

DASY4 Configuration:

- Probe: ES3DV3 - SN3036; ConvF(6.26, 6.26, 6.26); Calibrated: 16/9/2016

- Sensor-Surface: 4mm (Mechanical Surface Detection)

- Electronics: Dummy DAE – SN456; Calibrated: 12/9/2016

- Phantom: TWIN SAM; Type: QD000P40CA; Serial: TP-1218

- Measurement SW: DASY4, V4.5 Build 19; Postprocessing SW: SEMCAD, V1.8 Build 145

835 Head system check /Area Scan (91x151x1): Measurement grid: dx=10mm, dy=10mm

Maximum value of SAR (interpolated) = 0.973 mW/g

835 Head system check /Zoom Scan (7x7x7)/Cube 0: Measurement grid: dx=5mm, dy=5mm, dz=5mm

Reference Value = 33.7 V/m; Power Drift = 0.083 dB

Peak SAR (extrapolated) = 1.259 W/kg

SAR(1 g) = 0.937 mW/g; SAR(10 g) = 0.612 mW/g

Maximum value of SAR (measured) = 0.982 mW/g

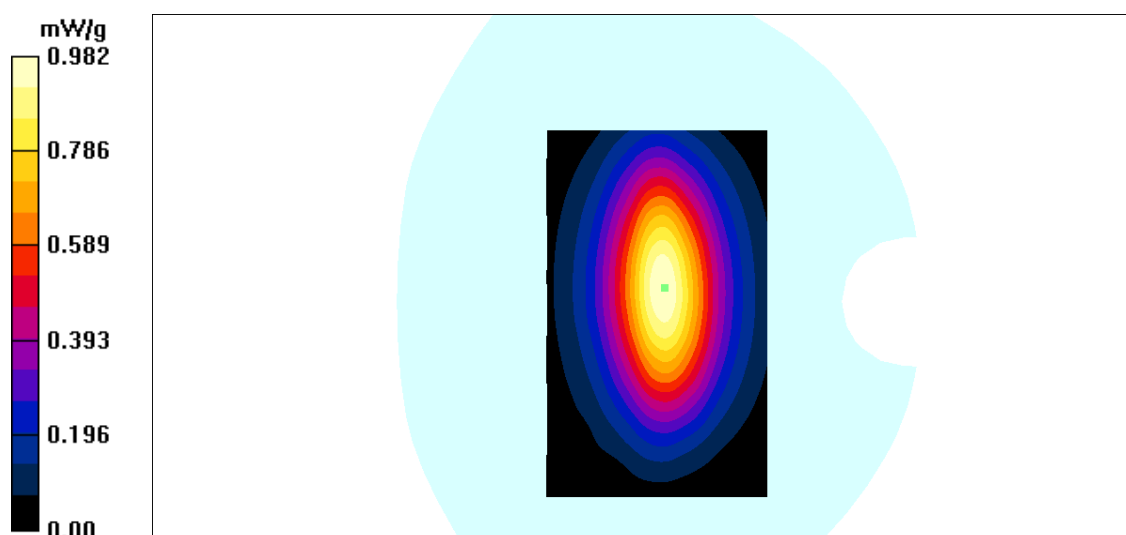

Test Laboratory: Bay Area Compliance Labs Corp. (Shenzhen)

DUT: Dipole 1900 MHz; Type: ALS-D-1900-S-2; S/N: 210-00710

Program Name: 1900MHz Head

Communication System: CW; Frequency: 1900 MHz; Duty Cycle: 1:1

Medium parameters used: $f = 1900 \text{ MHz}$; $\sigma = 1.40 \text{ S/m}$; $\epsilon_r = 39.86$; $\rho = 1000 \text{ kg/m}^3$

Phantom section: Flat Section

DASY4 Configuration:

- Probe: ES3DV3 - SN3036; ConvF(5.12, 5.12, 5.12); Calibrated: 16/9/2016
- Sensor-Surface: 4mm (Mechanical Surface Detection)
- Electronics: Dummy DAE – SN456; Calibrated: 12/9/2016
- Phantom: TWIN SAM; Type: QD000P40CA; Serial: TP-1218
- Measurement SW: DASY4, V4.5 Build 19; Postprocessing SW: SEMCAD, V1.8 Build 145

1900 head system check/Area Scan (71x91x1): Measurement grid: $dx=10\text{mm}$, $dy=10\text{mm}$

Maximum value of SAR (interpolated) = 4.65 mW/g

1900 head system check/Zoom Scan (7x7x7)/Cube 0: Measurement grid: $dx=5\text{mm}$, $dy=5\text{mm}$, $dz=5\text{mm}$

Reference Value = 51.7 V/m; Power Drift = 0.025 dB

Peak SAR (extrapolated) = 7.78 W/kg

SAR(1 g) = 3.95 mW/g; SAR(10 g) = 1.92 mW/g

Maximum value of SAR (measured) = 4.37 mW/g

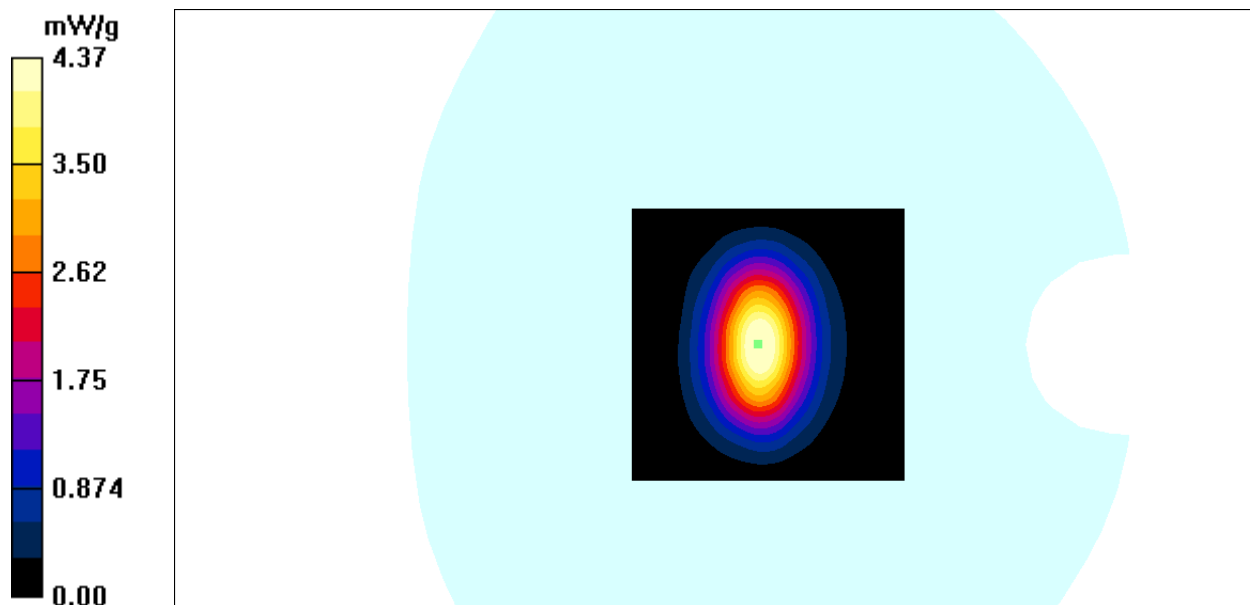

Performed on 2016-10-11:

Test Laboratory: Bay Area Compliance Labs Corp.(Shenzhen)

DUT: Dipole 835 MHz; Type: ALS-D-835-S-2; S/N: 180-00558

Program Name: 835 MHz Body

Communication System: CW; Frequency: 835 MHz; Duty Cycle: 1:1

Medium parameters used: $f = 835$ MHz; $\sigma = 0.97$ S/m; $\epsilon_r = 53.61$; $\rho = 1000$ kg/m³

Phantom section: Flat Section

DASY4 Configuration:

- Probe: ES3DV3 - SN3036; ConvF(6.20, 6.20, 6.20); Calibrated: 16/9/2016

- Sensor-Surface: 4mm (Mechanical Surface Detection)

- Electronics: Dummy DAE – SN456; Calibrated: 12/9/2016

- Phantom: TWIN SAM; Type: QD000P40CA; Serial: TP-1218

- Measurement SW: DASY4, V4.5 Build 19; Postprocessing SW: SEMCAD, V1.8 Build 145

835 Body system check /Area Scan (91x151x1): Measurement grid: dx=10mm, dy=10mm

Maximum value of SAR (interpolated) = 1.012 mW/g

835 Body system check /Zoom Scan (7x7x7)/Cube 0: Measurement grid: dx=5mm, dy=5mm, dz=5mm

Reference Value = 32.3 V/m; Power Drift = -0.024 dB

Peak SAR (extrapolated) = 1.102 W/kg

SAR(1 g) = 0.979 mW/g; SAR(10 g) = 0.613 mW/g

Maximum value of SAR (measured) = 1.05 mW/g

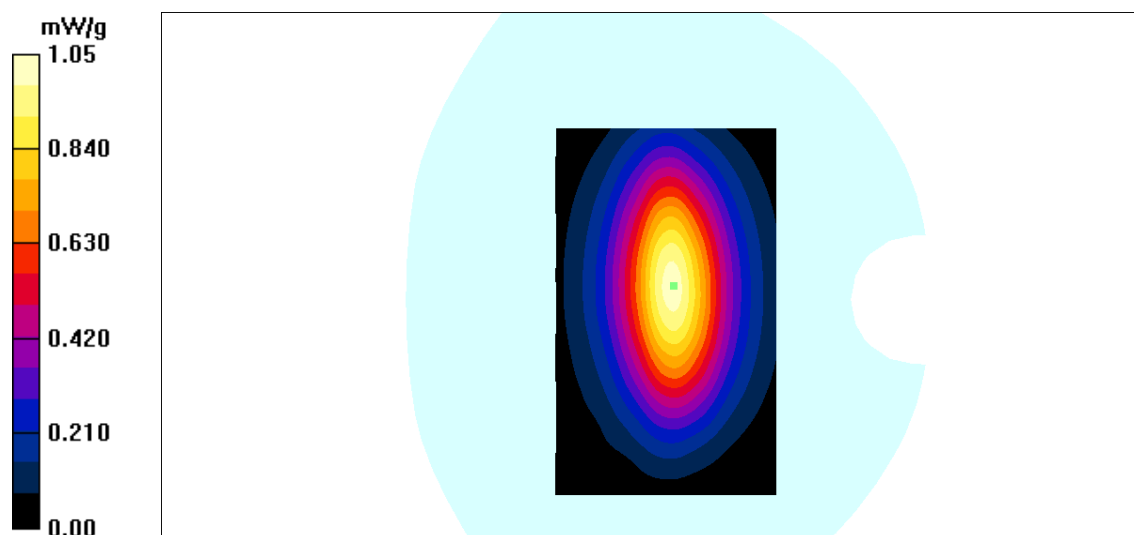

Test Laboratory: Bay Area Compliance Labs Corp. (Shenzhen)

DUT: Dipole 1900 MHz; Type: ALS-D-1900-S-2; S/N: 210-00710

Program Name: 1900MHz Body

Communication System: CW; Frequency: 1900 MHz; Duty Cycle: 1:1

Medium parameters used: $f = 1900$ MHz; $\sigma = 1.51$ S/m; $\epsilon_r = 52.59$; $\rho = 1000$ kg/m³

Phantom section: Flat Section

DASY4 Configuration:

- Probe: ES3DV3 - SN3036; ConvF(4.79, 4.79, 4.79); Calibrated: 16/9/2016
- Sensor-Surface: 4mm (Mechanical Surface Detection)
- Electronics: Dummy DAE – SN456; Calibrated: 12/9/2016
- Phantom: TWIN SAM; Type: QD000P40CA; Serial: TP-1218
- Measurement SW: DASY4, V4.5 Build 19; Postprocessing SW: SEMCAD, V1.8 Build 145

1900 Body system check/Area Scan (71x91x1): Measurement grid: dx=10mm, dy=10mm

Maximum value of SAR (interpolated) = 4.67 mW/g

1900 Body system check/Zoom Scan (7x7x7)/Cube 0: Measurement grid: dx=5mm, dy=5mm, dz=5mm

Reference Value = 52.3 V/m; Power Drift = -0.036 dB

Peak SAR (extrapolated) = 7.99 W/kg

SAR(1 g) = 3.97 mW/g; SAR(10 g) = 1.99 mW/g

Maximum value of SAR (measured) = 4.11 mW/g

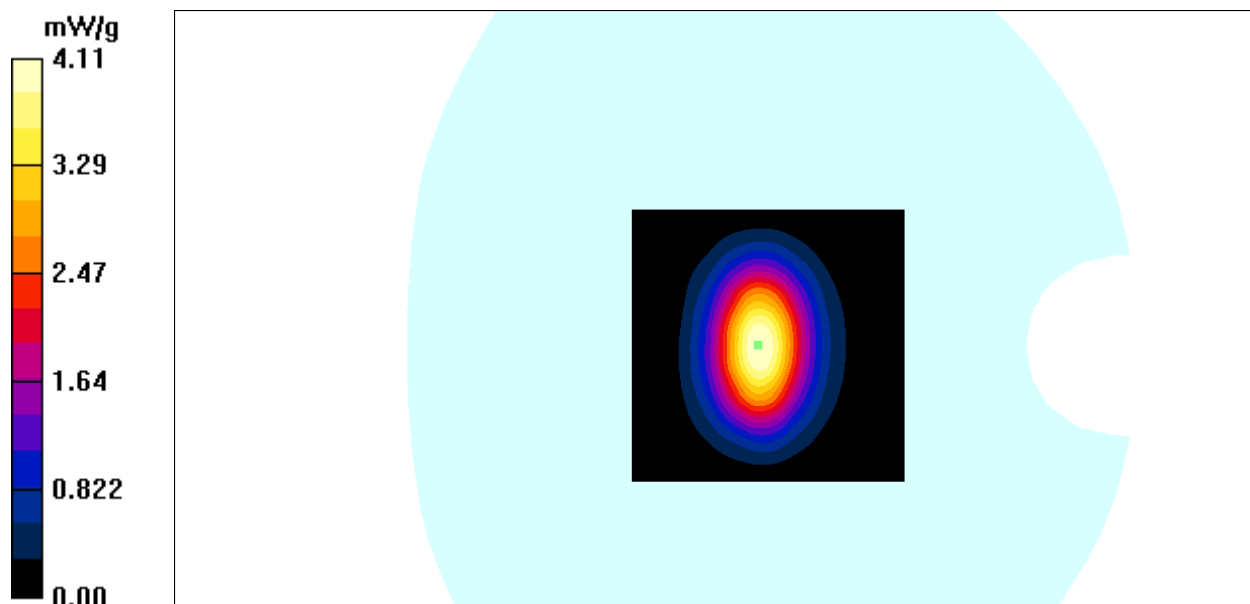

Performed on 2016-10-12:**Test Laboratory: Bay Area Compliance Labs Corp. (Shenzhen)****DUT: Dipole 1900 MHz; Type: ALS-D-1900-S-2; S/N: 210-00710****Program Name: 1900MHz Head**

Communication System: CW; Frequency: 1900 MHz; Duty Cycle: 1:1

Medium parameters used: $f = 1900$ MHz; $\sigma = 1.41$ S/m; $\epsilon_r = 39.88$; $\rho = 1000$ kg/m³

Phantom section: Flat Section

DASY4 Configuration:

- Probe: ES3DV3 - SN3036; ConvF(5.12, 5.12, 5.12); Calibrated: 16/9/2016

- Sensor-Surface: 4mm (Mechanical Surface Detection)

- Electronics: Dummy DAE – SN456; Calibrated: 12/9/2016

- Phantom: TWIN SAM; Type: QD000P40CA; Serial: TP-1218

- Measurement SW: DASY4, V4.5 Build 19; Postprocessing SW: SEMCAD, V1.8 Build 145

1900 head system check/Area Scan (71x91x1): Measurement grid: dx=10mm, dy=10mm

Maximum value of SAR (interpolated) = 4.54 mW/g

1900 head system check/Zoom Scan (7x7x7)/Cube 0: Measurement grid: dx=5mm, dy=5mm, dz=5mm

Reference Value = 52.3 V/m; Power Drift = 0.105 dB

Peak SAR (extrapolated) = 7.05 W/kg

SAR(1 g) = 3.89 mW/g; SAR(10 g) = 1.89 mW/g

Maximum value of SAR (measured) = 3.96 mW/g

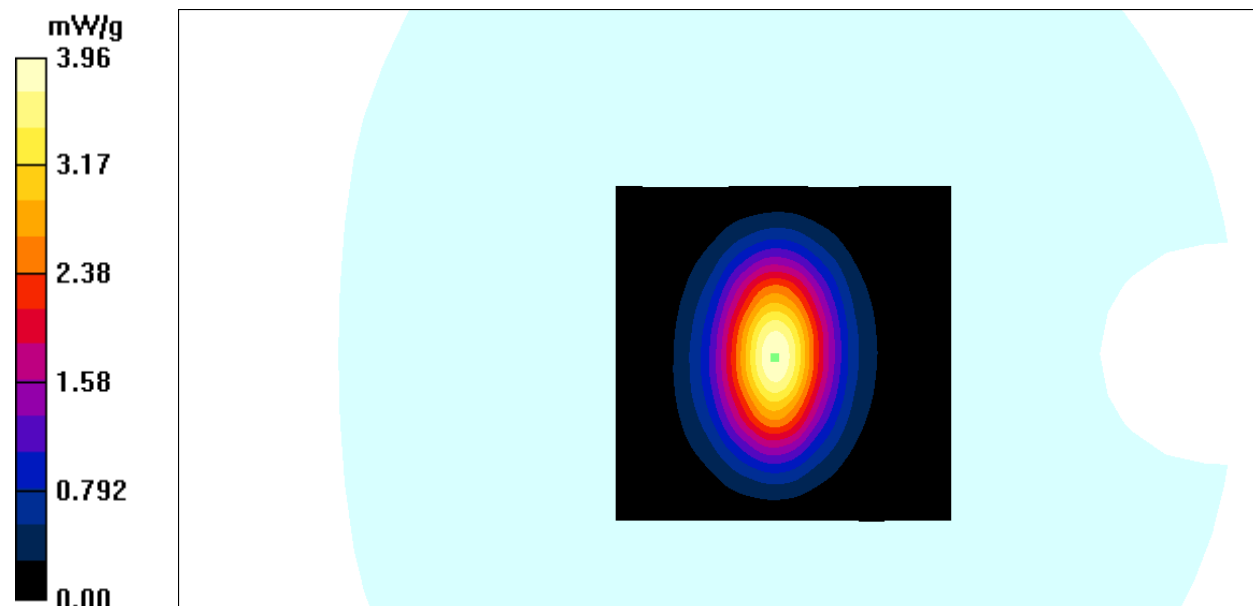

Test Laboratory: Bay Area Compliance Labs Corp. (Shenzhen)

DUT: Dipole 1900 MHz; Type: ALS-D-1900-S-2; S/N: 210-00710

Program Name: 1900MHz Body

Communication System: CW; Frequency: 1900 MHz; Duty Cycle: 1:1

Medium parameters used: $f = 1900 \text{ MHz}$; $\sigma = 1.50 \text{ S/m}$; $\epsilon_r = 52.48$; $\rho = 1000 \text{ kg/m}^3$

Phantom section: Flat Section

DASY4 Configuration:

- Probe: ES3DV3 - SN3036; ConvF(4.79, 4.79, 4.79); Calibrated: 16/9/2016
- Sensor-Surface: 4mm (Mechanical Surface Detection)
- Electronics: Dummy DAE – SN456; Calibrated: 12/9/2016
- Phantom: TWIN SAM; Type: QD000P40CA; Serial: TP-1218
- Measurement SW: DASY4, V4.5 Build 19; Postprocessing SW: SEMCAD, V1.8 Build 145

1900 Body system check/Area Scan (71x91x1): Measurement grid: $dx=10\text{mm}$, $dy=10\text{mm}$

Maximum value of SAR (interpolated) = 4.39 mW/g

1900 Body system check/Zoom Scan (7x7x7)/Cube 0: Measurement grid: $dx=5\text{mm}$, $dy=5\text{mm}$, $dz=5\text{mm}$

Reference Value = 50.9 V/m; Power Drift = -0.11 dB

Peak SAR (extrapolated) = 6.95 W/kg

SAR(1 g) = 3.90 mW/g; SAR(10 g) = 1.91 mW/g

Maximum value of SAR (measured) = 4.08 mW/g

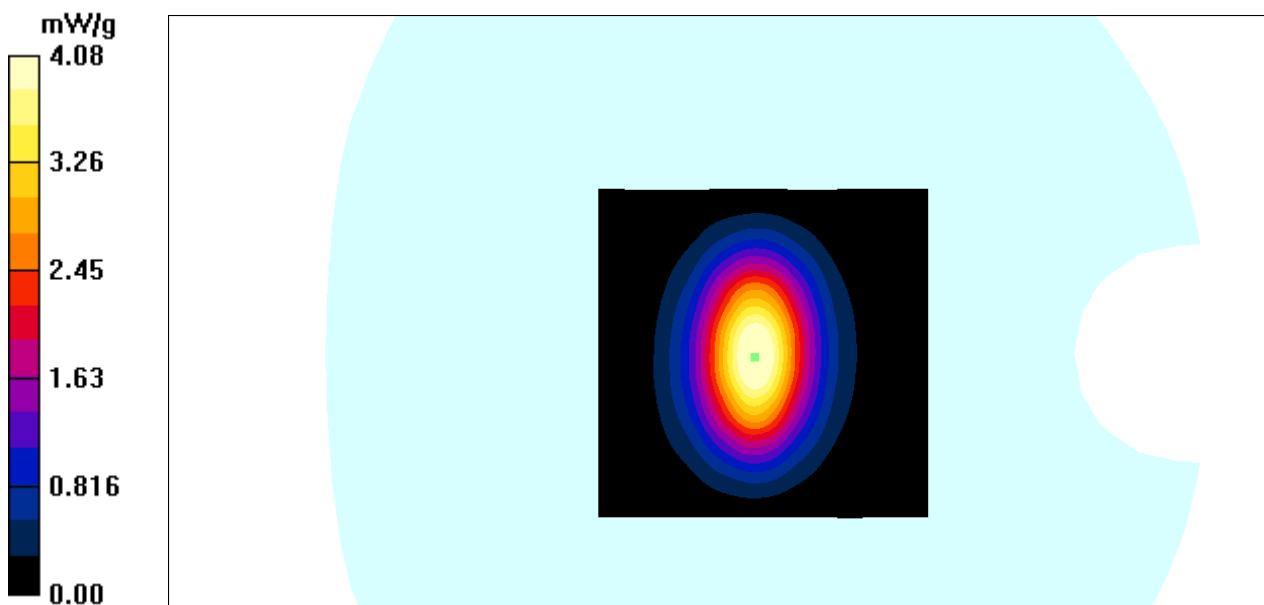

Performed on 2016-10-13:

Test Laboratory: Bay Area Compliance Labs Corp. (Shenzhen)
DUT: Dipole 1750 MHz; Type: ALS-D-1750-S-2; S/N: 198-00304
Program Name: 1750MHz Head

Communication System: CW; Frequency: 1750 MHz; Duty Cycle: 1:1
 Medium parameters used: $f = 1750 \text{ MHz}$; $\sigma = 1.40 \text{ S/m}$; $\epsilon_r = 39.91$; $\rho = 1000 \text{ kg/m}^3$
 Phantom section: Flat Section

DASY4 Configuration:

- Probe: ES3DV3 - SN3036; ConvF(5.34, 5.34, 5.34); Calibrated: 16/9/2016
- Sensor-Surface: 4mm (Mechanical Surface Detection)
- Electronics: Dummy DAE – SN456; Calibrated: 12/9/2016
- Phantom: TWIN SAM; Type: QD000P40CA; Serial: TP-1218
- Measurement SW: DASY4, V4.5 Build 19; Postprocessing SW: SEMCAD, V1.8 Build 145

1750 head system check/Area Scan (91x111x1): Measurement grid: $dx=10\text{mm}$, $dy=10\text{mm}$
 Maximum value of SAR (interpolated) = 3.78 mW/g

1750 head system check/Zoom Scan (7x7x7)/Cube 0: Measurement grid: $dx=5\text{mm}$, $dy=5\text{mm}$, $dz=5\text{mm}$
 Reference Value = 46.9 V/m; Power Drift = -0.131 dB
 Peak SAR (extrapolated) = 5.96 W/kg
SAR(1 g) = 3.58 mW/g; SAR(10 g) = 1.85 mW/g
 Maximum value of SAR (measured) = 3.67 mW/g

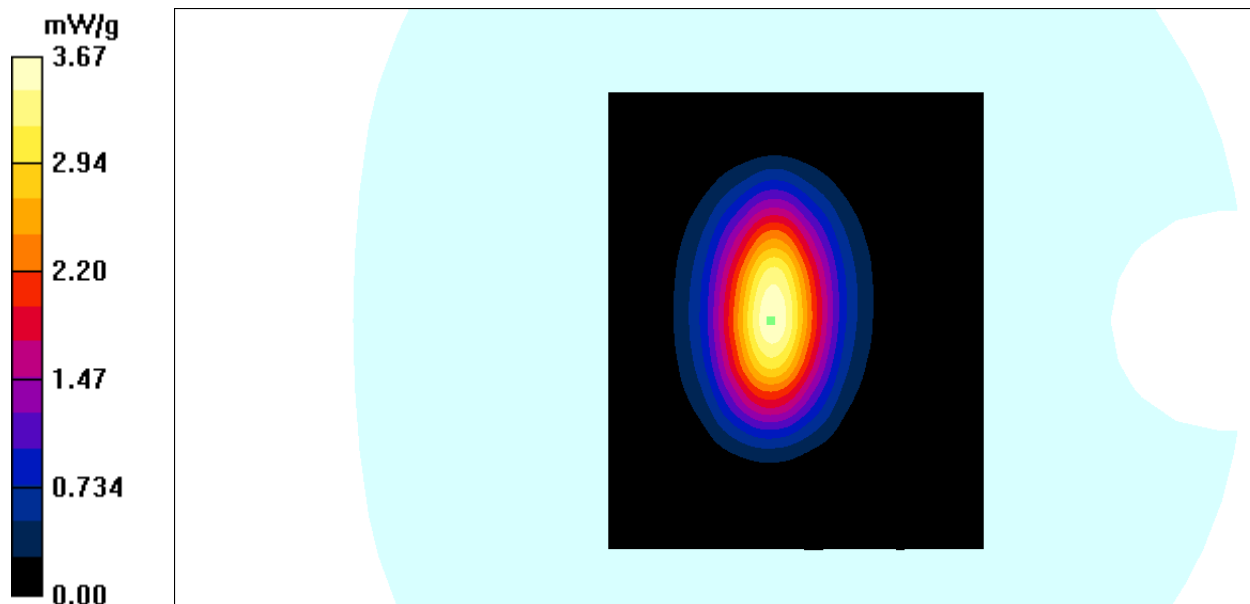

Test Laboratory: Bay Area Compliance Labs Corp.(Shenzhen)
DUT: Dipole 1750 MHz; Type: ALS-D-1750-S-2; S/N: 198-00304
Program Name: 1750MHz Body

Communication System: CW; Frequency: 1750 MHz; Duty Cycle: 1:1
 Medium parameters used: $f = 1750 \text{ MHz}$; $\sigma = 1.49 \text{ S/m}$; $\epsilon_r = 52.66$; $\rho = 1000 \text{ kg/m}^3$
 Phantom section: Flat Section

DASY4 Configuration:

- Probe: ES3DV3 - SN3036; ConvF(5.04, 5.04, 5.04); Calibrated: 16/9/2016
- Sensor-Surface: 4mm (Mechanical Surface Detection)
- Electronics: Dummy DAE – SN456; Calibrated: 12/9/2016
- Phantom: TWIN SAM; Type: QD000P40CA; Serial: TP-1218
- Measurement SW: DASY4, V4.5 Build 19; Postprocessing SW: SEMCAD, V1.8 Build 145

1750 Body system check/Area Scan (91x101x1): Measurement grid: $dx=10\text{mm}$, $dy=10\text{mm}$
 Maximum value of SAR (interpolated) = 3.98 mW/g

1750 Body system check/Zoom Scan (7x7x7)/Cube 0: Measurement grid: $dx=5\text{mm}$, $dy=5\text{mm}$, $dz=5\text{mm}$
 Reference Value = 49.3 V/m; Power Drift = -0.058 dB
 Peak SAR (extrapolated) = 6.33 W/kg
SAR(1 g) = 3.62 mW/g; SAR(10 g) = 1.83 mW/g
 Maximum value of SAR (measured) = 3.74 mW/g

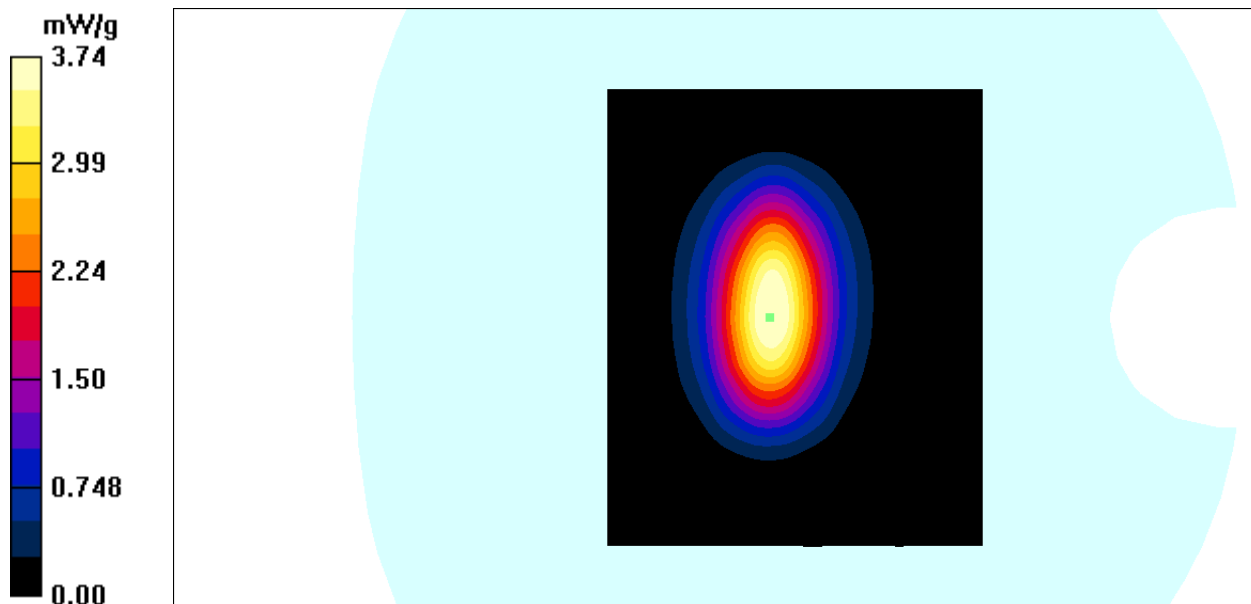

Performed on 2016-11-08:

Test Laboratory: Bay Area Compliance Labs Corp.(Shenzhen)

DUT: Dipole 2600 MHz; Type: D2600V2; S/N: 1073

Program Name: 2600MHz Head

Communication System: CW; Frequency: 2600 MHz; Duty Cycle: 1:1

Medium parameters used: $f = 2600$ MHz; $\sigma = 1.82$ S/m; $\epsilon_r = 40.16$; $\rho = 1000$ kg/m³

Phantom section: Flat Section

DASY4 Configuration:

- Probe: EX3DV4 - SN7431; ConvF(7.44, 7.44, 7.44); Calibrated: 04/10/2016

- Sensor-Surface: 4mm (Mechanical Surface Detection)

- Electronics: Dummy DAE – SN456; Calibrated: 12/9/2016

- Phantom: TWIN SAM; Type: QD000P40CA; Serial: TP-1218

- Measurement SW: DASY4, V4.5 Build 19; Postprocessing SW: SEMCAD, V1.8 Build 145

2600 head system check/Area Scan (81x101x1): Measurement grid: dx=10mm, dy=10mm

Maximum value of SAR (interpolated) = 6.55 mW/g

2600 head system check/Zoom Scan (7x7x7)/Cube 0: Measurement grid: dx=5mm, dy=5mm, dz=5mm

Reference Value = 57.4 V/m; Power Drift = 0.072 dB

Peak SAR (extrapolated) = 11.7 W/kg

SAR(1 g) = 5.62 mW/g; SAR(10 g) = 2.61 mW/g

Maximum value of SAR (measured) = 6.52 mW/g

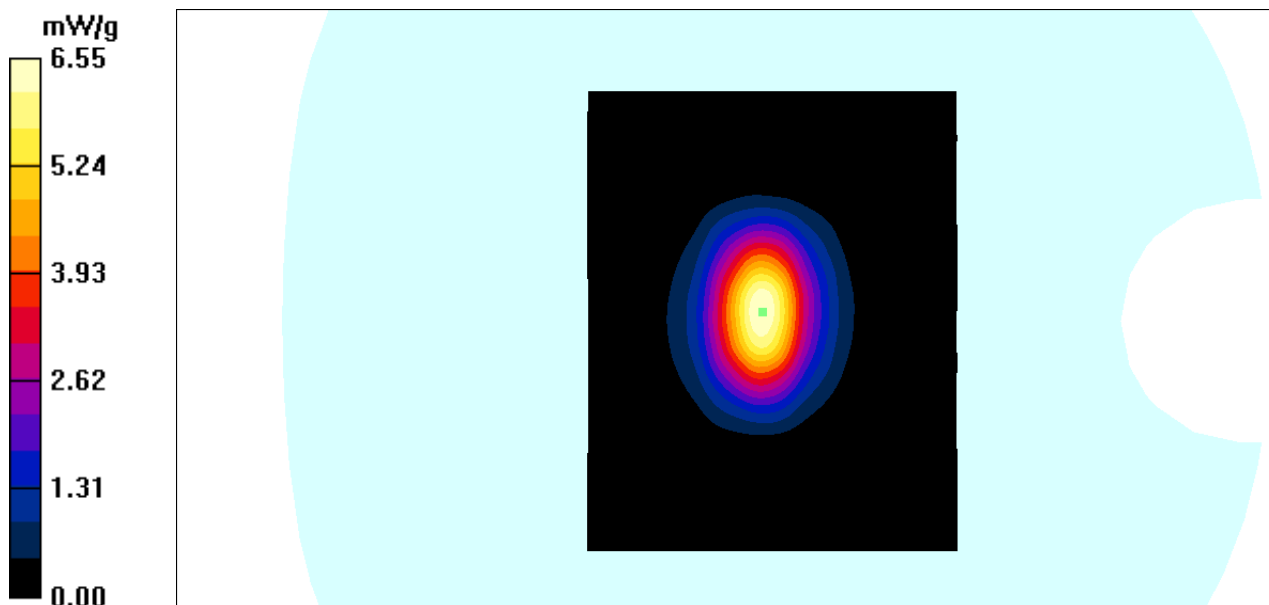

Test Laboratory: Bay Area Compliance Labs Corp.(Shenzhen)

DUT: Dipole 2600 MHz; Type: D2600V2; S/N: 1073

Program Name: 2600MHz Body

Communication System: CW; Frequency: 2600 MHz;Duty Cycle: 1:1

Medium parameters used: $f = 2600$ MHz; $\sigma = 1.98$ S/m; $\epsilon_r = 54.22$; $\rho = 1000$ kg/m³

Phantom section: Flat Section

DASY4 Configuration:

- Probe: EX3DV4 - SN7431; ConvF(7.47, 7.47, 7.47); Calibrated: 04/10/2016
- Sensor-Surface: 4mm (Mechanical Surface Detection)
- Electronics: Dummy DAE – SN456; Calibrated: 12/9/2016
- Phantom: TWIN SAM; Type: QD000P40CA; Serial: TP-1218
- Measurement SW: DASY4, V4.5 Build 19; Postprocessing SW: SEMCAD, V1.8 Build 145

2600 Body system check/Area Scan (81x101x1): Measurement grid: dx=10mm, dy=10mm

Maximum value of SAR (interpolated) = 6.37 mW/g

2600 Body system check/Zoom Scan (7x7x7)/Cube 0: Measurement grid: dx=5mm, dy=5mm, dz=5mm

Reference Value = 56.9 V/m; Power Drift = -0.154 dB

Peak SAR (extrapolated) = 11.1 W/kg

SAR(1 g) = 5.51 mW/g; SAR(10 g) = 2.57 mW/g

Maximum value of SAR (measured) = 6.23 mW/g

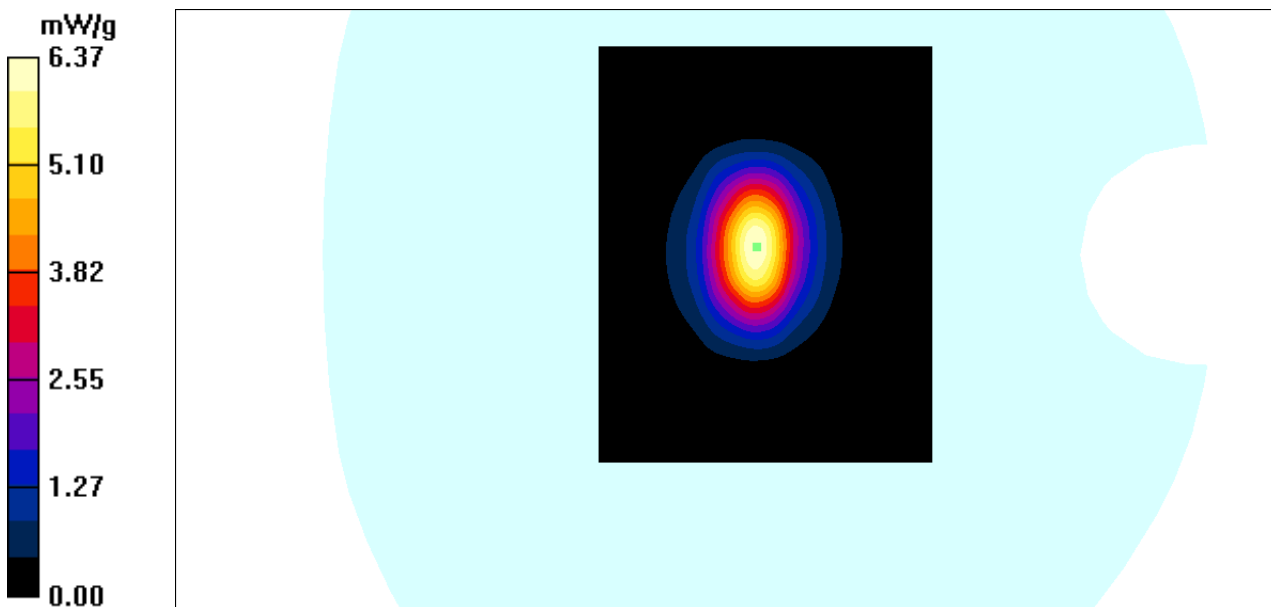

EUT TEST STRATEGY AND METHODOLOGY

Test Positions for Device Operating Next to a Person’s Ear

This category includes most wireless handsets with fixed, retractable or internal antennas located toward the top half of the device, with or without a foldout, sliding or similar keypad cover. The handset should have its earpiece located within the upper ¼ of the device, either along the centerline or off-centered, as perceived by its users. This type of handset should be positioned in a normal operating position with the “test device reference point” located along the “vertical centerline” on the front of the device aligned to the “ear reference point”. The “test device reference point” should be located at the same level as the center of the earpiece region. The “vertical centerline” should bisect the front surface of the handset at its top and bottom edges. A “ear reference point” is located on the outer surface of the head phantom on each ear spacer. It is located 1.5 cm above the center of the ear canal entrance in the “phantom reference plane” defined by the three lines joining the center of each “ear reference point” (left and right) and the tip of the mouth.

A handset should be initially positioned with the earpiece region pressed against the ear spacer of a head phantom. For the SCC-34/SC-2 head phantom, the device should be positioned parallel to the “N-F” line defined along the base of the ear spacer that contains the “ear reference point”. For interim head phantoms, the device should be positioned parallel to the cheek for maximum RF energy coupling. The “test device reference point” is aligned to the “ear reference point” on the head phantom and the “vertical centerline” is aligned to the “phantom reference plane”. This is called the “initial ear position”. While maintaining these three alignments, the body of the handset is gradually adjusted to each of the following positions for evaluating SAR:

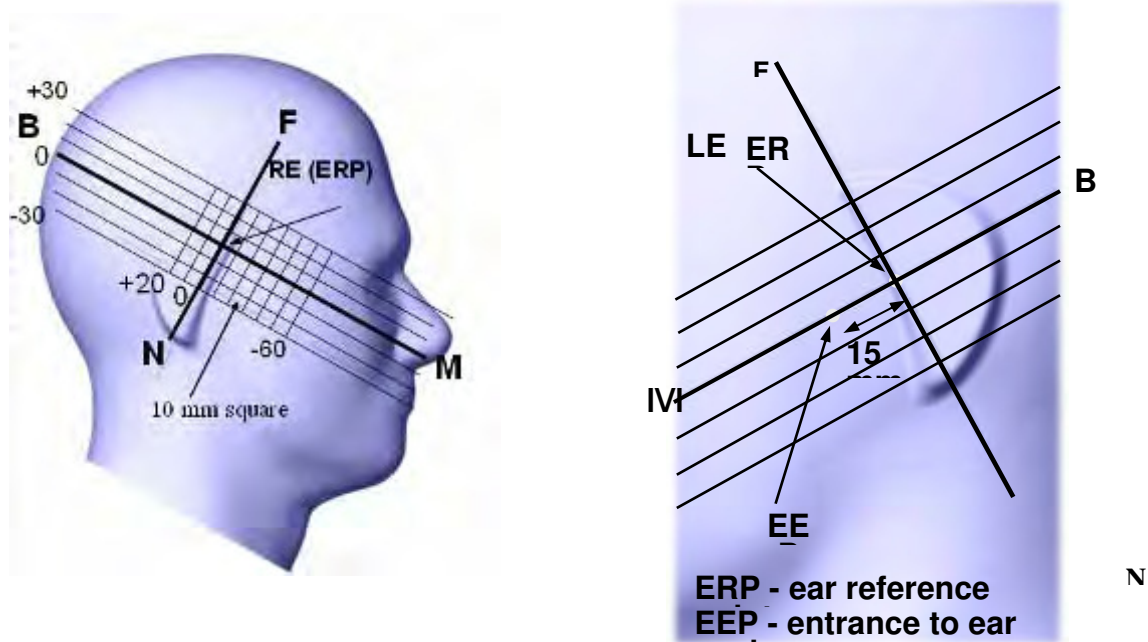

Cheek/Touch Position

The device is brought toward the mouth of the head phantom by pivoting against the “ear reference point” or along the “N-F” line for the SCC-34/SC-2 head phantom.

This test position is established:

- When any point on the display, keypad or mouthpiece portions of the handset is in contact with the phantom.
- (or) When any portion of a foldout, sliding or similar keypad cover opened to its intended self-adjusting normal use position is in contact with the cheek or mouth of the phantom.

For existing head phantoms – when the handset loses contact with the phantom at the pivoting point, rotation should continue until the device touches the cheek of the phantom or breaks its last contact from the ear spacer.

Cheek /Touch Position

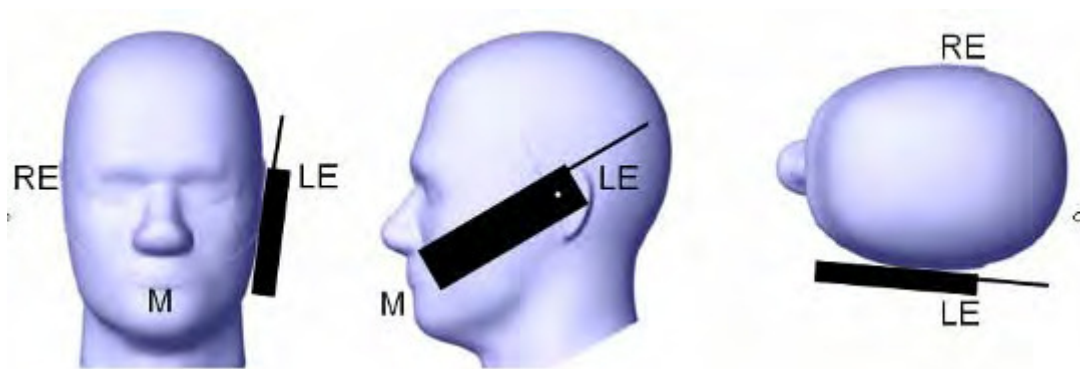

Ear/Tilt Position

With the handset aligned in the “Cheek/Touch Position”:

1) If the earpiece of the handset is not in full contact with the phantom’s ear spacer (in the “Cheek/Touch position”) and the peak SAR location for the “Cheek/Touch” position is located at the ear spacer region or corresponds to the earpiece region of the handset, the device should be returned to the “initial ear position” by rotating it away from the mouth until the earpiece is in full contact with the ear spacer.

2) (otherwise) The handset should be moved (translated) away from the cheek perpendicular to the line passes through both “ear reference points” (note: one of these ear reference points may not physically exist on a split head model) for approximate 2-3 cm. While it is in this position, the device handset is tilted away from the mouth with respect to the “test device reference point” until the inside angle between the vertical centerline on the front surface of the phone and the horizontal line passing through the ear reference point is by 15 80°. After the tilt, it is then moved (translated) back toward the head perpendicular to the line passes through both “ear reference points” until the device touches the phantom or the ear spacer. If the antenna touches the head first, the positioning process should be repeated with a tilt angle less than 15° so that the device and its antenna would touch the phantom simultaneously. This test position may require a device holder or positioner to achieve the translation and tilting with acceptable positioning repeatability.

If a device is also designed to transmit with its keypad cover closed for operating in the head position, such positions should also be considered in the SAR evaluation. The device should be tested on the left and right side of the head phantom in the “Cheek/Touch” and “Ear/Tilt” positions. When applicable, each configuration should be tested with the antenna in its fully extended and fully retracted positions. These test configurations should be tested at the high, middle and low frequency channels of each operating mode; for example, AMPS, CDMA, and TDMA. If the SAR measured at the middle channel for each test configuration (left, right, Cheek/Touch, Tile/Ear, extended and retracted) is at least 2.0 dB lower than the SAR limit, testing at the high and low channels is optional for such test configuration(s). If the transmission band of the test device is less than 10 MHz, testing at the high and low frequency channels is optional.

Ear /Tilt 15° Position

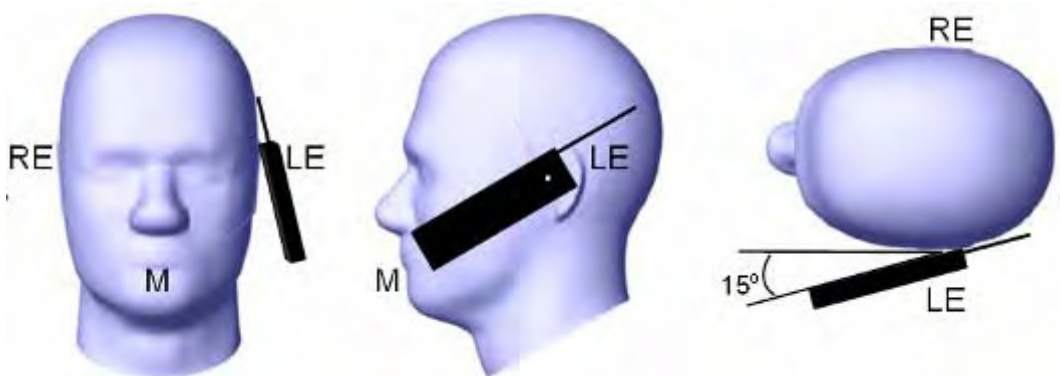

Test positions for body-worn and other configurations

Body-worn operating configurations should be tested with the belt-clips and holsters attached to the device and positioned against a flat phantom in normal use configurations. Devices with a headset output should be tested with a headset connected to the device. When multiple accessories that do not contain metallic components are supplied with the device, the device may be tested with only the accessory that dictates the closest spacing to the body. When multiple accessories that contain metallic components are supplied with the device, the device must be tested with each accessory that contains a unique metallic component. If multiple accessories share an identical metallic component (e.g., the same metallic belt-clip used with different holsters with no other metallic components), only the accessory that dictates the closest spacing to the body must be tested.

Body-worn accessories may not always be supplied or available as options for some devices that are intended to be authorized for body-worn use. A separation distance of 1.5 cm between the back of the device and a flat phantom is recommended for testing body-worn SAR compliance under such circumstances. Other separation distances may be used, but they should not exceed 2.5 cm. In these cases, the device may use body-worn accessories that provide a separation distance greater than that tested for the device provided however that the accessory contains no metallic components.

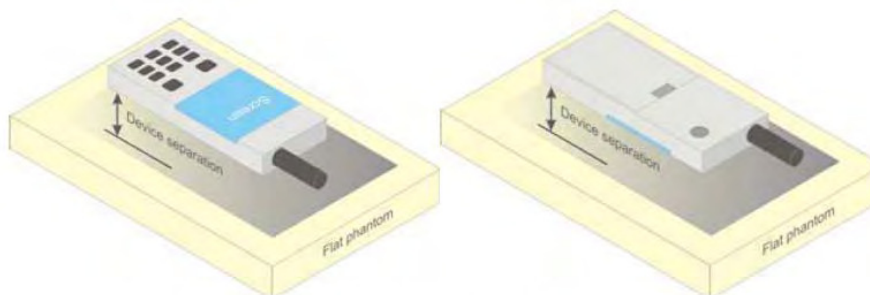

Figure 5 – Test positions for body-worn devices

SAR Evaluation Procedure

The evaluation was performed with the following procedure:

Step 1: Measurement of the SAR value at a fixed location above the ear point or central position was used as a reference value for assessing the power drop. The SAR at this point is measured at the start of the test and then again at the end of the testing.

Step 2: The SAR distribution at the exposed side of the head was measured at a distance of 4 mm from the inner surface of the shell. The area covered the entire dimension of the head or EUT and the horizontal grid spacing was 10 mm x 10 mm. Based on these data, the area of the maximum absorption was determined by spline interpolation. The first Area Scan covers the entire dimension of the EUT to ensure that the hotspot was correctly identified.

Step 3: Around this point, a volume of 30 mm x 30 mm x 30 mm was assessed by measuring 7x 7 x 7 points. On the basis of this data set, the spatial peak SAR value was evaluated under the following procedure:

- 1) The data at the surface were extrapolated, since the center of the dipoles is 1.2 mm away from the tip of the probe and the distance between the surface and the lowest measuring point is 1.3 mm. The extrapolation was based on a least square algorithm. A polynomial of the fourth order was calculated through the points in z-axes. This polynomial was then used to evaluate the points between the surface and the probe tip.
- 2) The maximum interpolated value was searched with a straightforward algorithm. Around this maximum the SAR values averaged over the spatial volumes (1 g or 10 g) were computed by the 3D-Spline interpolation algorithm. The 3D-Spline is composed of three one dimensional splines with the "Not a knot"-condition (in x, y and z-directions). The volume was integrated with the trapezoidal-algorithm. One thousand points (10 x 10 x 10) were interpolated to calculate the averages.

All neighboring volumes were evaluated until no neighboring volume with a higher average value was found.

Step 4: Re-measurement of the SAR value at the same location as in Step 1. If the value changed by more than 5%, the evaluation was repeated.

Test methodology

KDB 447498 D01 General RF Exposure Guidance v06.
KDB 648474 D04 Handset SAR v01r03.
KDB 865664 D01 SAR measurement 100 MHz to 6 GHz v01r04
KDB 865664 D02 RF Exposure Reporting v01r02
KDB 941225 D01 3G SAR Procedures v03r01
KDB 941225 D05 SAR for LTE Devices v02r03
KDB 941225 D06 Hotspot Mode v02r01

CONDUCTED OUTPUT POWER MEASUREMENT

Provision Applicable

The measured peak output power should be greater and within 5% than EMI measurement.

Test Procedure

The RF output of the transmitter was connected to the input of the EMI Test Receiver through sufficient attenuation.

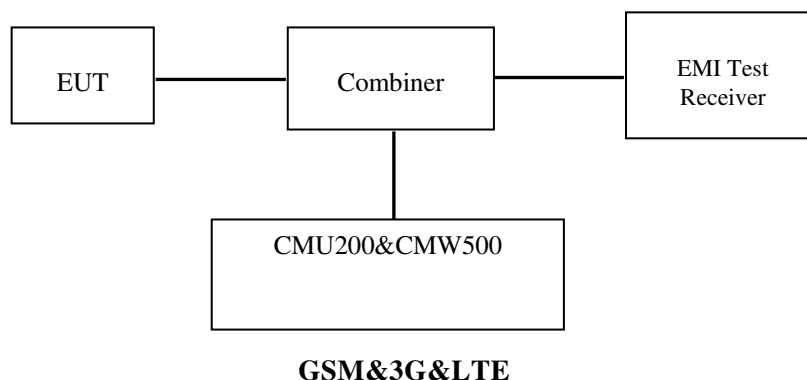

Radio Configuration

The power measurement was configured by the Wireless Communication Test Set CMU200 for all Radio configurations.

GSM

Function: Menu select > GSM Mobile Station > GSM 850/1900

Press Connection control to choose the different menus

Press RESET > choose all the reset all settings

Connection: Press Signal Off to turn off the signal and change settings

Network Support > GSM + only

MS Signal

> 33 dBm for GSM 850

> 30 dBm for PCS 1900

BS Signal: Enter the same channel number for TCH channel (test channel) and BCCH channel

Frequency Offset >+ 0 Hz

Mode > BCCH and TCH

BCCH Level > -85 dBm (May need to adjust if link is not stable)

BCCH Channel > choose desired test channel [Enter the same channel number for TCH channel (test channel) and BCCH channel]

Channel Type > Off

P0 > 4 dB

TCH > choose desired test channel

Hopping > Off

AF/RF: Enter appropriate offsets for Ext. Att. Output and Ext. Att. Input

Connection: Press Signal on to turn on the signal and change settings

GPRS

Function: Menu select > GSM Mobile Station > GSM 850/1900

Press Connection control to choose the different menus

Press RESET > choose all the reset all settings

Connection: Press Signal Off to turn off the signal and change settings

Network Support > GSM + GPRS or GSM + EGSM

Main Service > Packet Data

Service selection > Test Mode A – Auto Slot Config. off

MS Signal: Press Slot Config Bottom on the right twice to select and change the number of time slots and power setting

> Slot configuration > Uplink/Gamma

> 33 dBm for GPRS 850

> 30 dBm for GPRS 1900

BS Signal: Enter the same channel number for TCH channel (test channel) and BCCH channel

Frequency Offset >+ 0 Hz

Mode >BCCH and TCH

BCCH Level >-85 dBm (May need to adjust if link is not stable)

BCCH Channel > choose desired test channel [Enter the same channel number for TCH channel (test channel) and BCCH channel]

Channel Type > Off

P0 > 4 dB

Slot Config > Unchanged (if already set under MS signal)

TCH > choose desired test channel

Hopping >Off

Main Timeslot >3

Network: Coding Scheme >CS4 (GPRS)

Bit Stream >2E9-1 PSR Bit Stream

AF/RF: Enter appropriate offsets for Ext. Att. Output and Ext. Att. Input

Connection: Press Signal on to turn on the signal and change settings.

EGPRS

Function: Menu select > GSM Mobile Station > GSM 850/1900

Press Connection control to choose the different menus

Press RESET > choose all the reset all settings

Connection: Press Signal Off to turn off the signal and change settings

Network Support > GSM + EGPRS

Main Service > Packet Data

Service selection > Test Mode A – Auto Slot Config. off

MS Signal: Press Slot Config Bottom on the right twice to select and change the number of time slots and power setting

> Slot configuration > Uplink/Gamma

> 27 dBm for EGPRS 850

> 25 dBm for EGPRS 1900

BS Signal: Enter the same channel number for TCH channel (test channel) and BCCH channel

Frequency Offset >+ 0 Hz

Mode >BCCH and TCH

BCCH Level >-85 dBm (May need to adjust if link is not stable)

BCCH Channel > choose desired test channel [Enter the same channel number for TCH channel (test channel) and BCCH channel]

Channel Type > Off

P0 > 4 dB

Slot Config > Unchanged (if already set under MS signal)

TCH > choose desired test channel

Hopping >Off

Main Timeslot >3

Network: Coding Scheme >MCS5 (EGPRS)

Bit Stream >2E9-1 PSR Bit Stream

AF/RF: Enter appropriate offsets for Ext. Att. Output and Ext. Att. Input

Connection: Press Signal on to turn on the signal and change settings

WCDMA Release 99

The following tests were conducted according to the test requirements outlines in section 5.2 of the 3GPP TS34.121-1 specification. The EUT has a nominal maximum output power of 24dBm (+1.7/-3.7).

WCDMA General Settings	Loopback Mode	Test Mode 1
	Rel99 RMC	12.2kbps RMC
	Power Control Algorithm	Algorithm2
	β_c / β_d	8/15

HSDPA

The following tests were conducted according to the test requirements outlines in section 5.2 of the 3GPP TS34.121-1 specification.

	Mode	HSDPA	HSDPA	HSDPA	HSDPA
	Subset	1	2	3	4
WCDMA General Settings	Loopback Mode	Test Mode 1			
	Rel99 RMC	12.2kbps RMC			
	HSDPA FRC	H-Set1			
	Power Control Algorithm	Algorithm2			
	β_c	2/15	12/15	15/15	15/15
	β_d	15/15	15/15	8/15	4/15
	β_d (SF)	64			
	β_c / β_d	2/15	12/15	15/8	15/4
	β_{hs}	4/15	24/15	30/15	30/15
	MPR(dB)	0	0	0.5	0.5
HSDPA Specific Settings	DACK	8			
	DNAK	8			
	DCQI	8			
	Ack-Nack repetition factor	3			
	CQI Feedback	4ms			
	CQI Repetition Factor	2			
	A _{hs} = β_{hs} / β_c	30/15			

HSPA+

The following tests were conducted according to the test requirements in Table C.11.1.4 of 3GPP TS 34.121-1

Sub-test	β_c (Note3)	β_d	β_{hs} (Note1)	β_{ec}	β_{ed} (2xSF2) (Note 4)	β_{ed} (2xSF4) (Note 4)	CM (dB) (Note 2)	MPR (dB) (Note 2)	AG Index (Note 4)	E-TFCI (Note 5)	E-TFCI (boost)
1	1	0	30/15	30/15	β_{ed1} : 30/15 β_{ed2} : 30/15	β_{ed3} : 24/15 β_{ed4} : 24/15	3.5	2.5	14	105	105

- Note 1: $\Delta_{ACK}, \Delta_{NACK}$ and $\Delta_{CQI} = 30/15$ with $\beta_{hs} = 30/15 * \beta_c$.
- Note 2: CM = 3.5 and the MPR is based on the relative CM difference, MPR = MAX(CM-1,0).
- Note 3: DPDCH is not configured, therefore the β_c is set to 1 and $\beta_d = 0$ by default.
- Note 4: β_{ed} can not be set directly; it is set by Absolute Grant Value.
- Note 5: All the sub-tests require the UE to transmit 2SF2+2SF4 16QAM EDCH and they apply for UE using E-DPDCH category 7. E-DCH TTI is set to 2ms TTI and E-DCH table index = 2. To support these E-DCH configurations DPDCH is not allocated. The UE is signalled to use the extrapolation algorithm.

HSUPA

The following tests were conducted according to the test requirements outlines in section 5.2 of the 3GPP TS34.121-1 specification.

	Mode	HSUPA	HSUPA	HSUPA	HSUPA	HSUPA
	Subset	1	2	3	4	5
WCDMA General Settings	Loopback Mode	Test Mode 1				
	Rel99 RMC	12.2kbps RMC				
	HSDPA FRC	H-Set1				
	HSUPA Test	HSUPA Loopback				
	Power Control Algorithm	Algorithm2				
	β_c	11/15	6/15	15/15	2/15	15/15
	β_d	15/15	15/15	9/15	15/15	0
	β_{ec}	209/225	12/15	30/15	2/15	5/15
	β_c/β_d	11/15	6/15	15/9	2/15	-
	β_{hs}	22/15	12/15	30/15	4/15	5/15
	CM(dB)	1.0	3.0	2.0	3.0	1.0
MPR(dB)	0	2	1	2	0	
HSDPA Specific Settings	DACK	8				
	DNAK	8				
	DCQI	8				
	Ack-Nack repetition factor	3				
	CQI Feedback	4ms				
	CQI Repetition Factor	2				
	$A_{hs}=\beta_{hs}/\beta_c$	30/15				
HSUPA Specific Settings	DE-DPCCH	6	8	8	5	7
	DHARQ	0	0	0	0	0
	AG Index	20	12	15	17	21
	ETFCI	75	67	92	71	81
	Associated Max UL Data Rate kbps	242.1	174.9	482.8	205.8	308.9
	Reference E_FCIs	E-TFCI 11 E E-TFCI PO 4 E-TFCI 67 E-TFCI PO 18 E-TFCI 71 E-TFCI PO23 E-TFCI 75 E-TFCI PO26 E-TFCI 81 E-TFCI PO 27	E-TFCI 11 E-TFCI PO4 E-TFCI 92 E-TFCI PO 18	E-TFCI 11 E E-TFCI PO 4 E-TFCI 67 E-TFCI PO 18 E-TFCI 71 E-TFCI PO23 E-TFCI 75 E-TFCI PO26 E-TFCI 81 E-TFCI PO 27		

LTE

For UE Power Class 1 and 3, the allowed Maximum Power Reduction (MPR) for the maximum output power in Table 6.2.2-1 due to higher order modulation and transmit bandwidth configuration (resource blocks) is specified in Table 6.2.3-1.

Table 6.2.3-1: Maximum Power Reduction (MPR) for Power Class 1 and 3

Modulation	Channel bandwidth / Transmission bandwidth (N_{RB})						MPR (dB)
	1.4 MHz	3.0 MHz	5 MHz	10 MHz	15 MHz	20 MHz	
QPSK	> 5	> 4	> 8	> 12	> 16	> 18	≤ 1
16 QAM	≤ 5	≤ 4	≤ 8	≤ 12	≤ 16	≤ 18	≤ 1
16 QAM	> 5	> 4	> 8	> 12	> 16	> 18	≤ 2

For UE Power Class 1 and 3 the specific requirements and identified subclauses are specified in Table 6.2.4-1 along with the allowed A-MPR values that may be used to meet these requirements. The allowed A-MPR values specified below in Table 6.2.4.-1 to 6.2.4-15 are in addition to the allowed MPR requirements specified in subclause 6.2.3.

Table 6.2.4-1: Additional Maximum Power Reduction (A-MPR)

Network Signalling value	Requirements (subclause)	E-UTRA Band	Channel bandwidth (MHz)	Resources Blocks (N_{RB})	A-MPR (dB)
NS_01	6.6.2.1.1	Table 5.5-1	1.4, 3, 5, 10, 15, 20	Table 5.6-1	N/A
NS_03	6.6.2.2.1	2, 4, 10, 23, 25, 35, 36	3	>5	≤ 1
			5	>6	≤ 1
			10	>6	≤ 1
			15	>8	≤ 1
NS_04	6.6.2.2.2	41	20	>10	≤ 1
			5	>6	≤ 1
NS_05	6.6.3.3.1	1	10, 15, 20	≥ 50	≤ 1
NS_06	6.6.2.2.3	12, 13, 14, 17	1.4, 3, 5, 10	Table 5.6-1	N/A
NS_07	6.6.2.2.3 6.6.3.3.2	13	10	Table 6.2.4-2	
NS_08	6.6.3.3.3	19	10, 15	> 44	≤ 3
NS_09	6.6.3.3.4	21	10, 15	> 40	≤ 1
				> 55	≤ 2
NS_10		20	15, 20	Table 6.2.4-3	
NS_11	6.6.2.2.1	23	1.4, 3, 5, 10, 15, 20	Table 6.2.4-5	
NS_12	6.6.3.3.5	26	1.4, 3, 5	Table 6.2.4-6	
NS_13	6.6.3.3.6	26	5	Table 6.2.4-7	
NS_14	6.6.3.3.7	26	10, 15	Table 6.2.4-8	
NS_15	6.6.3.3.8	26	1.4, 3, 5, 10, 15	Table 6.2.4-9 Table 6.2.4-10	
NS_16	6.6.3.3.9	27	3, 5, 10	Table 6.2.4-11, Table 6.2.4-12, Table 6.2.4-13	
NS_17	6.6.3.3.10	28	5, 10	Table 5.6-1	N/A
NS_18	6.6.3.3.11	28	5	≥ 2	≤ 1
			10, 15, 20	≥ 1	≤ 4
NS_19	6.6.3.3.12	44	10, 15, 20	Table 6.2.4-14	
NS_20	6.2.2 6.6.2.2.1 6.6.3.2	23	5, 10, 15, 20	Table 6.2.4-15	
...					
NS_32	-	-	-	-	-

Wi-Fi

For 802.11b, 802.11g and 802.11n-HT20 mode, 11 channels are provided to testing:

Channel	Frequency (MHz)	Channel	Frequency (MHz)
1	2412	8	2447
2	2417	9	2452
3	2422	10	2457
4	2427	11	2462
5	2432	12	2467
6	2437	13	2472
7	2442	/	/

For 802.11b, 802.11g, 802.11n-HT20 mode, EUT was tested with Channel 1, 7 and 13.

For 802.11n-HT40 mode, 7 channels are provided to testing:

Channel	Frequency (MHz)	Channel	Frequency (MHz)
1	2422	6	2447
2	2427	7	2452
3	2432	8	2457
4	2437	9	2462
5	2442	/	/

EUT was tested with Channel 1, and 9.

Maximum Output Power among production units

Max Target Power for Production Unit (dBm)			
Mode/Band	Channel		
	Low	Middle	High
GSM 850	31.9	31.9	31.9
GPRS 1 TX Slot	31.9	31.9	31.9
GPRS 2 TX Slot	31.0	31.0	31.0
GPRS 3 TX Slot	28.8	28.8	28.8
GPRS 4 TX Slot	27.0	27.0	27.0
EDGE 1 TX Slot	27.5	27.5	27.5
EDGE 2 TX Slot	26.2	26.2	26.2
EDGE 3 TX Slot	24.1	24.1	24.1
EDGE 4 TX Slot	23.0	23.0	23.0
PCS 1900	29.0	29.0	29.0
GPRS 1 TX Slot	29.0	29.0	29.0
GPRS 2 TX Slot	28.2	28.2	28.2
GPRS 3 TX Slot	26.3	26.3	26.3
GPRS 4 TX Slot	25.3	25.3	25.3
EDGE 1 TX Slot	26.2	26.2	26.2
EDGE 2 TX Slot	25.0	25.0	25.0
EDGE 3 TX Slot	23.3	23.3	23.3
EDGE 4 TX Slot	22.9	22.9	22.9
WCDMA 850	Rel 99	22.4	22.4
	HSDPA	21.0	21.0
	HSUPA	21.5	21.5
WCDMA 1700	Rel 99	22.4	22.8
	HSDPA	21.8	21.8
	HSUPA	21.9	21.9
WCDMA 1900	Rel 99	22.7	22.6
	HSDPA	21.9	21.9
	HSUPA	21.8	21.8
LTE Band 2	22.5	22.5	22.5
LTE Band 4	21.6	21.6	21.6
LTE Band 5	22.0	22.0	22.0
LTE Band 7	22.2	22.2	22.2
Wi-Fi	9.8	9.8	9.8
Bluetooth	0.1	0.1	0.1

Test Results:**GSM:**

Band	Frequency (MHz)	Conducted Output Power (dBm)
GSM 850	824.2	31.87
	836.6	31.72
	848.8	31.73
PCS 1900	1850.2	28.86
	1880.0	28.86
	1909.8	28.91

GPRS:

Band	Channel No.	Frequency (MHz)	RF Output Power (dBm)			
			1 slot	2 slots	3 slots	4 slots
GSM 850	128	824.2	31.87	30.94	28.77	26.92
	190	836.6	31.79	30.78	27.97	26.95
	251	848.8	31.66	30.69	27.85	26.91
PCS 1900	512	1850.2	28.88	27.95	26.12	25.05
	661	1880	28.78	28.04	26.06	25.03
	810	1909.8	28.99	28.13	26.32	25.21

EGPRS:

Band	Channel No.	Frequency (MHz)	RF Output Power (dBm)			
			1 slot	2 slots	3 slots	4 slots
GSM 850	128	824.2	27.54	26.25	24.16	22.83
	190	836.6	27.22	26.05	24.09	23.18
	251	848.8	27.27	26.04	24.01	22.90
PCS 1900	512	1850.2	26.23	25.11	23.32	22.80
	661	1880	25.67	24.58	22.69	21.64
	810	1909.8	25.51	24.43	22.75	21.58

For SAR, the time based average power is relevant, the difference in between depends on the duty cycle of the TDMA signal.

Number of Time slot	1	2	3	4
Duty Cycle	1:8	1:4	1:2.66	1:2
Time based Ave. power compared to slotted Ave. power	-9 dB	-6 dB	-4.25 dB	-3 dB
Crest Factor	8	4	2.66	2

The time based average power for GPRS

Band	Channel No.	Frequency (MHz)	Time based average Power (dBm)			
			1 slot	2 slot	3 slots	4 slots
GSM 850	128	824.2	22.87	24.94	24.52	23.92
	190	836.6	22.79	24.78	23.72	23.95
	251	848.8	22.66	24.69	23.60	23.91
PCS 1900	512	1850.2	19.88	21.95	21.87	22.05
	661	1880	19.78	22.04	21.81	22.03
	810	1909.8	19.99	22.13	22.07	22.21

The time based average power for EGPRS

Band	Channel No.	Frequency (MHz)	Time based average Power (dBm)			
			1 slot	2 slot	3 slots	4 slots
GSM 850	128	824.2	18.54	20.25	19.91	19.83
	190	836.6	18.22	20.05	19.84	20.18
	251	848.8	18.27	20.04	19.76	19.90
PCS 1900	512	1850.2	17.23	19.11	19.07	19.80
	661	1880	16.67	18.58	18.44	18.64
	810	1909.8	16.51	18.43	18.50	18.58

Note:

1. Rohde & Schwarz Radio Communication Tester (CMU200) was used for the measurement of GSM peak and average output power for active timeslots.
2. For GSM voice, 1 timeslot has been activated with power level 5 (850 MHz band) and 0 (1900 MHz band).
3. For GPRS, 1, 2, 3 and 4 timeslots has been activated separately with power level 3(850 MHz band) and 3(1900 MHz band).
4. For EGPRS, 1, 2, 3 and 4 timeslots has been activated separately with power level 6(850 MHz band) and 5(1900 MHz band).

Results (12.2kbps RMC)

WCDMA 850:

Test Condition	Test Mode	3GPP Sub Test	Averaged Mean Power (dBm)		
			Low Frequency	Mid Frequency	High Frequency
Normal	RMC12.2k		22.30	22.31	22.39
	Rel 6 HSDPA	1	21.24	21.17	21.38
		2	21.10	21.09	21.32
		3	21.30	21.20	21.50
		4	21.21	21.09	21.29
	Rel 6 HSUPA	1	21.21	21.25	21.32
		2	21.11	21.15	21.29
		3	21.29	21.33	21.39
		4	21.13	21.12	21.20
		5	21.30	21.27	21.42

WCDMA 1700:

Test Condition	Test Mode	3GPP Sub Test	Averaged Mean Power (dBm)		
			Low Frequency	Mid Frequency	High Frequency
Normal	RMC12.2k		22.38	22.72	22.56
	Rel 6 HSDPA	1	21.44	21.69	21.54
		2	21.35	21.64	21.50
		3	21.53	21.74	21.57
		4	21.40	21.57	21.42
	Rel 6 HSUPA	1	21.38	21.74	21.52
		2	21.25	21.66	21.44
		3	21.44	21.80	21.66
		4	21.40	21.60	21.43
		5	21.48	21.76	21.66

WCDMA 1900:

Test Condition	Test Mode	3GPP Sub Test	Averaged Mean Power (dBm)		
			Low Frequency	Mid Frequency	High Frequency
Normal	RMC12.2k		22.66	22.59	22.32
	Rel 6 HSDPA	1	21.73	21.60	21.39
		2	21.67	21.51	21.29
		3	21.84	21.65	21.44
		4	21.62	21.50	21.34
	Rel 6 HSUPA	1	21.70	21.56	21.38
		2	21.59	21.48	21.34
		3	21.75	21.65	21.43
		4	21.57	21.48	21.32
		5	21.72	21.62	21.45

Note:

1. The default test configuration is to measure SAR with an established radio link between the EUT and a communication test set using a 12.2 kbps RMC (reference measurement Channel) Configured in Test Loop Model 1.
2. KDB 941225 D01-Body SAR is not required for HSDPA/HSUPA when the maximum average output of each RF channel is less than ¼ dB higher than measured 12.2kbps RMC or the maximum SAR for 12.2kbps RMC is < 75% of SAR limit.

LTE Band 2:

BW	Modulation	Resource Block Size& Resource Block Offset	Target MPR	Meas MPR	Ave Tx Power (dBm)		
					Low Channel	Mid Channel	High Channel
1.4M	QPSK	RB Size=1, RB Offset=0	0	0	22.32	22.18	22.3
		RB Size=1, RB Offset=2	0	0	22.36	22.24	22.21
		RB Size=1, RB Offset=5	0	0	22.35	22.46	22.09
		RB Size=3, RB Offset=0	1	1	22	22.16	22.22
		RB Size=3, RB Offset=1	1	1	22.21	22.2	22.12
		RB Size=3, RB Offset=2	1	1	22.03	22.27	22.12
		RB Size=6, RB Offset=0	1	1	21.81	21.76	21.97
	16QAM	RB Size=1, RB Offset=0	1	1	21.87	21.96	22.06
		RB Size=1, RB Offset=2	1	1	22.27	22.24	22.42
		RB Size=1, RB Offset=5	1	1	22.14	22.08	22.16
		RB Size=3, RB Offset=0	2	2	22.19	22.31	22.44
		RB Size=3, RB Offset=1	2	2	21.86	22.13	22.11
		RB Size=3, RB Offset=2	2	2	22.25	22.39	22.14
		RB Size=6, RB Offset=0	2	2	22.01	22.27	22.31
3M	QPSK	RB Size=1, RB Offset=0	0	0	22.06	21.89	21.88
		RB Size=1, RB Offset=7	0	0	21.42	21.63	21.68
		RB Size=1, RB Offset=14	0	0	22.07	22.25	22.25
		RB Size=8, RB Offset=0	1	1	21.81	22.03	22.06
		RB Size=8, RB Offset=4	1	1	21.39	21.61	21.68
		RB Size=8, RB Offset=7	1	1	22.02	21.81	21.9
		RB Size=15, RB Offset=0	1	1	21.81	21.75	21.99
	16QAM	RB Size=1, RB Offset=0	1	1	21.78	21.91	21.92
		RB Size=1, RB Offset=7	1	1	22.51	21.92	21.99
		RB Size=1, RB Offset=14	1	1	21.89	21.88	21.83
		RB Size=8, RB Offset=0	2	2	21.91	21.86	22.12
		RB Size=8, RB Offset=4	2	2	22.09	22.32	22.26
		RB Size=8, RB Offset=7	2	2	21.94	22.08	22.19
		RB Size=15, RB Offset=0	2	2	21.9	22.02	22.1
5M	QPSK	RB Size=1, RB Offset=0	0	0	22.15	22.35	22.57
		RB Size=1, RB Offset=12	0	0	22.12	22.32	22.44
		RB Size=1, RB Offset=24	0	0	21.93	21.82	22.06
		RB Size=12, RB Offset=0	1	1	21.74	21.86	21.86
		RB Size=12, RB Offset=6	1	1	21.93	21.77	21.81
		RB Size=12, RB Offset=11	1	1	21.8	21.91	21.7
		RB Size=25, RB Offset=0	1	1	21.98	22.05	22.05
	16QAM	RB Size=1, RB Offset=0	1	1	21.73	21.78	22.08
		RB Size=1, RB Offset=12	1	1	21.7	21.76	21.94
		RB Size=1, RB Offset=24	1	1	21.73	21.96	21.96
		RB Size=12, RB Offset=0	2	2	20.97	21.14	21.24
		RB Size=12, RB Offset=6	2	2	20.72	20.97	20.73
		RB Size=12, RB Offset=11	2	2	21.94	21.85	21.93
		RB Size=25, RB Offset=0	2	2	21.62	21.72	21.9

LTE Band 2:

BW	Modulation	Resource Block Size & Resource Block Offset	Target MPR	Meas MPR	Ave Tx Power (dBm)		
					Low Channel	Mid Channel	High Channel
10M	QPSK	RB Size=1, RB Offset=0	0	0	22.26	22.18	22.41
		RB Size=1, RB Offset=24	0	0	22.05	22.28	22.32
		RB Size=1, RB Offset=49	0	0	22.26	22.37	22.21
		RB Size=25, RB Offset=0	1	1	22.20	22.15	22.38
		RB Size=25, RB Offset=12	1	1	22.22	22.12	22.35
		RB Size=25, RB Offset=24	1	1	21.95	21.91	22.07
		RB Size=50, RB Offset=0	1	1	22.11	22.06	22.06
	16QAM	RB Size=1, RB Offset=0	1	1	22.31	22.35	22.51
		RB Size=1, RB Offset=24	1	1	22.28	22.41	22.41
		RB Size=1, RB Offset=49	1	1	21.98	21.91	22.25
		RB Size=25, RB Offset=0	2	2	21.89	21.73	21.85
		RB Size=25, RB Offset=12	2	2	21.89	22.03	21.81
		RB Size=25, RB Offset=24	2	2	21.92	22.03	21.88
		RB Size=50, RB Offset=0	2	2	21.85	21.87	22.06
15M	QPSK	RB Size=1, RB Offset=0	0	0	22.14	21.87	21.96
		RB Size=1, RB Offset=37	0	0	21.66	21.79	21.85
		RB Size=1, RB Offset=74	0	0	21.71	21.97	21.83
		RB Size=36, RB Offset=0	1	1	22.11	22.33	22.41
		RB Size=36, RB Offset=18	1	1	22.12	22.06	22.10
		RB Size=36, RB Offset=37	1	1	21.93	21.84	21.86
		RB Size=75, RB Offset=0	1	1	22.15	22.18	22.37
	16QAM	RB Size=1, RB Offset=0	1	1	21.86	21.89	22.02
		RB Size=1, RB Offset=37	1	1	21.93	22.00	21.96
		RB Size=1, RB Offset=74	1	1	22.06	22.09	22.31
		RB Size=36, RB Offset=0	2	2	21.99	22.29	22.36
		RB Size=36, RB Offset=18	2	2	22.28	22.07	22.23
		RB Size=36, RB Offset=37	2	2	22.40	22.28	22.36
		RB Size=75, RB Offset=0	2	2	22.16	22.20	22.23
20M	QPSK	RB Size=1, RB Offset=0	0	0	22.32	22.37	22.43
		RB Size=1, RB Offset=49	0	0	21.71	21.90	21.80
		RB Size=1, RB Offset=99	0	0	22.13	21.91	22.03
		RB Size=50, RB Offset=0	1	1	21.56	21.61	21.66
		RB Size=50, RB Offset=24	1	1	22.07	22.06	22.15
		RB Size=50, RB Offset=49	1	1	21.92	22.10	22.12
		RB Size=100, RB Offset=0	1	1	21.55	21.50	21.55
	16QAM	RB Size=1, RB Offset=0	1	1	21.84	22.02	22.07
		RB Size=1, RB Offset=49	1	1	21.62	22.00	21.83
		RB Size=1, RB Offset=99	1	1	21.99	21.88	21.84
		RB Size=50, RB Offset=0	2	2	22.02	22.30	21.76
		RB Size=50, RB Offset=24	2	2	21.72	21.78	21.82
		RB Size=50, RB Offset=49	2	2	21.82	21.96	22.01
		RB Size=100, RB Offset=0	2	2	21.02	20.99	21.00

LTE Band 4:

BW	Modulation	Resource Block Size & Resource Block Offset	Target MPR	Meas MPR	Ave Tx Power (dBm)		
					Low Channel	Mid Channel	High Channel
1.4M	QPSK	RB Size=1, RB Offset=0	0	0	21.33	21.36	21.47
		RB Size=1, RB Offset=2	0	0	21.51	21.49	21.58
		RB Size=1, RB Offset=5	0	0	21.44	21.58	21.29
		RB Size=3, RB Offset=0	1	1	21.28	21.16	21.36
		RB Size=3, RB Offset=1	1	1	21.50	21.20	21.38
		RB Size=3, RB Offset=2	1	1	21.31	21.47	21.36
		RB Size=6, RB Offset=0	1	1	21.01	21.09	21.17
	16QAM	RB Size=1, RB Offset=0	1	1	20.93	21.02	21.02
		RB Size=1, RB Offset=2	1	1	21.33	21.40	21.57
		RB Size=1, RB Offset=5	1	1	21.07	21.32	21.33
		RB Size=3, RB Offset=0	2	2	21.39	21.64	21.49
		RB Size=3, RB Offset=1	2	2	21.29	21.18	21.25
		RB Size=3, RB Offset=2	2	2	21.50	21.43	21.51
		RB Size=6, RB Offset=0	2	2	21.23	21.29	21.22
3M	QPSK	RB Size=1, RB Offset=0	0	0	21.42	20.94	20.98
		RB Size=1, RB Offset=7	0	0	20.60	20.90	20.89
		RB Size=1, RB Offset=14	0	0	21.21	21.36	21.50
		RB Size=8, RB Offset=0	1	1	21.07	21.10	21.20
		RB Size=8, RB Offset=4	1	1	20.80	20.71	20.70
		RB Size=8, RB Offset=7	1	1	20.95	21.12	21.25
		RB Size=15, RB Offset=0	1	1	20.85	21.12	21.15
	16QAM	RB Size=1, RB Offset=0	1	1	21.11	21.17	21.23
		RB Size=1, RB Offset=7	1	1	21.67	21.03	21.13
		RB Size=1, RB Offset=14	1	1	21.17	20.92	21.10
		RB Size=8, RB Offset=0	2	2	21.20	21.27	21.15
		RB Size=8, RB Offset=4	2	2	21.42	21.30	21.44
		RB Size=8, RB Offset=7	2	2	21.28	21.19	21.40
		RB Size=15, RB Offset=0	2	2	21.00	20.98	21.20
5M	QPSK	RB Size=1, RB Offset=0	0	0	21.52	21.45	21.45
		RB Size=1, RB Offset=12	0	0	21.43	21.56	21.57
		RB Size=1, RB Offset=24	0	0	20.94	21.08	21.02
		RB Size=12, RB Offset=0	1	1	21.05	21.10	21.11
		RB Size=12, RB Offset=6	1	1	21.15	20.97	21.06
		RB Size=12, RB Offset=11	1	1	20.82	21.06	21.13
		RB Size=25, RB Offset=0	1	1	20.91	21.27	21.14
	16QAM	RB Size=1, RB Offset=0	1	1	20.91	20.96	21.19
		RB Size=1, RB Offset=12	1	1	20.88	21.07	21.04
		RB Size=1, RB Offset=24	1	1	20.98	21.08	21.06
		RB Size=12, RB Offset=0	2	2	20.00	20.27	20.19
		RB Size=12, RB Offset=6	2	2	19.77	20.01	19.96
		RB Size=12, RB Offset=11	2	2	20.98	21.19	21.12
		RB Size=25, RB Offset=0	2	2	20.80	20.96	21.03

LTE Band 4:

BW	Modulation	Resource Block Size & Resource Block Offset	Target MPR	Meas MPR	Ave Tx Power (dBm)		
					Low Channel	Mid Channel	High Channel
10M	QPSK	RB Size=1, RB Offset=0	0	0	21.14	21.48	21.34
		RB Size=1, RB Offset=24	0	0	21.44	21.43	21.43
		RB Size=1, RB Offset=49	0	0	21.48	21.34	21.32
		RB Size=25, RB Offset=0	1	1	21.40	21.60	21.52
		RB Size=25, RB Offset=12	1	1	21.37	21.48	21.31
		RB Size=25, RB Offset=24	1	1	21.21	21.04	21.27
		RB Size=50, RB Offset=0	1	1	21.24	21.43	21.23
	16QAM	RB Size=1, RB Offset=0	1	1	21.31	21.57	21.71
		RB Size=1, RB Offset=24	1	1	21.43	21.33	21.35
		RB Size=1, RB Offset=49	1	1	21.25	21.04	21.43
		RB Size=25, RB Offset=0	2	2	20.97	20.96	20.90
		RB Size=25, RB Offset=12	2	2	20.91	20.98	21.05
		RB Size=25, RB Offset=24	2	2	21.09	21.17	21.11
		RB Size=50, RB Offset=0	2	2	21.10	21.13	21.22
15M	QPSK	RB Size=1, RB Offset=0	0	0	21.36	21.15	20.97
		RB Size=1, RB Offset=37	0	0	20.99	20.94	21.18
		RB Size=1, RB Offset=74	0	0	21.03	21.01	21.18
		RB Size=36, RB Offset=0	1	1	21.20	21.32	21.47
		RB Size=36, RB Offset=18	1	1	21.12	21.16	21.23
		RB Size=36, RB Offset=37	1	1	20.95	20.93	21.03
		RB Size=75, RB Offset=0	1	1	21.43	21.31	21.41
	16QAM	RB Size=1, RB Offset=0	1	1	20.96	21.06	21.27
		RB Size=1, RB Offset=37	1	1	21.02	20.97	21.09
		RB Size=1, RB Offset=74	1	1	21.36	21.38	21.47
		RB Size=36, RB Offset=0	2	2	21.38	21.25	21.32
		RB Size=36, RB Offset=18	2	2	21.19	21.35	21.41
		RB Size=36, RB Offset=37	2	2	21.55	21.29	21.33
		RB Size=75, RB Offset=0	2	2	21.28	21.23	21.42
20M	QPSK	RB Size=1, RB Offset=0	0	0	21.47	21.54	21.59
		RB Size=1, RB Offset=49	0	0	20.89	20.91	21.24
		RB Size=1, RB Offset=99	0	0	21.25	21.17	21.18
		RB Size=50, RB Offset=0	1	1	20.80	20.88	20.90
		RB Size=50, RB Offset=24	1	1	21.18	21.14	21.23
		RB Size=50, RB Offset=49	1	1	21.01	21.15	21.16
		RB Size=100, RB Offset=0	1	1	20.71	20.52	21.18
	16QAM	RB Size=1, RB Offset=0	1	1	21.18	21.08	21.11
		RB Size=1, RB Offset=49	1	1	20.87	21.17	21.04
		RB Size=1, RB Offset=99	1	1	21.07	21.01	21.04
		RB Size=50, RB Offset=0	2	2	21.16	21.52	20.98
		RB Size=50, RB Offset=24	2	2	21.02	20.91	21.08
		RB Size=50, RB Offset=49	2	2	21.05	21.17	21.16
		RB Size=100, RB Offset=0	2	2	20.22	20.25	20.29

LTE Band 5:

BW	Modulation	Resource Block Size& Resource Block Offset	Target MPR	Meas MPR	Ave Tx Power (dBm)		
					Low Channel	Mid Channel	High Channel
1.4M	QPSK	RB Size=1, RB Offset=0	0	0	22.02	21.86	22.06
		RB Size=1, RB Offset=2	0	0	21.86	22.00	21.93
		RB Size=1, RB Offset=5	0	0	22.07	22.17	21.94
		RB Size=3, RB Offset=0	1	1	21.72	21.72	22.04
		RB Size=3, RB Offset=1	1	1	21.87	21.82	21.96
		RB Size=3, RB Offset=2	1	1	21.86	21.83	21.84
		RB Size=6, RB Offset=0	1	1	21.38	21.50	21.58
	16QAM	RB Size=1, RB Offset=0	1	1	21.44	21.61	21.56
		RB Size=1, RB Offset=2	1	1	21.99	21.95	21.87
		RB Size=1, RB Offset=5	1	1	21.80	21.69	21.89
		RB Size=3, RB Offset=0	2	2	21.98	21.91	22.01
		RB Size=3, RB Offset=1	2	2	21.65	21.72	21.96
		RB Size=3, RB Offset=2	2	2	21.90	22.03	21.99
		RB Size=6, RB Offset=0	2	2	21.82	21.82	21.83
3M	QPSK	RB Size=1, RB Offset=0	0	0	21.94	21.59	21.63
		RB Size=1, RB Offset=7	0	0	21.20	21.19	21.44
		RB Size=1, RB Offset=14	0	0	21.81	21.95	21.82
		RB Size=8, RB Offset=0	1	1	21.55	21.81	21.68
		RB Size=8, RB Offset=4	1	1	21.26	21.29	21.17
		RB Size=8, RB Offset=7	1	1	21.64	21.71	21.73
		RB Size=15, RB Offset=0	1	1	21.39	21.48	21.66
	16QAM	RB Size=1, RB Offset=0	1	1	21.43	21.57	21.67
		RB Size=1, RB Offset=7	1	1	22.15	21.61	21.50
		RB Size=1, RB Offset=14	1	1	21.47	21.67	21.71
		RB Size=8, RB Offset=0	2	2	21.50	21.52	21.54
		RB Size=8, RB Offset=4	2	2	21.73	22.06	22.05
		RB Size=8, RB Offset=7	2	2	21.78	21.62	21.78
		RB Size=15, RB Offset=0	2	2	21.71	21.44	21.73
5M	QPSK	RB Size=1, RB Offset=0	0	0	22.06	21.88	22.00
		RB Size=1, RB Offset=12	0	0	21.76	21.86	22.13
		RB Size=1, RB Offset=24	0	0	21.69	21.43	21.62
		RB Size=12, RB Offset=0	1	1	21.50	21.62	21.74
		RB Size=12, RB Offset=6	1	1	21.67	21.64	21.63
		RB Size=12, RB Offset=11	1	1	21.36	21.37	21.54
		RB Size=25, RB Offset=0	1	1	21.69	21.75	21.64
	16QAM	RB Size=1, RB Offset=0	1	1	21.60	21.47	21.57
		RB Size=1, RB Offset=12	1	1	21.63	21.72	21.75
		RB Size=1, RB Offset=24	1	1	21.42	21.61	21.48
		RB Size=12, RB Offset=0	2	2	20.67	20.75	20.85
		RB Size=12, RB Offset=6	2	2	20.32	20.46	20.45
		RB Size=12, RB Offset=11	2	2	21.54	21.60	21.78
		RB Size=25, RB Offset=0	2	2	21.57	21.32	21.47

BW	Modulation	Resource Block Size & Resource Block Offset	Target MPR	Meas MPR	Ave Tx Power (dBm)		
					Low Channel	Mid Channel	High Channel
10M	QPSK	RB Size=1, RB Offset=0	0	0	21.81	21.78	21.97
		RB Size=1, RB Offset=24	0	0	21.71	21.82	21.79
		RB Size=1, RB Offset=49	0	0	21.99	21.87	21.91
		RB Size=25, RB Offset=0	1	1	21.87	21.89	21.91
		RB Size=25, RB Offset=12	1	1	21.85	21.73	21.81
		RB Size=25, RB Offset=24	1	1	21.64	21.44	21.76
		RB Size=50, RB Offset=0	1	1	21.70	21.95	21.73
	16QAM	RB Size=1, RB Offset=0	1	1	21.89	21.96	22.24
		RB Size=1, RB Offset=24	1	1	21.78	22.07	22.06
		RB Size=1, RB Offset=49	1	1	21.54	21.65	21.83
		RB Size=25, RB Offset=0	2	2	21.36	21.39	21.51
		RB Size=25, RB Offset=12	2	2	21.41	21.47	21.57
		RB Size=25, RB Offset=24	2	2	21.61	21.63	21.59
		RB Size=50, RB Offset=0	2	2	21.67	21.50	21.86

LTE Band 7:

BW	Modulation	Resource Block Size & Resource Block Offset	Target MPR	Meas MPR	Ave Tx Power (dBm)		
					Low Channel	Mid Channel	High Channel
5M	QPSK	RB Size=1, RB Offset=0	0	0	21.24	21.56	21.46
		RB Size=1, RB Offset=12	0	0	21.33	21.36	21.48
		RB Size=1, RB Offset=24	0	0	21.78	21.77	21.85
		RB Size=12, RB Offset=0	1	1	21.73	21.61	21.89
		RB Size=12, RB Offset=6	1	1	21.71	21.95	21.79
		RB Size=12, RB Offset=11	1	1	21.80	21.95	22.13
		RB Size=25, RB Offset=0	1	1	21.90	21.89	21.87
	16QAM	RB Size=1, RB Offset=0	1	1	21.94	21.77	21.73
		RB Size=1, RB Offset=12	1	1	20.84	20.87	21.15
		RB Size=1, RB Offset=24	1	1	20.56	20.60	20.67
		RB Size=12, RB Offset=0	2	2	21.82	21.96	21.95
		RB Size=12, RB Offset=6	2	2	21.95	22.28	22.13
		RB Size=12, RB Offset=11	2	2	21.94	21.90	22.05
		RB Size=25, RB Offset=0	2	2	21.90	21.74	21.96
10M	QPSK	RB Size=1, RB Offset=0	0	0	21.42	21.51	21.69
		RB Size=1, RB Offset=24	0	0	21.93	21.83	22.02
		RB Size=1, RB Offset=49	0	0	21.65	21.61	21.74
		RB Size=25, RB Offset=0	1	1	21.65	21.50	21.76
		RB Size=25, RB Offset=12	1	1	21.65	21.66	21.61
		RB Size=25, RB Offset=24	1	1	21.54	21.46	21.64
		RB Size=50, RB Offset=0	1	1	21.40	21.42	21.40
	16QAM	RB Size=1, RB Offset=0	1	1	21.80	21.85	21.97
		RB Size=1, RB Offset=24	1	1	21.67	21.94	21.74
		RB Size=1, RB Offset=49	1	1	21.91	21.86	22.10
		RB Size=25, RB Offset=0	2	2	21.82	21.84	22.00
		RB Size=25, RB Offset=12	2	2	21.84	21.82	22.02
		RB Size=25, RB Offset=24	2	2	21.98	21.88	21.87
		RB Size=50, RB Offset=0	2	2	21.02	21.02	20.93

BW	Modulation	Resource Block Size & Resource Block Offset	Target MPR	Meas MPR	Ave Tx Power (dBm)		
					Low Channel	Mid Channel	High Channel
15M	QPSK	RB Size=1, RB Offset=0	0	0	22.10	21.96	22.19
		RB Size=1, RB Offset=37	0	0	22.02	21.99	21.99
		RB Size=1, RB Offset=74	0	0	21.96	21.80	22.13
		RB Size=36, RB Offset=0	1	1	21.78	21.83	21.98
		RB Size=36, RB Offset=18	1	1	21.93	22.02	22.19
		RB Size=36, RB Offset=37	1	1	21.76	22.03	22.02
		RB Size=75, RB Offset=0	1	1	22.05	22.17	21.85
	16QAM	RB Size=1, RB Offset=0	1	1	21.61	21.48	21.65
		RB Size=1, RB Offset=37	1	1	21.86	21.76	21.63
		RB Size=1, RB Offset=74	1	1	21.48	21.55	21.62
		RB Size=36, RB Offset=0	2	2	21.51	21.61	21.52
		RB Size=36, RB Offset=18	2	2	21.93	21.90	21.90
		RB Size=36, RB Offset=37	2	2	21.46	21.53	21.82
		RB Size=75, RB Offset=0	2	2	21.44	21.67	21.58
20M	QPSK	RB Size=1, RB Offset=0	0	0	22.18	22.10	22.19
		RB Size=1, RB Offset=49	0	0	22.02	21.97	22.08
		RB Size=1, RB Offset=99	0	0	21.41	21.48	21.54
		RB Size=50, RB Offset=0	1	1	21.46	21.48	21.58
		RB Size=50, RB Offset=24	1	1	21.52	21.54	21.57
		RB Size=50, RB Offset=49	1	1	21.34	21.43	21.51
		RB Size=100, RB Offset=0	1	1	21.34	21.41	21.47
	16QAM	RB Size=1, RB Offset=0	1	1	21.74	22.01	21.83
		RB Size=1, RB Offset=49	1	1	21.65	21.89	21.93
		RB Size=1, RB Offset=99	1	1	21.80	21.91	21.76
		RB Size=50, RB Offset=0	2	2	21.77	22.06	21.86
		RB Size=50, RB Offset=24	2	2	21.70	21.74	21.92
		RB Size=50, RB Offset=49	2	2	21.82	21.84	21.90
		RB Size=100, RB Offset=0	2	2	20.97	21.07	21.46

Bluetooth

Mode	Channel No.	Channel frequency (MHz)	Conducted Output Power (dBm)
BDR(GFSK)	0	2402	0.05
	39	2441	-2.49
	78	2480	-0.30
EDR(4-DQPSK)	0	2402	-1.11
	39	2441	-3.90
	78	2480	-1.36
EDR-8DPSK	0	2402	-0.55
	39	2441	-3.51
	78	2480	-1.13
BLE	1	2402	-5.61
	20	2440	-7.44
	40	2480	-5.80

Wi-Fi

Mode	Channel No.	Channel frequency (MHz)	Conducted Output Power (dBm)
802.11b	1	2412	9.48
	7	2442	9.50
	13	2472	9.76
802.11g	1	2412	9.57
	7	2442	9.46
	13	2472	9.47
802.11n HT20	1	2412	9.22
	7	2442	9.44
	13	2472	9.66
802.11n HT40	1	2422	9.37
	5	2442	9.15
	9	2462	9.79

Note:

1. KDB 248227 D01 802.11 Wi-Fi SAR v02,§5.2.2: When the highest reported SAR for DSSS is adjusted by the ratio of OFDM to DSSS specified maximum output power and the adjusted SAR is ≤ 1.2 W/kg.
2. The output power was tested under data rate 1Mbps for 802.11b, 6Mbps for 802.11g, 6.5Mbps for 802.11n-HT20 and 13.5Mbps for 802.11n-HT40.

SAR MEASUREMENT RESULTS

This page summarizes the results of the performed dosimetric evaluation.

SAR Test Data

Environmental Conditions

Temperature:	22-24 °C
Relative Humidity:	50-53 %
ATM Pressure:	1001-1002 mbar

Testing was performed by Lance Li, Hans Zhao, River Rao and Sandy Zhang on 2016-10-10, 2016-10-11, 2016-10-12, 2016-10-13 and 2016-11-08

GSM 850:

EUT Position	Frequency (MHz)	Test Mode	Power Drift (dB)	Max. Meas. Power (dBm)	Max. Rated Power (dBm)	1g SAR (W/Kg)			
						Scaled Factor	Meas. SAR	Scaled SAR	Plot
Left Head Cheek	824.2	GSM	/	/	/	/	/	/	/
	836.6	GSM	-0.025	31.72	31.90	1.042	0.377	0.393	1#
	848.8	GSM	/	/	/	/	/	/	/
Left Head Tilt	824.2	GSM	/	/	/	/	/	/	/
	836.6	GSM	-0.076	31.72	31.90	1.042	0.198	0.206	2#
	848.8	GSM	/	/	/	/	/	/	/
Right Head Cheek	824.2	GSM	0.097	31.87	31.90	1.007	0.453	0.456	3#
	836.6	GSM	0.094	31.72	31.90	1.042	0.492	0.513	4#
	848.8	GSM	0.082	31.73	31.90	1.040	0.482	0.501	5#
Right Head Tilt	824.2	GSM	/	/	/	/	/	/	/
	836.6	GSM	-0.104	31.72	31.90	1.042	0.222	0.231	6#
	848.8	GSM	/	/	/	/	/	/	/

Note:

1. When the 1-g SAR is $\leq 0.8\text{W/Kg}$, testing for other channels are optional.
2. The EUT transmit and receive through the same GSM antenna while testing SAR.
3. When SAR or MPE is not measured at the maximum power level allowed for production units, the results must be scaled to the maximum tune-up tolerance limit according to the power applied to the individual channels tested to determine compliance.

PCS Band:

EUT Position	Frequency (MHz)	Test Mode	Power Drift (dB)	Max. Meas. Power (dBm)	Max. Rated Power (dBm)	1g SAR (W/Kg)			
						Scaled Factor	Meas. SAR	Scaled SAR	Plot
Left Head Cheek	1850.2	GSM	-0.065	28.86	29.00	1.033	0.138	0.143	7#
	1880.0	GSM	-0.052	28.86	29.00	1.033	0.165	0.170	8#
	1909.8	GSM	-0.085	28.91	29.00	1.021	0.215	0.220	9#
Left Head Tilt	1850.2	GSM	/	/	/	/	/	/	/
	1880.0	GSM	0.086	28.86	29.00	1.033	0.062	0.064	10#
	1909.8	GSM	/	/	/	/	/	/	/
Right Head Cheek	1850.2	GSM	/	/	/	/	/	/	/
	1880.0	GSM	0.067	28.86	29.00	1.033	0.142	0.147	11#
	1909.8	GSM	/	/	/	/	/	/	/
Right Head Tilt	1850.2	GSM	/	/	/	/	/	/	/
	1880.0	GSM	0.05	28.86	29.00	1.033	0.061	0.063	12#
	1909.8	GSM	/	/	/	/	/	/	/

Note:

1. When the 1-g SAR is $\leq 0.8\text{W/Kg}$, testing for other channels are optional.
2. The EUT transmit and receive through the same GSM antenna while testing SAR.
3. When SAR or MPE is not measured at the maximum power level allowed for production units, the results must be scaled to the maximum tune-up tolerance limit according to the power applied to the individual channels tested to determine compliance.

WCDMA 850

EUT Position	Frequency (MHz)	Test Mode	Power Drift (dB)	Max. Meas. Power (dBm)	Max. Rated Power (dBm)	1g SAR (W/Kg)			
						Scaled Factor	Meas. SAR	Scaled SAR	Plot
Left Head Cheek	826.4	RMC	0.027	22.30	22.40	1.023	0.182	0.186	13#
	836.6	RMC	0.019	22.31	22.40	1.021	0.245	0.250	14#
	846.6	RMC	0.023	22.39	22.40	1.002	0.271	0.272	15#
Left Head Tilt	826.4	RMC	/	/	/	/	/	/	/
	836.6	RMC	0.085	22.31	22.40	1.021	0.132	0.135	16#
	846.6	RMC	/	/	/	/	/	/	/
Right Head Cheek	826.4	RMC	/	/	/	/	/	/	/
	836.6	RMC	-0.082	22.31	22.40	1.021	0.18	0.184	17#
	846.6	RMC	/	/	/	/	/	/	/
Right Head Tilt	826.4	RMC	/	/	/	/	/	/	/
	836.6	RMC	0.062	22.31	22.40	1.021	0.075	0.077	18#
	846.6	RMC	/	/	/	/	/	/	/

WCDMA 1700

EUT Position	Frequency (MHz)	Test Mode	Power Drift (dB)	Max. Meas. Power (dBm)	Max. Rated Power (dBm)	1g SAR (W/Kg)			
						Scaled Factor	Meas. SAR	Scaled SAR	Plot
Left Head Cheek	1712.4	RMC	0.058	22.38	22.40	1.005	0.372	0.374	19#
	1732.6	RMC	0.057	22.76	22.80	1.009	0.398	0.402	20#
	1752.6	RMC	0.142	22.56	22.60	1.009	0.351	0.354	21#
Left Head Tilt	1712.4	RMC	/	/	/	/	/	/	/
	1732.6	RMC	0.073	22.76	22.80	1.009	0.152	0.153	22#
	1752.6	RMC	/	/	/	/	/	/	/
Right Head Cheek	1712.4	RMC	/	/	/	/	/	/	/
	1732.6	RMC	0.019	22.76	22.80	1.009	0.347	0.350	23#
	1752.6	RMC	/	/	/	/	/	/	/
Right Head Tilt	1712.4	RMC	/	/	/	/	/	/	/
	1732.6	RMC	-0.027	22.76	22.80	1.009	0.172	0.174	24#
	1752.6	RMC	/	/	/	/	/	/	/

WCDMA 1900

EUT Position	Frequency (MHz)	Test Mode	Power Drift (dB)	Max. Meas. Power (dBm)	Max. Rated Power (dBm)	1g SAR (W/Kg)			
						Scaled Factor	Meas. SAR	Scaled SAR	Plot
Left Head Cheek	1852.4	RMC	0.015	22.66	22.70	1.009	0.295	0.298	25#
	1880.0	RMC	0.079	22.59	22.60	1.002	0.243	0.243	26#
	1907.6	RMC	0.129	22.32	22.40	1.019	0.275	0.280	27#
Left Head Tilt	1852.4	RMC	/	/	/	/	/	/	/
	1880.0	RMC	-0.027	22.59	22.60	1.002	0.107	0.107	28#
	1907.6	RMC	/	/	/	/	/	/	/
Right Head Cheek	1852.4	RMC	/	/	/	/	/	/	/
	1880.0	RMC	0.039	22.59	22.60	1.002	0.239	0.239	29#
	1907.6	RMC	/	/	/	/	/	/	/
Right Head Tilt	1852.4	RMC	/	/	/	/	/	/	/
	1880.0	RMC	0.023	22.59	22.60	1.002	0.113	0.113	30#
	1907.6	RMC	/	/	/	/	/	/	/

Note:

1. When the 1-g SAR is $\leq 0.8W/Kg$, testing for other channels are optional.
2. The default test configuration is to measure SAR with an established radio link between the EUT and a communication test set using a 12.2 kbps RMC (reference measurement Channel) Configured in Test Loop Model.

LTE Band 2:

EUT Position	Frequency (MHz)	Bandwidth (MHz)	Test Mode	Power Drift (%)	Max. Meas. Power (dBm)	Max. Rated Power (dBm)	1g SAR (W/Kg)			
							Scaled Factor	Meas. SAR	Scaled SAR	Plot
Left Head Cheek	1860	20	1RB, Offset=0	/	/	/	/	/	/	/
	1880	20	1RB, Offset=0	/	/	/	/	/	/	/
	1900	20	1RB, Offset=0	0.049	22.43	22.50	1.016	0.285	0.290	31#
	1900	20	50%RB, Offset=24	0.032	22.15	22.50	1.084	0.213	0.231	32#
Left Head Tilt	1860	20	1RB, Offset=0	/	/	/	/	/	/	/
	1880	20	1RB, Offset=0	/	/	/	/	/	/	/
	1900	20	1RB, Offset=0	0.088	22.43	22.50	1.016	0.135	0.137	33#
	1900	20	50%RB, Offset=0	0.083	22.15	22.50	1.084	0.102	0.111	34#
Right Head Cheek	1860	20	1RB, Offset=0	/	/	/	/	/	/	/
	1880	20	1RB, Offset=0	/	/	/	/	/	/	/
	1900	20	1RB, Offset=0	0.129	22.43	22.50	1.016	0.297	0.302	35#
	1900	20	50%RB, Offset=0	0.022	22.15	22.50	1.084	0.311	0.337	36#
Right Head Tilt	1860	20	1RB, Offset=0	/	/	/	/	/	/	/
	1880	20	1RB, Offset=0	/	/	/	/	/	/	/
	1900	20	1RB, Offset=0	0.037	22.43	22.50	1.016	0.11	0.112	37#
	1900	20	50%RB, Offset=0	-0.089	22.15	22.50	1.084	0.11	0.119	38#

LTE Band 4:

EUT Position	Frequency (MHz)	Bandwidth (MHz)	Test Mode	Power Drift (%)	Max. Meas. Power (dBm)	Max. Rated Power (dBm)	1g SAR (W/Kg)			
							Scaled Factor	Meas. SAR	Scaled SAR	Plot
Left Head Cheek	1720	20	1RB, Offset=0	/	/	/	/	/	/	/
	1732.5	20	1RB, Offset=0	/	/	/	/	/	/	/
	1745	20	1RB, Offset=0	-0.087	21.59	21.6	1.002	0.385	0.386	39#
	1745	20	50%RB, Offset=24	-0.029	21.23	21.6	1.089	0.324	0.353	40#
Left Head Tilt	1720	20	1RB, Offset=0	/	/	/	/	/	/	/
	1732.5	20	1RB, Offset=0	/	/	/	/	/	/	/
	1745	20	1RB, Offset=0	-0.088	21.59	21.6	1.002	0.223	0.223	41#
	1745	20	50%RB, Offset=24	-0.046	21.23	21.6	1.089	0.186	0.203	42#
Right Head Cheek	1720	20	1RB, Offset=0	/	/	/	/	/	/	/
	1732.5	20	1RB, Offset=0	/	/	/	/	/	/	/
	1745	20	1RB, Offset=0	0.028	21.59	21.6	1.002	0.527	0.528	43#
	1745	20	50%RB, Offset=24	0.098	21.23	21.6	1.089	0.533	0.580	44#
Right Head Tilt	1720	20	1RB, Offset=0	/	/	/	/	/	/	/
	1732.5	20	1RB, Offset=0	/	/	/	/	/	/	/
	1745	20	1RB, Offset=0	0.020	21.59	21.6	1.002	0.22	0.220	45#
	1745	20	50%RB, Offset=24	0.092	21.23	21.6	1.089	0.202	0.220	46#

LTE Band 5:

EUT Position	Frequency (MHz)	Bandwidth (MHz)	Test Mode	Power Drift (%)	Max. Meas. Power (dBm)	Max. Rated Power (dBm)	1g SAR (W/Kg)			
							Scaled Factor	Meas. SAR	Scaled SAR	Plot
Left Head Cheek	829	10	1RB, Offset=0	/	/	/	/	/	/	/
	836.5	10	1RB, Offset=0	/	/	/	/	/	/	/
	844	10	1RB, Offset=0	0.027	21.97	22	1.007	0.201	0.202	47#
	844	10	50%RB, Offset=0	0.048	21.91	22	1.021	0.151	0.154	48#
Left Head Tilt	829	10	1RB, Offset=0	/	/	/	/	/	/	/
	836.5	10	1RB, Offset=0	/	/	/	/	/	/	/
	844	10	1RB, Offset=0	0.179	21.97	22	1.007	0.152	0.153	49#
	844	10	50%RB, Offset=0	0.103	21.91	22	1.021	0.192	0.196	50#
Right Head Cheek	829	10	1RB, Offset=0	/	/	/	/	/	/	/
	836.5	10	1RB, Offset=0	/	/	/	/	/	/	/
	844	10	1RB, Offset=0	0.032	21.97	22	1.007	0.216	0.218	51#
	844	10	50%RB, Offset=0	0.038	21.91	22	1.021	0.198	0.202	52#
Right Head Tilt	829	10	1RB, Offset=0	/	/	/	/	/	/	/
	836.5	10	1RB, Offset=0	/	/	/	/	/	/	/
	844	10	1RB, Offset=0	0.145	21.97	22	1.007	0.102	0.103	53#
	844	10	50%RB, Offset=0	0.102	21.91	22	1.021	0.092	0.094	54#

LTE Band 7:

EUT Position	Frequency (MHz)	Bandwidth (MHz)	Test Mode	Power Drift (%)	Max. Meas. Power (dBm)	Max. Rated Power (dBm)	1g SAR (W/Kg)			
							Scaled Factor	Meas. SAR	Scaled SAR	Plot
Left Head Cheek	2510	20	1RB, Offset=0	/	/	/	/	/	/	/
	2535	20	1RB, Offset=0	/	/	/	/	/	/	/
	2560	20	1RB, Offset=0	0.091	22.19	22.20	1.002	0.561	0.562	55#
	2560	20	50%RB, Offset=0	0.081	21.58	22.20	1.153	0.413	0.476	56#
Left Head Tilt	2510	20	1RB, Offset=0	/	/	/	/	/	/	/
	2535	20	1RB, Offset=0	/	/	/	/	/	/	/
	2560	20	1RB, Offset=0	0.113	22.19	22.20	1.002	0.287	0.288	57#
	2560	20	50%RB, Offset=0	0.109	21.58	22.20	1.153	0.207	0.239	58#
Right Head Cheek	2510	20	1RB, Offset=0	/	/	/	/	/	/	/
	2535	20	1RB, Offset=0	/	/	/	/	/	/	/
	2560	20	1RB, Offset=0	0.068	22.19	22.20	1.002	0.521	0.522	59#
	2560	20	50%RB, Offset=0	0.078	21.58	22.20	1.153	0.405	0.467	60#
Right Head Tilt	2510	20	1RB, Offset=0	/	/	/	/	/	/	/
	2535	20	1RB, Offset=0	/	/	/	/	/	/	/
	2560	20	1RB, Offset=0	0.072	22.19	22.20	1.002	0.289	0.290	61#
	2560	20	50%RB, Offset=0	0.072	21.58	22.20	1.153	0.226	0.261	62#

Note:

1. When the 1-g SAR is $\leq 0.8\text{W/Kg}$, testing for other channels are optional.
2. SAR for LTE band exposure configurations is measured according to the procedures of KDB 941225 D05 SAR for LTE Devices v02.
3. KDB941225D05- SAR for higher order modulation is required only when the highest maximum output power for the configuration in the higher order modulation is $> \frac{1}{2}$ dB higher than the same configuration in QPSK or when the reported SAR for the QPSK configuration is $> 1.45\text{ W/kg}$
4. KDB941225D05- For QPSK with 100% RB allocation, when the reported SAR measured for the Highest output power channel is $< 1.45\text{ W/kg}$, tests for the remaining required test channels are optional.
5. KDB941225D05- For QPSK with 100% RB allocation, SAR is not required when the highest maximum output power for 100 % RB allocation is less than the highest maximum output power in 50% and 1 RB allocations and the highest reported SAR for 1 RB and 50% RB allocation are $\leq 0.8\text{ W/kg}$.
6. KDB941225D05- Start with the largest channel bandwidth (20M) and measure SAR for QPSK with 1 RB allocation, using the RB offset and required test channel combination with the highest maximum output power among RB offset the upper edge, middle and lower edge of each required test channel.
7. Worst case SAR for 50% RB allocation is selected to be tested.

Mobile Hot-Spot Test Result

The DUT is capable of functioning as a Wi-Fi to Cellular Mobile hotspot. Additional SAR testing was performed according to KDB 941225 D06. Testing was performed with a separation of 1cm between the DUT and the flat phantom. The DUT was positioned for SAR tests with the back surfaces facing the phantom, and also with the edges facing the phantom in which the transmitting antenna is <2.5 cm from the edge. Each transmit band was utilized for SAR testing. The tested mode has been selected within each band that exhibits the highest time average output power.

Hot spot-GPRS (Frequency Band: 835)

EUT Position	Frequency (MHz)	Test Mode	Power Drift (dB)	Max. Meas. Power (dBm)	Max. Rated Power (dBm)	1g SAR (W/Kg)			Plot
						Scaled Factor	Meas. SAR	Scaled SAR	
Body-Headset-Back (10mm)	824.2	GSM	/	/	/	/	/	/	/
	836.6	GSM	0.029	31.72	31.90	1.042	0.472	0.492	63#
	848.8	GSM	/	/	/	/	/	/	/
Body-Back (10mm)	824.2	GPRS	-0.025	30.94	31.00	1.014	1.005	1.019	64#
	836.6	GPRS	-0.057	30.78	31.00	1.052	0.991	1.043	65#
	848.8	GPRS	-0.069	30.69	31.00	1.074	0.919	0.987	66#
Body-Left (10mm)	824.2	GPRS	/	/	/	/	/	/	/
	836.6	GPRS	-0.951	30.78	31.00	1.052	0.725	0.763	67#
	848.8	GPRS	/	/	/	/	/	/	/
Body-Right (10mm)	824.2	GPRS	-0.025	30.94	31.00	1.014	0.543	0.551	68#
	836.6	GPRS	-0.082	30.78	31.00	1.052	0.643	0.676	69#
	848.8	GPRS	-0.025	30.69	31.00	1.074	0.559	0.600	70#
Body-Bottom (10mm)	824.2	GPRS	/	/	/	/	/	/	/
	836.6	GPRS	-0.158	30.78	31.00	1.052	0.403	0.424	71#
	848.8	GPRS	/	/	/	/	/	/	/

Note:

1. When the 1-g SAR is $\leq 0.8\text{W/Kg}$, testing for other channels are optional.
2. The Multi-slot Classes of EUT is Class12 which has maximum 4 Downlink slots and 4 Uplink slots, the maximum active slots is 5, when perform the multiple slots scan, 3DL+2UL is the worst case.
3. The EUT transmit and receive through the same GSM antenna while testing SAR.

Hot spot-GPRS (Frequency Band: 1900)

EUT Position	Frequency (MHz)	Test Mode	Power Drift (dB)	Max. Meas. Power (dBm)	Max. Rated Power (dBm)	1g SAR (W/Kg)			
						Scaled Factor	Meas. SAR	Scaled SAR	Plot
Body-Headset-Back (10mm)	1850.2	GSM	/	/	/	/	/	/	/
	1880.0	GSM	-0.042	28.86	29.00	1.033	0.132	0.136	72#
	1909.8	GSM	/	/	/	/	/	/	/
Body-Back (10mm)	1850.2	GPRS	/	/	/	/	/	/	/
	1880.0	GPRS	0.062	25.03	25.3	1.064	0.307	0.327	73#
	1909.8	GPRS	/	/	/	/	/	/	/
Body-Left (10mm)	1850.2	GPRS	/	/	/	/	/	/	/
	1880.0	GPRS	0.046	25.03	25.3	1.064	0.085	0.090	74#
	1909.8	GPRS	/	/	/	/	/	/	/
Body-Right (10mm)	1850.2	GPRS	/	/	/	/	/	/	/
	1880.0	GPRS	-0.084	25.03	25.3	1.064	0.132	0.140	75#
	1909.8	GPRS	/	/	/	/	/	/	/
Body-Bottom (10mm)	1850.2	GPRS	/	/	/	/	/	/	/
	1880.0	GPRS	0.012	25.03	25.3	1.064	0.186	0.198	76#
	1909.8	GPRS	/	/	/	/	/	/	/

Note:

1. When the 1-g SAR is $\leq 0.8\text{W/Kg}$, testing for other channels are optional.
2. The Multi-slot Classes of EUT is Class12 which has maximum 4 Downlink slots and 4 Uplink slots, the maximum active slots is 5, when perform the multiple slots scan, 1DL+4UL is the worst case.
3. The EUT transmit and receive through the same GSM antenna while testing SAR.

Hot Spot-WCDMA 850

EUT Position	Frequency (MHz)	Test Mode	Power Drift (dB)	Max. Meas. Power (dBm)	Max. Rated Power (dBm)	1g SAR (W/Kg)			
						Scaled Factor	Meas. SAR	Scaled SAR	Plot
Body-Back (10mm)	826.4	RMC	/	/	/	/	/	/	/
	836.6	RMC	0.023	22.31	22.40	1.021	0.387	0.395	77#
	846.6	RMC	/	/	/	/	/	/	/
Body-Left (10mm)	826.4	RMC	/	/	/	/	/	/	/
	836.6	RMC	-0.071	22.31	22.40	1.021	0.219	0.224	78#
	846.6	RMC	/	/	/	/	/	/	/
Body-Right (10mm)	826.4	RMC	/	/	/	/	/	/	/
	836.6	RMC	0.080	22.31	22.40	1.021	0.259	0.264	79#
	846.6	RMC	/	/	/	/	/	/	/
Body-Bottom (10mm)	826.4	RMC	/	/	/	/	/	/	/
	836.6	RMC	0.047	22.31	22.40	1.021	0.162	0.165	80#
	846.6	RMC	/	/	/	/	/	/	/

Hot Spot-WCDMA 1700

EUT Position	Frequency (MHz)	Test Mode	Power Drift (dB)	Max. Meas. Power (dBm)	Max. Rated Power (dBm)	1g SAR (W/Kg)			
						Scaled Factor	Meas. SAR	Scaled SAR	Plot
Body-Back (10mm)	1712.4	RMC	/	/	/	/	/	/	/
	1732.6	RMC	0.125	22.72	22.8	1.019	0.632	0.644	81#
	1752.6	RMC	/	/	/	/	/	/	/
Body-Left (10mm)	1712.4	RMC	/	/	/	/	/	/	/
	1732.6	RMC	-0.170	22.72	22.8	1.019	0.232	0.236	82#
	1752.6	RMC	/	/	/	/	/	/	/
Body-Right (10mm)	1712.4	RMC	/	/	/	/	/	/	/
	1732.6	RMC	0.110	22.72	22.8	1.019	0.287	0.292	83#
	1752.6	RMC	/	/	/	/	/	/	/
Body-Bottom (10mm)	1712.4	RMC	/	/	/	/	/	/	/
	1732.6	RMC	0.068	22.72	22.8	1.019	0.563	0.574	84#
	1752.6	RMC	/	/	/	/	/	/	/

Hot Spot-WCDMA 1900

EUT Position	Frequency (MHz)	Test Mode	Power Drift (dB)	Max. Meas. Power (dBm)	Max. Rated Power (dBm)	1g SAR (W/Kg)			
						Scaled Factor	Meas. SAR	Scaled SAR	Plot
Body-Back (10mm)	1852.4	RMC	/	/	/	/	/	/	/
	1880.0	RMC	-0.087	22.59	22.60	1.002	0.582	0.583	85#
	1907.6	RMC	/	/	/	/	/	/	/
Body-Left (10mm)	1852.4	RMC	/	/	/	/	/	/	/
	1880.0	RMC	0.228	22.59	22.60	1.002	0.218	0.218	86#
	1907.6	RMC	/	/	/	/	/	/	/
Body-Right (10mm)	1852.4	RMC	/	/	/	/	/	/	/
	1880.0	RMC	0.087	22.59	22.60	1.002	0.287	0.288	87#
	1907.6	RMC	/	/	/	/	/	/	/
Body-Bottom (10mm)	1852.4	RMC	/	/	/	/	/	/	/
	1880.0	RMC	-0.052	22.59	22.60	1.002	0.641	0.642	88#
	1907.6	RMC	/	/	/	/	/	/	/

Note:

1. When the 1-g SAR is $\leq 0.8\text{W/Kg}$, testing for other channels are optional.
2. For WCDMA mode: the default test configuration is to measure SAR with an established radio link between the EUT and a communication test set using a 12.2 kbps RMC (reference measurement Channel) Configured in Test Loop Model.

Hot Spot-LTE Band 2

EUT Position	Frequency (MHz)	Bandwidth (MHz)	Test Mode	Power Drift (%)	Max. Meas. Power (dBm)	Max. Rated Power (dBm)	1g SAR (W/Kg)			
							Scaled Factor	Meas. SAR	Scaled SAR	Plot
Body-Back (10mm)	1860	20	1RB, Offset=0	/	/	/	/	/	/	/
	1880		1RB, Offset=0	/	/	/	/	/	/	/
	1900		1RB, Offset=0	-0.034	22.43	22.50	1.016	0.657	0.668	89#
	1900		50%RB, Offset=24	-0.094	22.15	22.50	1.084	0.567	0.615	90#
Body-Left (10mm)	1860		1RB, Offset=0	/	/	/	/	/	/	/
	1880		1RB, Offset=0	/	/	/	/	/	/	/
	1900		1RB, Offset=0	0.198	22.43	22.50	1.016	0.189	0.192	91#
	1900		50%RB, Offset=24	0.168	22.15	22.50	1.084	0.176	0.191	92#
Body-Right (10mm)	1860		1RB, Offset=0	/	/	/	/	/	/	/
	1880		1RB, Offset=0	/	/	/	/	/	/	/
	1900		1RB, Offset=0	0.133	22.43	22.50	1.016	0.321	0.326	93#
	1900		50%RB, Offset=24	0.120	22.15	22.50	1.084	0.243	0.263	94#
Body-Bottom (10mm)	1860		1RB, Offset=0	/	/	/	/	/	/	/
	1880		1RB, Offset=0	/	/	/	/	/	/	/
	1900		1RB, Offset=0	-0.035	22.43	22.50	1.016	0.615	0.625	95#
	1900		50%RB, Offset=24	-0.050	22.15	22.50	1.084	0.475	0.515	96#

Hot Spot-LTE Band 4

EUT Position	Frequency (MHz)	Bandwidth (MHz)	Test Mode	Power Drift (%)	Max. Meas. Power (dBm)	Max. Rated Power (dBm)	1g SAR (W/Kg)			
							Scaled Factor	Meas. SAR	Scaled SAR	Plot
Body-Back (10mm)	1720	20	1RB, Offset=0	-0.026	21.47	21.60	1.030	0.852	0.878	97#
	1732.5		1RB, Offset=0	-0.086	21.54	21.60	1.014	0.783	0.794	98#
	1745		1RB, Offset=0	-0.086	21.59	21.60	1.002	0.923	0.925	99#
	1745		50%RB, Offset=24	-0.036	21.23	21.60	1.089	0.652	0.710	100#
	1745		100%RB, Offset=0	-0.104	21.18	21.60	1.102	0.629	0.693	101#
Body-Left (10mm)	1720		1RB, Offset=0	/	/	/	/	/	/	/
	1732.5		1RB, Offset=0	/	/	/	/	/	/	/
	1745		1RB, Offset=0	0.034	21.59	21.60	1.002	0.201	0.201	102#
	1745		50%RB, Offset=0	0.042	21.23	21.60	1.089	0.175	0.191	103#
Body-Right (10mm)	1720		1RB, Offset=0	/	/	/	/	/	/	/
	1732.5		1RB, Offset=0	/	/	/	/	/	/	/
	1745		1RB, Offset=0	0.080	21.59	21.60	1.002	0.302	0.303	104#
	1745		50%RB, Offset=0	0.100	21.23	21.60	1.089	0.275	0.299	105#
Body-Bottom (10mm)	1720		1RB, Offset=0	/	/	/	/	/	/	/
	1732.5		1RB, Offset=0	/	/	/	/	/	/	/
	1745		1RB, Offset=0	-0.094	21.59	21.60	1.002	0.59	0.591	106#
	1745	50%RB, Offset=0	-0.074	21.23	21.60	1.089	0.437	0.476	107#	

Hot Spot-LTE Band 5

EUT Position	Frequency (MHz)	Bandwidth (MHz)	Test Mode	Power Drift (%)	Max. Meas. Power (dBm)	Max. Rated Power (dBm)	1g SAR (W/Kg)			
							Scaled Factor	Meas. SAR	Scaled SAR	Plot
Body-Back (10mm)	829	10	1RB, Offset=0	/	/	/	/	/	/	/
	836.5		1RB, Offset=0	/	/	/	/	/	/	/
	844		1RB, Offset=0	-0.013	21.97	22.00	1.007	0.426	0.429	108#
	844		50%RB, Offset=0	-0.022	21.91	22.00	1.021	0.362	0.370	109#
Body-Left (10mm)	829		1RB, Offset=0	/	/	/	/	/	/	/
	836.5		1RB, Offset=0	/	/	/	/	/	/	/
	844		1RB, Offset=0	-0.101	21.97	22.00	1.007	0.191	0.192	110#
	844		50%RB, Offset=0	-0.181	21.91	22.00	1.021	0.205	0.209	111#
Body-Right (10mm)	829		1RB, Offset=0	/	/	/	/	/	/	/
	836.5		1RB, Offset=0	/	/	/	/	/	/	/
	844		1RB, Offset=0	0.110	21.97	22.00	1.007	0.201	0.202	112#
	844		50%RB, Offset=0	0.120	21.91	22.00	1.021	0.192	0.196	113#
Body-Bottom (10mm)	829		1RB, Offset=0	/	/	/	/	/	/	/
	836.5		1RB, Offset=0	/	/	/	/	/	/	/
	844		1RB, Offset=0	0.038	21.97	22.00	1.007	0.106	0.107	114#
	844		50%RB, Offset=0	0.098	21.91	22.00	1.021	0.088	0.090	115#

Hot Spot-LTE Band 7

EUT Position	Frequency (MHz)	Bandwidth (MHz)	Test Mode	Power Drift (%)	Max. Meas. Power (dBm)	Max. Rated Power (dBm)	1g SAR (W/Kg)			
							Scaled Factor	Meas. SAR	Scaled SAR	Plot
Body-Back (10mm)	2510	20	1RB, Offset=0	0.084	22.18	22.20	1.005	0.997	1.002	116#
	2535		1RB, Offset=0	0.009	22.10	22.20	1.023	0.937	0.959	117#
	2560		1RB, Offset=0	0.074	22.19	22.20	1.002	0.952	0.954	118#
	2560		50%RB, Offset=0	0.039	21.58	22.20	1.153	0.674	0.777	119#
	2560		100%RB, Offset=0	-0.085	21.47	22.20	1.183	0.658	0.778	120#
Body-Left (10mm)	2510		1RB, Offset=0	/	/	/	/	/	/	/
	2535		1RB, Offset=0	/	/	/	/	/	/	/
	2560		1RB, Offset=0	-0.123	22.19	22.20	1.002	0.362	0.363	121#
	2560		50%RB, Offset=0	0.103	21.58	22.20	1.153	0.297	0.343	122#
Body-Right (10mm)	2510		1RB, Offset=0	/	/	/	/	/	/	/
	2535		1RB, Offset=0	/	/	/	/	/	/	/
	2560		1RB, Offset=0	0.075	22.19	22.20	1.002	0.483	0.484	123#
	2560		50%RB, Offset=0	0.025	21.58	22.20	1.153	0.387	0.446	124#
Body-Bottom (10mm)	2510		1RB, Offset=0	/	/	/	/	/	/	/
	2535		1RB, Offset=0	/	/	/	/	/	/	/
	2560		1RB, Offset=0	0.055	22.19	22.20	1.002	0.792	0.794	125#
	2560	50%RB, Offset=0	0.025	21.58	22.20	1.153	0.662	0.763	126#	

Note:

1. When the 1-g SAR is $\leq 0.8W/Kg$, testing for other channels are optional.
2. SAR for LTE band exposure configurations is measured according to the procedures of KDB 941225 D05 SAR for LTE Devices v02.
3. KDB941225D05- SAR for higher order modulation is required only when the highest maximum output power for the configuration in the higher order modulation is $> \frac{1}{2}$ dB higher than the same configuration in QPSK or when the reported SAR for the QPSK configuration is $> 1.45 W/kg$
4. KDB941225D05- For QPSK with 100% RB allocation, when the reported SAR measured for the Highest output power channel is $< 1.45 W/kg$, tests for the remaining required test channels are optional.
5. KDB941225D05- For QPSK with 100% RB allocation, SAR is not required when the highest maximum output power for 100 % RB allocation is less than the highest maximum output power in 50% and 1 RB allocations and the highest reported SAR for 1 RB and 50% RB allocation are $\leq 0.8 W/kg$.
6. KDB941225D05- Start with the largest channel bandwidth (20M) and measure SAR for QPSK with 1 RB allocation, using the RB offset and required test channel combination with the highest maximum output power among RB offset the upper edge, middle and lower edge of each required test channel.
7. Worst case SAR for 50% RB allocation is selected to be tested.

SAR SIMULTANEOUS TRANSMISSION DESCRIPTION

BT & Wi-Fi and LTE&GSM&3G Antennas Location:

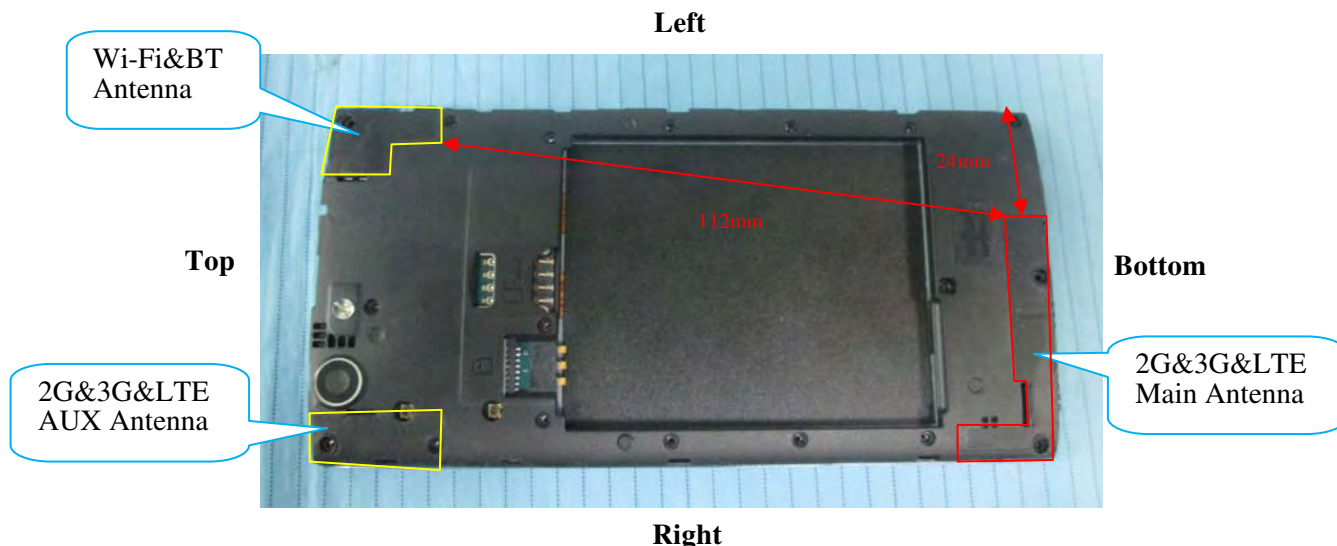

Simultaneous Transmission:

Description of Simultaneous Transmit Capabilities			Antennas Distance (mm)
Transmitter Combination	Simultaneous?	Hotspot?	
GSM + WCDMA	×	×	0
GSM + LTE	×	×	0
GSM + Bluetooth	√	×	112
GSM + Wi-Fi	√	√	112
WCDMA + LTE	×	×	0
WCDMA + Bluetooth	√	×	112
WCDMA + Wi-Fi	√	√	112
LTE+ Bluetooth	√	×	112
LTE+ Wi-Fi	√	√	112

Standalone SAR test exclusion considerations

Mode	Position	Max tune-up power		Distance (mm)	Calculated value	Threshold (1-g)	SAR Test Exclusion
		(dBm)	(mW)				
Wi-Fi	Head	9.80	9.55	0	3.0	3.0	Yes
Wi-Fi	Body	9.80	9.55	10	1.5		
Bluetooth	Head	0.10	1.02	0	0.3		
Bluetooth	Body	0.10	1.02	10	0.15		

The 1-g and 10-g SAR test exclusion thresholds for 100 MHz to 6 GHz at test separation distances ≤ 50 mm are determined by:

$$[(\text{max. power of channel, including tune-up tolerance, mW}) / (\text{min. test separation distance, mm})] \cdot [\sqrt{f(\text{GHz})}] \leq 3.0 \text{ for 1-g SAR and } \leq 7.5 \text{ for 10-g extremity SAR, where}$$

1. f(GHz) is the RF channel transmit frequency in GHz.
2. Power and distance are rounded to the nearest mW and mm before calculation.
3. The result is rounded to one decimal place for comparison.
4. When the minimum test separation distance is < 5 mm, a distance of 5 mm is applied to determine SAR test Exclusion.

Standalone SAR estimation:

Mode	Frequency (GHz)	Distance (mm)	Max tune-up power		Estimated 1-g (W/kg)
			(dBm)	(mW)	
BT Head	2.48	0	0.10	1.02	0.043
BT Body	2.48	10	0.10	1.02	0.022
Wi-Fi Head	2.472	0	9.80	9.55	0.400
Wi-Fi Body	2.472	10	9.80	9.55	0.200

When standalone SAR test exclusion applies to an antenna that transmits simultaneously with other antennas, the standalone SAR must be estimated according to following to determine simultaneous transmission SAR test exclusion:

$$[(\text{max. power of channel, including tune-up tolerance, mW})/(\text{min. test separation distance, mm})] \cdot [\sqrt{f(\text{GHz})/x}] \text{ W/kg for test separation distances } \leq 50 \text{ mm};$$

where $x = 7.5$ for 1-g SAR.

When the minimum test separation distance is < 5 mm, a distance of 5 mm is applied to determine SAR test Exclusion

Simultaneous SAR test exclusion considerations:

GSM with BT:

Mode	Position	Reported SAR (W/kg)		ΣSAR < 1.6W/kg
		GSM	BT	
GSM 850	Left Head Cheek	0.393	0.043	0.436
	Left Head Tilt	0.206	0.043	0.249
	Right Head Cheek	0.513	0.043	0.556
	Right Head Tilt	0.231	0.043	0.274
	Body-Headset-Back	0.492	0.022	0.514
PCS 1900	Left Head Cheek	0.220	0.043	0.263
	Left Head Tilt	0.064	0.043	0.107
	Right Head Cheek	0.147	0.043	0.190
	Right Head Tilt	0.063	0.043	0.106
	Body-Headset-Back	0.136	0.022	0.158

WCDMA with BT:

Mode	Position	Reported SAR (W/kg)		ΣSAR
		WCDMA	BT	< 1.6W/kg
WCDMA 850	Left Head Cheek	0.272	0.043	0.315
	Left Head Tilt	0.135	0.043	0.178
	Right Head Cheek	0.184	0.043	0.227
	Right Head Tilt	0.077	0.043	0.120
WCDMA 1700	Left Head Cheek	0.402	0.043	0.445
	Left Head Tilt	0.153	0.043	0.196
	Right Head Cheek	0.350	0.043	0.393
	Right Head Tilt	0.174	0.043	0.217
WCDMA 1900	Left Head Cheek	0.298	0.043	0.341
	Left Head Tilt	0.107	0.043	0.150
	Right Head Cheek	0.239	0.043	0.282
	Right Head Tilt	0.113	0.043	0.156

LTE with BT:

Mode	Position	Reported SAR (W/kg)		ΣSAR
		LTE	BT	< 1.6W/kg
LTE Band 2	Left Head Cheek	0.290	0.043	0.333
	Left Head Tilt	0.137	0.043	0.180
	Right Head Cheek	0.337	0.043	0.380
	Right Head Tilt	0.119	0.043	0.162
LTE Band 4	Left Head Cheek	0.386	0.043	0.429
	Left Head Tilt	0.223	0.043	0.266
	Right Head Cheek	0.580	0.043	0.623
	Right Head Tilt	0.220	0.043	0.263
LTE Band 5	Left Head Cheek	0.202	0.043	0.245
	Left Head Tilt	0.196	0.043	0.239
	Right Head Cheek	0.218	0.043	0.261
	Right Head Tilt	0.103	0.043	0.146
LTE Band 7	Left Head Cheek	0.562	0.043	0.605
	Left Head Tilt	0.288	0.043	0.331
	Right Head Cheek	0.522	0.043	0.565
	Right Head Tilt	0.290	0.043	0.333

GSM with Wi-Fi:

Mode	Position	Reported SAR (W/kg)		ΣSAR
		GSM	Wi-Fi	< 1.6W/kg
GSM 850	Left Head Cheek	0.393	0.400	0.793
	Left Head Tilt	0.206	0.400	0.606
	Right Head Cheek	0.513	0.400	0.913
	Right Head Tilt	0.231	0.400	0.631
	Body-Headset-Back	0.492	0.200	0.692
PCS 1900	Left Head Cheek	0.220	0.400	0.620
	Left Head Tilt	0.064	0.400	0.464
	Right Head Cheek	0.147	0.400	0.547
	Right Head Tilt	0.063	0.400	0.463
	Body-Headset-Back	0.136	0.200	0.336

WCDMA with Wi-Fi:

Mode	Position	Reported SAR (W/kg)		ΣSAR
		WCDMA	Wi-Fi	< 1.6W/kg
WCDMA 850	Left Head Cheek	0.272	0.400	0.672
	Left Head Tilt	0.135	0.400	0.535
	Right Head Cheek	0.184	0.400	0.584
	Right Head Tilt	0.077	0.400	0.477
WCDMA 1700	Left Head Cheek	0.402	0.400	0.802
	Left Head Tilt	0.153	0.400	0.553
	Right Head Cheek	0.350	0.400	0.750
	Right Head Tilt	0.174	0.400	0.574
WCDMA 1900	Left Head Cheek	0.298	0.400	0.698
	Left Head Tilt	0.107	0.400	0.507
	Right Head Cheek	0.239	0.400	0.639
	Right Head Tilt	0.113	0.400	0.513

LTE with Wi-Fi:

Mode	Position	Reported SAR (W/kg)		ΣSAR
		LTE	Wi-Fi	< 1.6W/kg
LTE Band 2	Left Head Cheek	0.290	0.400	0.690
	Left Head Tilt	0.137	0.400	0.537
	Right Head Cheek	0.337	0.400	0.737
	Right Head Tilt	0.119	0.400	0.519
LTE Band 4	Left Head Cheek	0.386	0.400	0.786
	Left Head Tilt	0.223	0.400	0.623
	Right Head Cheek	0.580	0.400	0.980
	Right Head Tilt	0.220	0.400	0.620
LTE Band 5	Left Head Cheek	0.202	0.400	0.602
	Left Head Tilt	0.196	0.400	0.596
	Right Head Cheek	0.218	0.400	0.618
	Right Head Tilt	0.103	0.400	0.503
LTE Band 7	Left Head Cheek	0.562	0.400	0.962
	Left Head Tilt	0.288	0.400	0.688
	Right Head Cheek	0.522	0.400	0.922
	Right Head Tilt	0.290	0.400	0.690

Evaluations for Simultaneous SAR, BT+WWAN					
Test Position	Body-Back (1.0cm)	Body-Left (1.0cm)	Body-Right (1.0cm)	Body-Bottom (1.0cm)	Body-Top (1.0cm)
Mode	Stand Alone 1-g SAR (W/Kg)				
GPRS 850	1.043	0.763	0.676	0.424	/
GPRS 1900	0.327	0.09	0.14	0.198	/
WCDMA 850	0.395	0.224	0.264	0.165	/
WCDMA 1700	0.644	0.236	0.292	0.574	/
WCDMA 1900	0.583	0.218	0.288	0.642	/
LTE Band 2	0.668	0.192	0.326	0.625	/
LTE Band 4	0.925	0.201	0.303	0.591	/
LTE Band 5	0.429	0.209	0.202	0.107	/
LTE Band 7	1.002	0.363	0.484	0.794	/
BT	0.022	0.022	0.022	0.022	0.022
	Σ 1-g SAR(W/Kg)				
GPRS 850 + BT	1.065	0.785	0.698	0.446	/
GPRS 1900 + BT	0.349	0.112	0.162	0.220	/
WCDMA 850 + BT	0.417	0.246	0.286	0.187	/
WCDMA 1700+ BT	0.666	0.258	0.314	0.596	/
WCDMA 1900+ BT	0.605	0.240	0.310	0.664	/
LTE Band 2+ BT	0.690	0.214	0.348	0.647	/
LTE Band 4+ BT	0.947	0.223	0.325	0.613	/
LTE Band 5+ BT	0.451	0.231	0.224	0.129	/
LTE Band 7+ BT	1.024	0.385	0.506	0.816	/
Evaluations for Simultaneous SAR, Mobile Hot Spot Positions					
Test Position	Body-Back (1.0cm)	Body-Left (1.0cm)	Body-Right (1.0cm)	Body-Bottom (1.0cm)	Body-Top (1.0cm)
Mode	Stand Alone 1-g SAR (W/Kg)				
GPRS 850	1.043	0.763	0.676	0.424	/
GPRS 1900	0.327	0.09	0.14	0.198	/
WCDMA 850	0.395	0.224	0.264	0.165	/
WCDMA 1700	0.644	0.236	0.292	0.574	/
WCDMA 1900	0.583	0.218	0.288	0.642	/
LTE Band 2	0.668	0.192	0.326	0.625	/
LTE Band 4	0.925	0.201	0.303	0.591	/
LTE Band 5	0.429	0.209	0.202	0.107	/
LTE Band 7	1.002	0.363	0.484	0.794	/
Wi-Fi	0.200	0.200	0.200	0.200	0.200
	Σ 1-g SAR(W/Kg)				
GPRS 850 + Wi-Fi	1.243	0.963	0.876	0.624	/
GPRS 1900 + Wi-Fi	0.527	0.290	0.340	0.398	/
WCDMA 850 + Wi-Fi	0.595	0.424	0.464	0.365	/
WCDMA 1700+ Wi-Fi	0.844	0.436	0.492	0.774	/
WCDMA 1900+ Wi-Fi	0.783	0.418	0.488	0.842	/
LTE Band 2+ Wi-Fi	0.868	0.392	0.526	0.825	/
LTE Band 4+ Wi-Fi	1.125	0.401	0.503	0.791	/
LTE Band 5+ Wi-Fi	0.629	0.409	0.402	0.307	/
LTE Band 7+ Wi-Fi	1.202	0.563	0.684	0.994	/

Note:

If the sum of the 1g SAR measured for the simultaneously transmitting antennas is less than the SAR limit, SAR measurement for simultaneous transmission is not required.

SAR Plots

Test Laboratory: Bay Area Compliance Labs Corp.(Shenzhen)

Test Plot 1#: GSM 850 Left Cheek Middle Channel

DUT: 3G/4G Smart Phone; Model: SKY 5.0LM

Communication System: 2G Bands; Frequency: 836.6 MHz; Duty Cycle: 1:8
Medium parameters used: $f = 836.6$ MHz; $\sigma = 0.90$ S/m; $\epsilon_r = 40.25$; $\rho = 1000$ kg/m³
Phantom section: Left Section

DASY4 Configuration:

- Probe: ES3DV3 - SN3036; ConvF(6.26, 6.26, 6.26); Calibrated: 16/9/2016
- Sensor-Surface: 4mm (Mechanical Surface Detection)
- Electronics: Dummy DAE - SN:456; Calibrated: 12/9/2016
- Phantom: TWIN SAM; Type: QD000P40CA; Serial: TP-1218
- Measurement SW: DASY4, V4.5 Build 19; Postprocessing SW: SEMCAD, V1.8 Build 145

GSM 850-Left-cheek-mid /Area Scan (101x121x1): Measurement grid: dx=10mm, dy=10mm
Maximum value of SAR (interpolated) = 0.442 mW/g

GSM 850-Left-cheek-mid /Zoom Scan (7x7x7)/Cube 0: Measurement grid: dx=5mm, dy=5mm, dz=5mm
Reference Value = 6.9 V/m; Power Drift = -0.025 dB
Peak SAR (extrapolated) = 0.558 W/kg
SAR(1 g) = 0.377 mW/g; SAR(10 g) = 0.257 mW/g
Maximum value of SAR (measured) = 0.378 mW/g

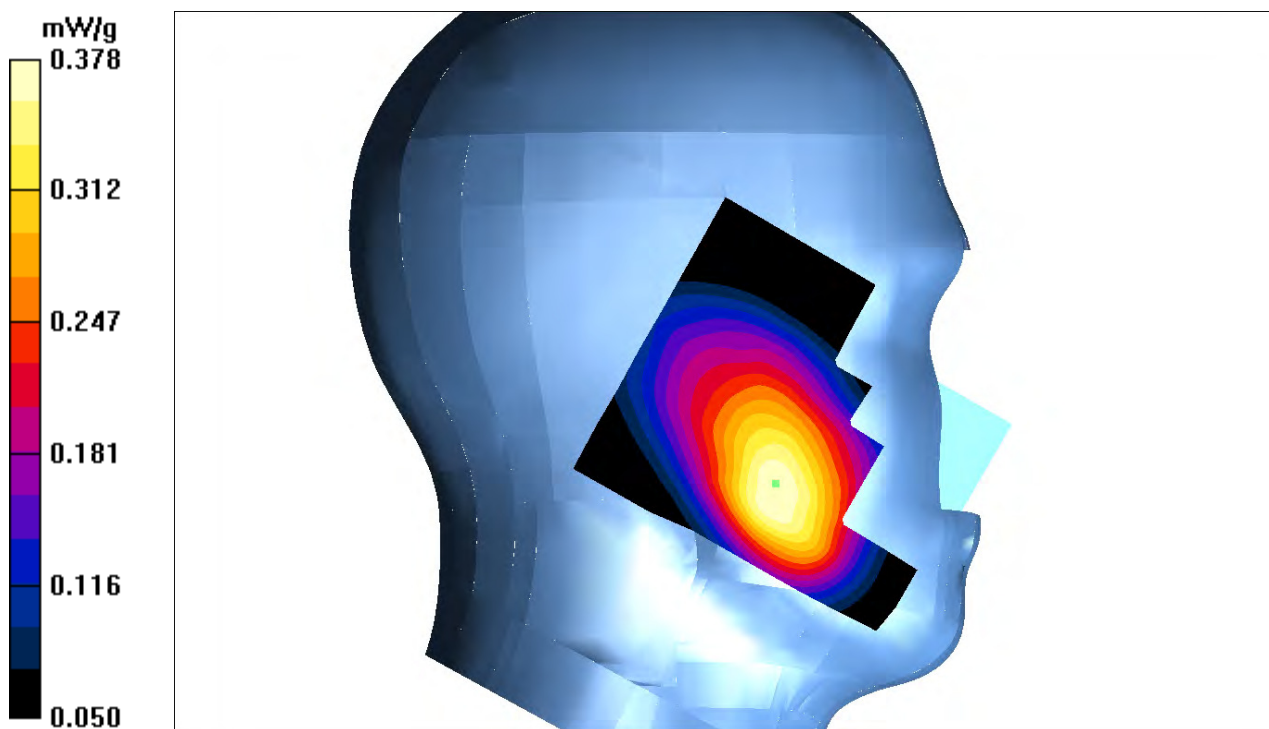

Test Laboratory: Bay Area Compliance Labs Corp.(Shenzhen)

Test Plot 2#:GSM 850 Left Tilt Middle Channel

DUT: 3G/4G Smart Phone ; Model:SKY 5.0LM

Communication System: 2G Band; Frequency: 836.6 MHz;Duty Cycle: 1:8
 Medium parameters used: $f = 836.6 \text{ MHz}$; $\sigma = 0.90 \text{ S/m}$; $\epsilon_r = 40.25$; $\rho = 1000 \text{ kg/m}^3$
 Phantom section: Left Section

DASY4 Configuration:

- Probe: ES3DV3 - SN3036; ConvF(6.26, 6.26, 6.26); Calibrated: 16/9/2016
- Sensor-Surface: 4mm (Mechanical Surface Detection)
- Electronics: Dummy DAE - SN:456; Calibrated: 12/9/2016
- Phantom: TWIN SAM; Type: QD000P40CA; Serial: TP-1218
- Measurement SW: DASY4, V4.5 Build 19; Postprocessing SW: SEMCAD, V1.8 Build 145

GSM 850-Left-tilt-mid /Area Scan (101x121x1): Measurement grid: $dx=10\text{mm}$, $dy=10\text{mm}$
 Maximum value of SAR (interpolated) = 0.213 mW/g

GSM 850-Left-tilt-mid /Zoom Scan (7x7x7)/Cube 0: Measurement grid: $dx=5\text{mm}$, $dy=5\text{mm}$, $dz=5\text{mm}$
 Reference Value = 6.4 V/m; Power Drift = -0.076 dB
 Peak SAR (extrapolated) = 0.218 W/kg
SAR(1 g) = 0.198 mW/g; SAR(10 g) = 0.108 mW/g
 Maximum value of SAR (measured) = 0.199 mW/g

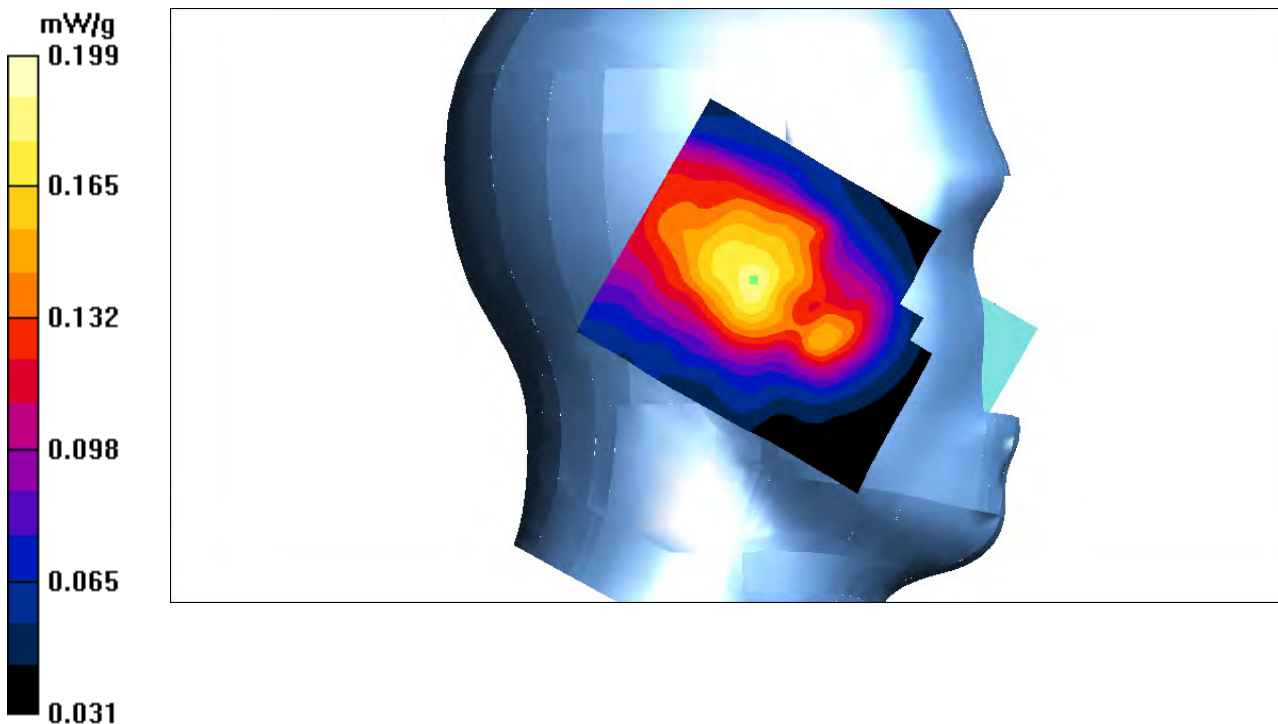

Test Laboratory: Bay Area Compliance Labs Corp.(Shenzhen)

Test Plot 3#:GSM 850 Right Cheek Low Channel

DUT: 3G/4G Smart Phone ; Model:SKY 5.0LM

Communication System: 2G Band; Frequency: 824.2 MHz;Duty Cycle: 1:8
 Medium parameters used: $f = 824.2 \text{ MHz}$; $\sigma = 0.87 \text{ S/m}$; $\epsilon_r = 40.05$; $\rho = 1000 \text{ kg/m}^3$
 Phantom section: Right Section

DASY4 Configuration:

- Probe: ES3DV3 - SN3036; ConvF(6.26, 6.26, 6.26); Calibrated: 16/9/2016
- Sensor-Surface: 4mm (Mechanical Surface Detection)
- Electronics: Dummy DAE - SN:456; Calibrated: 12/9/2016
- Phantom: TWIN SAM; Type: QD000P40CA; Serial: TP-1218
- Measurement SW: DASY4, V4.5 Build 19; Postprocessing SW: SEMCAD, V1.8 Build 145

GSM 850-Right-cheek-low /Area Scan (101x121x1): Measurement grid: $dx=10\text{mm}$, $dy=10\text{mm}$
 Maximum value of SAR (interpolated) = 0.462 mW/g

GSM 850-Right-cheek-low /Zoom Scan (7x7x7)/Cube 0: Measurement grid: $dx=5\text{mm}$, $dy=5\text{mm}$, $dz=5\text{mm}$

Reference Value = 6.83 V/m; Power Drift = 0.097 dB

Peak SAR (extrapolated) = 0.420 W/kg

SAR(1 g) = 0.453 mW/g; SAR(10 g) = 0.272 mW/g

Maximum value of SAR (measured) = 0.467 mW/g

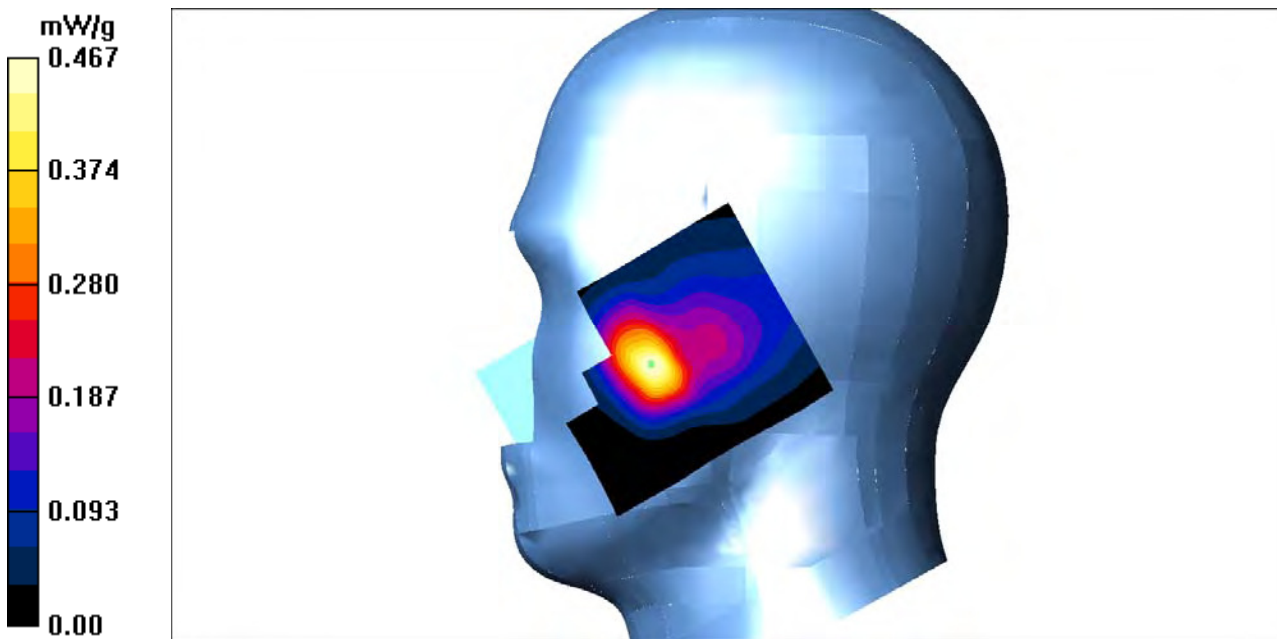

Test Laboratory: Bay Area Compliance Labs Corp.(Shenzhen)

Test Plot 4#:GSM 850 Right Cheek Middle Channel

DUT: 3G/4G Smart Phone ; Model:SKY 5.0LM

Communication System: 2G Band; Frequency: 836.6 MHz;Duty Cycle: 1:8
Medium parameters used: $f = 836.6$ MHz; $\sigma = 0.90$ S/m; $\epsilon_r = 40.25$; $\rho = 1000$ kg/m³
Phantom section: Right Section

DASY4 Configuration:

- Probe: ES3DV3 - SN3036; ConvF(6.26, 6.26, 6.26); Calibrated: 16/9/2016
- Sensor-Surface: 4mm (Mechanical Surface Detection)
- Electronics: Dummy DAE - SN:456; Calibrated: 12/9/2016
- Phantom: TWIN SAM; Type: QD000P40CA; Serial: TP-1218
- Measurement SW: DASY4, V4.5 Build 19; Postprocessing SW: SEMCAD, V1.8 Build 145

GSM 850-Right-cheek-mid /Area Scan (101x121x1): Measurement grid: dx=10mm, dy=10mm
Maximum value of SAR (interpolated) = 0.675 mW/g

GSM 850-Right-cheek-mid /Zoom Scan (7x7x7)/Cube 0: Measurement grid: dx=5mm, dy=5mm, dz=5mm

Reference Value = 4.38 V/m; Power Drift = 0.094 dB

Peak SAR (extrapolated) = 0.520 W/kg

SAR(1 g) = 0.492 mW/g; SAR(10 g) = 0.258 mW/g

Maximum value of SAR (measured) = 0.655 mW/g

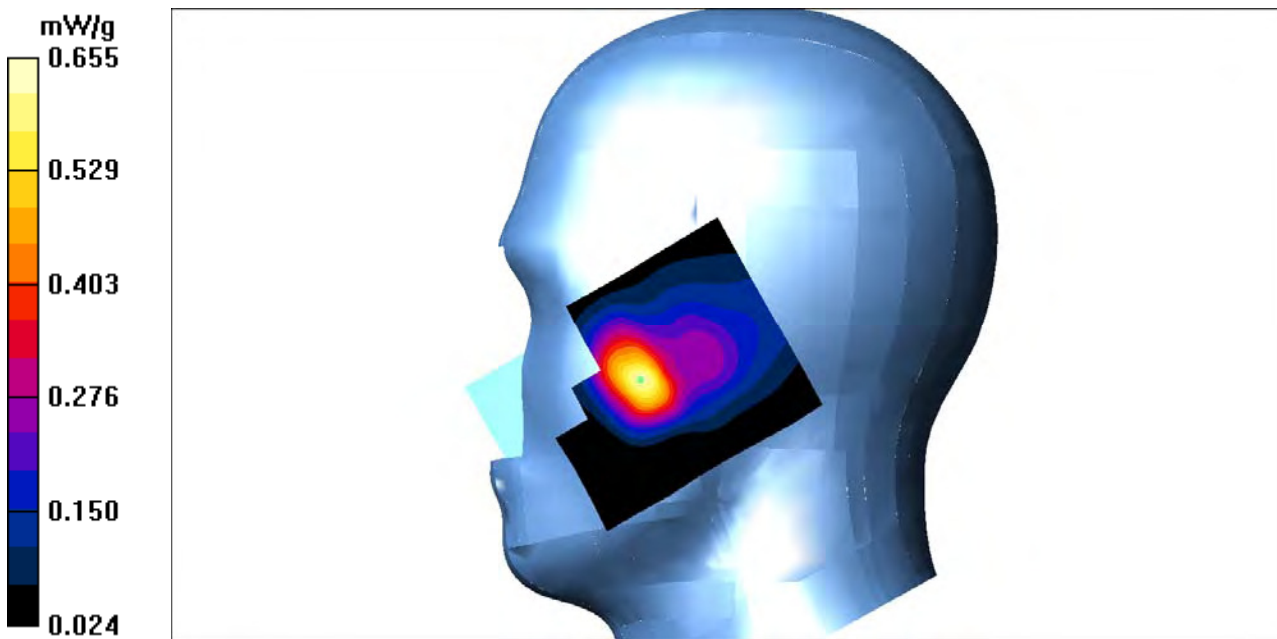

Test Laboratory: Bay Area Compliance Labs Corp.(Shenzhen)**Test Plot 5#: GSM 850 Right Cheek High Channel****DUT: 3G/4G Smart Phone; Model: SKY 5.0LM**

Communication System: 2G Band; Frequency: 848.8 MHz; Duty Cycle: 1:8
Medium parameters used: $f = 848.8$ MHz; $\sigma = 1.00$ S/m; $\epsilon_r = 40.57$; $\rho = 1000$ kg/m³
Phantom section: Right Section

DASY4 Configuration:

- Probe: ES3DV3 - SN3036; ConvF(6.26, 6.26, 6.26); Calibrated: 16/9/2016
- Sensor-Surface: 4mm (Mechanical Surface Detection)
- Electronics: Dummy DAE - SN:456; Calibrated: 12/9/2016
- Phantom: TWIN SAM; Type: QD000P40CA; Serial: TP-1218
- Measurement SW: DASY4, V4.5 Build 19; Postprocessing SW: SEMCAD, V1.8 Build 145

GSM 850-Right-cheek-high /Area Scan (101x121x1): Measurement grid: dx=10mm, dy=10mm
Maximum value of SAR (interpolated) = 0.788 mW/g

GSM 850-Right-cheek-high /Zoom Scan (7x7x7)/Cube 0: Measurement grid: dx=5mm, dy=5mm, dz=5mm

Reference Value = 3.77 V/m; Power Drift = 0.082 dB

Peak SAR (extrapolated) = 0.862 W/kg

SAR(1 g) = 0.482 mW/g; SAR(10 g) = 0.259 mW/g

Maximum value of SAR (measured) = 0.743 mW/g

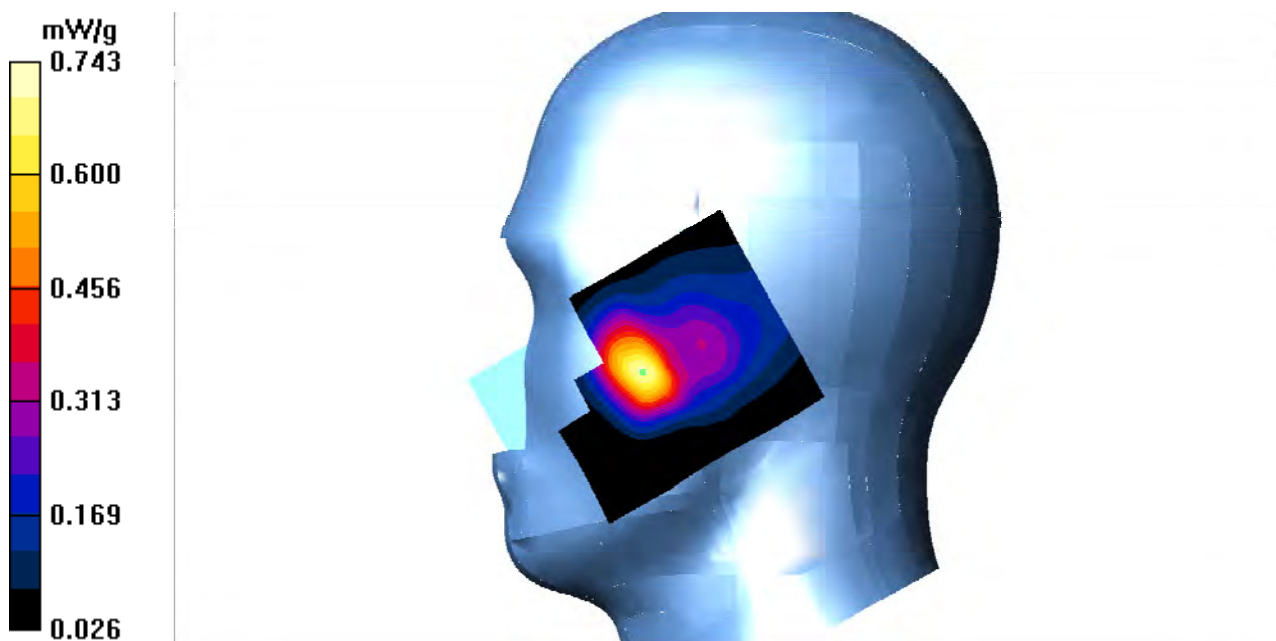

Test Laboratory: Bay Area Compliance Labs Corp.(Shenzhen)

Test Plot 6#:GSM 850 Right Tilt Middle Channel

DUT: 3G/4G Smart Phone; Model:SKY 5.0LM

Communication System: 2G Band; Frequency: 836.6 MHz;Duty Cycle: 1:8
 Medium parameters used: $f = 836.6 \text{ MHz}$; $\sigma = 0.90 \text{ S/m}$; $\epsilon_r = 40.25$; $\rho = 1000 \text{ kg/m}^3$
 Phantom section: Right Section

DASY4 Configuration:

- Probe: ES3DV3 - SN3036; ConvF(6.26, 6.26, 6.26); Calibrated: 16/9/2016
- Sensor-Surface: 4mm (Mechanical Surface Detection)
- Electronics: Dummy DAE - SN:456; Calibrated: 12/9/2016
- Phantom: TWIN SAM; Type: QD000P40CA; Serial: TP-1218
- Measurement SW: DASY4, V4.5 Build 19; Postprocessing SW: SEMCAD, V1.8 Build 145

GSM 850-Right-tilt-mid /Area Scan (101x121x1): Measurement grid: $dx=10\text{mm}$, $dy=10\text{mm}$
 Maximum value of SAR (interpolated) = 0.257 mW/g

GSM 850-Right-tilt-mid /Zoom Scan (7x7x7)/Cube 0: Measurement grid: $dx=5\text{mm}$, $dy=5\text{mm}$, $dz=5\text{mm}$
 Reference Value = 3.71 V/m; Power Drift = -0.104 dB
 Peak SAR (extrapolated) = 0.251 W/kg
SAR(1 g) = 0.222 mW/g; SAR(10 g) = 0.125 mW/g
 Maximum value of SAR (measured) = 0.234 mW/g

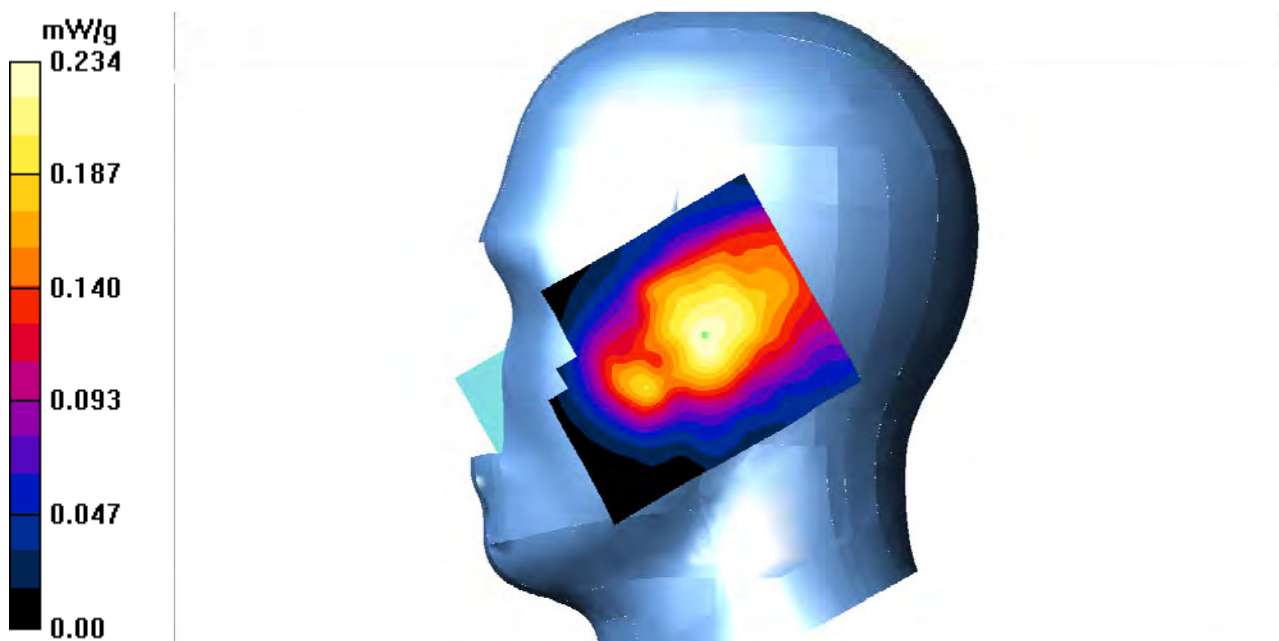

Test Laboratory: Bay Area Compliance Labs Corp.(Shenzhen)

Test Plot 7#: PCS 1900 Left Cheek Low Channel

DUT: 3G/4G Smart Phone; Model: SKY 5.0LM

Communication System: 2G Band; Frequency: 1850.2 MHz;Duty Cycle: 1:8
Medium parameters used: $f = 1850.2$ MHz; $\sigma = 1.36$ S/m; $\epsilon_r = 39.42$; $\rho = 1000$ kg/m³
Phantom section: Left Section

DASY4 Configuration:

- Probe: ES3DV3 - SN3036; ConvF(5.12, 5.12, 5.12); Calibrated: 16/9/2016
- Sensor-Surface: 4mm (Mechanical Surface Detection)
- Electronics: Dummy DAE - SN:456; Calibrated: 12/9/2016
- Phantom: TWIN SAM; Type: QD000P40CA; Serial: TP-1218
- Measurement SW: DASY4, V4.5 Build 19; Postprocessing SW: SEMCAD, V1.8 Build 145

PCS 1900-left-cheek-low /Area Scan (101x121x1): Measurement grid: dx=10mm, dy=10mm
Maximum value of SAR (interpolated) = 0.260 mW/g

PCS 1900-left-cheek-low /Zoom Scan (7x7x7)/Cube 0: Measurement grid: dx=5mm, dy=5mm, dz=5mm
Reference Value = 4.72 V/m; Power Drift = -0.065 dB
Peak SAR (extrapolated) = 0.249 W/kg
SAR(1 g) = 0.138 mW/g; SAR(10 g) = 0.079 mW/g
Maximum value of SAR (measured) = 0.225 mW/g

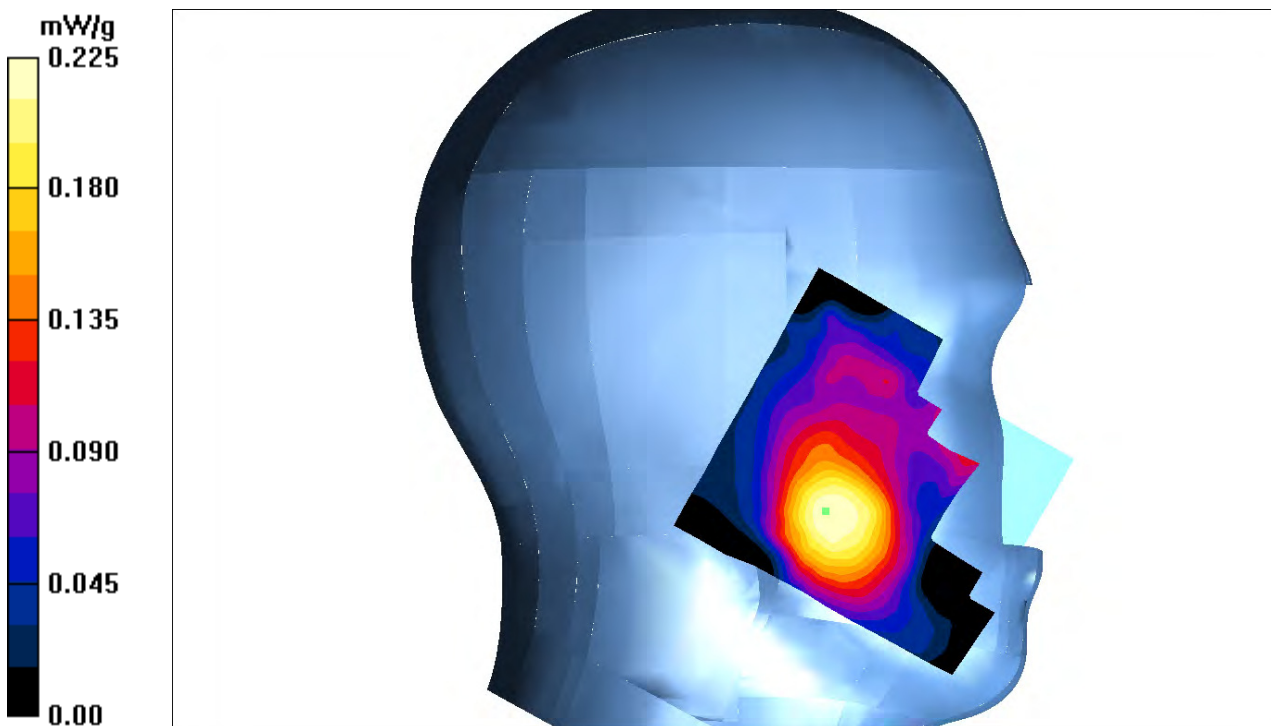

Test Laboratory: Bay Area Compliance Labs Corp.(Shenzhen)

Test Plot 8#: PCS 1900 Left Cheek Middle Channel

DUT: 3G/4G Smart Phone; Model: SKY 5.0LM

Communication System: 2G Band; Frequency: 1880.0 MHz;Duty Cycle: 1:8
 Medium parameters used: $f = 1880.0 \text{ MHz}$; $\sigma = 1.39 \text{ S/m}$; $\epsilon_r = 39.72$; $\rho = 1000 \text{ kg/m}^3$
 Phantom section: Left Section

DASY4 Configuration:

- Probe: ES3DV3 - SN3036; ConvF(5.12, 5.12, 5.12); Calibrated: 16/9/2016
- Sensor-Surface: 4mm (Mechanical Surface Detection)
- Electronics: Dummy DAE - SN:456; Calibrated: 12/9/2016
- Phantom: TWIN SAM; Type: QD000P40CA; Serial: TP-1218
- Measurement SW: DASY4, V4.5 Build 19; Postprocessing SW: SEMCAD, V1.8 Build 145

PCS 1900-left-cheek-mid /Area Scan (101x121x1): Measurement grid: $dx=10\text{mm}$, $dy=10\text{mm}$
 Maximum value of SAR (interpolated) = 0.227 mW/g

PCS 1900-left-cheek-mid /Zoom Scan (7x7x7)/Cube 0: Measurement grid: $dx=5\text{mm}$, $dy=5\text{mm}$, $dz=5\text{mm}$
 Reference Value = 3.70 V/m; Power Drift = -0.052 dB
 Peak SAR (extrapolated) = 0.208 W/kg
SAR(1 g) = 0.165 mW/g; SAR(10 g) = 0.084 mW/g
 Maximum value of SAR (measured) = 0.218 mW/g

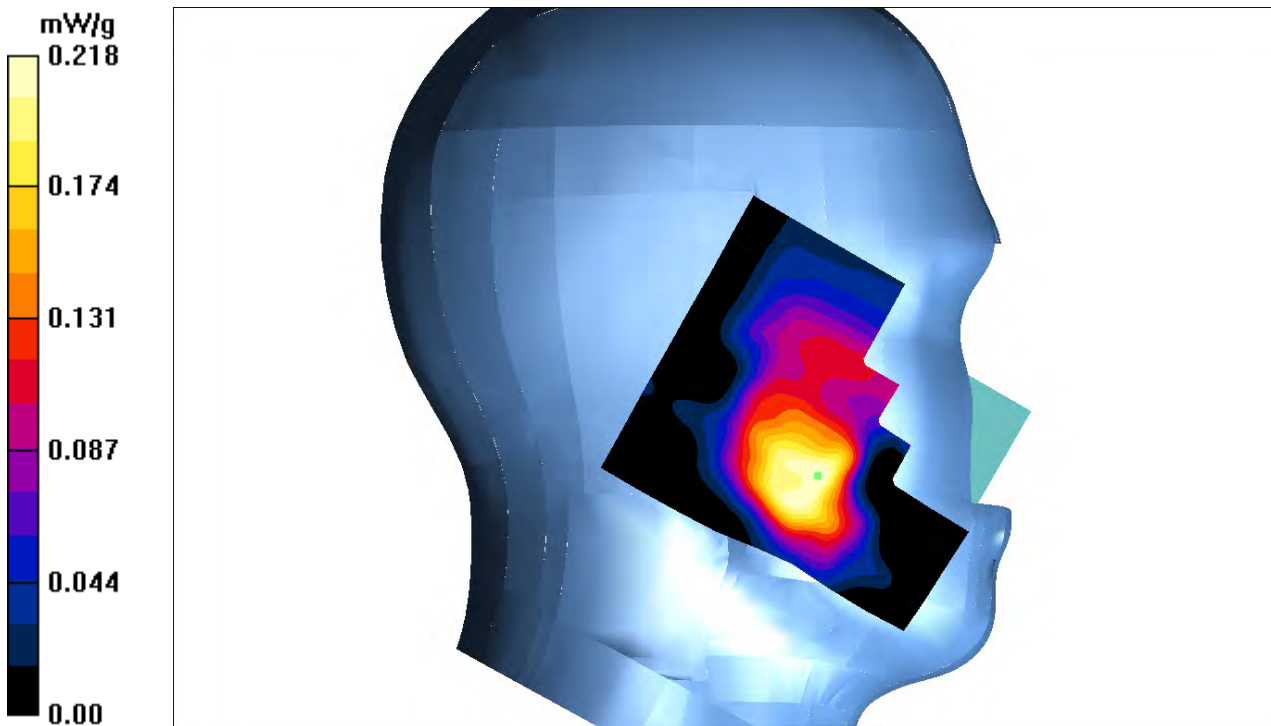

Test Laboratory: Bay Area Compliance Labs Corp.(Shenzhen)

Test Plot 9#:PCS 1900 Left Cheek High Channel

DUT: 3G/4G Smart Phone ; Model:SKY 5.0LM

Communication System: 2G Band; Frequency: 1909.8 MHz;Duty Cycle: 1:8
 Medium parameters used: $f = 1909.8 \text{ MHz}$; $\sigma = 1.42 \text{ S/m}$; $\epsilon_r = 40.12$; $\rho = 1000 \text{ kg/m}^3$
 Phantom section: Left Section

DASY4 Configuration:

- Probe: ES3DV3 - SN3036; ConvF(5.12, 5.12, 5.12); Calibrated: 16/9/2016
- Sensor-Surface: 4mm (Mechanical Surface Detection)
- Electronics: Dummy DAE - SN:456; Calibrated: 12/9/2016
- Phantom: TWIN SAM; Type: QD000P40CA; Serial: TP-1218
- Measurement SW: DASY4, V4.5 Build 19; Postprocessing SW: SEMCAD, V1.8 Build 145

PCS 1900-left-cheek-high /Area Scan (101x121x1): Measurement grid: $dx=10\text{mm}$, $dy=10\text{mm}$
 Maximum value of SAR (interpolated) = 0.244 mW/g

PCS 1900-left-cheek-high /Zoom Scan (7x7x7)/Cube 0: Measurement grid: $dx=5\text{mm}$, $dy=5\text{mm}$, $dz=5\text{mm}$
 Reference Value = 1.42 V/m; Power Drift = -0.085 dB
 Peak SAR (extrapolated) = 0.205 W/kg
SAR(1 g) = 0.215 mW/g; SAR(10 g) = 0.113 mW/g
 Maximum value of SAR (measured) = 0.233 mW/g

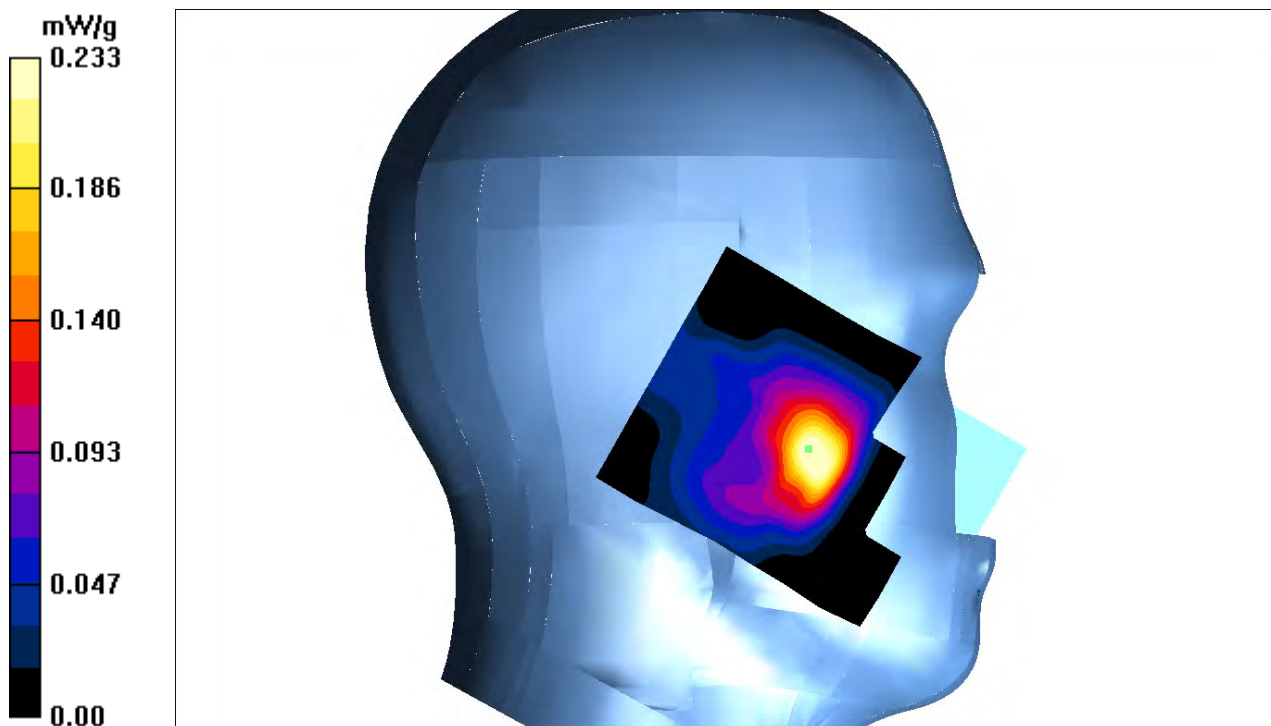

Test Laboratory: Bay Area Compliance Labs Corp.(Shenzhen)

Test Plot 10#:PCS 1900 Left Tilt Middle Channel

DUT: 3G/4G Smart Phone ; Model:SKY 5.0LM

Communication System: 2G Band; Frequency: 1880.0 MHz;Duty Cycle: 1:8
 Medium parameters used: $f = 1880.0 \text{ MHz}$; $\sigma = 1.39 \text{ S/m}$; $\epsilon_r = 39.72$; $\rho = 1000 \text{ kg/m}^3$
 Phantom section: Left Section

DASY4 Configuration:

- Probe: ES3DV3 - SN3036; ConvF(5.12, 5.12, 5.12); Calibrated: 16/9/2016
- Sensor-Surface: 4mm (Mechanical Surface Detection)
- Electronics: Dummy DAE - SN:456; Calibrated: 12/9/2016
- Phantom: TWIN SAM; Type: QD000P40CA; Serial: TP-1218
- Measurement SW: DASY4, V4.5 Build 19; Postprocessing SW: SEMCAD, V1.8 Build 145

PCS 1900-left-tilt-mid /Area Scan (101x121x1): Measurement grid: $dx=10\text{mm}$, $dy=10\text{mm}$
 Maximum value of SAR (interpolated) = 0.083 mW/g

PCS 1900-left-tilt-mid /Zoom Scan (7x7x7)/Cube 0: Measurement grid: $dx=5\text{mm}$, $dy=5\text{mm}$, $dz=5\text{mm}$
 Reference Value = 2.786 V/m; Power Drift = 0.086 dB
 Peak SAR (extrapolated) = 0.072 W/kg
SAR(1 g) = 0.062 mW/g; SAR(10 g) = 0.036 mW/g
 Maximum value of SAR (measured) = 0.068 mW/g

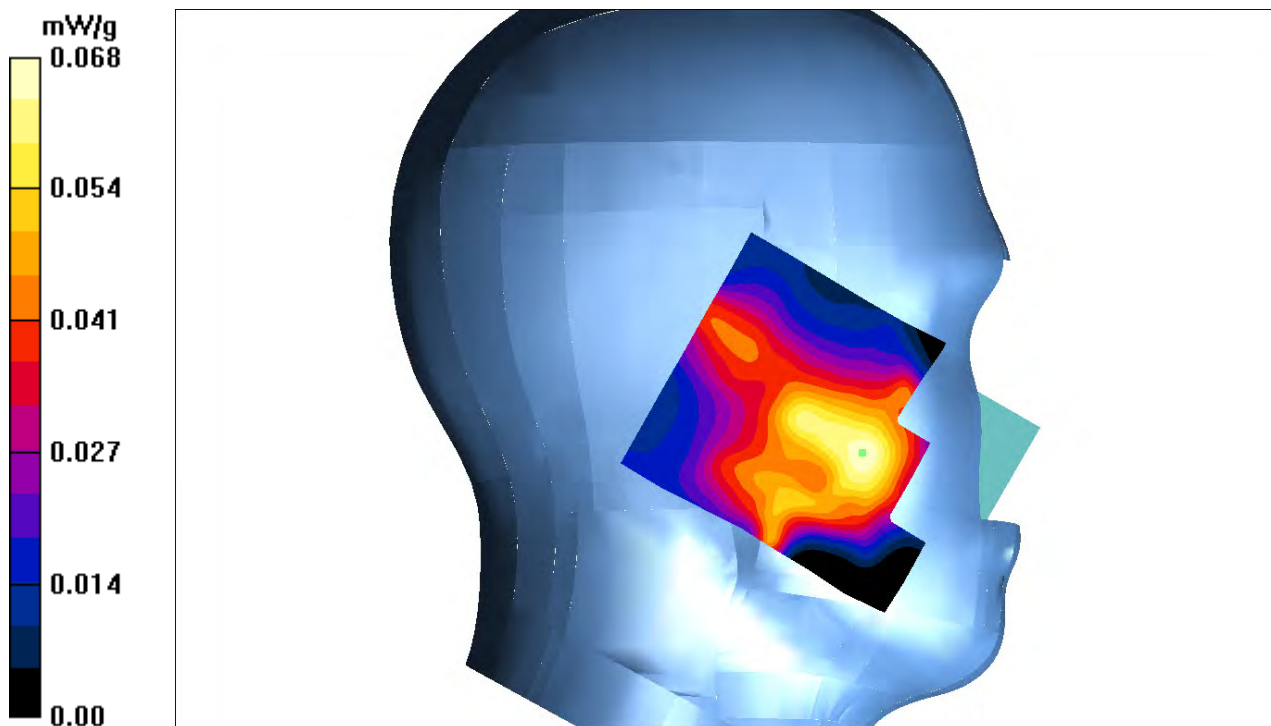

Test Laboratory: Bay Area Compliance Labs Corp.(Shenzhen)

Test Plot 11#:PCS 1900 Right Cheek Middle Channel

DUT: 3G/4G Smart Phone ; Model:SKY 5.0LM

Communication System: 2G Band; Frequency: 1880.0 MHz;Duty Cycle: 1:8
 Medium parameters used: $f = 1880.0$ MHz; $\sigma = 1.39$ S/m; $\epsilon_r = 39.72$; $\rho = 1000$ kg/m³
 Phantom section: Right Section

DASY4 Configuration:

- Probe: ES3DV3 - SN3036; ConvF(5.12, 5.12, 5.12); Calibrated: 16/9/2016
- Sensor-Surface: 4mm (Mechanical Surface Detection)
- Electronics: Dummy DAE - SN:456; Calibrated: 12/9/2016
- Phantom: TWIN SAM; Type: QD000P40CA; Serial: TP-1218
- Measurement SW: DASY4, V4.5 Build 19; Postprocessing SW: SEMCAD, V1.8 Build 145

PCS 1900-right-cheek-mid /Area Scan (101x121x1): Measurement grid: dx=10mm, dy=10mm
 Maximum value of SAR (interpolated) = 0.188 mW/g

PCS 1900-right-cheek-mid /Zoom Scan (7x7x7)/Cube 0: Measurement grid: dx=5mm, dy=5mm, dz=5mm

Reference Value = 2.89 V/m; Power Drift = 0.067 dB

Peak SAR (extrapolated) = 0.173 W/kg

SAR(1 g) = 0.142 mW/g; SAR(10 g) = 0.074 mW/g

Maximum value of SAR (measured) = 0.168 mW/g

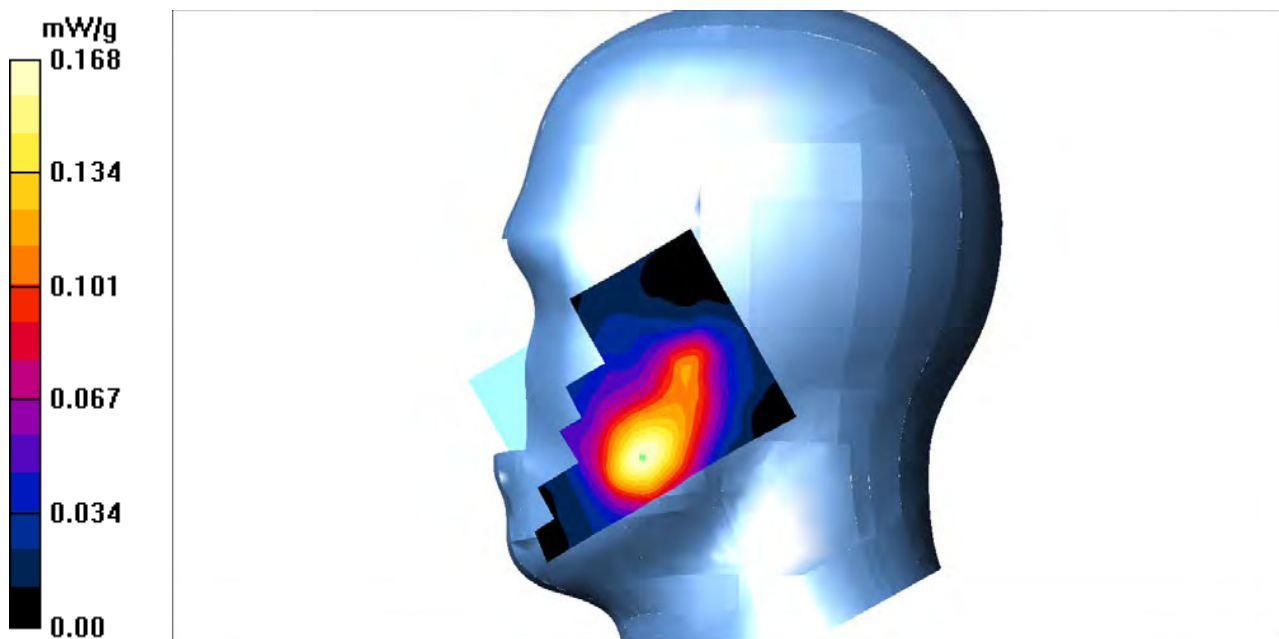

Test Laboratory: Bay Area Compliance Labs Corp.(Shenzhen)

Test Plot 12#:PCS 1900 Right Tilt Middle Channel

DUT: 3G/4G Smart Phone ; Model:SKY 5.0LM

Communication System: 2G Band; Frequency: 1880.0 MHz;Duty Cycle: 1:8
Medium parameters used: $f = 1880.0$ MHz; $\sigma = 1.39$ S/m; $\epsilon_r = 39.72$; $\rho = 1000$ kg/m³
Phantom section: Right Section

DASY4 Configuration:

- Probe: ES3DV3 - SN3036; ConvF(5.12, 5.12, 5.12); Calibrated: 16/9/2016
- Sensor-Surface: 4mm (Mechanical Surface Detection)
- Electronics: Dummy DAE - SN:456; Calibrated: 12/9/2016
- Phantom: TWIN SAM; Type: QD000P40CA; Serial: TP-1218
- Measurement SW: DASY4, V4.5 Build 19; Postprocessing SW: SEMCAD, V1.8 Build 145

PCS 1900-right-tilt-mid /Area Scan (101x121x1): Measurement grid: dx=10mm, dy=10mm
Maximum value of SAR (interpolated) = 0.077 mW/g

PCS 1900-right-tilt-mid /Zoom Scan (7x7x7)/Cube 0: Measurement grid: dx=5mm, dy=5mm, dz=5mm
Reference Value = 3.36 V/m; Power Drift = 0.056 dB
Peak SAR (extrapolated) = 0.078 W/kg
SAR(1 g) = 0.061 mW/g; SAR(10 g) = 0.042 mW/g
Maximum value of SAR (measured) = 0.064 mW/g

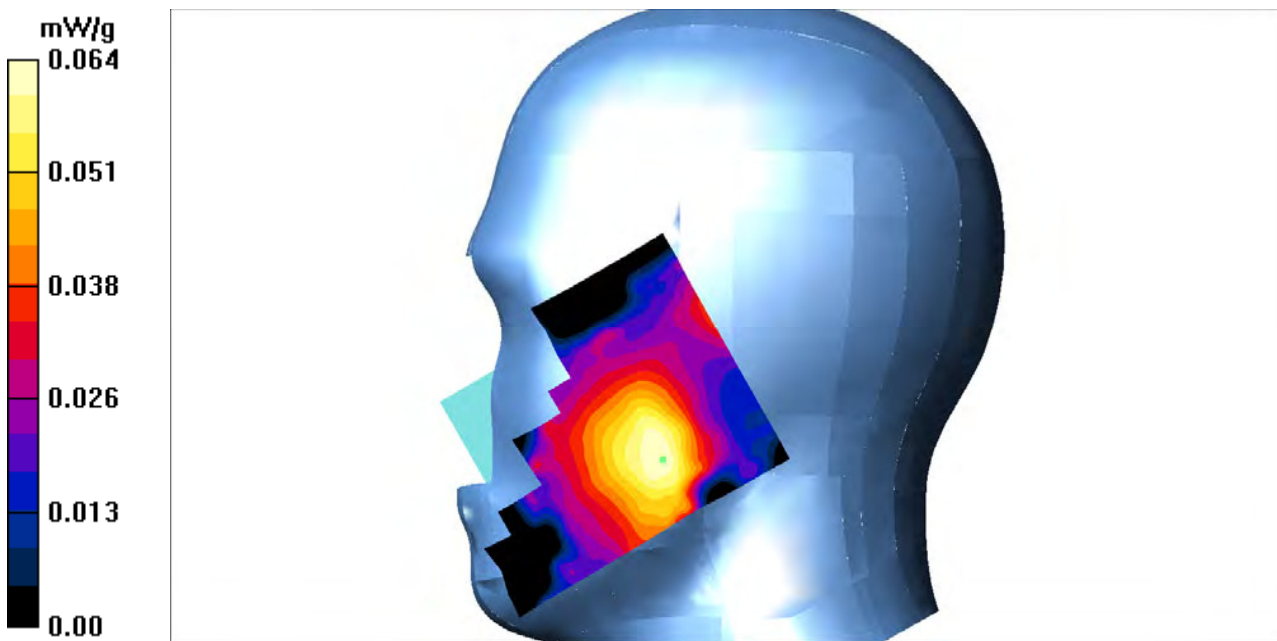

Test Laboratory: Bay Area Compliance Labs Corp.(Shenzhen)

Test Plot 13#:WCDMA 850 Left Cheek Low Channel

DUT: 3G/4G Smart Phone ; Model:SKY 5.0LM

Communication System: 3G Band; Frequency: 826.4 MHz; Duty Cycle: 1:1
 Medium parameters used: $f = 826.4 \text{ MHz}$; $\sigma = 0.88 \text{ S/m}$; $\epsilon_r = 40.13$; $\rho = 1000 \text{ kg/m}^3$
 Phantom section: Left Section

DASY4 Configuration:

- Probe: ES3DV3 - SN3036; ConvF(6.26, 6.26, 6.26); Calibrated: 16/9/2016
- Sensor-Surface: 4mm (Mechanical Surface Detection)
- Electronics: Dummy DAE - SN:456; Calibrated: 12/9/2016
- Phantom: TWIN SAM; Type: QD000P40CA; Serial: TP-1218
- Measurement SW: DASY4, V4.5 Build 19; Postprocessing SW: SEMCAD, V1.8 Build 145

WCDMA 850-left-cheek-Low /Area Scan (101x121x1): Measurement grid: $dx=10\text{mm}$, $dy=10\text{mm}$
 Maximum value of SAR (interpolated) = 0.195 mW/g

WCDMA 850-left-cheek-Low /Zoom Scan (7x7x7)/Cube 0: Measurement grid: $dx=5\text{mm}$, $dy=5\text{mm}$, $dz=5\text{mm}$
 Reference Value = 3.92 V/m; Power Drift = 0.027 dB
 Peak SAR (extrapolated) = 0.193 W/kg
SAR(1 g) = 0.182 mW/g; SAR(10 g) = 0.120 mW/g
 Maximum value of SAR (measured) = 0.187 mW/g

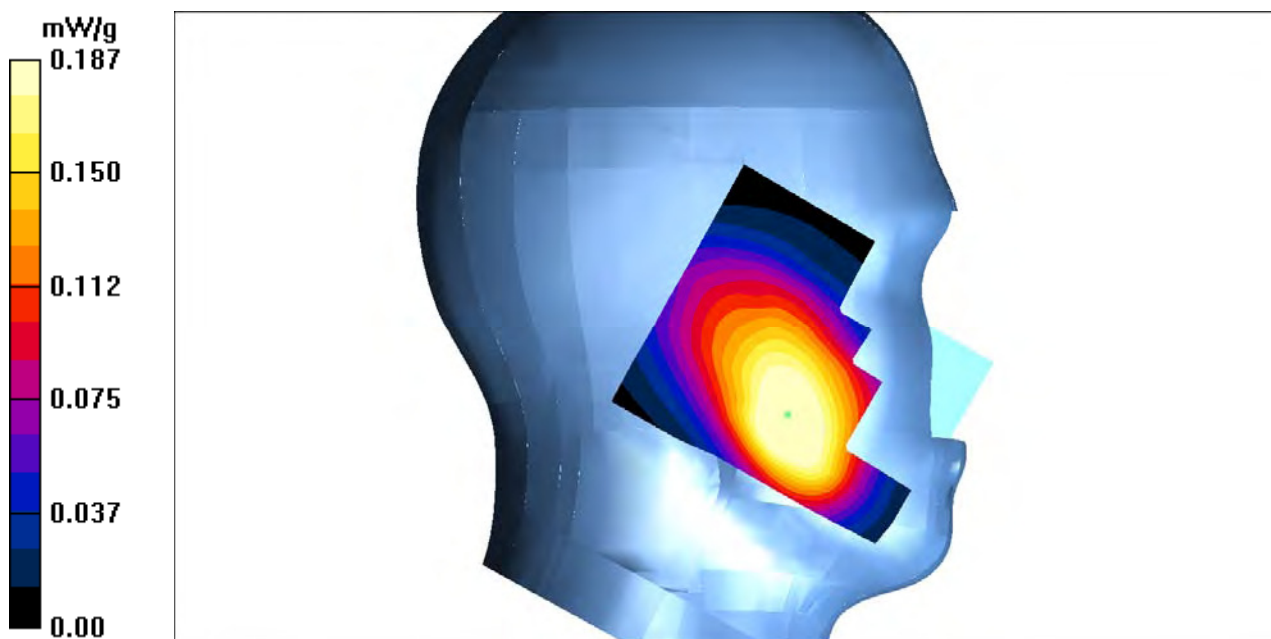

Test Laboratory: Bay Area Compliance Labs Corp.(Shenzhen)

Test Plot 14#: WCDMA 850 Left Cheek Middle Channel

DUT: 3G/4G Smart Phone; Model: SKY 5.0LM

Communication System: 3G Bands; Frequency: 836.6 MHz; Duty Cycle: 1:1
Medium parameters used: $f = 836.6$ MHz; $\sigma = 0.90$ S/m; $\epsilon_r = 40.25$; $\rho = 1000$ kg/m³
Phantom section: Left Section

DASY4 Configuration:

- Probe: ES3DV3 - SN3036; ConvF(6.26, 6.26, 6.26); Calibrated: 16/9/2016
- Sensor-Surface: 4mm (Mechanical Surface Detection)
- Electronics: Dummy DAE - SN:456; Calibrated: 12/9/2016
- Phantom: TWIN SAM; Type: QD000P40CA; Serial: TP-1218
- Measurement SW: DASY4, V4.5 Build 19; Postprocessing SW: SEMCAD, V1.8 Build 145

WCDMA 850-left-cheek-mid /Area Scan (101x121x1): Measurement grid: dx=10mm, dy=10mm
Maximum value of SAR (interpolated) = 0.245 mW/g

WCDMA 850-left-cheek-mid /Zoom Scan (7x7x7)/Cube 0: Measurement grid: dx=5mm, dy=5mm, dz=5mm

Reference Value = 4.72 V/m; Power Drift = 0.019 dB

Peak SAR (extrapolated) = 0.263 W/kg

SAR(1 g) = 0.245 mW/g; SAR(10 g) = 0.170 mW/g

Maximum value of SAR (measured) = 0.257 mW/g

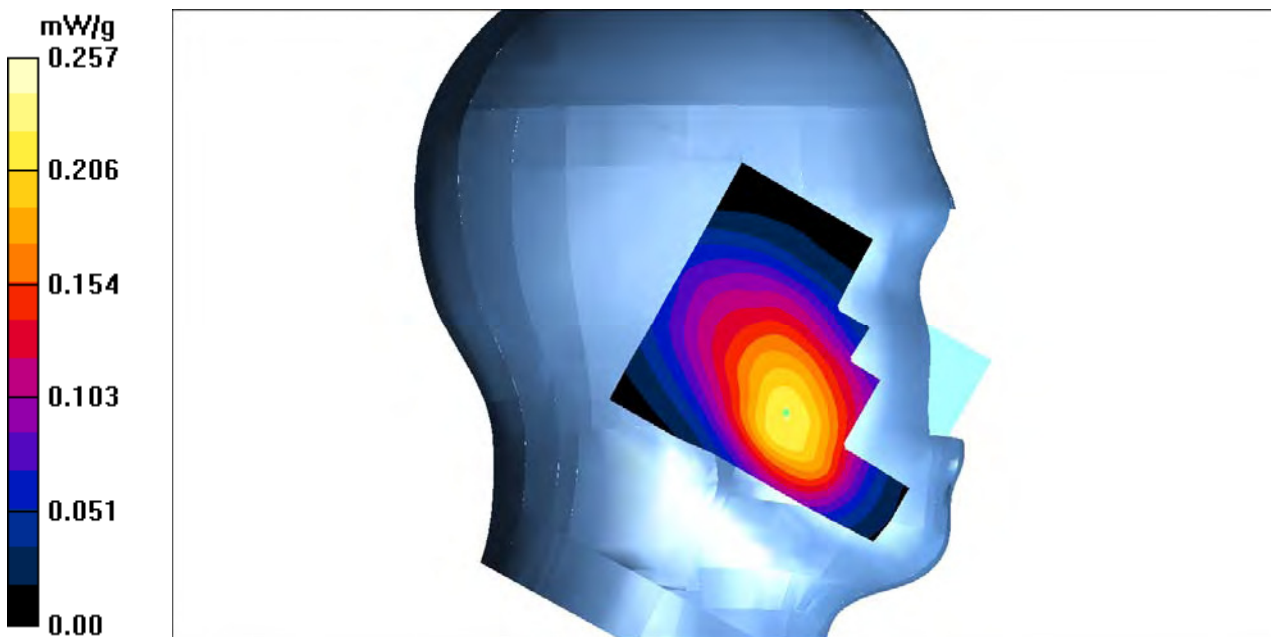

Test Laboratory: Bay Area Compliance Labs Corp.(Shenzhen)

Test Plot 15#:WCDMA 850 Left Cheek High Channel

DUT: 3G/4G Smart Phone ; Model:SKY 5.0LM

Communication System: 3G Band; Frequency: 846.6 MHz;Duty Cycle: 1:1
 Medium parameters used: $f = 846.6 \text{ MHz}$; $\sigma = 0.92 \text{ S/m}$; $\epsilon_r = 40.49$; $\rho = 1000 \text{ kg/m}^3$
 Phantom section: Left Section

DASY4 Configuration:

- Probe: ES3DV3 - SN3036; ConvF(6.26, 6.26, 6.26); Calibrated: 16/9/2016
- Sensor-Surface: 4mm (Mechanical Surface Detection)
- Electronics: Dummy DAE - SN:456; Calibrated: 12/9/2016
- Phantom: TWIN SAM; Type: QD000P40CA; Serial: TP-1218
- Measurement SW: DASY4, V4.5 Build 19; Postprocessing SW: SEMCAD, V1.8 Build 145

WCDMA 850-left-cheek-High /Area Scan (101x121x1): Measurement grid: $dx=10\text{mm}$, $dy=10\text{mm}$
 Maximum value of SAR (interpolated) = 0.295 mW/g

WCDMA 850-left-cheek-High /Zoom Scan (7x7x7)/Cube 0: Measurement grid: $dx=5\text{mm}$, $dy=5\text{mm}$, $dz=5\text{mm}$

Reference Value = 3.43 V/m; Power Drift = 0.023 dB

Peak SAR (extrapolated) = 0.313 W/kg

SAR(1 g) = 0.271 mW/g; SAR(10 g) = 0.127 mW/g

Maximum value of SAR (measured) = 0.286 mW/g

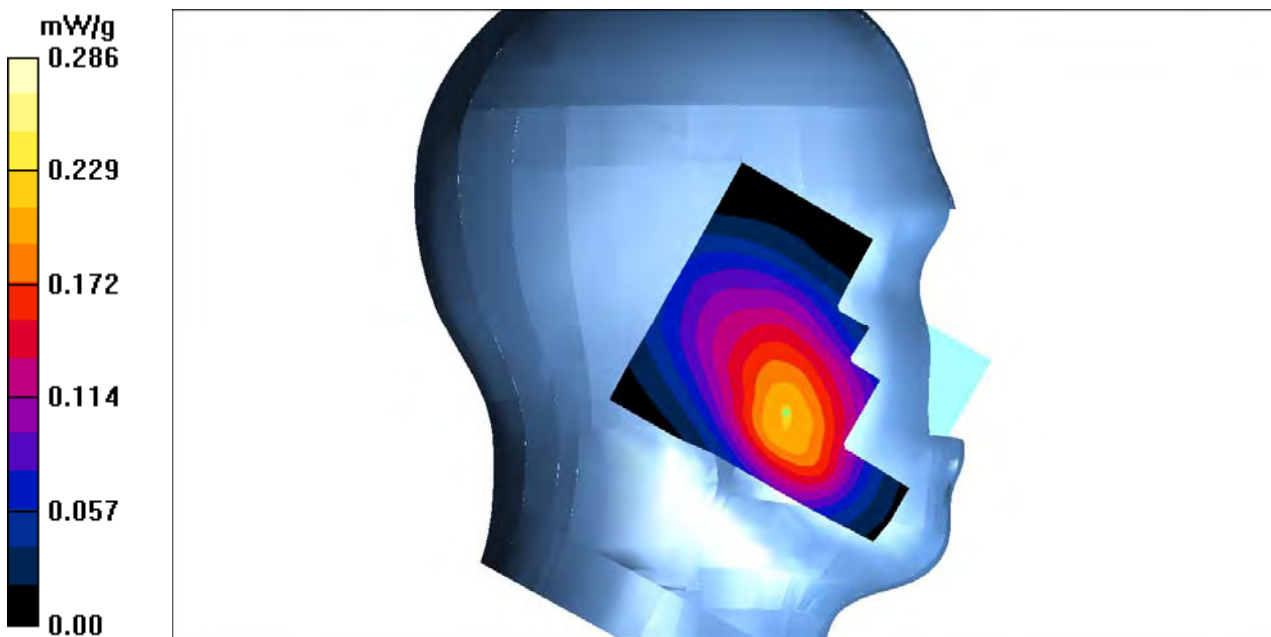

Test Laboratory: Bay Area Compliance Labs Corp.(Shenzhen)

Test Plot 16#:WCDMA 850 Left Tilt Middle Channel

DUT: 3G/4G Smart Phone ; Model:SKY 5.0LM

Communication System: 3G Band; Frequency: 836.6 MHz;Duty Cycle: 1:1
 Medium parameters used: $f = 836.6 \text{ MHz}$; $\sigma = 0.90 \text{ S/m}$; $\epsilon_r = 40.25$; $\rho = 1000 \text{ kg/m}^3$
 Phantom section: Left Section

DASY4 Configuration:

- Probe: ES3DV3 - SN3036; ConvF(6.26, 6.26, 6.26); Calibrated: 16/9/2016
- Sensor-Surface: 4mm (Mechanical Surface Detection)
- Electronics: Dummy DAE - SN:456; Calibrated: 12/9/2016
- Phantom: TWIN SAM; Type: QD000P40CA; Serial: TP-1218
- Measurement SW: DASY4, V4.5 Build 19; Postprocessing SW: SEMCAD, V1.8 Build 145

WCDMA 850-left-tilt-mid /Area Scan (101x121x1): Measurement grid: $dx=10\text{mm}$, $dy=10\text{mm}$
 Maximum value of SAR (interpolated) = 0.157 mW/g

WCDMA 850-left-tilt-mid /Zoom Scan (7x7x7)/Cube 0: Measurement grid: $dx=5\text{mm}$, $dy=5\text{mm}$, $dz=5\text{mm}$
 Reference Value = 3.72 V/m; Power Drift = 0.085 dB
 Peak SAR (extrapolated) = 0.142 W/kg
SAR(1 g) = 0.132 mW/g; SAR(10 g) = 0.083 mW/g
 Maximum value of SAR (measured) = 0.139 mW/g

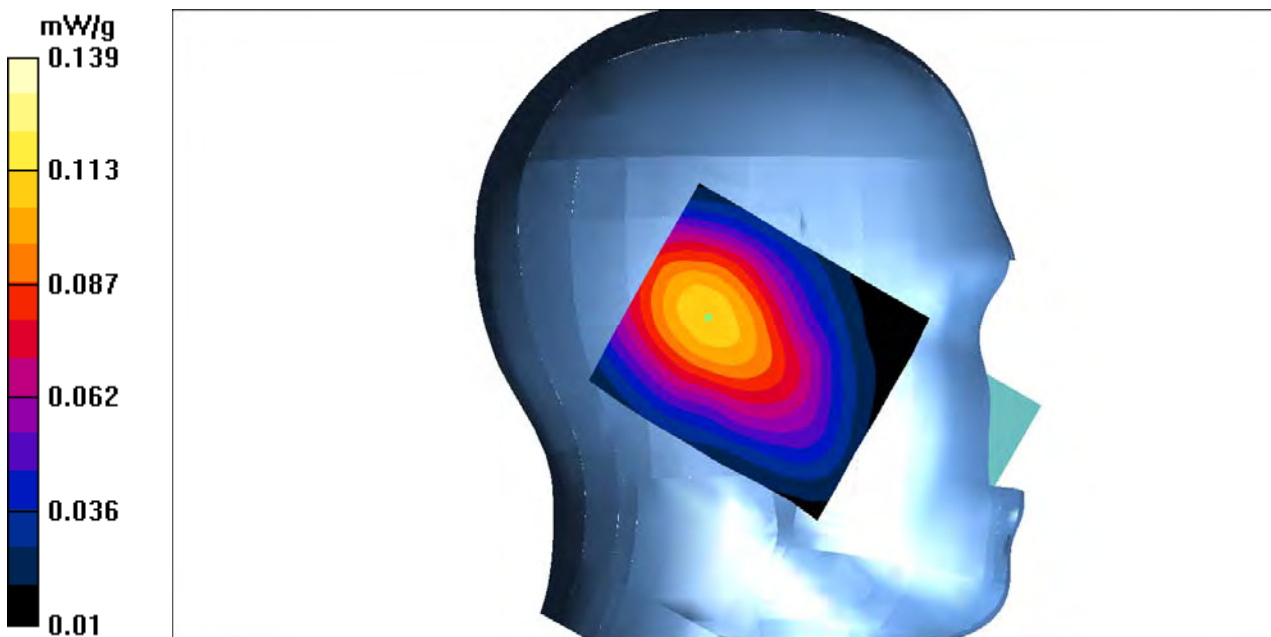

Test Laboratory: Bay Area Compliance Labs Corp.(Shenzhen)

Test Plot 17#:WCDMA 850 Right Cheek Middle Channel

DUT: 3G/4G Smart Phone ; Model:SKY 5.0LM

Communication System: 3G Band; Frequency: 836.6 MHz;Duty Cycle: 1:1
 Medium parameters used: $f = 836.6 \text{ MHz}$; $\sigma = 0.90 \text{ S/m}$; $\epsilon_r = 40.25$; $\rho = 1000 \text{ kg/m}^3$
 Phantom section: Right Section

DASY4 Configuration:

- Probe: ES3DV3 - SN3036; ConvF(6.26, 6.26, 6.26); Calibrated: 16/9/2016
- Sensor-Surface: 4mm (Mechanical Surface Detection)
- Electronics: Dummy DAE - SN:456; Calibrated: 12/9/2016
- Phantom: TWIN SAM; Type: QD000P40CA; Serial: TP-1218
- Measurement SW: DASY4, V4.5 Build 19; Postprocessing SW: SEMCAD, V1.8 Build 145

WCDMA 850-right-cheek-mid /Area Scan (101x121x1): Measurement grid: $dx=10\text{mm}$, $dy=10\text{mm}$
 Maximum value of SAR (interpolated) = 0.189 mW/g

WCDMA 850-right-cheek-mid /Zoom Scan (7x7x7)/Cube 0: Measurement grid: $dx=5\text{mm}$, $dy=5\text{mm}$, $dz=5\text{mm}$
 Reference Value = 4.27 V/m; Power Drift = -0.082 dB
 Peak SAR (extrapolated) = 0.194 W/kg
SAR(1 g) = 0.180 mW/g; SAR(10 g) = 0.097 mW/g
 Maximum value of SAR (measured) = 0.181 mW/g

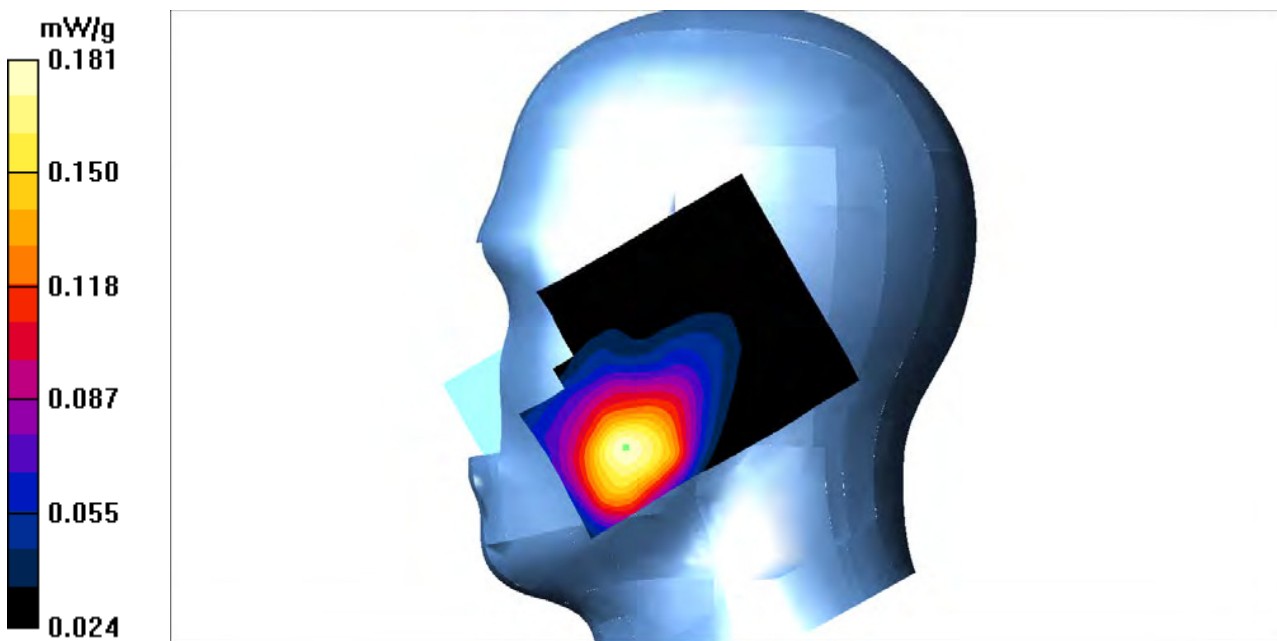

Test Laboratory: Bay Area Compliance Labs Corp.(Shenzhen)

Test Plot 18#:WCDMA 850 Right Tilt Middle Channel

DUT: 3G/4G Smart Phone ; Model:SKY 5.0LM

Communication System: 3G Band; Frequency: 836.6 MHz;Duty Cycle: 1:1
Medium parameters used: $f = 836.6$ MHz; $\sigma = 0.90$ S/m; $\epsilon_r = 40.25$; $\rho = 1000$ kg/m³
Phantom section: Right Section

DASY4 Configuration:

- Probe: ES3DV3 - SN3036; ConvF(6.26, 6.26, 6.26); Calibrated: 16/9/2016
- Sensor-Surface: 4mm (Mechanical Surface Detection)
- Electronics: Dummy DAE - SN:456; Calibrated: 12/9/2016
- Phantom: TWIN SAM; Type: QD000P40CA; Serial: TP-1218
- Measurement SW: DASY4, V4.5 Build 19; Postprocessing SW: SEMCAD, V1.8 Build 145

WCDMA 850-right-tilt-mid /Area Scan (101x121x1): Measurement grid: dx=10mm, dy=10mm
Maximum value of SAR (interpolated) = 0.092 mW/g

WCDMA 850-right-tilt-mid /Zoom Scan (7x7x7)/Cube 0: Measurement grid: dx=5mm, dy=5mm, dz=5mm

Reference Value = 4.79 V/m; Power Drift = 0.062 dB

Peak SAR (extrapolated) = 0.087 W/kg

SAR(1 g) = 0.075 mW/g; SAR(10 g) = 0.042 mW/g

Maximum value of SAR (measured) = 0.079 mW/g

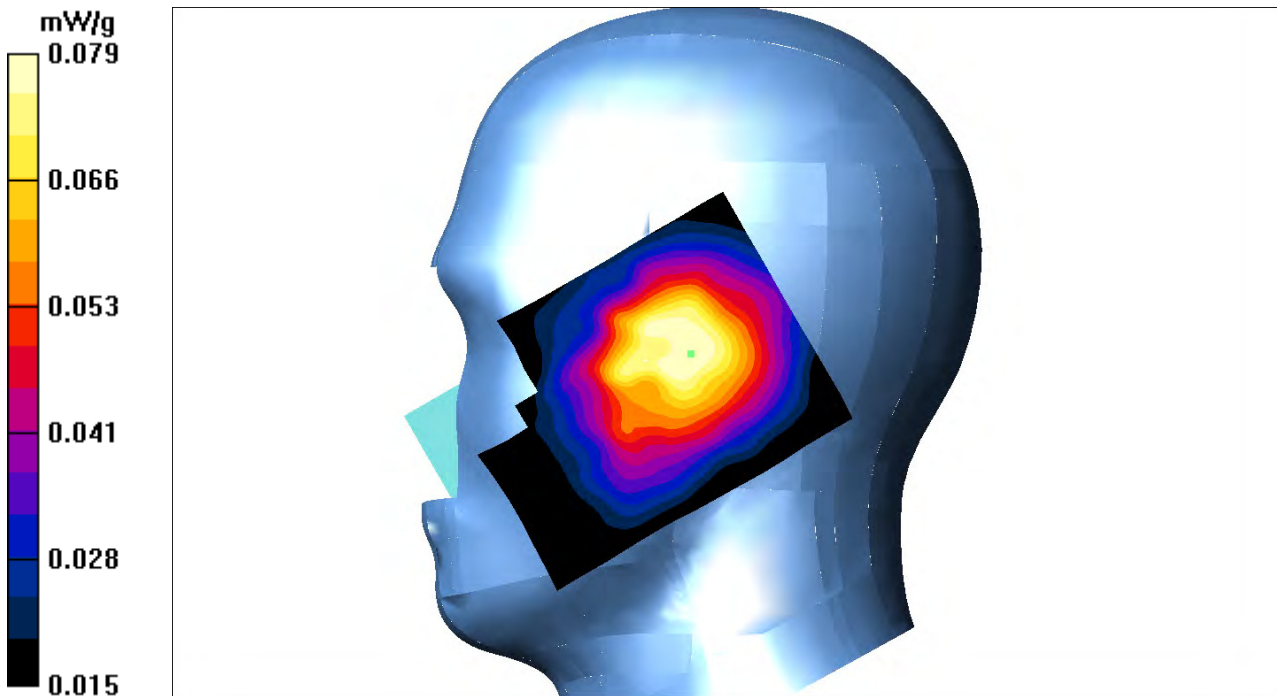

Test Laboratory: Bay Area Compliance Labs Corp.(Shenzhen)

Test Plot 19#:WCDMA 1700 Left Cheek Low Channel

DUT: 3G/4G Smart Phone ; Model:SKY 5.0LM

Communication System: 3G Band; Frequency: 1712.4 MHz;Duty Cycle: 1:1
 Medium parameters used: $f = 1712.4 \text{ MHz}$; $\sigma = 1.34 \text{ S/m}$; $\epsilon_r = 39.53$; $\rho = 1000 \text{ kg/m}^3$
 Phantom section: Left Section

DASY4 Configuration:

- Probe: ES3DV3 - SN3036; ConvF(5.34, 5.34, 5.34); Calibrated: 16/9/2016
- Sensor-Surface: 4mm (Mechanical Surface Detection)
- Electronics: Dummy DAE - SN:456; Calibrated: 12/9/2016
- Phantom: TWIN SAM; Type: QD000P40CA; Serial: TP-1218
- Measurement SW: DASY4, V4.5 Build 19; Postprocessing SW: SEMCAD, V1.8 Build 145

WCDMA 1700-left-cheek-low /Area Scan (101x121x1): Measurement grid: $dx=10\text{mm}$, $dy=10\text{mm}$
 Maximum value of SAR (interpolated) = 0.577 mW/g

WCDMA 1700-left-cheek-low /Zoom Scan (7x7x7)/Cube 0: Measurement grid: $dx=5\text{mm}$, $dy=5\text{mm}$, $dz=5\text{mm}$
 Reference Value = 3.82 V/m; Power Drift = 0.058 dB
 Peak SAR (extrapolated) = 0.498 W/kg
SAR(1 g) = 0.372 mW/g; SAR(10 g) = 0.306 mW/g
 Maximum value of SAR (measured) = 0.405 mW/g

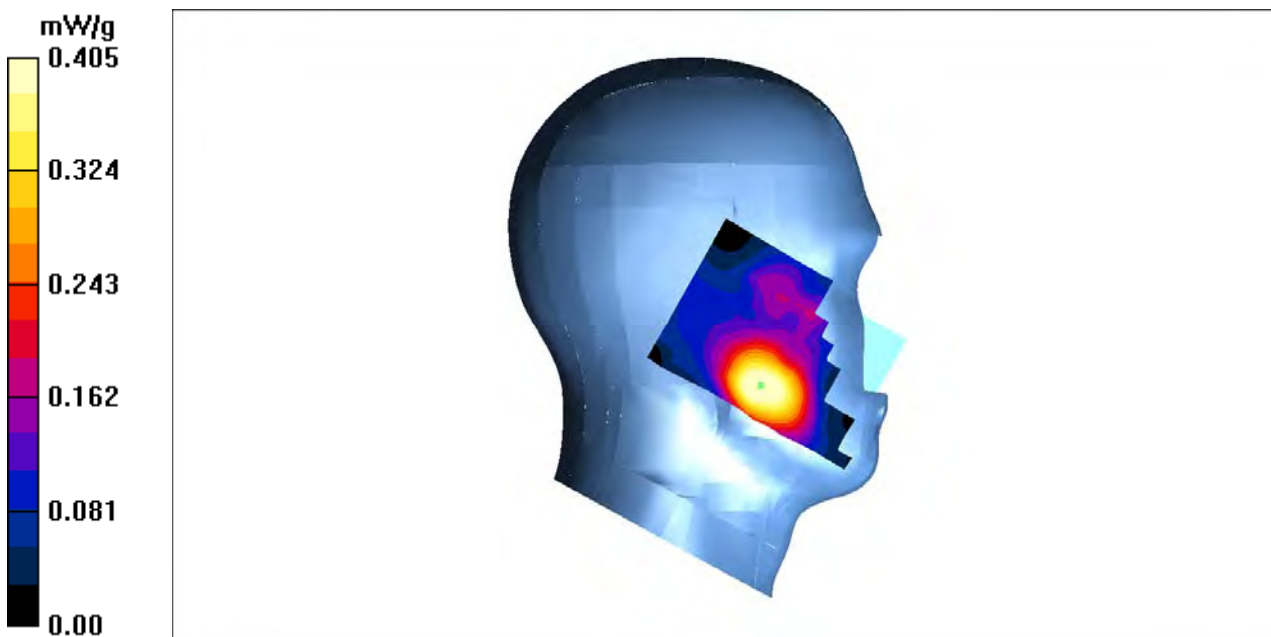

Test Laboratory: Bay Area Compliance Labs Corp.(Shenzhen)

Test Plot 20#:WCDMA 1700 Left Cheek Middle Channel

DUT: 3G/4G Smart Phone ; Model:SKY 5.0LM

Communication System: 3G Band; Frequency: 1732.6 MHz;Duty Cycle: 1:1
Medium parameters used: $f = 1732.6 \text{ MHz}$; $\sigma = 1.37 \text{ S/m}$; $\epsilon_r = 37.72$; $\rho = 1000 \text{ kg/m}^3$
Phantom section: Left Section

DASY4 Configuration:

- Probe: ES3DV3 - SN3036; ConvF(5.34, 5.34, 5.34); Calibrated: 16/9/2016
- Sensor-Surface: 4mm (Mechanical Surface Detection)
- Electronics: Dummy DAE - SN:456; Calibrated: 12/9/2016
- Phantom: TWIN SAM; Type: QD000P40CA; Serial: TP-1218
- Measurement SW: DASY4, V4.5 Build 19; Postprocessing SW: SEMCAD, V1.8 Build 145

WCDMA 1700-left-cheek-mid /Area Scan (101x121x1): Measurement grid: $dx=10\text{mm}$, $dy=10\text{mm}$
Maximum value of SAR (interpolated) = 0.487 mW/g

WCDMA 1700-left-cheek-mid /Zoom Scan (7x7x7)/Cube 0: Measurement grid: $dx=5\text{mm}$, $dy=5\text{mm}$, $dz=5\text{mm}$

Reference Value = 1.87 V/m; Power Drift = 0.057 dB

Peak SAR (extrapolated) = 0.198 W/kg

SAR(1 g) = 0.398 mW/g; SAR(10 g) = 0.236 mW/g

Maximum value of SAR (measured) = 0.420 mW/g

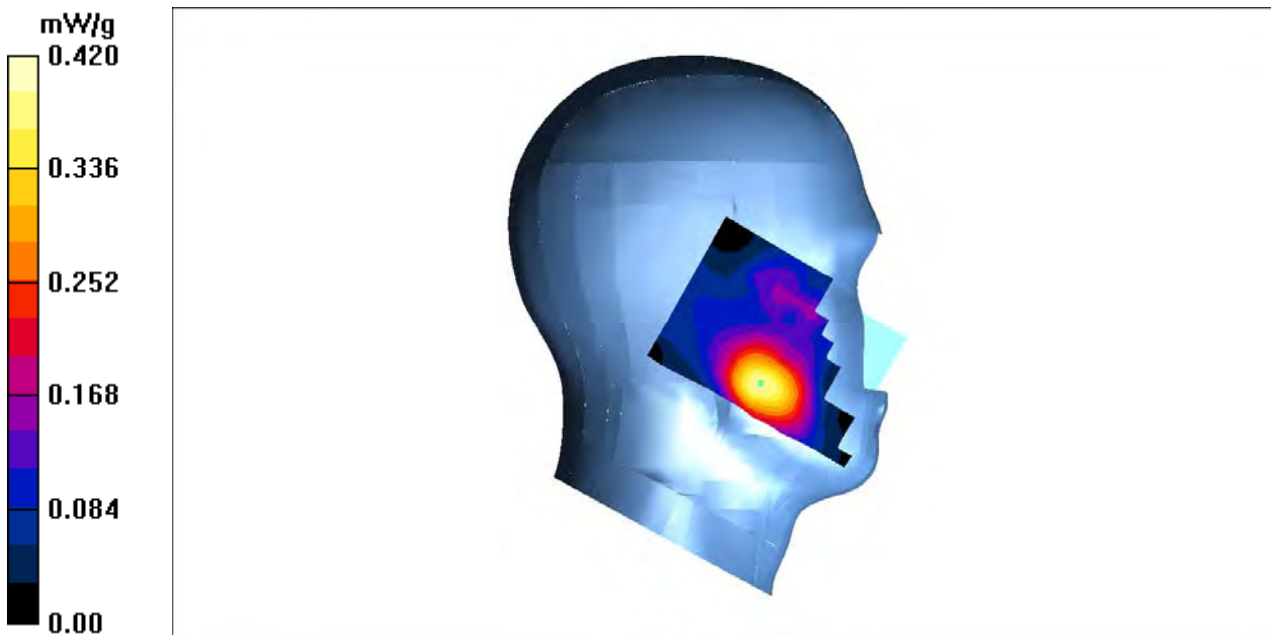

Test Laboratory: Bay Area Compliance Labs Corp.(Shenzhen)**Test Plot 21#:WCDMA 1700 Left Cheek High Channel****DUT: 3G/4G Smart Phone ; Model:SKY 5.0LM**

Communication System: 3G Band; Frequency: 1752.6 MHz;Duty Cycle: 1:1
Medium parameters used: $f = 1752.6$ MHz; $\sigma = 1.39$ S/m; $\epsilon_r = 39.98$; $\rho = 1000$ kg/m³
Phantom section: Left Section

DASY4 Configuration:

- Probe: ES3DV3 - SN3036; ConvF(5.34, 5.34, 5.34); Calibrated: 16/9/2016
- Sensor-Surface: 4mm (Mechanical Surface Detection)
- Electronics: Dummy DAE - SN:456; Calibrated: 12/9/2016
- Phantom: TWIN SAM; Type: QD000P40CA; Serial: TP-1218
- Measurement SW: DASY4, V4.5 Build 19; Postprocessing SW: SEMCAD, V1.8 Build 145

WCDMA 1700-left-cheek-high /Area Scan (101x121x1): Measurement grid: dx=10mm, dy=10mm
Maximum value of SAR (interpolated) = 0.377 mW/g

WCDMA 1700-left-cheek-high /Zoom Scan (7x7x7)/Cube 0: Measurement grid: dx=5mm, dy=5mm,
dz=5mm

Reference Value = 1.53 V/m; Power Drift = 0.142 dB

Peak SAR (extrapolated) = 0.398 W/kg

SAR(1 g) = 0.351 mW/g; SAR(10 g) = 0.186 mW/g

Maximum value of SAR (measured) = 0.372 mW/g

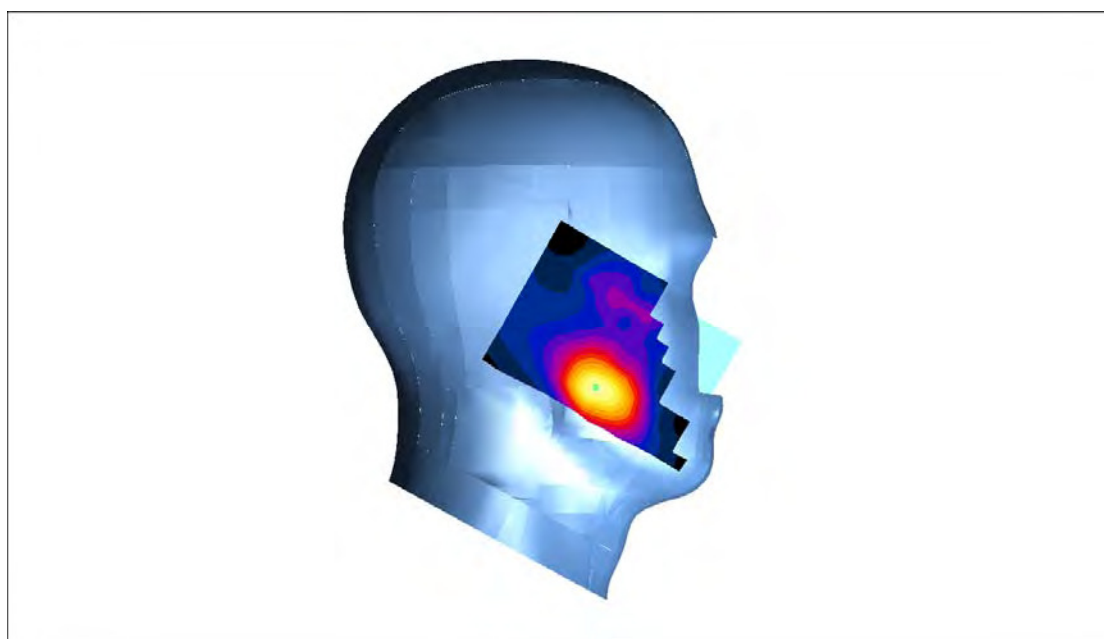
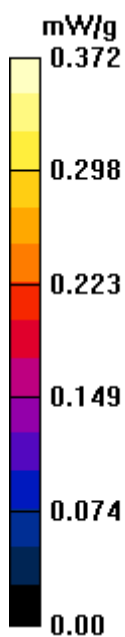

Test Laboratory: Bay Area Compliance Labs Corp.(Shenzhen)

Test Plot 22#:WCDMA 1700 Left Tilt Mid Channel

DUT: 3G/4G Smart Phone ; Model:SKY 5.0LM

Communication System: 3G Band; Frequency: 1752.6 MHz;Duty Cycle: 1:1
 Medium parameters used: $f = 1752.6 \text{ MHz}$; $\sigma = 1.39 \text{ S/m}$; $\epsilon_r = 39.98$; $\rho = 1000 \text{ kg/m}^3$
 Phantom section: Left Section

DASY4 Configuration:

- Probe: ES3DV3 - SN3036; ConvF(5.34, 5.34, 5.34); Calibrated: 16/9/2016
- Sensor-Surface: 4mm (Mechanical Surface Detection)
- Electronics: Dummy DAE - SN:456; Calibrated: 12/9/2016
- Phantom: TWIN SAM; Type: QD000P40CA; Serial: TP-1218
- Measurement SW: DASY4, V4.5 Build 19; Postprocessing SW: SEMCAD, V1.8 Build 145

WCDMA 1700-left-tilt-Mid /Area Scan (101x121x1): Measurement grid: $dx=10\text{mm}$, $dy=10\text{mm}$
 Maximum value of SAR (interpolated) = 0.182 mW/g

WCDMA 1700-left-tilt-Mid /Zoom Scan (7x7x7)/Cube 0: Measurement grid: $dx=5\text{mm}$, $dy=5\text{mm}$, $dz=5\text{mm}$

Reference Value = 3.55 V/m; Power Drift = 0.073 dB

Peak SAR (extrapolated) = 0.148 W/kg

SAR(1 g) = 0.152 mW/g; SAR(10 g) = 0.097 mW/g

Maximum value of SAR (measured) = 0.167 mW/g

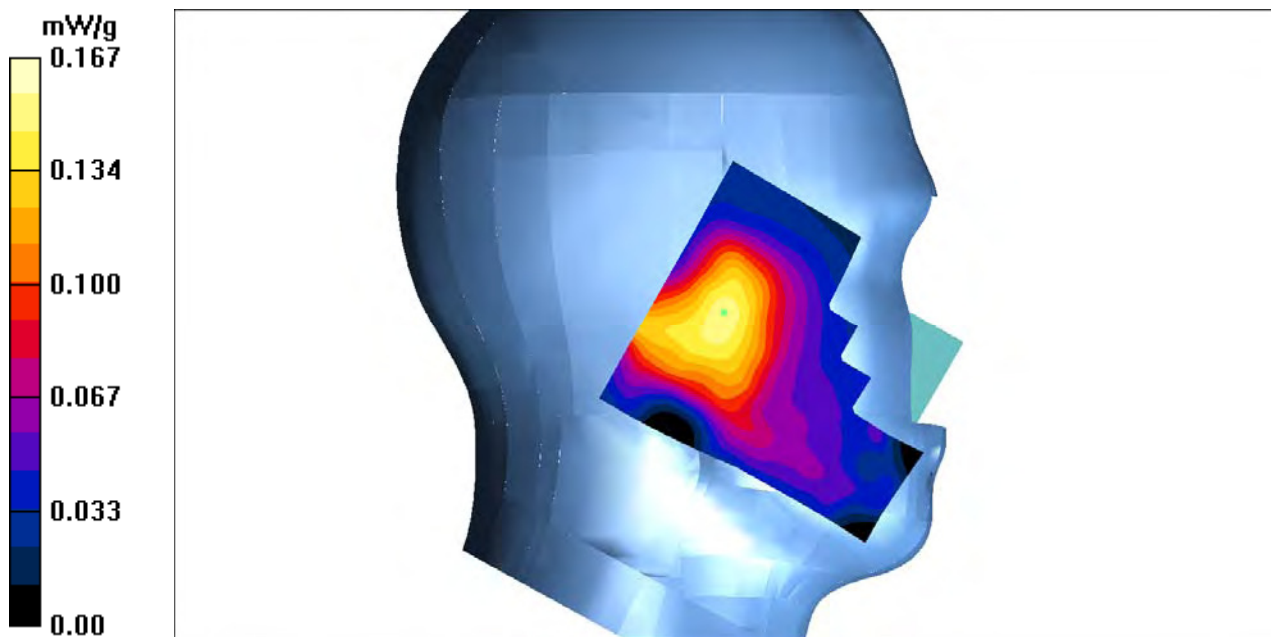

Test Laboratory: Bay Area Compliance Labs Corp.(Shenzhen)**Test Plot 23#:WCDMA 1700 Right Cheek Mid Channel****DUT: 3G/4G Smart Phone ; Model:SKY 5.0LM**

Communication System: 3G Band; Frequency: 1752.6 MHz;Duty Cycle: 1:1
Medium parameters used: $f = 1752.6$ MHz; $\sigma = 1.39$ S/m; $\epsilon_r = 39.98$; $\rho = 1000$ kg/m³
Phantom section: Right Section

DASY4 Configuration:

- Probe: ES3DV3 - SN3036; ConvF(5.34, 5.34, 5.34); Calibrated: 16/9/2016
- Sensor-Surface: 4mm (Mechanical Surface Detection)
- Electronics: Dummy DAE - SN:456; Calibrated: 12/9/2016
- Phantom: TWIN SAM; Type: QD000P40CA; Serial: TP-1218
- Measurement SW: DASY4, V4.5 Build 19; Postprocessing SW: SEMCAD, V1.8 Build 145

WCDMA 1700-right-cheek-Mid /Area Scan (101x121x1): Measurement grid: dx=10mm, dy=10mm
Maximum value of SAR (interpolated) = 0.376 mW/g

WCDMA 1700-right-cheek-Mid /Zoom Scan (7x7x7)/Cube 0: Measurement grid: dx=5mm, dy=5mm,
dz=5mm

Reference Value = 3.42 V/m; Power Drift = 0.019 dB

Peak SAR (extrapolated) = 0.394 W/kg

SAR(1 g) = 0.347 mW/g; SAR(10 g) = 0.187 mW/g

Maximum value of SAR (measured) = 0.395 mW/g

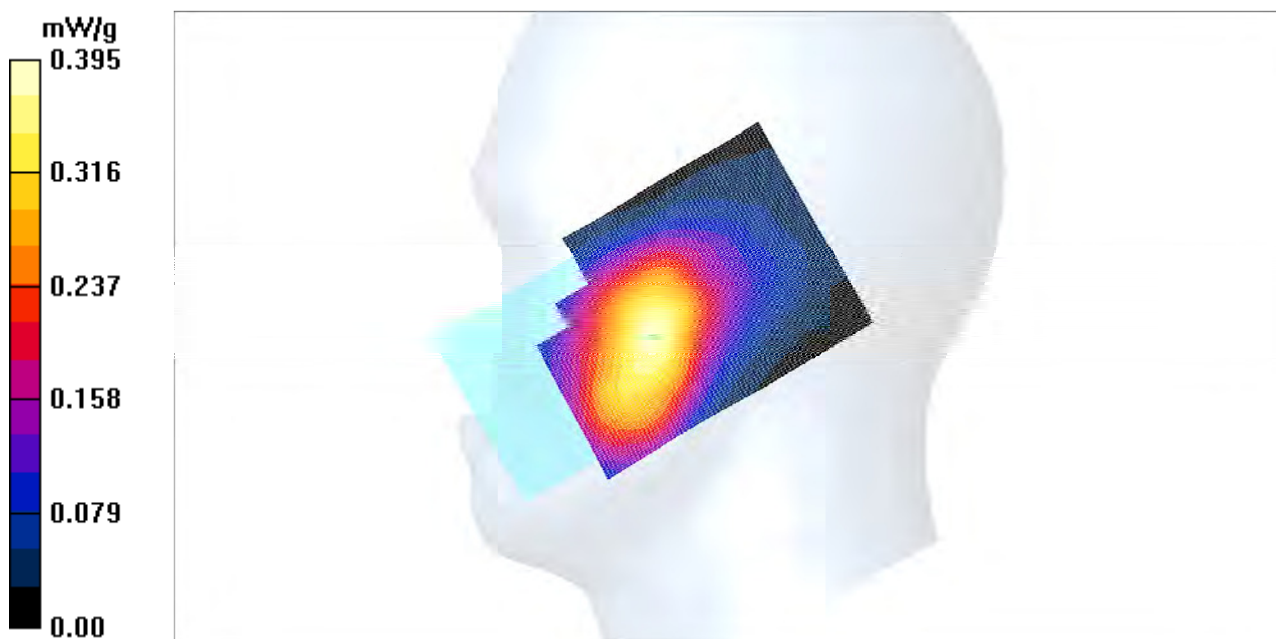

Test Laboratory: Bay Area Compliance Labs Corp.(Shenzhen)

Test Plot 24#:WCDMA 1700 Right Tilt Mid Channel

DUT: 3G/4G Smart Phone ; Model:SKY 5.0LM

Communication System: 3G Band; Frequency: 1752.6 MHz;Duty Cycle: 1:1
 Medium parameters used: $f = 1752.6 \text{ MHz}$; $\sigma = 1.39 \text{ S/m}$; $\epsilon_r = 39.98$; $\rho = 1000 \text{ kg/m}^3$
 Phantom section: Right Section

DASY4 Configuration:

- Probe: ES3DV3 - SN3036; ConvF(5.34, 5.34, 5.34); Calibrated: 16/9/2016
- Sensor-Surface: 4mm (Mechanical Surface Detection)
- Electronics: Dummy DAE - SN:456; Calibrated: 12/9/2016
- Phantom: TWIN SAM; Type: QD000P40CA; Serial: TP-1218
- Measurement SW: DASY4, V4.5 Build 19; Postprocessing SW: SEMCAD, V1.8 Build 145

WCDMA 1700-right-tilt-Mid /Area Scan (101x121x1): Measurement grid: $dx=10\text{mm}$, $dy=10\text{mm}$
 Maximum value of SAR (interpolated) = 0.193 mW/g

WCDMA 1700-right-tilt-Mid /Zoom Scan (7x7x7)/Cube 0: Measurement grid: $dx=5\text{mm}$, $dy=5\text{mm}$, $dz=5\text{mm}$

Reference Value = 3.23 V/m; Power Drift = -0.027 dB

Peak SAR (extrapolated) = 0.196 W/kg

SAR(1 g) = 0.172 mW/g; SAR(10 g) = 0.097 mW/g

Maximum value of SAR (measured) = 0.185 mW/g

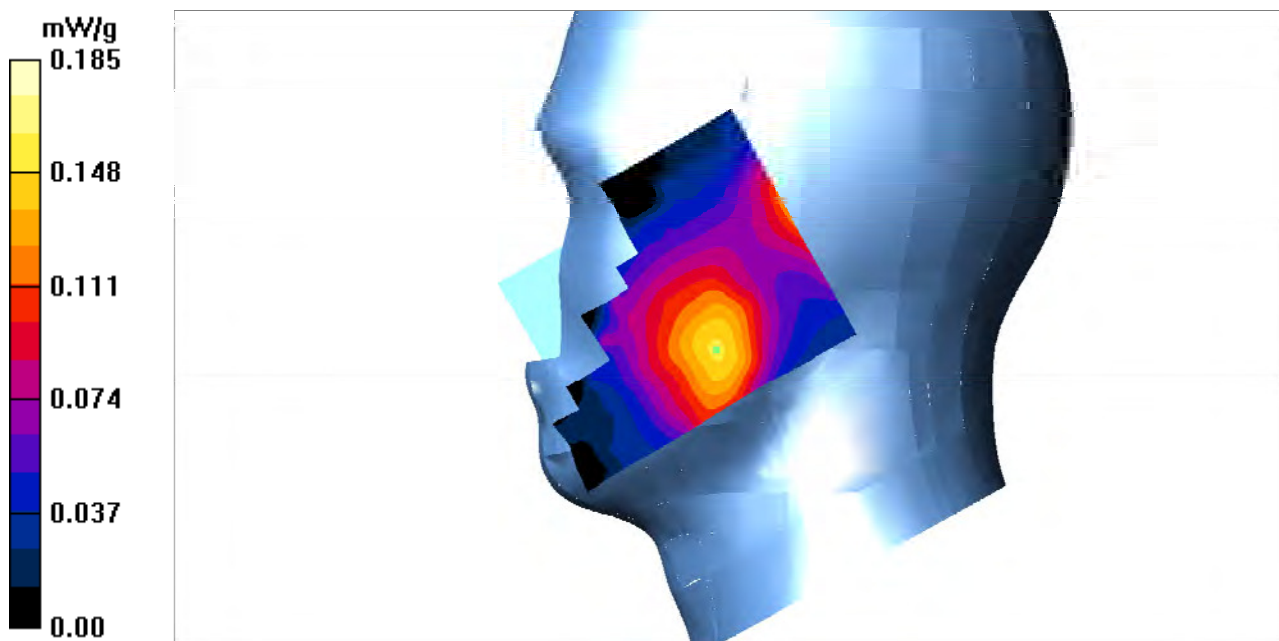

Test Laboratory: Bay Area Compliance Labs Corp.(Shenzhen)

Test Plot 25#:WCDMA 1900 Left Cheek Low Channel

DUT: 3G/4G Smart Phone ; Model:SKY 5.0LM

Communication System: 3G Band; Frequency: 1852.4 MHz;Duty Cycle: 1:1
 Medium parameters used: $f = 1852.4 \text{ MHz}$; $\sigma = 1.37 \text{ S/m}$; $\epsilon_r = 39.57$; $\rho = 1000 \text{ kg/m}^3$
 Phantom section: Left Section

DASY4 Configuration:

- Probe: ES3DV3 - SN3036; ConvF(5.12, 5.12, 5.12); Calibrated: 16/9/2016
- Sensor-Surface: 4mm (Mechanical Surface Detection)
- Electronics: Dummy DAE - SN:456; Calibrated: 12/9/2016
- Phantom: TWIN SAM; Type: QD000P40CA; Serial: TP-1218
- Measurement SW: DASY4, V4.5 Build 19; Postprocessing SW: SEMCAD, V1.8 Build 145

WCDMA 1900-Left-cheek-low /Area Scan (101x121x1): Measurement grid: $dx=10\text{mm}$, $dy=10\text{mm}$
 Maximum value of SAR (interpolated) = 0.576 mW/g

WCDMA 1900-Left-cheek-low /Zoom Scan (7x7x7)/Cube 0: Measurement grid: $dx=5\text{mm}$, $dy=5\text{mm}$, $dz=5\text{mm}$
 Reference Value = 2.42 V/m; Power Drift = 0.015 dB
 Peak SAR (extrapolated) = 0.434 W/kg
SAR(1 g) = 0.295 mW/g; SAR(10 g) = 0.187 mW/g
 Maximum value of SAR (measured) = 0.409 mW/g

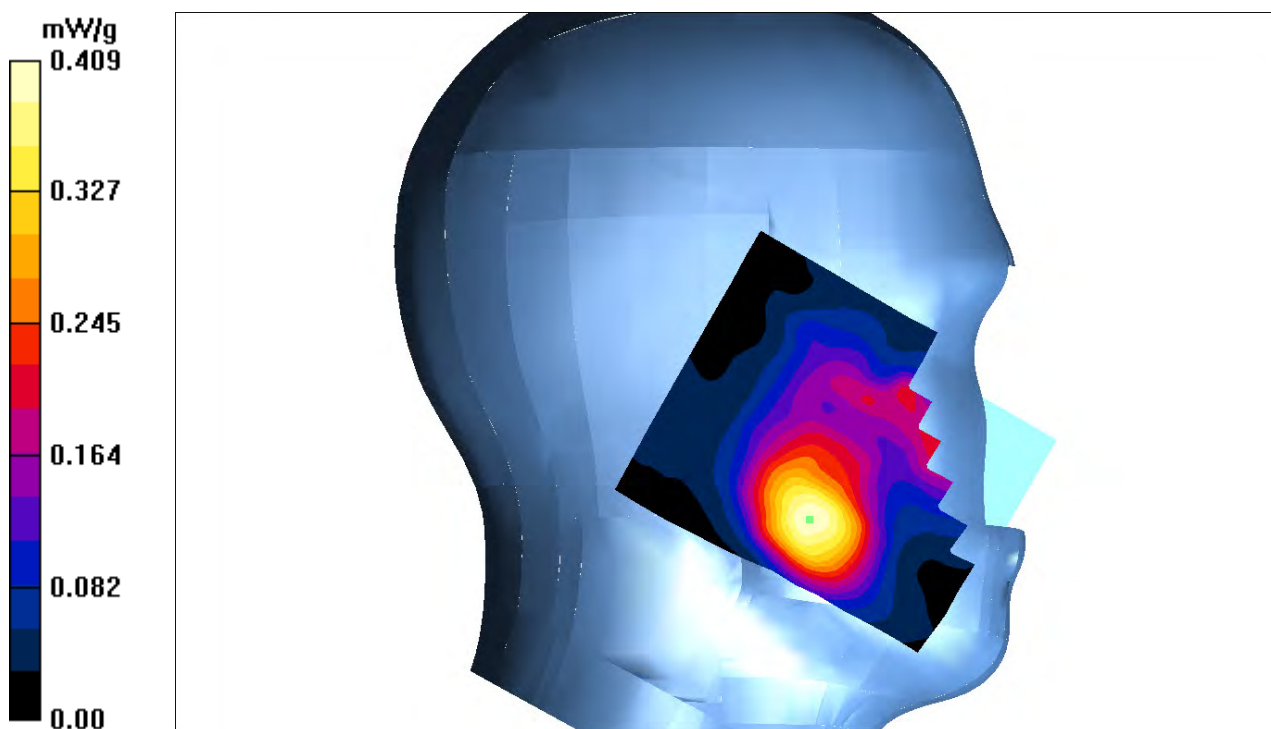

Test Laboratory: Bay Area Compliance Labs Corp.(Shenzhen)

Test Plot 26#:WCDMA 1900 Left Cheek Middle Channel

DUT: 3G/4G Smart Phone ; Model:SKY 5.0LM

Communication System: 3G Band; Frequency: 1880 MHz;Duty Cycle: 1:1
 Medium parameters used: $f = 1880 \text{ MHz}$; $\sigma = 1.39 \text{ S/m}$; $\epsilon_r = 39.72$; $\rho = 1000 \text{ kg/m}^3$
 Phantom section: Left Section

DASY4 Configuration:

- Probe: ES3DV3 - SN3036; ConvF(5.12, 5.12, 5.12); Calibrated: 16/9/2016
- Sensor-Surface: 4mm (Mechanical Surface Detection)
- Electronics: Dummy DAE - SN:456; Calibrated: 12/9/2016
- Phantom: TWIN SAM; Type: QD000P40CA; Serial: TP-1218
- Measurement SW: DASY4, V4.5 Build 19; Postprocessing SW: SEMCAD, V1.8 Build 145

WCDMA 1900-Left-cheek-mid /Area Scan (101x121x1): Measurement grid: $dx=10\text{mm}$, $dy=10\text{mm}$
 Maximum value of SAR (interpolated) = 0.236 mW/g

WCDMA 1900-Left-cheek-mid /Zoom Scan (7x7x7)/Cube 0: Measurement grid: $dx=5\text{mm}$, $dy=5\text{mm}$, $dz=5\text{mm}$
 Reference Value = 1.02 V/m; Power Drift = 0.079 dB
 Peak SAR (extrapolated) = 0.284 W/kg
SAR(1 g) = 0.243 mW/g; SAR(10 g) = 0.137 mW/g
 Maximum value of SAR (measured) = 0.246 mW/g

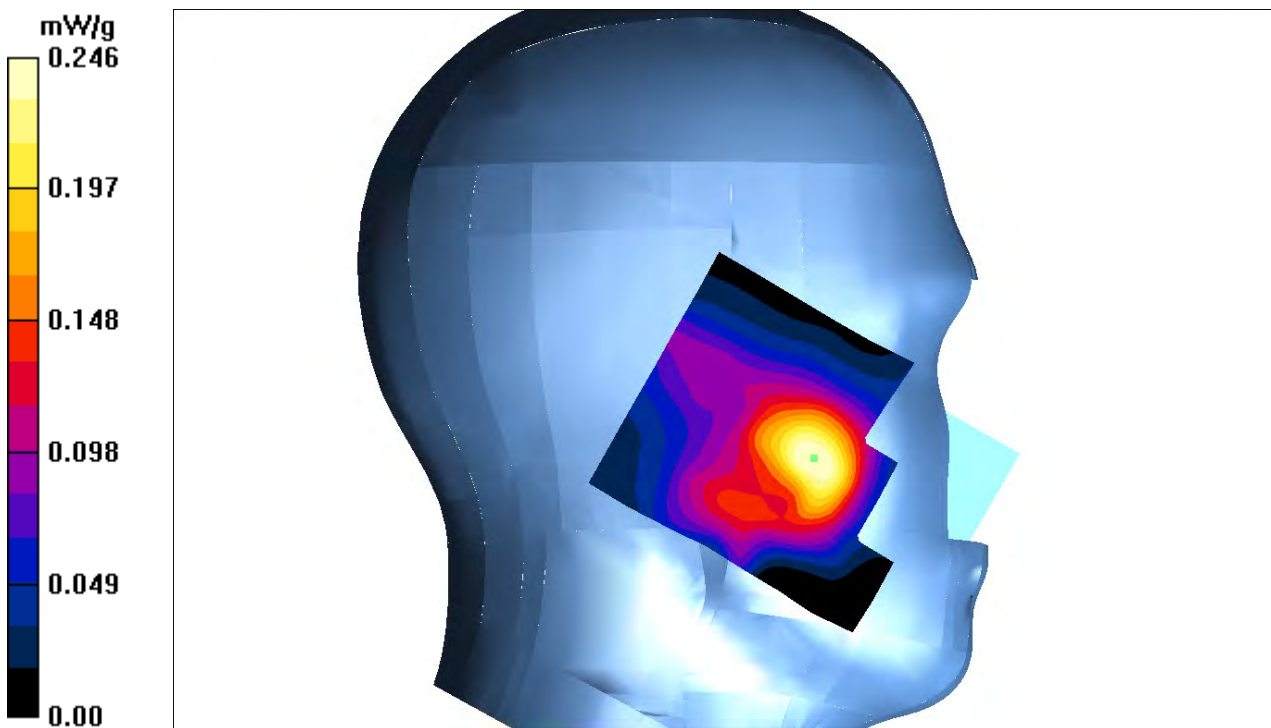

Test Laboratory: Bay Area Compliance Labs Corp.(Shenzhen)

Test Plot 27#:WCDMA 1900 Left Cheek High Channel

DUT: 3G/4G Smart Phone ; Model:SKY 5.0LM

Communication System: 3G Band; Frequency: 1907.6 MHz;Duty Cycle: 1:1
Medium parameters used: $f = 1907.6 \text{ MHz}$; $\sigma = 1.41 \text{ S/m}$; $\epsilon_r = 39.97$; $\rho = 1000 \text{ kg/m}^3$
Phantom section: Left Section

DASY4 Configuration:

- Probe: ES3DV3 - SN3036; ConvF(5.12, 5.12, 5.12); Calibrated: 16/9/2016
- Sensor-Surface: 4mm (Mechanical Surface Detection)
- Electronics: Dummy DAE - SN:456; Calibrated: 12/9/2016
- Phantom: TWIN SAM; Type: QD000P40CA; Serial: TP-1218
- Measurement SW: DASY4, V4.5 Build 19; Postprocessing SW: SEMCAD, V1.8 Build 145

WCDMA 1900-Left-cheek-high /Area Scan (101x121x1): Measurement grid: $dx=10\text{mm}$, $dy=10\text{mm}$
Maximum value of SAR (interpolated) = 0.386 mW/g

WCDMA 1900-Left-cheek-high /Zoom Scan (7x7x7)/Cube 0: Measurement grid: $dx=5\text{mm}$, $dy=5\text{mm}$, $dz=5\text{mm}$

Reference Value = 1.82 V/m; Power Drift = 0.129 dB

Peak SAR (extrapolated) = 0.294 W/kg

SAR(1 g) = 0.275 mW/g; SAR(10 g) = 0.187 mW/g

Maximum value of SAR (measured) = 0.342 mW/g

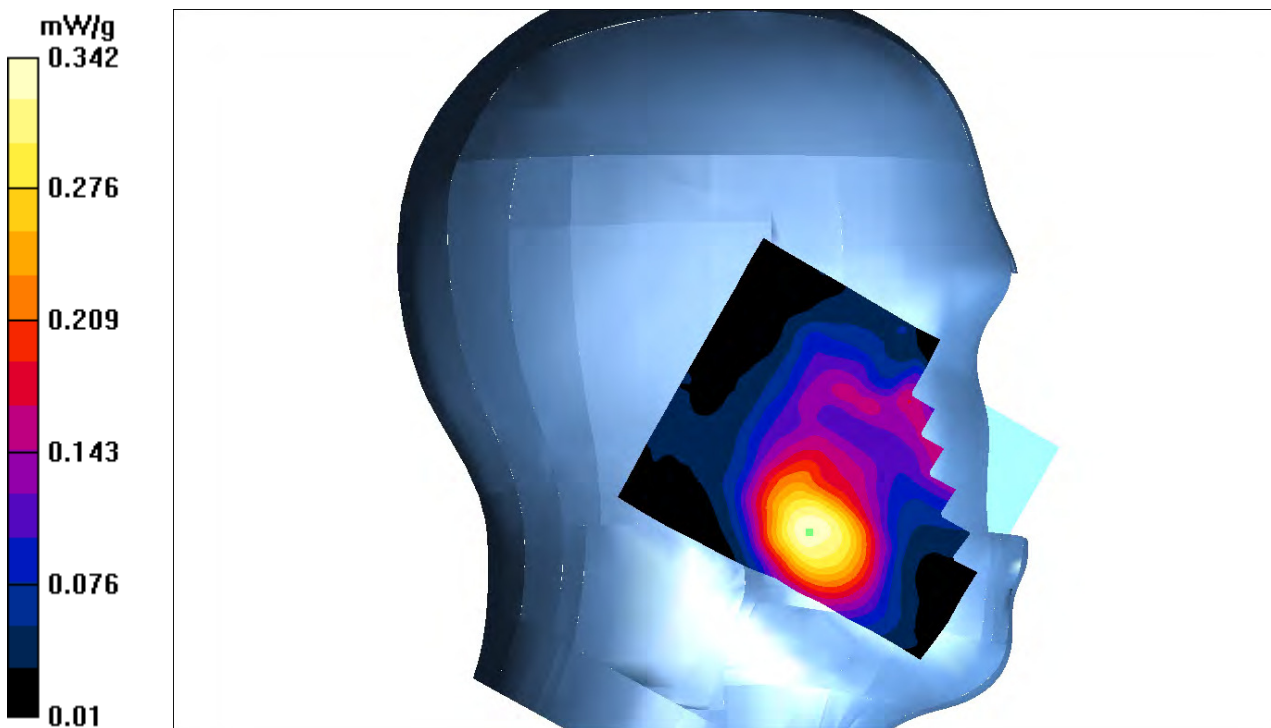

Test Laboratory: Bay Area Compliance Labs Corp.(Shenzhen)

Test Plot 28#:WCDMA 1900 Left Tilt Mid Channel

DUT: 3G/4G Smart Phone ; Model:SKY 5.0LM

Communication System: 3G Band; Frequency: 1880.0 MHz;Duty Cycle: 1:1
Medium parameters used: $f = 1880$ MHz; $\sigma = 1.39$ S/m; $\epsilon_r = 39.72$; $\rho = 1000$ kg/m³
Phantom section: Left Section

DASY4 Configuration:

- Probe: ES3DV3 - SN3036; ConvF(5.12, 5.12, 5.12); Calibrated: 16/9/2016
- Sensor-Surface: 4mm (Mechanical Surface Detection)
- Electronics: Dummy DAE - SN:456; Calibrated: 12/9/2016
- Phantom: TWIN SAM; Type: QD000P40CA; Serial: TP-1218
- Measurement SW: DASY4, V4.5 Build 19; Postprocessing SW: SEMCAD, V1.8 Build 145

WCDMA 1900-Left-tilt-Mid /Area Scan (101x121x1): Measurement grid: dx=10mm, dy=10mm
Maximum value of SAR (interpolated) = 0.187 mW/g

WCDMA 1900-Left-tilt-Mid /Zoom Scan (7x7x7)/Cube 0: Measurement grid: dx=5mm, dy=5mm, dz=5mm
Reference Value = 1.49 V/m; Power Drift = -0.027 dB
Peak SAR (extrapolated) = 0.123 W/kg
SAR(1 g) = 0.107 mW/g; SAR(10 g) = 0.078 mW/g
Maximum value of SAR (measured) = 0.114 mW/g

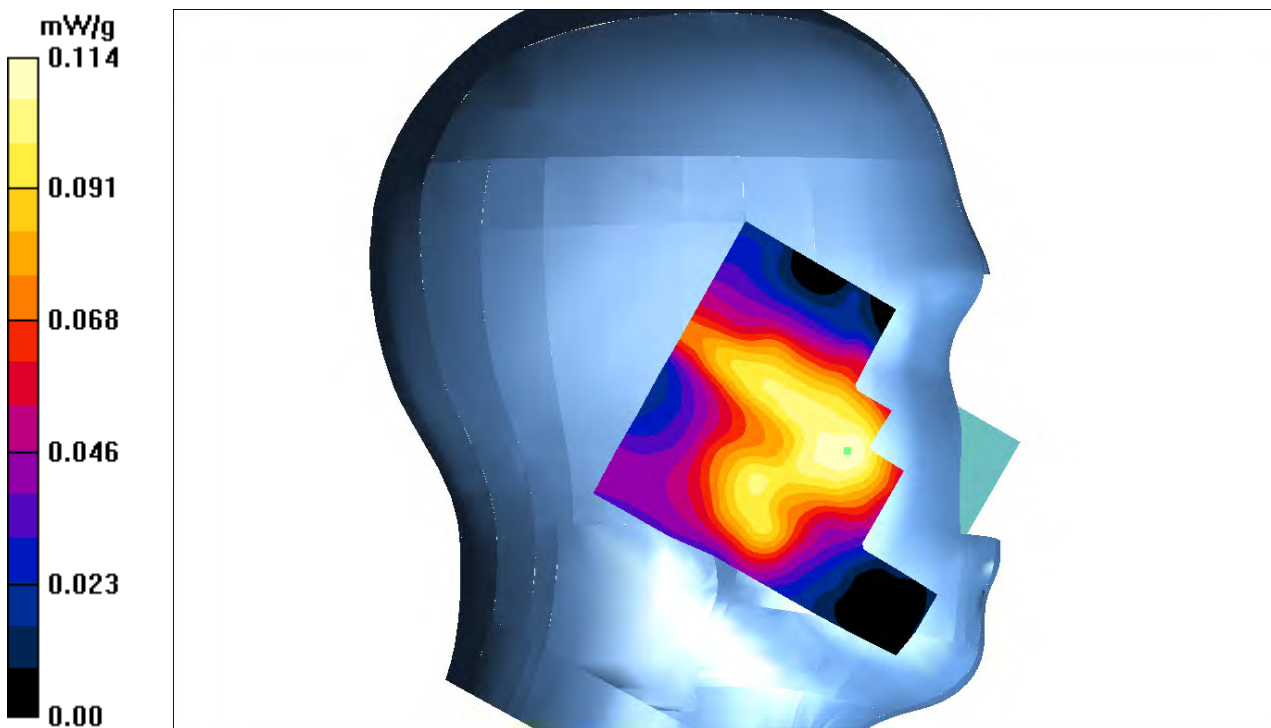

Test Laboratory: Bay Area Compliance Labs Corp.(Shenzhen)

Test Plot 29#:WCDMA 1900 Right Cheek Mid Channel

DUT: 3G/4G Smart Phone ; Model:SKY 5.0LM

Communication System: 3G Band; Frequency: 1880.0 MHz;Duty Cycle: 1:1
 Medium parameters used: $f = 1880$ MHz; $\sigma = 1.39$ S/m; $\epsilon_r = 39.72$; $\rho = 1000$ kg/m³
 Phantom section: Right Section

DASY4 Configuration:

- Probe: ES3DV3 - SN3036; ConvF(5.12, 5.12, 5.12); Calibrated: 16/9/2016
- Sensor-Surface: 4mm (Mechanical Surface Detection)
- Electronics: Dummy DAE - SN:456; Calibrated: 12/9/2016
- Phantom: TWIN SAM; Type: QD000P40CA; Serial: TP-1218
- Measurement SW: DASY4, V4.5 Build 19; Postprocessing SW: SEMCAD, V1.8 Build 145

WCDMA 1900-Right-cheek-Mid /Area Scan (101x121x1): Measurement grid: dx=10mm, dy=10mm
 Maximum value of SAR (interpolated) = 0.377 mW/g

WCDMA 1900-Right-cheek-Mid /Zoom Scan (7x7x7)/Cube 0: Measurement grid: dx=5mm, dy=5mm, dz=5mm

Reference Value = 1.57 V/m; Power Drift = 0.039 dB

Peak SAR (extrapolated) = 0.258 W/kg

SAR(1 g) = 0.239 mW/g; SAR(10 g) = 0.156 mW/g

Maximum value of SAR (measured) = 0.275 mW/g

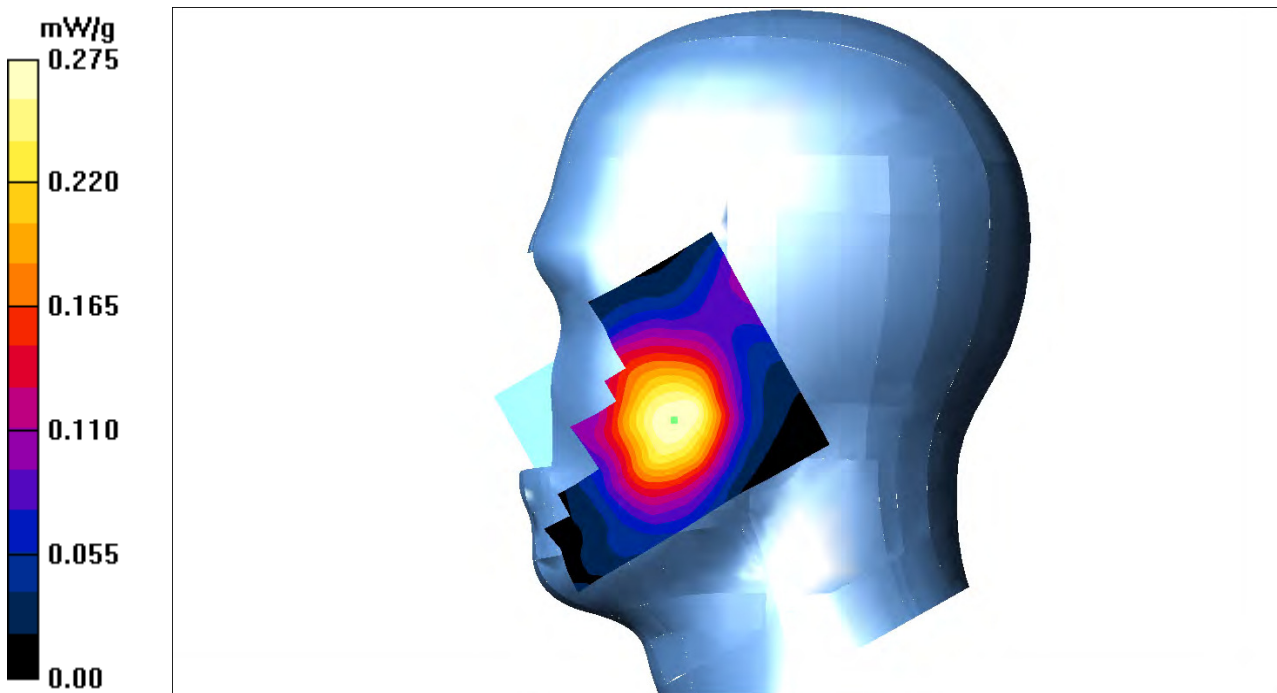

Test Laboratory: Bay Area Compliance Labs Corp.(Shenzhen)

Test Plot 30#:WCDMA 1900 Right Tilt Mid Channel

DUT: 3G/4G Smart Phone ; Model:SKY 5.0LM

Communication System: 3G Band; Frequency: 1880.0 MHz;Duty Cycle: 1:1
 Medium parameters used: $f = 1880 \text{ MHz}$; $\sigma = 1.39 \text{ S/m}$; $\epsilon_r = 39.72$; $\rho = 1000 \text{ kg/m}^3$
 Phantom section: Right Section

DASY4 Configuration:

- Probe: ES3DV3 - SN3036; ConvF(5.12, 5.12, 5.12); Calibrated: 16/9/2016
- Sensor-Surface: 4mm (Mechanical Surface Detection)
- Electronics: Dummy DAE - SN:456; Calibrated: 12/9/2016
- Phantom: TWIN SAM; Type: QD000P40CA; Serial: TP-1218
- Measurement SW: DASY4, V4.5 Build 19; Postprocessing SW: SEMCAD, V1.8 Build 145

WCDMA 1900-Right-tilt-Mid /Area Scan (101x121x1): Measurement grid: $dx=10\text{mm}$, $dy=10\text{mm}$
 Maximum value of SAR (interpolated) = 0.154 mW/g

WCDMA 1900-Right-tilt-Mid /Zoom Scan (7x7x7)/Cube 0: Measurement grid: $dx=5\text{mm}$, $dy=5\text{mm}$, $dz=5\text{mm}$

Reference Value = 1.89 V/m; Power Drift = 0.023 dB

Peak SAR (extrapolated) = 0.112 W/kg

SAR(1 g) = 0.113 mW/g; SAR(10 g) = 0.075 mW/g

Maximum value of SAR (measured) = 0.136 mW/g

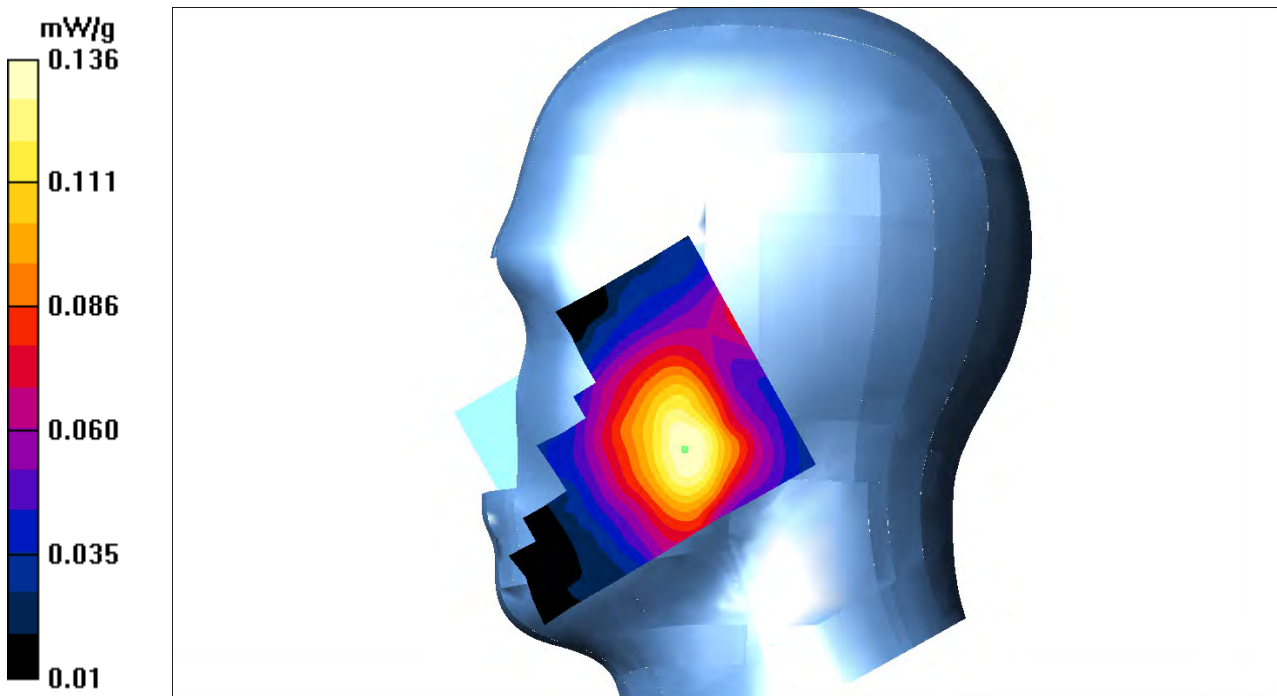

Test Laboratory: Bay Area Compliance Labs Corp.(Shenzhen)

Test Plot 31#:LTE Band 2 Left Cheek High Channel

DUT: 3G/4G Smart Phone ; Model:SKY 5.0LM

Communication System: LTE 4G Band; Frequency: 1900 MHz;Duty Cycle: 1:1
 Medium parameters used: $f = 1900$ MHz; $\sigma = 1.40$ S/m; $\epsilon_r = 39.86$; $\rho = 1000$ kg/m³
 Phantom section: Left Section

DASY4 Configuration:

- Probe: ES3DV3 - SN3036; ConvF(5.12, 5.12, 5.12); Calibrated: 16/9/2016
- Sensor-Surface: 4mm (Mechanical Surface Detection)
- Electronics: Dummy DAE - SN:456; Calibrated: 12/9/2016
- Phantom: TWIN SAM; Type: QD000P40CA; Serial: TP-1218
- Measurement SW: DASY4, V4.5 Build 19; Postprocessing SW: SEMCAD, V1.8 Build 145

LTE Band 2-left-cheek-high-1RB /Area Scan (101x121x1): Measurement grid: dx=10mm, dy=10mm
 Maximum value of SAR (interpolated) = 0.327 mW/g

LTE Band 2-left-cheek-high-1RB /Zoom Scan (7x7x7)/Cube 0: Measurement grid: dx=5mm, dy=5mm, dz=5mm

Reference Value = 1.73 V/m; Power Drift = 0.049 dB

Peak SAR (extrapolated) = 0.298 W/kg

SAR(1 g) = 0.285 mW/g; SAR(10 g) = 0.112 mW/g

Maximum value of SAR (measured) = 0.306 mW/g

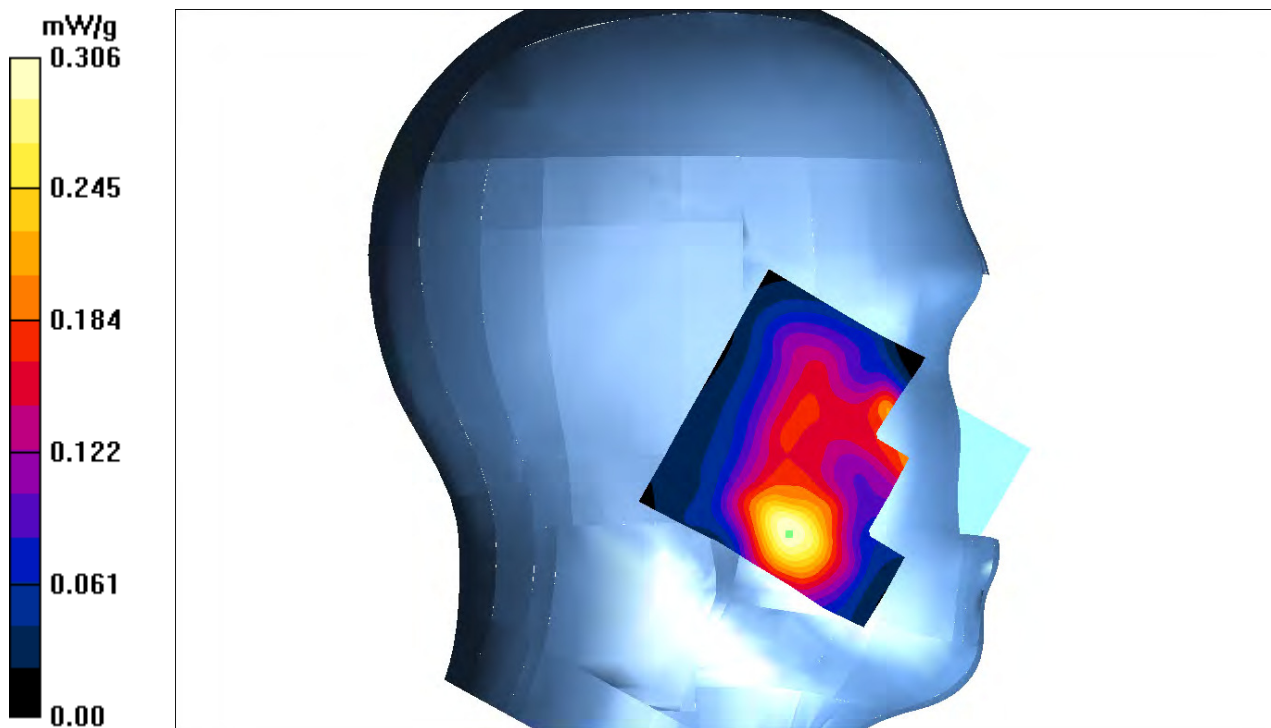

Test Laboratory: Bay Area Compliance Labs Corp.(Shenzhen)

Test Plot 32#:LTE Band 2 Left Cheek High Channel

DUT: 3G/4G Smart Phone ; Model:SKY 5.0LM

Communication System: LTE 4G Band; Frequency: 1900 MHz;Duty Cycle: 1:1
Medium parameters used: $f = 1900$ MHz; $\sigma = 1.40$ S/m; $\epsilon_r = 39.86$; $\rho = 1000$ kg/m³
Phantom section: Left Section

DASY4 Configuration:

- Probe: ES3DV3 - SN3036; ConvF(5.12, 5.12, 5.12); Calibrated: 16/9/2016
- Sensor-Surface: 4mm (Mechanical Surface Detection)
- Electronics: Dummy DAE - SN:456; Calibrated: 12/9/2016
- Phantom: TWIN SAM; Type: QD000P40CA; Serial: TP-1218
- Measurement SW: DASY4, V4.5 Build 19; Postprocessing SW: SEMCAD, V1.8 Build 145

LTE Band 2-left-cheek-high-50%RB /Area Scan (101x121x1): Measurement grid: dx=10mm, dy=10mm
Maximum value of SAR (interpolated) = 0.237 mW/g

LTE Band 2-left-cheek-high-50%RB /Zoom Scan (7x7x7)/Cube 0: Measurement grid: dx=5mm, dy=5mm, dz=5mm

Reference Value = 1.77 V/m; Power Drift = 0.032 dB

Peak SAR (extrapolated) = 0.258 W/kg

SAR(1 g) = 0.213 mW/g; SAR(10 g) = 0.136 mW/g

Maximum value of SAR (measured) = 0.227 mW/g

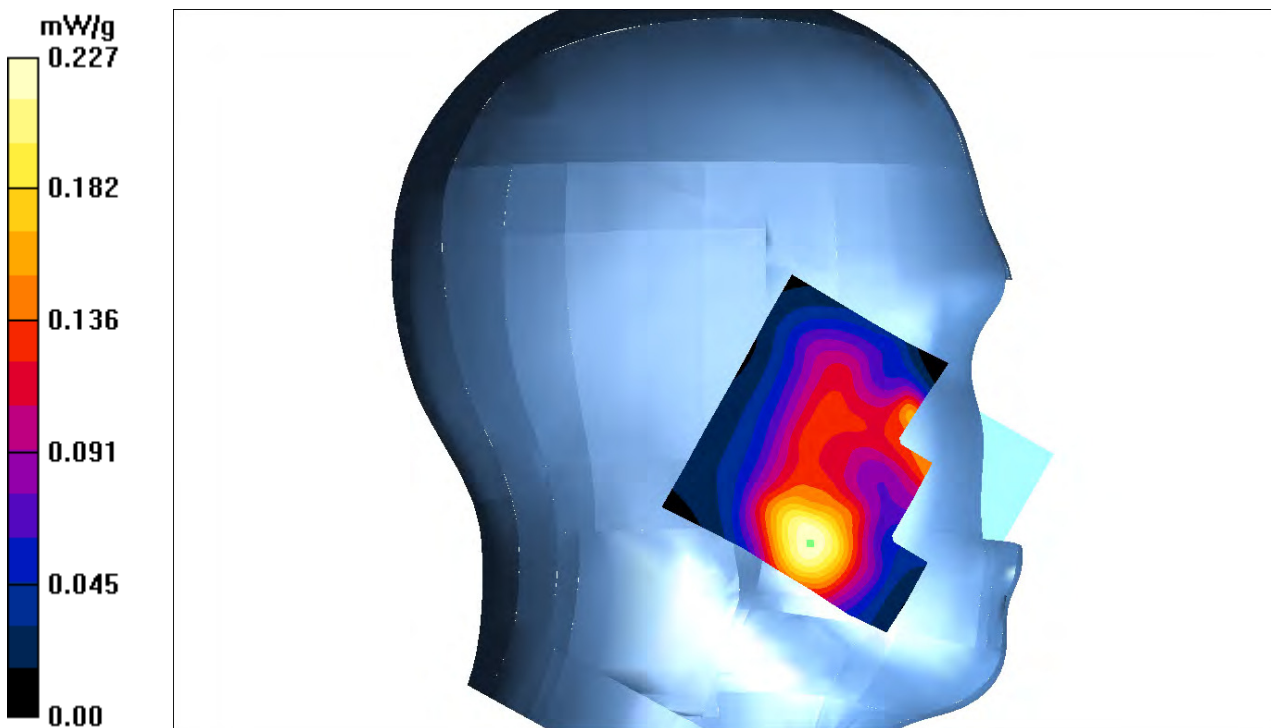

Test Laboratory: Bay Area Compliance Labs Corp.(Shenzhen)

Test Plot 33#:LTE Band 2 Left Tilt High Channel

DUT: 3G/4G Smart Phone ; Model:SKY 5.0LM

Communication System: LTE 4G Band; Frequency: 1900.0 MHz;Duty Cycle: 1:1
Medium parameters used: $f = 1900.0$ MHz; $\sigma = 1.38$ S/m; $\epsilon_r = 38.71$; $\rho = 1000$ kg/m³
Phantom section: Left Section

DASY4 Configuration:

- Probe: ES3DV3 - SN3036; ConvF(5.12, 5.12, 5.12); Calibrated: 16/9/2016
- Sensor-Surface: 4mm (Mechanical Surface Detection)
- Electronics: Dummy DAE - SN:456; Calibrated: 12/9/2016
- Phantom: TWIN SAM; Type: QD000P40CA; Serial: TP-1218
- Measurement SW: DASY4, V4.5 Build 19; Postprocessing SW: SEMCAD, V1.8 Build 145

LTE Band 2-left-tilt-high-1RB /Area Scan (101x121x1): Measurement grid: dx=10mm, dy=10mm
Maximum value of SAR (interpolated) = 0.167 mW/g

LTE Band 2-left-tilt-high-1RB /Zoom Scan (7x7x7)/Cube 0: Measurement grid: dx=5mm, dy=5mm, dz=5mm
Reference Value = 2.35 V/m; Power Drift = 0.088 dB
Peak SAR (extrapolated) = 0.158 W/kg
SAR(1 g) = 0.135 mW/g; SAR(10 g) = 0.087 mW/g
Maximum value of SAR (measured) = 0.147 mW/g

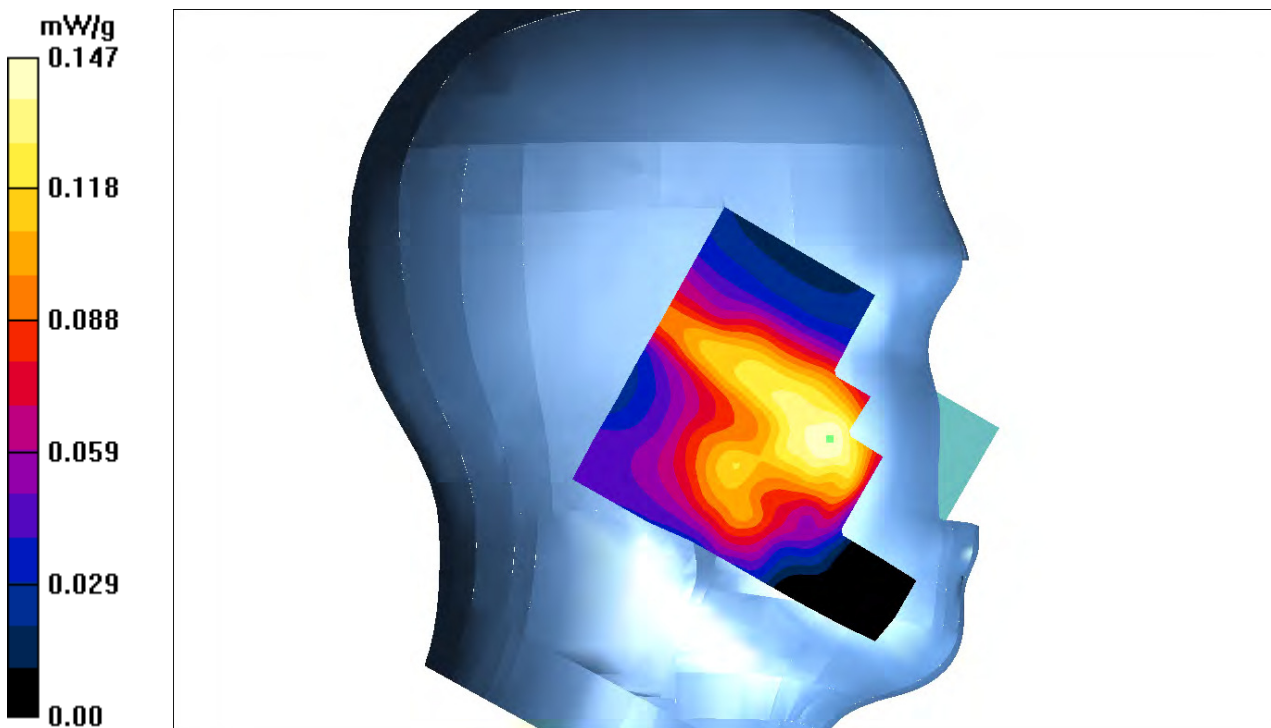

Test Laboratory: Bay Area Compliance Labs Corp.(Shenzhen)

Test Plot 34#:LTE Band 2 Left Tilt High Channel

DUT: 3G/4G Smart Phone ; Model:SKY 5.0LM

Communication System: LTE 4G Band; Frequency: 1900.0 MHz;Duty Cycle: 1:1
 Medium parameters used: $f = 1900$ MHz; $\sigma = 1.40$ S/m; $\epsilon_r = 39.86$; $\rho = 1000$ kg/m³
 Phantom section: Left Section

DASY4 Configuration:

- Probe: ES3DV3 - SN3036; ConvF(5.12, 5.12, 5.12); Calibrated: 16/9/2016
- Sensor-Surface: 4mm (Mechanical Surface Detection)
- Electronics: Dummy DAE - SN:456; Calibrated: 12/9/2016
- Phantom: TWIN SAM; Type: QD000P40CA; Serial: TP-1218
- Measurement SW: DASY4, V4.5 Build 19; Postprocessing SW: SEMCAD, V1.8 Build 145

LTE Band 2-left-tilt-high-50%RB /Area Scan (101x121x1): Measurement grid: dx=10mm, dy=10mm
 Maximum value of SAR (interpolated) = 0.192 mW/g

LTE Band 2-left-tilt-high-50%RB /Zoom Scan (7x7x7)/Cube 0: Measurement grid: dx=5mm, dy=5mm, dz=5mm

Reference Value = 2.95 V/m; Power Drift = 0.083 dB

Peak SAR (extrapolated) = 0.118 W/kg

SAR(1 g) = 0.102 mW/g; SAR(10 g) = 0.069 mW/g

Maximum value of SAR (measured) = 0.115 mW/g

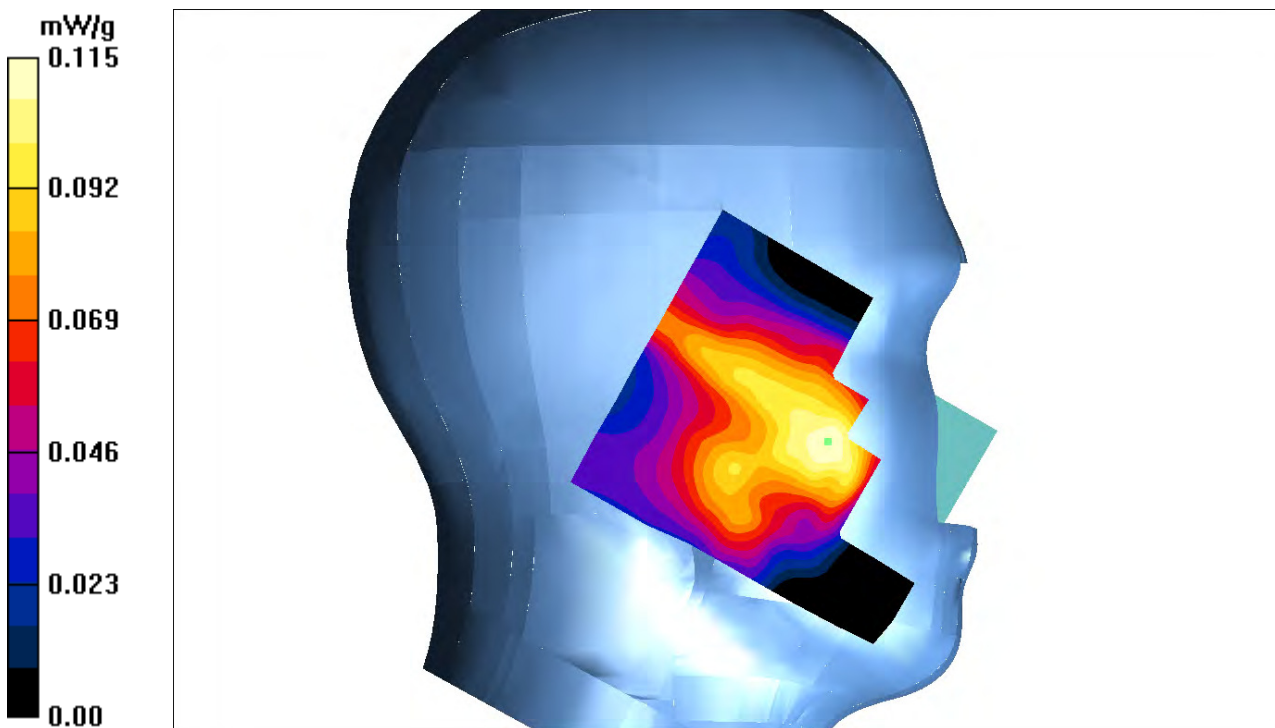

Test Laboratory: Bay Area Compliance Labs Corp.(Shenzhen)

Test Plot 35#:LTE Band 2 Right Cheek High Channel

DUT: 3G/4G Smart Phone ; Model:SKY 5.0LM

Communication System: LTE 4G Band; Frequency: 1900.0 MHz;Duty Cycle: 1:1
 Medium parameters used: $f = 1900$ MHz; $\sigma = 1.40$ S/m; $\epsilon_r = 39.86$; $\rho = 1000$ kg/m³
 Phantom section: Right Section

DASY4 Configuration:

- Probe: ES3DV3 - SN3036; ConvF(5.12, 5.12, 5.12); Calibrated: 16/9/2016
- Sensor-Surface: 4mm (Mechanical Surface Detection)
- Electronics: Dummy DAE - SN:456; Calibrated: 12/9/2016
- Phantom: TWIN SAM; Type: QD000P40CA; Serial: TP-1218
- Measurement SW: DASY4, V4.5 Build 19; Postprocessing SW: SEMCAD, V1.8 Build 145

LTE Band 2-right-cheek-high-1RB /Area Scan (101x121x1): Measurement grid: dx=10mm, dy=10mm
 Maximum value of SAR (interpolated) = 0.386 mW/g

LTE Band 2-right-cheek-high-1RB /Zoom Scan (7x7x7)/Cube 0: Measurement grid: dx=5mm, dy=5mm, dz=5mm

Reference Value = 2.52 V/m; Power Drift = 0.129 dB

Peak SAR (extrapolated) = 0.324 W/kg

SAR(1 g) = 0.297 mW/g; SAR(10 g) = 0.127 mW/g

Maximum value of SAR (measured) = 0.383 mW/g

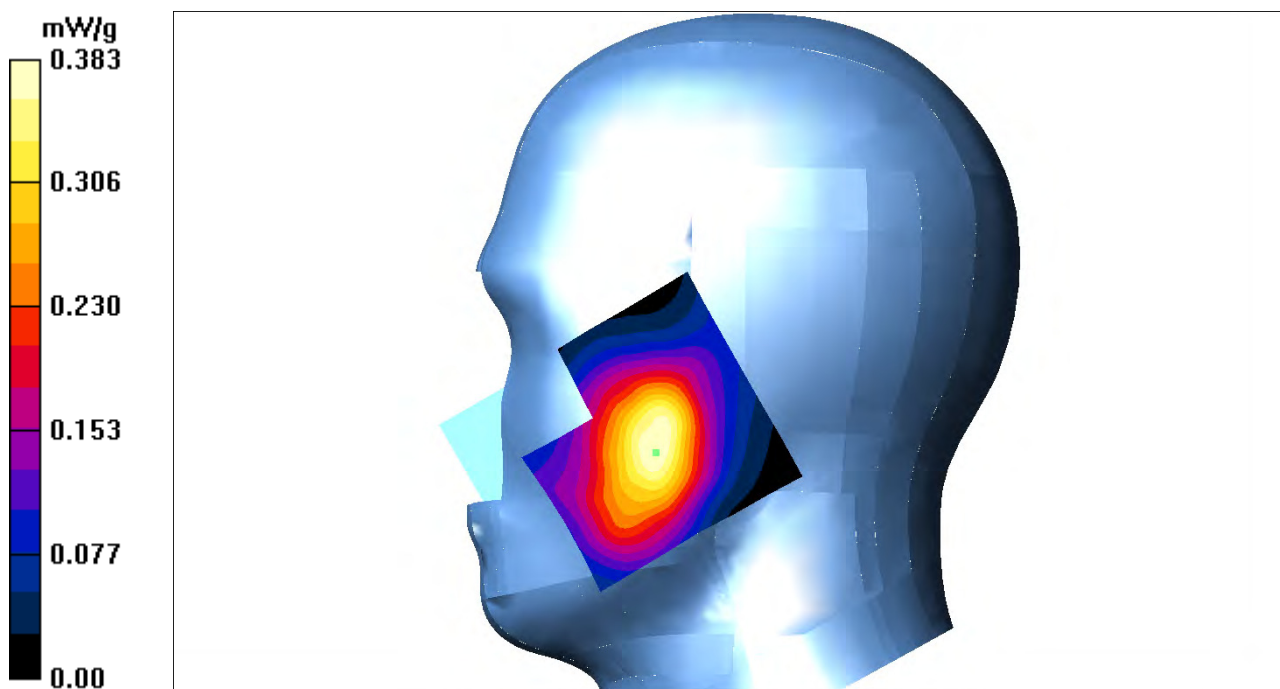

Test Laboratory: Bay Area Compliance Labs Corp.(Shenzhen)

Test Plot 36#:LTE Band 2 Right Cheek High Channel

DUT: 3G/4G Smart Phone ; Model:SKY 5.0LM

Communication System: LTE 4G Band; Frequency: 1900 MHz;Duty Cycle: 1:1
 Medium parameters used: $f = 1900$ MHz; $\sigma = 1.40$ S/m; $\epsilon_r = 39.86$; $\rho = 1000$ kg/m³
 Phantom section: Right Section

DASY4 Configuration:

- Probe: ES3DV3 - SN3036; ConvF(5.12, 5.12, 5.12); Calibrated: 16/9/2016
- Sensor-Surface: 4mm (Mechanical Surface Detection)
- Electronics: Dummy DAE - SN:456; Calibrated: 12/9/2016
- Phantom: TWIN SAM; Type: QD000P40CA; Serial: TP-1218
- Measurement SW: DASY4, V4.5 Build 19; Postprocessing SW: SEMCAD, V1.8 Build 145

LTE Band 2-right-cheek-high-50%RB /Area Scan (101x121x1): Measurement grid: dx=10mm, dy=10mm
 Maximum value of SAR (interpolated) = 0.356 mW/g

LTE Band 2-right-cheek-high-50%RB /Zoom Scan (7x7x7)/Cube 0: Measurement grid: dx=5mm, dy=5mm, dz=5mm
 Reference Value = 0.82 V/m; Power Drift = 0.022 dB
 Peak SAR (extrapolated) = 0.307 W/kg
SAR(1 g) = 0.311 mW/g; SAR(10 g) = 0.187 mW/g
 Maximum value of SAR (measured) = 0.363 mW/g

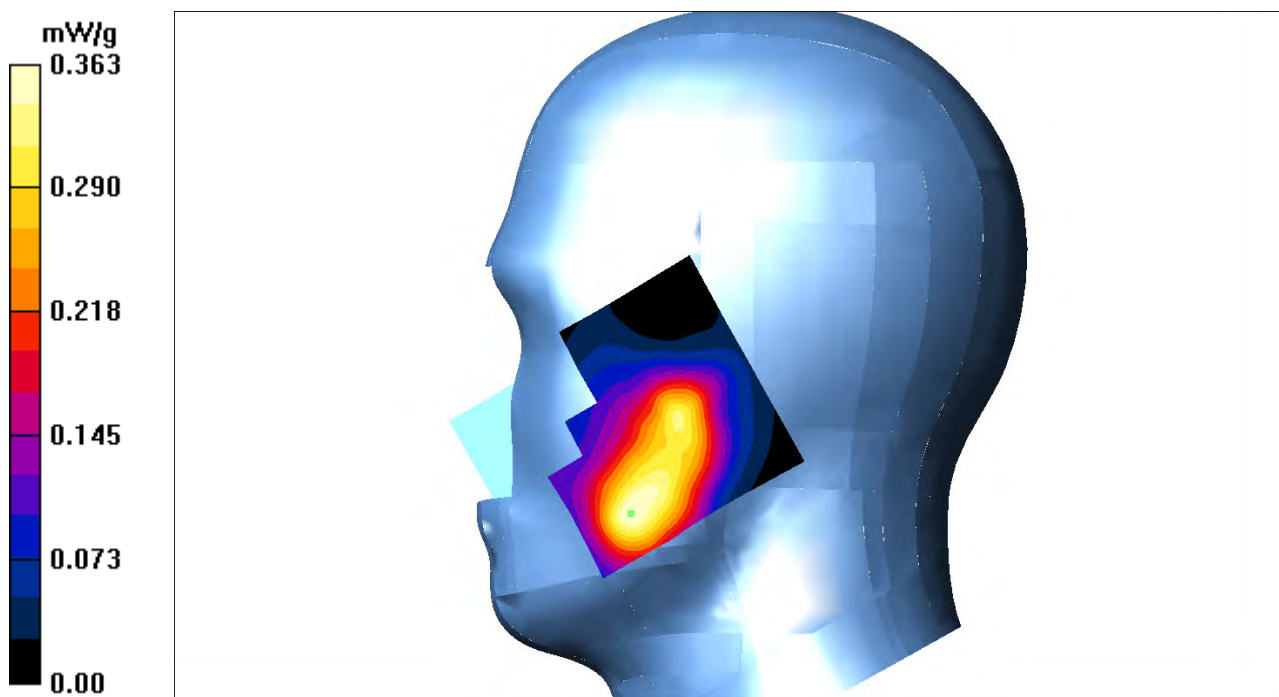

Test Laboratory: Bay Area Compliance Labs Corp.(Shenzhen)

Test Plot 37#:LTE Band 2 Right Tilt High Channel

DUT: 3G/4G Smart Phone ; Model:SKY 5.0LM

Communication System: LTE 4G Band; Frequency: 1900.0 MHz;Duty Cycle: 1:1
Medium parameters used: $f = 1900$ MHz; $\sigma = 1.40$ S/m; $\epsilon_r = 39.86$; $\rho = 1000$ kg/m³
Phantom section: Right Section

DASY4 Configuration:

- Probe: ES3DV3 - SN3036; ConvF(5.12, 5.12, 5.12); Calibrated: 16/9/2016
- Sensor-Surface: 4mm (Mechanical Surface Detection)
- Electronics: Dummy DAE - SN:456; Calibrated: 12/9/2016
- Phantom: TWIN SAM; Type: QD000P40CA; Serial: TP-1218
- Measurement SW: DASY4, V4.5 Build 19; Postprocessing SW: SEMCAD, V1.8 Build 145

LTE Band 2-right-tilt-high-1RB /Area Scan (101x121x1): Measurement grid: dx=10mm, dy=10mm
Maximum value of SAR (interpolated) = 0.146 mW/g

LTE Band 2-right-tilt-high-1RB /Zoom Scan (7x7x7)/Cube 0: Measurement grid: dx=5mm, dy=5mm, dz=5mm

Reference Value = 1.32 V/m; Power Drift = 0.037 dB

Peak SAR (extrapolated) = 0.124 W/kg

SAR(1 g) = 0.110 mW/g; SAR(10 g) = 0.053 mW/g

Maximum value of SAR (measured) = 0.111 mW/g

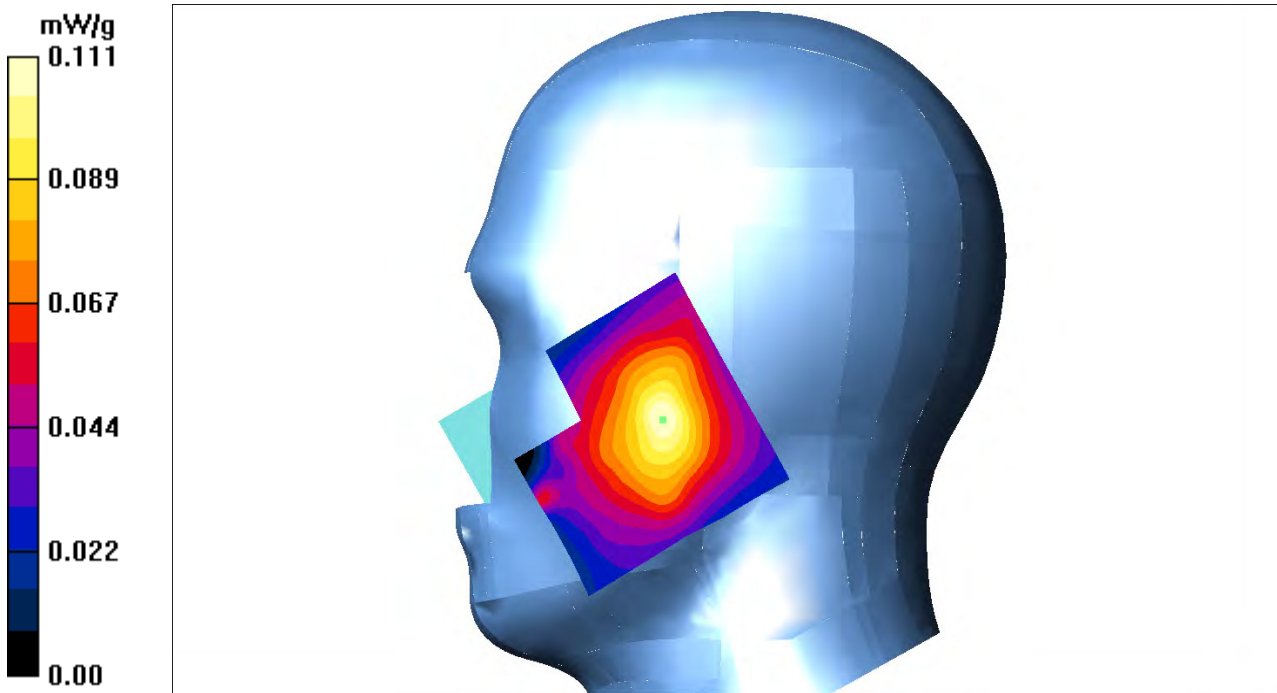

Test Laboratory: Bay Area Compliance Labs Corp.(Shenzhen)

Test Plot 38#:LTE Band 2 Right Tilt High Channel

DUT: 3G/4G Smart Phone ; Model:SKY 5.0LM

Communication System: LTE 4G Band; Frequency: 1900.0 MHz;Duty Cycle: 1:1
 Medium parameters used: $f = 1900$ MHz; $\sigma = 1.40$ S/m; $\epsilon_r = 39.86$; $\rho = 1000$ kg/m³
 Phantom section: Right Section

DASY4 Configuration:

- Probe: ES3DV3 - SN3036; ConvF(5.12, 5.12, 5.12); Calibrated: 16/9/2016
- Sensor-Surface: 4mm (Mechanical Surface Detection)
- Electronics: Dummy DAE - SN:456; Calibrated: 12/9/2016
- Phantom: TWIN SAM; Type: QD000P40CA; Serial: TP-1218
- Measurement SW: DASY4, V4.5 Build 19; Postprocessing SW: SEMCAD, V1.8 Build 145

LTE Band 2-right-tilt-high-50%RB /Area Scan (101x121x1): Measurement grid: dx=10mm, dy=10mm
 Maximum value of SAR (interpolated) = 0.133 mW/g

LTE Band 2-right-tilt-high-50%RB /Zoom Scan (7x7x7)/Cube 0: Measurement grid: dx=5mm, dy=5mm, dz=5mm

Reference Value = 1.23 V/m; Power Drift = -0.089 dB

Peak SAR (extrapolated) = 0.136 W/kg

SAR(1 g) = 0.110 mW/g; SAR(10 g) = 0.077 mW/g

Maximum value of SAR (measured) = 0.112 mW/g

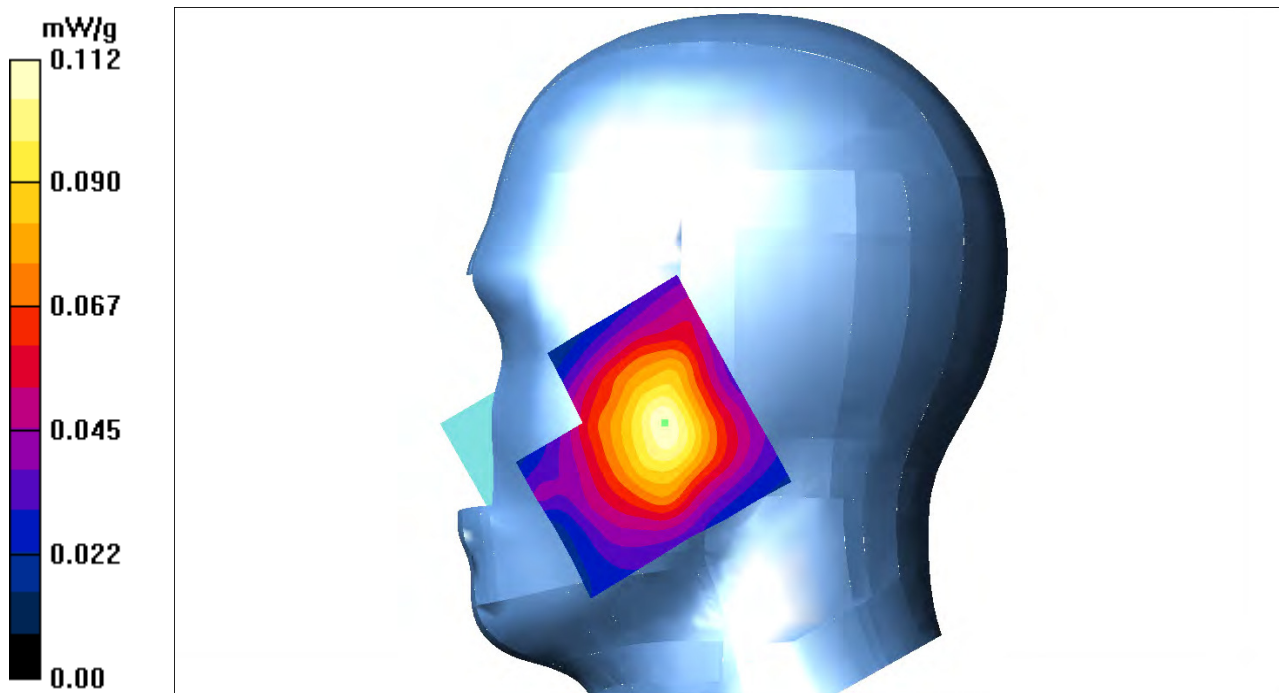

Test Laboratory: Bay Area Compliance Labs Corp.(Shenzhen)

Test Plot 39#:LTE Band 4 Left Cheek High Channel

DUT: 3G/4G Smart Phone ; Model:SKY 5.0LM

Communication System: LTE 4G Band; Frequency: 1745 MHz;Duty Cycle: 1:1
Medium parameters used: $f = 1745 \text{ MHz}$; $\sigma = 1.38 \text{ S/m}$; $\epsilon_r = 39.89$; $\rho = 1000 \text{ kg/m}^3$
Phantom section: Left Section

DASY4 Configuration:

- Probe: ES3DV3 - SN3036; ConvF(5.34, 5.34, 5.34); Calibrated: 16/9/2016
- Sensor-Surface: 4mm (Mechanical Surface Detection)
- Electronics: Dummy DAE - SN:456; Calibrated: 12/9/2016
- Phantom: TWIN SAM; Type: QD000P40CA; Serial: TP-1218
- Measurement SW: DASY4, V4.5 Build 19; Postprocessing SW: SEMCAD, V1.8 Build 145

LTE Band 4-left-cheek-high-1RB /Area Scan (101x121x1): Measurement grid: $dx=10\text{mm}$, $dy=10\text{mm}$
Maximum value of SAR (interpolated) = 0.392 mW/g

LTE Band 4-left-cheek-high-1RB /Zoom Scan (7x7x7)/Cube 0: Measurement grid: $dx=5\text{mm}$, $dy=5\text{mm}$, $dz=5\text{mm}$
Reference Value = 7.48 V/m; Power Drift = -0.087 dB
Peak SAR (extrapolated) = 0.441 W/kg
SAR(1 g) = 0.385 mW/g; SAR(10 g) = 0.216 mW/g
Maximum value of SAR (measured) = 0.393 mW/g

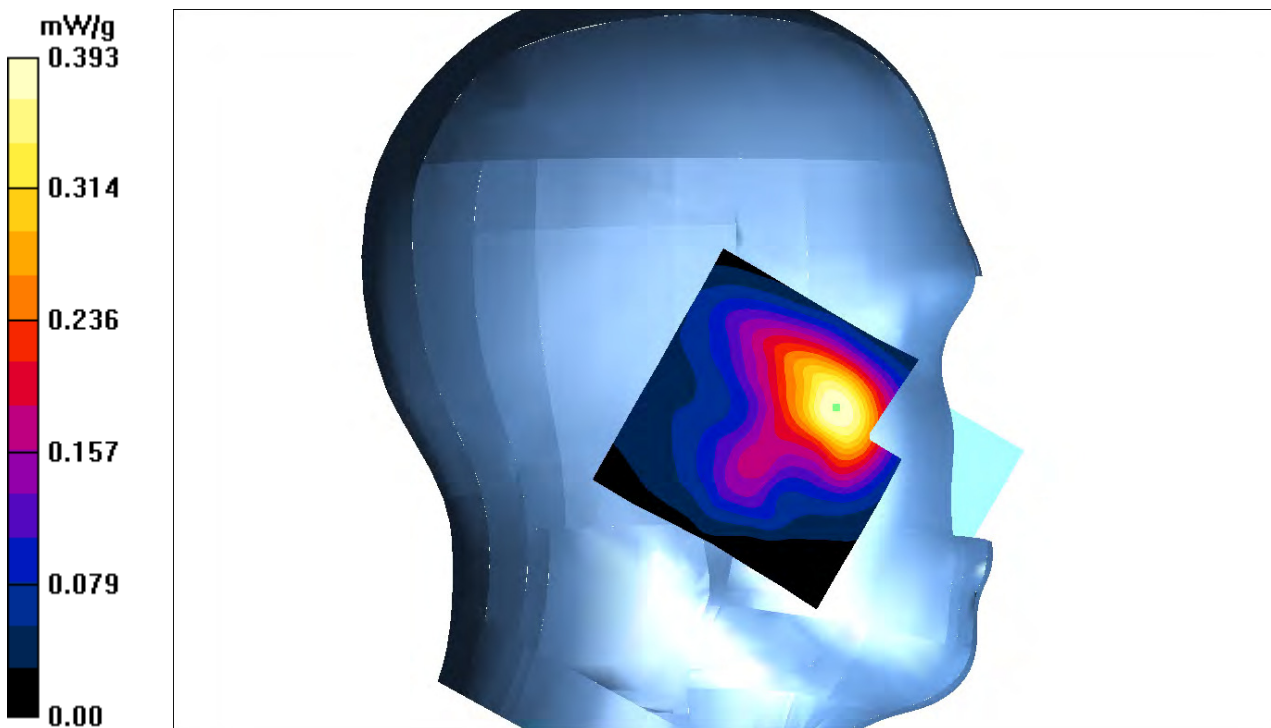

Test Laboratory: Bay Area Compliance Labs Corp.(Shenzhen)

Test Plot 40#:LTE Band 4 Left Cheek High Channel

DUT: 3G/4G Smart Phone ; Model:SKY 5.0LM

Communication System: LTE 4G Band; Frequency: 1745 MHz;Duty Cycle: 1:1
Medium parameters used: $f = 1745 \text{ MHz}$; $\sigma = 1.38 \text{ S/m}$; $\epsilon_r = 39.89$; $\rho = 1000 \text{ kg/m}^3$
Phantom section: Left Section

DASY4 Configuration:

- Probe: ES3DV3 - SN3036; ConvF(5.34, 5.34, 5.34); Calibrated: 16/9/2016
- Sensor-Surface: 4mm (Mechanical Surface Detection)
- Electronics: Dummy DAE - SN:456; Calibrated: 12/9/2016
- Phantom: TWIN SAM; Type: QD000P40CA; Serial: TP-1218
- Measurement SW: DASY4, V4.5 Build 19; Postprocessing SW: SEMCAD, V1.8 Build 145

LTE Band 4-left-cheek-high-50%RB /Area Scan (101x121x1): Measurement grid: $dx=10\text{mm}$, $dy=10\text{mm}$
Maximum value of SAR (interpolated) = 0.392 mW/g

LTE Band 4-left-cheek-high-50%RB /Zoom Scan (7x7x7)/Cube 0: Measurement grid: $dx=5\text{mm}$, $dy=5\text{mm}$, $dz=5\text{mm}$

Reference Value = 3.49 V/m; Power Drift = -0.029 dB

Peak SAR (extrapolated) = 0.377 W/kg

SAR(1 g) = 0.324 mW/g; SAR(10 g) = 0.216 mW/g

Maximum value of SAR (measured) = 0.340 mW/g

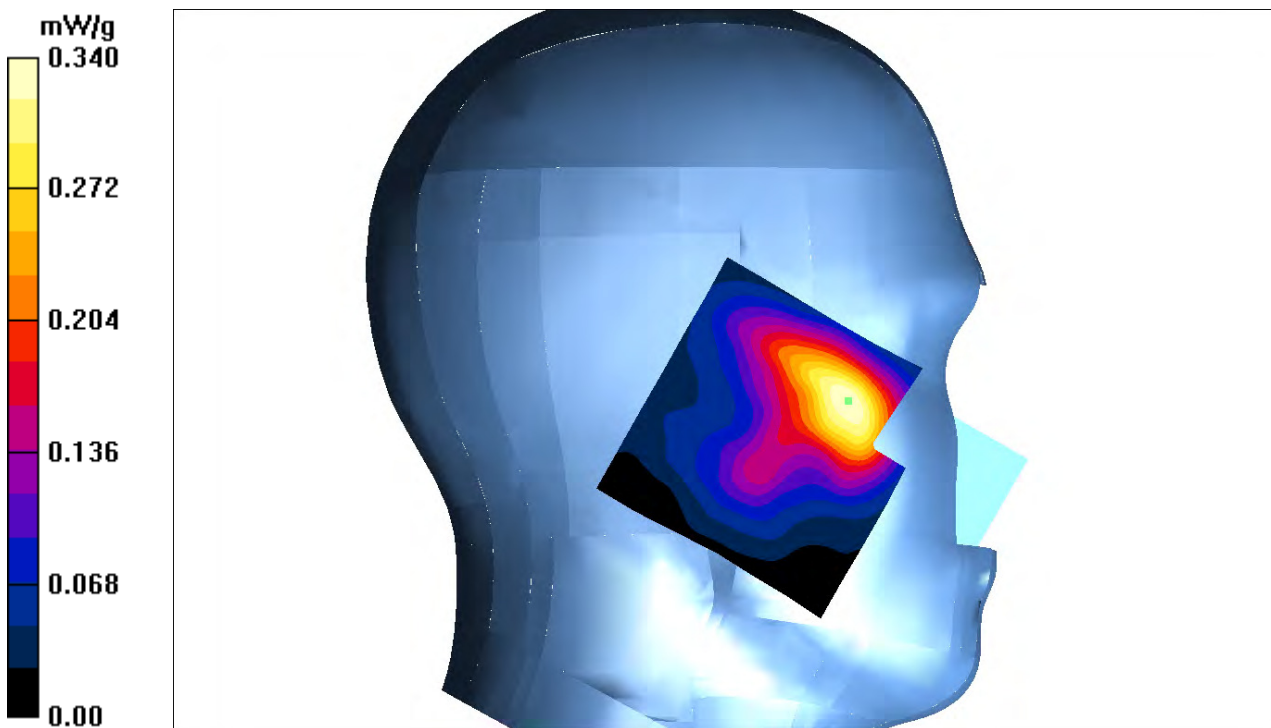

Test Laboratory: Bay Area Compliance Labs Corp.(Shenzhen)

Test Plot 41#:LTE Band 4 Left Tilt High Channel

DUT: 3G/4G Smart Phone ; Model:SKY 5.0LM

Communication System: LTE 4G Band; Frequency: 1745 MHz;Duty Cycle: 1:1
 Medium parameters used: $f = 1745 \text{ MHz}$; $\sigma = 1.38 \text{ S/m}$; $\epsilon_r = 39.89$; $\rho = 1000 \text{ kg/m}^3$
 Phantom section: Left Section

DASY4 Configuration:

- Probe: ES3DV3 - SN3036; ConvF(5.34, 5.34, 5.34); Calibrated: 16/9/2016
- Sensor-Surface: 4mm (Mechanical Surface Detection)
- Electronics: Dummy DAE - SN:456; Calibrated: 12/9/2016
- Phantom: TWIN SAM; Type: QD000P40CA; Serial: TP-1218
- Measurement SW: DASY4, V4.5 Build 19; Postprocessing SW: SEMCAD, V1.8 Build 145

LTE Band 4-left-tilt-high-1RB /Area Scan (101x121x1): Measurement grid: $dx=10\text{mm}$, $dy=10\text{mm}$
 Maximum value of SAR (interpolated) = 0.285 mW/g

LTE Band 4-left-tilt-high-1RB /Zoom Scan (7x7x7)/Cube 0: Measurement grid: $dx=5\text{mm}$, $dy=5\text{mm}$, $dz=5\text{mm}$
 Reference Value = 3.20 V/m; Power Drift = -0.088 dB
 Peak SAR (extrapolated) = 0.267 W/kg
SAR(1 g) = 0.223 mW/g; SAR(10 g) = 0.182 mW/g
 Maximum value of SAR (measured) = 0.228 mW/g

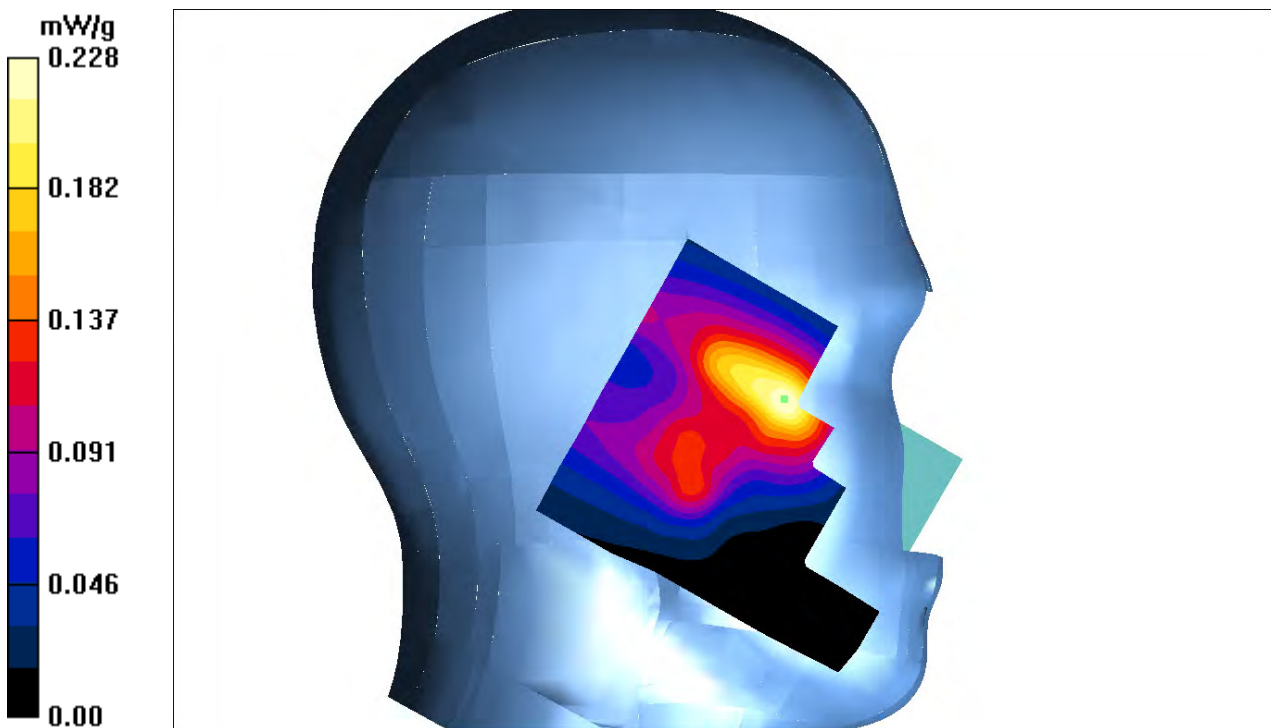

Test Laboratory: Bay Area Compliance Labs Corp.(Shenzhen)

Test Plot 42#:LTE Band 4 Left Tilt High Channel

DUT: 3G/4G Smart Phone ; Model:SKY 5.0LM

Communication System: LTE 4G Band; Frequency: 1745 MHz;Duty Cycle: 1:1
 Medium parameters used: $f = 1745 \text{ MHz}$; $\sigma = 1.38 \text{ S/m}$; $\epsilon_r = 39.89$; $\rho = 1000 \text{ kg/m}^3$
 Phantom section: Left Section

DASY4 Configuration:

- Probe: ES3DV3 - SN3036; ConvF(5.34, 5.34, 5.34); Calibrated: 16/9/2016
- Sensor-Surface: 4mm (Mechanical Surface Detection)
- Electronics: Dummy DAE - SN:456; Calibrated: 12/9/2016
- Phantom: TWIN SAM; Type: QD000P40CA; Serial: TP-1218
- Measurement SW: DASY4, V4.5 Build 19; Postprocessing SW: SEMCAD, V1.8 Build 145

LTE Band 4-left-tilt-high-50%RB /Area Scan (101x121x1): Measurement grid: $dx=10\text{mm}$, $dy=10\text{mm}$
 Maximum value of SAR (interpolated) = 0.215 mW/g

LTE Band 4-left-tilt-high-50%RB /Zoom Scan (7x7x7)/Cube 0: Measurement grid: $dx=5\text{mm}$, $dy=5\text{mm}$, $dz=5\text{mm}$

Reference Value = 6.03 V/m; Power Drift = -0.046 dB
 Peak SAR (extrapolated) = 0.223 W/kg
SAR(1 g) = 0.186 mW/g; SAR(10 g) = 0.092 mW/g
 Maximum value of SAR (measured) = 0.211 mW/g

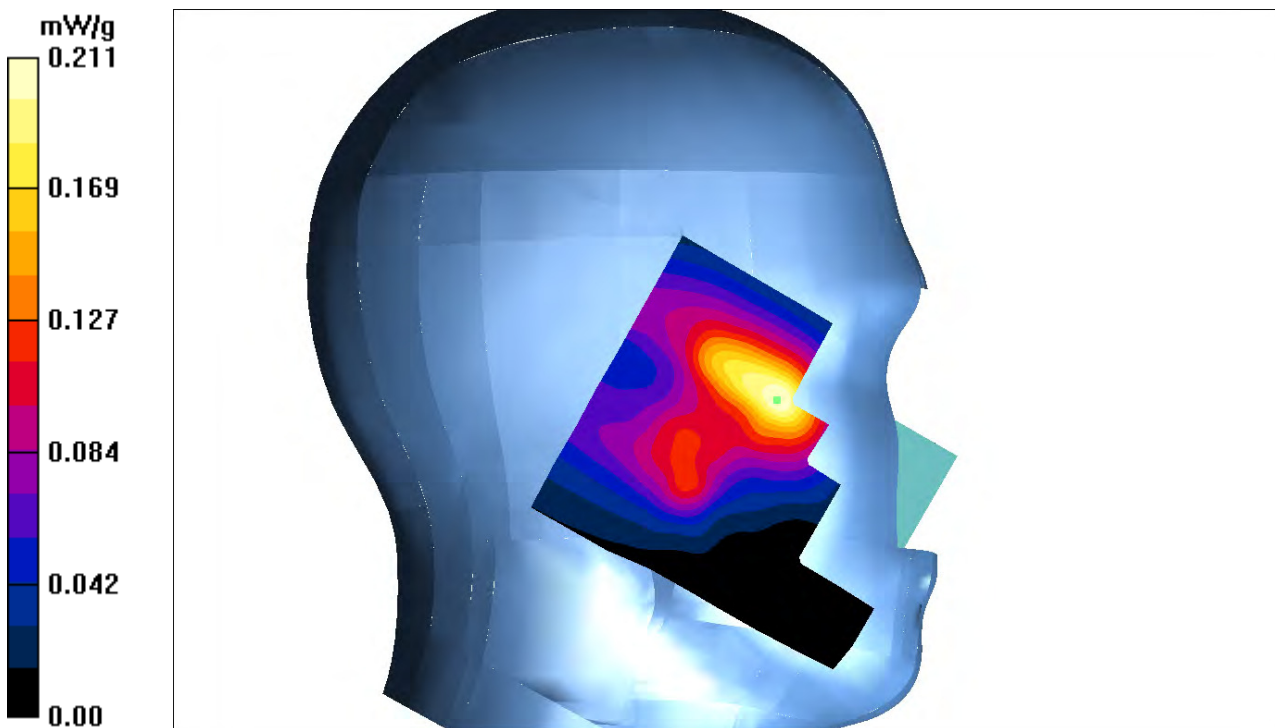

Test Laboratory: Bay Area Compliance Labs Corp.(Shenzhen)

Test Plot 43#:LTE Band 4 Right Cheek High Channel

DUT: 3G/4G Smart Phone ; Model:SKY 5.0LM

Communication System: LTE 4G Band; Frequency: 1745 MHz;Duty Cycle: 1:1
 Medium parameters used: $f = 1745 \text{ MHz}$; $\sigma = 1.38 \text{ S/m}$; $\epsilon_r = 39.89$; $\rho = 1000 \text{ kg/m}^3$
 Phantom section: Right Section

DASY4 Configuration:

- Probe: ES3DV3 - SN3036; ConvF(5.34, 5.34, 5.34); Calibrated: 16/9/2016
- Sensor-Surface: 4mm (Mechanical Surface Detection)
- Electronics: Dummy DAE - SN:456; Calibrated: 12/9/2016
- Phantom: TWIN SAM; Type: QD000P40CA; Serial: TP-1218
- Measurement SW: DASY4, V4.5 Build 19; Postprocessing SW: SEMCAD, V1.8 Build 145

LTE Band 4-right-cheek-high-1RB /Area Scan (101x121x1): Measurement grid: $dx=10\text{mm}$, $dy=10\text{mm}$
 Maximum value of SAR (interpolated) = 0.594 mW/g

LTE Band 4-right-cheek-high-1RB /Zoom Scan (7x7x7)/Cube 0: Measurement grid: $dx=5\text{mm}$, $dy=5\text{mm}$, $dz=5\text{mm}$

Reference Value = 8.49 V/m; Power Drift = 0.028 dB

Peak SAR (extrapolated) = 0.639 W/kg

SAR(1 g) = 0.527 mW/g; SAR(10 g) = 0.370 mW/g

Maximum value of SAR (measured) = 0.556 mW/g

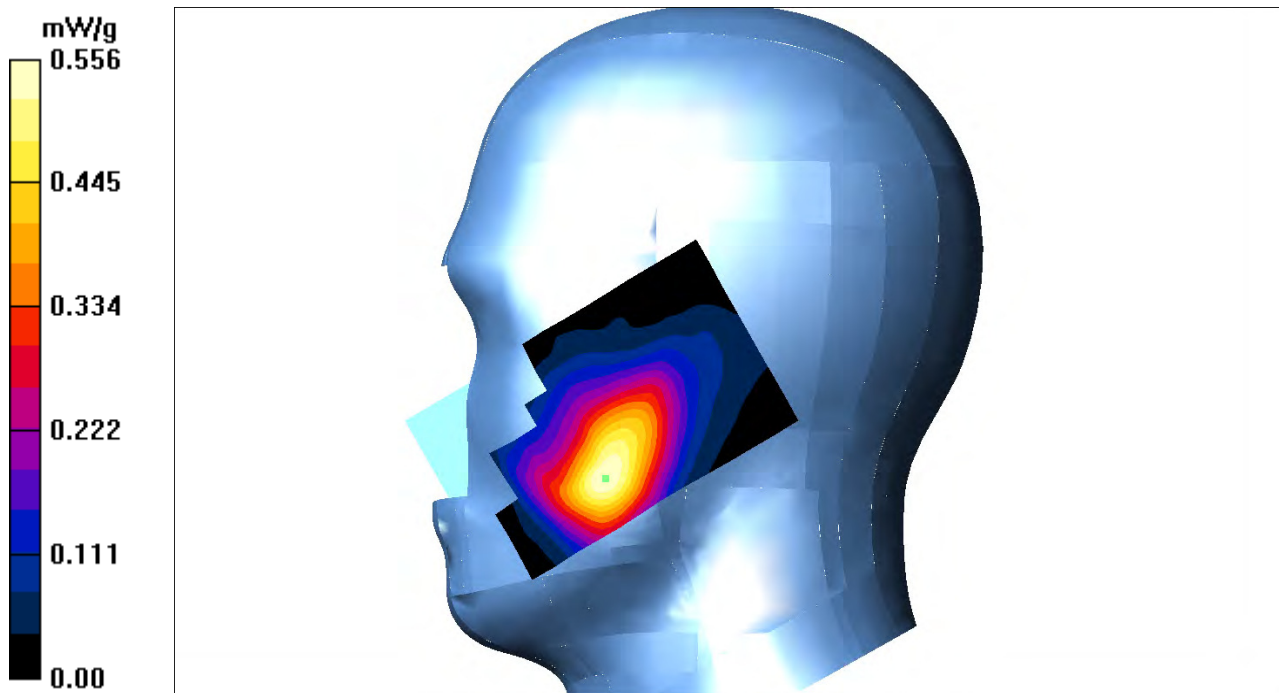

Test Laboratory: Bay Area Compliance Labs Corp.(Shenzhen)

Test Plot 44#:LTE Band 4 Right Cheek High Channel

DUT: 3G/4G Smart Phone ; Model:SKY 5.0LM

Communication System: LTE 4G Band; Frequency: 1745 MHz;Duty Cycle: 1:1
Medium parameters used: $f = 1745 \text{ MHz}$; $\sigma = 1.38 \text{ S/m}$; $\epsilon_r = 39.89$; $\rho = 1000 \text{ kg/m}^3$
Phantom section: Right Section

DASY4 Configuration:

- Probe: ES3DV3 - SN3036; ConvF(5.34, 5.34, 5.34); Calibrated: 16/9/2016
- Sensor-Surface: 4mm (Mechanical Surface Detection)
- Electronics: Dummy DAE - SN:456; Calibrated: 12/9/2016
- Phantom: TWIN SAM; Type: QD000P40CA; Serial: TP-1218
- Measurement SW: DASY4, V4.5 Build 19; Postprocessing SW: SEMCAD, V1.8 Build 145

LTE Band 4-right-cheek-high-50%RB /Area Scan (101x121x1): Measurement grid: $dx=10\text{mm}$, $dy=10\text{mm}$
Maximum value of SAR (interpolated) = 0.594 mW/g

LTE Band 4-right-cheek-high-50%RB /Zoom Scan (7x7x7)/Cube 0: Measurement grid: $dx=5\text{mm}$, $dy=5\text{mm}$, $dz=5\text{mm}$
Reference Value = 7.20 V/m; Power Drift = 0.098 dB
Peak SAR (extrapolated) = 0.589 W/kg
SAR(1 g) = 0.533 mW/g; SAR(10 g) = 0.370 mW/g
Maximum value of SAR (measured) = 0.542 mW/g

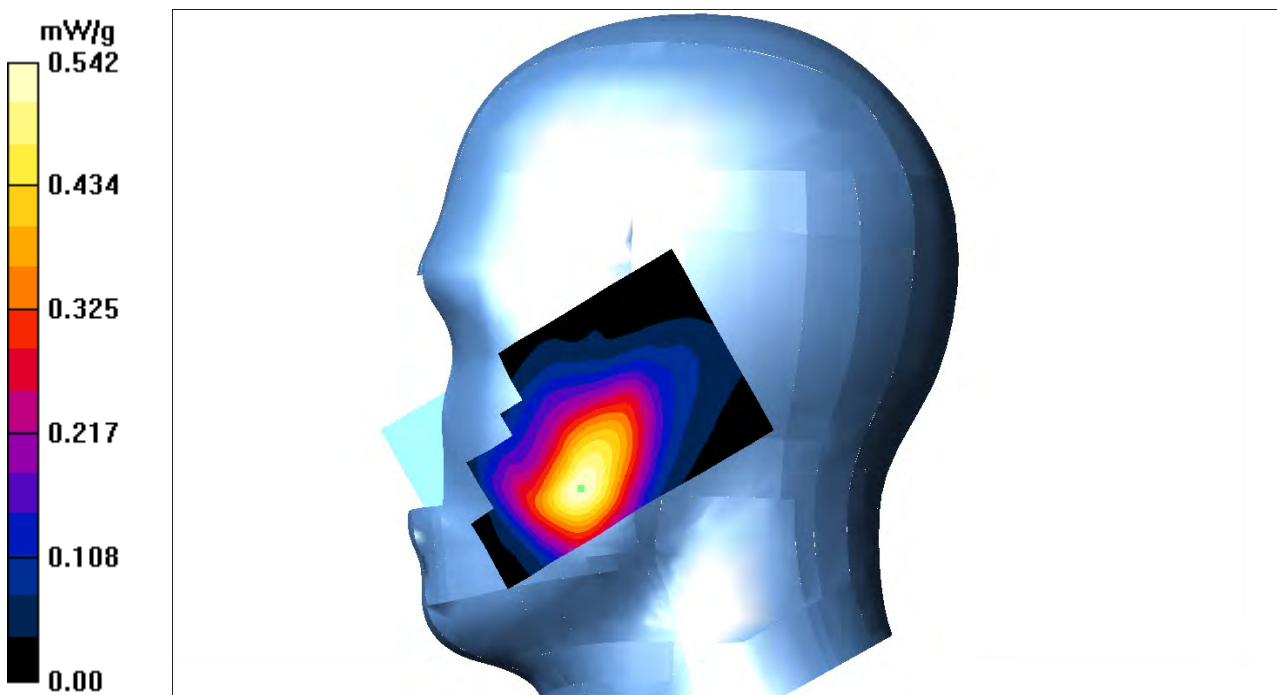

Test Laboratory: Bay Area Compliance Labs Corp.(Shenzhen)

Test Plot 45#:LTE Band 4 Right Tilt High Channel

DUT: 3G/4G Smart Phone ; Model:SKY 5.0LM

Communication System: LTE 4G Band; Frequency: 1745 MHz;Duty Cycle: 1:1
 Medium parameters used: $f = 1745 \text{ MHz}$; $\sigma = 1.38 \text{ S/m}$; $\epsilon_r = 39.89$; $\rho = 1000 \text{ kg/m}^3$
 Phantom section: Right Section

DASY4 Configuration:

- Probe: ES3DV3 - SN3036; ConvF(5.34, 5.34, 5.34); Calibrated: 16/9/2016
- Sensor-Surface: 4mm (Mechanical Surface Detection)
- Electronics: Dummy DAE - SN:456; Calibrated: 12/9/2016
- Phantom: TWIN SAM; Type: QD000P40CA; Serial: TP-1218
- Measurement SW: DASY4, V4.5 Build 19; Postprocessing SW: SEMCAD, V1.8 Build 145

LTE Band 4-right-tilt-high-1RB /Area Scan (101x121x1): Measurement grid: $dx=10\text{mm}$, $dy=10\text{mm}$
 Maximum value of SAR (interpolated) = 0.255 mW/g

LTE Band 4-right-tilt-high-1RB /Zoom Scan (7x7x7)/Cube 0: Measurement grid: $dx=5\text{mm}$, $dy=5\text{mm}$, $dz=5\text{mm}$

Reference Value = 4.35 V/m; Power Drift = 0.020 dB

Peak SAR (extrapolated) = 0.187 W/kg

SAR(1 g) = 0.220 mW/g; SAR(10 g) = 0.116 mW/g

Maximum value of SAR (measured) = 0.221 mW/g

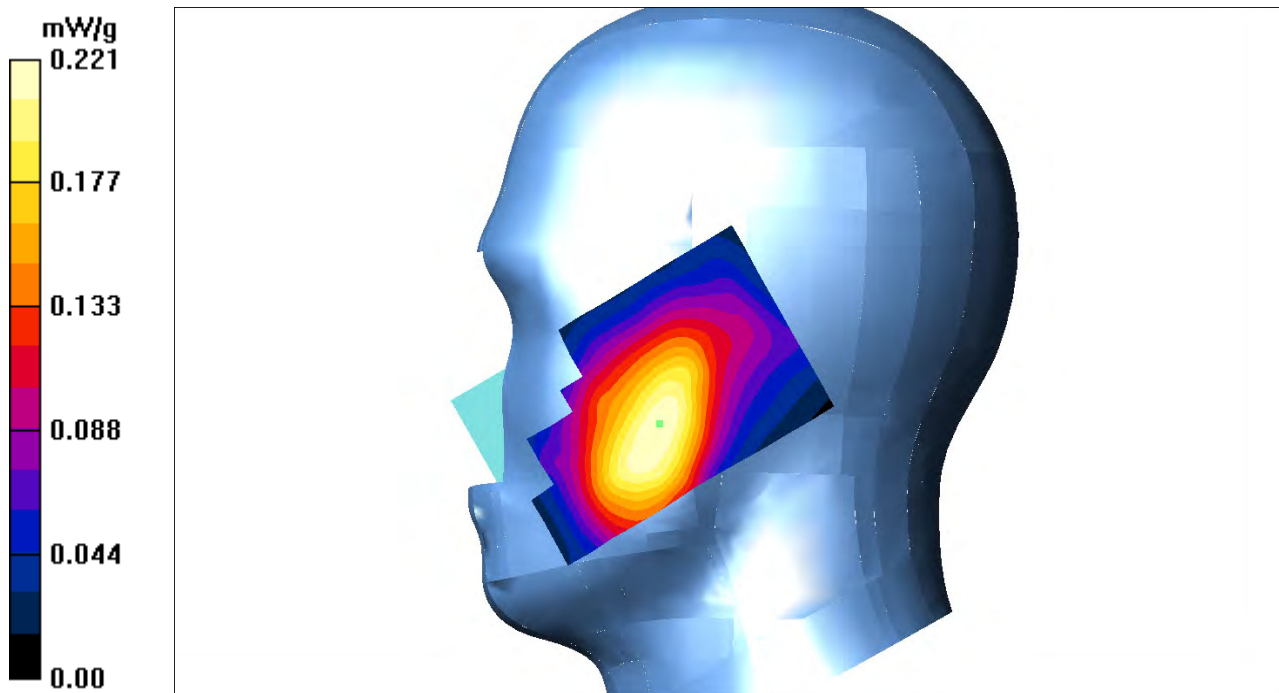

Test Laboratory: Bay Area Compliance Labs Corp.(Shenzhen)

Test Plot 46#:LTE Band 4 Right Tilt High Channel

DUT: 3G/4G Smart Phone ; Model:SKY 5.0LM

Communication System: LTE 4G Band; Frequency: 1745 MHz;Duty Cycle: 1:1
 Medium parameters used: $f = 1745 \text{ MHz}$; $\sigma = 1.38 \text{ S/m}$; $\epsilon_r = 39.89$; $\rho = 1000 \text{ kg/m}^3$
 Phantom section: Right Section

DASY4 Configuration:

- Probe: ES3DV3 - SN3036; ConvF(5.34, 5.34, 5.34); Calibrated: 16/9/2016
- Sensor-Surface: 4mm (Mechanical Surface Detection)
- Electronics: Dummy DAE - SN:456; Calibrated: 12/9/2016
- Phantom: TWIN SAM; Type: QD000P40CA; Serial: TP-1218
- Measurement SW: DASY4, V4.5 Build 19; Postprocessing SW: SEMCAD, V1.8 Build 145

LTE Band 4-right-tilt-high-50%RB /Area Scan (101x121x1): Measurement grid: $dx=10\text{mm}$, $dy=10\text{mm}$
 Maximum value of SAR (interpolated) = 0.235 mW/g

LTE Band 4-right-tilt-high-50%RB /Zoom Scan (7x7x7)/Cube 0: Measurement grid: $dx=5\text{mm}$, $dy=5\text{mm}$, $dz=5\text{mm}$

Reference Value = 3.45 V/m; Power Drift = 0.092 dB

Peak SAR (extrapolated) = 0.198 W/kg

SAR(1 g) = 0.202 mW/g; SAR(10 g) = 0.136 mW/g

Maximum value of SAR (measured) = 0.221 mW/g

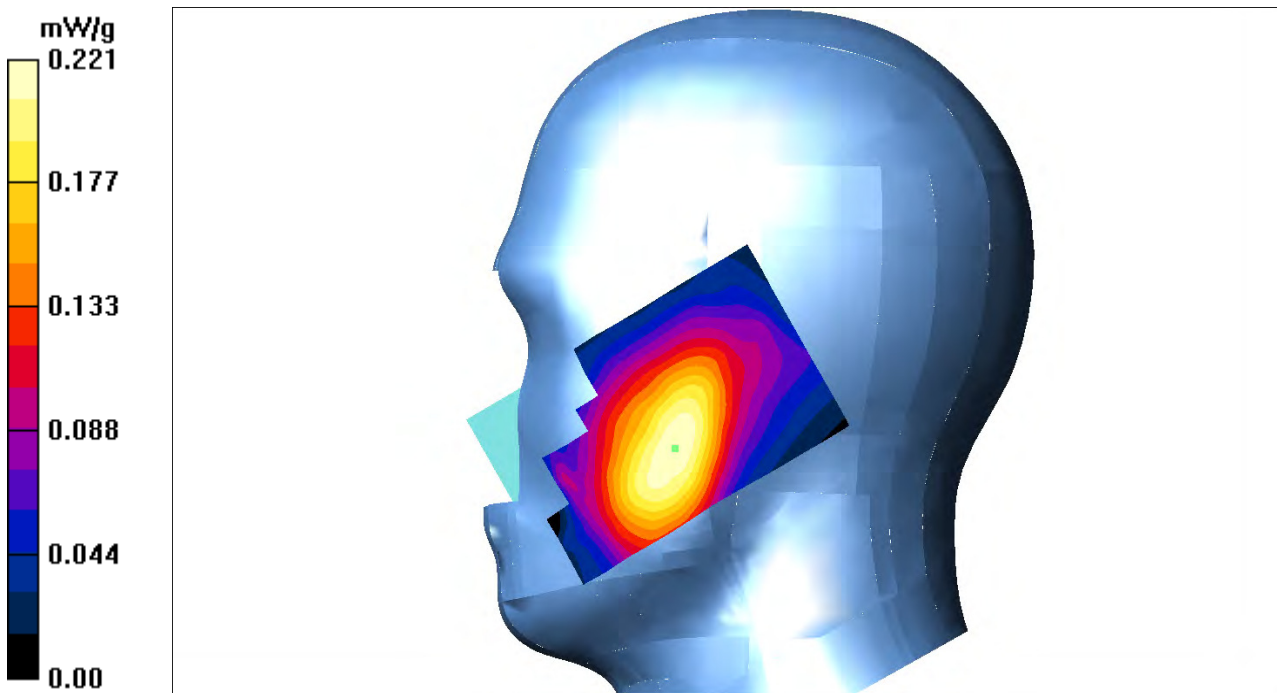

Test Laboratory: Bay Area Compliance Labs Corp.(Shenzhen)

Test Plot 47#: LTE Band 5 Left Cheek High Channel

DUT: 3G/4G Smart Phone; Model: SKY 5.0LM

Communication System: LTE 4G Band; Frequency: 844 MHz; Duty Cycle: 1:1
Medium parameters used: $f = 844 \text{ MHz}$; $\sigma = 0.91 \text{ S/m}$; $\epsilon_r = 40.39$; $\rho = 1000 \text{ kg/m}^3$
Phantom section: Left Section

DASY4 Configuration:

- Probe: ES3DV3 - SN3036; ConvF(6.26, 6.26, 6.26); Calibrated: 16/9/2016
- Sensor-Surface: 4mm (Mechanical Surface Detection)
- Electronics: Dummy DAE - SN:456; Calibrated: 12/9/2016
- Phantom: TWIN SAM; Type: QD000P40CA; Serial: TP-1218
- Measurement SW: DASY4, V4.5 Build 19; Postprocessing SW: SEMCAD, V1.8 Build 145

LTE Band 5-left-cheek-high-1RB /Area Scan (101x121x1): Measurement grid: $dx=10\text{mm}$, $dy=10\text{mm}$
Maximum value of SAR (interpolated) = 0.293 mW/g

LTE Band 5-left-cheek-high-1RB /Zoom Scan (7x7x7)/Cube 0: Measurement grid: $dx=5\text{mm}$, $dy=5\text{mm}$, $dz=5\text{mm}$
Reference Value = 4.86V/m; Power Drift = 0.027 dB
Peak SAR (extrapolated) = 0.214 W/kg
SAR(1 g) = 0.201 mW/g; SAR(10 g) = 0.108 mW/g
Maximum value of SAR (measured) = 0.203 mW/g

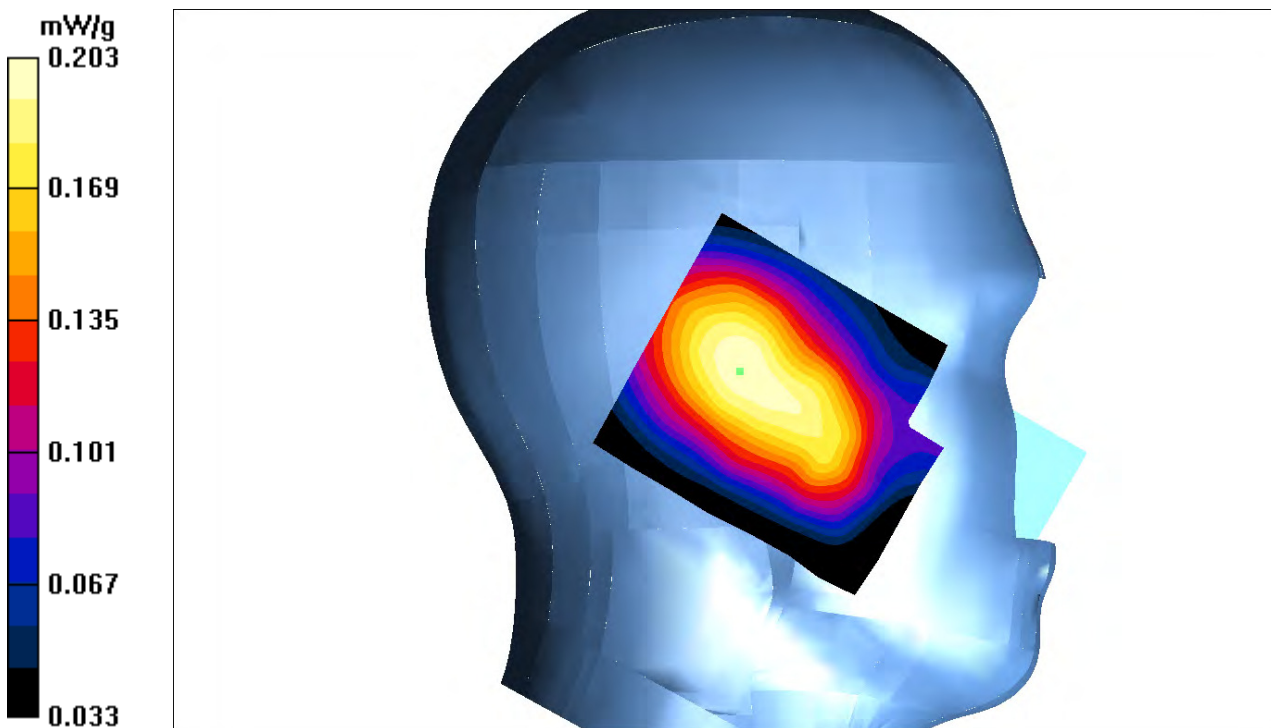

Test Laboratory: Bay Area Compliance Labs Corp.(Shenzhen)

Test Plot 48#: LTE Band 5 Left Cheek High Channel

DUT: 3G/4G Smart Phone ; Model:SKY 5.0LM

Communication System: LTE 4G Band; Frequency: 844 MHz; Duty Cycle: 1:1
 Medium parameters used: $f = 844 \text{ MHz}$; $\sigma = 0.91 \text{ S/m}$; $\epsilon_r = 40.39$; $\rho = 1000 \text{ kg/m}^3$
 Phantom section: Left Section

DASY4 Configuration:

- Probe: ES3DV3 - SN3036; ConvF(6.26, 6.26, 6.26); Calibrated: 16/9/2016
- Sensor-Surface: 4mm (Mechanical Surface Detection)
- Electronics: Dummy DAE - SN:456; Calibrated: 12/9/2016
- Phantom: TWIN SAM; Type: QD000P40CA; Serial: TP-1218
- Measurement SW: DASY4, V4.5 Build 19; Postprocessing SW: SEMCAD, V1.8 Build 145

LTE Band 5-left-cheek-high-50%RB /Area Scan (101x121x1): Measurement grid: $dx=10\text{mm}$, $dy=10\text{mm}$
 Maximum value of SAR (interpolated) = 0.133 mW/g

LTE Band 5-left-cheek-high-50%RB /Zoom Scan (7x7x7)/Cube 0: Measurement grid: $dx=5\text{mm}$, $dy=5\text{mm}$, $dz=5\text{mm}$

Reference Value = 4.26V/m; Power Drift = 0.048 dB

Peak SAR (extrapolated) = 0.184 W/kg

SAR(1 g) = 0.151 mW/g; SAR(10 g) = 0.136 mW/g

Maximum value of SAR (measured) = 0.162 mW/g

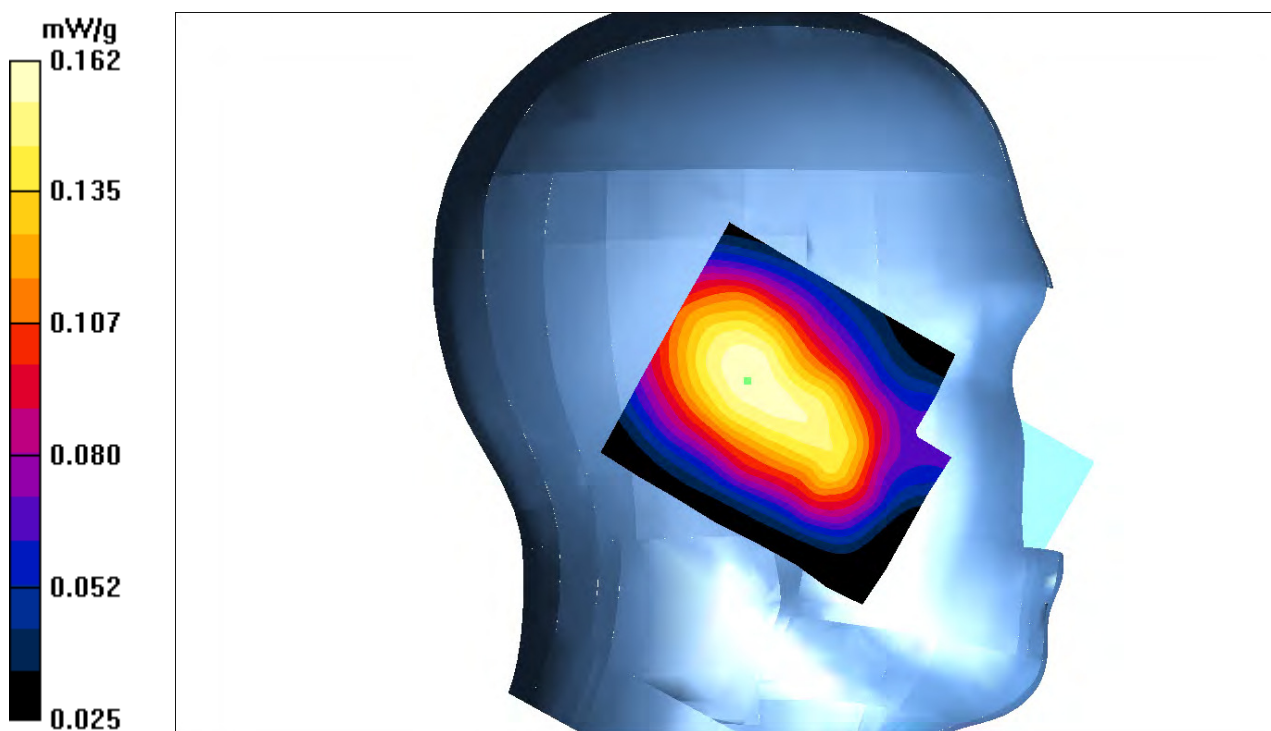

Test Laboratory: Bay Area Compliance Labs Corp.(Shenzhen)

Test Plot 49#: LTE Band 5 Left Tilt High Channel

DUT: 3G/4G Smart Phone; Model: SKY 5.0LM

Communication System: LTE 4G Band; Frequency: 844 MHz; Duty Cycle: 1:1
Medium parameters used: $f = 844 \text{ MHz}$; $\sigma = 0.91 \text{ S/m}$; $\epsilon_r = 40.39$; $\rho = 1000 \text{ kg/m}^3$
Phantom section: Left Section

DASY4 Configuration:

- Probe: ES3DV3 - SN3036; ConvF(6.26, 6.26, 6.26); Calibrated: 16/9/2016
- Sensor-Surface: 4mm (Mechanical Surface Detection)
- Electronics: Dummy DAE - SN:456; Calibrated: 12/9/2016
- Phantom: TWIN SAM; Type: QD000P40CA; Serial: TP-1218
- Measurement SW: DASY4, V4.5 Build 19; Postprocessing SW: SEMCAD, V1.8 Build 145

LTE Band 5-left-tilt-high-1RB /Area Scan (101x121x1): Measurement grid: $dx=10\text{mm}$, $dy=10\text{mm}$
Maximum value of SAR (interpolated) = 0.185 mW/g

LTE Band 5-left-tilt-high-1RB /Zoom Scan (7x7x7)/Cube 0: Measurement grid: $dx=5\text{mm}$, $dy=5\text{mm}$, $dz=5\text{mm}$
Reference Value = 2.98 V/m; Power Drift = 0.179 dB
Peak SAR (extrapolated) = 0.169 W/kg
SAR(1 g) = 0.152 mW/g; SAR(10 g) = 0.083 mW/g
Maximum value of SAR (measured) = 0.168 mW/g

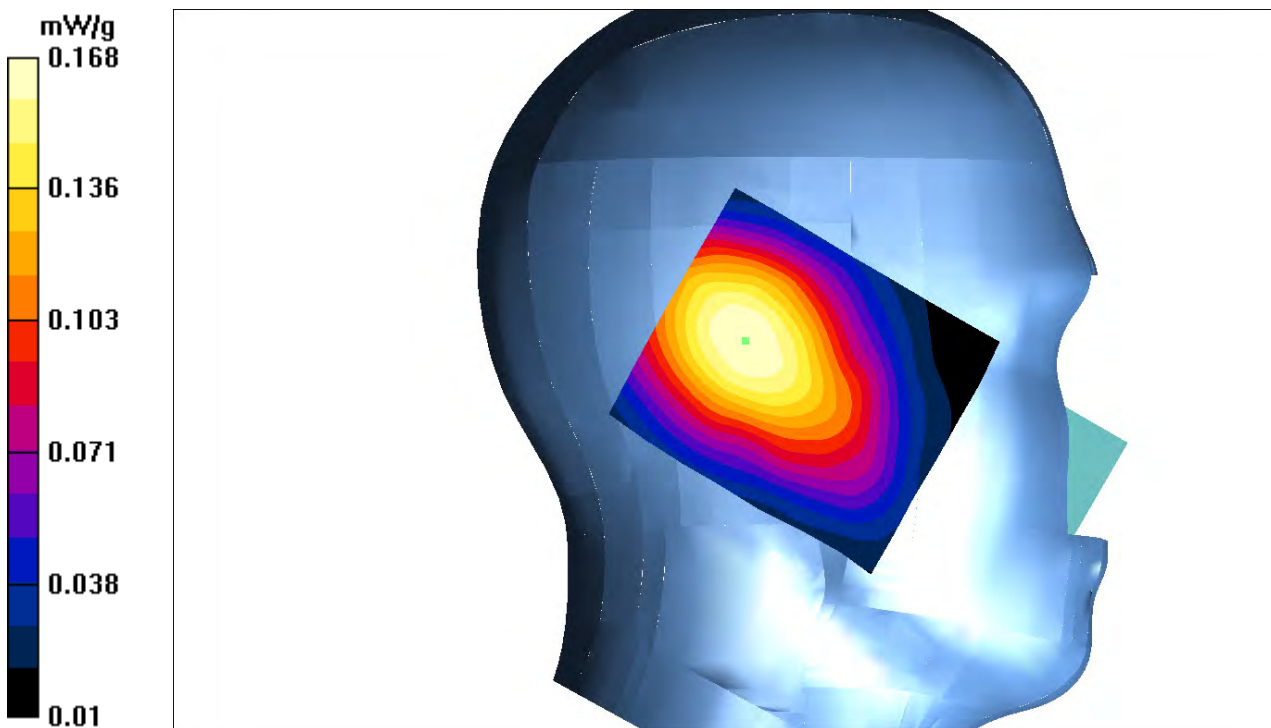

Test Laboratory: Bay Area Compliance Labs Corp.(Shenzhen)

Test Plot 50#: LTE Band 5 Left Tilt High Channel

DUT: 3G/4G Smart Phone ; Model:SKY 5.0LM

Communication System: LTE 4G Band; Frequency: 844 MHz;Duty Cycle: 1:1
 Medium parameters used: $f = 844 \text{ MHz}$; $\sigma = 0.91 \text{ S/m}$; $\epsilon_r = 40.39$; $\rho = 1000 \text{ kg/m}^3$
 Phantom section: Left Section

DASY4 Configuration:

- Probe: ES3DV3 - SN3036; ConvF(6.26, 6.26, 6.26); Calibrated: 16/9/2016
- Sensor-Surface: 4mm (Mechanical Surface Detection)
- Electronics: Dummy DAE - SN:456; Calibrated: 12/9/2016
- Phantom: TWIN SAM; Type: QD000P40CA; Serial: TP-1218
- Measurement SW: DASY4, V4.5 Build 19; Postprocessing SW: SEMCAD, V1.8 Build 145

LTE Band 5-left-tilt-high-50%RB /Area Scan (101x121x1): Measurement grid: $dx=10\text{mm}$, $dy=10\text{mm}$
 Maximum value of SAR (interpolated) = 0.236 mW/g

LTE Band 5-left-tilt-high-50%RB /Zoom Scan (7x7x7)/Cube 0: Measurement grid: $dx=5\text{mm}$, $dy=5\text{mm}$, $dz=5\text{mm}$

Reference Value = 5.28 V/m; Power Drift = 0.103 dB

Peak SAR (extrapolated) = 0.187 W/kg

SAR(1 g) = 0.192 mW/g; SAR(10 g) = 0.099 mW/g

Maximum value of SAR (measured) = 0.217 mW/g

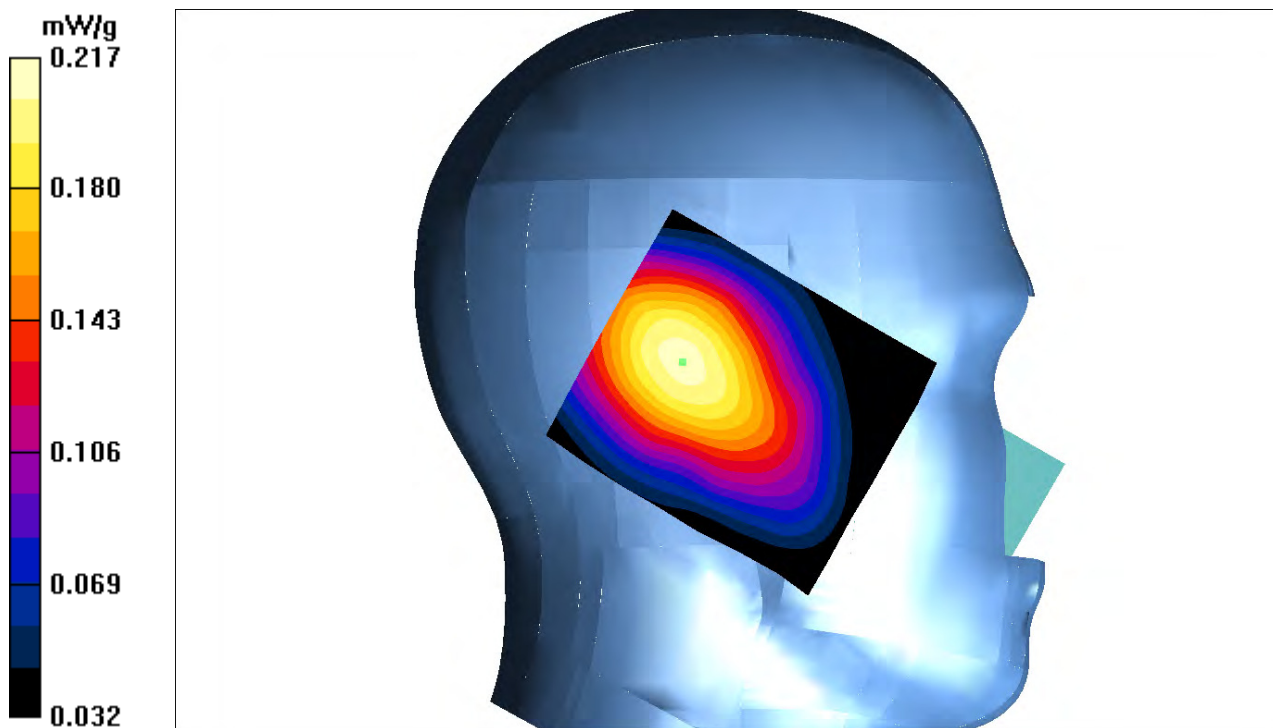

Test Laboratory: Bay Area Compliance Labs Corp.(Shenzhen)

Test Plot 51#: LTE Band 5 Right Cheek High Channel

DUT: 3G/4G Smart Phone ; Model:SKY 5.0LM

Communication System: LTE 4G Band; Frequency: 844 MHz;Duty Cycle: 1:1
 Medium parameters used: $f = 844 \text{ MHz}$; $\sigma = 0.91 \text{ S/m}$; $\epsilon_r = 40.39$; $\rho = 1000 \text{ kg/m}^3$
 Phantom section: Left Section

DASY4 Configuration:

- Probe: ES3DV3 - SN3036; ConvF(6.26, 6.26, 6.26); Calibrated: 16/9/2016
- Sensor-Surface: 4mm (Mechanical Surface Detection)
- Electronics: Dummy DAE - SN:456; Calibrated: 12/9/2016
- Phantom: TWIN SAM; Type: QD000P40CA; Serial: TP-1218
- Measurement SW: DASY4, V4.5 Build 19; Postprocessing SW: SEMCAD, V1.8 Build 145

LTE Band 5-right-cheek-high-1RB /Area Scan (101x121x1): Measurement grid: $dx=10\text{mm}$, $dy=10\text{mm}$
 Maximum value of SAR (interpolated) = 0.258 mW/g

LTE Band 5-right-cheek-high-1RB /Zoom Scan (7x7x7)/Cube 0: Measurement grid: $dx=5\text{mm}$, $dy=5\text{mm}$, $dz=5\text{mm}$

Reference Value = 3.72 V/m; Power Drift = 0.032 dB

Peak SAR (extrapolated) = 0.238 W/kg

SAR(1 g) = 0.216 mW/g; SAR(10 g) = 0.135 mW/g

Maximum value of SAR (measured) = 0.256 mW/g

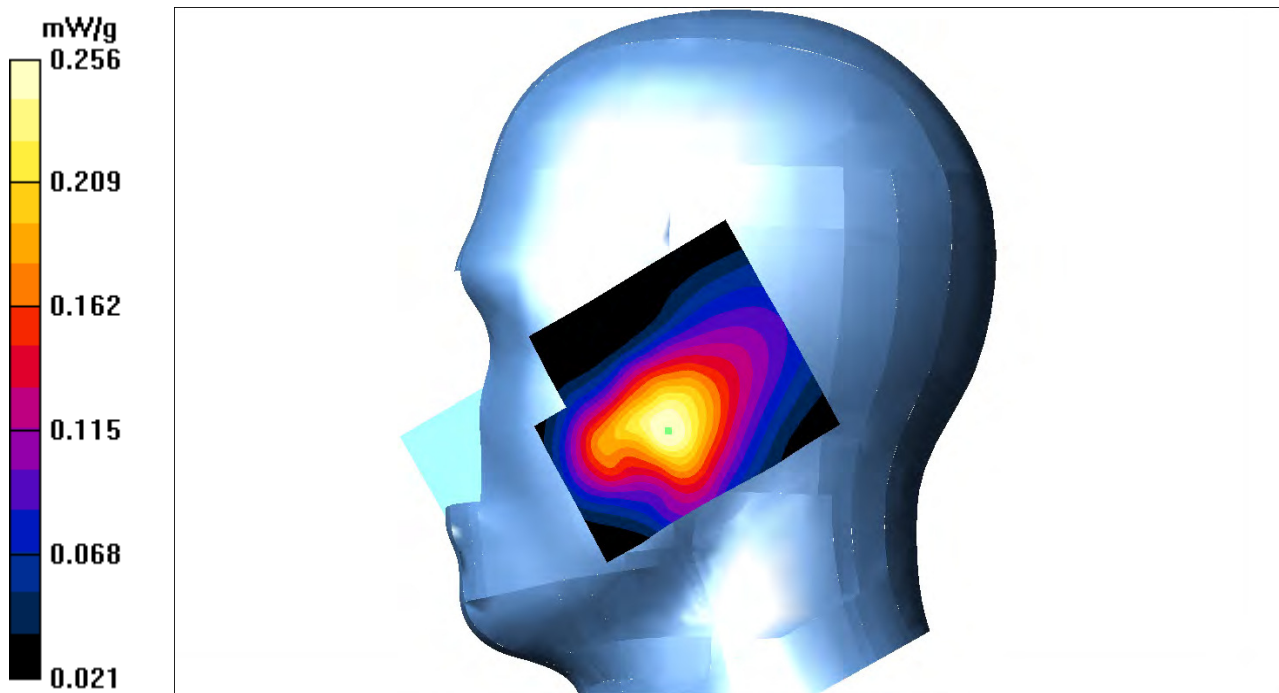

Test Laboratory: Bay Area Compliance Labs Corp.(Shenzhen)

Test Plot 52#: LTE Band 5 Right Cheek High Channel

DUT: 3G/4G Smart Phone ; Model:SKY 5.0LM

Communication System: LTE 4G Band; Frequency: 844 MHz;Duty Cycle: 1:1
Medium parameters used: $f = 844 \text{ MHz}$; $\sigma = 0.91 \text{ S/m}$; $\epsilon_r = 40.39$; $\rho = 1000 \text{ kg/m}^3$
Phantom section: Left Section

DASY4 Configuration:

- Probe: ES3DV3 - SN3036; ConvF(6.26, 6.26, 6.26); Calibrated: 16/9/2016
- Sensor-Surface: 4mm (Mechanical Surface Detection)
- Electronics: Dummy DAE - SN:456; Calibrated: 12/9/2016
- Phantom: TWIN SAM; Type: QD000P40CA; Serial: TP-1218
- Measurement SW: DASY4, V4.5 Build 19; Postprocessing SW: SEMCAD, V1.8 Build 145

LTE Band 5-right-cheek-high-50%RB /Area Scan (101x121x1): Measurement grid: $dx=10\text{mm}$, $dy=10\text{mm}$
Maximum value of SAR (interpolated) = 0.228 mW/g

LTE Band 5-right-cheek-high-50%RB /Zoom Scan (7x7x7)/Cube 0: Measurement grid: $dx=5\text{mm}$, $dy=5\text{mm}$, $dz=5\text{mm}$
Reference Value = 3.13 V/m; Power Drift = 0.038 dB
Peak SAR (extrapolated) = 0.208 W/kg
SAR(1 g) = 0.198 mW/g; SAR(10 g) = 0.095 mW/g
Maximum value of SAR (measured) = 0.214 mW/g

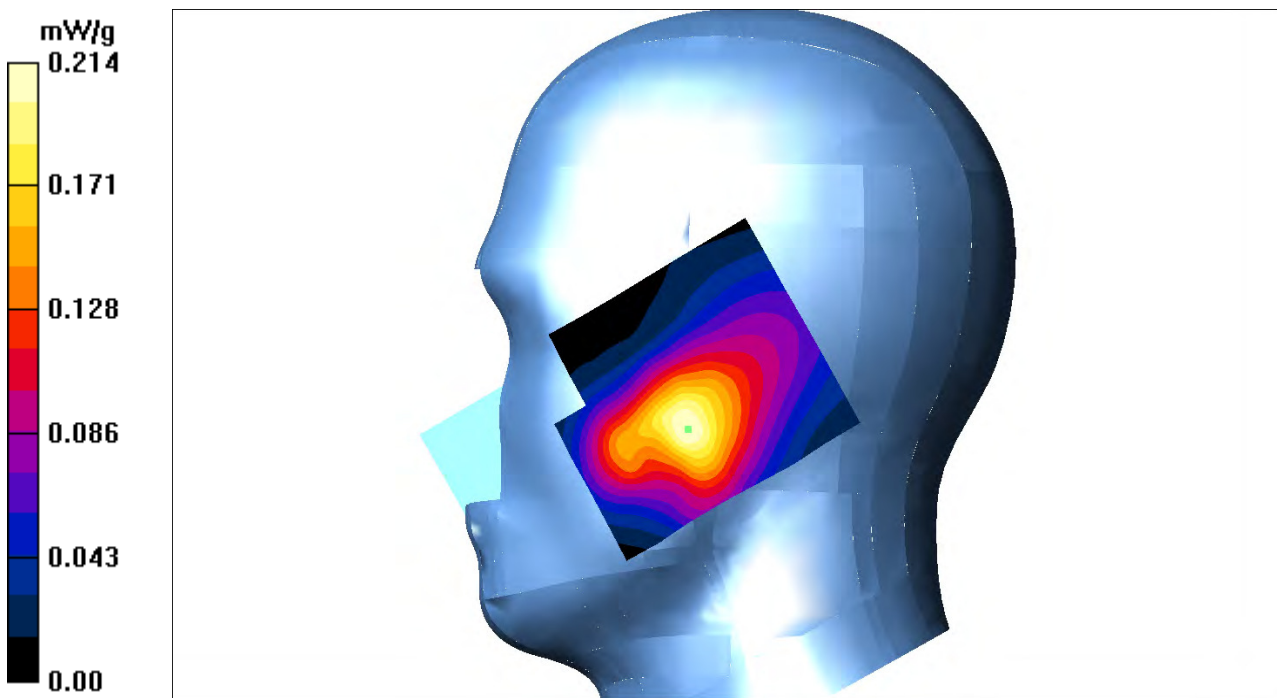

Test Laboratory: Bay Area Compliance Labs Corp.(Shenzhen)

Test Plot 53#: LTE Band 5 Right Tilt High Channel

DUT: 3G/4G Smart Phone ; Model:SKY 5.0LM

Communication System: LTE 4G Band; Frequency: 844 MHz;Duty Cycle: 1:1
Medium parameters used: $f = 844$ MHz; $\sigma = 0.91$ S/m; $\epsilon_r = 40.39$; $\rho = 1000$ kg/m³
Phantom section: Left Section

DASY4 Configuration:

- Probe: ES3DV3 - SN3036; ConvF(6.26, 6.26, 6.26); Calibrated: 16/9/2016
- Sensor-Surface: 4mm (Mechanical Surface Detection)
- Electronics: Dummy DAE - SN:456; Calibrated: 12/9/2016
- Phantom: TWIN SAM; Type: QD000P40CA; Serial: TP-1218
- Measurement SW: DASY4, V4.5 Build 19; Postprocessing SW: SEMCAD, V1.8 Build 145

LTE Band 5-right-tilt-high-1RB /Area Scan (101x121x1): Measurement grid: dx=10mm, dy=10mm
Maximum value of SAR (interpolated) = 0.132 mW/g

LTE Band 5-right-tilt-high-1RB /Zoom Scan (7x7x7)/Cube 0: Measurement grid: dx=5mm, dy=5mm, dz=5mm

Reference Value = 2.69 V/m; Power Drift = 0.145 dB

Peak SAR (extrapolated) = 0.139 W/kg

SAR(1 g) = 0.102 mW/g; SAR(10 g) = 0.068 mW/g

Maximum value of SAR (measured) = 0.120 mW/g

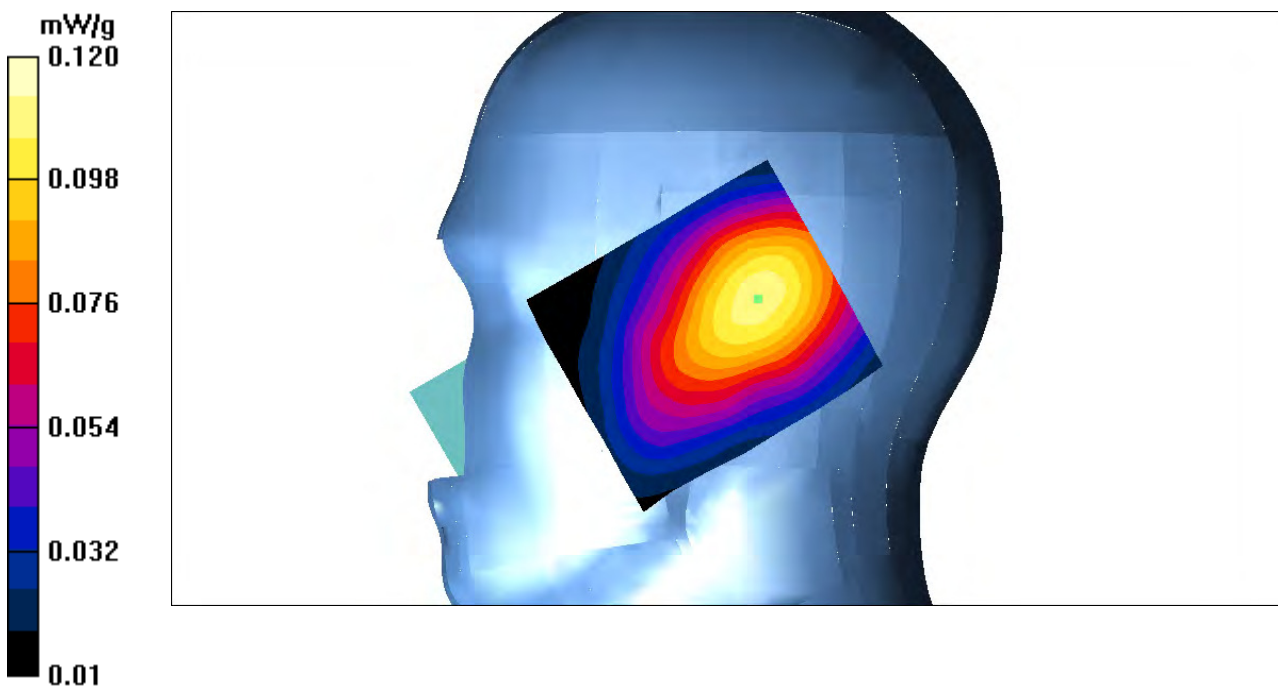

Test Laboratory: Bay Area Compliance Labs Corp.(Shenzhen)

Test Plot 54#: LTE Band 5 Right Tilt High Channel

DUT: 3G/4G Smart Phone; Model:SKY 5.0LM

Communication System: LTE 4G Band; Frequency: 844 MHz;Duty Cycle: 1:1
 Medium parameters used: $f = 844 \text{ MHz}$; $\sigma = 0.91 \text{ S/m}$; $\epsilon_r = 40.39$; $\rho = 1000 \text{ kg/m}^3$
 Phantom section: Left Section

DASY4 Configuration:

- Probe: ES3DV3 - SN3036; ConvF(6.26, 6.26, 6.26); Calibrated: 16/9/2016
- Sensor-Surface: 4mm (Mechanical Surface Detection)
- Electronics: Dummy DAE - SN:456; Calibrated: 12/9/2016
- Phantom: TWIN SAM; Type: QD000P40CA; Serial: TP-1218
- Measurement SW: DASY4, V4.5 Build 19; Postprocessing SW: SEMCAD, V1.8 Build 145

LTE Band 5-right-tilt-high-50%RB /Area Scan (101x121x1): Measurement grid: $dx=10\text{mm}$, $dy=10\text{mm}$
 Maximum value of SAR (interpolated) = 0.107 mW/g

LTE Band 5-right-tilt-high-50%RB /Zoom Scan (7x7x7)/Cube 0: Measurement grid: $dx=5\text{mm}$, $dy=5\text{mm}$, $dz=5\text{mm}$

Reference Value = 2.69 V/m; Power Drift = 0.102 dB

Peak SAR (extrapolated) = 0.118 W/kg

SAR(1 g) = 0.092 mW/g; SAR(10 g) = 0.058 mW/g

Maximum value of SAR (measured) = 0.096 mW/g

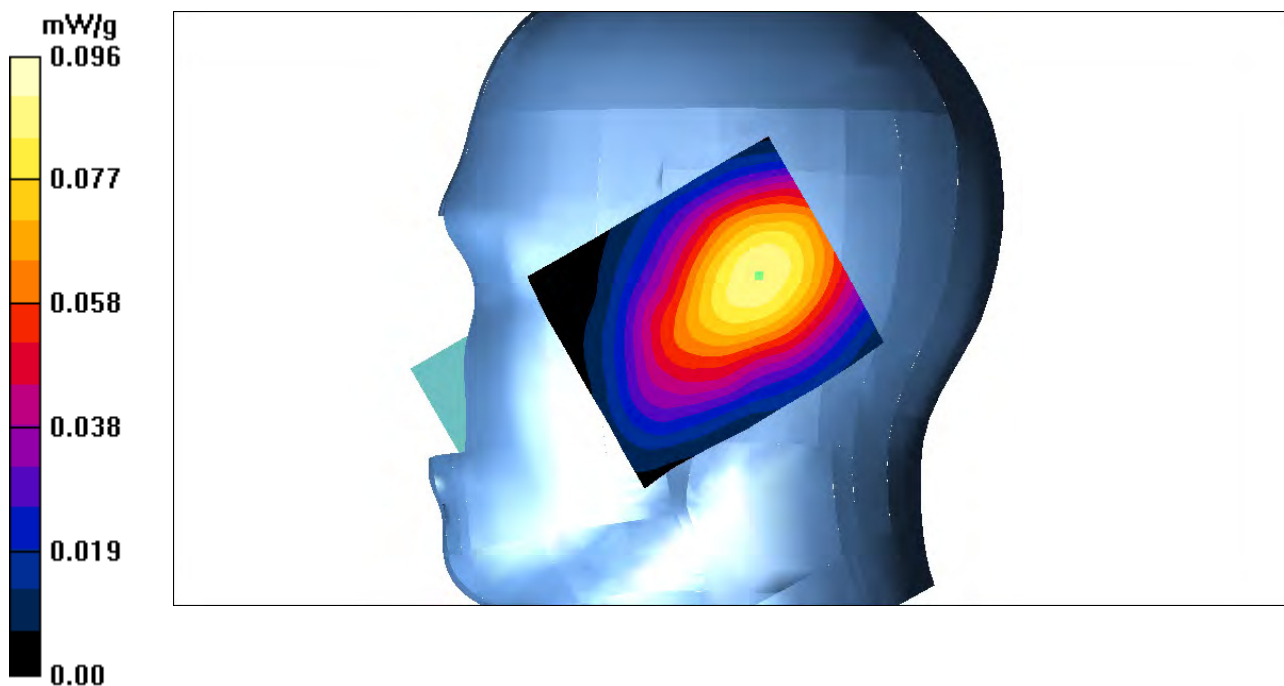

Test Laboratory: Bay Area Compliance Labs Corp.(Shenzhen)

Test Plot 55#: LTE Band 7 Left Cheek High Channel

DUT: 3G/4G Smart Phone ; Model: SKY 5.0LM

Communication System: LTE 4G Band; Frequency: 2560 MHz;Duty Cycle: 1:1
Medium parameters used: $f = 2560$ MHz; $\sigma = 1.89$ S/m; $\epsilon_r = 39.89$; $\rho = 1000$ kg/m³
Phantom section: Left Section

DASY4 Configuration:

- Probe: EX3DV4 - SN7431; ConvF(7.44, 7.44, 7.44); Calibrated: 04/10/2016
- Sensor-Surface: 4mm (Mechanical Surface Detection)
- Electronics: Dummy DAE - SN:456; Calibrated: 12/9/2016
- Phantom: TWIN SAM; Type: QD000P40CA; Serial: TP-1218
- Measurement SW: DASY4, V4.5 Build 19; Postprocessing SW: SEMCAD, V1.8 Build 145

LTE Band 7-left-cheek-high-1RB /Area Scan (101x121x1): Measurement grid: dx=10mm, dy=10mm
Maximum value of SAR (interpolated) = 0.633 mW/g

LTE Band 7-left-cheek-high-1RB /Zoom Scan (7x7x7)/Cube 0: Measurement grid: dx=5mm, dy=5mm, dz=5mm

Reference Value = 6.27V/m; Power Drift = 0.091 dB

Peak SAR (extrapolated) = 0.583 W/kg

SAR(1 g) = 0.561 mW/g; SAR(10 g) = 0.316 mW/g

Maximum value of SAR (measured) = 0.574 mW/g

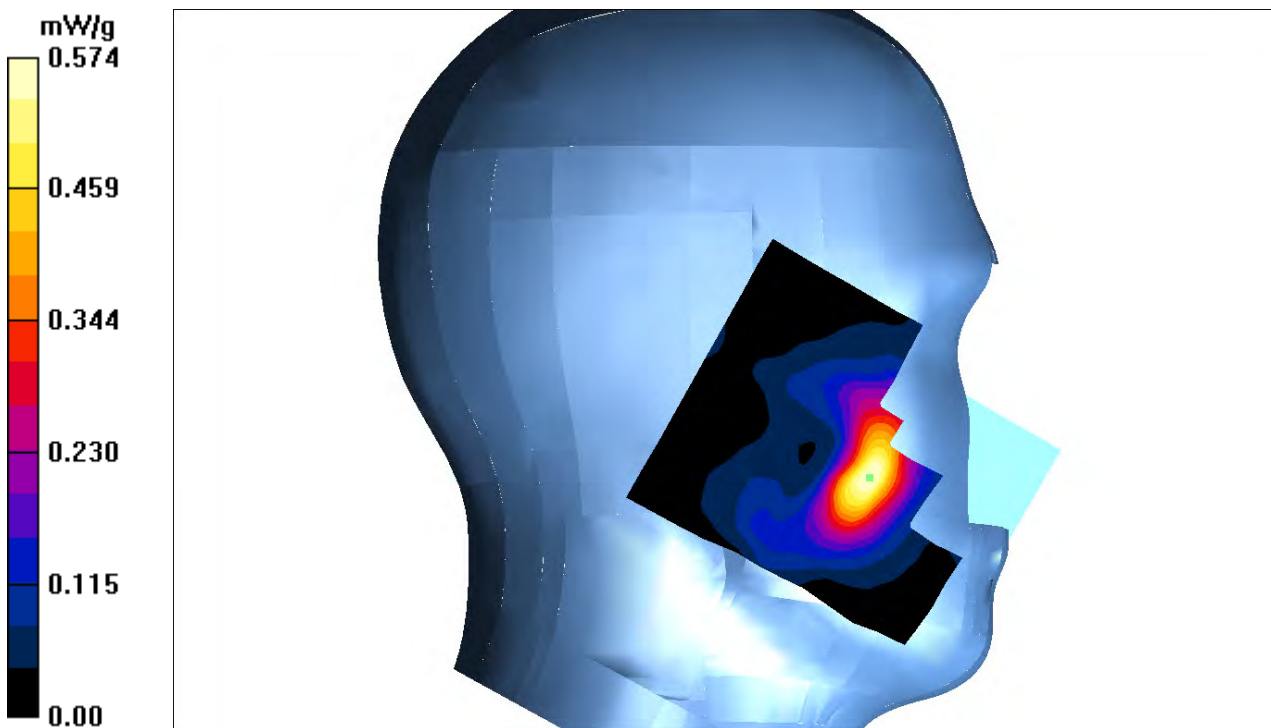

Test Laboratory: Bay Area Compliance Labs Corp.(Shenzhen)

Test Plot 56#: LTE Band 7 Left Cheek High Channel

DUT: 3G/4G Smart Phone ; Model: SKY 5.0LM

Communication System: LTE 4G Band; Frequency: 2560 MHz;Duty Cycle: 1:1
 Medium parameters used: $f = 2560$ MHz; $\sigma = 1.89$ S/m; $\epsilon_r = 39.89$; $\rho = 1000$ kg/m³
 Phantom section: Left Section

DASY4 Configuration:

- Probe: EX3DV4 - SN7431; ConvF(7.44, 7.44, 7.44); Calibrated: 04/10/2016
- Sensor-Surface: 4mm (Mechanical Surface Detection)
- Electronics: Dummy DAE - SN:456; Calibrated: 12/9/2016
- Phantom: TWIN SAM; Type: QD000P40CA; Serial: TP-1218
- Measurement SW: DASY4, V4.5 Build 19; Postprocessing SW: SEMCAD, V1.8 Build 145

LTE Band 7-left-cheek-high-50%RB /Area Scan (101x121x1): Measurement grid: dx=10mm, dy=10mm
 Maximum value of SAR (interpolated) = 0.433 mW/g

LTE Band 7-left-cheek-high-50%RB /Zoom Scan (7x7x7)/Cube 0: Measurement grid: dx=5mm, dy=5mm, dz=5mm

Reference Value = 3.97V/m; Power Drift = 0.081 dB

Peak SAR (extrapolated) = 0.454 W/kg

SAR(1 g) = 0.413 mW/g; SAR(10 g) = 0.286 mW/g

Maximum value of SAR (measured) = 0.422 mW/g

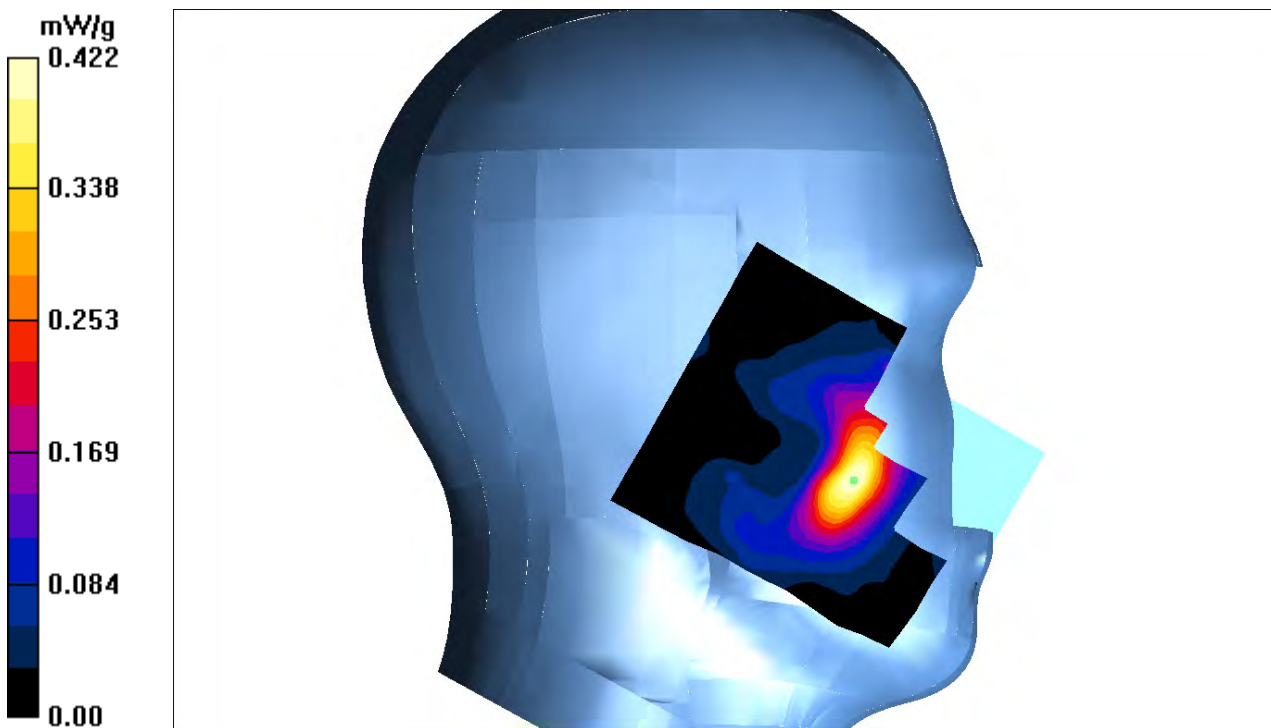

Test Laboratory: Bay Area Compliance Labs Corp.(Shenzhen)

Test Plot 57#: LTE Band 7 Left Tilt High Channel

DUT: 3G/4G Smart Phone ; Model: SKY 5.0LM

Communication System: LTE 4G Band; Frequency: 2560 MHz;Duty Cycle: 1:1
 Medium parameters used: $f = 2560$ MHz; $\sigma = 1.89$ S/m; $\epsilon_r = 39.89$; $\rho = 1000$ kg/m³
 Phantom section: Left Section

DASY4 Configuration:

- Probe: EX3DV4 - SN7431; ConvF(7.44, 7.44, 7.44); Calibrated: 04/10/2016
- Sensor-Surface: 4mm (Mechanical Surface Detection)
- Electronics: Dummy DAE - SN:456; Calibrated: 12/9/2016
- Phantom: TWIN SAM; Type: QD000P40CA; Serial: TP-1218
- Measurement SW: DASY4, V4.5 Build 19; Postprocessing SW: SEMCAD, V1.8 Build 145

LTE Band 7-left-tilt-high-1RB /Area Scan (101x121x1): Measurement grid: dx=10mm, dy=10mm
 Maximum value of SAR (interpolated) = 0.356 mW/g

LTE Band 7-left-tilt-high-1RB /Zoom Scan (7x7x7)/Cube 0: Measurement grid: dx=5mm, dy=5mm, dz=5mm
 Reference Value = 5.92 V/m; Power Drift = 0.113 dB
 Peak SAR (extrapolated) = 0.308 W/kg
SAR(1 g) = 0.287 mW/g; SAR(10 g) = 0.150 mW/g
 Maximum value of SAR (measured) = 0.316 mW/g

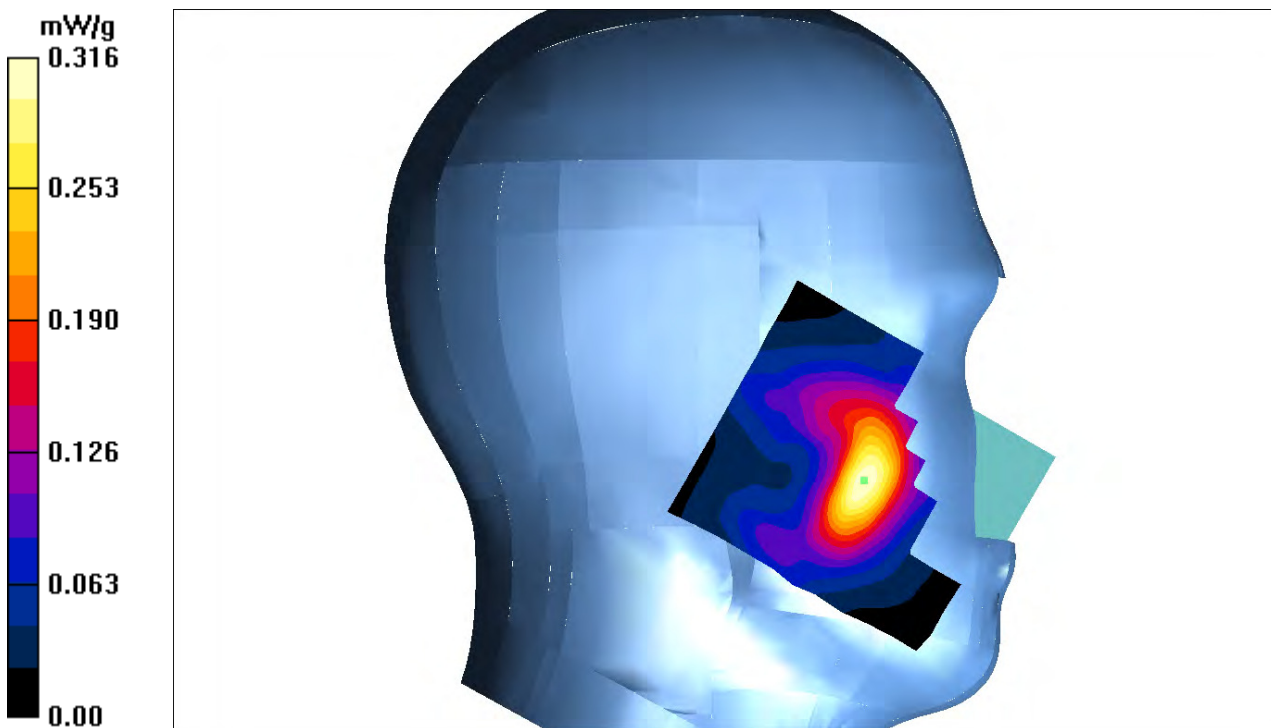

Test Laboratory: Bay Area Compliance Labs Corp.(Shenzhen)

Test Plot 58#: LTE Band 7 Left Tilt High Channel

DUT: 3G/4G Smart Phone ; Model: SKY 5.0LM

Communication System: LTE 4G Band; Frequency: 2560 MHz;Duty Cycle: 1:1
Medium parameters used: $f = 2560$ MHz; $\sigma = 1.89$ S/m; $\epsilon_r = 39.89$; $\rho = 1000$ kg/m³
Phantom section: Left Section

DASY4 Configuration:

- Probe: EX3DV4 - SN7431; ConvF(7.44, 7.44, 7.44); Calibrated: 04/10/2016
- Sensor-Surface: 4mm (Mechanical Surface Detection)
- Electronics: Dummy DAE - SN:456; Calibrated: 12/9/2016
- Phantom: TWIN SAM; Type: QD000P40CA; Serial: TP-1218
- Measurement SW: DASY4, V4.5 Build 19; Postprocessing SW: SEMCAD, V1.8 Build 145

LTE Band 7-left-tilt-high-50%RB /Area Scan (101x121x1): Measurement grid: dx=10mm, dy=10mm
Maximum value of SAR (interpolated) = 0.266 mW/g

LTE Band 7-left-tilt-high-50%RB /Zoom Scan (7x7x7)/Cube 0: Measurement grid: dx=5mm, dy=5mm, dz=5mm

Reference Value = 5.27 V/m; Power Drift = 0.109 dB

Peak SAR (extrapolated) = 0.239 W/kg

SAR(1 g) = 0.207 mW/g; SAR(10 g) = 0.130 mW/g

Maximum value of SAR (measured) = 0.234 mW/g

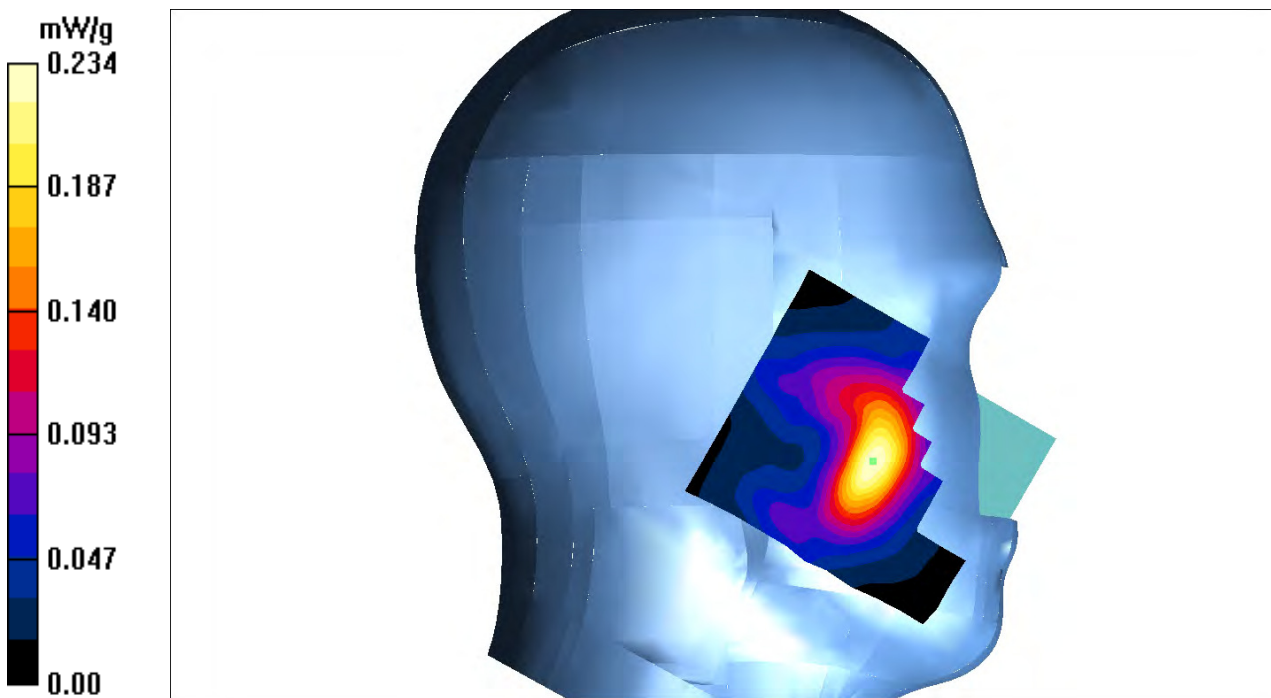

Test Laboratory: Bay Area Compliance Labs Corp.(Shenzhen)

Test Plot 59#: LTE Band 7 Right Cheek High Channel

DUT: 3G/4G Smart Phone ; Model: SKY 5.0LM

Communication System: LTE 4G Band; Frequency: 2560 MHz;Duty Cycle: 1:1
 Medium parameters used: $f = 2560$ MHz; $\sigma = 1.89$ S/m; $\epsilon_r = 39.89$; $\rho = 1000$ kg/m³
 Phantom section: Right Section

DASY4 Configuration:

- Probe: EX3DV4 - SN7431; ConvF(7.44, 7.44, 7.44); Calibrated: 04/10/2016
- Sensor-Surface: 4mm (Mechanical Surface Detection)
- Electronics: Dummy DAE - SN:456; Calibrated: 12/9/2016
- Phantom: TWIN SAM; Type: QD000P40CA; Serial: TP-1218
- Measurement SW: DASY4, V4.5 Build 19; Postprocessing SW: SEMCAD, V1.8 Build 145

LTE Band 7-right-cheek-high-1RB /Area Scan (101x121x1): Measurement grid: dx=10mm, dy=10mm
 Maximum value of SAR (interpolated) = 0.588 mW/g

LTE Band 7-right-cheek-high-1RB /Zoom Scan (7x7x7)/Cube 0: Measurement grid: dx=5mm, dy=5mm, dz=5mm

Reference Value = 7.27 V/m; Power Drift = 0.068 dB

Peak SAR (extrapolated) = 0.558 W/kg

SAR(1 g) = 0.521 mW/g; SAR(10 g) = 0.365 mW/g

Maximum value of SAR (measured) = 0.538 mW/g

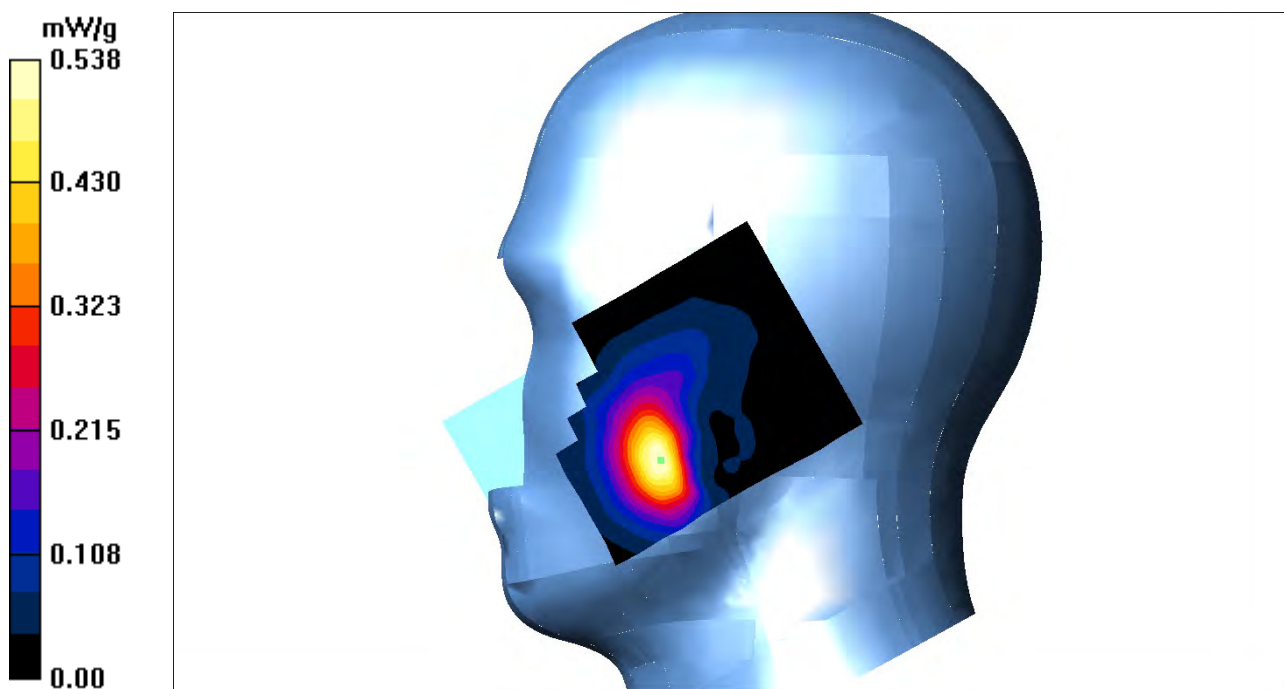

Test Laboratory: Bay Area Compliance Labs Corp.(Shenzhen)

Test Plot 60#: LTE Band 7 Right Cheek High Channel

DUT: 3G/4G Smart Phone ; Model: SKY 5.0LM

Communication System: LTE 4G Band; Frequency: 2560 MHz;Duty Cycle: 1:1
Medium parameters used: $f = 2560$ MHz; $\sigma = 1.89$ S/m; $\epsilon_r = 39.89$; $\rho = 1000$ kg/m³
Phantom section: Right Section

DASY4 Configuration:

- Probe: EX3DV4 - SN7431; ConvF(7.44, 7.44, 7.44); Calibrated: 04/10/2016
- Sensor-Surface: 4mm (Mechanical Surface Detection)
- Electronics: Dummy DAE - SN:456; Calibrated: 12/9/2016
- Phantom: TWIN SAM; Type: QD000P40CA; Serial: TP-1218
- Measurement SW: DASY4, V4.5 Build 19; Postprocessing SW: SEMCAD, V1.8 Build 145

LTE Band 7-right-cheek-high-50%RB /Area Scan (101x121x1): Measurement grid: dx=10mm, dy=10mm
Maximum value of SAR (interpolated) = 0.488 mW/g

LTE Band 7-right-cheek-high-50%RB /Zoom Scan (7x7x7)/Cube 0: Measurement grid: dx=5mm, dy=5mm, dz=5mm
Reference Value = 3.73 V/m; Power Drift = 0.078 dB
Peak SAR (extrapolated) = 0.558 W/kg
SAR(1 g) = 0.405 mW/g; SAR(10 g) = 0.265 mW/g
Maximum value of SAR (measured) = 0.407 mW/g

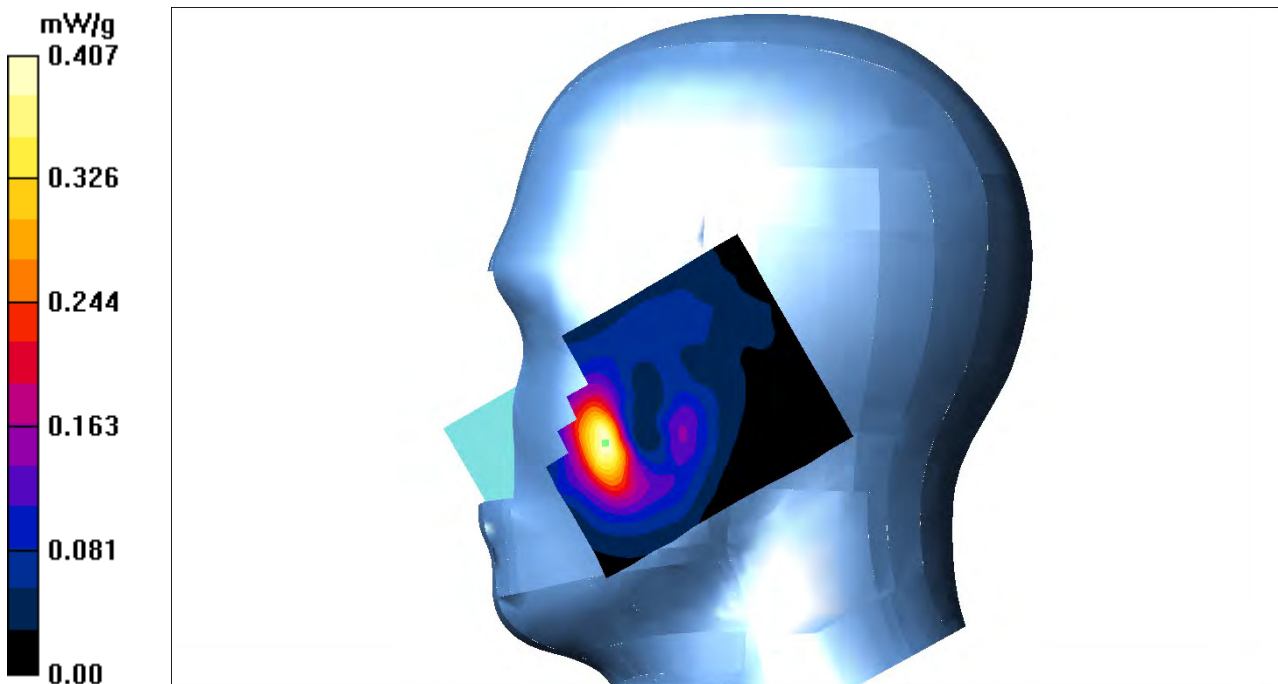

Test Laboratory: Bay Area Compliance Labs Corp.(Shenzhen)

Test Plot 61#: LTE Band 7 Right Tilt High Channel

DUT: 3G/4G Smart Phone ; Model: SKY 5.0LM

Communication System: LTE 4G Band; Frequency: 2560 MHz;Duty Cycle: 1:1
Medium parameters used: $f = 2560$ MHz; $\sigma = 1.89$ S/m; $\epsilon_r = 39.89$; $\rho = 1000$ kg/m³
Phantom section: Right Section

DASY4 Configuration:

- Probe: EX3DV4 - SN7431; ConvF(7.44, 7.44, 7.44); Calibrated: 04/10/2016
- Sensor-Surface: 4mm (Mechanical Surface Detection)
- Electronics: Dummy DAE - SN:456; Calibrated: 12/9/2016
- Phantom: TWIN SAM; Type: QD000P40CA; Serial: TP-1218
- Measurement SW: DASY4, V4.5 Build 19; Postprocessing SW: SEMCAD, V1.8 Build 145

LTE Band 7-right-tilt-high-1RB /Area Scan (101x121x1): Measurement grid: dx=10mm, dy=10mm
Maximum value of SAR (interpolated) = 0.372 mW/g

LTE Band 7-right-tilt-high-1RB /Zoom Scan (7x7x7)/Cube 0: Measurement grid: dx=5mm, dy=5mm, dz=5mm

Reference Value = 3.69 V/m; Power Drift = 0.072 dB

Peak SAR (extrapolated) = 0.298 W/kg

SAR(1 g) = 0.289 mW/g; SAR(10 g) = 0.127 mW/g

Maximum value of SAR (measured) = 0.316 mW/g

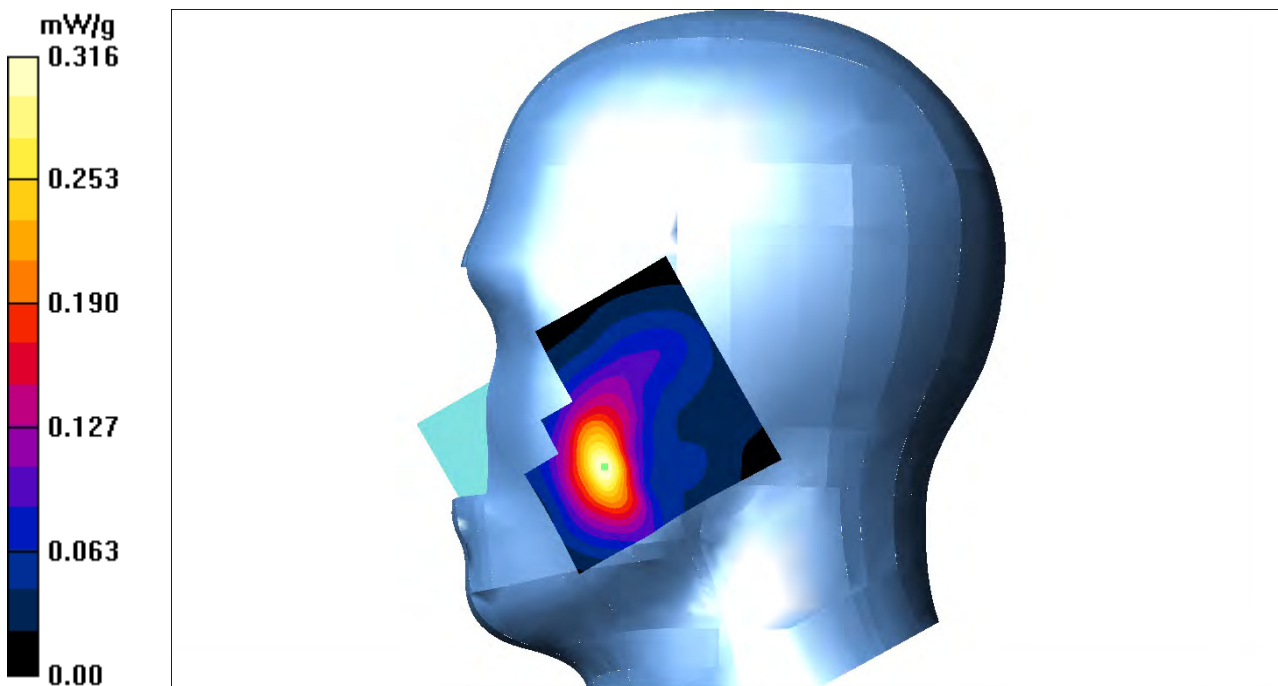

Test Laboratory: Bay Area Compliance Labs Corp.(Shenzhen)

Test Plot 62#: LTE Band 7 Right Tilt High Channel

DUT: 3G/4G Smart Phone ; Model: SKY 5.0LM

Communication System: LTE 4G Band; Frequency: 2560 MHz;Duty Cycle: 1:1
 Medium parameters used: $f = 2560$ MHz; $\sigma = 1.89$ S/m; $\epsilon_r = 39.89$; $\rho = 1000$ kg/m³
 Phantom section: Right Section

DASY4 Configuration:

- Probe: EX3DV4 - SN7431; ConvF(7.44, 7.44, 7.44); Calibrated: 04/10/2016
- Sensor-Surface: 4mm (Mechanical Surface Detection)
- Electronics: Dummy DAE - SN:456; Calibrated: 12/9/2016
- Phantom: TWIN SAM; Type: QD000P40CA; Serial: TP-1218
- Measurement SW: DASY4, V4.5 Build 19; Postprocessing SW: SEMCAD, V1.8 Build 145

LTE Band 7-right-tilt-high-50%RB /Area Scan (101x121x1): Measurement grid: dx=10mm, dy=10mm
 Maximum value of SAR (interpolated) = 0.252 mW/g

LTE Band 7-right-tilt-high-50%RB /Zoom Scan (7x7x7)/Cube 0: Measurement grid: dx=5mm, dy=5mm, dz=5mm

Reference Value = 2.69 V/m; Power Drift = 0.072 dB

Peak SAR (extrapolated) = 0.247 W/kg

SAR(1 g) = 0.226 mW/g; SAR(10 g) = 0.138 mW/g

Maximum value of SAR (measured) = 0.238 mW/g

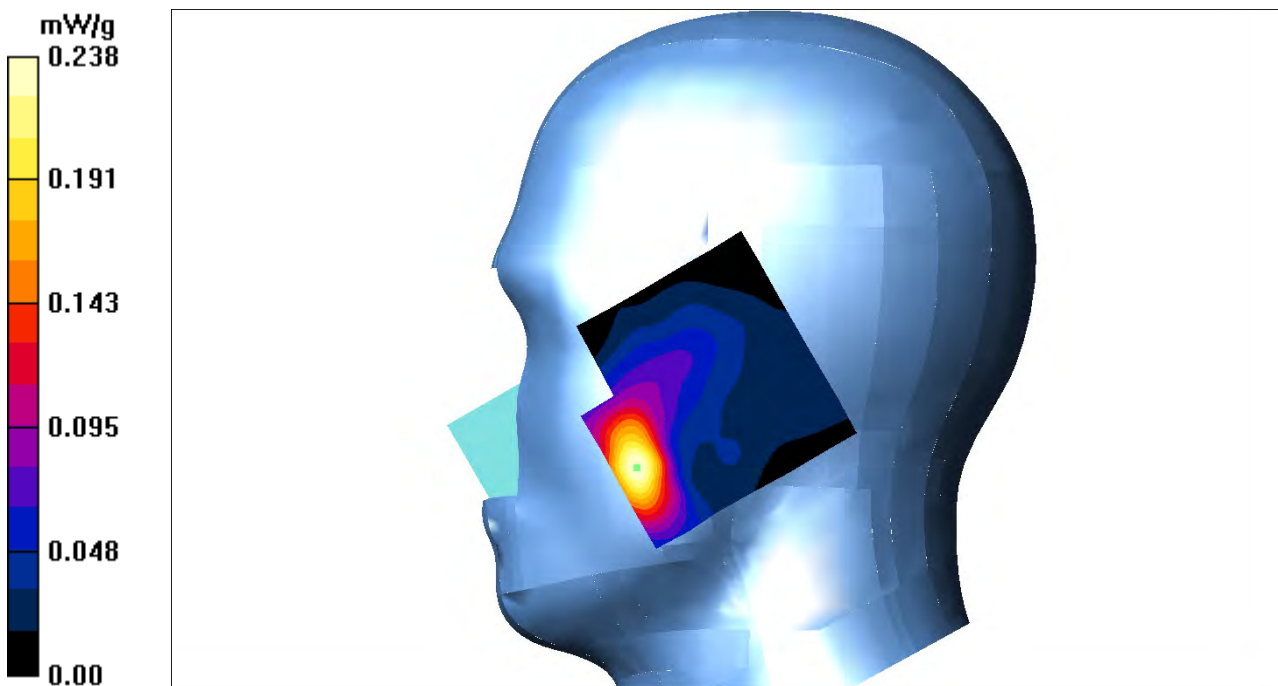

Test Laboratory: Bay Area Compliance Labs Corp.(Shenzhen)

Test Plot 63#:GSM 850 Body Worn Headset Middle Channel

DUT: 3G/4G Smart Phone ; Model:SKY 5.0LM

Communication System: 2G Band; Frequency: 836.6 MHz;Duty Cycle: 1:8
 Medium parameters used: $f = 836.6 \text{ MHz}$; $\sigma = 0.97 \text{ S/m}$; $\epsilon_r = 53.62$; $\rho = 1000 \text{ kg/m}^3$
 Phantom section: Flat Section

DASY4 Configuration:

- Probe: ES3DV3 - SN3036; ConvF(6.20, 6.20, 6.20); Calibrated: 16/9/2016
- Sensor-Surface: 4mm (Mechanical Surface Detection)
- Electronics: Dummy DAE - SN:456; Calibrated: 12/9/2016
- Phantom: TWIN SAM; Type: QD000P40CA; Serial: TP-1218
- Measurement SW: DASY4, V4.5 Build 19; Postprocessing SW: SEMCAD, V1.8 Build 145

GSM 850-body-worn-headset-mid/Area Scan (81x101x1): Measurement grid: $dx=10\text{mm}$, $dy=10\text{mm}$
 Maximum value of SAR (interpolated) = 0.481 mW/g

GSM 850-body-worn-headset-mid /Zoom Scan (7x7x7)/Cube 0: Measurement grid: $dx=5\text{mm}$, $dy=5\text{mm}$, $dz=5\text{mm}$

Reference Value = 3.43 V/m; Power Drift = 0.029 dB

Peak SAR (extrapolated) = 0.554 W/kg

SAR(1 g) = 0.472 mW/g; SAR(10 g) = 0.274 mW/g

Maximum value of SAR (measured) = 0.481 mW/g

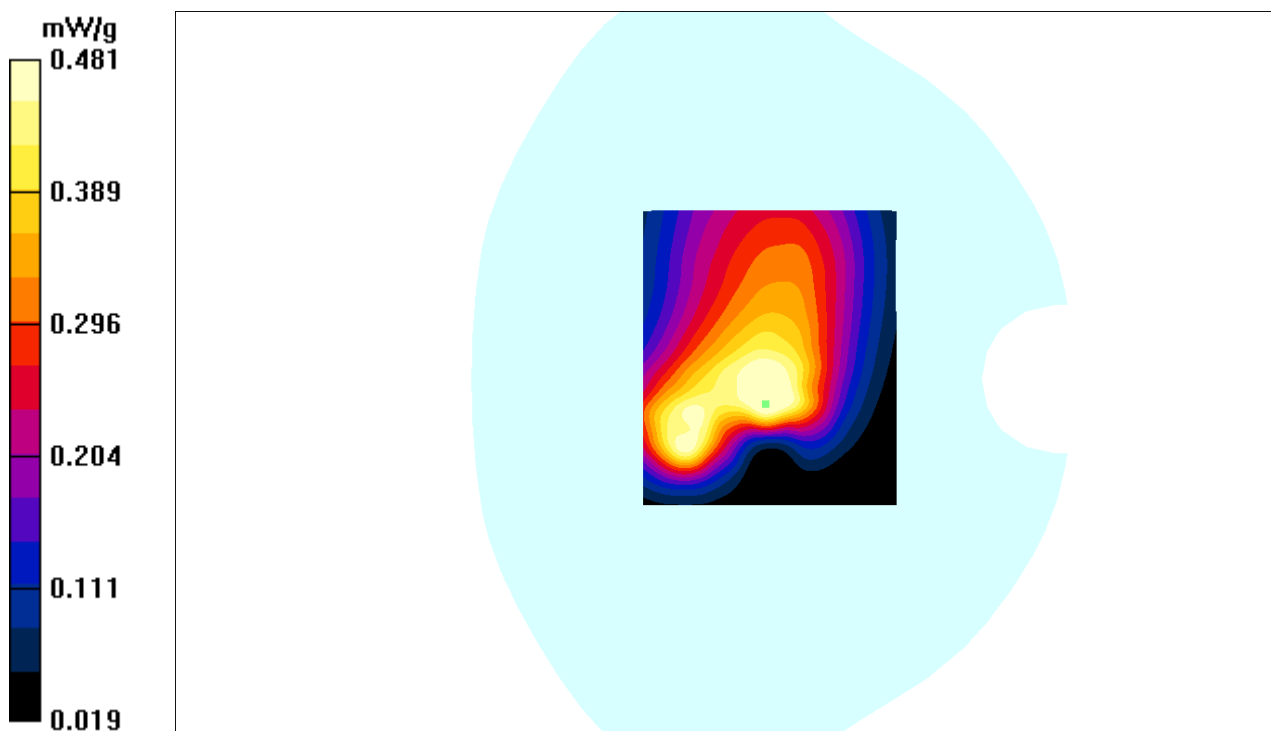

Test Laboratory: Bay Area Compliance Labs Corp.(Shenzhen)

Test Plot 64#:GSM 850 Body Worn Back Low Channel

DUT: 3G/4G Smart Phone ; Model:SKY 5.0LM

Communication System: 2G-gprs-2slots; Frequency: 824.2 MHz;Duty Cycle: 1:4
Medium parameters used: $f = 824.2 \text{ MHz}$; $\sigma = 0.94 \text{ S/m}$; $\epsilon_r = 53.31$; $\rho = 1000 \text{ kg/m}^3$
Phantom section: Flat Section

DASY4 Configuration:

- Probe: ES3DV3 - SN3036; ConvF(6.20, 6.20, 6.20); Calibrated: 16/9/2016
- Sensor-Surface: 4mm (Mechanical Surface Detection)
- Electronics: Dummy DAE - SN:456; Calibrated: 12/9/2016
- Phantom: TWIN SAM; Type: QD000P40CA; Serial: TP-1218
- Measurement SW: DASY4, V4.5 Build 19; Postprocessing SW: SEMCAD, V1.8 Build 145

GSM 850-body-worn-back-low/Area Scan (61x81x1): Measurement grid: $dx=10\text{mm}$, $dy=10\text{mm}$
Maximum value of SAR (interpolated) = 0.998 mW/g

GSM 850-body-worn-back-low /Zoom Scan (7x7x7)/Cube 0: Measurement grid: $dx=5\text{mm}$, $dy=5\text{mm}$, $dz=5\text{mm}$

Reference Value = 2.51 V/m; Power Drift = -0.025 dB

Peak SAR (extrapolated) = 0.957 W/kg

SAR(1 g) = 1.005 mW/g; SAR(10 g) = 0.662 mW/g

Maximum value of SAR (measured) = 1.040 mW/g

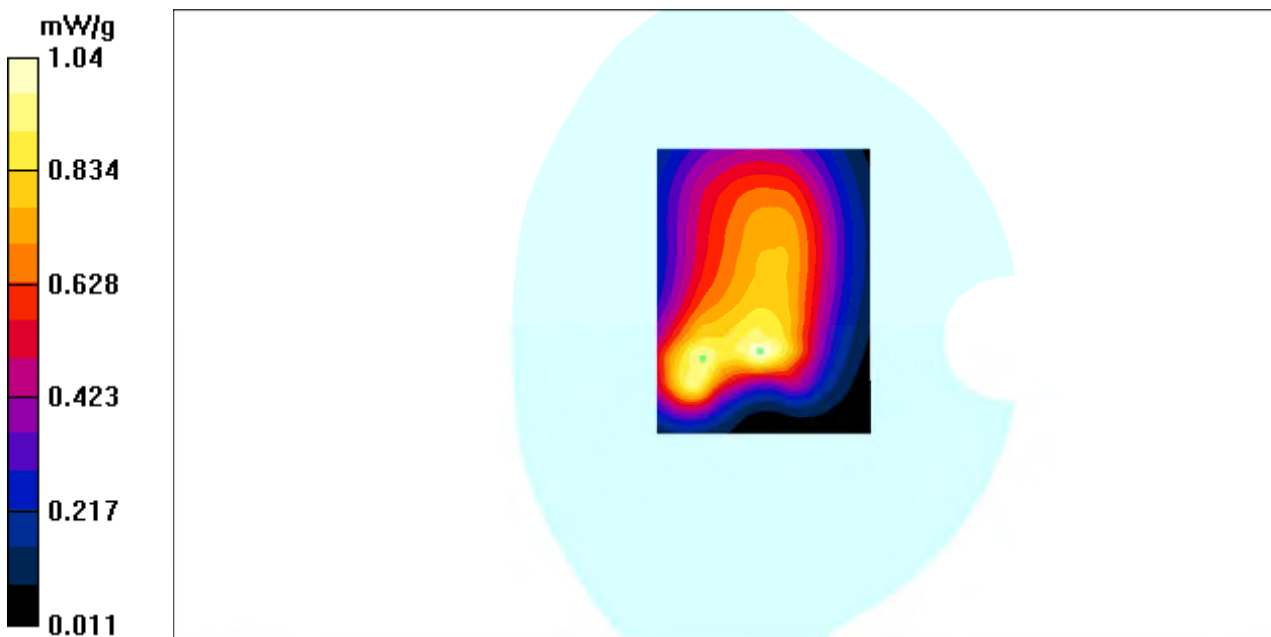

Test Laboratory: Bay Area Compliance Labs Corp.(Shenzhen)

Test Plot 65#:GSM 850 Body Worn Back Middle Channel

DUT: 3G/4G Smart Phone ; Model:SKY 5.0LM

Communication System: 2G-gprs-2slots; Frequency: 836.6 MHz;Duty Cycle: 1:4
Medium parameters used: $f = 836.6$ MHz; $\sigma = 0.97$ S/m; $\epsilon_r = 53.62$; $\rho = 1000$ kg/m³
Phantom section: Flat Section

DASY4 Configuration:

- Probe: ES3DV3 - SN3036; ConvF(6.20, 6.20, 6.20); Calibrated: 16/9/2016
- Sensor-Surface: 4mm (Mechanical Surface Detection)
- Electronics: Dummy DAE - SN:456; Calibrated: 12/9/2016
- Phantom: TWIN SAM; Type: QD000P40CA; Serial: TP-1218
- Measurement SW: DASY4, V4.5 Build 19; Postprocessing SW: SEMCAD, V1.8 Build 145

GSM 850-body-worn-back-mid/Area Scan (81x101x1): Measurement grid: dx=10mm, dy=10mm
Maximum value of SAR (interpolated) = 0.978 mW/g

GSM 850-body-worn-back-mid /Zoom Scan (7x7x7)/Cube 0: Measurement grid: dx=5mm, dy=5mm, dz=5mm

Reference Value = 8.21 V/m; Power Drift = -0.057 dB

Peak SAR (extrapolated) = 0.997 W/kg

SAR(1 g) = 0.991 mW/g; SAR(10 g) = 0.587 mW/g

Maximum value of SAR (measured) = 1.020 mW/g

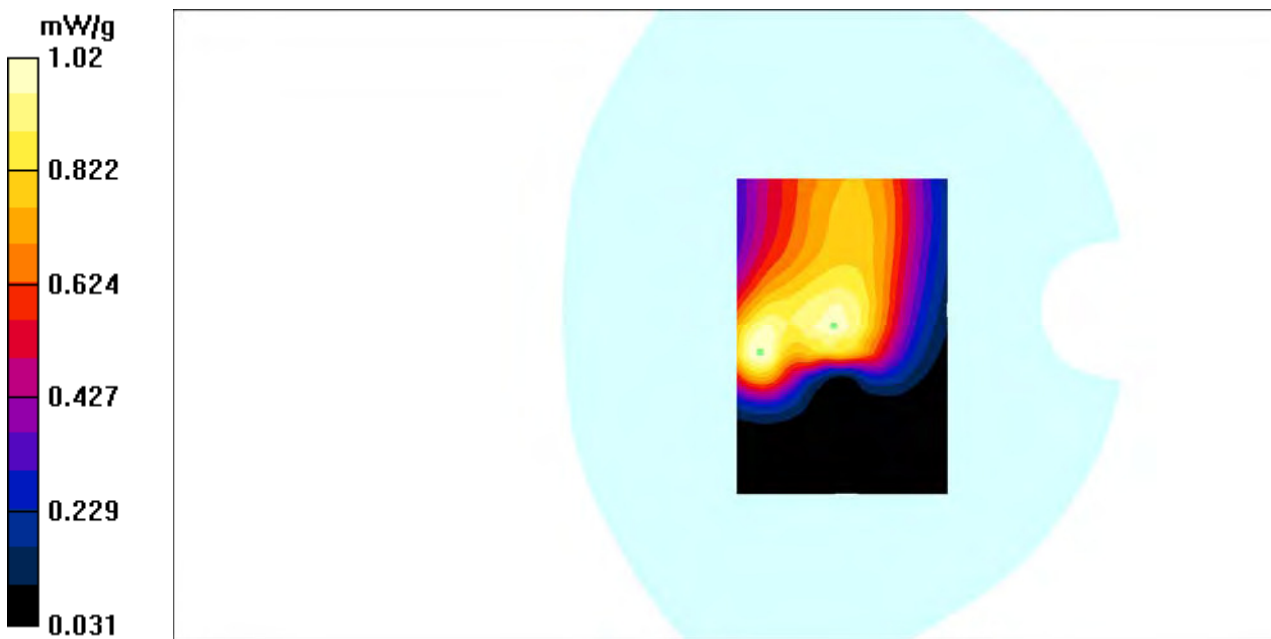

Test Laboratory: Bay Area Compliance Labs Corp.(Shenzhen)

Test Plot 66#:GSM 850 Body Worn Back High Channel

DUT: 3G/4G Smart Phone ; Model:SKY 5.0LM

Communication System: 2G-gprs-2slots; Frequency: 848.8 MHz;Duty Cycle: 1:4
Medium parameters used: $f = 848.8 \text{ MHz}$; $\sigma = 1.00 \text{ S/m}$; $\epsilon_r = 53.92$; $\rho = 1000 \text{ kg/m}^3$
Phantom section: Flat Section

DASY4 Configuration:

- Probe: ES3DV3 - SN3036; ConvF(6.20, 6.20, 6.20); Calibrated: 16/9/2016
- Sensor-Surface: 4mm (Mechanical Surface Detection)
- Electronics: Dummy DAE - SN:456; Calibrated: 12/9/2016
- Phantom: TWIN SAM; Type: QD000P40CA; Serial: TP-1218
- Measurement SW: DASY4, V4.5 Build 19; Postprocessing SW: SEMCAD, V1.8 Build 145

GSM 850-body-worn-back-high/Area Scan (81x101x1): Measurement grid: $dx=10\text{mm}$, $dy=10\text{mm}$
Maximum value of SAR (interpolated) = 0.978 mW/g

GSM 850-body-worn-back-high /Zoom Scan (7x7x7)/Cube 0: Measurement grid: $dx=5\text{mm}$, $dy=5\text{mm}$, $dz=5\text{mm}$

Reference Value = 5.41 V/m; Power Drift = -0.069 dB

Peak SAR (extrapolated) = 0.987 W/kg

SAR(1 g) = 0.919 mW/g; SAR(10 g) = 0.559 mW/g

Maximum value of SAR (measured) = 0.996 mW/g

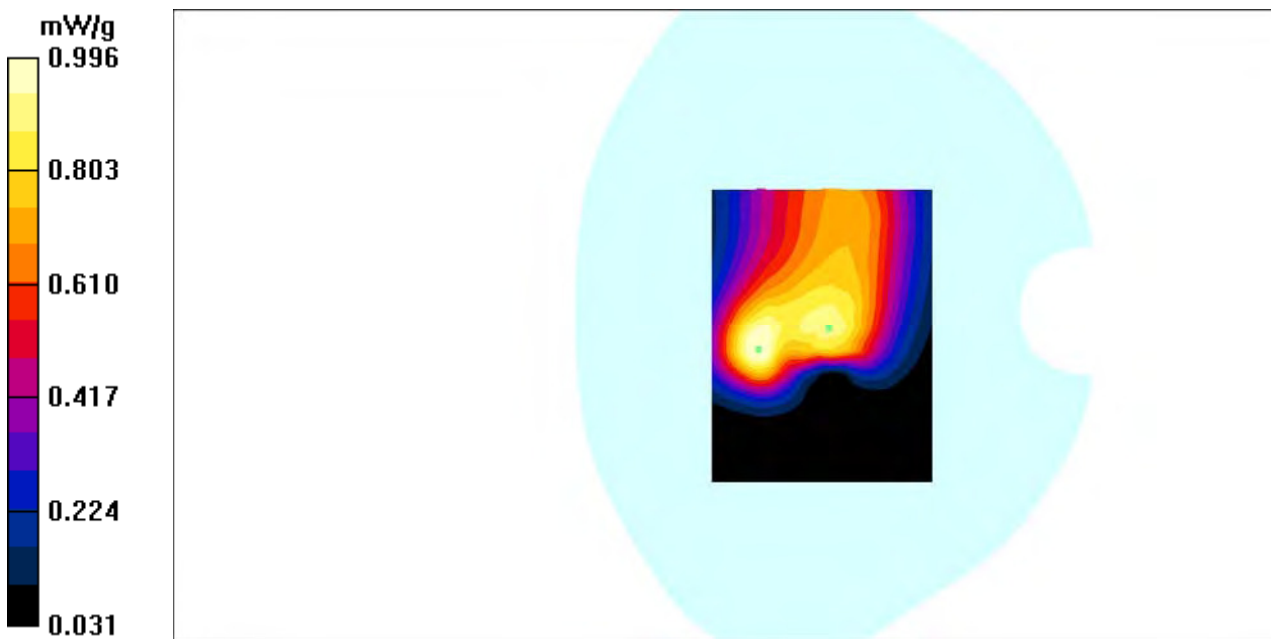

Test Laboratory: Bay Area Compliance Labs Corp.(Shenzhen)

Test Plot #67:GSM 850 Body Worn Left Middle Channel

DUT: 3G/4G Smart Phone ; Model:SKY 5.0LM

Communication System: 2G-gprs-2slots; Frequency: 836.6 MHz;Duty Cycle: 1:4
Medium parameters used: $f = 836.6$ MHz; $\sigma = 0.97$ S/m; $\epsilon_r = 53.62$; $\rho = 1000$ kg/m³
Phantom section: Flat Section

DASY4 Configuration:

- Probe: ES3DV3 - SN3036; ConvF(6.20, 6.20, 6.20); Calibrated: 16/9/2016
- Sensor-Surface: 4mm (Mechanical Surface Detection)
- Electronics: Dummy DAE - SN:456; Calibrated: 12/9/2016
- Phantom: TWIN SAM; Type: QD000P40CA; Serial: TP-1218
- Measurement SW: DASY4, V4.5 Build 19; Postprocessing SW: SEMCAD, V1.8 Build 145

GSM 850-body-worn-left-Middle/Area Scan (91x111x1): Measurement grid: dx=10mm, dy=10mm
Maximum value of SAR (interpolated) = 0.947 mW/g

GSM 850-body-worn-left-Middle /Zoom Scan (7x7x7)/Cube 0: Measurement grid: dx=5mm, dy=5mm, dz=5mm
Reference Value = 8.35 V/m; Power Drift = -0.951 dB
Peak SAR (extrapolated) = 0.823 W/kg
SAR(1 g) = 0.725 mW/g; SAR(10 g) = 0.472 mW/g
Maximum value of SAR (measured) = 0.817 mW/g

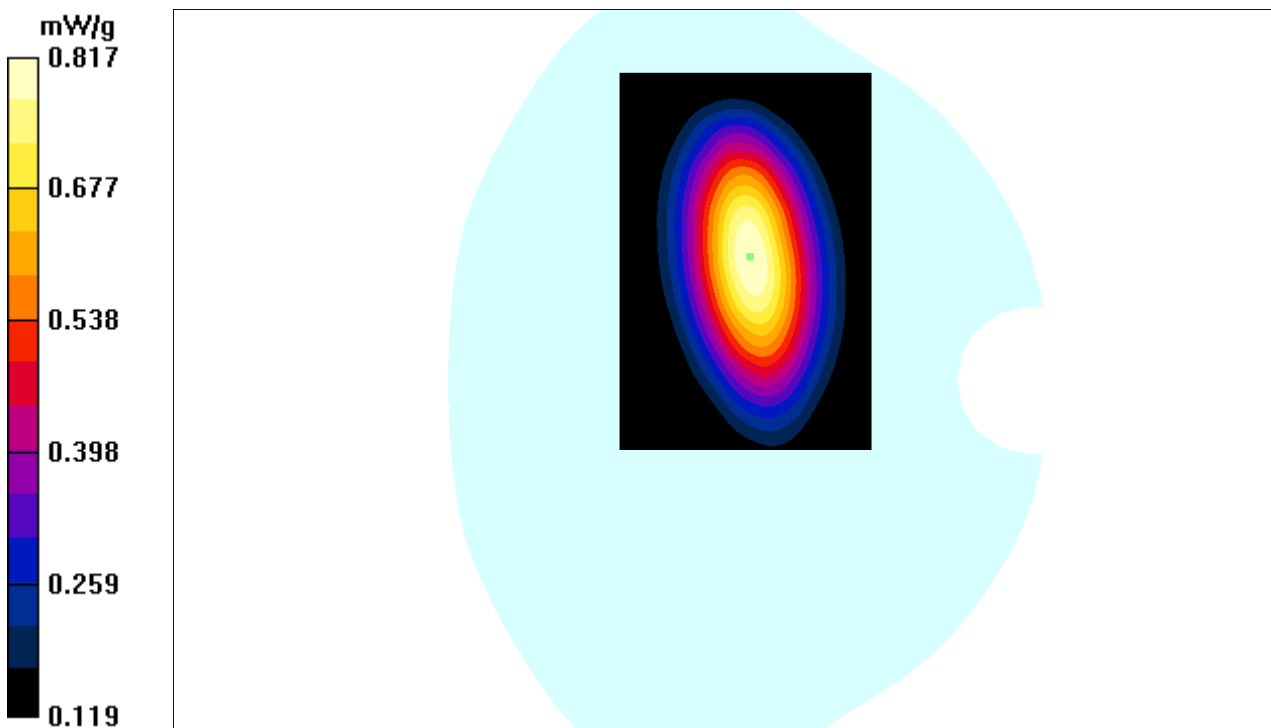

Test Laboratory: Bay Area Compliance Labs Corp.(Shenzhen)

Test Plot 68#:GSM 850 Body Worn Right Low Channel

DUT: 3G/4G Smart Phone ; Model:SKY 5.0LM

Communication System: 2G-gprs-2slots; Frequency: 824.2 MHz;Duty Cycle: 1:4
 Medium parameters used: $f = 824.2 \text{ MHz}$; $\sigma = 0.94 \text{ S/m}$; $\epsilon_r = 53.31$; $\rho = 1000 \text{ kg/m}^3$
 Phantom section: Flat Section

DASY4 Configuration:

- Probe: ES3DV3 - SN3036; ConvF(6.20, 6.20, 6.20); Calibrated: 16/9/2016
- Sensor-Surface: 4mm (Mechanical Surface Detection)
- Electronics: Dummy DAE - SN:456; Calibrated: 12/9/2016
- Phantom: TWIN SAM; Type: QD000P40CA; Serial: TP-1218
- Measurement SW: DASY4, V4.5 Build 19; Postprocessing SW: SEMCAD, V1.8 Build 145

GSM 850-body-worn-Right-low/Area Scan (81x111x1): Measurement grid: dx=10mm, dy=10mm
 Maximum value of SAR (interpolated) = 0.618 mW/g

GSM 850-body-worn-Right-low /Zoom Scan (7x7x7)/Cube 0: Measurement grid: dx=5mm, dy=5mm, dz=5mm

Reference Value = 5.39 V/m; Power Drift = -0.025 dB

Peak SAR (extrapolated) = 0.607 W/kg

SAR(1 g) = 0.543 mW/g; SAR(10 g) = 0.317 mW/g

Maximum value of SAR (measured) = 0.552 mW/g

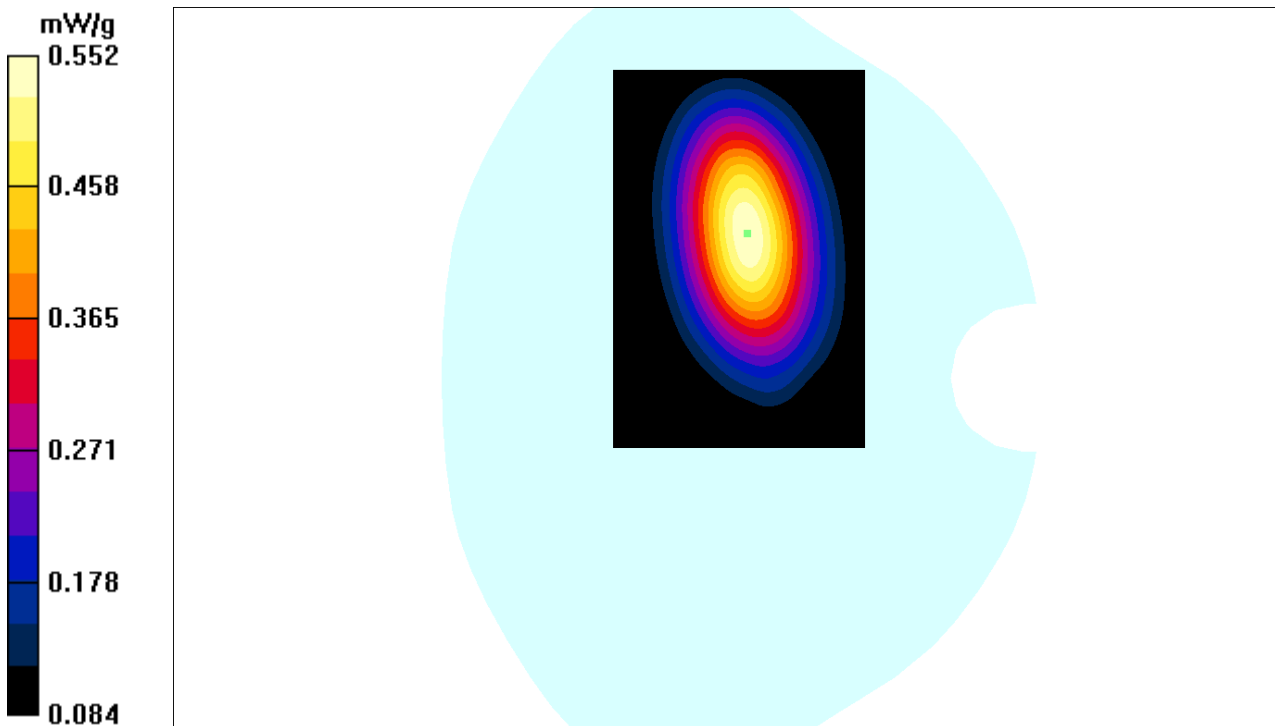

Test Laboratory: Bay Area Compliance Labs Corp.(Shenzhen)

Test Plot 69#:GSM 850 Body Worn Right Middle Channel

DUT: 3G/4G Smart Phone ; Model:SKY 5.0LM

Communication System: 2G-gprs-2slots; Frequency: 836.6 MHz;Duty Cycle: 1:4
Medium parameters used: $f = 836.6$ MHz; $\sigma = 0.97$ S/m; $\epsilon_r = 53.62$; $\rho = 1000$ kg/m³
Phantom section: Flat Section

DASY4 Configuration:

- Probe: ES3DV3 - SN3036; ConvF(6.20, 6.20, 6.20); Calibrated: 16/9/2016
- Sensor-Surface: 4mm (Mechanical Surface Detection)
- Electronics: Dummy DAE - SN:456; Calibrated: 12/9/2016
- Phantom: TWIN SAM; Type: QD000P40CA; Serial: TP-1218
- Measurement SW: DASY4, V4.5 Build 19; Postprocessing SW: SEMCAD, V1.8 Build 145

GSM 850-body-worn-Right-mid/Area Scan (91x111x1): Measurement grid: dx=10mm, dy=10mm
Maximum value of SAR (interpolated) = 0.728 mW/g

GSM 850-body-worn-Right-mid /Zoom Scan (7x7x7)/Cube 0: Measurement grid: dx=5mm, dy=5mm, dz=5mm

Reference Value = 6.13 V/m; Power Drift = -0.082 dB

Peak SAR (extrapolated) = 0.687 W/kg

SAR(1 g) = 0.643 mW/g; SAR(10 g) = 0.427 mW/g

Maximum value of SAR (measured) = 0.644 mW/g

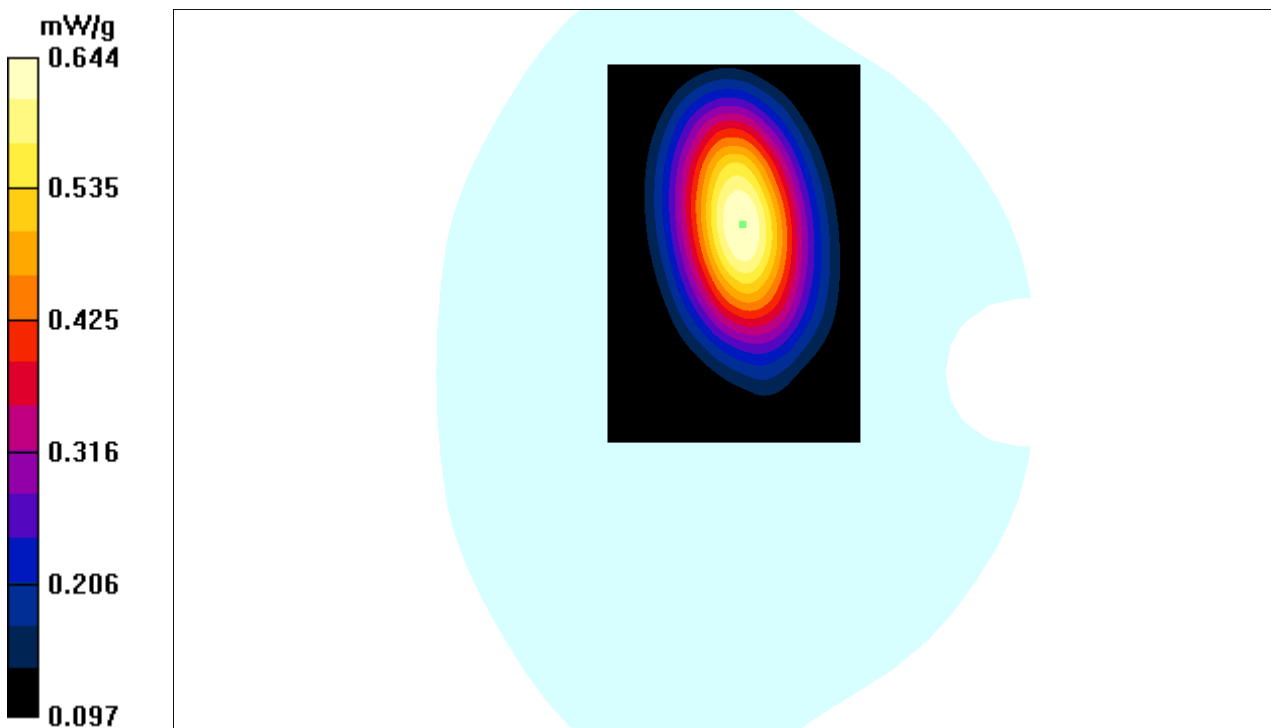

Test Laboratory: Bay Area Compliance Labs Corp.(Shenzhen)

Test Plot 70#:GSM 850 Body Worn Right High Channel

DUT: 3G/4G Smart Phone ; Model:SKY 5.0LM

Communication System: 2G-gprs-2slots; Frequency: 848.8 MHz;Duty Cycle: 1:4
Medium parameters used: $f = 848.8 \text{ MHz}$; $\sigma = 1.00 \text{ S/m}$; $\epsilon_r = 53.92$; $\rho = 1000 \text{ kg/m}^3$
Phantom section: Flat Section

DASY4 Configuration:

- Probe: ES3DV3 - SN3036; ConvF(6.20, 6.20, 6.20); Calibrated: 16/9/2016
- Sensor-Surface: 4mm (Mechanical Surface Detection)
- Electronics: Dummy DAE - SN:456; Calibrated: 12/9/2016
- Phantom: TWIN SAM; Type: QD000P40CA; Serial: TP-1218
- Measurement SW: DASY4, V4.5 Build 19; Postprocessing SW: SEMCAD, V1.8 Build 145

GSM 850-body-worn-Right-high/Area Scan (91x111x1): Measurement grid: $dx=10\text{mm}$, $dy=10\text{mm}$
Maximum value of SAR (interpolated) = 0.628 mW/g

GSM 850-body-worn-Right-high /Zoom Scan (7x7x7)/Cube 0: Measurement grid: $dx=5\text{mm}$, $dy=5\text{mm}$, $dz=5\text{mm}$

Reference Value = 7.1 V/m; Power Drift = -0.025 dB

Peak SAR (extrapolated) = 0.827 W/kg

SAR(1 g) = 0.559 mW/g; SAR(10 g) = 0.338 mW/g

Maximum value of SAR (measured) = 0.574 mW/g

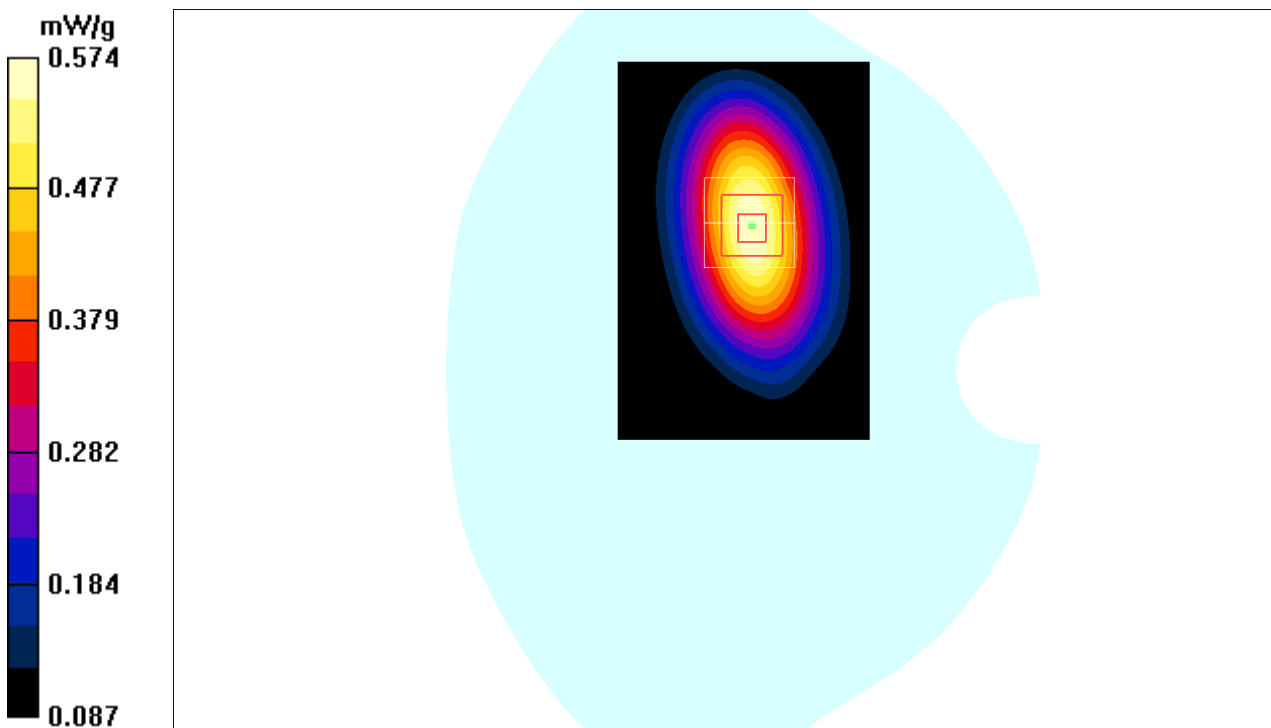

Test Laboratory: Bay Area Compliance Labs Corp.(Shenzhen)

Test Plot 71#:GSM 850 Body Worn Bottom Middle Channel

DUT: 3G/4G Smart Phone ; Model:SKY 5.0LM

Communication System: 2G-gprs-2slots; Frequency: 836.6 MHz;Duty Cycle: 1:4
Medium parameters used: $f = 836.6 \text{ MHz}$; $\sigma = 0.97 \text{ S/m}$; $\epsilon_r = 53.62$; $\rho = 1000 \text{ kg/m}^3$
Phantom section: Flat Section

DASY4 Configuration:

- Probe: ES3DV3 - SN3036; ConvF(6.20, 6.20, 6.20); Calibrated: 16/9/2016
- Sensor-Surface: 4mm (Mechanical Surface Detection)
- Electronics: Dummy DAE - SN:456; Calibrated: 12/9/2016
- Phantom: TWIN SAM; Type: QD000P40CA; Serial: TP-1218
- Measurement SW: DASY4, V4.5 Build 19; Postprocessing SW: SEMCAD, V1.8 Build 145

GSM 850-body-worn-bottom-Middle/Area Scan (81x101x1): Measurement grid: $dx=10\text{mm}$, $dy=10\text{mm}$
Maximum value of SAR (interpolated) = 0.412 mW/g

GSM 850-body-worn-bottom-Middle /Zoom Scan (7x7x7)/Cube 0: Measurement grid: $dx=5\text{mm}$,
 $dy=5\text{mm}$, $dz=5\text{mm}$
Reference Value = 6.09 V/m; Power Drift = -0.158 dB
Peak SAR (extrapolated) = 0.431 W/kg
SAR(1 g) = 0.403 mW/g; SAR(10 g) = 0.237 mW/g
Maximum value of SAR (measured) = 0.407 mW/g

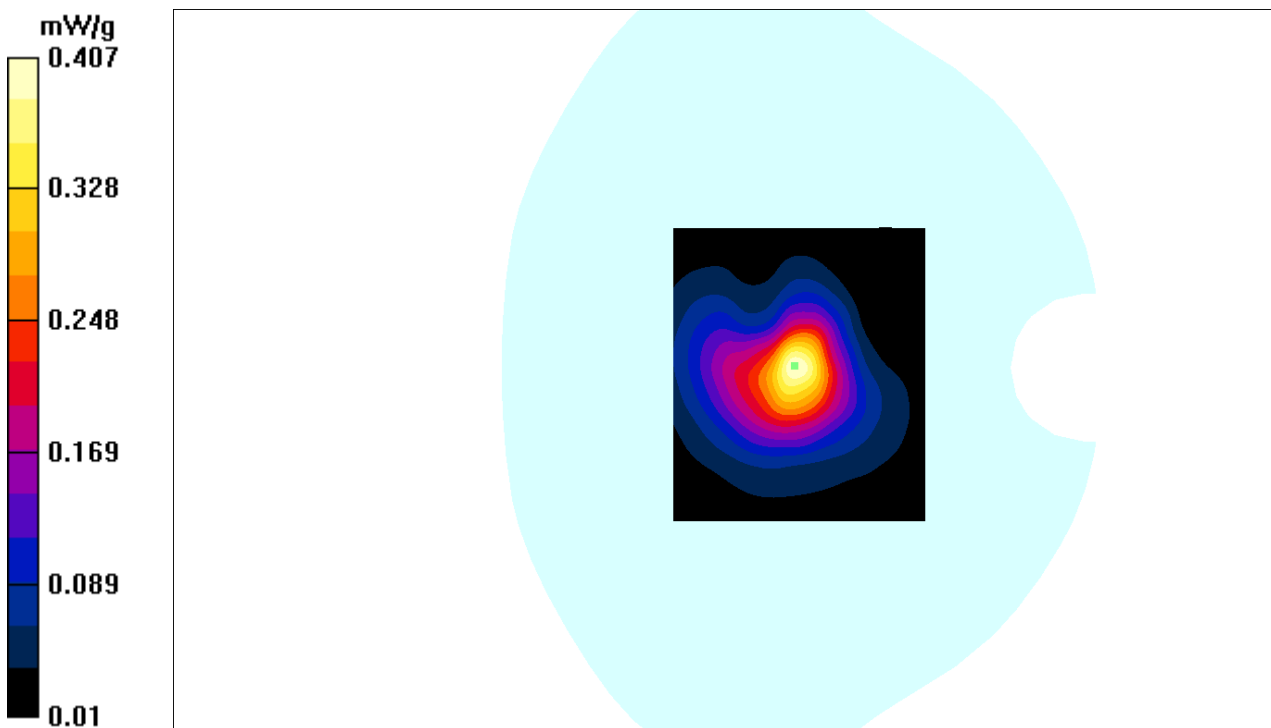

Test Laboratory: Bay Area Compliance Labs Corp.(Shenzhen)

Test Plot 72#:PCS 1900 Body Worn Headset Middle Channel

DUT: 3G/4G Smart Phone ; Model:SKY 5.0LM

Communication System: 2G Band; Frequency: 1880 MHz;Duty Cycle: 1:8
Medium parameters used: $f = 1880 \text{ MHz}$; $\sigma = 1.50 \text{ S/m}$; $\epsilon_r = 52.46$; $\rho = 1000 \text{ kg/m}^3$
Phantom section: Flat Section

DASY4 Configuration:

- Probe: ES3DV3 - SN3036; ConvF(4.79, 4.79, 4.79); Calibrated: 16/9/2016
- Sensor-Surface: 4mm (Mechanical Surface Detection)
- Electronics: Dummy DAE - SN:456; Calibrated: 12/9/2016
- Phantom: TWIN SAM; Type: QD000P40CA; Serial: TP-1218
- Measurement SW: DASY4, V4.5 Build 19; Postprocessing SW: SEMCAD, V1.8 Build 145

PCS 1900-body-worn-headset-mid /Area Scan (81x101x1): Measurement grid: $dx=10\text{mm}$, $dy=10\text{mm}$
Maximum value of SAR (interpolated) = 0.202 mW/g

PCS 1900-body-worn-headset-mid /Zoom Scan (7x7x7)/Cube 0: Measurement grid: $dx=5\text{mm}$, $dy=5\text{mm}$, $dz=5\text{mm}$

Reference Value = 5.13 V/m; Power Drift = -0.042 dB

Peak SAR (extrapolated) = 0.196 W/kg

SAR(1 g) = 0.132 mW/g; SAR(10 g) = 0.072 mW/g

Maximum value of SAR (measured) = 0.165 mW/g

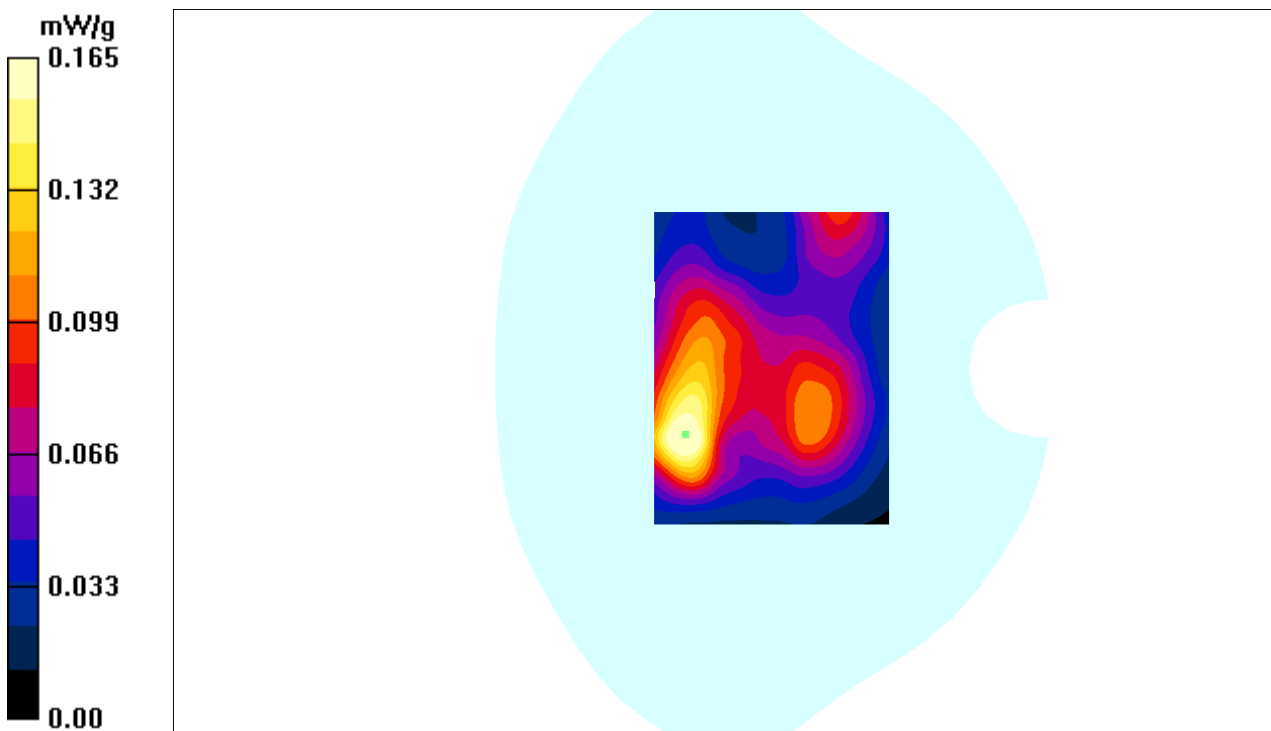

Test Laboratory: Bay Area Compliance Labs Corp.(Shenzhen)

Test Plot 73#:PCS 1900 Body Worn Back Middle Channel

DUT: 3G/4G Smart Phone ; Model:SKY 5.0LM

Communication System: 2G-gprs-4slots; Frequency: 1880 MHz;Duty Cycle: 1:2
Medium parameters used: $f = 1880 \text{ MHz}$; $\sigma = 1.50 \text{ S/m}$; $\epsilon_r = 52.46$; $\rho = 1000 \text{ kg/m}^3$
Phantom section: Flat Section

DASY4 Configuration:

- Probe: ES3DV3 - SN3036; ConvF(4.79, 4.79, 4.79); Calibrated: 16/9/2016
- Sensor-Surface: 4mm (Mechanical Surface Detection)
- Electronics: Dummy DAE - SN:456; Calibrated: 12/9/2016
- Phantom: TWIN SAM; Type: QD000P40CA; Serial: TP-1218
- Measurement SW: DASY4, V4.5 Build 19; Postprocessing SW: SEMCAD, V1.8 Build 145

PCS 1900-body-worn-back-mid /Area Scan (81x101x1): Measurement grid: $dx=10\text{mm}$, $dy=10\text{mm}$
Maximum value of SAR (interpolated) = 0.338 mW/g

PCS 1900-body-worn-back-mid /Zoom Scan (7x7x7)/Cube 0: Measurement grid: $dx=5\text{mm}$, $dy=5\text{mm}$, $dz=5\text{mm}$

Reference Value = 5.83 V/m; Power Drift = 0.062 dB

Peak SAR (extrapolated) = 0.326 W/kg

SAR(1 g) = 0.307 mW/g; SAR(10 g) = 0.218 mW/g

Maximum value of SAR (measured) = 0.316 mW/g

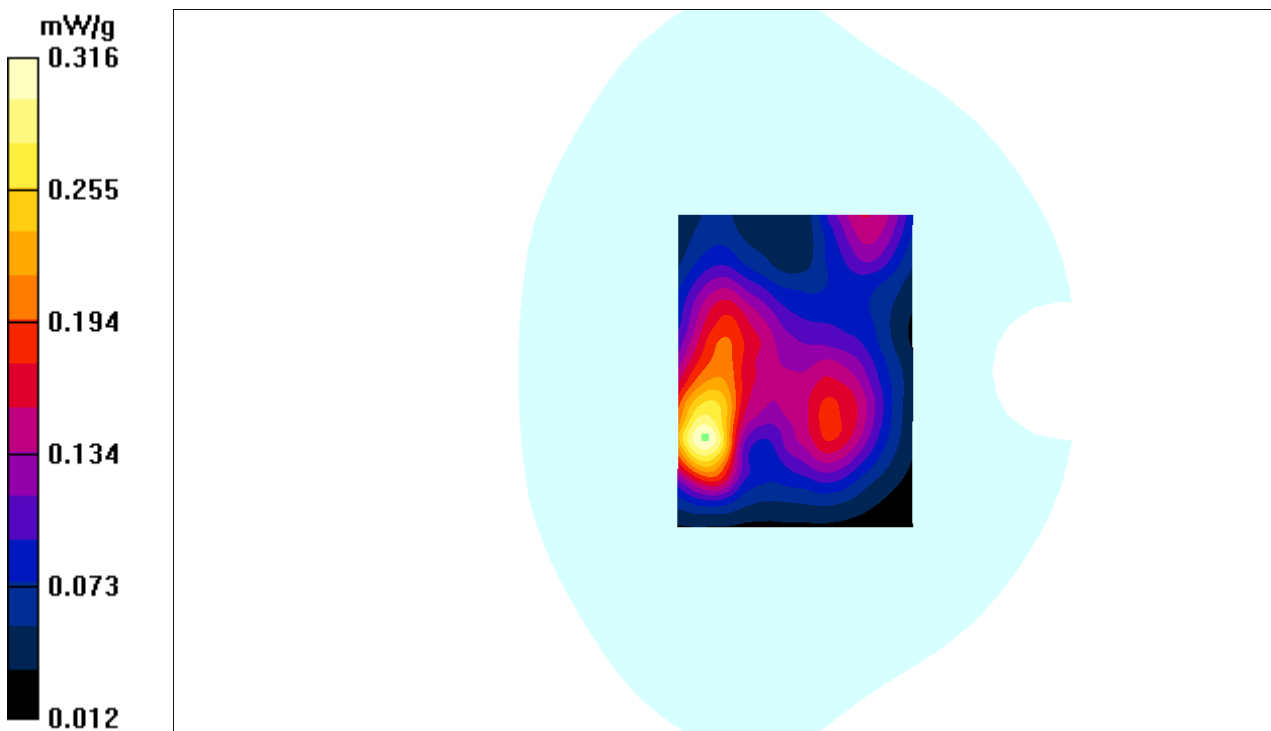

Test Laboratory: Bay Area Compliance Labs Corp.(Shenzhen)

Test Plot 74#:PCS 1900 Body Worn Left Middle Channel

DUT: 3G/4G Smart Phone ; Model:SKY 5.0LM

Communication System: 2G-gprs-4slots; Frequency: 1880 MHz;Duty Cycle: 1:2
Medium parameters used: $f = 1880 \text{ MHz}$; $\sigma = 1.50 \text{ S/m}$; $\epsilon_r = 52.46$; $\rho = 1000 \text{ kg/m}^3$
Phantom section: Flat Section

DASY4 Configuration:

- Probe: ES3DV3 - SN3036; ConvF(4.79, 4.79, 4.79); Calibrated: 16/9/2016
- Sensor-Surface: 4mm (Mechanical Surface Detection)
- Electronics: Dummy DAE - SN:456; Calibrated: 12/9/2016
- Phantom: TWIN SAM; Type: QD000P40CA; Serial: TP-1218
- Measurement SW: DASY4, V4.5 Build 19; Postprocessing SW: SEMCAD, V1.8 Build 145

PCS 1900-body-worn-left-mid /Area Scan (71x111x1): Measurement grid: $dx=10\text{mm}$, $dy=10\text{mm}$
Maximum value of SAR (interpolated) = 0.113 mW/g

PCS 1900-body-worn-left-mid /Zoom Scan (7x7x7)/Cube 0: Measurement grid: $dx=5\text{mm}$, $dy=5\text{mm}$, $dz=5\text{mm}$

Reference Value = 7.01 V/m; Power Drift = 0.046 dB

Peak SAR (extrapolated) = 0.238 W/kg

SAR(1 g) = 0.085 mW/g; SAR(10 g) = 0.062 mW/g

Maximum value of SAR (measured) = 0.109mW/g

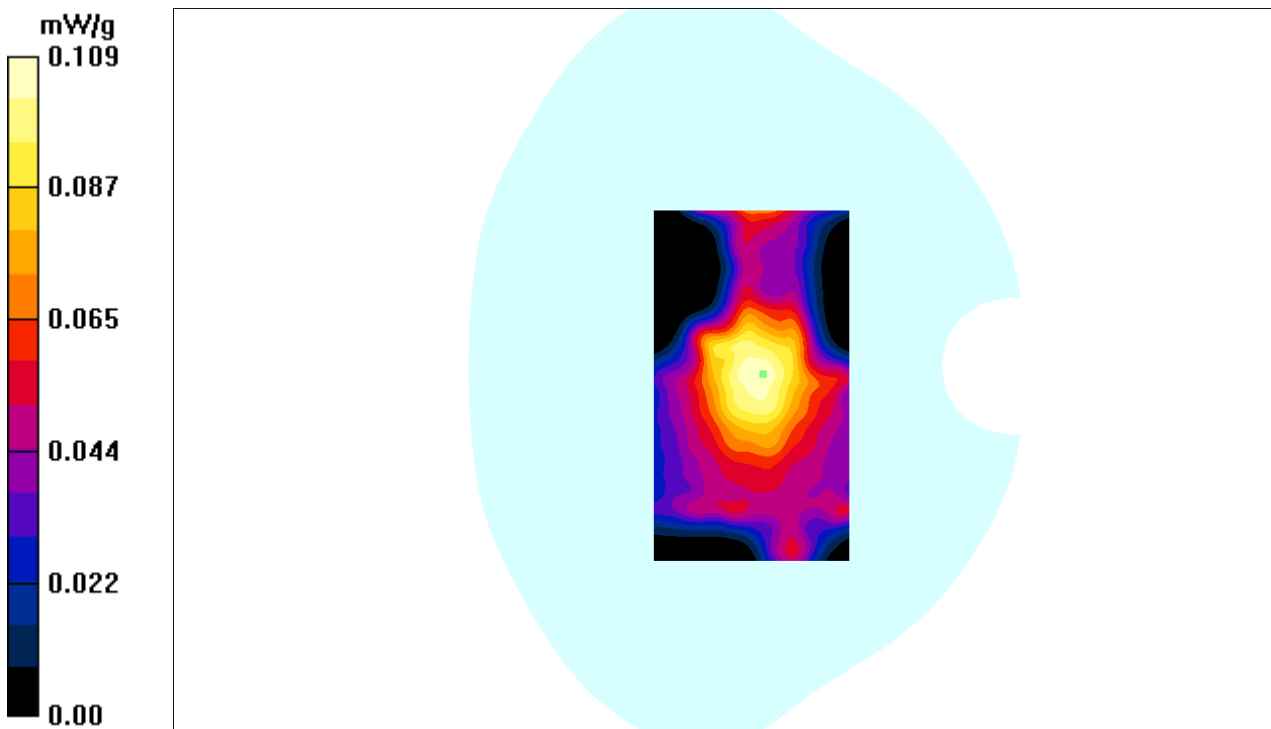

Test Laboratory: Bay Area Compliance Labs Corp.(Shenzhen)

Test Plot 75#:PCS 1900 Body Worn Right Middle Channel

DUT: 3G/4G Smart Phone ; Model:SKY 5.0LM

Communication System: 2G-gprs-4slots; Frequency: 1880 MHz;Duty Cycle: 1:2
Medium parameters used: $f = 1880 \text{ MHz}$; $\sigma = 1.50 \text{ S/m}$; $\epsilon_r = 52.46$; $\rho = 1000 \text{ kg/m}^3$
Phantom section: Flat Section

DASY4 Configuration:

- Probe: ES3DV3 - SN3036; ConvF(4.79, 4.79, 4.79); Calibrated: 16/9/2016
- Sensor-Surface: 4mm (Mechanical Surface Detection)
- Electronics: Dummy DAE - SN:456; Calibrated: 12/9/2016
- Phantom: TWIN SAM; Type: QD000P40CA; Serial: TP-1218
- Measurement SW: DASY4, V4.5 Build 19; Postprocessing SW: SEMCAD, V1.8 Build 145

PCS 1900-body-worn-right-mid /Area Scan (81x101x1): Measurement grid: $dx=10\text{mm}$, $dy=10\text{mm}$
Maximum value of SAR (interpolated) = 0.168 mW/g

PCS 1900-body-worn-right-mid /Zoom Scan (7x7x7)/Cube 0: Measurement grid: $dx=5\text{mm}$, $dy=5\text{mm}$, $dz=5\text{mm}$
Reference Value = 3.13 V/m; Power Drift = -0.084 dB
Peak SAR (extrapolated) = 0.146 W/kg
SAR(1 g) = 0.132 mW/g; SAR(10 g) = 0.089 mW/g
Maximum value of SAR (measured) = 0.157 mW/g

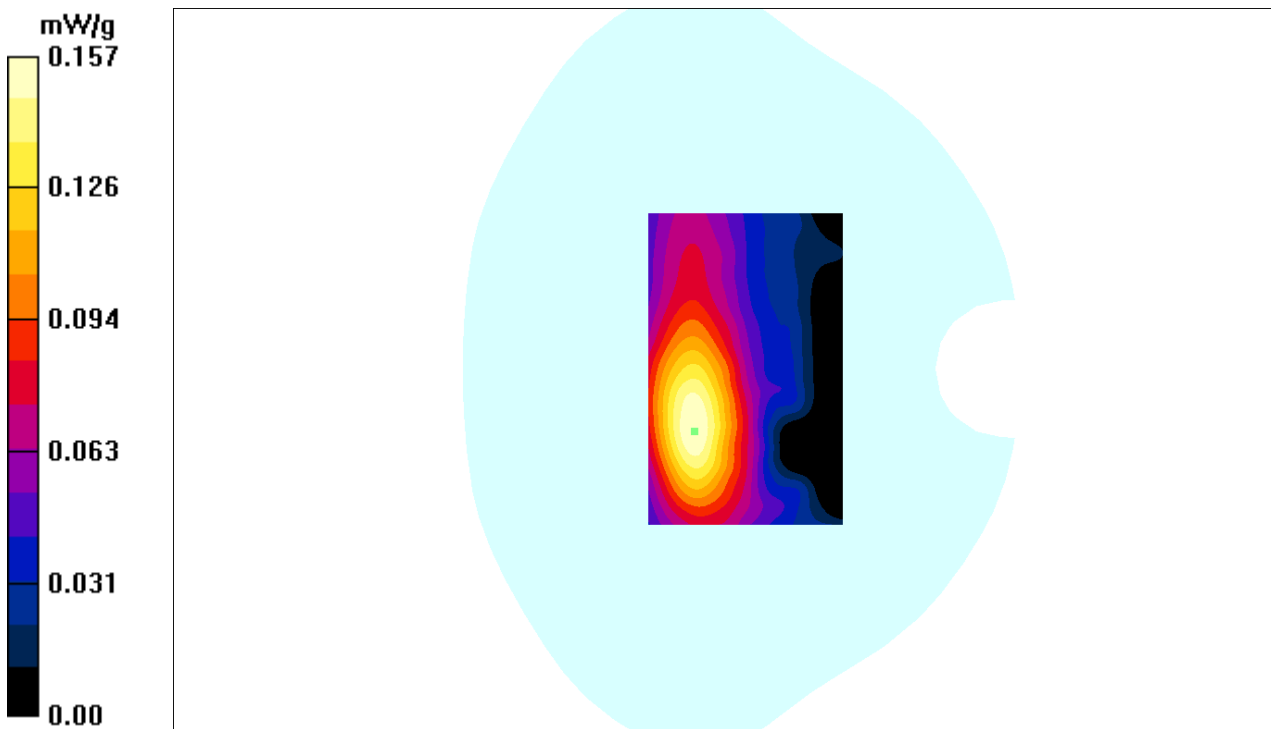

Test Laboratory: Bay Area Compliance Labs Corp.(Shenzhen)

Test Plot 76#:PCS 1900 Body Worn Bottom Middle Channel

DUT: 3G/4G Smart Phone ; Model:SKY 5.0LM

Communication System: 2G-gprs-4slots; Frequency: 1880 MHz;Duty Cycle: 1:2
Medium parameters used: $f = 1880 \text{ MHz}$; $\sigma = 1.50 \text{ S/m}$; $\epsilon_r = 52.46$; $\rho = 1000 \text{ kg/m}^3$
Phantom section: Flat Section

DASY4 Configuration:

- Probe: ES3DV3 - SN3036; ConvF(4.79, 4.79, 4.79); Calibrated: 16/9/2016
- Sensor-Surface: 4mm (Mechanical Surface Detection)
- Electronics: Dummy DAE - SN:456; Calibrated: 12/9/2016
- Phantom: TWIN SAM; Type: QD000P40CA; Serial: TP-1218
- Measurement SW: DASY4, V4.5 Build 19; Postprocessing SW: SEMCAD, V1.8 Build 145

PCS 1900-body-worn-bottom-mid /Area Scan (61x81x1): Measurement grid: $dx=10\text{mm}$, $dy=10\text{mm}$
Maximum value of SAR (interpolated) = 0.240 mW/g

PCS 1900-body-worn-bottom-mid /Zoom Scan (7x7x7)/Cube 0: Measurement grid: $dx=5\text{mm}$, $dy=5\text{mm}$, $dz=5\text{mm}$

Reference Value = 3.25 V/m; Power Drift = 0.012 dB

Peak SAR (extrapolated) = 0.217 W/kg

SAR(1 g) = 0.186 mW/g; SAR(10 g) = 0.127 mW/g

Maximum value of SAR (measured) = 0.196 mW/g

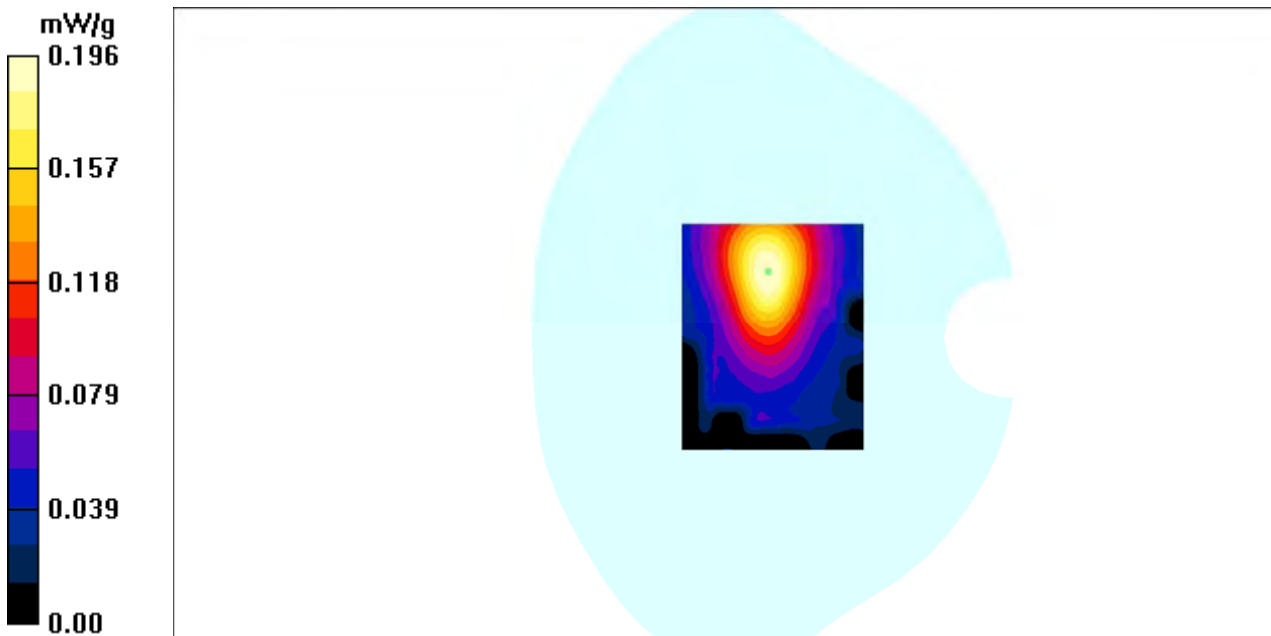

Test Laboratory: Bay Area Compliance Labs Corp.(Shenzhen)

Test Plot 77#: WCDMA 850 Body Worn Back Middle Channel

DUT: 3G/4G Smart Phone; Model: SKY 5.0LM

Communication System: 3G Band; Frequency: 836.6 MHz;Duty Cycle: 1:1
Medium parameters used: $f = 836.6$ MHz; $\sigma = 0.97$ S/m; $\epsilon_r = 53.62$; $\rho = 1000$ kg/m³
Phantom section: Flat Section

DASY4 Configuration:

- Probe: ES3DV3 - SN3036; ConvF(6.20, 6.20, 6.20); Calibrated: 16/9/2016
- Sensor-Surface: 4mm (Mechanical Surface Detection)
- Electronics: Dummy DAE - SN:456; Calibrated: 12/9/2016
- Phantom: TWIN SAM; Type: QD000P40CA; Serial: TP-1218
- Measurement SW: DASY4, V4.5 Build 19; Postprocessing SW: SEMCAD, V1.8 Build 145

WCDMA 850-body-worn-back-mid/Area Scan (91x111x1): Measurement grid: dx=10mm, dy=10mm
Maximum value of SAR (interpolated) = 0.387 mW/g

WCDMA 850-body-worn-back-mid /Zoom Scan (7x7x7)/Cube 0: Measurement grid: dx=5mm, dy=5mm, dz=5mm

Reference Value = 12.9 V/m; Power Drift = 0.023 dB

Peak SAR (extrapolated) = 0.412 W/kg

SAR(1 g) = 0.387 mW/g; SAR(10 g) = 0.228 mW/g

Maximum value of SAR (measured) = 0.389 mW/g

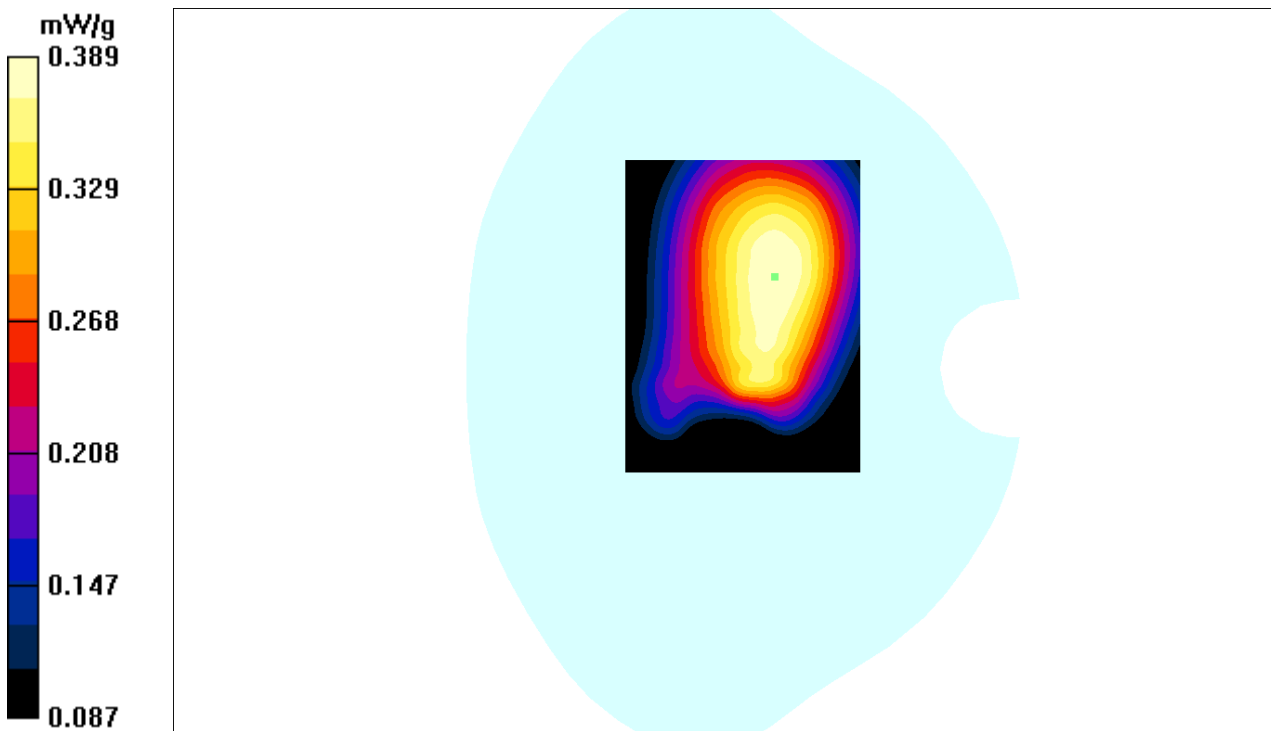

Test Laboratory: Bay Area Compliance Labs Corp.(Shenzhen)

Test Plot 78#:WCDMA 850 Body Worn Left Middle Channel

DUT: 3G/4G Smart Phone ; Model:SKY 5.0LM

Communication System: 3G Band; Frequency: 836.6 MHz;Duty Cycle: 1:1
 Medium parameters used: $f = 836.6 \text{ MHz}$; $\sigma = 0.97 \text{ S/m}$; $\epsilon_r = 53.62$; $\rho = 1000 \text{ kg/m}^3$
 Phantom section: Flat Section

DASY4 Configuration:

- Probe: ES3DV3 - SN3036; ConvF(6.20, 6.20, 6.20); Calibrated: 16/9/2016
- Sensor-Surface: 4mm (Mechanical Surface Detection)
- Electronics: Dummy DAE - SN:456; Calibrated: 12/9/2016
- Phantom: TWIN SAM; Type: QD000P40CA; Serial: TP-1218
- Measurement SW: DASY4, V4.5 Build 19; Postprocessing SW: SEMCAD, V1.8 Build 145

WCDMA 850-body-worn-left-mid/Area Scan (91x111x1): Measurement grid: $dx=10\text{mm}$, $dy=10\text{mm}$
 Maximum value of SAR (interpolated) = 0.339 mW/g

WCDMA 850-body-worn-left-mid /Zoom Scan (7x7x7)/Cube 0: Measurement grid: $dx=5\text{mm}$, $dy=5\text{mm}$, $dz=5\text{mm}$
 Reference Value = 3.15 V/m; Power Drift = -0.071 dB
 Peak SAR (extrapolated) = 0.351 W/kg
SAR(1 g) = 0.219 mW/g; SAR(10 g) = 0.103 mW/g
 Maximum value of SAR (measured) = 0.331 mW/g

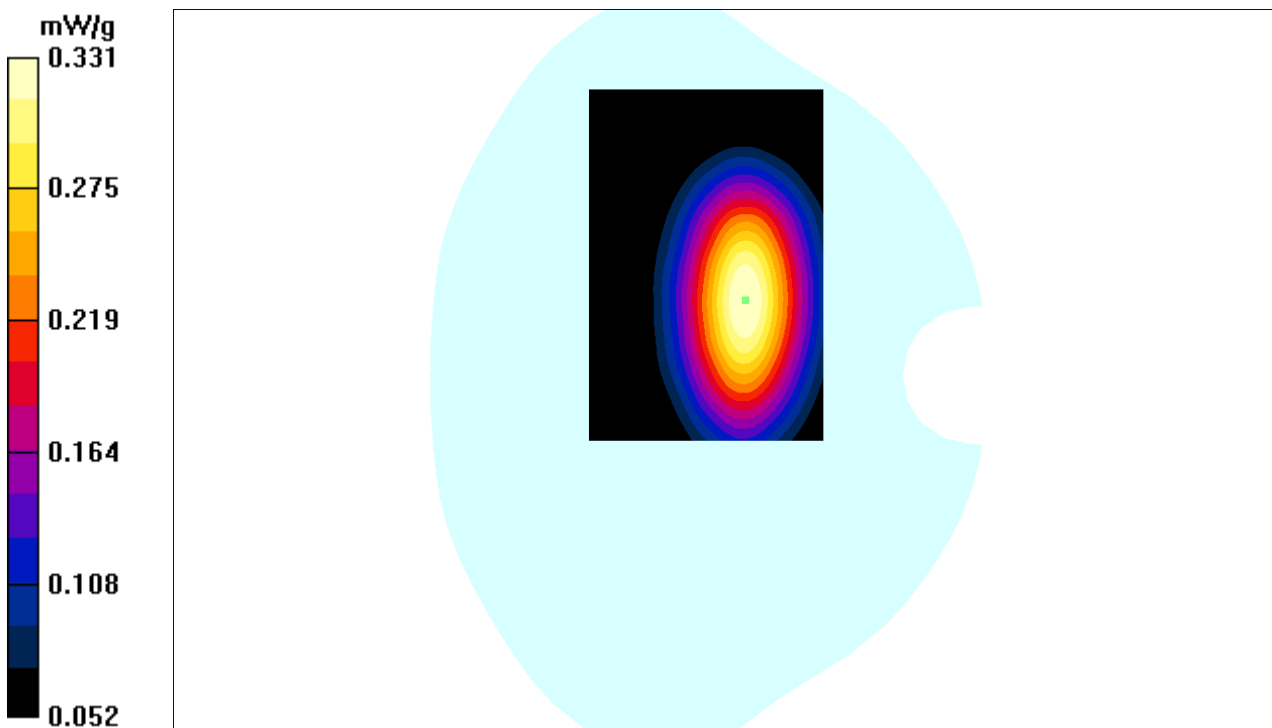

Test Laboratory: Bay Area Compliance Labs Corp.(Shenzhen)

Test Plot 79#:WCDMA 850 Body Worn Right Middle Channel

DUT: 3G/4G Smart Phone ; Model:SKY 5.0LM

Communication System: 3G Band; Frequency: 836.6 MHz;Duty Cycle: 1:1
Medium parameters used: $f = 836.6 \text{ MHz}$; $\sigma = 0.97 \text{ S/m}$; $\epsilon_r = 53.62$; $\rho = 1000 \text{ kg/m}^3$
Phantom section: Flat Section

DASY4 Configuration:

- Probe: ES3DV3 - SN3036; ConvF(6.20, 6.20, 6.20); Calibrated: 16/9/2016
- Sensor-Surface: 4mm (Mechanical Surface Detection)
- Electronics: Dummy DAE - SN:456; Calibrated: 12/9/2016
- Phantom: TWIN SAM; Type: QD000P40CA; Serial: TP-1218
- Measurement SW: DASY4, V4.5 Build 19; Postprocessing SW: SEMCAD, V1.8 Build 145

WCDMA 850-body-worn-right-mid/Area Scan (91x111x1): Measurement grid: $dx=10\text{mm}$, $dy=10\text{mm}$
Maximum value of SAR (interpolated) = 0.271 mW/g

WCDMA 850-body-worn-right-mid /Zoom Scan (7x7x7)/Cube 0: Measurement grid: $dx=5\text{mm}$,
 $dy=5\text{mm}$, $dz=5\text{mm}$
Reference Value =3.9 V/m; Power Drift = 0.08 dB
Peak SAR (extrapolated) = 0.268 W/kg
SAR(1 g) = 0.259 mW/g; SAR(10 g) = 0.135 mW/g
Maximum value of SAR (measured) = 0.261 mW/g

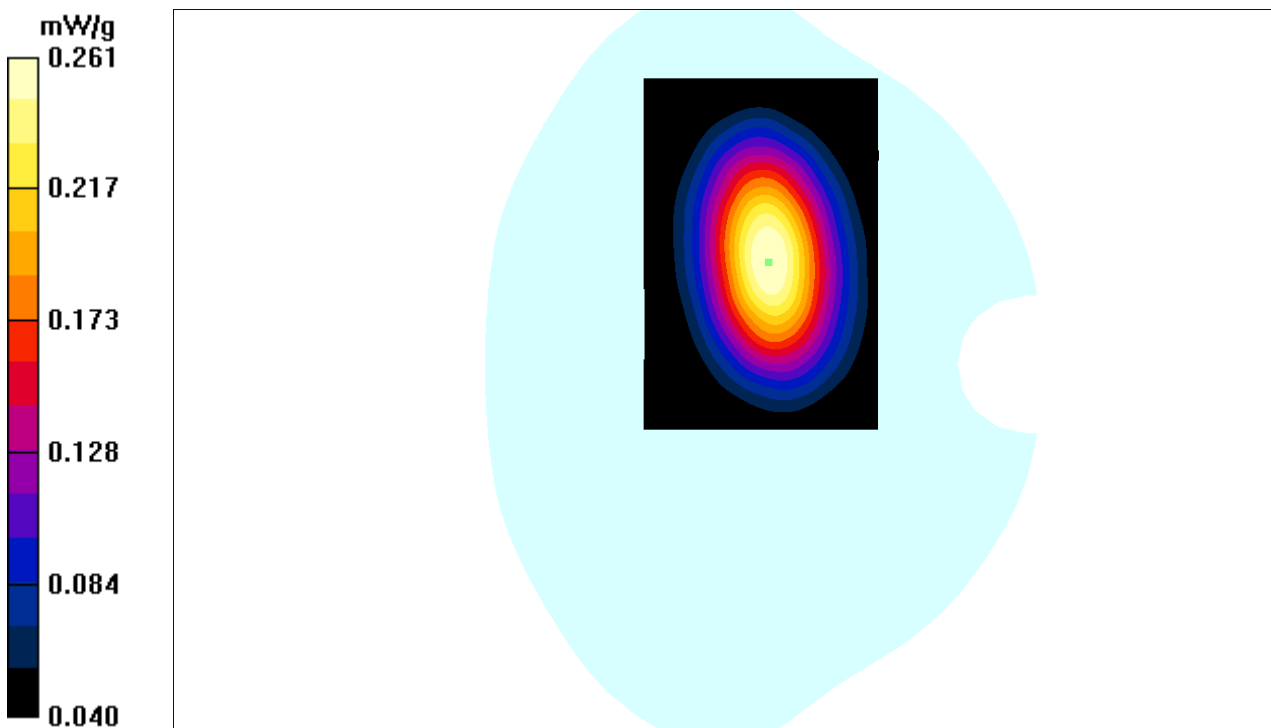

Test Laboratory: Bay Area Compliance Labs Corp.(Shenzhen)

Test Plot 80#: WCDMA 850 Body Worn Bottom Middle Channel

DUT: 3G/4G Smart Phone; Model: SKY 5.0LM

Communication System: 3G Band; Frequency: 836.6 MHz;Duty Cycle: 1:1
Medium parameters used: $f = 836.6 \text{ MHz}$; $\sigma = 0.97 \text{ S/m}$; $\epsilon_r = 53.62$; $\rho = 1000 \text{ kg/m}^3$
Phantom section: Flat Section

DASY4 Configuration:

- Probe: ES3DV3 - SN3036; ConvF(6.20, 6.20, 6.20); Calibrated: 16/9/2016
- Sensor-Surface: 4mm (Mechanical Surface Detection)
- Electronics: Dummy DAE - SN:456; Calibrated: 12/9/2016
- Phantom: TWIN SAM; Type: QD000P40CA; Serial: TP-1218
- Measurement SW: DASY4, V4.5 Build 19; Postprocessing SW: SEMCAD, V1.8 Build 145

WCDMA 850-body-worn-bottom-mid/Area Scan (81x101x1): Measurement grid: $dx=10\text{mm}$, $dy=10\text{mm}$
Maximum value of SAR (interpolated) = 0.212 mW/g

WCDMA 850-body-worn-bottom-mid /Zoom Scan (7x7x7)/Cube 0: Measurement grid: $dx=5\text{mm}$, $dy=5\text{mm}$, $dz=5\text{mm}$

Reference Value = 7.24 V/m; Power Drift = 0.047 dB

Peak SAR (extrapolated) = 0.189 W/kg

SAR(1 g) = 0.162 mW/g; SAR(10 g) = 0.099 mW/g

Maximum value of SAR (measured) = 0.175 mW/g

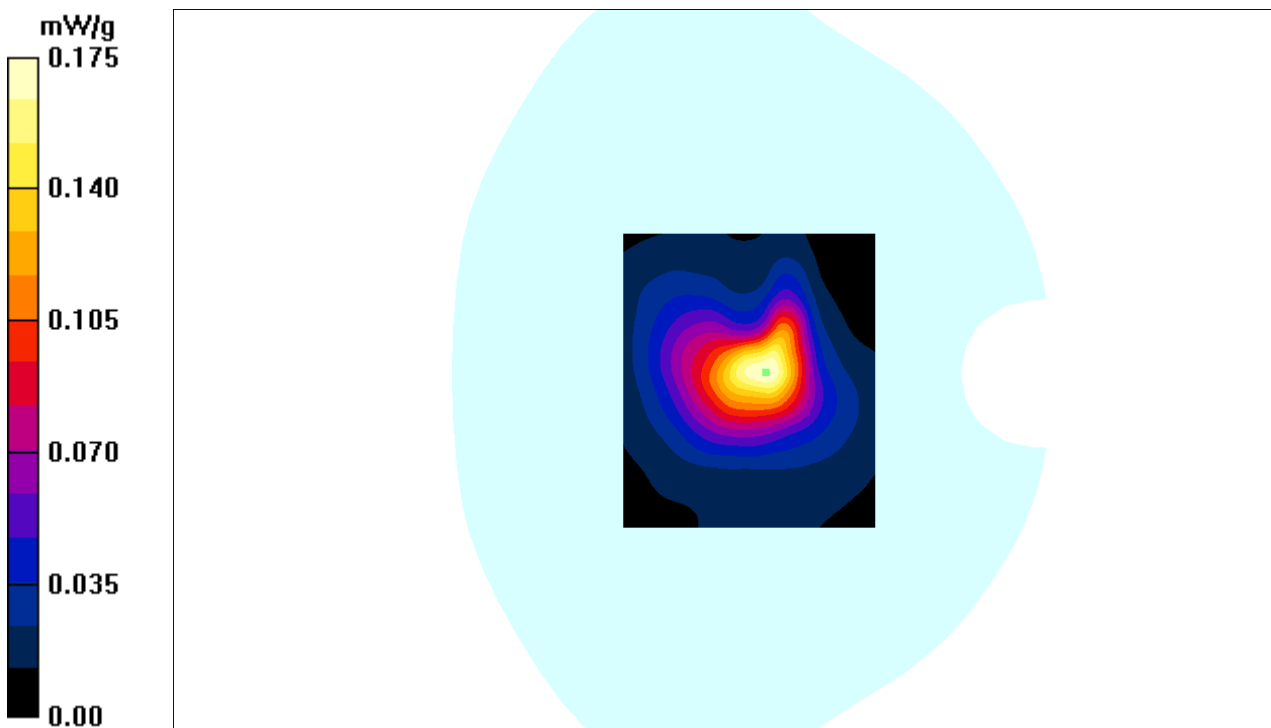

Test Laboratory: Bay Area Compliance Labs Corp.(Shenzhen)

Test Plot 81#: WCDMA 1700 Body Worn Back Middle Channel

DUT: 3G/4G Smart Phone; Model: SKY 5.0LM

Communication System: 3G Band; Frequency: 1732.6 MHz;Duty Cycle: 1:1
Medium parameters used: $f = 1732.6 \text{ MHz}$; $\sigma = 1.47 \text{ S/m}$; $\epsilon_r = 52.42$; $\rho = 1000 \text{ kg/m}^3$
Phantom section: Flat Section

DASY4 Configuration:

- Probe: ES3DV3 - SN3036; ConvF(5.04, 5.04, 5.04); Calibrated: 16/9/2016
- Sensor-Surface: 4mm (Mechanical Surface Detection)
- Electronics: Dummy DAE - SN:456; Calibrated: 12/9/2016
- Phantom: TWIN SAM; Type: QD000P40CA; Serial: TP-1218
- Measurement SW: DASY4, V4.5 Build 19; Postprocessing SW: SEMCAD, V1.8 Build 145

WCDMA 1700-body-worn-back-mid/Area Scan (81x101x1): Measurement grid: $dx=10\text{mm}$, $dy=10\text{mm}$
Maximum value of SAR (interpolated) = 0.664 mW/g

WCDMA 1700-body-worn-back-mid /Zoom Scan (7x7x7)/Cube 0: Measurement grid: $dx=5\text{mm}$, $dy=5\text{mm}$, $dz=5\text{mm}$
Reference Value = 6.9 V/m; Power Drift = 0.125 dB
Peak SAR (extrapolated) = 0.616 W/kg
SAR(1 g) = 0.632 mW/g; SAR(10 g) = 0.378 mW/g
Maximum value of SAR (measured) = 0.649 mW/g

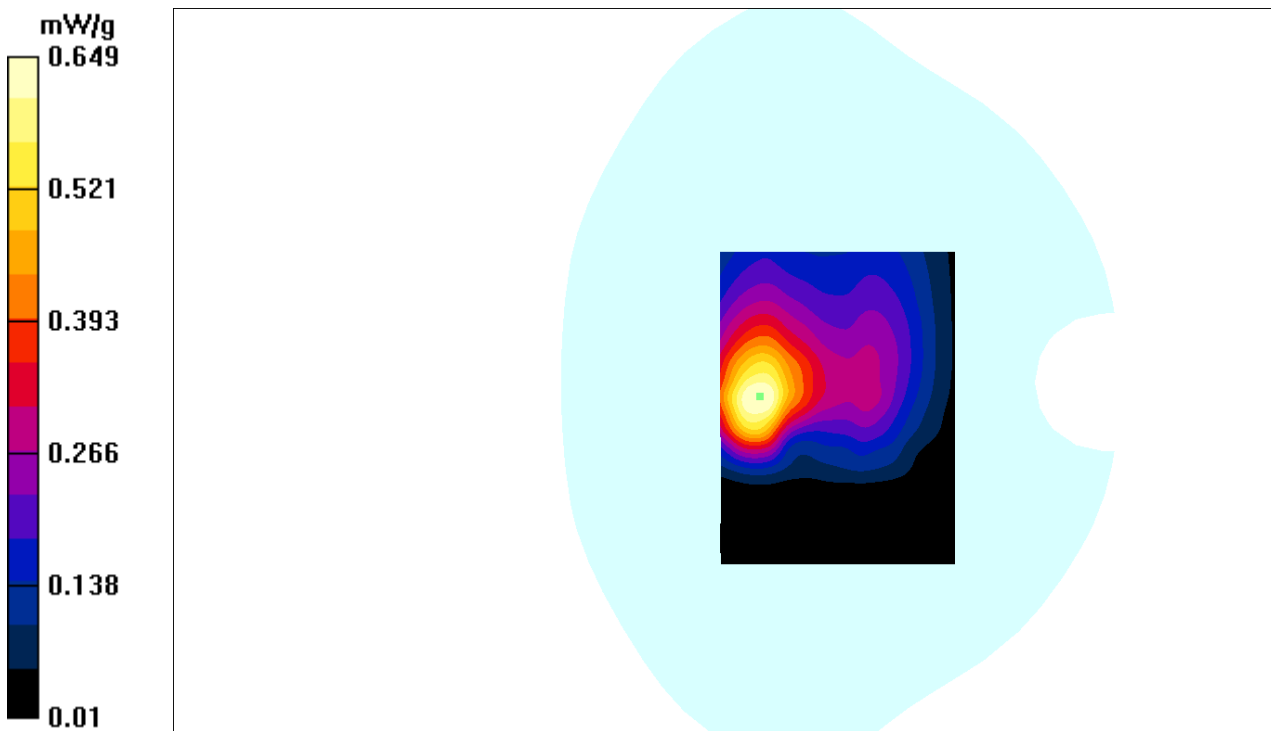

Test Laboratory: Bay Area Compliance Labs Corp.(Shenzhen)

Test Plot 82#:WCDMA 1700 Body Worn Left Middle Channel

DUT: 3G/4G Smart Phone ; Model:SKY 5.0LM

Communication System: 3G Band; Frequency: 1732.6 MHz;Duty Cycle: 1:1
Medium parameters used: $f = 1732.6 \text{ MHz}$; $\sigma = 1.47 \text{ S/m}$; $\epsilon_r = 52.42$; $\rho = 1000 \text{ kg/m}^3$
Phantom section: Flat Section

DASY4 Configuration:

- Probe: ES3DV3 - SN3036; ConvF(5.04, 5.04, 5.04); Calibrated: 16/9/2016
- Sensor-Surface: 4mm (Mechanical Surface Detection)
- Electronics: Dummy DAE - SN:456; Calibrated: 12/9/2016
- Phantom: TWIN SAM; Type: QD000P40CA; Serial: TP-1218
- Measurement SW: DASY4, V4.5 Build 19; Postprocessing SW: SEMCAD, V1.8 Build 145

WCDMA 1700-body-worn-left-mid/Area Scan (81x101x1): Measurement grid: $dx=10\text{mm}$, $dy=10\text{mm}$
Maximum value of SAR (interpolated) = 0.211 mW/g

WCDMA 1700-body-worn-left-mid /Zoom Scan (7x7x7)/Cube 0: Measurement grid: $dx=5\text{mm}$,
 $dy=5\text{mm}$, $dz=5\text{mm}$
Reference Value = 6.1 V/m; Power Drift = -0.170 dB
Peak SAR (extrapolated) = 0.247 W/kg
SAR(1 g) = 0.232 mW/g; SAR(10 g) = 0.152 mW/g
Maximum value of SAR (measured) = 0.240 mW/g

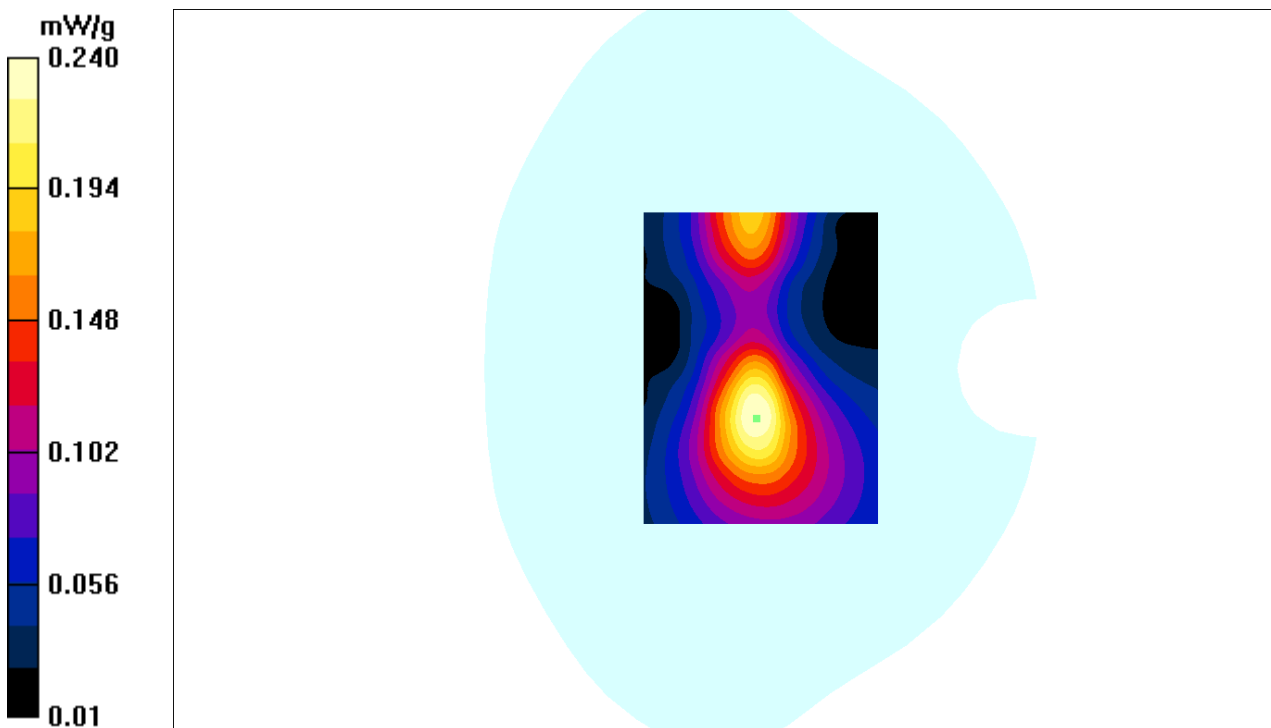

Test Laboratory: Bay Area Compliance Labs Corp.(Shenzhen)

Test Plot 83#:WCDMA 1700 Body Worn Right Middle Channel

DUT: 3G/4G Smart Phone ; Model:SKY 5.0LM

Communication System: 3G Band; Frequency: 1732.6 MHz;Duty Cycle: 1:1
Medium parameters used: $f = 1732.6$ MHz; $\sigma = 1.47$ S/m; $\epsilon_r = 52.42$; $\rho = 1000$ kg/m³
Phantom section: Flat Section

DASY4 Configuration:

- Probe: ES3DV3 - SN3036; ConvF(5.04, 5.04, 5.04); Calibrated: 16/9/2016
- Sensor-Surface: 4mm (Mechanical Surface Detection)
- Electronics: Dummy DAE - SN:456; Calibrated: 12/9/2016
- Phantom: TWIN SAM; Type: QD000P40CA; Serial: TP-1218
- Measurement SW: DASY4, V4.5 Build 19; Postprocessing SW: SEMCAD, V1.8 Build 145

WCDMA 1700-body-worn-right-mid/Area Scan (91x111x1): Measurement grid: dx=10mm, dy=10mm
Maximum value of SAR (interpolated) = 0.321 mW/g

WCDMA 1700-body-worn-right-mid /Zoom Scan (7x7x7)/Cube 0: Measurement grid: dx=5mm, dy=5mm, dz=5mm
Reference Value =5.3 V/m; Power Drift = 0.11 dB
Peak SAR (extrapolated) = 0.188 W/kg
SAR(1 g) = 0.287 mW/g; SAR(10 g) = 0.129 mW/g
Maximum value of SAR (measured) = 0.301 mW/g

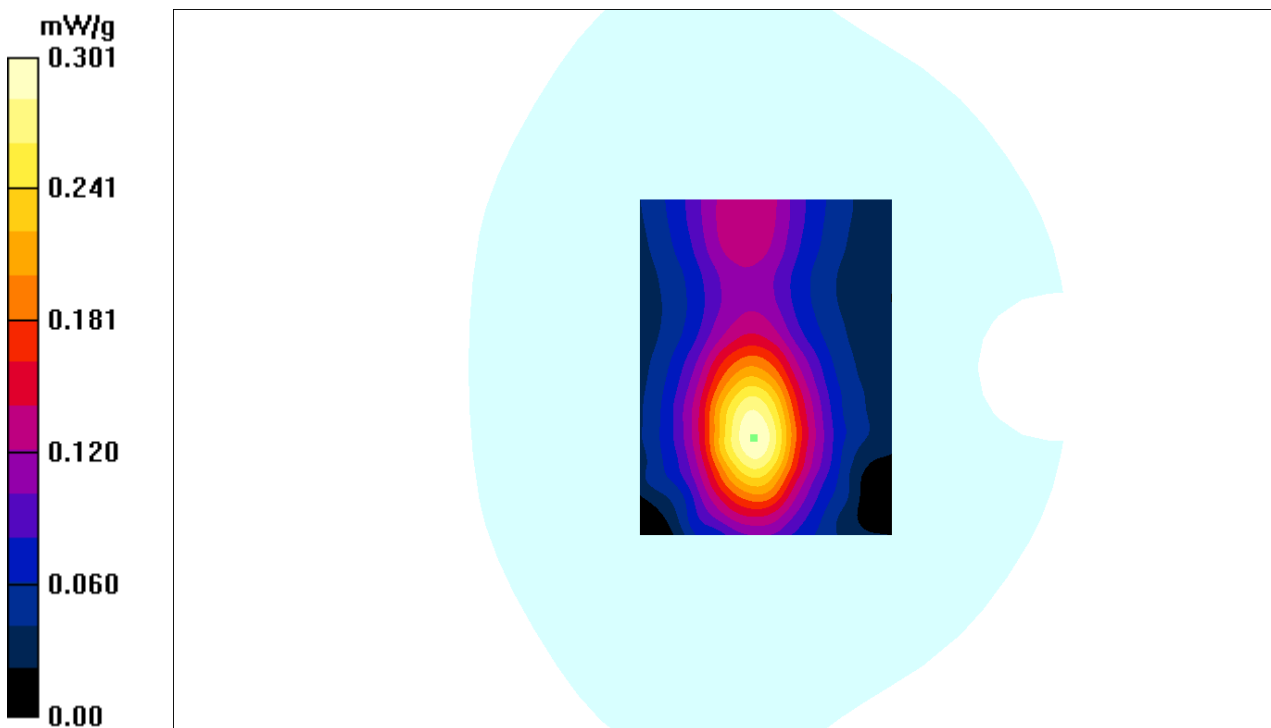

Test Laboratory: Bay Area Compliance Labs Corp.(Shenzhen)

Test Plot 84#:WCDMA 1700 Body Worn Bottom Middle Channel

DUT: 3G/4G Smart Phone ; Model:SKY 5.0LM

Communication System: 3G Band; Frequency: 1732.6 MHz;Duty Cycle: 1:1
Medium parameters used: $f = 1732.6 \text{ MHz}$; $\sigma = 1.47 \text{ S/m}$; $\epsilon_r = 52.42$; $\rho = 1000 \text{ kg/m}^3$
Phantom section: Flat Section

DASY4 Configuration:

- Probe: ES3DV3 - SN3036; ConvF(5.04, 5.04, 5.04); Calibrated: 16/9/2016
- Sensor-Surface: 4mm (Mechanical Surface Detection)
- Electronics: Dummy DAE - SN:456; Calibrated: 12/9/2016
- Phantom: TWIN SAM; Type: QD000P40CA; Serial: TP-1218
- Measurement SW: DASY4, V4.5 Build 19; Postprocessing SW: SEMCAD, V1.8 Build 145

WCDMA 1700-body-worn-bottom-mid/Area Scan (81x91x1): Measurement grid: $dx=10\text{mm}$, $dy=10\text{mm}$
Maximum value of SAR (interpolated) = 0.627 mW/g

WCDMA 1700-body-worn-bottom-mid /Zoom Scan (7x7x7)/Cube 0: Measurement grid: $dx=5\text{mm}$, $dy=5\text{mm}$, $dz=5\text{mm}$
Reference Value = 5.14 V/m; Power Drift = 0.068 dB
Peak SAR (extrapolated) = 0.182 W/kg
SAR(1 g) = 0.563 mW/g; SAR(10 g) = 0.419 mW/g
Maximum value of SAR (measured) = 0.629 mW/g

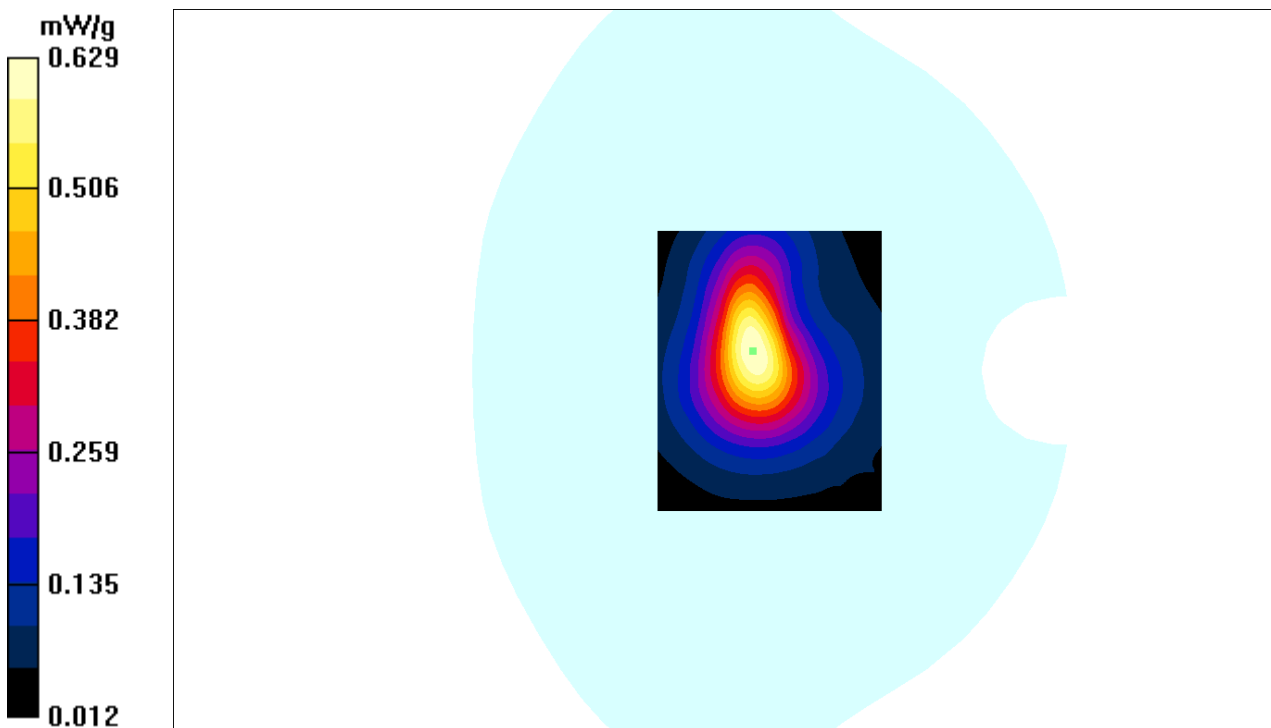

Test Laboratory: Bay Area Compliance Labs Corp.(Shenzhen)

Test Plot 85#:WCDMA 1900 Body Worn Back Middle Channel

DUT: 3G/4G Smart Phone ; Model:SKY 5.0LM

Communication System: 3G Band; Frequency: 1880.0 MHz;Duty Cycle: 1:1
Medium parameters used: $f = 1880.0$ MHz; $\sigma = 1.50$ S/m; $\epsilon_r = 52.46$; $\rho = 1000$ kg/m³
Phantom section: Flat Section

DASY4 Configuration:

- Probe: ES3DV3 - SN3036; ConvF(4.79, 4.79, 4.79); Calibrated: 16/9/2016
- Sensor-Surface: 4mm (Mechanical Surface Detection)
- Electronics: Dummy DAE - SN:456; Calibrated: 12/9/2016
- Phantom: TWIN SAM; Type: QD000P40CA; Serial: TP-1218
- Measurement SW: DASY4, V4.5 Build 19; Postprocessing SW: SEMCAD, V1.8 Build 145

WCDMA 1900-body-worn-back-Middle/Area Scan (61x101x1): Measurement grid: dx=10mm, dy=10mm
Maximum value of SAR (interpolated) = 0.567 mW/g

WCDMA 1900-body-worn-back-Middle /Zoom Scan (7x7x7)/Cube 0: Measurement grid: dx=5mm, dy=5mm, dz=5mm
Reference Value = 5.51 V/m; Power Drift = -0.087 dB
Peak SAR (extrapolated) = 0.602 W/kg
SAR(1 g) = 0.582 mW/g; SAR(10 g) = 0.372 mW/g
Maximum value of SAR (measured) = 0.614 mW/g

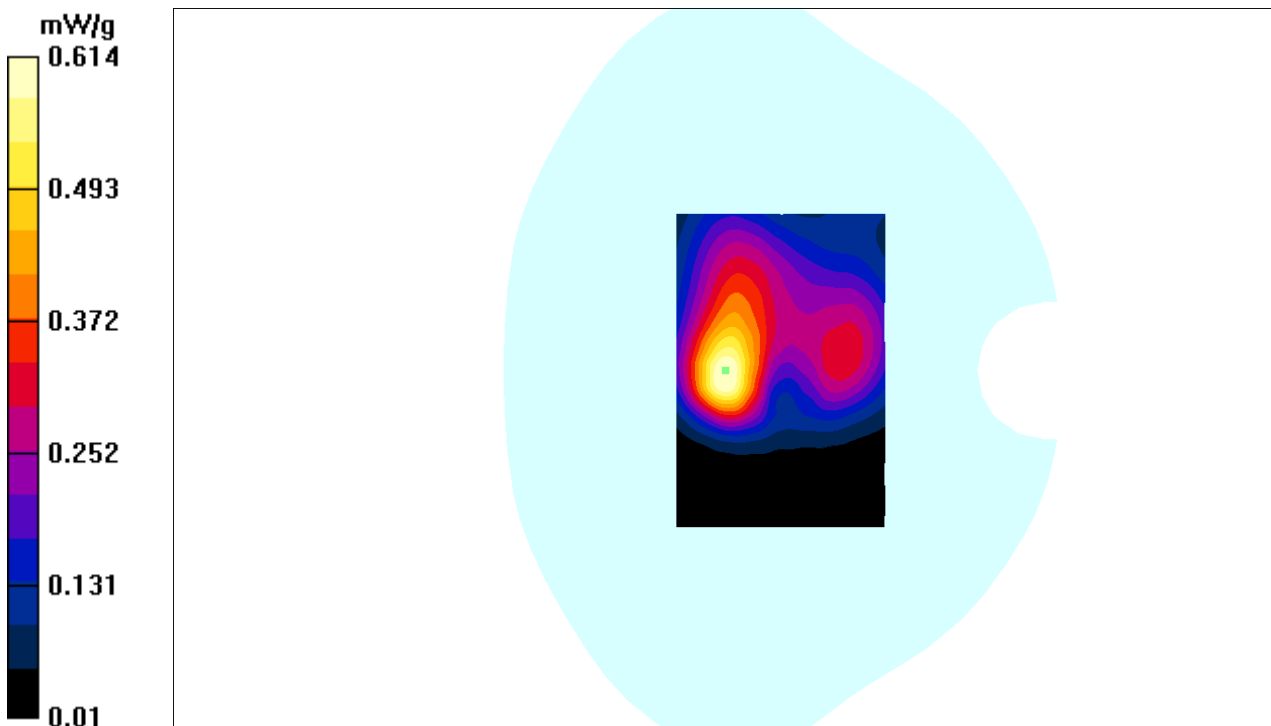

Test Laboratory: Bay Area Compliance Labs Corp.(Shenzhen)

Test Plot 86#:WCDMA 1900 Body Worn Left Middle Channel

DUT: 3G/4G Smart Phone ; Model:SKY 5.0LM

Communication System: 3G Band; Frequency: 1880.0 MHz;Duty Cycle: 1:1
Medium parameters used: $f = 1880.0$ MHz; $\sigma = 1.50$ S/m; $\epsilon_r = 52.46$; $\rho = 1000$ kg/m³
Phantom section: Flat Section

DASY4 Configuration:

- Probe: ES3DV3 - SN3036; ConvF(4.79, 4.79, 4.79); Calibrated: 16/9/2016
- Sensor-Surface: 4mm (Mechanical Surface Detection)
- Electronics: Dummy DAE - SN:456; Calibrated: 12/9/2016
- Phantom: TWIN SAM; Type: QD000P40CA; Serial: TP-1218
- Measurement SW: DASY4, V4.5 Build 19; Postprocessing SW: SEMCAD, V1.8 Build 145

WCDMA 1900-body-worn-left-Middle/Area Scan (61x81x1): Measurement grid: dx=10mm, dy=10mm
Maximum value of SAR (interpolated) = 0.320 mW/g

WCDMA 1900-body-worn-left-Middle /Zoom Scan (7x7x7)/Cube 0: Measurement grid: dx=5mm, dy=5mm, dz=5mm

Reference Value = 3.85 V/m; Power Drift = 0.228 dB

Peak SAR (extrapolated) = 0.245 W/kg

SAR(1 g) = 0.218 mW/g; SAR(10 g) = 0.159 mW/g

Maximum value of SAR (measured) = 0.246 mW/g

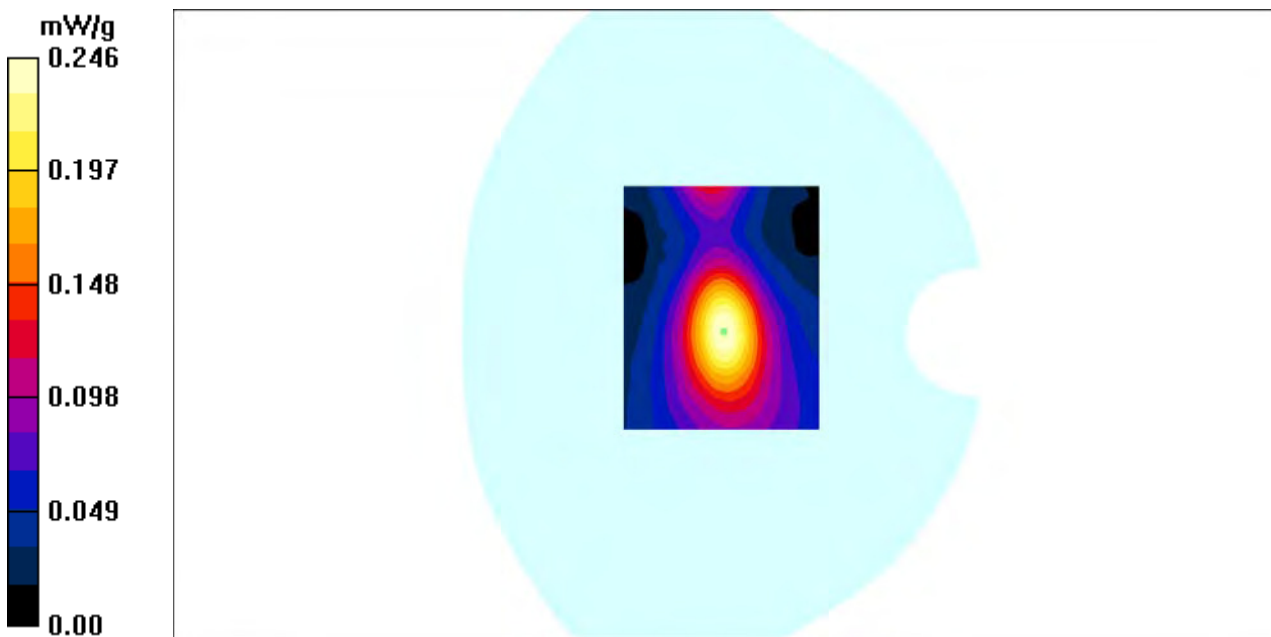

Test Laboratory: Bay Area Compliance Labs Corp.(Shenzhen)

Test Plot 87#: WCDMA 1900 Body Worn Right Middle Channel

DUT: 3G/4G Smart Phone ; Model:SKY 5.0LM

Communication System: 3G Band; Frequency: 1880.0 MHz;Duty Cycle: 1:1
Medium parameters used: $f = 1880.0$ MHz; $\sigma = 1.50$ S/m; $\epsilon_r = 52.46$; $\rho = 1000$ kg/m³
Phantom section: Flat Section

DASY4 Configuration:

- Probe: ES3DV3 - SN3036; ConvF(4.79, 4.79, 4.79); Calibrated: 16/9/2016
- Sensor-Surface: 4mm (Mechanical Surface Detection)
- Electronics: Dummy DAE - SN:456; Calibrated: 12/9/2016
- Phantom: TWIN SAM; Type: QD000P40CA; Serial: TP-1218
- Measurement SW: DASY4, V4.5 Build 19; Postprocessing SW: SEMCAD, V1.8 Build 145

WCDMA 1900-body-worn-right-Middle/Area Scan (61x81x1): Measurement grid: dx=10mm, dy=10mm
Maximum value of SAR (interpolated) = 0.356 mW/g

WCDMA 1900-body-worn-right-Middle /Zoom Scan (7x7x7)/Cube 0: Measurement grid: dx=5mm, dy=5mm, dz=5mm
Reference Value = 6.19 V/m; Power Drift = 0.087 dB
Peak SAR (extrapolated) = 0.315 W/kg
SAR(1 g) = 0.287 mW/g; SAR(10 g) = 0.148 mW/g
Maximum value of SAR (measured) = 0.291 mW/g

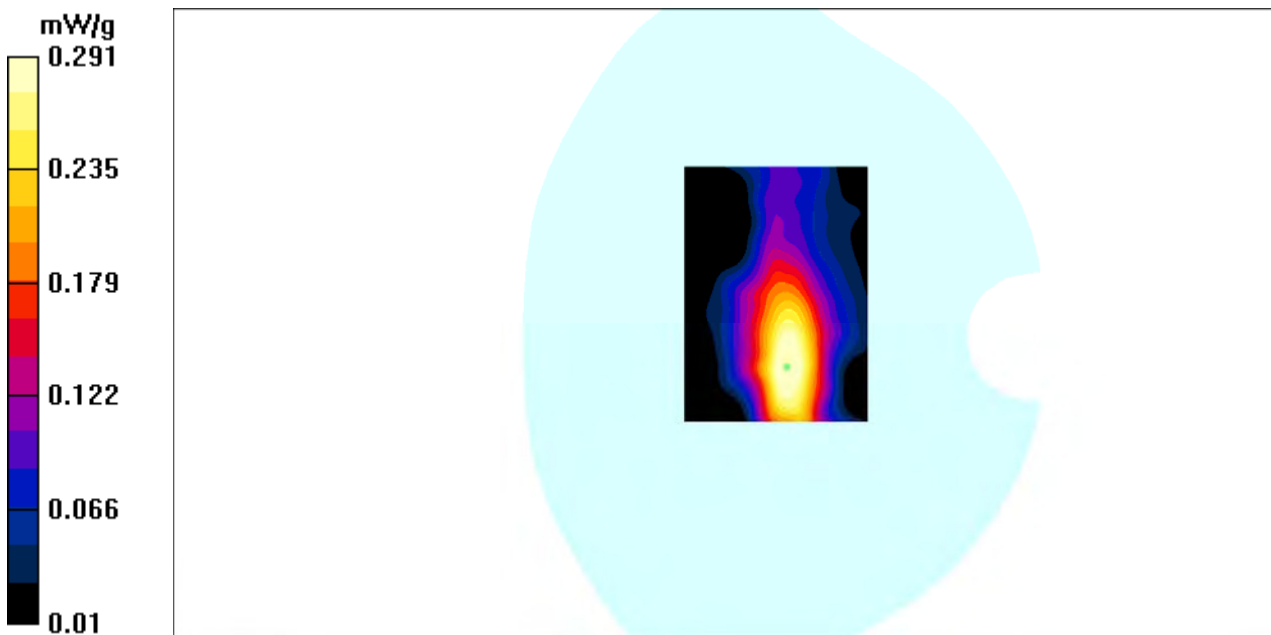

Test Laboratory: Bay Area Compliance Labs Corp.(Shenzhen)

Test Plot 88#:WCDMA 1900 Body Worn Bottom Middle Channel

DUT: 3G/4G Smart Phone ; Model:SKY 5.0LM

Communication System: 3G Band; Frequency: 1880.0 MHz;Duty Cycle: 1:1
Medium parameters used: $f = 1880.0$ MHz; $\sigma = 1.50$ S/m; $\epsilon_r = 52.46$; $\rho = 1000$ kg/m³
Phantom section: Flat Section

DASY4 Configuration:

- Probe: ES3DV3 - SN3036; ConvF(4.79, 4.79, 4.79); Calibrated: 16/9/2016
- Sensor-Surface: 4mm (Mechanical Surface Detection)
- Electronics: Dummy DAE - SN:456; Calibrated: 12/9/2016
- Phantom: TWIN SAM; Type: QD000P40CA; Serial: TP-1218
- Measurement SW: DASY4, V4.5 Build 19; Postprocessing SW: SEMCAD, V1.8 Build 145

WCDMA 1900-body-worn-bottom-Middle/Area Scan (81x101x1): Measurement grid: dx=10mm, dy=10mm
Maximum value of SAR (interpolated) = 0.726 mW/g

WCDMA 1900-body-worn-bottom-Middle /Zoom Scan (7x7x7)/Cube 0: Measurement grid: dx=5mm, dy=5mm, dz=5mm
Reference Value = 8.98 V/m; Power Drift = -0.052 dB
Peak SAR (extrapolated) = 0.631 W/kg
SAR(1 g) = 0.641 mW/g; SAR(10 g) = 0.379 mW/g
Maximum value of SAR (measured) = 0.662 mW/g

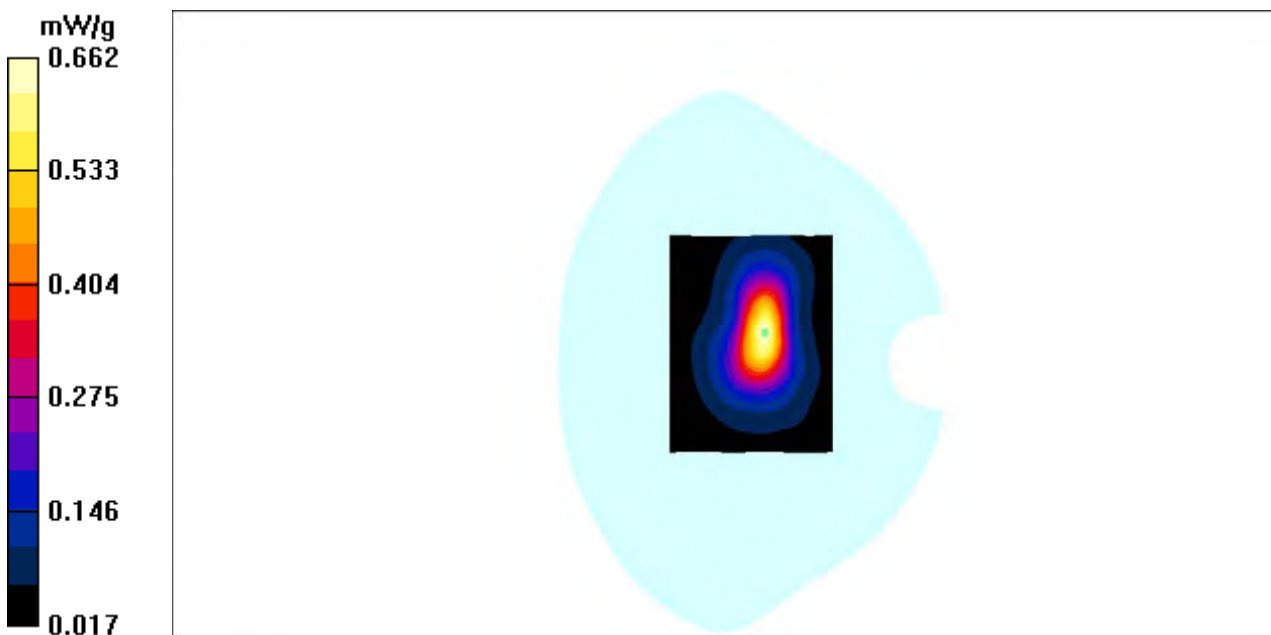

Test Laboratory: Bay Area Compliance Labs Corp.(Shenzhen)

Test Plot 89#: LTE Band 2 Body Worn Back High Channel

DUT: 3G/4G Smart Phone; Model: SKY 5.0LM

Communication System: LTE 4G Band; Frequency: 1900 MHz;Duty Cycle: 1:1
Medium parameters used: $f = 1900$ MHz; $\sigma = 1.51$ S/m; $\epsilon_r = 52.59$; $\rho = 1000$ kg/m³
Phantom section: Flat Section

DASY4 Configuration:

- Probe: ES3DV3 - SN3036; ConvF(4.79, 4.79, 4.79); Calibrated: 16/9/2016
- Sensor-Surface: 4mm (Mechanical Surface Detection)
- Electronics: Dummy DAE - SN:456; Calibrated: 12/9/2016
- Phantom: TWIN SAM; Type: QD000P40CA; Serial: TP-1218
- Measurement SW: DASY4, V4.5 Build 19; Postprocessing SW: SEMCAD, V1.8 Build 145

LTE Band 2-body-worn-back-high-1RB /Area Scan (81x101x1): Measurement grid: dx=10mm, dy=10mm
Maximum value of SAR (interpolated) = 0.767 mW/g

LTE Band 2-body-worn-back-high-1RB /Zoom Scan (7x7x7)/Cube 0: Measurement grid: dx=5mm, dy=5mm, dz=5mm
Reference Value = 7.21 V/m; Power Drift = -0.034 dB
Peak SAR (extrapolated) = 0.702 W/kg
SAR(1 g) = 0.657 mW/g; SAR(10 g) = 0.392 mW/g
Maximum value of SAR (measured) = 0.669 mW/g

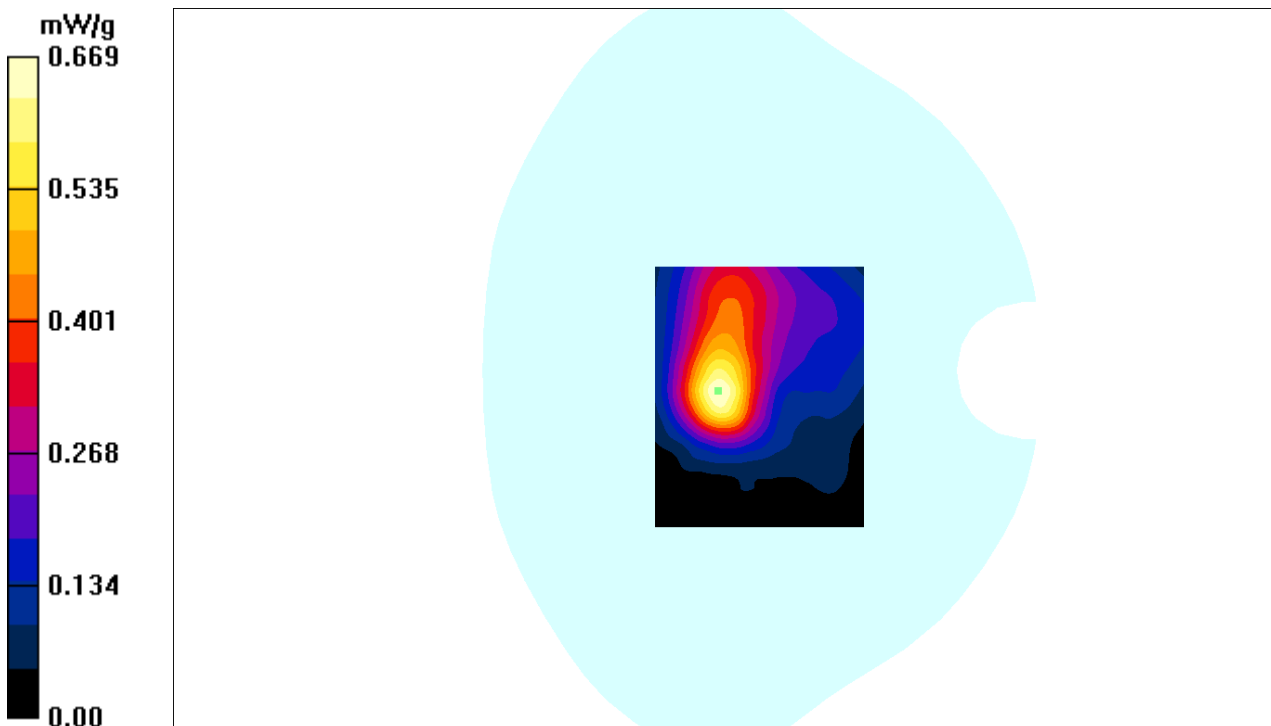

Test Laboratory: Bay Area Compliance Labs Corp.(Shenzhen)

Test Plot 90#:LTE Band 2 Body Worn Back High Channel

DUT: 3G/4G Smart Phone; Model: SKY 5.0LM

Communication System: LTE 4G Band; Frequency: 1900 MHz;Duty Cycle: 1:1
Medium parameters used: $f = 1900$ MHz; $\sigma = 1.51$ S/m; $\epsilon_r = 52.59$; $\rho = 1000$ kg/m³
Phantom section: Flat Section

DASY4 Configuration:

- Probe: ES3DV3 - SN3036; ConvF(4.79, 4.79, 4.79); Calibrated: 16/9/2016
- Sensor-Surface: 4mm (Mechanical Surface Detection)
- Electronics: Dummy DAE - SN:456; Calibrated: 12/9/2016
- Phantom: TWIN SAM; Type: QD000P40CA; Serial: TP-1218
- Measurement SW: DASY4, V4.5 Build 19; Postprocessing SW: SEMCAD, V1.8 Build 145

LTE Band 2-body-worn-back-high-50%RB /Area Scan (61x81x1): Measurement grid: dx=10mm, dy=10mm
Maximum value of SAR (interpolated) = 0.597 mW/g

LTE Band 2-body-worn-back-high-50%RB /Zoom Scan (7x7x7)/Cube 0: Measurement grid: dx=5mm, dy=5mm, dz=5mm
Reference Value = 2.91 V/m; Power Drift = -0.094 dB
Peak SAR (extrapolated) = 0.622 W/kg
SAR(1 g) = 0.567 mW/g; SAR(10 g) = 0.392 mW/g
Maximum value of SAR (measured) = 0.580 mW/g

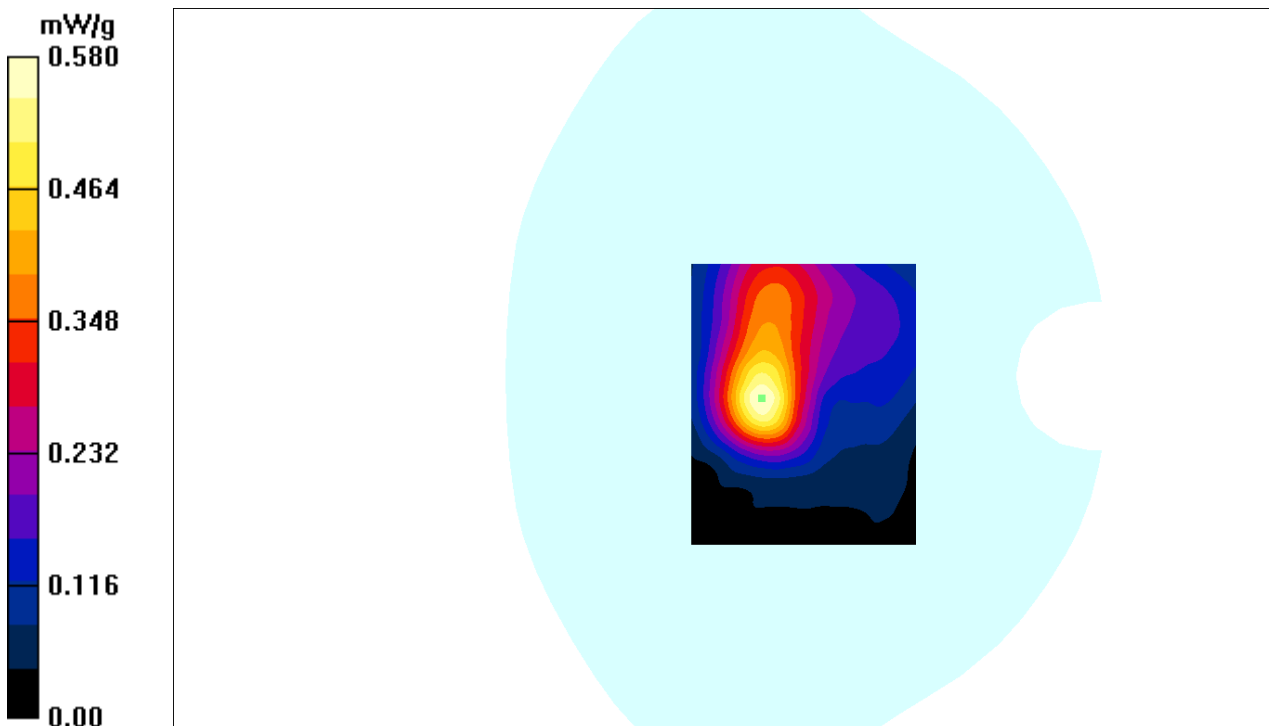

Test Laboratory: Bay Area Compliance Labs Corp.(Shenzhen)

Test Plot 91#:LTE Band 2 Body Worn Left High Channel

DUT: 3G/4G Smart Phone ; Model:SKY 5.0LM

Communication System: LTE 4G Band; Frequency: 1900 MHz;Duty Cycle: 1:1
Medium parameters used: $f = 1900$ MHz; $\sigma = 1.51$ S/m; $\epsilon_r = 52.59$; $\rho = 1000$ kg/m³
Phantom section: Flat Section

DASY4 Configuration:

- Probe: ES3DV3 - SN3036; ConvF(4.79, 4.79, 4.79); Calibrated: 16/9/2016
- Sensor-Surface: 4mm (Mechanical Surface Detection)
- Electronics: Dummy DAE - SN:456; Calibrated: 12/9/2016
- Phantom: TWIN SAM; Type: QD000P40CA; Serial: TP-1218
- Measurement SW: DASY4, V4.5 Build 19; Postprocessing SW: SEMCAD, V1.8 Build 145

LTE Band 2-body-worn-left-high-1RB/Area Scan (81x101x1): Measurement grid: dx=10mm, dy=10mm
Maximum value of SAR (interpolated) = 0.198 mW/g

LTE Band 2-body-worn-left-high-1RB /Zoom Scan (7x7x7)/Cube 0: Measurement grid: dx=5mm, dy=5mm, dz=5mm

Reference Value = 7.23 V/m; Power Drift = 0.108 dB

Peak SAR (extrapolated) = 0.195 W/kg

SAR(1 g) = 0.189 mW/g; SAR(10 g) = 0.109 mW/g

Maximum value of SAR (measured) = 0.211 mW/g

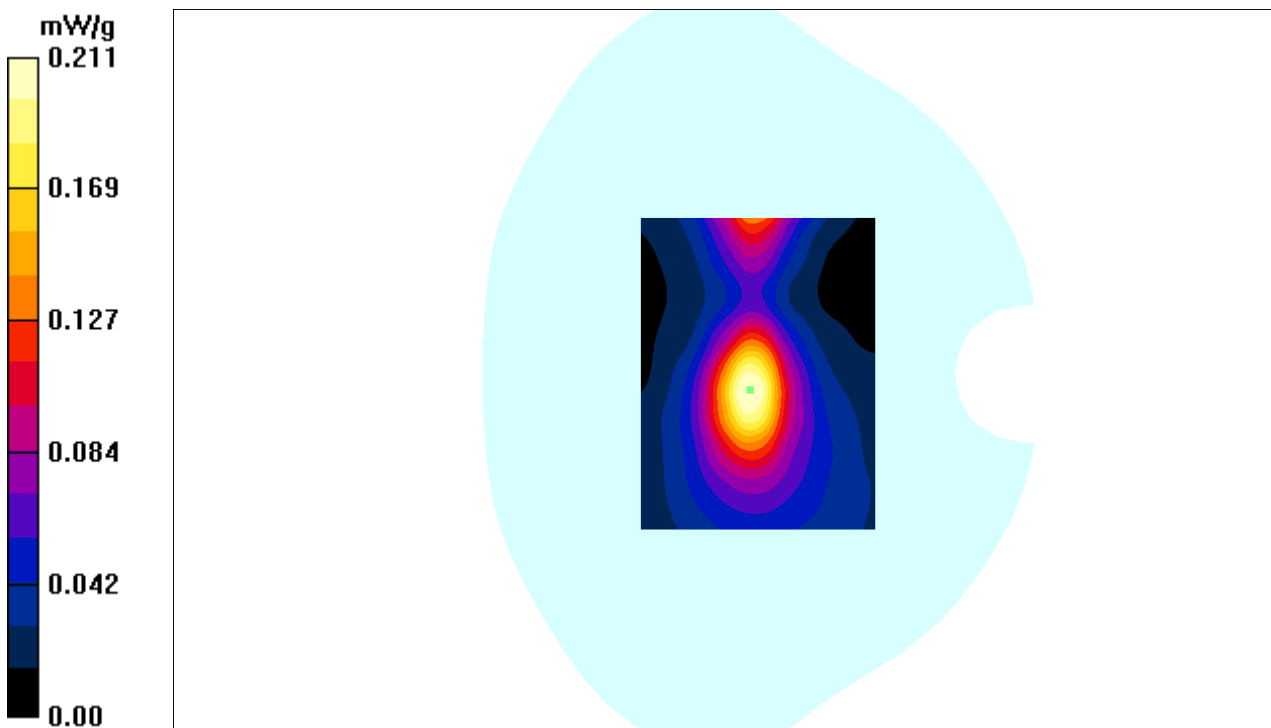

Test Laboratory: Bay Area Compliance Labs Corp.(Shenzhen)

Test Plot 92#:LTE Band 2 Body Worn Left High Channel

DUT: 3G/4G Smart Phone ; Model:SKY 5.0LM

Communication System: LTE 4G Band; Frequency: 1900 MHz;Duty Cycle: 1:1
Medium parameters used: $f = 1900$ MHz; $\sigma = 1.51$ S/m; $\epsilon_r = 52.59$; $\rho = 1000$ kg/m³
Phantom section: Flat Section

DASY4 Configuration:

- Probe: ES3DV3 - SN3036; ConvF(4.79, 4.79, 4.79); Calibrated: 16/9/2016
- Sensor-Surface: 4mm (Mechanical Surface Detection)
- Electronics: Dummy DAE - SN:456; Calibrated: 12/9/2016
- Phantom: TWIN SAM; Type: QD000P40CA; Serial: TP-1218
- Measurement SW: DASY4, V4.5 Build 19; Postprocessing SW: SEMCAD, V1.8 Build 145

LTE Band 2-body-worn-left-high-50%RB/Area Scan (91x111x1): Measurement grid: dx=10mm, dy=10mm
Maximum value of SAR (interpolated) = 0.190 mW/g

LTE Band 2-body-worn-left-high-50%RB /Zoom Scan (7x7x7)/Cube 0: Measurement grid: dx=5mm, dy=5mm, dz=5mm
Reference Value = 3.03 V/m; Power Drift = 0.168 dB
Peak SAR (extrapolated) = 0.145 W/kg
SAR(1 g) = 0.176 mW/g; SAR(10 g) = 0.139 mW/g
Maximum value of SAR (measured) = 0.224 mW/g

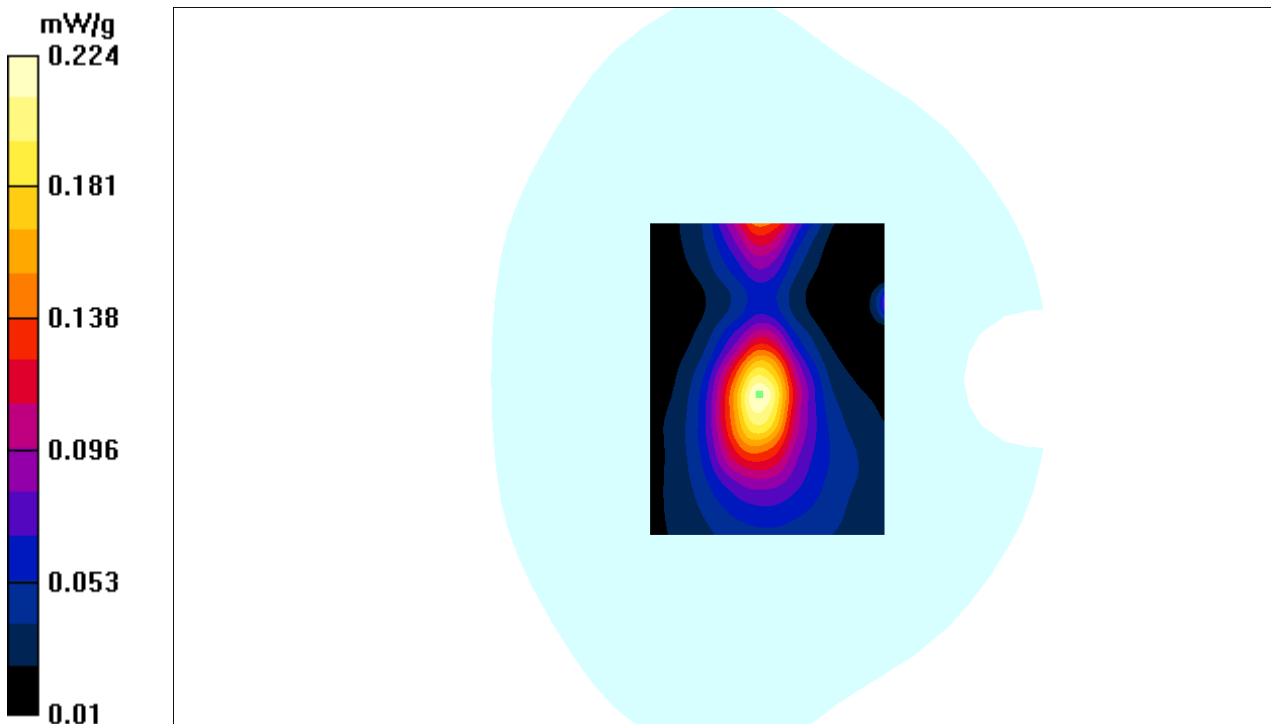

Test Laboratory: Bay Area Compliance Labs Corp.(Shenzhen)

Test Plot 93#:LTE Band 2 Body Worn Right High Channel

DUT: 3G/4G Smart Phone ; Model:SKY 5.0LM

Communication System: LTE 4G Band; Frequency: 1900 MHz;Duty Cycle: 1:1
 Medium parameters used: $f = 1900 \text{ MHz}$; $\sigma = 1.51 \text{ S/m}$; $\epsilon_r = 52.59$; $\rho = 1000 \text{ kg/m}^3$
 Phantom section: Flat Section

DASY4 Configuration:

- Probe: ES3DV3 - SN3036; ConvF(4.79, 4.79, 4.79); Calibrated: 16/9/2016
- Sensor-Surface: 4mm (Mechanical Surface Detection)
- Electronics: Dummy DAE - SN:456; Calibrated: 12/9/2016
- Phantom: TWIN SAM; Type: QD000P40CA; Serial: TP-1218
- Measurement SW: DASY4, V4.5 Build 19; Postprocessing SW: SEMCAD, V1.8 Build 145

LTE Band 2-body-worn-right-high-1RB/Area Scan (91x111x1): Measurement grid: $dx=10\text{mm}$, $dy=10\text{mm}$
 Maximum value of SAR (interpolated) = 0.376 mW/g

LTE Band 2-body-worn-right-high-1RB /Zoom Scan (7x7x7)/Cube 0: Measurement grid: $dx=5\text{mm}$, $dy=5\text{mm}$, $dz=5\text{mm}$
 Reference Value = 4.19 V/m; Power Drift = 0.133 dB
 Peak SAR (extrapolated) = 0.295 W/kg
SAR(1 g) = 0.321 mW/g; SAR(10 g) = 0.208 mW/g
 Maximum value of SAR (measured) = 0.366 mW/g

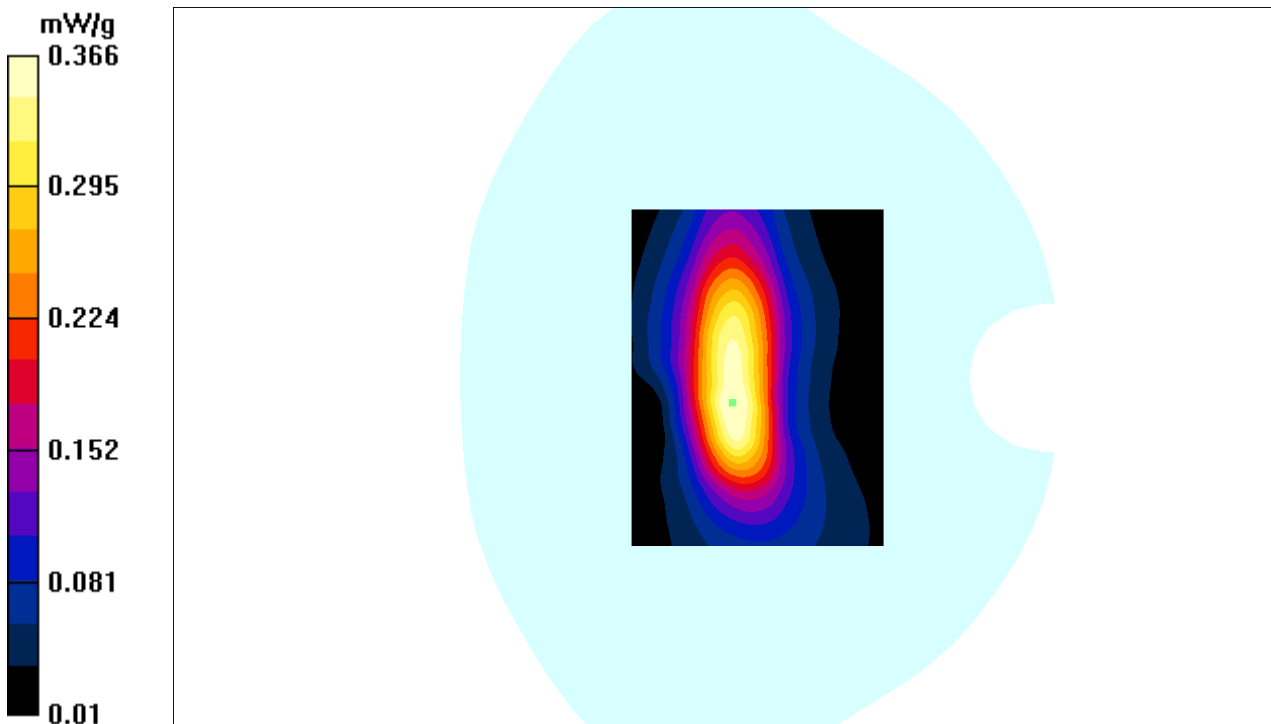

Test Laboratory: Bay Area Compliance Labs Corp.(Shenzhen)

Test Plot 94#:LTE Band 2 Body Worn Right High Channel

DUT: 3G/4G Smart Phone ; Model:SKY 5.0LM

Communication System: LTE 4G Band; Frequency: 1900 MHz;Duty Cycle: 1:1
Medium parameters used: $f = 1900$ MHz; $\sigma = 1.51$ S/m; $\epsilon_r = 52.59$; $\rho = 1000$ kg/m³
Phantom section: Flat Section

DASY4 Configuration:

- Probe: ES3DV3 - SN3036; ConvF(4.79, 4.79, 4.79); Calibrated: 16/9/2016
- Sensor-Surface: 4mm (Mechanical Surface Detection)
- Electronics: Dummy DAE - SN:456; Calibrated: 12/9/2016
- Phantom: TWIN SAM; Type: QD000P40CA; Serial: TP-1218
- Measurement SW: DASY4, V4.5 Build 19; Postprocessing SW: SEMCAD, V1.8 Build 145

LTE Band 2-body-worn-right-high-50%RB/Area Scan (91x111x1): Measurement grid: dx=10mm, dy=10mm
Maximum value of SAR (interpolated) = 0.256 mW/g

LTE Band 2-body-worn-right-high-50%RB /Zoom Scan (7x7x7)/Cube 0: Measurement grid: dx=5mm, dy=5mm, dz=5mm
Reference Value = 4.19 V/m; Power Drift = 0.120 dB
Peak SAR (extrapolated) = 0.385 W/kg
SAR(1 g) = 0.243 mW/g; SAR(10 g) = 0.028 mW/g
Maximum value of SAR (measured) = 0.307 mW/g

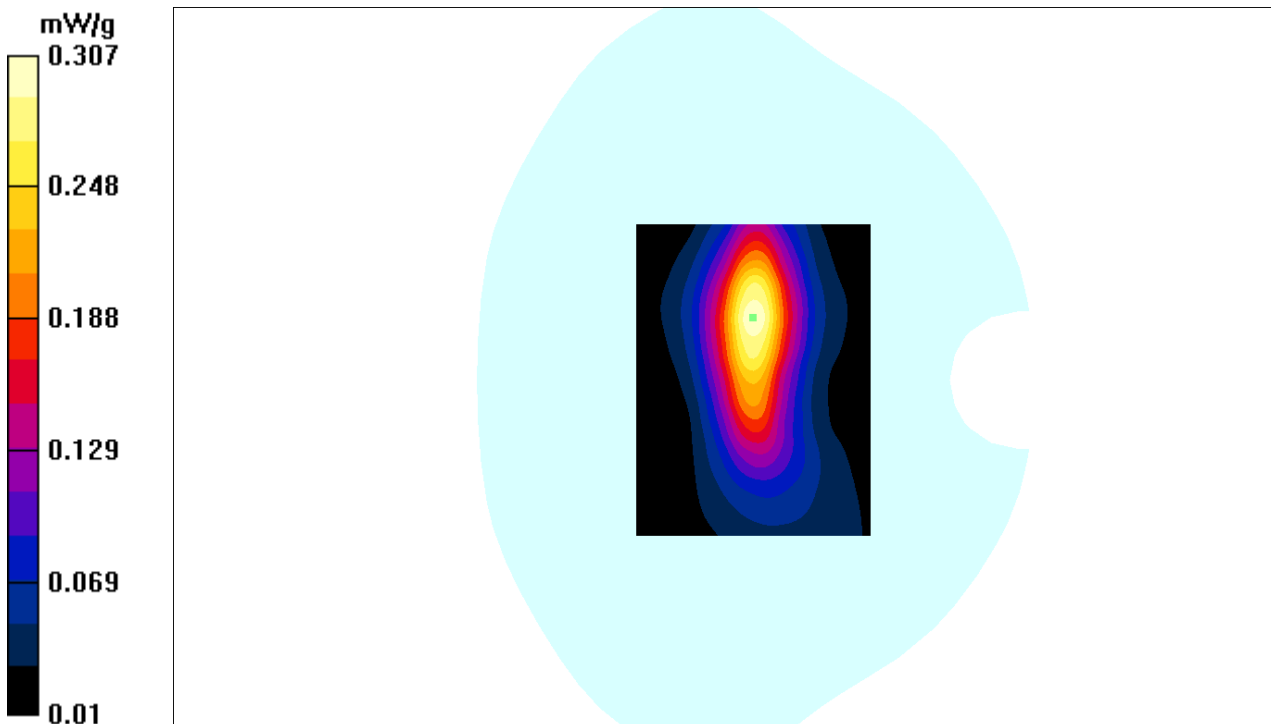

Test Laboratory: Bay Area Compliance Labs Corp.(Shenzhen)

Test Plot 95#:LTE Band 2 Body Worn Bottom High Channel

DUT: 3G/4G Smart Phone ; Model:SKY 5.0LM

Communication System: LTE 4G Band; Frequency: 1900 MHz;Duty Cycle: 1:1
Medium parameters used: $f = 1900$ MHz; $\sigma = 1.51$ S/m; $\epsilon_r = 52.59$; $\rho = 1000$ kg/m³
Phantom section: Flat Section

DASY4 Configuration:

- Probe: ES3DV3 - SN3036; ConvF(4.79, 4.79, 4.79); Calibrated: 16/9/2016
- Sensor-Surface: 4mm (Mechanical Surface Detection)
- Electronics: Dummy DAE - SN:456; Calibrated: 12/9/2016
- Phantom: TWIN SAM; Type: QD000P40CA; Serial: TP-1218
- Measurement SW: DASY4, V4.5 Build 19; Postprocessing SW: SEMCAD, V1.8 Build 145

LTE Band 2-body-worn-bottom-high-1RB/Area Scan (91x111x1): Measurement grid: dx=10mm, dy=10mm
Maximum value of SAR (interpolated) = 0.696 mW/g

LTE Band 2-body-worn-bottom-high-1RB /Zoom Scan (7x7x7)/Cube 0: Measurement grid: dx=5mm, dy=5mm, dz=5mm
Reference Value = 3.83 V/m; Power Drift = -0.035 dB
Peak SAR (extrapolated) = 0.671 W/kg
SAR(1 g) = 0.615 mW/g; SAR(10 g) = 0.359 mW/g
Maximum value of SAR (measured) = 0.680 mW/g

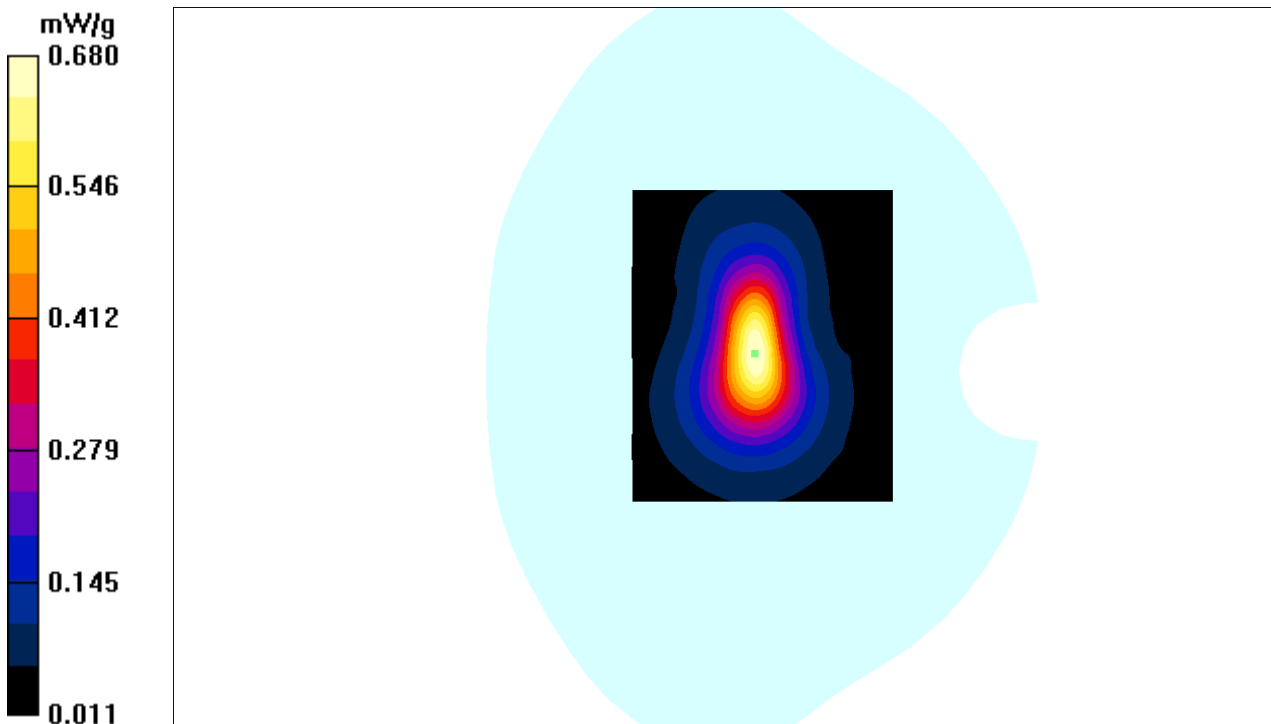

Test Laboratory: Bay Area Compliance Labs Corp.(Shenzhen)

Test Plot 96#:LTE Band 2 Body Worn Bottom High Channel

DUT: 3G/4G Smart Phone ; Model:SKY 5.0LM

Communication System: LTE 4G Band; Frequency: 1900 MHz;Duty Cycle: 1:1
Medium parameters used: $f = 1900$ MHz; $\sigma = 1.51$ S/m; $\epsilon_r = 52.59$; $\rho = 1000$ kg/m³
Phantom section: Flat Section

DASY4 Configuration:

- Probe: ES3DV3 - SN3036; ConvF(4.79, 4.79, 4.79); Calibrated: 16/9/2016
- Sensor-Surface: 4mm (Mechanical Surface Detection)
- Electronics: Dummy DAE - SN:456; Calibrated: 12/9/2016
- Phantom: TWIN SAM; Type: QD000P40CA; Serial: TP-1218
- Measurement SW: DASY4, V4.5 Build 19; Postprocessing SW: SEMCAD, V1.8 Build 145

LTE Band 2-body-worn-bottom-high-50%RB/Area Scan (91x111x1): Measurement grid: dx=10mm, dy=10mm
Maximum value of SAR (interpolated) = 0.566 mW/g

LTE Band 2-body-worn-bottom-high-50%RB /Zoom Scan (7x7x7)/Cube 0: Measurement grid: dx=5mm, dy=5mm, dz=5mm
Reference Value = 7.23 V/m; Power Drift = -0.050 dB
Peak SAR (extrapolated) = 0.571 W/kg
SAR(1 g) = 0.475 mW/g; SAR(10 g) = 0.249 mW/g
Maximum value of SAR (measured) = 0.542 mW/g

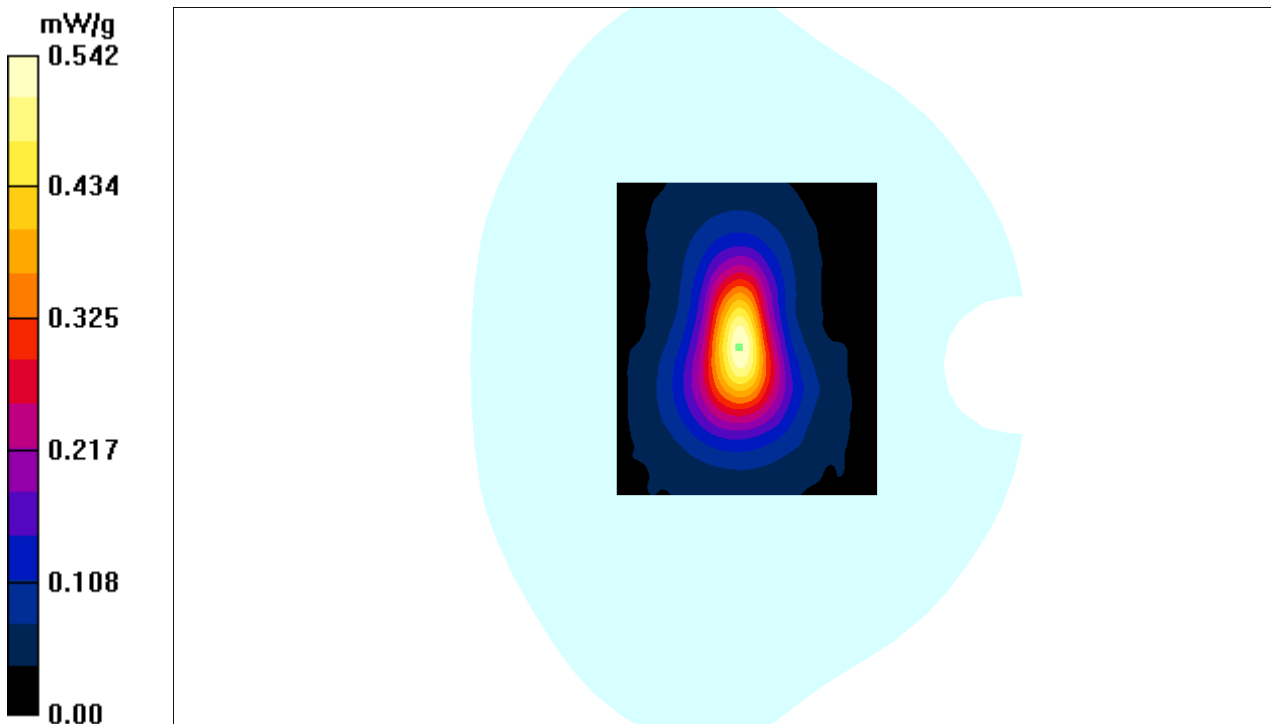

Test Laboratory: Bay Area Compliance Labs Corp.(Shenzhen)

Test Plot 97#:LTE Band 4 Body Worn Back Low Channel

DUT: 3G/4G Smart Phone ; Model:SKY 5.0LM

Communication System: LTE 4G Band; Frequency: 1720 MHz;Duty Cycle: 1:1
Medium parameters used: $f = 1720 \text{ MHz}$; $\sigma = 1.45 \text{ S/m}$; $\epsilon_r = 52.23$; $\rho = 1000 \text{ kg/m}^3$
Phantom section: Flat Section

DASY4 Configuration:

- Probe: ES3DV3 - SN3036; ConvF(5.04, 5.04, 5.04); Calibrated: 16/9/2016
- Sensor-Surface: 4mm (Mechanical Surface Detection)
- Electronics: Dummy DAE - SN:456; Calibrated: 12/9/2016
- Phantom: TWIN SAM; Type: QD000P40CA; Serial: TP-1218
- Measurement SW: DASY4, V4.5 Build 19; Postprocessing SW: SEMCAD, V1.8 Build 145

LTE Band 4-body-worn-Low-1RB /Area Scan (81x101x1): Measurement grid: $dx=10\text{mm}$, $dy=10\text{mm}$
Maximum value of SAR (interpolated) = 1.087 mW/g

LTE Band 4-body-worn-Low-1RB /Zoom Scan (7x7x7)/Cube 0: Measurement grid: $dx=5\text{mm}$, $dy=5\text{mm}$, $dz=5\text{mm}$
Reference Value = 5.4 V/m; Power Drift = -0.026 dB
Peak SAR (extrapolated) = 1.02 W/kg
SAR(1 g) = 0.852 mW/g; SAR(10 g) = 0.537 mW/g
Maximum value of SAR (measured) = 0.921 mW/g

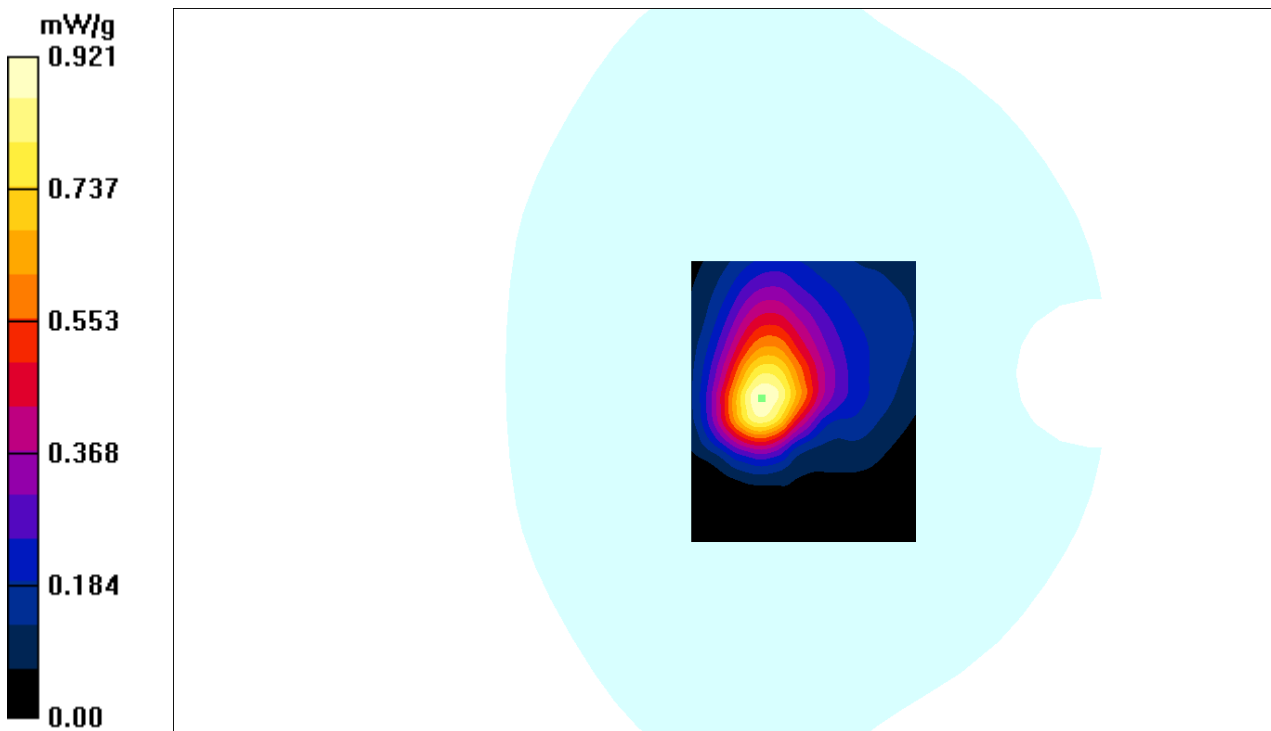

Test Laboratory: Bay Area Compliance Labs Corp.(Shenzhen)

Test Plot 98#:LTE Band 4 Body Worn Back Mid Channel

DUT: 3G/4G Smart Phone ; Model:SKY 5.0LM

Communication System: LTE 4G Band; Frequency: 1732.5 MHz;Duty Cycle: 1:1
Medium parameters used: $f = 1732.5$ MHz; $\sigma = 1.47$ S/m; $\epsilon_r = 52.42$; $\rho = 1000$ kg/m³
Phantom section: Flat Section

DASY4 Configuration:

- Probe: ES3DV3 - SN3036; ConvF(5.04, 5.04, 5.04); Calibrated: 16/9/2016
- Sensor-Surface: 4mm (Mechanical Surface Detection)
- Electronics: Dummy DAE - SN:456; Calibrated: 12/9/2016
- Phantom: TWIN SAM; Type: QD000P40CA; Serial: TP-1218
- Measurement SW: DASY4, V4.5 Build 19; Postprocessing SW: SEMCAD, V1.8 Build 145

LTE Band 4-body-worn-Mid-1RB /Area Scan (91x111x1): Measurement grid: dx=10mm, dy=10mm
Maximum value of SAR (interpolated) = 0.798 mW/g

LTE Band 4-body-worn-Mid-1RB /Zoom Scan (7x7x7)/Cube 0: Measurement grid: dx=5mm, dy=5mm, dz=5mm
Reference Value = 6.4 V/m; Power Drift = -0.086 dB
Peak SAR (extrapolated) = 1.32 W/kg
SAR(1 g) = 0.783 mW/g; SAR(10 g) = 0.533 mW/g
Maximum value of SAR (measured) = 0.802 mW/g

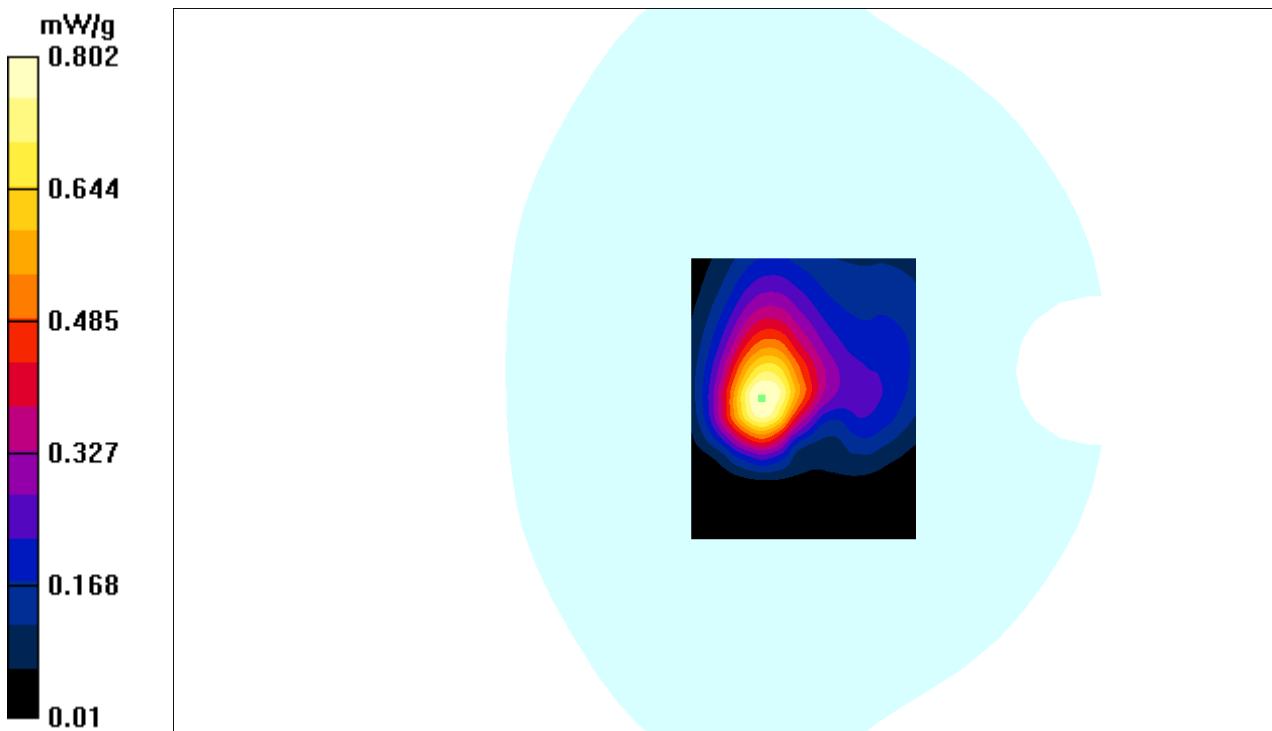

Test Laboratory: Bay Area Compliance Labs Corp.(Shenzhen)

Test Plot 99#:LTE Band 4 Body Worn Back High Channel

DUT: 3G/4G Smart Phone ; Model:SKY 5.0LM

Communication System: LTE 4G Band; Frequency: 1745 MHz;Duty Cycle: 1:1
Medium parameters used: $f = 1745$ MHz; $\sigma = 1.48$ S/m; $\epsilon_r = 52.59$; $\rho = 1000$ kg/m³
Phantom section: Flat Section

DASY4 Configuration:

- Probe: ES3DV3 - SN3036; ConvF(5.04, 5.04, 5.04); Calibrated: 16/9/2016
- Sensor-Surface: 4mm (Mechanical Surface Detection)
- Electronics: Dummy DAE - SN:456; Calibrated: 12/9/2016
- Phantom: TWIN SAM; Type: QD000P40CA; Serial: TP-1218
- Measurement SW: DASY4, V4.5 Build 19; Postprocessing SW: SEMCAD, V1.8 Build 145

LTE Band 4-body-worn-high-1RB /Area Scan (81x101x1): Measurement grid: dx=10mm, dy=10mm
Maximum value of SAR (interpolated) = 0.987 mW/g

LTE Band 4-body-worn-high-1RB /Zoom Scan (7x7x7)/Cube 0: Measurement grid: dx=5mm, dy=5mm, dz=5mm
Reference Value = 7.4 V/m; Power Drift = -0.086 dB
Peak SAR (extrapolated) = 0.962 W/kg
SAR(1 g) = 0.923 mW/g; SAR(10 g) = 0.533 mW/g
Maximum value of SAR (measured) = 0.946 mW/g

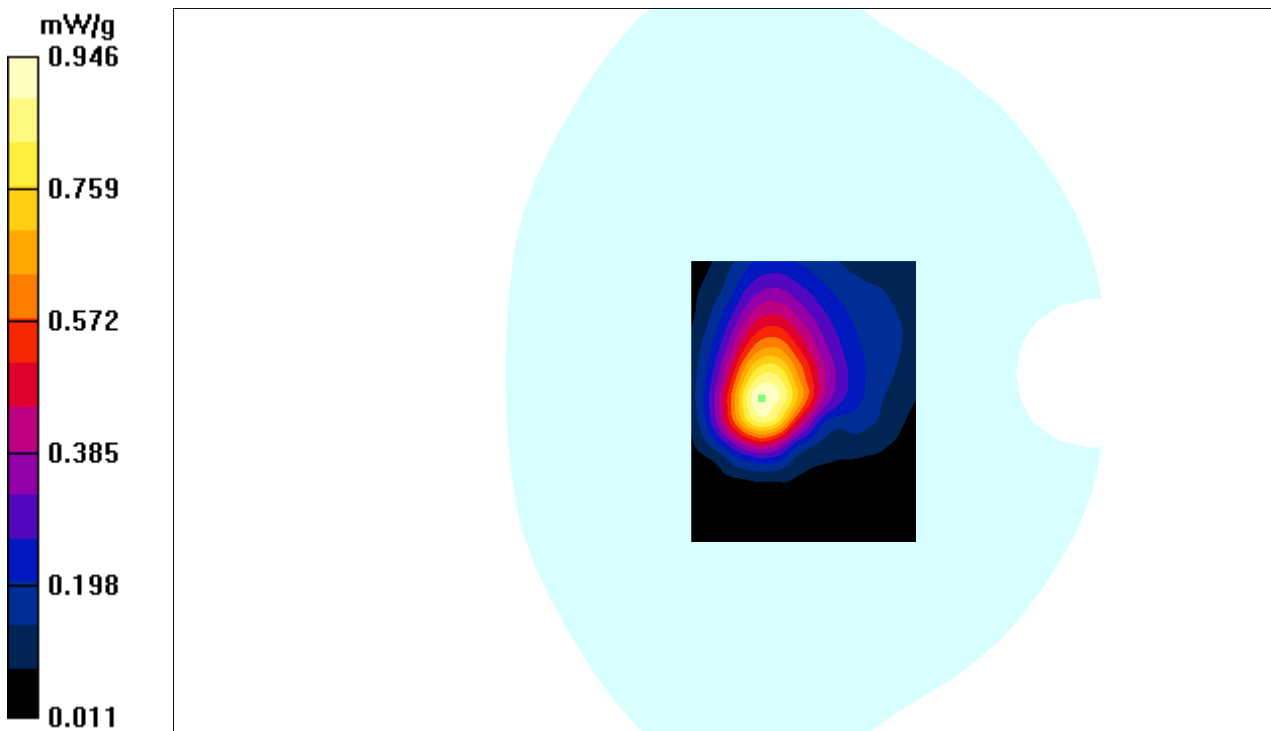

Test Laboratory: Bay Area Compliance Labs Corp.(Shenzhen)

Test Plot 100#:LTE Band 4 Body Worn Back High Channel

DUT: 3G/4G Smart Phone ; Model:SKY 5.0LM

Communication System: LTE 4G Band; Frequency: 1745 MHz;Duty Cycle: 1:1
Medium parameters used: $f = 1745$ MHz; $\sigma = 1.48$ S/m; $\epsilon_r = 52.59$; $\rho = 1000$ kg/m³
Phantom section: Flat Section

DASY4 Configuration:

- Probe: ES3DV3 - SN3036; ConvF(5.04, 5.04, 5.04); Calibrated: 16/9/2016
- Sensor-Surface: 4mm (Mechanical Surface Detection)
- Electronics: Dummy DAE - SN:456; Calibrated: 12/9/2016
- Phantom: TWIN SAM; Type: QD000P40CA; Serial: TP-1218
- Measurement SW: DASY4, V4.5 Build 19; Postprocessing SW: SEMCAD, V1.8 Build 145

LTE Band 4-body-worn-high-50%RB /Area Scan (81x101x1): Measurement grid: dx=10mm, dy=10mm
Maximum value of SAR (interpolated) = 0.657 mW/g

LTE Band 4-body-worn-high-50%RB /Zoom Scan (7x7x7)/Cube 0: Measurement grid: dx=5mm, dy=5mm, dz=5mm

Reference Value = 10.4 V/m; Power Drift = -0.036 dB

Peak SAR (extrapolated) = 1.32 W/kg

SAR(1 g) = 0.652 mW/g; SAR(10 g) = 0.329 mW/g

Maximum value of SAR (measured) = 0.665 mW/g

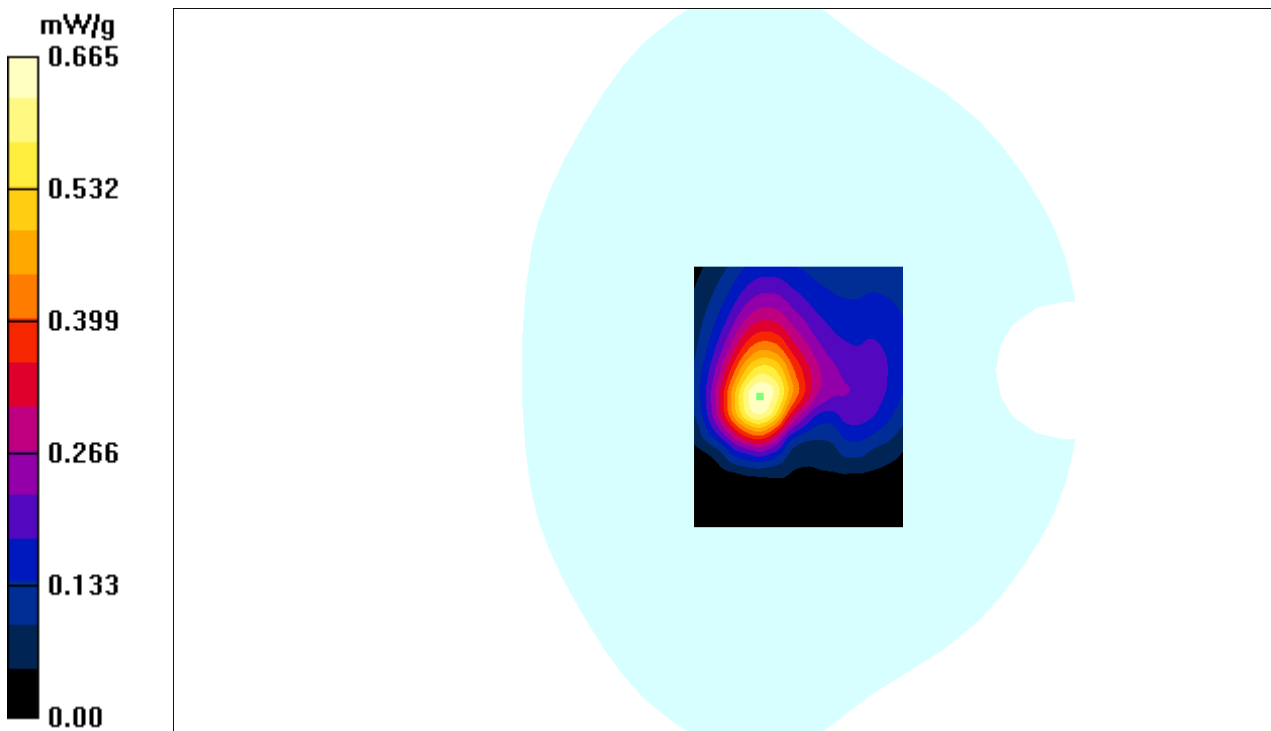

Test Laboratory: Bay Area Compliance Labs Corp.(Shenzhen)

Test Plot 101#:LTE Band 4 Body Worn Back High Channel

DUT: 3G/4G Smart Phone ; Model:SKY 5.0LM

Communication System: LTE 4G Band; Frequency: 1745 MHz;Duty Cycle: 1:1
Medium parameters used: $f = 1745$ MHz; $\sigma = 1.48$ S/m; $\epsilon_r = 52.59$; $\rho = 1000$ kg/m³
Phantom section: Flat Section

DASY4 Configuration:

- Probe: ES3DV3 - SN3036; ConvF(5.04, 5.04, 5.04); Calibrated: 16/9/2016
- Sensor-Surface: 4mm (Mechanical Surface Detection)
- Electronics: Dummy DAE - SN:456; Calibrated: 12/9/2016
- Phantom: TWIN SAM; Type: QD000P40CA; Serial: TP-1218
- Measurement SW: DASY4, V4.5 Build 19; Postprocessing SW: SEMCAD, V1.8 Build 145

LTE Band 4-body-worn-high-100%RB /Area Scan (81x101x1): Measurement grid: dx=10mm, dy=10mm
Maximum value of SAR (interpolated) = 0.687 mW/g

LTE Band 4-body-worn-high-100%RB /Zoom Scan (7x7x7)/Cube 0: Measurement grid: dx=5mm, dy=5mm, dz=5mm
Reference Value = 9.75 V/m; Power Drift = -0.104 dB
Peak SAR (extrapolated) = 1.19 W/kg
SAR(1 g) = 0.629 mW/g; SAR(10 g) = 0.329 mW/g
Maximum value of SAR (measured) = 0.691 mW/g

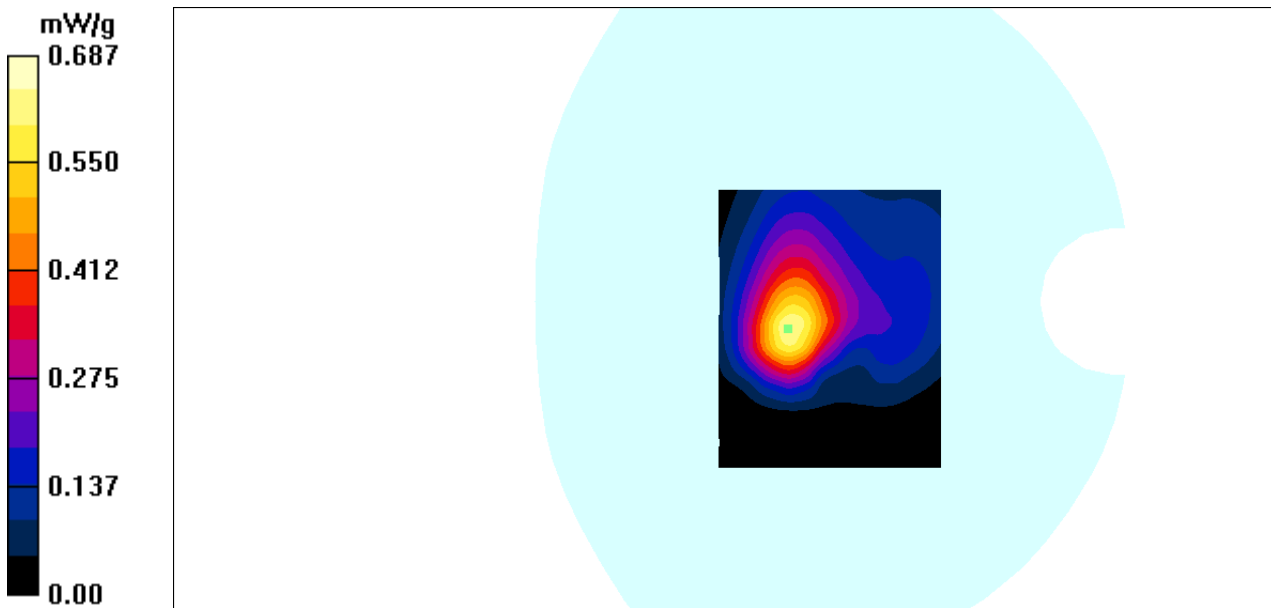

Test Laboratory: Bay Area Compliance Labs Corp.(Shenzhen)

Test Plot 102#:LTE Band 4 Body Worn Left High Channel

DUT: 3G/4G Smart Phone ; Model:SKY 5.0LM

Communication System: LTE 4G Band; Frequency: 1745 MHz;Duty Cycle: 1:1
 Medium parameters used: $f = 1745 \text{ MHz}$; $\sigma = 1.48 \text{ S/m}$; $\epsilon_r = 52.59$; $\rho = 1000 \text{ kg/m}^3$
 Phantom section: Flat Section

DASY4 Configuration:

- Probe: ES3DV3 - SN3036; ConvF(5.04, 5.04, 5.04); Calibrated: 16/9/2016
- Sensor-Surface: 4mm (Mechanical Surface Detection)
- Electronics: Dummy DAE - SN:456; Calibrated: 12/9/2016
- Phantom: TWIN SAM; Type: QD000P40CA; Serial: TP-1218
- Measurement SW: DASY4, V4.5 Build 19; Postprocessing SW: SEMCAD, V1.8 Build 145

LTE Band 4-body-worn-left-high-1RB /Area Scan (91x101x1): Measurement grid: $dx=10\text{mm}$, $dy=10\text{mm}$
 Maximum value of SAR (interpolated) = 0.214 mW/g

LTE Band 4-body-worn-left-high-1RB /Zoom Scan (7x7x7)/Cube 0: Measurement grid: $dx=5\text{mm}$, $dy=5\text{mm}$, $dz=5\text{mm}$
 Reference Value = 4.1 V/m; Power Drift = 0.034 dB
 Peak SAR (extrapolated) = 0.252 W/kg
SAR(1 g) = 0.201 mW/g; SAR(10 g) = 0.108 mW/g
 Maximum value of SAR (measured) = 0.202 mW/g

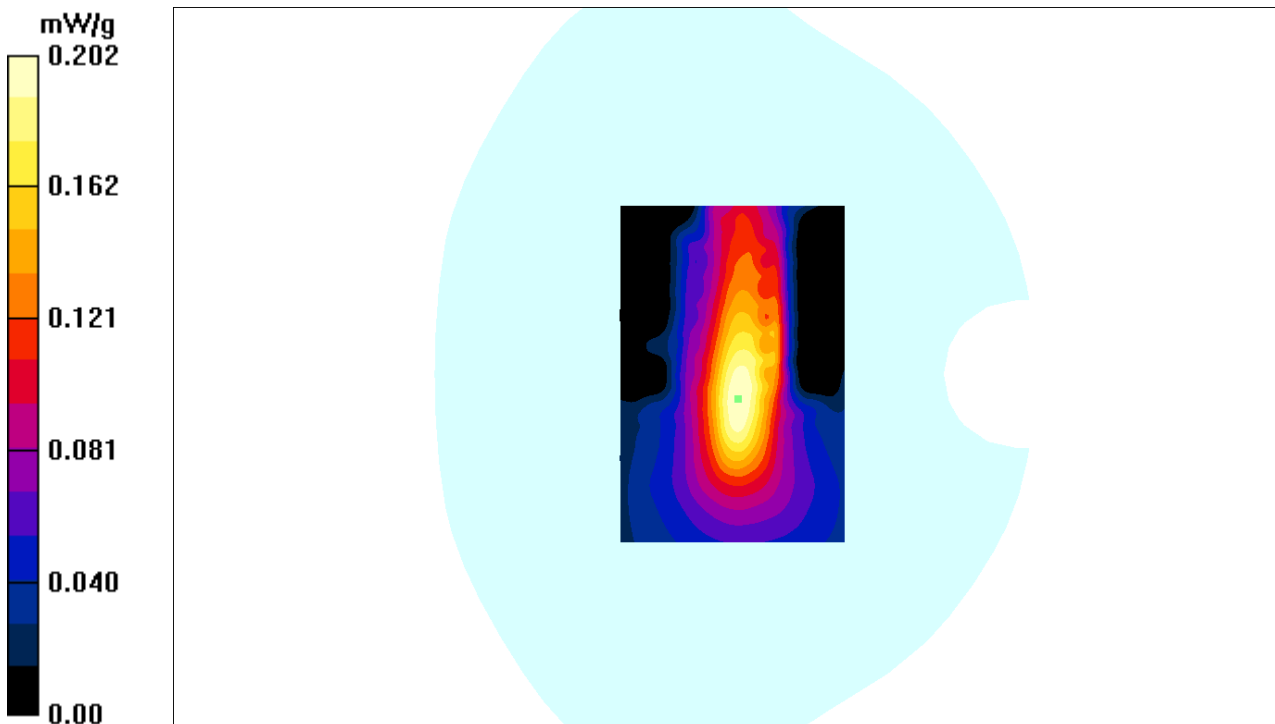

Test Laboratory: Bay Area Compliance Labs Corp.(Shenzhen)

Test Plot 103#:LTE Band 4 Body Worn Left High Channel

DUT: 3G/4G Smart Phone ; Model:SKY 5.0LM

Communication System: LTE 4G Band; Frequency: 1745 MHz;Duty Cycle: 1:1
Medium parameters used: $f = 1745 \text{ MHz}$; $\sigma = 1.48 \text{ S/m}$; $\epsilon_r = 52.59$; $\rho = 1000 \text{ kg/m}^3$
Phantom section: Flat Section

DASY4 Configuration:

- Probe: ES3DV3 - SN3036; ConvF(5.04, 5.04, 5.04); Calibrated: 16/9/2016
- Sensor-Surface: 4mm (Mechanical Surface Detection)
- Electronics: Dummy DAE - SN:456; Calibrated: 12/9/2016
- Phantom: TWIN SAM; Type: QD000P40CA; Serial: TP-1218
- Measurement SW: DASY4, V4.5 Build 19; Postprocessing SW: SEMCAD, V1.8 Build 145

LTE Band 4-body-worn-left-high-50%RB /Area Scan (91x111x1): Measurement grid: $dx=10\text{mm}$, $dy=10\text{mm}$
Maximum value of SAR (interpolated) = 0.287 mW/g

LTE Band 4-body-worn-left-high-50%RB /Zoom Scan (7x7x7)/Cube 0: Measurement grid: $dx=5\text{mm}$, $dy=5\text{mm}$, $dz=5\text{mm}$
Reference Value = 6.17 V/m; Power Drift = 0.042 dB
Peak SAR (extrapolated) = 0.192 W/kg
SAR(1 g) = 0.175 mW/g; SAR(10 g) = 0.108 mW/g
Maximum value of SAR (measured) = 0.181 mW/g

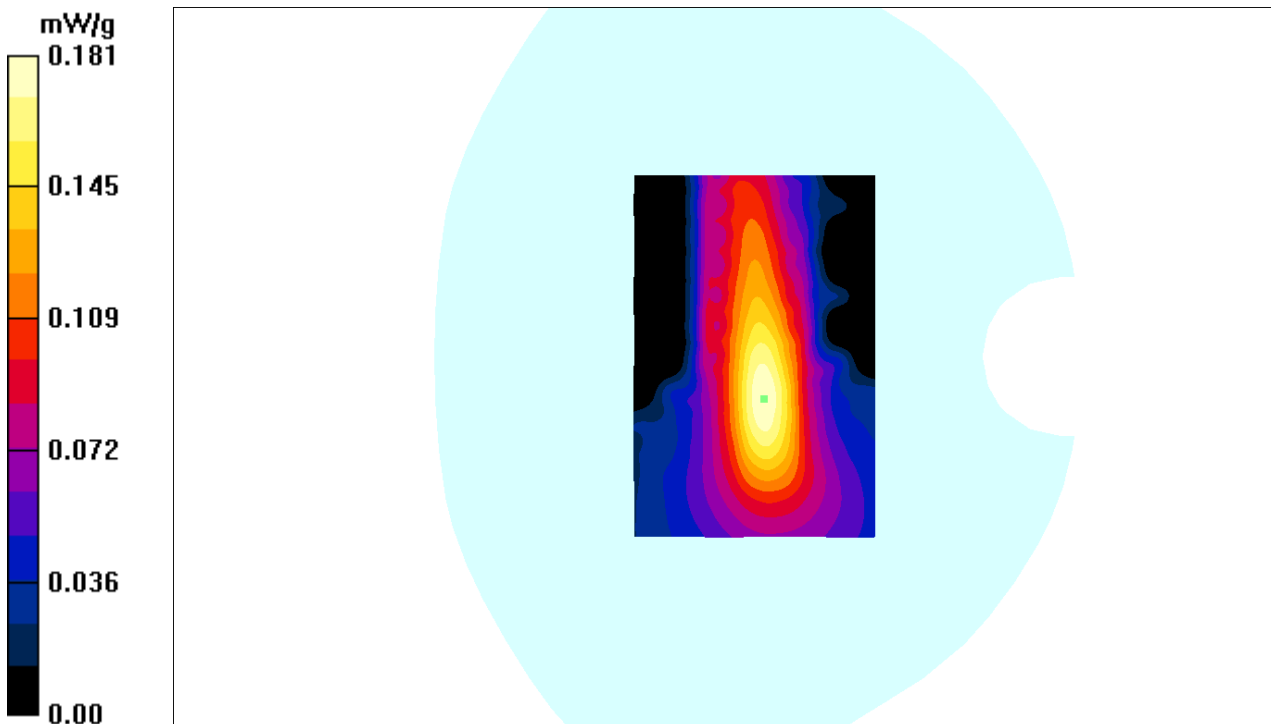

Test Laboratory: Bay Area Compliance Labs Corp.(Shenzhen)

Test Plot 104#:LTE Band 4 Body Worn Right High Channel

DUT: 3G/4G Smart Phone ; Model:SKY 5.0LM

Communication System: LTE 4G Band; Frequency: 1745 MHz;Duty Cycle: 1:1
Medium parameters used: $f = 1745$ MHz; $\sigma = 1.48$ S/m; $\epsilon_r = 52.59$; $\rho = 1000$ kg/m³
Phantom section: Flat Section

DASY4 Configuration:

- Probe: ES3DV3 - SN3036; ConvF(5.04, 5.04, 5.04); Calibrated: 16/9/2016
- Sensor-Surface: 4mm (Mechanical Surface Detection)
- Electronics: Dummy DAE - SN:456; Calibrated: 12/9/2016
- Phantom: TWIN SAM; Type: QD000P40CA; Serial: TP-1218
- Measurement SW: DASY4, V4.5 Build 19; Postprocessing SW: SEMCAD, V1.8 Build 145

LTE Band 4-body-worn-right-high-1RB /Area Scan (81x101x1): Measurement grid: dx=10mm, dy=10mm
Maximum value of SAR (interpolated) = 0.356 mW/g

LTE Band 4-body-worn-right-high-1RB /Zoom Scan (7x7x7)/Cube 0: Measurement grid: dx=5mm, dy=5mm, dz=5mm
Reference Value = 3.15 V/m; Power Drift = 0.08 dB
Peak SAR (extrapolated) = 0.296 W/kg
SAR(1 g) = 0.302 mW/g; SAR(10 g) = 0.262 mW/g
Maximum value of SAR (measured) = 0.319 mW/g

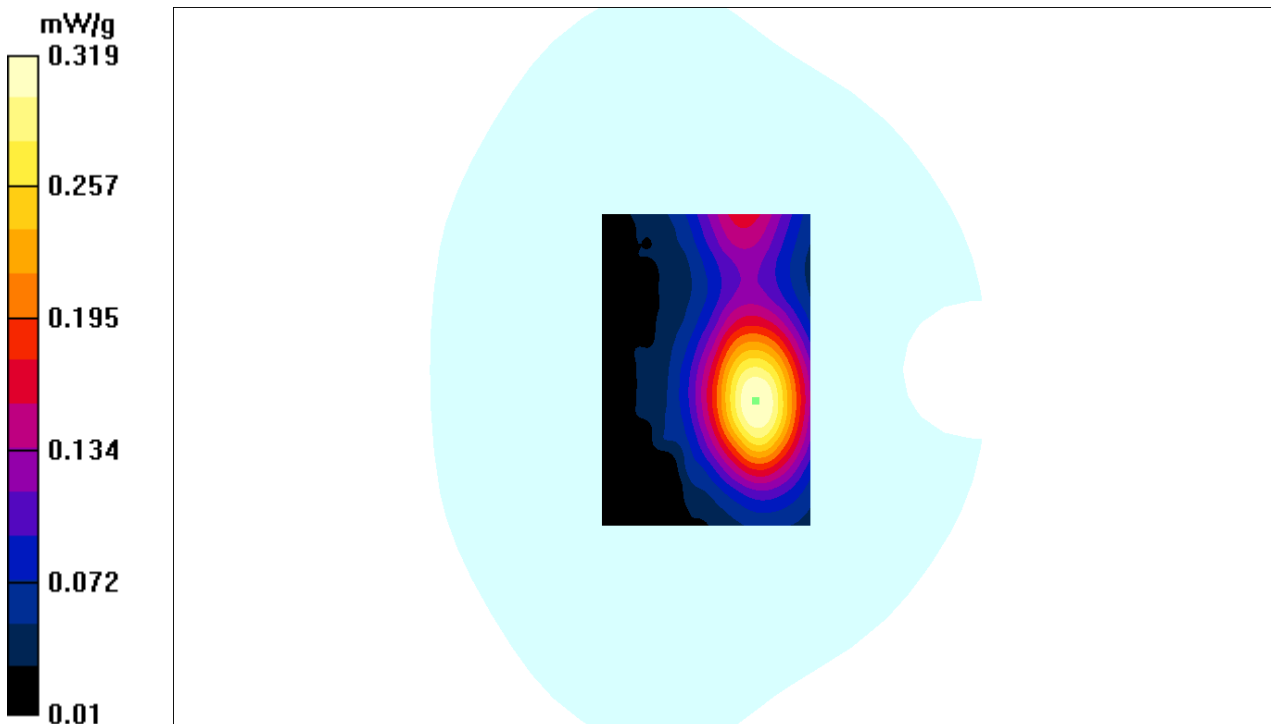

Test Laboratory: Bay Area Compliance Labs Corp.(Shenzhen)

Test Plot 105#:LTE Band 4 Body Worn Right High Channel

DUT: 3G/4G Smart Phone ; Model:SKY 5.0LM

Communication System: LTE 4G Band; Frequency: 1745 MHz;Duty Cycle: 1:1
 Medium parameters used: $f = 1745 \text{ MHz}$; $\sigma = 1.48 \text{ S/m}$; $\epsilon_r = 52.59$; $\rho = 1000 \text{ kg/m}^3$
 Phantom section: Flat Section

DASY4 Configuration:

- Probe: ES3DV3 - SN3036; ConvF(5.04, 5.04, 5.04); Calibrated: 16/9/2016
- Sensor-Surface: 4mm (Mechanical Surface Detection)
- Electronics: Dummy DAE - SN:456; Calibrated: 12/9/2016
- Phantom: TWIN SAM; Type: QD000P40CA; Serial: TP-1218
- Measurement SW: DASY4, V4.5 Build 19; Postprocessing SW: SEMCAD, V1.8 Build 145

LTE Band 4-body-worn-right-high-50%RB /Area Scan (91x111x1): Measurement grid: $dx=10\text{mm}$, $dy=10\text{mm}$
 Maximum value of SAR (interpolated) = 0.236 mW/g

LTE Band 4-body-worn-right-high-50%RB /Zoom Scan (7x7x7)/Cube 0: Measurement grid: $dx=5\text{mm}$, $dy=5\text{mm}$, $dz=5\text{mm}$
 Reference Value = 3.10 V/m; Power Drift = 0.10 dB
 Peak SAR (extrapolated) = 0.296 W/kg
SAR(1 g) = 0.275 mW/g; SAR(10 g) = 0.152 mW/g
 Maximum value of SAR (measured) = 0.289 mW/g

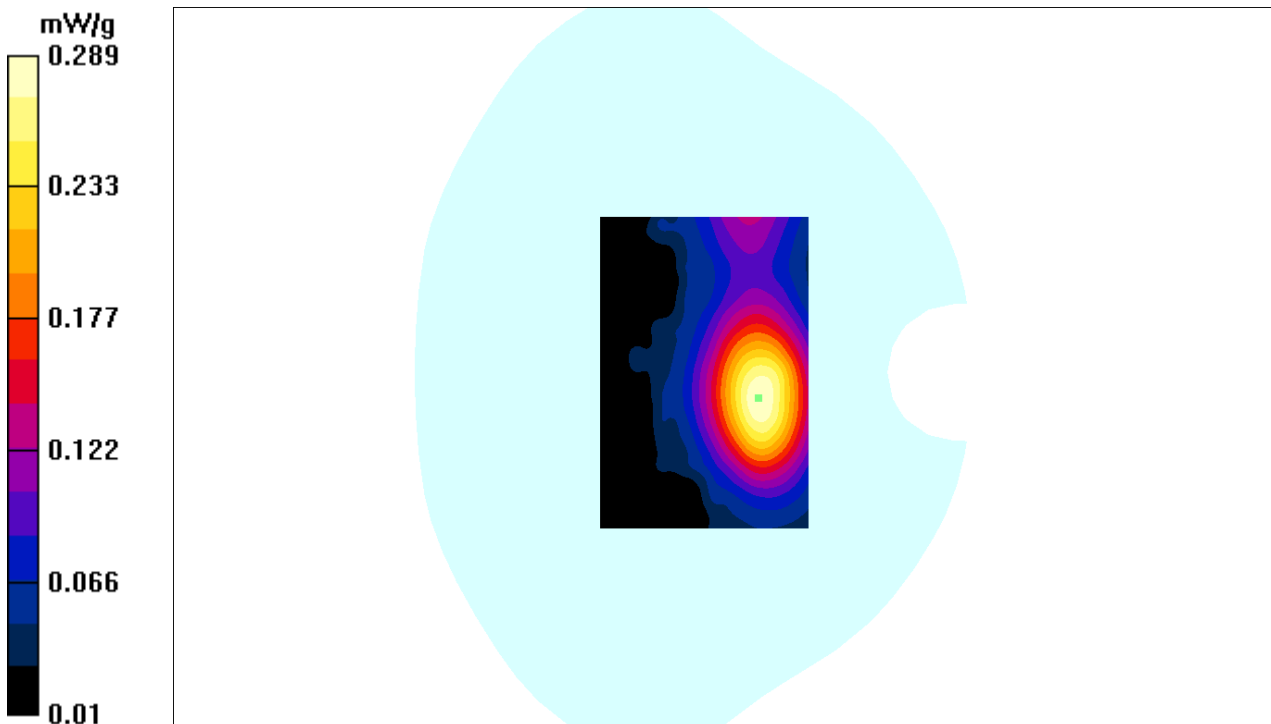

Test Laboratory: Bay Area Compliance Labs Corp.(Shenzhen)

Test Plot 106#:LTE Band 4 Body Worn Bottom High Channel

DUT: 3G/4G Smart Phone ; Model:SKY 5.0LM

Communication System: LTE 4G Band; Frequency: 1745 MHz;Duty Cycle: 1:1
Medium parameters used: $f = 1745$ MHz; $\sigma = 1.48$ S/m; $\epsilon_r = 52.59$; $\rho = 1000$ kg/m³
Phantom section: Flat Section

DASY4 Configuration:

- Probe: ES3DV3 - SN3036; ConvF(5.04, 5.04, 5.04); Calibrated: 16/9/2016
- Sensor-Surface: 4mm (Mechanical Surface Detection)
- Electronics: Dummy DAE - SN:456; Calibrated: 12/9/2016
- Phantom: TWIN SAM; Type: QD000P40CA; Serial: TP-1218
- Measurement SW: DASY4, V4.5 Build 19; Postprocessing SW: SEMCAD, V1.8 Build 145

LTE Band 4-body-worn-bottom-high-1RB /Area Scan (81x111x1): Measurement grid: dx=10mm, dy=10mm
Maximum value of SAR (interpolated) = 0.521 mW/g

LTE Band 4-body-worn-bottom-high-1RB /Zoom Scan (7x7x7)/Cube 0: Measurement grid: dx=5mm, dy=5mm, dz=5mm
Reference Value = 4.8 V/m; Power Drift = -0.094 dB
Peak SAR (extrapolated) = 0.666 W/kg
SAR(1 g) = 0.590 mW/g; SAR(10 g) = 0.315 mW/g
Maximum value of SAR (measured) = 0.670 mW/g

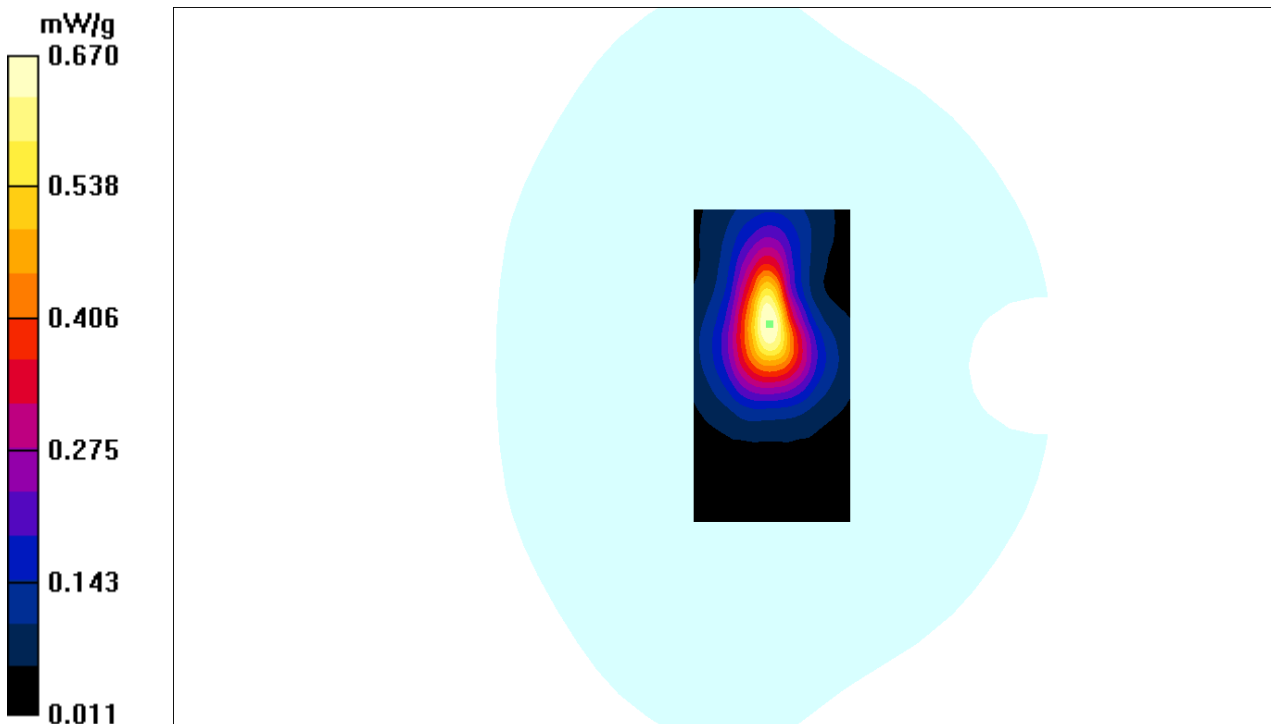

Test Laboratory: Bay Area Compliance Labs Corp.(Shenzhen)

Test Plot 107#:LTE Band 4 Body Worn Bottom High Channel

DUT: 3G/4G Smart Phone ; Model:SKY 5.0LM

Communication System: LTE 4G Band; Frequency: 1745 MHz;Duty Cycle: 1:1
Medium parameters used: $f = 1745 \text{ MHz}$; $\sigma = 1.48 \text{ S/m}$; $\epsilon_r = 52.59$; $\rho = 1000 \text{ kg/m}^3$
Phantom section: Flat Section

DASY4 Configuration:

- Probe: ES3DV3 - SN3036; ConvF(5.04, 5.04, 5.04); Calibrated: 16/9/2016
- Sensor-Surface: 4mm (Mechanical Surface Detection)
- Electronics: Dummy DAE - SN:456; Calibrated: 12/9/2016
- Phantom: TWIN SAM; Type: QD000P40CA; Serial: TP-1218
- Measurement SW: DASY4, V4.5 Build 19; Postprocessing SW: SEMCAD, V1.8 Build 145

LTE Band 4-body-worn-bottom-high-50%RB /Area Scan (81x111x1): Measurement grid: $dx=10\text{mm}$, $dy=10\text{mm}$
Maximum value of SAR (interpolated) = 0.491 mW/g

LTE Band 4-body-worn-bottom-high-50%RB /Zoom Scan (7x7x7)/Cube 0: Measurement grid:
 $dx=5\text{mm}$, $dy=5\text{mm}$, $dz=5\text{mm}$
Reference Value = 5.8 V/m; Power Drift = -0.074 dB
Peak SAR (extrapolated) = 0.566 W/kg
SAR(1 g) = 0.437 mW/g; SAR(10 g) = 0.255 mW/g
Maximum value of SAR (measured) = 0.463 mW/g

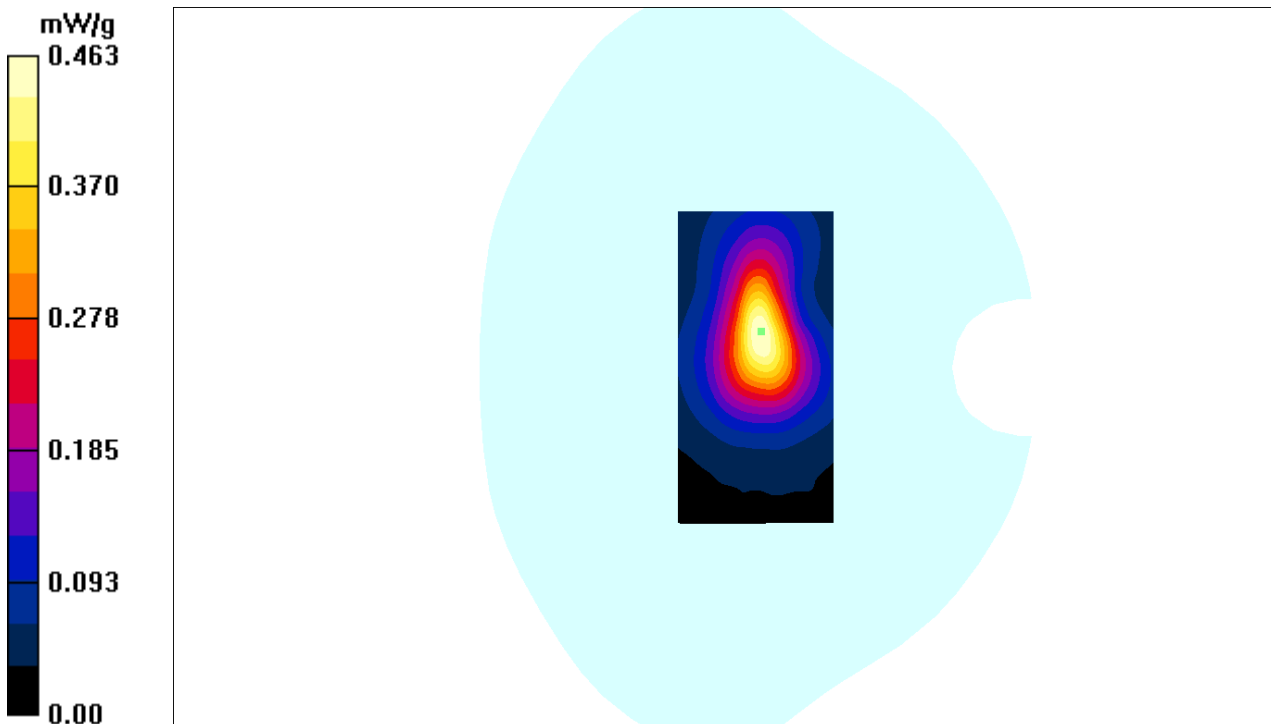

Test Laboratory: Bay Area Compliance Labs Corp.(Shenzhen)

Test Plot 108#:LTE Band 5 Body Worn Back High Channel

DUT: 3G/4G Smart Phone ; Model:SKY 5.0LM

Communication System: LTE 4G Band; Frequency: 844 MHz;Duty Cycle: 1:1
 Medium parameters used: $f = 844 \text{ MHz}$; $\sigma = 0.98 \text{ S/m}$; $\epsilon_r = 53.71$; $\rho = 1000 \text{ kg/m}^3$
 Phantom section: Flat Section

DASY4 Configuration:

- Probe: ES3DV3 - SN3036; ConvF(6.20, 6.20, 6.20); Calibrated: 16/9/2016
- Sensor-Surface: 4mm (Mechanical Surface Detection)
- Electronics: Dummy DAE - SN:456; Calibrated: 12/9/2016
- Phantom: TWIN SAM; Type: QD000P40CA; Serial: TP-1218
- Measurement SW: DASY4, V4.5 Build 19; Postprocessing SW: SEMCAD, V1.8 Build 145

LTE Band 5-body-worn-back- High -1RB /Area Scan (81x101x1): Measurement grid: $dx=10\text{mm}$, $dy=10\text{mm}$
 Maximum value of SAR (interpolated) = 0.464 mW/g

LTE Band 5-body-worn-back- High -1RB /Zoom Scan (7x7x7)/Cube 0: Measurement grid: $dx=5\text{mm}$, $dy=5\text{mm}$, $dz=5\text{mm}$
 Reference Value = 3.75 V/m; Power Drift = -0.013 dB
 Peak SAR (extrapolated) = 0.416 W/kg
SAR(1 g) = 0.426 mW/g; SAR(10 g) = 0.268 mW/g
 Maximum value of SAR (measured) = 0.426 mW/g

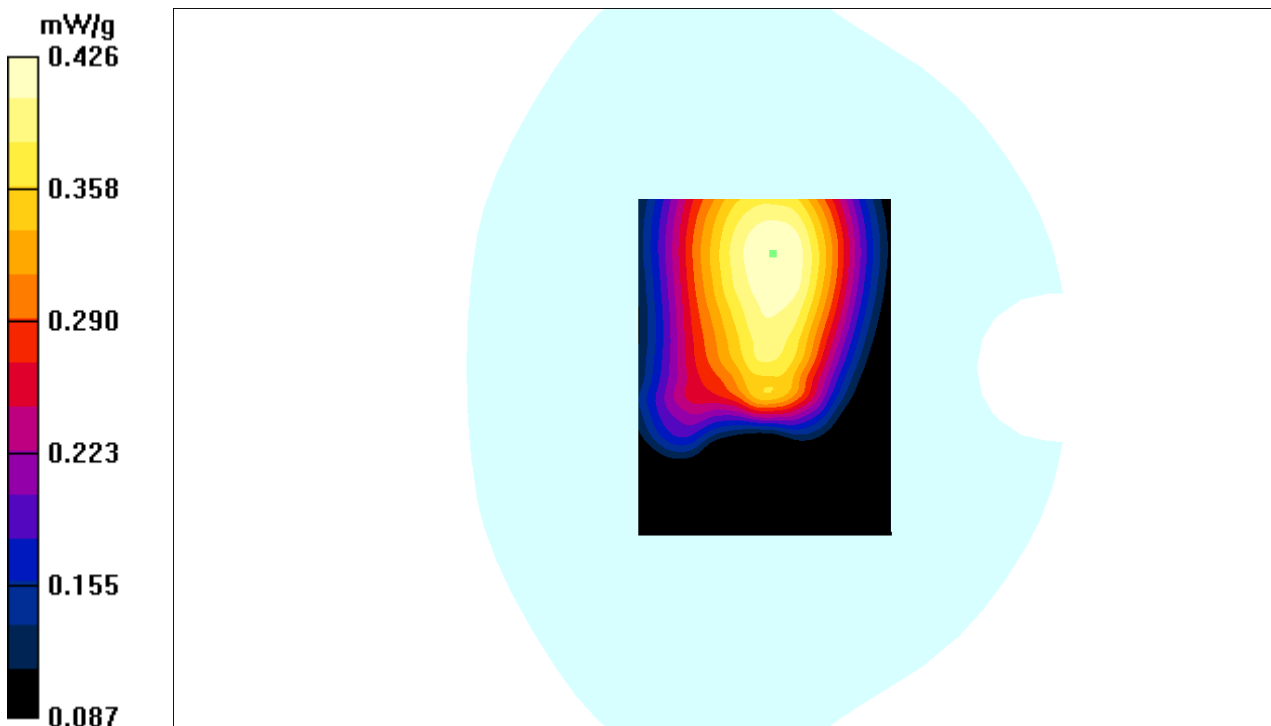

Test Laboratory: Bay Area Compliance Labs Corp.(Shenzhen)

Test Plot 109#:LTE Band 5 Body Worn Back High Channel

DUT: 3G/4G Smart Phone ; Model:SKY 5.0LM

Communication System: LTE 4G Band; Frequency: 844 MHz;Duty Cycle: 1:1
Medium parameters used: $f = 844 \text{ MHz}$; $\sigma = 0.98 \text{ S/m}$; $\epsilon_r = 53.71$; $\rho = 1000 \text{ kg/m}^3$
Phantom section: Flat Section

DASY4 Configuration:

- Probe: ES3DV3 - SN3036; ConvF(6.20, 6.20, 6.20); Calibrated: 16/9/2016
- Sensor-Surface: 4mm (Mechanical Surface Detection)
- Electronics: Dummy DAE - SN:456; Calibrated: 12/9/2016
- Phantom: TWIN SAM; Type: QD000P40CA; Serial: TP-1218
- Measurement SW: DASY4, V4.5 Build 19; Postprocessing SW: SEMCAD, V1.8 Build 145

LTE Band 5-body-worn-back- High -50%RB /Area Scan (91x111x1): Measurement grid: $dx=10\text{mm}$, $dy=10\text{mm}$
Maximum value of SAR (interpolated) = 0.358 mW/g

LTE Band 5-body-worn-back- High -50%RB /Zoom Scan (7x7x7)/Cube 0: Measurement grid:
 $dx=5\text{mm}$, $dy=5\text{mm}$, $dz=5\text{mm}$
Reference Value = 3.9 V/m; Power Drift = -0.022 dB
Peak SAR (extrapolated) = 0.406 W/kg
SAR(1 g) = 0.362 mW/g; SAR(10 g) = 0.210 mW/g
Maximum value of SAR (measured) = 0.382 mW/g

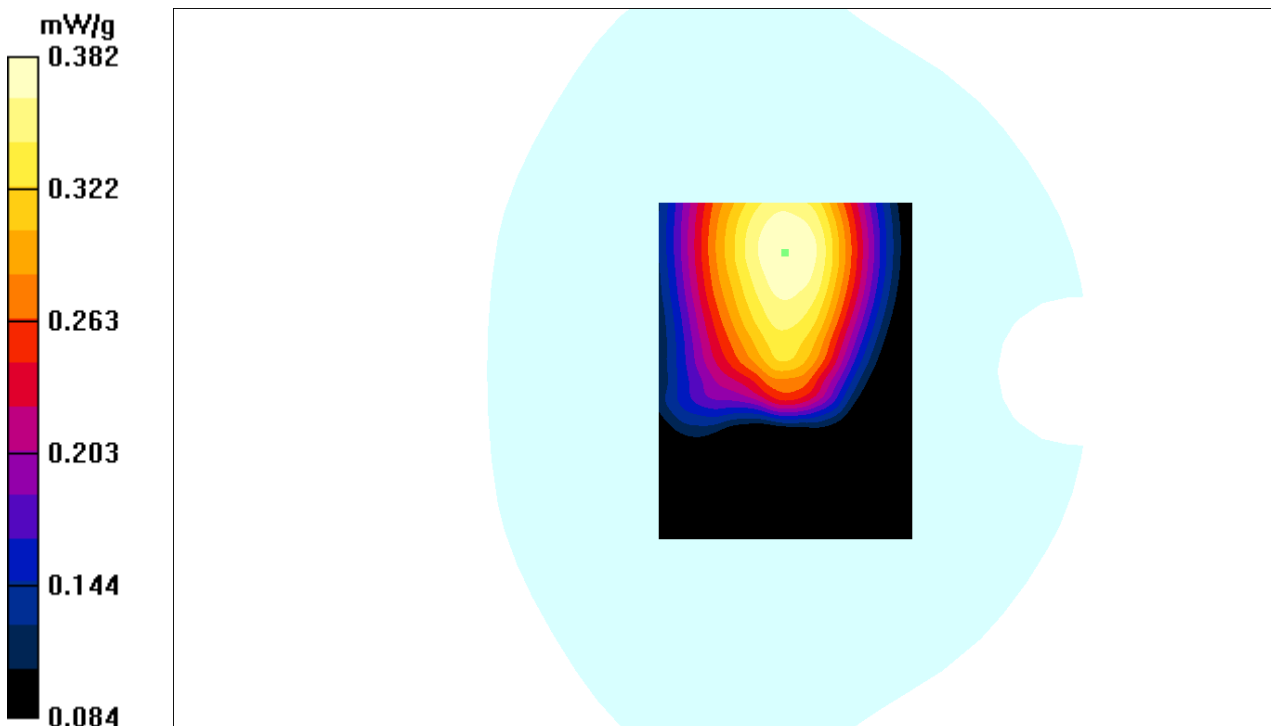

Test Laboratory: Bay Area Compliance Labs Corp.(Shenzhen)

Test Plot 110#:LTE Band 5 Body Worn Left HighChannel

DUT: 3G/4G Smart Phone ; Model:SKY 5.0LM

Communication System: LTE 4G Band; Frequency: 844 MHz;Duty Cycle: 1:1
Medium parameters used: $f = 844 \text{ MHz}$; $\sigma = 0.98 \text{ S/m}$; $\epsilon_r = 53.71$; $\rho = 1000 \text{ kg/m}^3$
Phantom section: Flat Section

DASY4 Configuration:

- Probe: ES3DV3 - SN3036; ConvF(6.20, 6.20, 6.20); Calibrated: 16/9/2016
- Sensor-Surface: 4mm (Mechanical Surface Detection)
- Electronics: Dummy DAE - SN:456; Calibrated: 12/9/2016
- Phantom: TWIN SAM; Type: QD000P40CA; Serial: TP-1218
- Measurement SW: DASY4, V4.5 Build 19; Postprocessing SW: SEMCAD, V1.8 Build 145

LTE Band 5-body-worn-left- High -1RB /Area Scan (91x111x1): Measurement grid: $dx=10\text{mm}$, $dy=10\text{mm}$
Maximum value of SAR (interpolated) = 0.221 mW/g

LTE Band 5-body-worn-left- High -1RB /Zoom Scan (7x7x7)/Cube 0: Measurement grid: $dx=5\text{mm}$, $dy=5\text{mm}$, $dz=5\text{mm}$
Reference Value = 7.1 V/m; Power Drift = -0.101 dB
Peak SAR (extrapolated) = 0.231 W/kg
SAR(1 g) = 0.191 mW/g; SAR(10 g) = 0.103 mW/g
Maximum value of SAR (measured) = 0.215 mW/g

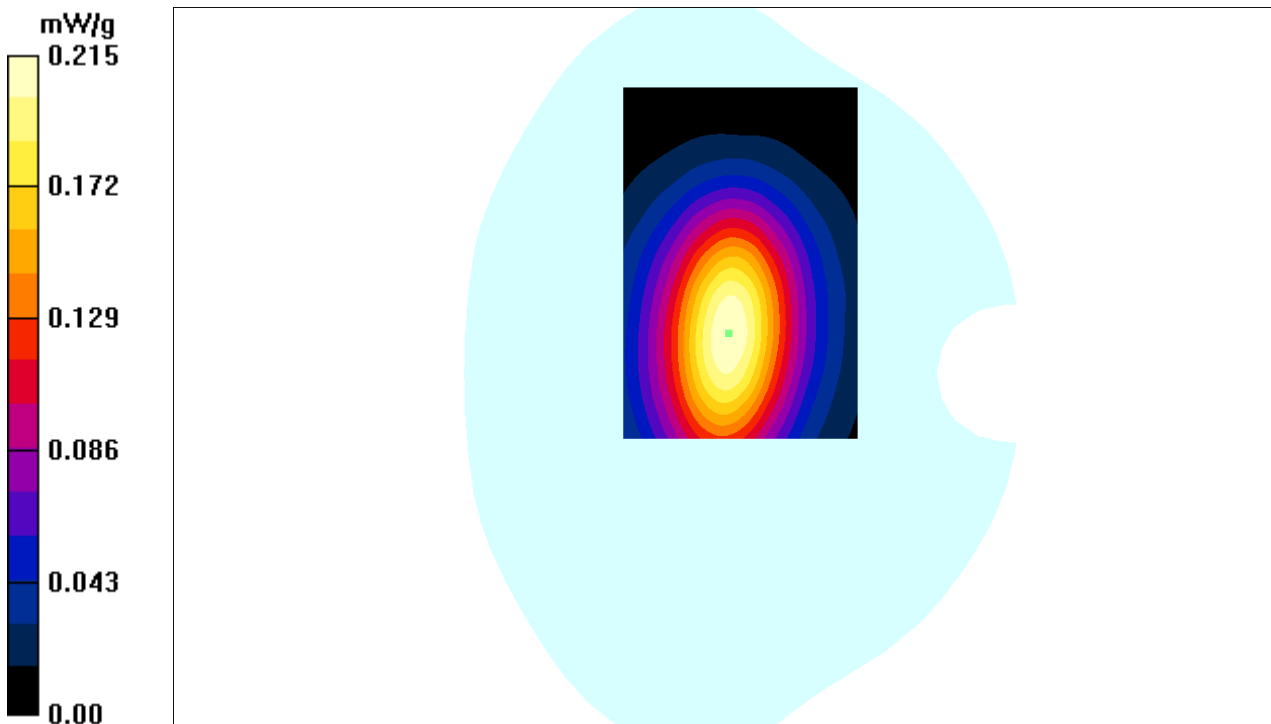

Test Laboratory: Bay Area Compliance Labs Corp.(Shenzhen)

Test Plot 111#:LTE Band 5 Body Worn Left High Channel

DUT: 3G/4G Smart Phone ; Model:SKY 5.0LM

Communication System: LTE 4G Band; Frequency: 844 MHz;Duty Cycle: 1:1
Medium parameters used: $f = 844 \text{ MHz}$; $\sigma = 0.98 \text{ S/m}$; $\epsilon_r = 53.71$; $\rho = 1000 \text{ kg/m}^3$
Phantom section: Flat Section

DASY4 Configuration:

- Probe: ES3DV3 - SN3036; ConvF(6.20, 6.20, 6.20); Calibrated: 16/9/2016
- Sensor-Surface: 4mm (Mechanical Surface Detection)
- Electronics: Dummy DAE - SN:456; Calibrated: 12/9/2016
- Phantom: TWIN SAM; Type: QD000P40CA; Serial: TP-1218
- Measurement SW: DASY4, V4.5 Build 19; Postprocessing SW: SEMCAD, V1.8 Build 145

LTE Band 5-body-worn-left- High-50%RB /Area Scan (91x111x1): Measurement grid: $dx=10\text{mm}$, $dy=10\text{mm}$
Maximum value of SAR (interpolated) = 0.241 mW/g

LTE Band 5-body-worn-left- High -50%RB /Zoom Scan (7x7x7)/Cube 0: Measurement grid: $dx=5\text{mm}$, $dy=5\text{mm}$, $dz=5\text{mm}$
Reference Value = 2.1 V/m; Power Drift = -0.181 dB
Peak SAR (extrapolated) = 0.231 W/kg
SAR(1 g) = 0.205 mW/g; SAR(10 g) = 0.123 mW/g
Maximum value of SAR (measured) = 0.213 mW/g

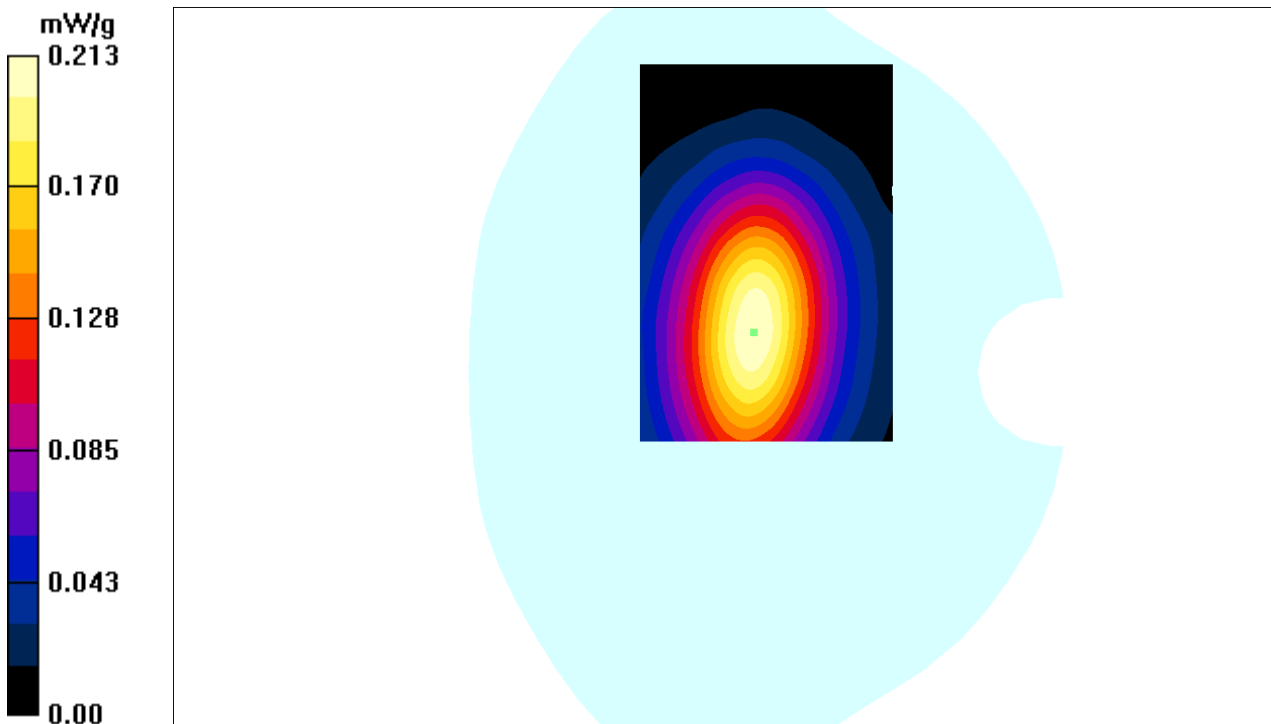

Test Laboratory: Bay Area Compliance Labs Corp.(Shenzhen)

Test Plot 112#:LTE Band 5 Body Worn Right High Channel

DUT: 3G/4G Smart Phone ; Model:SKY 5.0LM

Communication System: LTE 4G Band; Frequency: 844 MHz;Duty Cycle: 1:1
 Medium parameters used: $f = 844 \text{ MHz}$; $\sigma = 0.98 \text{ S/m}$; $\epsilon_r = 53.71$; $\rho = 1000 \text{ kg/m}^3$
 Phantom section: Flat Section

DASY4 Configuration:

- Probe: ES3DV3 - SN3036; ConvF(6.20, 6.20, 6.20); Calibrated: 16/9/2016
- Sensor-Surface: 4mm (Mechanical Surface Detection)
- Electronics: Dummy DAE - SN:456; Calibrated: 12/9/2016
- Phantom: TWIN SAM; Type: QD000P40CA; Serial: TP-1218
- Measurement SW: DASY4, V4.5 Build 19; Postprocessing SW: SEMCAD, V1.8 Build 145

LTE Band 5-body-worn-right- High -1RB /Area Scan (91x111x1): Measurement grid: $dx=10\text{mm}$, $dy=10\text{mm}$
 Maximum value of SAR (interpolated) = 0.231 mW/g

LTE Band 5-body-worn-right- High -1RB /Zoom Scan (7x7x7)/Cube 0: Measurement grid: $dx=5\text{mm}$, $dy=5\text{mm}$, $dz=5\text{mm}$
 Reference Value = 5.9 V/m; Power Drift = 0.11 dB
 Peak SAR (extrapolated) = 0.218 W/kg
SAR(1 g) = 0.201 mW/g; SAR(10 g) = 0.109 mW/g
 Maximum value of SAR (measured) = 0.205 mW/g

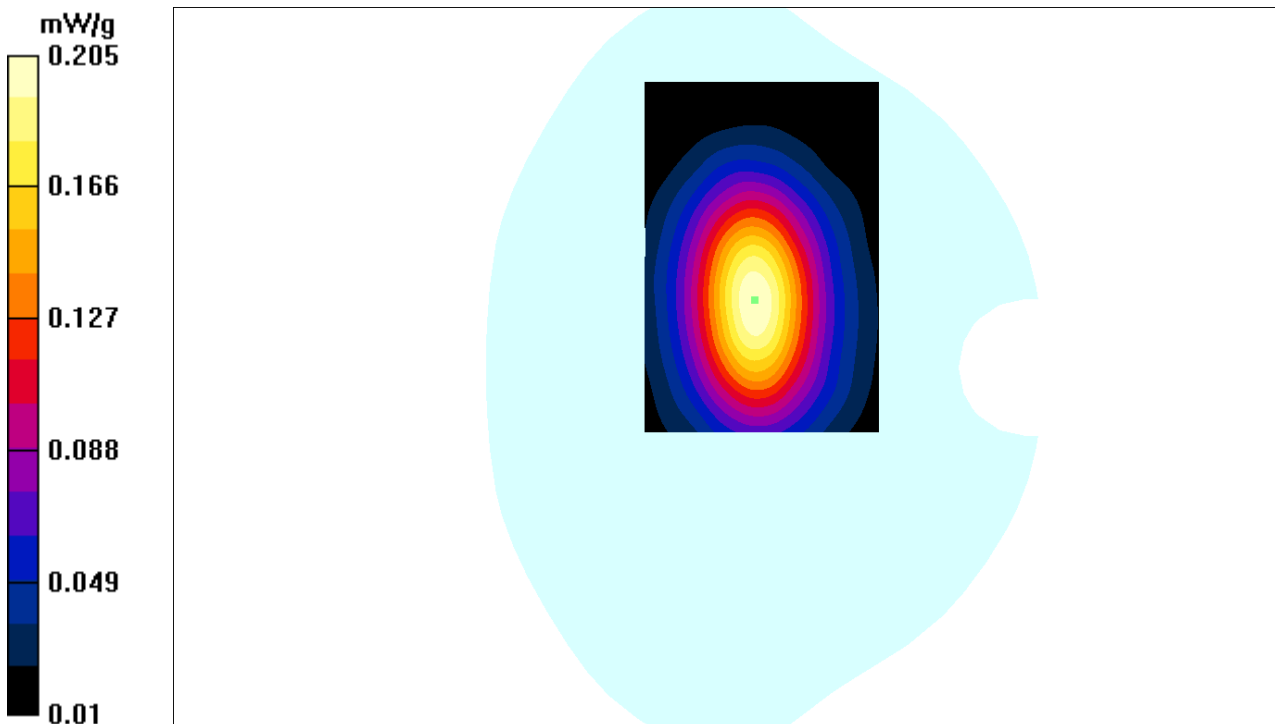

Test Laboratory: Bay Area Compliance Labs Corp.(Shenzhen)

Test Plot 113#:LTE Band 5 Body Worn Right High Channel

DUT: 3G/4G Smart Phone ; Model:SKY 5.0LM

Communication System: LTE 4G Band; Frequency: 844 MHz;Duty Cycle: 1:1
Medium parameters used: $f = 844 \text{ MHz}$; $\sigma = 0.98 \text{ S/m}$; $\epsilon_r = 53.71$; $\rho = 1000 \text{ kg/m}^3$
Phantom section: Flat Section

DASY4 Configuration:

- Probe: ES3DV3 - SN3036; ConvF(6.20, 6.20, 6.20); Calibrated: 16/9/2016
- Sensor-Surface: 4mm (Mechanical Surface Detection)
- Electronics: Dummy DAE - SN:456; Calibrated: 12/9/2016
- Phantom: TWIN SAM; Type: QD000P40CA; Serial: TP-1218
- Measurement SW: DASY4, V4.5 Build 19; Postprocessing SW: SEMCAD, V1.8 Build 145

LTE Band 5-body-worn-right- High -50%RB /Area Scan (81x101x1): Measurement grid: $dx=10\text{mm}$, $dy=10\text{mm}$
Maximum value of SAR (interpolated) = 0.226 mW/g

LTE Band 5-body-worn-right- High -50%RB /Zoom Scan (7x7x7)/Cube 0: Measurement grid:
 $dx=5\text{mm}$, $dy=5\text{mm}$, $dz=5\text{mm}$
Reference Value =2.93 V/m; Power Drift = 0.12 dB
Peak SAR (extrapolated) = 0.198 W/kg
SAR(1 g) = 0.192 mW/g; SAR(10 g) = 0.123 mW/g
Maximum value of SAR (measured) = 0.207 mW/g

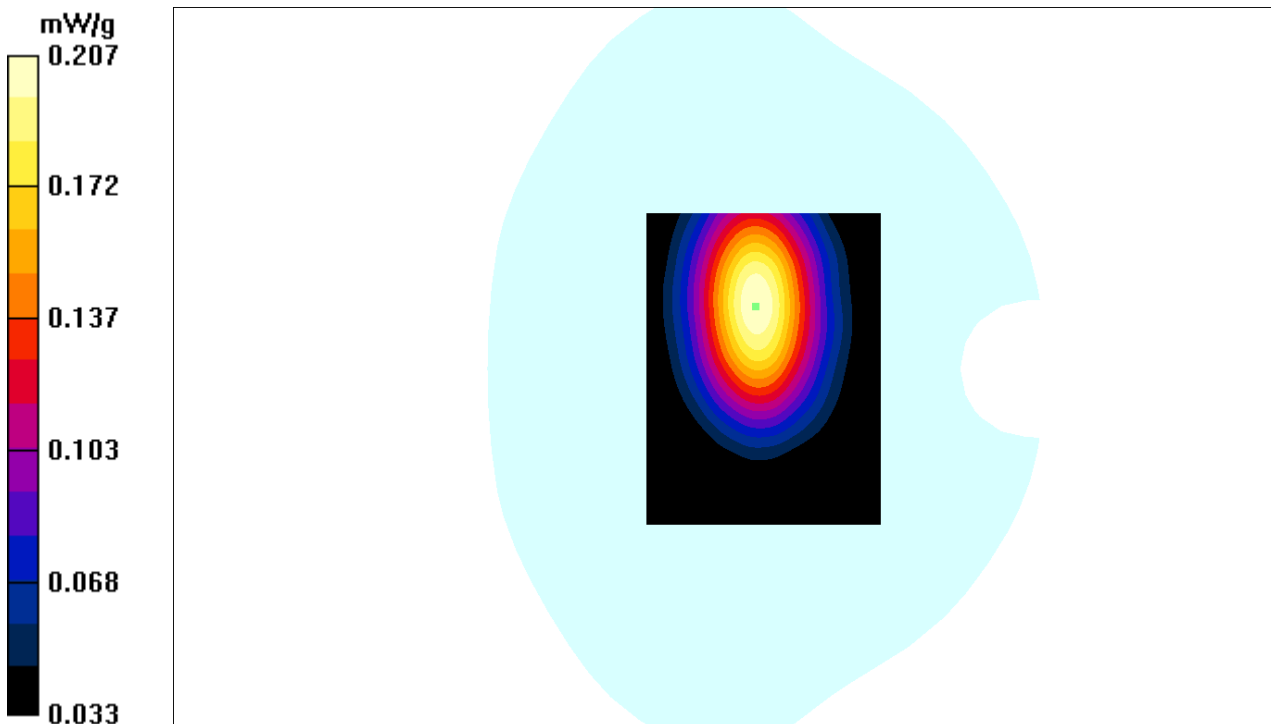

Test Laboratory: Bay Area Compliance Labs Corp.(Shenzhen)

Test Plot 114#:LTE Band 5 Body Worn Bottom High Channel

DUT: 3G/4G Smart Phone ; Model:SKY 5.0LM

Communication System: LTE 4G Band; Frequency: 844 MHz;Duty Cycle: 1:1
 Medium parameters used: $f = 844 \text{ MHz}$; $\sigma = 0.98 \text{ S/m}$; $\epsilon_r = 53.71$; $\rho = 1000 \text{ kg/m}^3$
 Phantom section: Flat Section

DASY4 Configuration:

- Probe: ES3DV3 - SN3036; ConvF(6.20, 6.20, 6.20); Calibrated: 16/9/2016
- Sensor-Surface: 4mm (Mechanical Surface Detection)
- Electronics: Dummy DAE - SN:456; Calibrated: 12/9/2016
- Phantom: TWIN SAM; Type: QD000P40CA; Serial: TP-1218
- Measurement SW: DASY4, V4.5 Build 19; Postprocessing SW: SEMCAD, V1.8 Build 145

LTE Band 5-body-worn-bottom- High -1RB /Area Scan (61x81x1): Measurement grid: $dx=10\text{mm}$, $dy=10\text{mm}$
 Maximum value of SAR (interpolated) = 0.122 mW/g

LTE Band 5-body-worn-bottom- High -1RB /Zoom Scan (7x7x7)/Cube 0: Measurement grid: $dx=5\text{mm}$, $dy=5\text{mm}$, $dz=5\text{mm}$
 Reference Value = 0.104 V/m; Power Drift = 0.038 dB
 Peak SAR (extrapolated) = 0.102 W/kg
SAR(1 g) = 0.106 mW/g; SAR(10 g) = 0.069 mW/g
 Maximum value of SAR (measured) = 0.122 mW/g

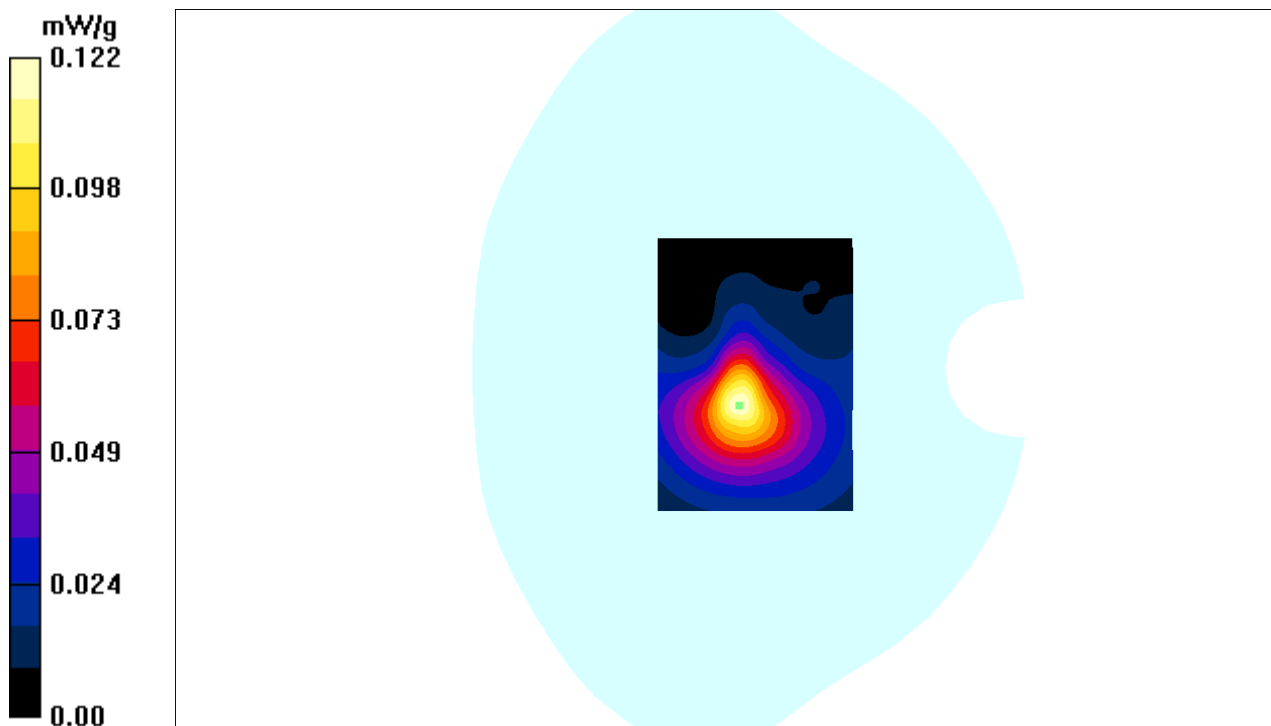

Test Laboratory: Bay Area Compliance Labs Corp.(Shenzhen)

Test Plot 115#:LTE Band 5 Body Worn Bottom High Channel

DUT: 3G/4G Smart Phone ; Model:SKY 5.0LM

Communication System: LTE 4G Band; Frequency: 844 MHz;Duty Cycle: 1:1
Medium parameters used: $f = 844 \text{ MHz}$; $\sigma = 0.98 \text{ S/m}$; $\epsilon_r = 53.71$; $\rho = 1000 \text{ kg/m}^3$
Phantom section: Flat Section

DASY4 Configuration:

- Probe: ES3DV3 - SN3036; ConvF(6.20, 6.20, 6.20); Calibrated: 16/9/2016
- Sensor-Surface: 4mm (Mechanical Surface Detection)
- Electronics: Dummy DAE - SN:456; Calibrated: 12/9/2016
- Phantom: TWIN SAM; Type: QD000P40CA; Serial: TP-1218
- Measurement SW: DASY4, V4.5 Build 19; Postprocessing SW: SEMCAD, V1.8 Build 145

LTE Band 5-body-worn-bottom- High -50%RB /Area Scan (91x111x1): Measurement grid: $dx=10\text{mm}$, $dy=10\text{mm}$
Maximum value of SAR (interpolated) = 0.092 mW/g

LTE Band 5-body-worn-bottom- High -50%RB /Zoom Scan (7x7x7)/Cube 0: Measurement grid:
 $dx=5\text{mm}$, $dy=5\text{mm}$, $dz=5\text{mm}$
Reference Value = 2.01 V/m; Power Drift = 0.098 dB
Peak SAR (extrapolated) = 0.092 W/kg
SAR(1 g) = 0.088 mW/g; SAR(10 g) = 0.059 mW/g
Maximum value of SAR (measured) = 0.093 mW/g

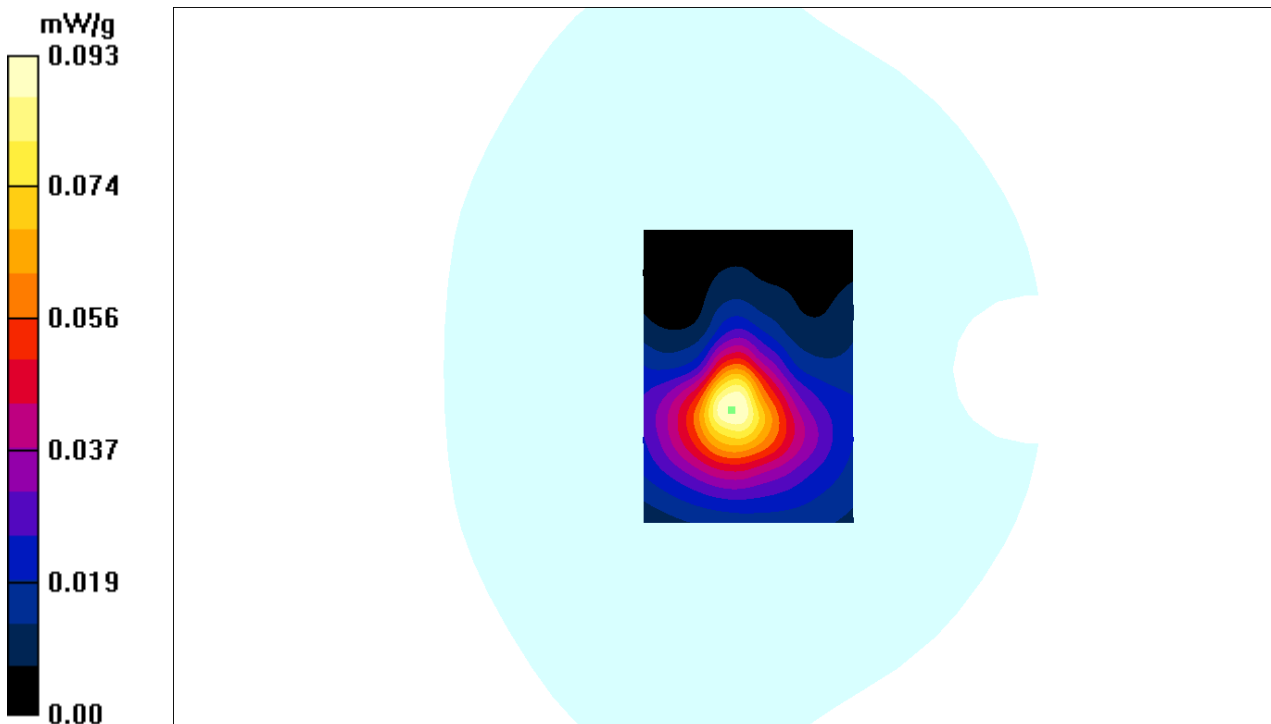

Test Laboratory: Bay Area Compliance Labs Corp.(Shenzhen)

Test Plot 116#: LTE Band 7 Body Worn Back Low Channel

DUT: 3G/4G Smart Phone ; Model: SKY 5.0LM

Communication System: LTE 4G Band; Frequency: 2510 MHz;Duty Cycle: 1:1
Medium parameters used: $f = 2510$ MHz; $\sigma = 2.02$ S/m; $\epsilon_r = 53.93$; $\rho = 1000$ kg/m³
Phantom section: Flat Section

DASY4 Configuration:

- Probe: EX3DV4 - SN7431; ConvF(7.47, 7.47, 7.47); Calibrated: 04/10/2016
- Sensor-Surface: 4mm (Mechanical Surface Detection)
- Electronics: Dummy DAE - SN:456; Calibrated: 12/9/2016
- Phantom: TWIN SAM; Type: QD000P40CA; Serial: TP-1218
- Measurement SW: DASY4, V4.5 Build 19; Postprocessing SW: SEMCAD, V1.8 Build 145

LTE Band 7 -body-worn-back-Low-1RB /Area Scan (91x111x1): Measurement grid: dx=10mm, dy=10mm
Maximum value of SAR (interpolated) = 1.056 mW/g

LTE Band 7 -body-worn-back-Low-1RB /Zoom Scan (7x7x7)/Cube 0: Measurement grid: dx=5mm, dy=5mm, dz=5mm
Reference Value = 6.26 V/m; Power Drift = 0.084 dB
Peak SAR (extrapolated) = 0.977 W/kg
SAR(1 g) = 0.997 mW/g; SAR(10 g) = 0.556 mW/g
Maximum value of SAR (measured) = 1.010 mW/g

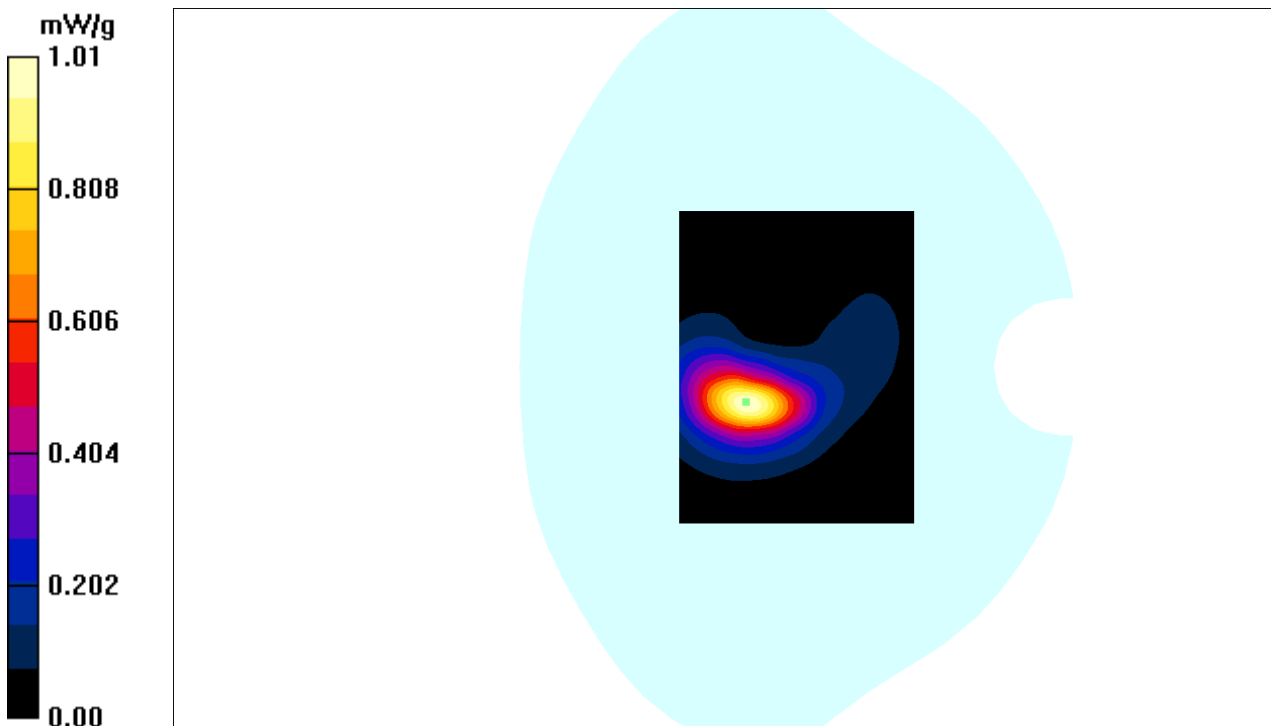

Test Laboratory: Bay Area Compliance Labs Corp.(Shenzhen)

Test Plot 117#: LTE Band 7 Body Worn Back Middle Channel

DUT: 3G/4G Smart Phone ; Model: SKY 5.0LM

Communication System: LTE 4G Band; Frequency: 2535 MHz;Duty Cycle: 1:1
Medium parameters used: $f = 2535$ MHz; $\sigma = 2.04$ S/m; $\epsilon_r = 53.86$; $\rho = 1000$ kg/m³
Phantom section: Flat Section

DASY4 Configuration:

- Probe: EX3DV4 - SN7431; ConvF(7.47, 7.47, 7.47); Calibrated: 04/10/2016
- Sensor-Surface: 4mm (Mechanical Surface Detection)
- Electronics: Dummy DAE - SN:456; Calibrated: 12/9/2016
- Phantom: TWIN SAM; Type: QD000P40CA; Serial: TP-1218
- Measurement SW: DASY4, V4.5 Build 19; Postprocessing SW: SEMCAD, V1.8 Build 145

LTE Band 7 -body-worn-back-Middle-1RB /Area Scan (91x111x1): Measurement grid: dx=10mm, dy=10mm
Maximum value of SAR (interpolated) = 0.956 mW/g

LTE Band 7 -body-worn-back-Middle-1RB /Zoom Scan (7x7x7)/Cube 0: Measurement grid: dx=5mm, dy=5mm, dz=5mm
Reference Value = 4.86 V/m; Power Drift = 0.009 dB
Peak SAR (extrapolated) = 0.817 W/kg
SAR(1 g) = 0.937 mW/g; SAR(10 g) = 0.556 mW/g
Maximum value of SAR (measured) = 0.987 mW/g

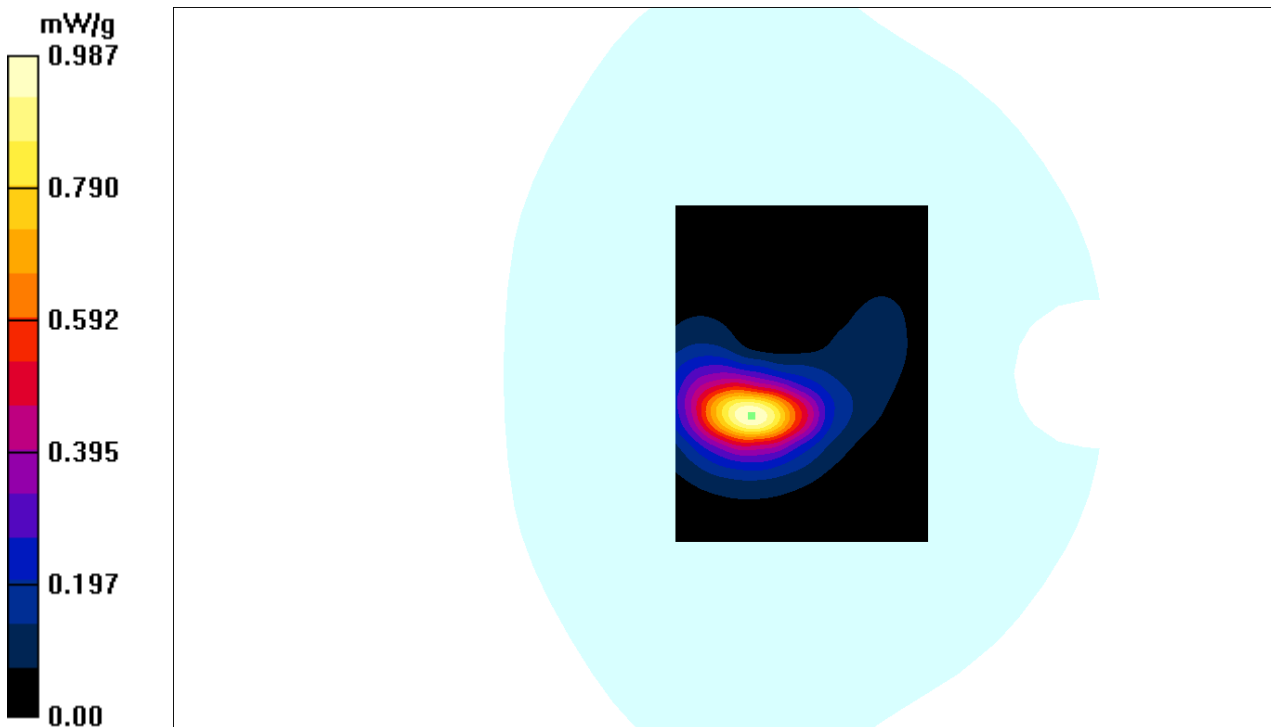

Test Laboratory: Bay Area Compliance Labs Corp.(Shenzhen)

Test Plot 118#: LTE Band 7 Body Worn Back High Channel

DUT: 3G/4G Smart Phone ; Model: SKY 5.0LM

Communication System: LTE 4G Band; Frequency: 2560 MHz;Duty Cycle: 1:1
Medium parameters used: $f = 2560$ MHz; $\sigma = 2.05$ S/m; $\epsilon_r = 53.88$; $\rho = 1000$ kg/m³
Phantom section: Flat Section

DASY4 Configuration:

- Probe: EX3DV4 - SN7431; ConvF(7.47, 7.47, 7.47); Calibrated: 04/10/2016
- Sensor-Surface: 4mm (Mechanical Surface Detection)
- Electronics: Dummy DAE - SN:456; Calibrated: 12/9/2016
- Phantom: TWIN SAM; Type: QD000P40CA; Serial: TP-1218
- Measurement SW: DASY4, V4.5 Build 19; Postprocessing SW: SEMCAD, V1.8 Build 145

LTE Band 7 -body-worn-back-high-1RB /Area Scan (91x111x1): Measurement grid: dx=10mm, dy=10mm
Maximum value of SAR (interpolated) = 0.956 mW/g

LTE Band 7 -body-worn-back-high-1RB /Zoom Scan (7x7x7)/Cube 0: Measurement grid: dx=5mm, dy=5mm, dz=5mm
Reference Value = 5.86 V/m; Power Drift = 0.074 dB
Peak SAR (extrapolated) = 0.917 W/kg
SAR(1 g) = 0.952 mW/g; SAR(10 g) = 0.456 mW/g
Maximum value of SAR (measured) = 0.960 mW/g

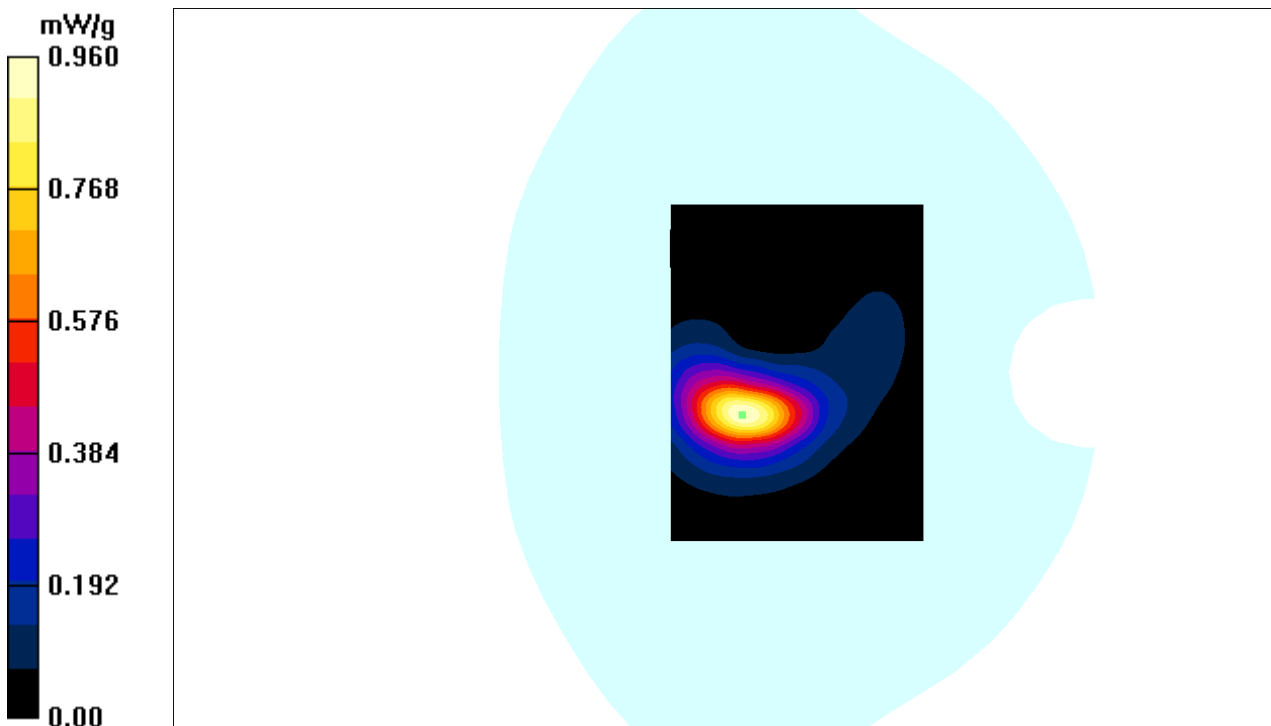

Test Laboratory: Bay Area Compliance Labs Corp.(Shenzhen)

Test Plot 119#: LTE Band 7 Body Worn Back High Channel

DUT: 3G/4G Smart Phone ; Model: SKY 5.0LM

Communication System: LTE 4G Band; Frequency: 2560 MHz;Duty Cycle: 1:1
Medium parameters used: $f = 2560$ MHz; $\sigma = 2.05$ S/m; $\epsilon_r = 53.88$; $\rho = 1000$ kg/m³
Phantom section: Flat Section

DASY4 Configuration:

- Probe: EX3DV4 - SN7431; ConvF(7.47, 7.47, 7.47); Calibrated: 04/10/2016
- Sensor-Surface: 4mm (Mechanical Surface Detection)
- Electronics: Dummy DAE - SN:456; Calibrated: 12/9/2016
- Phantom: TWIN SAM; Type: QD000P40CA; Serial: TP-1218
- Measurement SW: DASY4, V4.5 Build 19; Postprocessing SW: SEMCAD, V1.8 Build 145

LTE Band 7 -body-worn-back-high-50%RB /Area Scan (91x111x1): Measurement grid: dx=10mm, dy=10mm
Maximum value of SAR (interpolated) = 0.726 mW/g

LTE Band 7 -body-worn-back-high-50%RB /Zoom Scan (7x7x7)/Cube 0: Measurement grid: dx=5mm, dy=5mm, dz=5mm
Reference Value = 3.26 V/m; Power Drift = 0.039 dB
Peak SAR (extrapolated) = 0.727 W/kg
SAR(1 g) = 0.674 mW/g; SAR(10 g) = 0.356 mW/g
Maximum value of SAR (measured) = 0.719 mW/g

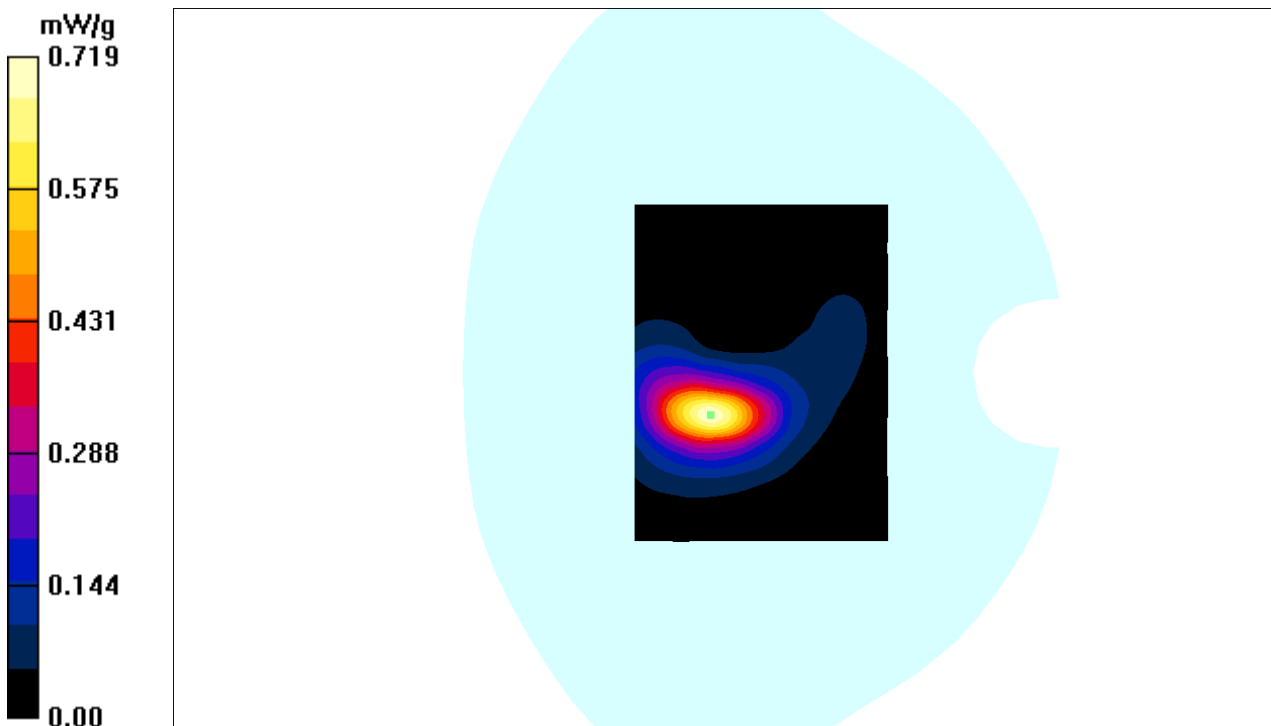

Test Laboratory: Bay Area Compliance Labs Corp.(Shenzhen)

Test Plot 120#: LTE Band 7 Body Worn Back High Channel

DUT: 3G/4G Smart Phone ; Model: SKY 5.0LM

Communication System: LTE 4G Band; Frequency: 2560 MHz;Duty Cycle: 1:1
Medium parameters used: $f = 2560$ MHz; $\sigma = 2.05$ S/m; $\epsilon_r = 53.88$; $\rho = 1000$ kg/m³
Phantom section: Flat Section

DASY4 Configuration:

- Probe: EX3DV4 - SN7431; ConvF(7.47, 7.47, 7.47); Calibrated: 04/10/2016
- Sensor-Surface: 4mm (Mechanical Surface Detection)
- Electronics: Dummy DAE - SN:456; Calibrated: 12/9/2016
- Phantom: TWIN SAM; Type: QD000P40CA; Serial: TP-1218
- Measurement SW: DASY4, V4.5 Build 19; Postprocessing SW: SEMCAD, V1.8 Build 145

LTE Band 7 -body-worn-back-high-100%RB /Area Scan (91x111x1): Measurement grid: dx=10mm, dy=10mm
Maximum value of SAR (interpolated) = 0.708 mW/g

LTE Band 7 -body-worn-back-high-100%RB /Zoom Scan (7x7x7)/Cube 0: Measurement grid: dx=5mm, dy=5mm, dz=5mm
Reference Value = 2.98 V/m; Power Drift = -0.085 dB
Peak SAR (extrapolated) = 1.026 W/kg
SAR(1 g) = 0.658 mW/g; SAR(10 g) = 0.356 mW/g
Maximum value of SAR (measured) = 0.707 mW/g

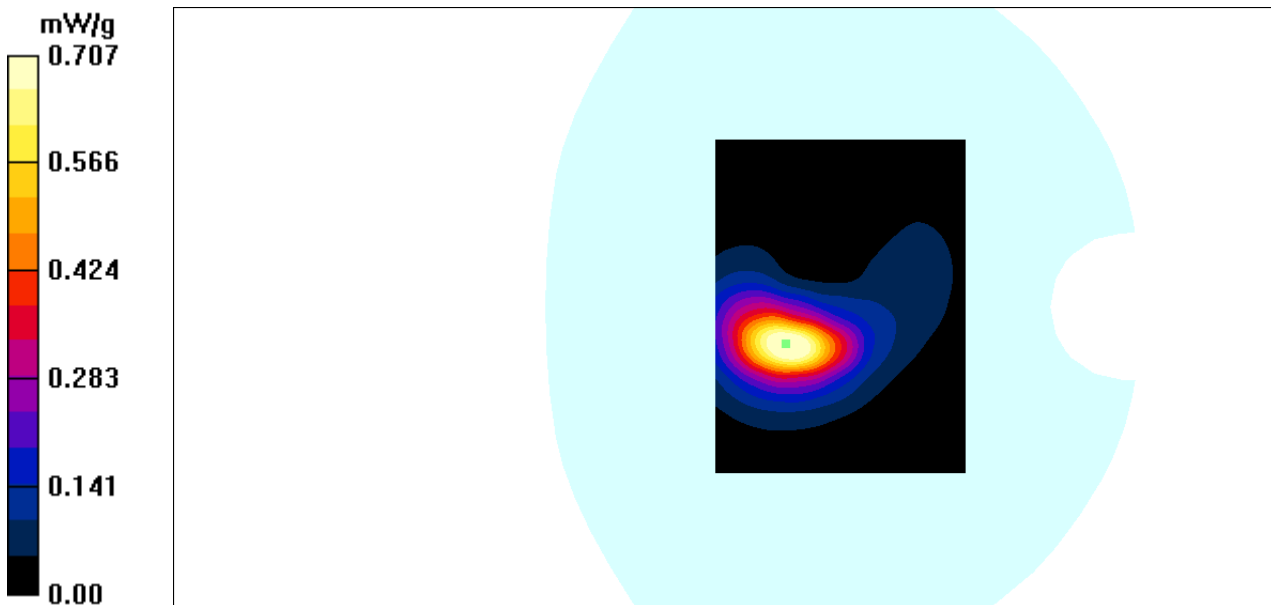

Test Laboratory: Bay Area Compliance Labs Corp.(Shenzhen)

Test Plot 121#: LTE Band 7 Body Worn Left High Channel

DUT: 3G/4G Smart Phone ; Model: SKY 5.0LM

Communication System: LTE 4G Band; Frequency: 2560 MHz;Duty Cycle: 1:1
Medium parameters used: $f = 2560$ MHz; $\sigma = 2.05$ S/m; $\epsilon_r = 53.88$; $\rho = 1000$ kg/m³
Phantom section: Flat Section

DASY4 Configuration:

- Probe: EX3DV4 - SN7431; ConvF(7.47, 7.47, 7.47); Calibrated: 04/10/2016
- Sensor-Surface: 4mm (Mechanical Surface Detection)
- Electronics: Dummy DAE - SN:456; Calibrated: 12/9/2016
- Phantom: TWIN SAM; Type: QD000P40CA; Serial: TP-1218
- Measurement SW: DASY4, V4.5 Build 19; Postprocessing SW: SEMCAD, V1.8 Build 145

LTE Band 7 -body-worn-left-high-1RB /Area Scan (91x111x1): Measurement grid: dx=10mm, dy=10mm
Maximum value of SAR (interpolated) = 0.341 mW/g

LTE Band 7 -body-worn-left-high-1RB /Zoom Scan (7x7x7)/Cube 0: Measurement grid: dx=5mm, dy=5mm, dz=5mm
Reference Value = 2.82 V/m; Power Drift = -0.123 dB
Peak SAR (extrapolated) = 0.391 W/kg
SAR(1 g) = 0.362 mW/g; SAR(10 g) = 0.218 mW/g
Maximum value of SAR (measured) = 0.378 mW/g

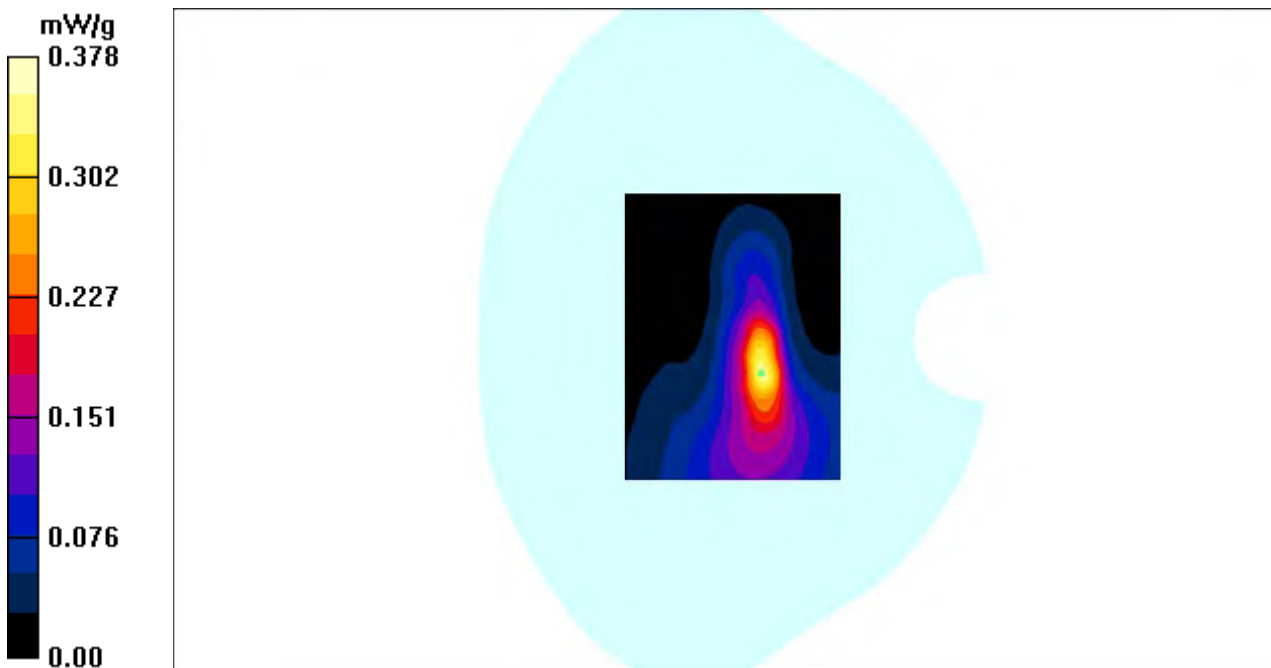

Test Laboratory: Bay Area Compliance Labs Corp.(Shenzhen)

Test Plot 122#: LTE Band 7 Body Worn Left High Channel

DUT: 3G/4G Smart Phone ; Model: SKY 5.0LM

Communication System: LTE 4G Band; Frequency: 2560 MHz;Duty Cycle: 1:1
Medium parameters used: $f = 2560$ MHz; $\sigma = 2.05$ S/m; $\epsilon_r = 53.88$; $\rho = 1000$ kg/m³
Phantom section: Flat Section

DASY4 Configuration:

- Probe: EX3DV4 - SN7431; ConvF(7.47, 7.47, 7.47); Calibrated: 04/10/2016
- Sensor-Surface: 4mm (Mechanical Surface Detection)
- Electronics: Dummy DAE - SN:456; Calibrated: 12/9/2016
- Phantom: TWIN SAM; Type: QD000P40CA; Serial: TP-1218
- Measurement SW: DASY4, V4.5 Build 19; Postprocessing SW: SEMCAD, V1.8 Build 145

LTE Band 7 -body-worn-left-high-50%RB /Area Scan (81x101x1): Measurement grid: dx=10mm, dy=10mm
Maximum value of SAR (interpolated) = 0.341 mW/g

LTE Band 7 -body-worn-left-high-50%RB /Zoom Scan (7x7x7)/Cube 0: Measurement grid: dx=5mm, dy=5mm, dz=5mm
Reference Value = 3.53 V/m; Power Drift = 0.103 dB
Peak SAR (extrapolated) = 0.291 W/kg
SAR(1 g) = 0.297 mW/g; SAR(10 g) = 0.178 mW/g
Maximum value of SAR (measured) = 0.307 mW/g

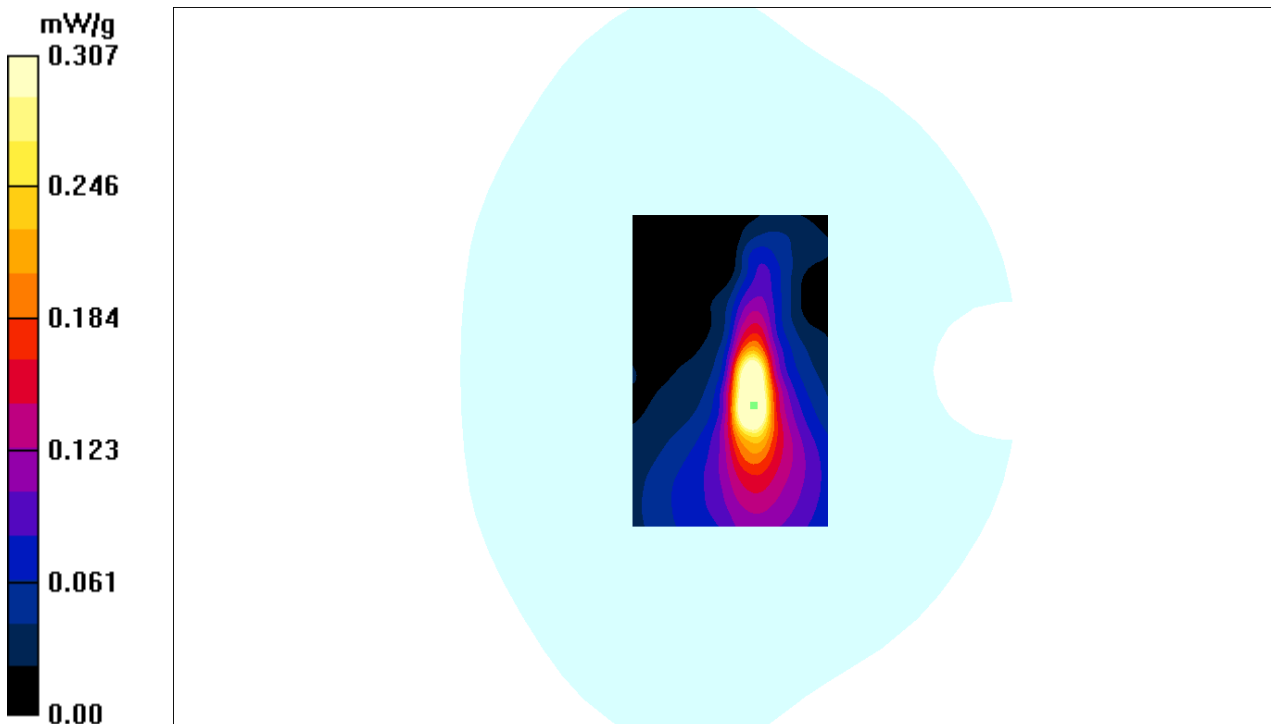

Test Laboratory: Bay Area Compliance Labs Corp.(Shenzhen)

Test Plot 123#: LTE Band 7 Body Worn Right High Channel

DUT: 3G/4G Smart Phone ; Model: SKY 5.0LM

Communication System: LTE 4G Band; Frequency: 2560 MHz;Duty Cycle: 1:1
Medium parameters used: $f = 2560$ MHz; $\sigma = 2.05$ S/m; $\epsilon_r = 53.88$; $\rho = 1000$ kg/m³
Phantom section: Flat Section

DASY4 Configuration:

- Probe: EX3DV4 - SN7431; ConvF(7.47, 7.47, 7.47); Calibrated: 04/10/2016
- Sensor-Surface: 4mm (Mechanical Surface Detection)
- Electronics: Dummy DAE - SN:456; Calibrated: 12/9/2016
- Phantom: TWIN SAM; Type: QD000P40CA; Serial: TP-1218
- Measurement SW: DASY4, V4.5 Build 19; Postprocessing SW: SEMCAD, V1.8 Build 145

LTE Band 7 -body-worn-right-high-1RB /Area Scan (91x111x1): Measurement grid: dx=10mm, dy=10mm
Maximum value of SAR (interpolated) = 0.532 mW/g

LTE Band 7 -body-worn-right-high-1RB /Zoom Scan (7x7x7)/Cube 0: Measurement grid: dx=5mm, dy=5mm, dz=5mm
Reference Value = 3.68 V/m; Power Drift = 0.075 dB
Peak SAR (extrapolated) = 0.2604 W/kg
SAR(1 g) = 0.483 mW/g; SAR(10 g) = 0.327 mW/g
Maximum value of SAR (measured) = 0.587 mW/g

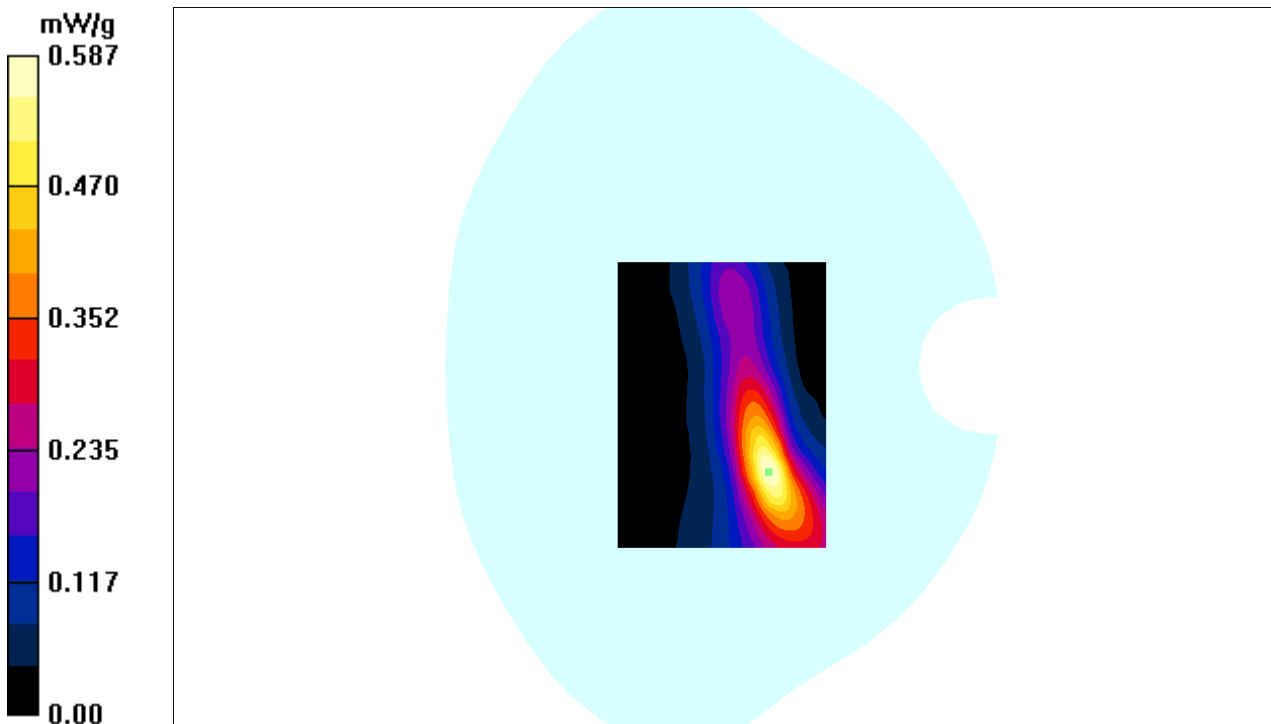

Test Laboratory: Bay Area Compliance Labs Corp.(Shenzhen)

Test Plot 124#: LTE Band 7 Body Worn Right High Channel

DUT: 3G/4G Smart Phone ; Model: SKY 5.0LM

Communication System: LTE 4G Band; Frequency: 2560 MHz;Duty Cycle: 1:1
 Medium parameters used: $f = 2560$ MHz; $\sigma = 2.05$ S/m; $\epsilon_r = 53.88$; $\rho = 1000$ kg/m³
 Phantom section: Flat Section

DASY4 Configuration:

- Probe: EX3DV4 - SN7431; ConvF(7.47, 7.47, 7.47); Calibrated: 04/10/2016
- Sensor-Surface: 4mm (Mechanical Surface Detection)
- Electronics: Dummy DAE - SN:456; Calibrated: 12/9/2016
- Phantom: TWIN SAM; Type: QD000P40CA; Serial: TP-1218
- Measurement SW: DASY4, V4.5 Build 19; Postprocessing SW: SEMCAD, V1.8 Build 145

LTE Band 7 -body-worn-right-high-50%RB /Area Scan (91x111x1): Measurement grid: dx=10mm, dy=10mm
 Maximum value of SAR (interpolated) = 0.462 mW/g

LTE Band 7 -body-worn-right-high-50%RB /Zoom Scan (7x7x7)/Cube 0: Measurement grid: dx=5mm, dy=5mm, dz=5mm
 Reference Value = 3.28 V/m; Power Drift = 0.025 dB
 Peak SAR (extrapolated) = 0.504 W/kg
SAR(1 g) = 0.387 mW/g; SAR(10 g) = 0.283 mW/g
 Maximum value of SAR (measured) = 0.439 mW/g

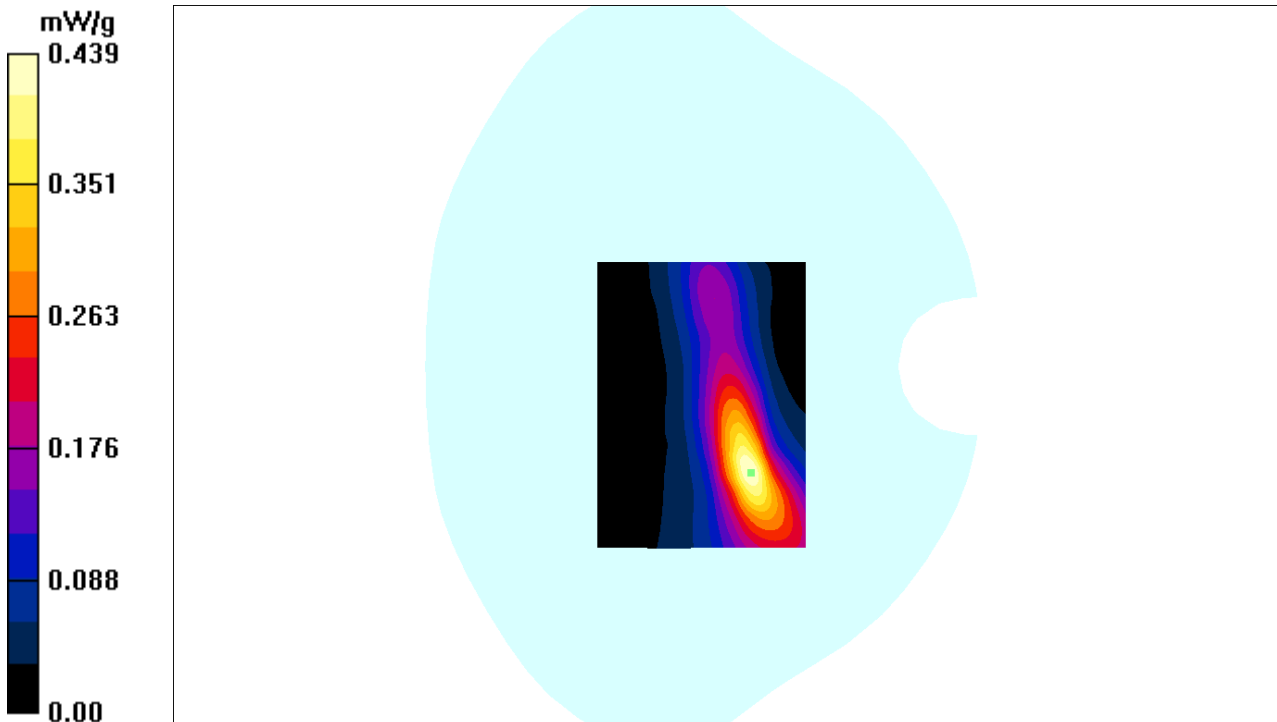

Test Laboratory: Bay Area Compliance Labs Corp.(Shenzhen)

Test Plot 125#: LTE Band 7 Body Worn Bottom High Channel

DUT: 3G/4G Smart Phone ; Model: SKY 5.0LM

Communication System: LTE 4G Band; Frequency: 2560 MHz;Duty Cycle: 1:1
Medium parameters used: $f = 2560$ MHz; $\sigma = 2.05$ S/m; $\epsilon_r = 53.88$; $\rho = 1000$ kg/m³
Phantom section: Flat Section

DASY4 Configuration:

- Probe: EX3DV4 - SN7431; ConvF(7.47, 7.47, 7.47); Calibrated: 04/10/2016
- Sensor-Surface: 4mm (Mechanical Surface Detection)
- Electronics: Dummy DAE - SN:456; Calibrated: 12/9/2016
- Phantom: TWIN SAM; Type: QD000P40CA; Serial: TP-1218
- Measurement SW: DASY4, V4.5 Build 19; Postprocessing SW: SEMCAD, V1.8 Build 145

LTE Band 7 -body-worn-bottom-high-1RB /Area Scan (91x111x1): Measurement grid: dx=10mm, dy=10mm
Maximum value of SAR (interpolated) = 0.962 mW/g

LTE Band 7 -body-worn-bottom-high-1RB /Zoom Scan (7x7x7)/Cube 0: Measurement grid: dx=5mm, dy=5mm, dz=5mm
Reference Value = 3.98 V/m; Power Drift = 0.055 dB
Peak SAR (extrapolated) = 0.904 W/kg
SAR(1 g) = 0.792 mW/g; SAR(10 g) = 0.427 mW/g
Maximum value of SAR (measured) = 0.862 mW/g

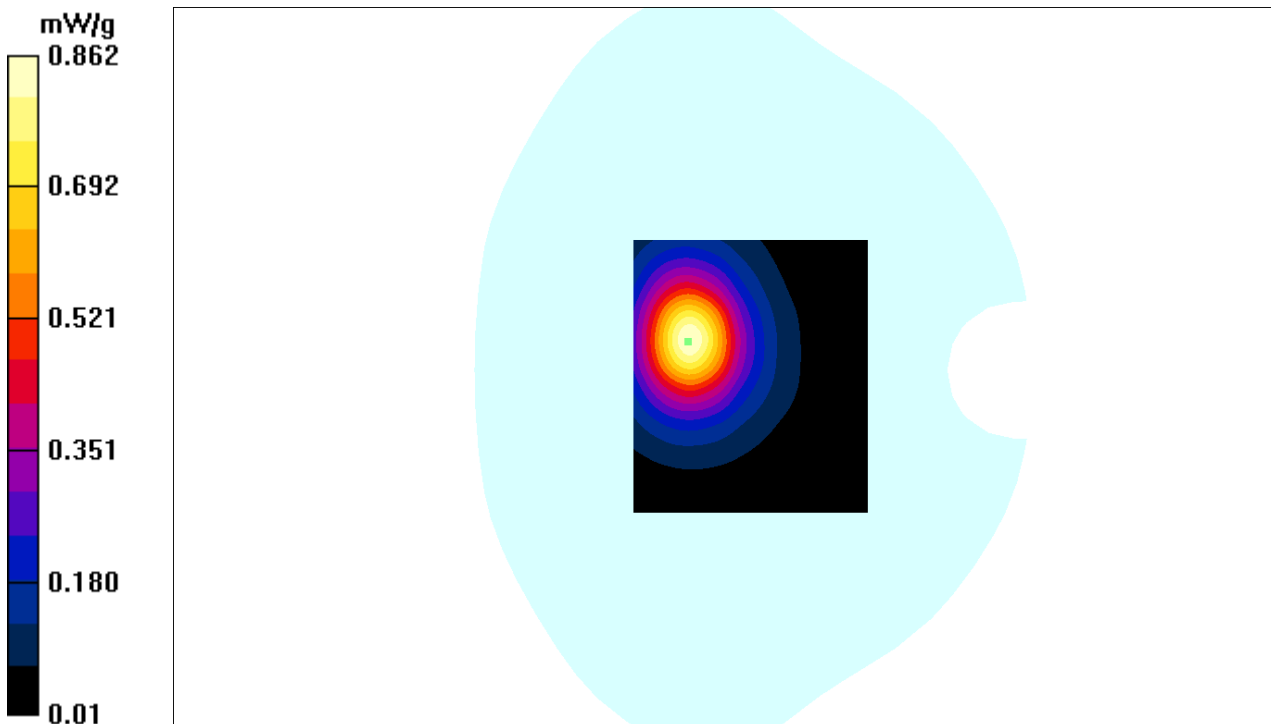

Test Laboratory: Bay Area Compliance Labs Corp.(Shenzhen)

Test Plot 126#: LTE Band 7 Body Worn Bottom High Channel

DUT: 3G/4G Smart Phone ; Model: SKY 5.0LM

Communication System: LTE 4G Band; Frequency: 2560 MHz;Duty Cycle: 1:1
Medium parameters used: $f = 2560$ MHz; $\sigma = 2.05$ S/m; $\epsilon_r = 53.88$; $\rho = 1000$ kg/m³
Phantom section: Flat Section

DASY4 Configuration:

- Probe: EX3DV4 - SN7431; ConvF(7.47, 7.47, 7.47); Calibrated: 04/10/2016
- Sensor-Surface: 4mm (Mechanical Surface Detection)
- Electronics: Dummy DAE - SN:456; Calibrated: 12/9/2016
- Phantom: TWIN SAM; Type: QD000P40CA; Serial: TP-1218
- Measurement SW: DASY4, V4.5 Build 19; Postprocessing SW: SEMCAD, V1.8 Build 145

LTE Band 7 -body-worn-bottom-high-50%RB /Area Scan (61x101x1): Measurement grid: dx=10mm, dy=10mm
Maximum value of SAR (interpolated) = 0.842 mW/g

LTE Band 7 -body-worn-bottom-high-50%RB /Zoom Scan (7x7x7)/Cube 0: Measurement grid: dx=5mm, dy=5mm, dz=5mm
Reference Value = 3.67 V/m; Power Drift = 0.025 dB
Peak SAR (extrapolated) = 0.924 W/kg
SAR(1 g) = 0.662 mW/g; SAR(10 g) = 0.427 mW/g
Maximum value of SAR (measured) = 0.802 mW/g

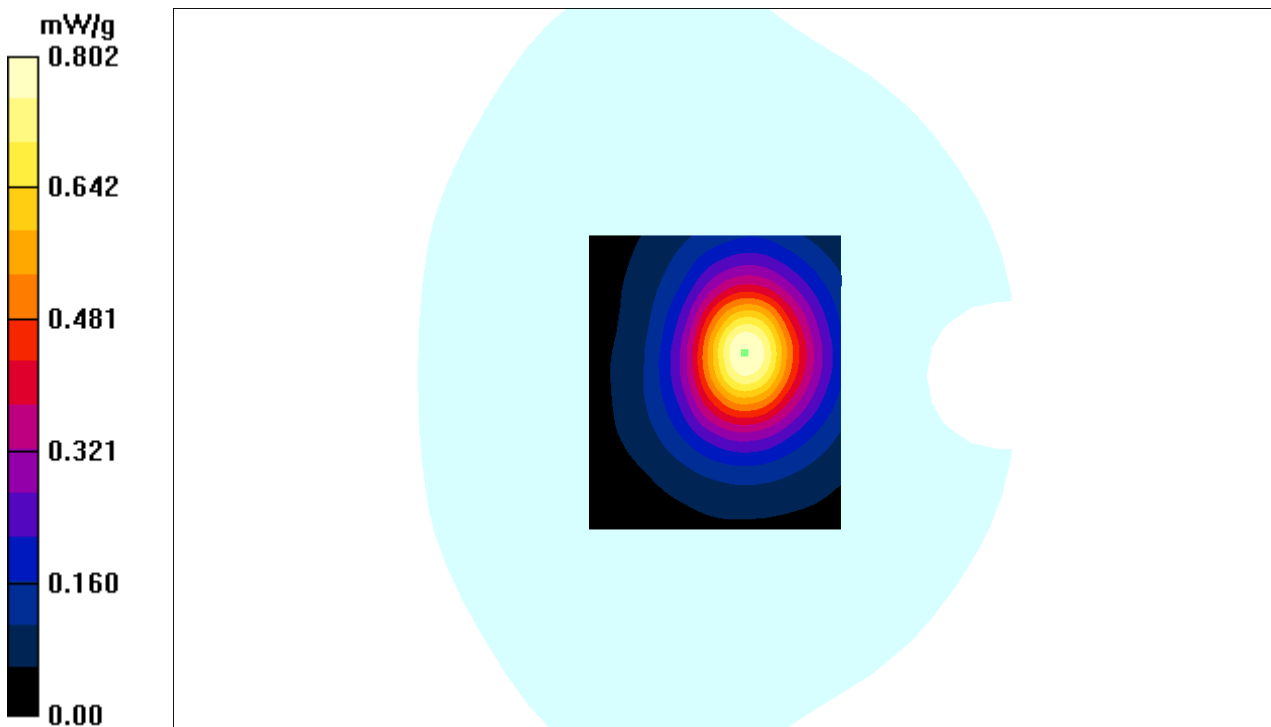

APPENDIX A MEASUREMENT UNCERTAINTY

The uncertainty budget has been determined for the DASY4 measurement system and is given in the following Table.

DASY4 Uncertainty Budget According to IEEE 1528								
Error Description	Uncertainty Value	Prob. Dist.	Div.	(c i) 1g	(c i) 10g	Std. Unc. (1g)	Std. Unc. (10g)	(v i) v _{eff}
Measurement System								
Probe Calibration	± 6.0 %	N	1	1	1	± 6.0 %	± 6.0 %	∞
Axial Isotropy	± 4.7 %	R	$\sqrt{3}$	0.7	0.7	± 1.9 %	± 1.9 %	∞
Hemispherical Isotropy	± 9.6 %	R	$\sqrt{3}$	0.7	0.7	± 3.9 %	± 3.9 %	∞
Boundary Effects	± 1.0 %	R	$\sqrt{3}$	1	1	± 0.6 %	± 0.6 %	∞
Linearity	± 4.7 %	R	$\sqrt{3}$	1	1	± 2.7 %	± 2.7 %	∞
System Detection Limits	± 1.0 %	R	$\sqrt{3}$	1	1	± 0.6 %	± 0.6 %	∞
Readout Electronics	± 0.3 %	N	1	1	1	± 0.3 %	± 0.3 %	∞
Response Time	± 0.8 %	R	$\sqrt{3}$	1	1	± 0.5 %	± 0.5 %	∞
Integration Time	± 2.6 %	R	$\sqrt{3}$	1	1	± 1.5 %	± 1.5 %	∞
RF Ambient Noise	± 3.0 %	R	$\sqrt{3}$	1	1	± 1.7 %	± 1.7 %	∞
RF Ambient Conditions	± 3.0 %	R	$\sqrt{3}$	1	1	± 1.7 %	± 1.7 %	∞
Probe Positioner	± 0.4 %	R	$\sqrt{3}$	1	1	± 0.2 %	± 0.2 %	∞
Probe Positioning	± 2.9 %	R	$\sqrt{3}$	1	1	± 1.7 %	± 1.7 %	∞
Max. SAR Eval.	± 1.0 %	R	$\sqrt{3}$	1	1	± 0.6 %	± 0.6 %	∞
Test Sample Related								
Device Positioning	± 2.9 %	N	1	1	1	± 2.9 %	± 2.9 %	145
Device Holder	± 3.6 %	N	1	1	1	± 3.6 %	± 2.6 %	5
Power Drift	± 5.0 %	R		1	1	± 2.9 %	± 2.9 %	∞
Phantom and Setup								
Phantom Uncertainty	± 4.0 %	R	$\sqrt{3}$	1	1	± 2.3 %	± 2.3 %	∞
Liquid Conductivity (Target)	± 5.0 %	R	$\sqrt{3}$	0.64	0.43	± 1.8 %	± 1.2 %	∞
Liquid Conductivity (meas.)	± 2.5 %	N	1	0.64	0.43	± 1.6 %	± 1.1 %	∞
Liquid Permittivity (Target)	± 5.0 %	R	$\sqrt{3}$	0.6	0.49	± 1.7 %	± 1.4 %	∞
Liquid Permittivity (Target)	± 2.5 %	N	1	0.6	0.49	± 1.5 %	± 1.0 %	∞
Combined Std. Uncertainty	-	-	-	-	-	± 10.7 %	± 10.4 %	330
Expanded STD Uncertainty	-	-	-	-	-	± 21.4 %	± 20.8 %	-

DASY4 Uncertainty Budget According to IEC 62209-2								
Error Description	Uncertainty Value	Prob. Dist.	Div.	(c i) 1g	(c i) 10g	Std. Unc. (1g)	Std. Unc. (10g)	(v i) v _{eff}
Measurement System								
Probe Calibration	± 6.0 %	N	1	1	1	± 6.0 %	± 6.0 %	∞
Axial Isotropy	± 4.7 %	R	$\sqrt{3}$	0.7	0.7	± 1.9 %	± 1.9 %	∞
Boundary Effects	± 1.0 %	R	$\sqrt{3}$	1	1	± 0.6 %	± 0.6 %	∞
Linearity	± 4.7 %	R	$\sqrt{3}$	1	1	± 2.7 %	± 2.7 %	∞
System Detection Limits	± 1.0 %	R	$\sqrt{3}$	1	1	± 0.6 %	± 0.6 %	∞
Readout Electronics	± 0.3 %	N	1	1	1	± 0.3 %	± 0.3 %	∞
Response Time	± 0.8 %	R	$\sqrt{3}$	1	1	± 0.5 %	± 0.5 %	∞
Integration Time	± 2.6 %	R	$\sqrt{3}$	1	1	± 1.5 %	± 1.5 %	∞
RF Ambient Noise	± 3.0 %	R	$\sqrt{3}$	1	1	± 1.7 %	± 1.7 %	∞
RF Ambient Conditions	± 3.0 %	R	$\sqrt{3}$	1	1	± 1.7 %	± 1.7 %	∞
Probe Positioner	± 0.4 %	R	$\sqrt{3}$	1	1	± 0.2 %	± 0.2 %	∞
Probe Positioning	± 2.9 %	R	$\sqrt{3}$	1	1	± 1.7 %	± 1.7 %	∞
Max. SAR Eval.	± 1.0 %	R	$\sqrt{3}$	1	1	± 0.6 %	± 0.6 %	∞
Test Sample Related								
Device Positioning	± 2.9 %	N	1	1	1	± 2.9 %	± 2.9 %	145
Device Holder	± 3.6 %	N	1	1	1	± 3.6 %	± 2.6 %	5
Power Drift	± 5.0 %	R		1	1	± 2.9 %	± 2.9 %	∞
Phantom and Setup								
Phantom Uncertainty	± 4.0 %	R	$\sqrt{3}$	1	1	± 2.3 %	± 2.3 %	∞
Liquid Conductivity (Target)	± 5.0 %	R	$\sqrt{3}$	0.64	0.43	± 1.8 %	± 1.2 %	∞
Liquid Conductivity (meas.)	± 2.5 %	N	1	0.64	0.43	± 1.6 %	± 1.1 %	∞
Liquid Permittivity (Target)	± 5.0 %	R	$\sqrt{3}$	0.6	0.49	± 1.7 %	± 1.4 %	∞
Liquid Permittivity (meas.)	± 2.5 %	N	1	0.6	0.49	± 1.5 %	± 1.0 %	∞
Combined Std. Uncertainty	-	-	-	-	-	± 10.7 %	± 10.4 %	330
Expanded STD Uncertainty	-	-	-	-	-	± 21.4 %	± 20.8 %	-

Appendixes

Refer to separated files for the following appendixes.

APPENDIX B PROBE&DIPOLES CALIBRATION CERTIFICATES.

APPENDIX C DIPOLES CALIBRATION CERTIFICATES.

APPENDIX D&E EUT AND TEST POSITION PHOTOS

APPENDIX F INFORMATIVE REFERENCES

- [1] Federal Communications Commission, "Report and order: Guidelines for evaluating the environmental effects of radiofrequency radiation", Tech. Rep. FCC 96-326, FCC, Washington, D.C. 20554, 1996.
- [2] David L. Means Kwok Chan, Robert F. Cleveland, "Evaluating compliance with FCC guidelines for human exposure to radiofrequency electromagnetic fields", Tech. Rep., Federal Communication Commission, Office of Engineering & Technology, Washington, DC, 1997.
- [3] Thomas Schmid, Oliver Egger, and Niels Kuster, "Automated E-field scanning system for dosimetric assessments", IEEE Transactions on Microwave Theory and Techniques, vol. 44, pp. 105-113, Jan. 1996.
- [4] Niels Kuster, Ralph Kastle, and Thomas Schmid, "Dosimetric evaluation of mobile communications equipment with known precision", IEICE Transactions on Communications, vol. E80-B, no. 5, pp. 645-652, May 1997.
- [5] CENELEC, "Considerations for evaluating of human exposure to electromagnetic fields (EMFs) from mobile telecommunication equipment (MTE) in the frequency range 30MHz - 6GHz", Tech. Rep., CENELEC, European Committee for Electrotechnical Standardization, Brussels, 1997.
- [6] ANSI, ANSI/IEEE C95.1-1992: IEEE Standard for Safety Levels with Respect to Human Exposure to Radio Frequency Electromagnetic Fields, 3 kHz to 300 GHz, The Institute of Electrical and Electronics Engineers, Inc., New York, NY 10017, 1992.
- [7] Katja Pokovic, Thomas Schmid, and Niels Kuster, "Robust setup for precise calibration of E-field probes in tissue simulating liquids at mobile communications frequencies", in ICECOM '97, Dubrovnik, October 15-17, 1997, pp. 120-24.
- [8] Katja Pokovic, Thomas Schmid, and Niels Kuster, "E-field probe with improved isotropy in brain simulating liquids", in Proceedings of the ELMAR, Zadar, Croatia, 23-25 June, 1996, pp. 172-175.
- [9] Volker Hombach, Klaus Meier, Michael Burkhardt, Eberhard Kuhn, and Niels Kuster, "The dependence of EM energy absorption upon human head modeling at 900 MHz", IEEE Transactions on Microwave Theory and Techniques, vol. 44, no. 10, pp. 1865-1873, Oct. 1996.
- [10] Klaus Meier, Ralf Kastle, Volker Hombach, Roger Tay, and Niels Kuster, "The dependence of EM energy absorption upon human head modeling at 1800 MHz", IEEE Transactions on Microwave Theory and Techniques, Oct. 1997, in press.
- [11] W. Gander, Computermathematik, Birkhaeuser, Basel, 1992.
- [12] W. H. Press, S. A. Teukolsky, W. T. Vetterling, and B. P. Flannery, Numerical Recipes in C, The Art of Scientific Computing, Second Edition, Cambridge University Press, 1992. Dosimetric Evaluation of Sample device, month 1998 9
- [13] NIS81 NAMAS, "The treatment of uncertainty in EMC measurement", Tech. Rep., NAMAS Executive, National Physical Laboratory, Teddington, Middlesex, England, 1994.
- [14] Barry N. Taylor and Christ E. Kuyatt, "Guidelines for evaluating and expressing the uncertainty of NIST measurement results", Tech. Rep., National Institute of Standards and Technology, 1994. Dosimetric Evaluation of Sample device, month 1998 10.

***** END OF REPORT *****