

SAR EVALUATION REPORT

For

Sky Phone LLC

1348 Washington Av., Suite 350 Miami Beach FL United States

FCC ID: 2ABOSGCFUEGO35

Report Type: Original Report	Product Type: 3G Smart Phone
Test Engineer: Terry XiaHou	<i>Terry XiaHou</i>
Report Number: RSZ160805001-20	
Report Date: 2016-08-16	
Reviewed By: Wilson Chen	<i>Wilson Chen</i>
Prepared By: SAR Engineer	
Bay Area Compliance Laboratories Corp. (Shenzhen) 6/F, the 3rd Phase of WanLi Industrial Building, ShiHua Road, FuTian Free Trade Zone Shenzhen, Guangdong, China Tel: +86-755-33320018 Fax: +86-755-33320008 www.baclcorp.com.cn	

Attestation of Test Results		
EUT Information	Company Name	Sky Phone LLC
	EUT Description	3G Smart Phone
	FCC ID	2ABOSGCFUEGO35
	Model Number	Fuego 3.5
	Test Date	2016-08-09 to 2016-08-10
Frequency	Max. SAR Level(s) Reported	Limit (W/Kg)
GSM 850	0.488 W/kg 1g Head SAR 1.143 W/kg 1g Body SAR 1.082 W/kg 1g Body SAR(Hotspot)	1.6
PCS 1900	0.657 W/kg 1g Head SAR 0.598 W/kg 1g Body SAR 0.517 W/kg 1g Body SAR(Hotspot)	
WCDMA 850	0.443 W/kg 1g Head SAR 0.660 W/kg 1g Body SAR 0.585 W/kg 1g Body SAR(Hotspot)	
WCDMA 1900	1.213 W/kg 1g Head SAR 1.292 W/kg 1g Body SAR 1.244 W/kg 1g Body SAR(Hotspot)	
Simultaneous	1.513 W/kg 1g Head SAR 1.592 W/kg 1g Body SAR	
Hotspot	1.394 W/kg 1g Body SAR	
Applicable Standards	ANSI/IEEE C95.1: 2005 IEEE Standard for Safety Levels with Respect to Human Exposure to Radio Frequency Electromagnetic Fields, 3 kHz to 300 GHz.	
	ANSI/IEEE C95.3 : 2002 IEEE Recommended Practice for Measurements and Computations of Radio Frequency Electromagnetic Fields With Respect to Human Exposure to Such Fields, 100 kHz—300 GHz.	
	FCC 47 CFR Part 2.1093 Radiofrequency radiation exposure evaluation: portable devices	
	IEEE1528: 2013 IEEE Recommended Practice for Determining the Peak Spatial-Average Specific Absorption Rate (SAR) in the Human Head from Wireless Communications Devices: Measurement Techniques	
	IEC 62209-1: 2006 Human exposure to radio frequency fields from hand-held and body-mounted wireless communication devices – Human models, instrumentation, and procedures – Part 1: Procedure to determine the specific absorption rate (SAR) for hand-held devices used in close proximity to the ear (frequency range of 300 MHz to 3GHz)	
	IEC 62209-2: 2010 Human exposure to radio frequency fields from hand-held and body-mounted wireless communication devices-Human models, instrumentation, and procedures-Part 2: Procedure to determine the specific absorption rate (SAR) for wireless communication devices used in close proximity to the human body (frequency range of 30 MHz to 6 GHz)	
	KDB procedures KDB 447498 D01 General RF Exposure Guidance v06. KDB 648474 D04 Handset SAR v01r03. KDB 865664 D01 SAR measurement 100 MHz to 6 GHz v01r04 KDB 865664 D02 RF Exposure Reporting v01r02 KDB 941225 D01 3G SAR Procedures v03r01 KDB 941225 D06 Hotspot Mode v02r01	

Note: This wireless device has been shown to be capable of compliance for localized specific absorption rate (SAR) for General Population/Uncontrolled Exposure limits specified in ANSI/IEEE Standards and has been tested in accordance with the measurement procedures specified in IEEE 1528-2013 and RF exposure KDB procedures.
The results and statements contained in this report pertain only to the device(s) evaluated.

TABLE OF CONTENTS

DOCUMENT REVISION HISTORY	5
EUT DESCRIPTION	6
TECHNICAL SPECIFICATION.....	6
REFERENCE, STANDARDS, AND GUIDELINES	7
SAR LIMITS	8
FACILITIES	9
DASY4 SAR EVALUATION PROCEDURE	10
POWER REFERENCE MEASUREMENT	10
AREA SCAN	10
ZOOM SCAN	11
POWER DRIFT MEASUREMENT	11
Z-SCAN	11
EQUIPMENT LIST AND CALIBRATION	21
EQUIPMENTS LIST & CALIBRATION INFORMATION	21
SAR MEASUREMENT SYSTEM VERIFICATION	22
LIQUID VERIFICATION.....	22
SYSTEM ACCURACY VERIFICATION	23
SAR SYSTEM VALIDATION DATA	24
EUT TEST STRATEGY AND METHODOLOGY	28
TEST POSITIONS FOR DEVICE OPERATING NEXT TO A PERSON’S EAR.....	28
CHEEK/TOUCH POSITION	29
EAR/TILT POSITION.....	29
TEST POSITIONS FOR BODY-WORN AND OTHER CONFIGURATIONS	30
SAR EVALUATION PROCEDURE	31
TEST METHODOLOGY	31
CONDUCTED OUTPUT POWER MEASUREMENT	32
PROVISION APPLICABLE.....	32
TEST PROCEDURE.....	32
MAXIMUM OUTPUT POWER AMONG PRODUCTION UNITS	37
TEST RESULTS:.....	38
SAR MEASUREMENT RESULTS	41
SAR TEST DATA	41
SAR SIMULTANEOUS TRANSMISSION DESCRIPTION	48
APPENDIX A MEASUREMENT UNCERTAINTY	60
APPENDIX B PROBE CALIBRATION CERTIFICATES	62
APPENDIX C DIPOLE CALIBRATION CERTIFICATES	73
APPENDIX D EUT TEST POSITION PHOTOS	91
LIQUID DEPTH \geq 15CM	91
LEFT HEAD TOUCH SETUP PHOTO.....	91
LEFT HEAD TILT SETUP PHOTO.....	92
RIGHT HEAD TOUCH SETUP PHOTO	92
RIGHT HEAD TILT SETUP PHOTO	93
BODY-WORN-HEADSET BACK SETUP PHOTO.....	93
BODY-WORN BACK SETUP PHOTO	94
BODY-WORN LEFT SETUP PHOTO.....	94
BODY-WORN RIGHT SETUP PHOTO	95
BODY-WORN BOTTOM SETUP PHOTO.....	95
APPENDIX F INFORMATIVE REFERENCES	96

DOCUMENT REVISION HISTORY

Revision Number	Report Number	Description of Revision	Date of Revision
0	RSZ160805001-20	Original Report	2016-08-16

EUT DESCRIPTION

This report has been prepared on behalf of Sky Phone LLC and their product, FCC ID: 2ABOSGCFUEGO35, Model: Fuego 3.5, or the EUT (Equipment under Test) as referred to in the rest of this report.

*Note:

1. The device is capable of personal hotspot mode. Wi-Fi Hotspot mode permits the device to share its cellular data connection with other 2.4 GHz Wi-Fi enabled devices.

Technical Specification

Product Type	Portable
Exposure Category:	Population / Uncontrolled
Antenna Type(s):	Internal Antenna
Body-Worn Accessories:	Headset
Face-Head Accessories:	None
Multi-slot Class:	Class12
Operation Mode :	GSM Voice, GPRS Data, WCDMA(Rel99, HSUPA, HSDPA, HSPA+), Bluetooth and Wi-Fi
Frequency Band:	GSM 850 : 824-849 MHz(TX) ; 869-894 MHz(RX) PCS 1900: 1850-1910 MHz(TX) ; 1930-1990 MHz(RX) WCDMA 850: 824-849 MHz(TX) ; 869-894 MHz(RX) WCDMA 1900: 1850-1910 MHz(TX) ; 1930-1990 MHz(RX) Wi-Fi(802.11b/g/n20/n40): 2412MHz-2472MHz Bluetooth:2402-2480MHz
Conducted RF Power:	GSM 850 : 32.92 dBm PCS 1900: 29.35 dBm WCDMA 850: 22.68 dBm WCDMA 1900: 22.02 dBm Wi-Fi(802.11b/g/n20/n40): 8.58 dBm Bluetooth3.0: 1.30 dBm BLE: -6.24 dBm
Dimensions (L*W*H):	117 mm (L) × 63 mm (W) × 12 mm (H)
Power Source:	3.7 V _{DC} Rechargeable Battery
Normal Operation:	Head and Body-worn

REFERENCE, STANDARDS, AND GUIDELINES

FCC:

The Report and Order requires routine SAR evaluation prior to equipment authorization of portable transmitter devices, including portable telephones. For consumer products, the applicable limit is 1.6 mW/g as recommended by the ANSI/IEEE standard C95.1-1992 [6] for an uncontrolled environment (Paragraph 65). According to the Supplement C of OET Bulletin 65 "Evaluating Compliance with FCC Guide-lines for Human Exposure to Radio frequency Electromagnetic Fields", released on Jun 29, 2001 by the FCC, the device should be evaluated at maximum output power (radiated from the antenna) under "worst-case" conditions for normal or intended use, incorporating normal antenna operating positions, device peak performance frequencies and positions for maximum RF energy coupling.

This report describes the methodology and results of experiments performed on wireless data terminal. The objective was to determine if there is RF radiation and if radiation is found, what is the extent of radiation with respect to safety limits. SAR (Specific Absorption Rate) is the measure of RF exposure determined by the amount of RF energy absorbed by human body (or its parts) – to determine how the RF energy couples to the body or head which is a primary health concern for body worn devices. The limit below which the exposure to RF is considered safe by regulatory bodies in North America is 1.6 mW/g average over 1 gram of tissue mass.

CE:

The order requires routine SAR evaluation prior to equipment authorization of portable transmitter devices, including portable telephones. For consumer products, the applicable limit is 2 mW/g as recommended by EN62209-1 for an uncontrolled environment. According to the Standard, the device should be evaluated at maximum output power (radiated from the antenna) under "worst-case" conditions for normal or intended use, incorporating normal antenna operating positions, device peak performance frequencies and positions for maximum RF energy coupling.

This report describes the methodology and results of experiments performed on wireless data terminal. The objective was to determine if there is RF radiation and if radiation is found, what is the extent of radiation with respect to safety limits. SAR (Specific Absorption Rate) is the measure of RF exposure determined by the amount of RF energy absorbed by human body (or its parts) – to determine how the RF energy couples to the body or head which is a primary health concern for body worn devices. The limit below which the exposure to RF is considered safe by regulatory bodies in Europe is 2 mW/g average over 10 gram of tissue mass.

The test configurations were laid out on a specially designed test fixture to ensure the reproducibility of measurements. Each configuration was scanned for SAR. Analysis of each scan was carried out to characterize the above effects in the device.

SAR Limits

FCC Limit (1g Tissue)

EXPOSURE LIMITS	SAR (W/kg)	
	(General Population / Uncontrolled Exposure Environment)	(Occupational / Controlled Exposure Environment)
Spatial Average (averaged over the whole body)	0.08	0.4
Spatial Peak (averaged over any 1 g of tissue)	1.60	8.0
Spatial Peak (hands/wrists/feet/ankles averaged over 10 g)	4.0	20.0

CE Limit (10g Tissue)

EXPOSURE LIMITS	SAR (W/kg)	
	(General Population / Uncontrolled Exposure Environment)	(Occupational / Controlled Exposure Environment)
Spatial Average (averaged over the whole body)	0.08	0.4
Spatial Peak (averaged over any 10 g of tissue)	2.0	10
Spatial Peak (hands/wrists/feet/ankles averaged over 10 g)	4.0	20.0

Population/Uncontrolled Environments are defined as locations where there is the exposure of individual who have no knowledge or control of their exposure.

Occupational/Controlled Environments are defined as locations where there is exposure that may be incurred by people who are aware of the potential for exposure (i.e. as a result of employment or occupation).

General Population/Uncontrolled environments Spatial Peak limit 1.6W/kg (FCC) & 2 W/kg (CE) applied to the EUT.

FACILITIES

The test site used by Bay Area Compliance Laboratories Corp. (Shenzhen) to collect data is located at 6/F, the 3rd Phase of WanLi Industrial Building, Shi Hua Road, Fu Tian Free Trade Zone, Shenzhen, Guangdong, P.R. of China

DASY4 SAR Evaluation Procedure

Power Reference Measurement

The Power Reference Measurement and Power Drift Measurement jobs are useful jobs for monitoring the power drift of the device under test in the batch process. Both jobs measure the field at a specified reference position, at a selectable distance from the phantom surface. The reference position can be either the selected section's grid reference point or a user point in this section. The reference job projects the selected point onto the phantom surface, orients the probe perpendicularly to the surface, and approaches the surface using the selected detection method. The Minimum distance of probe sensors to surface determines the closest measurement point to phantom surface. By default, the Minimum distance of probe sensors to surface is 4mm. This distance can be modified by the user, but cannot be smaller than the Distance of sensor calibration points to probe tip as defined in the probe properties (for example, 2.7mm for an ES3DV3 probe type).

Area Scan

The Area Scan is used as a fast scan in two dimensions to find the area of high field values, before doing a finer measurement around the hot spot. The sophisticated interpolation routines implemented in DASY4 software can find the maximum locations even in relatively coarse grids.

The scanning area is defined by an editable grid. This grid is anchored at the grid reference point of the selected section in the phantom. When the Area Scan's property sheet is brought-up, grid settings can be edited by a user.

When an Area Scan has measured all reachable points, it computes the field maxima found in the scanned area, within a range of the global maximum. The range (in dB) is specified in the standards for compliance testing. For example, a 2 dB range is required in IEEE 1528-2013, IEC 62209-1:2006 and IEC 62209-2:2010 standards, whereby 3 dB is a requirement when compliance is assessed in accordance with the ARIB standard (Japan). If only one Zoom Scan follows the Area Scan, then only the absolute maximum will be taken as reference. For cases where multiple maximums are detected, the number of Zoom Scans has to be increased accordingly.

After measurement is completed, all maxima and their coordinates are listed in the Results property page. The maximum selected in the list is highlighted in the 3-D view. For the secondary maxima returned from an Area Scan, the user can specify a lower limit (peak SAR value), in addition to the Find secondary maxima within x dB condition. Only the primary maximum and any secondary maxima within x dB from the primary maximum and above this limit will be measured.

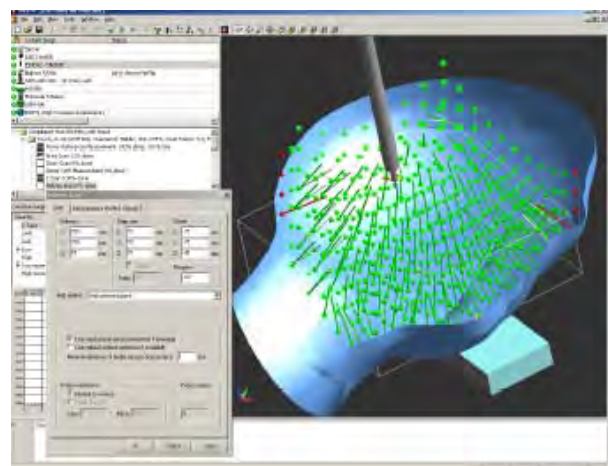
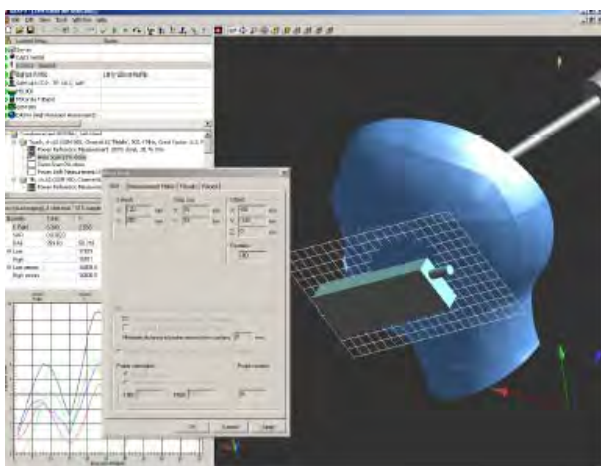

Zoom Scan

Zoom Scans are used to assess the peak spatial SAR values within a cubic averaging volume containing 1 g and 10 g of simulated tissue. The default Zoom Scan measures 5 x 5 x 7 points within a cube whose base faces are centered around the maxima found in a preceding area scan job within the same procedure. When the measurement is done, the Zoom Scan evaluates the averaged SAR for 1 g and 10 g and displays these values next to the job's label.

Power drift measurement

The Power Drift Measurement job measures the field at the same location as the most recent power reference measurement job within the same procedure, and with the same settings. The Power Drift Measurement gives the field difference in dB from the reading conducted within the last Power Reference Measurement. Several drift measurements are possible for one reference measurement. This allows a user to monitor the power drift of the device under test within a batch process. The measurement procedure is the same as Step 1.

Z-Scan

The Z Scan job measures points along a vertical straight line. The line runs along the Z axis of a one-dimensional grid. A user can anchor the grid to the section reference point, to any defined user point or to the current probe location. As with any other grids, the local Z axis of the anchor location establishes the Z axis of the grid.

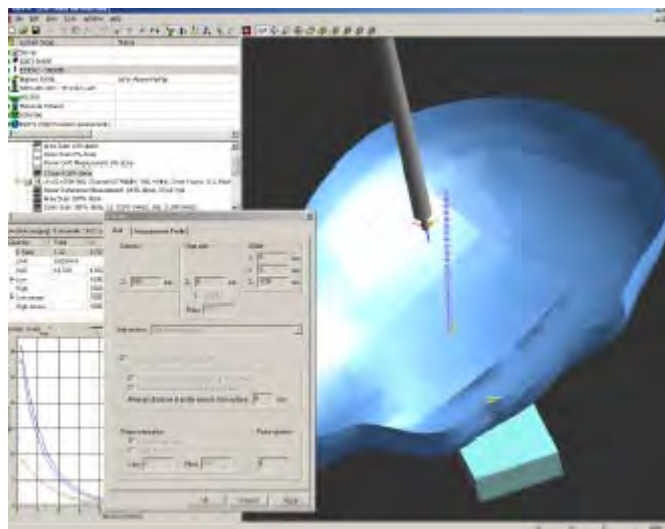

Description of Test System

These measurements were performed with the automated near-field scanning system DASY4 from Schmid & Partner Engineering AG (SPEAG) which is the fourth generation of the system shown in the figure hereinafter:



The system is based on a high precision robot (working range greater than 0.9m), which positions the probes with a positional repeatability of better than $\pm 0.02\text{mm}$. Special E- and H-field probes have been developed for measurements close to material discontinuity, the sensors of which are directly loaded with a Schottky diode and connected via highly resistive lines to the data acquisition unit.

The SAR measurements were conducted with the dosimetric probe ES3DV3 SN: 3036 (manufactured by SPEAG), designed in the classical triangular configuration and optimized for dosimetric evaluation. The probe has been calibrated according to the procedure with accuracy of better than $\pm 10\%$. The spherical isotropy was evaluated with the procedure and found to be better than $\pm 0.25\text{dB}$.

Measurement System Diagram

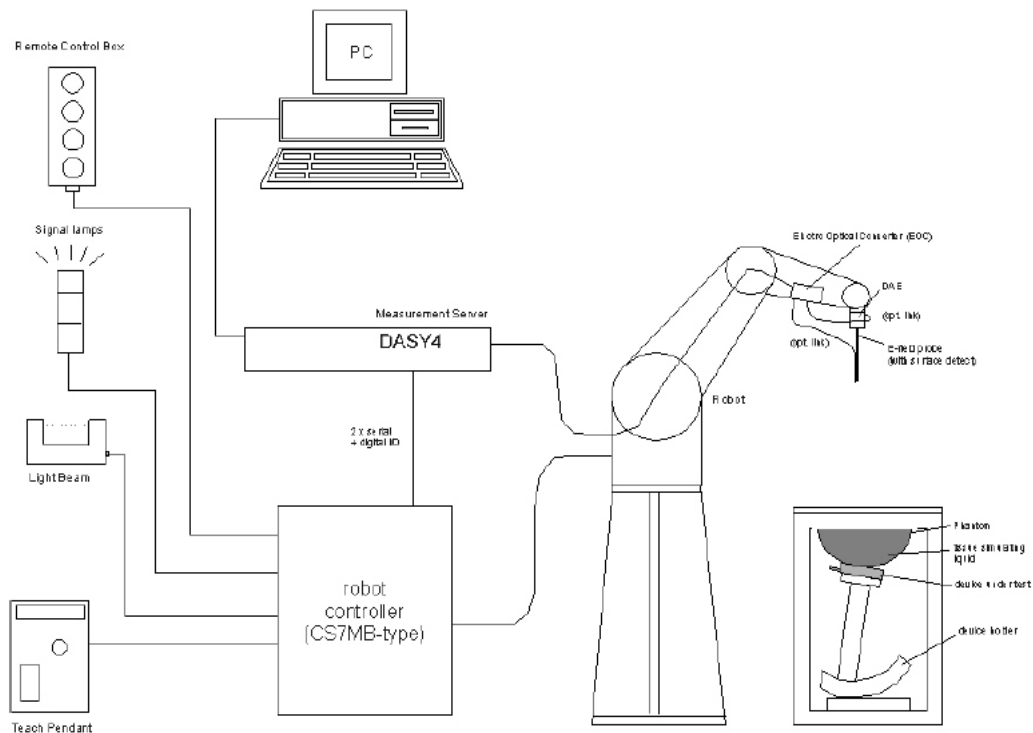

- A standard high precision 6-axis robot (Stäubli RX family) with controller, teach pendant and software. An arm extension for accommodating the data acquisition electronics (DAE).
- A dosimetric probe, i.e., an isotropic E-field probe optimized and calibrated for usage in tissue simulating liquid. The probe is equipped with an optical surface detector system.
- A data acquisition electronics (DAE) which performs the signal amplification, signal multiplexing, AD-conversion, offset measurements, mechanical surface detection, collision detection, etc. The unit is battery powered with standard or rechargeable batteries. The signal is optically transmitted to the EOC.
- The Electro-optical converter (EOC) performs the conversion between optical and electrical of the signals for the digital communication to the DAE and for the analog signal from the optical surface detection. The EOC is connected to the measurement server.
- The function of the measurement server is to perform the time critical tasks such as signal filtering, control of the robot operation and fast movement interrupts.
- A probe alignment unit which improves the (absolute) accuracy of the probe positioning.
- A computer operating Windows 2000 or Windows XP.
- DASY4 software.
- Remote control with teach pendant and additional circuitry for robot safety such as warning lamps, etc.
- The SAM twin phantom enabling testing left-hand and right-hand usage.
- The device holder for handheld smart phones.
- Tissue simulating liquid mixed according to the given recipes.
- Validation dipole kits allowing system validation.

System Components

- DASY4 Measurement Server
- Data Acquisition Electronics
- Probes
- Light Beam Unit
- Medium
- SAM Twin Phantom
- Device Holder for SAM Twin Phantom
- System Validation Kits
- Robot

DASY4 Measurement Server

The DASY4 measurement server is based on a PC/104 CPU board with a 166MHz low-power Pentium, 32MB chip disk and 64MB RAM. The necessary circuits for communication with either the DAE4 (or DAE3) electronic box as well as the 16-bit AD-converter system for optical detection and digital I/O interface are contained on the DASY4 I/O-board, which is directly connected to the PC/104 bus of the CPU board.



The measurement server performs all real-time data evaluation for field measurements and surface detection, controls robot movements and handles safety operation. The PC-operating system cannot interfere with these time critical processes. All connections are supervised by a watchdog, and disconnection of any of the cables to the measurement server will automatically disarm the robot and disable all program-controlled robot movements. Furthermore, the measurement server is equipped with two expansion slots which are reserved for future applications. Please note that the expansion slots do not have a standardized pin out and therefore only the expansion cards provided by SPEAG can be inserted. Expansion cards from any other supplier could seriously damage the measurement server.

Data Acquisition Electronics

The data acquisition electronics DAE3 consists of a highly sensitive electrometer grade preamplifier with auto-zeroing, a channel and gain-switching multiplexer, a fast 16 bit AD-converter and a command decoder and control logic unit. Transmission to the measurement server is accomplished through an optical downlink for data and status information as well as an optical uplink for commands and the clock.



Probes

The DASY system can support many different probe types.

Dosimetric Probes: These probes are specially designed and calibrated for use in liquids with high permittivities. They should not be used in air, since the spherical isotropy in air is poor (± 2 dB). The dosimetric probes have special calibrations in various liquids at different frequencies.

Free Space Probes: These are electric and magnetic field probes specially designed for measurements in free space. The z-sensor is aligned to the probe axis and the rotation angle of the x-sensor is specified.

This allows the DASY system to automatically align the probe to the measurement grid for field component measurement. The free space probes are generally not calibrated in liquid. (The H-field probes can be used in liquids without any change of parameters.)

Temperature Probes: Small and sensitive temperature probes for general use. They use a completely different parameter set and different evaluation procedures. Temperature rise features allow direct SAR evaluations with these probes.

ES3DV3 Probe Specification

Construction Symmetrical design with triangular core
 Built-in optical fiber for surface detection System
 Built-in shielding against static charges
 Calibration In air from 150 MHz to 3.7 GHz
 In brain and muscle simulating tissue at
 Frequencies of 450 MHz, 900 MHz and
 1.8 GHz (accuracy $\pm 8\%$)
 Frequency 10 MHz to > 6 GHz; Linearity: ± 0.2 dB
 (30 MHz to 3 GHz)
 Directivity ± 0.2 dB in brain tissue (rotation around
 probe axis)
 ± 0.4 dB in brain tissue (rotation normal probe axis)
 Dynamic 5 mW/g to > 100 mW/g;
 Range Linearity: ± 0.2 dB
 Surface ± 0.2 mm repeatability in air and clear liquids
 Detection over diffuse reflecting surfaces.
 Dimensions Overall length: 330 mm
 Tip length: 16 mm
 Body diameter: 12 mm
 Tip diameter: 6.8 mm
 Distance from probe tip to dipole centers: 2.7 mm
 Application General dosimetric up to 3 GHz

Compliance tests of smart phones

Fast automatic scanning in arbitrary phantoms

The SAR measurements were conducted with the dosimetric probe ES3DV3 designed in the classical triangular configuration and optimized for dosimetric evaluation. The probe is constructed using the thick film technique; with printed resistive lines on ceramic substrates. The probe is equipped with an optical multi-fiber line ending at the front of the probe tip. It is connected to the EOC box on the robot arm and provides an automatic detection of the phantom surface. Half of the fibers are connected to a pulsed infrared transmitter, the other half to a synchronized receiver. As the probe approaches the surface, the reflection from the surface produces a coupling from the transmitting to the receiving fibers. This reflection increases first during the approach, reaches maximum and then decreases. If the probe is flatly touching the surface, the coupling is zero. The distance of the coupling maximum to the surface is independent of the surface reflectivity and largely independent of the surface to probe angle. The DASY3 software reads the reflection during a software approach and looks for the maximum using a 2nd order fitting. The approach is stopped when reaching the maximum.

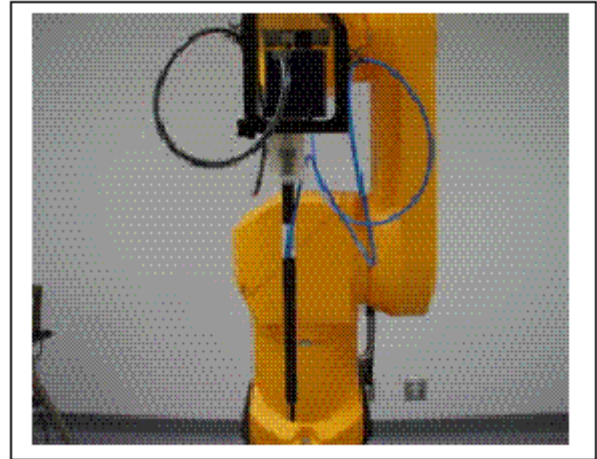

Photograph of the probe

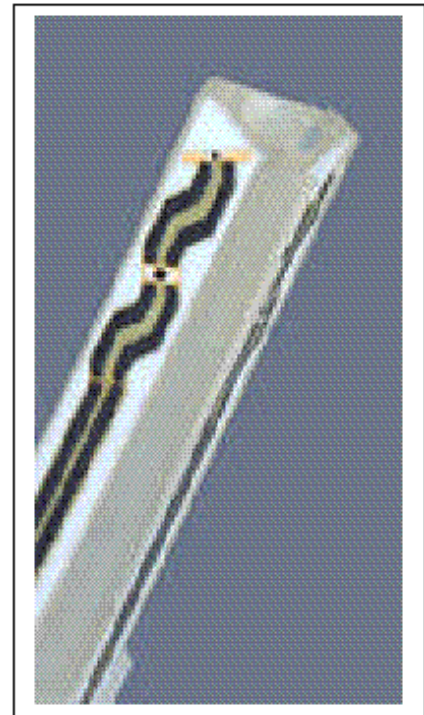

Inside view of
ES3DV3 E-field Probe

E-Field Probe Calibration Process

Each probe is calibrated according to a dosimetric assessment procedure described in [6] with accuracy better than +/- 10%. The spherical isotropy was evaluated with the procedure described in [7] and found to be better than +/-0.25dB. The sensitivity parameters (NormX, NormY, NormZ), the diode compression parameter (DCP) and the conversion factor (ConvF) of the probe are tested.

The free space E-field from amplified probe outputs is determined in a test chamber. This is performed in a TEM cell for frequencies below 1 GHz, and in a waveguide above 1 GHz for free space. For the free space calibration, the probe is placed in the volumetric center of the cavity and at the proper orientation with the field. The probe is then rotated 360 degrees.

E-field temperature correlation calibration is performed in a flat phantom filled with the appropriate simulated brain tissue. The measured free space E-field in the medium correlates to temperature rise in dielectric medium. For temperature correlation calibration a RF transparent thermistor-based temperature probe is used in conjunction with the E-field probe.

Data Evaluation

The DASY4 post-processing software (SEMCAD) automatically executes the following procedures to calculate the field units from the microvolt readings at the probe connector. The parameters used in the evaluation are stored in the configuration modules of the software:

Probe parameters:	- Sensitivity	Normi, ai0, ai1, ai2
	- Conversion factor	ConvFi
	- Diode compression point	dcp _i
Device parameters:	- Frequency	f
	- Crest factor	cf
Media parameters:	- Conductivity	σ
	- Density	ρ

These parameters must be set correctly in the software. They can be found in the component documents or they can be imported into the software from the configuration files issued for the DASY components. In the direct measuring mode of the multimeter option, the parameters of the actual system setup are used. In the scan visualization and export modes, the parameters stored in the corresponding document files are used. The first step of the evaluation is a linearization of the filtered input signal to account for the compression characteristics of the detector diode. The compensation depends on the input signal, the diode type and the DC-transmission factor from the diode to the evaluation electronics. If the exciting field is pulsed, the crest factor of the signal must be known to correctly compensate for peak power. The formula for each channel can be given as:

$$V_i = U_i + U_i^2 \cdot \frac{cf}{dcp_i}$$

With	V _i	= compensated signal of channel i (i=x, y, z)
	U _i	= input signal of channel i (i=x, y, z)
	cf	= crest factor of exciting field (DASY parameter)
	dcp _i	= diode compression point (DASY parameter)

From the compensated input signals the primary field data for each channel can be evaluated:

$$\text{E - fieldprobes : } E_i = \sqrt{\frac{V_i}{\text{Norm}_i \cdot \text{ConF}}}$$

$$\text{H - fieldprobes : } H_i = \sqrt{V_i} \cdot \frac{a_{i0} + a_{i1}f + a_{i2}f^2}{f}$$

With V_i = compensated signal of channel i (i=x, y, z)
 Norm_i = sensor sensitivity of channel i (i=x, y, z)
 $\mu\text{V}/(\text{V}/\text{m})^2$ for E-field probes
 ConF = sensitivity enhancement in solution
 a_{ij} = sensor sensitivity factors for H-field probes
 f = carrier frequency [GHz]
 E_i = electric field strength of channel i in V/m
 H_i = diode compression point (DASY parameter)

The RSS value of the field components gives the total field strength (Hermitian magnitude):

$$E_{tot} = \sqrt{E_x^2 + E_y^2 + E_z^2}$$

The primary field data are used to calculate the derived field units.

$$\text{SAR} = E_{tot}^2 \cdot \frac{\sigma}{\rho \cdot 1'000}$$

With SAR = local specific absorption rate in mW/g
 E_{tot} = total field strength in V/m
 σ = conductivity in [mho/meter] or [Siemens/meter]
 ρ = equivalent tissue density in g/cm^3

Note that the density is normally set to 1, to account for actual brain density rather than the density of the simulation liquid.

Light Beam Unit

The light beam switch allows automatic “tooling” of the probe. During the process, the actual position of the probe tip with respect to the robot arm is measured, as well as the probe length and the horizontal probe offset. The software then corrects all movements, so that the robot coordinates are valid for the probe tip. The repeatability of this process is better than 0.1 mm. If a position has been taught with an aligned probe, the same position will be reached with another aligned probe within 0.1 mm, even if the other probe has different dimensions. During probe rotations, the probe tip will keep its actual position.

Medium

Parameters:

The parameters of the tissue simulating liquid strongly influence the SAR in the liquid. The parameters for the different frequencies are defined in the corresponding compliance standards (e.g., IEC 62209-1:2005, IEC62209-2:2010, IEEE 1528-2013).

Parameter measurements

Several measurement systems are available for measuring the dielectric parameters of liquids:

- The open coax test method (e.g., HP85070B dielectric probe kit) is easy to use, but has only moderate accuracy. It is calibrated with open, short, and deionized water and the calibrations a critical process.
- The transmission line method (e.g., model 1500T from DAMASKOS, INC.) measures the transmission and reflection in a liquid filled high precision line. It needs standard two port calibration and is probably more accurate than the open coax method.
- The reflection line method measures the reflection in a liquid filled shorted precision lined. The method is not suitable for these liquids because of its low sensitivity.
- The slotted line method scans the field magnitude and phase along a liquid filled line. The evaluation is straight forward and only needs a simple response calibration. The method is very accurate, but can only be used in high loss liquids and at frequencies above 100 to 200MHz. Cleaning the line can be tedious.

IEEE SCC-34/SC-2 P1528 Recommended Tissue Dielectric Parameters

Frequency (MHz)	Head Tissue		Body Tissue	
	ϵ_r	σ (S/m)	ϵ_r	σ (S/m)
150	52.3	0.76	61.9	0.80
300	45.3	0.87	58.2	0.92
450	43.5	0.87	56.7	0.94
835	41.5	0.90	55.2	0.97
900	41.5	0.97	55.0	1.05
915	41.5	0.98	55.0	1.06
1450	40.5	1.20	54.0	1.30
1610	40.3	1.29	53.8	1.40
1800-2000	40.0	1.40	53.3	1.52
2450	39.2	1.80	52.7	1.95
3000	38.5	2.40	52.0	2.73
5800	35.3	5.27	48.2	6.00

SAM Twin Phantom

The SAM twin phantom is a fiberglass shell phantom with 2mm shell thickness (except the ear region where shell thickness increases to 6mm). It has three measurement areas:

- Left hand
- Right hand
- Flat phantom

The phantom table comes in two sizes: A 100 x 50 x 85 cm (L x W x H) table for use with free standing robots (DASY4 professional system option) or as a second phantom and a 100 x 75 x 85 cm(L x W x H) table with reinforcements for table mounted robots (DASY4 compact system option) .

The bottom plate contains three pair of bolts for locking the device holder. The device holder positions are adjusted to the standard measurement positions in the three sections. Only one device holder is necessary if two phantoms are used (e.g., for different liquids) A white cover is provided to tap the phantom during o_-periods to prevent water evaporation and changes in the liquid parameters. Free space scans of devices on the cover are possible. On the phantom top, three reference markers are provided to identify the phantom position with respect to the robot.

The phantom can be used with the following tissue simulating liquids:

- Water-sugar based liquids can be left permanently in the phantom. Always cover the liquid if the system is not used, otherwise the parameters will change due to water evaporation.
- Glycol based liquids should be used with care. As glycol is a softener for most plastics, the liquid should be taken out of the phantom and the phantom should be dried when the system is not used (desirable at least once a week).
- Do not use other organic solvents without previously testing the phantom's compatibility.

Device Holder for SAM Twin Phantom

The SAR in the phantom is approximately inversely proportional to the square of the distance between the source and the liquid surface. For a source in 5mm distance, a positioning uncertainty of $\pm 0.5\text{mm}$ would produce a SAR uncertainty of $\pm 20\%$. An accurate device positioning is therefore crucial for accurate and repeatable measurements. The positions, in which the devices must be measured, are defined by the standards.

The DASY device holder is designed to cope with different positions given in the standard. It has two scales for the device rotation (with respect to the body axis) and the device inclination (with respect to the line between the ear reference points). The rotation centers for both scales is the ear reference point (ERP). Thus the device needs no repositioning when changing the angles.



The DASY device holder has been made out of low-loss POM material having the following dielectric parameters: relative permittivity $\epsilon=3$ and loss tangent $\tan \delta=0.02$. The amount of dielectric material has been reduced in the closest vicinity of the device, since measurements have suggested that the influence of the clamp on the test results could thus be lowered.

System Validation Kits

Each DASY system is equipped with one or more system validation kits. These units, together with the predefined measurement procedures within the DASY software, enable the user to conduct the system performance check and system validation. For that purpose a well-defined SAR distribution in the flat section of the SAM twin phantom is produced.

System validation kit includes a dipole, tripod holder to fix it underneath the flat phantom and a corresponding distance holder. Dipoles are available for the variety of frequencies between 300MHz and 6 GHz (dipoles for other frequencies or media and other calibration conditions are available upon request).

The dipoles are highly symmetric and matched at the center frequency for the specified liquid and distance to the flat phantom (or flat section of the SAM-twin phantom). The accurate distance between the liquid surface and the dipole center is achieved with a distance holder that snaps on the dipole.

Robot

The DASY4 system uses the high precision industrial robots RX60L, RX90 and RX90L, as well as the RX60BL and RX90BL types out of the newer series from Stäubli SA (France). The RX robot series offers many features that are important for our application:

- High precision (repeatability 0.02mm)
- High reliability (industrial design)
- Low maintenance costs (virtually maintenance-free due to direct drive gears; no belt drives)
- Jerk-free straight movements (brushless synchronous motors; no stepper motors)
- Low ELF interference (the closed metallic construction shields against motor control fields)

For the newly delivered DASY4 systems as well as for the older DASY3 systems delivered since 1999, the CS7MB robot controller version from Stäubli is used. Previously delivered systems have either a CS7 or CS7M controller; the differences to the CS7MB are mainly in the hardware, but some procedures in the robot software from Stäubli are also not completely the same. The following descriptions about robot hard- and software correspond to CS7MB controller with software version 13.1 (edit S5). The actual commands, procedures and configurations, also including details in hardware, might differ if an older robot controller is in use. In this case please also refer to the Stäubli manuals for further information.



EQUIPMENT LIST AND CALIBRATION

Equipments List & Calibration Information

Equipment	Model	Calibration Date	Calibration Due Date	S/N
Robot	RX60BL	N/A	N/A	F02/5S01A1/A/01
Robot Controller	CS7MBs&p RX60BL	N/A	N/A	F02/5S01A1/C/01
DASY4 Test Software	DASY4, V4.5 Build 19	N/A	N/A	N/A
Data Acquisition Electronics	DAE3	2015-08-17	2016-08-17	456
E-Field Probe	ES3DV3	2015-08-20	2016-08-20	3036
Dipole, 835MHz	ALS-D-835-S-2	2014-10-08	2017-10-08	180-00558
Dipole, 1900MHz	ALS-D-1900-S-2	2014-10-09	2017-10-09	210-00710
Dipole Spacer	ALS-DS-U	N/A	N/A	250-00907
Device holder/Positioner	MD4HHTV5	N/A	N/A	SD 000 H01 KA
SPEAG SAM Twin Phantom	Twin SAM	N/A	N/A	Tp-1218
Simulated Tissue 835 MHz Head	ALS-TS-835-H	Each Time	/	270-01002
Simulated Tissue 835 MHz Body	ALS-TS-835-B	Each Time	/	270-02101
Simulated Tissue 1900 MHz Head	ALS-TS-1900-H	Each Time	/	295-01103
Simulated Tissue 1900 MHz Body	ALS-TS-1900-B	Each Time	/	295-02102
Directional couple	DC6180A	N/A	N/A	0325849
Power Amplifier	5S1G4	N/A	N/A	71377
Attenuator	3dB	N/A	N/A	5402
Dielectric probe kit	HP85070B	2016-06-13	2017-06-13	US33020324
Network analyzer	8752C	2016-06-03	2017-06-03	3410A02356
Synthesized Sweeper	HP 8341B	2016-06-03	2017-06-03	2624A00116
UNIVERSAL RADIO COMMUNICATION TESTER	CMU200	2015-11-23	2016-11-23	106891
EMI Test Receiver	ESCI	2016-06-13	2017-06-13	101746

SAR MEASUREMENT SYSTEM VERIFICATION

Liquid Verification

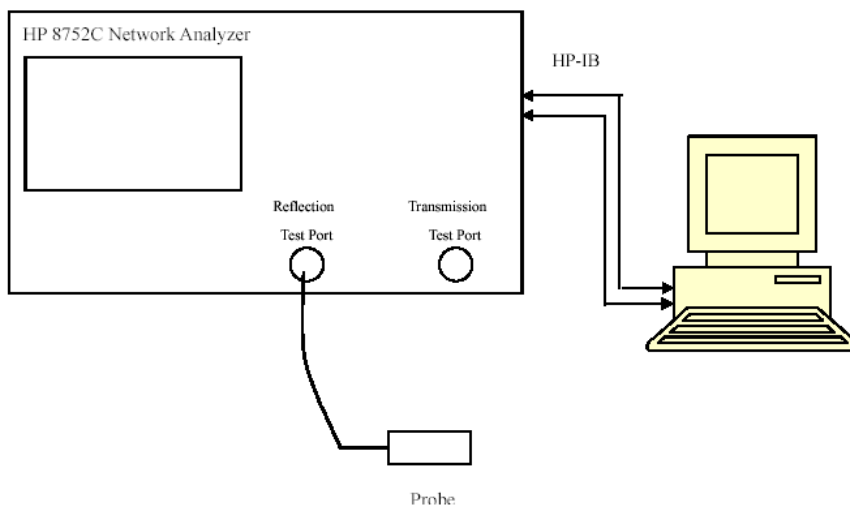

Liquid Verification Setup Block Diagram

Liquid Verification Results

Frequency	Liquid Type	Liquid Parameter		Target Value		Delta (%)		Tolerance (%)
		ϵ_r	σ (S/m)	ϵ_r	σ (S/m)	$\Delta\epsilon_r$	$\Delta\sigma$ (S/m)	
824.2	Head	41.21	0.92	41.50	0.90	-0.699	2.222	± 5
	Body	55.49	0.98	55.20	0.97	0.525	1.031	± 5
826.4	Head	41.45	0.91	41.50	0.90	-0.120	1.111	± 5
	Body	55.18	1.00	55.20	0.97	-0.036	3.093	± 5
836.6	Head	41.71	0.90	41.50	0.90	0.506	0.000	± 5
	Body	54.92	0.97	55.20	0.97	-0.507	0.000	± 5
846.6	Head	41.60	0.92	41.50	0.90	0.241	2.222	± 5
	Body	55.00	0.99	55.20	0.97	-0.362	2.062	± 5
848.8	Head	41.64	0.94	41.50	0.90	0.337	4.444	± 5
	Body	55.28	0.99	55.20	0.97	0.145	2.062	± 5

*Liquid Verification was performed on 2016-08-09.

Frequency	Liquid Type	Liquid Parameter		Target Value		Delta (%)		Tolerance (%)
		ϵ_r	σ (S/m)	ϵ_r	σ (S/m)	$\Delta\epsilon_r$	$\Delta\sigma$ (S/m)	
1850.2	Head	40.00	1.43	40.00	1.40	0.000	2.143	± 5
	Body	53.29	1.50	53.30	1.52	-0.019	-1.316	± 5
1852.4	Head	40.14	1.38	40.00	1.40	0.350	-1.429	± 5
	Body	53.36	1.53	53.30	1.52	0.113	0.658	± 5
1880.0	Head	40.02	1.40	40.00	1.40	0.050	0.000	± 5
	Body	53.38	1.51	53.30	1.52	0.150	-0.658	± 5
1907.6	Head	40.18	1.38	40.00	1.40	0.450	-1.429	± 5
	Body	53.18	1.49	53.30	1.52	-0.225	-1.974	± 5
1909.8	Head	40.36	1.40	40.00	1.40	0.900	0.000	± 5
	Body	53.42	1.49	53.30	1.52	0.225	-1.974	± 5

*Liquid Verification was performed on 2016-08-10.

System Accuracy Verification

Prior to the assessment, the system validation kit was used to test whether the system was operating within its specifications of $\pm 10\%$. The validation results are tabulated below. And also the corresponding SAR plot is attached as well in the SAR plots files.

System Verification Setup Block Diagram

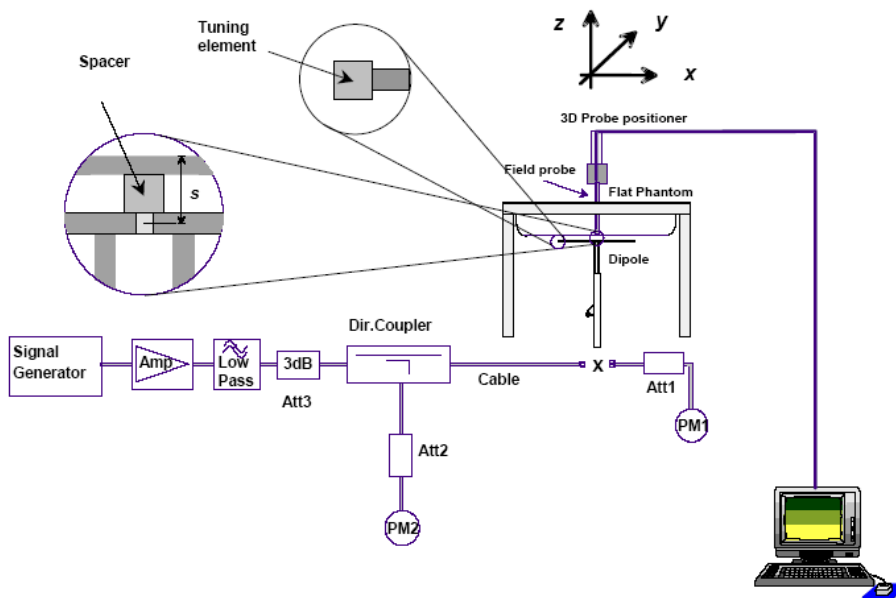

System Accuracy Check Results

Date	Frequency Band	Liquid Type	Measured SAR (W/Kg)		Target Value (W/Kg)	Delta (%)	Tolerance (%)
2016-08-09	835	Head	1g	0.937*10	9.773	-4.124	± 10
		Body	1g	0.918*10	9.736	-5.711	± 10
2016-08-10	1900	Head	1g	3.815*10	39.481	-3.371	± 10
		Body	1g	3.950*10	39.715	-0.541	± 10

Note:

The power inputted to dipole is 0.1Watt,the SAR values are normalized to 1 Watt forward power by multiplying 10 times.

SAR SYSTEM VALIDATION DATA

Test Laboratory: Bay Area Compliance Labs Corp.(Shenzhen)

DUT: Dipole 835 MHz; Type: ALS-D-835-S-2; S/N: 180-00558

Program Name: 835 MHz Head

Communication System: CW; Frequency: 835 MHz; Duty Cycle: 1:1
Medium parameters used: $f = 835 \text{ MHz}$; $\sigma = 0.94 \text{ S/m}$; $\epsilon_r = 41.99$; $\rho = 1000 \text{ kg/m}^3$
Phantom section: Flat Section

DASY4 Configuration:

- Probe: ES3DV3 - SN3036; ConvF(5.96, 5.96, 5.96); Calibrated: 20/08/2015
- Sensor-Surface: 4mm (Mechanical Surface Detection)
- Electronics: Dummy DAE – SN456; Calibrated: 17/08/2015
- Phantom: TWIN SAM; Type: QD000P40CA; Serial: TP-1218
- Measurement SW: DASY4, V4.5 Build 19; Postprocessing SW: SEMCAD, V1.8 Build 145

835 Head system check /Area Scan (91x141x1): Measurement grid: $dx=10\text{mm}$, $dy=10\text{mm}$
Maximum value of SAR (interpolated) = 1.017 mW/g

835 Head system check /Zoom Scan (7x7x7)/Cube 0: Measurement grid: $dx=5\text{mm}$, $dy=5\text{mm}$, $dz=5\text{mm}$
Reference Value = 36.4 V/m; Power Drift = -0.052 dB
Peak SAR (extrapolated) = 1.30 W/kg
SAR(1 g) = 0.937 mW/g; SAR(10 g) = 0.611 mW/g
Maximum value of SAR (measured) = 0.973 mW/g

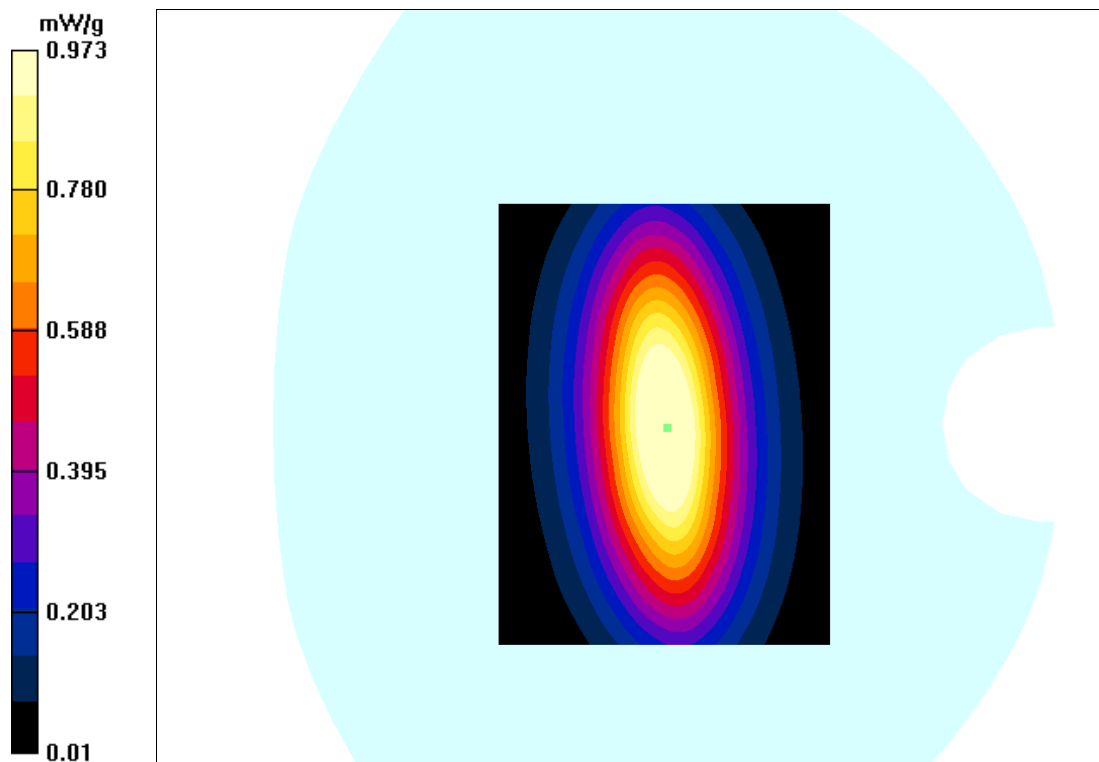

Test Laboratory: Bay Area Compliance Labs Corp.(Shenzhen)

DUT: Dipole 835 MHz; Type: ALS-D-835-S-2; S/N: 180-00558

Program Name: 835 MHz Body

Communication System: CW; Frequency: 835 MHz; Duty Cycle: 1:1

Medium parameters used: $f = 835 \text{ MHz}$; $\sigma = 0.97 \text{ S/m}$; $\epsilon_r = 55.62$; $\rho = 1000 \text{ kg/m}^3$

Phantom section: Flat Section

DASY4 Configuration:

- Probe: ES3DV3 - SN3036; ConvF(6.00, 6.00, 6.00); Calibrated: 20/08/2015
- Sensor-Surface: 4mm (Mechanical Surface Detection)
- Electronics: Dummy DAE – SN456; Calibrated: 17/08/2015
- Phantom: TWIN SAM; Type: QD000P40CA; Serial: TP-1218
- Measurement SW: DASY4, V4.5 Build 19; Postprocessing SW: SEMCAD, V1.8 Build 145

835 Body system check /Area Scan (91x141x1): Measurement grid: $dx=10\text{mm}$, $dy=10\text{mm}$

Maximum value of SAR (interpolated) = 1.12 mW/g

835 Body system check /Zoom Scan (7x7x7)/Cube 0: Measurement grid: $dx=5\text{mm}$, $dy=5\text{mm}$, $dz=5\text{mm}$

Reference Value = 35.7 V/m; Power Drift = -0.180 dB

Peak SAR (extrapolated) = 1.210 W/kg

SAR(1 g) = 0.918 mW/g; SAR(10 g) = 0.623 mW/g

Maximum value of SAR (measured) = 0.983 mW/g

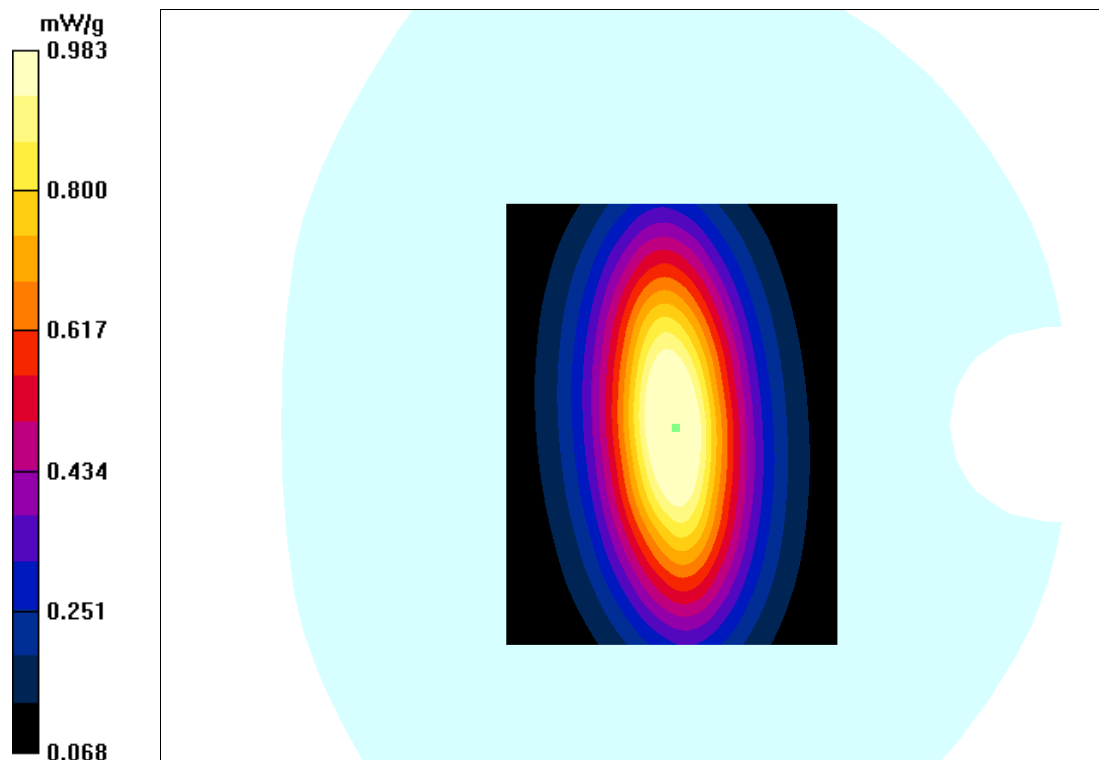

Test Laboratory: Bay Area Compliance Labs Corp.(Shenzhen)
DUT: Dipole 1900 MHz; Type: ALS-D-1900-S-2; S/N: 210-00710
Program Name: 1900MHz Head

Communication System: CW; Frequency: 1900 MHz; Duty Cycle: 1:1
Medium parameters used: $f = 1900 \text{ MHz}$; $\sigma = 1.41 \text{ S/m}$; $\epsilon_r = 39.72$; $\rho = 1000 \text{ kg/m}^3$
Phantom section: Flat Section

DASY4 Configuration:

- Probe: ES3DV3 - SN3036; ConvF(4.9, 4.9, 4.9); Calibrated: 20/08/2015
- Sensor-Surface: 4mm (Mechanical Surface Detection)
- Electronics: Dummy DAE – SN456; Calibrated: 17/08/2015
- Phantom: TWIN SAM; Type: QD000P40CA; Serial: TP-1218
- Measurement SW: DASY4, V4.5 Build 19; Postprocessing SW: SEMCAD, V1.8 Build 145

1900 head system check/Area Scan (81x81x1): Measurement grid: $dx=10\text{mm}$, $dy=10\text{mm}$
Maximum value of SAR (interpolated) = 3.98 mW/g

1900 head system check/Zoom Scan (6x6x7)/Cube 0: Measurement grid: $dx=6\text{mm}$, $dy=6\text{mm}$, $dz=5\text{mm}$
Reference Value = 61.72 V/m; Power Drift = 0.026 dB
Peak SAR (extrapolated) = 6.05 W/kg
SAR(1 g) = 3.815 mW/g; SAR(10 g) = 1.967 mW/g
Maximum value of SAR (measured) = 3.89 mW/g

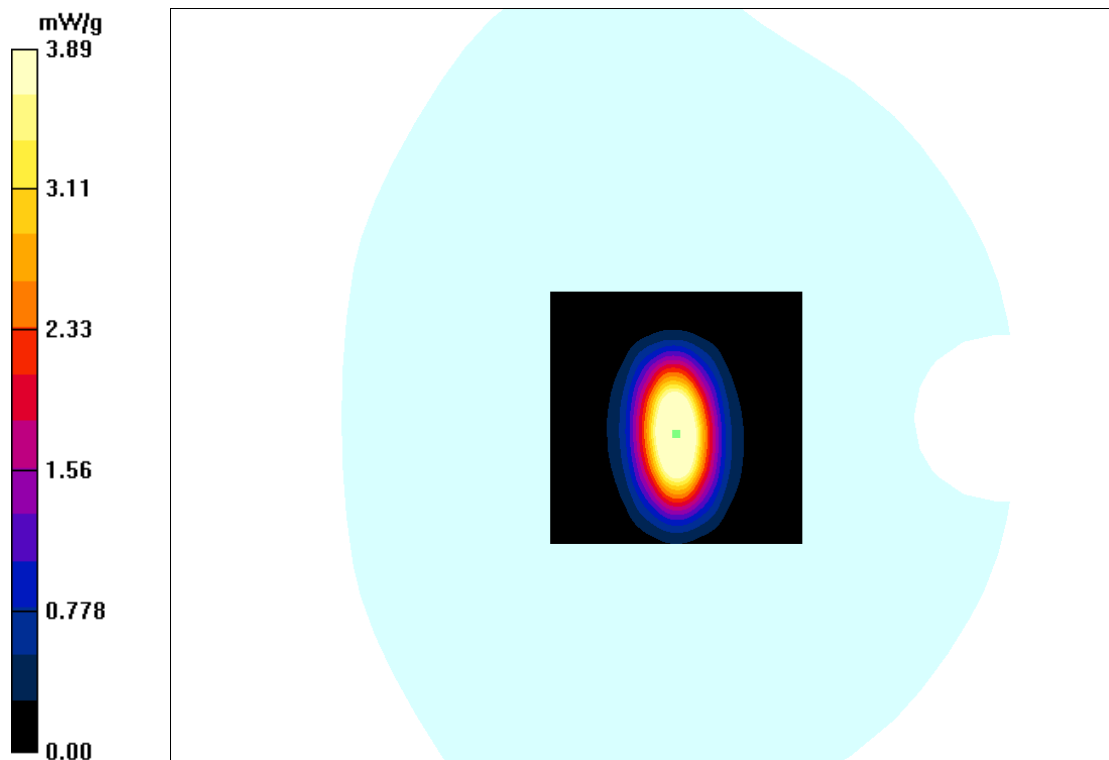

Test Laboratory: Bay Area Compliance Labs Corp.(Shenzhen)
DUT: Dipole 1900 MHz; Type: ALS-D-1900-S-2; S/N: 210-00710
Program Name: 1900MHz Body

Communication System: CW; Frequency: 1900 MHz;Duty Cycle: 1:1
Medium parameters used: $f = 1900 \text{ MHz}$; $\sigma = 1.51 \text{ S/m}$; $\epsilon_r = 52.97$; $\rho = 1000 \text{ kg/m}^3$
Phantom section: Flat Section

DASY4 Configuration:

- Probe: ES3DV3 - SN3036; ConvF(4.56, 4.56, 4.56); Calibrated: 20/08/2015
- Sensor-Surface: 4mm (Mechanical Surface Detection)
- Electronics: Dummy DAE – SN456; Calibrated: 17/08/2015
- Phantom: TWIN SAM; Type: QD000P40CA; Serial: TP-1218
- Measurement SW: DASY4, V4.5 Build 19; Postprocessing SW: SEMCAD, V1.8 Build 145

1900 Body system check/Area Scan (81x81x1): Measurement grid: $dx=10\text{mm}$, $dy=10\text{mm}$
Maximum value of SAR (interpolated) = 4.142 mW/g

1900 Body system check/Zoom Scan (6x6x7)/Cube 0: Measurement grid: $dx=6\text{mm}$, $dy=6\text{mm}$, $dz=5\text{mm}$
Reference Value = 61.63 V/m; Power Drift = -0.094 dB
Peak SAR (extrapolated) = 6.733 W/kg
SAR(1 g) = 3.950 mW/g; SAR(10 g) = 2.038 mW/g
Maximum value of SAR (measured) = 4.05 mW/g

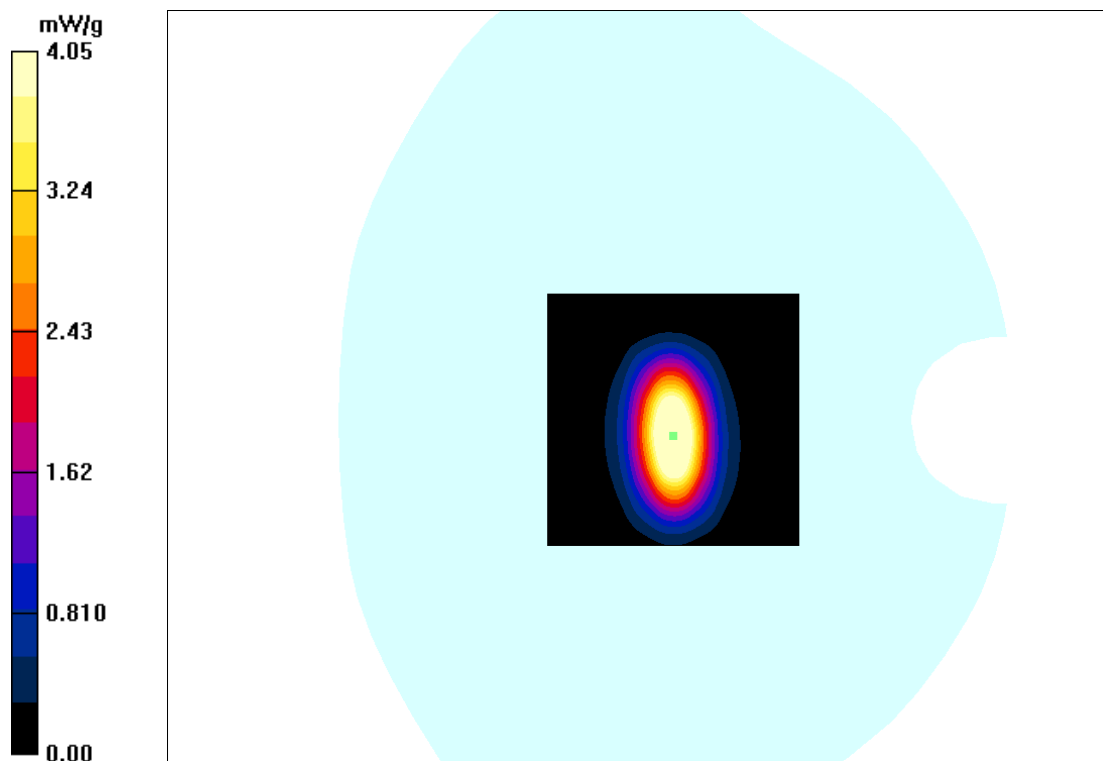

EUT TEST STRATEGY AND METHODOLOGY

Test Positions for Device Operating Next to a Person’s Ear

This category includes most wireless handsets with fixed, retractable or internal antennas located toward the top half of the device, with or without a foldout, sliding or similar keypad cover. The handset should have its earpiece located within the upper ¼ of the device, either along the centerline or off-centered, as perceived by its users. This type of handset should be positioned in a normal operating position with the “test device reference point” located along the “vertical centerline” on the front of the device aligned to the “ear reference point”. The “test device reference point” should be located at the same level as the center of the earpiece region. The “vertical centerline” should bisect the front surface of the handset at its top and bottom edges. A “ear reference point” is located on the outer surface of the head phantom on each ear spacer. It is located 1.5 cm above the center of the ear canal entrance in the “phantom reference plane” defined by the three lines joining the center of each “ear reference point” (left and right) and the tip of the mouth.

A handset should be initially positioned with the earpiece region pressed against the ear spacer of a head phantom. For the SCC-34/SC-2 head phantom, the device should be positioned parallel to the “N-F” line defined along the base of the ear spacer that contains the “ear reference point”. For interim head phantoms, the device should be positioned parallel to the cheek for maximum RF energy coupling. The “test device reference point” is aligned to the “ear reference point” on the head phantom and the “vertical centerline” is aligned to the “phantom reference plane”. This is called the “initial ear position”. While maintaining these three alignments, the body of the handset is gradually adjusted to each of the following positions for evaluating SAR:

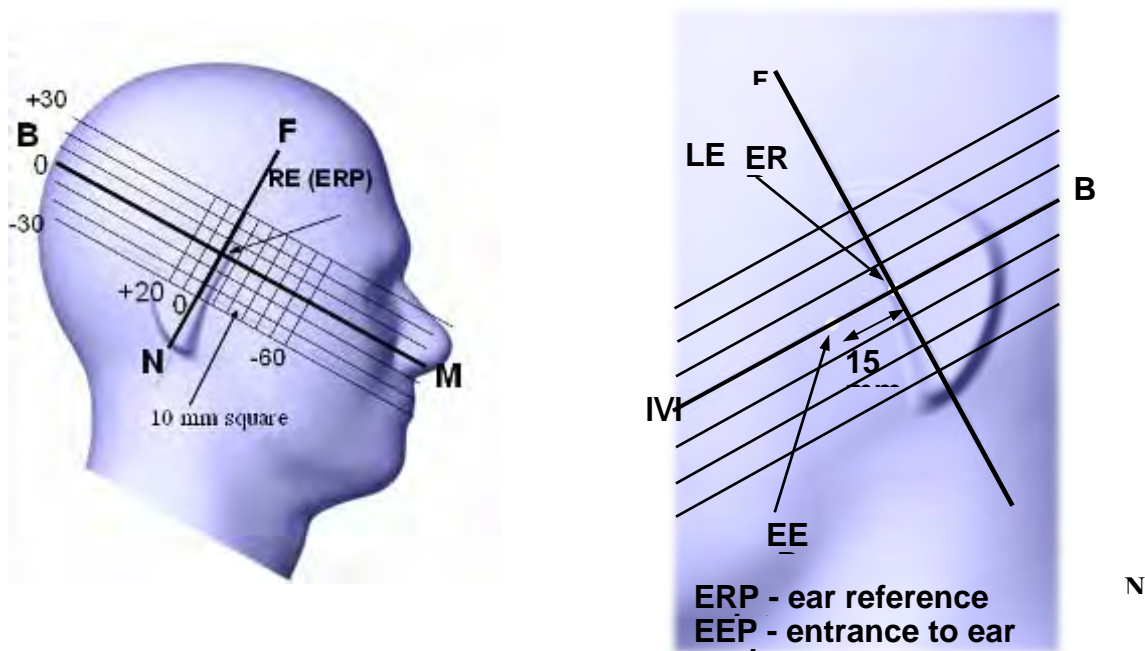

Cheek/Touch Position

The device is brought toward the mouth of the head phantom by pivoting against the “ear reference point” or along the “N-F” line for the SCC-34/SC-2 head phantom.

This test position is established:

- When any point on the display, keypad or mouthpiece portions of the handset is in contact with the phantom.
- (or) When any portion of a foldout, sliding or similar keypad cover opened to its intended self-adjusting normal use position is in contact with the cheek or mouth of the phantom.

For existing head phantoms – when the handset loses contact with the phantom at the pivoting point, rotation should continue until the device touches the cheek of the phantom or breaks its last contact from the ear spacer.

Cheek /Touch Position

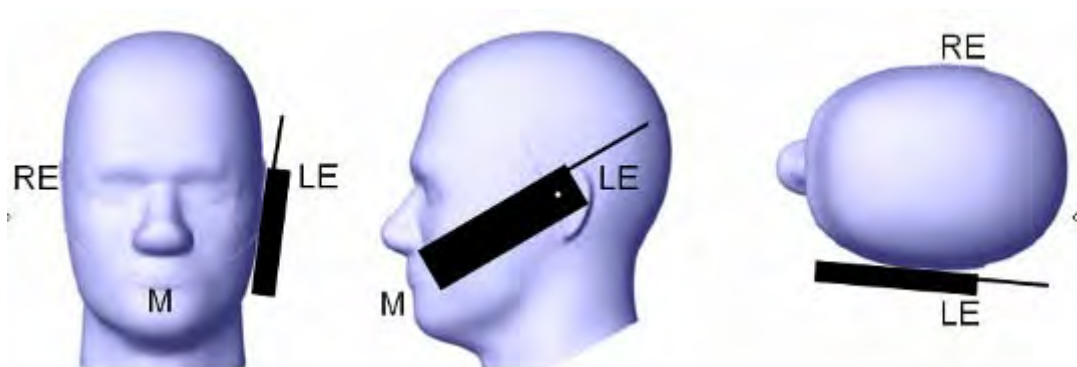

Ear/Tilt Position

With the handset aligned in the “Cheek/Touch Position”:

1) If the earpiece of the handset is not in full contact with the phantom’s ear spacer (in the “Cheek/Touch position”) and the peak SAR location for the “Cheek/Touch” position is located at the ear spacer region or corresponds to the earpiece region of the handset, the device should be returned to the “initial ear position” by rotating it away from the mouth until the earpiece is in full contact with the ear spacer.

2) (otherwise) The handset should be moved (translated) away from the cheek perpendicular to the line passes through both “ear reference points” (note: one of these ear reference points may not physically exist on a split head model) for approximate 2-3 cm. While it is in this position, the device handset is tilted away from the mouth with respect to the “test device reference point” until the inside angle between the vertical centerline on the front surface of the phone and the horizontal line passing through the ear reference point is by 15 80°. After the tilt, it is then moved (translated) back toward the head perpendicular to the line passes through both “ear reference points” until the device touches the phantom or the ear spacer. If the antenna touches the head first, the positioning process should be repeated with a tilt angle less than 15° so that the device and its antenna would touch the phantom simultaneously. This test position may require a device holder or positioner to achieve the translation and tilting with acceptable positioning repeatability.

If a device is also designed to transmit with its keypad cover closed for operating in the head position, such positions should also be considered in the SAR evaluation. The device should be tested on the left and right side of the head phantom in the “Cheek/Touch” and “Ear/Tilt” positions. When applicable, each configuration should be tested with the antenna in its fully extended and fully retracted positions. These test configurations should be tested at the high, middle and low frequency channels of each operating mode; for example, AMPS, CDMA, and TDMA. If the SAR measured at the middle channel for each test configuration (left, right, Cheek/Touch, Tile/Ear, extended and retracted) is at least 2.0 dB lower than the SAR limit, testing at the high and low channels is optional for such test configuration(s). If the transmission band of the test device is less than 10 MHz, testing at the high and low frequency channels is optional.

Ear /Tilt 15° Position

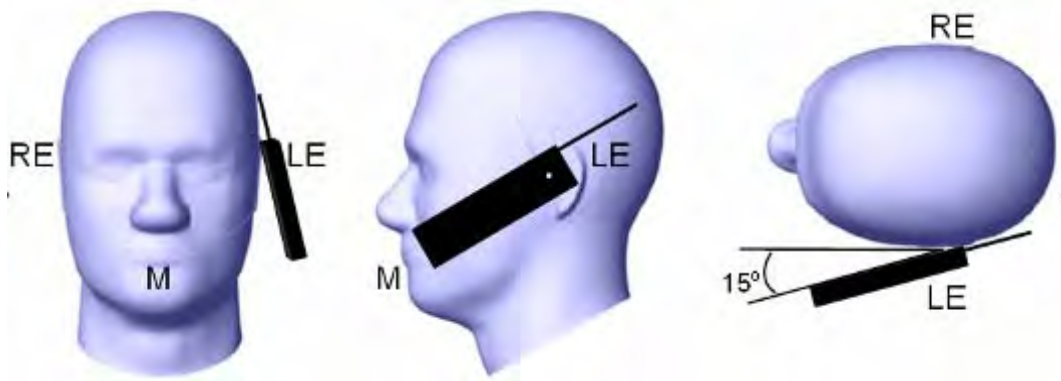

Test positions for body-worn and other configurations

Body-worn operating configurations should be tested with the belt-clips and holsters attached to the device and positioned against a flat phantom in normal use configurations. Devices with a headset output should be tested with a headset connected to the device. When multiple accessories that do not contain metallic components are supplied with the device, the device may be tested with only the accessory that dictates the closest spacing to the body. When multiple accessories that contain metallic components are supplied with the device, the device must be tested with each accessory that contains a unique metallic component. If multiple accessories share an identical metallic component (e.g., the same metallic belt-clip used with different holsters with no other metallic components), only the accessory that dictates the closest spacing to the body must be tested.

Body-worn accessories may not always be supplied or available as options for some devices that are intended to be authorized for body-worn use. A separation distance of 1.5 cm between the back of the device and a flat phantom is recommended for testing body-worn SAR compliance under such circumstances. Other separation distances may be used, but they should not exceed 2.5 cm. In these cases, the device may use body-worn accessories that provide a separation distance greater than that tested for the device provided however that the accessory contains no metallic components.

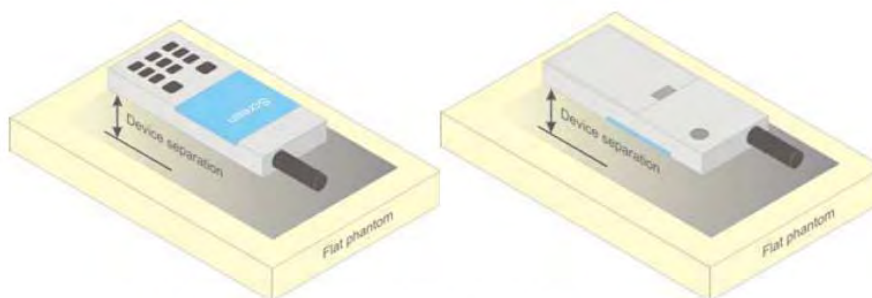

Figure 5 – Test positions for body-worn devices

SAR Evaluation Procedure

The evaluation was performed with the following procedure:

Step 1: Measurement of the SAR value at a fixed location above the ear point or central position was used as a reference value for assessing the power drop. The SAR at this point is measured at the start of the test and then again at the end of the testing.

Step 2: The SAR distribution at the exposed side of the head was measured at a distance of 4 mm from the inner surface of the shell. The area covered the entire dimension of the head or EUT and the horizontal grid spacing was 10 mm x 10 mm. Based on these data, the area of the maximum absorption was determined by spline interpolation. The first Area Scan covers the entire dimension of the EUT to ensure that the hotspot was correctly identified.

Step 3: Around this point, a volume of 35 mm x 35 mm x 35 mm was assessed by measuring 7x 7 x 7 points. On the basis of this data set, the spatial peak SAR value was evaluated under the following procedure:

- 1) The data at the surface were extrapolated, since the center of the dipoles is 1.2 mm away from the tip of the probe and the distance between the surface and the lowest measuring point is 1.3 mm. The extrapolation was based on a least square algorithm. A polynomial of the fourth order was calculated through the points in z-axes. This polynomial was then used to evaluate the points between the surface and the probe tip.
- 2) The maximum interpolated value was searched with a straightforward algorithm. Around this maximum the SAR values averaged over the spatial volumes (1 g or 10 g) were computed by the 3D-Spline interpolation algorithm. The 3D-Spline is composed of three one dimensional splines with the "Not a knot"-condition (in x, y and z-directions). The volume was integrated with the trapezoidal-algorithm. One thousand points (10 x 10 x 10) were interpolated to calculate the averages.

All neighboring volumes were evaluated until no neighboring volume with a higher average value was found.

Step 4: Re-measurement of the SAR value at the same location as in Step 1. If the value changed by more than 5%, the evaluation was repeated.

Test methodology

KDB 447498 D01 General RF Exposure Guidance v06.

KDB 648474 D04 Handset SAR v01r03.

KDB 865664 D01 SAR measurement 100 MHz to 6 GHz v01r04

KDB 865664 D02 RF Exposure Reporting v01r02

KDB 941225 D01 3G SAR Procedures v03r01

KDB 941225 D06 Hotspot Mode v02r01

CONDUCTED OUTPUT POWER MEASUREMENT

Provision Applicable

The measured peak output power should be greater and within 5% than EMI measurement.

Test Procedure

The RF output of the transmitter was connected to the input of the EMI Test Receiver through sufficient attenuation.

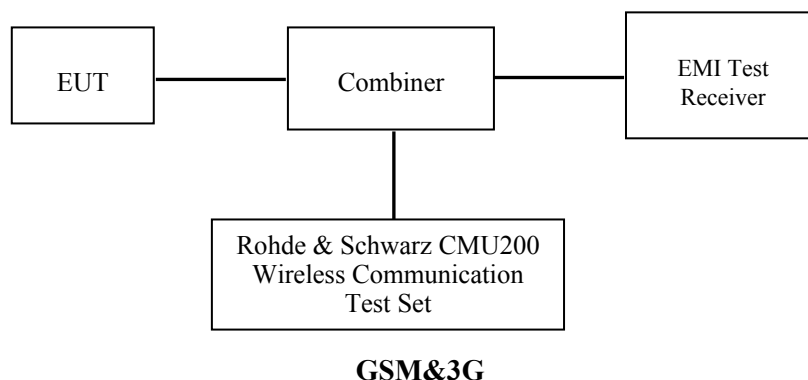

Radio Configuration

The power measurement was configured by the Wireless Communication Test Set CMU200 for all Radio configurations.

GSM

Function: Menu select > GSM Mobile Station > GSM 850/1900

Press Connection control to choose the different menus

Press RESET > choose all the reset all settings

Connection: Press Signal Off to turn off the signal and change settings

Network Support > GSM + only

MS Signal

> 33 dBm for GSM 850

> 30 dBm for PCS 1900

BS Signal: Enter the same channel number for TCH channel (test channel) and BCCH channel

Frequency Offset > + 0 Hz

Mode > BCCH and TCH

BCCH Level > -85 dBm (May need to adjust if link is not stable)

BCCH Channel > choose desired test channel [Enter the same channel number for TCH channel (test channel) and BCCH channel]

Channel Type > Off

P0 > 4 dB

TCH > choose desired test channel

Hopping > Off

AF/RF: Enter appropriate offsets for Ext. Att. Output and Ext. Att. Input

Connection: Press Signal on to turn on the signal and change settings

GPRS

Function: Menu select > GSM Mobile Station > GSM 850/1900

Press Connection control to choose the different menus

Press RESET > choose all the reset all settings

Connection: Press Signal Off to turn off the signal and change settings

Network Support > GSM + GPRS

Main Service > Packet Data

Service selection > Test Mode A – Auto Slot Config. off

MS Signal: Press Slot Config Bottom on the right twice to select and change the number of time slots and power setting

> Slot configuration > Uplink/Gamma

> 33 dBm for GPRS 850

> 30 dBm for GPRS 1900

BS Signal: Enter the same channel number for TCH channel (test channel) and BCCH channel

Frequency Offset >+ 0 Hz

Mode >BCCH and TCH

BCCH Level >-85 dBm (May need to adjust if link is not stable)

BCCH Channel > choose desired test channel [Enter the same channel number for TCH channel (test channel) and BCCH channel]

Channel Type > Off

P0 > 4 dB

Slot Config > Unchanged (if already set under MS signal)

TCH > choose desired test channel

Hopping >Off

Main Timeslot >3

Network: Coding Scheme >CS4 (GPRS)

Bit Stream >2E9-1 PSR Bit Stream

AF/RF: Enter appropriate offsets for Ext. Att. Output and Ext. Att. Input

Connection: Press Signal on to turn on the signal and change settings

WCDMA Release 99

The following tests were conducted according to the test requirements outlines in section 5.2 of the 3GPP TS34.121-1 specification. The EUT has a nominal maximum output power of 24dBm (+1.7/-3.7).

WCDMA General Settings	Loopback Mode	Test Mode 1
	Rel99 RMC	12.2kbps RMC
	Power Control Algorithm	Algorithm2
	β_c / β_d	8/15

HSDPA

The following tests were conducted according to the test requirements outlines in section 5.2 of the 3GPP TS34.121-1 specification.

	Mode	HSDPA	HSDPA	HSDPA	HSDPA
	Subset	1	2	3	4
WCDMA General Settings	Loopback Mode	Test Mode 1			
	Rel99 RMC	12.2kbps RMC			
	HSDPA FRC	H-Set1			
	Power Control Algorithm	Algorithm2			
	β_c	2/15	12/15	15/15	15/15
	β_d	15/15	15/15	8/15	4/15
	β_d (SF)	64			
	β_c / β_d	2/15	12/15	15/8	15/4
	β_{hs}	4/15	24/15	30/15	30/15
MPR(dB)	0	0	0.5	0.5	
HSDPA Specific Settings	DACK	8			
	DNAK	8			
	DCQI	8			
	Ack-Nack repetition factor	3			
	CQI Feedback	4ms			
	CQI Repetition Factor	2			
	$A_{hs} = \beta_{hs} / \beta_c$	30/15			

HSUPA

The following tests were conducted according to the test requirements outlines in section 5.2 of the 3GPP TS34.121-1 specification.

	Mode	HSUPA	HSUPA	HSUPA	HSUPA	HSUPA
	Subset	1	2	3	4	5
WCDMA General Settings	Loopback Mode	Test Mode 1				
	Rel99 RMC	12.2kbps RMC				
	HSDPA FRC	H-Set1				
	HSUPA Test	HSUPA Loopback				
	Power Control Algorithm	Algorithm2				
	β_c	11/15	6/15	15/15	2/15	15/15
	β_d	15/15	15/15	9/15	15/15	0
	β_{ec}	209/225	12/15	30/15	2/15	5/15
	β_c/β_d	11/15	6/15	15/9	2/15	-
	β_{hs}	22/15	12/15	30/15	4/15	5/15
	CM(dB)	1.0	3.0	2.0	3.0	1.0
MPR(dB)	0	2	1	2	0	
HSDPA Specific Settings	DACK	8				
	DNAK	8				
	DCQI	8				
	Ack-Nack repetition factor	3				
	CQI Feedback	4ms				
	CQI Repetition Factor	2				
	$A_{hs}=\beta_{hs}/\beta_c$	30/15				
HSUPA Specific Settings	DE-DPCCH	6	8	8	5	7
	DHARQ	0	0	0	0	0
	AG Index	20	12	15	17	21
	ETFCI	75	67	92	71	81
	Associated Max UL Data Rate kbps	242.1	174.9	482.8	205.8	308.9
	Reference E_FCI	E-TFCI 11 E E-TFCI PO 4 E-TFCI 67 E-TFCI PO 18 E-TFCI 71 E-TFCI PO23 E-TFCI 75 E-TFCI PO26 E-TFCI 81 E-TFCI PO 27	E-TFCI 11 E-TFCI PO4 E-TFCI 92 E-TFCI PO 18	E-TFCI 11 E-TFCI PO 18 E-TFCI 71 E-TFCI PO23 E-TFCI 75 E-TFCI PO26 E-TFCI 81 E-TFCI PO 27	E-TFCI 11 E E-TFCI PO 4 E-TFCI 67 E-TFCI PO 18 E-TFCI 71 E-TFCI PO23 E-TFCI 75 E-TFCI PO26 E-TFCI 81 E-TFCI PO 27	

HSPA+

The following tests were conducted according to the test requirements in Table C.11.1.4 of 3GPP TS 34.121-1

Sub-test	β_c (Note3)	β_d	β_{HS} (Note1)	β_{ec}	β_{ed} (2xSF2) (Note 4)	β_{ed} (2xSF4) (Note 4)	CM (dB) (Note 2)	MPR (dB) (Note 2)	AG Index (Note 4)	E-TFCI (Note 5)	E-TFCI (boost)
1	1	0	30/15	30/15	β_{ed1} : 30/15 β_{ed2} : 30/15	β_{ed3} : 24/15 β_{ed4} : 24/15	3.5	2.5	14	105	105

Note 1: $\Delta_{ACK}, \Delta_{NACK}$ and $\Delta_{CQI} = 30/15$ with $\beta_{hs} = 30/15 * \beta_c$.

Note 2: CM = 3.5 and the MPR is based on the relative CM difference, MPR = MAX(CM-1,0).

Note 3: DPDCH is not configured, therefore the β_c is set to 1 and $\beta_d = 0$ by default.

Note 4: β_{ed} can not be set directly; it is set by Absolute Grant Value.

Note 5: All the sub-tests require the UE to transmit 2SF2+2SF4 16QAM EDCH and they apply for UE using E-DPDCH category 7. E-DCH TTI is set to 2ms TTI and E-DCH table index = 2. To support these E-DCH configurations DPDCH is not allocated. The UE is signalled to use the extrapolation algorithm.

Wi-Fi

For 802.11b, 802.11g and 802.11n-HT20 mode, 13 channels are provided to testing:

Channel	Frequency (MHz)	Channel	Frequency (MHz)
1	2412	8	2447
2	2417	9	2452
3	2422	10	2457
4	2427	11	2462
5	2432	12	2467
6	2437	13	2472
7	2442	/	/

For 802.11b, 802.11g, 802.11n-HT20 mode, EUT was tested with Channel 1, 6 and 13.

For 802.11n-HT40 mode, 9 channels are provided to testing:

Channel	Frequency (MHz)	Channel	Frequency (MHz)
1	2422	6	2447
2	2427	7	2452
3	2432	8	2457
4	2437	9	2462
5	2442	/	/

EUT was tested with Channel 1, 5 and 9.

Maximum Output Power among production units

Max Target Power for Production Unit (dBm)			
Mode/Band	Channel		
	Low	Middle	High
GMS 850	33.00	33.00	33.00
GPRS850 1 slot	33.00	33.00	33.00
GPRS850 2 slots	31.70	31.70	31.70
GPRS850 3 slots	29.70	29.70	29.70
GPRS850 4 slots	28.50	28.50	28.50
PCS 1900	29.40	29.40	29.40
GPRS1900 1 slot	29.40	29.40	29.40
GPRS1900 2 slots	28.50	28.50	28.50
GPRS1900 3 slots	26.60	26.60	26.60
GPRS1900 4 slots	25.50	25.50	25.50
WCDMA 850	RMC	22.70	22.70
	HSDPA	21.70	21.70
	HSUPA	21.80	21.80
	HSPA+	21.10	21.10
WCDMA 1900	RMC	22.10	22.10
	HSDPA	21.10	21.10
	HSUPA	21.10	21.10
	HSPA+	21.10	21.10
Wi-Fi(802.11b/g/n20/n40)	8.60	8.60	8.60
Bluetooth3.0	1.40	1.40	1.40
BLE	-6.00	-6.00	-6.00

Test Results:

GSM:

Band	Frequency (MHz)	Conducted Output Power	
		Meas. Power (dBm)	Meas. Power (W)
GSM 850	824.2	32.92	1.959
	836.6	32.91	1.954
	848.8	32.86	1.932
PCS 1900	1850.2	29.35	0.861
	1880.0	29.32	0.855
	1909.8	29.23	0.838

GPRS:

Band	Channel No.	Frequency (MHz)	RF Output Power (dBm)			
			1 slot	2 slot	3 slots	4 slots
GSM 850	128	824.2	32.94	31.59	29.62	28.42
	190	836.6	32.95	31.61	29.64	28.44
	251	848.8	32.86	31.53	29.55	28.36
PCS 1900	512	1850.2	29.37	28.49	26.53	25.41
	661	1880.0	29.35	28.48	26.54	25.44
	810	1909.8	29.27	28.41	26.52	25.46

For SAR, the time based average power is relevant, the difference in between depends on the duty cycle of the TDMA signal.

Number of Time slot	1	2	3	4
Duty Cycle	1:8	1:4	1:2.66	1:2
Time based Ave. power compared to slotted Ave. power	-9 dB	-6 dB	-4.25 dB	-3 dB
Crest Factor	8	4	2.66	2

The time based average power for GPRS

Band	Channel No.	Frequency (MHz)	Time based average Power (dBm)			
			1 slot	2 slot	3 slots	4 slots
GSM 850	128	824.2	23.94	25.59	25.37	25.42
	190	836.6	23.95	25.61	25.39	25.44
	251	848.8	23.86	25.53	25.30	25.36
PCS 1900	512	1850.2	20.37	22.49	22.28	22.41
	661	1880.0	20.35	22.48	22.29	22.44
	810	1909.8	20.27	22.41	22.27	22.46

Note:

1. Rohde & Schwarz Radio Communication Tester (CMU200) was used for the measurement of GSM peak and average output power for active timeslots.
2. For GSM voice, 1 timeslot has been activated with power level 5 (850 MHz band) and 0 (1900 MHz band).
3. For GPRS, 1, 2, 3 and 4 timeslots has been activated separately with power level 3(850 MHz band) and 3(1900 MHz band).

Results (12.2kbps RMC)

WCDMA 850

Test Condition	Test Mode	3GPP Sub Test	Averaged Mean Power (dBm)		
			Low Frequency	Mid Frequency	High Frequency
Normal	RMC12.2k		22.63	22.68	22.54
	Rel 6 HSDPA	1	21.49	21.61	21.50
		2	21.42	21.50	21.46
		3	21.58	21.66	21.56
		4	21.45	21.53	21.41
	Rel 6 HSUPA	1	21.58	21.63	21.54
		2	21.50	21.57	21.41
		3	21.64	21.75	21.66
		4	21.47	21.56	21.51
		5	21.66	21.66	21.61
	HSPA+	1	21.56	21.67	21.50

WCDMA 1900

Test Condition	Test Mode	3GPP Sub Test	Averaged Mean Power (dBm)		
			Low Frequency	Mid Frequency	High Frequency
Normal	RMC12.2k		21.91	21.98	22.02
	Rel 6 HSDPA	1	20.82	20.95	20.97
		2	20.74	20.88	20.90
		3	20.91	20.98	21.05
		4	20.71	20.85	20.90
	Rel 6 HSUPA	1	20.76	20.89	20.95
		2	20.68	20.84	20.91
		3	20.87	20.94	21.00
		4	20.64	20.82	20.90
		5	20.87	20.98	21.06
	HSPA+	1	20.79	20.91	21.02

Note:

1. The default test configuration is to measure SAR with an established radio link between the EUT and a communication test set using a 12.2 kbps RMC (reference measurement Channel) Configured in Test Loop Model 1.
2. KDB 941225 D01-Body SAR is not required for HSDPA/HSUPA/HSPA+ when the maximum average output of each RF channel is less than ¼ dB higher than measured 12.2kbps RMC or the maximum SAR for 12.2kbps RMC is < 75% of SAR limit.

Bluetooth

Mode	Channel No.	Channel frequency (MHz)	Conducted Output Power	
			(dBm)	(mW)
BDR(GFSK)	0	2402	0.28	1.067
	39	2441	1.04	1.271
	78	2480	1.30	1.349
EDR(4-DQPSK)	0	2402	0.03	1.007
	39	2441	0.79	1.199
	78	2480	0.79	1.199
EDR(8-DPSK)	0	2402	0.28	1.067
	39	2441	0.91	1.233
	78	2480	1.17	1.309
BLE	0	2402	-6.24	0.238
	19	2440	-6.24	0.238
	39	2480	-6.42	0.228

Wi-Fi

Mode	Channel No.	Channel frequency (MHz)	Conducted Output Power	
			(dBm)	(mW)
802.11b	1	2412	8.25	6.683
	7	2442	8.38	6.887
	13	2472	8.58	7.211
802.11g	1	2412	8.04	6.368
	7	2442	8.30	6.761
	13	2472	8.18	6.577
802.11n HT20	1	2412	8.02	6.339
	7	2442	8.25	6.683
	13	2472	8.25	6.683
802.11n HT40	1	2422	8.00	6.310
	5	2442	8.04	6.368
	9	2462	8.11	6.471

Note:

1. The output power was tested under data rate 1Mbps for 802.11b, 6Mbps for 802.11g, 6.5Mbps for 802.11n HT20, 13.5Mbps for 802.11n HT40.

SAR MEASUREMENT RESULTS

This page summarizes the results of the performed dosimetric evaluation.

SAR Test Data

Environmental Conditions

Temperature:	21-24 °C
Relative Humidity:	50-53 %
ATM Pressure:	1001-1002 mbar

Testing was performed by Terry XiaHou on 2016-08-09 to 2016-08-10.

GSM 850:

EUT Position	Frequency (MHz)	Test Mode	Power Drift (dB)	Max. Meas. Power (dBm)	Max. Rated Power (dBm)	1g SAR (W/Kg)			
						Scaled Factor	Meas. SAR	Scaled SAR	Plot
Left Head Cheek	824.2	GSM	/	/	/	/	/	/	/
	836.6	GSM	0.134	32.91	33.00	1.021	0.478	0.488	1#
	848.8	GSM	/	/	/	/	/	/	/
Left Head Tilt	824.2	GSM	/	/	/	/	/	/	/
	836.6	GSM	0.119	32.91	33.00	1.021	0.237	0.242	/
	848.8	GSM	/	/	/	/	/	/	/
Right Head Cheek	824.2	GSM	/	/	/	/	/	/	/
	836.6	GSM	-0.139	32.91	33.00	1.021	0.472	0.482	/
	848.8	GSM	/	/	/	/	/	/	/
Right Head Tilt	824.2	GSM	/	/	/	/	/	/	/
	836.6	GSM	-0.100	32.91	33.00	1.021	0.229	0.234	/
	848.8	GSM	/	/	/	/	/	/	/
Body-Back-Headset (5mm)	824.2	GSM	0.152	32.92	33.00	1.019	1.102	1.122	/
	836.6	GSM	0.095	32.91	33.00	1.021	1.12	1.143	5#
	848.8	GSM	0.110	32.86	33.00	1.033	1.079	1.114	/

Note:

1. When the 1-g SAR is ≤ 0.8 W/Kg, testing for other channels are optional.
2. The EUT transmit and receive through the same GSM antenna while testing SAR.
3. When SAR or MPE is not measured at the maximum power level allowed for production units, the results must be scaled to the maximum tune-up tolerance limit according to the power applied to the individual channels tested to determine compliance.
4. When the maximum output power variation across the required test channels is $> \frac{1}{2}$ dB, instead of the middle channel, the highest output power channel must be used.

PCS Band:

EUT Position	Frequency (MHz)	Test Mode	Power Drift (dB)	Max. Meas. Power (dBm)	Max. Rated Power (dBm)	1g SAR (W/Kg)			
						Scaled Factor	Meas. SAR	Scaled SAR	Plot
Left Head Cheek	1850.2	GSM	/	/	/	/	/	/	/
	1880	GSM	0.033	29.32	29.40	1.019	0.627	0.639	/
	1909.8	GSM	/	/	/	/	/	/	/
Left Head Tilt	1850.2	GSM	/	/	/	/	/	/	/
	1880	GSM	0.062	29.32	29.40	1.019	0.351	0.358	/
	1909.8	GSM	/	/	/	/	/	/	/
Right Head Cheek	1850.2	GSM	/	/	/	/	/	/	/
	1880	GSM	-0.036	29.32	29.40	1.019	0.645	0.657	2#
	1909.8	GSM	/	/	/	/	/	/	/
Right Head Tilt	1850.2	GSM	/	/	/	/	/	/	/
	1880	GSM	0.173	29.32	29.40	1.019	0.356	0.363	/
	1909.8	GSM	/	/	/	/	/	/	/
Body-Back-Headset (5mm)	1850.2	GSM	/	/	/	/	/	/	/
	1880	GSM	-0.084	29.32	29.40	1.019	0.587	0.598	6#
	1909.8	GSM	/	/	/	/	/	/	/

Note:

1. When the 1-g SAR is $\leq 0.8\text{W/Kg}$, testing for other channels are optional.
2. The EUT transmit and receive through the same GSM antenna while testing SAR.
3. When SAR or MPE is not measured at the maximum power level allowed for production units, the results must be scaled to the maximum tune-up tolerance limit according to the power applied to the individual channels tested to determine compliance.
4. When the maximum output power variation across the required test channels is $> \frac{1}{2}$ dB, instead of the middle channel, the highest output power channel must be used.

WCDMA 850 Band:

EUT Position	Frequency (MHz)	Test Mode	Power Drift (dB)	Max. Meas. Power (dBm)	Max. Rated Power (dBm)	1g SAR (W/Kg)			
						Scaled Factor	Meas. SAR	Scaled SAR	Plot
Left Head Cheek	826.4	RMC	/	/	/	/	/	/	/
	836.6	RMC	0.168	22.68	22.70	1.005	0.441	0.443	3#
	846.6	RMC	/	/	/	/	/	/	/
Left Head Tilt	826.4	RMC	/	/	/	/	/	/	/
	836.6	RMC	-0.010	22.68	22.70	1.005	0.213	0.214	/
	846.6	RMC	/	/	/	/	/	/	/
Right Head Cheek	826.4	RMC	/	/	/	/	/	/	/
	836.6	RMC	0.188	22.68	22.70	1.005	0.427	0.429	/
	846.6	RMC	/	/	/	/	/	/	/
Right Head Tilt	826.4	RMC	/	/	/	/	/	/	/
	836.6	RMC	-0.089	22.68	22.70	1.005	0.205	0.206	/
	846.6	RMC	/	/	/	/	/	/	/
Body-Back-Headset (5mm)	826.4	RMC	/	/	/	/	/	/	/
	836.6	RMC	-0.176	22.68	22.70	1.005	0.657	0.660	7#
	846.6	RMC	/	/	/	/	/	/	/

WCDMA 1900 Band:

EUT Position	Frequency (MHz)	Test Mode	Power Drift (dB)	Max. Meas. Power (dBm)	Max. Rated Power (dBm)	1g SAR (W/Kg)			
						Scaled Factor	Meas. SAR	Scaled SAR	Plot
Left Head Cheek	1852.4	RMC	-0.009	21.91	22.10	1.045	1.092	1.141	/
	1880	RMC	0.068	21.98	22.10	1.028	1.150	1.182	/
	1907.6	RMC	-0.052	22.02	22.10	1.019	1.128	1.149	/
Left Head Tilt	1852.4	RMC	/	/	/	/	/	/	/
	1880	RMC	0.042	21.98	22.10	1.028	0.612	0.629	/
	1907.6	RMC	/	/	/	/	/	/	/
Right Head Cheek	1852.4	RMC	0.121	21.91	22.10	1.045	1.102	1.151	/
	1880	RMC	0.143	21.98	22.10	1.028	1.180	1.213	4#
	1907.6	RMC	0.003	22.02	22.10	1.019	1.075	1.095	/
Right Head Tilt	1852.4	RMC	/	/	/	/	/	/	/
	1880	RMC	0.081	21.98	22.10	1.028	0.601	0.618	/
	1907.6	RMC	/	/	/	/	/	/	/
Body-Back-Headset (5mm)	1852.4	RMC	0.075	21.91	22.10	1.045	1.045	1.092	/
	1880	RMC	0.091	21.98	22.10	1.028	1.288	1.292	8#
	1907.6	RMC	0.062	22.02	22.10	1.019	1.019	1.038	/

Note:

1. When the 1-g SAR is ≤ 0.8 W/Kg, testing for other channels are optional.
2. The EUT transmit and receive through the same antenna while testing SAR.

3. The default test configuration is to measure SAR with an established radio link between the EUT and a communication test set using a 12.2 kbps RMC (reference measurement Channel) Configured in Test Loop Model.
4. KDB 941225 D01-Body SAR is not required for HSDPA/HSUPA/HSPA+ when the maximum average output of each RF channel is less than $\frac{1}{4}$ dB higher than measured 12.2kbps RMC or the maximum SAR for 12.2kbps RMC is $< 75\%$ of SAR limit.
5. When SAR or MPE is not measured at the maximum power level allowed for production units, the results must be scaled to the maximum tune-up tolerance limit according to the power applied to the individual channels tested to determine compliance.

Mobile Hot-Spot Test Result

The DUT is capable of functioning as a Wi-Fi to Cellular Mobile hotspot. Additional SAR testing was performed according to KDB 941225 D06. Testing was performed with a separation of 1cm between the DUT and the flat phantom. The DUT was positioned for SAR tests with the front and back surfaces facing the phantom, and also with the edges facing the phantom in which the transmitting antenna is <2.5 cm from the edge. Each transmit band was utilized for SAR testing. The tested mode has been selected within each band that exhibits the highest time average output power.

Hot spot-GPRS (Frequency Band: 850)

EUT Position	Frequency (MHz)	Test Mode	Power Drift (dB)	Max. Meas. Power (dBm)	Max. Rated Power (dBm)	1g SAR (W/Kg)			
						Scaled Factor	Meas. SAR	Scaled SAR	Plot
Body-Back (10mm)	824.2	GPRS	-0.146	31.59	31.70	1.026	1.013	1.039	/
	836.6	GPRS	0.090	31.61	31.70	1.021	1.060	1.082	/
	848.8	GPRS	0.022	31.53	31.70	1.040	0.985	1.024	/
Body-Left (10mm)	824.2	GPRS	/	/	/	/	/	/	/
	836.6	GPRS	-0.127	31.61	31.70	1.021	0.472	0.482	/
	848.8	GPRS	/	/	/	/	/	/	/
Body-Right (10mm)	824.2	GPRS	/	/	/	/	/	/	/
	836.6	GPRS	-0.177	31.61	31.70	1.021	0.625	0.638	/
	848.8	GPRS	/	/	/	/	/	/	/
Body-Bottom (10mm)	824.2	GPRS	/	/	/	/	/	/	/
	836.6	GPRS	0.111	31.61	31.70	1.021	0.283	0.289	/
	848.8	GPRS	/	/	/	/	/	/	/

Note:

1. When the 1-g SAR is $\leq 0.8\text{W/Kg}$, testing for other channels are optional.
2. According to IEEE 1528-2013, the middle channel is required to be tested first.
3. KDB 447498D01- When the maximum output power variation across the required test channels is $> \frac{1}{2}$ dB, instead of the middle channel, the highest output power channel must be used.
2. The EUT is a Capability Class B mobile phone which can be attached to both GPRS and GSM services.
3. The Multi-slot Classes of EUT is Class12 which has maximum 4 Downlink slots and 4 Uplink slots, the maximum active slots is 5, when perform the multiple slots scan, 3DL+2UL is the worst case.
4. The EUT transmit and receive through the same GSM antenna while testing SAR.
5. When SAR or MPE is not measured at the maximum power level allowed for production units, the results must be scaled to the maximum tune-up tolerance limit according to the power applied to the individual channels tested to determine compliance.

Hot spot-GPRS (Frequency Band: 1900)

EUT Position	Frequency (MHz)	Test Mode	Power Drift (dB)	Max. Meas. Power (dBm)	Max. Rated Power (dBm)	1g SAR (W/Kg)			
						Scaled Factor	Meas. SAR	Scaled SAR	Plot
Body-Back (10mm)	1850.2	GPRS	/	/	/	/	/	/	/
	1880.0	GPRS	-0.074	28.48	28.50	1.005	0.515	0.517	/
	1909.8	GPRS	/	/	/	/	/	/	/
Body-Left (10mm)	1850.2	GPRS	/	/	/	/	/	/	/
	1880.0	GPRS	-0.042	28.48	28.50	1.005	0.202	0.203	/
	1909.8	GPRS	/	/	/	/	/	/	/
Body-Right (10mm)	1850.2	GPRS	/	/	/	/	/	/	/
	1880.0	GPRS	0.003	28.48	28.50	1.005	0.271	0.272	/
	1909.8	GPRS	/	/	/	/	/	/	/
Body-Bottom (10mm)	1850.2	GPRS	/	/	/	/	/	/	/
	1880.0	GPRS	0.164	28.48	28.50	1.005	0.408	0.410	/
	1909.8	GPRS	/	/	/	/	/	/	/

Note:

1. When the 1-g SAR is $\leq 0.8\text{W/Kg}$, testing for other channels are optional.
2. According to IEEE 1528-2013, the middle channel is required to be tested first.
3. KDB 447498D01- When the maximum output power variation across the required test channels is $> \frac{1}{2}$ dB, instead of the middle channel, the highest output power channel must be used.
4. The EUT is a Capability Class B mobile phone which can be attached to both GPRS and GSM services.
5. The Multi-slot Classes of EUT is Class12 which has maximum 4 Downlink slots and 4 Uplink slots, the maximum active slots is 5, when perform the multiple slots scan, 3DL+2UL is the worst case.
6. The EUT transmit and receive through the same GSM antenna while testing SAR.
7. When SAR or MPE is not measured at the maximum power level allowed for production units, the results must be scaled to the maximum tune-up tolerance limit according to the power applied to the individual channels tested to determine compliance.

Hot Spot-WCDMA 850 Band

EUT Position	Frequency (MHz)	Test Mode	Power Drift (dB)	Max. Meas. Power (dBm)	Max. Rated Power (dBm)	1g SAR (W/Kg)			
						Scaled Factor	Meas. SAR	Scaled SAR	Plot
Body-Back (10mm)	826.4	RMC	/	/	/	/	/	/	/
	836.6	RMC	-0.176	22.68	22.70	1.005	0.582	0.585	/
	846.6	RMC	/	/	/	/	/	/	/
Body-Left (10mm)	826.4	RMC	/	/	/	/	/	/	/
	836.6	RMC	-0.046	22.68	22.70	1.005	0.268	0.269	/
	846.6	RMC	/	/	/	/	/	/	/
Body-Right (10mm)	826.4	RMC	/	/	/	/	/	/	/
	836.6	RMC	-0.061	22.68	22.70	1.005	0.402	0.404	/
	846.6	RMC	/	/	/	/	/	/	/
Body-Bottom (10mm)	826.4	RMC	/	/	/	/	/	/	/
	836.6	RMC	-0.043	22.68	22.70	1.005	0.119	0.120	/
	846.6	RMC	/	/	/	/	/	/	/

Hot Spot-WCDMA 1900 Band

EUT Position	Frequency (MHz)	Test Mode	Power Drift (dB)	Max. Meas. Power (dBm)	Max. Rated Power (dBm)	1g SAR (W/Kg)			
						Scaled Factor	Meas. SAR	Scaled SAR	Plot
Body-Back (10mm)	1852.4	RMC	0.079	21.91	22.10	1.045	1.032	1.078	/
	1880.0	RMC	0.090	21.98	22.10	1.028	1.210	1.244	/
	1907.6	RMC	0.116	22.02	22.10	1.019	1.170	1.192	/
Body-Left (10mm)	1852.4	RMC	/	/	/	/	/	/	/
	1880.0	RMC	0.132	21.98	22.10	1.028	0.493	0.507	/
	1907.6	RMC	/	/	/	/	/	/	/
Body-Right (10mm)	1852.4	RMC	/	/	/	/	/	/	/
	1880.0	RMC	0.114	21.98	22.10	1.028	0.413	0.425	/
	1907.6	RMC	/	/	/	/	/	/	/
Body-Bottom (10mm)	1852.4	RMC	-0.105	21.91	22.10	1.045	0.792	0.828	/
	1880.0	RMC	0.041	21.98	22.10	1.028	0.839	0.862	/
	1907.6	RMC	-0.098	22.02	22.10	1.019	0.820	0.836	/

Note:

1. When the 1-g SAR is $\leq 0.8\text{W/Kg}$, testing for other channels are optional.
2. According to IEEE 1528-2013, the middle channel is required to be tested first.
3. KDB 447498D01- When the maximum output power variation across the required test channels is $> \frac{1}{2}$ dB, instead of the middle channel, the highest output power channel must be used.
4. The default test configuration is to measure SAR with an established radio link between the EUT and a communication test set using a 12.2 kbps RMC (reference measurement Channel) Configured in Test Loop Model.
5. When SAR or MPE is not measured at the maximum power level allowed for production units, the results must be scaled to the maximum tune-up tolerance limit according to the power applied to the individual channels tested to determine compliance.

SAR SIMULTANEOUS TRANSMISSION DESCRIPTION

Bluetooth & Wi-Fi and GSM&3G Antennas Location:

Right

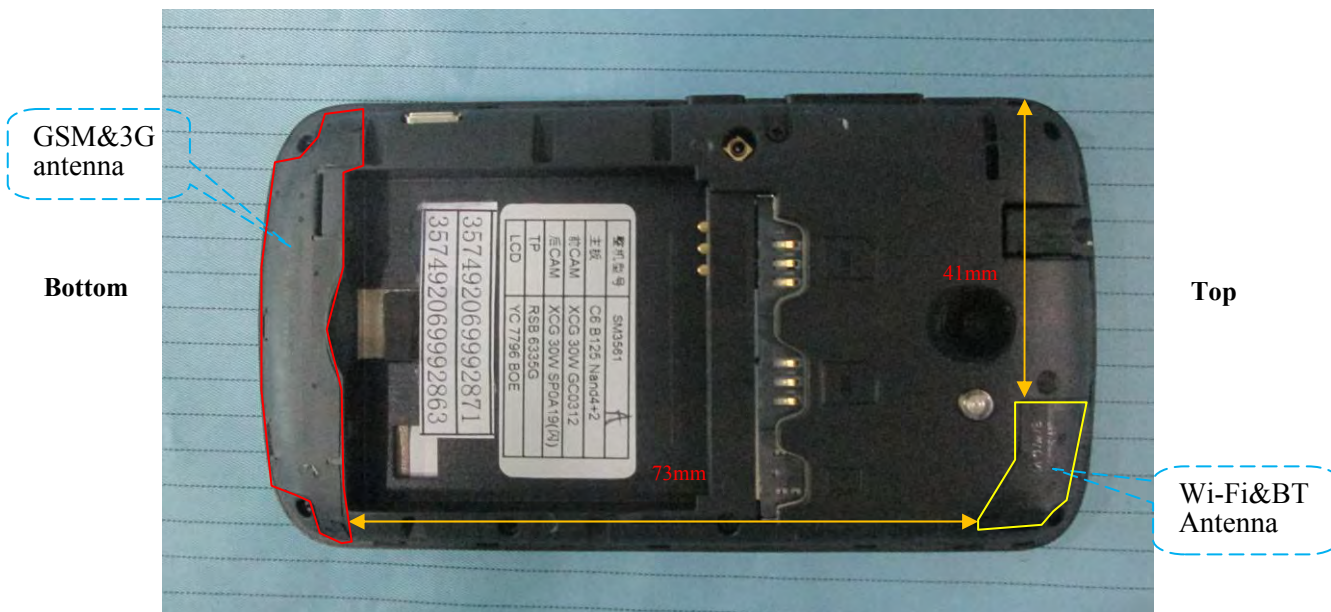

Bottom

Top

Left

Simultaneous Transmission:

Description of Simultaneous Transmit Capabilities			Antennas Distance (mm)
Transmitter Combination	Simultaneous?	Hotspot?	
GSM + WCDMA	×	×	0
GSM + Bluetooth	√	×	73
GSM + WLAN	√	√	73
WCDMA + Bluetooth	√	×	73
WCDMA + WLAN	√	√	73

Standalone SAR test exclusion considerations

Mode	Frequency (GHz)	Test Position	P _{avg} (dBm)	P _{avg} (mW)	Distance (mm)	Calculated value	Threshold (1-g)	SAR Test Exclusion
Bluetooth	2.480	Head	1.40	1.38	0	0.4	3.0	Yes
Bluetooth	2.480	Body	1.40	1.38	5	0.4	3.0	Yes
Bluetooth	2.480	Body	1.40	1.38	10	0.2	3.0	Yes
Wi-Fi	2.472	Head	8.60	7.244	0	2.3	3.0	Yes
Wi-Fi	2.472	Body	8.60	7.244	5	2.3	3.0	Yes
Wi-Fi	2.472	Body	8.60	7.244	10	1.1	3.0	Yes

The 1-g and 10-g SAR test exclusion thresholds for 100 MHz to 6 GHz at *test separation distances* ≤ 50 mm are determined by:

$[(\text{max. power of channel, including tune-up tolerance, mW})/(\text{min. test separation distance, mm})] \cdot [\sqrt{f(\text{GHz})}] \leq 3.0$ for 1-g SAR and ≤ 7.5 for 10-g extremity SAR, where

1. f(GHz) is the RF channel transmit frequency in GHz.
2. Power and distance are rounded to the nearest mW and mm before calculation.
3. The result is rounded to one decimal place for comparison.
4. When the minimum test separation distance is < 5 mm, a distance of 5 mm is applied to determine SAR test Exclusion.

Standalone SAR estimation:

Mode	Frequency (GHz)	Distance (mm)	P _{avg} (dBm)	P _{avg} (mW)	Estimated 1-g (W/kg)
Bluetooth Head	2.480	0	1.40	1.38	0.06
Bluetooth Body-Headset	2.480	5	1.40	1.38	0.06
Bluetooth Body	2.480	10	1.40	1.38	0.03
Wi-Fi Head	2.472	0	8.60	7.24	0.30
Wi-Fi Body-Headset	2.472	5	8.60	7.24	0.30
Wi-Fi Body	2.472	10	8.60	7.24	0.15

When standalone SAR test exclusion applies to an antenna that transmits simultaneously with other antennas, the standalone SAR must be estimated according to following to determine simultaneous transmission SAR test exclusion:

$[(\text{max. power of channel, including tune-up tolerance, mW})/(\text{min. test separation distance,mm})] \cdot [\sqrt{f(\text{GHz})}/x]$ W/kg for test separation distances ≤ 50 mm;

where $x = 7.5$ for 1-g SAR.

When the minimum test separation distance is < 5 mm, a distance of 5 mm is applied to determine SAR test Exclusion

Simultaneous SAR test exclusion considerations:

GSM with BT:

Mode	Position	Reported SAR (W/kg)		ΣSAR
		GSM	BT	< 1.6W/kg
GSM 850	Left Head Cheek	0.488	0.06	0.548
	Left Head Tilt	0.242	0.06	0.302
	Right Head Cheek	0.482	0.06	0.542
	Right Head Tilt	0.234	0.06	0.294
	Body-Headset-Back	1.143	0.06	1.203
PCS 1900	Left Head Cheek	0.639	0.06	0.699
	Left Head Tilt	0.358	0.06	0.418
	Right Head Cheek	0.657	0.06	0.717
	Right Head Tilt	0.363	0.06	0.423
	Body-Headset-Back	0.598	0.06	0.658

WCDMA with BT:

Mode	Position	Reported SAR (W/kg)		ΣSAR
		WCDMA	BT	< 1.6W/kg
WCDMA 850	Left Head Cheek	0.443	0.06	0.503
	Left Head Tilt	0.214	0.06	0.274
	Right Head Cheek	0.429	0.06	0.489
	Right Head Tilt	0.206	0.06	0.266
	Body-Headset-Back	0.660	0.06	0.720
WCDMA 1900	Left Head Cheek	1.182	0.06	1.242
	Left Head Tilt	0.629	0.06	0.689
	Right Head Cheek	1.213	0.06	1.273
	Right Head Tilt	0.618	0.06	0.678
	Body-Headset-Back	1.292	0.06	1.352

GSM with Wi-Fi:

Mode	Position	Reported SAR (W/kg)		ΣSAR
		GSM	Wi-Fi	< 1.6W/kg
GSM 850	Left Head Cheek	0.488	0.30	0.788
	Left Head Tilt	0.242	0.30	0.542
	Right Head Cheek	0.482	0.30	0.782
	Right Head Tilt	0.234	0.30	0.534
	Body-Headset-Back	1.143	0.30	1.443
PCS 1900	Left Head Cheek	0.639	0.30	0.939
	Left Head Tilt	0.358	0.30	0.658
	Right Head Cheek	0.657	0.30	0.957
	Right Head Tilt	0.363	0.30	0.663
	Body-Headset-Back	0.598	0.30	0.898

WCDMA with Wi-Fi:

Mode	Position	Reported SAR (W/kg)		ΣSAR
		WCDMA	Wi-Fi	< 1.6W/kg
WCDMA 850	Left Head Cheek	0.443	0.30	0.743
	Left Head Tilt	0.214	0.30	0.514
	Right Head Cheek	0.429	0.30	0.729
	Right Head Tilt	0.206	0.30	0.506
	Body-Headset-Back	0.660	0.30	0.960
WCDMA 1900	Left Head Cheek	1.182	0.30	1.482
	Left Head Tilt	0.629	0.30	0.929
	Right Head Cheek	1.213	0.30	1.513
	Right Head Tilt	0.618	0.30	0.918
	Body-Headset-Back	1.292	0.30	1.592

Conclusion:

Σ SAR < 1.6 W/kg therefore simultaneous transmission SAR with Volume Scans is **not** required.

Evaluations for Simultaneous SAR, Mobile Hot Spot Positions					
Test Position	Body-Back (1.0cm)	Body-Left (1.0cm)	Body-Right (1.0cm)	Body-Bottom (1.0cm)	Body-Top (1.0cm)
Mode	Stand Alone 1-g SAR (W/Kg)				
GPRS 850	1.082	0.482	0.638	0.289	/
GPRS 1900	0.517	0.203	0.272	0.410	/
WCDMA 850	0.585	0.269	0.404	0.120	/
WCDMA 1900	1.244	0.507	0.425	0.862	/
Wi-Fi	0.15	0.15	/	/	0.15
	Σ 1-g SAR (W/Kg)				
GPRS 850 + Wi-Fi	1.232	0.632	/	/	/
GPRS 1900 + Wi-Fi	0.667	0.353	/	/	/
WCDMA 850 + Wi-Fi	0.735	0.41	/	/	/
WCDMA 1900+ Wi-Fi	1.394	0.657	/	/	/

Note:

If the sum of the 1g SAR measured for the simultaneously transmitting antennas is less than the SAR limit, SAR measurement for simultaneous transmission is not required.

SAR Plots (Summary of the Highest SAR Values)

Test Laboratory: Bay Area Compliance Labs Corp.(Shenzhen)

Test Plot 1#:GSM 850 Left Cheek Middle Channel

DUT: 3G Smart Phone; Type: Fuego 3.5

Communication System: 2G Band; Frequency: 836.6 MHz;Duty Cycle: 1:8
Medium parameters used: $f = 836.6$ MHz; $\sigma = 0.90$ S/m; $\epsilon_r = 41.71$; $\rho = 1000$ kg/m³
Phantom section: Left Section

DASY4 Configuration:

- Probe: ES3DV3 - SN3036; ConvF(5.96, 5.96, 5.96); Calibrated: 20/08/2015
- Sensor-Surface: 4mm (Mechanical Surface Detection)
- Electronics: Dummy DAE - SN:456; Calibrated: 17/08/2015
- Phantom: TWIN SAM; Type: QD000P40CA; Serial: TP-1218
- Measurement SW: DASY4, V4.5 Build 19; Postprocessing SW: SEMCAD, V1.8 Build 145

GSM850-head-left-mid /Area Scan (101x121x1): Measurement grid: dx=10mm, dy=10mm
Maximum value of SAR (interpolated) = 0.529 mW/g

GSM850-head-left-mid /Zoom Scan (7x7x7)/Cube 0: Measurement grid: dx=5mm, dy=5mm, dz=5mm
Reference Value = 7.66 V/m; Power Drift = 0.134 dB
Peak SAR (extrapolated) = 0.515 W/kg
SAR(1 g) = 0.478 mW/g; SAR(10 g) = 0.394 mW/g
Maximum value of SAR (measured) = 0.496 mW/g

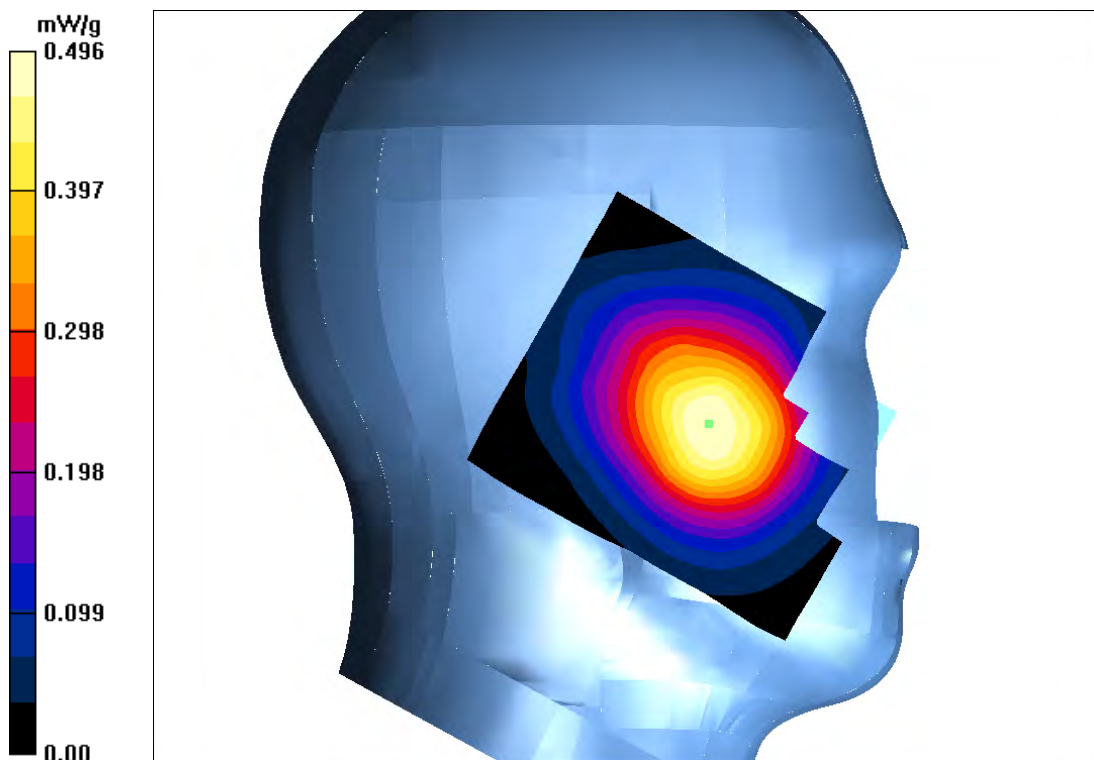

Test Laboratory: Bay Area Compliance Labs Corp.(Shenzhen)

Test Plot 2#:PCS 1900 Right Cheek Middle Channel

DUT: 3G Smart Phone; Type: Fuego 3.5

Communication System: 2G Band; Frequency: 1880 MHz;Duty Cycle: 1:8
Medium parameters used: $f = 1880 \text{ MHz}$; $\sigma = 1.40 \text{ S/m}$; $\epsilon_r = 40.02$; $\rho = 1000 \text{ kg/m}^3$
Phantom section: Right Section

DASY4 Configuration:

- Probe: ES3DV3 - SN3036; ConvF(4.9, 4.9, 4.9); Calibrated: 20/08/2015
- Sensor-Surface: 4mm (Mechanical Surface Detection)
- Electronics: Dummy DAE - SN:456; Calibrated: 17/08/2015
- Phantom: TWIN SAM; Type: QD000P40CA; Serial: TP-1218
- Measurement SW: DASY4, V4.5 Build 19; Postprocessing SW: SEMCAD, V1.8 Build 145

PCS 1900-head-right-mid /Area Scan (111x121x1): Measurement grid: $dx=10\text{mm}$, $dy=10\text{mm}$
Maximum value of SAR (interpolated) = 0.746 mW/g

PCS 1900-head-right-mid /Zoom Scan (7x7x7)/Cube 0: Measurement grid: $dx=5\text{mm}$, $dy=5\text{mm}$, $dz=5\text{mm}$
Reference Value = 5.63 V/m; Power Drift = -0.036 dB
Peak SAR (extrapolated) = 1.13 W/kg
SAR(1 g) = 0.645 mW/g; SAR(10 g) = 0.335 mW/g
Maximum value of SAR (measured) = 0.736 mW/g

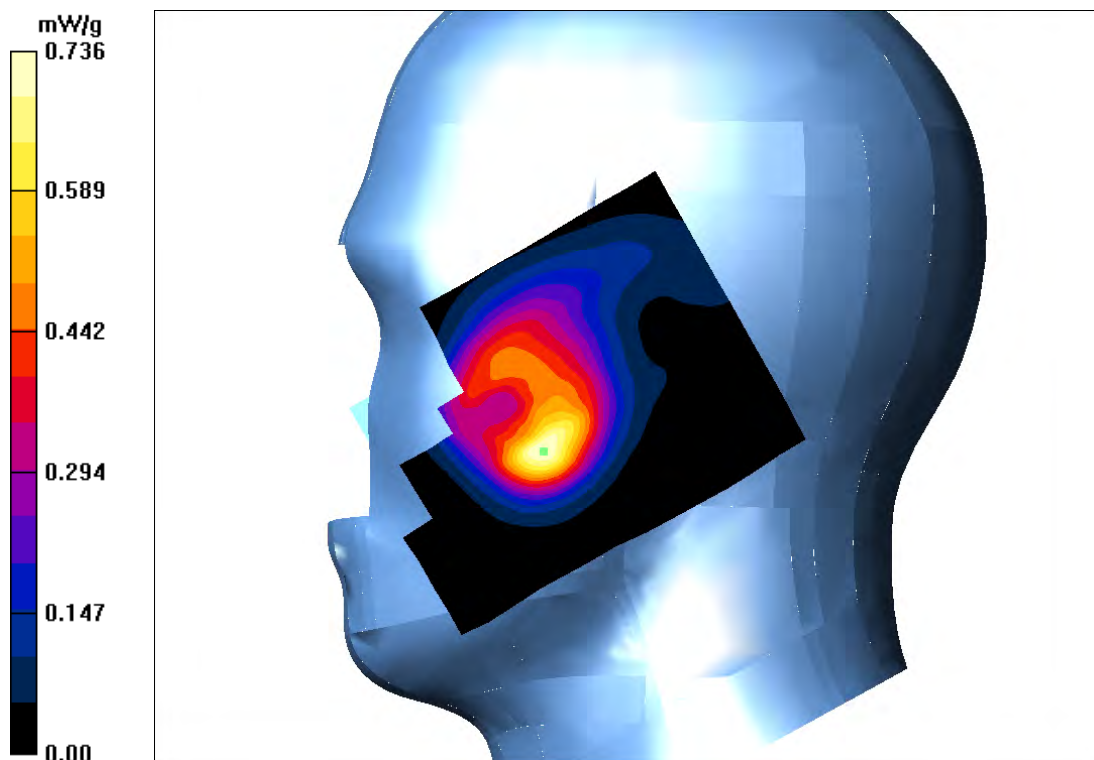

Test Laboratory: Bay Area Compliance Labs Corp.(Shenzhen)

Test Plot 3#:WCDMA 850 Left Cheek Middle Channel

DUT: 3G Smart Phone; Type: Fuego 3.5

Communication System: 3G Band; Frequency: 836.6 MHz;Duty Cycle: 1:1
Medium parameters used: $f = 836.6 \text{ MHz}$; $\sigma = 0.90 \text{ S/m}$; $\epsilon_r = 41.71$; $\rho = 1000 \text{ kg/m}^3$
Phantom section: Left Section

DASY4 Configuration:

- Probe: ES3DV3 - SN3036; ConvF(5.96, 5.96, 5.96); Calibrated: 20/08/2015
- Sensor-Surface: 4mm (Mechanical Surface Detection)
- Electronics: Dummy DAE - SN:456; Calibrated: 17/08/2015
- Phantom: TWIN SAM; Type: QD000P40CA; Serial: TP-1218
- Measurement SW: DASY4, V4.5 Build 19; Postprocessing SW: SEMCAD, V1.8 Build 145

WCDMA 850-head-left-mid /Area Scan (101x121x1): Measurement grid: $dx=10\text{mm}$, $dy=10\text{mm}$
Maximum value of SAR (interpolated) = 0.451 mW/g

WCDMA 850-head-left-mid /Zoom Scan (7x7x7)/Cube 0: Measurement grid: $dx=5\text{mm}$, $dy=5\text{mm}$, $dz=5\text{mm}$
Reference Value = 8.02 V/m; Power Drift = 0.168 dB
Peak SAR (extrapolated) = 0.499 W/kg
SAR(1 g) = 0.441 mW/g; SAR(10 g) = 0.353 mW/g
Maximum value of SAR (measured) = 0.459 mW/g

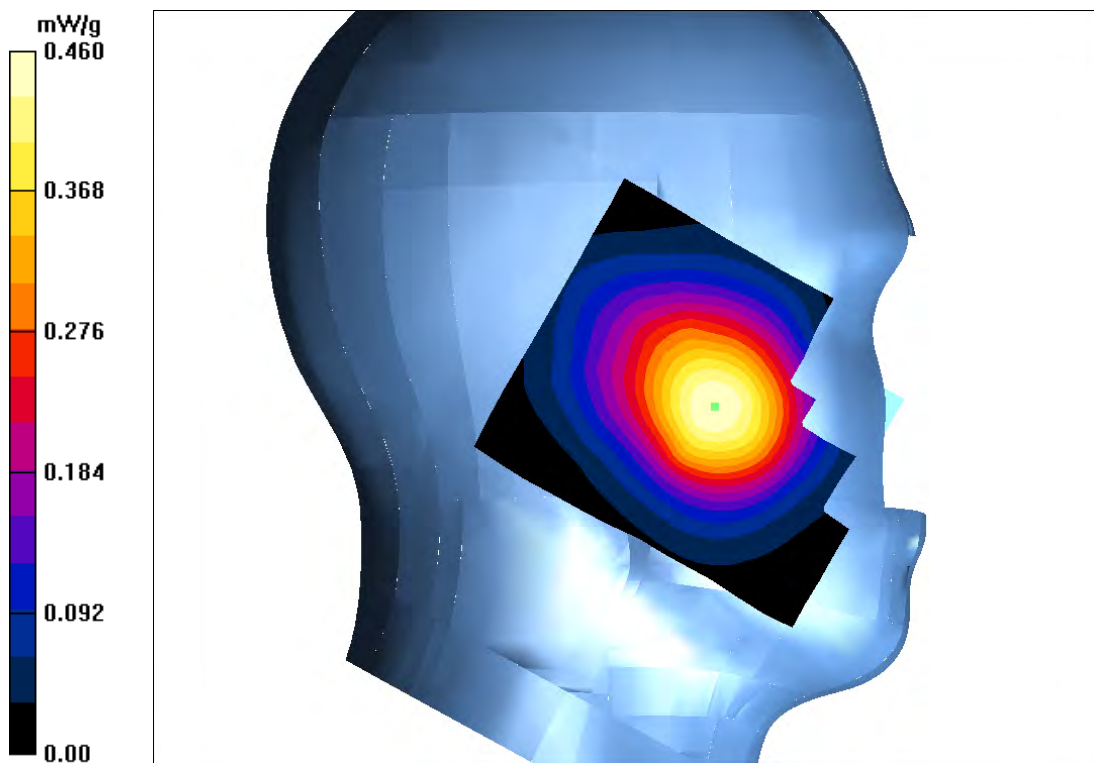

Test Laboratory: Bay Area Compliance Labs Corp.(Shenzhen)

Test Plot 4#:WCDMA 1900 Right Cheek Middle Channel

DUT: 3G Smart Phone; Type: Fuego 3.5

Communication System: 3G Band; Frequency: 1880 MHz;Duty Cycle: 1:1
Medium parameters used: $f = 1880$ MHz; $\sigma = 1.40$ S/m; $\epsilon_r = 40.02$; $\rho = 1000$ kg/m³
Phantom section: Right Section

DASY4 Configuration:

- Probe: ES3DV3 - SN3036; ConvF(4.9, 4.9, 4.9); Calibrated: 20/08/2015
- Sensor-Surface: 4mm (Mechanical Surface Detection)
- Electronics: Dummy DAE - SN:456; Calibrated: 17/08/2015
- Phantom: TWIN SAM; Type: QD000P40CA; Serial: TP-1218
- Measurement SW: DASY4, V4.5 Build 19; Postprocessing SW: SEMCAD, V1.8 Build 145

WCDMA 1900-head-right-mid /Area Scan (111x121x1): Measurement grid: dx=10mm, dy=10mm
Maximum value of SAR (interpolated) = 1.383 mW/g

WCDMA 1900-head-right-mid /Zoom Scan (7x7x7)/Cube 0: Measurement grid: dx=5mm, dy=5mm, dz=5mm
Reference Value = 7.60 V/m; Power Drift = 0.143 dB
Peak SAR (extrapolated) = 2.21 W/kg
SAR(1 g) = 1.18 mW/g; SAR(10 g) = 0.604 mW/g
Maximum value of SAR (measured) = 1.35 mW/g

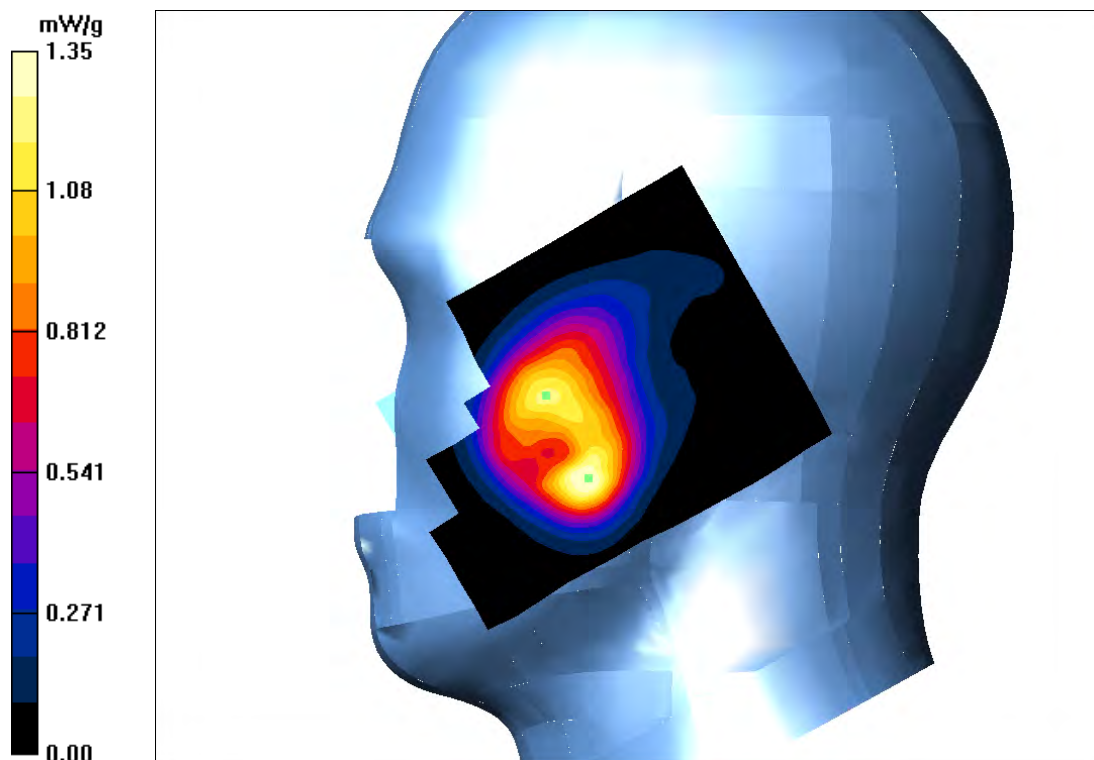

Test Laboratory: Bay Area Compliance Labs Corp.(Shenzhen)

Test Plot 5#:GSM 850 Body-Back-Headset Middle Channel

DUT: 3G Smart Phone; Type: Fuego 3.5

Communication System: 2G Band; Frequency: 836.6 MHz;Duty Cycle: 1:8
Medium parameters used: $f = 836.6 \text{ MHz}$; $\sigma = 0.97 \text{ S/m}$; $\epsilon_r = 54.92$; $\rho = 1000 \text{ kg/m}^3$
Phantom section: Flat Section

DASY4 Configuration:

- Probe: ES3DV3 - SN3036; ConvF(6.00, 6.00, 6.00); Calibrated: 20/08/2015
- Sensor-Surface: 4mm (Mechanical Surface Detection)
- Electronics: Dummy DAE - SN:456; Calibrated: 17/08/2015
- Phantom: TWIN SAM; Type: QD000P40CA; Serial: TP-1218
- Measurement SW: DASY4, V4.5 Build 19; Postprocessing SW: SEMCAD, V1.8 Build 145

GSM850-Body-Back-Headset-mid/Area Scan (101x131x1): Measurement grid: $dx=10\text{mm}$, $dy=10\text{mm}$
Maximum value of SAR (interpolated) = 1.304 mW/g

GSM850-Body-Back-Headset-mid /Zoom Scan (7x7x7)/Cube 0: Measurement grid: $dx=5\text{mm}$, $dy=5\text{mm}$, $dz=5\text{mm}$
Reference Value = 34.7 V/m; Power Drift = 0.095 dB
Peak SAR (extrapolated) = 1.25 W/kg
SAR(1 g) = 1.12 mW/g; SAR(10 g) = 0.883 mW/g
Maximum value of SAR (measured) = 1.26 mW/g

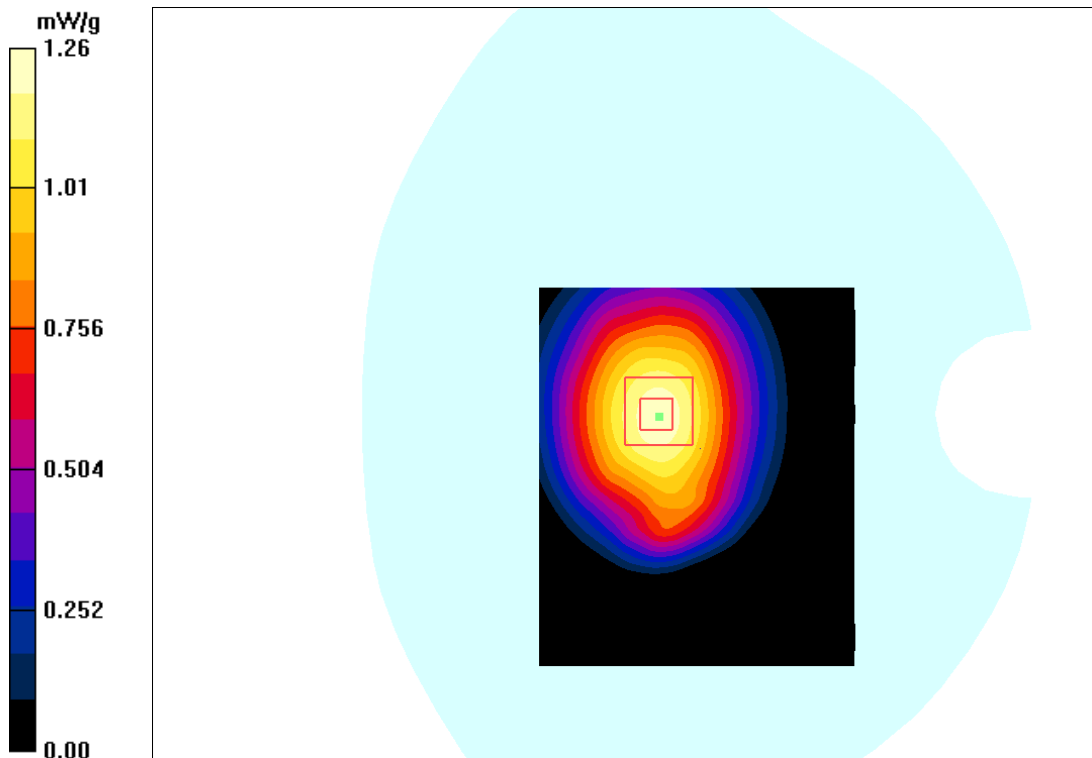

Test Laboratory: Bay Area Compliance Labs Corp.(Shenzhen)

Test Plot 6#:PCS 1900 Body-Back-Headset Middle Channel

DUT: 3G Smart Phone; Type: Fuego 3.5

Communication System: 2G Band; Frequency: 1880 MHz;Duty Cycle: 1:8
 Medium parameters used: $f=1880$ MHz; $\sigma = 1.51$ S/m; $\epsilon_r = 53.38$; $\rho = 1000$ kg/m³
 Phantom section: Flat Section

DASY4 Configuration:

- Probe: ES3DV3 - SN3036; ConvF(4.56, 4.56, 4.56); Calibrated: 20/08/2015
- Sensor-Surface: 4mm (Mechanical Surface Detection)
- Electronics: Dummy DAE - SN:456; Calibrated: 17/08/2015
- Phantom: TWIN SAM; Type: QD000P40CA; Serial: TP-1218
- Measurement SW: DASY4, V4.5 Build 19; Postprocessing SW: SEMCAD, V1.8 Build 145

PCS 1900-Body-Back-Headset-mid/Area Scan (111x131x1): Measurement grid: dx=10mm, dy=10mm
 Maximum value of SAR (interpolated) = 0.688 mW/g

PCS 1900-Body-Back-Headset-mid /Zoom Scan (7x7x7)/Cube 0: Measurement grid: dx=5mm, dy=5mm, dz=5mm

Reference Value = 18.9 V/m; Power Drift = -0.084 dB

Peak SAR (extrapolated) = 0.987 W/kg

SAR(1 g) = 0.587 mW/g; SAR(10 g) = 0.357 mW/g

Maximum value of SAR (measured) = 0.638 mW/g

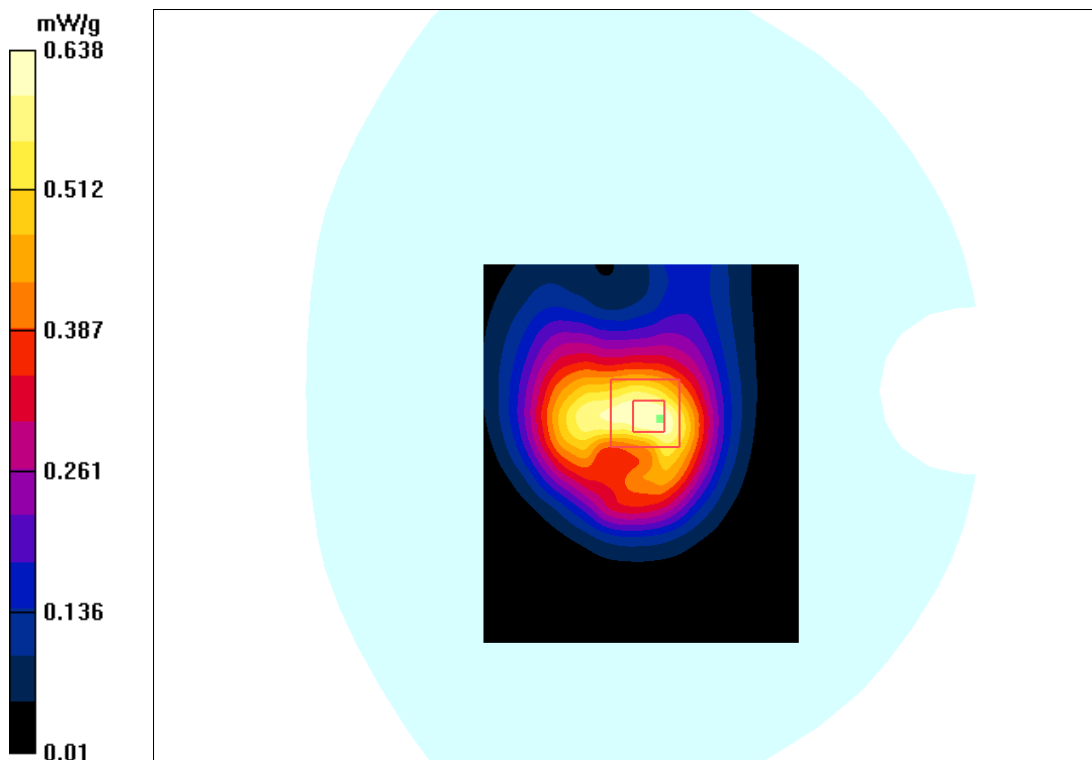

Test Laboratory: Bay Area Compliance Labs Corp.(Shenzhen)

Test Plot 7#:WCDMA 850 Body-Back-Headset Middle Channel

DUT: 3G Smart Phone; Type: Fuego 3.5

Communication System: 3G Band; Frequency: 836.6 MHz;Duty Cycle: 1:1
Medium parameters used: $f = 836.6 \text{ MHz}$; $\sigma = 0.97 \text{ S/m}$; $\epsilon_r = 54.92$; $\rho = 1000 \text{ kg/m}^3$
Phantom section: Flat Section

DASY4 Configuration:

- Probe: ES3DV3 - SN3036; ConvF(6.00, 6.00, 6.00); Calibrated: 20/08/2015
- Sensor-Surface: 4mm (Mechanical Surface Detection)
- Electronics: Dummy DAE - SN:456; Calibrated: 17/08/2015
- Phantom: TWIN SAM; Type: QD000P40CA; Serial: TP-1218
- Measurement SW: DASY4, V4.5 Build 19; Postprocessing SW: SEMCAD, V1.8 Build 145

WCDMA 850-Body-Back-Headset -mid/Area Scan (101x131x1): Measurement grid: $dx=10\text{mm}$, $dy=10\text{mm}$
Maximum value of SAR (interpolated) = 0.651 mW/g

WCDMA 850-Body-Back-Headset-mid /Zoom Scan (7x7x7)/Cube 0: Measurement grid: $dx=5\text{mm}$, $dy=5\text{mm}$, $dz=5\text{mm}$

Reference Value = 24.5 V/m; Power Drift = -0.176 dB

Peak SAR (extrapolated) = 1.24 W/kg

SAR(1 g) = 0.657 mW/g; SAR(10 g) = 0.389 mW/g

Maximum value of SAR (measured) = 0.733 mW/g

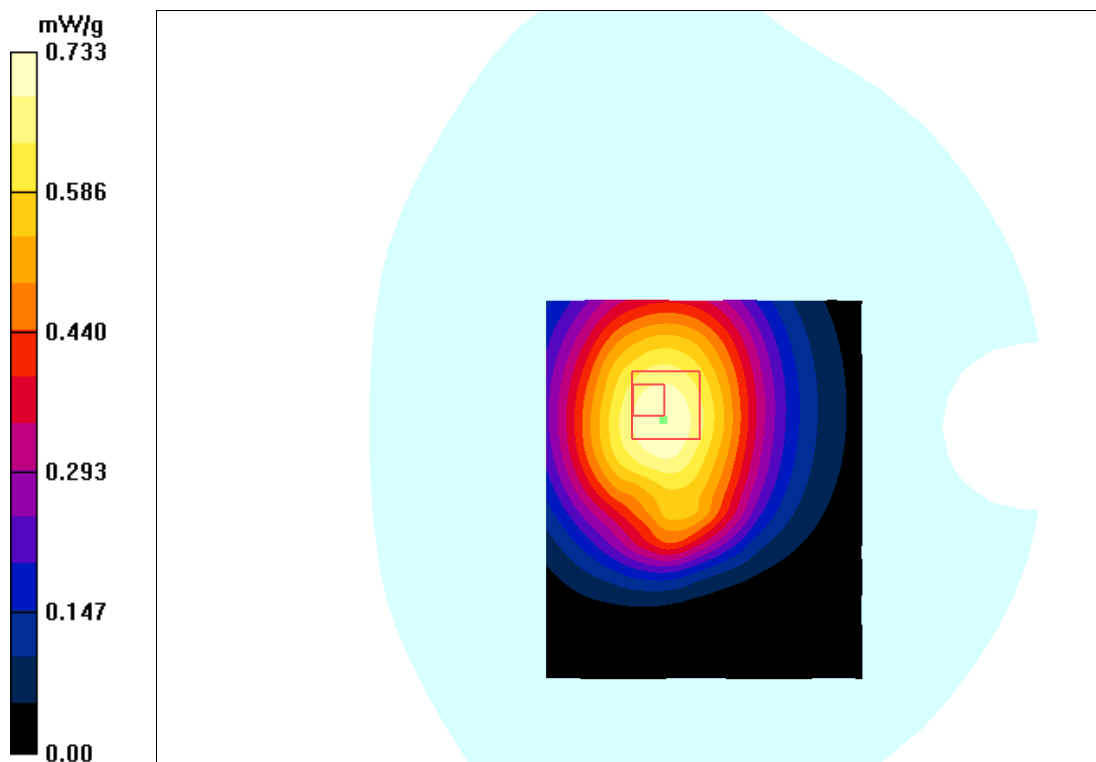

Test Laboratory: Bay Area Compliance Labs Corp.(Shenzhen)

Test Plot 8#:WCDMA 1900 Body-Back-Headset Middle Channel

DUT: 3G Smart Phone; Type: Fuego 3.5

Communication System: 3G Band; Frequency: 1880.0 MHz;Duty Cycle: 1:1
Medium parameters used: $f=1880$ MHz; $\sigma = 1.51$ S/m; $\epsilon_r = 53.38$; $\rho = 1000$ kg/m³
Phantom section: Flat Section

DASY4 Configuration:

- Probe: ES3DV3 - SN3036; ConvF(4.56, 4.56, 4.56); Calibrated: 20/08/2015
- Sensor-Surface: 4mm (Mechanical Surface Detection)
- Electronics: Dummy DAE - SN:456; Calibrated: 17/08/2015
- Phantom: TWIN SAM; Type: QD000P40CA; Serial: TP-1218
- Measurement SW: DASY4, V4.5 Build 19; Postprocessing SW: SEMCAD, V1.8 Build 145

WCDMA 1900-Body-Back-Headset -mid/Area Scan (11x131x1): Measurement grid: dx=10mm, dy=10mm
Maximum value of SAR (interpolated) = 1.447 mW/g

WCDMA 1900-Body-Back-Headset-mid /Zoom Scan (7x7x7)/Cube 0: Measurement grid: dx=5mm, dy=5mm, dz=5mm
Reference Value = 25.4 V/m; Power Drift = 0.091 dB
Peak SAR (extrapolated) = 2.383 W/kg
SAR(1 g) = 1.253 mW/g; SAR(10 g) = 0.789 mW/g
Maximum value of SAR (measured) = 1.43 mW/g

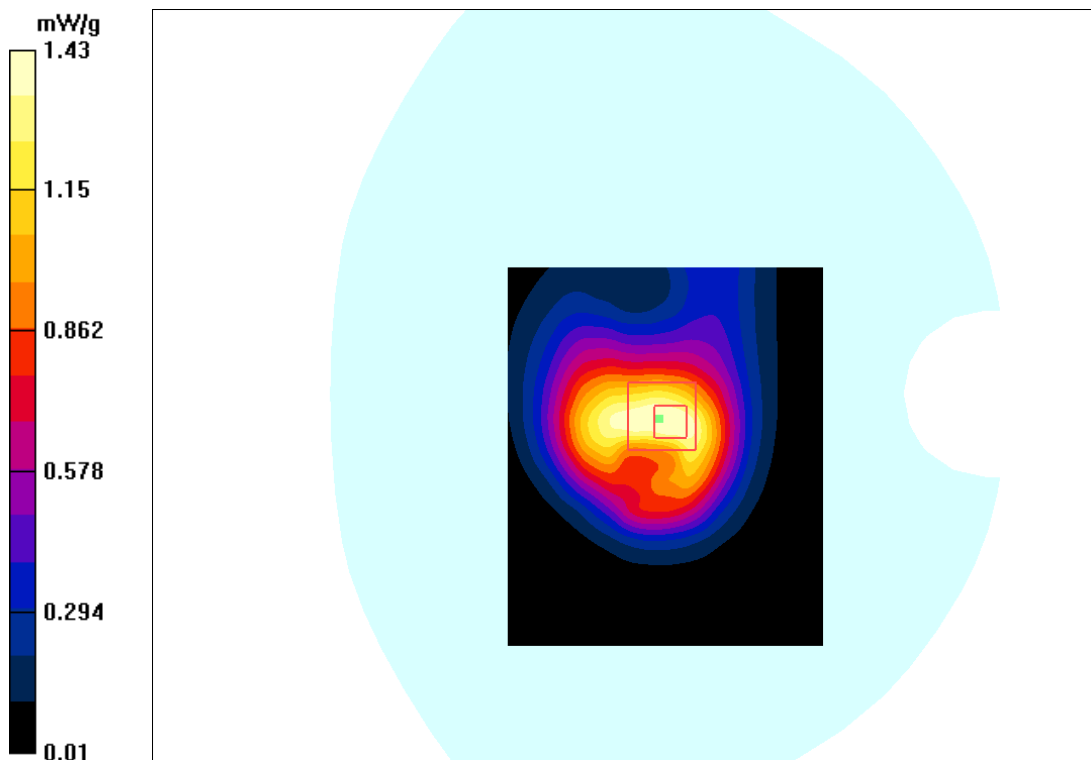

APPENDIX A MEASUREMENT UNCERTAINTY

The uncertainty budget has been determined for the DASY4 measurement system and is given in the following Table.

DASY4 Uncertainty Budget According to IEEE 1528								
Error Description	Uncertainty Value	Prob. Dist.	Div.	(c i) 1g	(c i) 10g	Std. Unc. (1g)	Std. Unc. (10g)	(v i) v _{eff}
Measurement System								
Probe Calibration	± 6.0 %	N	1	1	1	± 6.0 %	± 6.0 %	∞
Axial Isotropy	± 4.7 %	R	$\sqrt{3}$	0.7	0.7	± 1.9 %	± 1.9 %	∞
Hemispherical Isotropy	± 9.6 %	R	$\sqrt{3}$	0.7	0.7	± 3.9 %	± 3.9 %	∞
Boundary Effects	± 1.0 %	R	$\sqrt{3}$	1	1	± 0.6 %	± 0.6 %	∞
Linearity	± 4.7 %	R	$\sqrt{3}$	1	1	± 2.7 %	± 2.7 %	∞
System Detection Limits	± 1.0 %	R	$\sqrt{3}$	1	1	± 0.6 %	± 0.6 %	∞
Readout Electronics	± 0.3 %	N	1	1	1	± 0.3 %	± 0.3 %	∞
Response Time	± 0.8 %	R	$\sqrt{3}$	1	1	± 0.5 %	± 0.5 %	∞
Integration Time	± 2.6 %	R	$\sqrt{3}$	1	1	± 1.5 %	± 1.5 %	∞
RF Ambient Noise	± 3.0 %	R	$\sqrt{3}$	1	1	± 1.7 %	± 1.7 %	∞
RF Ambient Conditions	± 3.0 %	R	$\sqrt{3}$	1	1	± 1.7 %	± 1.7 %	∞
Probe Positioner	± 0.4 %	R	$\sqrt{3}$	1	1	± 0.2 %	± 0.2 %	∞
Probe Positioning	± 2.9 %	R	$\sqrt{3}$	1	1	± 1.7 %	± 1.7 %	∞
Max. SAR Eval.	± 1.0 %	R	$\sqrt{3}$	1	1	± 0.6 %	± 0.6 %	∞
Test Sample Related								
Device Positioning	± 2.9 %	N	1	1	1	± 2.9 %	± 2.9 %	145
Device Holder	± 3.6 %	N	1	1	1	± 3.6 %	± 2.6 %	5
Power Drift	± 5.0 %	R		1	1	± 2.9 %	± 2.9 %	∞
Phantom and Setup								
Phantom Uncertainty	± 4.0 %	R	$\sqrt{3}$	1	1	± 2.3 %	± 2.3 %	∞
Liquid Conductivity (Target)	± 5.0 %	R	$\sqrt{3}$	0.64	0.43	± 1.8 %	± 1.2 %	∞
Liquid Conductivity (meas.)	± 2.5 %	N	1	0.64	0.43	± 1.6 %	± 1.1 %	∞
Liquid Permittivity (Target)	± 5.0 %	R	$\sqrt{3}$	0.6	0.49	± 1.7 %	± 1.4 %	∞
Liquid Permittivity (Target)	± 2.5 %	N	1	0.6	0.49	± 1.5 %	± 1.0 %	∞
Combined Std. Uncertainty	-	-	-	-	-	± 10.7 %	± 10.4 %	330
Expanded STD Uncertainty	-	-	-	-	-	± 21.4 %	± 20.8 %	-

DASY4 Uncertainty Budget According to IEC 62209-2								
Error Description	Uncertainty Value	Prob. Dist.	Div.	(c i) 1g	(c i) 10g	Std. Unc. (1g)	Std. Unc. (10g)	(v i) v _{eff}
Measurement System								
Probe Calibration	± 6.0 %	N	1	1	1	± 6.0 %	± 6.0 %	∞
Axial Isotropy	± 4.7 %	R	$\sqrt{3}$	0.7	0.7	± 1.9 %	± 1.9 %	∞
Boundary Effects	± 1.0 %	R	$\sqrt{3}$	1	1	± 0.6 %	± 0.6 %	∞
Linearity	± 4.7 %	R	$\sqrt{3}$	1	1	± 2.7 %	± 2.7 %	∞
System Detection Limits	± 1.0 %	R	$\sqrt{3}$	1	1	± 0.6 %	± 0.6 %	∞
Readout Electronics	± 0.3 %	N	1	1	1	± 0.3 %	± 0.3 %	∞
Response Time	± 0.8 %	R	$\sqrt{3}$	1	1	± 0.5 %	± 0.5 %	∞
Integration Time	± 2.6 %	R	$\sqrt{3}$	1	1	± 1.5 %	± 1.5 %	∞
RF Ambient Noise	± 3.0 %	R	$\sqrt{3}$	1	1	± 1.7 %	± 1.7 %	∞
RF Ambient Conditions	± 3.0 %	R	$\sqrt{3}$	1	1	± 1.7 %	± 1.7 %	∞
Probe Positioner	± 0.4 %	R	$\sqrt{3}$	1	1	± 0.2 %	± 0.2 %	∞
Probe Positioning	± 2.9 %	R	$\sqrt{3}$	1	1	± 1.7 %	± 1.7 %	∞
Max. SAR Eval.	± 1.0 %	R	$\sqrt{3}$	1	1	± 0.6 %	± 0.6 %	∞
Test Sample Related								
Device Positioning	± 2.9 %	N	1	1	1	± 2.9 %	± 2.9 %	145
Device Holder	± 3.6 %	N	1	1	1	± 3.6 %	± 2.6 %	5
Power Drift	± 5.0 %	R		1	1	± 2.9 %	± 2.9 %	∞
Phantom and Setup								
Phantom Uncertainty	± 4.0 %	R	$\sqrt{3}$	1	1	± 2.3 %	± 2.3 %	∞
Liquid Conductivity (Target)	± 5.0 %	R	$\sqrt{3}$	0.64	0.43	± 1.8 %	± 1.2 %	∞
Liquid Conductivity (meas.)	± 2.5 %	N	1	0.64	0.43	± 1.6 %	± 1.1 %	∞
Liquid Permittivity (Target)	± 5.0 %	R	$\sqrt{3}$	0.6	0.49	± 1.7 %	± 1.4 %	∞
Liquid Permittivity (meas.)	± 2.5 %	N	1	0.6	0.49	± 1.5 %	± 1.0 %	∞
Combined Std. Uncertainty	-	-	-	-	-	± 10.7 %	± 10.4 %	330
Expanded STD Uncertainty	-	-	-	-	-	± 21.4 %	± 20.8 %	-

APPENDIX B PROBE CALIBRATION CERTIFICATES

**Calibration Laboratory of
Schmid & Partner
Engineering AG**
Zeughausstrasse 43, 8004 Zurich, Switzerland



S Schweizerischer Kalibrierdienst
C Service suisse d'étalonnage
S Servizio svizzero di taratura
S Swiss Calibration Service

Accredited by the Swiss Accreditation Service (SAS)
The Swiss Accreditation Service is one of the signatories to the EA
Multilateral Agreement for the recognition of calibration certificates

Accreditation No.: **SCS 0108**

Client **BACL**

Certificate No: **ES3-3036_Aug15**

CALIBRATION CERTIFICATE

Object **ES3DV3 - SN:3036**

Calibration procedure(s) **QA CAL-01.v9, QA CAL-12.v9, QA CAL-14.v4, QA CAL-23.v5,
QA CAL-25.v6
Calibration procedure for dosimetric E-field probes**

Calibration date: **August 20, 2015**

This calibration certificate documents the traceability to national standards, which realize the physical units of measurements (SI).
The measurements and the uncertainties with confidence probability are given on the following pages and are part of the certificate.

All calibrations have been conducted in the closed laboratory facility: environment temperature (22 ± 3)°C and humidity < 70%.

Calibration Equipment used (M&TE critical for calibration)

Primary Standards	ID	Cal Date (Certificate No.)	Scheduled Calibration
Power meter E4419B	GB41293874	01-Apr-15 (No. 217-02128)	Mar-16
Power sensor E4412A	MY41498087	01-Apr-15 (No. 217-02128)	Mar-16
Reference 3 dB Attenuator	SN: S5054 (3c)	01-Apr-15 (No. 217-02129)	Mar-16
Reference 20 dB Attenuator	SN: S5277 (20x)	01-Apr-15 (No. 217-02132)	Mar-16
Reference 30 dB Attenuator	SN: S5129 (30b)	01-Apr-15 (No. 217-02133)	Mar-16
Reference Probe ES3DV2	SN: 3013	30-Dec-14 (No. ES3-3013_Dec14)	Dec-15
DAE4	SN: 660	14-Jan-15 (No. DAE4-660_Jan15)	Jan-16
Secondary Standards	ID	Check Date (in house)	Scheduled Check
RF generator HP 8648C	US3642U01700	4-Aug-99 (in house check Apr-13)	In house check: Apr-16
Network Analyzer HP 8753E	US37390585	18-Oct-01 (in house check Oct-14)	In house check: Oct-15

	Name	Function	Signature
Calibrated by:	Jeton Kastrati	Laboratory Technician	
Approved by:	Katja Pokovic	Technical Manager	

Issued: August 20, 2015

This calibration certificate shall not be reproduced except in full without written approval of the laboratory.

**Calibration Laboratory of
Schmid & Partner
Engineering AG**
Zeughausstrasse 43, 8004 Zurich, Switzerland



S Schweizerischer Kalibrierdienst
S Service suisse d'étalonnage
S Servizio svizzero di taratura
S Swiss Calibration Service

Accredited by the Swiss Accreditation Service (SAS)
The Swiss Accreditation Service is one of the signatories to the EA
Multilateral Agreement for the recognition of calibration certificates

Accreditation No.: **SCS 0108**

Glossary:

TSL	tissue simulating liquid
NORM _{x,y,z}	sensitivity in free space
ConvF	sensitivity in TSL / NORM _{x,y,z}
DCP	diode compression point
CF	crest factor (1/duty_cycle) of the RF signal
A, B, C, D	modulation dependent linearization parameters
Polarization φ	φ rotation around probe axis
Polarization θ	θ rotation around an axis that is in the plane normal to probe axis (at measurement center), i.e., θ = 0 is normal to probe axis
Connector Angle	information used in DASY system to align probe sensor X to the robot coordinate system

Calibration is Performed According to the Following Standards:

- a) IEEE Std 1528-2013, "IEEE Recommended Practice for Determining the Peak Spatial-Averaged Specific Absorption Rate (SAR) in the Human Head from Wireless Communications Devices: Measurement Techniques", June 2013
- b) IEC 62209-1, "Procedure to measure the Specific Absorption Rate (SAR) for hand-held devices used in close proximity to the ear (frequency range of 300 MHz to 3 GHz)", February 2005
- c) IEC 62209-2, "Procedure to determine the Specific Absorption Rate (SAR) for wireless communication devices used in close proximity to the human body (frequency range of 30 MHz to 6 GHz)", March 2010
- d) KDB 865664, "SAR Measurement Requirements for 100 MHz to 6 GHz"

Methods Applied and Interpretation of Parameters:

- *NORM_{x,y,z}*: Assessed for E-field polarization θ = 0 (f ≤ 900 MHz in TEM-cell; f > 1800 MHz: R22 waveguide). *NORM_{x,y,z}* are only intermediate values, i.e., the uncertainties of *NORM_{x,y,z}* does not affect the E²-field uncertainty inside TSL (see below *ConvF*).
- *NORM(f)_{x,y,z} = NORM_{x,y,z} * frequency_response* (see Frequency Response Chart). This linearization is implemented in DASY4 software versions later than 4.2. The uncertainty of the frequency response is included in the stated uncertainty of *ConvF*.
- *DCP_{x,y,z}*: DCP are numerical linearization parameters assessed based on the data of power sweep with CW signal (no uncertainty required). DCP does not depend on frequency nor media.
- *PAR*: PAR is the Peak to Average Ratio that is not calibrated but determined based on the signal characteristics
- *A_{x,y,z}; B_{x,y,z}; C_{x,y,z}; D_{x,y,z}; VR_{x,y,z}*: A, B, C, D are numerical linearization parameters assessed based on the data of power sweep for specific modulation signal. The parameters do not depend on frequency nor media. VR is the maximum calibration range expressed in RMS voltage across the diode.
- *ConvF and Boundary Effect Parameters*: Assessed in flat phantom using E-field (or Temperature Transfer Standard for f ≤ 800 MHz) and inside waveguide using analytical field distributions based on power measurements for f > 800 MHz. The same setups are used for assessment of the parameters applied for boundary compensation (alpha, depth) of which typical uncertainty values are given. These parameters are used in DASY4 software to improve probe accuracy close to the boundary. The sensitivity in TSL corresponds to *NORM_{x,y,z} * ConvF* whereby the uncertainty corresponds to that given for *ConvF*. A frequency dependent *ConvF* is used in DASY version 4.4 and higher which allows extending the validity from ± 50 MHz to ± 100 MHz.
- *Spherical isotropy (3D deviation from isotropy)*: in a field of low gradients realized using a flat phantom exposed by a patch antenna.
- *Sensor Offset*: The sensor offset corresponds to the offset of virtual measurement center from the probe tip (on probe axis). No tolerance required.
- *Connector Angle*: The angle is assessed using the information gained by determining the *NORM_x* (no uncertainty required).

ES3DV3 – SN:3036

August 20, 2015

Probe ES3DV3

SN:3036

Manufactured: August 21, 2003
Calibrated: August 20, 2015

Calibrated for DASY/EASY Systems
(Note: non-compatible with DASY2 system!)

ES3DV3- SN:3036

August 20, 2015

DASY/EASY - Parameters of Probe: ES3DV3 - SN:3036

Basic Calibration Parameters

	Sensor X	Sensor Y	Sensor Z	Unc (k=2)
Norm ($\mu\text{V}/(\text{V}/\text{m})^2$) ^A	1.22	1.34	1.49	$\pm 10.1\%$
DCP (mV) ^B	102.6	104.5	104.8	

Modulation Calibration Parameters

UID	Communication System Name		A dB	B dB/ μV	C	D dB	VR mV	Unc ^E (k=2)
0	CW	X	0.0	0.0	1.0	0.00	207.4	$\pm 3.5\%$
		Y	0.0	0.0	1.0		222.8	
		Z	0.0	0.0	1.0		226.3	

The reported uncertainty of measurement is stated as the standard uncertainty of measurement multiplied by the coverage factor k=2, which for a normal distribution corresponds to a coverage probability of approximately 95%.

^A The uncertainties of Norm X,Y,Z do not affect the E²-field uncertainty inside TSL (see Pages 5 and 6).

^B Numerical linearization parameter: uncertainty not required.

^E Uncertainty is determined using the max. deviation from linear response applying rectangular distribution and is expressed for the square of the field value.

ES3DV3- SN:3036

August 20, 2015

DASY/EASY - Parameters of Probe: ES3DV3 - SN:3036

Calibration Parameter Determined in Head Tissue Simulating Media

f (MHz) ^C	Relative Permittivity ^F	Conductivity (S/m) ^F	ConvF X	ConvF Y	ConvF Z	Alpha ^G	Depth (mm) ^G	Unc (k=2)
150	52.3	0.76	7.06	7.06	7.06	0.05	1.20	± 13.3 %
450	43.5	0.87	6.58	6.58	6.58	0.19	1.90	± 13.3 %
750	41.9	0.89	6.13	6.13	6.13	0.25	2.28	± 12.0 %
835	41.5	0.90	5.96	5.96	5.96	0.31	1.86	± 12.0 %
1750	40.1	1.37	5.10	5.10	5.10	0.58	1.37	± 12.0 %
1900	40.0	1.40	4.90	4.90	4.90	0.71	1.22	± 12.0 %
2450	39.2	1.80	4.34	4.34	4.34	0.59	1.44	± 12.0 %
3700	37.7	3.12	3.84	3.84	3.84	0.35	2.20	± 13.1 %

^C Frequency validity above 300 MHz of ± 100 MHz only applies for DASY v4.4 and higher (see Page 2), else it is restricted to ± 50 MHz. The uncertainty is the RSS of the ConvF uncertainty at calibration frequency and the uncertainty for the indicated frequency band. Frequency validity below 300 MHz is ± 10, 25, 40, 50 and 70 MHz for ConvF assessments at 30, 64, 128, 150 and 220 MHz respectively. Above 5 GHz frequency validity can be extended to ± 110 MHz.

^F At frequencies below 3 GHz, the validity of tissue parameters (ϵ and σ) can be relaxed to ± 10% if liquid compensation formula is applied to measured SAR values. At frequencies above 3 GHz, the validity of tissue parameters (ϵ and σ) is restricted to ± 5%. The uncertainty is the RSS of the ConvF uncertainty for indicated target tissue parameters.

^G Alpha/Depth are determined during calibration. SPEAG warrants that the remaining deviation due to the boundary effect after compensation is always less than ± 1% for frequencies below 3 GHz and below ± 2% for frequencies between 3-6 GHz at any distance larger than half the probe tip diameter from the boundary.

ES3DV3- SN:3036

August 20, 2015

DASY/EASY - Parameters of Probe: ES3DV3 - SN:3036

Calibration Parameter Determined in Body Tissue Simulating Media

f (MHz) ^C	Relative Permittivity ^F	Conductivity (S/m) ^F	ConvF X	ConvF Y	ConvF Z	Alpha ^G	Depth (mm) ^G	Unc (k=2)
150	61.9	0.80	6.82	6.82	6.82	0.08	1.20	± 13.3 %
450	56.7	0.94	6.69	6.69	6.69	0.14	1.20	± 13.3 %
750	55.5	0.96	6.10	6.10	6.10	0.40	1.64	± 12.0 %
835	55.2	0.97	6.00	6.00	6.00	0.49	1.55	± 12.0 %
1750	53.4	1.49	4.75	4.75	4.75	0.51	1.48	± 12.0 %
1900	53.3	1.52	4.56	4.56	4.56	0.48	1.60	± 12.0 %
2450	52.7	1.95	4.19	4.19	4.19	0.80	1.09	± 12.0 %
3700	51.0	3.55	3.58	3.58	3.58	0.50	2.12	± 13.1 %

^C Frequency validity above 300 MHz of ± 100 MHz only applies for DASY v4.4 and higher (see Page 2), else it is restricted to ± 50 MHz. The uncertainty is the RSS of the ConvF uncertainty at calibration frequency and the uncertainty for the indicated frequency band. Frequency validity below 300 MHz is ± 10, 25, 40, 50 and 70 MHz for ConvF assessments at 30, 64, 128, 150 and 220 MHz respectively. Above 5 GHz frequency validity can be extended to ± 110 MHz.

^F At frequencies below 3 GHz, the validity of tissue parameters (ϵ and σ) can be relaxed to ± 10% if liquid compensation formula is applied to measured SAR values. At frequencies above 3 GHz, the validity of tissue parameters (ϵ and σ) is restricted to ± 5%. The uncertainty is the RSS of the ConvF uncertainty for indicated target tissue parameters.

^G Alpha/Depth are determined during calibration. SPEAG warrants that the remaining deviation due to the boundary effect after compensation is always less than ± 1% for frequencies below 3 GHz and below ± 2% for frequencies between 3-6 GHz at any distance larger than half the probe tip diameter from the boundary.

ES3DV3- SN:3036

August 20, 2015

Frequency Response of E-Field (TEM-Cell:ifi110 EXX, Waveguide: R22)

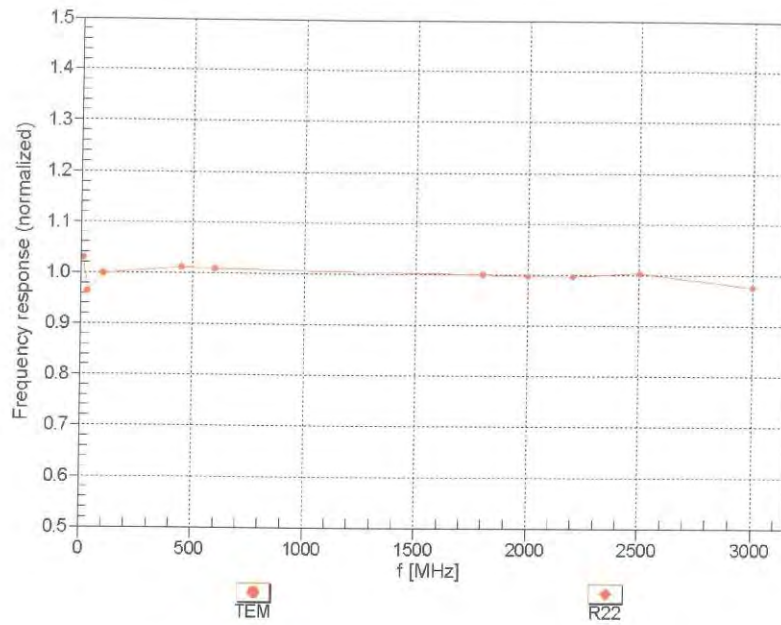

Uncertainty of Frequency Response of E-field: $\pm 6.3\%$ (k=2)

ES3DV3- SN:3036

August 20, 2015

Receiving Pattern (ϕ), $\theta = 0^\circ$

f=600 MHz,TEM

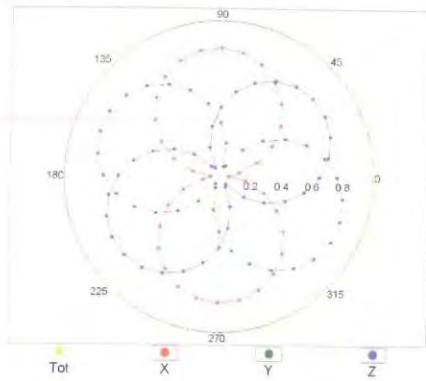

f=1800 MHz,R22

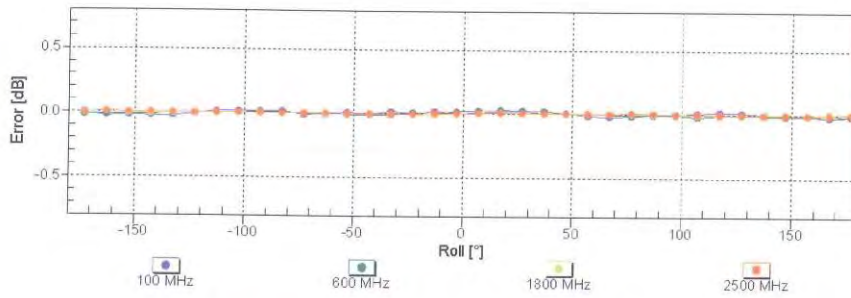
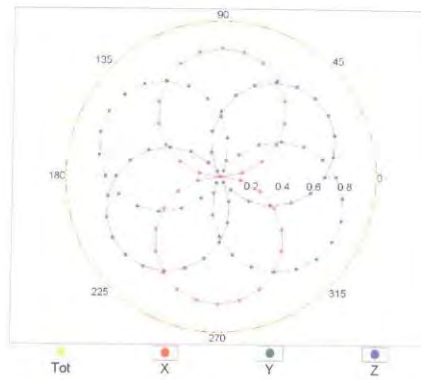

Uncertainty of Axial Isotropy Assessment: $\pm 0.5\%$ (k=2)

ES3DV3- SN:3036

August 20, 2015

Dynamic Range $f(SAR_{head})$ (TEM cell, $f_{eval}=1900$ MHz)

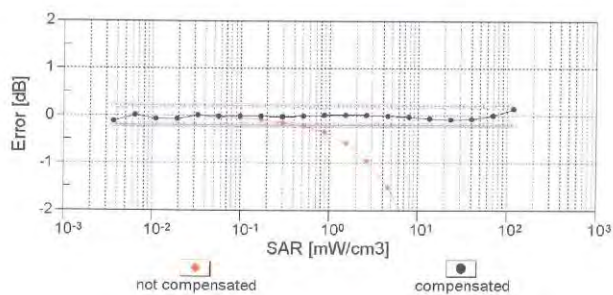
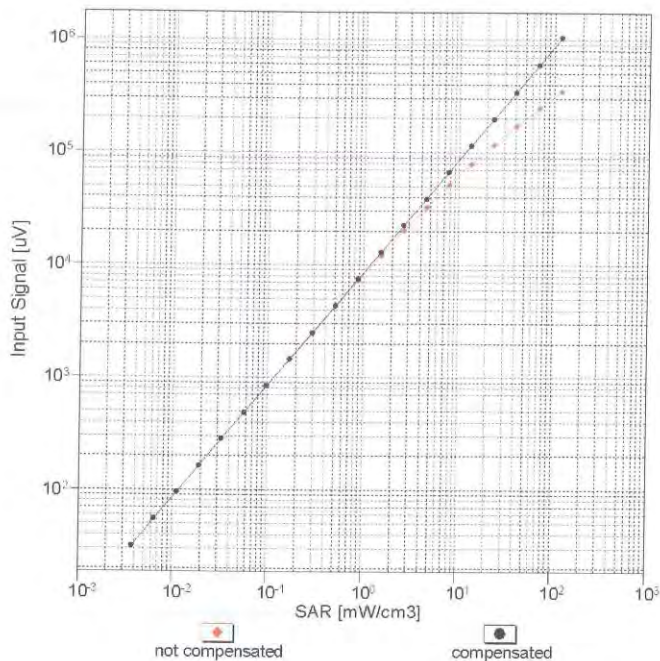

Uncertainty of Linearity Assessment: $\pm 0.6\%$ ($k=2$)

ES3DV3- SN:3036

August 20, 2015

Conversion Factor Assessment

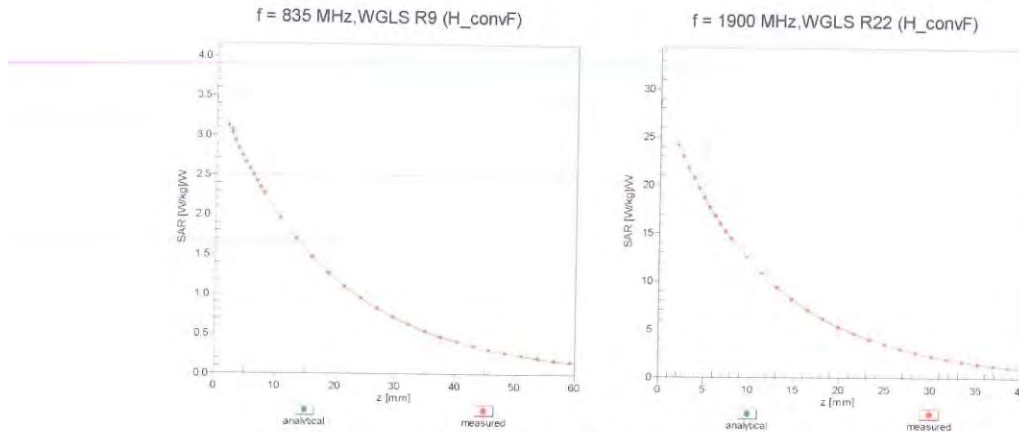

Deviation from Isotropy in Liquid Error (ϕ, θ), f = 900 MHz

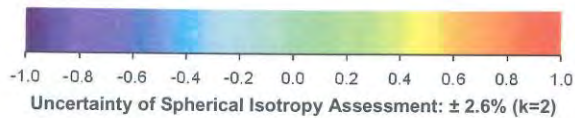
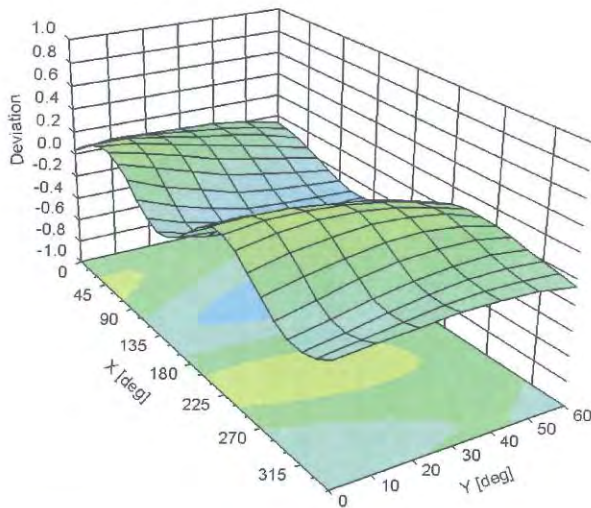

ES3DV3-SN:3036

August 20, 2015

DASY/EASY - Parameters of Probe: ES3DV3 - SN:3036

Other Probe Parameters

Sensor Arrangement	Triangular
Connector Angle (°)	17.1
Mechanical Surface Detection Mode	enabled
Optical Surface Detection Mode	disabled
Probe Overall Length	337 mm
Probe Body Diameter	10 mm
Tip Length	10 mm
Tip Diameter	4 mm
Probe Tip to Sensor X Calibration Point	2 mm
Probe Tip to Sensor Y Calibration Point	2 mm
Probe Tip to Sensor Z Calibration Point	2 mm
Recommended Measurement Distance from Surface	3 mm

APPENDIX C DIPOLE CALIBRATION CERTIFICATES

NCL CALIBRATION LABORATORIES

Calibration File No: DC-1599
Project Number: BAC-dipole-cal-5779

CERTIFICATE OF CALIBRATION

It is certified that the equipment identified below has been calibrated in the
NCL CALIBRATION LABORATORIES by qualified personnel following recognized
procedures and using transfer standards traceable to NRC/NIST.

Validation Dipole(Head and Body)

Manufacturer: APREL Laboratories

Part number: ALS-D-835-S-2

Frequency: 835 MHz

Serial No: 180-00558

Customer: Bay Area Compliance Laboratory (China)

Calibrated: 8th October 2014
Released on: 8th October 2014

This Calibration Certificate is Incomplete Unless Accompanied with the Calibration Results Summary

Released By: _____



Art Brennan, Quality Manager

NCL CALIBRATION LABORATORIES

Suite 102, 303 Terry Fox Dr.
Kanata, ONTARIO
CANADA K2K 3J1

Division of APREL Lab.
TEL: (613) 435-8300
FAX: (613)435-8306

NCL Calibration Laboratories

Division of APREL Laboratories.

Conditions

Dipole 180-00558 was received with a damaged connection for a re-calibration.

Ambient Temperature of the Laboratory: 22 °C +/- 0.5°C

Temperature of the Tissue: 21 °C +/- 0.5°C

Attestation

The below named signatories have conducted the calibration and review of the data which is presented in this calibration report.

We the undersigned attest that to the best of our knowledge the calibration of this subject has been accurately conducted and that all information contained within the results pages have been reviewed for accuracy.



Art Brennan, Quality Manager



Maryna Nesterova Calibration Engineer

Primary Measurement Standards

Instrument	Serial Number	Cal due date
Tektronix USB Power Meter	11C940	May 14, 2015
Network Analyzer Anritsu 37347C	002106	Feb. 20, 2015

This page has been reviewed for content and attested to by signature within this document.

NCL Calibration Laboratories

Division of APREL Laboratories.

Calibration Results Summary

The following results relate the Calibrated Dipole and should be used as a quick reference for the user.

Mechanical Dimensions

Length: 162.2 mm
 Height: 89.4 mm

Electrical Specification

Tissue	Frequency	SWR:	Return Loss	Impedance
Head	835 MHz	1.066 U	-30.344 dB	49.001 Ω
Body	835 MHz	1.089 U	-28.118 dB	53.117 Ω

System Validation Results

Tissue	Frequency	1 Gram	10 Gram	Peak
Head	835 MHz	9.773	6.174	14.713
Body	835 MHz	9.736	6.297	14.513

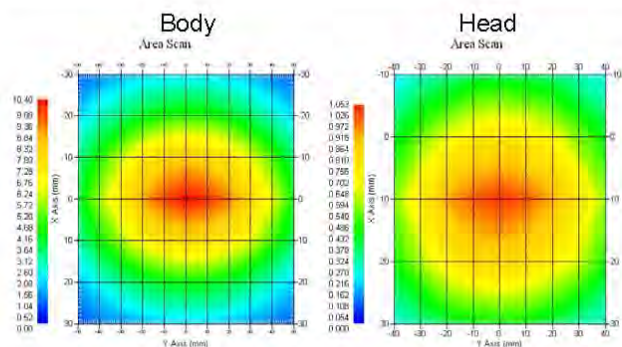

This page has been reviewed for content and attested to by signature within this document.

NCL Calibration Laboratories

Division of APREL Laboratories.

Introduction

This Calibration Report has been produced in line with the SSI Dipole Calibration Procedure SSI-TP-018-ALSAS. The results contained within this report are for Validation Dipole 180-00558. The calibration routine consisted of a three-step process. Step 1 was a mechanical verification of the dipole to ensure that it meets the mechanical specifications. Step 2 was an Electrical Calibration for the Validation Dipole, where the SWR, Impedance, and the Return loss were assessed. Step 3 involved a System Validation using the ALSAS-10U, along with APREL E-020 30 MHz to 6 GHz E-Field Probe Serial Number 225.

References

- IEC-62209 "Human exposure to radio frequency fields from hand-held and body-mounted wireless communication devices – Human models, instrumentation, and procedures"
- Part 2: "Procedure to determine the Specific Absorption Rate (SAR) for hand-held devices used in close proximity of the ear (frequency range of 30 MHz to 6 GHz)"
- TP-D01-032-E020-V2 E-Field probe calibration procedure
- D22-012-Tissue dielectric tissue calibration procedure
- D28-002-Dipole procedure for validation of SAR system using a dipole
- IEEE 1309 Draft Standard for Calibration of Electromagnetic Field Sensors and Probes, Excluding Antennas, from 9kHz to 40GHz

Conditions

Dipole 180-00558 was repaired prior to this calibration. The repair reliability depends upon correct usage of the dipole.

Ambient Temperature of the Laboratory: 22 °C +/- 0.5°C
Temperature of the Tissue: 20 °C +/- 0.5°C

Dipole Calibration uncertainty

The calibration uncertainty for the dipole is made up of various parameters presented below.

Mechanical	1%
Positioning Error	1.22%
Electrical	1.7%
Tissue	2.2%
Dipole Validation	2.2%
TOTAL	8.32% (16.64% K=2)

This page has been reviewed for content and attested to by signature within this document.

NCL Calibration Laboratories

Division of APREL Laboratories.

Dipole Calibration Results

Mechanical Verification

APREL Length	APREL Height	Measured Length	Measured Height
161.0 mm	89.8 mm	162.2 mm	89.4 mm

Electrical Verification

Tissue Type	Return Loss:	SWR:	Impedance:
Head	-30.344 dB	1.066 U	49.001 Ω
Body	-28.118 dB	1.089 U	53.117 Ω □

Tissue Validation

	Dielectric constant, ε _r	Conductivity, σ [S/m]
Head Tissue 835MHz	43.42	0.94
Body Tissue 835MHz	55.77	1.01

This page has been reviewed for content and attested to by signature within this document.

NCL Calibration Laboratories

Division of APREL Laboratories.

The Following Graphs are the results as displayed on the Vector Network Analyzer.

S11 Parameter Return Loss

Head Tissue: Frequency Range 0.817 to 0.848 GHz

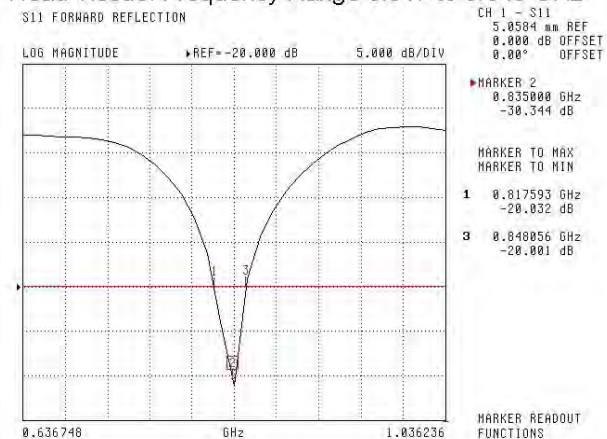

Body Tissue: Frequency Range 0.823 to 0.851 GHz

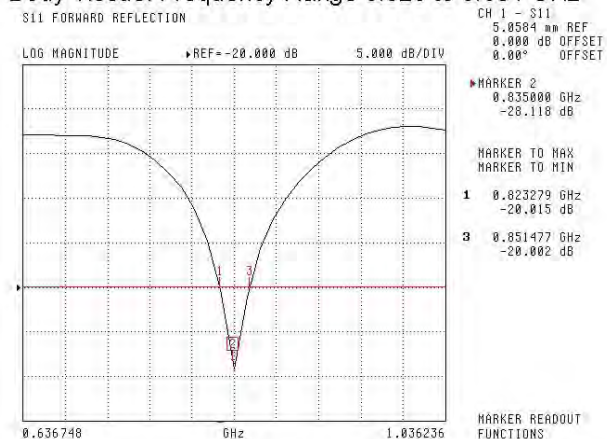

This page has been reviewed for content and attested to by signature within this document.

NCL Calibration Laboratories

Division of APREL Laboratories.

SWR
Head

S11 FORWARD REFLECTION

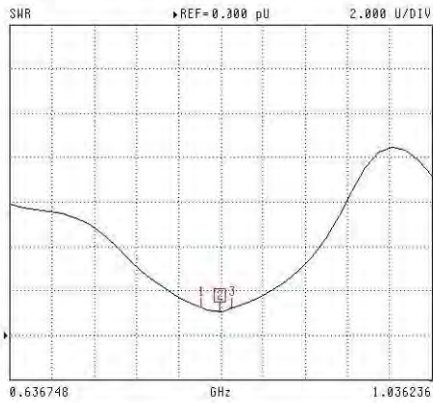

CH 1 - S11
5.0584 mm REF
0.000 dB OFFSET
0.00° OFFSET

MARKER 2
0.835000 GHz
1.066 U

MARKER TO MAX
MARKER TO MIN

- 1 0.817593 GHz
1.251 U
- 3 0.848056 GHz
1.235 U

MARKER READOUT
FUNCTIONS

Body

S11 FORWARD REFLECTION

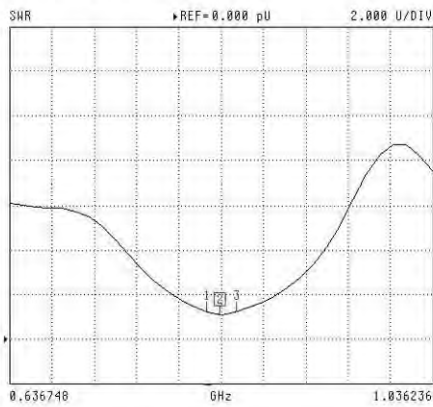

CH 1 - S11
5.0584 mm REF
0.000 dB OFFSET
0.00° OFFSET

MARKER 2
0.835000 GHz
1.089 U

MARKER TO MAX
MARKER TO MIN

- 1 0.823279 GHz
1.226 U
- 3 0.851477 GHz
1.234 U

MARKER READOUT
FUNCTIONS

This page has been reviewed for content and attested to by signature within this document.

NCL Calibration Laboratories

Division of APREL Laboratories.

Smith Chart Dipole Impedance

Head

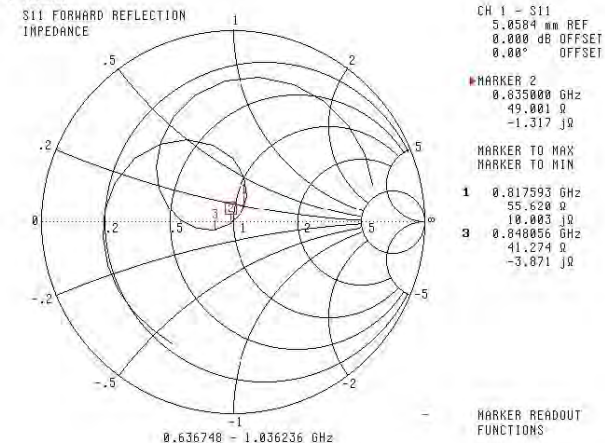

Body

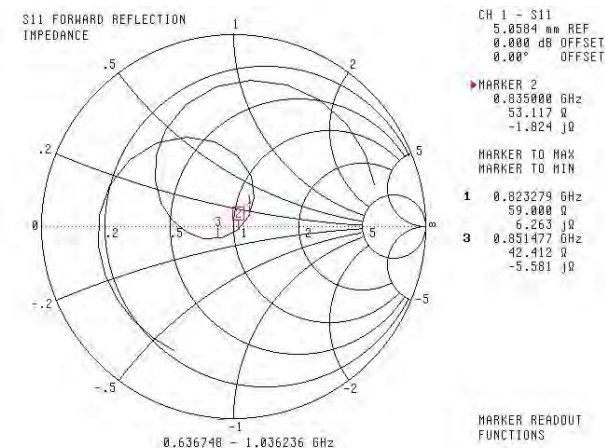

This page has been reviewed for content and attested to by signature within this document.

NCL Calibration Laboratories

Division of APREL Laboratories.

Test Equipment

The test equipment used during Probe Calibration, manufacturer, model number and, current calibration status are listed and located on the main APREL server R:\NCL\Calibration Equipment\Instrument List 2014.

This page has been reviewed for content and attested to by signature within this document.

9

NCL CALIBRATION LABORATORIES

Calibration File No: DC-1601
Project Number: BAC-dipole -cal-5779

CERTIFICATE OF CALIBRATION

It is certified that the equipment identified below has been calibrated in the
NCL CALIBRATION LABORATORIES by qualified personnel following recognized
procedures and using transfer standards traceable to NRC/NIST.

Validation Dipole (Head & Body)

Manufacturer: APREL Laboratories
Part number: ALS-D-1900-S-2
Frequency: 1900 MHz
Serial No: 210-00710

Customer: Bay Area Compliance Laboratory (China)

Calibrated: 9th October, 2014
Released on: 9th October, 2014

This Calibration Certificate is Incomplete Unless Accompanied with the Calibration Results Summary

Released By: 
Art Brennan, Quality Manager

NCL CALIBRATION LABORATORIES

Suite 102, 303 Terry Fox Dr.
Kanata, ONTARIO
CANADA K2K 3J1

Division of APREL Lab.
TEL: (613) 435-8300
FAX: (613)435-8306

NCL Calibration Laboratories

Division of APREL Laboratories.

Conditions

Dipole 210-00710 was received in good condition and was a re-calibration.

Ambient Temperature of the Laboratory: 22 °C +/- 0.5°C

Temperature of the Tissue: 21 °C +/- 0.5°C

Attestation

The below named signatories have conducted the calibration and review of the data which is presented in this calibration report.

We the undersigned attest that to the best of our knowledge the calibration of this subject has been accurately conducted and that all information contained within the results pages have been reviewed for accuracy.



Art Brennan, Quality Manager



Maryna Nesterova Calibration Engineer

Primary Measurement Standards

Instrument	Serial Number	Cal due date
Tektronix USB Power Meter	11C940	May 14, 2015
Network Analyzer Anritsu 37347C	002106	Feb. 20, 2015

This page has been reviewed for content and attested to by signature within this document.

NCL Calibration Laboratories

Division of APREL Laboratories.

Calibration Results Summary

The following results relate the Calibrated Dipole and should be used as a quick reference for the user.

Mechanical Dimensions

Length: 67.1 mm
Height: 38.9 mm

Electrical Specification

Tissue	Frequency	SWR:	Return Loss	Impedance
Head	1900MHz	1.084 U	-27.92 dB	52.247 Ω
Body	1900MHz	1.128 U	-24.40 dB	52.618 Ω

System Validation Results

Tissue	Frequency	1 Gram	10 Gram	Peak
Head	1900 MHz	39.481	20.44	73.364
Body	1900 MHz	39.715	20.552	73.565

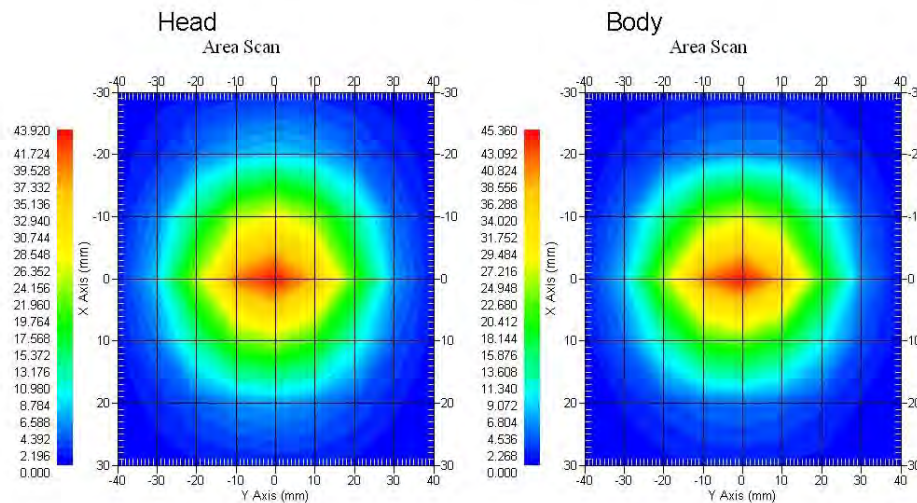

This page has been reviewed for content and attested to by signature within this document.

NCL Calibration Laboratories

Division of APREL Laboratories.

Introduction

This Calibration Report has been produced in line with the SSI Dipole Calibration Procedure SSI-TP-018-ALSAS. The results contained within this report are for Validation Dipole 210-00710. The calibration routine consisted of a three-step process. Step 1 was a mechanical verification of the dipole to ensure that it meets the mechanical specifications. Step 2 was an Electrical Calibration for the Validation Dipole, where the SWR, Impedance, and the Return loss were assessed. Step 3 involved a System Validation using the ALSAS-10U, along with APREL E-020 30 MHz to 6 GHz E-Field Probe Serial Number 225.

References

- IEC-62209 "Human exposure to radio frequency fields from hand-held and body-mounted wireless communication devices – Human models, instrumentation, and procedures"
- Part 2: "Procedure to determine the Specific Absorption Rate (SAR) for hand-held devices used in close proximity of the ear (frequency range of 30 MHz to 6 GHz)"
- TP-D01-032-E020-V2 E-Field probe calibration procedure
- D22-012-Tissue dielectric tissue calibration procedure
- D28-002-Dipole procedure for validation of SAR system using a dipole
- IEEE 1309 Draft Standard for Calibration of Electromagnetic Field Sensors and Probes, Excluding Antennas, from 9kHz to 40GHz

Conditions

Dipole 210-00710 was a recalibration.

Ambient Temperature of the Laboratory: 22 °C +/- 0.5°C

Temperature of the Tissue: 20 °C +/- 0.5°C

Dipole Calibration uncertainty

The calibration uncertainty for the dipole is made up of various parameters presented below.

Mechanical	1%
Positioning Error	1.22%
Electrical	1.7%
Tissue	2.2%
Dipole Validation	2.2%
TOTAL	8.32% (16.64% K=2)

This page has been reviewed for content and attested to by signature within this document.

4

NCL Calibration Laboratories

Division of APREL Laboratories.

Dipole Calibration Results

Mechanical Verification

APREL Length	APREL Height	Measured Length	Measured Height
68.0 mm	39.5 mm	67.1mm	38.9 mm

Electrical Validation

Tissue	Frequency	SWR:	Return Loss	Impedance
Head	1900MHz	1.084 U	-27.92 dB	52.247 Ω
Body	1900MHz	1.128 U	-24.40 dB	52.618 Ω

Tissue Validation

	Dielectric constant, ϵ_r	Conductivity, σ [S/m]
Head Tissue 1900MHz	40.20	1.38
Body Tissue 1900MHz	52.63	1.46

This page has been reviewed for content and attested to by signature within this document.

NCL Calibration Laboratories

Division of APREL Laboratories.

The Following Graphs are the results as displayed on the Vector Network Analyzer.

S11 Parameter Return Loss

Head: Frequency Range 1.865 to 1.937 GHz

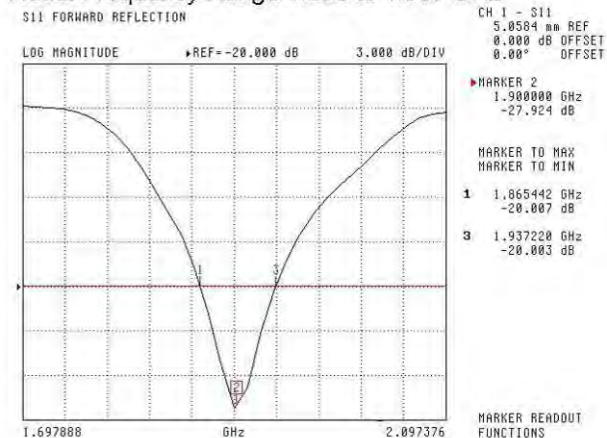

Body: Frequency Range 1.869 to 1.931 MHz

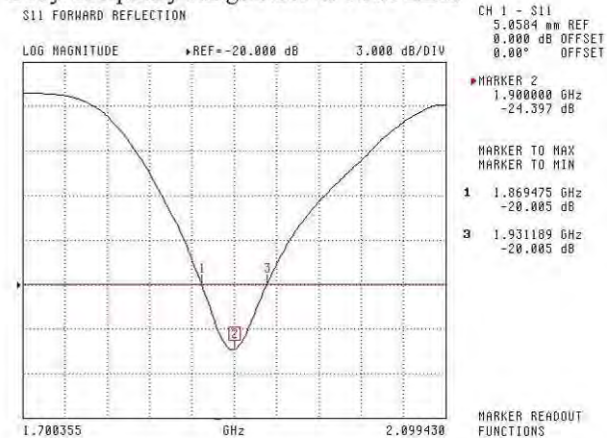

This page has been reviewed for content and attested to by signature within this document.

NCL Calibration Laboratories

Division of APREL Laboratories.

SWR

Head

S11 FORWARD REFLECTION

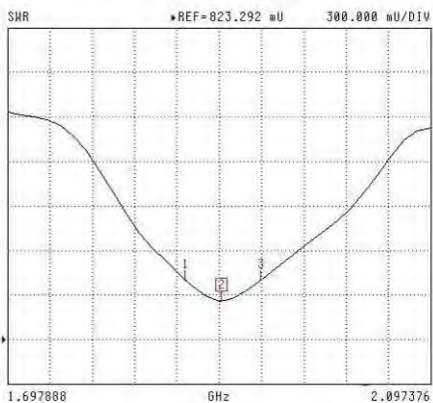

CH 1 - S11
5.0584 m REF
0.000 dB OFFSET
0.00° OFFSET

MARKER 2
1.900000 GHz
1.004 U

MARKER TO MAX
MARKER TO MIN

- 1 1.865442 GHz
1.226 U
- 3 1.937228 GHz
1.224 U

MARKER READOUT
FUNCTIONS

Body

S11 FORWARD REFLECTION

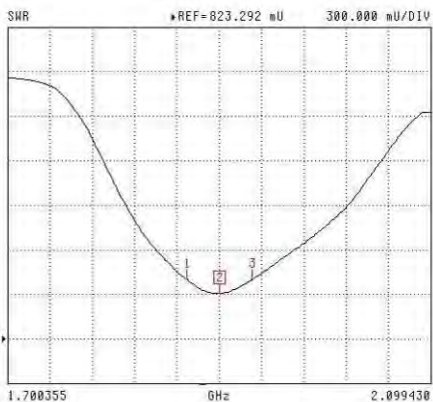

CH 1 - S11
5.0584 m REF
0.000 dB OFFSET
0.00° OFFSET

MARKER 2
1.900000 GHz
1.128 U

MARKER TO MAX
MARKER TO MIN

- 1 1.869475 GHz
1.223 U
- 3 1.931189 GHz
1.223 U

MARKER READOUT
FUNCTIONS

This page has been reviewed for content and attested to by signature within this document.

7

NCL Calibration Laboratories

Division of APREL Laboratories.

Smith Chart Dipole Impedance

Head

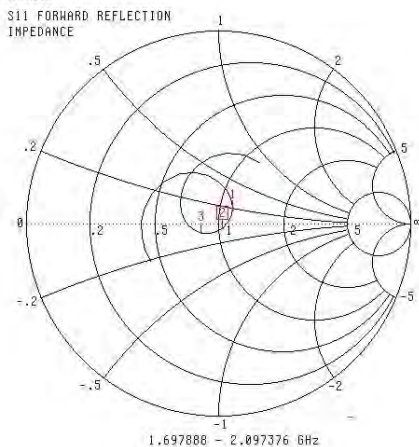

CH 1 - S11
5.0584 mm REF
0.000 dB OFFSET
0.00° OFFSET

MARKER 2
1.900000 GHz
52.247 Ω
-3.103 jΩ

MARKER TO MAX
MARKER TO MIN

1 1.865442 GHz
57.627 Ω
7.644 jΩ

3 1.937220 GHz
41.868 Ω
-4.273 jΩ

MARKER READOUT FUNCTIONS

Body

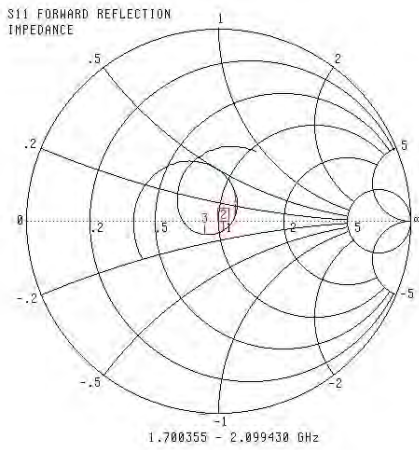

CH 1 - S11
5.0584 mm REF
0.000 dB OFFSET
0.00° OFFSET

MARKER 2
1.900000 GHz
52.618 Ω
-5.535 jΩ

MARKER TO MAX
MARKER TO MIN

1 1.869475 GHz
60.277 Ω
4.049 jΩ

3 1.931189 GHz
43.257 Ω
-6.479 jΩ

MARKER READOUT FUNCTIONS

This page has been reviewed for content and attested to by signature within this document.

NCL Calibration Laboratories

Division of APREL Laboratories.

Test Equipment

The test equipment used during Probe Calibration, manufacturer, model number and, current calibration status are listed and located on the main APREL server R:\NCL\Calibration Equipment\Instrument List 2014

This page has been reviewed for content and attested to by signature within this document.

9

APPENDIX D EUT TEST POSITION PHOTOS

Liquid depth ≥ 15 cm

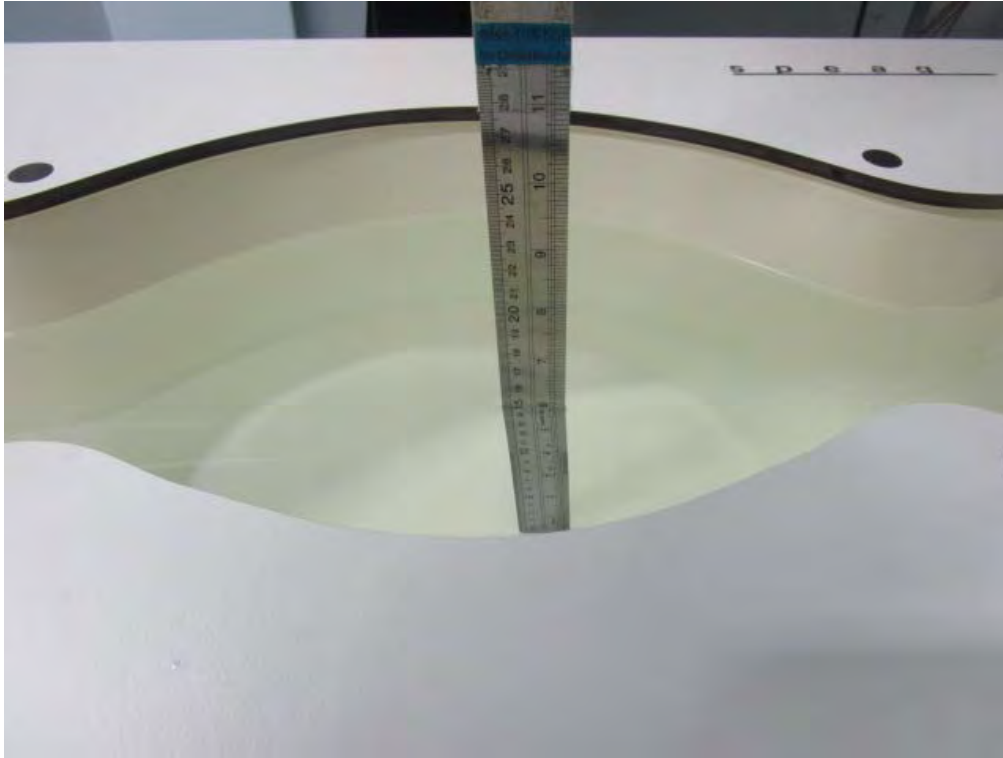

Left Head Touch Setup Photo



Left Head Tilt Setup Photo



Right Head Touch Setup Photo

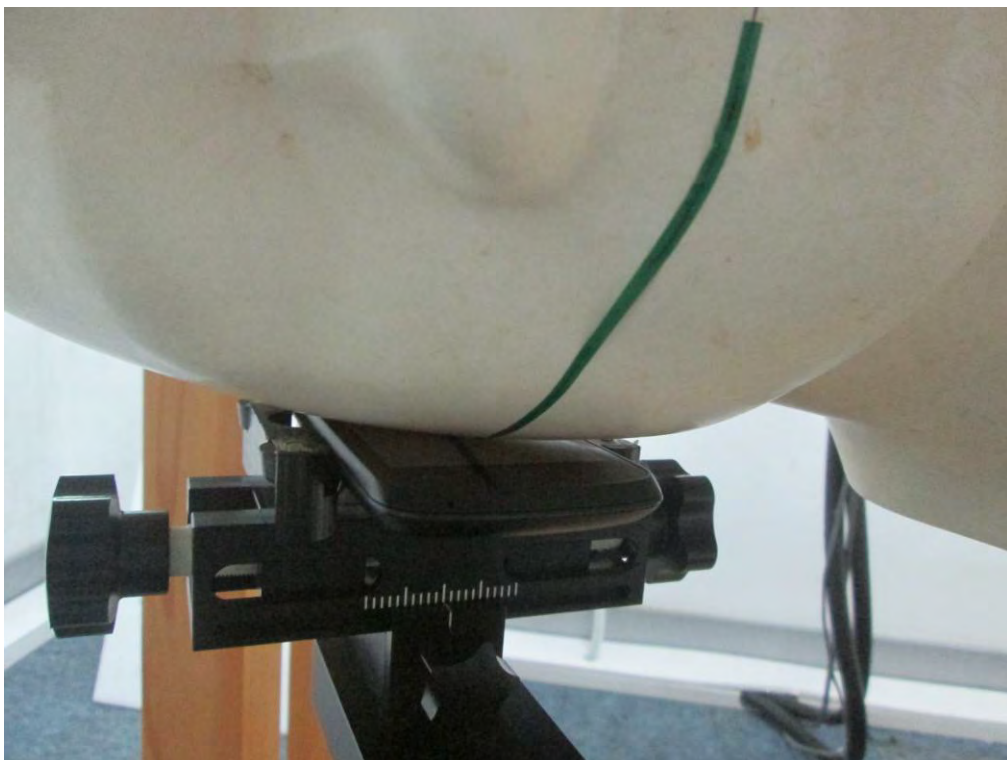

Right Head Tilt Setup Photo



Body-worn-headset Back Setup Photo

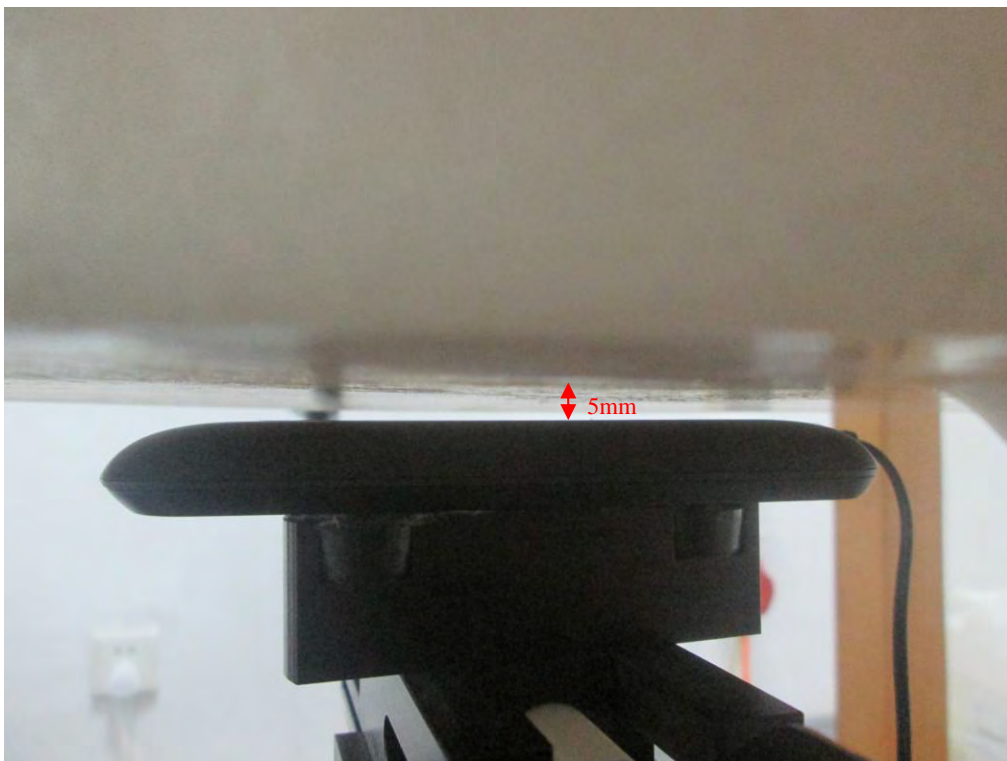

Body-worn Back Setup Photo

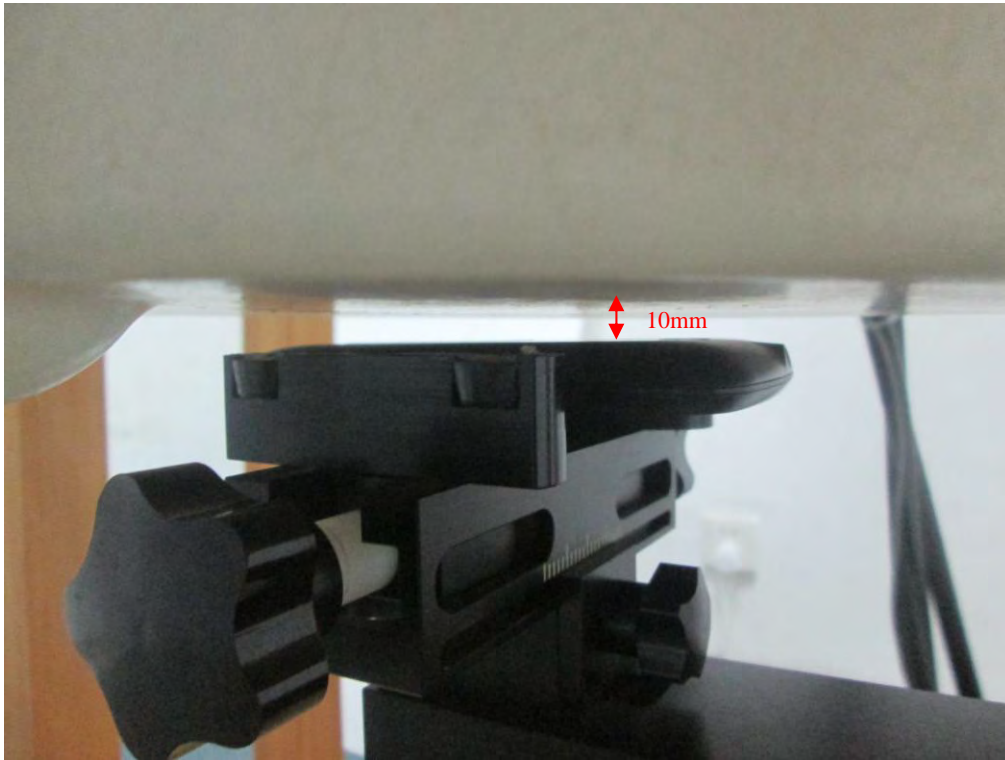

Body-worn Left Setup Photo



Body-worn Right Setup Photo



Body-worn Bottom Setup Photo



APPENDIX F INFORMATIVE REFERENCES

- [1] Federal Communications Commission, "Report and order: Guidelines for evaluating the environmental effects of radiofrequency radiation", Tech. Rep. FCC 96-326, FCC, Washington, D.C. 20554, 1996.
- [2] David L. Means Kwok Chan, Robert F. Cleveland, "Evaluating compliance with FCC guidelines for human exposure to radiofrequency electromagnetic fields", Tech. Rep., Federal Communication Commission, Office of Engineering & Technology, Washington, DC, 1997.
- [3] Thomas Schmid, Oliver Egger, and Niels Kuster, "Automated E-field scanning system for dosimetric assessments", IEEE Transactions on Microwave Theory and Techniques, vol. 44, pp. 105-113, Jan. 1996.
- [4] Niels Kuster, Ralph Kastle, and Thomas Schmid, "Dosimetric evaluation of mobile communications equipment with known precision", IEEE Transactions on Communications, vol. E80-B, no. 5, pp. 645-652, May 1997.
- [5] CENELEC, "Considerations for evaluating of human exposure to electromagnetic fields (EMFs) from mobile telecommunication equipment (MTE) in the frequency range 30MHz - 6GHz", Tech. Rep., CENELEC, European Committee for Electrotechnical Standardization, Brussels, 1997.
- [6] ANSI, ANSI/IEEE C95.1-1992: IEEE Standard for Safety Levels with Respect to Human Exposure to Radio Frequency Electromagnetic Fields, 3 kHz to 300 GHz, The Institute of Electrical and Electronics Engineers, Inc., New York, NY 10017, 1992.
- [7] Katja Pokovic, Thomas Schmid, and Niels Kuster, "Robust setup for precise calibration of E-field probes in tissue simulating liquids at mobile communications frequencies", in ICECOM '97, Dubrovnik, October 15-17, 1997, pp. 120-24.
- [8] Katja Pokovic, Thomas Schmid, and Niels Kuster, "E-field probe with improved isotropy in brain simulating liquids", in Proceedings of the ELMAR, Zadar, Croatia, 23-25 June, 1996, pp. 172-175.
- [9] Volker Hombach, Klaus Meier, Michael Burkhardt, Eberhard Kuhn, and Niels Kuster, "The dependence of EM energy absorption upon human head modeling at 900 MHz", IEEE Transactions on Microwave Theory and Techniques, vol. 44, no. 10, pp. 1865-1873, Oct. 1996.
- [10] Klaus Meier, Ralf Kastle, Volker Hombach, Roger Tay, and Niels Kuster, "The dependence of EM energy absorption upon human head modeling at 1800 MHz", IEEE Transactions on Microwave Theory and Techniques, Oct. 1997, in press.
- [11] W. Gander, Computermathematik, Birkhaeuser, Basel, 1992.
- [12] W. H. Press, S. A. Teukolsky, W. T. Vetterling, and B. P. Flannery, Numerical Recipes in C, The Art of Scientific Computing, Second Edition, Cambridge University Press, 1992. Dosimetric Evaluation of Sample device, month 1998 9
- [13] NIS81 NAMAS, "The treatment of uncertainty in EMC measurement", Tech. Rep., NAMAS Executive, National Physical Laboratory, Teddington, Middlesex, England, 1994.
- [14] Barry N. Taylor and Christ E. Kuyatt, "Guidelines for evaluating and expressing the uncertainty of NIST measurement results", Tech. Rep., National Institute of Standards and Technology, 1994. Dosimetric Evaluation of Sample device, month 1998 10.

***** END OF REPORT *****