

# SAR EVALUATION REPORT

For

## Sky Phone LLC

1348 Washington Av. Suite 350, Miami Beach, FL, 33139, United States

**FCC ID: 2ABOSGC201402**

<b>Report Type:</b> Original Report	<b>Product Type:</b> Mobile phone
<b>Test Engineer:</b> <u>Wilson Chen</u>	<i>Wilson Chen</i>
<b>Report Number:</b> <u>RSZ140126002-20</u>	
<b>Report Date:</b> <u>2014-02-11</u>	
<b>Reviewed By:</b> <u>Sandy Wang SAR Engineer</u>	<i>Sandy Wang</i>
<b>Prepared By:</b> <u>Bay Area Compliance Laboratories Corp. (Shenzhen) 6/F, the 3rd Phase of WanLi Industrial Building, ShiHua Road, FuTian Free Trade Zone Shenzhen, Guangdong, China Tel: +86-755-33320018 Fax: +86-755-33320008 <a href="http://www.baclcorp.com.cn">www.baclcorp.com.cn</a></u>	

Attestation of Test Results		
<b>EUT Information</b>	<b>Company Name</b>	Sky Phone LLC
	<b>EUT Description</b>	Mobile phone
	<b>FCC ID</b>	2ABOSGC201402
	<b>Model Number</b>	SKY3.5
	<b>Test Date</b>	2014-02-05 to 2013-02-06
<b>Frequency</b>	<b>Max. SAR Level(s) Reported</b>	<b>Limit(W/Kg)</b>
<b>GSM 850</b>	0.811 W/kg 1g Head SAR 1.353 W/kg 1g Body SAR	<b>1.6</b>
<b>PCS 1900</b>	0.723 W/kg 1g Head SAR 1.041 W/kg 1g Body SAR	
<b>WCDMA850</b>	0.637 W/kg 1g Head SAR 0.497 W/kg 1g Body SAR	
<b>WCDMA1900</b>	0.990 W/kg 1g Head SAR 1.245 W/kg 1g Body SAR	
<b>Simultaneous</b>	1.407 W/kg 1g Head SAR 1.562 W/kg 1g Body SAR	
<b>Applicable Standards</b>	<b>ANSI/IEEE C95.1: 2005</b> IEEE Standard for Safety Levels with Respect to Human Exposure to Radio Frequency Electromagnetic Fields,3 kHz to 300 GHz.	
	<b>ANSI/IEEE C95.3: 2002</b> IEEE Recommended Practice for Measurements and Computations of Radio Frequency Electromagnetic Fields With Respect to Human Exposure to SuchFields,100 kHz—300 GHz.	
	<b>IEEE1528: 2003</b> IEEE Recommended Practice for Determining the Peak Spatial-Average Specific Absorption Rate (SAR) in the Human Head from Wireless Communications Devices: Measurement Techniques	
	<b>KDB procedures</b> KDB 447498 D01 Mobile and Portable Devices RF Exposure Procedures and Equipment Authorization Policies. KDB 648474 D04 SAR Evaluation Considerations for Wireless Handsets KDB 865664 D01 SAR Measurement Requirements for 100 MHz to 6 GHz KDB 941225 D01 SAR Measurement Procedures for 3G Devices-CDMA 2000/EV-Do WCDMA/HSDPA/HSUPA KDB 941225 D06 SAR Evaluation Procedures for Portable Devices with Wireless Router Capabilities.	
<p><b>Note:</b> This wireless device has been shown to be capable of compliance for localized specific absorption rate (SAR) for General Population/Uncontrolled Exposure limits specified in ANSI/IEEE Standards and has been tested in accordance with the measurement procedures specified in IEEE 1528-2003 and RF exposure KDB procedures.</p> <p><b>The results and statements contained in this report pertain only to the device(s) evaluated.</b></p>		

## TABLE OF CONTENTS

<b>DOCUMENT REVISION HISTORY .....</b>	<b>5</b>
<b>EUT DESCRIPTION .....</b>	<b>6</b>
TECHNICAL SPECIFICATION .....	6
<b>REFERENCE, STANDARDS, AND GUIDELINES .....</b>	<b>7</b>
SAR LIMITS .....	8
<b>FACILITIES .....</b>	<b>9</b>
<b>DESCRIPTION OF TEST SYSTEM .....</b>	<b>10</b>
<b>EQUIPMENT LIST AND CALIBRATION .....</b>	<b>17</b>
EQUIPMENTS LIST & CALIBRATION INFORMATION .....	17
<b>SAR MEASUREMENT SYSTEM VERIFICATION .....</b>	<b>18</b>
LIQUID VERIFICATION .....	18
SYSTEM ACCURACY VERIFICATION .....	21
SAR SYSTEM VALIDATION DATA .....	22
<b>EUT TEST STRATEGY AND METHODOLOGY .....</b>	<b>30</b>
TEST POSITIONS FOR DEVICE OPERATING NEXT TO A PERSON’S EAR .....	30
CHEEK/TOUCH POSITION .....	31
EAR/TILT POSITION .....	31
TEST POSITIONS FOR BODY-WORN AND OTHER CONFIGURATIONS .....	32
SAR EVALUATION PROCEDURE .....	33
<b>CONDUCTED OUTPUT POWER MEASUREMENT .....</b>	<b>34</b>
PROVISION APPLICABLE .....	34
TEST PROCEDURE .....	34
MAXIMUM OUTPUT POWER AMONG PRODUCTION UNITS .....	34
TEST RESULTS: .....	35
<b>SAR MEASUREMENT RESULTS .....</b>	<b>41</b>
SAR TEST DATA .....	41
<b>SAR SIMULTANEOUS TRANSMISSION DESCRIPTION .....</b>	<b>48</b>
EUT SCAN RESULTS .....	53
<b>APPENDIX A MEASUREMENT UNCERTAINTY .....</b>	<b>107</b>
<b>APPENDIX B – PROBE CALIBRATION CERTIFICATES .....</b>	<b>108</b>
<b>APPENDIX C DIPOLE CALIBRATION CERTIFICATES .....</b>	<b>118</b>
<b>APPENDIX D EUT TEST POSITION PHOTOS .....</b>	<b>138</b>
LIQUID DEPTH $\geq$ 15CM .....	138
BODY-WORN FRONT SETUP PHOTO .....	138
BODY-WORN BACK SETUP PHOTO .....	139
BODY-WORN LEFT SETUP PHOTO .....	139
BODY-WORN RIGHT SETUP PHOTO .....	140
BODY-WORN BOTTOM SETUP PHOTO .....	140
LEFT HEAD TOUCH SETUP PHOTO .....	141
LEFT HEAD TILT SETUP PHOTO .....	141
RIGHT HEAD TOUCH SETUP PHOTO .....	142
RIGHT HEAD TILT SETUP PHOTO .....	142
<b>APPENDIX E EUT PHOTOS .....</b>	<b>143</b>
EUT – FRONT VIEW .....	143

EUT – BACK VIEW ..... 143  
EUT – LEFT SIDE VIEW ..... 144  
EUT – RIGHT SIDE VIEW ..... 144  
EUT – TOP VIEW ..... 145  
EUT – BOTTOM VIEW..... 145  
EUT – BATTERY OFF VIEW..... 146  
**APPENDIX F INFORMATIVE REFERENCES ..... 147**

---

**DOCUMENT REVISION HISTORY**

---

Revision Number	Report Number	Description of Revision	Date of Revision
0	RSZ140126002-20	Original Report	2014-02-11

## EUT DESCRIPTION

This report has been prepared on behalf of *Sky Phone LLC* and their product, FCC ID: 2ABOSGC201402, Model: SKY3.5 or the EUT (Equipment under Test) as referred to in the rest of this report. The EUT is a *Mobile phone*.

### Technical Specification

<b>Product Type</b>	Portable
<b>Exposure Category:</b>	Population / Uncontrolled
<b>Antenna Type(s):</b>	Internal Antenna
<b>Body-Worn Accessories:</b>	Headset
<b>Face-Head Accessories:</b>	None
<b>Multi-slot Class:</b>	Class 12
<b>Operation Mode :</b>	GSM Voice, GPRS Data, WCDMA, Wi-Fi and Bluetooth
<b>Frequency Band:</b>	GSM850 : 824-849 MHz (TX); 869-894 MHz (RX) PCS1900: 1850-1910 MHz (TX); 1930-1990 MHz (RX) WCDMA850: 824-849 MHz (TX); 869-894 MHz (RX) WCDMA1900: 1850-1910 MHz (TX); 1930-1990 MHz (RX) Wi-Fi: 2412-2462MHz, 2422-2452 MHz Bluetooth : 2402-2480 MHz
<b>Conducted RF Power:</b>	GSM850 : 32.89 dBm PCS1900:29.37 dBm WCDMA850: 22.61 dBm WCDMA1900: 22.58 dBm Wi-Fi: 9.80 dBm Bluetooth: 4.78 dBm
<b>Dimensions (L*W*H):</b>	113 mm (L) × 58 mm (W) × 8 mm (H)
<b>Power Source:</b>	3.7 V <sub>DC</sub> 1200 mAh Rechargeable Battery
<b>Normal Operation:</b>	Head and Body-worn

---

## REFERENCE, STANDARDS, AND GUIDELINES

---

### FCC:

The Report and Order requires routine SAR evaluation prior to equipment authorization of portable transmitter devices, including portable telephones. For consumer products, the applicable limit is 1.6 mW/g as recommended by the ANSI/IEEE standard C95.1-1992 [6] for an uncontrolled environment (Paragraph 65). According to the Supplement C of OET Bulletin 65 "Evaluating Compliance with FCC Guide-lines for Human Exposure to Radio frequency Electromagnetic Fields", released on Jun 29, 2001 by the FCC, the device should be evaluated at maximum output power (radiated from the antenna) under "worst-case" conditions for normal or intended use, incorporating normal antenna operating positions, device peak performance frequencies and positions for maximum RF energy coupling.

This report describes the methodology and results of experiments performed on wireless data terminal. The objective was to determine if there is RF radiation and if radiation is found, what is the extent of radiation with respect to safety limits. SAR (Specific Absorption Rate) is the measure of RF exposure determined by the amount of RF energy absorbed by human body (or its parts) – to determine how the RF energy couples to the body or head which is a primary health concern for body worn devices. The limit below which the exposure to RF is considered safe by regulatory bodies in North America is 1.6 mW/g average over 1 gram of tissue mass.

### CE:

The order requires routine SAR evaluation prior to equipment authorization of portable transmitter devices, including portable telephones. For consumer products, the applicable limit is 2 mW/g as recommended by EN62209-1 for an uncontrolled environment. According to the Standard, the device should be evaluated at maximum output power (radiated from the antenna) under "worst-case" conditions for normal or intended use, incorporating normal antenna operating positions, device peak performance frequencies and positions for maximum RF energy coupling.

This report describes the methodology and results of experiments performed on wireless data terminal. The objective was to determine if there is RF radiation and if radiation is found, what is the extent of radiation with respect to safety limits. SAR (Specific Absorption Rate) is the measure of RF exposure determined by the amount of RF energy absorbed by human body (or its parts) – to determine how the RF energy couples to the body or head which is a primary health concern for body worn devices. The limit below which the exposure to RF is considered safe by regulatory bodies in Europe is 2 mW/g average over 10 gram of tissue mass.

The test configurations were laid out on a specially designed test fixture to ensure the reproducibility of measurements. Each configuration was scanned for SAR. Analysis of each scan was carried out to characterize the above effects in the device.

**SAR Limits**

FCC Limit (1g Tissue)

EXPOSURE LIMITS	SAR (W/kg)	
	(General Population / Uncontrolled Exposure Environment)	(Occupational / Controlled Exposure Environment)
Spatial Average (averaged over the whole body)	0.08	0.4
Spatial Peak (averaged over any 1 g of tissue)	1.60	8.0
Spatial Peak (hands/wrists/feet/ankles averaged over 10 g)	4.0	20.0

CE Limit (10g Tissue)

EXPOSURE LIMITS	SAR (W/kg)	
	(General Population / Uncontrolled Exposure Environment)	(Occupational / Controlled Exposure Environment)
Spatial Average (averaged over the whole body)	0.08	0.4
Spatial Peak (averaged over any 10 g of tissue)	2.0	10
Spatial Peak (hands/wrists/feet/ankles averaged over 10 g)	4.0	20.0

Population/Uncontrolled Environments are defined as locations where there is the exposure of individual who have no knowledge or control of their exposure.

Occupational/Controlled Environments are defined as locations where there is exposure that may be incurred by people who are aware of the potential for exposure (i.e. as a result of employment or occupation).

General Population/Uncontrolled environments Spatial Peak limit 1.6W/kg (FCC) & 2 W/kg (CE) applied to the EUT.



## **FACILITIES**

---

The test site used by Bay Area Compliance Laboratories Corp. (Shenzhen) to collect data is located at 6/F, the 3rd Phase of WanLi Industrial Building, Shi Hua Road, Fu Tian Free Trade Zone, Shenzhen, Guangdong, P.R. of China

## DESCRIPTION OF TEST SYSTEM

These measurements were performed with ALSAS 10 Universal Integrated SAR Measurement system from APREL Laboratories.

### ALSAS-10U System Description

ALSAS-10-U is fully compliant with the technical and scientific requirements of IEEE 1528, IEC 62209, CENELEC, ARIB, ACA, and the Federal Communications Commission. The system comprises of a six axes articulated robot which utilizes a dedicated controller. ALSAS-10U uses the latest methodologies. And FDTD modeling to provide a platform which is repeatable with minimum uncertainty.

### Applications

Predefined measurement procedures compliant with the guidelines of CENELEC, IEEE, IEC, FCC, etc are utilized during the assessment for the device. Automatic detection for all SAR maxima are embedded within the core architecture for the system, ensuring that peak locations used for centering the zoom scan are within a 1mm resolution and a 0.05mm repeatable position. System operation range currently available up-to 6 GHz in simulated tissue.

### Area Scans

Area scans are defined prior to the measurement process being executed with a user defined variable spacing between each measurement point (integral) allowing low uncertainty measurements to be conducted. Scans defined for FCC applications utilize a 10mm<sup>2</sup> step integral, with 1mm interpolation used to locate the peak SAR area used for zoom scan assessments.

Where the system identifies multiple SAR peaks (which are within 25% of peak value) the system will provide the user with the option of assessing each peak location individually for zoom scan averaging.

### Zoom Scan (Cube Scan Averaging)

The averaging zoom scan volume utilized in the ALSAS-10U software is in the shape of a cube and the side dimension of a 1 g or 10 g mass is dependent on the density of the liquid representing the simulated tissue. A density of 1000 kg/m<sup>3</sup> is used to represent the head and body tissue density and not the phantom liquid density, in order to be consistent with the definition of the liquid dielectric properties, i.e. the side length of the 1 g cube is 10mm, with the side length of the 10 g cube 21,5mm.

When the cube intersects with the surface of the phantom, it is oriented so that 3 vertices touch the surface of the shell or the center of a face is tangent to the surface. The face of the cube closest to the surface is modified in order to conform to the tangent surface.

The zoom scan integer steps can be user defined so as to reduce uncertainty, but normal practice for typical test applications (including FCC) utilize a physical step of 5x5x8 (8mmx8mmx5mm) providing a volume of 32mm<sup>3</sup> in the X & Y axis, and 35mm in the Z axis.

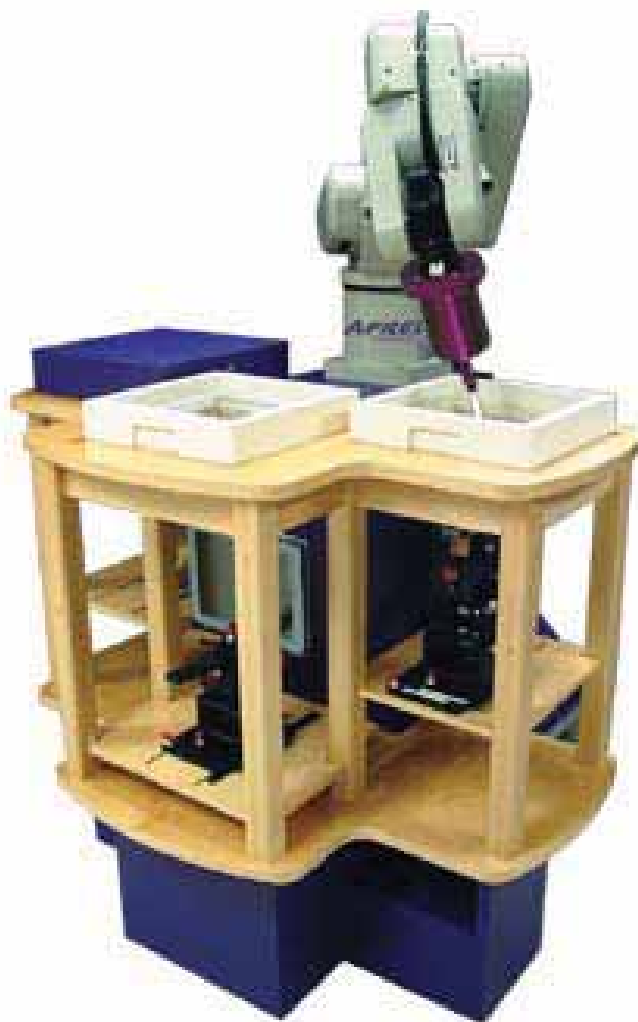

### ALSAS-10U Interpolation and Extrapolation Uncertainty

The overall uncertainty for the methodology and algorithms the used during the SAR calculation was evaluated using the data from IEEE 1528 based on the example f3 algorithm:

$$f_3(x, y, z) = A \frac{a^2}{\frac{a^2}{4} + x'^2 + y'^2} \cdot \left( e^{-\frac{2z}{a}} + \frac{a^2}{2(a + 2z)^2} \right)$$

### Isotropic E-Field Probe

The isotropic E-Field probe has been fully calibrated and assessed for isotropicity, and boundary effect within a controlled environment. Depending on the frequency for which the probe is calibrated the method utilized for calibration will change.

The E-Field probe utilizes a triangular sensor arrangement as detailed in the diagram below:

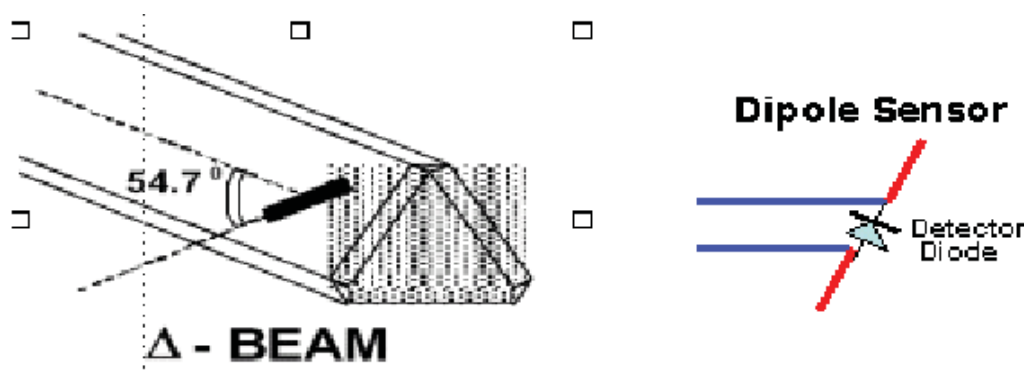

SAR is assessed with a calibrated probe which moves at a default height of 5mm from the center of the diode, which is mounted to the sensor, to the phantom surface (in the Z Axis). The 5mm offset height has been selected so as to minimize any resultant boundary effect due to the probe being in close proximity to the phantom surface.

The following algorithm is an example of the function used by the system for linearization of the output from the probe when measuring complex modulation schemes.

$$V_i = U_i + U_i^2 \cdot \frac{cf}{dcp_i}$$

**Isotropic E-Field Probe Specification**

<b>Calibration Method</b>	Frequency Dependent Below 1 GHz Calibration in air performed in a TEM Cell Above 1 GHz Calibration in air performed in waveguide
<b>Sensitivity</b>	0.70 $\mu\text{V}/(\text{V}/\text{m})^2$ to 0.85 $\mu\text{V}/(\text{V}/\text{m})^2$
<b>Dynamic Range</b>	0.0005 W/kg to 100 W/kg
<b>Isotropic Response</b>	Better than 0.1 dB
<b>Diode Compression Point (DCP)</b>	Calibration for Specific Frequency
<b>Probe Tip Diameter</b>	< 2.9 mm
<b>Sensor Offset</b>	1.56 (+/- 0.02 mm)
<b>Probe Length</b>	289 mm
<b>Video Bandwidth</b>	@ 500 Hz: 1 dB @ 1.02 kHz: 3 dB
<b>Boundary Effect</b>	Less than 2.1% for distance greater than 0.58 mm
<b>Spatial Resolution</b>	The spatial resolution uncertainty is less than 1.5% for 4.9mm diameter probe. The spatial resolution uncertainty is less than 1.0% for 2.5mm diameter probe

**Boundary Detection Unit and Probe Mounting Device**

ALSAS-10U incorporates a boundary detection unit with a sensitivity of 0.05mm for detecting all types of surfaces. The robust design allows for detection during probe tilt (probe normalize) exercises, and utilizes a second stage emergency stop. The signal electronics are fed directly into the robot controller for high accuracy surface detection in lateral and axial detection modes (X, Y, & Z).

The probe is mounted directly onto the Boundary Detection unit for accurate tooling and displacement calculations controlled by the robot kinematics. The probe is connect to an isolated probe interconnect where the output stage of the probe is fed directly into the amplifier stage of the Daq-Paq.

**Daq-Paq (Analog to Digital Electronics)**

ALSAS-10U incorporates a fully calibrated Daq-Paq (analog to digital conversion system) which has a 4 channel input stage, sent via a 2 stage auto-set amplifier module. The input signal is amplified accordingly so as to offer a dynamic range from 5 $\mu\text{V}$  to 800mV. Integration of the fields measured is carried out at board level utilizing a Co-Processor which then sends the measured fields down into the main computational module in digitized form via an RS232 communications port. Probe linearity and duty cycle compensation is carried out within the main Daq-Paq module.

<b>ADC</b>	12 Bit
<b>Amplifier Range</b>	20 mV to 200 mV and 150 mV to 800 mV
<b>Field Integration</b>	Local Co-Processor utilizing proprietary integration algorithms
<b>Number of Input Channels</b>	4 in total 3 dedicated and 1 spare
<b>Communication</b>	Packet data via RS232

### Axis Articulated Robot

ALSAS-10U utilizes a six axis articulated robot, which is controlled using a Pentium based real-time movement controller. The movement kinematics engine utilizes proprietary (Thermo CRS) interpolation and extrapolation algorithms, which allow full freedom of movement for each of the six joints within the working envelope. Utilization of joint 6 allows for full probe rotation with a tolerance better than 0.05mm around the central axis.



<b>Robot/Controller Manufacturer</b>	Thermo CRS
<b>Number of Axis</b>	Six independently controlled axis
<b>Positioning Repeatability</b>	0.05 mm
<b>Controller Type</b>	Single phase Pentium based C500C
<b>Robot Reach</b>	710 mm
<b>Communication</b>	RS232 and LAN compatible

### ALSAS Universal Workstation

ALSAS Universal workstation allows for repeatability and fast adaptability. It allows users to do calibration, testing and measurements using different types of phantoms with one set up, which significantly speeds up the measurement process.

### Universal Device Positioner

The universal device positioner allows complete freedom of movement of the EUT. Developed to hold a EUT in a free-space scenario any additional loading attributable to the material used in the construction of the positioner has been eliminated. Repeatability has been enhanced through the linear scales which form the design used to indicate positioning for any given test scenario in all major axes. A 15° tilt indicator is included for the of aid cheek to tilt movements for head SAR analysis. Overall uncertainty for measurements have been reduced due to the design of the Universal device positioner, which allows positioning of a device in as near to a free-space scenario as possible, and by providing the means for complete repeatability.



**Phantom Types**

The ALSAS-10U allows the integration of multiple phantom types. SAM Phantoms fully compliant with IEEE 1528, Universal Phantom, and Universal Flat.

**APREL SAM Phantoms**

The SAM phantoms developed using the IEEE SAM CAD file. They are fully compliant with the requirements for both IEEE 1528 and FCC Supplement C. Both the left and right SAM phantoms are interchangeable, transparent and include the IEEE 1528 grid with visible NF and MB lines.

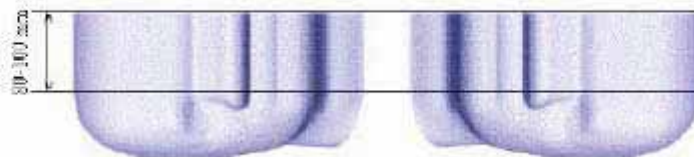

### **APREL Laboratories Universal Phantom**

The Universal Phantom is used on the ALSAS-10U as a system validation phantom. The Universal Phantom has been fully validated both experimentally from 800MHz to 6GHz and numerically using XFDTD numerical software.

The shell thickness is 2mm overall, with a 4mm spacer located at the NF/MB intersection providing an overall thickness of 6mm in line with the requirements of IEEE-1528.

The design allows for fast and accurate measurements, of handsets, by allowing the conservative SAR to be evaluated at on frequency for both left and right head experiments in one measurement.



### Tissue Dielectric Parameters for Head and Body Phantoms

The head tissue dielectric parameters recommended by the IEEE SCC-34/SC-2 in P1528 have been incorporated in the following table. These head parameters are derived from planar layer models simulating the highest expected SAR for the dielectric properties and tissue thickness variations in a human head. Other head and body tissue parameters that have not been specified in P1528 are derived from the tissue dielectric parameters computed from the 4-Cole-Cole equations described in Reference [12] and extrapolated according to the head parameters specified in P1528.

Ingredients (% by weight)	Frequency (MHz)									
	450		835		915		1900		2450	
Tissue Type	Head	Body	Head	Body	Head	Body	Head	Body	Head	Body
Water	38.56	51.16	41.45	52.4	41.05	56.0	54.9	40.4	62.7	73.2
Salt (NaCl)	3.95	1.49	1.45	1.4	1.35	0.76	0.18	0.5	0.5	0.04
Sugar	56.32	46.78	56.0	45.0	56.5	41.76	0.0	58.0	0.0	0.0
HEC	0.98	0.52	1.0	1.0	1.0	1.21	0.0	1.0	0.0	0.0
Bactericide	0.19	0.05	0.1	0.1	0.1	0.27	0.0	0.1	0.0	0.0
Triton x-100	0.0	0.0	0.0	0.0	0.0	0.0	0.0	0.0	36.8	0.0
DGBE	0.0	0.0	0.0	0.0	0.0	0.0	44.92	0.0	0.0	26.7
Dielectric Constant	43.42	58.0	42.54	56.1	42.0	56.8	39.9	54.0	39.8	52.5
Conductivity (s/m)	0.85	0.83	0.91	0.95	1.0	1.07	1.42	1.45	1.88	1.78

### Recommended Tissue Dielectric Parameters for Head and Body

Frequency (MHz)	Head Tissue		Body Tissue	
	$\epsilon_r$	$\sigma$ (S/m)	$\epsilon_r$	$\sigma$ (S/m)
150	52.3	0.76	61.9	0.80
300	45.3	0.87	58.2	0.92
450	43.5	0.87	56.7	0.94
835	41.5	0.90	55.2	0.97
900	41.5	0.97	55.0	1.05
915	41.5	0.98	55.0	1.06
1450	40.5	1.20	54.0	1.30
1610	40.3	1.29	53.8	1.40
1800-2000	40.0	1.40	53.3	1.52
2450	39.2	1.80	52.7	1.95
3000	38.5	2.40	52.0	2.73
5800	35.3	5.27	48.2	6.00



## EQUIPMENT LIST AND CALIBRATION

### Equipments List & Calibration Information

Equipment	Model	Calibration Date	S/N
CRS F3 robot	ALS-F3	N/A	RAF0805352
CRS F3 Software	ALS-F3-SW	N/A	N/A
CRS C500C controller	ALS-C500	N/A	RCF0805379
Probe mounting device & Boundary Detection Sensor System	ALS-PMDPS-3	N/A	120-00270
Universal Work Station	ALS-UWS	N/A	100-00157
Data Acquisition Package	ALS-DAQ-PAQ-3	2013-10-08	110-00212
Miniature E-Field Probe	ALS-E-020	2013-10-08	500-00283
Dipole, 835MHz	ALS-D-835-S-2	2011-08-25	180-00558
Dipole, 1900MHz	ALS-D-1900-S-2	2011-08-25	210-00710
Dipole Spacer	ALS-DS-U	N/A	250-00907
Device holder/Positioner	ALS-H-E-SET-2	N/A	170-00510
Left ear SAM phantom	ALS-P-SAM-L	N/A	130-00311
Right ear SAM phantom	ALS-P-SAM-R	N/A	140-00359
UniPhantom	ALS-P-UP-1	N/A	150-00413
Simulated Tissue 835 MHz Head	ALS-TS-835-H	Each Time	270-01002
Simulated Tissue 835 MHz Body	ALS-TS-835-B	Each Time	270-02101
Simulated Tissue 1900 MHz Head	ALS-TS-1900-H	Each Time	295-01103
Simulated Tissue 1900 MHz Body	ALS-TS-1900-B	Each Time	295-02102
Power Amplifier	5S1G4	N/A	71377
Synthesized Sweeper	HP 8341B	2013-05-09	2624A00116
UNIVERSAL RADIO COMMUNICATION TESTER	CMU200	2013-11-23	106891
EMI Test Receiver	ESCI	2013-11-12	101120

# SAR MEASUREMENT SYSTEM VERIFICATION

## Liquid Verification

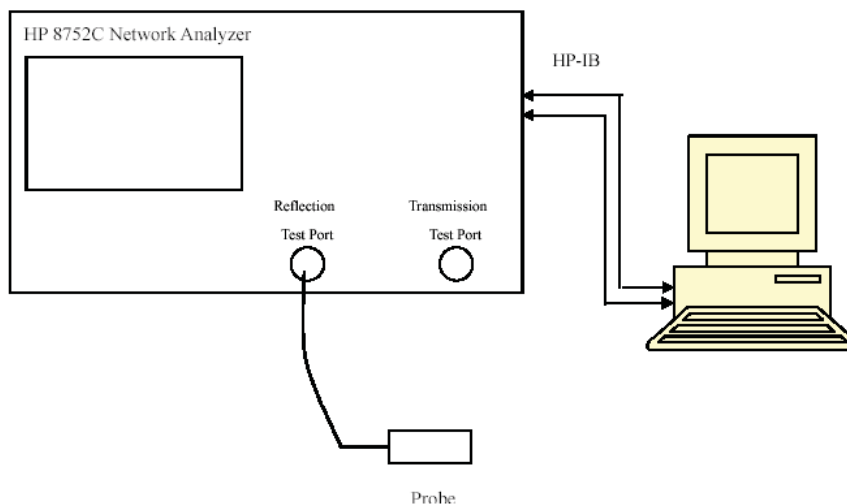

Liquid Verification Setup Block Diagram

## Liquid Verification Results

Frequency	Liquid Type	Liquid Parameter		Target Value		Delta (%)		Tolerance (%)
		$\epsilon_r$	O' (S/m)	$\epsilon_r$	O' (S/m)	$\Delta\epsilon_r$	$\Delta O'$ (S/m)	
824.2	Head	41.10	0.90	41.50	0.90	-0.962	0.000	±5
	Body	55.15	0.95	55.20	0.97	-0.094	-2.062	±5
826.4	Head	40.98	0.90	41.50	0.90	-1.255	0.000	±5
	Body	55.16	0.95	55.20	0.97	-0.065	-2.062	±5
836.6	Head	41.04	0.91	41.50	0.90	-1.107	1.111	±5
	Body	55.23	0.96	55.20	0.97	0.048	-1.031	±5
846.6	Head	40.90	0.93	41.50	0.90	-1.457	3.333	±5
	Body	55.29	0.98	55.20	0.97	0.162	1.031	±5
848.8	Head	40.82	0.93	41.50	0.90	-1.646	3.333	±5
	Body	55.31	0.99	55.20	0.97	0.191	2.062	±5
1850.2	Head	40.14	1.38	40.00	1.40	0.338	-1.429	±5
	Body	54.12	1.49	53.30	1.52	1.536	-1.974	±5
1852.4	Head	40.13	1.38	40.00	1.40	0.330	-1.429	±5
	Body	54.07	1.48	53.30	1.52	1.444	-2.632	±5
1880.0	Head	40.19	1.40	40.00	1.40	0.463	0.000	±5
	Body	53.87	1.53	53.30	1.52	1.072	0.658	±5
1907.6	Head	40.28	1.42	40.00	1.40	0.708	1.429	±5
	Body	53.84	1.55	53.30	1.52	1.008	1.974	±5
1909.8	Head	40.29	1.42	40.00	1.40	0.727	1.429	±5
	Body	53.95	1.54	53.30	1.52	1.216	1.316	±5

\*Liquid Verification was performed on 2014-02-05.

Please refer to the following tables.

835 MHz Head				835 MHz Body		
Frequency (MHz)	e'	e''		Frequency (MHz)	e'	e''
824.0	41.1008	19.6464		824.0	55.1483	20.6424
824.5	41.0607	19.6483		824.5	55.1514	20.5419
825.0	41.0440	19.6488		825.0	55.1546	20.5545
825.5	40.9389	19.6494		825.5	55.1577	20.5669
826.0	40.9572	19.6499		826.0	55.1608	20.7020
826.5	40.9791	19.6505		826.5	55.1640	20.7657
827.0	40.9556	19.6510		827.0	55.1671	20.6802
827.5	41.0029	19.6516		827.5	55.1702	20.5583
828.0	41.0225	19.6521		828.0	55.1734	20.5929
828.5	41.0290	19.6527		828.5	55.1765	20.5503
829.0	41.0799	19.6533		829.0	55.1797	20.6545
829.5	41.0284	19.6538		829.5	55.1828	20.5973
830.0	41.0647	19.6544		830.0	55.1859	20.4752
830.5	41.0248	19.6549		830.5	55.1891	20.5396
831.0	40.9978	19.6555		831.0	55.1922	20.5248
831.5	41.0173	19.6560		831.5	55.1953	20.7322
832.0	40.9791	19.6566		832.0	55.1985	20.7098
832.5	40.9540	19.6571		832.5	55.2016	20.4865
833.0	40.9945	19.6577		833.0	55.2048	20.4199
833.5	41.0259	19.6582		833.5	55.2079	20.5314
834.0	41.0233	19.6588		834.0	55.2110	20.6832
834.5	41.0219	19.6594		834.5	55.2142	20.5762
835.0	41.0468	19.6599		835.0	55.2183	20.5197
835.5	41.0478	19.6608		835.5	55.2205	20.7674
836.0	41.0514	19.6616		836.0	55.2236	20.7743
836.5	41.0404	19.6625		836.5	55.2267	20.6321
837.0	41.0232	19.6633		837.0	55.2299	20.4592
837.5	41.0174	19.6642		837.5	55.2330	20.4954
838.0	41.0406	19.6650		838.0	55.2361	20.7797
838.5	40.9991	19.6659		838.5	55.2393	20.7949
839.0	40.9890	19.6667		839.0	55.2424	20.7169
839.5	40.9915	19.6676		839.5	55.2456	20.6519
840.0	41.0026	19.6685		840.0	55.2487	20.7190
840.5	40.9919	19.6693		840.5	55.2518	20.7644
841.0	40.9752	19.6702		841.0	55.2550	20.7195
841.5	41.0046	19.6710		841.5	55.2581	20.6563
842.0	41.0063	19.6719		842.0	55.2612	20.8321
842.5	41.0100	19.6727		842.5	55.2644	20.8006
843.0	41.0041	19.6636		843.0	55.2675	20.7610
843.5	40.9278	19.6644		843.5	55.2707	20.7165
844.0	41.0041	19.6653		844.0	55.2738	20.7342
844.5	40.9584	19.6661		844.5	55.2769	20.7601
845.0	40.8844	19.6670		845.0	55.2801	20.6695
845.5	40.8997	19.6678		845.5	55.2832	20.6159
846.0	40.8543	19.6888		846.0	55.2864	20.7889
846.5	40.8952	19.6896		846.5	55.2895	20.8503
847.0	40.8755	19.6905		847.0	55.2926	20.7992
847.5	40.8787	19.6913		847.5	55.2958	20.7195
848.0	40.8523	19.6922		848.0	55.2989	20.8096
848.5	40.8569	19.6930		848.5	55.3020	20.8877
849.0	40.8171	19.6939		849.0	55.3052	20.8879

1900 MHz Head				1900 MHz Body		
Frequency (MHz)	e'	e''		Frequency (MHz)	e'	e''
1850.0	40.1352	13.3837		1850.0	54.1188	14.4496
1851.2	40.1342	13.3839		1851.2	54.0507	14.4070
1852.4	40.1322	13.3841		1852.4	54.0695	14.4081
1853.6	40.1302	13.3843		1853.6	54.0461	14.3844
1854.8	40.1312	13.3845		1854.8	53.9489	14.4038
1856.0	40.1322	13.3847		1856.0	54.0520	14.4403
1857.2	40.1332	13.3849		1857.2	54.0451	14.4663
1858.4	40.1342	13.3851		1858.4	54.0271	14.3875
1859.6	40.1352	13.3853		1859.6	54.0088	14.3818
1860.8	40.1392	13.3855		1860.8	53.9046	14.4346
1862.0	40.1432	13.3857		1862.0	53.9323	14.2618
1863.2	40.1472	13.3859		1863.2	53.8783	14.2746
1864.4	40.1512	13.3861		1864.4	53.9130	14.2917
1865.6	40.1552	13.3863		1865.6	53.9195	14.2627
1866.8	40.1592	13.3865		1866.8	53.9945	14.2533
1868.0	40.1632	13.3867		1868.0	54.0629	14.2694
1869.2	40.1672	13.3869		1869.2	54.0720	14.2918
1870.4	40.1712	13.3871		1870.4	53.9855	14.3433
1871.6	40.1751	13.3873		1871.6	53.9279	14.3440
1872.8	40.1791	13.3875		1872.8	53.9663	14.3730
1874.0	40.1801	13.3877		1874.0	53.8928	14.3813
1875.2	40.1811	13.3879		1875.2	53.9559	14.4445
1876.4	40.1821	13.3881		1876.4	53.8591	14.3673
1877.6	40.1831	13.3883		1877.6	53.9613	14.4473
1878.8	40.1841	13.3885		1878.8	53.9891	14.5792
1880.0	40.1851	13.3887		1880.0	53.8715	14.5981
1881.2	40.1881	13.3889		1881.2	53.8297	14.5952
1882.4	40.1911	13.3891		1882.4	53.9252	14.5665
1883.6	40.1941	13.3893		1883.6	53.8907	14.5226
1884.8	40.1971	13.3895		1884.8	53.9156	14.5453
1886.0	40.2001	13.3897		1886.0	53.9508	14.4775
1887.2	40.2031	13.3899		1887.2	53.9316	14.4537
1888.4	40.2081	13.3901		1888.4	54.0214	14.4880
1889.6	40.2131	13.3902		1889.6	53.9519	14.4926
1890.8	40.2181	13.3904		1890.8	53.9976	14.5494
1892.0	40.2231	13.3906		1892.0	53.9855	14.3456
1893.2	40.2281	13.3908		1893.2	53.9580	14.3065
1894.4	40.2331	13.3910		1894.4	53.9306	14.3556
1895.6	40.2381	13.3912		1895.6	53.9235	14.6894
1896.8	40.2431	13.3914		1896.8	53.9134	14.6875
1898.0	40.2481	13.3916		1898.0	53.9137	14.6681
1899.2	40.2531	13.3918		1899.2	53.9907	14.6685
1900.4	40.2581	13.3920		1900.4	53.9556	14.5672
1901.6	40.2631	13.3922		1901.6	53.9591	14.6565
1902.8	40.2671	13.3924		1902.8	53.9282	14.6165
1904.0	40.2711	13.3926		1904.0	54.0099	14.5854
1905.2	40.2750	13.3928		1905.2	53.9217	14.5539
1906.4	40.2790	13.3930		1906.4	53.9116	14.4788
1907.6	40.2830	13.3932		1907.6	53.8372	14.5956
1908.8	40.2870	13.3934		1908.8	53.9215	14.5310
1910.0	40.2910	13.3936		1910.0	53.9481	14.4947

### System Accuracy Verification

Prior to the assessment, the system validation kit was used to test whether the system was operating within its specifications of  $\pm 10\%$ . The validation results are tabulated below. And also the corresponding SAR plot is attached as well in the SAR plots files.

### System Verification Setup Block Diagram

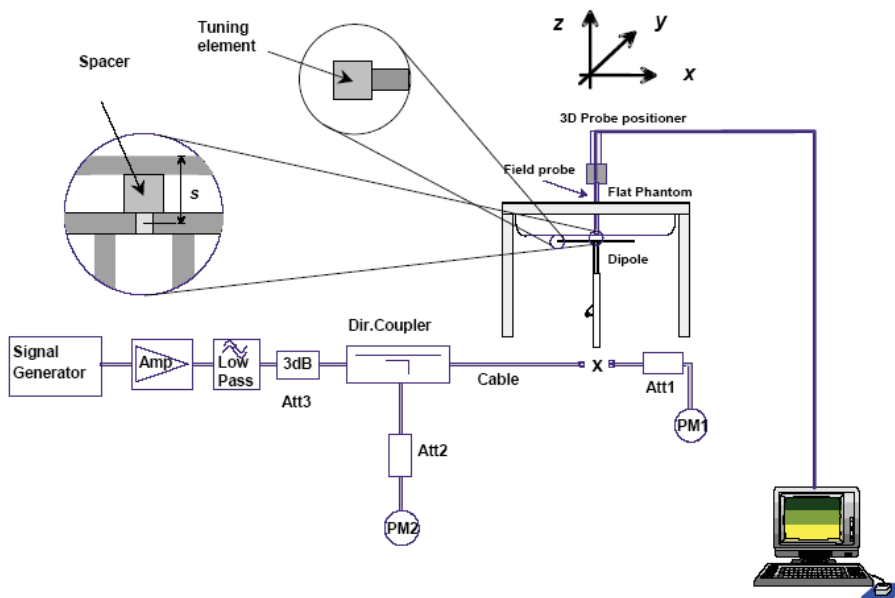

### Probe and dipole antenna List and Detail

Manufacturer	Description	Model	Serial Number	Calibration Date	Calibration Due Date
APREL	Probe	ALS-E-020	500-00283	2013-10-08	2014-10-07
APREL	Dipole antenna(850MHz)	ALS-D-835-S-2	180-00558	2011-08-25	2014-08-24
APREL	Dipole antenna(1900MHz)	ALS-D-1900-S-2	210-00710	2011-08-25	2014-08-24

### System Accuracy Check Results

Date	Frequency Band	Liquid Type	Measured SAR (W/Kg)		Target Value (W/Kg)	Delta (%)	Tolerance (%)
2014-02-05	835	Head	1g	9.687	9.590	1.011	$\pm 10$
		Body	1g	9.598	9.684	-0.888	$\pm 10$
	1900	Head	1g	40.346	39.648	1.760	$\pm 10$
		Body	1g	39.587	39.769	-0.458	$\pm 10$

\*All SAR values are normalized to 1 Watt forward power.

**SAR SYSTEM VALIDATION DATA****Test Laboratory: Bay Area Compliance Lab Corp. (Shenzhen)****System Performance Check 835 MHz Head Liquid****Dipole 835 MHz; Type: ALS-D-835-S-2; S/N: 180-00558**

## Product Data

Device Name : Dipole 835 MHz  
 Serial No. : 180-00558  
 Type : Dipole  
 Model : ALS-D-835-S-2  
 Frequency Band : 835  
 Max. Transmit Pwr : 1 W  
 Drift Time : 3 min(s)  
 Power Drift-Start : 10.786 W/kg  
 Power Drift-Finish : 10.351 W/kg  
 Power Drift (%) : -4.033

## Phantom Data

Name : APREL-Uni  
 Type : Uni-Phantom  
 Size (mm) : 280 x 280 x 200  
 Serial No. : System Default  
 Location : Center  
 Description : Default  
 Phantom Data

## Tissue Data

Type : Head  
 Serial No. : 270-01002  
 Frequency : 835.0 MHz  
 Last Calib. Date : 05-Feb-2014  
 Temperature : 20.00 °C  
 Ambient Temp. : 21.00 °C  
 Humidity : 56.00 RH%  
 Epsilon : 41.05 F/m  
 Sigma : 0.91 S/m  
 Density : 1000.00 kg/cu. m

## Probe Data

Name : E-Field  
 Model : E-020  
 Type : E-Field Triangle  
 Serial No. : 500-00283  
 Last Calib. Date : 08-Oct-2013  
 Frequency Band : 835  
 Duty Cycle Factor : 1  
 Conversion Factor : 5.9  
 Probe Sensitivity : 1.20 1.20 1.20  $\mu\text{V}/(\text{V}/\text{m})^2$   
 Compression Point : 95.00 mV  
 Offset : 1.56 mm

## Measurement Data

Crest Factor : 1  
 Scan Type : Complete  
 Tissue Temp. : 21.00 °C  
 Ambient Temp. : 21.00 °C  
 Area Scan : 7x9x1 : Measurement x=10mm, y=10mm, z=4mm  
 Zoom Scan : 7x7x7 : Measurement x=5mm, y=5mm, z=5mm

1 gram SAR value : 9.687 W/kg  
 10 gram SAR value : 6.358 W/kg  
 Area Scan Peak SAR : 9.988 W/kg  
 Zoom Scan Peak SAR : 15.578 W/kg

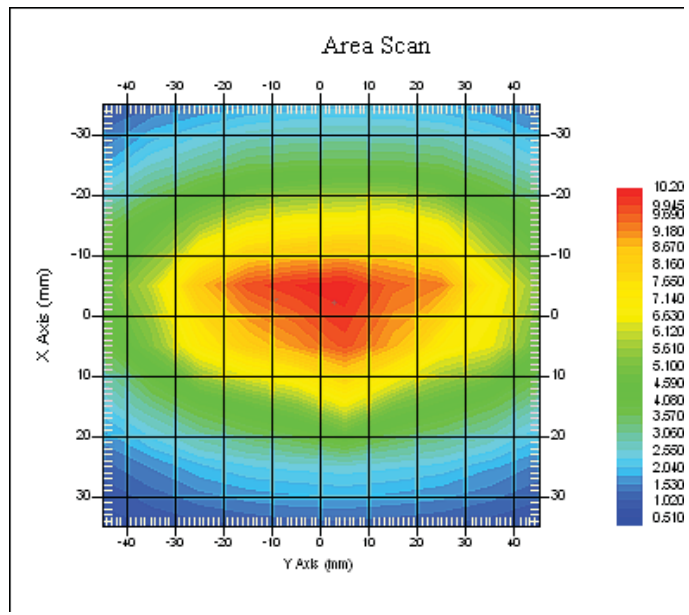

**835 MHz System Validation with Head Tissue**

**Test Laboratory: Bay Area Compliance Lab Corp. (Shenzhen)****System Performance Check 835 MHz Body Liquid****Dipole 835 MHz; Type: ALS-D-835-S-2; S/N: 180-00558**

## Product Data

Device Name : Dipole 835 MHz  
Serial No. : 180-00558  
Type : Dipole  
Model : ALS-D-835-S-2  
Frequency Band : 835  
Max. Transmit Pwr : 1 W  
Drift Time : 3 min(s)  
Power Drift-Start : 9.126 W/kg  
Power Drift-Finish : 9.357 W/kg  
Power Drift (%) : 2.531

## Phantom Data

Name : APREL-Uni  
Type : Uni-Phantom  
Size (mm) : 280 x 280 x 200  
Serial No. : System Default  
Location : Center  
Description : Default  
Phantom Data

## Tissue Data

Type : Body  
Serial No. : 270-02101  
Frequency : 835.0 MHz  
Last Calib. Date : 05-Feb-2014  
Temperature : 20.00 °C  
Ambient Temp. : 21.00 °C  
Humidity : 56.00 RH%  
Epsilon : 55.22 F/m  
Sigma : 0.96 S/m  
Density : 1000.00 kg/cu. m

## Probe Data

Name : E-Field  
Model : E-020  
Type : E-Field Triangle  
Serial No. : 500-00283  
Last Calib. Date : 08-Oct-2013  
Frequency Band : 835  
Duty Cycle Factor : 1  
Conversion Factor : 5.9  
Probe Sensitivity : 1.20 1.20 1.20  $\mu\text{V}/(\text{V}/\text{m})^2$   
Compression Point : 95.00 mV  
Offset : 1.56 mm

## Measurement Data

Crest Factor : 1  
Scan Type : Complete  
Tissue Temp. : 21.00 °C  
Ambient Temp. : 21.00 °C  
Area Scan : 7x9x1 : Measurement x=10mm, y=10mm, z=4mm  
Zoom Scan : 7x7x7 : Measurement x=5mm, y=5mm, z=5mm



1 gram SAR value : 9.598 W/kg  
 10 gram SAR value : 6.356 W/kg  
 Area Scan Peak SAR : 10.458 W/kg  
 Zoom Scan Peak SAR : 16.659 W/kg

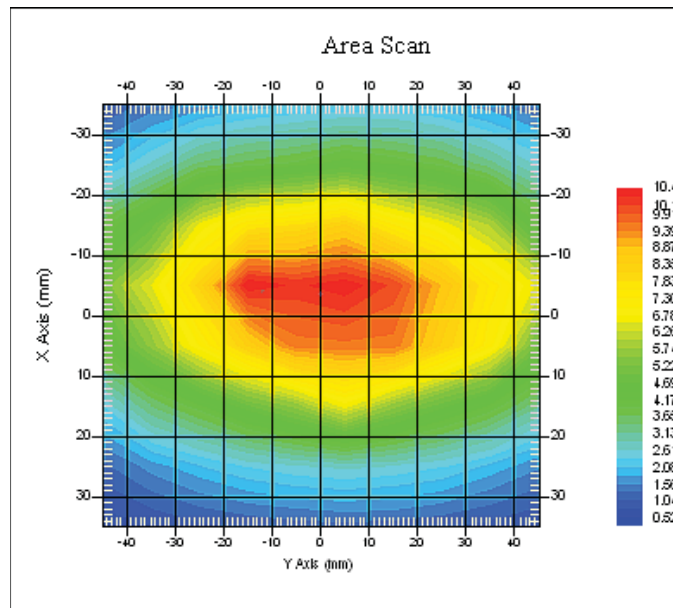

**835 MHz System Validation with Body Tissue**

**Test Laboratory: Bay Area Compliance Lab Corp. (Shenzhen)****System Performance Check 1900 MHz Head Liquid****Dipole 1900 MHz; Type: ALS-D-1900-S-2; S/N: 210-00710**

## Product Data

Device Name : Dipole 1900MHz  
Serial No. : 210-00710  
Type : Dipole  
Model : ALS-D-1900-S-2  
Frequency Band : 1900  
Max. Transmit Pwr : 1 W  
Drift Time : 3 min(s)  
Power Drift-Start : 35.346 W/kg  
Power Drift-Finish : 34.985 W/kg  
Power Drift (%) : -0.798

## Phantom Data

Name : APREL-Uni  
Type : Uni-Phantom  
Size (mm) : 280 x 280 x 200  
Serial No. : System Default  
Location : Center  
Description : Default

## Tissue Data

Type : Head  
Serial No. : 295-01103  
Frequency : 1900.00 MHz  
Last Calib. Date : 05-Feb-2014  
Temperature : 20.00 °C  
Ambient Temp. : 21.00 °C  
Humidity : 56.00 RH%  
Epsilon : 40.26 F/m  
Sigma : 1.41 S/m  
Density : 1000.00 kg/cu. M

## Probe Data

Name : E-Field  
Model : E-020  
Type : E-Field Triangle  
Serial No. : 500-00283  
Last Calib. Date : 08-Oct-2013  
Frequency Band : 1900  
Duty Cycle Factor : 1  
Conversion Factor : 4.8  
Probe Sensitivity : 1.20 1.20 1.20  $\mu\text{V}/(\text{V}/\text{m})^2$   
Compression Point : 95.00 mV  
Offset : 1.56 mm

## Measurement Data

Crest Factor : 1  
Scan Type : Complete  
Tissue Temp. : 20.00 °C  
Ambient Temp. : 20.00 °C  
Area Scan : 7x9x1 : Measurement x=10mm, y=10mm, z=4mm  
Zoom Scan : 7x7x7 : Measurement x=5mm, y=5mm, z=5mm

1 gram SAR value : 40.346 W/kg  
10 gram SAR value : 20.588 W/kg  
Area Scan Peak SAR : 41.569 W/kg  
Zoom Scan Peak SAR : 92.657 W/kg

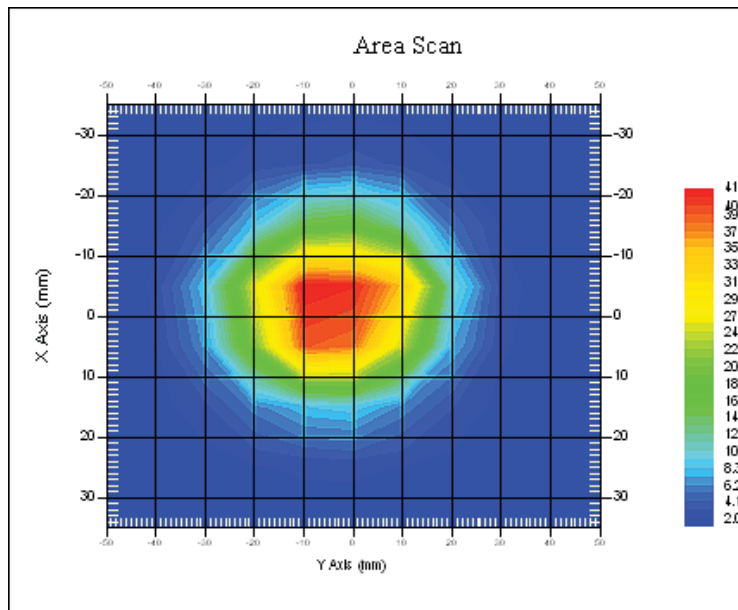

**1900 MHz System Validation with Head Tissue**

**Test Laboratory: Bay Area Compliance Lab Corp. (Shenzhen)****System Performance Check 1900 MHz Body Liquid****Dipole 1900 MHz; Type: ALS-D-1900-S-2; S/N: 210-00710**

## Product Data

Device Name : Dipole 1900MHz  
Serial No. : 210-00710  
Type : Dipole  
Model : ALS-D-1900-S-2  
Frequency Band : 1900  
Max. Transmit Pwr : 1 W  
Drift Time : 3 min(s)  
Power Drift-Start : 35.346 W/kg  
Power Drift-Finish : 34.985 W/kg  
Power Drift (%) : -1.021

## Phantom Data

Name : APREL-Uni  
Type : Uni-Phantom  
Size (mm) : 280 x 280 x 200  
Serial No. : System Default  
Location : Center  
Description : Default

## Tissue Data

Type : Body  
Serial No. : 295-02102  
Frequency : 1900.00 MHz  
Last Calib. Date : 05-Feb-2014  
Temperature : 20.00 °C  
Ambient Temp. : 21.00 °C  
Humidity : 56.00 RH%  
Epsilon : 53.96 F/m  
Sigma : 1.54 S/m  
Density : 1000.00 kg/cu. m

## Probe Data

Name : E-Field  
Model : E-020  
Type : E-Field Triangle  
Serial No. : 500-00283  
Last Calib. Date : 08-Oct-2012  
Frequency Band : 1900  
Duty Cycle Factor : 1  
Conversion Factor : 4.5  
Probe Sensitivity : 1.20 1.20 1.20  $\mu\text{V}/(\text{V}/\text{m})^2$   
Compression Point : 95.00 mV  
Offset : 1.56 mm

## Measurement Data

Crest Factor : 1  
Scan Type : Complete  
Tissue Temp. : 20.00 °C  
Ambient Temp. : 21.00 °C  
Area Scan : 7x9x1 : Measurement x=10mm, y=10mm, z=4mm  
Zoom Scan : 7x7x7 : Measurement x=5mm, y=5mm, z=5mm

1 gram SAR value : 39.587 W/kg  
 10 gram SAR value : 20.697 W/kg  
 Area Scan Peak SAR : 42.230 W/kg  
 Zoom Scan Peak SAR : 92.357 W/kg

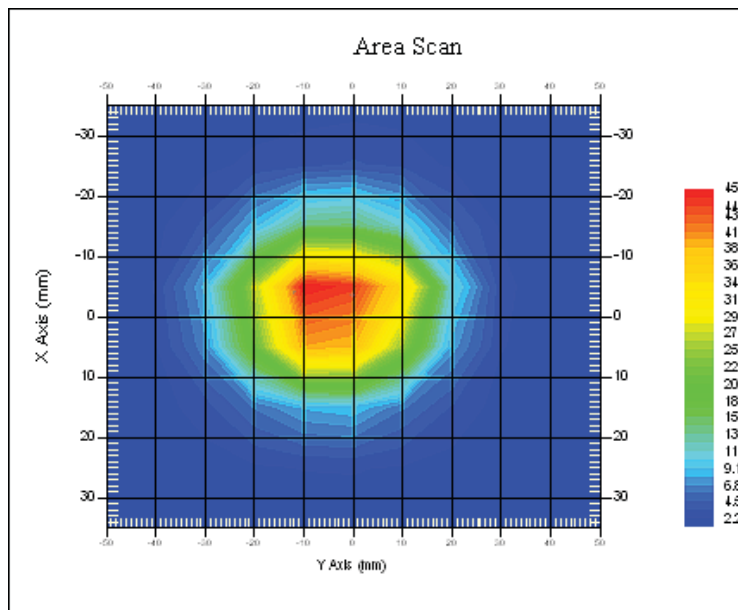

**1900 MHz System Validation with Body Tissue**

## EUT TEST STRATEGY AND METHODOLOGY

### Test Positions for Device Operating Next to a Person’s Ear

This category includes most wireless handsets with fixed, retractable or internal antennas located toward the top half of the device, with or without a foldout, sliding or similar keypad cover. The handset should have its earpiece located within the upper ¼ of the device, either along the centerline or off-centered, as perceived by its users. This type of handset should be positioned in a normal operating position with the “test device reference point” located along the “vertical centerline” on the front of the device aligned to the “ear reference point”. The “test device reference point” should be located at the same level as the center of the earpiece region. The “vertical centerline” should bisect the front surface of the handset at its top and bottom edges. A “ear reference point” is located on the outer surface of the head phantom on each ear spacer. It is located 1.5 cm above the center of the ear canal entrance in the “phantom reference plane” defined by the three lines joining the center of each “ear reference point” (left and right) and the tip of the mouth.

A handset should be initially positioned with the earpiece region pressed against the ear spacer of a head phantom. For the SCC-34/SC-2 head phantom, the device should be positioned parallel to the “N-F” line defined along the base of the ear spacer that contains the “ear reference point”. For interim head phantoms, the device should be positioned parallel to the cheek for maximum RF energy coupling. The “test device reference point” is aligned to the “ear reference point” on the head phantom and the “vertical centerline” is aligned to the “phantom reference plane”. This is called the “initial ear position”. While maintaining these three alignments, the body of the handset is gradually adjusted to each of the following positions for evaluating SAR:

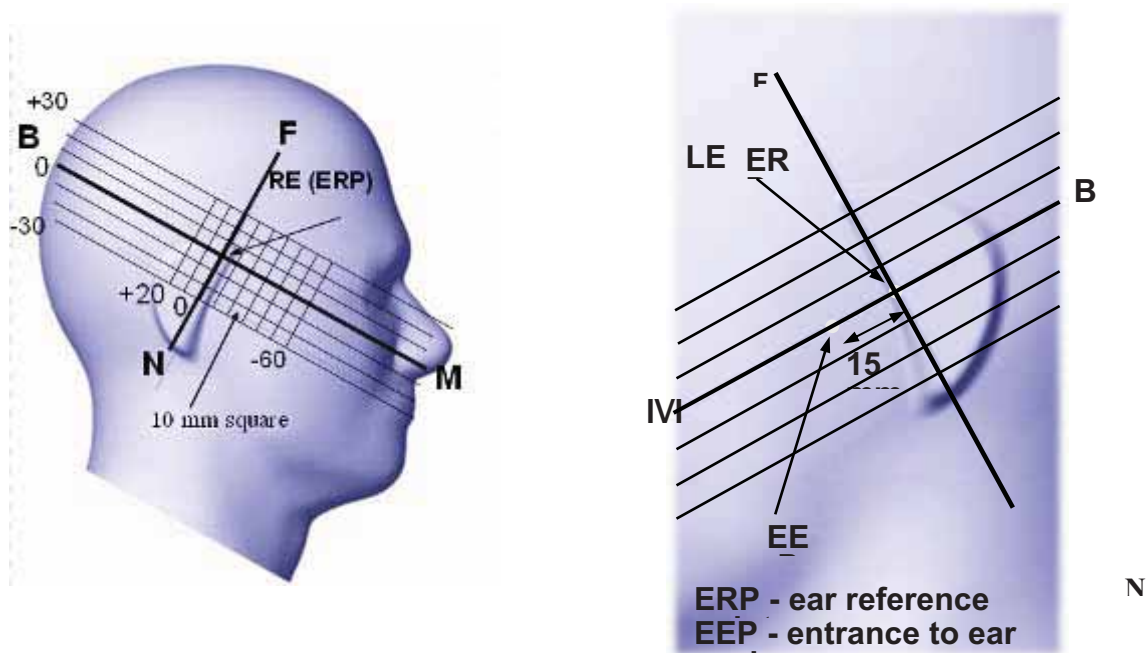

## Cheek/Touch Position

The device is brought toward the mouth of the head phantom by pivoting against the “ear reference point” or along the “N-F” line for the SCC-34/SC-2 head phantom.

This test position is established:

- When any point on the display, keypad or mouthpiece portions of the handset is in contact with the phantom.
- (or) When any portion of a foldout, sliding or similar keypad cover opened to its intended self-adjusting normal use position is in contact with the cheek or mouth of the phantom.

For existing head phantoms – when the handset loses contact with the phantom at the pivoting point, rotation should continue until the device touches the cheek of the phantom or breaks its last contact from the ear spacer.

### Cheek /Touch Position

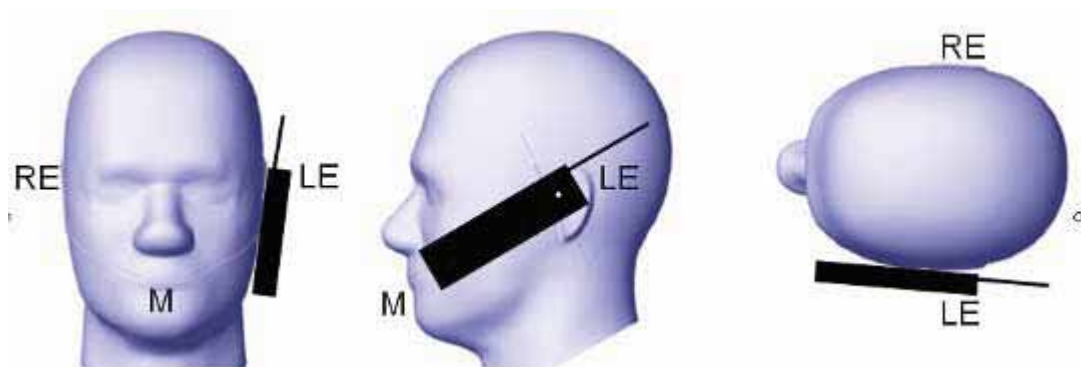

## Ear/Tilt Position

With the handset aligned in the “Cheek/Touch Position”:

1) If the earpiece of the handset is not in full contact with the phantom’s ear spacer (in the “Cheek/Touch position”) and the peak SAR location for the “Cheek/Touch” position is located at the ear spacer region or corresponds to the earpiece region of the handset, the device should be returned to the “initial ear position” by rotating it away from the mouth until the earpiece is in full contact with the ear spacer.

2) (otherwise) The handset should be moved (translated) away from the cheek perpendicular to the line passes through both “ear reference points” (note: one of these ear reference points may not physically exist on a split head model) for approximate 2-3 cm. While it is in this position, the device handset is tilted away from the mouth with respect to the “test device reference point” until the inside angle between the vertical centerline on the front surface of the phone and the horizontal line passing through the ear reference point is by 15 80°. After the tilt, it is then moved (translated) back toward the head perpendicular to the line passes through both “ear reference points” until the device touches the phantom or the ear spacer. If the antenna touches the head first, the positioning process should be repeated with a tilt angle less than 15° so that the device and its antenna would touch the phantom simultaneously. This test position may require a device holder or positioner to achieve the translation and tilting with acceptable positioning repeatability.

If a device is also designed to transmit with its keypad cover closed for operating in the head position, such positions should also be considered in the SAR evaluation. The device should be tested on the left and right side of the head phantom in the “Cheek/Touch” and “Ear/Tilt” positions. When applicable, each configuration should be tested with the antenna in its fully extended and fully retracted positions. These test configurations should be tested at the high, middle and low frequency channels of each operating mode; for example, AMPS, CDMA, and TDMA. If the SAR measured at the middle channel for each test configuration (left, right, Cheek/Touch, Tile/Ear, extended and retracted) is at least 2.0 dB lower than the SAR limit, testing at the high and low channels is optional for such test configuration(s). If the transmission band of the test device is less than 10 MHz, testing at the high and low frequency channels is optional.

### Ear /Tilt 15° Position

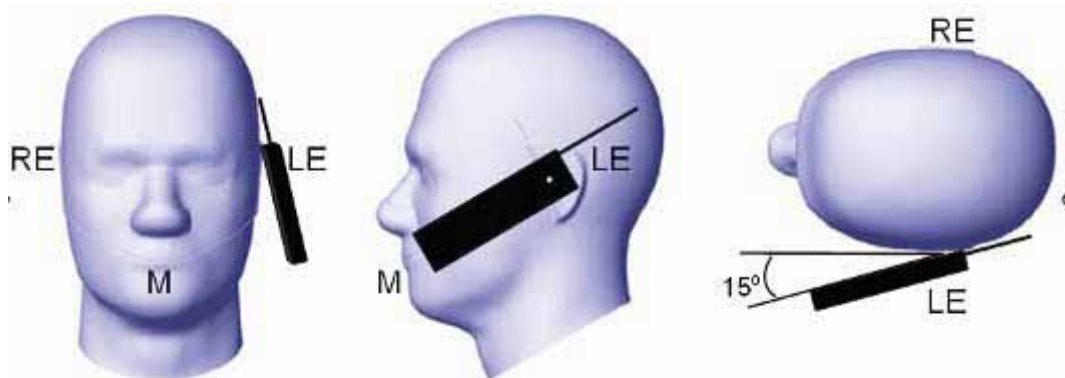

### **Test positions for body-worn and other configurations**

Body-worn operating configurations should be tested with the belt-clips and holsters attached to the device and positioned against a flat phantom in normal use configurations. Devices with a headset output should be tested with a headset connected to the device. When multiple accessories that do not contain metallic components are supplied with the device, the device may be tested with only the accessory that dictates the closest spacing to the body. When multiple accessories that contain metallic components are supplied with the device, the device must be tested with each accessory that contains a unique metallic component. If multiple accessories share an identical metallic component (e.g., the same metallic belt-clip used with different holsters with no other metallic components), only the accessory that dictates the closest spacing to the body must be tested.

Body-worn accessories may not always be supplied or available as options for some devices that are intended to be authorized for body-worn use. A separation distance of 1.5 cm between the back of the device and a flat phantom is recommended for testing body-worn SAR compliance under such circumstances. Other separation distances may be used, but they should not exceed 2.5 cm. In these cases, the device may use body-worn accessories that provide a separation distance greater than that tested for the device provided however that the accessory contains no metallic components.



## SAR Evaluation Procedure

The evaluation was performed with the following procedure:

Step 1: Measurement of the SAR value at a fixed location above the ear point or central position was used as a reference value for assessing the power drop. The SAR at this point is measured at the start of the test and then again at the end of the testing.

Step 2: The SAR distribution at the exposed side of the head was measured at a distance of 4 mm from the inner surface of the shell. The area covered the entire dimension of the head or EUT and the horizontal grid spacing was 10 mm x 10 mm. Based on these data, the area of the maximum absorption was determined by spline interpolation. The first Area Scan covers the entire dimension of the EUT to ensure that the hotspot was correctly identified.

Step 3: Around this point, a volume of 35 mm x 35 mm x 35 mm was assessed by measuring 7x 7 x 7 points. On the basis of this data set, the spatial peak SAR value was evaluated under the following procedure:

- 1) The data at the surface were extrapolated, since the center of the dipoles is 1.2 mm away from the tip of the probe and the distance between the surface and the lowest measuring point is 1.3 mm. The extrapolation was based on a least square algorithm. A polynomial of the fourth order was calculated through the points in z-axes. This polynomial was then used to evaluate the points between the surface and the probe tip.
- 2) The maximum interpolated value was searched with a straightforward algorithm. Around this maximum the SAR values averaged over the spatial volumes (1 g or 10 g) were computed by the 3D-Spline interpolation algorithm. The 3D-Spline is composed of three one dimensional splines with the "Not a knot"-condition (in x, y and z-directions). The volume was integrated with the trapezoidal-algorithm. One thousand points (10 x 10 x 10) were interpolated to calculate the averages.

All neighboring volumes were evaluated until no neighboring volume with a higher average value was found.

Step 4: Re-measurement of the SAR value at the same location as in Step 1. If the value changed by more than 5%, the evaluation was repeated.

## CONDUCTED OUTPUT POWER MEASUREMENT

### Provision Applicable

The measured peak output power should be greater and within 5% than EMI measurement.

### Test Procedure

The RF output of the transmitter was connected to the input of the EMI Test Receiver through sufficient attenuation.

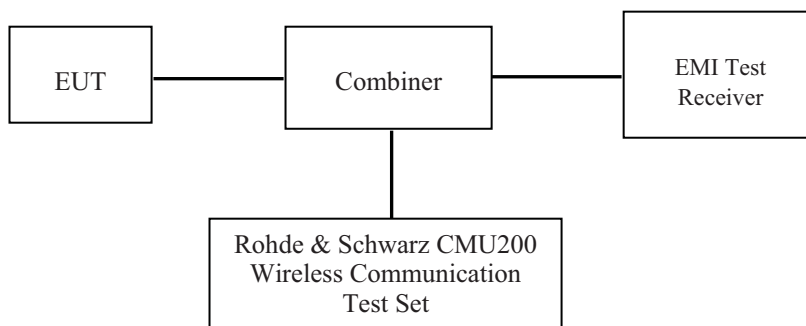

### GSM&3G

### Maximum Output Power among production units

Max Target Power for Production Unit (dBm)			
Mode/Band	Channel		
	Low	Middle	High
GSM 850	33.00	33.00	33.00
GPRS 1 slot	33.00	33.00	33.00
GPRS 2 slot	32.50	32.50	32.50
GPRS 3 slot	30.00	30.00	30.00
GPRS 4 slot	29.00	29.00	29.00
PCS 1900	29.50	29.50	29.50
GPRS 1 slot	29.50	29.50	29.50
GPRS 2 slot	28.50	28.50	28.50
GPRS 3 slot	27.00	27.00	27.00
GPRS 4 slot	25.50	25.50	25.50
WCDMA850	23.00	23.00	23.00
WCDMA1900	23.00	23.00	23.00
WiFi	10.00	10.00	10.00
Bluetooth	5.00	5.00	5.00

**Test Results:**

**GSM**

Band	Frequency (MHz)	Conducted Peak Output Power	
		Meas. Power (dBm)	Meas. Power (W)
GSM 850	824.2	32.76	1.888
	836.6	32.84	1.923
	848.8	32.89	1.945
PCS 1900	1850.2	29.23	0.838
	1880.0	29.31	0.853
	1909.8	29.37	0.865

**GPRS**

Band	Channel No.	Frequency (MHz)	RF Peak Output Power (dBm)			
			1 slot	2 slot	3 slots	4 slots
GSM 850	128	824.2	32.71	32.04	29.83	28.65
	190	836.6	32.80	32.06	29.78	28.62
	251	848.8	32.85	32.05	29.73	28.58
PCS 1900	512	1850.2	29.20	28.36	26.44	25.30
	661	1880.0	29.28	28.44	26.53	25.42
	810	1909.8	29.34	28.49	26.59	25.49

For SAR, the time based average power is relevant, the difference in between depends on the duty cycle of the TDMA signal.

Number of Time slot	1	2	3	4
Duty Cycle	1:8	1:4	1:2.66	1:2
Time based Ave. power compared to slotted Ave. power	-9 dB	-6 dB	-4.25 dB	-3 dB
Crest Factor	8	4	2.66	2

**The time based average power for GPRS**

Band	Channel No.	Frequency (MHz)	Time based average Power (dBm)			
			1 slot	2 slot	3 slots	4 slots
GSM 850	128	824.2	23.71	26.04	25.58	25.65
	190	836.6	23.80	26.06	25.53	25.62
	251	848.8	23.85	26.05	25.48	25.58
PCS 1900	512	1850.2	20.20	22.36	22.19	22.30
	661	1880.0	20.28	22.44	22.28	22.42
	810	1909.8	20.34	22.49	22.34	22.49

**Note:**

1. Rohde & Schwarz Radio Communication Tester (CMU200) was used for the measurement of GSM peak and average output power for active timeslots.
2. For GSM voice, 1 timeslot has been activated with power level 5 (850 MHz band) and 0 (1900 MHz band).
3. For GPRS, 1, 2 timeslots has been activated separately with power level 5(850 MHz band) and 0(1900 MHz band).

**WCDMA-Release 99:**

The following tests were conducted according to the test requirements outlines in section 5.2 of the 3GPP TS34.121-1 specification. The EUT has a nominal maximum output power of 24dBm (+1.7/-3.7).

<b>WCDMA General Settings</b>	<b>Loopback Mode</b>	Test Mode 1
	<b>Rel99 RMC</b>	12.2kbps RMC
	<b>Power Control Algorithm</b>	Algorithm2
	<b><math>\beta_c / \beta_d</math></b>	8/15

**Results (12.2kbps RMC)**

Band	Frequency (MHz)	Channel NO.	Conducted Output Power	
			(dBm)	(Watt)
WCDMA 850	826.4	4132	22.40	0.174
	836.6	4183	22.61	0.182
	846.6	4233	22.51	0.178
WCDMA 1900	1852.4	9262	22.45	0.176
	1880.0	9400	22.58	0.181
	1907.6	9538	22.56	0.180

**WCDMA HSDPA**

The following tests were conducted according to the test requirements outlines in section 5.2 of the 3GPP TS34.121-1 specification.

	Mode	HSDPA	HSDPA	HSDPA	HSDPA
	Subset	1	2	3	4
WCDMA General Settings	Loopback Mode	Test Mode 1			
	Rel99 RMC	12.2kbps RMC			
	HSDPA FRC	H-Set1			
	Power Control Algorithm	Algorithm2			
	$\beta_c$	2/15	12/15	15/15	15/15
	$\beta_d$	15/15	15/15	8/15	4/15
	$\beta_d$ (SF)	64			
	$\beta_c / \beta_d$	2/15	12/15	15/8	15/4
	$\beta_{hs}$	4/15	24/15	30/15	30/15
	MPR(dB)	0	0	0.5	0.5
HSDPA Specific Settings	$D_{ACK}$	8			
	$D_{NAK}$	8			
	$D_{CQI}$	8			
	Ack-Nack repetition factor	3			
	CQI Feedback	4ms			
	CQI Repetition Factor	2			
	$A_{hs} = \beta_{hs} / \beta_c$	30/15			

**Results (HSDPA)**

Band	Frequency (MHz)	Channel NO.	Conducted Output Power (dBm)			
			Subset 1	Subset 2	Subset 3	Subset 4
WCDMA 850	826.4	4132	21.57	21.53	21.44	21.54
	836.6	4183	21.72	21.69	21.65	21.72
	846.6	4233	21.58	21.55	21.53	21.57
WCDMA 1900	1852.4	9262	21.43	21.39	21.37	21.42
	1880.0	9400	21.56	21.52	21.48	21.53
	1907.6	9538	21.49	21.39	21.54	21.51

**WCDMA HSUPA**

The following tests were conducted according to the test requirements outlines in section 5.2 of the 3GPP TS34.121-1 specification.

	Mode	HSUPA	HSUPA	HSUPA	HSUPA	HSUPA
	Subset	1	2	3	4	5
WCDMA General Settings	Loopback Mode	Test Mode 1				
	Rel99 RMC	12.2kbps RMC				
	HSDPA FRC	H-Set1				
	HSUPA Test	HSUPA Loopback				
	Power Control Algorithm	Algorithm2				
	$\beta_c$	11/15	6/15	15/15	2/15	15/15
	$\beta_d$	15/15	15/15	9/15	15/15	0
	$\beta_{ec}$	209/225	12/15	30/15	2/15	5/15
	$\beta_c/\beta_d$	11/15	6/15	15/9	2/15	-
	$\beta_{hs}$	22/15	12/15	30/15	4/15	5/15
	CM(dB)	1.0	3.0	2.0	3.0	1.0
MPR(dB)	0	2	1	2	0	
HSDPA Specific Settings	DACK	8				
	DNAK	8				
	DCQI	8				
	Ack-Nack repetition factor	3				
	CQI Feedback	4ms				
	CQI Repetition Factor	2				
	$A_{hs} = \beta_{hs}/\beta_c$	30/15				
HSUPA Specific Settings	DE-DPCCH	6	8	8	5	7
	DHARQ	0	0	0	0	0
	AG Index	20	12	15	17	21
	ETFCI	75	67	92	71	81
	Associated Max UL Data Rate kbps	242.1	174.9	482.8	205.8	308.9
	Reference E_FCIs	E-TFCI 11 E E-TFCI PO 4 E-TFCI 67 E-TFCI PO 18 E-TFCI 71 E-TFCI PO23 E-TFCI 75 E-TFCI PO26 E-TFCI 81 E-TFCI PO 27		E-TFCI 11 E-TFCI PO4 E-TFCI 92 E-TFCI PO 18	E-TFCI 11 E E-TFCI PO 4 E-TFCI 67 E-TFCI PO 18 E-TFCI 71 E-TFCI PO23 E-TFCI 75 E-TFCI PO26 E-TFCI 81 E-TFCI PO 27	

**Results (HSUPA)**

Band	Frequency (MHz)	Channel NO.	Conducted Output Power (dBm)				
			Subset 1	Subset 2	Subset 3	Subset 4	Subset 5
WCDMA 850	826.4	4132	21.56	21.51	21.43	21.54	21.53
	836.6	4183	21.70	21.69	21.73	21.72	21.70
	846.6	4233	21.54	21.54	21.46	21.55	21.53
WCDMA 1900	1852.4	9262	21.41	21.38	21.30	21.43	21.40
	1880.0	9400	21.55	21.53	21.49	21.54	21.47
	1907.6	9538	21.56	21.42	21.54	21.52	21.46

**Note:**

1. The default test configuration is to measure SAR with an established radio link between the EUT and a communication test set using a 12.2 kbps RMC (reference measurement Channel) Configured in Test Loop Model 1.
2. KDB 941225 D01-Body SAR is not required for HSDPA when the maximum average output of each RF channel with HSDPA active is less than ¼ dB higher than measured without HSDPA using 12.2kbps RMC or the maximum SAR for 12.2kbps RMC is < 75% of SAR limit.
3. KDB 941225 D01-Body SAR is not required for HSUPA when the maximum average output of each RF channel with HSUPA active is less than ¼ dB higher than measured without HSUPA using 12.2kbps RMC and the maximum SAR for 12.2kbps RMC is < 75% of SAR limit.

**Bluetooth**

Mode	Channel frequency (MHz)	Reading power (dBm)	Power output (mw)	Limit (mw)
BDR(GFSK)	(Low)2402	2.50	1.778	1000
	(Middle)2441	3.25	2.113	1000
	(High)2480	4.78	3.006	1000
EDR(4-DQPSK)	(Low)2402	1.94	1.563	1000
	(Middle)2441	3.50	2.239	1000
	(High)2480	4.45	2.786	1000
EDR-8DPSK	(Low)2402	2.39	1.734	1000
	(Middle)2441	3.70	2.344	1000
	(High)2480	4.75	2.985	1000

**WiFi**

Band	Frequency (MHz)	Conducted Output Power	
		(dBm)	(mw)
802.11b	2412	9.80	9.550
	2437	9.76	9.462
	2462	9.58	9.078
802.11g	2412	9.23	8.375
	2437	9.32	8.551
	2462	9.37	8.650
802.11n-HT20	2412	9.24	8.395
	2437	9.32	8.551
	2462	9.22	8.356
802.11n-HT40	2422	9.56	9.036
	2437	9.69	9.311
	2452	9.60	9.120

**Note:**

1. The output power was tested under data rate 1Mbps for 802.11b, 6Mbps for 802.11g, 6.5Mbps for 802.11n-HT20 and 13.5Mbps for 802.11n-HT40.



## SAR MEASUREMENT RESULTS

This page summarizes the results of the performed dosimetric evaluation.

### SAR Test Data

#### Environmental Conditions

<b>Temperature:</b>	21-24 °C
<b>Relative Humidity:</b>	50-53 %
<b>ATM Pressure:</b>	1001-1002 mbar

Testing was performed by Wilson Chen from 2014-02-05 to 2014-02-06.

### GSM 850:

EUT Position	Frequency (MHz)		Test Mode	Power Drift (%)	Max. Meas. Power (dBm)	Max. Rated Power (dBm)	FCC 1g SAR (W/Kg)		
	Channel	MHz					Scaled Factor	Meas. SAR	Scaled SAR
Left Head Cheek	128(Low)	824.2	GSM	-0.957	32.76	33.00	1.057	0.767	0.811
	190(Middle)	836.6	GSM	0.342	32.84	33.00	1.038	0.734	0.762
	251(High)	848.8	GSM	-1.251	32.89	33.00	1.026	0.556	0.570
Left Head Tilt	128(Low)	824.2	GSM	/	/	/	/	/	/
	190(Middle)	836.6	GSM	0.869	32.84	33.00	1.038	0.255	0.265
	251(High)	848.8	GSM	/	/	/	/	/	/
Right Head Cheek	128(Low)	824.2	GSM	/	/	/	/	/	/
	190(Middle)	836.6	GSM	-1.936	32.84	33.00	1.038	0.636	0.660
	251(High)	848.8	GSM	/	/	/	/	/	/
Right Head Tilt	128(Low)	824.2	GSM	/	/	/	/	/	/
	190(Middle)	836.6	GSM	0.258	32.84	33.00	1.038	0.426	0.442
	251(High)	848.8	GSM	/	/	/	/	/	/
Body-Front-Headset (10mm)	128(Low)	824.2	GSM	/	/	/	/	/	/
	190(Middle)	836.6	GSM	0.987	32.84	33.00	1.038	0.387	0.402
	251(High)	848.8	GSM	/	/	/	/	/	/
Body-Back-Headset (10mm)	128(Low)	824.2	GSM	/	/	/	/	/	/
	190(Middle)	836.6	GSM	0.020	32.84	33.00	1.038	0.582	0.604
	251(High)	848.8	GSM	/	/	/	/	/	/

**PCS Band:**

EUT Position	Frequency (MHz)		Test Mode	Power Drift (%)	Max. Meas. Power (dBm)	Max. Rated Power (dBm)	FCC 1g SAR (W/Kg)		
	Channel	MHz					Scaled Factor	Meas. SAR	Scaled SAR
Left Head Cheek	512(Low)	1850.2	GSM	-0.391	29.23	29.50	1.064	0.665	0.708
	661(Middle)	1880.0	GSM	-0.087	29.31	29.50	1.045	0.692	0.723
	810(High)	1909.8	GSM	-0.733	29.37	29.50	1.030	0.666	0.686
Left Head Tilt	512(Low)	1850.2	GSM	/	/	/	/	/	/
	661(Middle)	1880.0	GSM	-0.232	29.31	29.50	1.045	0.211	0.220
	810(High)	1909.8	GSM	/	/	/	/	/	/
Right Head Cheek	512(Low)	1850.2	GSM	/	/	/	/	/	/
	661(Middle)	1880.0	GSM	0.589	29.31	29.50	1.045	0.464	0.485
	810(High)	1909.8	GSM	/	/	/	/	/	/
Right Head Tilt	512(Low)	1850.2	GSM	/	/	/	/	/	/
	661(Middle)	1880.0	GSM	-0.597	29.31	29.50	1.045	0.236	0.247
	810(High)	1909.8	GSM	/	/	/	/	/	/
Body-Front-Headset (10mm)	512(Low)	1850.2	GSM	/	/	/	/	/	/
	661(Middle)	1880.0	GSM	0.395	29.31	29.50	1.045	0.441	0.461
	810(High)	1909.8	GSM	/	/	/	/	/	/
Body-Back-Headset (10mm)	512(Low)	1850.2	GSM	/	/	/	/	/	/
	661(Middle)	1880.0	GSM	-0.737	29.31	29.50	1.045	0.571	0.597
	810(High)	1909.8	GSM	/	/	/	/	/	/

**Note:**

1. When the 1-g SAR is  $\leq 0.8\text{W/Kg}$ , testing for other channels are optional.
2. The EUT transmit and receive through the same GSM antenna while testing SAR.
3. When SAR or MPE is not measured at the maximum power level allowed for production units, the results must be scaled to the maximum tune-up tolerance limit according to the power applied to the individual channels tested to determine compliance.

**WCDMA 850**

EUT Position	Frequency (MHz)		Test Mode	Power Drift (%)	Max. Meas. Power (dBm)	Max. Rated Power (dBm)	FCC 1g SAR (W/Kg)		
	Channel	MHz					Scaled Factor	Meas. SAR	Scaled SAR
Left Head Cheek	4132	826.4	WCDMA 850	/	/	/	/	/	/
	4183	836.6	WCDMA 850	-1.678	22.61	23.00	1.094	0.582	0.637
	4233	846.6	WCDMA 850	/	/	/	/	/	/
Left Head Tilt	4132	826.4	WCDMA 850	/	/	/	/	/	/
	4183	836.6	WCDMA 850	1.441	22.61	23.00	1.094	0.319	0.349
	4233	846.6	WCDMA 850	/	/	/	/	/	/
Right Head Cheek	4132	826.4	WCDMA 850	/	/	/	/	/	/
	4183	836.6	WCDMA 850	1.452	22.61	23.00	1.094	0.293	0.321
	4233	846.6	WCDMA 850	/	/	/	/	/	/
Right Head Tilt	4132	826.4	WCDMA 850	/	/	/	/	/	/
	4183	836.6	WCDMA 850	1.700	22.61	23.00	1.094	0.269	0.294
	4233	846.6	WCDMA 850	/	/	/	/	/	/

**WCDMA1900**

EUT Position	Frequency (MHz)		Test Mode	Power Drift (%)	Max. Meas. Power (dBm)	Max. Rated Power (dBm)	FCC 1g SAR (W/Kg)		
	Channel	MHz					Scaled Factor	Meas. SAR	Scaled SAR
Left Head Cheek	9262	1852.4	WCDMA1900	-0.405	22.45	23.00	1.135	0.869	0.986
	9400	1880.0	WCDMA1900	-0.589	22.58	23.00	1.102	0.898	0.989
	9538	1907.6	WCDMA1900	-0.564	22.56	23.00	1.107	0.895	0.990
Left Head Tilt	9262	1852.4	WCDMA1900	/	/	/	/	/	/
	9400	1880.0	WCDMA1900	-1.529	22.58	23.00	1.102	0.307	0.338
	9538	1907.6	WCDMA1900	/	/	/	/	/	/
Right Head Cheek	9262	1852.4	WCDMA1900	/	/	/	/	/	/
	9400	1880.0	WCDMA1900	-1.490	22.58	23.00	1.102	0.54	0.595
	9538	1907.6	WCDMA1900	/	/	/	/	/	/
Right Head Tilt	9262	1852.4	WCDMA1900	/	/	/	/	/	/
	9400	1880.0	WCDMA1900	3.914	22.58	23.00	1.102	0.392	0.432
	9538	1907.6	WCDMA1900	/	/	/	/	/	/

**Note:**

1. When the 1-g SAR is  $\leq 0.8$ W/Kg, testing for other channels are optional.
2. The default test configuration is to measure SAR with an established radio link between the EUT and a communication test set using a 12.2 kbps RMC (reference measurement Channel) Configured in Test Loop Model.
3. KDB 941225 D01-Body SAR is not required for HSDPA when the maximum average output of each RF channel with HSDPA active is less than  $\frac{1}{4}$  dB higher than measured without HSDPA using 12.2kbps RMC or the maximum SAR for 12.2kbps RMC is  $< 75\%$  of SAR limit.

4. KDB 941225 D01-Body SAR is not required for HSUPA when the maximum average output of each RF channel with HSUPA active is less than ¼ dB higher than measured without HSUPA using 12.2kbps RMC and the maximum SAR for 12.2kbps RMC is < 75% of SAR limit.
5. When SAR or MPE is not measured at the maximum power level allowed for production units, the results must be scaled to the maximum tune-up tolerance limit according to the power applied to the individual channels tested to determine compliance.

**Mobile Hot-Spot Test Result**

The DUT is capable of functioning as a WiFi to Cellular Mobile hotspot. Additional SAR testing was performed according to KDB 941225 D06. Testing was performed with a separation of 1cm between the DUT and the flat phantom. The DUT was positioned for SAR tests with the front and back surfaces facing the phantom, and also with the edges facing the phantom in which the transmitting antenna is <2.5 cm from the edge. Each transmit band was utilized for SAR testing. The tested mode has been selected within each band that exhibits the highest time average output power.

**Hot spot-GPRS (Frequency Band: 835)**

EUT Position	Frequency (MHz)		Test Mode	Power Drift (%)	Max. Meas. Power (dBm)	Max. Rated Power (dBm)	FCC 1g SAR (W/Kg)		
	Channel	MHz					Scaled Factor	Meas. SAR	Scaled SAR
Body-Front (10mm)	128(Low)	824.2	GPRS	-0.395	32.04	32.50	1.112	0.909	1.011
	190(Middle)	836.6	GPRS	-0.982	32.06	32.50	1.107	0.96	1.062
	251(High)	848.8	GPRS	-0.757	32.05	32.50	1.109	0.892	0.989
Body-Back (10mm)	128(Low)	824.2	GPRS	2.916	32.04	32.50	1.112	1.201	1.335
	190(Middle)	836.6	GPRS	0.589	32.06	32.50	1.107	1.223	1.353
	251(High)	848.8	GPRS	4.296	32.05	32.50	1.109	1.173	1.301
Body-Left (10mm)	128(Low)	824.2	GPRS	/	/	/	/	/	/
	190(Middle)	836.6	GPRS	-0.067	32.06	32.50	1.107	0.456	0.505
	251(High)	848.8	GPRS	/	/	/	/	/	/
Body-Right (10mm)	128(Low)	824.2	GPRS	/	/	/	/	/	/
	190(Middle)	836.6	GPRS	-3.167	32.06	32.50	1.107	0.45	0.498
	251(High)	848.8	GPRS	/	/	/	/	/	/
Body-Bottom (10mm)	128(Low)	824.2	GPRS	/	/	/	/	/	/
	190(Middle)	836.6	GPRS	0.599	32.06	32.50	1.107	0.145	0.160
	251(High)	848.8	GPRS	/	/	/	/	/	/

**Note:**

1. When the 1-g SAR is ≤ 0.8W/Kg, testing for other channels are optional.
2. The EUT is a Capability Class B mobile phone which can be attached to both GPRS and GSM services.
3. The Multi-slot Classes of EUT is Class 12 which has maximum 4 Downlink slots and 4 Uplink slots, the maximum active slots is 5, when perform the multiple slots scan, 3DL+2UL is the worst case.
4. The EUT transmit and receive through the same GSM antenna while testing SAR.
5. When SAR or MPE is not measured at the maximum power level allowed for production units, the results must be scaled to the maximum tune-up tolerance limit according to the power applied to the individual channels tested to determine compliance.

**Hot spot-GPRS (Frequency Band: 1900)**

EUT Position	Frequency (MHz)		Test Mode	Power Drift (%)	Max. Meas. Power (dBm)	Max. Rated Power (dBm)	FCC 1g SAR (W/Kg)		
	Channel	MHz					Scaled Factor	Meas. SAR	Scaled SAR
Body-Front (10mm)	512(Low)	1850.2	GPRS	/	/	/	/	/	/
	661(Middle)	1880.0	GPRS	0.539	28.44	28.50	1.014	0.609	0.617
	810(High)	1909.8	GPRS	/	/	/	/	/	/
Body-Back (10mm)	512(Low)	1850.2	GPRS	-0.970	28.36	28.50	1.033	0.865	0.893
	661(Middle)	1880.0	GPRS	4.851	28.44	28.50	1.014	1.027	1.041
	810(High)	1909.8	GPRS	0.880	28.49	28.50	1.002	0.788	0.790
Body-Left (10mm)	512(Low)	1850.2	GPRS	/	/	/	/	/	/
	661(Middle)	1880.0	GPRS	0.903	28.44	28.50	1.014	0.165	0.167
	810(High)	1909.8	GPRS	/	/	/	/	/	/
Body-Right (10mm)	512(Low)	1850.2	GPRS	/	/	/	/	/	/
	661(Middle)	1880.0	GPRS	0.090	28.44	28.50	1.014	0.13	0.132
	810(High)	1909.8	GPRS	/	/	/	/	/	/
Body-Bottom (10mm)	512(Low)	1850.2	GPRS	/	/	/	/	/	/
	661(Middle)	1880.0	GPRS	0.035	28.44	28.50	1.014	0.203	0.206
	810(High)	1909.8	GPRS	/	/	/	/	/	/

**Note:**

1. When the 1-g SAR is  $\leq 0.8\text{W/Kg}$ , testing for other channels are optional.
2. The EUT is a Capability Class B mobile phone which can be attached to both GPRS and GSM services.
3. The Multi-slot Classes of EUT is Class12 which has maximum 4 Downlink slots and 4 Uplink slots, the maximum active slots is 5, when perform the multiple slots scan, 3DL+2UL is the worst case.
4. The EUT transmit and receive through the same GSM antenna while testing SAR.
5. When SAR or MPE is not measured at the maximum power level allowed for production units, the results must be scaled to the maximum tune-up tolerance limit according to the power applied to the individual channels tested to determine compliance.

**Hot Spot-WCDMA850**

EUT Position	Frequency (MHz)		Test Mode	Power Drift (%)	Max. Meas. Power (dBm)	Max. Rated Power (dBm)	FCC 1g SAR (W/Kg)		
	Channel	MHz					Scaled Factor	Meas. SAR	Scaled SAR
Body-Front (10mm)	4132	826.4	WCDMA850	/	/	/	/	/	/
	4183	836.6	WCDMA850	1.132	22.61	23.00	1.094	0.367	0.401
	4233	846.6	WCDMA850	/	/	/	/	/	/
Body-Back (10mm)	4132	826.4	WCDMA850	/	/	/	/	/	/
	4183	836.6	WCDMA850	-1.605	22.61	23.00	1.094	0.454	0.497
	4233	846.6	WCDMA850	/	/	/	/	/	/
Body-Left (10mm)	4132	826.4	WCDMA850	/	/	/	/	/	/
	4183	836.6	WCDMA850	0.026	22.61	23.00	1.094	0.214	0.234
	4233	846.6	WCDMA850	/	/	/	/	/	/
Body-Right (10mm)	4132	826.4	WCDMA850	/	/	/	/	/	/
	4183	836.6	WCDMA850	0.910	22.61	23.00	1.094	0.147	0.161
	4233	846.6	WCDMA850	/	/	/	/	/	/
Body-Bottom (10mm)	9262	826.4	WCDMA850	/	/	/	/	/	/
	9400	836.6	WCDMA850	2.001	22.61	23.00	1.094	0.036	0.039
	9538	846.6	WCDMA850	/	/	/	/	/	/

**Hot Spot-WCDMA1900**

EUT Position	Frequency (MHz)		Test Mode	Power Drift (%)	Max. Meas. Power (dBm)	Max. Rated Power (dBm)	FCC 1g SAR (W/Kg)		
	Channel	MHz					Scaled Factor	Meas. SAR	Scaled SAR
Body-Front (10mm)	9262	1852.4	WCDMA1900	/	/	/	/	/	/
	9400	1880.0	WCDMA1900	-3.192	22.58	23.00	1.102	0.472	0.520
	9538	1907.6	WCDMA1900	/	/	/	/	/	/
Body-Back (10mm)	9262	1852.4	WCDMA1900	1.367	22.45	23.00	1.135	1.097	1.245
	9400	1880.0	WCDMA1900	1.985	22.58	23.00	1.102	0.789	0.869
	9538	1907.6	WCDMA1900	1.104	22.56	23.00	1.107	0.855	0.946
Body-Left (10mm)	9262	1852.4	WCDMA1900	/	/	/	/	/	/
	9400	1880.0	WCDMA1900	-0.258	22.58	23.00	1.102	0.123	0.135
	9538	1907.6	WCDMA1900	/	/	/	/	/	/
Body-Right (10mm)	9262	1852.4	WCDMA1900	/	/	/	/	/	/
	9400	1880.0	WCDMA1900	-0.770	22.58	23.00	1.102	0.032	0.035
	9538	1907.6	WCDMA1900	/	/	/	/	/	/
Body-Bottom (10mm)	9262	1852.4	WCDMA1900	/	/	/	/	/	/
	9400	1880.0	WCDMA1900	-4.039	22.58	23.00	1.102	0.172	0.189
	9538	1907.6	WCDMA1900	/	/	/	/	/	/

**Note:**

1. When the 1-g SAR is  $\leq 0.8W/Kg$ , testing for other channels are optional.
2. The default test configuration is to measure SAR with an established radio link between the EUT and a communication test set using a 12.2 kbps RMC (reference measurement Channel) Configured in Test Loop Model.
3. KDB 941225 D01-Body SAR is not required for HSDPA when the maximum average output of each RF channel with HSDPA active is less than  $\frac{1}{4}$  dB higher than measured without HSDPA using 12.2kbps RMC or the maximum SAR for 12.2kbps RMC is  $< 75\%$  of SAR limit.
4. KDB 941225 D01-Body SAR is not required for HSUPA when the maximum average output of each RF channel with HSUPA active is less than  $\frac{1}{4}$  dB higher than measured without HSUPA using 12.2kbps RMC and the maximum SAR for 12.2kbps RMC is  $< 75\%$  of SAR limit.

## SAR SIMULTANEOUS TRANSMISSION DESCRIPTION

### KDB 447498D01 General RF Exposure Guidance v05

Stand-alone and simultaneous SAR evaluation for a cell phone with multiple transmitters is based on the antennas distance of each radio.

#### BT, WiFi, GSM and 3G Antenna Location:

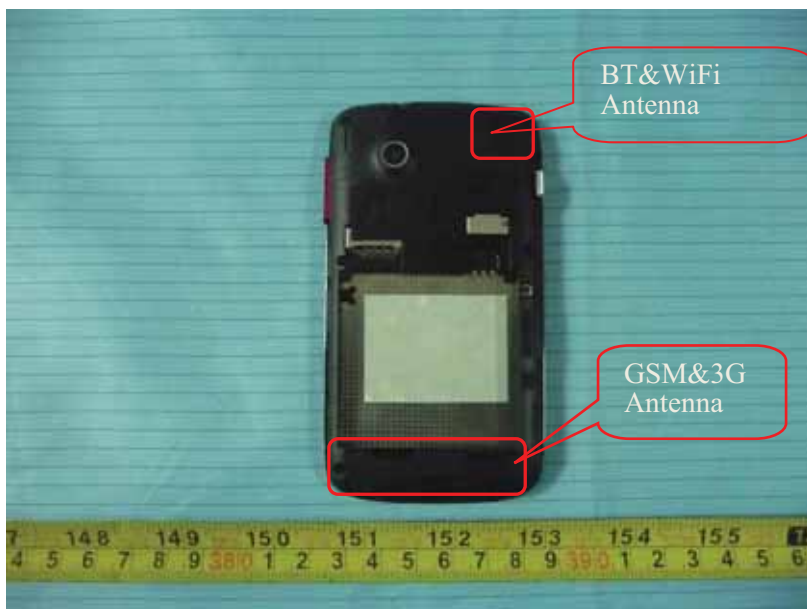

#### Antenna Information:

Description of Simultaneous Transmit Capabilities			Antennas Distance (mm)
Transmitter Combination	Simultaneous?	Hotspot?	
GSM + GPRS	×	×	0
GSM + WCDMA	×	×	0
GSM + Bluetooth	√	×	80
GSM + WiFi	√	√	80
GPRS + WCDMA	×	×	0
GPRS + Bluetooth	√	×	80
GPRS + WiFi	√	√	80
WCDMA + Bluetooth	√	×	80
WCDMA + WiFi	√	√	80



**Standalone SAR test exclusion considerations**

Head Position:

Mode	Frequency (MHz)	P <sub>avg</sub> (dBm)	P <sub>avg</sub> (mW)	Distance (mm)	Calculated value	Threshold (1-g)	SAR Test Exclusion
GSM850	850	23.89	244.906	0	45.2	3.0	No
PCS1900	1900	20.37	108.893	0	30.0	3.0	No
WCDMSA850	850	22.61	182.390	0	33.6	3.0	No
WCDMSA1900	1900	22.58	181.134	0	49.9	3.0	No
Bluetooth	2450	4.78	3.006	0	0.9	3.0	Yes
WiFi	2450	9.80	9.550	0	3.0	3.0	Yes

Body Position:

Mode	Frequency (MHz)	P <sub>avg</sub> (dBm)	P <sub>avg</sub> (mW)	Distance (mm)	Calculated value	Threshold (1-g)	SAR Test Exclusion
GSM850	850	26.06	403.645	10	37.2	3.0	No
PCS1900	1900	22.49	177.419	10	24.5	3.0	No
WCDMSA850	850	22.61	182.390	10	16.8	3.0	No
WCDMSA1900	1900	22.58	181.134	10	25.0	3.0	No
Bluetooth	2450	4.78	3.006	10	0.5	3.0	Yes
WiFi	2450	9.80	9.550	10	1.5	3.0	Yes

The 1-g and 10-g SAR test exclusion thresholds for 100 MHz to 6 GHz at *test separation distances* ≤ 50 mm are determined by:

$$[(\text{max. power of channel, including tune-up tolerance, mW}) / (\text{min. test separation distance, mm})] \cdot$$

$$[\sqrt{f(\text{GHz})}] \leq 3.0 \text{ for 1-g SAR and } \leq 7.5 \text{ for 10-g extremity SAR, where}$$

1. f(GHz) is the RF channel transmit frequency in GHz.
2. Power and distance are rounded to the nearest mW and mm before calculation.
3. The result is rounded to one decimal place for comparison.
4. When the minimum test separation distance is < 5 mm, a distance of 5 mm is applied to determine SAR test Exclusion.

**Simultaneous SAR test exclusion considerations:**

GSM with BT:

Mode	Position	Reported SAR (W/kg)		ΣSAR (W/kg)
		GSM	BT	
GSM850	Left Head Cheek	0.811	0.132	0.943
	Left Head Tile	0.265	0.132	0.397
	Right Head Cheek	0.660	0.132	0.792
	Right Head Tilt	0.442	0.132	0.574
	Body-Headset-Front	0.402	0.066	0.468
	Body-Headset-Back	0.604	0.066	0.670
PCS1900	Left Head Cheek	0.723	0.132	0.855
	Left Head Tile	0.220	0.132	0.352
	Right Head Cheek	0.485	0.132	0.617
	Right Head Tilt	0.247	0.132	0.379
	Body-Headset-Front	0.461	0.066	0.527
	Body-Headset-Back	0.597	0.066	0.663

WCDMA with BT:

Mode	Position	Reported SAR (W/kg)		ΣSAR (W/kg)
		WCDMA	BT	
WCDMA 850	Left Head Cheek	0.637	0.132	0.769
	Left Head Tile	0.349	0.132	0.481
	Right Head Cheek	0.321	0.132	0.453
	Right Head Tilt	0.294	0.132	0.426
	Body-Headset-Front	0.401	0.066	0.467
	Body-Headset-Back	0.497	0.066	0.563
WCDMA 1900	Left Head Cheek	0.990	0.132	1.122
	Left Head Tile	0.338	0.132	0.470
	Right Head Cheek	0.595	0.132	0.727
	Right Head Tilt	0.432	0.132	0.564
	Body-Headset-Front	0.520	0.066	0.586
	Body-Headset-Back	1.245	0.066	1.311

GSM with WiFi:

Mode	Position	Reported SAR (W/kg)		ΣSAR (W/kg)
		GSM	WiFi	
GSM850	Left Head Cheek	0.811	0.417	1.228
	Left Head Tile	0.265	0.417	0.682
	Right Head Cheek	0.660	0.417	1.077
	Right Head Tilt	0.442	0.417	0.859
	Body-Headset-Front	0.402	0.209	0.611
	Body-Headset-Back	0.604	0.209	0.813
PCS1900	Left Head Cheek	0.723	0.417	1.140
	Left Head Tile	0.220	0.417	0.637
	Right Head Cheek	0.485	0.417	0.902
	Right Head Tilt	0.247	0.417	0.664
	Body-Headset-Front	0.461	0.209	0.670
	Body-Headset-Back	0.597	0.209	0.806

WCDMA with WiFi:

Mode	Position	Reported SAR (W/kg)		ΣSAR (W/kg)
		WCDMA	WiFi	
WCDMA 850	Left Head Cheek	0.637	0.417	1.054
	Left Head Tile	0.349	0.417	0.766
	Right Head Cheek	0.321	0.417	0.738
	Right Head Tilt	0.294	0.417	0.711
	Body-Headset-Front	0.401	0.209	0.610
	Body-Headset-Back	0.497	0.209	0.706
WCDMA 1900	Left Head Cheek	0.990	0.417	<b>1.407</b>
	Left Head Tile	0.338	0.417	0.755
	Right Head Cheek	0.595	0.417	1.012
	Right Head Tilt	0.432	0.417	0.849
	Body-Headset-Front	0.520	0.209	0.729
	Body-Headset-Back	1.245	0.209	1.454

Mode	Frequency (GHz)	Distance (mm)	P <sub>avg</sub> (dBm)	P <sub>avg</sub> (mW)	Estimated 1-g (W/kg)
Bluetooth Head	2.45	0	5.00	3.162	0.132
Bluetooth Body	2.45	10	5.00	3.162	0.066
WiFi Head	2.45	0	10.00	10.000	0.417
WiFi Body	2.45	10	10.00	10.000	0.209

**Note:**

When standalone SAR test exclusion applies to an antenna that transmits simultaneously with other antennas, the standalone SAR must be estimated according to following to determine simultaneous transmission SAR test exclusion:

$$[(\text{max. power of channel, including tune-up tolerance, mW})/(\text{min. test separation distance, mm})] \cdot [\sqrt{f(\text{GHz})}/x]$$

W/kg for test separation distances  $\leq 50$  mm;

where  $x = 7.5$  for 1-g SAR.

When the minimum test separation distance is  $< 5$  mm, a distance of 5 mm is applied to determine SAR test Exclusion

**Conclusion:**

$\Sigma$ SAR  $< 1.6$  W/kg therefore simultaneous transmission SAR with Volume Scans is **not** required.

Hotspot:

Evaluations for Simultaneous SAR, Mobile Hot Spot Positions						
Test Position	Body-Front (1.0cm)	Body-Back (1.0cm)	Body-Left (1.0cm)	Body-Right (1.0cm)	Body-Bottom (1.0cm)	Body-Top (1.0cm)
Mode	Stand Alone 1-g SAR (W/Kg)					
GSM 850	1.062	1.353	0.505	0.498	0.160	/
PCS 1900	0.617	1.041	0.167	0.132	0.206	/
WCDMA850	0.401	0.497	0.234	0.161	0.039	/
WCDMA 1900	0.520	1.245	0.135	0.035	0.189	/
WiFi	0.209	0.209	0.209	/	/	0.209
	$\Sigma$ 1-g SAR(W/Kg)					
GSM850 + WiFi	1.271	<b>1.562</b>	0.714	/	/	/
PCS 1900 + WiFi	0.826	1.250	0.376	/	/	/
WCDMA850 + WiFi	0.610	0.706	0.443	/	/	/
WCDMA 1900 + WiFi	0.729	1.454	0.344	/	/	/

**Note:**

If the sum of the 1g SAR measured for the simultaneously transmitting antennas is less than the SAR limit, SAR measurement for simultaneous transmission is not required.

**EUT SCAN RESULTS**

**Test Laboratory: Bay Area Compliance Lab Corp. (Shenzhen)**

**Left Head Cheek (824.2 MHz Low Channel)**

Measurement Data

Test mode : GSM  
 Crest Factor : 8  
 Scan Type : Complete  
 Area Scan : 11x8x1: Measurement x=10mm, y=10mm, z=4mm  
 Zoom Scan : 7x7x7: Measurement x=5mm, y=5mm, z=5mm  
 Power Drift-Start : 0.012 W/kg  
 Power Drift-Finish : 0.012 W/kg  
 Power Drift (%) : -0.957

Tissue Data

Type : Head  
 Frequency : 824.2 MHz  
 Epsilon : 41.10 F/m  
 Sigma : 0.90 S/m  
 Density : 1000.00 kg/cu. m

Probe Data

Serial No. : 500-00283  
 Frequency Band : 835  
 Duty Cycle Factor : 8  
 Conversion Factor : 5.9  
 Probe Sensitivity : 1.20 1.20 1.20  $\mu\text{V}/(\text{V}/\text{m})^2$   
 Compression Point : 95.00 mV  
 Offset : 1.56 mm

1 gram SAR value : 0.767 W/kg  
 10 gram SAR value : 0.483 W/kg  
 Area Scan Peak SAR : 0.931 W/kg  
 Zoom Scan Peak SAR : 1.261 W/kg

**Plot 1#**

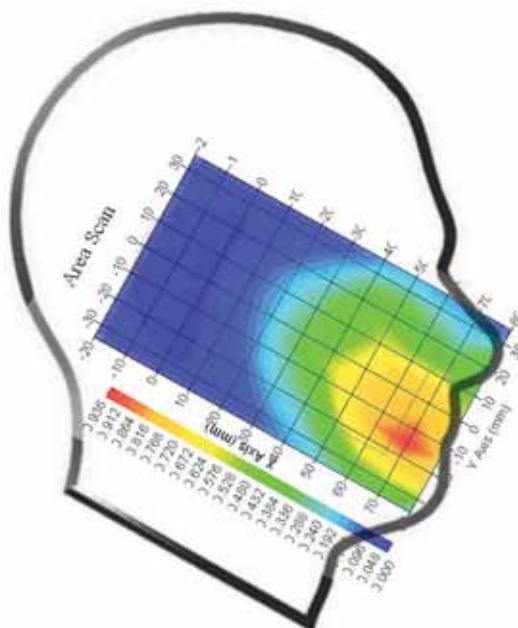

**Test Laboratory: Bay Area Compliance Lab Corp. (Shenzhen)**

**Left Head Cheek (836.6 MHz Middle Channel)**

Measurement Data

Test mode : GSM  
 Crest Factor : 8  
 Scan Type : Complete  
 Area Scan : 11x8x1: Measurement x=10mm, y=10mm, z=4mm  
 Zoom Scan : 7x7x7: Measurement x=5mm, y=5mm, z=5mm  
 Power Drift-Start : 0.001 W/kg  
 Power Drift-Finish : 0.001 W/kg  
 Power Drift (%) : 0.342

Tissue Data

Type : Head  
 Frequency : 836.6 MHz  
 Epsilon : 41.04 F/m  
 Sigma : 0.91 S/m  
 Density : 1000.00 kg/cu. m

Probe Data

Serial No. : 500-00283  
 Frequency Band : 835  
 Duty Cycle Factor : 8  
 Conversion Factor : 5.9  
 Probe Sensitivity : 1.20 1.20 1.20  $\mu\text{V}/(\text{V}/\text{m})^2$   
 Compression Point : 95.00 mV  
 Offset : 1.56 mm

1 gram SAR value : 0.734 W/kg  
 10 gram SAR value : 0.453 W/kg  
 Area Scan Peak SAR : 0.851 W/kg  
 Zoom Scan Peak SAR : 1.521 W/kg

**Plot 2#**

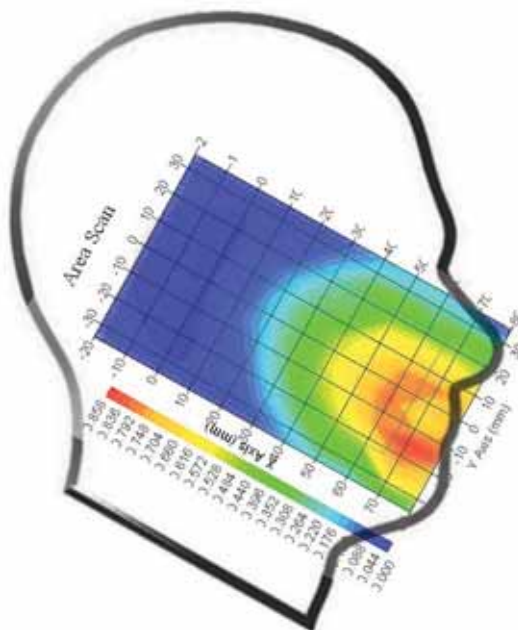

**Test Laboratory: Bay Area Compliance Lab Corp. (Shenzhen)**

**Left Head Cheek (848.8 MHz High Channel)**

Measurement Data

Test mode : GSM  
 Crest Factor : 8  
 Scan Type : Complete  
 Area Scan : 11x8x1: Measurement x=10mm, y=10mm, z=4mm  
 Zoom Scan : 7x7x7: Measurement x=5mm, y=5mm, z=5mm  
 Power Drift-Start : 0.005 W/kg  
 Power Drift-Finish : 0.005 W/kg  
 Power Drift (%) : -1.251

Tissue Data

Type : Head  
 Frequency : 848.8 MHz  
 Epsilon : 40.82 F/m  
 Sigma : 0.93 S/m  
 Density : 1000.00 kg/cu. m

Probe Data

Serial No. : 500-00283  
 Frequency Band : 835  
 Duty Cycle Factor : 8  
 Conversion Factor : 5.9  
 Probe Sensitivity : 1.20 1.20 1.20  $\mu\text{V}/(\text{V}/\text{m})^2$   
 Compression Point : 95.00 mV  
 Offset : 1.56 mm

1 gram SAR value : 0.556 W/kg  
 10 gram SAR value : 0.329 W/kg  
 Area Scan Peak SAR : 0.688 W/kg  
 Zoom Scan Peak SAR : 1.010 W/kg

**Plot 3#**

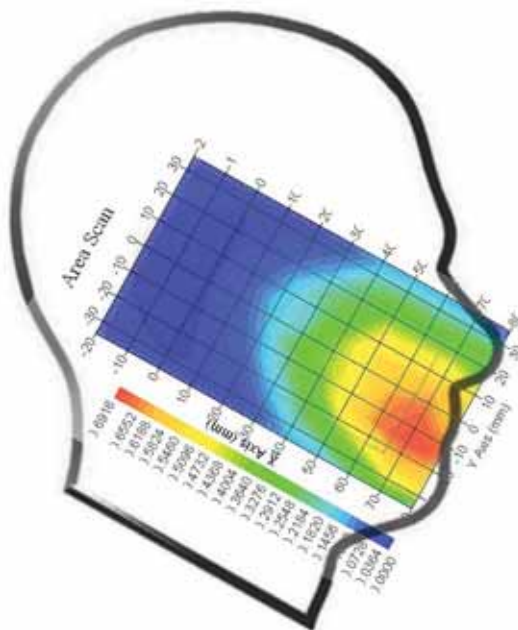

**Test Laboratory: Bay Area Compliance Lab Corp. (Shenzhen)**

**Left Head Tilt (836.6 MHz Middle Channel)**

Measurement Data

Test mode : GSM  
 Crest Factor : 8  
 Scan Type : Complete  
 Area Scan : 11x8x1: Measurement x=10mm, y=10mm, z=4mm  
 Zoom Scan : 7x7x7: Measurement x=5mm, y=5mm, z=5mm  
 Power Drift-Start : 0.046 W/kg  
 Power Drift-Finish : 0.046 W/kg  
 Power Drift (%) : 0.869

Tissue Data

Type : Head  
 Frequency : 836.6 MHz  
 Epsilon : 41.04 F/m  
 Sigma : 0.91 S/m  
 Density : 1000.00 kg/cu. m

Probe Data

Serial No. : 500-00283  
 Frequency Band : 835  
 Duty Cycle Factor : 8  
 Conversion Factor : 5.9  
 Probe Sensitivity : 1.20 1.20 1.20  $\mu\text{V}/(\text{V}/\text{m})^2$   
 Compression Point : 95.00 mV  
 Offset : 1.56 mm

1 gram SAR value : 0.255 W/kg  
 10 gram SAR value : 0.176 W/kg  
 Area Scan Peak SAR : 0.329 W/kg  
 Zoom Scan Peak SAR : 0.450 W/kg

**Plot 4#**

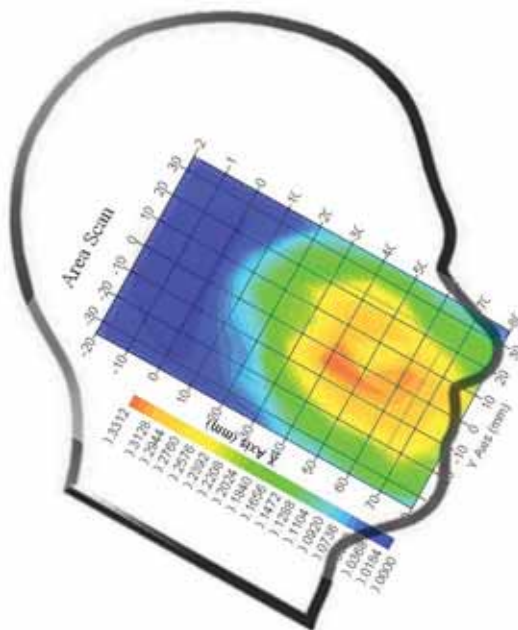



**Test Laboratory: Bay Area Compliance Lab Corp. (Shenzhen)**

**Right Head Cheek (836.6 MHz Middle Channel)**

Measurement Data

Test mode : GSM  
 Crest Factor : 8  
 Scan Type : Complete  
 Area Scan : 11x8x1: Measurement x=10mm, y=10mm, z=4mm  
 Zoom Scan : 7x7x7: Measurement x=5mm, y=5mm, z=5mm  
 Power Drift-Start : 0.005 W/kg  
 Power Drift-Finish : 0.004 W/kg  
 Power Drift (%) : -1.936

Tissue Data

Type : Head  
 Frequency : 836.6 MHz  
 Epsilon : 41.04 F/m  
 Sigma : 0.91 S/m  
 Density : 1000.00 kg/cu. m

Probe Data

Serial No. : 500-00283  
 Frequency Band : 835  
 Duty Cycle Factor : 8  
 Conversion Factor : 5.9  
 Probe Sensitivity : 1.20 1.20 1.20  $\mu\text{V}/(\text{V}/\text{m})^2$   
 Compression Point : 95.00 mV  
 Offset : 1.56 mm

1 gram SAR value : 0.636 W/kg  
 10 gram SAR value : 0.405 W/kg  
 Area Scan Peak SAR : 0.839 W/kg  
 Zoom Scan Peak SAR : 1.341 W/kg

**Plot 5#**

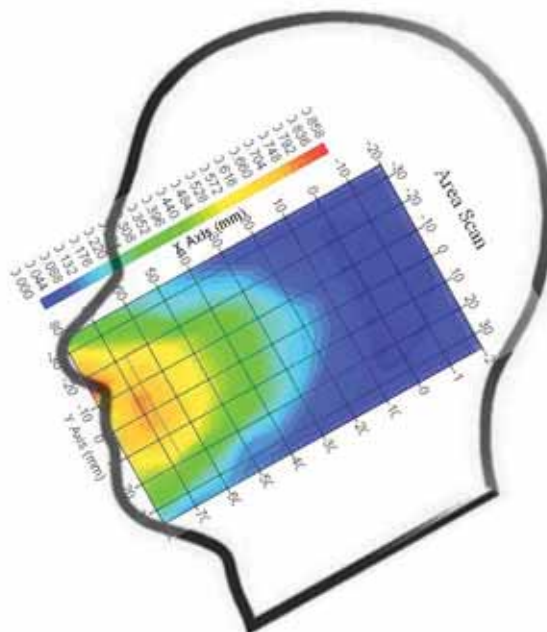

**Test Laboratory: Bay Area Compliance Lab Corp. (Shenzhen)**

**Right Head Tilt (836.6 MHz Middle Channel)**

Measurement Data

Test mode : GSM  
 Crest Factor : 8  
 Scan Type : Complete  
 Area Scan : 11x8x1: Measurement x=10mm, y=10mm, z=4mm  
 Zoom Scan : 7x7x7: Measurement x=5mm, y=5mm, z=5mm  
 Power Drift-Start : 0.049 W/kg  
 Power Drift-Finish : 0.049 W/kg  
 Power Drift (%) : 0.258

Tissue Data

Type : Head  
 Frequency : 836.6 MHz  
 Epsilon : 41.04 F/m  
 Sigma : 0.91 S/m  
 Density : 1000.00 kg/cu. m

Probe Data

Serial No. : 500-00283  
 Frequency Band : 835  
 Duty Cycle Factor : 8  
 Conversion Factor : 5.9  
 Probe Sensitivity : 1.20 1.20 1.20  $\mu\text{V}/(\text{V}/\text{m})^2$   
 Compression Point : 95.00 mV  
 Offset : 1.56 mm

1 gram SAR value : 0.426 W/kg  
 10 gram SAR value : 0.148 W/kg  
 Area Scan Peak SAR : 0.431 W/kg  
 Zoom Scan Peak SAR : 0.740 W/kg

**Plot 6#**

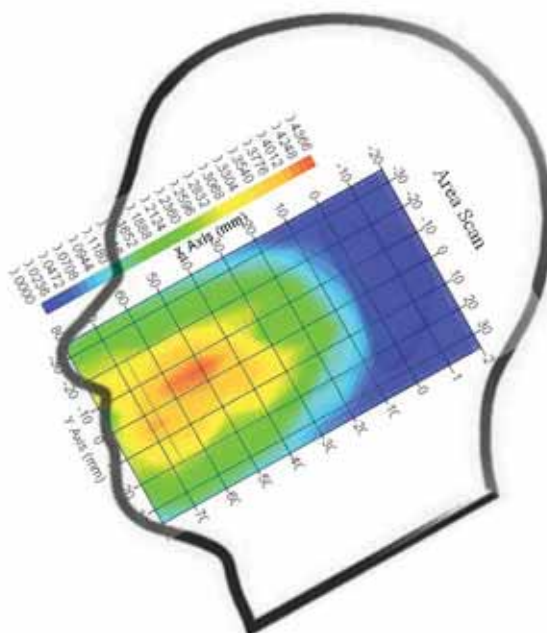

**Test Laboratory: Bay Area Compliance Lab Corp. (Shenzhen)**

**Body-worn Front-Headset (836.6 MHz Middle Channel)**

Measurement Data

Test mode : GSM  
 Crest Factor : 8  
 Scan Type : Complete  
 Area Scan : 8x11x1 : Measurement x=10mm, y=10mm, z=4mm  
 Zoom Scan : 7x7x7 : Measurement x=5mm, y=5mm, z=5mm  
 Power Drift-Start : 0.226 W/kg  
 Power Drift-Finish : 0.226 W/kg  
 Power Drift (%) : 0.987

Tissue Data

Type : Body  
 Frequency : 836.6 MHz  
 Epsilon : 55.23 F/m  
 Sigma : 0.96 S/m  
 Density : 1000.00 kg/cu. m

Probe Data

Serial No. : 500-00283  
 Frequency Band : 835  
 Duty Cycle Factor : 8  
 Conversion Factor : 5.9  
 Probe Sensitivity : 1.20 1.20 1.20  $\mu\text{V}/(\text{V}/\text{m})^2$   
 Compression Point : 95.00 mV  
 Offset : 1.56 mm

1 gram SAR value : 0.387 W/kg  
 10 gram SAR value : 0.220 W/kg  
 Area Scan Peak SAR : 0.414 W/kg  
 Zoom Scan Peak SAR : 0.900 W/kg

**Plot 7#**

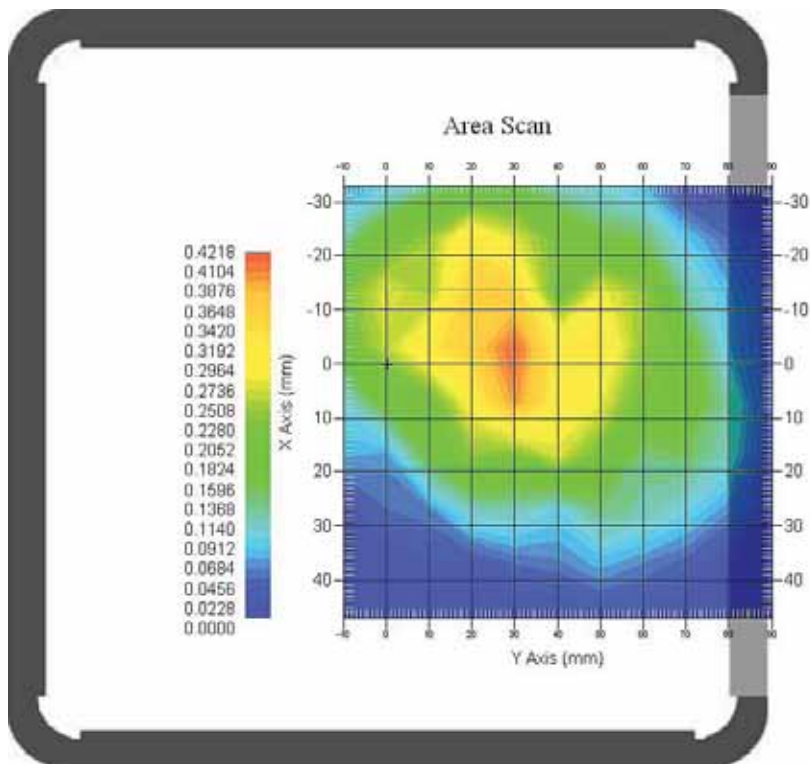

**Test Laboratory: Bay Area Compliance Lab Corp. (Shenzhen)**

**Body-worn Back-Headset (836.6 MHz Middle Channel)**

Measurement Data

Test mode : GSM  
 Crest Factor : 8  
 Scan Type : Complete  
 Area Scan : 8x11x1 : Measurement x=10mm, y=10mm, z=4mm  
 Zoom Scan : 7x7x7 : Measurement x=5mm, y=5mm, z=5mm  
 Power Drift-Start : 0.539 W/kg  
 Power Drift-Finish : 0.541 W/kg  
 Power Drift (%) : 0.020

Tissue Data

Type : Body  
 Frequency : 836.6 MHz  
 Epsilon : 55.23 F/m  
 Sigma : 0.96 S/m  
 Density : 1000.00 kg/cu. m

Probe Data

Serial No. : 500-00283  
 Frequency Band : 835  
 Duty Cycle Factor : 8  
 Conversion Factor : 5.9  
 Probe Sensitivity : 1.20 1.20 1.20  $\mu\text{V}/(\text{V}/\text{m})^2$   
 Compression Point : 95.00 mV  
 Offset : 1.56 mm

1 gram SAR value : 0.582 W/kg  
 10 gram SAR value : 0.362 W/kg  
 Area Scan Peak SAR : 0.661 W/kg  
 Zoom Scan Peak SAR : 0.900 W/kg

**Plot 8#**

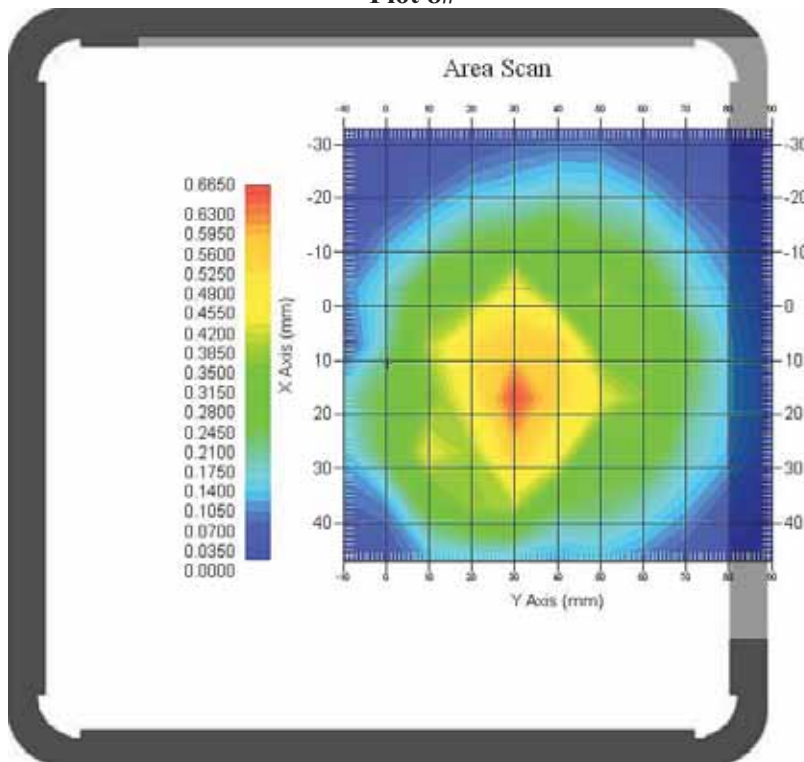

**Test Laboratory: Bay Area Compliance Lab Corp. (Shenzhen)**

**Left Head Cheek (1850.2 MHz Low Channel)**

Measurement Data

Test mode : GSM  
 Crest Factor : 8  
 Scan Type : Complete  
 Area Scan : 11x8x1 : Measurement x=10mm, y=10mm, z=4mm  
 Zoom Scan : 7x7x7 : Measurement x=5mm, y=5mm, z=5mm  
 Power Drift-Start : 0.031 W/kg  
 Power Drift-Finish : 0.031 W/kg  
 Power Drift (%) : -0.391

Tissue Data

Type : Head  
 Frequency : 1850.2 MHz  
 Epsilon : 40.14 F/m  
 Sigma : 1.38 S/m  
 Density : 1000.00 kg/cu. m

Probe Data

Serial No. : 500-00283  
 Frequency Band : 1900  
 Duty Cycle Factor : 8  
 Conversion Factor : 4.8  
 Probe Sensitivity : 1.20 1.20 1.20  $\mu\text{V}/(\text{V}/\text{m})^2$   
 Compression Point : 95.00 mV  
 Offset : 1.56 mm

1 gram SAR value : 0.665 W/kg  
 10 gram SAR value : 0.357 W/kg  
 Area Scan Peak SAR : 0.677 W/kg  
 Zoom Scan Peak SAR : 1.221 W/kg

**Plot 9#**

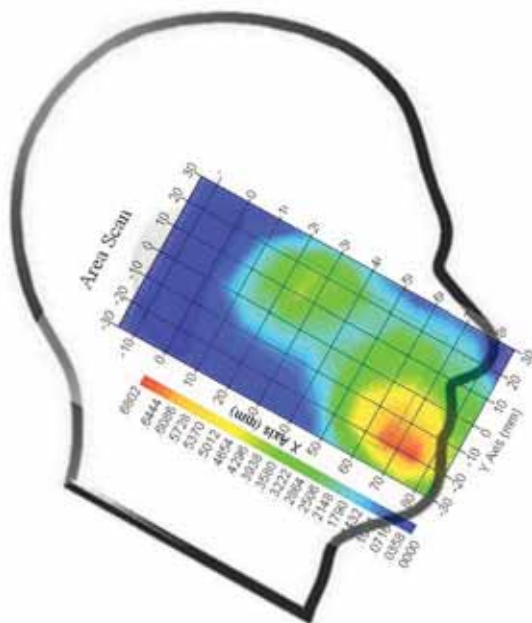

**Test Laboratory: Bay Area Compliance Lab Corp. (Shenzhen)**

**Left Head Cheek (1880 MHz Middle Channel)**

Measurement Data

Test mode : GSM  
 Crest Factor : 8  
 Scan Type : Complete  
 Area Scan : 11x8x1 : Measurement x=10mm, y=10mm, z=4mm  
 Zoom Scan : 7x7x7 : Measurement x=5mm, y=5mm, z=5mm  
 Power Drift-Start : 0.032 W/kg  
 Power Drift-Finish : 0.032 W/kg  
 Power Drift (%) : -0.087

Tissue Data

Type : Head  
 Frequency : 1880 MHz  
 Epsilon : 40.19 F/m  
 Sigma : 1.40 S/m  
 Density : 1000.00 kg/cu. m

Probe Data

Serial No. : 500-00283  
 Frequency Band : 1900  
 Duty Cycle Factor : 8  
 Conversion Factor : 4.8  
 Probe Sensitivity : 1.20 1.20 1.20  $\mu\text{V}/(\text{V}/\text{m})^2$   
 Compression Point : 95.00 mV  
 Offset : 1.56 mm

1 gram SAR value : 0.692 W/kg  
 10 gram SAR value : 0.377 W/kg  
 Area Scan Peak SAR : 0.651 W/kg  
 Zoom Scan Peak SAR : 1.391 W/kg

**Plot 10#**

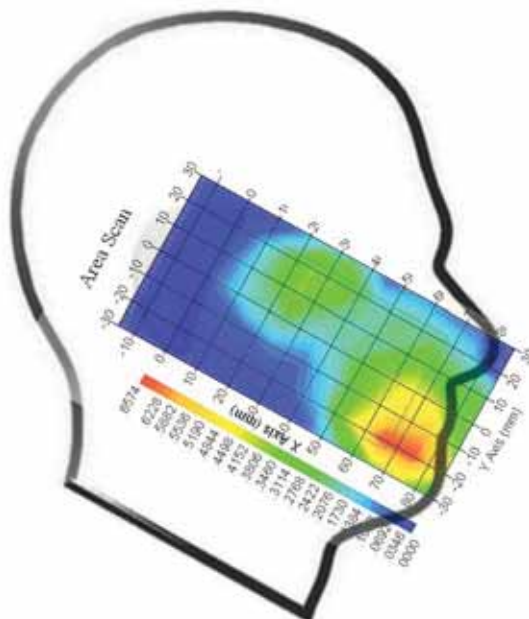

**Test Laboratory: Bay Area Compliance Lab Corp. (Shenzhen)**

**Left Head Cheek (1909.8 MHz High Channel)**

Measurement Data

Test mode : GSM  
 Crest Factor : 8  
 Scan Type : Complete  
 Area Scan : 11x8x1 : Measurement x=10mm, y=10mm, z=4mm  
 Zoom Scan : 7x7x7 : Measurement x=5mm, y=5mm, z=5mm  
 Power Drift-Start : 0.039 W/kg  
 Power Drift-Finish : 0.039 W/kg  
 Power Drift (%) : -0.733

Tissue Data

Type : Head  
 Frequency : 1909.8 MHz  
 Epsilon : 40.29 F/m  
 Sigma : 1.42 S/m  
 Density : 1000.00 kg/cu. m

Probe Data

Serial No. : 500-00283  
 Frequency Band : 1900  
 Duty Cycle Factor : 8  
 Conversion Factor : 4.8  
 Probe Sensitivity : 1.20 1.20 1.20  $\mu\text{V}/(\text{V}/\text{m})^2$   
 Compression Point : 95.00 mV  
 Offset : 1.56 mm

1 gram SAR value : 0.666 W/kg  
 10 gram SAR value : 0.347 W/kg  
 Area Scan Peak SAR : 0.676 W/kg  
 Zoom Scan Peak SAR : 1.231 W/kg

**Plot 11#**

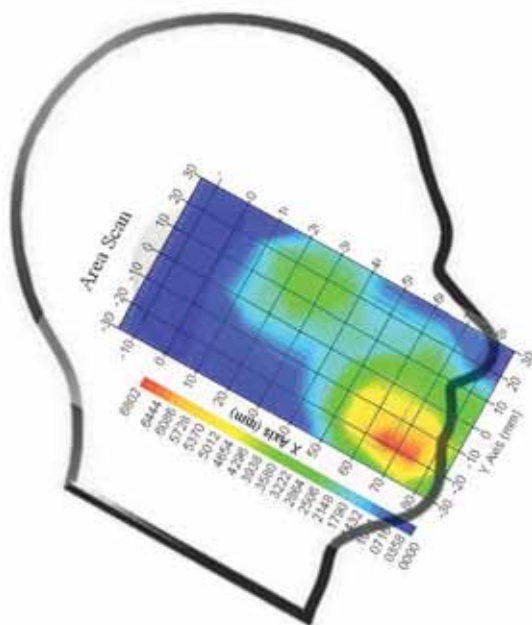

**Test Laboratory: Bay Area Compliance Lab Corp. (Shenzhen)**

**Left Head Tilt (1880 MHz Middle Channel)**

Measurement Data

Test mode : GSM  
 Crest Factor : 8  
 Scan Type : Complete  
 Area Scan : 11x8x1 : Measurement x=10mm, y=10mm, z=4mm  
 Zoom Scan : 7x7x7 : Measurement x=5mm, y=5mm, z=5mm  
 Power Drift-Start : 0.100 W/kg  
 Power Drift-Finish : 0.100 W/kg  
 Power Drift (%) : -0.232

Tissue Data

Type : Head  
 Frequency : 1880 MHz  
 Epsilon : 40.19 F/m  
 Sigma : 1.40 S/m  
 Density : 1000.00 kg/cu. M

Probe Data

Serial No. : 500-00283  
 Frequency Band : 1900  
 Duty Cycle Factor : 8  
 Conversion Factor : 4.8  
 Probe Sensitivity : 1.20 1.20 1.20  $\mu\text{V}/(\text{V}/\text{m})^2$   
 Compression Point : 95.00 mV  
 Offset : 1.56 mm

1 gram SAR value : 0.211 W/kg  
 10 gram SAR value : 0.136 W/kg  
 Area Scan Peak SAR : 0.201 W/kg  
 Zoom Scan Peak SAR : 0.320 W/kg

**Plot 12#**

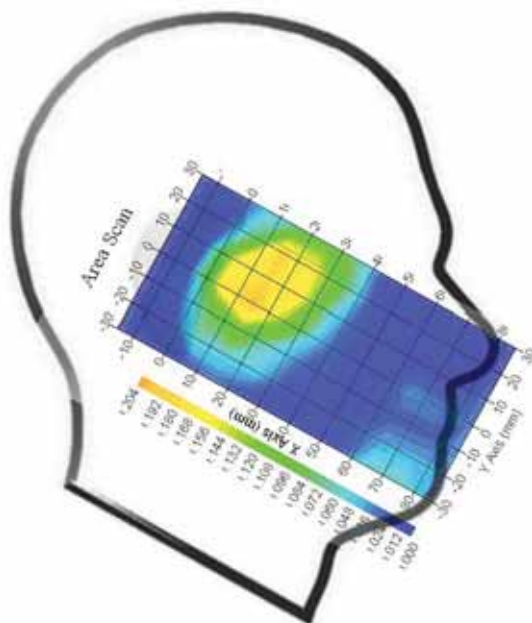



**Test Laboratory: Bay Area Compliance Lab Corp. (Shenzhen)**

**Right Head Cheek (1880 MHz Middle Channel)**

Measurement Data

Test mode : GSM  
 Crest Factor : 8  
 Scan Type : Complete  
 Area Scan : 11x8x1 : Measurement x=10mm, y=10mm, z=4mm  
 Zoom Scan : 7x7x7 : Measurement x=5mm, y=5mm, z=5mm  
 Power Drift-Start : 0.001 W/kg  
 Power Drift-Finish : 0.001 W/kg  
 Power Drift (%) : 0.589

Tissue Data

Type : Head  
 Frequency : 1880 MHz  
 Epsilon : 40.19 F/m  
 Sigma : 1.40 S/m  
 Density : 1000.00 kg/cu. m

Probe Data

Serial No. : 500-00283  
 Frequency Band : 1900  
 Duty Cycle Factor : 8  
 Conversion Factor : 4.8  
 Probe Sensitivity : 1.20 1.20 1.20  $\mu\text{V}/(\text{V}/\text{m})^2$   
 Compression Point : 95.00 mV  
 Offset : 1.56 mm

1 gram SAR value : 0.464 W/kg  
 10 gram SAR value : 0.253 W/kg  
 Area Scan Peak SAR : 0.491 W/kg  
 Zoom Scan Peak SAR : 0.640 W/kg

**Plot 13#**

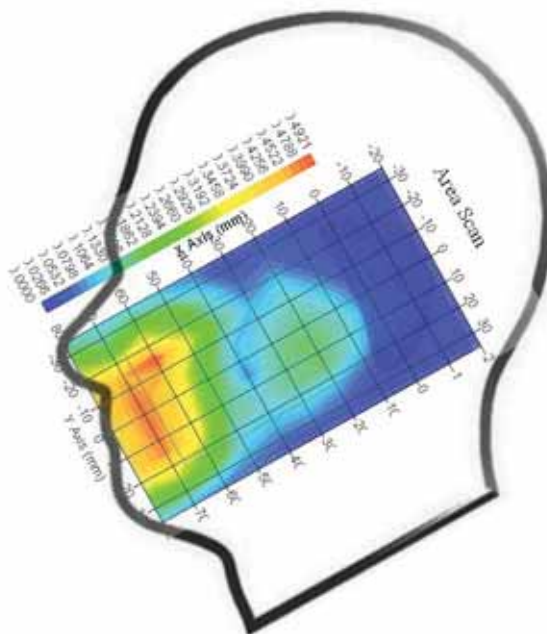

**Test Laboratory: Bay Area Compliance Lab Corp. (Shenzhen)**

**Right Head Tilt (1880 MHz Middle Channel)**

Measurement Data

Test mode : GSM  
 Crest Factor : 8  
 Scan Type : Complete  
 Area Scan : 11x8x1 : Measurement x=10mm, y=10mm, z=4mm  
 Zoom Scan : 7x7x7 : Measurement x=5mm, y=5mm, z=5mm  
 Power Drift-Start : 0.021 W/kg  
 Power Drift-Finish : 0.021 W/kg  
 Power Drift (%) : -0.597

Tissue Data

Type : Head  
 Frequency : 1880 MHz  
 Epsilon : 40.19 F/m  
 Sigma : 1.40 S/m  
 Density : 1000.00 kg/cu. m

Probe Data

Serial No. : 500-00283  
 Frequency Band : 1900  
 Duty Cycle Factor : 8  
 Conversion Factor : 4.8  
 Probe Sensitivity : 1.20 1.20 1.20  $\mu\text{V}/(\text{V}/\text{m})^2$   
 Compression Point : 95.00 mV  
 Offset : 1.56 mm

1 gram SAR value : 0.236 W/kg  
 10 gram SAR value : 0.116 W/kg  
 Area Scan Peak SAR : 0.281 W/kg  
 Zoom Scan Peak SAR : 0.540 W/kg

**Plot 14#**

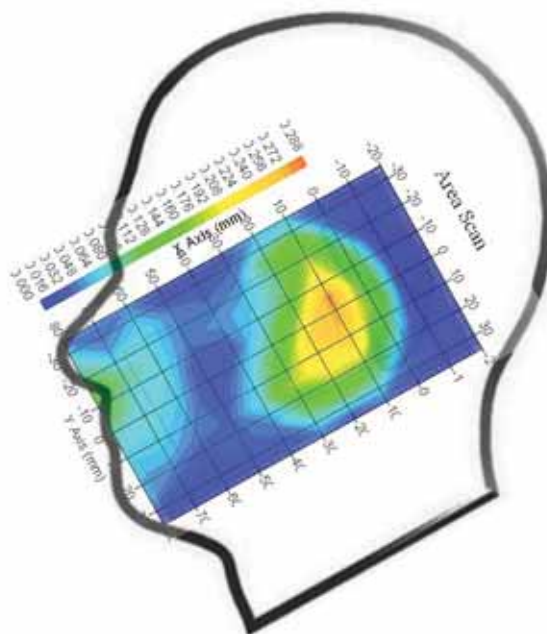

**Test Laboratory: Bay Area Compliance Lab Corp. (Shenzhen)**

**Body-worn Front-Headset (1880 MHz Middle Channel)**

Measurement Data

Test mode : GSM  
 Crest Factor : 8  
 Scan Type : Complete  
 Area Scan : 8x11x1 : Measurement x=10mm, y=10mm, z=4mm  
 Zoom Scan : 7x7x7 : Measurement x=5mm, y=5mm, z=5mm  
 Power Drift-Start : 0.070 W/kg  
 Power Drift-Finish : 0.071 W/kg  
 Power Drift (%) : 0.395

Tissue Data

Type : Body  
 Frequency : 1880 MHz  
 Epsilon : 53.87 F/m  
 Sigma : 1.53 S/m  
 Density : 1000.00 kg/cu. m

Probe Data

Serial No. : 500-00283  
 Frequency Band : 1900  
 Duty Cycle Factor : 8  
 Conversion Factor : 4.5  
 Probe Sensitivity : 1.20 1.20 1.20  $\mu\text{V}/(\text{V/m})^2$   
 Compression Point : 95.00 mV  
 Offset : 1.56 mm

1 gram SAR value : 0.441 W/kg  
 10 gram SAR value : 0.206 W/kg  
 Area Scan Peak SAR : 0.488 W/kg  
 Zoom Scan Peak SAR : 1.150 W/kg

**Plot 15#**

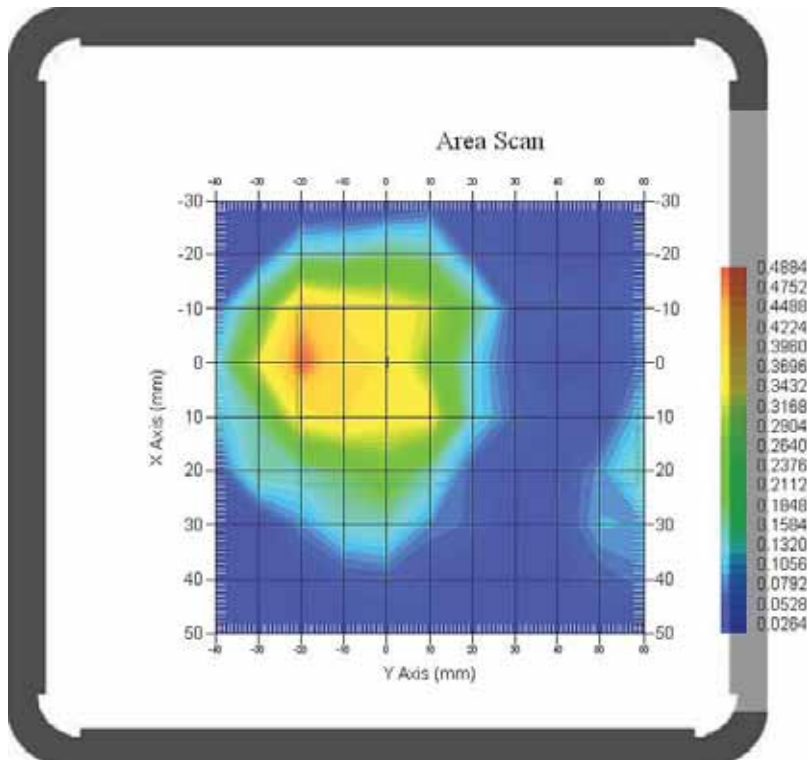

**Test Laboratory: Bay Area Compliance Lab Corp. (Shenzhen)**

**Body- worn Back- Headset (1880 MHz Middle Channel)**

Measurement Data

Test mode : GSM  
 Crest Factor : 8  
 Scan Type : Complete  
 Area Scan : 8x11x1 : Measurement x=10mm, y=10mm, z=4mm  
 Zoom Scan : 7x7x7 : Measurement x=5mm, y=5mm, z=5mm  
 Power Drift-Start : 0.209 W/kg  
 Power Drift-Finish : 0.208W/kg  
 Power Drift (%) :-0.737

Tissue Data

Type : Body  
 Frequency : 1880 MHz  
 Epsilon : 53.87 F/m  
 Sigma : 1.53 S/m  
 Density : 1000.00 kg/cu. m

Probe Data

Serial No. : 500-00283  
 Frequency Band : 1900  
 Duty Cycle Factor : 8  
 Conversion Factor : 4.5  
 Probe Sensitivity : 1.20 1.20 1.20  $\mu\text{V}/(\text{V}/\text{m})^2$   
 Compression Point : 95.00 mV  
 Offset : 1.56 mm

1 gram SAR value : 0.571 W/kg  
 10 gram SAR value : 0.284 W/kg  
 Area Scan Peak SAR : 0.645 W/kg  
 Zoom Scan Peak SAR : 0.990 W/kg

**Plot 16#**

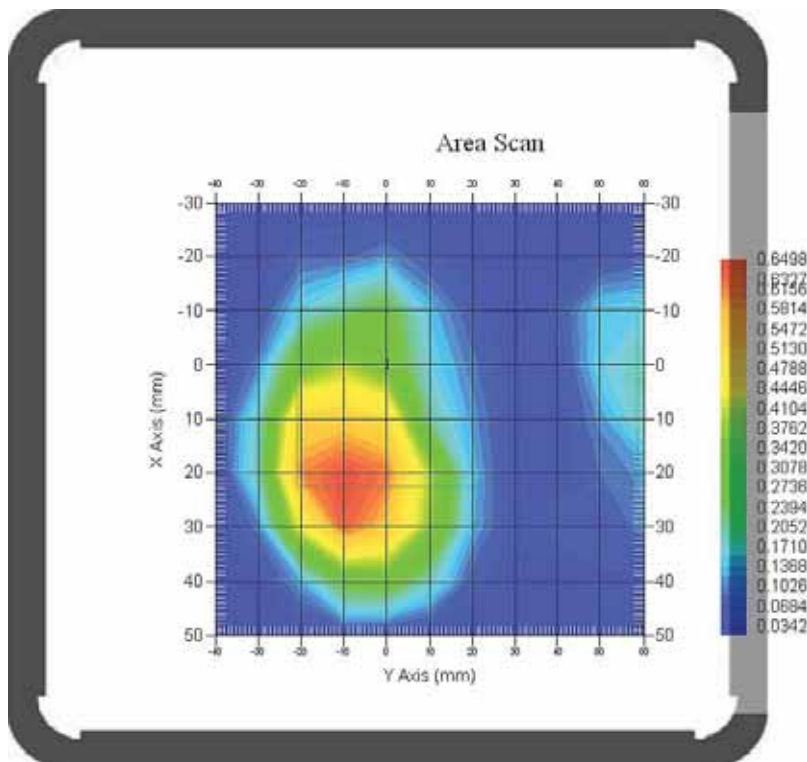

**Test Laboratory: Bay Area Compliance Lab Corp. (Shenzhen)**

**WCDMA850; Left Head Cheek (836.6 MHz Middle Channel)**

Measurement Data

Test mode : WCDMA850  
 Crest Factor : 1  
 Scan Type : Complete  
 Area Scan : 11x8x1: Measurement x=10mm, y=10mm, z=4mm  
 Zoom Scan : 7x7x7: Measurement x=5mm, y=5mm, z=5mm  
 Power Drift-Start : 0.001 W/kg  
 Power Drift-Finish : 0.001 W/kg  
 Power Drift (%) : -1.678

Tissue Data

Type : Head  
 Frequency : 836.6 MHz  
 Epsilon : 41.04 F/m  
 Sigma : 0.91 S/m  
 Density : 1000.00 kg/cu. m

Probe Data

Serial No. : 500-00283  
 Frequency Band : 835  
 Duty Cycle Factor : 1  
 Conversion Factor : 5.9  
 Probe Sensitivity : 1.20 1.20 1.20  $\mu\text{V}/(\text{V}/\text{m})^2$   
 Compression Point : 95.00 mV  
 Offset : 1.56 mm

1 gram SAR value : 0.582 W/kg  
 10 gram SAR value : 0.368 W/kg  
 Area Scan Peak SAR : 0.667 W/kg  
 Zoom Scan Peak SAR : 0.940 W/kg

**Plot 17#**

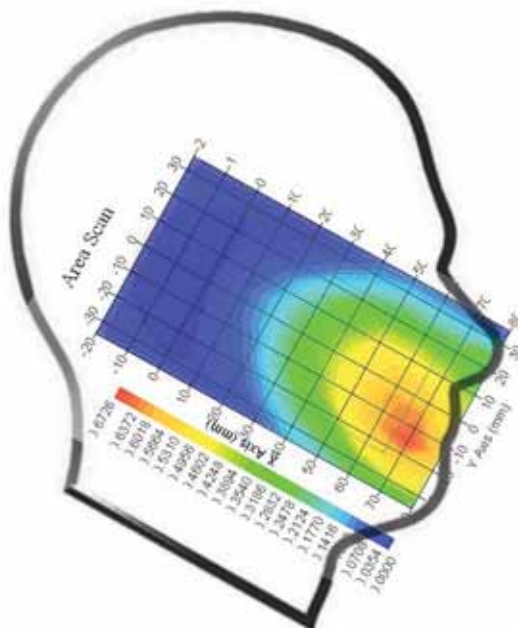

**Test Laboratory: Bay Area Compliance Lab Corp. (Shenzhen)**

**WCDMA850; Left Head Tilt (836.6 MHz Middle Channel)**

Measurement Data

Test mode : WCDMA850  
 Crest Factor : 1  
 Scan Type : Complete  
 Area Scan : 11x8x1: Measurement x=10mm, y=10mm, z=4mm  
 Zoom Scan : 7x7x7: Measurement x=5mm, y=5mm, z=5mm  
 Power Drift-Start : 0.028 W/kg  
 Power Drift-Finish : 0.029 W/kg  
 Power Drift (%) : 1.441

Tissue Data

Type : Head  
 Frequency : 836.6 MHz  
 Epsilon : 41.04 F/m  
 Sigma : 0.91 S/m  
 Density : 1000.00 kg/cu. m

Probe Data

Serial No. : 500-00283  
 Frequency Band : 835  
 Duty Cycle Factor : 1  
 Conversion Factor : 5.9  
 Probe Sensitivity : 1.20 1.20 1.20  $\mu\text{V}/(\text{V}/\text{m})^2$   
 Compression Point : 95.00 mV  
 Offset : 1.56 mm

1 gram SAR value : 0.319 W/kg  
 10 gram SAR value : 0.159 W/kg  
 Area Scan Peak SAR : 0.317 W/kg  
 Zoom Scan Peak SAR : 0.390 W/kg

**Plot 18#**

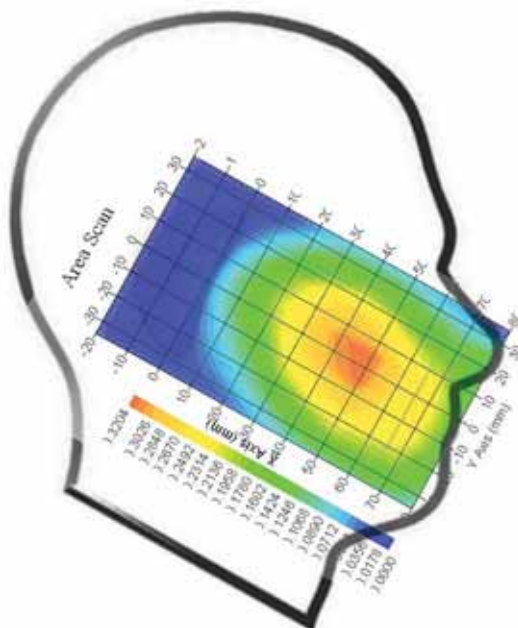

**Test Laboratory: Bay Area Compliance Lab Corp. (Shenzhen)**

**WCDMA850; Right Head Cheek (836.6 MHz Middle Channel)**

Measurement Data

Test mode : WCDMA850  
 Crest Factor : 1  
 Scan Type : Complete  
 Area Scan : 11x8x1: Measurement x=10mm, y=10mm, z=4mm  
 Zoom Scan : 7x7x7: Measurement x=5mm, y=5mm, z=5mm  
 Power Drift-Start : 0.001 W/kg  
 Power Drift-Finish : 0.001 W/kg  
 Power Drift (%) : 1.452

Tissue Data

Type : Head  
 Frequency : 836.6 MHz  
 Epsilon : 41.04 F/m  
 Sigma : 0.91 S/m  
 Density : 1000.00 kg/cu. m

Probe Data

Serial No. : 500-00283  
 Frequency Band : 835  
 Duty Cycle Factor : 1  
 Conversion Factor : 5.9  
 Probe Sensitivity : 1.20 1.20 1.20  $\mu\text{V}/(\text{V}/\text{m})^2$   
 Compression Point : 95.00 mV  
 Offset : 1.56 mm

1 gram SAR value : 0.293 W/kg  
 10 gram SAR value : 0.180 W/kg  
 Area Scan Peak SAR : 0.586 W/kg  
 Zoom Scan Peak SAR : 0.370 W/kg

**Plot 19#**

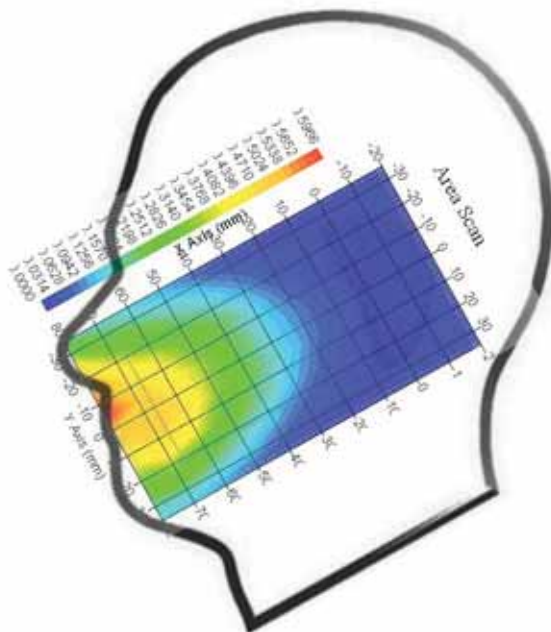

**Test Laboratory: Bay Area Compliance Lab Corp. (Shenzhen)**

**WCDMA850; Right Head Tilt (836.6 MHz Middle Channel)**

Measurement Data

Test mode : WCDMA850  
 Crest Factor : 1  
 Scan Type : Complete  
 Area Scan : 11x8x1: Measurement x=10mm, y=10mm, z=4mm  
 Zoom Scan : 7x7x7: Measurement x=5mm, y=5mm, z=5mm  
 Power Drift-Start : 0.042 W/kg  
 Power Drift-Finish : 0.043 W/kg  
 Power Drift (%) : 1.700

Tissue Data

Type : Head  
 Frequency : 836.6 MHz  
 Epsilon : 41.04 F/m  
 Sigma : 0.91 S/m  
 Density : 1000.00 kg/cu. m

Probe Data

Serial No. : 500-00283  
 Frequency Band : 835  
 Duty Cycle Factor : 1  
 Conversion Factor : 5.9  
 Probe Sensitivity : 1.20 1.20 1.20  $\mu\text{V}/(\text{V}/\text{m})^2$   
 Compression Point : 95.00 mV  
 Offset : 1.56 mm

1 gram SAR value : 0.269 W/kg  
 10 gram SAR value : 0.198 W/kg  
 Area Scan Peak SAR : 0.272 W/kg  
 Zoom Scan Peak SAR : 0.350 W/kg

**Plot 20#**

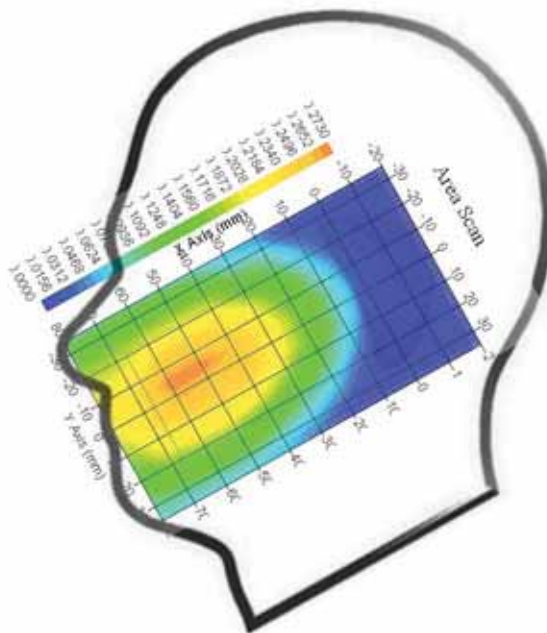



**Test Laboratory: Bay Area Compliance Lab Corp. (Shenzhen)**

**WCDMA1900; Left Head Cheek (1852.4 MHz Low Channel)**

Measurement Data

Test mode : WCDMA1900  
 Crest Factor : 1  
 Scan Type : Complete  
 Area Scan : 11x9x1: Measurement x=10mm, y=10mm, z=4mm  
 Zoom Scan : 7x7x7: Measurement x=5mm, y=5mm, z=5mm  
 Power Drift-Start : 0.088 W/kg  
 Power Drift-Finish : 0.087 W/kg  
 Power Drift (%) : -0.405

Tissue Data

Type : Head  
 Frequency : 1852.4 MHz  
 Epsilon : 40.13 F/m  
 Sigma : 1.38 S/m  
 Density : 1000.00 kg/cu. m

Probe Data

Serial No. : 500-00283  
 Frequency Band : 1900  
 Duty Cycle Factor : 1  
 Conversion Factor : 4.8  
 Probe Sensitivity : 1.20 1.20 1.20  $\mu\text{V}/(\text{V}/\text{m})^2$   
 Compression Point : 95.00 mV  
 Offset : 1.56 mm

1 gram SAR value : 0.869 W/kg  
 10 gram SAR value : 0.405 W/kg  
 Area Scan Peak SAR : 0.950 W/kg  
 Zoom Scan Peak SAR : 1.431 W/kg

**Plot 21#**

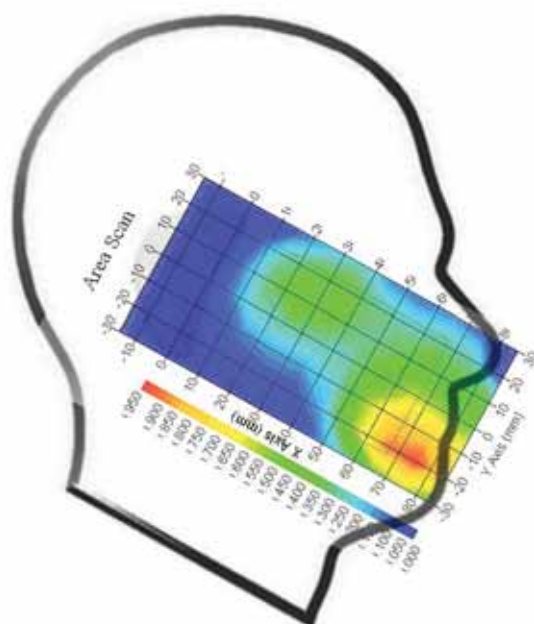

**Test Laboratory: Bay Area Compliance Lab Corp. (Shenzhen)**

**WCDMA1900; Left Head Cheek (1880.0 MHz Middle Channel)**

Measurement Data

Test mode : WCDMA1900  
 Crest Factor : 1  
 Scan Type : Complete  
 Area Scan : 11x9x1: Measurement x=10mm, y=10mm, z=4mm  
 Zoom Scan : 7x7x7: Measurement x=5mm, y=5mm, z=5mm  
 Power Drift-Start : 0.088 W/kg  
 Power Drift-Finish : 0.087 W/kg  
 Power Drift (%) : -0.589

Tissue Data

Type : Head  
 Frequency : 1880.0 MHz  
 Epsilon : 40.19 F/m  
 Sigma : 1.40 S/m  
 Density : 1000.00 kg/cu. m

Probe Data

Serial No. : 500-00283  
 Frequency Band : 1900  
 Duty Cycle Factor : 1  
 Conversion Factor : 4.8  
 Probe Sensitivity : 1.20 1.20 1.20  $\mu\text{V}/(\text{V}/\text{m})^2$   
 Compression Point : 95.00 mV  
 Offset : 1.56 mm

1 gram SAR value : 0.898 W/kg  
 10 gram SAR value : 0.485 W/kg  
 Area Scan Peak SAR : 1.018 W/kg  
 Zoom Scan Peak SAR : 1.621 W/kg

**Plot 21#**

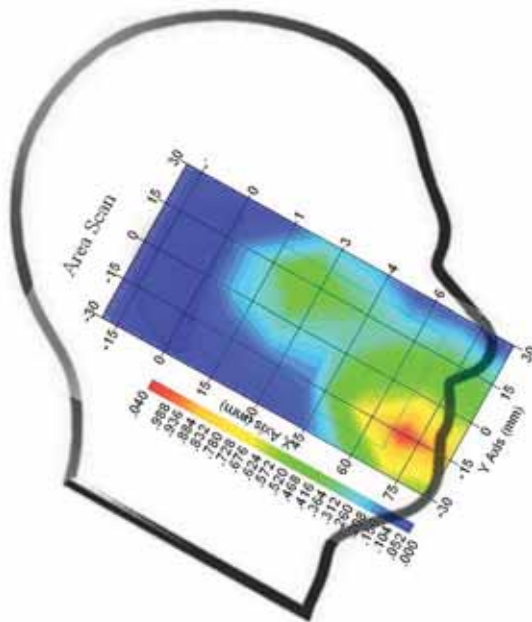

**Test Laboratory: Bay Area Compliance Lab Corp. (Shenzhen)**

**WCDMA1900; Left Head Cheek (1907.6 MHz High Channel)**

Measurement Data

Test mode : WCDMA1900  
 Crest Factor : 1  
 Scan Type : Complete  
 Area Scan : 11x9x1: Measurement x=10mm, y=10mm, z=4mm  
 Zoom Scan : 7x7x7: Measurement x=5mm, y=5mm, z=5mm  
 Power Drift-Start : 0.088 W/kg  
 Power Drift-Finish : 0.087 W/kg  
 Power Drift (%) : -0.564

Tissue Data

Type : Head  
 Frequency : 1907.6 MHz  
 Epsilon : 40.28 F/m  
 Sigma : 1.42 S/m  
 Density : 1000.00 kg/cu. m

Probe Data

Serial No. : 500-00283  
 Frequency Band : 1900  
 Duty Cycle Factor : 1  
 Conversion Factor : 4.8  
 Probe Sensitivity : 1.20 1.20 1.20  $\mu\text{V}/(\text{V}/\text{m})^2$   
 Compression Point : 95.00 mV  
 Offset : 1.56 mm

1 gram SAR value : 0.895 W/kg  
 10 gram SAR value : 0.475 W/kg  
 Area Scan Peak SAR : 0.924 W/kg  
 Zoom Scan Peak SAR : 1.621 W/kg

**Plot 22#**

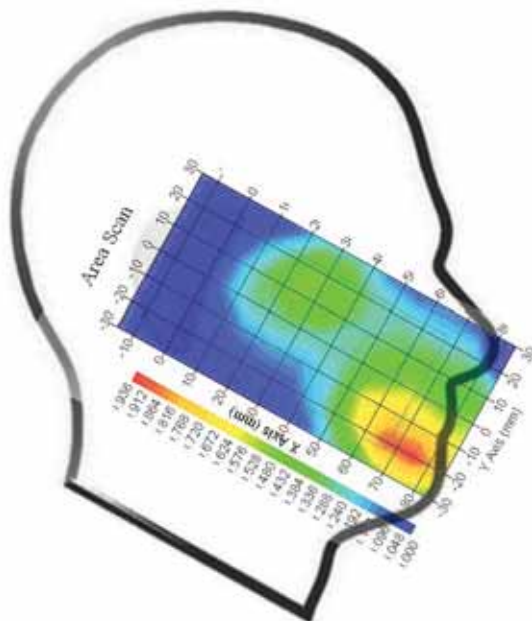

**Test Laboratory: Bay Area Compliance Lab Corp. (Shenzhen)**

**WCDMA1900; Left Head Tilt (1880 MHz Middle Channel)**

Measurement Data

Test mode : WCDMA1900  
 Crest Factor : 1  
 Scan Type : Complete  
 Area Scan : 11x9x1: Measurement x=10mm, y=10mm, z=4mm  
 Zoom Scan : 7x7x7: Measurement x=5mm, y=5mm, z=5mm  
 Power Drift-Start : 0.164 W/kg  
 Power Drift-Finish : 0.161 W/kg  
 Power Drift (%) : -1.529

Tissue Data

Type : Head  
 Frequency : 1880.0 MHz  
 Epsilon : 40.19 F/m  
 Sigma : 1.40 S/m  
 Density : 1000.00 kg/cu. m

Probe Data

Serial No. : 500-00283  
 Frequency Band : 1900  
 Duty Cycle Factor : 1  
 Conversion Factor : 4.8  
 Probe Sensitivity : 1.20 1.20 1.20  $\mu\text{V}/(\text{V}/\text{m})^2$   
 Compression Point : 95.00 mV  
 Offset : 1.56 mm

1 gram SAR value : 0.307 W/kg  
 10 gram SAR value : 0.163 W/kg  
 Area Scan Peak SAR : 0.340 W/kg  
 Zoom Scan Peak SAR : 0.520 W/kg

**Plot 23#**

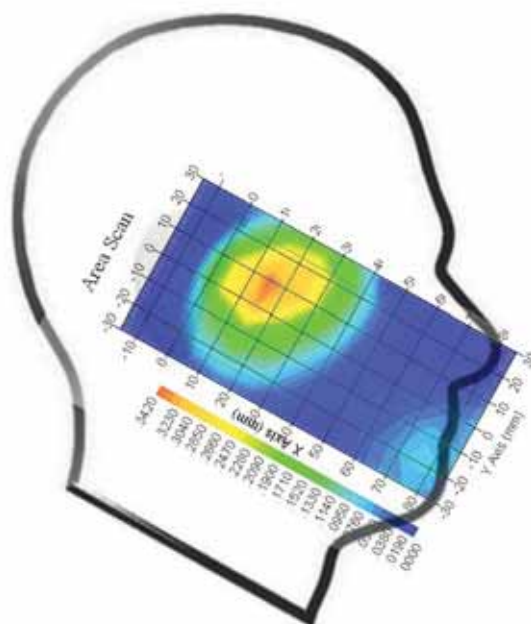

**Test Laboratory: Bay Area Compliance Lab Corp. (Shenzhen)**

**WCDMA1900; Right Head Cheek (1880 MHz Middle Channel)**

Measurement Data

Test mode : WCDMA1900  
 Crest Factor : 1  
 Scan Type : Complete  
 Area Scan : 11x9x1: Measurement x=10mm, y=10mm, z=4mm  
 Zoom Scan : 7x7x7: Measurement x=5mm, y=5mm, z=5mm  
 Power Drift-Start : 0.026 W/kg  
 Power Drift-Finish : 0.026 W/kg  
 Power Drift (%) : -1.490

Tissue Data

Type : Head  
 Frequency : 1880.0 MHz  
 Epsilon : 40.19 F/m  
 Sigma : 1.40 S/m  
 Density : 1000.00 kg/cu. m

Probe Data

Serial No. : 500-00283  
 Frequency Band : 1900  
 Duty Cycle Factor : 1  
 Conversion Factor : 4.8  
 Probe Sensitivity : 1.20 1.20 1.20  $\mu\text{V}/(\text{V}/\text{m})^2$   
 Compression Point : 95.00 mV  
 Offset : 1.56 mm

1 gram SAR value : 0.540 W/kg  
 10 gram SAR value : 0.313 W/kg  
 Area Scan Peak SAR : 0.618 W/kg  
 Zoom Scan Peak SAR : 0.960 W/kg

**Plot 24#**

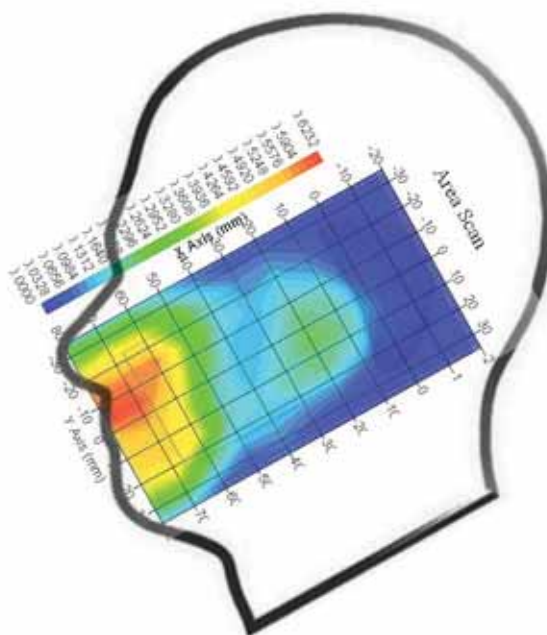

**Test Laboratory: Bay Area Compliance Lab Corp. (Shenzhen)**

**WCDMA1900; Right Head Tilt (1880 MHz Middle Channel)**

Measurement Data

Test mode : WCDMA1900  
 Crest Factor : 1  
 Scan Type : Complete  
 Area Scan : 11x9x1: Measurement x=10mm, y=10mm, z=4mm  
 Zoom Scan : 7x7x7: Measurement x=5mm, y=5mm, z=5mm  
 Power Drift-Start : 0.199 W/kg  
 Power Drift-Finish : 0.201 W/kg  
 Power Drift (%) : 3.914

Tissue Data

Type : Head  
 Frequency : 1880.0 MHz  
 Epsilon : 40.19 F/m  
 Sigma : 1.40 S/m  
 Density : 1000.00 kg/cu. m

Probe Data

Serial No. : 500-00283  
 Frequency Band : 1900  
 Duty Cycle Factor : 1  
 Conversion Factor : 4.8  
 Probe Sensitivity : 1.20 1.20 1.20  $\mu\text{V}/(\text{V}/\text{m})^2$   
 Compression Point : 95.00 mV  
 Offset : 1.56 mm

1 gram SAR value : 0.392 W/kg  
 10 gram SAR value : 0.196 W/kg  
 Area Scan Peak SAR : 0.392 W/kg  
 Zoom Scan Peak SAR : 0.810 W/kg

**Plot 25#**

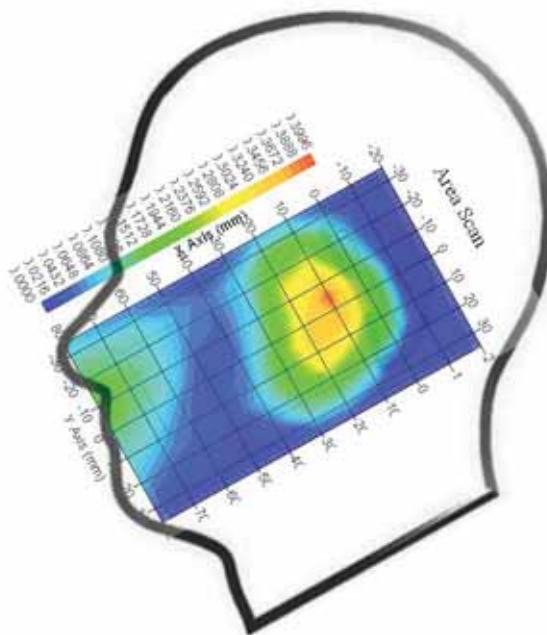

**Test Laboratory: Bay Area Compliance Lab Corp. (Shenzhen)**

**Hot Spot: Body-Front (824.2 MHz Low Channel)**

Measurement Data

Test mode : GPRS  
 Crest Factor : 4  
 Scan Type : Complete  
 Area Scan : 9x11x1 : Measurement x=10mm, y=10mm, z=4mm  
 Zoom Scan : 7x7x7 : Measurement x=5mm, y=5mm, z=5mm  
 Power Drift-Start : 0.588 W/kg  
 Power Drift-Finish : 0.586 W/kg  
 Power Drift (%) : -0.395

Tissue Data

Type : Body  
 Frequency : 836.6 MHz  
 Epsilon : 55.23 F/m  
 Sigma : 0.96 S/m  
 Density : 1000.00 kg/cu. m

Probe Data

Serial No. : 500-00283  
 Frequency Band : 835  
 Duty Cycle Factor : 4  
 Conversion Factor : 5.9  
 Probe Sensitivity : 1.20 1.20 1.20  $\mu\text{V}/(\text{V}/\text{m})^2$   
 Compression Point : 95.00 mV  
 Offset : 1.56 mm

1 gram SAR value : 0.909 W/kg  
 10 gram SAR value : 0.571 W/kg  
 Area Scan Peak SAR : 0.983 W/kg  
 Zoom Scan Peak SAR : 1.481 W/kg

**Plot 26#**

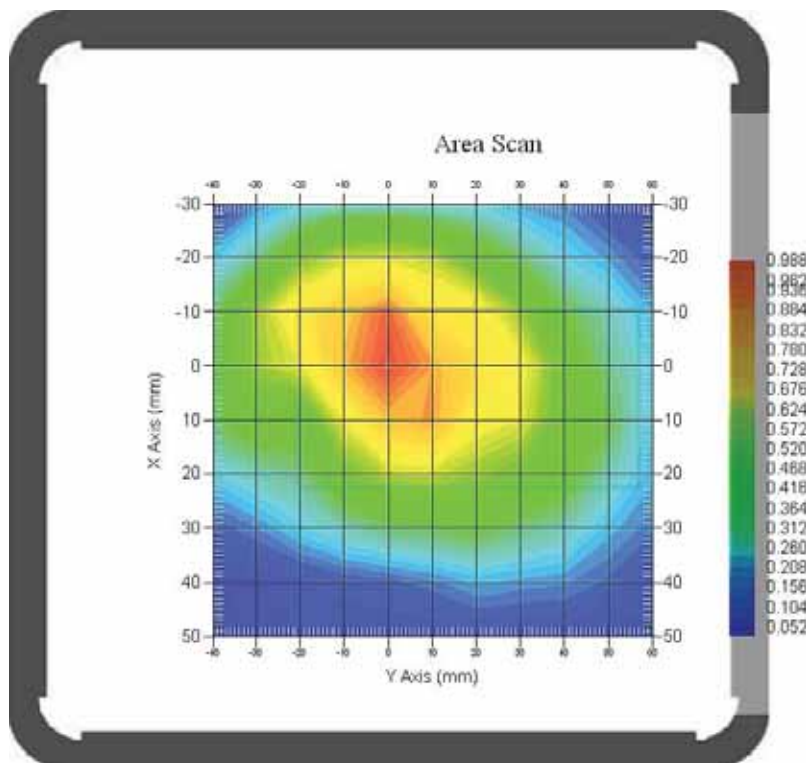

**Test Laboratory: Bay Area Compliance Lab Corp. (Shenzhen)**

**Hot Spot: Body-Front (836.6 MHz Middle Channel)**

Measurement Data

Test mode : GPRS  
 Crest Factor : 4  
 Scan Type : Complete  
 Area Scan : 9x11x1 : Measurement x=10mm, y=10mm, z=4mm  
 Zoom Scan : 7x7x7 : Measurement x=5mm, y=5mm, z=5mm  
 Power Drift-Start : 0.588 W/kg  
 Power Drift-Finish : 0.586 W/kg  
 Power Drift (%) : -0.982

Tissue Data

Type : Body  
 Frequency : 836.6 MHz  
 Epsilon : 55.23 F/m  
 Sigma : 0.96 S/m  
 Density : 1000.00 kg/cu. m

Probe Data

Serial No. : 500-00283  
 Frequency Band : 835  
 Duty Cycle Factor : 4  
 Conversion Factor : 5.9  
 Probe Sensitivity : 1.20 1.20 1.20  $\mu\text{V}/(\text{V}/\text{m})^2$   
 Compression Point : 95.00 mV  
 Offset : 1.56 mm

1 gram SAR value : 0.960 W/kg  
 10 gram SAR value : 0.605 W/kg  
 Area Scan Peak SAR : 0.996 W/kg  
 Zoom Scan Peak SAR : 1.291 W/kg

**Plot 27#**

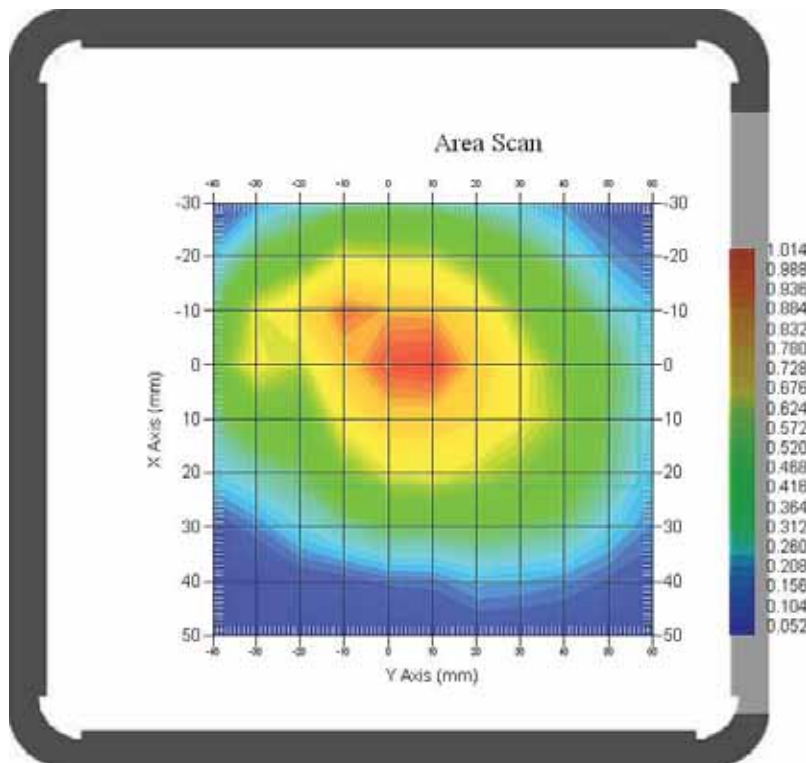



**Test Laboratory: Bay Area Compliance Lab Corp. (Shenzhen)**

**Hot Spot: Body-Front (848.8 MHz High Channel)**

Measurement Data

Test mode : GPRS  
 Crest Factor : 4  
 Scan Type : Complete  
 Area Scan : 9x11x1 : Measurement x=10mm, y=10mm, z=4mm  
 Zoom Scan : 7x7x7 : Measurement x=5mm, y=5mm, z=5mm  
 Power Drift-Start : 0.588 W/kg  
 Power Drift-Finish : 0.586 W/kg  
 Power Drift (%) : -0.757

Tissue Data

Type : Body  
 Frequency : 836.6 MHz  
 Epsilon : 55.23 F/m  
 Sigma : 0.96 S/m  
 Density : 1000.00 kg/cu. m

Probe Data

Serial No. : 500-00283  
 Frequency Band : 835  
 Duty Cycle Factor : 4  
 Conversion Factor : 5.9  
 Probe Sensitivity : 1.20 1.20 1.20  $\mu\text{V}/(\text{V}/\text{m})^2$   
 Compression Point : 95.00 mV  
 Offset : 1.56 mm

1 gram SAR value : 0.892 W/kg  
 10 gram SAR value : 0.572 W/kg  
 Area Scan Peak SAR : 1.038 W/kg  
 Zoom Scan Peak SAR : 1.281 W/kg

**Plot 28#**

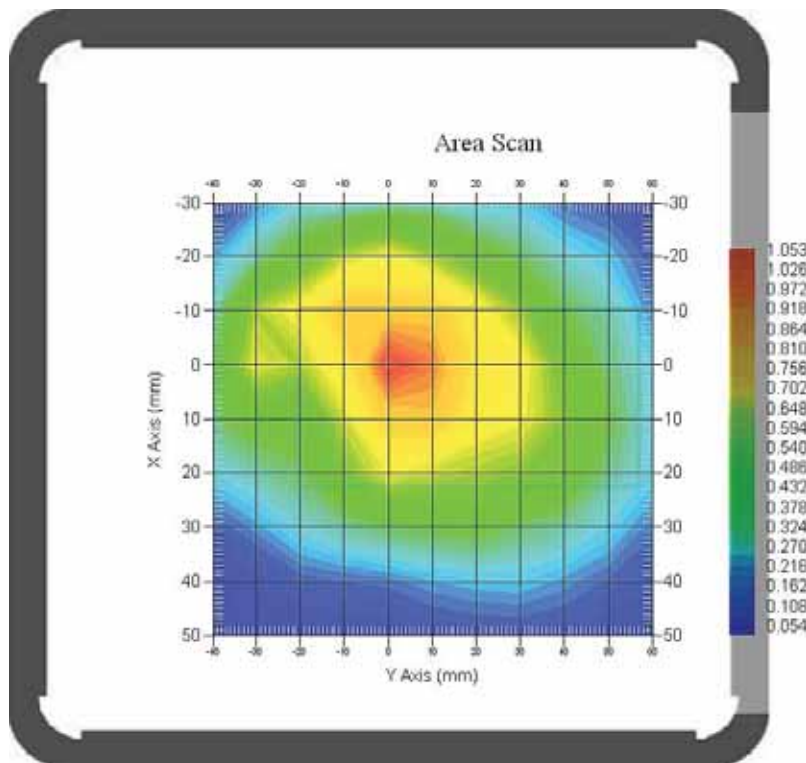

**Test Laboratory: Bay Area Compliance Lab Corp. (Shenzhen)**

**Hot Spot: Body -Back (824.2 MHz Low Channel)**

Measurement Data

Test mode : GPRS  
 Crest Factor : 4  
 Scan Type : Complete  
 Area Scan : 8x11x1 : Measurement x=10mm, y=10mm, z=4mm  
 Zoom Scan : 7x7x7 : Measurement x=5mm, y=5mm, z=5mm  
 Power Drift-Start : 0.501 W/kg  
 Power Drift-Finish : 0.511 W/kg  
 Power Drift (%) : 2.916

Tissue Data

Type : Body  
 Frequency : 824.2 MHz  
 Epsilon : 55.15 F/m  
 Sigma : 0.95 S/m  
 Density : 1000.00 kg/cu. m

Probe Data

Serial No. : 500-00283  
 Frequency Band : 835  
 Duty Cycle Factor : 4  
 Conversion Factor : 5.9  
 Probe Sensitivity : 1.20 1.20 1.20  $\mu\text{V}/(\text{V}/\text{m})^2$   
 Compression Point : 95.00 mV  
 Offset : 1.56 mm

1 gram SAR value : 1.201 W/kg  
 10 gram SAR value : 0.776 W/kg  
 Area Scan Peak SAR : 1.290 W/kg  
 Zoom Scan Peak SAR : 1.791 W/kg

**Plot 29#**

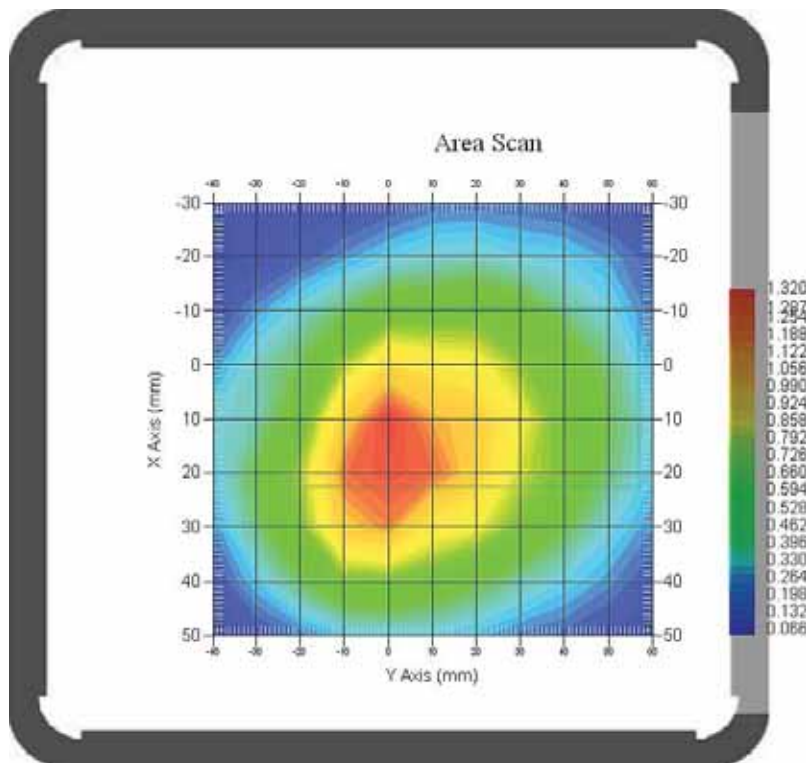

**Test Laboratory: Bay Area Compliance Lab Corp. (Shenzhen)**

**Hot Spot: Body -Back (836.6 MHz Middle Channel)**

Measurement Data

Test mode : GPRS  
 Crest Factor : 4  
 Scan Type : Complete  
 Area Scan : 8x11x1 : Measurement x=10mm, y=10mm, z=4mm  
 Zoom Scan : 7x7x7 : Measurement x=5mm, y=5mm, z=5mm  
 Power Drift-Start : 0.677 W/kg  
 Power Drift-Finish : 0.678 W/kg  
 Power Drift (%) : 0.598

Tissue Data

Type : Body  
 Frequency : 836.6MHz  
 Epsilon : 55.23 F/m  
 Sigma : 0.96 S/m  
 Density : 1000.00 kg/cu. m

Probe Data

Serial No. : 500-00283  
 Frequency Band : 835  
 Duty Cycle Factor : 4  
 Conversion Factor : 5.9  
 Probe Sensitivity : 1.20 1.20 1.20  $\mu\text{V}/(\text{V/m})^2$   
 Compression Point : 95.00 mV  
 Offset : 1.56 mm

1 gram SAR value : 1.223 W/kg  
 10 gram SAR value : 0.831 W/kg  
 Area Scan Peak SAR : 1.368 W/kg  
 Zoom Scan Peak SAR : 1.771 W/kg

**Plot 30#**

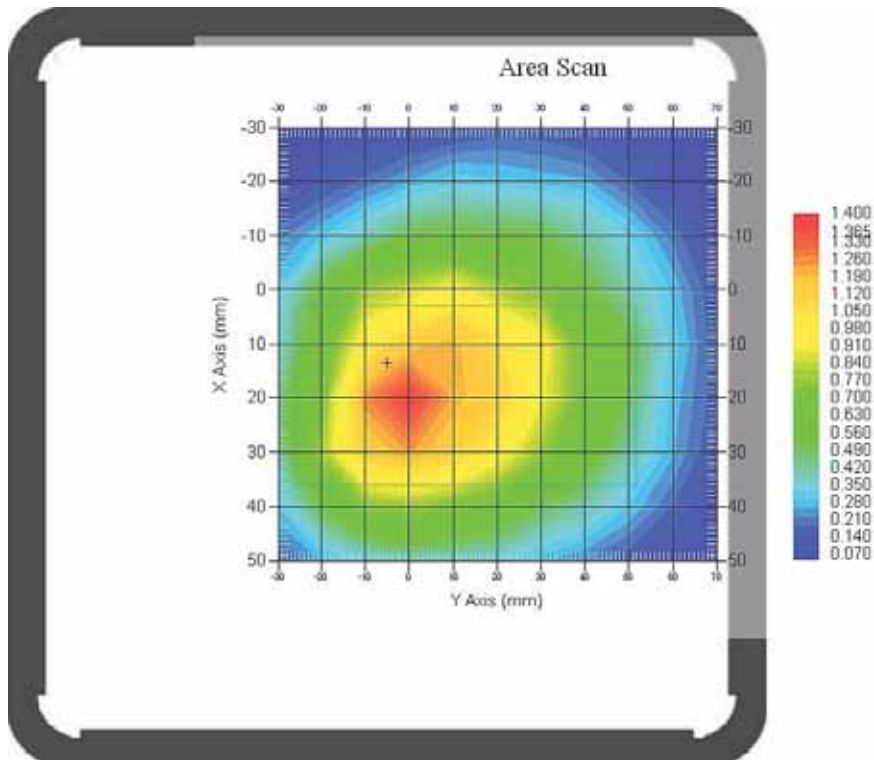

**Test Laboratory: Bay Area Compliance Lab Corp. (Shenzhen)**

**Hot Spot: Body -Back (848.8 MHz High Channel)**

Measurement Data

Test mode : GPRS  
 Crest Factor : 4  
 Scan Type : Complete  
 Area Scan : 8x11x1 : Measurement x=10mm, y=10mm, z=4mm  
 Zoom Scan : 7x7x7 : Measurement x=5mm, y=5mm, z=5mm  
 Power Drift-Start : 0.547 W/kg  
 Power Drift-Finish : 0.569 W/kg  
 Power Drift (%) : 4.296

Tissue Data

Type : Body  
 Frequency : 848.8MHz  
 Epsilon : 55.31 F/m  
 Sigma : 0.99 S/m  
 Density : 1000.00 kg/cu. m

Probe Data

Serial No. : 500-00283  
 Frequency Band : 835  
 Duty Cycle Factor : 4  
 Conversion Factor : 5.9  
 Probe Sensitivity : 1.20 1.20 1.20  $\mu\text{V}/(\text{V}/\text{m})^2$   
 Compression Point : 95.00 mV  
 Offset : 1.56 mm

1 gram SAR value : 1.173 W/kg  
 10 gram SAR value : 0.743 W/kg  
 Area Scan Peak SAR : 1.299 W/kg  
 Zoom Scan Peak SAR : 1.821 W/kg

**Plot 31#**

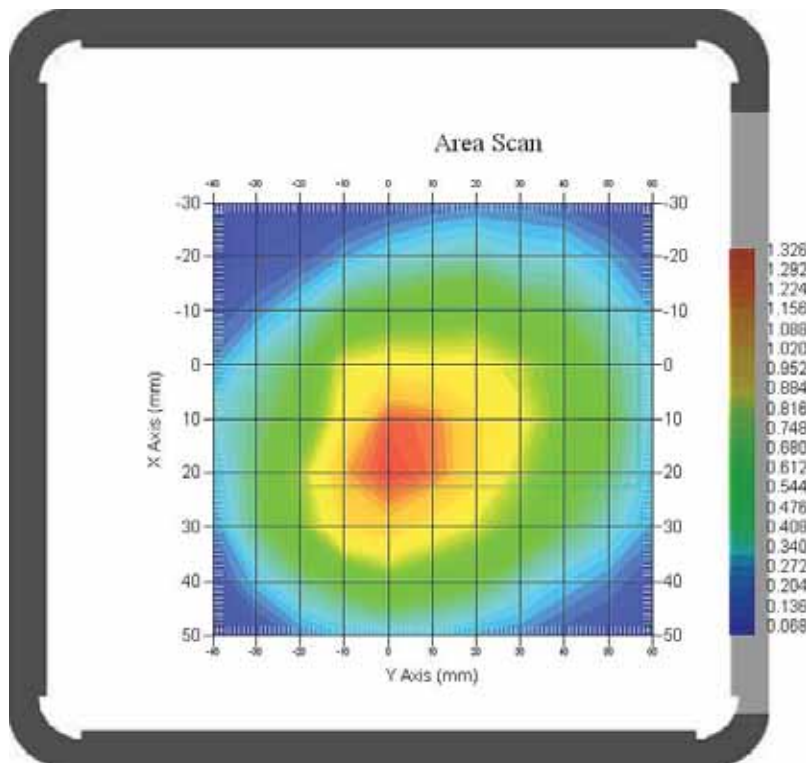

**Test Laboratory: Bay Area Compliance Lab Corp. (Shenzhen)**

**Hot Spot: Body-Left (836.6 MHz Middle Channel)**

Measurement Data

Test mode : GPRS  
 Crest Factor : 4  
 Scan Type : Complete  
 Area Scan : 8x11x1 : Measurement x=10mm, y=10mm, z=4mm  
 Zoom Scan : 7x7x7 : Measurement x=5mm, y=5mm, z=5mm  
 Power Drift-Start : 0.400 W/kg  
 Power Drift-Finish : 0.399 W/kg  
 Power Drift (%) : -0.067

Tissue Data

Type : Body  
 Frequency : 836.6MHz  
 Epsilon : 55.23 F/m  
 Sigma : 0.96 S/m  
 Density : 1000.00 kg/cu. m

Probe Data

Serial No. : 500-00283  
 Frequency Band : 835  
 Duty Cycle Factor : 4  
 Conversion Factor : 5.9  
 Probe Sensitivity : 1.20 1.20 1.20  $\mu\text{V}/(\text{V/m})^2$   
 Compression Point : 95.00 mV  
 Offset : 1.56 mm

1 gram SAR value : 0.456 W/kg  
 10 gram SAR value : 0.287 W/kg  
 Area Scan Peak SAR : 0.482 W/kg  
 Zoom Scan Peak SAR : 0.700 W/kg

**Plot 32#**

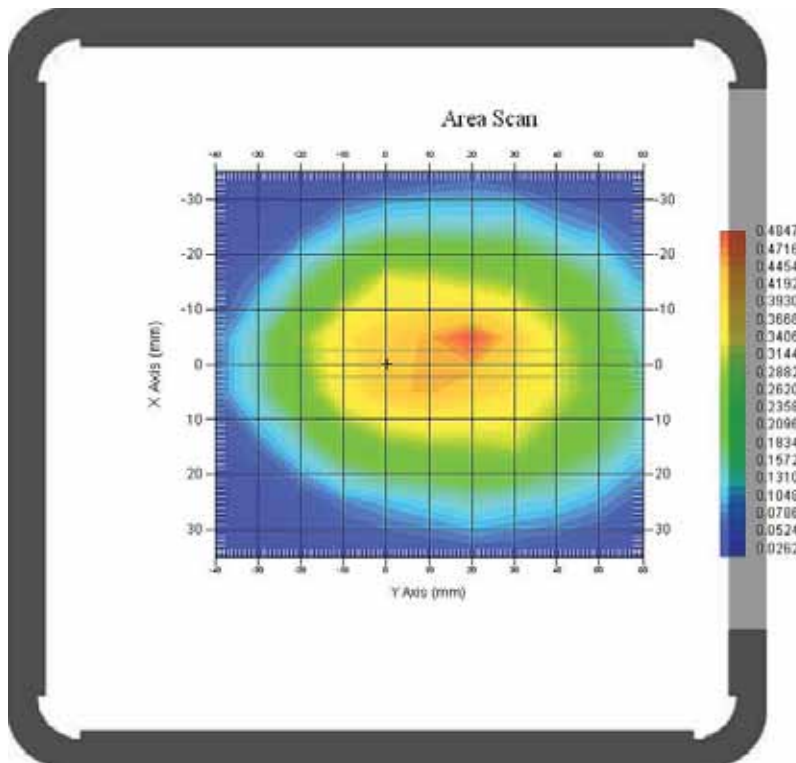

**Test Laboratory: Bay Area Compliance Lab Corp. (Shenzhen)**

**Hot Spot: Body -Right (836.6 MHz Middle Channel)**

Measurement Data

Test mode : GPRS  
 Crest Factor : 4  
 Scan Type : Complete  
 Area Scan : 8x11x1 : Measurement x=10mm, y=10mm, z=4mm  
 Zoom Scan : 7x7x7 : Measurement x=5mm, y=5mm, z=5mm  
 Power Drift-Start : 0.398 W/kg  
 Power Drift-Finish : 0.386 W/kg  
 Power Drift (%) : -3.167

Tissue Data

Type : Body  
 Frequency : 836.6 MHz  
 Epsilon : 55.23 F/m  
 Sigma : 0.96 S/m  
 Density : 1000.00 kg/cu. m

Probe Data

Serial No. : 500-00283  
 Frequency Band : 835  
 Duty Cycle Factor : 4  
 Conversion Factor : 5.9  
 Probe Sensitivity : 1.20 1.20 1.20  $\mu\text{V}/(\text{V}/\text{m})^2$   
 Compression Point : 95.00 mV  
 Offset : 1.56 mm

1 gram SAR value : 0.450 W/kg  
 10 gram SAR value : 0.281 W/kg  
 Area Scan Peak SAR : 0.463 W/kg  
 Zoom Scan Peak SAR : 0.670 W/kg

**Plot 33#**

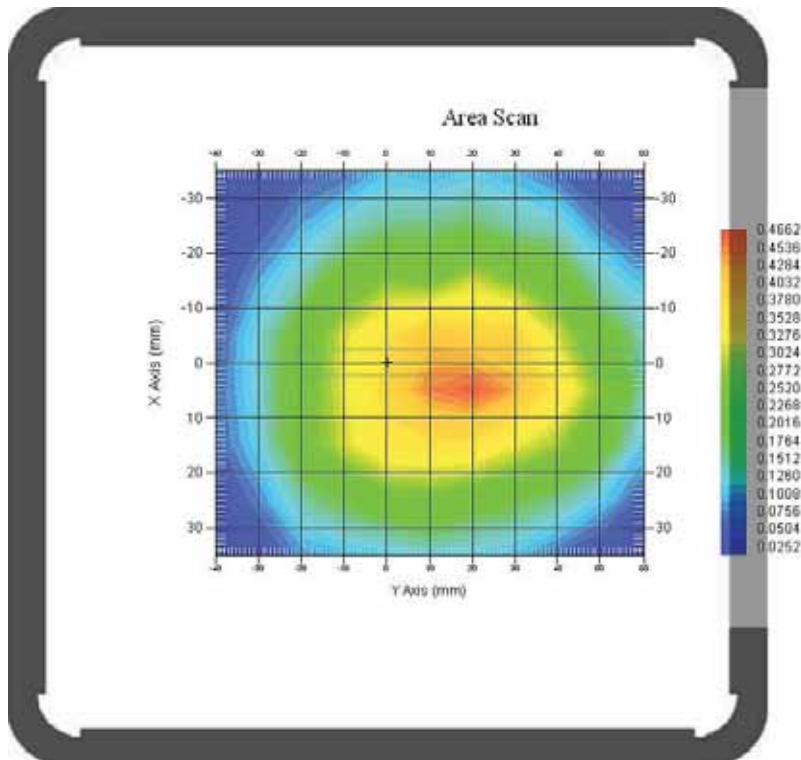

**Test Laboratory: Bay Area Compliance Lab Corp. (Shenzhen)**

**Hot Spot: Body -Bottom (836.6 MHz Middle Channel)**

Measurement Data

Test mode : GPRS  
 Crest Factor : 4  
 Scan Type : Complete  
 Area Scan : 8x11x1 : Measurement x=10mm, y=10mm, z=4mm  
 Zoom Scan : 7x7x7 : Measurement x=5mm, y=5mm, z=5mm  
 Power Drift-Start : 0.020 W/kg  
 Power Drift-Finish : 0.020 W/kg  
 Power Drift (%) : 0.599

Tissue Data

Type : Body  
 Frequency : 836.6MHz  
 Epsilon : 55.23 F/m  
 Sigma : 0.96 S/m  
 Density : 1000.00 kg/cu. m

Probe Data

Serial No. : 500-00283  
 Frequency Band : 835  
 Duty Cycle Factor : 4  
 Conversion Factor : 5.9  
 Probe Sensitivity : 1.20 1.20 1.20  $\mu\text{V}/(\text{V}/\text{m})^2$   
 Compression Point : 95.00 mV  
 Offset : 1.56 mm

1 gram SAR value : 0.145 W/kg  
 10 gram SAR value : 0.115 W/kg  
 Area Scan Peak SAR : 0.212 W/kg  
 Zoom Scan Peak SAR : 0.270 W/kg

**Plot34#**

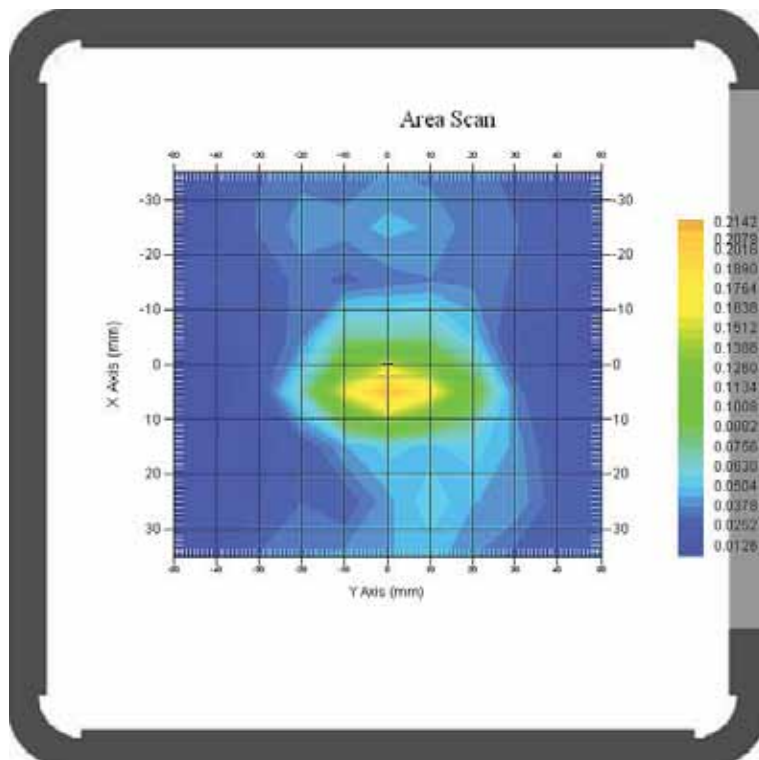

**Test Laboratory: Bay Area Compliance Lab Corp. (Shenzhen)**

**Hot Spot: Body-Front (1880 MHz Middle Channel)**

Measurement Data

Test mode : GPRS  
 Crest Factor : 4  
 Scan Type : Complete  
 Area Scan : 8x11x1 : Measurement x=10mm, y=10mm, z=4mm  
 Zoom Scan : 7x7x7 : Measurement x=5mm, y=5mm, z=5mm  
 Power Drift-Start : 0.287 W/kg  
 Power Drift-Finish : 0.289 W/kg  
 Power Drift (%) : 0.539

Tissue Data

Type : Body  
 Frequency : 1880 MHz  
 Epsilon : 53.87 F/m  
 Sigma : 1.53 S/m  
 Density : 1000.00 kg/cu. m

Probe Data

Serial No. : 500-00283  
 Frequency Band : 1900  
 Duty Cycle Factor : 4  
 Conversion Factor : 4.5  
 Probe Sensitivity : 1.20 1.20 1.20  $\mu\text{V}/(\text{V}/\text{m})^2$   
 Compression Point : 95.00 mV  
 Offset : 1.56 mm

1 gram SAR value : 0.609 W/kg  
 10 gram SAR value : 0.286 W/kg  
 Area Scan Peak SAR : 0.680 W/kg  
 Zoom Scan Peak SAR : 1.111 W/kg

**Plot 35#**

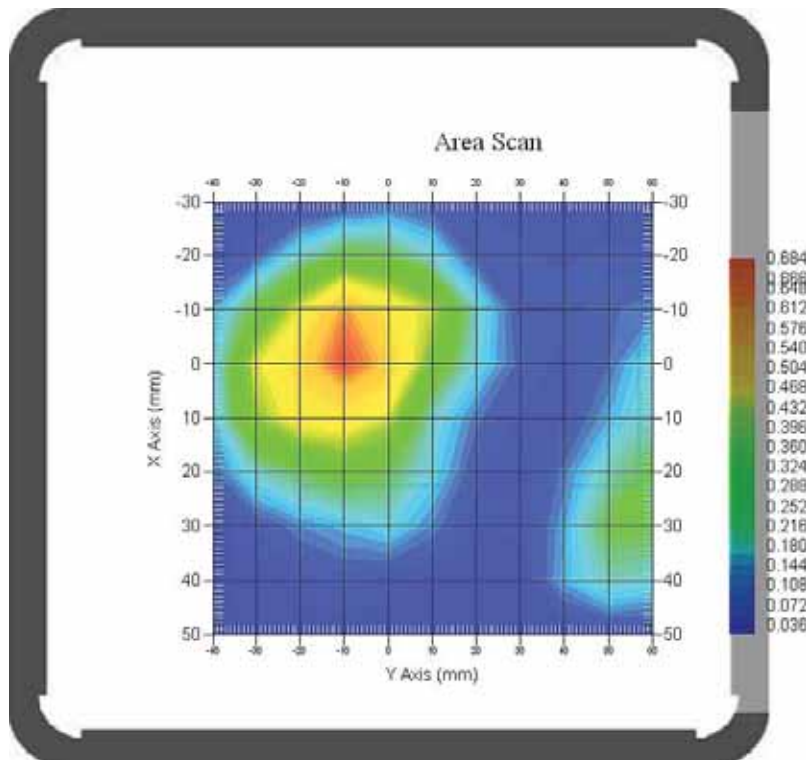



**Test Laboratory: Bay Area Compliance Lab Corp. (Shenzhen)**

**Hot Spot: Body-Back (1850.2 MHz Low Channel)**

Measurement Data

Test mode : GPRS  
 Crest Factor : 4  
 Scan Type : Complete  
 Area Scan : 8x11x1 : Measurement x=10mm, y=10mm, z=4mm  
 Zoom Scan : 7x7x7 : Measurement x=5mm, y=5mm, z=5mm  
 Power Drift-Start : 0.635 W/kg  
 Power Drift-Finish : 0.634 W/kg  
 Power Drift (%) :- 0.970

Tissue Data

Type : Body  
 Frequency : 1850.2 MHz  
 Epsilon : 54.12 F/m  
 Sigma : 1.49 S/m  
 Density : 1000.00 kg/cu. m

Probe Data

Serial No. : 500-00283  
 Frequency Band : 1900  
 Duty Cycle Factor : 4  
 Conversion Factor : 4.5  
 Probe Sensitivity : 1.20 1.20 1.20  $\mu\text{V}/(\text{V}/\text{m})^2$   
 Compression Point : 95.00 mV  
 Offset : 1.56 mm

1 gram SAR value : 0.865 W/kg  
 10 gram SAR value : 0.536 W/kg  
 Area Scan Peak SAR : 1.012 W/kg  
 Zoom Scan Peak SAR : 2.041 W/kg

**Plot 36#**

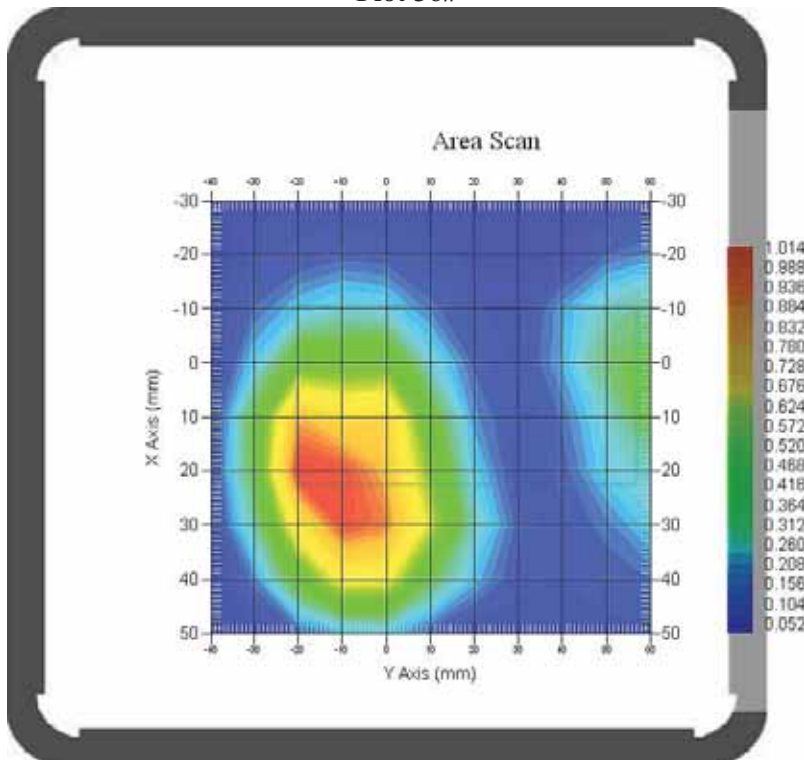

**Test Laboratory: Bay Area Compliance Lab Corp. (Shenzhen)**

**Hot Spot: Body -Back (1880 MHz Middle Channel)**

Measurement Data

Test mode : GPRS  
 Crest Factor : 4  
 Scan Type : Complete  
 Area Scan : 8x11x1 : Measurement x=10mm, y=10mm, z=4mm  
 Zoom Scan : 7x7x7 : Measurement x=5mm, y=5mm, z=5mm  
 Power Drift-Start : 0.611 W/kg  
 Power Drift-Finish : 0.637 W/kg  
 Power Drift (%) : 4.851

Tissue Data

Type : Body  
 Frequency : 1880 MHz  
 Epsilon : 53.87 F/m  
 Sigma : 1.53 S/m  
 Density : 1000.00 kg/cu. m

Probe Data

Serial No. : 500-00283  
 Frequency Band : 1900  
 Duty Cycle Factor : 4  
 Conversion Factor : 4.5  
 Probe Sensitivity : 1.20 1.20 1.20  $\mu\text{V}/(\text{V/m})^2$   
 Compression Point : 95.00 mV  
 Offset : 1.56 mm

1 gram SAR value : 1.027 W/kg  
 10 gram SAR value : 0.542 W/kg  
 Area Scan Peak SAR : 1.106 W/kg  
 Zoom Scan Peak SAR : 1.891 W/kg

**Plot 37#**

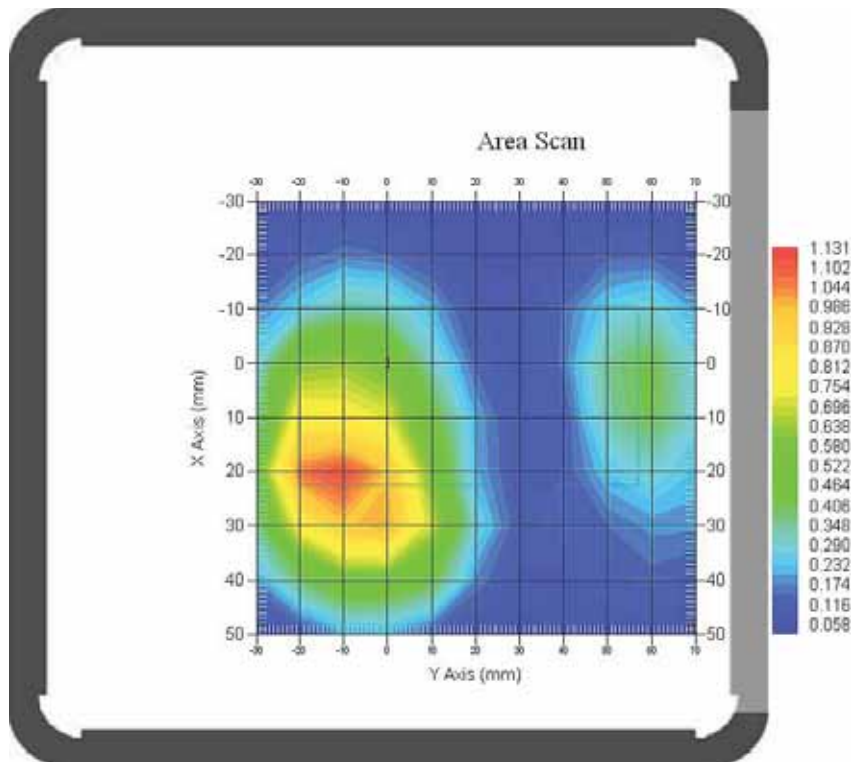

**Test Laboratory: Bay Area Compliance Lab Corp. (Shenzhen)**

**Hot Spot: Body -Back (1909.8 MHz High Channel)**

Measurement Data

Test mode : GPRS  
 Crest Factor : 4  
 Scan Type : Complete  
 Area Scan : 8x11x1 : Measurement x=10mm, y=10mm, z=4mm  
 Zoom Scan : 7x7x7 : Measurement x=5mm, y=5mm, z=5mm  
 Power Drift-Start : 0.737 W/kg  
 Power Drift-Finish : 0.738 W/kg  
 Power Drift (%) : 0.880

Tissue Data

Type : Body  
 Frequency : 1909.8 MHz  
 Epsilon : 53.95 F/m  
 Sigma : 1.54 S/m  
 Density : 1000.00 kg/cu. m

Probe Data

Serial No. : 500-00283  
 Frequency Band : 1900  
 Duty Cycle Factor : 4  
 Conversion Factor : 4.5  
 Probe Sensitivity : 1.20 1.20 1.20  $\mu\text{V}/(\text{V}/\text{m})^2$   
 Compression Point : 95.00 mV  
 Offset : 1.56 mm

1 gram SAR value : 0.788 W/kg  
 10 gram SAR value : 0.519 W/kg  
 Area Scan Peak SAR : 0.977 W/kg  
 Zoom Scan Peak SAR : 1.791 W/kg

**Plot 38#**

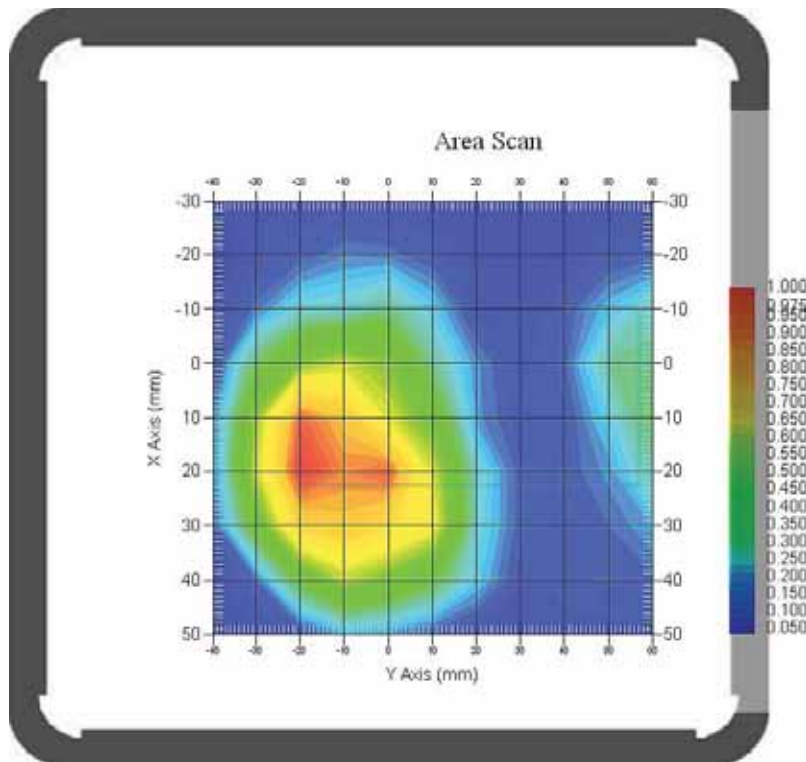

**Test Laboratory: Bay Area Compliance Lab Corp. (Shenzhen)**

**Hot Spot: Body-Left (1880 MHz Middle Channel)**

Measurement Data

Test mode : GPRS  
 Crest Factor : 4  
 Scan Type : Complete  
 Area Scan : 8x11x1 : Measurement x=10mm, y=10mm, z=4mm  
 Zoom Scan : 7x7x7 : Measurement x=5mm, y=5mm, z=5mm  
 Power Drift-Start : 0.040 W/kg  
 Power Drift-Finish : 0.041 W/kg  
 Power Drift (%) : 0.903

Tissue Data

Type : Body  
 Frequency : 1880 MHz  
 Epsilon : 53.87 F/m  
 Sigma : 1.53 S/m  
 Density : 1000.00 kg/cu. m

Probe Data

Serial No. : 500-00283  
 Frequency Band : 1900  
 Duty Cycle Factor : 4  
 Conversion Factor : 4.5  
 Probe Sensitivity : 1.20 1.20 1.20  $\mu\text{V}/(\text{V}/\text{m})^2$   
 Compression Point : 95.00 mV  
 Offset : 1.56 mm

1 gram SAR value : 0.165 W/kg  
 10 gram SAR value : 0.065 W/kg  
 Area Scan Peak SAR : 0.175 W/kg  
 Zoom Scan Peak SAR : 0.450 W/kg

**Plot 39#**

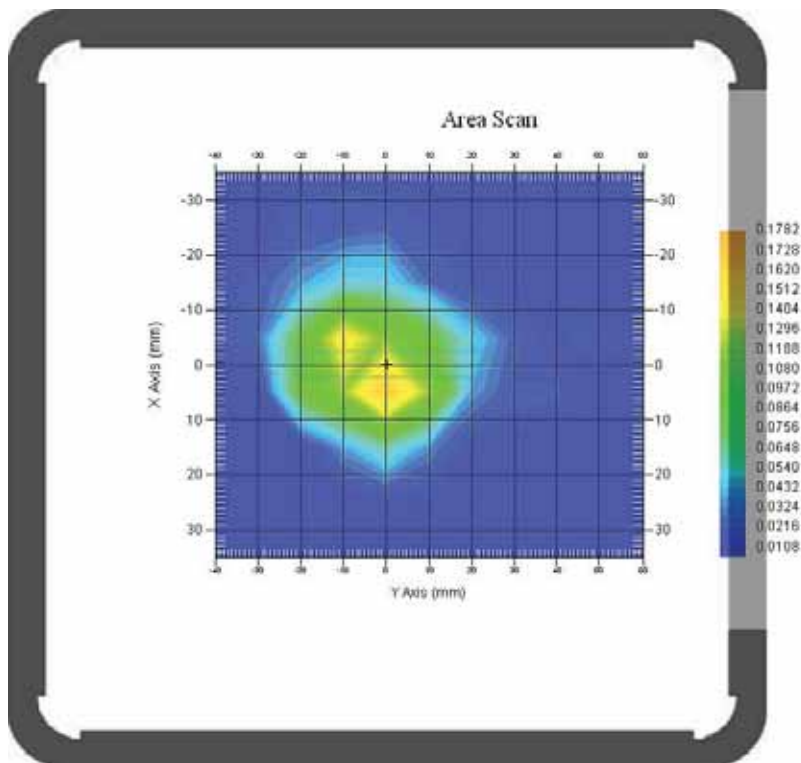

**Test Laboratory: Bay Area Compliance Lab Corp. (Shenzhen)**

**Hot Spot: Body-Right (1880 MHz Middle Channel)**

Measurement Data

Test mode : GPRS  
 Crest Factor : 4  
 Scan Type : Complete  
 Area Scan : 8x11x1 : Measurement x=10mm, y=10mm, z=4mm  
 Zoom Scan : 7x7x7 : Measurement x=5mm, y=5mm, z=5mm  
 Power Drift-Start : 0.060 W/kg  
 Power Drift-Finish : 0.059 W/kg  
 Power Drift (%) : 0.090

Tissue Data

Type : Body  
 Frequency : 1880 MHz  
 Epsilon : 53.87 F/m  
 Sigma : 1.53 S/m  
 Density : 1000.00 kg/cu. m

Probe Data

Serial No. : 500-00283  
 Frequency Band : 1900  
 Duty Cycle Factor : 4  
 Conversion Factor : 4.5  
 Probe Sensitivity : 1.20 1.20 1.20  $\mu\text{V}/(\text{V}/\text{m})^2$   
 Compression Point : 95.00 mV  
 Offset : 1.56 mm

1 gram SAR value : 0.130 W/kg  
 10 gram SAR value : 0.048 W/kg  
 Area Scan Peak SAR : 0.144 W/kg  
 Zoom Scan Peak SAR : 0.470 W/kg

**Plot 40#**

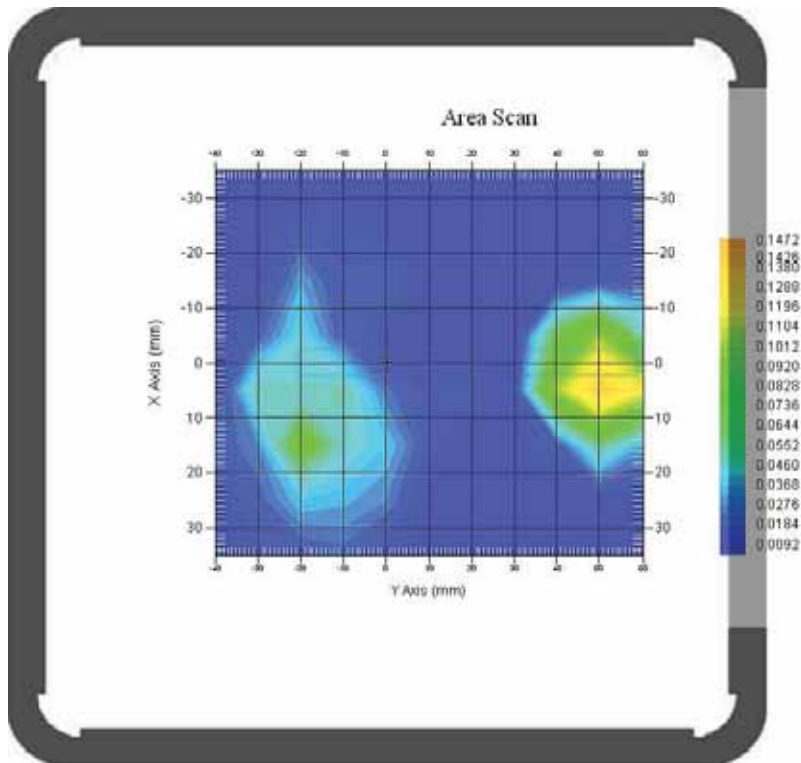

**Test Laboratory: Bay Area Compliance Lab Corp. (Shenzhen)**

**Hot Spot: Body-Bottom (1880 MHz Middle Channel)**

Measurement Data

Test mode : GPRS  
 Crest Factor : 4  
 Scan Type : Complete  
 Area Scan : 8x11x1 : Measurement x=10mm, y=10mm, z=4mm  
 Zoom Scan : 7x7x7 : Measurement x=5mm, y=5mm, z=5mm  
 Power Drift-Start : 0.095 W/kg  
 Power Drift-Finish : 0.095 W/kg  
 Power Drift (%) : 0.035

Tissue Data

Type : Body  
 Frequency : 1880 MHz  
 Epsilon : 53.87 F/m  
 Sigma : 1.53 S/m  
 Density : 1000.00 kg/cu. m

Probe Data

Serial No. : 500-00283  
 Frequency Band : 1900  
 Duty Cycle Factor : 4  
 Conversion Factor : 4.5  
 Probe Sensitivity : 1.20 1.20 1.20  $\mu\text{V}/(\text{V}/\text{m})^2$   
 Compression Point : 95.00 mV  
 Offset : 1.56 mm

1 gram SAR value : 0.203 W/kg  
 10 gram SAR value : 0.083 W/kg  
 Area Scan Peak SAR : 0.289 W/kg  
 Zoom Scan Peak SAR : 0.450 W/kg

**Plot 41#**

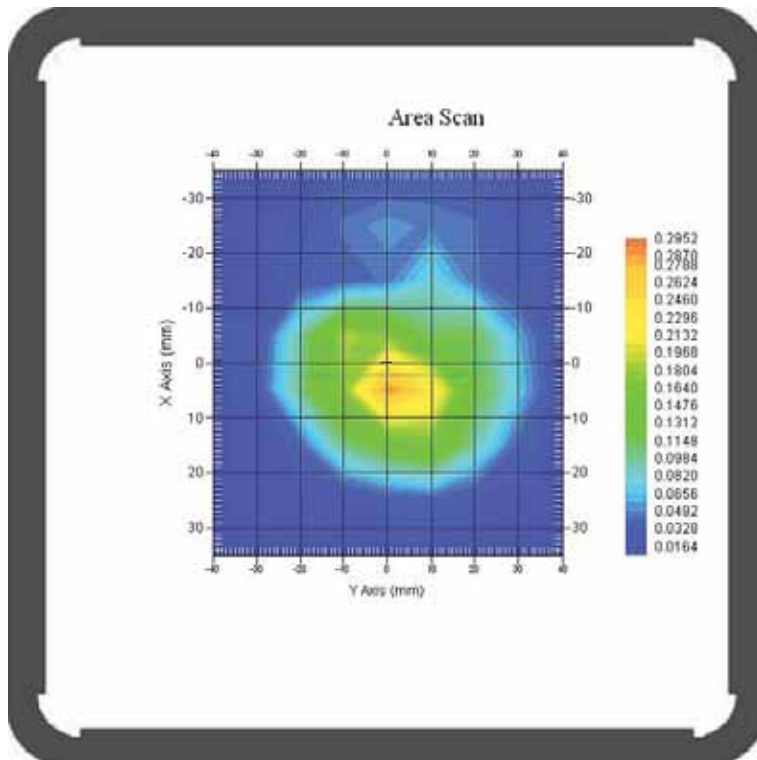

**Test Laboratory: Bay Area Compliance Lab Corp. (Shenzhen)**

**Hot Spot: WCDMA850; Body-Front (836.6 MHz Middle Channel)**

Measurement Data

Test mode : WCDMA850  
 Crest Factor : 1  
 Scan Type : Complete  
 Area Scan : 9x11x1 : Measurement x=10mm, y=10mm, z=4mm  
 Zoom Scan : 7x7x7 : Measurement x=5mm, y=5mm, z=5mm  
 Power Drift-Start : 0.256 W/kg  
 Power Drift-Finish : 0.259 W/kg  
 Power Drift (%) : 1.132

Tissue Data

Type : Body  
 Frequency : 836.6 MHz  
 Epsilon : 55.23 F/m  
 Sigma : 0.96 S/m  
 Density : 1000.00 kg/cu. m

Probe Data

Serial No. : 500-00283  
 Frequency : 835  
 Duty Cycle Factor : 1  
 Conversion Factor : 5.9  
 Probe Sensitivity : 1.20 1.20 1.20  $\mu\text{V}/(\text{V}/\text{m})^2$   
 Compression Point : 95.00 mV  
 Offset : 1.56 mm

1 gram SAR value : 0.367 W/kg  
 10 gram SAR value : 0.234 W/kg  
 Area Scan Peak SAR : 0.375 W/kg  
 Zoom Scan Peak SAR : 0.550 W/kg

**Plot 42#**

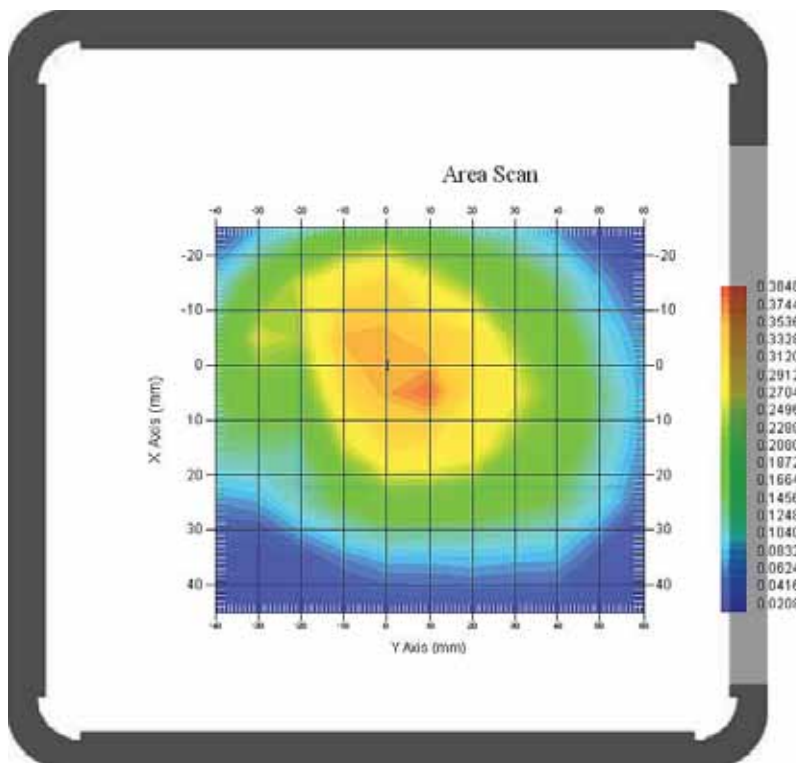

**Test Laboratory: Bay Area Compliance Lab Corp. (Shenzhen)**

**Hot Spot: WCDMA850; Body-Back (836.6 MHz Middle Channel)**

Measurement Data

Test mode : WCDMA850  
 Crest Factor : 1  
 Scan Type : Complete  
 Area Scan : 9x11x1 : Measurement x=10mm, y=10mm, z=4mm  
 Zoom Scan : 7x7x7 : Measurement x=5mm, y=5mm, z=5mm  
 Power Drift-Start : 0.355 W/kg  
 Power Drift-Finish : 0.353 W/kg  
 Power Drift (%) : -1.605

Tissue Data

Type : Body  
 Frequency : 836.6 MHz  
 Epsilon : 55.23 F/m  
 Sigma : 0.96 S/m  
 Density : 1000.00 kg/cu. m

Probe Data

Serial No. : 500-00283  
 Frequency : 835  
 Duty Cycle Factor : 1  
 Conversion Factor : 5.9  
 Probe Sensitivity : 1.20 1.20 1.20  $\mu\text{V}/(\text{V}/\text{m})^2$   
 Compression Point : 95.00 mV  
 Offset : 1.56 mm

1 gram SAR value : 0.454 W/kg  
 10 gram SAR value : 0.275 W/kg  
 Area Scan Peak SAR : 0.519 W/kg  
 Zoom Scan Peak SAR : 0.690 W/kg

**Plot 43#**

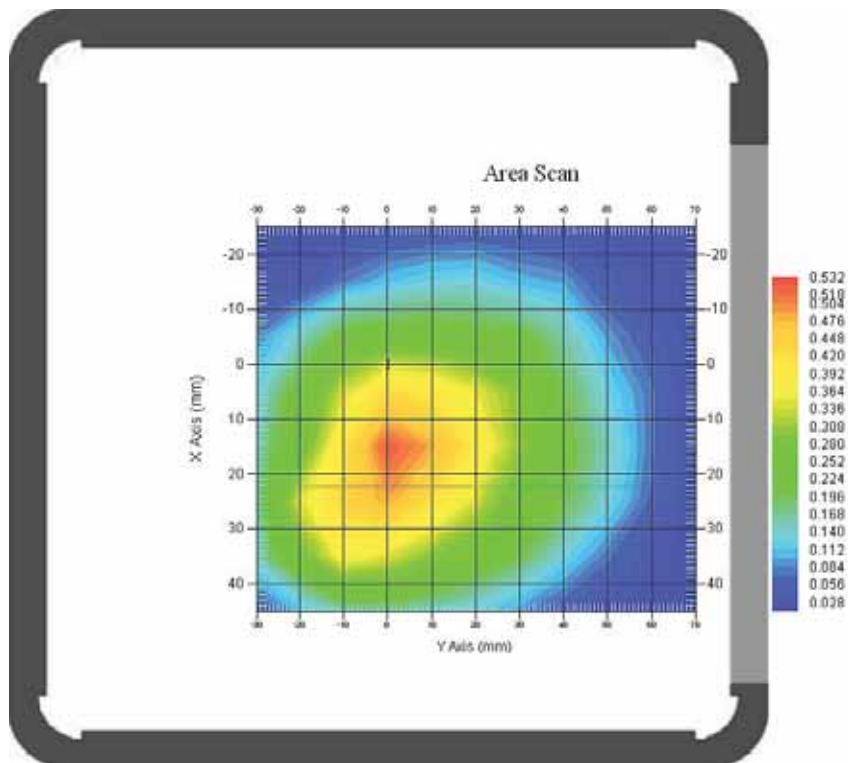



**Test Laboratory: Bay Area Compliance Lab Corp. (Shenzhen)**

**Hot Spot: WCDMA850; Body-Left (836.6 MHz Middle Channel)**

Measurement Data

Test mode : WCDMA850  
 Crest Factor : 1  
 Scan Type : Complete  
 Area Scan : 7x11x1 : Measurement x=10mm, y=10mm, z=4mm  
 Zoom Scan : 7x7x7 : Measurement x=5mm, y=5mm, z=5mm  
 Power Drift-Start : 0.164 W/kg  
 Power Drift-Finish : 0.165 W/kg  
 Power Drift (%) : 0.026

Tissue Data

Type : Body  
 Frequency : 836.6 MHz  
 Epsilon : 55.23 F/m  
 Sigma : 0.96 S/m  
 Density : 1000.00 kg/cu. m

Probe Data

Serial No. : 500-00283  
 Frequency : 835  
 Duty Cycle Factor : 1  
 Conversion Factor : 5.9  
 Probe Sensitivity : 1.20 1.20 1.20  $\mu\text{V}/(\text{V/m})^2$   
 Compression Point : 95.00 mV  
 Offset : 1.56 mm

1 gram SAR value : 0.214 W/kg  
 10 gram SAR value : 0.124 W/kg  
 Area Scan Peak SAR : 0.225 W/kg  
 Zoom Scan Peak SAR : 0.330 W/kg

**Plot 44#**

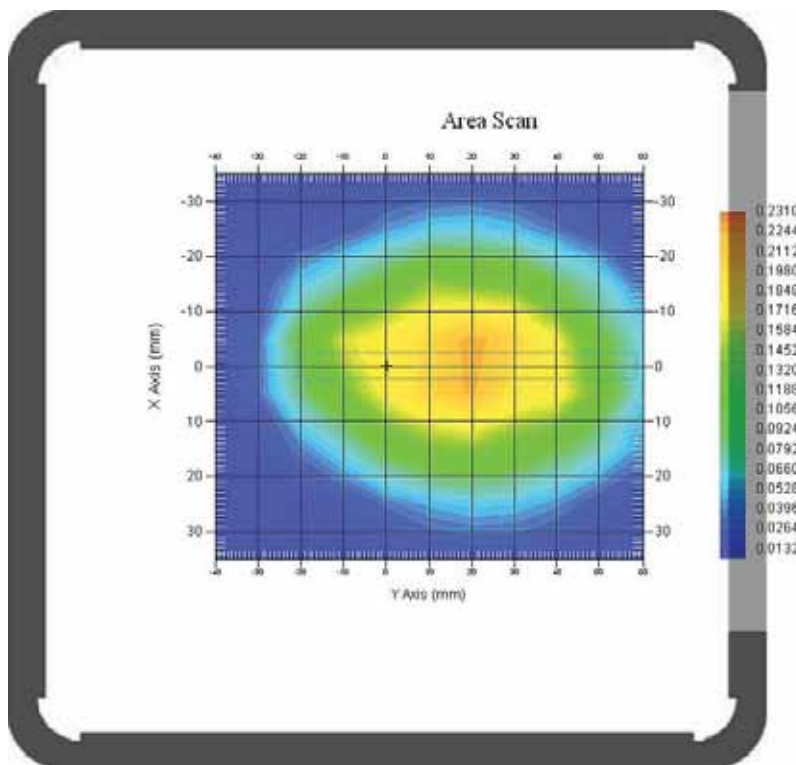

**Test Laboratory: Bay Area Compliance Lab Corp. (Shenzhen)**

**Hot Spot: WCDMA850; Body-Right (836.6 MHz Middle Channel)**

Measurement Data

Test mode : WCDMA850  
 Crest Factor : 1  
 Scan Type : Complete  
 Area Scan : 7x11x1 : Measurement x=10mm, y=10mm, z=4mm  
 Zoom Scan : 7x7x7 : Measurement x=5mm, y=5mm, z=5mm  
 Power Drift-Start : 0.134 W/kg  
 Power Drift-Finish : 0.135 W/kg  
 Power Drift (%) : 0.910

Tissue Data

Type : Body  
 Frequency : 836.6 MHz  
 Epsilon : 55.23 F/m  
 Sigma : 0.96 S/m  
 Density : 1000.00 kg/cu. m

Probe Data

Serial No. : 500-00283  
 Frequency : 835  
 Duty Cycle Factor : 1  
 Conversion Factor : 5.9  
 Probe Sensitivity : 1.20 1.20 1.20  $\mu\text{V}/(\text{V}/\text{m})^2$   
 Compression Point : 95.00 mV  
 Offset : 1.56 mm

1 gram SAR value : 0.147 W/kg  
 10 gram SAR value : 0.083 W/kg  
 Area Scan Peak SAR : 0.150 W/kg  
 Zoom Scan Peak SAR : 0.220 W/kg

**Plot 45#**

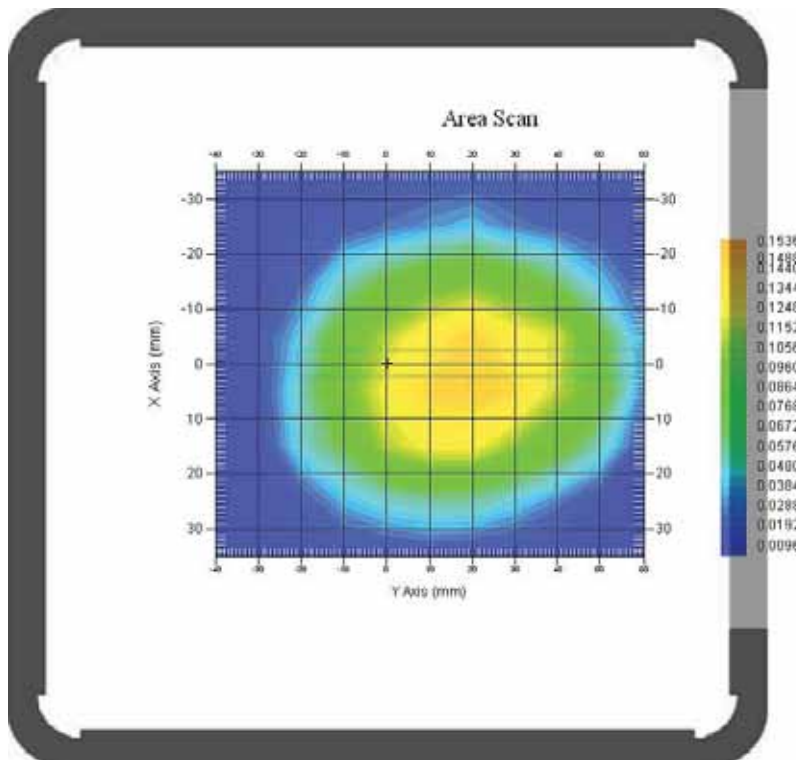

**Test Laboratory: Bay Area Compliance Lab Corp. (Shenzhen)**

**Hot Spot: WCDMA850; Body-Bottom (836.6 MHz Middle Channel)**

Measurement Data

Test mode : WCDMA850  
 Crest Factor : 1  
 Scan Type : Complete  
 Area Scan : 7x9x1 : Measurement x=10mm, y=10mm, z=4mm  
 Zoom Scan : 7x7x7 : Measurement x=5mm, y=5mm, z=5mm  
 Power Drift-Start : 0.003 W/kg  
 Power Drift-Finish : 0.003 W/kg  
 Power Drift (%) : 2.001

Tissue Data

Type : Body  
 Frequency : 836.6 MHz  
 Epsilon : 55.23 F/m  
 Sigma : 0.96 S/m  
 Density : 1000.00 kg/cu. m

Probe Data

Serial No. : 500-00283  
 Frequency : 835  
 Duty Cycle Factor : 1  
 Conversion Factor : 5.9  
 Probe Sensitivity : 1.20 1.20 1.20  $\mu\text{V}/(\text{V}/\text{m})^2$   
 Compression Point : 95.00 mV  
 Offset : 1.56 mm

1 gram SAR value : 0.036 W/kg  
 10 gram SAR value : 0.010 W/kg  
 Area Scan Peak SAR : 0.034 W/kg  
 Zoom Scan Peak SAR : 0.130 W/kg

**Plot 46#**

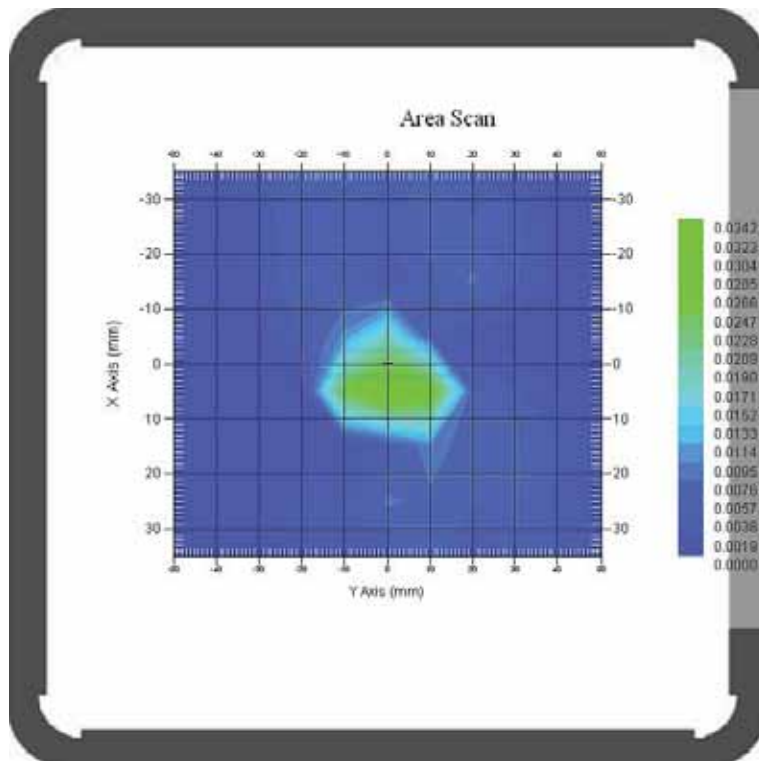

**Test Laboratory: Bay Area Compliance Lab Corp. (Shenzhen)**

**Hot Spot: WCDMA1900; Body-Front (1880 MHz Middle Channel)**

Measurement Data

Test mode : WCDMA1900  
 Crest Factor : 1  
 Scan Type : Complete  
 Area Scan : 9x11x1 : Measurement x=10mm, y=10mm, z=4mm  
 Zoom Scan : 7x7x7 : Measurement x=5mm, y=5mm, z=5mm  
 Power Drift-Start : 0.166 W/kg  
 Power Drift-Finish : 0.161 W/kg  
 Power Drift (%) : -3.192

Tissue Data

Type : Body  
 Frequency : 1880.0 MHz  
 Epsilon : 53.87 F/m  
 Sigma : 1.53 S/m  
 Density : 1000.00 kg/cu. m

Probe Data

Serial No. : 500-00283  
 Frequency : 1900  
 Duty Cycle Factor : 1  
 Conversion Factor : 4.5  
 Probe Sensitivity : 1.20 1.20 1.20  $\mu\text{V}/(\text{V}/\text{m})^2$   
 Compression Point : 95.00 mV  
 Offset : 1.56 mm

1 gram SAR value : 0.472 W/kg  
 10 gram SAR value : 0.240 W/kg  
 Area Scan Peak SAR : 0.537 W/kg  
 Zoom Scan Peak SAR : 0.870 W/kg

**Plot 47#**

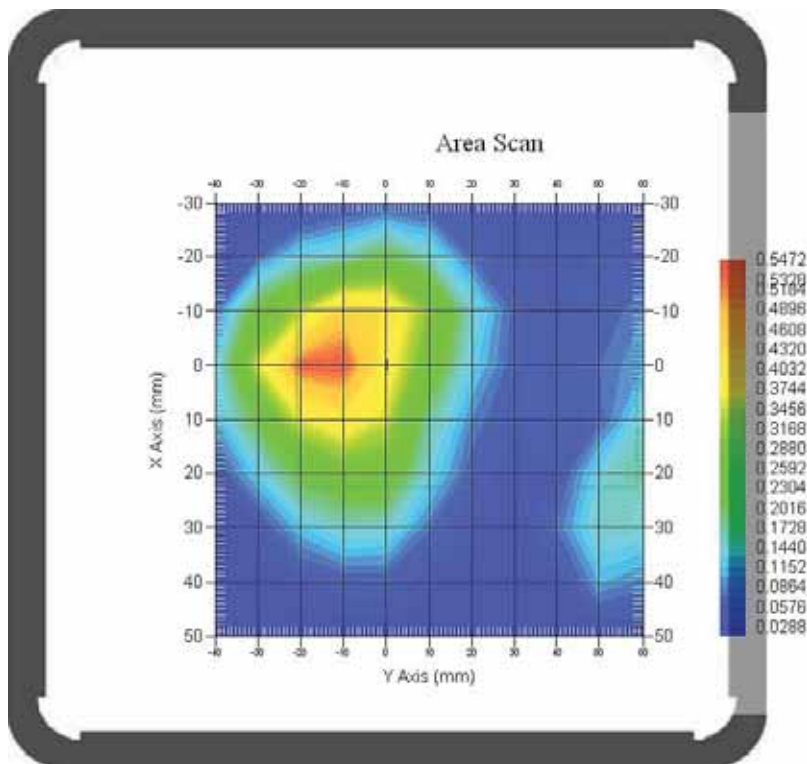

**Test Laboratory: Bay Area Compliance Lab Corp. (Shenzhen)**

**Hot Spot: WCDMA1900; Body-Back (1852.4 MHz Low Channel)**

Measurement Data

Test mode : WCDMA1900  
 Crest Factor : 1  
 Scan Type : Complete  
 Area Scan : 9x11x1 : Measurement x=10mm, y=10mm, z=4mm  
 Zoom Scan : 7x7x7 : Measurement x=5mm, y=5mm, z=5mm  
 Power Drift-Start : 0.066 W/kg  
 Power Drift-Finish : 0.067 W/kg  
 Power Drift (%) : 1.367

Tissue Data

Type : Body  
 Frequency : 1852.4 MHz  
 Epsilon : 53.87 F/m  
 Sigma : 1.53 S/m  
 Density : 1000.00 kg/cu. m

Probe Data

Serial No. : 500-00283  
 Frequency : 1900  
 Duty Cycle Factor : 1  
 Conversion Factor : 4.5  
 Probe Sensitivity : 1.20 1.20 1.20  $\mu\text{V}/(\text{V}/\text{m})^2$   
 Compression Point : 95.00 mV  
 Offset : 1.56 mm

1 gram SAR value : 1.097 W/kg  
 10 gram SAR value : 0.509 W/kg  
 Area Scan Peak SAR : 1.156 W/kg  
 Zoom Scan Peak SAR : 2.061 W/kg

**Plot 48#**

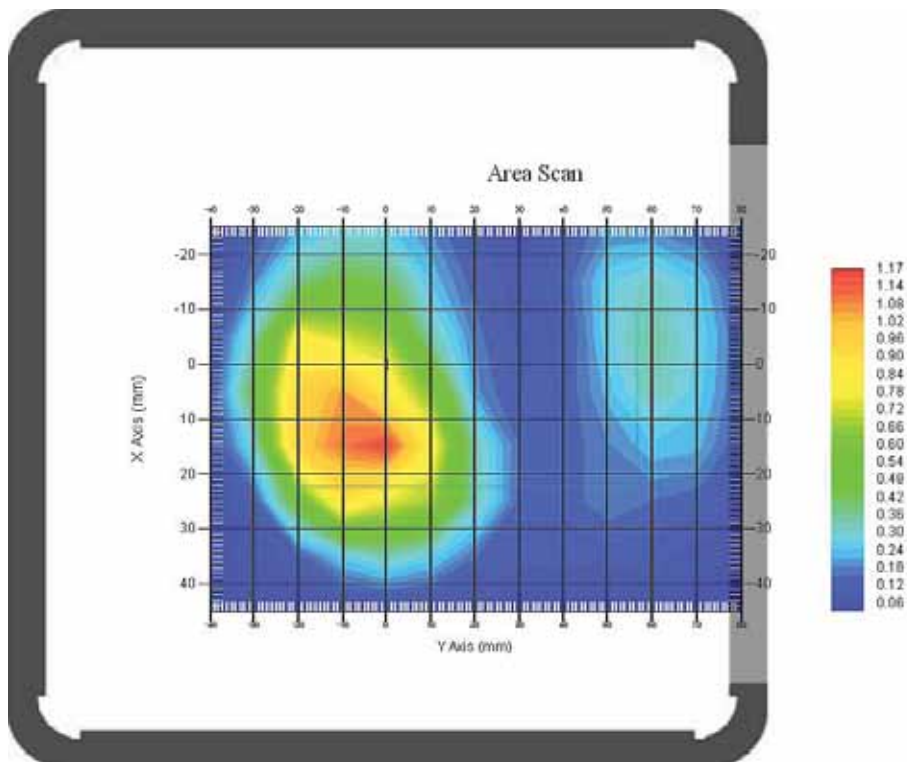

**Test Laboratory: Bay Area Compliance Lab Corp. (Shenzhen)**

**Hot Spot: WCDMA1900; Body-Back (1880.0 MHz Middle Channel)**

Measurement Data

Test mode : WCDMA1900  
 Crest Factor : 1  
 Scan Type : Complete  
 Area Scan : 9x11x1 : Measurement x=10mm, y=10mm, z=4mm  
 Zoom Scan : 7x7x7 : Measurement x=5mm, y=5mm, z=5mm  
 Power Drift-Start : 0.066 W/kg  
 Power Drift-Finish : 0.067 W/kg  
 Power Drift (%) : 1.985

Tissue Data

Type : Body  
 Frequency : 1880.0 MHz  
 Epsilon : 53.87 F/m  
 Sigma : 1.53 S/m  
 Density : 1000.00 kg/cu. m

Probe Data

Serial No. : 500-00283  
 Frequency : 1900  
 Duty Cycle Factor : 1  
 Conversion Factor : 4.5  
 Probe Sensitivity : 1.20 1.20 1.20  $\mu\text{V}/(\text{V}/\text{m})^2$   
 Compression Point : 95.00 mV  
 Offset : 1.56 mm

1 gram SAR value : 0.789 W/kg  
 10 gram SAR value : 0.427 W/kg  
 Area Scan Peak SAR : 0.768 W/kg  
 Zoom Scan Peak SAR : 1.381 W/kg

**Plot 49#**

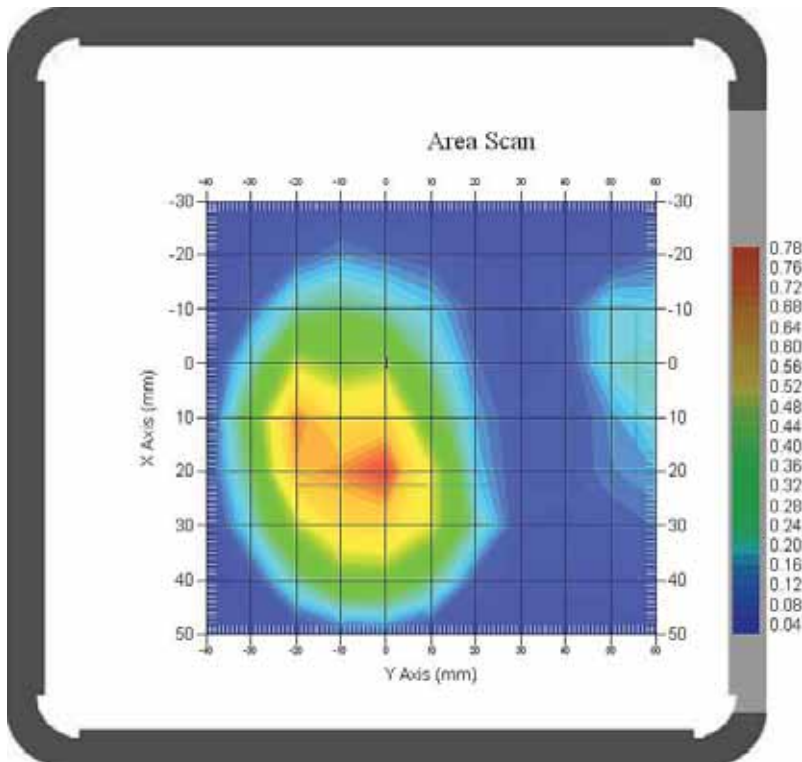

**Test Laboratory: Bay Area Compliance Lab Corp. (Shenzhen)**

**Hot Spot: WCDMA1900; Body-Back (1907.6 MHz High Channel)**

Measurement Data

Test mode : WCDMA1900  
 Crest Factor : 1  
 Scan Type : Complete  
 Area Scan : 9x11x1 : Measurement x=10mm, y=10mm, z=4mm  
 Zoom Scan : 7x7x7 : Measurement x=5mm, y=5mm, z=5mm  
 Power Drift-Start : 0.066 W/kg  
 Power Drift-Finish : 0.067 W/kg  
 Power Drift (%) : 1.104

Tissue Data

Type : Body  
 Frequency : 1907.6 MHz  
 Epsilon : 53.87 F/m  
 Sigma : 1.53 S/m  
 Density : 1000.00 kg/cu. m

Probe Data

Serial No. : 500-00283  
 Frequency : 1900  
 Duty Cycle Factor : 1  
 Conversion Factor : 4.5  
 Probe Sensitivity : 1.20 1.20 1.20  $\mu\text{V}/(\text{V}/\text{m})^2$   
 Compression Point : 95.00 mV  
 Offset : 1.56 mm

1 gram SAR value : 0.855 W/kg  
 10 gram SAR value : 0.576 W/kg  
 Area Scan Peak SAR : 0.805 W/kg  
 Zoom Scan Peak SAR : 1.471 W/kg

**Plot 50#**

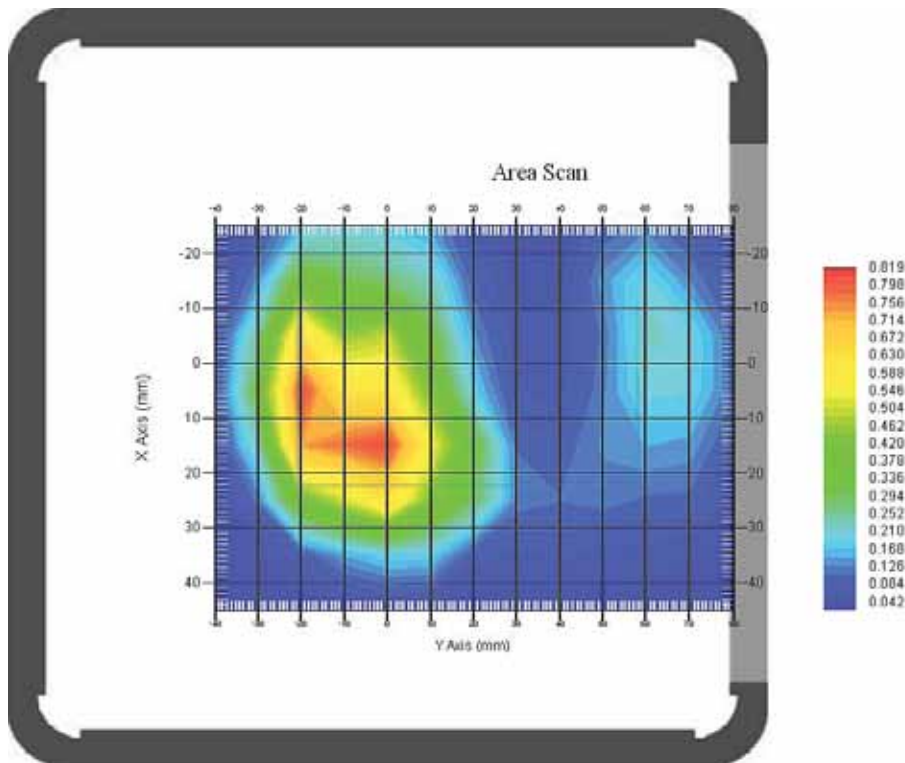

**Test Laboratory: Bay Area Compliance Lab Corp. (Shenzhen)**

**Hot Spot: WCDMA1900; Body-Left (1880 MHz Middle Channel)**

Measurement Data

Test mode : WCDMA1900  
 Crest Factor : 1  
 Scan Type : Complete  
 Area Scan : 7x11x1 : Measurement x=10mm, y=10mm, z=4mm  
 Zoom Scan : 7x7x7 : Measurement x=5mm, y=5mm, z=5mm  
 Power Drift-Start : 0.064 W/kg  
 Power Drift-Finish : 0.063 W/kg  
 Power Drift (%) : -0.258

Tissue Data

Type : Body  
 Frequency : 1880.0 MHz  
 Epsilon : 53.87 F/m  
 Sigma : 1.53 S/m  
 Density : 1000.00 kg/cu. m

Probe Data

Serial No. : 500-00283  
 Frequency : 1900  
 Duty Cycle Factor : 1  
 Conversion Factor : 4.5  
 Probe Sensitivity : 1.20 1.20 1.20  $\mu\text{V}/(\text{V}/\text{m})^2$   
 Compression Point : 95.00 mV  
 Offset : 1.56 mm

1 gram SAR value : 0.123 W/kg  
 10 gram SAR value : 0.044 W/kg  
 Area Scan Peak SAR : 0.137 W/kg  
 Zoom Scan Peak SAR : 0.350 W/kg

**Plot 51#**

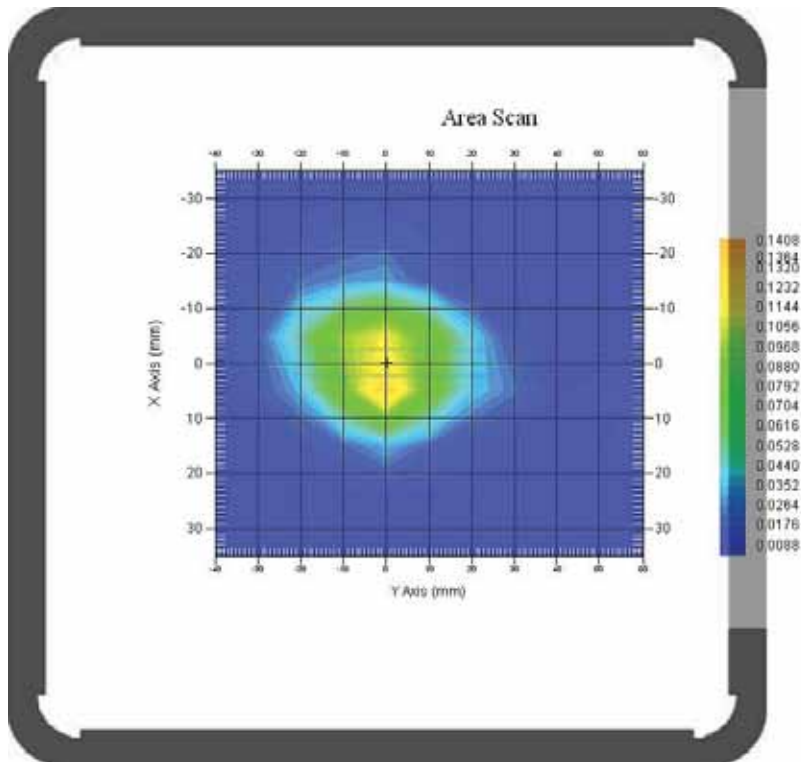



**Test Laboratory: Bay Area Compliance Lab Corp. (Shenzhen)**

**Hot Spot: WCDMA1900; Body-Right (1880 MHz Middle Channel)**

Measurement Data

Test mode : WCDMA1900  
 Crest Factor : 1  
 Scan Type : Complete  
 Area Scan : 7x11x1 : Measurement x=10mm, y=10mm, z=4mm  
 Zoom Scan : 7x7x7 : Measurement x=5mm, y=5mm, z=5mm  
 Power Drift-Start : 0.001 W/kg  
 Power Drift-Finish : 0.001 W/kg  
 Power Drift (%) : -0.770

Tissue Data

Type : Body  
 Frequency : 1880.0 MHz  
 Epsilon : 53.87 F/m  
 Sigma : 1.53 S/m  
 Density : 1000.00 kg/cu. m

Probe Data

Serial No. : 500-00283  
 Frequency : 1900  
 Duty Cycle Factor : 1  
 Conversion Factor : 4.5  
 Probe Sensitivity : 1.20 1.20 1.20  $\mu\text{V}/(\text{V}/\text{m})^2$   
 Compression Point : 95.00 mV  
 Offset : 1.56 mm

1 gram SAR value : 0.032 W/kg  
 10 gram SAR value : 0.014 W/kg  
 Area Scan Peak SAR : 0.043 W/kg  
 Zoom Scan Peak SAR : 0.110 W/kg

**Plot 52#**

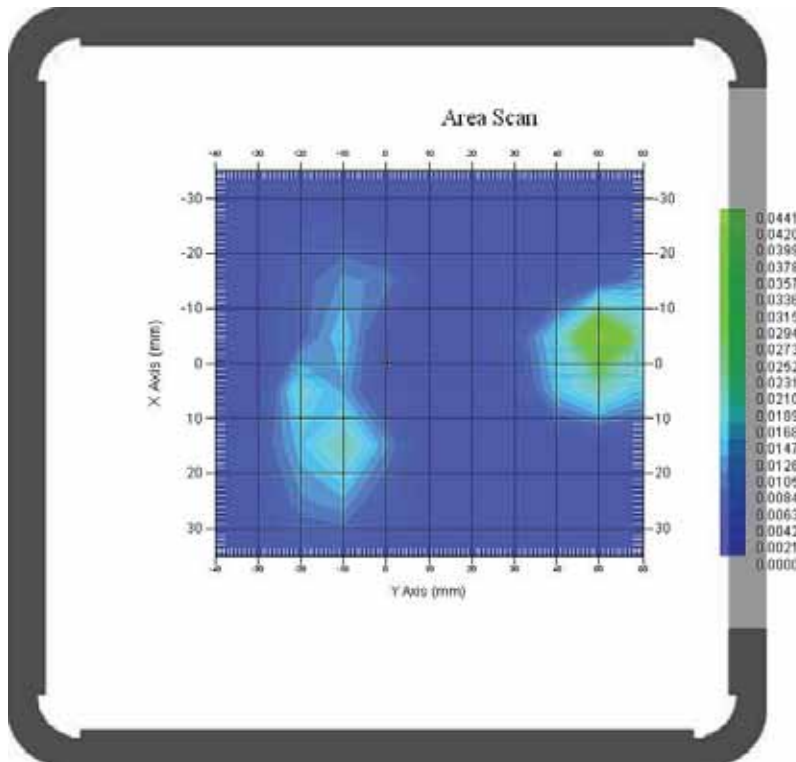

**Test Laboratory: Bay Area Compliance Lab Corp. (Shenzhen)**

**Hot Spot: WCDMA1900; Body-Bottom (1880 MHz Middle Channel)**

Measurement Data

Test mode : WCDMA1900  
 Crest Factor : 1  
 Scan Type : Complete  
 Area Scan : 7x9x1 : Measurement x=10mm, y=10mm, z=4mm  
 Zoom Scan : 7x7x7 : Measurement x=5mm, y=5mm, z=5mm  
 Power Drift-Start : 0.133 W/kg  
 Power Drift-Finish : 0.127 W/kg  
 Power Drift (%) : -4.039

Tissue Data

Type : Body  
 Frequency : 1880.0 MHz  
 Epsilon : 53.87 F/m  
 Sigma : 1.53 S/m  
 Density : 1000.00 kg/cu. m

Probe Data

Serial No. : 500-00283  
 Frequency : 1900  
 Duty Cycle Factor : 1  
 Conversion Factor : 4.5  
 Probe Sensitivity : 1.20 1.20 1.20  $\mu\text{V}/(\text{V}/\text{m})^2$   
 Compression Point : 95.00 mV  
 Offset : 1.56 mm

1 gram SAR value : 0.172 W/kg  
 10 gram SAR value : 0.066 W/kg  
 Area Scan Peak SAR : 0.145 W/kg  
 Zoom Scan Peak SAR : 0.430 W/kg

**Plot 53#**

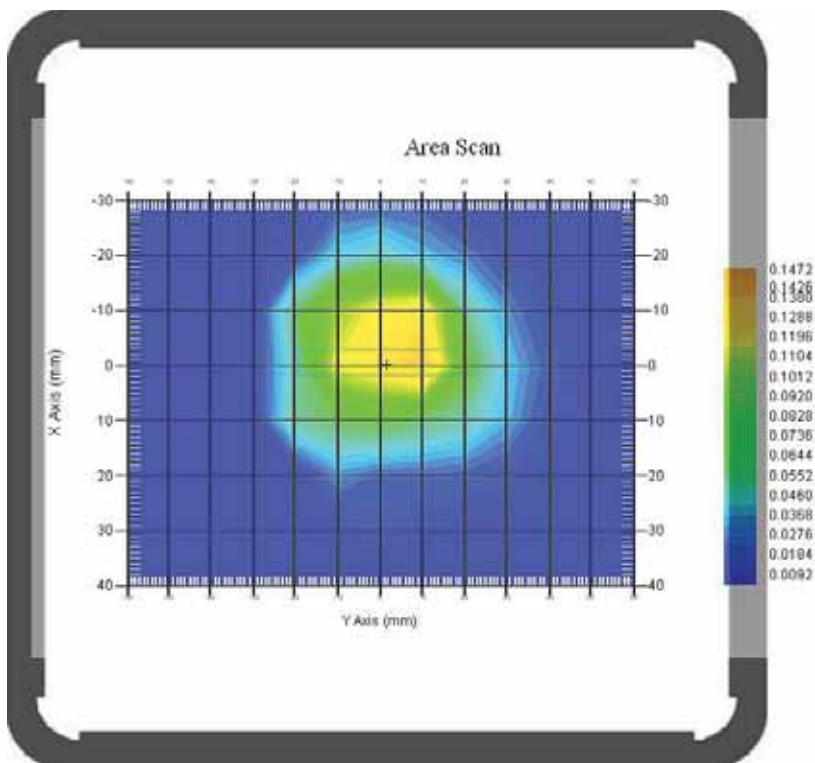

## APPENDIX A MEASUREMENT UNCERTAINTY

The uncertainty budget has been determined for the measurement system and is given in the following Table.

**Measurement Uncertainty for 300MHz to 3GHz**

Source of Uncertainty	Tolerance Value	Probability Distribution	Divisor	$c_1^1$ (1-g)	$c_1^1$ (10-g)	Standard Uncertainty (1-g) %	Standard Uncertainty (10-g) %
<b>Measurement System</b>							
Probe Calibration	3.5	normal	1	1	1	3.5	3.5
Axial Isotropy	3.7	rectangular	$\sqrt{3}$	$(1-cp)^{1/2}$	$(\frac{1-cp}{2})^1$	1.5	1.5
Hemispherical Isotropy	10.9	rectangular	$\sqrt{3}$	$\sqrt{cp}$	$\sqrt{cp}$	4.4	4.4
Boundary Effect	1.0	rectangular	$\sqrt{3}$	1	1	0.6	0.6
Linearity	4.7	rectangular	$\sqrt{3}$	1	1	2.7	2.7
Detection Limit	1.0	rectangular	$\sqrt{3}$	1	1	0.6	0.6
Readout Electronics	1.0	normal	1	1	1	1.0	1.0
Response Time	0.8	rectangular	$\sqrt{3}$	1	1	0.5	0.5
Integration Time	1.7	rectangular	$\sqrt{3}$	1	1	1.0	1.0
RF Ambient Condition -Noise	0.006	rectangular	$\sqrt{3}$	1	1	0.003	0.003
RF Ambient Condition - Reflections	3.0	rectangular	$\sqrt{3}$	1	1	1.7	1.7
Probe Positioner Mech. Restrictions	0.4	rectangular	$\sqrt{3}$	1	1	0.2	0.2
<b>Restriction</b>							
Probe Positioning with respect to Phantom Shell	2.9	rectangular	$\sqrt{3}$	1	1	1.7	1.7
Extrapolation and Integration	3.7	rectangular	$\sqrt{3}$	1	1	2.1	2.1
Test Sample Positioning	0.023	normal	1	1	1	0.023	0.023
Device Holder Uncertainty	6.215	normal	1	1	1	6.215	6.215
Drift of Output Power	4.627	rectangular	$\sqrt{3}$	1	1	2.67	2.67
<b>Phantom and Setup</b>							
Phantom Uncertainty(shape & thickness tolerance)	3.4	rectangular	$\sqrt{3}$	1	1	2.0	2.0
Liquid Conductivity(target)	5.0	rectangular	$\sqrt{3}$	0.7	0.5	2.0	1.4
Liquid Conductivity(meas.)	1.938	normal	1	0.7	0.5	1.36	0.97
Liquid Permittivity(target)	5.0	rectangular	$\sqrt{3}$	0.6	0.5	1.7	1.4
Liquid Permittivity(meas.)	3.093	normal	1	0.6	0.5	1.86	1.55
Combined Uncertainty		RSS				10.78	10.55
Expanded uncertainty (coverage factor=2)		Normal(k=2)				21.56	21.10

## APPENDIX B – PROBE CALIBRATION CERTIFICATES

### NCL CALIBRATION LABORATORIES

Calibration File No.: PC-1537

Task No: BACL-5745

## CERTIFICATE OF CALIBRATION

It is certified that the equipment identified below has been calibrated in the NCL CALIBRATION LABORATORIES by qualified personnel following recognized procedures and using transfer standards traceable to NRC/NIST.

Equipment: Miniature Isotropic RF Probe

Record of Calibration

Head and Body

Manufacturer: APREL Laboratories

Model No.: E-020

Serial No.: 500-00283

Calibration Procedure: D01-032-E020-V2, D22-012-Tissue, D28-002-Dipole  
Project No: BACL-5745

Calibrated: 8<sup>th</sup> October 2013  
Released on: 8<sup>th</sup> October 2013

This Calibration Certificate is Incomplete Unless Accompanied with the Calibration Results Summary

Released By: \_\_\_\_\_



Art Brennan, Quality Manager

### **NCL** CALIBRATION LABORATORIES

Suite 102, 303 Terry Fox Dr.  
OTTAWA, ONTARIO  
CANADA K2K 3J1

Division of APREL Lab.  
TEL: (813) 435-8300  
FAX: (813) 435-8308

## **NCL Calibration Laboratories**

---

Division of APREL Inc.

### **Introduction**

This Calibration Report reproduces the results of the calibration performed in line with the references listed below. Calibration is performed using accepted methodologies as per the references listed below. Probes are calibrated for air, and tissue and the values reported are the results from the physical quantification of the probe through meteorological practices.

### **Calibration Method**

Probes are calibrated using the following methods.

<1000MHz

TEM Cell for sensitivity in air

Standard phantom using temperature transfer method for sensitivity in tissue

>1000MHz

Waveguide\* method to determine sensitivity in air and tissue

\*Waveguide is numerically (simulation) assessed to determine the field distribution and power

The boundary effect for the probe is assessed using a standard flat phantom where the probe output is compared against a numerically simulated series of data points

### **References**

- IEEE Standard 1528  
IEEE Recommended Practice for Determining the Peak Spatial-Average Specific Absorption Rate (SAR) in the Human Head from Wireless Communications Devices: Measurement Techniques
- EN 62209-1  
Human Exposure to RF Fields from hand-held and body-mounted wireless communication devices - Human models, instrumentation, and procedures-Part 1: Procedure to measure the Specific Absorption Rate (SAR) for hand-held mobile wireless devices
- IEC 62209-2  
Human exposure to RF fields from hand-held and body-mounted wireless devices - Human models, instrumentation, and procedures - Part 2: specific absorption rate (SAR) for wireless communication devices (30 MHz - 6 GHz)
- TP-D01-032-E020-V2 E-Field probe calibration procedure
- D22-012-Tissue dielectric tissue calibration procedure
- D28-002-Dipole procedure for validation of SAR system using a dipole
- IEEE 1309 Standard for Calibration of Electromagnetic Field Sensors and Probes, Excluding Antennas, from 9kHz to 40GHz

---

Page 2 of 10

This page has been reviewed for content and attested to on Page 2 of this document.

**NCL Calibration Laboratories**

Division of APREL Inc.

**Conditions**

Probe 500-00283 was a recalibration.

**Ambient Temperature of the Laboratory:** 22 °C +/- 1.5°C

**Temperature of the Tissue:** 21 °C +/- 1.5°C

**Relative Humidity:** < 60%

**Primary Measurement Standards**

Instrument	Serial Number	Cal due date
Tektronix USB Power Meter	11C940	May 14, 2015
Signal Generator HP 83640B	3844A00689	Feb 12, 2015

**Secondary Measurement Standards**

Network Analyzer Anritsu 37347C	002106	Feb. 20, 2015
---------------------------------	--------	---------------

**Attestation**

The below named signatories have conducted the calibration and review of the data which is presented in this calibration report.

**We the undersigned attest that to the best of our knowledge the calibration of this subject has been accurately conducted and that all information contained within the results pages have been reviewed for accuracy.**



Art Brennan, Quality Manager



Dan Brooks, Test Engineer

Page 3 of 10

This page has been reviewed for content and attested to on Page 2 of this document.

**NCL Calibration Laboratories**

Division of APREL Inc.

**Probe Summary**

<b>Probe Type:</b>	E-Field Probe E020
<b>Serial Number:</b>	500-00283
<b>Frequency:</b>	As presented on page 5
<b>Sensor Offset:</b>	1.56
<b>Sensor Length:</b>	2.5
<b>Tip Enclosure:</b>	Composite*
<b>Tip Diameter:</b>	< 2.9 mm
<b>Tip Length:</b>	55 mm
<b>Total Length:</b>	289 mm

\*Resistive to recommended tissue recipes per IEEE-1528

**Sensitivity in Air**

<b>Channel X:</b>	1.2 $\mu\text{V}/(\text{V}/\text{m})^2$
<b>Channel Y:</b>	1.2 $\mu\text{V}/(\text{V}/\text{m})^2$
<b>Channel Z:</b>	1.2 $\mu\text{V}/(\text{V}/\text{m})^2$
<b>Diode Compression Point:</b>	95 mV

**NCL Calibration Laboratories**

Division of APREL Inc.

Calibration for Tissue (Head H, Body B)

Frequency	Tissue Type	Measured Epsilon	Measured Sigma	Standard Uncertainty (%)	Calibration Frequency Range (MHz)	Conversion Factor
450 H	Head	44.29	0.86	3.5	±50	5.7
450 B	Body	56.6	0.94	3.5	±50	5.8
750 H	Head	42.7	0.85	3.5	±50	5.6
750 B	Body	56.6	0.94	3.5	±50	5.5
835 H	Head	42.35	0.938	3.5	±50	5.9
835 B	Body	56.65	1.018	3.5	±50	5.9
900 H	Head	X	X	X	X	X
900 B	Body	X	X	X	X	X
1450 H	Head	X	X	X	X	X
1450 B	Body	X	X	X	X	X
1500 H	Head	X	X	X	X	X
1500 B	Body	X	X	X	X	X
1640 H	Head	X	X	X	X	X
1640 B	Body	X	X	X	X	X
1750 H	Head	38.51	1.36	3.5	±75	5.4
1750 B	Body	51.79	1.53	3.5	±75	5.3
1800 H	Head	38.26	1.41	3.5	±75	5.0
1800 B	Body	51.61	1.58	3.5	±75	5.0
1900 H	Head	38.03	1.36	3.5	±75	4.8
1900 B	Body	53.13	1.58	3.5	±75	4.5
2000 H	Head	X	X	X	X	X
2000 B	Body	X	X	X	X	X
2100 H	Head	X	X	X	X	X
2100 B	Body	X	X	X	X	X
2300 H	Head	X	X	X	X	X
2300 B	Body	X	X	X	X	X
2450 H	Head	37.64	1.88	3.5	±75	4.9
2450 B	Body	50.7	2.03	3.5	±75	4.3
2600 H	Head	X	X	X	X	X
2600 B	Body	X	X	X	X	X
3000 H	Head	X	X	X	X	X
3000 B	Body	X	X	X	X	X
3600 H	Head	X	X	X	X	X
3600 B	Body	X	X	X	X	X
5250 H	Head	34.65	4.8	3.5	±100	2.7
5250 B	Body	47.6	5.3	3.5	±100	2.6
5600 H	Head	33.2	5.15	3.5	±100	2.5
5600 B	Body	45.21	5.57	3.5	±100	2.2
5800 H	Head	32.72	5.38	3.5	±100	3.2
5800 B	Body	44.28	6.04	3.5	±100	2.5



**NCL Calibration Laboratories**

---

Division of APREL Inc.

**Boundary Effect:**

Uncertainty resulting from the boundary effect is less than 2.1% for the distance between the tip of the probe and the tissue boundary, when less than 0.58mm.

**Spatial Resolution:**

The spatial resolution uncertainty is less than 1.5% for 4.9mm diameter probe.  
The spatial resolution uncertainty is less than 1.0% for 2.5mm diameter probe.

**DAQ-PAQ Contribution**

To minimize the uncertainty calculation all tissue sensitivity values were calculated using a load impedance of 5 M $\Omega$ .

---

Page 6 of 10

This page has been reviewed for content and attested to on Page 2 of this document.

**NCL Calibration Laboratories**

Division of APREL Inc.

**Receiving Pattern Air**

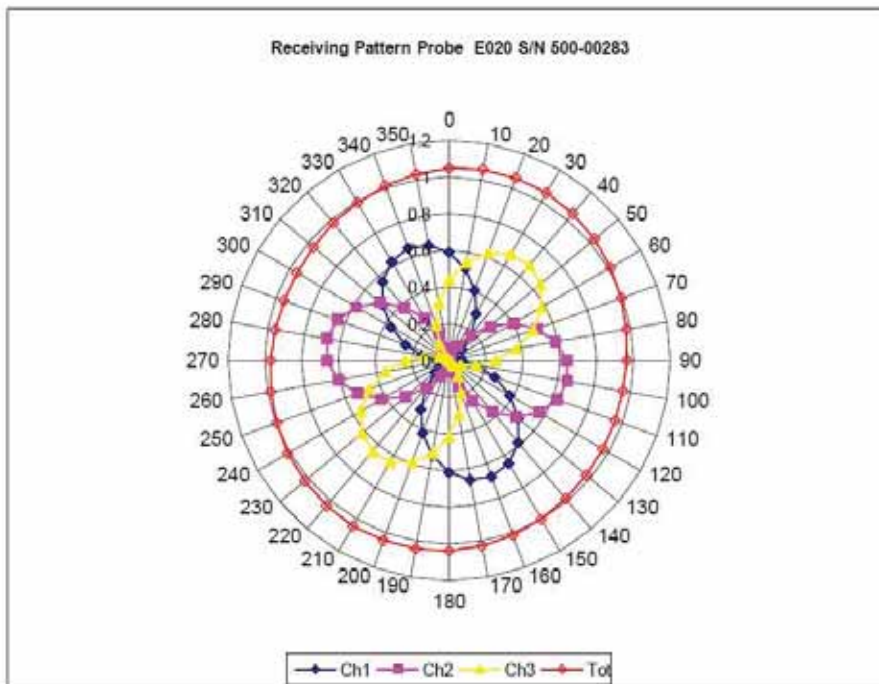

Page 7 of 10

This page has been reviewed for content and attested to on Page 2 of this document.

**NCL Calibration Laboratories**

Division of APREL Inc.

**Isotropy Error Air**

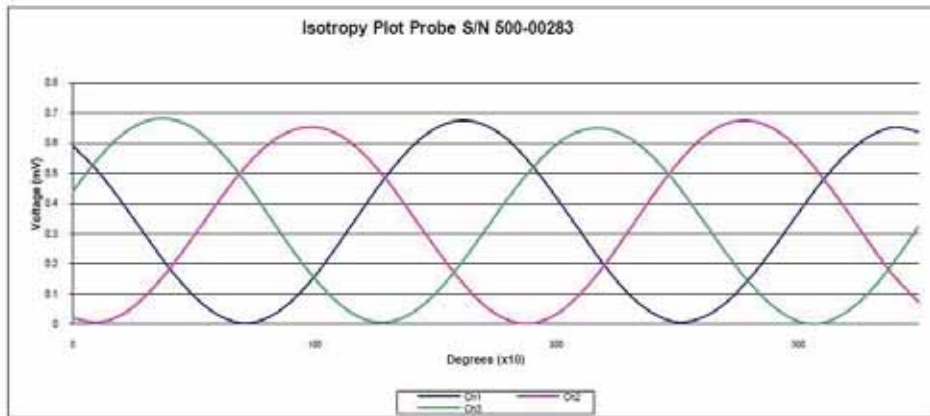
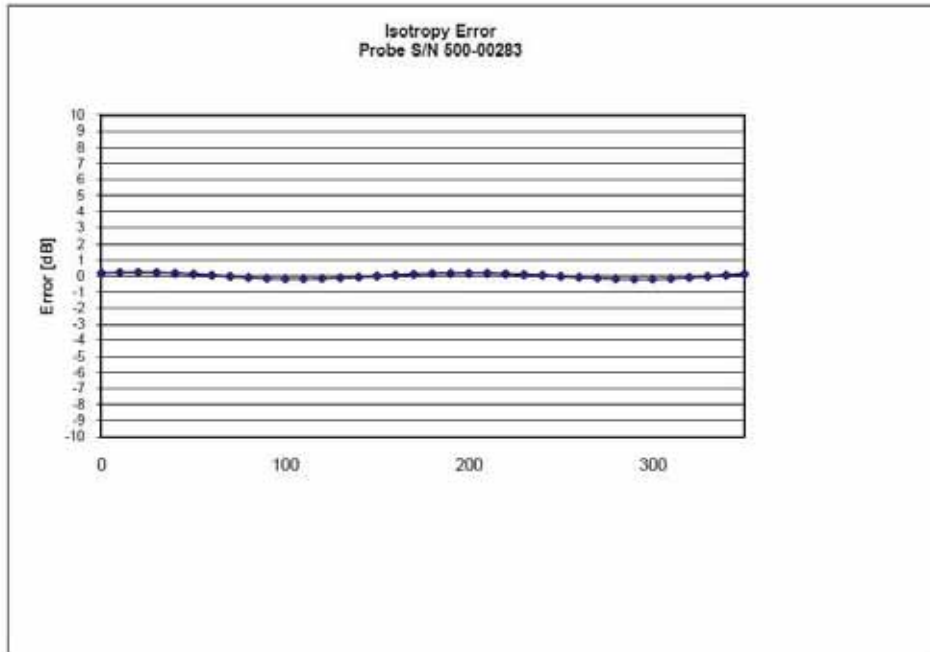

**Isotropicity Tissue:** 0.10 dB

**NCL Calibration Laboratories**

Division of APREL Inc.

**Dynamic Range**

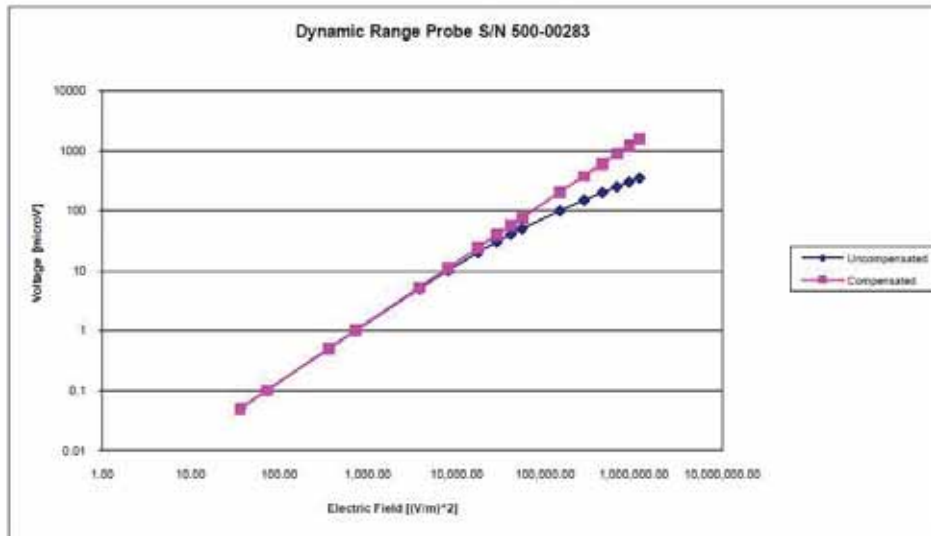

Page 9 of 10

This page has been reviewed for content and attested to on Page 2 of this document.

**NCL Calibration Laboratories**

Division of APREL Inc.

**Video Bandwidth**

Probe Frequency Characteristics

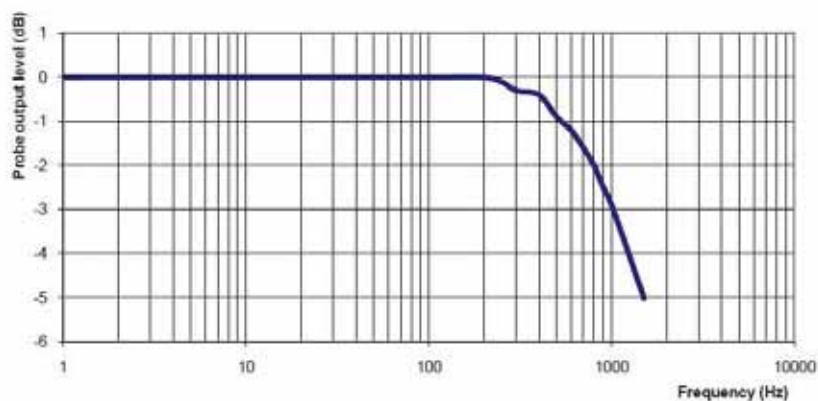

Video Bandwidth at 500 Hz                    1 dB  
Video Bandwidth at 1.02 KHz:                3 dB

**Test Equipment**

The test equipment used during Probe Calibration, manufacturer, model number and, current calibration status are listed and located on the main APREL server R:\NCL\Calibration Equipment\Instrument List May 2013.

## APPENDIX C DIPOLE CALIBRATION CERTIFICATES

### NCL CALIBRATION LABORATORIES

Calibration File No: DC-1327  
Project Number: BAC-dipole-cal-5618

## CERTIFICATE OF CALIBRATION

It is certified that the equipment identified below has been calibrated in the  
**NCL CALIBRATION LABORATORIES** by qualified personnel following recognized  
procedures and using transfer standards traceable to NRC/NIST.

Validation Dipole(Head and Body)

Manufacturer: APREL Laboratories  
Part number: ALS-D-835-S-2  
Frequency: 835 MHz  
Serial No: 180-00558

Customer: Bay Area Compliance Laboratory

Calibrated: 25<sup>th</sup> August 2011  
Released on: 25<sup>th</sup> August 2011

This Calibration Certificate is Incomplete Unless Accompanied with the Calibration Results Summary

Released By: \_\_\_\_\_

**NCL** CALIBRATION LABORATORIES

Suite 102, 303 Terry Fox Dr.  
Kanata, ONTARIO  
CANADA K2K 3J1

Division of APREL Lab.  
TEL: (613) 435-8300  
FAX: (613)435-8306

**NCL Calibration Laboratories**

Division of APREL Laboratories.

**Conditions**

Dipole 180-00558 was received in good condition and a re-calibration.

**Ambient Temperature of the Laboratory:** 22 °C +/- 0.5°C

**Temperature of the Tissue:** 21 °C +/- 0.5°C

We the undersigned attest that to the best of our knowledge the calibration of this device has been accurately conducted and that all information contained within this report has been reviewed for accuracy.



-----  
Stuart Nicol



-----  
C. Teodorian

Primary Measurement Standards Instrument	Serial Number	Cal due date
Power meter Anritsu MA2408A	245025437	Nov.4, 2011
Power Sensor Anritsu MA2481D	103555	Nov 4, 2011
Attenuator HP 8495A (70dB) 1	944A10711	Aug.8, 2012
Network Analyzer Agilent E5071C	1334746J	Feb. 8, 2012
Secondary Measurement Standards		
Signal Generator Agilent E4438C	-506 MY55182336	June 7, 2012

This page has been reviewed for content and attested to by signature within this document.

**NCL Calibration Laboratories**

Division of APREL Laboratories.

**Calibration Results Summary**

The following results relate the Calibrated Dipole and should be used as a quick reference for the user.

**Mechanical Dimensions**

**Length:** 162.2 mm  
**Height:** 89.4 mm

**Electrical Specification**

Tissue	Frequency	SWR:	Return Loss	Impedance
Head	835 MHz	1.0417 U	-35.395dB	49.020 Ω
Body	835 MHz	1.1177 U	-25.424dB	55.435 Ω

**System Validation Results**

Tissue	Frequency	1 Gram	10 Gram	Peak
Head	835 MHz	9.590	6.003	15.013
Body	835 MHz	9.684	6.263	14.23

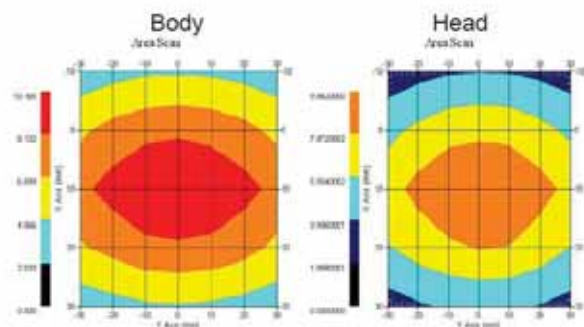

This page has been reviewed for content and attested to by signature within this document.



**NCL Calibration Laboratories**

Division of APREL Laboratories.

**Introduction**

This Calibration Report has been produced in line with the SSI Dipole Calibration Procedure SSI-TP-018-ALSAS. The results contained within this report are for Validation Dipole 180-00558. The calibration routine consisted of a three-step process. Step 1 was a mechanical verification of the dipole to ensure that it meets the mechanical specifications. Step 2 was an Electrical Calibration for the Validation Dipole, where the SWR, Impedance, and the Return loss were assessed. Step 3 involved a System Validation using the ALSAS-10U, along with APREL E-020 130 MHz to 26 GHz E-Field Probe Serial Number 212.

**References**

SSI-TP-018-ALSAS Dipole Calibration Procedure  
 SSI-TP-016 Tissue Calibration Procedure  
 IEEE 1528 "Recommended Practice for Determining the Peak Spatial-Average Specific Absorption Rate (SAR) in the Human Body Due to Wireless Communications Devices: Experimental Techniques"

**Conditions**

Dipole 180-00558 was new taken from stock.

**Ambient Temperature of the Laboratory:** 22 °C +/- 0.5°C  
**Temperature of the Tissue:** 20 °C +/- 0.5°C

**Dipole Calibration uncertainty**

The calibration uncertainty for the dipole is made up of various parameters presented below.

<b>Mechanical</b>	1%
<b>Positioning Error</b>	1.22%
<b>Electrical</b>	1.7%
<b>Tissue</b>	2.2%
<b>Dipole Validation</b>	2.2%
<b>TOTAL</b>	<b>8.32% (16.64% K=2)</b>

This page has been reviewed for content and attested to by signature within this document.

**NCL Calibration Laboratories**

Division of APREL Laboratories.

**Dipole Calibration Results**

**Mechanical Verification**

APREL Length	APREL Height	Measured Length	Measured Height
161.0 mm	89.8 mm	162.2 mm	89.4 mm

Tissue Type	Return Loss:	SWR:	Impedance:
Head	-35.395 dB	1.0417 U	49.020Ω
Body	-25.454 dB	1.1177 U	55.435Ω

**Tissue Validation**

	Dielectric constant, $\epsilon_r$	Conductivity, $\sigma$ [S/m]
Head Tissue 835MHz	41.78	0.92
Body Tissue 835MHz	56.37	0.95

This page has been reviewed for content and attested to by signature within this document.

**NCL Calibration Laboratories**

Division of APREL Laboratories.

The Following Graphs are the results as displayed on the Vector Network Analyzer.

**S11 Parameter Return Loss**

**Head Tissue**

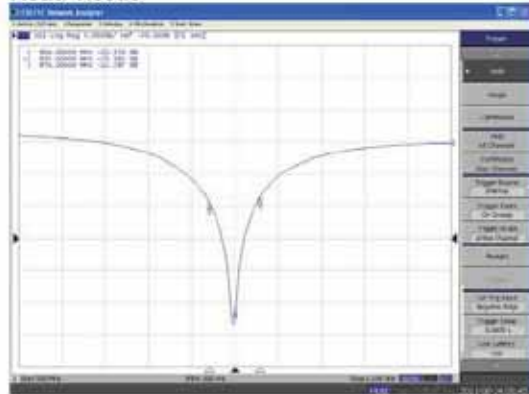

**Body Tissue**

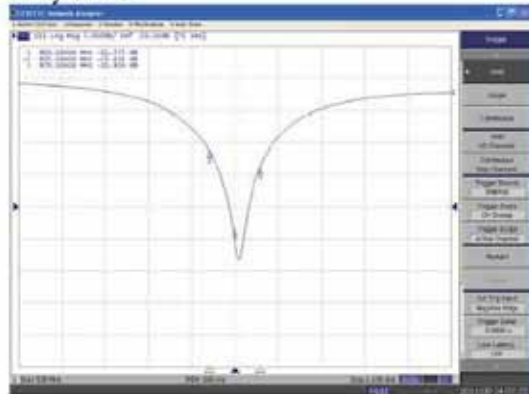

This page has been reviewed for content and attested to by signature within this document.

6

**NCL Calibration Laboratories**

Division of APREL Laboratories.

**SWR  
Head**

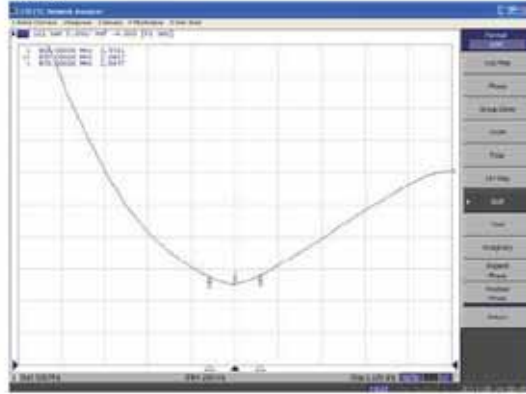

**Body**

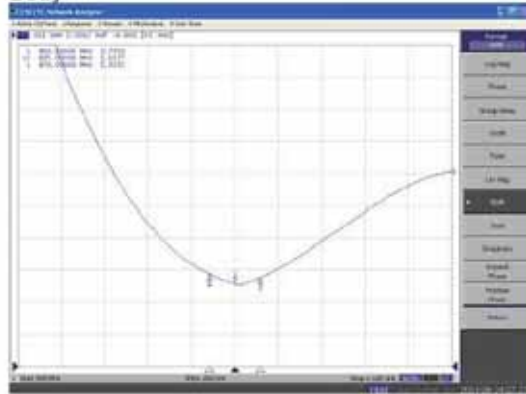

This page has been reviewed for content and attested to by signature within this document.

7

**NCL Calibration Laboratories**

Division of APREL Laboratories.

**Smith Chart Dipole Impedance**



This page has been reviewed for content and attested to by signature within this document.

**NCL Calibration Laboratories**

Division of APREL Laboratories.

---

**Test Equipment**

The test equipment used during Probe Calibration, manufacturer, model number and, current calibration status are listed and located on the main APREL server R:\NCL\Calibration Equipment\Instrument List 2011.

This page has been reviewed for content and attested to by signature within this document.

9

### 835MHz Dipole Calibration By BACL at 2013-12-20

#### Mechanical Verification

APREL Length	APREL Height	Measured Length	Measured Height
161.0 mm	89.8 mm	161.1 mm	89.7 mm

Tissue Type	Measured Return Loss	Measured Impedance
Head	-33.135 dB	51.898 Ω
Body	-25.362 dB	50.604 Ω

#### Test Graphs:

Head Tissue

Return Loss :

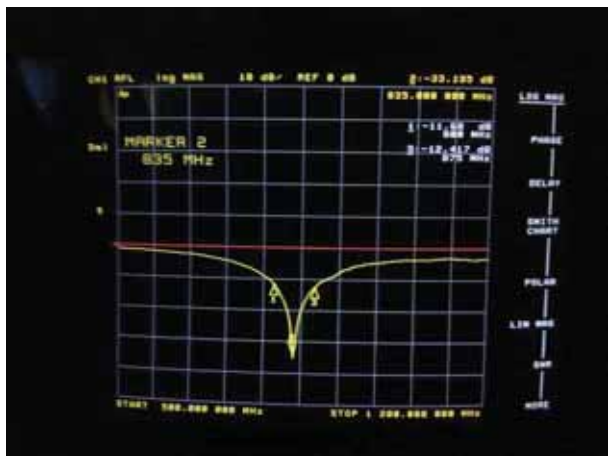

Impedance :



Body Tissue

Return Loss :

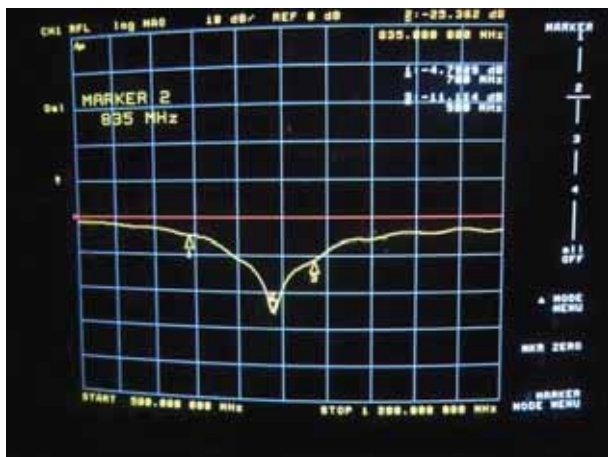

Impedance :

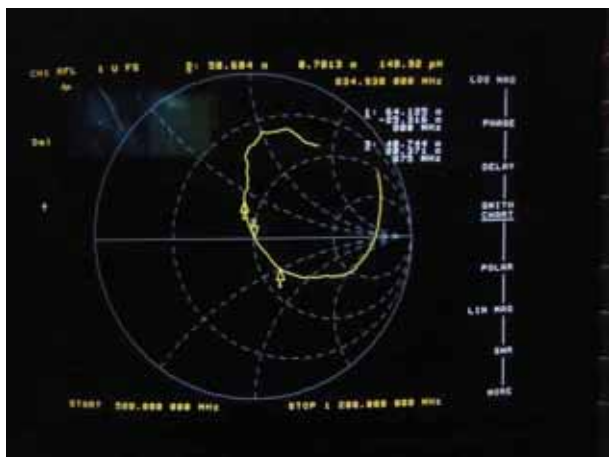

**NCL CALIBRATION LABORATORIES**

Calibration File No: DC-1331  
Project Number: BAC-dipole -cal-5615

**CERTIFICATE OF CALIBRATION**

It is certified that the equipment identified below has been calibrated in the  
**NCL CALIBRATION LABORATORIES** by qualified personnel following recognized  
procedures and using transfer standards traceable to NRC/NIST.

Validation Dipole (Head & Body)

Manufacturer: APREL Laboratories  
Part number: ALS-D-1900-S-2  
Frequency: 1900 MHz  
Serial No: 210-00710

Customer: Bay Area Compliance Laboratory

Calibrated: 25<sup>th</sup> August, 2011  
Released on: 25<sup>th</sup> August, 2011

This Calibration Certificate is Incomplete Unless Accompanied with the Calibration Results Summary

Released By: \_\_\_\_\_

**NCL CALIBRATION LABORATORIES**

Suite 102, 303 Terry Fox Dr.  
Kanata, ONTARIO  
CANADA K2K 3J1

Division of APREL Lab.  
TEL: (613) 435-8300  
FAX: (613)435-8306



**NCL Calibration Laboratories**

Division of APREL Laboratories.

**Conditions**

Dipole 210-00710 was received in good condition and was a re-calibration.

**Ambient Temperature of the Laboratory:** 22 °C +/- 0.5°C

**Temperature of the Tissue:** 21 °C +/- 0.5°C

We the undersigned attest that to the best of our knowledge the calibration of this device has been accurately conducted and that all information contained within this report has been reviewed for accuracy.



Stuart Nicol



C. Teodorian

**Primary Measurement Standards**

Instrument	Serial Number	Cal due date
Power meter Anritsu MA2408A	245025437	Nov.4, 2011
Power Sensor Anritsu MA2481D	103555	Nov 4, 2011
Attenuator HP 8495A (70dB) 1	944A10711	Aug.8, 2012
Network Analyzer Agilent E5071C	1334746J	Feb. 8, 2012

**Secondary Measurement Standards**

Signal Generator Agilent E4438C	-506 MY55182336	June 7, 2012
---------------------------------	-----------------	--------------

This page has been reviewed for content and attested to by signature within this document.

**NCL Calibration Laboratories**

Division of APREL Laboratories.

**Calibration Results Summary**

The following results relate the Calibrated Dipole and should be used as a quick reference for the user.

**Mechanical Dimensions**

**Length:** 67.1 mm  
**Height:** 38.9 mm

**Electrical Specification**

Tissue	Frequency	SWR:	Return Loss	Impedance
Head	1900MHz	1.0417 U	-35.395dB	49.020 Ω
Body	1900MHz	1.1177 U	-25.424dB	55.435 Ω

**System Validation Results**

Tissue	Frequency	1 Gram	10 Gram	Peak
Head	1900 MHz	39.648	20.311	73.365
Body	1900 MHz	39.769	20.176	75.866

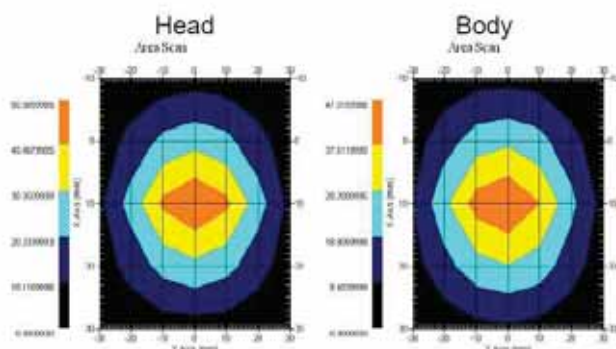

This page has been reviewed for content and attested to by signature within this document.

**NCL Calibration Laboratories**

Division of APREL Laboratories.

**Introduction**

This Calibration Report has been produced in line with the SSI Dipole Calibration Procedure SSI-TP-018-ALSAS. The results contained within this report are for Validation Dipole 210-00710. The calibration routine consisted of a three-step process. Step 1 was a mechanical verification of the dipole to ensure that it meets the mechanical specifications. Step 2 was an Electrical Calibration for the Validation Dipole, where the SWR, Impedance, and the Return loss were assessed. Step 3 involved a System Validation using the ALSAS-10U, along with APREL E-020 130 MHz to 26 GHz E-Field Probe Serial Number 212.

**References**

SSI-TP-018-ALSAS Dipole Calibration Procedure  
 SSI-TP-016 Tissue Calibration Procedure  
 IEEE 1528 "Recommended Practice for Determining the Peak Spatial-Average Specific Absorption Rate (SAR) in the Human Body Due to Wireless Communications Devices: Experimental Techniques"

**Conditions**

Dipole 210-00710 was new taken from stock.

**Ambient Temperature of the Laboratory:** 22 °C +/- 0.5°C  
**Temperature of the Tissue:** 20 °C +/- 0.5°C

**Dipole Calibration uncertainty**

The calibration uncertainty for the dipole is made up of various parameters presented below.

<b>Mechanical</b>	1%
<b>Positioning Error</b>	1.22%
<b>Electrical</b>	1.7%
<b>Tissue</b>	2.2%
<b>Dipole Validation</b>	2.2%
<b>TOTAL</b>	<b>8.32% (16.64% K=2)</b>

This page has been reviewed for content and attested to by signature within this document.

**NCL Calibration Laboratories**

Division of APREL Laboratories.

**Dipole Calibration Results**

**Mechanical Verification**

APREL Length	APREL Height	Measured Length	Measured Height
68.0 mm	39.5 mm	67.1mm	38.9 mm

**Electrical Validation**

Tissue Type	Return Loss:	SWR:	Impedance:
Head	-29.360 dB	1.0732 U	47.869 Ω
Body	-22.799 dB	1.1566 U	48.022 Ω

**Tissue Validation**

	Dielectric constant, $\epsilon_r$	Conductivity, $\sigma$ [S/m]
Head Tissue 1900MHz	38.4	1.43
Body Tissue 1900MHz	51.87	1.59

This page has been reviewed for content and attested to by signature within this document.

**NCL Calibration Laboratories**

Division of APREL Laboratories.

The Following Graphs are the results as displayed on the Vector Network Analyzer.

**S11 Parameter Return Loss**

Head

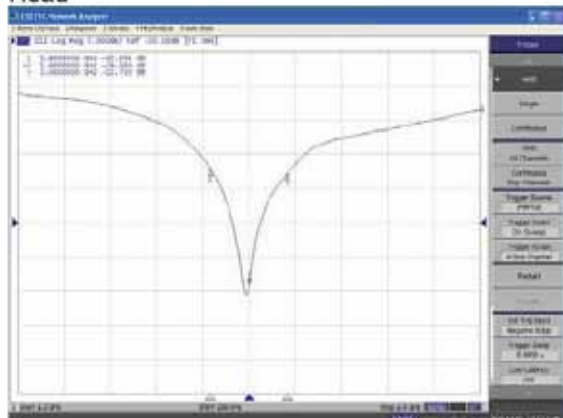

Body

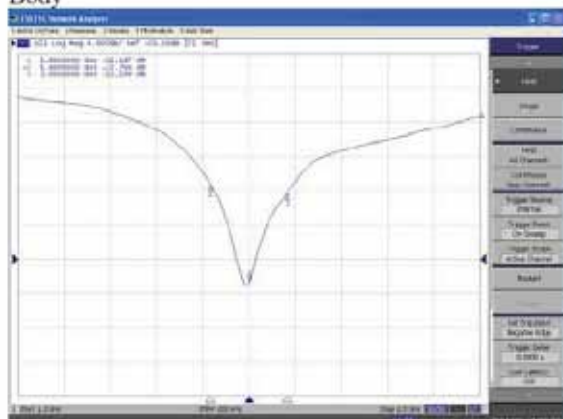

This page has been reviewed for content and attested to by signature within this document.

**NCL Calibration Laboratories**

Division of APREL Laboratories.

**SWR**

**Head**



**Body**

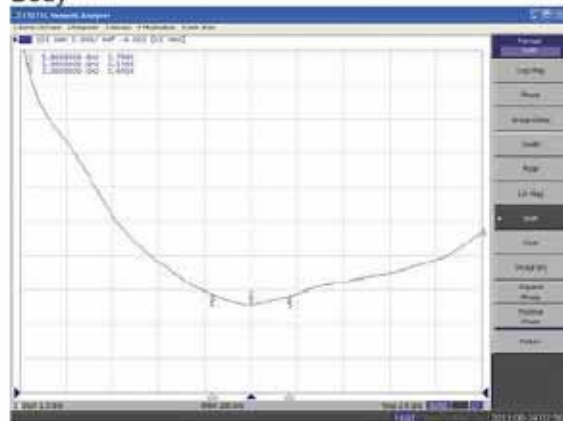

This page has been reviewed for content and attested to by signature within this document.

**NCL Calibration Laboratories**

Division of APREL Laboratories.

**Smith Chart Dipole Impedance**

Head

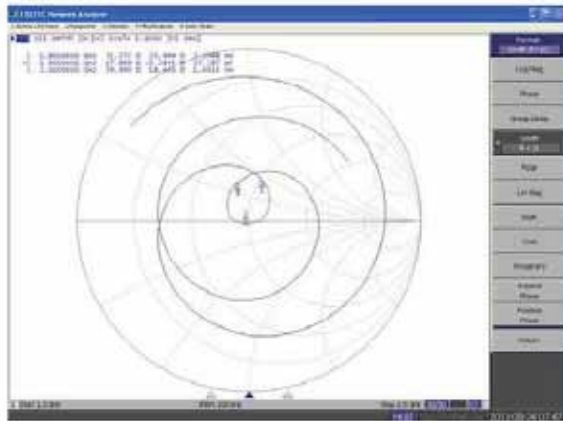

Body

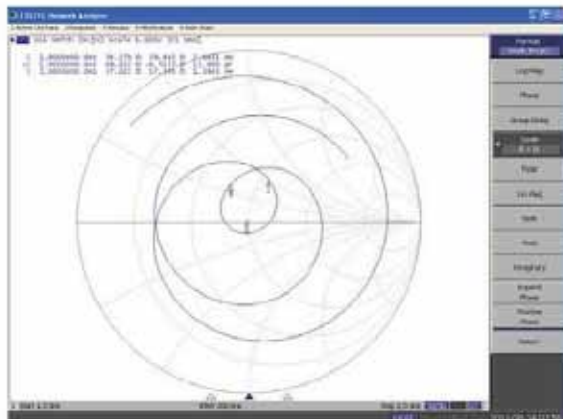

This page has been reviewed for content and attested to by signature within this document.

**NCL Calibration Laboratories**

Division of APREL Laboratories.

---

**Test Equipment**

The test equipment used during Probe Calibration, manufacturer, model number and, current calibration status are listed and located on the main APREL server R:\NCL\Calibration Equipment\Instrument List 2011

This page has been reviewed for content and attested to by signature within this document.

9



### 1900MHz Dipole Calibration By BACL at 2013-12-20

#### Mechanical Verification

APREL Length	APREL Height	Measured Length	Measured Height
68.0 mm	39.4 mm	68.3 mm	39.2 mm

Tissue Type	Measured Return Loss	Measured Impedance
Head	-28.083 dB	47.477 $\Omega$
Body	-22.022 dB	48.076 $\Omega$

#### Test Graphs:

Head Tissue

Return Loss :

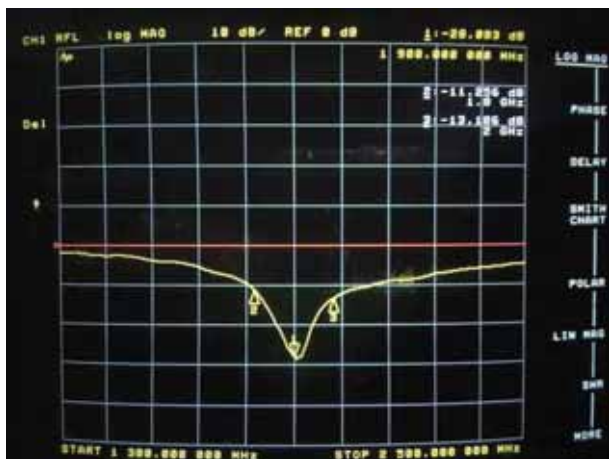

Impedance :



Body Tissue

Return Loss :

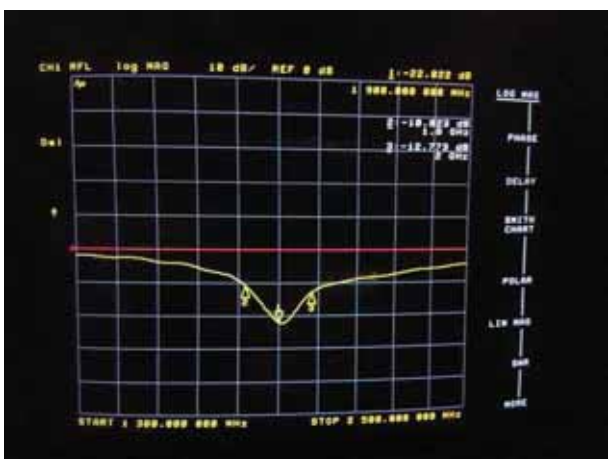

Impedance :

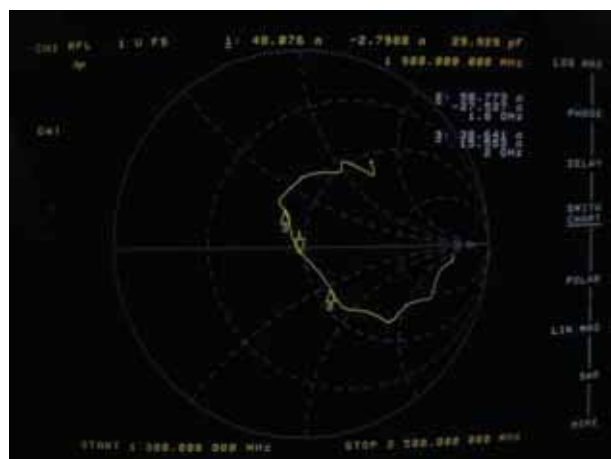

## APPENDIX D EUT TEST POSITION PHOTOS

Liquid depth  $\geq 15\text{cm}$

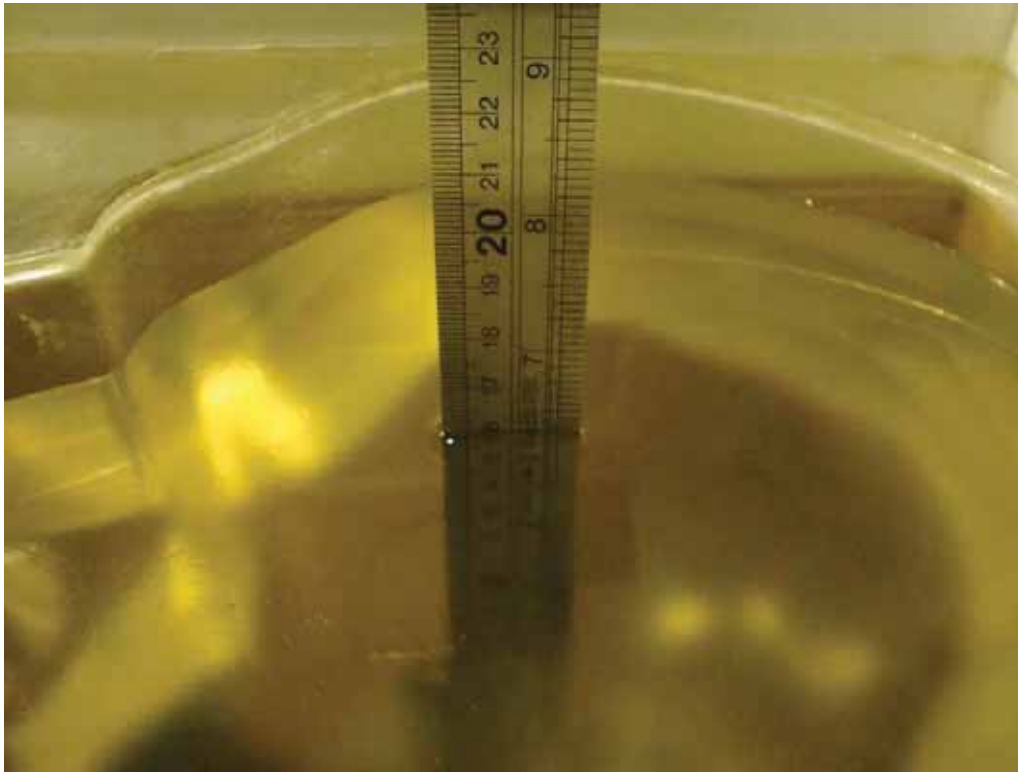

Body-worn Front Setup Photo

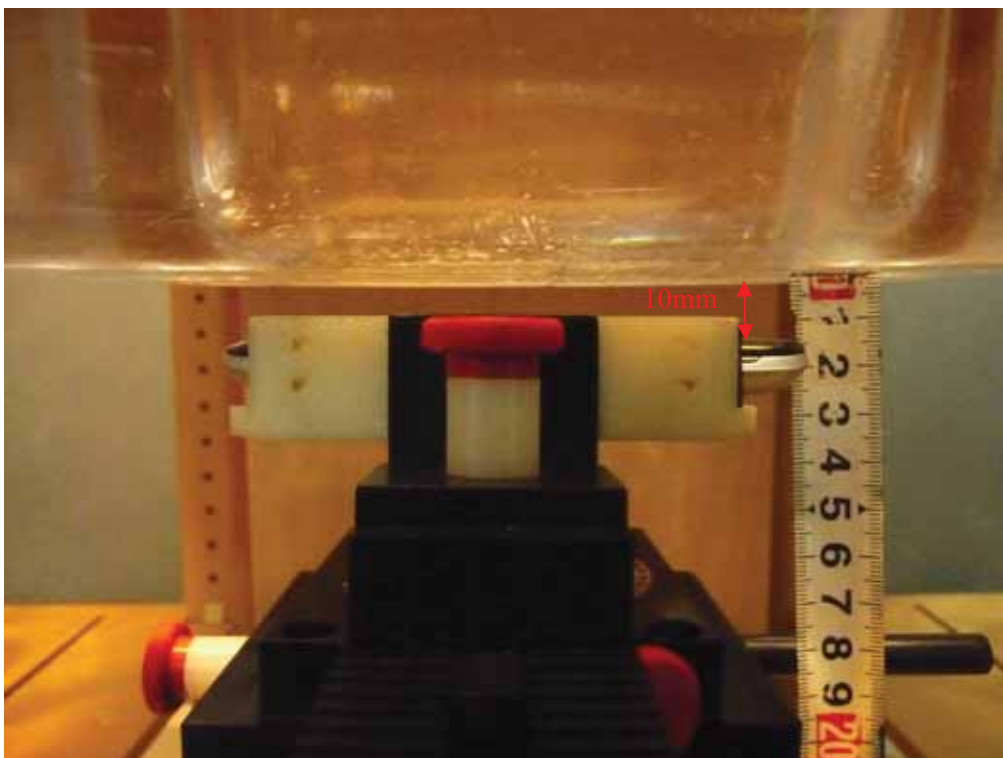

**Body-worn Back Setup Photo**

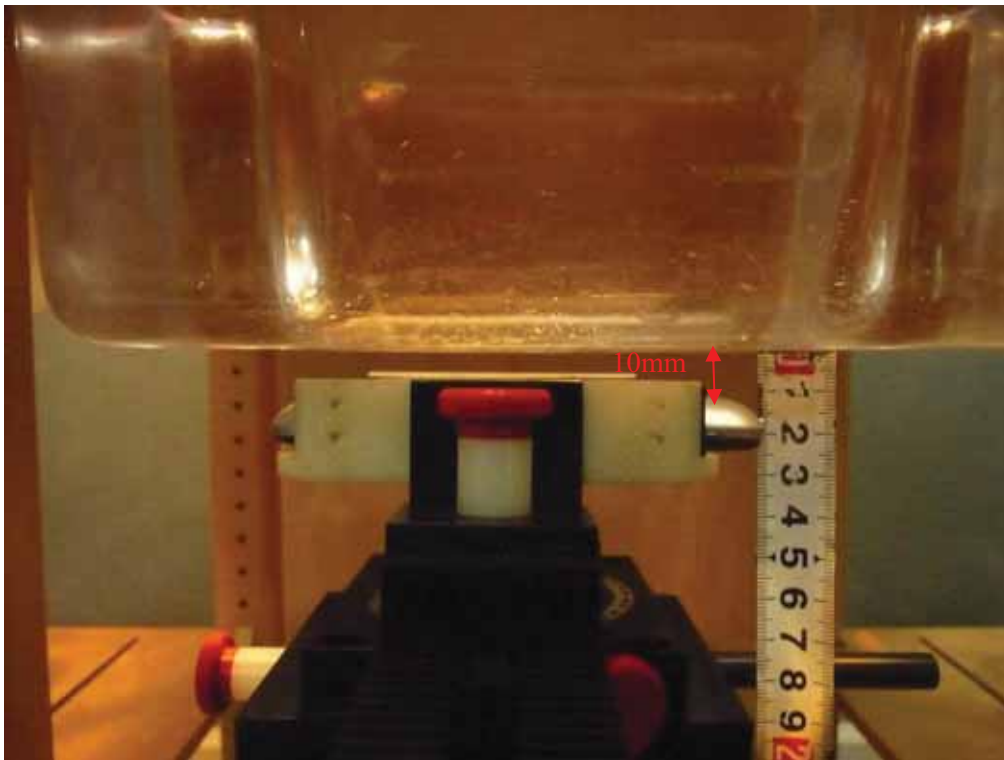

**Body-worn Left Setup Photo**



**Body-worn Right Setup Photo**



**Body-worn Bottom Setup Photo**

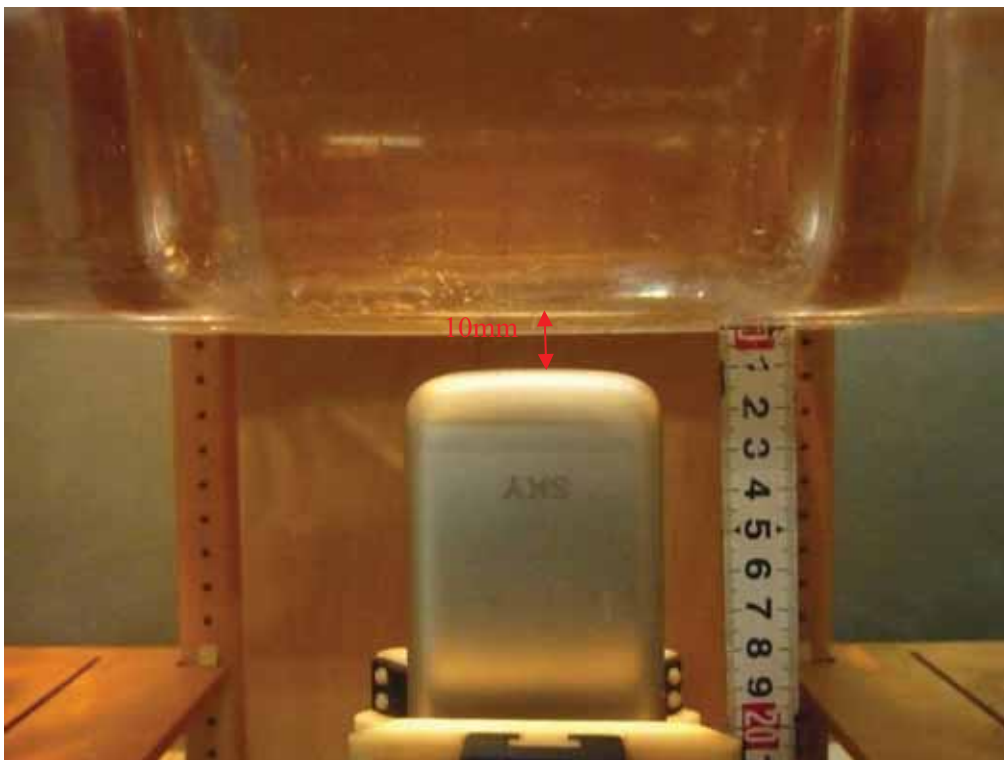

**Left Head Touch Setup Photo**



**Left Head Tilt Setup Photo**



**Right Head Touch Setup Photo**



**Right Head Tilt Setup Photo**



## APPENDIX E EUT PHOTOS

---

**EUT – Front View**



**EUT – Back View**



**EUT – Left Side View**



**EUT – Right Side View**





**EUT – Top View**



**EUT – Bottom View**



**EUT – Battery off View**



---

## APPENDIX F INFORMATIVE REFERENCES

---

- [1] Federal Communications Commission, "Report and order: Guidelines for evaluating the environmental effects of radiofrequency radiation", Tech. Rep. FCC 96-326, FCC, Washington, D.C. 20554, 1996.
- [2] David L. Means Kwok Chan, Robert F. Cleveland, "Evaluating compliance with FCC guidelines for human exposure to radiofrequency electromagnetic fields", Tech. Rep., Federal Communication Commission, Office of Engineering & Technology, Washington, DC, 1997.
- [3] Thomas Schmid, Oliver Egger, and Niels Kuster, "Automated E-field scanning system for dosimetric assessments", IEEE Transactions on Microwave Theory and Techniques, vol. 44, pp. 105-113, Jan. 1996.
- [4] Niels Kuster, Ralph Kastle, and Thomas Schmid, "Dosimetric evaluation of mobile communications equipment with known precision", IEEE Transactions on Communications, vol. E80-B, no. 5, pp. 645-652, May 1997.
- [5] CENELEC, "Considerations for evaluating of human exposure to electromagnetic fields (EMFs) from mobile telecommunication equipment (MTE) in the frequency range 30MHz - 6GHz", Tech. Rep., CENELEC, European Committee for Electrotechnical Standardization, Brussels, 1997.
- [6] ANSI, ANSI/IEEE C95.1-1992: IEEE Standard for Safety Levels with Respect to Human Exposure to Radio Frequency Electromagnetic Fields, 3 kHz to 300 GHz, The Institute of Electrical and Electronics Engineers, Inc., New York, NY 10017, 1992.
- [7] Katja Pokovic, Thomas Schmid, and Niels Kuster, "Robust setup for precise calibration of E-field probes in tissue simulating liquids at mobile communications frequencies", in ICECOM '97, Dubrovnik, October 15-17, 1997, pp. 120-24.
- [8] Katja Pokovic, Thomas Schmid, and Niels Kuster, "E-field probe with improved isotropy in brain simulating liquids", in Proceedings of the ELMAR, Zadar, Croatia, 23-25 June, 1996, pp. 172-175.
- [9] Volker Hombach, Klaus Meier, Michael Burkhardt, Eberhard Kuhn, and Niels Kuster, "The dependence of EM energy absorption upon human head modeling at 900 MHz", IEEE Transactions on Microwave Theory and Techniques, vol. 44, no. 10, pp. 1865-1873, Oct. 1996.
- [10] Klaus Meier, Ralf Kastle, Volker Hombach, Roger Tay, and Niels Kuster, "The dependence of EM energy absorption upon human head modeling at 1800 MHz", IEEE Transactions on Microwave Theory and Techniques, Oct. 1997, in press.
- [11] W. Gander, Computermathematik, Birkhaeuser, Basel, 1992.
- [12] W. H. Press, S. A. Teukolsky, W. T. Vetterling, and B. P. Flannery, Numerical Recipes in C, The Art of Scientific Computing, Second Edition, Cambridge University Press, 1992. Dosimetric Evaluation of Sample device, month 1998 9
- [13] NIS81 NAMAS, "The treatment of uncertainty in EMC measurement", Tech. Rep., NAMAS Executive, National Physical Laboratory, Teddington, Middlesex, England, 1994.
- [14] Barry N. Taylor and Christ E. Kuyatt, "Guidelines for evaluating and expressing the uncertainty of NIST measurement results", Tech. Rep., National Institute of Standards and Technology, 1994. Dosimetric Evaluation of Sample device, month 1998 10.

\*\*\*\*\* END OF REPORT \*\*\*\*\*