

FCC RF Test Report

Product Type : WCDMA Mobile Phone
Applicant : Sky Phone LLC
Address : 1348 Washington Av., Miami Beach
Trade Name : SKY DEVICE
Model Number : SKY 5.0Q
Test Specification : FCC 47 CFR PART 15 SUBPART C: Oct., 2013
RSS-210 Issue 8 December 2010
ANSI C63.4:2009
Receive Date : 20 June, 2014
Test Period : 23 June, 2014 to 23 July, 2014
Issue Date : 14, Aug 2014

Issue by

A Test Lab Techno Corp.
No. 140-1, Changan Street, Bade City,
Taoyuan County 334, Taiwan R.O.C.
Tel : +886-3-2710188 / Fax : +886-3-2710190



Taiwan Accreditation Foundation accreditation number: 1330

Note: This report shall not be reproduced except in full, without the written approval of A Test Lab Techno Corp. This document may be altered or revised by A Test Lab Techno Corp. personnel only, and shall be noted in the revision section of the document. The client should not use it to claim product endorsement by TAF, or any government agencies. The test results in the report only apply to the tested sample.



Revision History

Rev.	Issue Date	Revisions	Revised By
00	31 July, 2014	Initial Issue	
01	14 Aug, 2014	Test report number corrected	



Verification of Compliance

Issued Date: 07/31/2014

Product Type : WCDMA Mobile Phone
 Applicant : Sky Phone LLC
 Address : 1348 Washington Av., Miami Beach
 Trade Name : SKY DEVICE
 Model Number : SKY 5.0Q
 FCC ID : 2ABOSGC140603
 EUT Rated Voltage : AC 120V; DC 3.7V battery, DC 5.0V USB charge;
 Test Voltage : AC 120V; DC 3.7V;
 Applicable Standard : FCC 47 CFR PART 15 SUBPART C: Oct., 2013
 RSS-210 Issue 8 December 2010
 ANSI C63.4:2009

Test Result : Complied

Performing Lab. : A Test Lab Techno Corp.
 No. 140-1, Changan Street, Bade City,
 Taoyuan County 334, Taiwan R.O.C.
 Tel : +886-3-2710188 / Fax : +886-3-2710190
 Taiwan Accreditation Foundation accreditation number: 1330
<http://www.atl-lab.com.tw/e-index.htm>



The above equipment was tested by A Test Lab Techno Corp. The test data, data evaluation, test procedures, and equipment configurations shown in this report were made in accordance with the procedures given in ANSI C63.4: 2009 and the energy emitted by the sample tested as described in this report is in compliance with the requirements of FCC Rules Part 15.207, 15.209, 15.247 .

The test results of this report relate only to the tested sample identified in this report.

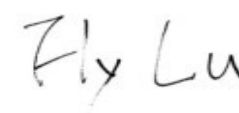
Approved By :  Reviewed By : 
 (Manager) (Murphy Wang) (Testing Engineer) (Fly Lu)



CONTENT

1	GeneralInformation.....	5
1.1	Applied Standard	5
1.2	TestLocation	5
1.3	TestEnvironmentCondition	5
2	TestSummary	6
3	Description of the Equipmentunder Test (EUT).....	7
3.1	GeneralDescription	7
3.2	Technical Description	7
3.3	TestModes	8
3.4	EUTConfigurations	9
3.5	TestEnvironments	10
3.6	TestSetups	10
3.7	TestConditions	13
4	Main Test Instruments	15



1 General Information

1.1 Applied Standard

Applied Rules: FCC 47 CFR PART 15 SUBPART C: Oct., 2013

TestMethod: FCC 558074 D01 DTS Meas Guidance
FCC KDB 662911 D01 Multiple Transmitter Output

1.2 Test Location

TestLocation 1: A Test Lab Techno Corp.

Address: No. 140-1, Changan Street, Bade City, Taoyuan County 334, Taiwan
R.O.C.

1.3 Test Environment Condition

AmbientTemperature: 19.5to 25°C

AmbientRelativeHumidity: 40 to 55 %

AtmosphericPressure: Notapplicable

2 Test Summary

TestItem	FCC Part No.	Requirements	TestResult	Verdict (NOTE2)
DTS (6 dB) Bandwidth	15.247(a)(2)	≥ 500 kHz.	Appendix A	Pass
Maximum Peak ConductedOutputPower	15.247(b)(3)	For directionalgain:< 30dBm – (G[dBi] – 6 [dB]), peak;Otherwise:< 30dBm,	Appendix B	Pass
MaximumPowerSpectral DensityLevel	15.247(e)	For directionalgain:< 8dBm/3 kHz – (G[dBi] – 6[dB]), peak.Otherwise:< 8 dBm/3 kHz, peak.	Appendix C	Pass
Band Edges Compliance	15.247(d)	< -20dB/100 kHz if total peakpower ≤powerlimit.	Appendix D	Pass
UnwantedEmissions intoNon-RestrictedFrequency	15.247(d)	< -20dB/100 kHz if totalpeakpower ≤powerlimit.	Appendix E	Pass
UnwantedEmissions intoRestricted FrequencyBands (Conducted)	15.247(d) 15.209 (NOTE1)	FCC Part 15.209 fieldstrength limit;	Appendix F	Pass
Unwanted Emissions intoRestricted FrequencyBands (Radiated)				
AC PowerLineConducted Emissions	15.207	FCC Part 15.207 conducted limit;	Appendix G	Pass



3 Description of the Equipment under Test (EUT)

3.1 General Description

Product	WCDMA Mobile Phone	
Trade Name	SKY DEVICE	
Model Number	SKY 4.5Q	
Applicant	Sky Phone LLC 1348 Washington Av., Miami Beach	
Manufacturer	Shenzhen Malata Mobile Communication CO.,LTD 25/F, Malata Technology Building, NO9998 Shennan Rd, Hi-tech Park, Nanshan, Shenzhen, P.R. China 518057.	
FCC ID	2ABOSGC14060	
Mode	Frequency (MHz)	Modulation
IEEE 802.11b	2412 ~ 2462	CCK(DSSS)
IEEE 802.11g	2412 ~ 2462	OFDM
IEEE 802.11n-HT20	2412 ~ 2462	16-QAM, 64-QAM
IEEE 802.11n-HT40	2422 ~ 2452	16-QAM, 64-QAM
Antenna Delivery	1*Tx + 1*Rx	
Type of Antenna	Internal	
Antenna Gain (dBi)	0 dBi	
Maximum Transmit Power (EIRP)	IEEE 802.11b: 16.31 dBm IEEE 802.11g: 14.39 dBm IEEE 802.11n-HT20: 14.59 dBm IEEE 802.11n-HT40: 13.53 dBm	

NOTE: Only WLAN test data included in this report.

3.2 EUT Identity

IMEI No.	
SIM 1	868817019960176
SIM 2	868817019960034

NOTE: Unless otherwise noted in the report, the functional boards installed in the units shall be selected from the below list, but not means all the functional boards listed below shall be installed in one unit.



3.3 Test Modes

NOTE: Typical working modes for each IEEE 802.11 mode are selected to perform tests.

Test Mode	Test Modes Description
11B	IEEE 802.11b with data rate of 11 Mbps using SISO mode.
11G	IEEE 802.11g with data rate of 54 Mbps using SISO mode.
11N20	IEEE 802.11n with data rate of MCS7 and bandwidth of 20MHz using SISO mode.
11N40	IEEE 802.11n with data rate of MCS7 and bandwidth of 40MHz using SISO mode.



3.4 EUT Configurations

3.4.1 General Configurations

Configuration	Description
Test AntennaPorts	Until otherwise specified, <ul style="list-style-type: none"> - All TX tests are performed at all TX antenna ports of the EUT, and - All RX tests are performed at all RX antenna ports of the EUT.
Multiple RF Sources	Other than the tested RF source of the EUT, other RF source(s) are disabled or shutdown during measurements.

Note: The EUT was programmed to be in continuously transmitting mode and the transmit duty cycle is not less than 98%.

3.4.2 Customized Configurations

TestMode	RF Ch.	BG Port	TX Freq. [MHz]	RX Freq. [MHz]	Ch. BW [MHz]
11B	L	BG 1	ChNo. 1 / 2412MHz	---	20
		BG2		---	20
	M	BG 1	ChNo. 6 / 2437 MHz	---	20
		BG2		---	20
	H	BG 1	ChNo. 11/ 2462MHz	---	20
		BG2		---	20
11G	L	BG 1	ChNo. 1 / 2412MHz	---	20
		BG2		---	20
	M	BG 1	ChNo. 6 / 2437 MHz	---	20
		BG2		---	20
	H	BG 1	ChNo. 11/ 2462MHz	---	20
		BG2		---	20
11N20	L	BG 1	ChNo. 1 / 2412MHz	---	20
		BG2		---	20
	M	BG 1	ChNo. 6 / 2437 MHz	---	20
		BG2		---	20
	H	BG 1	ChNo. 11/ 2462MHz	---	20
		BG2		---	20
11N40	L	BG 1	ChNo. 3/ 2422MHz	---	40
		BG2		---	40
	M	BG 1	ChNo. 6 / 2437 MHz	---	40
		BG2		---	40
	H	BG 1	ChNo. 9/ 2452 MHz	---	40
		BG2		---	40

3.5 Test Environments

NOTE: The values used in the test report may be stringent than the declared.

Environment Parameter	Selected Values During Tests		
	Temperature	Voltage	Relative Humidity
NTNV	Ambient	3.7VDC	Ambient

3.6 Test Setups

3.6.1 Test Setup 1

The WLAN component's antenna ports(s) of the EUT are reconnected to the measurement instrument per an appropriate attenuator. The EUT is controlled by PC/software to emit the specified signals for the purpose of measurements.

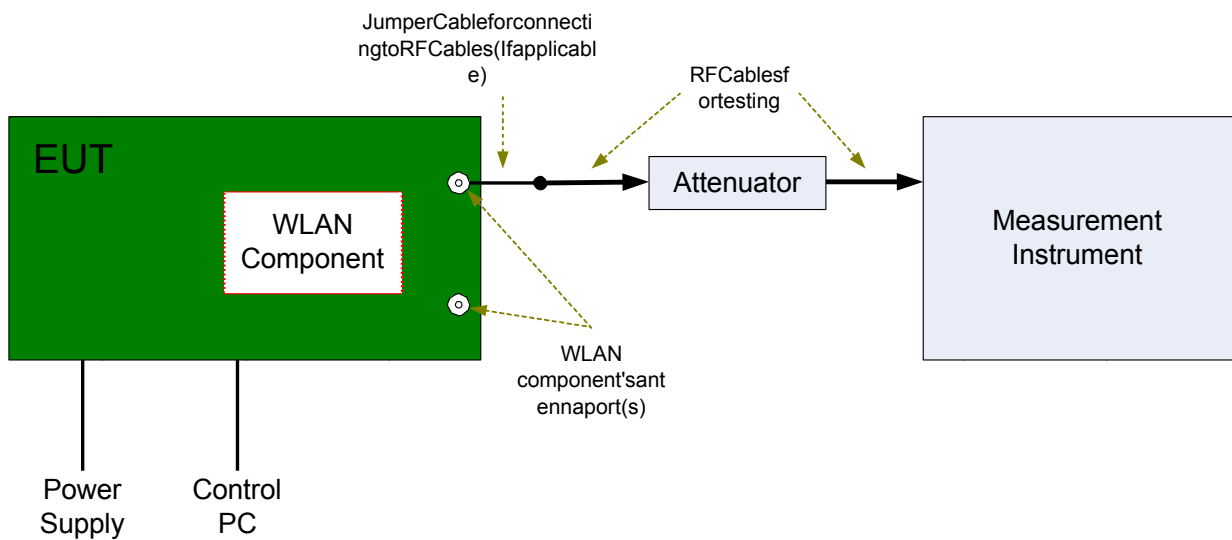

3.6.2 Test Setup 2

The test site semi-anechoic chamber has met the requirement of NSA tolerance 4dB according to the standards: ANSI C63.4. The test distance is 3m. This setup is according to ANSI C63.4 and CAN/CSA-CEI/IEC CISPR 22.

The maximum emission value is acquired by adjusting the antenna height, polarisation and turntable azimuth. Normally, the height range of antenna is 1m to 4m, the azimuth range of turntable is 0° to 360°, and there receive antenna has two polarizations Vertical (V) and Horizontal (H).

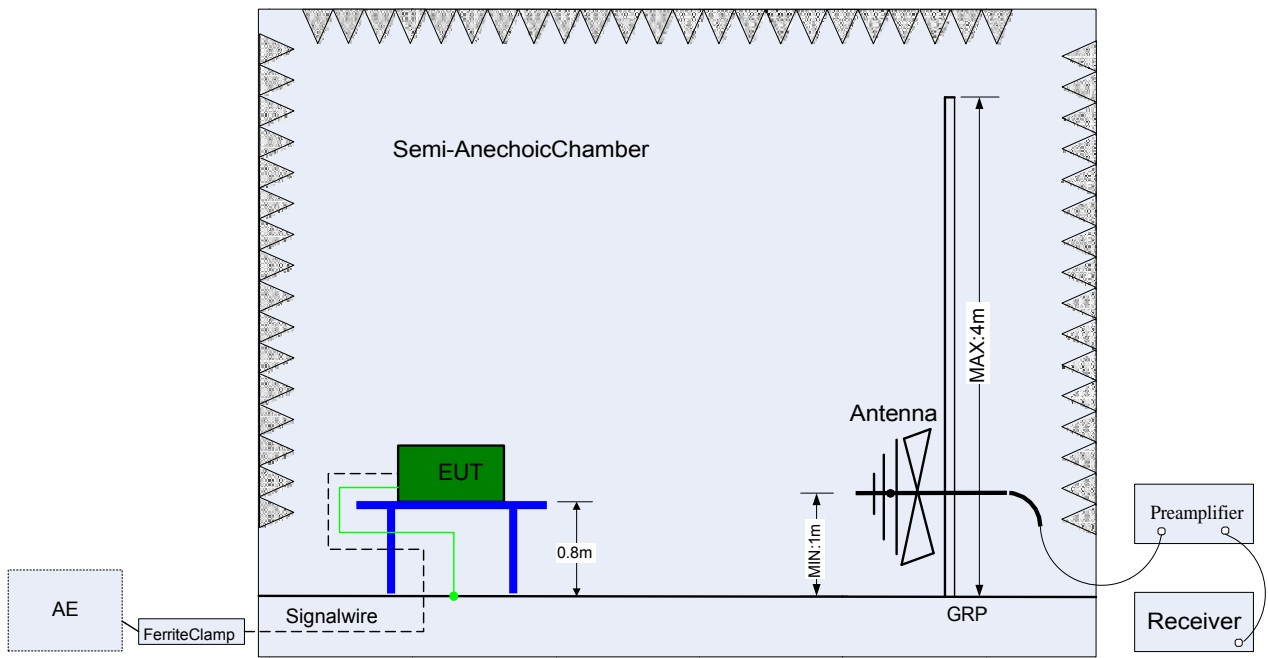

(Below 1 GHz)

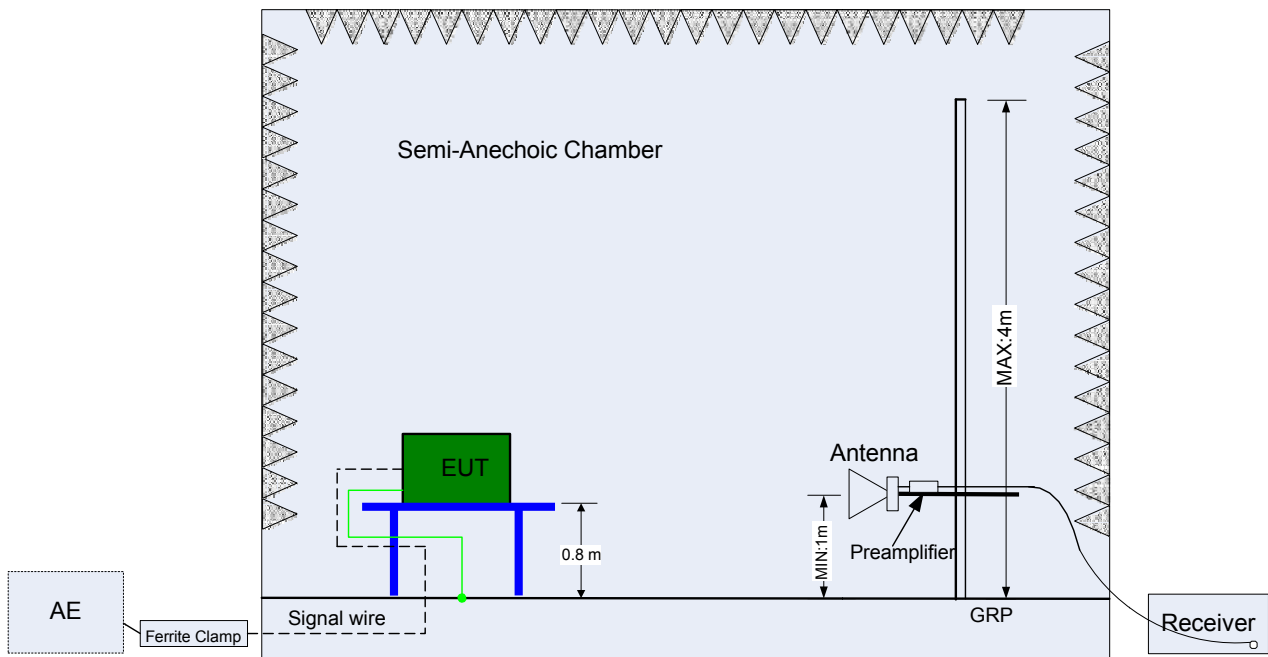

(Above 1GHz)

3.6.3 Test Setup 3

The mains cable of the EUT (maybe per AC/DC Adapter) must be connected to LISN. The LISN shall be placed 0.8 m from the boundary of EUT and bonded to a ground reference plane for LISN mounted on top of the ground reference plane. This distance is between the closest points of the LISN and the EUT. All other units of the EUT and associated equipment shall be at least 0.8 m from the LISN.

Ground connections, where required for safety purposes, shall be connected to the reference ground point of the LISN and, where not otherwise provided or specified by the manufacturer, shall be of same length as the mains cable and run parallel to the mains connection at a separation distance of not more than 0.1 m.

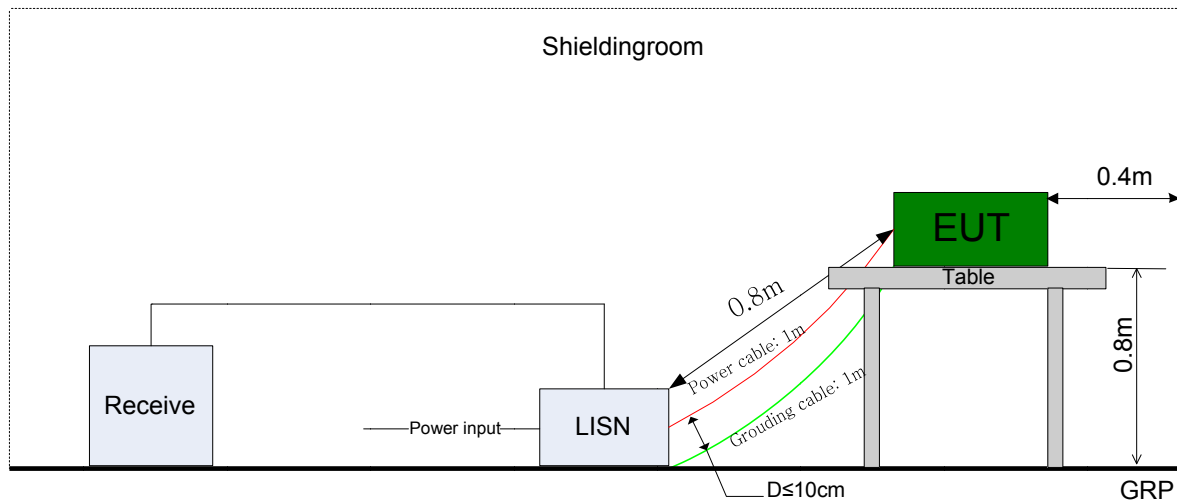



3.7 Test Conditions

TestCase	TestConditions	
	Configuration	Description
DTS (6 dB) Bandwidth	MeasurementMethod	FCC KDB 558074 §7.1.1Option2.
	TestEnvironment	NTNV
	TestSetup	TestSetup1
	EUTConfiguration	11B_L,11B_M,11B_H 11G_L,11G_M,11G_H 11N20_L, 11 N20_M, 11 N20_H 11N40_L, 11 N40_M, 11 N40_H
Maximum PeakConducte dOutputPower	MeasurementMethod	FCC KDB 558074§7.2.1.2 Option2 (integrated band powermethod).
	TestEnvironment	NTNV
	TestSetup	TestSetup1
	EUTConfiguration	11B_L,11B_M,11B_H 11G_L,11G_M,11G_H 11N20_L, 11 N20_M, 11 N20_H 11N40_L, 11 N40_M, 11 N40_H
MaximumPower Spectral DensityLevel	MeasurementMethod	FCC KDB 558074 §7.3.1Option 1 (peak PSD).
	TestEnvironment	NTNV
	TestSetup	TestSetup1
	EUTConfiguration	11B_L,11B_M,11B_H 11G_L,11G_M,11G_H 11N20_L, 11 N20_M, 11 N20_H 11N40_L, 11 N40_M, 11 N40_H
UnwantedEmission s intoNon- RestrictedFrequenc yBands	MeasurementMethod	FCC KDB 558074§7.4.1, use PeakPSD.
	TestEnvironment	NTNV
	TestSetup	TestSetup1
	EUTConfiguration	11B_L,11B_M,11B_H 11G_L,11G_M,11G_H 11N20_L, 11 N20_M, 11 N20_H 11N40_L, 11 N40_M, 11 N40_H
UnwantedEmission s intoRestrictedFreq uencyBands(Cond ucted)	MeasurementMethod	FCC KDB 558074§7.4.2,Conducted(antenna-port).
	TestEnvironment	NTNV
	TestSetup	TestSetup1
	EUTConfiguration	11B_L,11B_M,11B_H 11G_L,11G_M,11G_H 11N20_L, 11 N20_M, 11 N20_H 11N40_L, 11 N40_M,11 N40_H
UnwantedEmi ssions into Restricted	MeasurementMethod	FCC KDB 558074§7.4.2,Radiated(cabinet/case emissionswith impedancematching for antenna-port).
	TestEnvironment	NTNV



TestCase	TestConditions	
	Configuration	Description
AC PowerLineCon ductedEmissio ns	MeasurementMethod	AC mainsconducted.
	TestEnvironment	NTNV
	TestSetup	TestSetup3
	EUTConfiguration	11B_L (Worst Conf.).

Note: For RadiatedEmissions, By preliminary testing and verifying three axis (X, Y and Z) position of EUT transmitted status, it was found that "Z axis" position was the worst, then the final test was executed the worst condition and test data were recorded in this report.

4 Main Test Instruments

EquipmentName	Manufacturer	Model	Serial Number	CalDate	Cal. Period
MXA Signal Analyzer	Agilent	N9020A	MY53420615	2014.05.12	1 years
Power Sensor	Agilent	U2021XA	MY53180015	2013.09.27	1 years
Power Sensor	Agilent	U2021XA	MY53260040	2013.09.27	1 years
Power Sensor	Agilent	U2021XA	MY53360002	2013.09.27	1 years
Power Sensor	Agilent	U2021XA	MY53360006	2013.09.27	1 years
USB Modular Simultaneous Data Acquisition	Agilent	U2531A	TW53353509	N.C.R	1 years
USB Modular Simultaneous Data Acquisition	Agilent	U2531A	TW53353511	N.C.R	1 years
Test Receiver	R&S	ESCI	100367	2014.06.18	1 year
LISN	R&S	ENV216	101040	2014.03.07	1 year
LISN	R&S	ENV216	101041	2014.03.07	1 year
RF Pre-selector	Agilent	N9039A	MY46520256	2014.01.21	1 years
Spectrum Analyzer	Agilent	E4446A	MY46180578	2014.01.21	1 years
Pre Amplifier	Agilent	8449B	3008A02237	2014.01.21	1 years
Pre Amplifier	Agilent	8447D	2944A10961	2014.01.21	1 years
Broadband Antenna (30MHz~1GHz)	SCHWARZBECK MESS-ELEKTRONIK	VULB9163	9163-270	2014.07.01	1 years
Horn Antenna (1~18GHz)	SCHWARZBECK MESS-ELEKTRONIK	BBHA9120D	9120D-550	2014.06.10	1 years
Horn Antenna (18~40GHz)	SCHWARZBECK MESS-ELEKTRONIK	BBHA9170	9170-320	2014.06.13	1 years
Loop Antenna	COM-POWER CORPORATION	AL-130	121014	2013.08.14	1 years

END

Appendix for Test Report

Appendix A: DTS 6dB Emission Bandwidth

1. Result Table

EUT Conf.	Test Channel	6dB Bandwidth [MHz]	Verdict
11B	LCH	10.06	PASS
11B	MCH	10.08	PASS
11B	HCH	9.56	PASS
11G	LCH	15.46	PASS
11G	MCH	15.79	PASS
11G	HCH	15.35	PASS
11N20_SISO	LCH	15.97	PASS
11N20_SISO	MCH	15.03	PASS
11N20_SISO	HCH	16.13	PASS
11N40_SISO	LCH	35.15	PASS
11N40_SISO	MCH	35.22	PASS
11N40_SISO	HCH	35.18	PASS

Test Plot

2.1. 11B_LCH

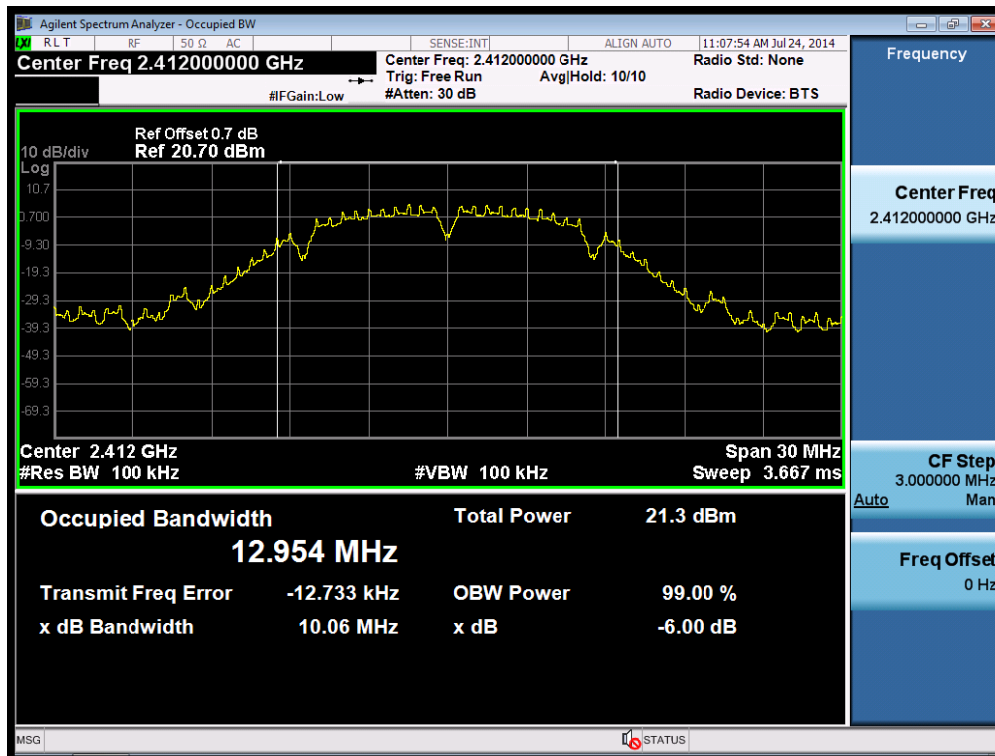

2.2. 11B_MCH

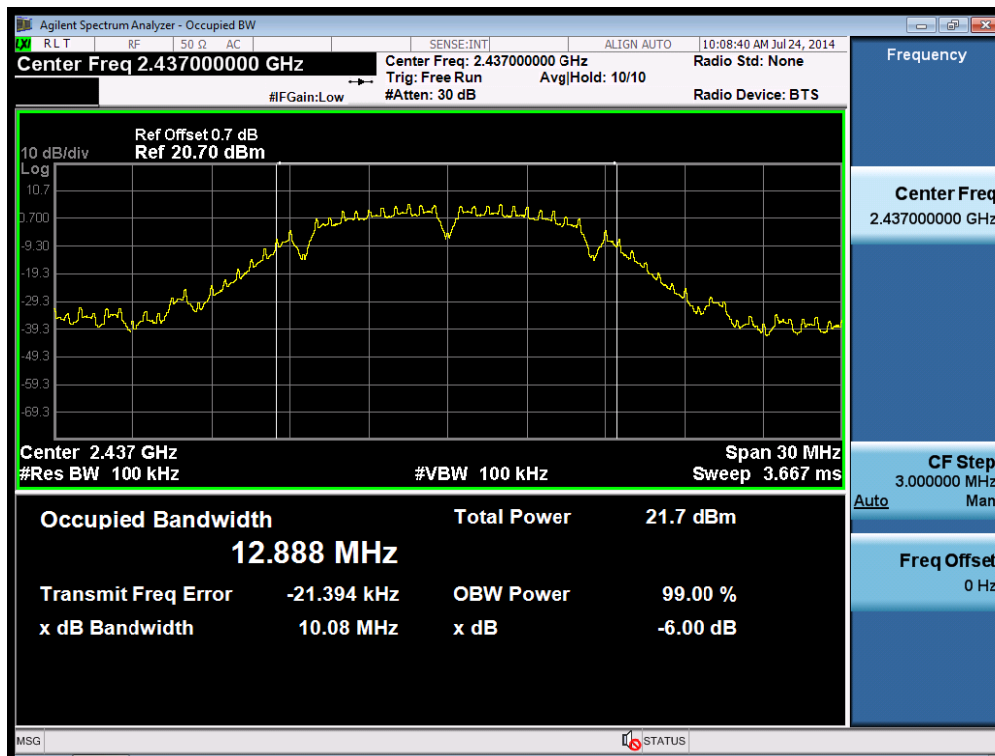

2.3. 11B_HCH

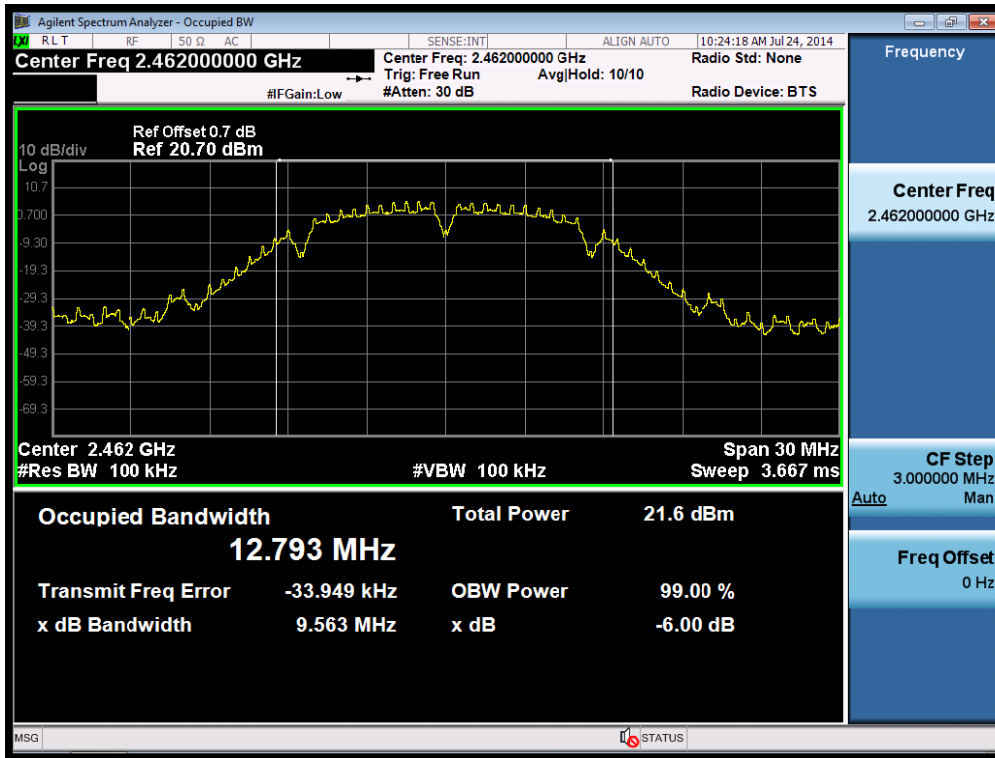

2.4. 11G_LCH

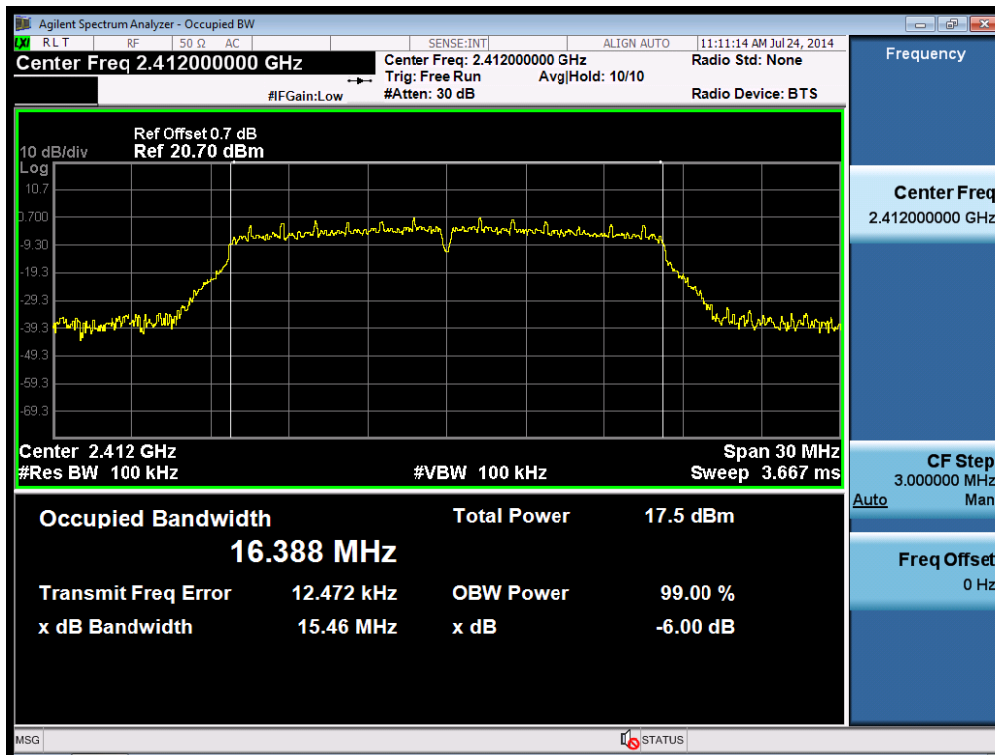



2.5. 11G_MCH

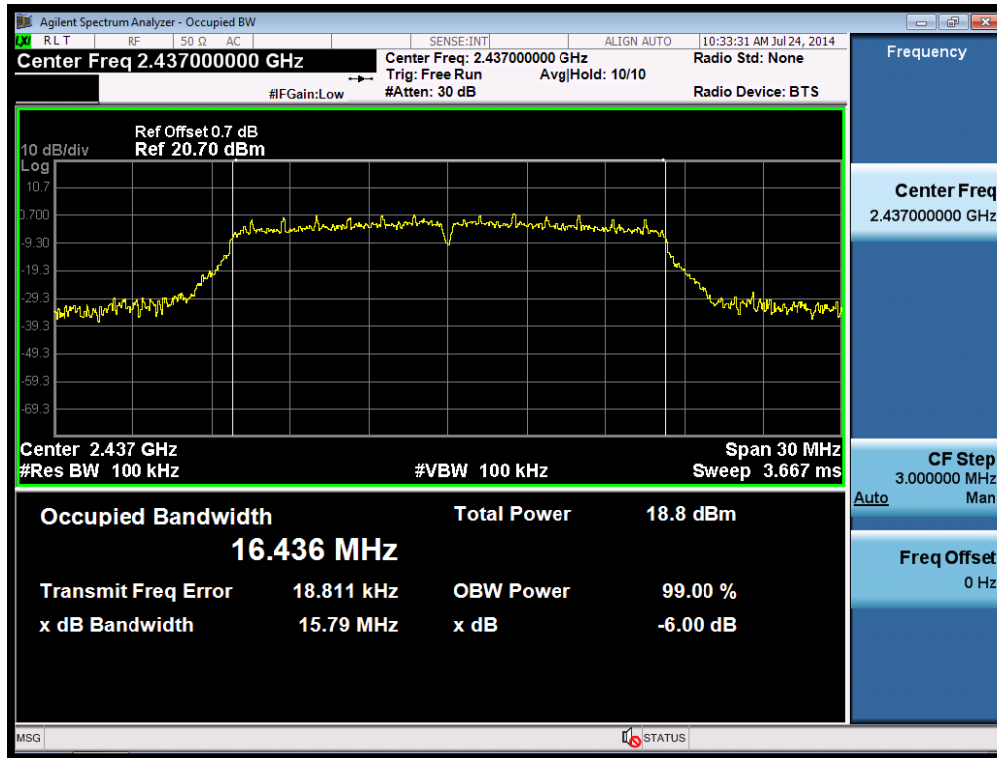

2.6. 11G_HCH

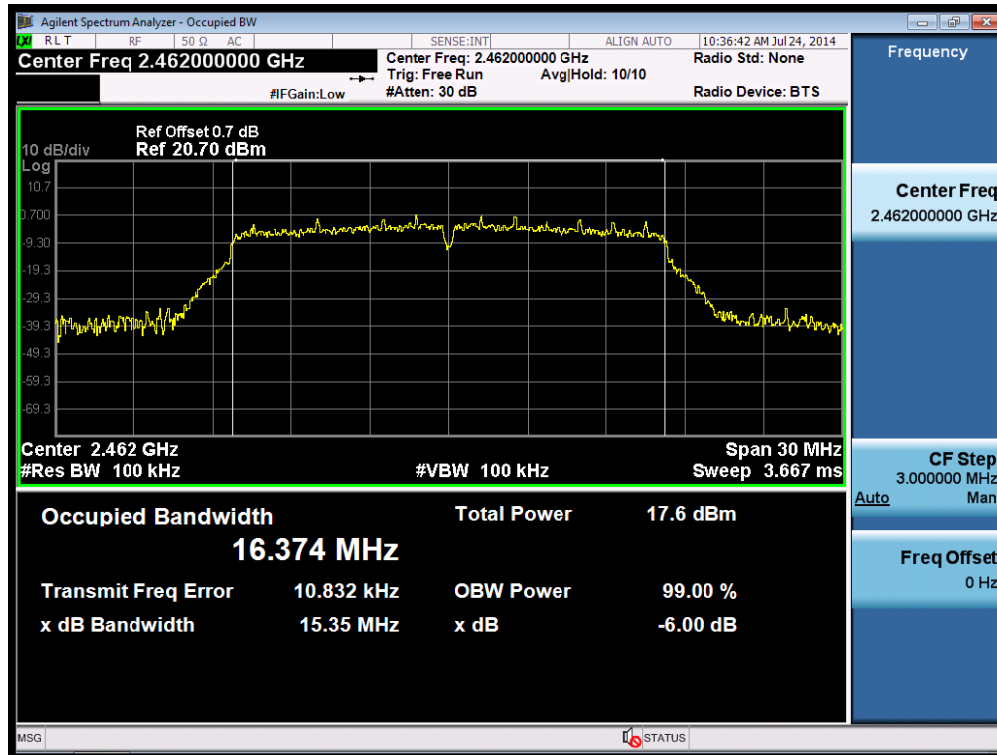



2.7. 11N20_SISO_LCH

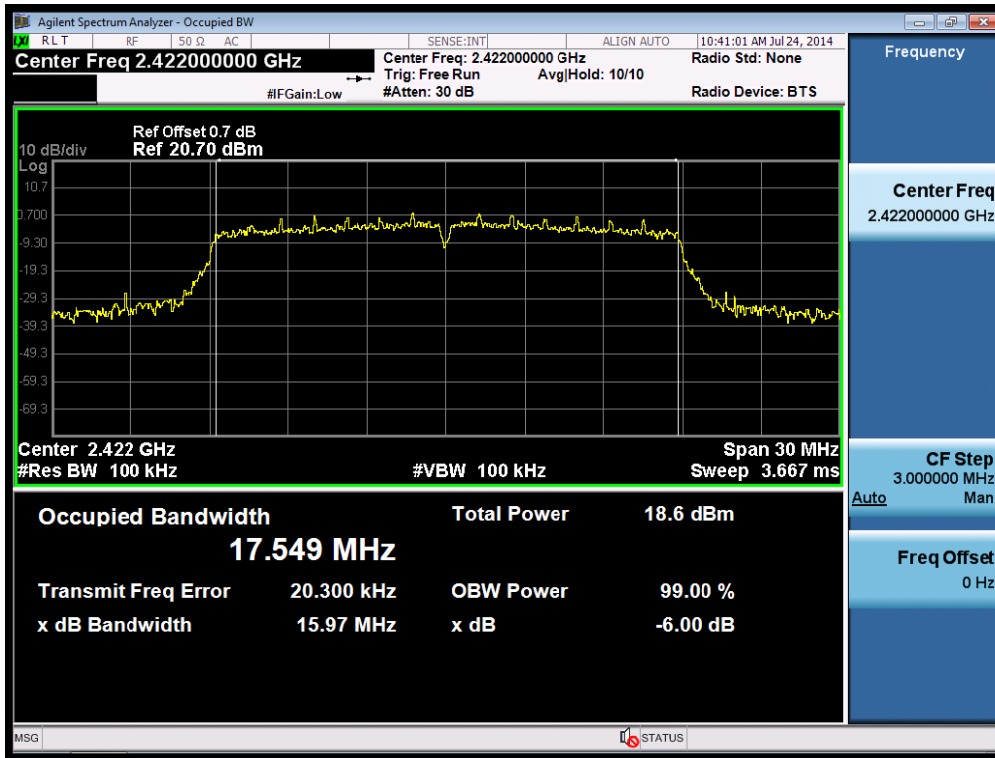

2.8. 11N20_SISO_MCH

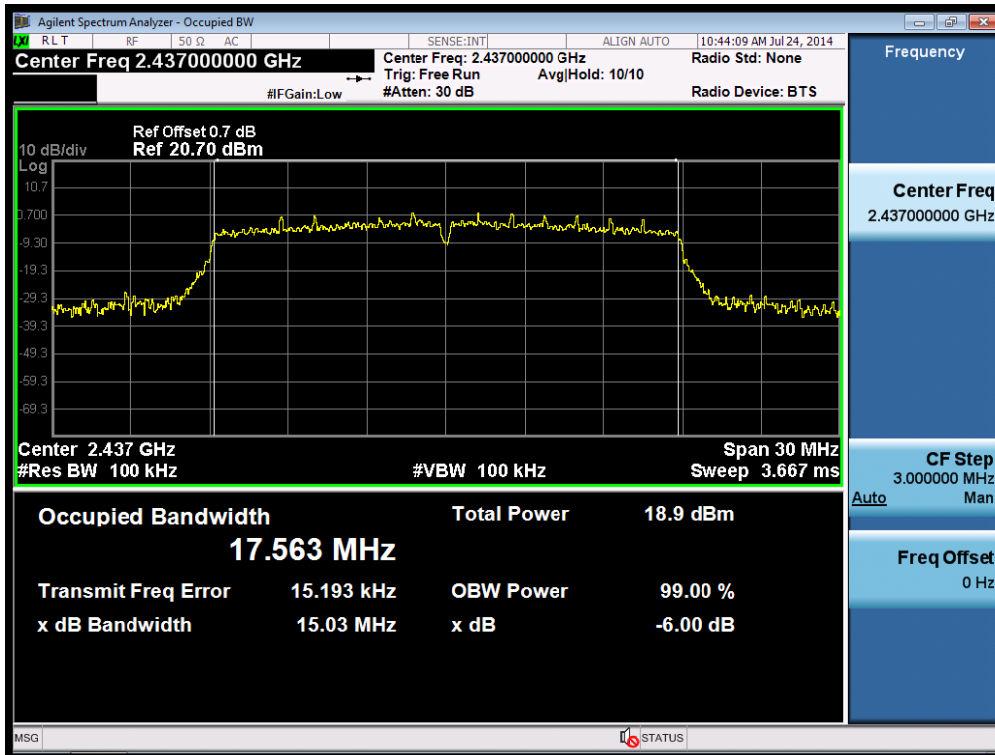

2.9. 11N20_SISO_HCH

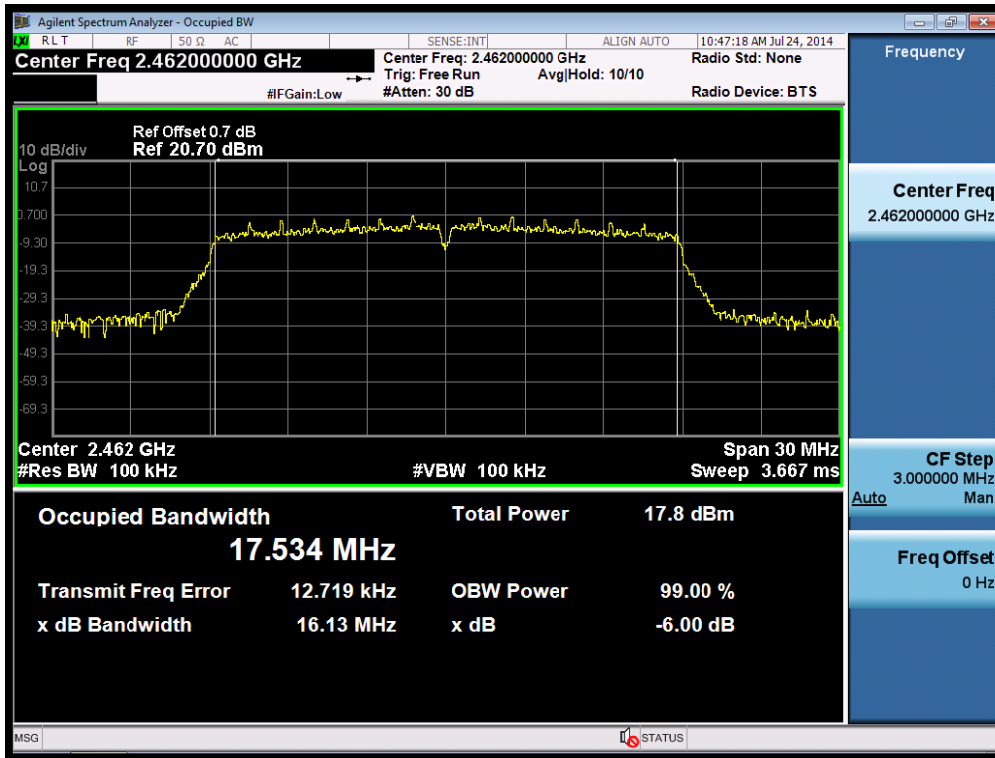

2.10. 11N40_SISO_LCH

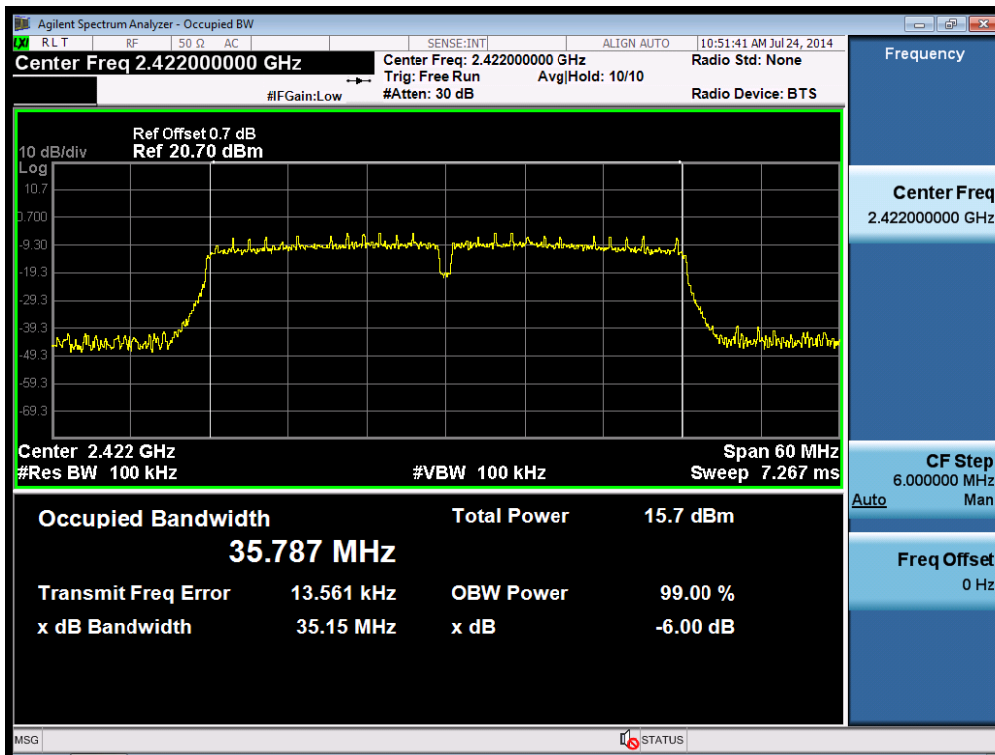

2.11. 11N40_SISO_MCH

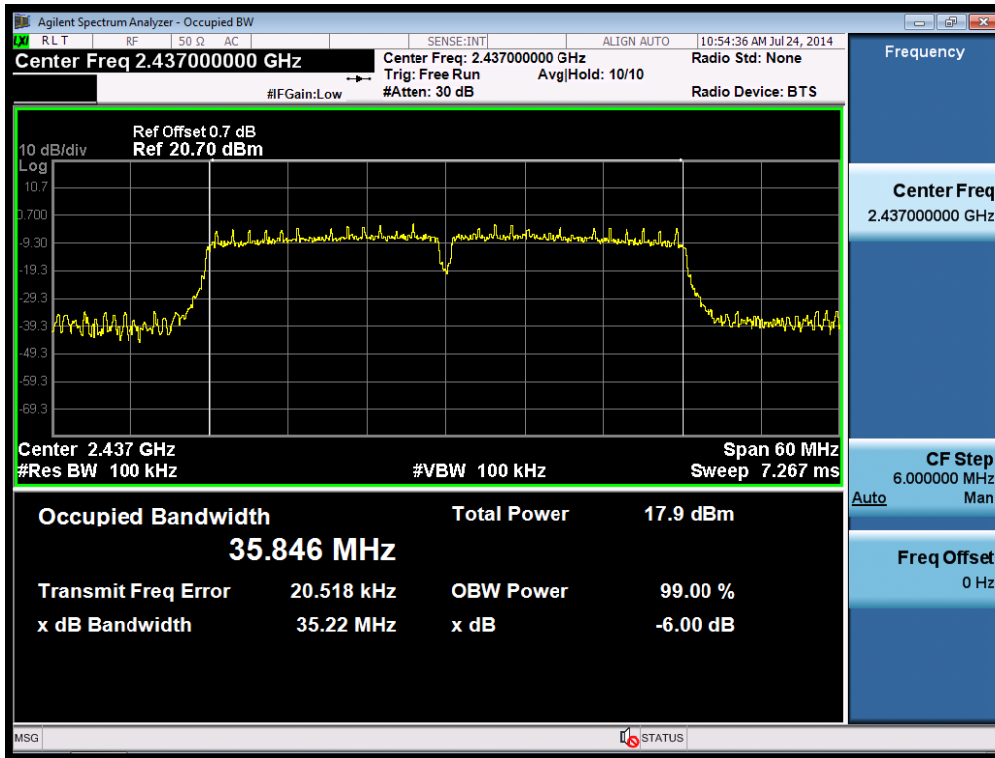

2.12. 11N40_SISO_HCH

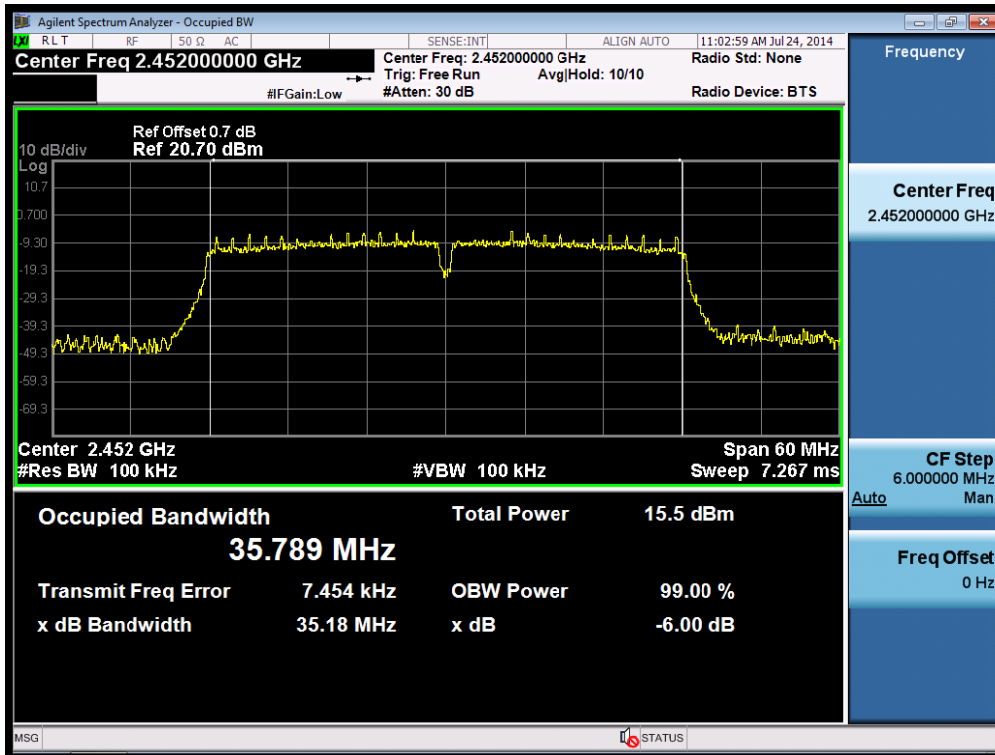

Appendix B: Conducted Peak Output Power

1. Result Table

EUT Conf.	Test Channel	Meas.Level [dBm]	Verdict
11B	LCH	16.20	PASS
11B	MCH	16.28	PASS
11B	HCH	16.31	PASS
11G	LCH	14.26	PASS
11G	MCH	14.38	PASS
11G	HCH	14.39	PASS
11N20_SISO	LCH	14.38	PASS
11N20_SISO	MCH	14.47	PASS
11N20_SISO	HCH	14.59	PASS
11N40_SISO	LCH	13.48	PASS
11N40_SISO	MCH	13.53	PASS
11N40_SISO	HCH	13.40	PASS

Appendix C: Maximum Power Spectral Density Level

1. Result Table

EUT Conf.	Test Channel	PSD [dBm]	Verdict
11B	LCH	4.46	PASS
11B	MCH	2.2	PASS
11B	HCH	1.56	PASS
11G	LCH	-4.6	PASS
11G	MCH	-3.29	PASS
11G	HCH	-3.65	PASS
11N20_SISO	LCH	-3.01	PASS
11N20_SISO	MCH	-2.29	PASS
11N20_SISO	HCH	-3.52	PASS
11N40_SISO	LCH	-9.99	PASS
11N40_SISO	MCH	-7.7	PASS
11N40_SISO	HCH	-10.26	PASS

2. Test Plot

2.1. 11B_LCH



2.2. 11B_MCH



2.3. 11B_HCH



2.4. 11G_LCH

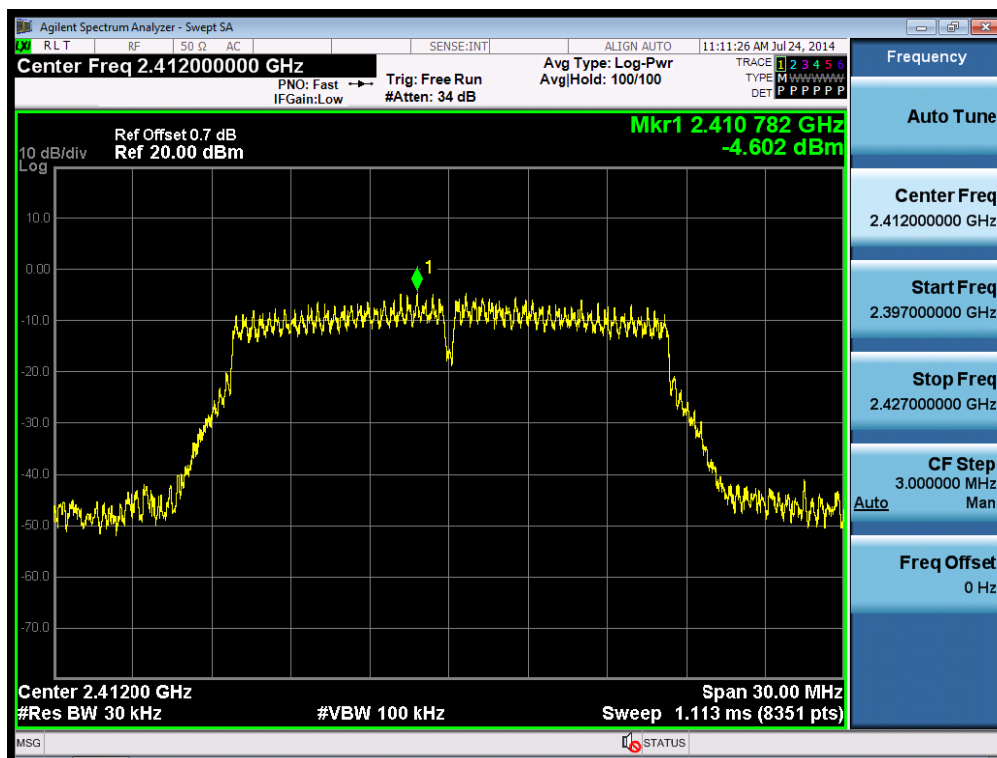

2.5. 11G_MCH

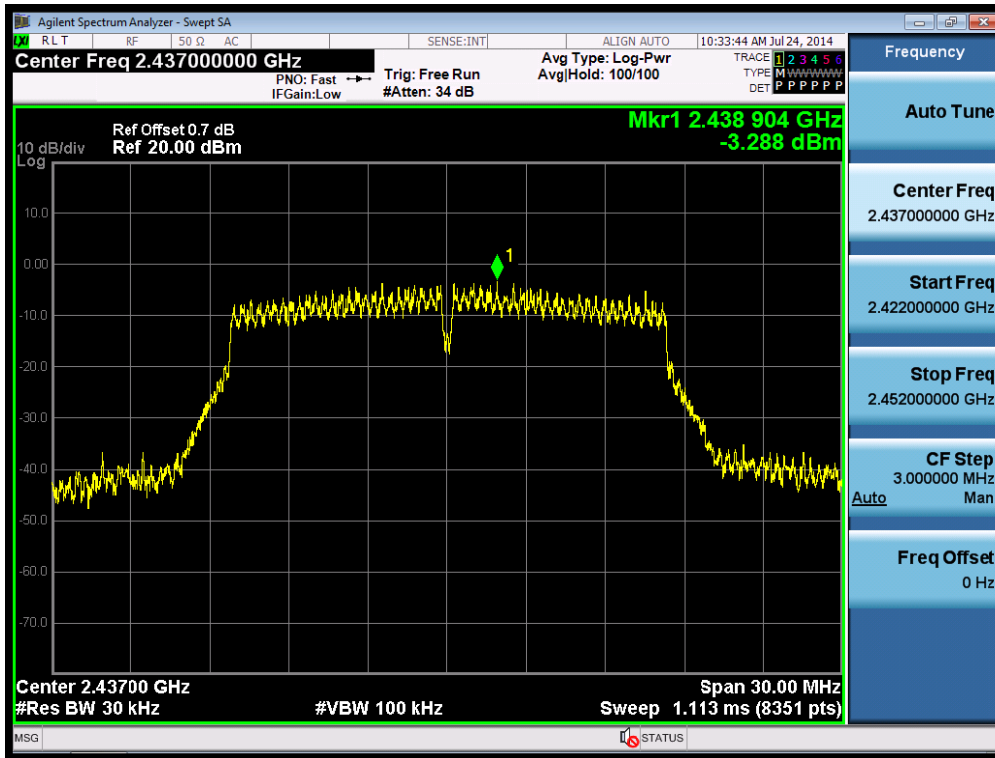

2.6. 11G_HCH

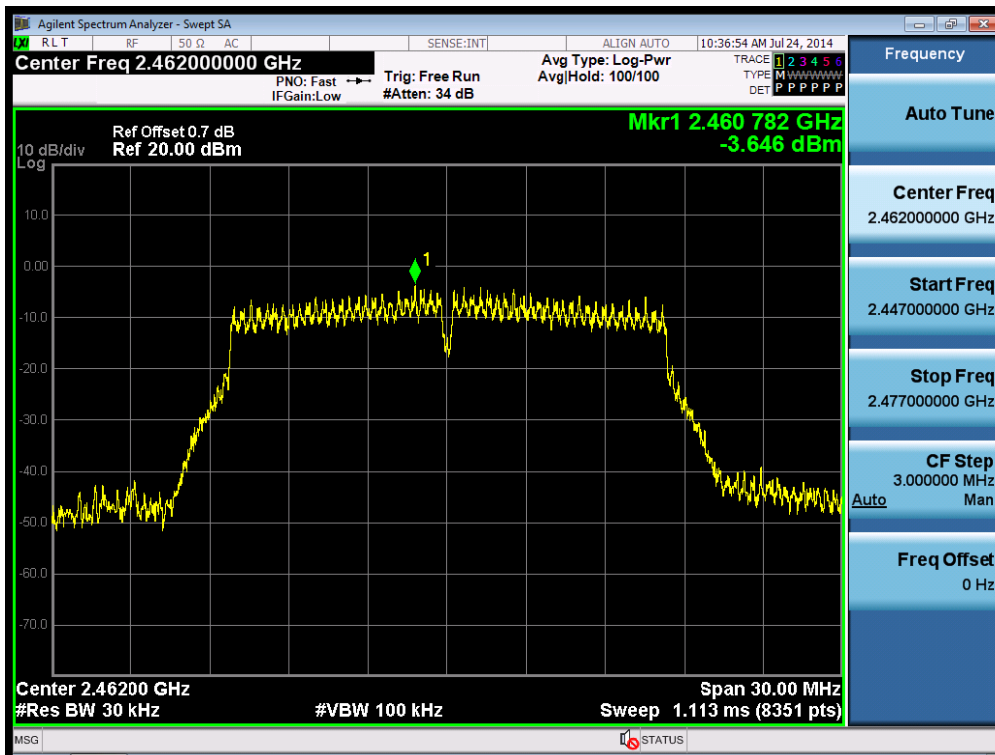

2.7. 11N20_SISO_LCH

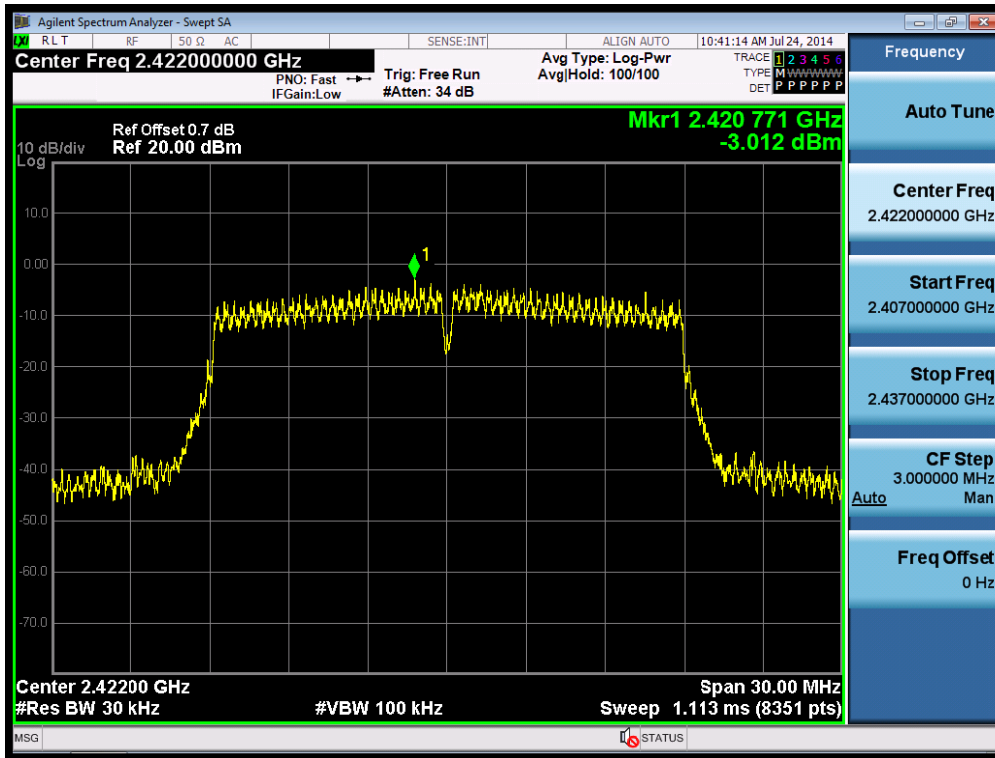

2.8. 11N20_SISO_MCH

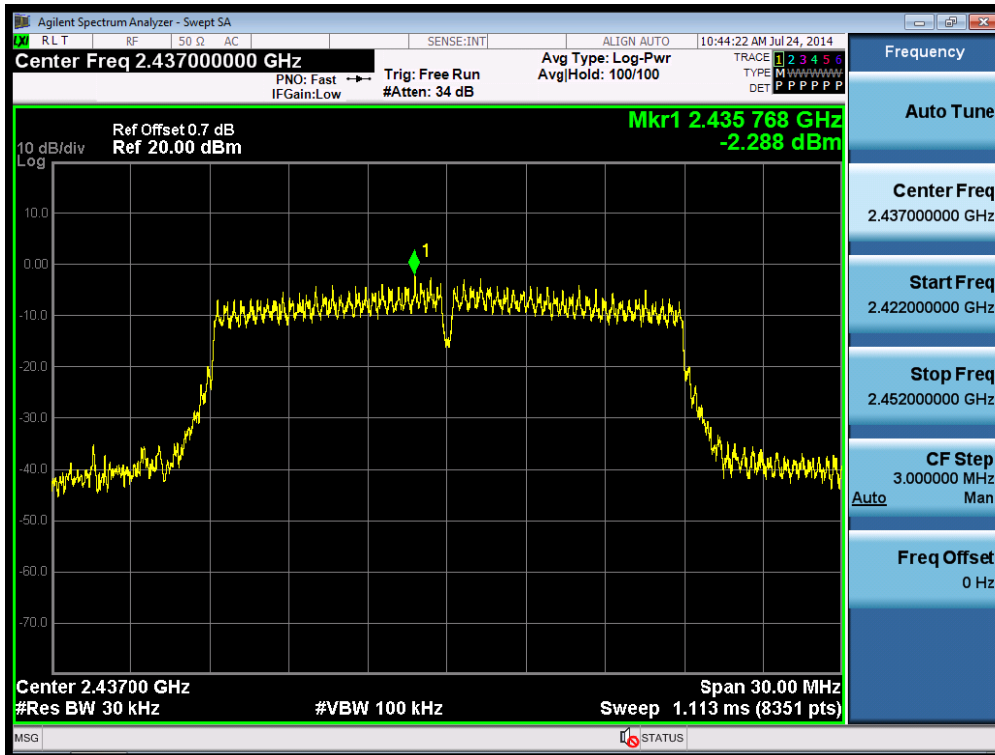

2.9. 11N20_SISO_HCH



2.10. 11N40_SISO_LCH

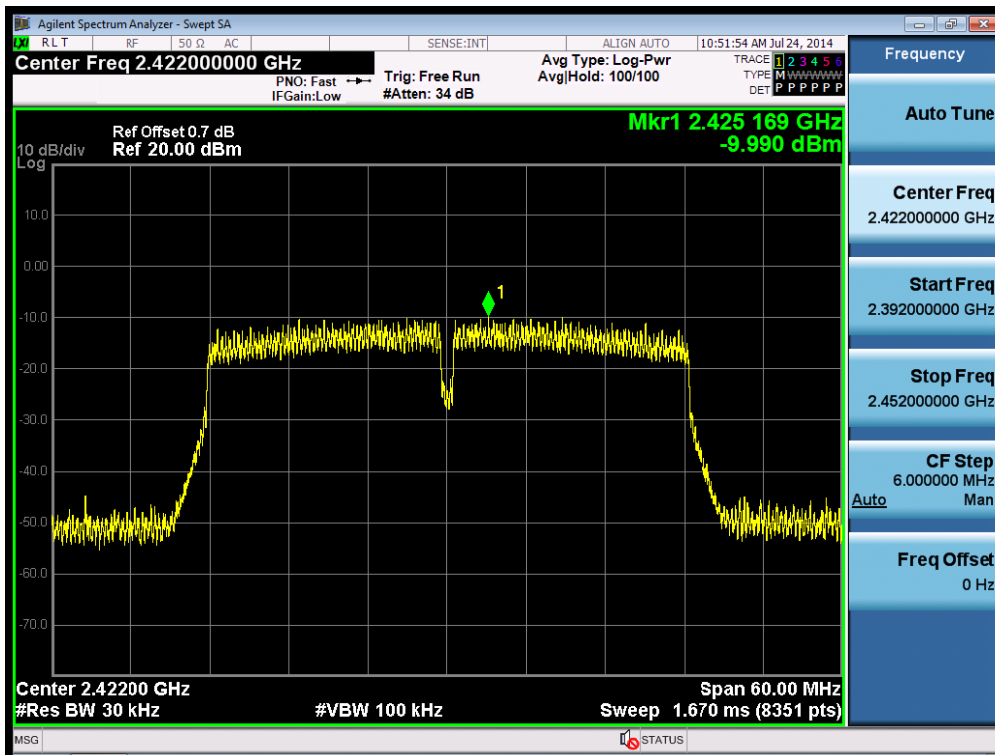

2.11. 11N40_SISO_MCH

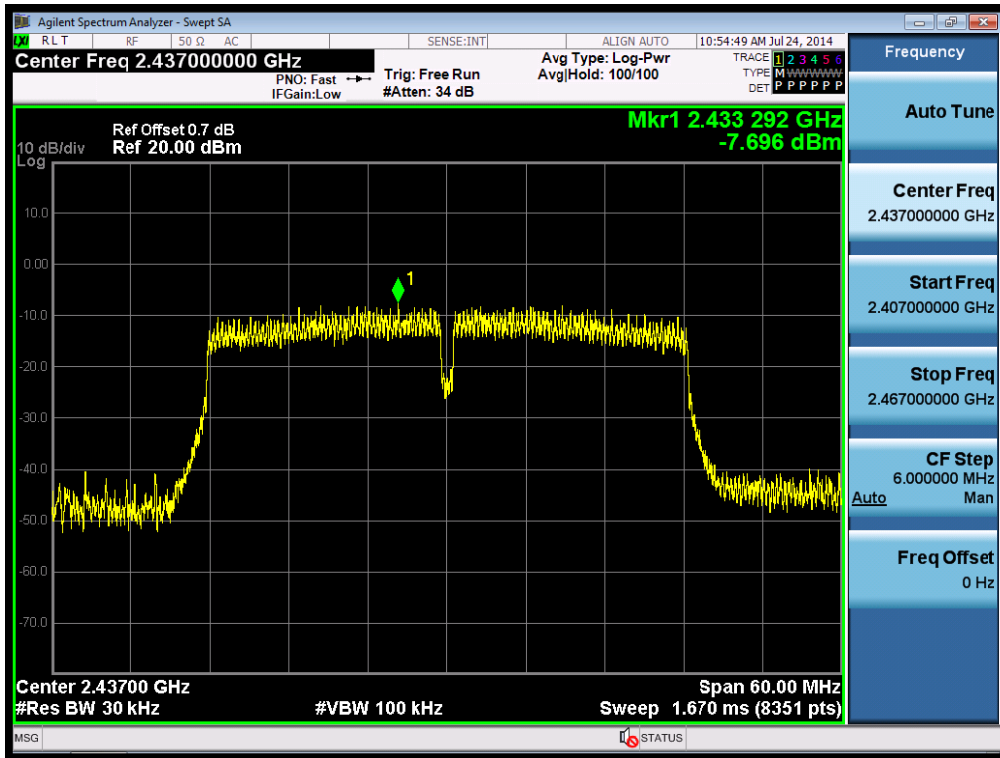

2.12. 11N40_SISO_HCH

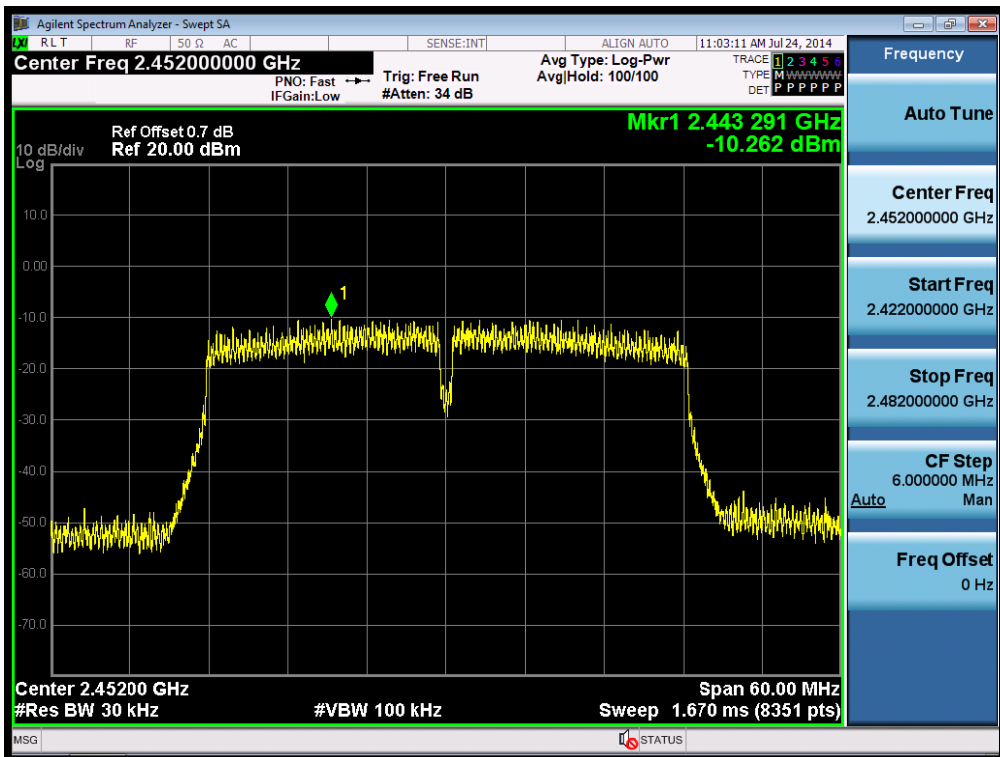

Appendix D: Band Edges Compliance

1. Result Table

EUT Conf.	Test Channel	Carrier Power[dBm]	Max.Spurious Level [dBm]	Limit [dBm]	Verdict
11B	LCH	5.67	-31.54	-14.33	PASS
11B	HCH	5.98	-34.72	-14.02	PASS
11G	LCH	0.28	-34.76	-19.72	PASS
11G	HCH	0.59	-39.08	-19.41	PASS
11N20_SISO	LCH	0.91	-41.07	-19.09	PASS
11N20_SISO	HCH	0.63	-37.09	-19.37	PASS
11N40_SISO	LCH	-5.04	-40.13	-25.04	PASS
11N40_SISO	HCH	-5.08	-40.72	-25.08	PASS

2. Test Plot

2.1. 11B_LCH

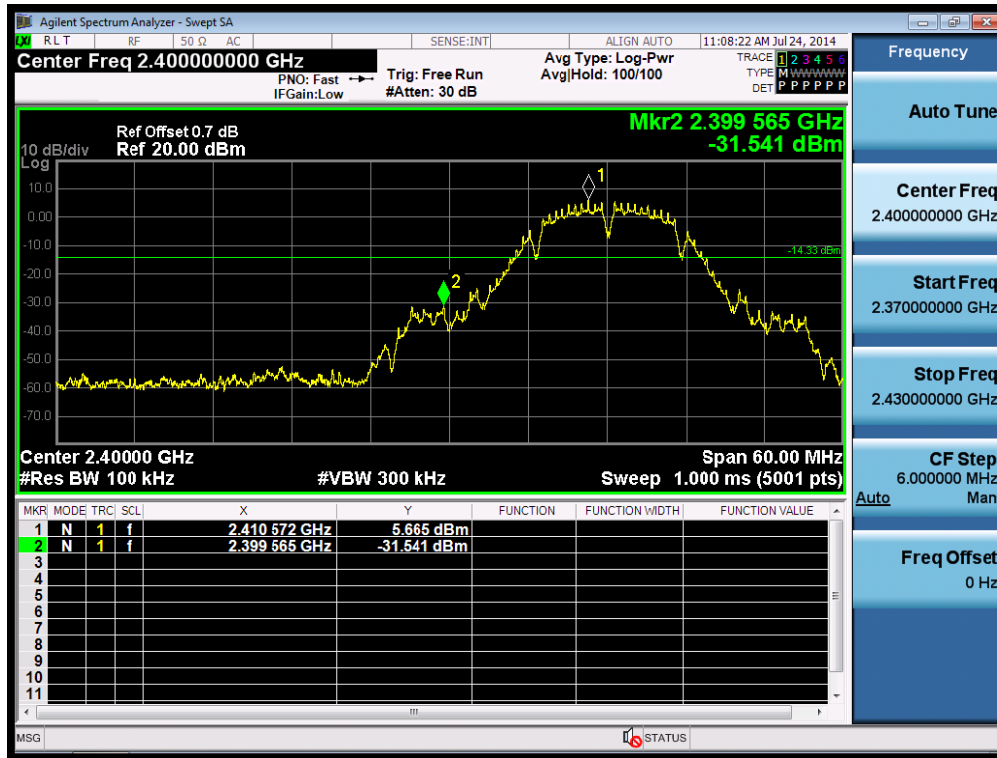

2.2. 11G_HCH

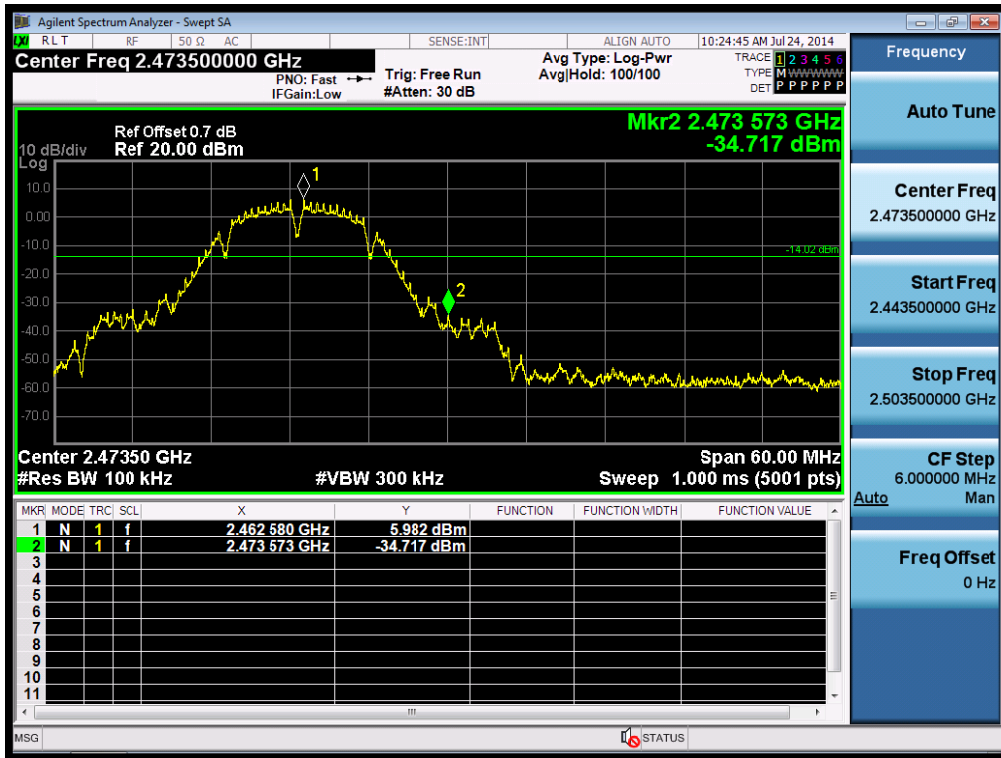

2.3. 11G_LCH

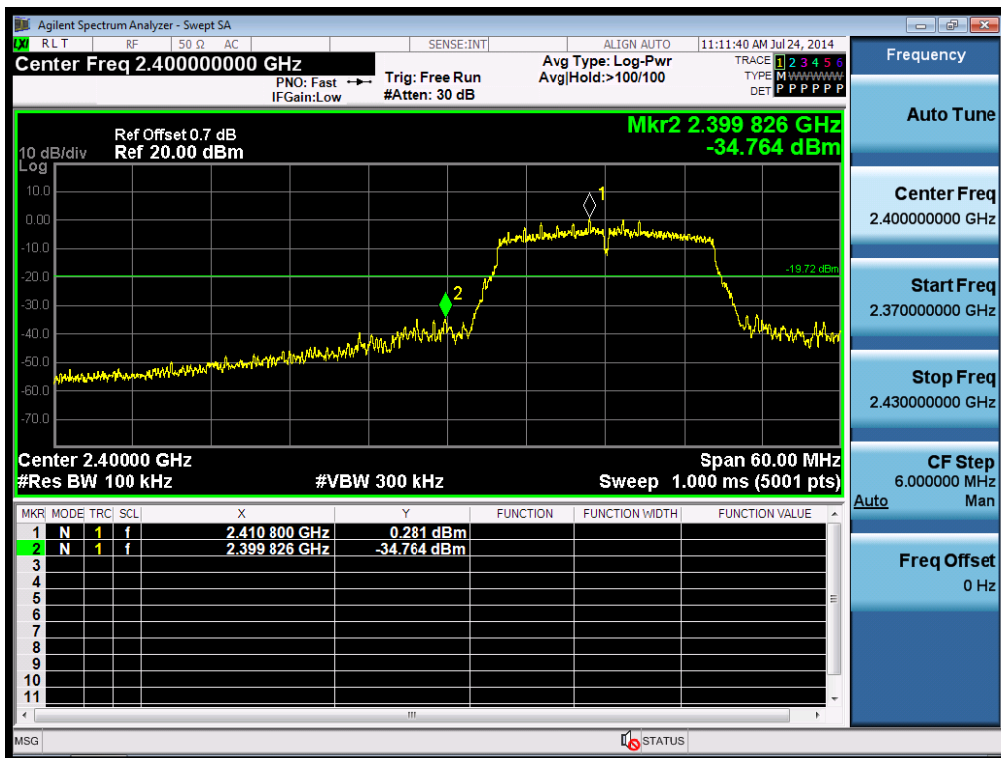

2.4. 11G_HCH

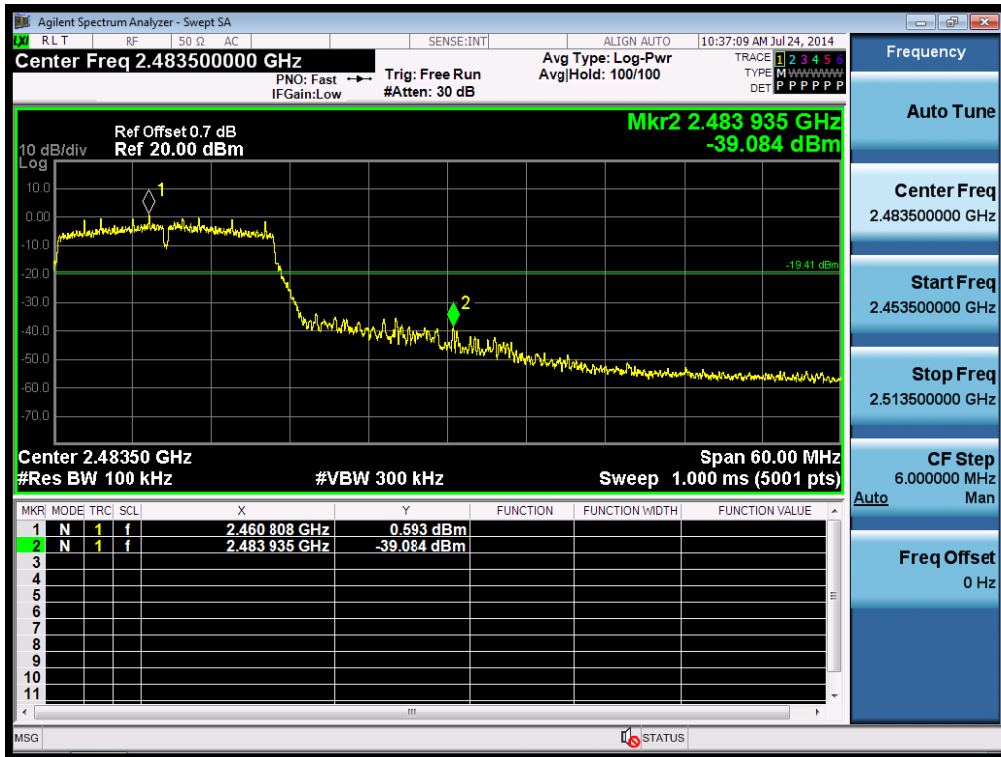

2.5. 11N20_SISO_LCH

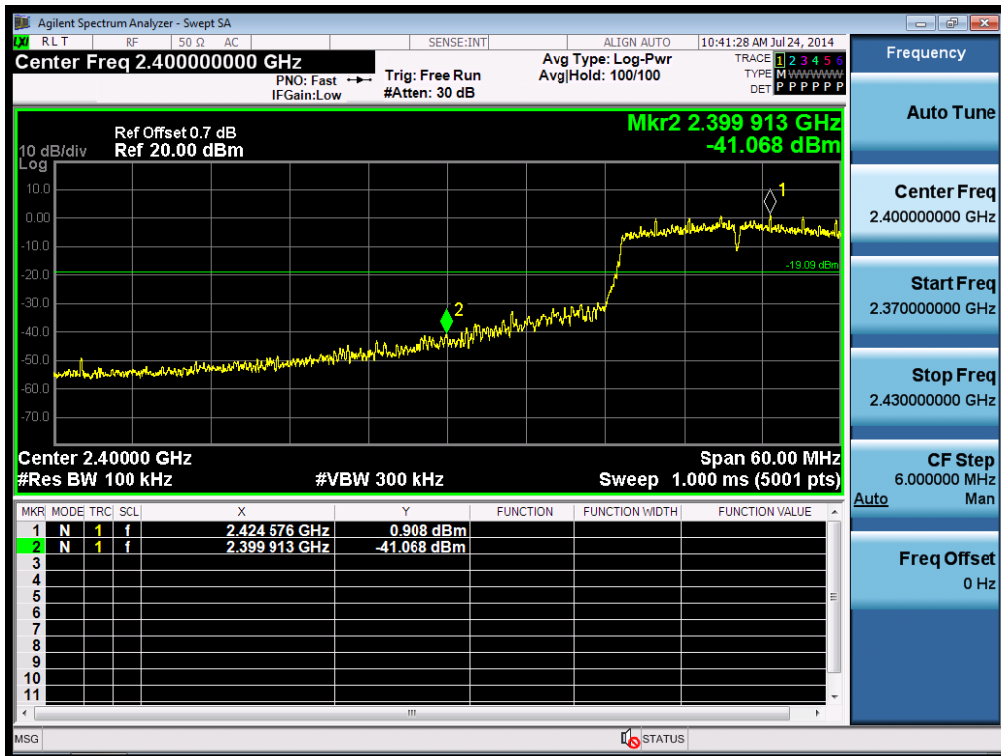

2.6. 11N20_SISO_HCH

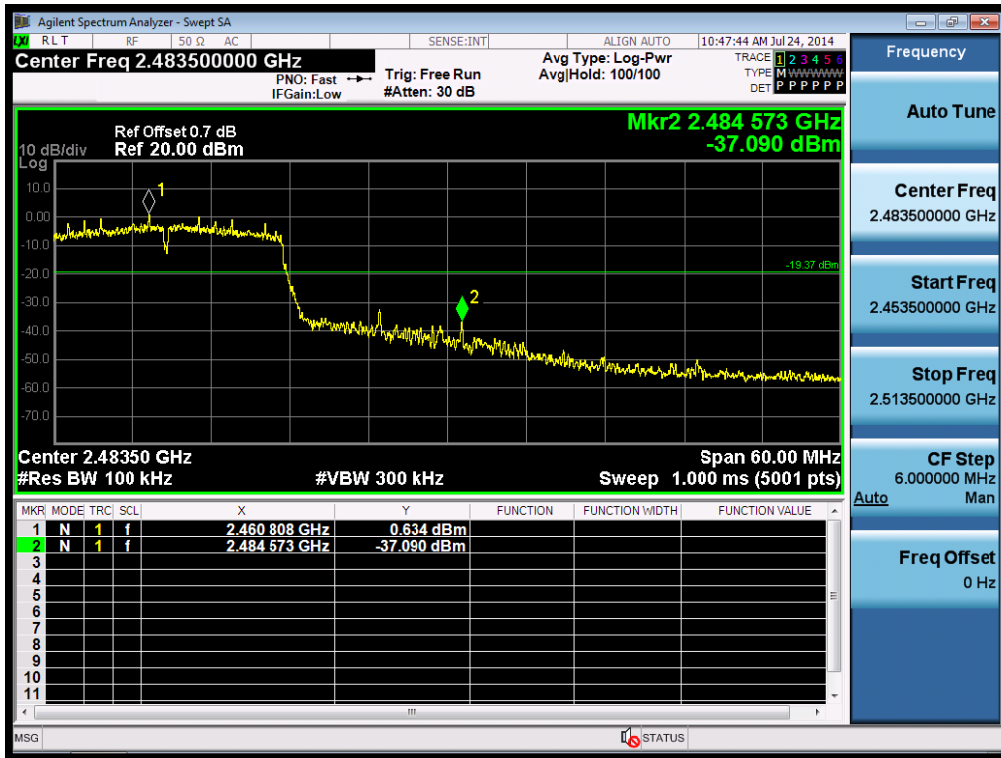

2.7. 11N40_SISO_LCH

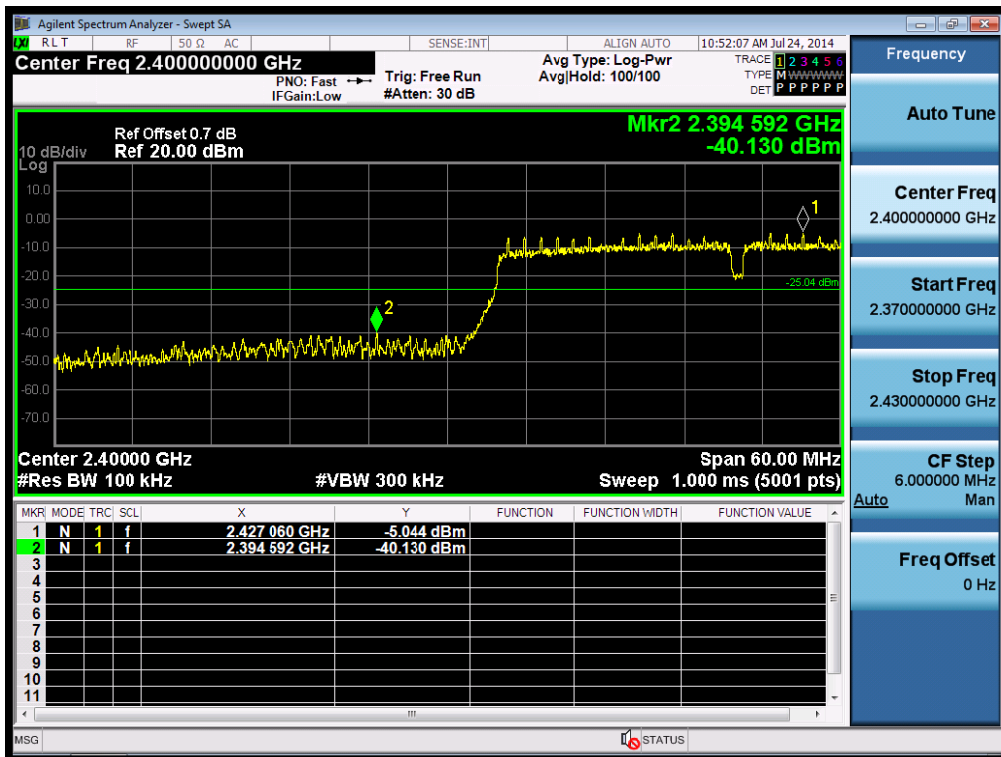

2.8. 11N40_SISO_HCH

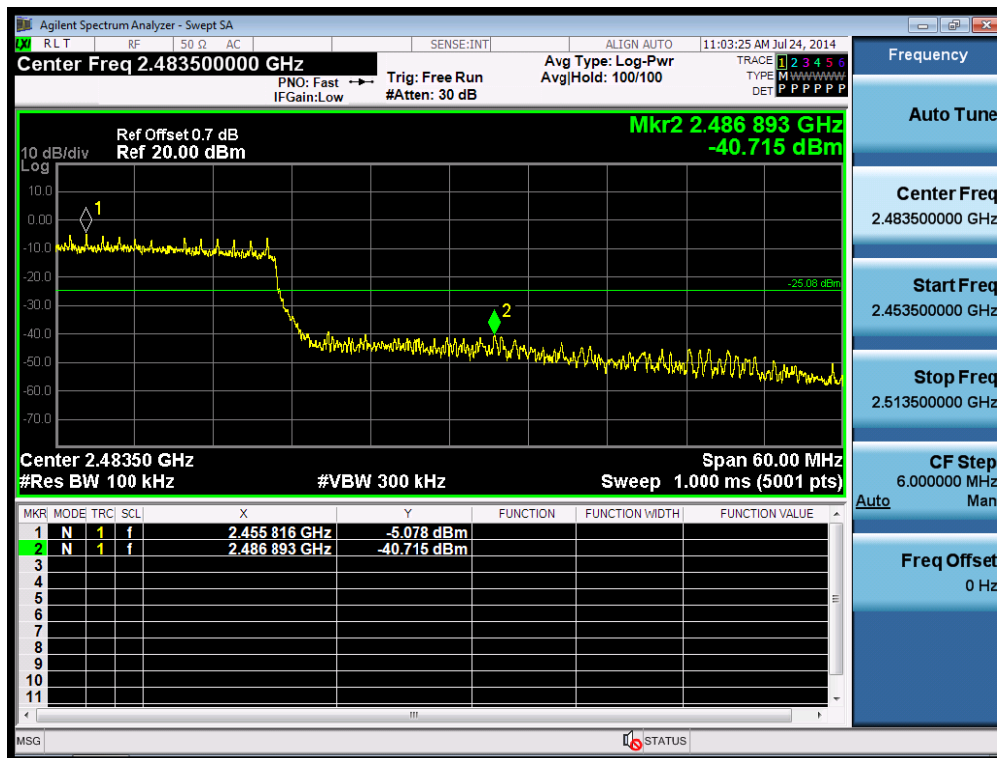

Appendix E: Conducted RF Spurious Emission

1. Result Table

EUT Conf.	Test Channel	Pref [dBm]	Puw[dBm]	Verdict
11B	LCH	5.64	<Limit	PASS
11B	MCH	5.98	<Limit	PASS
11B	HCH	6.07	<Limit	PASS
11G	LCH	-0.02	<Limit	PASS
11G	MCH	0.74	<Limit	PASS
11G	HCH	0.71	<Limit	PASS
11N20_SISO	LCH	1.33	<Limit	PASS
11N20_SISO	MCH	1.17	<Limit	PASS
11N20_SISO	HCH	0.5	<Limit	PASS
11N40_SISO	LCH	-4.86	<Limit	PASS
11N40_SISO	MCH	-2.76	<Limit	PASS
11N40_SISO	HCH	-4.69	<Limit	PASS

2. Test Plot

2.1. 11B_LCH

Pref:

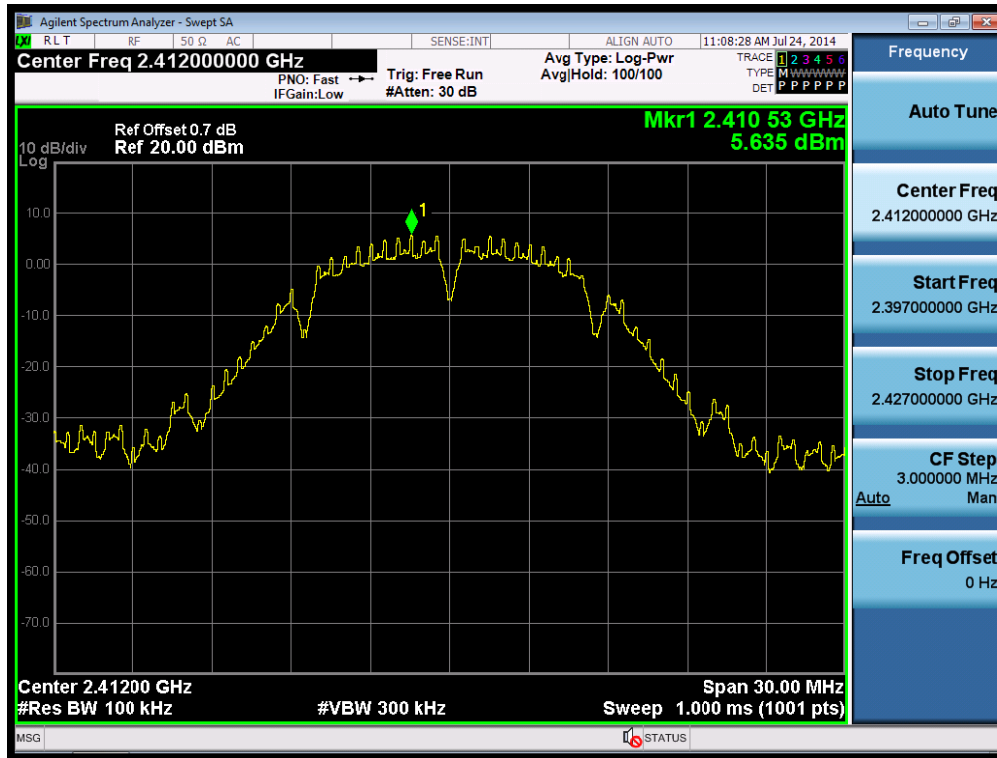

Puw:

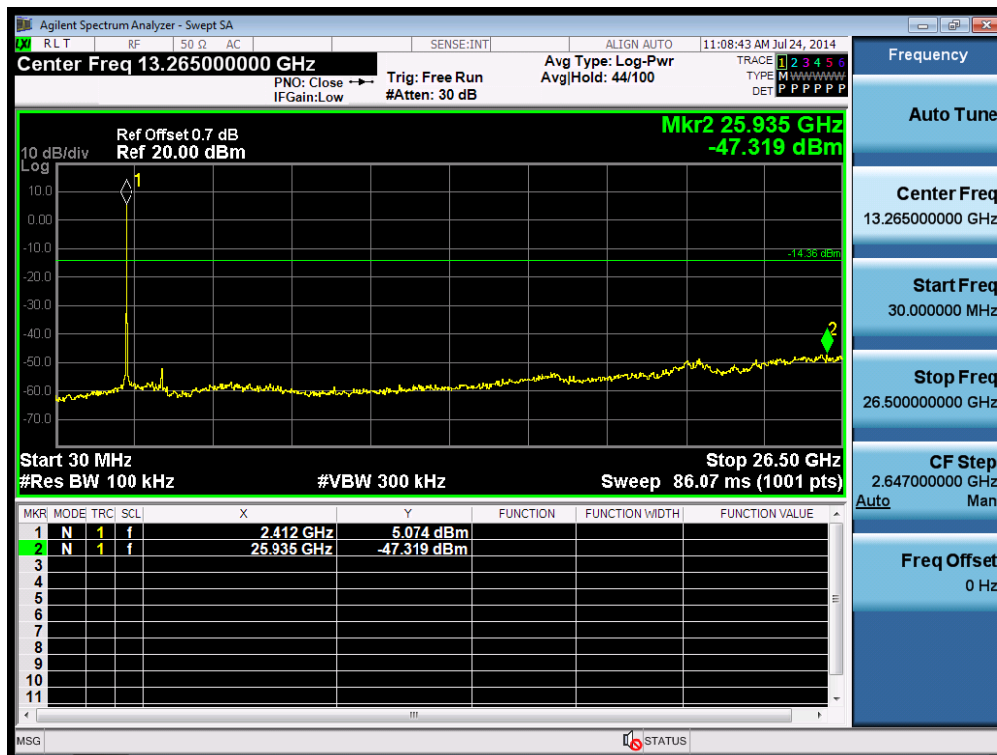

2.2. 11B_MCH

Pref:



Puw:

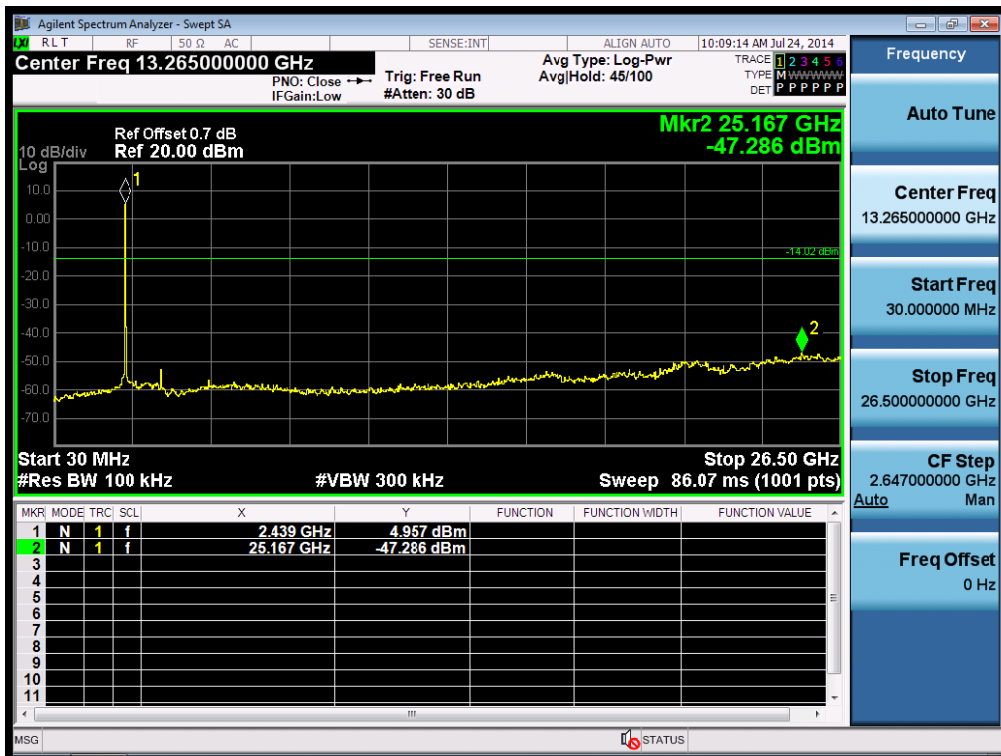

2.3. 11G_HCH

Pref:

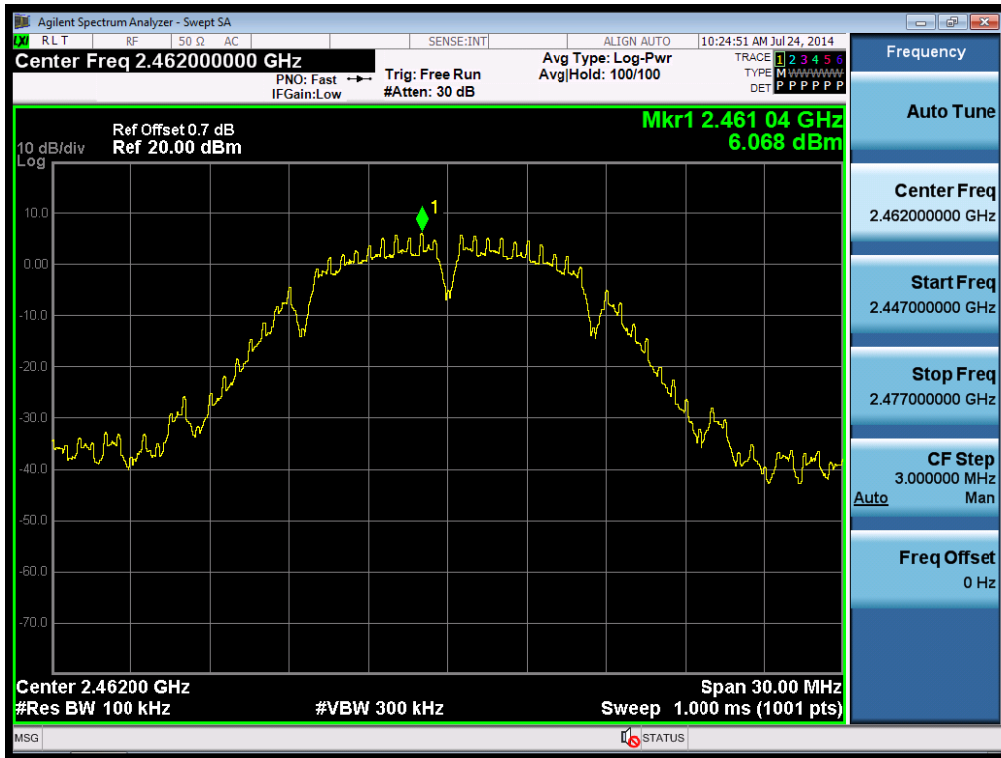

Puw:

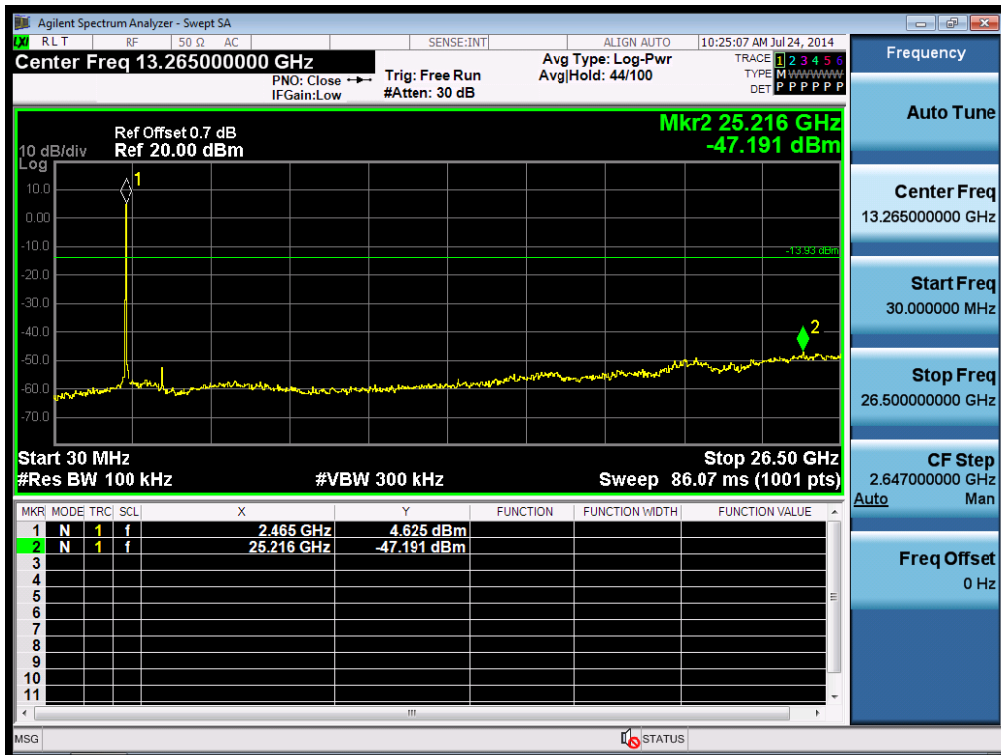

2.4. 11G_LCH

Pref:



Puw:

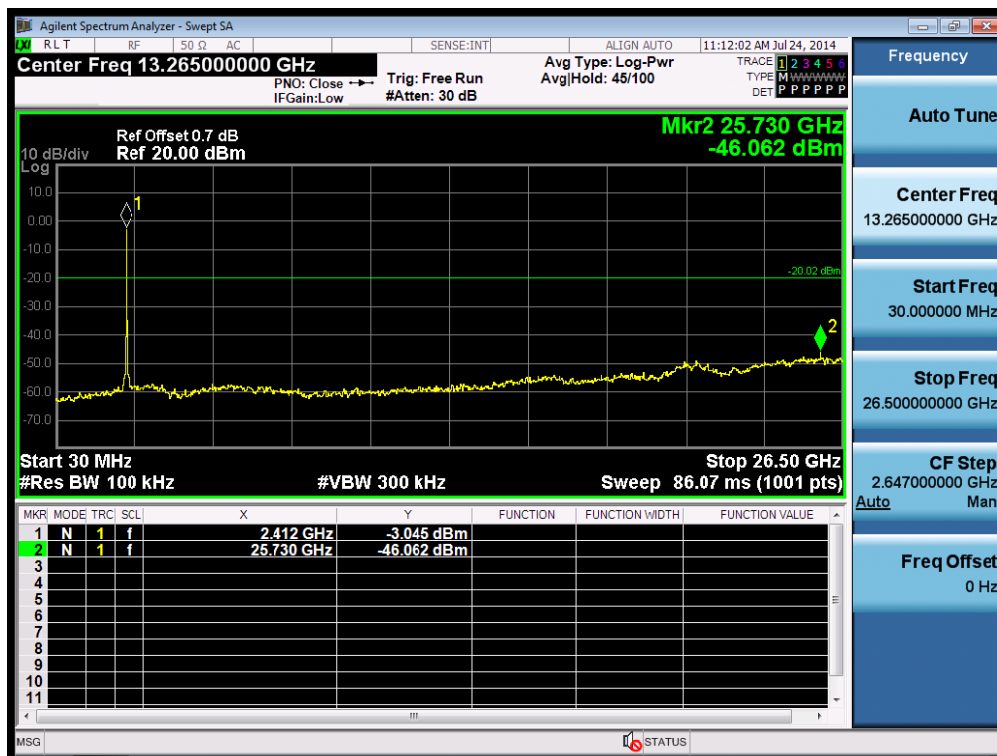

2.5. 11G_MCH

Pref:



Puw:

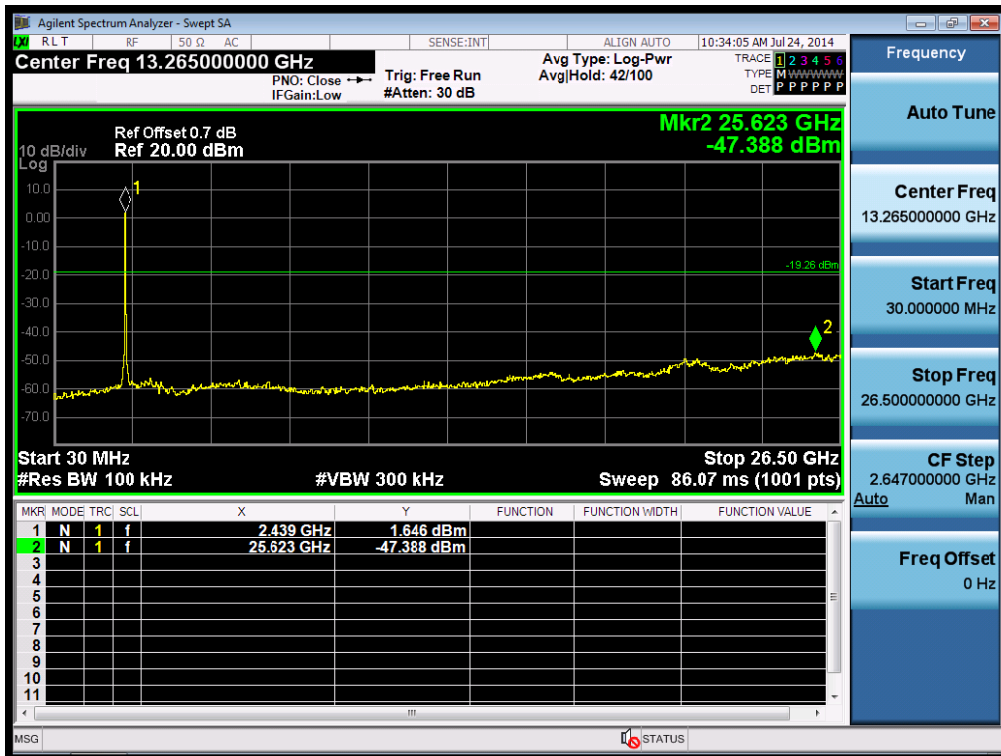

2.6. 11G_HCH

Pref:

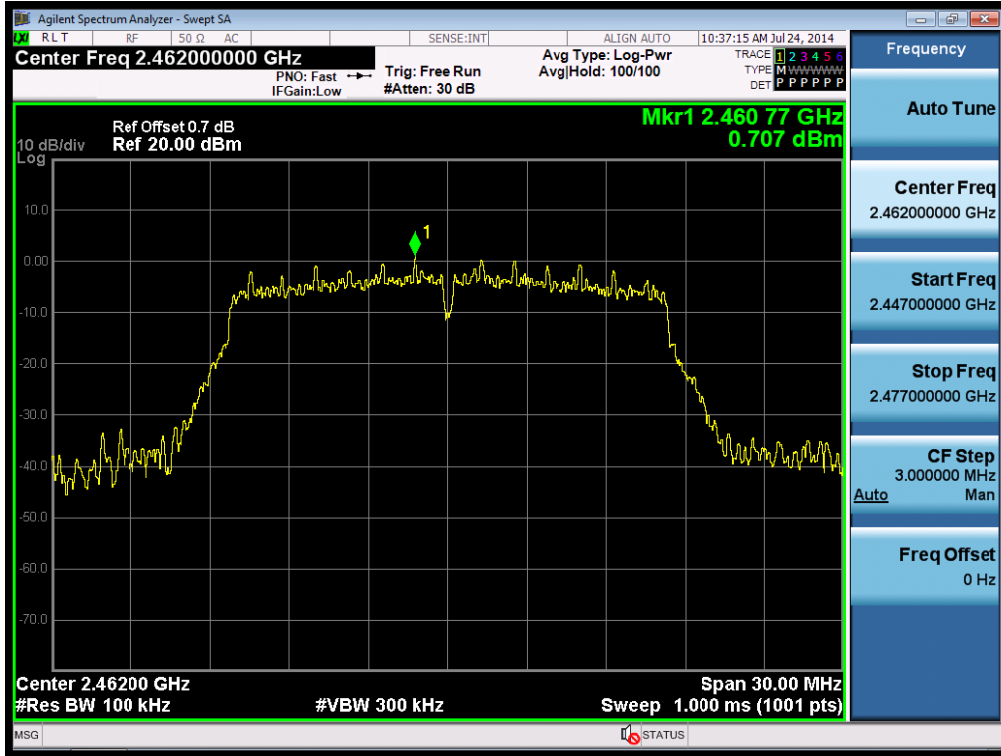

Puw:

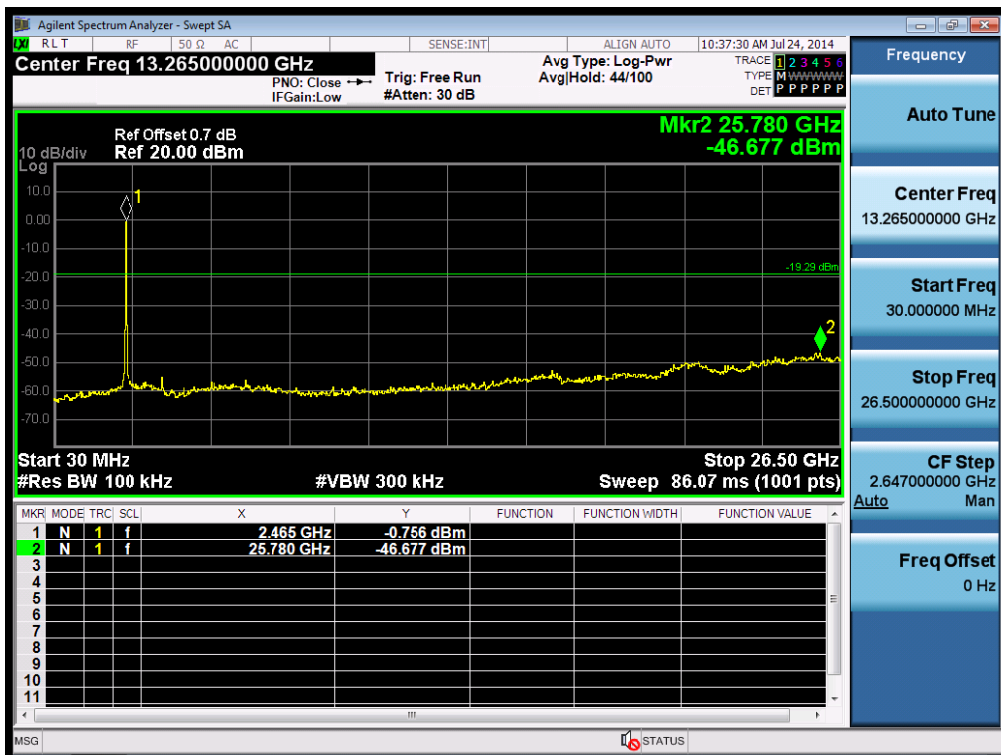

2.7. 11N20_SISO_LCH

Pref:



Puw:

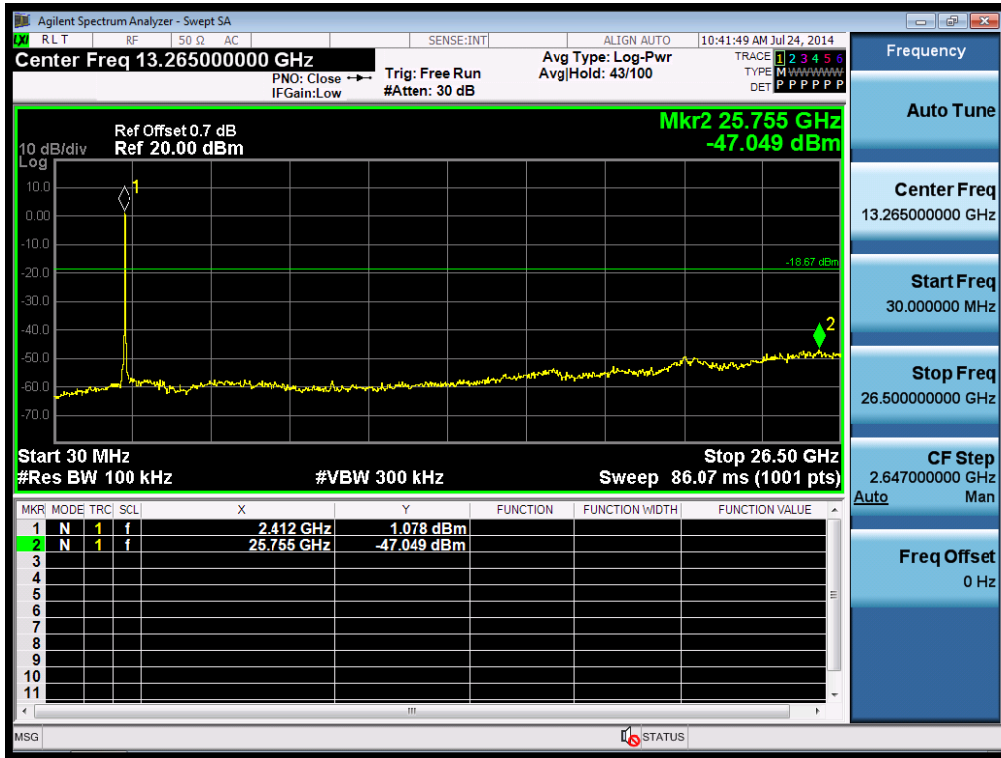

2.8. 11N20_SISO_MCH

Pref:



Puw:

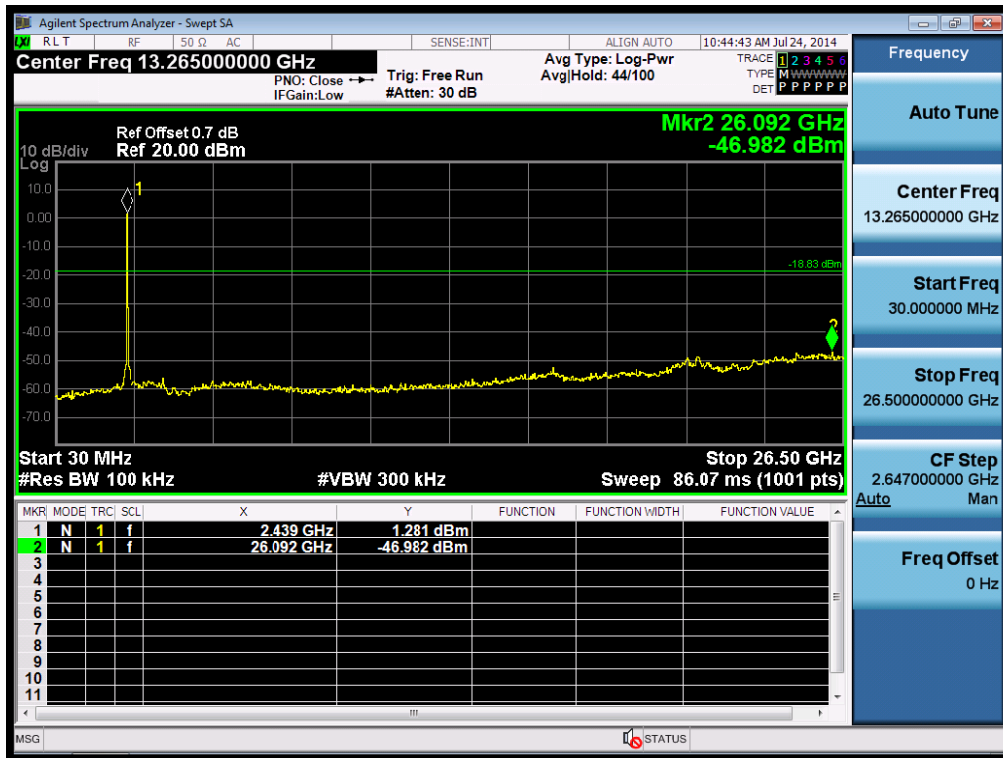

2.9. 11N20_SISO_HCH

Pref:



Puw:

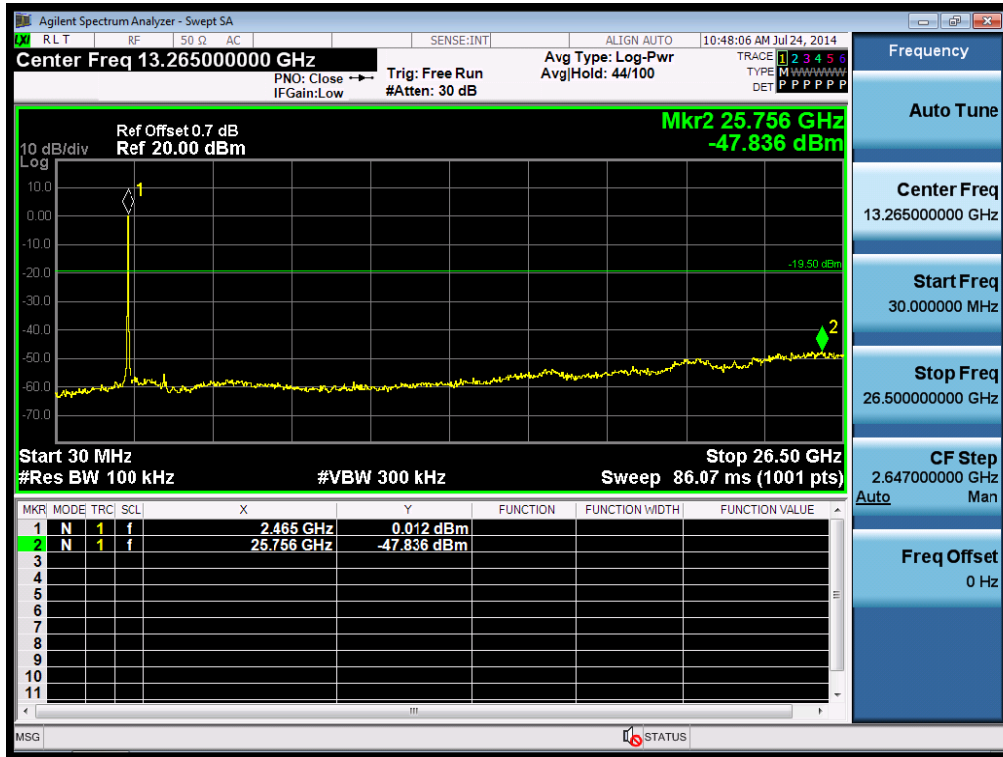

2.10. 11N40_SISO_LCH

Pref:

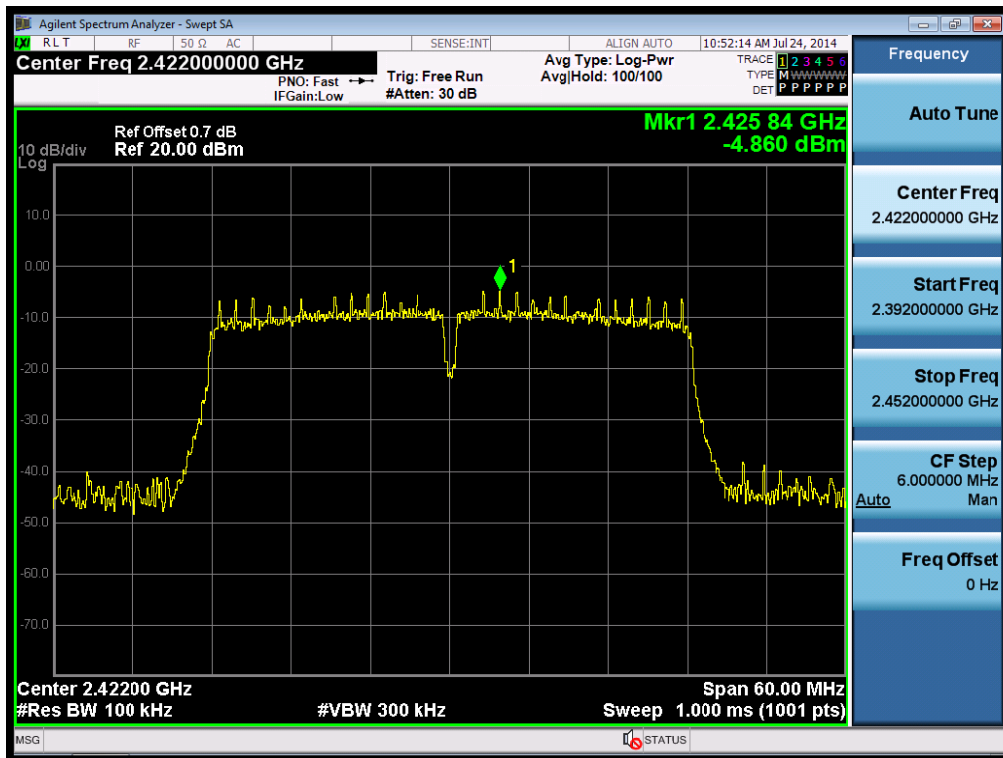

Puw:

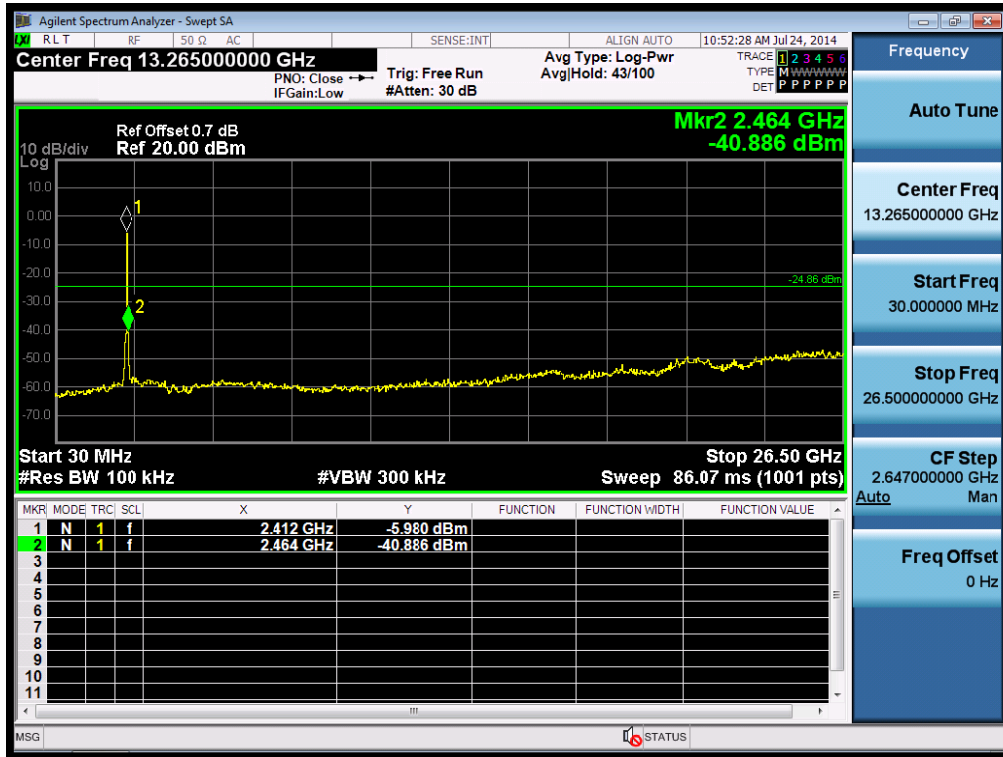

2.11. 11N40_SISO_MCH

Pref:

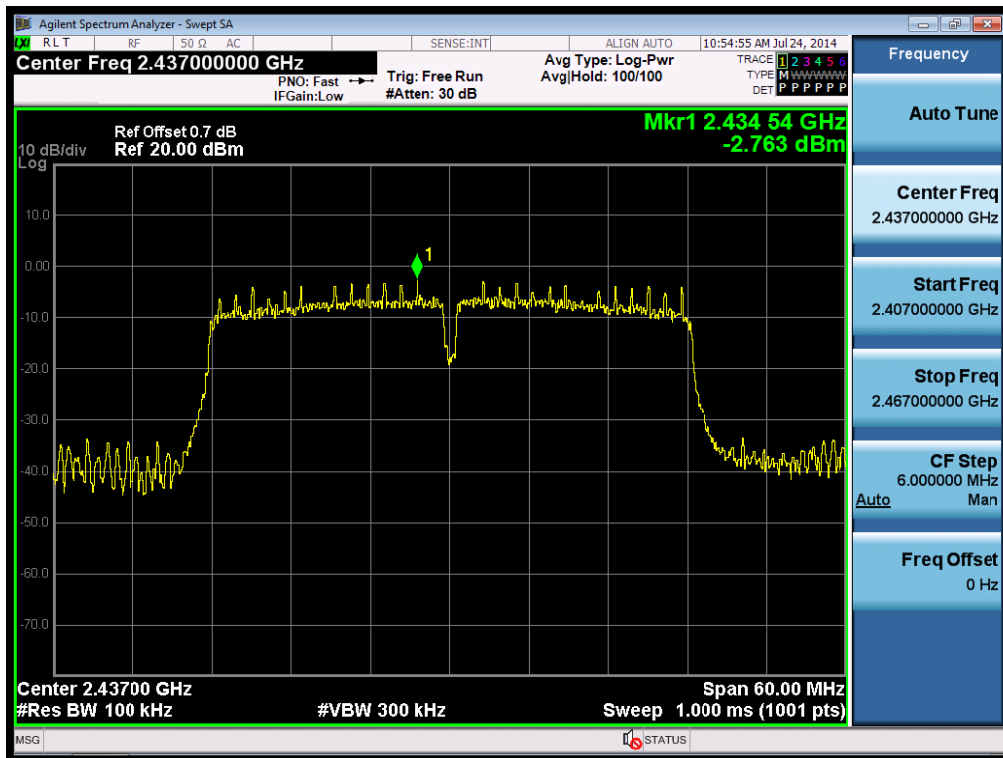

Puw:

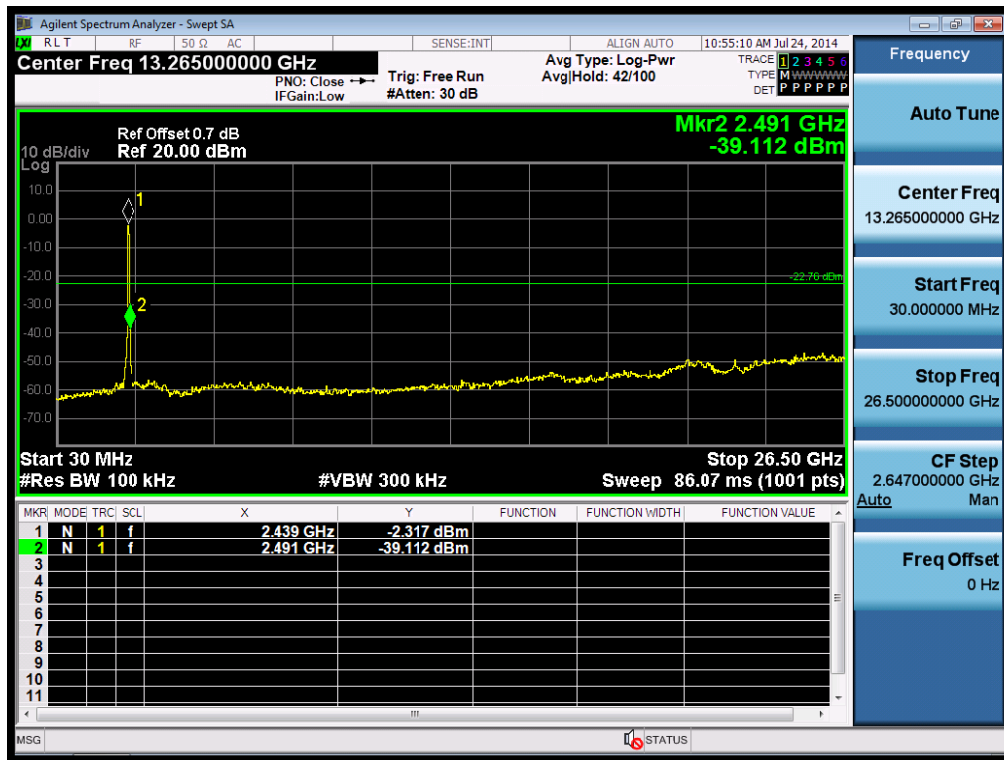

2.12. 11N40_SISO_HCH

Pref:

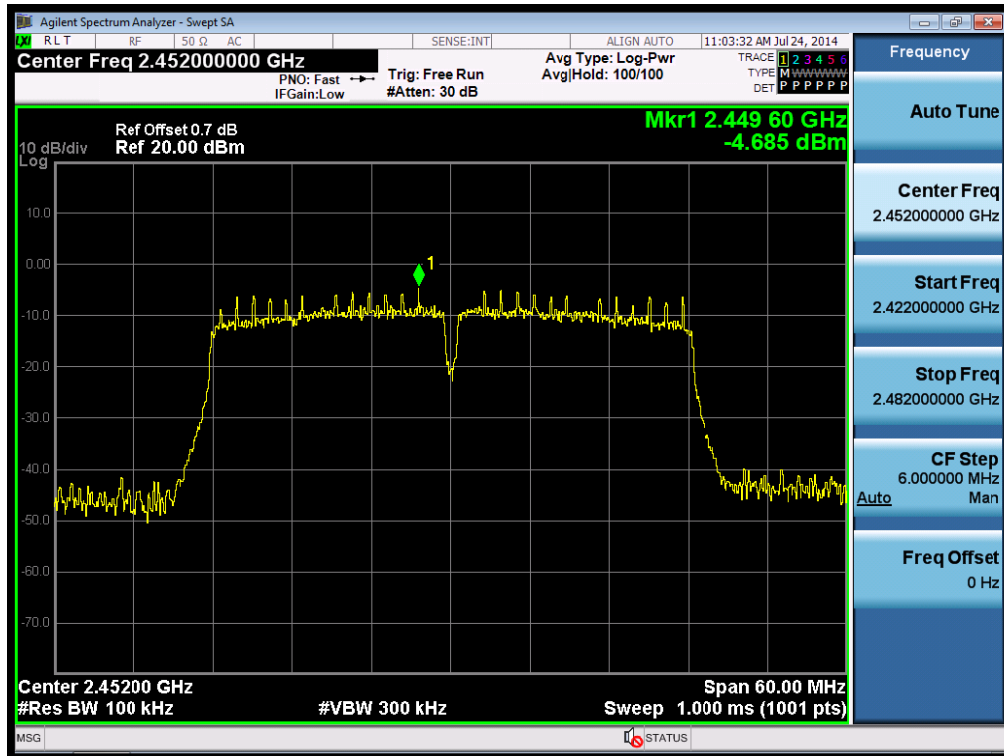



Puw:

