

FCC RF Test Report For BT 4.0

Product Type : WCDMA Mobile Phone
Applicant : Sky Phone LLC
Address : 1348 Washington Av., Miami Beach
Trade Name : SKY DEVICE
Model Number : N500
Test Specification : FCC 47 CFR PART 15 SUBPART C: Oct., 2013
RSS-210 Issue 8 December 2010
ANSI C63.4:2009
Receive Date : 20 June, 2014
Test Period : 23 June, 2014 to 23 July, 2014
Issue Date : 31, July 2014

Issue by

A Test Lab Techno Corp.
No. 140-1, Changan Street, Bade City,
Taoyuan County 334, Taiwan R.O.C.
Tel : +886-3-2710188 / Fax : +886-3-2710190



Taiwan Accreditation Foundation accreditation number: 1330

Note: This report shall not be reproduced except in full, without the written approval of A Test Lab Techno Corp. This document may be altered or revised by A Test Lab Techno Corp. personnel only, and shall be noted in the revision section of the document. The client should not use it to claim product endorsement by TAF, or any government agencies. The test results in the report only apply to the tested sample.



Revision History

Rev.	Issue Date	Revisions	Revised By
00	31 July, 2014	Initial Issue	



Verification of Compliance

Issued Date: 07/31/2014

Product Type : WCDMA Mobile Phone
 Applicant : Sky Phone LLC
 Address : 1348 Washington Av., Miami Beach
 Trade Name : SKY DEVICE
 Model Number : N500
 FCC ID : 2ABOSGC140602
 EUT Rated Voltage : AC 120V; DC 3.7V battery, DC 5.0V USB charge;
 Test Voltage : AC 120V; DC 3.7V;
 Applicable Standard : FCC 47 CFR PART 15 SUBPART C: Oct., 2013
 RSS-210 Issue 8 December 2010
 ANSI C63.4:2009

Test Result : Complied

Performing Lab. : A Test Lab Techno Corp.
 No. 140-1, Changan Street, Bade City,
 Taoyuan County 334, Taiwan R.O.C.
 Tel : +886-3-2710188 / Fax : +886-3-2710190
 Taiwan Accreditation Foundation accreditation number: 1330
<http://www.atl-lab.com.tw/e-index.htm>



The above equipment was tested by A Test Lab Techno Corp. The test data, data evaluation, test procedures, and equipment configurations shown in this report were made in accordance with the procedures given in ANSI C63.4: 2009 and the energy emitted by the sample tested as described in this report is in compliance with the requirements of FCC Rules Part 15.207, 15.209, 15.247 .

The test results of this report relate only to the tested sample identified in this report.

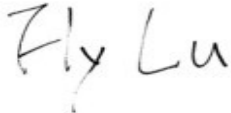
Approved By :  Reviewed By : 
 (Manager) (Murphy Wang) (Testing Engineer) (Fly Lu)



CONTENT

1	GeneralInformation.....	5
1.1	Applied Standard	5
1.2	TestLocation	5
1.3	TestEnvironmentCondition	5
2	TestSummary	6
3	Description of the Equipmentunder Test (EUT).....	7
3.1	GeneralDescription	7
3.2	Technical Description	7
3.3	TestModes	8
3.4	EUTConfigurations	9
3.5	TestEnvironments	10
3.6	TestSetups	10
3.7	TestConditions	13
4	Main Test Instruments	15

1 General Information**1.1 Applied Standard**

Applied Rules: FCC 47 CFR PART 15 SUBPART C: Oct., 2013

TestMethod: FCC 558074 D01 DTS Meas Guidance
FCC KDB 662911 D01MultipleTransmitter Output

1.2 Test Location

TestLocation 1: A Test Lab Techno Corp.

Address: No. 140-1, Changan Street, Bade City, Taoyuan County 334, Taiwan
R.O.C.

1.3 Test Environment Condition

AmbientTemperature: 19.5to 25°C

AmbientRelativeHumidity: 40 to 55 %

AtmosphericPressure: Notapplicable

2 Test Summary

TestItem	FCC Part No.	Requirements	TestResult	Verdict (NOTE2)
DTS (6 dB) Bandwidth	15.247(a)(2)	≥ 500 kHz.	Appendix A	Pass
Maximum Peak ConductedOutputPower	15.247(b)(3)	For directionalgain:< 30dBm – (G[dBi] – 6 [dB]), peak;Otherwise:< 30dBm,	Appendix B	Pass
MaximumPowerSpectral DensityLevel	15.247(e)	For directionalgain:< 8dBm/3 kHz – (G[dBi] – 6[dB]), peak.Otherwise:< 8 dBm/3 kHz, peak.	Appendix C	Pass
Band Edges Compliance	15.247(d)	< -20dB/100 kHz if total peakpower ≤powerlimit.	Appendix D	Pass
UnwantedEmissionsintoNon-RestrictedFrequency Bands	15.247(d)	< -20dB/100 kHz if totalpeakpower ≤powerlimit.	Appendix E	Pass
UnwantedEmissionsintoRestrictedFrequencyBands (Conducted)	15.247(d) 15.209 (NOTE1)	FCC Part 15.209 fieldstrengthlimit;	Appendix F	Pass
Unwanted Emissions intoRestrictedFrequencyBands (Radiated)				
AC PowerLineConducted Emissions	15.207	FCC Part 15.207 conducted limit;	Appendix G	Pass



3 Description of the Equipment under Test (EUT)

3.1 General Description

Product	WCDMA Mobile Phone
Trade Name	SKY DEVICE
Model Number	N500
Applicant	Sky Phone LLC 1348 Washington Av., Miami Beach
Manufacturer	Shenzhen Malata Mobile Communication CO.,LTD 25/F, Malata Technology Building, NO9998 Shennan Rd, Hi-tech Park, Nanshan, Shenzhen, P.R. China 518057.
FCC ID	2ABOSGC140602
Frequency Range	2402 ~ 2480 MHz
Modulation Type	GFSK
Type of Antenna	Internal
Antenna Gain (dBi)	0 dBi
RF Output Power (Conducted)	BT4.0:-4.975dBm

NOTE: Only Bluetooth test data included in this report.

3.2 EUT Identity

IMEI No.	
SIM 1	868817019960176
SIM 2	868817019960034

NOTE:

Unless otherwise noted in the report, the functional boards installed in the units shall be selected from the below list, but not means all the functional boards listed below shall be installed in one unit.



3.3 EUT Configurations

3.3.1 General Configurations

Configuration	Description
TestAntennaPorts	Until otherwise specified, <ul style="list-style-type: none">- All TX tests are performed at all TX antenna ports of the EUT, and- All RX tests are performed at all RX antenna ports of the EUT.
Multiple RF Sources	Other than the tested RF source of the EUT, other RF source(s) are disabled or shutdown during measurements.

Note: The EUT was programmed to be in continuously transmitting mode and the transmit duty cycle is not less than 98%.

3.3.2 Customized Configurations

#EUTConf.	SignalDescription	OperatingFrequency
TM1_ Ch0	GFSK modulation	Ch No. 0 / 2402MHz
TM1_ Ch19	GFSK modulation	Ch No. 19/ 2440MHz
TM1_ Ch39	GFSK modulation	Ch No. 39/ 2480MHz

3.4 Test Environments

NOTE: The values used in the test report may be stringent than the declared.

Environment Parameter	Selected Values During Tests		
	Temperature	Voltage	Relative Humidity
NTNV	Ambient	3.7VDC	Ambient

3.5 Test Setups

3.6.1 Test Setup 1

The WLAN component's antenna port(s) of the EUT are reconnected to the measurement instrument per an appropriate attenuator. The EUT is controlled by PC/software to emit the specified signals for the purpose of measurements.

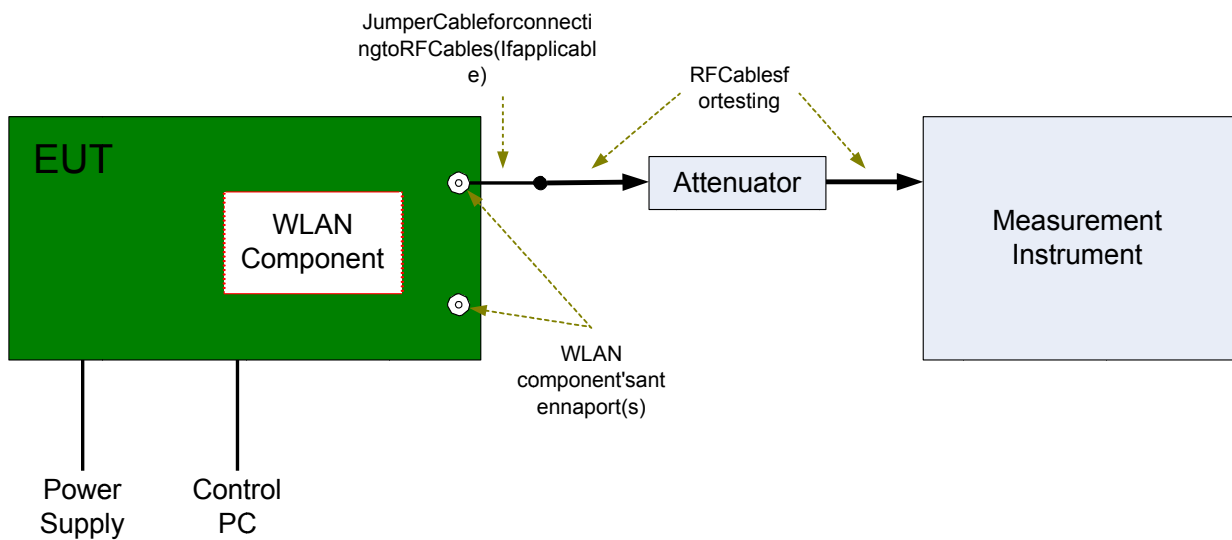

3.6.2 Test Setup 2

The test site is semi-anechoic chamber has met the requirement of NSA tolerance 4dB according to the standards: ANSI C63.4. The test distance is 3m. This setup is according to ANSI C63.4 and CAN/CSA-CEI/IEC CISPR 22.

The maximum emission value is acquired by adjusting the antenna height, polarisation and turntable azimuth. Normally, the height range of antenna is 1m to 4m, the azimuth range of turntable is 0° to 360°, and the receive antenna has two polarizations Vertical (V) and Horizontal (H).

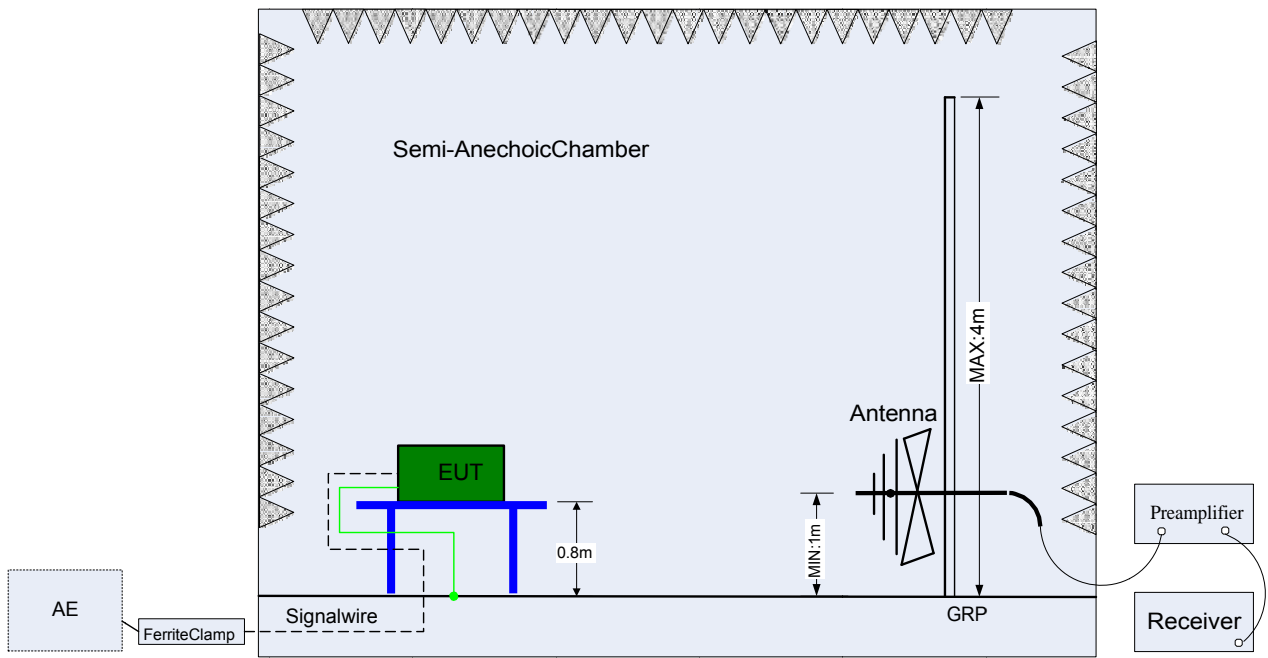

(Below 1 GHz)

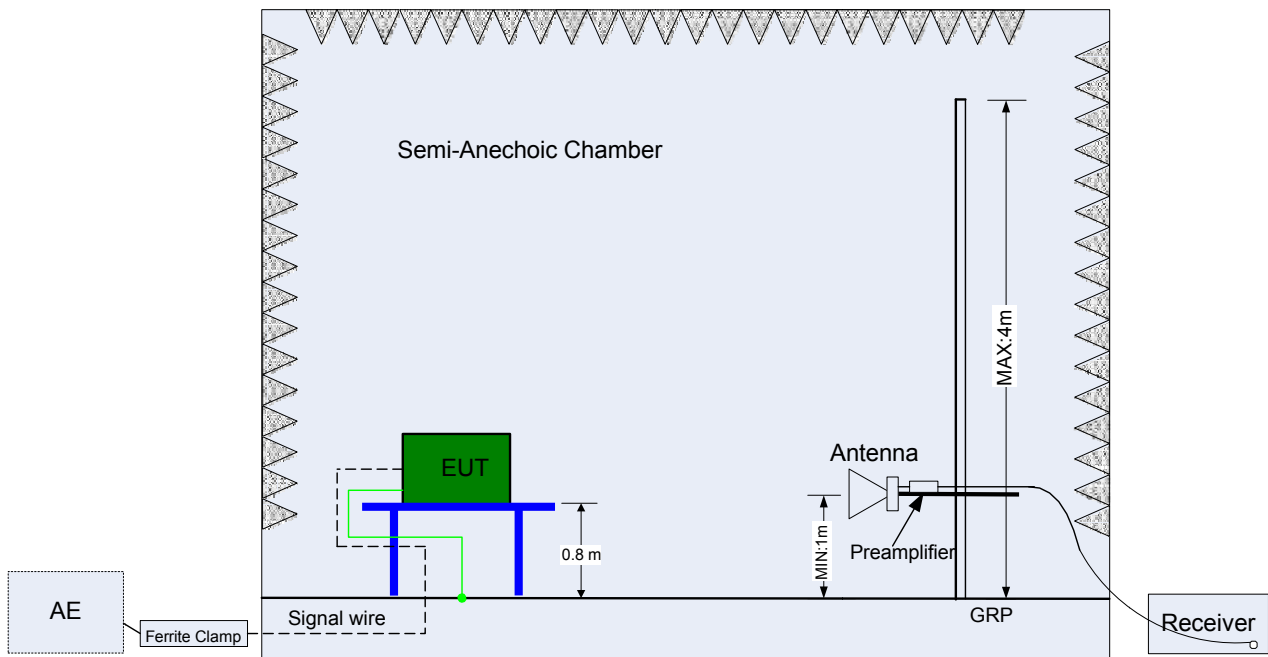

(Above 1GHz)

3.6.3 Test Setup 3

The mains cable of the EUT (maybe per AC/DC Adapter) must be connected to LISN. The LISN shall be placed 0.8 m from the boundary of EUT and bonded to a ground reference plane for LISN mounted on top of the ground reference plane. This distance is between the closest points of the LISN and the EUT. All other units of the EUT and associated equipments shall be at least 0.8 m from the LISN.

Ground connections, where required for safety purposes, shall be connected to the reference ground point of the LISN and, where not otherwise provided or specified by the manufacturer, shall be of same length as the mains cable and run parallel to the mains connection at a separation distance of not more than 0.1 m.

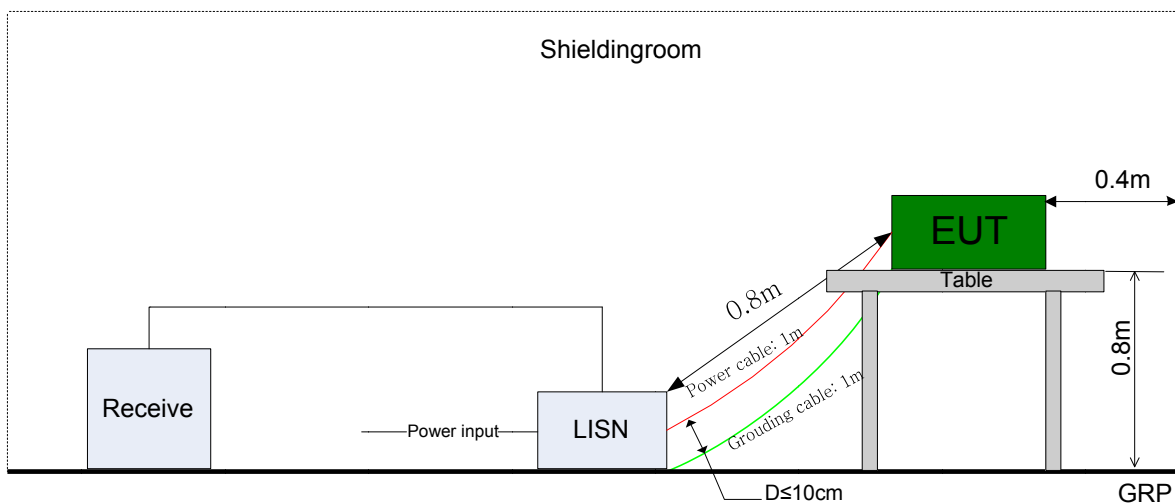



3.6 Test Conditions

TestCase	TestConditions	
	Configuration	Description
DTS (6 dB) Bandwidth	MeasurementMethod	FCC KDB 558074 §7.1.1Option2.
	TestEnvironment	NTNV
	TestSetup	TestSetup1
	EUTConfiguration	TM1_ Ch0 TM1_ Ch19 TM1_ Ch39
MaximumPeak ConductedOut putPower	MeasurementMethod	FCC KDB 558074§7.2.1.2 Option2 (integrated band powermethod).
	TestEnvironment	NTNV
	TestSetup	TestSetup1
	EUTConfiguration	TM1_ Ch0 TM1_ Ch19 TM1_ Ch39
MaximumPower SpectralDensity Level	MeasurementMethod	FCC KDB 558074 §7.3.1Option 1 (peak PSD).
	TestEnvironment	NTNV
	TestSetup	TestSetup1
	EUTConfiguration	TM1_ Ch0 TM1_ Ch19 TM1_ Ch39
UnwantedEmission sintoNon- RestrictedFrequency Bands	MeasurementMethod	FCC KDB 558074§7.4.1, use PeakPSD.
	TestEnvironment	NTNV
	TestSetup	TestSetup1
	EUTConfiguration	TM1_ Ch0 TM1_ Ch19 TM1_ Ch39
UnwantedEmission sintoRestrictedFreq uencyBands(Cond ucted)	MeasurementMethod	FCC KDB 558074§7.4.2,Conducted(antenna-port).
	TestEnvironment	NTNV
	TestSetup	TestSetup1
	EUTConfiguration	TM1_ Ch0 TM1_ Ch19 TM1_ Ch39
UnwantedEmi ssions into Restricted	MeasurementMethod	FCC KDB 558074§7.4.2,Radiated(cabinet/case emissionswith impedancematching for antenna-port).
	TestEnvironment	NTNV



TestCase	TestConditions	
	Configuration	Description
AC PowerLineCon ductedEmissio ns	MeasurementMethod	AC mainsconducted.
	TestEnvironment	NTNV
	TestSetup	TestSetup3
	EUTConfiguration	TM1_ Ch19(Worst Conf.).

Note: For RadiatedEmissions, By preliminary testing and verifying three axis (X, Y and Z) position of EUT transmitted status, it was found that "Z axis" position was the worst, then the final test was executed the worst condition and test data were recorded in this report.

4 Main Test Instruments

EquipmentName	Manufacturer	Model	Serial Number	CalDate	Cal. Period
MXA Signal Analyzer	Agilent	N9020A	MY53420615	2014.05.12	1 years
Power Sensor	Agilent	U2021XA	MY53180015	2013.09.27	1 years
Power Sensor	Agilent	U2021XA	MY53260040	2013.09.27	1 years
Power Sensor	Agilent	U2021XA	MY53360002	2013.09.27	1 years
Power Sensor	Agilent	U2021XA	MY53360006	2013.09.27	1 years
USB Modular Simultaneous Data Acquisition	Agilent	U2531A	TW53353509	N.C.R	1 years
USB Modular Simultaneous Data Acquisition	Agilent	U2531A	TW53353511	N.C.R	1 years
Test Receiver	R&S	ESCI	100367	2014.06.18	1 year
LISN	R&S	ENV216	101040	2014.03.07	1 year
LISN	R&S	ENV216	101041	2014.03.07	1 year
RF Pre-selector	Agilent	N9039A	MY46520256	2014.01.21	1 years
Spectrum Analyzer	Agilent	E4446A	MY46180578	2014.01.21	1 years
Pre Amplifier	Agilent	8449B	3008A02237	2014.01.21	1 years
Pre Amplifier	Agilent	8447D	2944A10961	2014.01.21	1 years
Broadband Antenna (30MHz~1GHz)	SCHWARZBECK MESS-ELEKTRONIK	VULB9163	9163-270	2014.07.01	1 years
Horn Antenna (1~18GHz)	SCHWARZBECK MESS-ELEKTRONIK	BBHA9120D	9120D-550	2014.06.10	1 years
Horn Antenna (18~40GHz)	SCHWARZBECK MESS-ELEKTRONIK	BBHA9170	9170-320	2014.06.13	1 years
Loop Antenna	COM-POWER CORPORATION	AL-130	121014	2013.08.14	1 years

END

Appendix for Test Report

Appendix A: DTS 6dB Emission Bandwidth

1. Result Table

EUT Conf.	Test Channel	6dB Bandwidth [MHz]	Verdict
CH0	LCH	0.71	PASS
CH19	MCH	0.70	PASS
Ch39	HCH	0.70	PASS

2. Test Plot

2.1. LCH

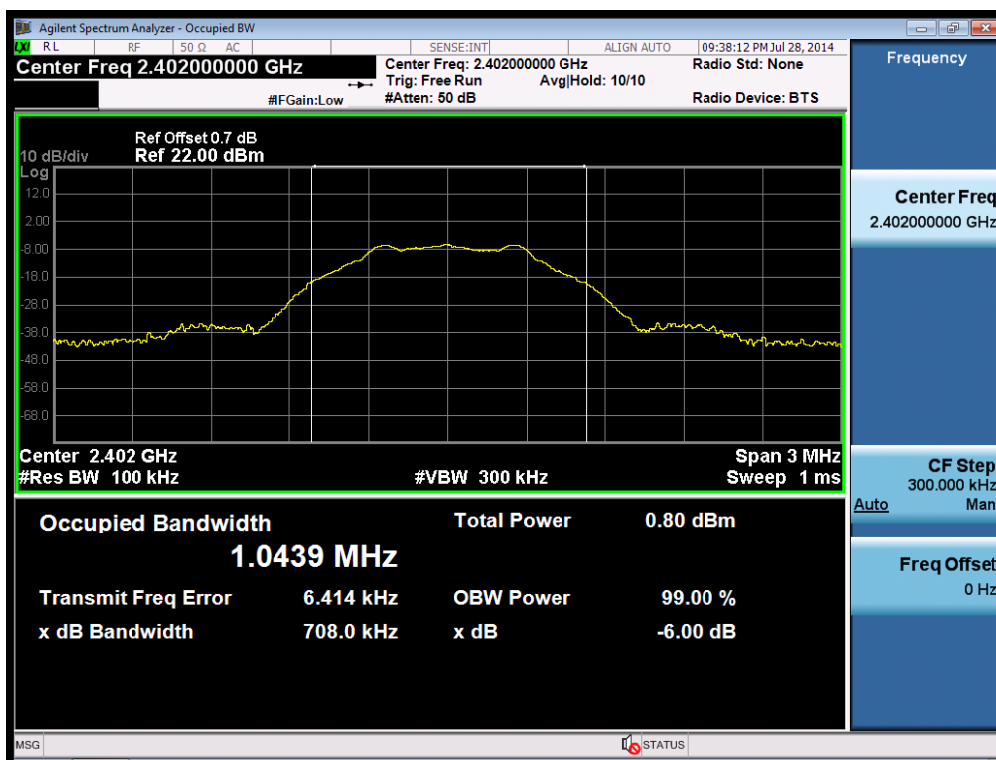



2.2. MCH



2.3. HCH



Appendix B: Conducted Peak Output Power

1. Result Table

EUT Conf.	Test Channel	Meas.Level [dBm]	Verdict
CH0	LCH	-5.295	PASS
CH19	MCH	-4.975	PASS
Ch39	HCH	-5.041	PASS

2. Test Plot

2.1. LCH

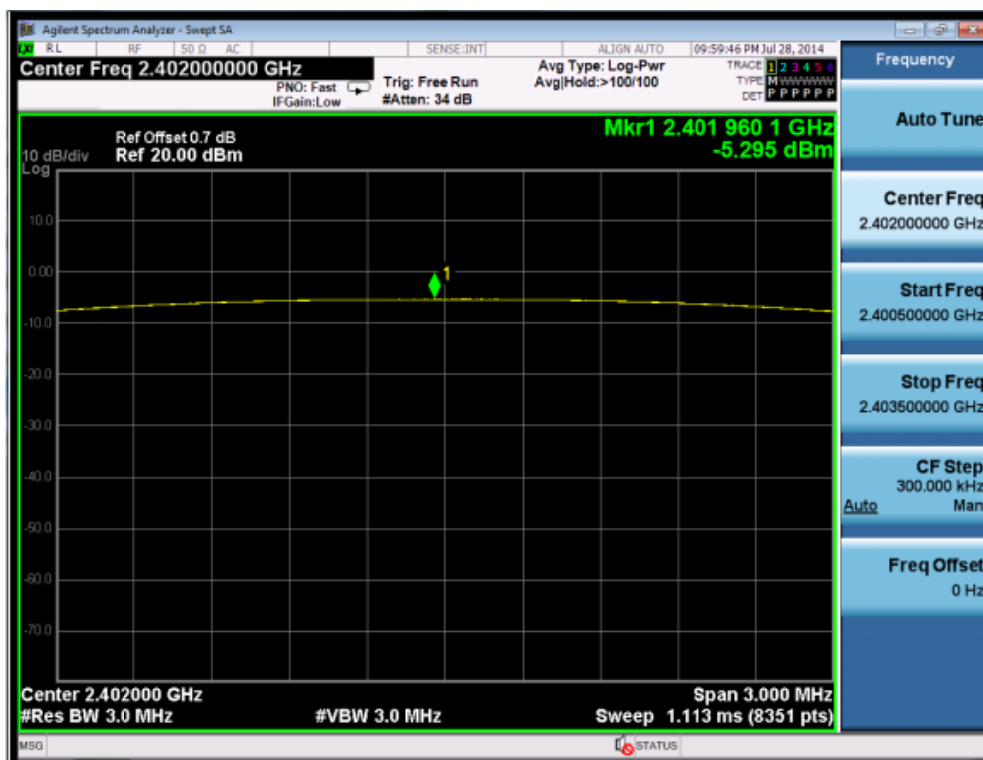



2.2. MCH



2.3. HCH

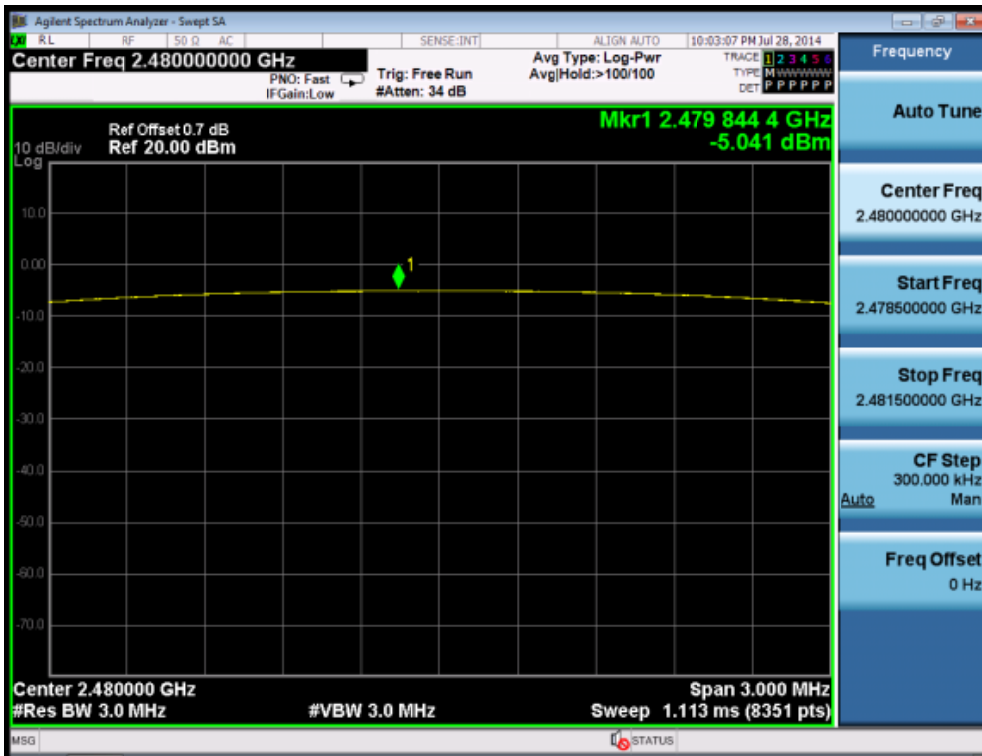

Appendix C: Maximum Power Spectral Density Level

1. Result Table

EUT Conf.	Test Channel	PSD [dBm]	Verdict
CH0	LCH	-9.72	PASS
CH19	MCH	-9.42	PASS
Ch39	HCH	-9.38	PASS

2. Test Plot

2.1. LCH



2.2. MCH



2.3. HCH



Appendix D: Band Edges Compliance

1. Result Table

EUT Conf.	Test Channel	Carrier Power[dBm]	Max.Spurious Level [dBm]	Limit [dBm]	Verdict
CH0	LCH	-6.37	-65.13	-26.37	PASS
CH39	HCH	-5.99	-64.89	-25.99	PASS

2. Test Plot

2.1. LCH

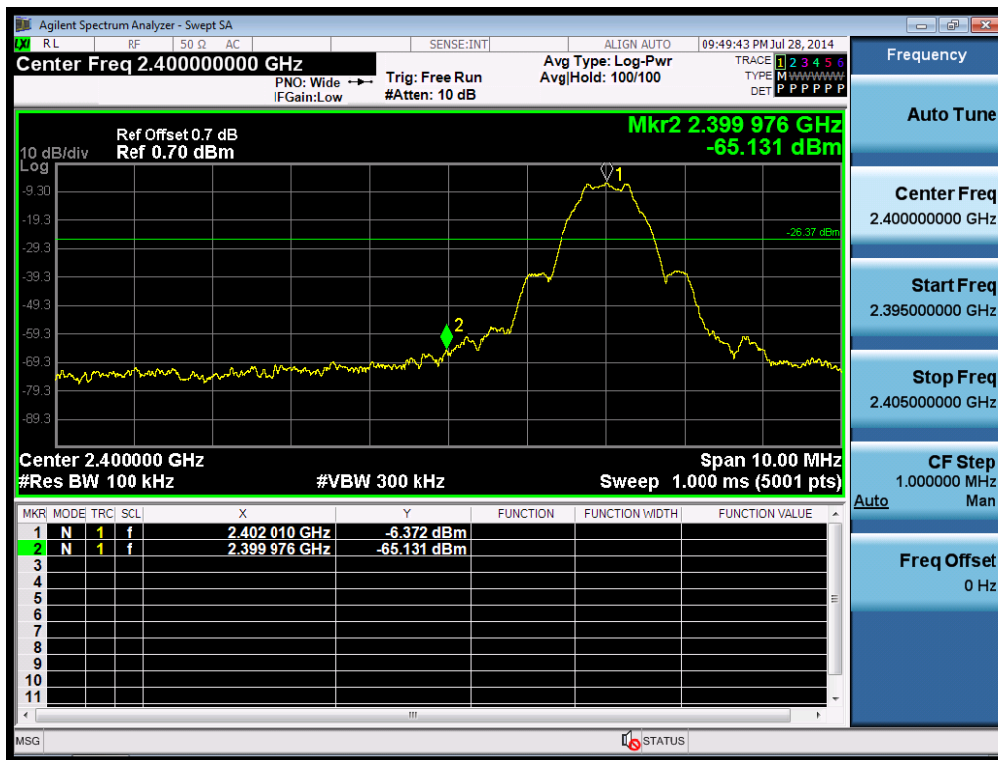



2.2. HCH



Appendix E: Conducted RF Spurious Emission

1. Result Table

EUT Conf.	Test Channel	Pref [dBm]	Puw[dBm]	Verdict
CH0	LCH	-6.24	<Limit	PASS
CH19	MCH	-5.87	<Limit	PASS
Ch39	HCH	-5.94	<Limit	PASS

2. Test Plot

2.1. LCH

Pref:





Puw:

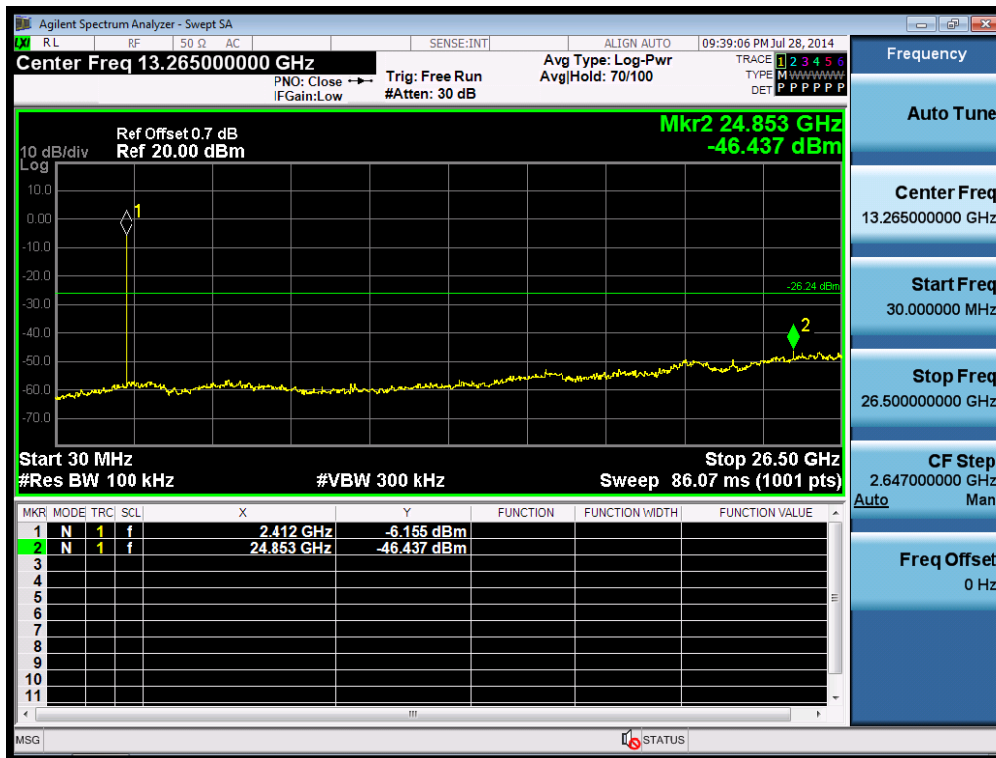

2.2. MCH

Pref:



Puw:

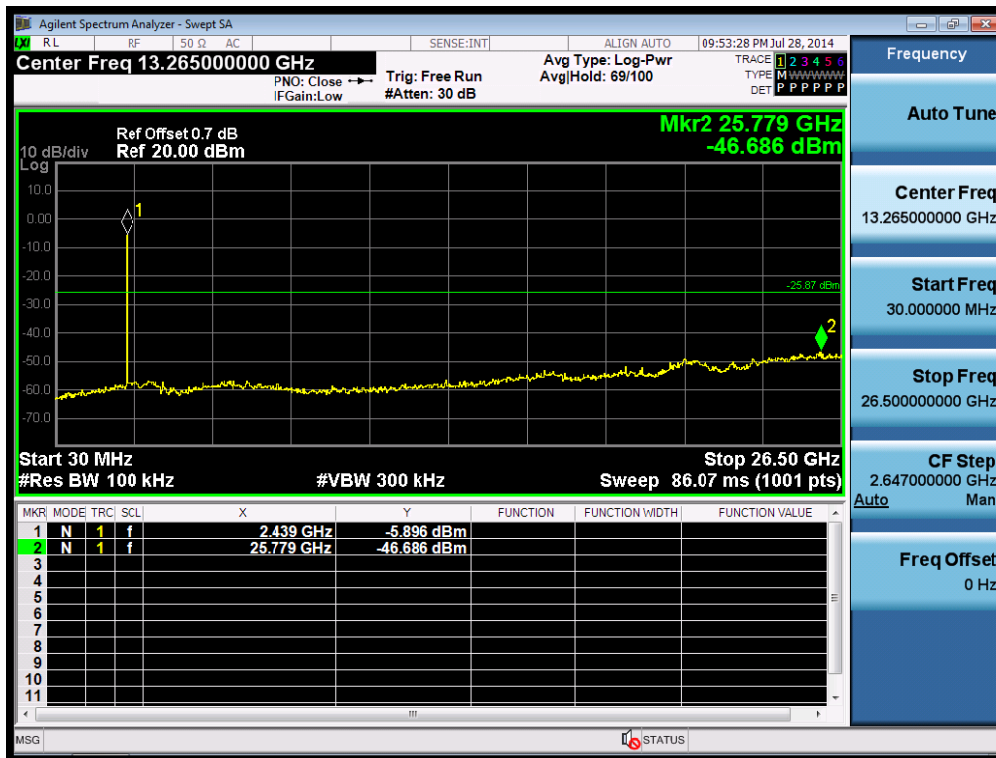

2.3. HCH

Pref:





Puw:

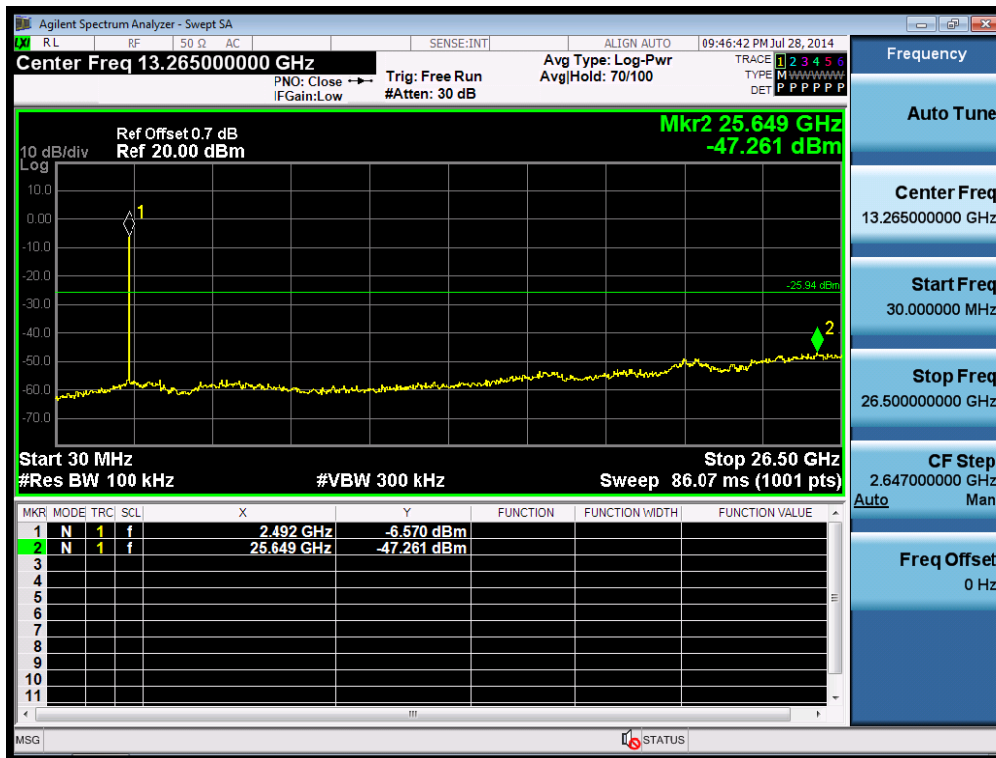

Appendix F: Radiated Spurious Emission & Spurious in Restricted Band

Part 1: Testing Range of “9kHz to 30MHz”

Note 1: The test for testing range of “9kHz to 30MHz” is measured with a loop antenna. This range will not be presented for each Test Mode and each Channel.

Note 2: The emissions in this range are mainly from background noise, so this report will not show the plot unless insistent emission (within 20dB down below the limit) is detected.

Part 2: Testing Range of “30 MHz to 1 GHz”

Note 1: The test results and plot for testing range of “30MHz to 1GHz” showed as below is the WORST case for all Test Modes and Channels. This range will not be presented for each Test Mode and each Channel.

30MHz~1GHz(Horizontal)

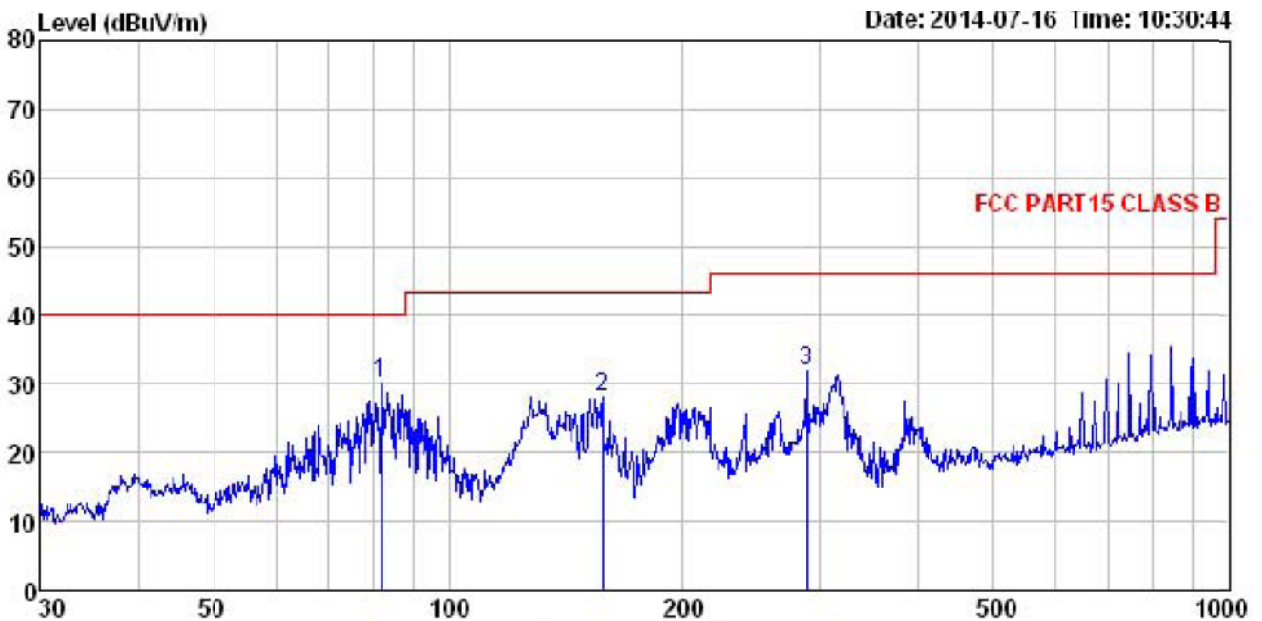

MEASUREMENT RESULT: QP Detector

	Read Freq	Antenna Level	Antenna Factor	Cable Loss	Preamp Factor	Level	Limit Line	Over Limit	Remark
	MHz	dBuV	dB/m	dB	dB	dBuV/m	dBuV/m	dB	
1	82.071	49.67	9.28	0.86	29.62	30.19	40.00	-9.81	
2	157.559	47.42	8.58	1.33	29.15	28.18	43.50	-15.32	
3	287.990	45.84	12.84	1.74	28.47	31.95	46.00	-14.05	

30MHz~1GHz(Vertical)



MEASUREMENTRESULT:QPDetector

	Freq	ReadAntenna Level	Antenna Factor	Cable Loss	Preamp Factor	Level	Limit Line	Over Limit	Remark
	MHz	dBuV	dB/m	dB	dB	dBuV/m	dBuV/m	dB	
1	84.405	52.23	10.16	0.88	29.60	33.67	40.00	-6.33	
2	193.095	47.92	10.56	1.37	28.88	30.97	43.50	-12.53	
3	287.990	38.59	12.84	1.74	28.47	24.70	46.00	-21.30	

Part3: Testing Range of“1GHz to 25 GHz”

Note1: Twolimitsarerequiredinthetestingrangeabove1GHz,thatisPeaklimit(74dB μ V/m)andAverageLimit(54dB μ V/m).

Note 2: For other frequencies, if their emissions are not stronger than the background noise, they will not be recorded in this report.

Above 1GHz
Low channel

Frequency (MHz)	Corr.Amp. (dB μ V/m)	Detector (PK/Ave.)	Corr. (dB)	Limit (dB μ V/m)	Margin (dB)	Polarization
4804	55.82	PK	-8.12	74.0	18.18	H
7206	37.01	PK	2.36	74.0	36.99	H
9608	37.68	PK	4.57	74.0	36.32	H
4804	38.56	Ave.	-8.12	54.0	15.44	V
7206	28.50	Ave.	2.36	54.0	25.50	V
9608	27.49	Ave.	4.57	54.0	26.51	V

Middle channel

Frequency (MHz)	Corr.Amp. (dB μ V/m)	Detector (PK/Ave.)	Corr. (dB)	Limit (dB μ V/m)	Margin (dB)	Polarization
4884	54.79	PK	-6.25	74.0	19.21	H
7326	38.02	PK	3.48	74.0	35.98	H
9768	35.66	PK	6.78	74.0	38.34	H
4884	36.81	Ave.	-6.25	54.0	17.19	V
7326	29.34	Ave.	3.48	54.0	24.66	V
9768	26.79	Ave.	6.78	54.0	27.21	V

High channel

Frequency (MHz)	Corr.Amp. (dB μ V/m)	Detector (PK/Ave.)	Corr. (dB)	Limit (dB μ V/m)	Margin (dB)	Polarization
4960	55.13	PK	-5.12	74.0	18.87	H
7440	39.45	PK	4.02	74.0	34.55	H
9920	34.01	PK	7.10	74.0	39.99	H
4960	30.12	Ave.	-5.12	54.0	23.88	V
7440	25.5	Ave.	4.02	54.0	28.5	V
9920	21.82	Ave.	7.10	54.0	32.18	V

Part 4: Band Edges

Low Channel

HORIZONTAL:

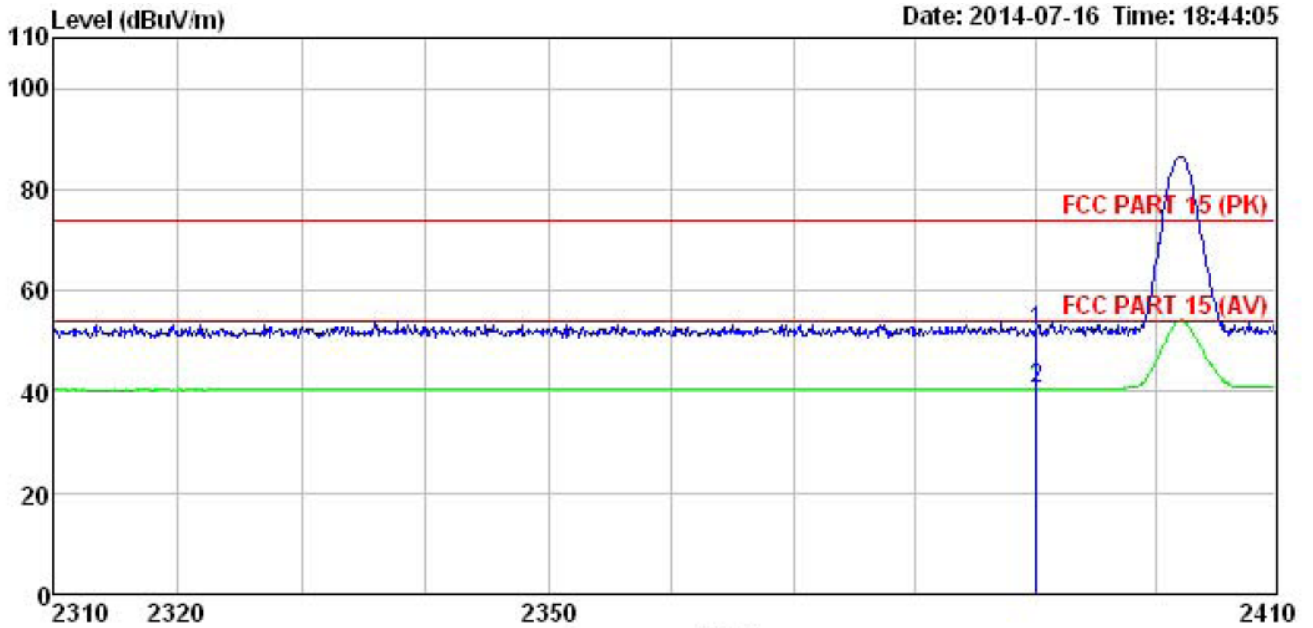

	ReadAntenna	Cable	Preamp	Limit	Over				
Freq	Level	Factor	Loss	Factor	Level	Line			
MHz	dBuV	dB/m	dB	dB	dBuV/m	dBuV/m			
1	2390.000	18.80	27.58	5.67	0.00	52.05	74.00	-21.95	Peak
2	2390.000	7.44	27.58	5.67	0.00	40.69	54.00	-13.31	Average

VERTICAL:

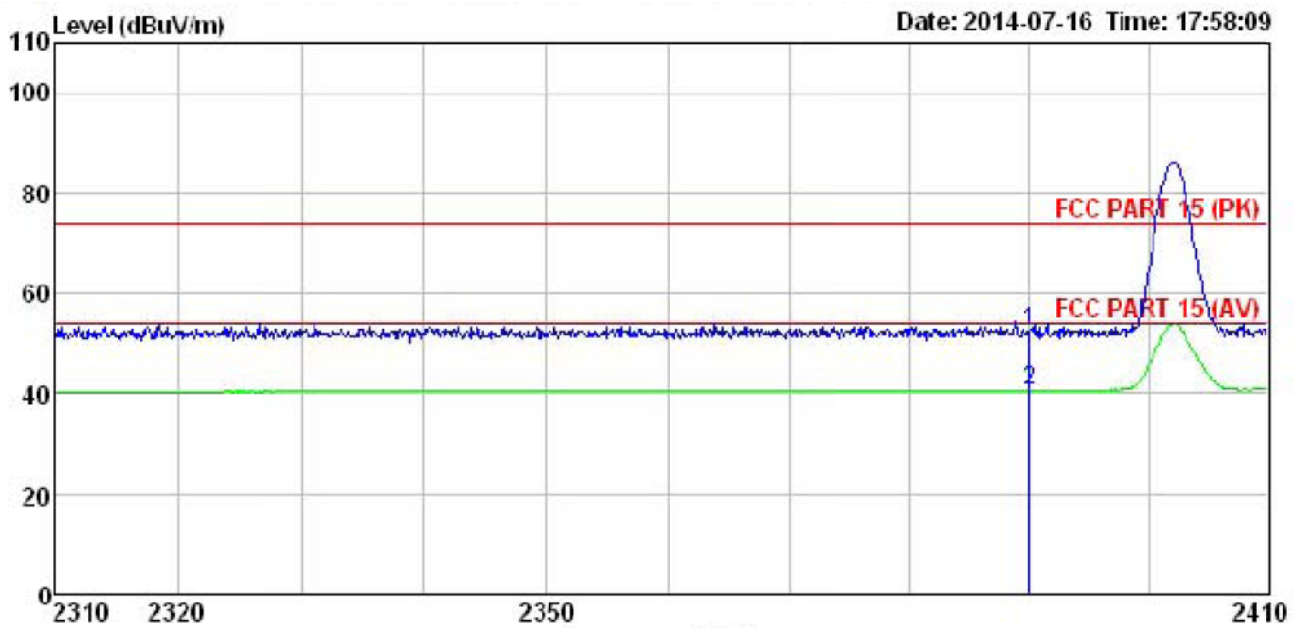

	ReadAntenna	Cable	Preamp	Limit	Over		
Freq	Level	Factor	Loss	Factor	Level	Line	Limit Remark
MHz	dBuV	dB/m	dB	dB	dBuV/m	dBuV/m	dB
1	2390.000	19.09	27.58	5.67	0.00	52.34	74.00 -21.66 Peak
2	2390.000	7.42	27.58	5.67	0.00	40.67	54.00 -13.33 Average

High Channel

HORIZONTAL:

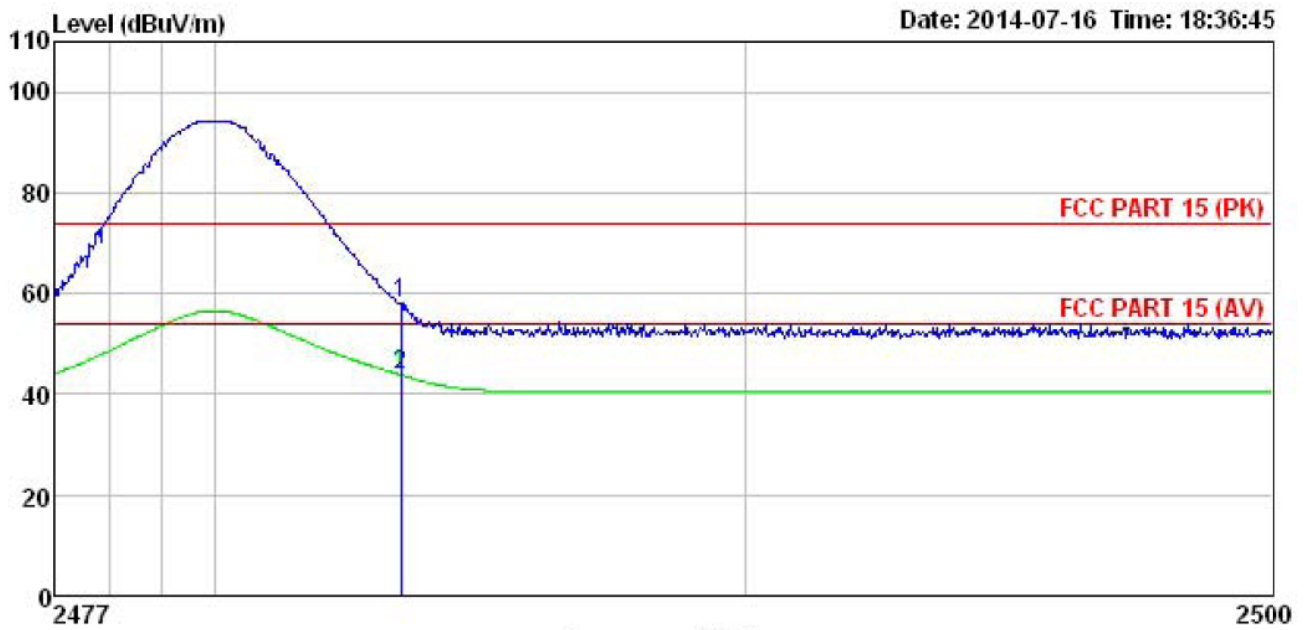

	Freq	ReadAntenna Level	Antenna Factor	Cable Loss	Preamp Factor	Level	Limit	Over	Remark
	MHz	dBuV	dB/m	dB	dB	dBuV/m	dBuV/m	dB	
1	2483.500	24.74	27.52	5.70	0.00	57.96	74.00	-16.04	Peak
2	2483.500	10.48	27.52	5.70	0.00	43.70	54.00	-10.30	Average

VERTICAL:

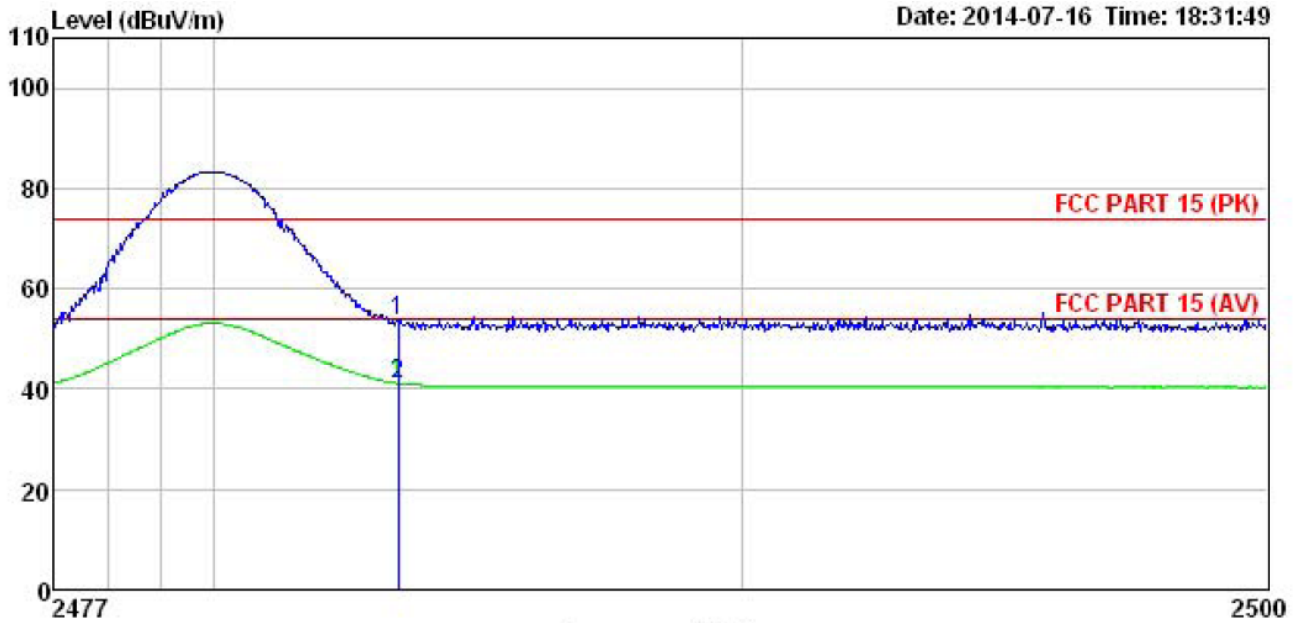

	Freq	ReadAntenna Level	Antenna Factor	Cable Loss	Preamp Factor	Level	Limit Line	Over Limit	Remark
	MHz	dBuV	dB/m	dB	dB	dBuV/m	dBuV/m	dB	
1	2483.500	20.25	27.52	5.70	0.00	53.47	74.00	-20.53	Peak
2	2483.500	7.88	27.52	5.70	0.00	41.10	54.00	-12.90	Average

AppendixG:ConductedEmissionatPowerPort

Channel 19

Line

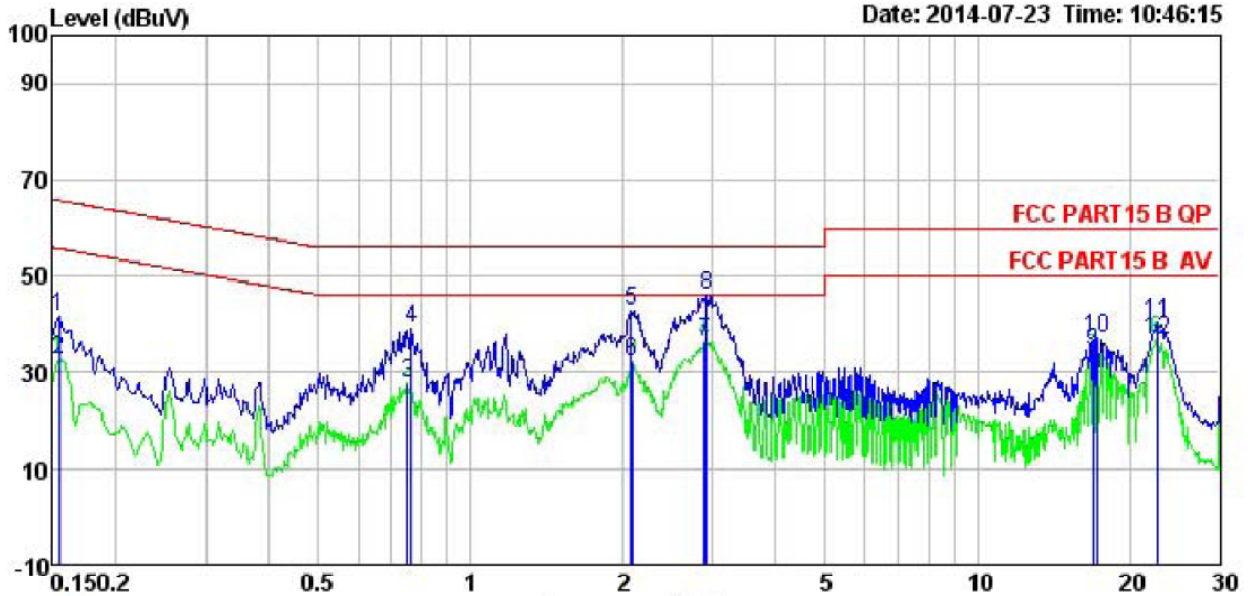

	Read Freq	Read Level	LISN Factor	Cable Loss	Level	Limit Line	Over Limit	Remark
	MHz	dBuV	dB	dB	dBuV	dBuV	dB	
1	0.154	30.62	0.27	10.78	41.67	65.78	-24.11	Peak
2	0.154	21.72	0.27	10.78	32.77	55.78	-23.01	Average
3	0.751	16.76	0.23	10.79	27.78	46.00	-18.22	Average
4	0.767	27.96	0.23	10.80	38.99	56.00	-17.01	Peak
5	2.066	31.75	0.26	10.96	42.97	56.00	-13.03	Peak
6	2.077	20.84	0.26	10.96	32.06	46.00	-13.94	Average
7	2.900	25.23	0.27	10.92	36.42	46.00	-9.58	Average
8	2.931	34.91	0.27	10.92	46.10	56.00	-9.90	Peak
9	16.928	23.15	0.33	10.91	34.39	50.00	-15.61	Average
10	17.199	25.78	0.33	10.91	37.02	60.00	-22.98	Peak
11	22.655	29.20	0.44	10.89	40.53	60.00	-19.47	Peak
12	22.655	25.54	0.44	10.89	36.87	50.00	-13.13	Average

Neutral

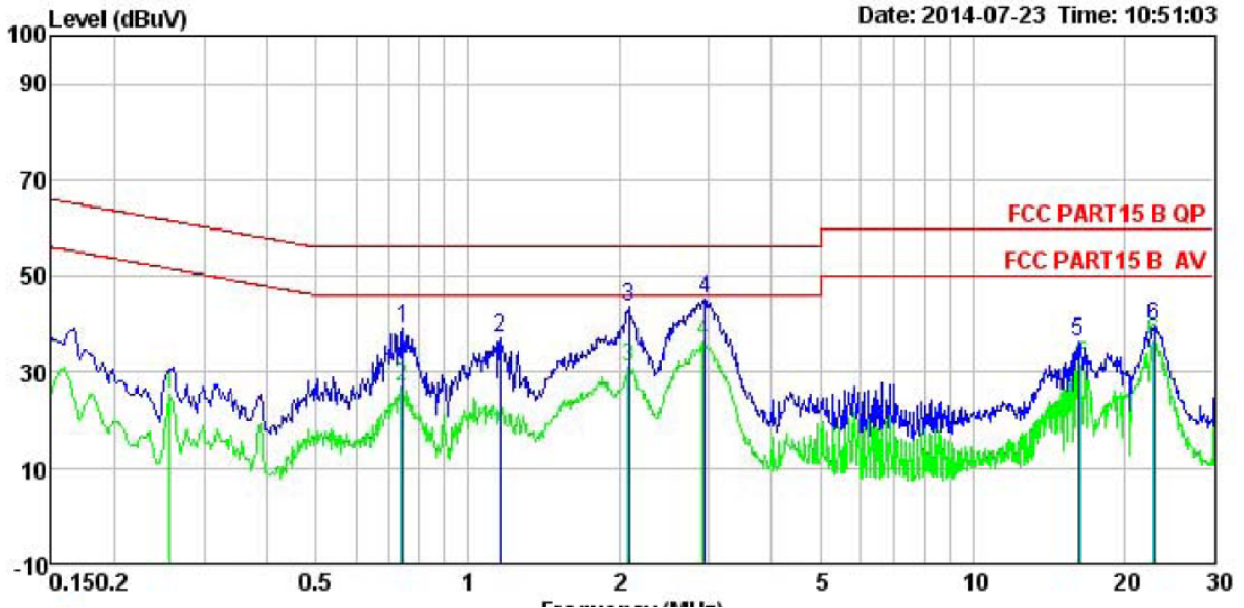

	Read Freq	Read Level	LISN Factor	Cable Loss	Level	Limit Line	Over Limit	Remark
	MHz	dBuV	dB	dB	dBuV	dBuV	dB	
1	0.747	28.17	0.19	10.79	39.15	56.00	-16.85	Peak
2	1.160	26.11	0.23	10.89	37.23	56.00	-18.77	Peak
3	2.077	32.28	0.29	10.96	43.53	56.00	-12.47	Peak
4	2.946	33.96	0.29	10.92	45.17	56.00	-10.83	Peak
5	16.140	25.17	0.25	10.91	36.33	60.00	-23.67	Peak
6	22.896	28.19	0.40	10.89	39.48	60.00	-20.52	Peak

END