



A Test Lab Techno Corp.

Changan Lab : No. 140 -1, Changan Street, Bade City, Taoyuan County, Taiwan R.O.C.

Tel : 886-3-271-0188 / Fax : 886-3-271-0190

SAR EVALUATION REPORT



Test Report No.	: 1407FS13-02
Applicant	: Sky Phone LLC
Product Type	: WCDMA Mobile Phone
Trade Name	: SKY DEVICE
Model Number	: SKY 4.5D
Date of Received	: Jun. 25, 2014
Test Period	: Jul. 07 ~ Jul. 16, 2014
Date of Issued	: Aug. 08, 2014
Test Environment	: Ambient Temperature : 22 ± 2 °C Relative Humidity : 40 - 70 %
Standard	: KDB 865664 D01 SAR Measurement 100 MHz to 6 GHz v01r03 KDB 865664 D02 RF Exposure Reporting v01r01 ANSI/IEEE C95.1-1999 IEEE Std. 1528-2013 IEEE Std. 1528a-2005 47 CFR Part §2.1093; KDB 447498 D01 KDB 248227 D01 KDB 941225 D01 KDB 941225 D02 KDB 941225 D03 KDB 941225 D06 KDB 648474 D03 KDB 648474 D04
Max. Reported SAR	: 0.811 W/kg Head SAR 1.032 W/kg Body SAR
Test Lab Location	: Chang-an Lab



1. The test operations have to be performed with cautious behavior, the test results are as attached.
2. The test results are under chamber environment of A Test Lab Techno Corp. A Test Lab Techno Corp. does not assume responsibility for any conclusions and generalizations drawn from the test results with regard to other specimens or samples.
3. The measurement report has to be written approval of A Test Lab Techno Corp. It may only be reproduced or published in full. This report shall not be reproduced except in full, without the written approval of A Test Lab Techno Corp. The test results in the report only apply to the tested sample.

Approved By : Bill Hu
(Bill Hu)

Tested By : Sky Chou
(Sky Chou)



Contents

1. Description of Equipment under Test (EUT)	4
2. Introduction.....	6
2.1 SAR Definition	6
3. SAR Measurement Setup	7
3.1 DASY E-Field Probe System.....	8
3.2 Data Acquisition Electronic (DAE) System.....	11
3.3 Robot.....	11
3.4 Measurement Server.....	11
3.5 Device Holder.....	12
3.6 Phantom - SAM v4.0	12
3.7 Oval Flat Phantom - ELI 4.0.....	13
3.8 Data Storage and Evaluation.....	13
4. Tissue Simulating Liquids.....	16
4.1 Ingredients.....	17
4.2 Recipes.....	17
4.3 Liquid Depth	18
5. SAR Testing with RF Transmitters	19
5.1 SAR Testing with GSM/GPRS Transmitters.....	19
5.2 SAR Testing with WCDMA Transmitters	19
5.3 SAR Testing with HSDPA Transmitters	19
5.4 Power reduction	21
5.5 SAR Testing with 802.11 Transmitters.....	22
5.6 General Device Setup	22
5.7 Conducted Power.....	24
5.8 Antenna location.....	33
5.9 Stand-alone SAR Evaluate.....	37
5.10 Simultaneous Transmitting Evaluate.....	37
5.11 SAR test reduction according to KDB	42
6. System Verification and Validation	43
6.1 Symmetric Dipoles for System Verification	43
6.2 Liquid Parameters	44
6.3 Verification Summary	47
6.4 Validation Summary	48
7. Test Equipment List.....	49
8. Measurement Uncertainty	50
9. Measurement Procedure.....	52
9.1 Spatial Peak SAR Evaluation	52
9.2 Area & Zoom Scan Procedures	53
9.3 Volume Scan Procedures.....	53
9.4 SAR Averaged Methods.....	53
9.5 Power Drift Monitoring.....	53



10. SAR Test Results Summary	54
10.1 Head Measurement SAR	54
10.2 Body Measurement SAR.....	56
10.3 Hot-spot mode Measurement SAR	56
10.4 Extremity Measurement SAR	58
10.5 SAR Measurement Variability.....	58
10.6 Std. C95.1-1999 RF Exposure Limit.....	59
11. Conclusion.....	60
12. References	60
13. SAR Measurement Guidance	60
Appendix A - System Performance Check	61
Appendix B - SAR Measurement Data	73
Appendix C - Calibration.....	148



1. Description of Equipment under Test (EUT)

Applicant	Sky Phone LLC	
Applicant Address	1348 Washington Av., Miami Beach	
Manufacture	Shenzhen Malata Mobile Communication CO.,LTD	
Manufacture Address	25/F,Malata Technology Building,NO9998 Shennan Rd,Hi-tech Park,Nanshan,Shenzhen,P.R. China 518057.	
Product Type	WCDMA Mobile Phone	
Trade Name	SKY DEVICE	
Model Number	SKY 4.5D	
FCC ID	2ABOSGC140601	
IMEI No.	IMEI 1: 868817019960135, IMEI 2: 868817019960093	
RF Function	GSM/GPRS 850 GSM/GPRS 1900 WCDMA(RMC 12.2K) / HSDPA / HSUPA Band II WCDMA(RMC 12.2K) / HSDPA / HSUPA Band IV WCDMA(RMC 12.2K) / HSDPA / HSUPA Band V IEEE 802.11b / 802.11g / 802.11n (2.4GHz) 20MHz IEEE 802.11n (2.4GHz) 40MHz Bluetooth v3.0 GPRS Multi Class: 12	
Tx Frequency	Band	Operate Frequency (MHz)
	GSM/GPRS 850	824.2 - 848.8
	GSM/GPRS 1900	1850.2 - 1909.8
	WCDMA(RMC 12.2K) / HSDPA / HSUPA Band II	1852.4 - 1907.6
	WCDMA (RMC 12.2K) / HSDPA / HSUPA Band IV	1712.4 - 1752.6
	WCDMA (RMC 12.2K) / HSDPA / HSUPA Band V	826.4 - 846.6
	IEEE 802.11b / 802.11g / 802.11n (2.4GHz) 20MHz	2412 - 2462
	IEEE 802.11n (2.4GHz) 40MHz	2422 - 2452
	Bluetooth v3.0	2402 - 2480
RF Conducted Power (Avg.)	Band	Power (W / dBm)
	GSM/GPRS 850 (Time-Avg.)	0.338 / 25.29
	GSM/GPRS 1900 (Time-Avg.)	0.173 / 22.39
	WCDMA(RMC 12.2K) / HSDPA / HSUPA Band II	0.167 / 22.22
	WCDMA (RMC 12.2K) / HSDPA / HSUPA Band IV	0.168 / 22.25
	WCDMA (RMC 12.2K) / HSDPA / HSUPA Band V	0.187 / 22.71
	IEEE 802.11b	0.048 / 16.82
	IEEE 802.11g	0.022 / 13.47
	IEEE 802.11n (2.4GHz) 20MHz	0.022 / 13.45
	IEEE 802.11n (2.4GHz) 40MHz	0.016 / 11.98
Bluetooth v3.0	0.006 / -1.02	



Max. Reported SAR	0.811 W/kg Head SAR 1.032 W/kg Body SAR
Device Category	Portable Device (Production Unit)
RF Exposure Environment	General Population / Uncontrolled
Battery Option	Standard Trade Name: MALATA Model: N451 Spec: DC 3.7V / 1700mAH
Application Type	Certification

This wireless portable device has been shown to be capable of compliance for localized specific absorption rate (SAR) for uncontrolled environment / general population exposure limits specified in Standard C95.1-1999 and had been tested in accordance with the measurement procedures specified in IEEE Std. 1528-2013 and IEEE Std. 1528a-2005.



2. Introduction

The A Test Lab Techno Corp. has performed measurements of the maximum potential exposure to the user of **Sky Phone LLC Trade Name : SKY DEVICE Model(s) : SKY 4.5D**. The test procedures, as described in American National Standards, Institute C95.1-1999 [1] , FCC/OET Bulletin 65 Supplement C [July 2001] were employed and they specify the maximum exposure limit of 1.6mW/g as averaged over any 1 gram of tissue for portable devices being used within 20cm between user and EUT in the uncontrolled environment. A description of the product and operating configuration, detailed summary of the test results, methodology and procedures used in the equipment used are included within this test report.

2.1 SAR Definition

Specific Absorption Rate (SAR) is defined as the time derivative (rate) of the incremental energy (dw) absorbed by (dissipated in) an incremental mass (dm) contained in a volume element (dv) of a given density (ρ). It is also defined as the rate of RF energy absorption per unit mass at a point in an absorbing body (see Figure 2).

$$\text{SAR} = \frac{d}{dt} \left(\frac{dw}{dm} \right) = \frac{d}{dt} \left(\frac{dw}{\rho dv} \right)$$

Figure 2. SAR Mathematical Equation

SAR is expressed in units of Watts per kilogram (W/kg)

$$\text{SAR} = \frac{\sigma E^2}{\rho}$$

Where :

σ = conductivity of the tissue (S/m)

ρ = mass density of the tissue (kg/m³)

E = RMS electric field strength (V/m)

*Note :

The primary factors that control rate of energy absorption were found to be the wavelength of the incident field in relations to the dimensions and geometry of the irradiated organism, the orientation of the organism in relation to the polarity of field vectors, the presence of reflecting surfaces, and whether conductive contact is made by the organism with a ground plane [2]

3. SAR Measurement Setup

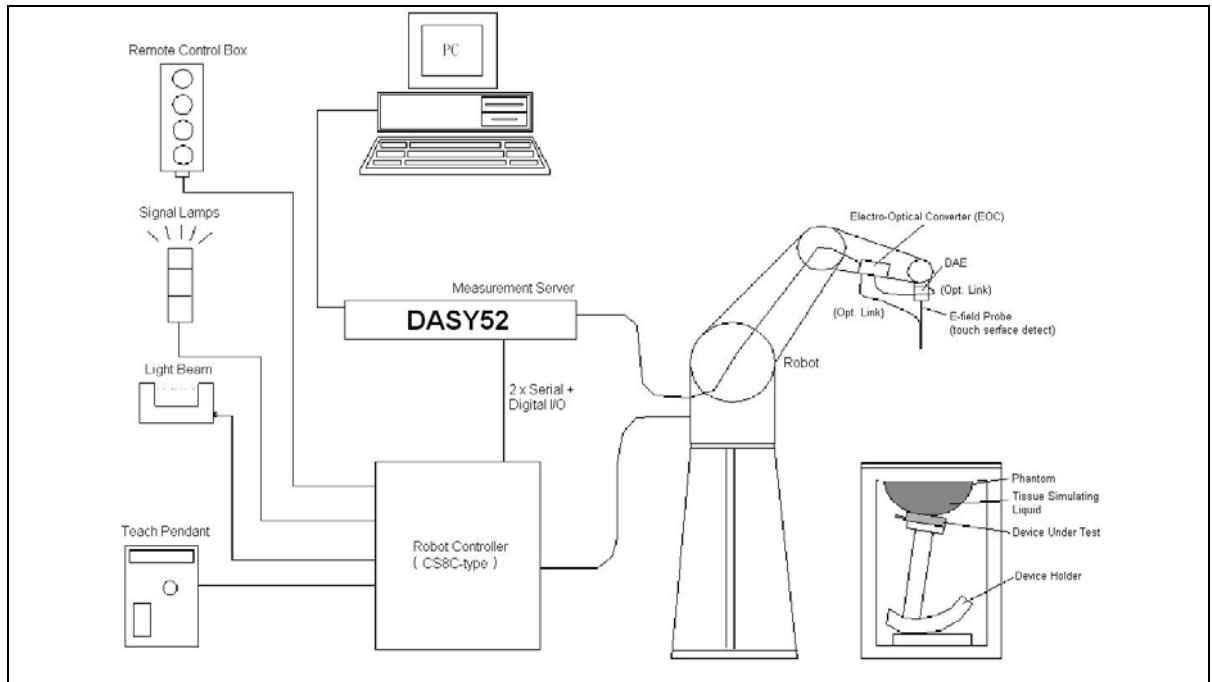

The DASY52 system for performing compliance tests consists of the following items:

1. A standard high precision 6-axis robot (Stäubli TX family) with controller, teach pendant and software. An arm extension for accommodating the data acquisition electronics (DAE).
2. A dosimetric probe, i.e., an isotropic E-field probe optimized and calibrated for usage in tissue simulating liquid. The probe is equipped with an optical surface detector system.
3. A data acquisition electronics (DAE) which performs the signal amplification, signal multiplexing, AD-conversion, offset measurements, mechanical surface detection, collision detection, etc. The unit is battery powered with standard or rechargeable batteries. The signal is optically transmitted to the EOC.
4. The function of the measurement server is to perform the time critical tasks such as signal filtering, control of the robot operation and fast movement interrupts.
5. A probe alignment unit which improves the (absolute) accuracy of the probe positioning.
6. A computer operating Windows 2000 or Windows XP.
7. DASY52 software.
8. Remote controls with teach pendant and additional circuitry for robot safety such as warning lamps, etc.
9. The SAM twin phantom enabling testing left-hand and right-hand usage.
10. The device holder for handheld mobile phones.
11. Tissue simulating liquid mixed according to the given recipes.
12. Validation dipole kits allowing validating the proper functioning of the system.



3.1 DASYS E-Field Probe System

The SAR measurements were conducted with the dosimetric probe (manufactured by SPEAG), designed in the classical triangular configuration [3] and optimized for dosimetric evaluation. The probe is constructed using the thick film technique; with printed resistive lines on ceramic substrates. The probe is equipped with an optical multi-fiber line ending at the front of the probe tip. It is connected to the EOC box on the robot arm and provides an automatic detection of the phantom surface. Half of the fibers are connected to a pulsed infrared transmitter, the other half to a synchronized receiver. As the probe approaches the surface, the reflection from the surface produces a coupling from the transmitting to the receiving fibers. This reflection increases first during the approach, reaches maximum and then decreases. If the probe is flatly touching the surface, the coupling is zero. The distance of the coupling maximum to the surface is independent of the surface reflectivity and largely independent of the surface to probe angle. The DASYS software reads the reflection during a software approach and looks for the maximum using a 2nd order fitting. The approach is stopped when reaching the maximum.

3.1.1 E-Field Probe Specification

Construction	Symmetrical design with triangular core Built-in optical fiber for surface detection System Built-in shielding against static charges PEEK enclosure material (resistant to organic solvents, e.q., glycol)
Calibration	In air from 10 MHz to 6 GHz In brain and muscle simulating tissue at frequencies of 835MHz, 1750MHz, 1900MHz and 2450MHz (accuracy $\pm 8\%$) Calibration for other liquids and frequencies upon request
Frequency	± 0.2 dB (30 MHz to 6 GHz)
Directivity	± 0.3 dB in brain tissue (rotation around probe axis) ± 0.5 dB in brain tissue (rotation normal probe axis) Dynamic Range 10 μ W/g to > 100mW/g; Linearity: ± 0.2 dB
Dimensions	Overall length: 337mm Tip length: 9mm Body diameter: 10mm Tip diameter: 2.5mm Distance from probe tip to dipole centers: 1.0mm
Application	General dosimetry up to 6GHz Compliance tests of mobile phones Fast automatic scanning in arbitrary phantoms



Figure 3. E-field Probe



Figure 4. Probe setup on robot



3.1.2 E-Field Probe Calibration process

Dosimetric Assessment Procedure

Each E-Probe/Probe Amplifier combination has unique calibration parameters. A TEM cell calibration procedure is conducted to determine the proper amplifier settings to enter in the probe parameters. The amplifier settings are determined for a given frequency by subjecting the probe to a known E-field density (1 mW/cm²) using an RF Signal generator, TEM cell, and RF Power Meter.

Free Space Assessment

The free space E-field from amplified probe outputs is determined in a test chamber. This calibration can be performed in a TEM cell if the frequency is below 1 GHz and in a waveguide or other methodologies above 1 GHz for free space. For the free space calibration, the probe is placed in the volumetric center of the cavity and at the proper orientation with the field. The probe is rotated 360 degrees until the three channels show the maximum reading. The power density readings equates to 1 mW/cm².

Temperature Assessment

E-field temperature correlation calibration is performed in a flat phantom filled with the appropriate simulated head tissue. The E-field in the medium correlates with the temperature rise in the dielectric medium. For temperature correlation calibration a RF transparent thermistor-based temperature probe is used in conjunction with the E-field probe.

$$SAR = C \frac{\Delta T}{\Delta t}$$

Where :

- Δt = Exposure time (30 seconds),
- C = Heat capacity of tissue (head or body),
- ΔT = Temperature increase due to RF exposure.

$$\text{Or } SAR = \frac{|E|^2 \sigma}{\rho}$$

Where :

- σ = Simulated tissue conductivity,
- ρ = Tissue density (kg/m³).



3.2 Data Acquisition Electronic (DAE) System

Cell Controller

Processor : Intel Core(TM)2 CPU
Clock Speed : @ 1.86GHz
Operating System : Windows XP Professional

Data Converter

Features : Signal Amplifier, multiplexer, A/D converter, and control logic
Software : DASY52 v52.8 (7) & SEMCAD X Version 14.6.10 (7164)
Connecting Lines : Optical downlink for data and status info
Optical uplink for commands and clock

3.3 Robot

Positioner : Stäubli Unimation Corp. Robot Model: TX90XL
Repeatability : ± 0.02 mm
No. of Axis : 6

3.4 Measurement Server

Processor : PC/104 with a 400MHz intel ULV Celeron
I/O-board : Link to DAE4 (or DAE3)
16-bit A/D converter for surface detection system
Digital I/O interface
Serial link to robot
Direct emergency stop output for robot

3.5 Device Holder

The DASY device holder is constructed of low-loss POM material having the following dielectric parameters: relative permittivity $\epsilon=3$ and loss tangent $\delta=0.02$. The amount of dielectric material has been reduced in the closest vicinity of the device, since measurements have suggested that the influence of the clamp on the test results could thus be lowered.

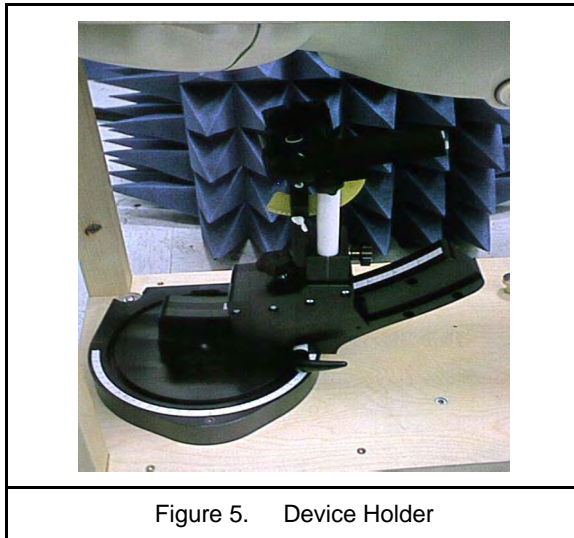

3.6 Phantom - SAM v4.0

The shell corresponds to the specifications of the Specific Anthropomorphic Mannequin (SAM) phantom defined in IEEE 1528 and IEC 62209. It enables the dosimetric evaluation of left and right hand phone usage as well as body mounted usage at the flat phantom region. A cover prevents evaporation of the liquid. Reference markings on the phantom allow the complete setup of all predefined phantom positions and measurement grids by manually teaching three points with the robot.

Shell Thickness	2 ±0.2 mm
Filling Volume	Approx. 25 liters
Dimensions	1000x500 mm (LxW)
Table 1. Specification of SAM v4.0	



Figure 6. SAM Twin Phantom

3.7 Oval Flat Phantom - ELI 4.0

The shell corresponds to the specifications of the Specific Anthropomorphic Mannequin (Oval Flat) phantom defined in IEEE 1528-2013, IEEE Std. 1528a-2005, CENELEC 50361 and IEC 62209. It enables the dosimetric evaluation of wireless portable device usage as well as body mounted usage at the flat phantom region. A cover prevents evaporation of the liquid. Reference markings on the phantom allow the complete setup of all predefined phantom positions and measurement grids by manually teaching three points with the robot.

Shell Thickness	2 ±0.2 mm
Filling Volume	Approx. 30 liters
Dimensions	190×600×400 mm (H×L×W)
Table 2. Specification of ELI 4.0	

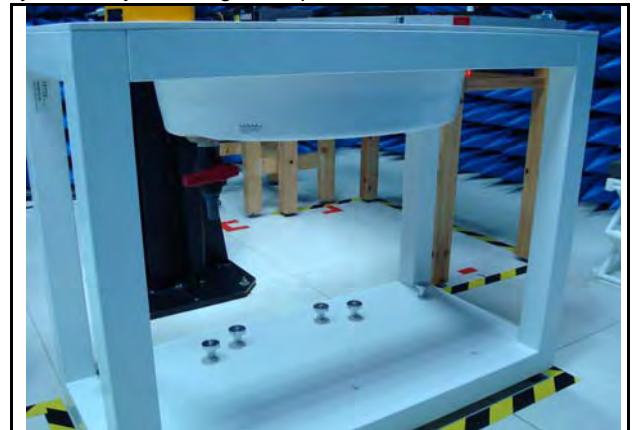

Figure 7. Oval Flat Phantom

3.8 Data Storage and Evaluation

3.8.1 Data Storage

The DASY software stores the assessed data from the data acquisition electronics as raw data (in microvolt readings from the probe sensors), together with all the necessary software parameters for the data evaluation (probe calibration data, liquid parameters and device frequency and modulation data) in measurement files with the extension DA4 or DA5. The post processing software evaluates the desired unit and format for output each time the data is visualized or exported. This allows verification of the complete software setup even after the measurement and allows correction of erroneous parameter settings. For example, if a measurement has been performed with an incorrect crest factor parameter in the device setup, the parameter can be corrected afterwards and the data can be reevaluated.



3.8.2 Data Evaluation

The DASY post processing software (SEMCAD) automatically executes the following procedures to calculate the field units from the microvolt readings at the probe connector. The parameters used in the evaluation are stored in the configuration modules of the software :

- Probe parameters : - Sensitivity $Norm_i, ai0, ai1, ai2$
- Conversion factor $ConvFi$
- Diode compression point dcp_i
- Device parameters : - Frequency f
- Crest factor cf
- Media parameters : - Conductivity σ
- Density ρ

These parameters must be set correctly in the software. They can be found in the component documents or they can be imported into the software from the configuration files issued for the DASY components. In the direct measuring mode of the multimeter option, the parameters of the actual system setup are used. In the scan visualization and export modes, the parameters stored in the corresponding document files are used.

The first step of the evaluation is a linearization of the filtered input signal to account for the compression characteristics of the detector diode. The compensation depends on the input signal, the diode type and the DC-transmission factor from the diode to the evaluation electronics. If the exciting field is pulsed, the crest factor of the signal must be known to correctly compensate for peak power. The formula for each channel can be given as :

$$V_i = U_i + U_i^2 \cdot \frac{cf}{dcp_i}$$

- With V_i = compensated signal of channel i (i = x, y, z)
 U_i = input signal of channel i (i = x, y, z)
 cf = crest factor of exciting field (DASY parameter)
 dcp_i = diode compression point (DASY parameter)

From the compensated input signals the primary field data for each channel can be evaluated :

E-field probes :
$$E_i = \sqrt{\frac{V_i}{Norm_i \cdot ConvF}}$$



$$H_i = \sqrt{V_i} \cdot \frac{a_{i0} + a_{i1}f + a_{i2}f^2}{f}$$

H-field probes :

- with V_i = compensated signal of channel i (i = x, y, z)
Normi = sensor sensitivity of channel i (i = x, y, z)
 $\mu V/(V/m)^2$ for E-field Probes
ConvF = sensitivity enhancement in solution
 a_{ij} = sensor sensitivity factors for H-field probes
 f = carrier frequency [GHz]
 E_i = electric field strength of channel i in V/m
 H_i = magnetic field strength of channel i in A/m

The RSS value of the field components gives the total field strength (Hermitian magnitude) :

$$E_{tot} = \sqrt{E_x^2 + E_y^2 + E_z^2}$$

The primary field data are used to calculate the derived field units.

$$SAR = E_{tot}^2 \cdot \frac{\sigma}{\rho \cdot 1000}$$

- with SAR = local specific absorption rate in mW/g
 E_{tot} = total field strength in V/m
 σ = conductivity in [mho/m] or [Siemens/m]
 ρ = equivalent tissue density in g/cm³

* Note : That the density is set to 1, to account for actual head tissue density rather than the density of the tissue simulating liquid.

The power flow density is calculated assuming the excitation field to be a free space field.

$$P_{pwe} = \frac{E_{tot}^2}{3770} \quad \text{or} \quad P_{pwe} = \frac{H_{tot}^2}{37.7}$$

- with P_{pwe} = equivalent power density of a plane wave in mW/cm²
 E_{tot} = total electric field strength in V/m
 H_{tot} = total magnetic field strength in A/m



4. Tissue Simulating Liquids

The mixture is calibrated to obtain proper dielectric constant (permittivity) and conductivity of the tissue. The dielectric parameters of the liquids were verified prior to the SAR evaluation using an 85070C Dielectric Probe Kit and an E5071B Network Analyzer.

IEEE SCC-34/SC-2 in 1528 recommended Tissue Dielectric Parameters

The head tissue dielectric parameters recommended by the IEEE SCC-34/SC-2 in 1528 have been incorporated in the following table. These head parameters are derived from planar layer models simulating the highest expected SAR for the dielectric properties and tissue thickness variations in human head. Other head and body tissue parameters that have not been specified in 1528 are derived from the tissue dielectric parameters computed from the 4-Cole-Cole equation and extrapolated according to the head parameter specified in 1528.

Target Frequency	Head		Body	
(MHz)	ϵ_r	σ (S/m)	ϵ_r	σ (S/m)
150	52.3	0.76	61.9	0.80
300	45.3	0.87	58.2	0.92
450	43.5	0.87	56.7	0.94
835	41.5	0.90	55.2	0.97
900	41.5	0.97	55.0	1.05
915	41.5	0.98	55.0	1.06
1450	40.5	1.20	54.0	1.30
1610	40.3	1.29	53.8	1.40
1800 - 2000	40.0	1.40	53.3	1.52
2450	39.2	1.80	52.7	1.95
3000	38.5	2.40	52.0	2.73
5800	35.3	5.27	48.2	6.00
(ϵ_r = relative permittivity, σ = conductivity and $\rho = 1000$ kg/m ³)				

Table 3. Tissue dielectric parameters for head and body phantoms



4.1 Ingredients

The following ingredients are used:

- Water: deionized water (pure H₂O), resistivity ≥ 16 M Ω -as basis for the liquid
- Sugar: refined white sugar (typically 99.7 % sucrose, available as crystal sugar in food shops)
-to reduce relative permittivity
- Salt: pure NaCl -to increase conductivity
- Cellulose: Hydroxyethyl-cellulose, medium viscosity (75-125 mPa.s, 2% in water, 20 °C), CAS # 54290 -to increase viscosity and to keep sugar in solution.
- Preservative: Preventol D-7 Bayer AG, D-51368 Leverkusen, CAS # 55965-84-9 -to prevent the spread of bacteria and molds
- DGBE: Diethylenglycol-monobutyl ether (DGBE), Fluka Chemie GmbH, CAS # 112-34-5 -to reduce relative permittivity

4.2 Recipes

The following tables give the recipes for tissue simulating liquids to be used in different frequency bands.

Note: The goal dielectric parameters (at 22 °C) must be achieved within a tolerance of ±5% for ε and ±5% for σ.

Ingredients (% by weight)	Frequency (MHz)											
	750		835		1750		1900		2450		2600	
Tissue Type	Head	Body	Head	Body	Head	Body	Head	Body	Head	Body	Head	Body
Water	39.28	51.30	41.45	52.40	54.50	40.20	54.90	40.40	62.70	73.20	60.30	71.40
Salt (NaCl)	1.47	1.42	1.45	1.50	0.17	0.49	0.18	0.50	0.50	0.10	0.60	0.20
Sugar	58.15	46.18	56.00	45.00	0.00	0.00	0.00	0.00	0.00	0.00	0.00	0.00
HEC	1.00	1.00	1.00	1.00	0.00	0.00	0.00	0.00	0.00	0.00	0.00	0.00
Bactericide	0.10	0.10	0.10	0.10	0.00	0.00	0.00	0.00	0.00	0.00	0.00	0.00
Triton X-100	0.00	0.00	0.00	0.00	0.00	0.00	0.00	0.00	0.00	0.00	0.00	0.00
DGBE	0.00	0.00	0.00	0.00	45.33	59.31	44.92	59.10	36.80	26.70	39.10	28.40
Dielectric Constant	41.88	54.60	42.54	56.10	40.10	53.60	39.90	54.00	39.80	52.50	39.80	52.50
Conductivity (S/m)	0.90	0.97	0.91	0.95	1.39	1.49	1.42	1.45	1.88	1.78	1.88	1.78

Salt: 99% Pure Sodium Chloride

Sugar: 98% Pure Sucrose

Water: De-ionized, 16 M Ω⁺ resistivity

HEC: Hydroxyethyl Cellulose

DGBE: 99% Di(ethylene glycol) butyl ether, [2-(2-butoxyethoxy)ethanol]

Triton X-100 (ultra pure): Polyethylene glycol mono [4-(1,1, 3, 3-tetramethylbutyl)phenyl]ether

4.3 Liquid Depth

According to KDB865664 ,the depth of tissue-equivalent liquid in a phantom must be ≥ 15.0 cm with $\leq \pm 0.5$ cm variation for SAR measurements ≤ 3 GHz and ≥ 10.0 cm with $\leq \pm 0.5$ cm variation for measurements > 3 GHz.

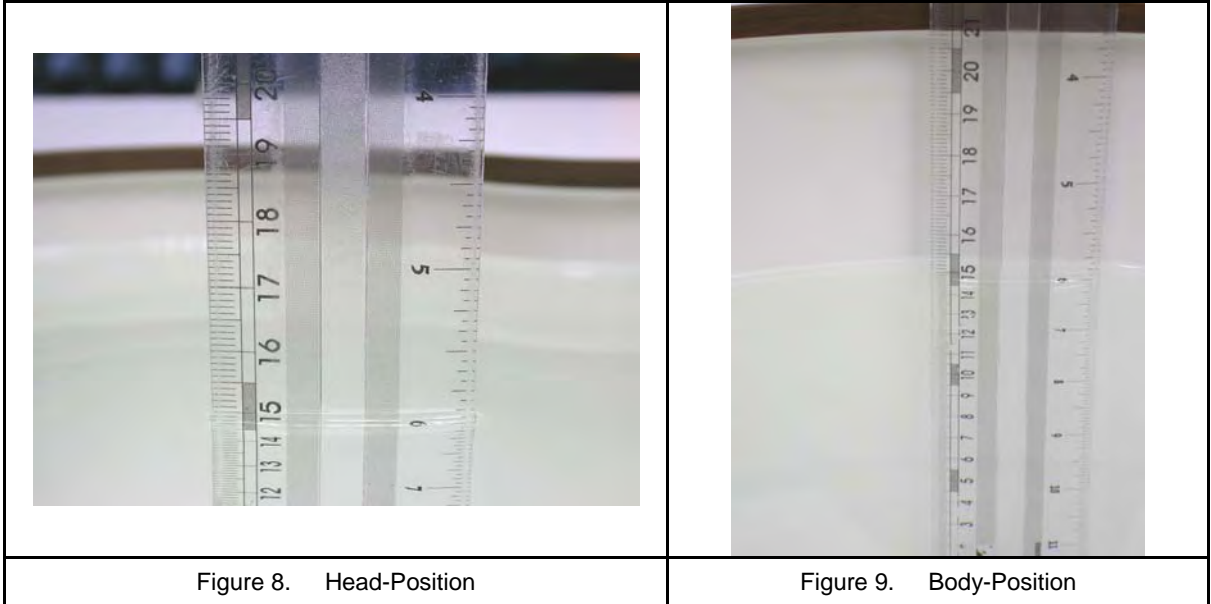



5. SAR Testing with RF Transmitters

5.1 SAR Testing with GSM/GPRS Transmitters

Configure the basestation to support GMSK and 8PSK call respectively, and set timeslot transmission for GMSK GSM/GPRS and 8PSK EDGE. Measure and record power outputs for both modulations, that test is applicable.

5.2 SAR Testing with WCDMA Transmitters

Configure the basestation to support all WCDMA tests in respect to the 3GPP 34.121. Measure the power at Ch4132, 4183 and 4233 for US cell; Ch9262, 9400 and 9538 for US PCS Band.

- Step 1: set a Test Mode 1 loop back with a 12.2kbps Reference Measurement Channel (RMC).
- Step 2: set and send continuously up power control commands to the device.
- Step 3: measure the power at the device antenna connector using the power meter with average detector and test SAR

5.3 SAR Testing with HSDPA Transmitters

HSDPA Date Devices setup for SAR Measurement

HSDPA should be configured according to the UE category of a test device. The number of HS-DSCH/HS-PDSCHs, HARQ processes, minimum inter-TTI interval, transport block sizes and RV coding sequence are defined by the H-set. To maintain a consistent test configuration and stable transmission conditions, QPSK is used in the H-set for SAR testing. HS-DPCCH should be configured with a CQI feedback cycle of 4 ms with a CQI repetition factor of 2 to maintain a constant rate of active CQI slots. DPCCH and DPDCH gain factors (β_c , β_d), and HS-DPCCH power offset parameters (Δ_{ACK} , Δ_{NACK} , Δ_{CQI}) should be set according to values indicated in the Table below. The CQI value is determined by the UE category, transport block size, number of HS-PDSCHs and modulation used in the H-set.

Setup for Release 5 HSDPA							
Sub-test	β_c	β_d	β_d (SF)	β_c/β_d	$\beta_{hs}^{(1,2)}$	CM ⁽³⁾ (dB)	MRP ⁽³⁾ (dB)
1	2/15	15/15	64	2/15	4/15	0.0	0.0
2	12/15(4)	15/15(4)	64	12/15(4)	24/15	1.0	0.0
3	15/15	8/15	64	15/8	30/15	1.5	0.5
4	15/15	4/15	64	15/4	30/15	1.5	0.5

Note

1. Δ_{ACK} , Δ_{NACK} and $\Delta_{CQI} = 8 \Leftrightarrow A_{hs} = \beta_{hs}/\beta_c = 30/15 \Leftrightarrow \beta_{hs} = 30/15 * \beta_c$
2. For the HS-DPCCH power mask requirement test in clause 5.2C, 5.7A, and the Error Vector Magnitude (EVM) with HS-DPCCH test in clause 5.13.1A and HSDPA EVM with phase discontinuity in clause 5.13.1AA, Δ_{ACK} and $\Delta_{NACK} = 30/15$ with $\beta_{hs} = 30/15 * \beta_c$ and $\Delta_{CQI} = 24/15$ with $\beta_{hs} = 24/15 * \beta_c$
3. CM = 1 for $\beta_c/\beta_d = 12/15$, $\beta_{hs}/\beta_c = 24/15$. For all other combinations of DPDCH, DPCCH and HS-DPCCH the MPR is based on the relative CM difference. This is applicable for only UEs that support HSDPA in release 6 and later releases.
4. For subtest 2 the β_c/β_d ratio of 12/15 for the TFC during the measurement period (TF1, TF0) is achieved by setting the signaled gain factors for the reference TFC (TF1, TF0) to $\beta_c = 11/15$ and $\beta_d = 15/15$.



HSPA Data Devices setup for SAR Measurement.

The following procedures are applicable to HSPA (HSUPA/HSDPA) data devices operating under 3GPP Release 6. Body exposure conditions generally apply to these devices, including handsets and data modems operating in various electronic devices. HSUPA operates in conjunction with WCDMA and HSDPA. SAR is initially measured in WCDMA test configurations without HSPA. The default test configuration is to establish a radio link between the DUT and a communication test set to configure a 12.2 kbps RMC (reference measurement channel) in Test Loop Mode 1. SAR for HSPA is selectively measured with HS-DPCCH, EDPCCH and E-DPDCH, all enabled, along with a 12.2 kbps RMC using the highest SAR configuration in WCDMA with 12.2 kbps RMC only. An FRC is configured according to HSDPCCH Sub-test 1 using H-set 1 and QPSK. HSPA is configured according to E-DCH Subtest 5 requirements. SAR for other HSPA sub-test configurations is also confirmed selectively according to output power, exposure conditions and E-DCH UE Category. Maximum output power is verified according to procedures in applicable versions of 3GPP TS 34.121 and SAR must be measured according to these maximum output conditions. The UE Categories for HSDPCCH and HSPA should be clearly identified in the SAR report. The following procedures are applicable only if Maximum Power Reduction (MPR) is implemented according to Cubic Metric (CM) requirements.

When voice transmission and head exposure conditions are applicable to a WCDMA/HSPA data device, head exposure is measured according to the 'Head SAR Measurements' procedures in the 'WCDMA Handsets' section of this document. SAR for body exposure configurations are measured according to the 'Body SAR Measurements' procedures in the 'WCDMA Handsets' section of this document. In addition, body SAR is also measured for HSPA when the maximum average output of each RF channel with HSPA active is at least ¼ dB higher than that measured without HSPA using 12.2 kbps RMC or the maximum SAR for 12.2 kbps RMC is above 75% of the SAR limit. Body SAR for HSPA is measured with E-DCH Sub-test 5, using H-Set 1 and QPSK for FRC and a 12.2 kbps RMC configured in Test Loop Mode 1 with power control algorithm 2, according to the highest body SAR configuration in 12.2 kbps RMC without HSPA. When VOIP is applicable for head exposure, SAR is not required when the maximum output of each RF channel with HSPA is less than ¼ dB higher than that measured using 12.2 kbps RMC; otherwise, the same HSPA configuration used for body measurements should be used to test for head exposure.

Due to inner loop power control requirements in HSPA, a commercial communication test set should be used for the output power and SAR tests. The 12.2 kbps RMC, FRC H-set 1 and E-DCH configurations for HSPA should be configured according to the β values indicated below as well as other applicable procedures described in the 'WCDMA Handset' and 'Release 5 HSDPA Data Devices' sections of this document.



The highest body SAR measured in Antenna Extended & Retracted configurations on a channel in 12.2 kbps RMC. The possible channels are the High, Middle & Low channel. Contact the FCC Laboratory for test and approval requirements if the maximum output power measured in E-DCH Sub-test 2 - 4 is higher than Sub-test 5.

Setup for Release 6 HSPA / Release 7 HSPA+													
Sub-test	β_c	β_d	β_d (SF)	β_c/β_d	$\beta_{hs}^{(1)}$	β_{ec}	β_{ed}	Bed (SF)	Bed (codes)	CM ⁽²⁾ (dB)	MPR (dB)	AG ⁽⁴⁾ Index	E-TFCI
1	11/15 ⁽³⁾	15/15 ⁽³⁾	64	11/15 ⁽³⁾	22/15	209/225	1039/225	4	1	1.0	0.0	20	75
2	6/15	15/15	64	6/15	12/15	12/15	94/75	4	1	3.0	2.0	12	67
3	15/15	9/15	64	15/9	30/15	30/15	$\beta_{ed1}: 47/15$ $\beta_{ed2}: 47/15$	4	2	2.0	1.0	15	92
4	2/15	15/15	64	2/15	4/15	2/15	56/75	4	1	3.0	2.0	17	71
5	15/15 ⁽⁴⁾	15/15 ⁽⁴⁾	64	15/15 ⁽⁴⁾	30/15	24/15	134/15	4	1	1.0	0.0	21	81

Note

- Δ_{ACK} , Δ_{NACK} and $\Delta_{CQI} = 8 \Leftrightarrow A_{hs} = \beta_{hs}/\beta_c = 30/15 \Leftrightarrow \beta_{hs} = 30/15 * \beta_c$.
- CM = 1 for $\beta_c/\beta_d = 12/15$, $\beta_{hs}/\beta_c = 24/15$. For all other combinations of DPDCH, DPCCH, HS-DPCCH, E-DPDCH and E-DPCCH the MPR is based on the relative CM difference.
- For subtest 1 the β_c/β_d ratio of 11/15 for the TFC during the measurement period (TF1, TF0) is achieved by setting the signaled gain factors for the reference TFC (TF1, TF1) to $\beta_c = 10/15$ and $\beta_d = 15/15$.
- For subtest 5 the β_c/β_d ratio of 15/15 for the TFC during the measurement period (TF1, TF0) is achieved by setting the signaled gain factors for the reference TFC (TF1, TF1) to $\beta_c = 14/15$ and $\beta_d = 15/15$.
- Testing UE using E-DPDCH Physical Layer category 1 Sub-test 3 is not required according to TS 25.306 Table 5.1g.
- β_{ed} can not be set directly; it is set by Absolute Grant Value.

5.4 Power reduction

No power reduction issue.



5.5 SAR Testing with 802.11 Transmitters

Normal network operating configurations are not suitable for measuring the SAR of 802.11 b/g transmitters. Unpredictable fluctuations in network traffic and antenna diversity conditions can introduce undesirable variations in SAR results. The SAR for these devices should be measured using chipset based test mode software to ensure the results are consistent and reliable.

5.6 General Device Setup

Chipset based test mode software is hardware dependent and generally varies among manufacturers. The device operating parameters established in test mode for SAR measurements must be identical to those programmed in production units, including output power levels, amplifier gain settings and other RF performance tuning parameters. The test frequencies should correspond to actual channel frequencies defined for domestic use. SAR for devices with switched diversity should be measured with only one antenna transmitting at a time during each SAR measurement, according to a fixed modulation and data rate. The same data pattern should be used for all measurements.

Frequency Channel Configurations

802.11 b/g operating modes are tested independently according to the service requirements in each frequency band. 802.11 b/g modes are tested on channels 1, 6 and 11. These are referred to as the "default test channels". 802.11g mode was evaluated only if the output power was 0.25 dB higher than the 802.11b mode.



IEEE 802.11 Test Channels per FCC Requirement								
Mode	GHz	Channel	Turbo Channel	Default Test "Channels"				
				§15.247		UNII		
				802.11b	802.11g			
IEEE 802.11 b/g	2412	1 [#]		✓	▽			
	2437	6	6	✓	▽			
	2462	11 [#]		✓	▽			
IEEE 802.11a	UNII	5.18	36	42 (5.21 GHz)			✓	
		5.20	40					*
		5.22	44					*
		5.24	48	50 (5.25 GHz)			✓	
		5.26	52				✓	
		5.28	56	58 (5.29 GHz)				*
		5.30	60					*
		5.32	64				✓	
		5.500	100	Unknown				*
		5.520	104				✓	
		5.540	108					*
		5.560	112					*
		5.580	116				✓	
		5.600	120					*
		5.620	124				✓	
		5.640	128					*
		5.660	132					*
		5.680	136					✓
	5.700	140				*		
	UNII or §15.247	5.745	149		✓		✓	
		5.765	153	152 (5.76 GHz)		*		*
5.785		157		✓			*	
5.805		161	160 (5.80 GHz)		*	✓		
§15.247	5.825	165		✓				

✓ = "default test channels"

* = possible 802.11a channels with maximum average output > the "default test channels"

▽ = possible 802.11g channels with maximum average output ¼ dB ≥ the "default test channels"

= when output power is reduced for channel 1 and/or 11 to meet restricted band requirements the



5.7 Conducted Power

Band	Modulation	Data Rate	CH	Frequency (MHz)	Average Power_SIM1 (dBm)	
					Time Average	Burst Average
GSM 850	GMSK	1Down1Up Duty factor 1/8	Lowest	824.2	23.27	32.30
			Middle	836.6	23.27	32.30
			Highest	848.8	23.37	32.40
GPRS 850 Multi Class :12 Max Up:4 Max Down:4 Sum:5	GMSK	4Down1Up Duty factor 1/8	Lowest	824.2	23.17	32.20
			Middle	836.6	23.17	32.20
			Highest	848.8	23.27	32.30
		3Down2Up Duty factor 2/8	Lowest	824.2	24.98	31.00
			Middle	836.6	25.18	31.20
			Highest	848.8	25.18	31.20
		2Down3Up Duty factor 3/8	Lowest	824.2	24.84	29.10
			Middle	836.6	24.94	29.20
			Highest	848.8	24.94	29.20
		1Down4Up Duty factor 4/8	Lowest	824.2	25.09	28.10
			Middle	836.6	25.19	28.20
			Highest	848.8	25.29	28.30

Band	Modulation	Data Rate	CH	Frequency (MHz)	Average Power_SIM2 (dBm)	
					Time Average	Burst Average
GSM 850	GMSK	1Down1Up Duty factor 1/8	Lowest	824.2	23.17	32.20
			Middle	836.6	23.17	32.20
			Highest	848.8	23.27	32.30
GPRS 850 Multi Class :12 Max Up:4 Max Down:4 Sum:5	GMSK	4Down1Up Duty factor 1/8	Lowest	824.2	23.07	32.10
			Middle	836.6	23.07	32.10
			Highest	848.8	23.17	32.20
		3Down2Up Duty factor 2/8	Lowest	824.2	24.88	30.90
			Middle	836.6	24.98	31.00
			Highest	848.8	25.08	31.10
		2Down3Up Duty factor 3/8	Lowest	824.2	24.74	29.00
			Middle	836.6	24.84	29.10
			Highest	848.8	24.84	29.10
		1Down4Up Duty factor 4/8	Lowest	824.2	25.09	28.10
			Middle	836.6	25.09	28.10
			Highest	848.8	25.19	28.20

Note: 1. Time Average power slot duty cycle factor calculate:

1up: Average burst power+10*LOG(1/8)

2up: Average burst power+10*LOG(2/8)

3up: Average burst power+10*LOG(3/8)

4up: Average burst power+10*LOG(4/8)



Band	Modulation	Data Rate	CH	Frequency (MHz)	Average Power_SIM1 (dBm)	
					Time Average	Burst Average
GSM 1900	GMSK	1Down1Up Duty factor 1/8	Lowest	1850.2	20.37	29.40
			Middle	1880.0	20.27	29.30
			Highest	1909.8	20.17	29.20
GPRS 1900 Multi Class :12 Max Up:4 Max Down:4 Sum:5	GMSK	4Down1Up Duty factor 1/8	Lowest	1850.2	20.17	29.20
			Middle	1880.0	20.17	29.20
			Highest	1909.8	20.07	29.10
		3Down2Up Duty factor 2/8	Lowest	1850.2	22.08	28.10
			Middle	1880.0	22.18	28.20
			Highest	1909.8	22.18	28.20
		2Down3Up Duty factor 3/8	Lowest	1850.2	21.94	26.20
			Middle	1880.0	22.04	26.30
			Highest	1909.8	22.04	26.30
		1Down4Up Duty factor 4/8	Lowest	1850.2	22.29	25.30
			Middle	1880.0	22.29	25.30
			Highest	1909.8	22.39	25.40

Band	Modulation	Data Rate	CH	Frequency (MHz)	Average Power_SIM2 (dBm)	
					Time Average	Burst Average
GSM 1900	GMSK	1Down1Up Duty factor 1/8	Lowest	1850.2	20.17	29.20
			Middle	1880.0	20.17	29.20
			Highest	1909.8	20.07	29.10
GPRS 1900 Multi Class :12 Max Up:4 Max Down:4 Sum:5	GMSK	4Down1Up Duty factor 1/8	Lowest	1850.2	20.07	29.10
			Middle	1880.0	20.07	29.10
			Highest	1909.8	19.97	29.00
		3Down2Up Duty factor 2/8	Lowest	1850.2	21.98	28.00
			Middle	1880.0	22.08	28.10
			Highest	1909.8	22.08	28.10
		2Down3Up Duty factor 3/8	Lowest	1850.2	21.84	26.10
			Middle	1880.0	21.94	26.20
			Highest	1909.8	21.84	26.10
		1Down4Up Duty factor 4/8	Lowest	1850.2	22.19	25.20
			Middle	1880.0	22.29	25.30
			Highest	1909.8	22.29	25.30

Note: 1. Time Average power slot duty cycle factor calculate:

- 1up: Average burst power+10*LOG(1/8)
- 2up: Average burst power+10*LOG(2/8)
- 3up: Average burst power+10*LOG(3/8)
- 4up: Average burst power+10*LOG(4/8)



Band	Modulation	Sub-test	CH	Frequency (MHz)	Burst Average Power (dBm)	
					SIM1	SIM2
WCDMA Band II	RMC12.2K	---	Lowest	1852.4	21.75	21.73
			Middle	1880.0	22.07	22.06
			Highest	1907.6	22.22	22.21
HSDPA Band II	QPSK	1	Lowest	1852.4	21.12	21.05
			Middle	1880.0	21.42	21.35
			Highest	1907.6	21.60	21.52
		2	Lowest	1852.4	21.10	21.02
			Middle	1880.0	21.41	21.34
			Highest	1907.6	21.58	21.50
		3	Lowest	1852.4	20.66	20.59
			Middle	1880.0	20.97	20.90
			Highest	1907.6	21.15	21.07
		4	Lowest	1852.4	20.64	20.56
			Middle	1880.0	20.95	20.88
			Highest	1907.6	21.13	21.05
HSUPA Band II	QPSK	1	Lowest	1852.4	19.82	19.81
			Middle	1880.0	20.16	20.15
			Highest	1907.6	20.32	20.30
		2	Lowest	1852.4	17.88	17.86
			Middle	1880.0	18.20	18.19
			Highest	1907.6	18.37	18.36
		3	Lowest	1852.4	18.84	18.83
			Middle	1880.0	19.19	19.17
			Highest	1907.6	19.34	19.32
		4	Lowest	1852.4	17.85	17.83
			Middle	1880.0	18.18	18.17
			Highest	1907.6	18.35	18.33
		5	Lowest	1852.4	19.80	19.79
			Middle	1880.0	20.14	20.12
			Highest	1907.6	20.29	20.28

Band	Modulation	Sub-test	CH	Frequency (MHz)	Burst Average Power (dBm)	
					SIM1	SIM2
WCDMA Band IV	RMC12.2K	---	Lowest	1712.4	21.55	21.53
			Middle	1732.6	22.25	22.22
			Highest	1752.6	21.45	21.43
HSDPA Band IV	QPSK	1	Lowest	1712.4	21.10	21.11
			Middle	1732.6	21.80	21.79
			Highest	1752.6	21.02	21.03
		2	Lowest	1712.4	21.07	21.09
			Middle	1732.6	21.78	21.77
			Highest	1752.6	21.00	21.01
		3	Lowest	1712.4	20.66	20.64
			Middle	1732.6	21.36	21.34
			Highest	1752.6	20.56	20.58
		4	Lowest	1712.4	20.63	20.62
			Middle	1732.6	21.33	21.32
			Highest	1752.6	20.54	20.56
HSUPA Band IV	QPSK	1	Lowest	1712.4	19.59	19.56
			Middle	1732.6	20.31	20.28
			Highest	1752.6	19.50	19.48
		2	Lowest	1712.4	17.62	17.61
			Middle	1732.6	18.36	18.33
			Highest	1752.6	17.56	17.52
		3	Lowest	1712.4	18.62	18.57
			Middle	1732.6	19.34	19.31
			Highest	1752.6	18.52	18.51
		4	Lowest	1712.4	17.60	17.58
			Middle	1732.6	18.34	18.31
			Highest	1752.6	17.53	17.50
		5	Lowest	1712.4	19.57	19.53
			Middle	1732.6	20.29	20.25
			Highest	1752.6	19.47	19.46



Band	Modulation	Sub-test	CH	Frequency (MHz)	Burst Average Power (dBm)	
					SIM1	SIM2
WCDMA Band V	RMC12.2K	---	Lowest	826.4	21.78	21.77
			Middle	836.6	22.71	22.70
			Highest	846.6	21.67	21.65
HSDPA Band V	QPSK	1	Lowest	826.4	21.15	21.15
			Middle	836.6	22.04	22.05
			Highest	846.6	21.02	21.02
		2	Lowest	826.4	21.13	21.14
			Middle	836.6	22.01	22.02
			Highest	846.6	21.00	21.00
		3	Lowest	826.4	20.69	20.70
			Middle	836.6	21.59	21.59
			Highest	846.6	20.58	20.58
		4	Lowest	826.4	20.67	20.67
			Middle	836.6	21.57	21.57
			Highest	846.6	20.55	20.55
HSUPA Band V	QPSK	1	Lowest	826.4	19.83	19.82
			Middle	836.6	20.78	20.76
			Highest	846.6	19.77	19.76
		2	Lowest	826.4	17.88	17.87
			Middle	836.6	18.82	18.81
			Highest	846.6	17.81	17.80
		3	Lowest	826.4	18.85	18.83
			Middle	836.6	19.81	19.80
			Highest	846.6	18.79	18.77
		4	Lowest	826.4	17.86	17.85
			Middle	836.6	18.80	18.78
			Highest	846.6	17.80	17.78
		5	Lowest	826.4	19.80	19.79
			Middle	836.6	20.76	20.74
			Highest	846.6	19.75	19.73



Band	Data Rate	CH	Frequency (MHz)	Average Power (dBm)
IEEE 802.11b	1 M	1	2412.0	15.63
		6	2437.0	16.21
		11	2462.0	16.24
	2 M	1	2412.0	16.47
		6	2437.0	16.16
		11	2462.0	16.05
	5.5 M	1	2412.0	16.82
		6	2437.0	16.39
		11	2462.0	16.25
	11 M	1	2412.0	16.16
		6	2437.0	16.12
		11	2462.0	16.42
IEEE 802.11g	6 M	1	2412.0	13.47
		6	2437.0	13.23
		11	2462.0	13.17
	9 M	1	2412.0	13.14
		6	2437.0	13.13
		11	2462.0	13.07
	12 M	1	2412.0	13.26
		6	2437.0	13.25
		11	2462.0	13.18
	18 M	1	2412.0	13.39
		6	2437.0	13.12
		11	2462.0	13.07
	24 M	1	2412.0	13.05
		6	2437.0	13.03
		11	2462.0	13.26
	36 M	1	2412.0	12.74
		6	2437.0	13.17
		11	2462.0	12.94
	48 M	1	2412.0	12.85
		6	2437.0	13.08
		11	2462.0	12.78
	54 M	1	2412.0	12.91
		6	2437.0	12.89
		11	2462.0	12.81



Band	Data Rate	CH	Frequency (MHz)	Average Power (dBm)
IEEE 802.11n 20MHz (2.4 GHz)	6.5 M	1	2412.0	13.16
		6	2437.0	13.45
		11	2462.0	13.39
	13.0 M	1	2412.0	13.22
		6	2437.0	13.18
		11	2462.0	13.21
	19.5 M	1	2412.0	13.15
		6	2437.0	13.11
		11	2462.0	13.29
	26.0 M	1	2412.0	12.92
		6	2437.0	13.12
		11	2462.0	13.04
	39.0 M	1	2412.0	12.88
		6	2437.0	13.12
		11	2462.0	13.03
	52.0 M	1	2412.0	12.85
		6	2437.0	13.06
		11	2462.0	12.78
	58.5 M	1	2412.0	13.08
		6	2437.0	13.13
		11	2462.0	13.04
65.0 M	1	2412.0	13.04	
	6	2437.0	12.84	
	11	2462.0	12.92	



Band	Data Rate	CH	Frequency (MHz)	Average Power (dBm)
IEEE 802.11n 40MHz (2.4 GHz)	13.5 M	3	2422.0	11.81
		6	2437.0	11.98
		9	2452.0	11.86
	27.0 M	3	2422.0	11.82
		6	2437.0	11.97
		9	2452.0	11.64
	40.5 M	3	2422.0	11.74
		6	2437.0	11.97
		9	2452.0	11.61
	54.0 M	3	2422.0	11.94
		6	2437.0	11.63
		9	2452.0	11.65
	81.0 M	3	2422.0	11.94
		6	2437.0	11.97
		9	2452.0	11.56
	108.0 M	3	2422.0	11.75
		6	2437.0	11.62
		9	2452.0	11.56
	121.5 M	3	2422.0	11.71
		6	2437.0	11.63
		9	2452.0	11.58
135.0 M	3	2422.0	11.56	
	6	2437.0	11.52	
	9	2452.0	11.51	



Band	CH	Frequency (MHz)	Packet Type	Average Power (dBm)
Bluetooth GFSK	0	2402	DH1	-5.71
			DH3	-2.41
			DH5	-1.76
	39	2441	DH1	-5.11
			DH3	-1.74
			DH5	-1.03
	78	2480	DH1	-5.23
			DH3	-1.85
			DH5	-1.02
Bluetooth $\pi/4$ -DQPSK	0	2402	DH1	-7.42
			DH3	-4.46
			DH5	-3.78
	39	2441	DH1	-6.75
			DH3	-3.78
			DH5	-3.11
	78	2480	DH1	-6.90
			DH3	-3.98
			DH5	-3.40
Bluetooth 8DPSK	0	2402	DH1	-7.38
			DH3	-4.44
			DH5	-3.76
	39	2441	DH1	-6.72
			DH3	-3.75
			DH5	-3.06
	78	2480	DH1	-6.87
			DH3	-3.95
			DH5	-3.35



5.8 Antenna location

Antenna-User			
Distance of WWAN to edge		Distance of WLAN and Bluetooth to edge	
WWAN to Side 1	2mm	WLAN and Bluetooth to Side 1	2mm
WWAN to Side 2	1mm	WLAN and Bluetooth to Side 2	1mm
WWAN to Side 3	118mm	WLAN and Bluetooth to Side 3	1mm
WWAN to Side 4	2mm	WLAN and Bluetooth to Side 4	118mm
WWAN to Side 5	8mm	WLAN and Bluetooth Side 5	2mm
WWAN to Side 6	2mm	WLAN and Bluetooth Side 6	60mm
Antenna-Antenna			
Antenna account		Distance (mm)	
WWAN to WLAN and Bluetooth		118	

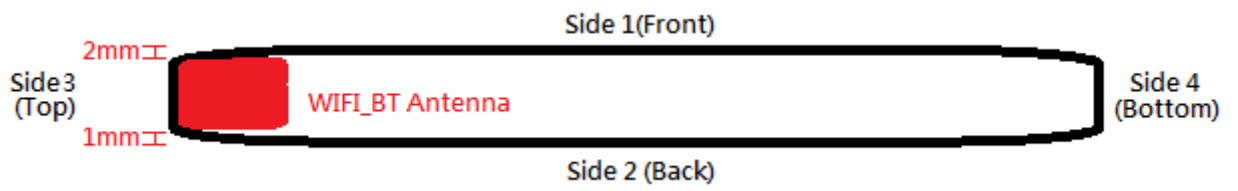
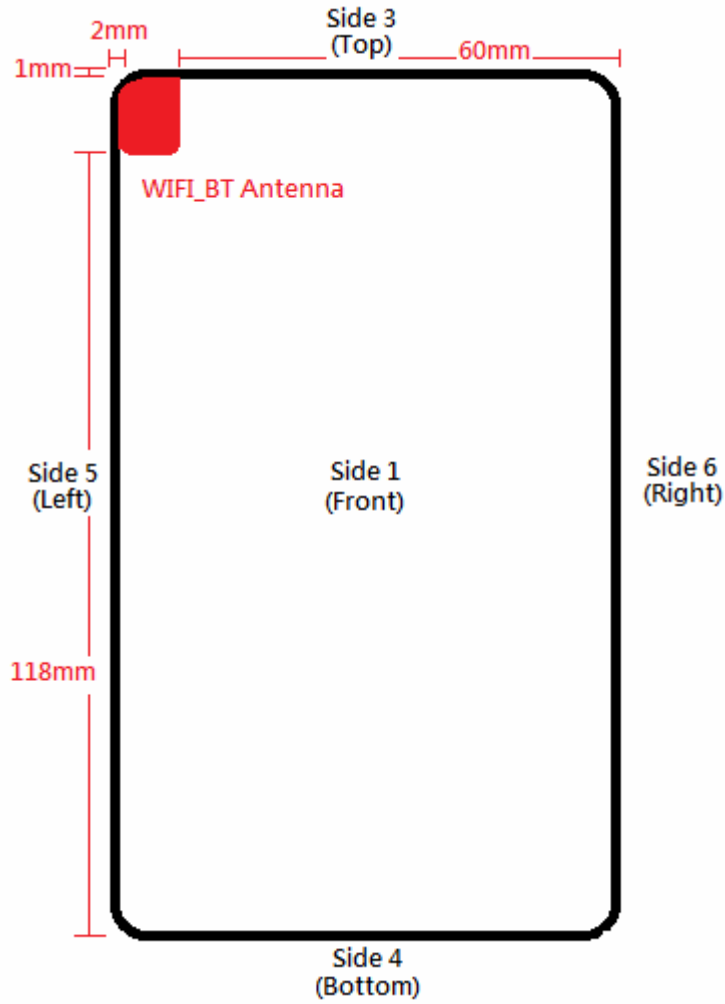

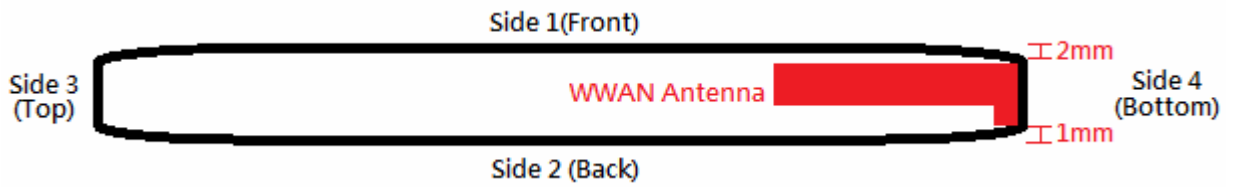
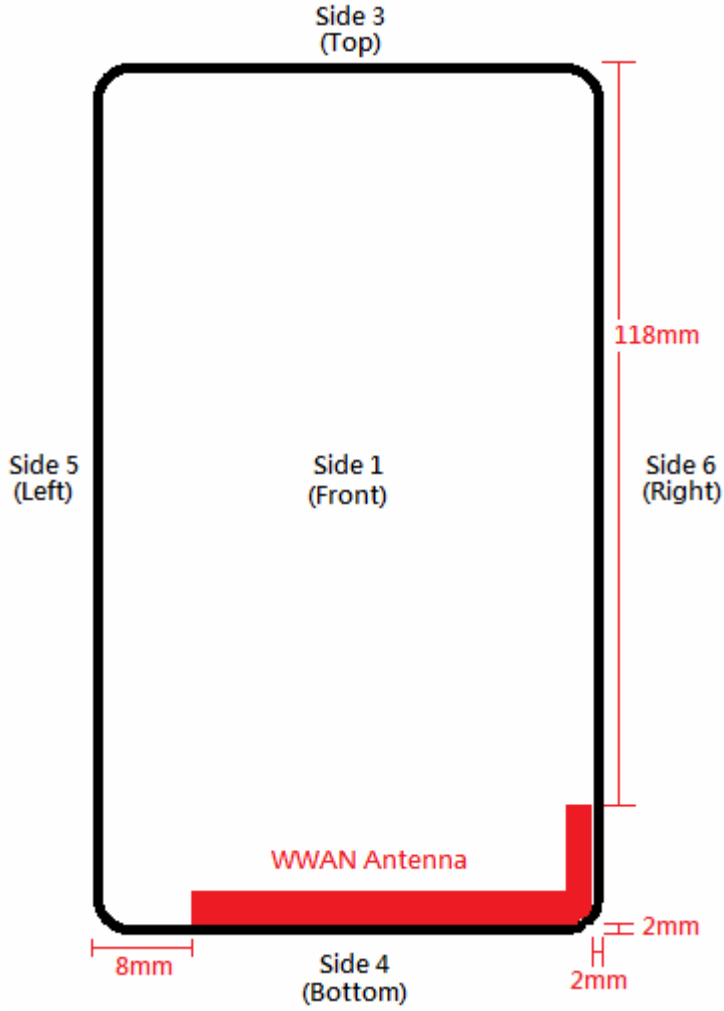

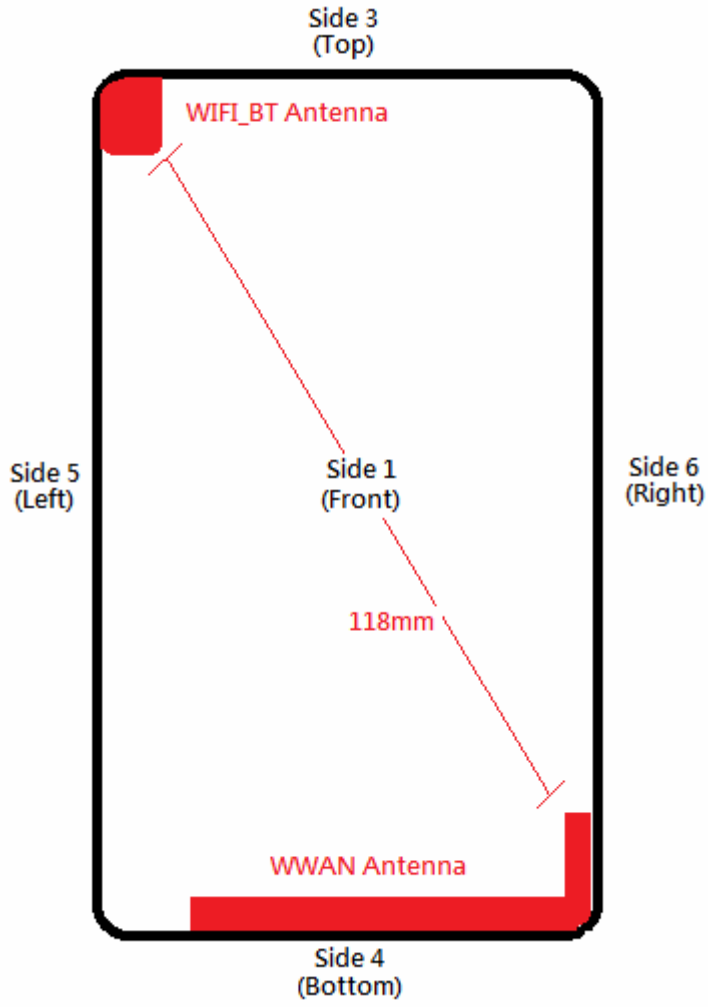



5.9 Stand-alone SAR Evaluate

Transmitter and antenna implementation as below:

Band	WWAN antenna	WLAN and Bluetooth antenna
WWAN	V	-
WLAN	-	V
Bluetooth	-	V

Stand-alone transmission configurations as below:

Band	RC	RT	LC	LT	Side 1	Side 2	Side 3	Side 4	Side 5	Side 6
GSM 850	V	V	V	V	V	V	-	V	V	V
GPRS 850	V	V	V	V	V	V	-	V	V	V
GSM 1900	V	V	V	V	V	V	-	V	V	V
GPRS 1900	V	V	V	V	V	V	-	V	V	V
WCDMA/HSDPA/HSUPA Band II	V	V	V	V	V	V	-	V	V	V
WCDMA/HSDPA/HSUPA Band IV	V	V	V	V	V	V	-	V	V	V
WCDMA/HSDPA/HSUPA Band V	V	V	V	V	V	V	-	V	V	V
IEEE 802.11b	V	V	V	V	V	V	V	-	V	-
Bluetooth v3.0	-	-	-	-	V	V	-	-	-	-

Note: The "-" on behalf of Stand-alone SAR is not required (Refer to KDB941225 D06 for the Hotspot mode SAR test requirements for hand-held and other near-body use conditions)

5.10 Simultaneous Transmitting Evaluate

Simultaneous transmission configurations as below:

Condition	Side	Frequency Band	
		WWAN Antenna	WLAN and Bluetooth Antenna
1	RC	V	V
2	RT	V	V
3	LC	V	V
4	LT	V	V
5	1	V	V
6	2	V	V
7	3	V	V
8	4	V	V
9	5	V	V
10	6	V	V



5.10.1 Estimated SAR

Estimated SAR for test separation distances ≤ 50 mm

Antenna	Side	Band	Channel	Power-Tune up (dBm)	Frequency (GHz)	Distance (mm)	Power (mW)	Estimated SAR ¹⁹ (mW/Kg)
Bluetooth_Antenna	RC	Bluetooth v3.0	78	0.5	2.4800	5	1	0.042
Bluetooth_Antenna	RT	Bluetooth v3.0	78	0.5	2.4800	5	1	0.042
Bluetooth_Antenna	LC	Bluetooth v3.0	78	0.5	2.4800	5	1	0.042
Bluetooth_Antenna	LT	Bluetooth v3.0	78	0.5	2.4800	5	1	0.042
WWAN_Antenna	Side 3	GPRS 850	251	25.5	0.8488	50	355	0.872
		GPRS 1900	810	23.0	1.9098	50	200	0.737
		WCDMA Band II	9538	23.0	1.9076	50	200	0.737
		WCDMA Band IV	1413	23.0	1.7326	50	200	0.702
		WCDMA Band V	4183	23.0	0.8366	50	200	0.488
Bluetooth_Antenna	Side 4	Bluetooth v3.0	78	0.5	2.4800	5	1	0.042
Bluetooth_Antenna		Bluetooth v3.0	78	0.5	2.4800	50	1	0.004
WLAN_Antenna	Side 4	IEEE 802.11b	1	17.0	2.4120	50	50	0.207
Bluetooth_Antenna		Bluetooth v3.0	78	0.5	2.4800	5	1	0.042
Bluetooth_Antenna	Side 5	Bluetooth v3.0	78	0.5	2.4800	5	1	0.042
Bluetooth_Antenna	Side 6	Bluetooth v3.0	78	0.5	2.4800	50	1	0.004
WLAN_Antenna		IEEE 802.11b	1	17.0	2.4120	50	50	0.207

Note : 1. The side 3 WCDMA / GPRS is an antenna which test separation distances is 118mm, and the test distance replace 50mm for 118mm assessment for estimated SAR.

2. The side 4 Wi-Fi / Bluetooth is an antenna which test separation distances is 118mm, and the test distance replaces 50mm for 118mm assessment for estimated SAR.

3. The side 6 Wi-Fi / Bluetooth is an antenna which test separation distances is 60mm, and the test distance replaces 50mm for 60mm assessment for estimated SAR.



5.10.2 Sum of 1-g SAR of all simultaneously transmitting

When the sum of 1-g SAR of all simultaneously transmitting antennas in and operating mode and exposure condition combination is within the SAR limit, SAR test exclusion applies to that simultaneous transmission configuration.

Sum of 1-g SAR of summary as below:

Phantom Position	Spacing (mm)	ASSY	WWAN Antenna		WLAN ANtenna		Bluetooth Antenna		Σ SAR ^{1g} (W/Kg)	Event
			Band	SAR ^{1g} (W/Kg)	Band	SAR ^{1g} (W/Kg)	Band	SAR ^{1g} (W/Kg)		
Head	RC	N/A	GSM 850	0.426	IEEE 802.11b	0.672	Bluetooth	*0.042	1.140	<1.6
		N/A	GPRS 850	0.767	IEEE 802.11b	0.672	Bluetooth	*0.042	1.481	<1.6
		N/A	GSM 1900	0.239	IEEE 802.11b	0.672	Bluetooth	*0.042	0.953	<1.6
		N/A	GPRS 1900	0.295	IEEE 802.11b	0.672	Bluetooth	*0.042	1.009	<1.6
		N/A	WCDMA Band II	0.357	IEEE 802.11b	0.672	Bluetooth	*0.042	1.071	<1.6
		N/A	WCDMA Band IV	0.332	IEEE 802.11b	0.672	Bluetooth	*0.042	1.046	<1.6
		N/A	WCDMA Band V	0.372	IEEE 802.11b	0.672	Bluetooth	*0.042	1.086	<1.6
	RT	N/A	GSM 850	0.255	IEEE 802.11b	0.488	Bluetooth	*0.042	0.785	<1.6
		N/A	GPRS 850	0.459	IEEE 802.11b	0.488	Bluetooth	*0.042	0.989	<1.6
		N/A	GSM 1900	0.120	IEEE 802.11b	0.488	Bluetooth	*0.042	0.650	<1.6
		N/A	GPRS 1900	0.133	IEEE 802.11b	0.488	Bluetooth	*0.042	0.663	<1.6
		N/A	WCDMA Band II	0.160	IEEE 802.11b	0.488	Bluetooth	*0.042	0.690	<1.6
		N/A	WCDMA Band IV	0.144	IEEE 802.11b	0.488	Bluetooth	*0.042	0.674	<1.6
		N/A	WCDMA Band V	0.233	IEEE 802.11b	0.488	Bluetooth	*0.042	0.763	<1.6
	LC	N/A	GSM 850	0.481	IEEE 802.11b	0.285	Bluetooth	*0.042	0.808	<1.6
		N/A	GPRS 850	0.811	IEEE 802.11b	0.285	Bluetooth	*0.042	1.138	<1.6
		N/A	GSM 1900	0.208	IEEE 802.11b	0.285	Bluetooth	*0.042	0.535	<1.6
		N/A	GPRS 1900	0.245	IEEE 802.11b	0.285	Bluetooth	*0.042	0.572	<1.6
		N/A	WCDMA Band II	0.326	IEEE 802.11b	0.285	Bluetooth	*0.042	0.653	<1.6
		N/A	WCDMA Band IV	0.329	IEEE 802.11b	0.285	Bluetooth	*0.042	0.656	<1.6
		N/A	WCDMA Band V	0.408	IEEE 802.11b	0.285	Bluetooth	*0.042	0.735	<1.6
LT	N/A	GSM 850	0.255	IEEE 802.11b	0.301	Bluetooth	*0.042	0.598	<1.6	
	N/A	GPRS 850	0.461	IEEE 802.11b	0.301	Bluetooth	*0.042	0.804	<1.6	
	N/A	GSM 1900	0.116	IEEE 802.11b	0.301	Bluetooth	*0.042	0.459	<1.6	
	N/A	GPRS 1900	0.129	IEEE 802.11b	0.301	Bluetooth	*0.042	0.472	<1.6	
	N/A	WCDMA Band II	0.156	IEEE 802.11b	0.301	Bluetooth	*0.042	0.499	<1.6	
	N/A	WCDMA Band IV	0.127	IEEE 802.11b	0.301	Bluetooth	*0.042	0.470	<1.6	
	N/A	WCDMA Band V	0.228	IEEE 802.11b	0.301	Bluetooth	*0.042	0.571	<1.6	



Phantom Position		Spacing (mm)	ASSY	WWAN Antenna		WLAN Antenna		Bluetooth Antenna		Σ SAR ^{1g} (W/Kg)	Event
				Band	SAR ^{1g} (W/Kg)	Band	SAR ^{1g} (W/Kg)	Band	SAR ^{1g} (W/Kg)		
Flat	Side 1	10	N/A	GSM 850	0.412	IEEE 802.11b	0.129	Bluetooth	0.03	0.571	<1.6
		10	N/A	GPRS 850	0.896	IEEE 802.11b	0.129	Bluetooth	0.03	1.055	<1.6
		10	N/A	GSM 1900	0.314	IEEE 802.11b	0.129	Bluetooth	0.03	0.473	<1.6
		10	N/A	GPRS 1900	0.453	IEEE 802.11b	0.129	Bluetooth	0.03	0.612	<1.6
		10	N/A	WCDMA Band II	0.603	IEEE 802.11b	0.129	Bluetooth	0.03	0.762	<1.6
		10	N/A	WCDMA Band IV	0.441	IEEE 802.11b	0.129	Bluetooth	0.03	0.600	<1.6
		10	N/A	WCDMA Band V	0.533	IEEE 802.11b	0.129	Bluetooth	0.03	0.692	<1.6
	Side 2	10	N/A	GSM 850	0.523	IEEE 802.11b	0.139	Bluetooth	0.05	0.712	<1.6
		10	N/A	GPRS 850	1.032	IEEE 802.11b	0.139	Bluetooth	0.05	1.221	<1.6
		10	N/A	GSM 1900	0.394	IEEE 802.11b	0.139	Bluetooth	0.05	0.583	<1.6
		10	N/A	GPRS 1900	0.496	IEEE 802.11b	0.139	Bluetooth	0.05	0.685	<1.6
		10	N/A	WCDMA Band II	0.606	IEEE 802.11b	0.139	Bluetooth	0.05	0.795	<1.6
		10	N/A	WCDMA Band IV	0.733	IEEE 802.11b	0.139	Bluetooth	0.05	0.922	<1.6
		10	N/A	WCDMA Band V	0.638	IEEE 802.11b	0.139	Bluetooth	0.05	0.827	<1.6
Flat	Side 3	10	N/A	GPRS 850	*0.872	IEEE 802.11b	0.100	Bluetooth	*0.042	1.014	<1.6
		10	N/A	GPRS 1900	*0.737	IEEE 802.11b	0.100	Bluetooth	*0.042	0.879	<1.6
		10	N/A	WCDMA Band II	*0.737	IEEE 802.11b	0.100	Bluetooth	*0.042	0.879	<1.6
		10	N/A	WCDMA Band IV	*0.702	IEEE 802.11b	0.100	Bluetooth	*0.042	0.844	<1.6
		10	N/A	WCDMA Band V	*0.488	IEEE 802.11b	0.100	Bluetooth	*0.042	0.630	<1.6
	Side 4	10	N/A	GPRS 850	0.135	IEEE 802.11b	*0.207	Bluetooth	*0.004	0.346	<1.6
		10	N/A	GPRS 1900	0.604	IEEE 802.11b	*0.207	Bluetooth	*0.004	0.815	<1.6
		10	N/A	WCDMA Band II	0.771	IEEE 802.11b	*0.207	Bluetooth	*0.004	0.982	<1.6
		10	N/A	WCDMA Band IV	0.525	IEEE 802.11b	*0.207	Bluetooth	*0.004	0.736	<1.6
		10	N/A	WCDMA Band V	0.072	IEEE 802.11b	*0.207	Bluetooth	*0.004	0.283	<1.6

Note: *=Estimated SAR



Phantom Position	Spacing (mm)	ASSY	WWAN Antenna		WLAN Antenna		Bluetooth Antenna		Σ SAR ^{1g} (W/Kg)	Event	
			Band	SAR ^{1g} (W/Kg)	Band	SAR ^{1g} (W/Kg)	Band	SAR ^{1g} (W/Kg)			
Flat	Side 5	10	N/A	GPRS 850	0.635	IEEE 802.11b	0.119	Bluetooth	*0.042	0.796	<1.6
		10	N/A	GPRS 1900	0.117	IEEE 802.11b	0.119	Bluetooth	*0.042	0.278	<1.6
		10	N/A	WCDMA Band II	0.138	IEEE 802.11b	0.119	Bluetooth	*0.042	0.299	<1.6
		10	N/A	WCDMA Band IV	0.095	IEEE 802.11b	0.119	Bluetooth	*0.042	0.256	<1.6
		10	N/A	WCDMA Band V	0.394	IEEE 802.11b	0.119	Bluetooth	*0.042	0.555	<1.6
	Side 6	10	N/A	GPRS 850	0.573	IEEE 802.11b	*0.207	Bluetooth	*0.004	0.784	<1.6
		10	N/A	GPRS 1900	0.150	IEEE 802.11b	*0.207	Bluetooth	*0.004	0.361	<1.6
		10	N/A	WCDMA Band II	0.175	IEEE 802.11b	*0.207	Bluetooth	*0.004	0.386	<1.6
		10	N/A	WCDMA Band IV	0.124	IEEE 802.11b	*0.207	Bluetooth	*0.004	0.335	<1.6
		10	N/A	WCDMA Band V	0.351	IEEE 802.11b	*0.207	Bluetooth	*0.004	0.562	<1.6

Note: *=Estimated SAR

5.10.3 SAR to peak location separation ratio (SPLSR)

When the sum of SAR is larger than the limit, SAR test exclusion is determined by the SAR to peak location separation ratio. The ratio is determined by $(SAR1 + SAR2)^{1.5}/R_i$, rounded to two decimal digits, and must be ≤ 0.04 for all antenna pairs in the configuration to qualify for 1-g SAR test exclusion.

All of sum of SAR < 1.6 W/Kg, therefore SPLSR is not required.



5.11 SAR test reduction according to KDB

General:

- The test data reported are the worst-case SAR value with the position set in a typical configuration. Test procedures used were according to IEEE1528-2013 and IEEE Std. 1528a-2005.
- All modes of operation were investigated, and worst-case results are reported.
- Tissue parameters and temperatures are listed on the SAR plots.
- Batteries are fully charged for all readings.
- When the Channel's SAR 1g of maximum conducted power is > 0.8 mW/g, low, middle and high channel are supposed to be tested.

KDB 447498:

- The test data reported are the worst-case SAR value with the position set in a typical configuration. Test procedures used were according to FCC/OET Bulletin 65, Supplement C [June 2001], IEEE1528-2013 and IEEE Std. 1528a-2005.

KDB 865664:

- Repeated measurement is not required when the original highest measured SAR is < 0.80 W/kg.
- When the original highest measured SAR is ≥ 0.80 W/kg, repeat that measurement once.
- Perform a second repeated measurement only if the ratio of largest to smallest SAR for the original and first repeated measurements is > 1.20 or when the original or repeated measurement is ≥ 1.45 W/kg.
- Perform a third repeated measurement only if the original, first or second repeated measurement is ≥ 1.5 W/kg and the ratio of largest to smallest SAR for the original, first and second repeated measurements is > 1.20 .

KDB 941225:

- In order to qualify for the above test reduction, the maximum burst-averaged output power for each mode (GMS/GPRS/EDGE) and the corresponding multi-slot class must be clearly identified in the SAR report for each frequency band. We perform worst case SAR with maximum time-average power on GMS/GPRS/EDGE mode.
- When HSDPA & (HSUPA / HSPA+ uplink with QPSK) power are not more than WCDMA 12.2K RMC 0.25dB and the SAR value of WCDMA BII/BV < 1.2 mW/g, therefore HSDPA & HSUPA / HSPA+ Stand-alone SAR is not required.
- SAR must be measured for all sides and surfaces with a transmitting antenna located within 25 mm from that surface or edge.

KDB 248227:

- If the conducted power of (802.11g and 802.11n) are higher than 802.11b 0.25dB, (802.11g and 802.11n) are supposed to be tested.

6. System Verification and Validation

6.1 Symmetric Dipoles for System Verification

Construction	Symmetrical dipole with 1/4 balun enables measurement of feed point impedance with NWA matched for use near flat phantoms filled with head simulating solutions Includes distance holder and tripod adaptor Calibration Calibrated SAR value for specified position and input power at the flat phantom in head simulating solutions.
Frequency	835, 1750, 1900 and 2450 MHz
Return Loss	> 20 dB at specified verification position
Power Capability	> 100 W (f < 1GHz); > 40 W (f > 1GHz)
Options	Dipoles for other frequencies or solutions and other calibration conditions are available upon request
Dimensions	D835V2: dipole length 161 mm; overall height 340 mm D1750V2: dipole length 75.2 mm; overall height 301.5 mm D1900V2: dipole length 67.7 mm; overall height 300 mm D2450V2: dipole length 51.5 mm; overall height 300 mm

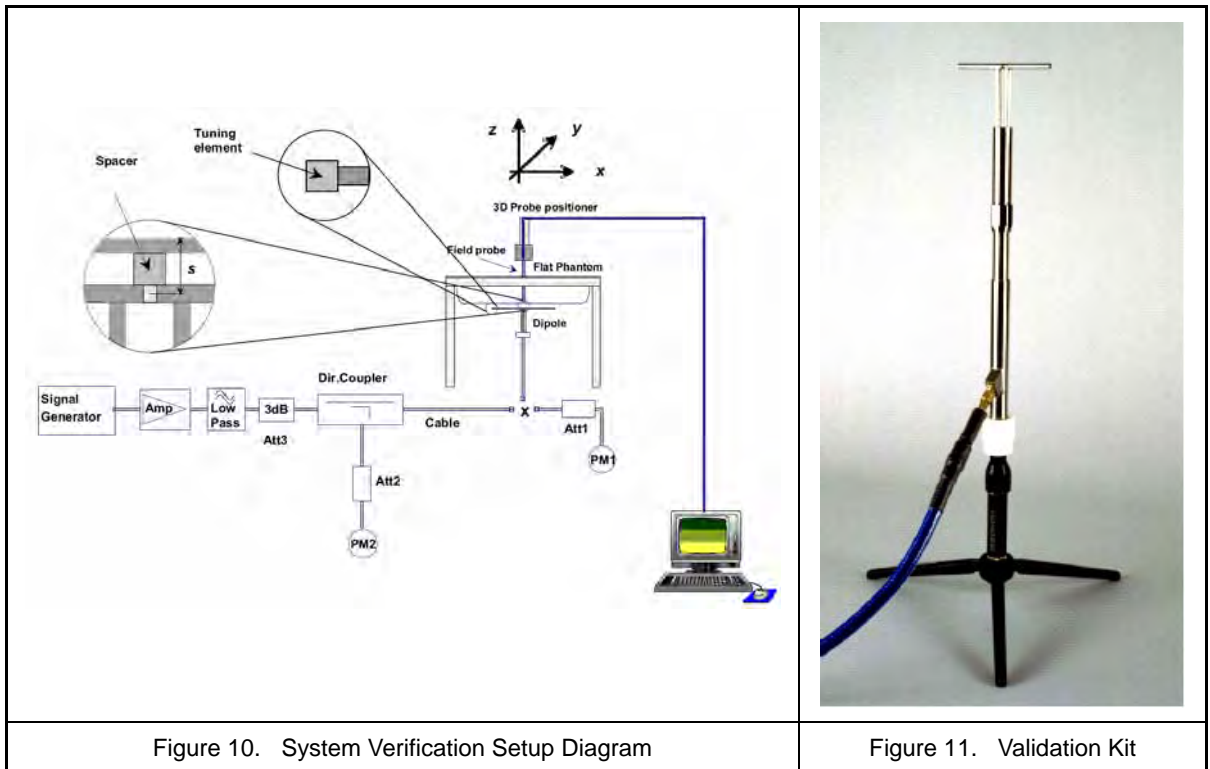



6.2 Liquid Parameters

Liquid Verify								
Ambient Temperature : 22 ± 2 °C ; Relative Humidity : 40 -70%								
Liquid Type	Frequency	Temp (°C)	Parameters	Target Value	Measured Value	Deviation (%)	Limit (%)	Measured Date
835MHz (Head)	820MHz	22.0	ϵ_r	41.57	43.43	4.47%	± 5	2014/07/07
			σ	0.898	0.887	-1.23%	± 5	
	835MHz	22.0	ϵ_r	41.50	43.31	4.36%	± 5	
			σ	0.900	0.918	2.00%	± 5	
	850MHz	22.0	ϵ_r	41.50	43.41	4.60%	± 5	
			σ	0.916	0.945	3.17%	± 5	
835MHz (Body)	820MHz	22.0	ϵ_r	55.26	56.48	2.21%	± 5	2014/07/08
			σ	0.969	0.973	0.41%	± 5	
	835MHz	22.0	ϵ_r	55.20	56.43	2.23%	± 5	
			σ	0.970	0.990	2.06%	± 5	
	850MHz	22.0	ϵ_r	55.15	56.33	2.14%	± 5	
			σ	0.988	1.005	1.72%	± 5	
835MHz (Head)	820MHz	22.0	ϵ_r	41.57	43.43	4.47%	± 5	2014/07/09
			σ	0.898	0.887	-1.23%	± 5	
	835MHz	22.0	ϵ_r	41.50	43.31	4.36%	± 5	
			σ	0.900	0.918	2.00%	± 5	
	850MHz	22.0	ϵ_r	41.50	43.41	4.60%	± 5	
			σ	0.916	0.945	3.17%	± 5	
835MHz (Head)	820MHz	22.0	ϵ_r	41.57	43.43	4.47%	± 5	2014/07/12
			σ	0.898	0.887	-1.23%	± 5	
	835MHz	22.0	ϵ_r	41.50	43.31	4.36%	± 5	
			σ	0.900	0.918	2.00%	± 5	
	850MHz	22.0	ϵ_r	41.50	43.41	4.60%	± 5	
			σ	0.916	0.945	3.17%	± 5	

Table 4. Measured Tissue dielectric parameters for body phantoms -1



Liquid Verify								
Ambient Temperature : 22 ± 2 °C ; Relative Humidity : 40 -70%								
Liquid Type	Frequency	Temp (°C)	Parameters	Target Value	Measured Value	Deviation (%)	Limit (%)	Measured Date
1750MHz (Head)	1700MHz	22.0	ϵ_r	40.14	41.51	3.41%	± 5	2014/07/16
			σ	1.343	1.360	1.27%	± 5	
	1750MHz	22.0	ϵ_r	40.07	41.39	3.29%	± 5	
			σ	1.371	1.397	1.90%	± 5	
	1800MHz	22.0	ϵ_r	40.00	41.28	3.20%	± 5	
			σ	1.400	1.442	3.00%	± 5	
1750MHz (Body)	1700MHz	22.0	ϵ_r	53.56	52.33	-2.30%	± 5	2014/07/16
			σ	1.457	1.499	2.88%	± 5	
	1750MHz	22.0	ϵ_r	53.43	52.70	-1.37%	± 5	
			σ	1.488	1.546	3.90%	± 5	
	1800MHz	22.0	ϵ_r	53.30	52.40	-1.69%	± 5	
			σ	1.520	1.576	3.68%	± 5	
1900MHz (Head)	1850MHz	22.0	ϵ_r	40.00	40.63	1.58%	± 5	2014/07/10
			σ	1.400	1.344	-4.00%	± 5	
	1900MHz	22.0	ϵ_r	40.00	40.48	1.20%	± 5	
			σ	1.400	1.392	-0.57%	± 5	
	1930MHz	22.0	ϵ_r	40.00	40.38	0.95%	± 5	
			σ	1.400	1.424	1.71%	± 5	
1900MHz (Body)	1850MHz	22.0	ϵ_r	53.30	52.36	-1.76%	± 5	2014/07/10
			σ	1.520	1.456	-4.21%	± 5	
	1900MHz	22.0	ϵ_r	53.30	52.46	-1.58%	± 5	
			σ	1.520	1.475	-2.96%	± 5	
	1930MHz	22.0	ϵ_r	53.30	52.01	-2.42%	± 5	
			σ	1.520	1.549	1.91%	± 5	
1900MHz (Head)	1850MHz	22.0	ϵ_r	40.00	40.63	1.58%	± 5	2014/07/11
			σ	1.400	1.344	-4.00%	± 5	
	1900MHz	22.0	ϵ_r	40.00	40.48	1.20%	± 5	
			σ	1.400	1.392	-0.57%	± 5	
	1930MHz	22.0	ϵ_r	40.00	40.38	0.95%	± 5	
			σ	1.400	1.424	1.71%	± 5	

Table 5. Measured Tissue dielectric parameters for body phantoms -2



Liquid Verify								
Ambient Temperature : 22 ± 2 °C ; Relative Humidity : 40 -70%								
Liquid Type	Frequency	Temp (°C)	Parameters	Target Value	Measured Value	Deviation (%)	Limit (%)	Measured Date
1900MHz (Body)	1850MHz	22.0	ϵ_r	53.30	52.36	-1.76%	± 5	2014/07/14
			σ	1.520	1.456	-4.21%	± 5	
	1900MHz	22.0	ϵ_r	53.30	52.46	-1.58%	± 5	
			σ	1.520	1.475	-2.96%	± 5	
	1930MHz	22.0	ϵ_r	53.30	52.01	-2.42%	± 5	
			σ	1.520	1.549	1.91%	± 5	
2450MHz (Head)	2400MHz	22.0	ϵ_r	39.29	38.48	-2.06%	± 5	2014/07/11
			σ	1.756	1.779	1.31%	± 5	
	2450MHz	22.0	ϵ_r	39.20	38.36	-2.14%	± 5	
			σ	1.800	1.840	2.22%	± 5	
	2500MHz	22.0	ϵ_r	39.13	38.16	-2.48%	± 5	
			σ	1.853	1.884	1.67%	± 5	
2450MHz (Body)	2400MHz	22.0	ϵ_r	52.77	54.02	2.37%	± 5	2014/07/11
			σ	1.902	1.881	-1.10%	± 5	
	2450MHz	22.0	ϵ_r	52.70	54.46	3.34%	± 5	
			σ	1.950	1.980	1.54%	± 5	
	2500MHz	22.0	ϵ_r	52.64	53.61	1.84%	± 5	
			σ	2.021	2.016	-0.25%	± 5	

Table 6. Measured Tissue dielectric parameters for body phantoms -3



6.3 Verification Summary

Prior to the assessment, the system validation kit was used to test whether the system was operating within its specifications of $\pm 7\%$. The verification was performed at 835, 1750, 1900 and 2450MHz.

Mixture Type	Frequency (MHz)	Power	SAR _{1g} (W/Kg)	SAR _{10g} (W/Kg)	Drift (dB)	Difference percentage		Probe Model / Serial No.	Dipole Model / Serial No.	1W Target		Date
						1g	10g			SAR _{1g} (W/Kg)	SAR _{10g} (W/Kg)	
Head	835	250 mW	2.32	1.51	-0.13	-0.20%	-0.80%	EX3DV4 SN:3977	D835V2 SN:4d082	9.30	6.09	Jul. 07, 2014
		Normalize to 1 Watt	9.28	6.04								
Body	835	250 mW	2.47	1.63	-0.13	4.60%	4.50%	EX3DV4 SN:3977	D835V2 SN:4d082	9.45	6.24	Jul. 08, 2014
		Normalize to 1 Watt	9.88	6.52								
Head	835	250 mW	2.38	1.55	-0.06	2.40%	1.80%	EX3DV4 SN:3977	D835V2 SN:4d082	9.30	6.09	Jul. 09, 2014
		Normalize to 1 Watt	9.52	6.20								
Head	835	250 mW	2.32	1.51	-0.01	-0.20%	-0.80%	EX3DV4 SN:3977	D835V2 SN:4d082	9.30	6.09	Jul. 12, 2014
		Normalize to 1 Watt	9.28	6.04								
Head	1750	250 mW	9.24	4.73	0.07	0.70%	-3.00%	EX3DV4 SN:3977	D1750V2 SN:1023	36.70	19.50	Jul. 16, 2014
		Normalize to 1 Watt	36.96	18.92								
Body	1750	250 mW	9.53	4.92	0.19	0.60%	-0.35%	EX3DV4 SN:3977	D1750V2 SN:1023	37.90	20.40	Jul. 16, 2014
		Normalize to 1 Watt	38.12	19.68								
Head	1900	250 mW	9.95	5.06	0.18	-1.20%	-4.10%	EX3DV4 SN:3977	D1900V2 SN:5d111	40.30	21.10	Jul. 10, 2014
		Normalize to 1 Watt	39.80	20.24								
Body	1900	250 mW	10.30	5.24	0.09	2.00%	-2.10%	EX3DV4 SN:3977	D1900V2 SN:5d111	40.40	21.40	Jul. 10, 2014
		Normalize to 1 Watt	41.20	20.96								
Head	1900	250 mW	9.94	5.12	0.09	-1.30%	-2.90%	EX3DV4 SN:3977	D1900V2 SN:5d111	40.30	21.10	Jul. 11, 2014
		Normalize to 1 Watt	39.76	20.48								
Body	1900	250 mW	10.40	5.29	0.05	3.00%	-1.10%	EX3DV4 SN:3977	D1900V2 SN:5d111	40.40	21.40	Jul. 14, 2014
		Normalize to 1 Watt	41.60	21.16								
Head	2450	250 mW	13.20	5.97	0.15	1.50%	-1.70%	EX3DV4 SN:3977	D2450V2 SN:712	52.00	24.30	Jul. 11, 2014
		Normalize to 1 Watt	52.80	23.88								
Body	2450	250 mW	13.10	5.93	0	4.20%	0.90%	EX3DV4 SN:3977	D2450V2 SN:712	50.30	23.50	Jul. 11, 2014
		Normalize to 1 Watt	52.40	23.72								



6.4 Validation Summary

Per FCC KDB 865664 D02v01, SAR system validation status should be documented to confirm measurement accuracy. The SAR systems (including SAR probes, system components and software versions) used for this device were validated against its performance specifications prior to the SAR measurements. Reference dipoles were used with the required tissue- equivalent media for system validation, according to the procedures outlined in IEEE 1528-2013 and FCC KDB 865664 D01v01r03. Since SAR probe calibrations are frequency dependent, each probe calibration point was validated at a frequency within the valid frequency range of the probe calibration point, using the system that normally operates with the probe for routine SAR measurements and according to the required tissue-equivalent media.

A tabulated summary of the system validation status including the validation date(s), measurement frequencies, SAR probes and tissue dielectric parameters as below.

Probe Type Model / Serial No.	Prob Cal. Point (MHz)	Head / Body	Cond.	Perm.	CW Validation			Mod. Validation			Date
			ϵ_r	σ	Sensitivity	Probe	Probe	Mod. Type	Duty Factor	PAR	
						Linearity	Isotropy				
EX3DV4 SN:3977	835	Head	43.31	0.918	Pass	Pass	Pass	GMSK/ QPSK	Pass	N/A	Jul. 07, 2014
EX3DV4 SN:3977	835	Body	56.43	0.990	Pass	Pass	Pass	GMSK/ QPSK	Pass	N/A	Jul. 08, 2014
EX3DV4 SN:3977	835	Head	43.31	0.918	Pass	Pass	Pass	GMSK/ QPSK	Pass	N/A	Jul. 09, 2014
EX3DV4 SN:3977	835	Head	43.31	0.918	Pass	Pass	Pass	GMSK/ QPSK	Pass	N/A	Jul. 12, 2014
EX3DV4 SN:3977	1750	Head	41.39	1.397	Pass	Pass	Pass	GMSK/ QPSK	Pass	N/A	Jul. 16, 2014
EX3DV4 SN:3977	1750	Body	52.70	1.546	Pass	Pass	Pass	GMSK/ QPSK	Pass	N/A	Jul. 16, 2014
EX3DV4 SN:3977	1900	Head	40.48	1.392	Pass	Pass	Pass	GMSK/ QPSK	Pass	N/A	Jul. 10, 2014
EX3DV4 SN:3977	1900	Body	52.46	1.475	Pass	Pass	Pass	GMSK/ QPSK	Pass	N/A	Jul. 10, 2014
EX3DV4 SN:3977	1900	Head	40.48	1.392	Pass	Pass	Pass	GMSK/ QPSK	Pass	N/A	Jul. 11, 2014
EX3DV4 SN:3977	1900	Body	52.46	1.475	Pass	Pass	Pass	GMSK/ QPSK	Pass	N/A	Jul. 14, 2014
EX3DV4 SN:3977	2450	Head	38.36	1.840	Pass	Pass	Pass	OFDM	N/A	Pass	Jul. 11, 2014
EX3DV4 SN:3977	2450	Body	54.46	1.980	Pass	Pass	Pass	OFDM	N/A	Pass	Jul. 11, 2014



7. Test Equipment List

Manufacturer	Name of Equipment	Type/Model	Serial Number	Calibration	
				Last Cal.	Due Date
SPEAG	835MHz System Validation Kit	D835V2	4d082	Jul. 30, 2013	Jul. 29, 2014
SPEAG	1750MHz System Validation Kit	D1750V2	1023	Jun. 17, 2014	Jun. 18, 2015
SPEAG	1900MHz System Validation Kit	D1900V2	5d111	Jul. 29, 2013	Jul. 28, 2014
SPEAG	2450MHz System Validation Kit	D2450V2	712	Mar. 04, 2014	Mar. 03, 2015
SPEAG	Dosimetric E-Field Probe	EX3DV4	3977	Feb. 17, 2014	Feb. 16, 2015
SPEAG	Data Acquisition Electronics	DAE4	779	Feb. 25, 2014	Feb. 24, 2015
SPEAG	Device Holder	N/A	N/A	NCR	
SPEAG	Measurement Server	SE UMS 011 AA	1025	NCR	
SPEAG	Phantom	SAM V4.0	TP-1150	NCR	
SPEAG	Robot	Staubli TX90XL	F07/564ZA1/C/01	NCR	
SPEAG	Software	DASY52 V5.2.8 (7)	N/A	NCR	
SPEAG	Software	SEMCAD X V14.6.10 (7164)	N/A	NCR	
Agilent	Dielectric Probe Kit	85070C	US99360094	NCR	
Agilent	ENA Series Network Analyzer	E5071B	MY42404655	Apr. 10, 2014	Apr. 09, 2015
R&S	Power Sensor	NRP-Z22	100179	May 20, 2014	May 19, 2015
Agilent	MXF-G-B RF Vector Signal Generator	N5182B	MY53050382	May 30, 2014	May 29, 2015
Agilent	Dual Directional Coupler	778D	50334	NCR	
Mini-Circuits	Power Amplifier	ZHL-42W-SMA	D111103#5	NCR	
Mini-Circuits	Power Amplifier	ZVE-8G-SMA	D042005 671800514	NCR	
Aisi	Attenuator	IEAT 3dB	N/A	NCR	

Table 7. Test Equipment List



8. Measurement Uncertainty

Measurement uncertainties in SAR measurements are difficult to quantify due to several variables including biological, physiological, and environmental. However, we estimate the measurement uncertainties in SAR to be less than $\pm 19.62\%$ [8] . The frequency range of the measurement uncertainty is 750 ~ 5800MHz $\pm 10.1\%$

According to Std. C95.3 [9] , the overall uncertainties are difficult to assess and will vary with the type of meter and usage situation. However, accuracy's of ± 1 to 3 dB can be expected in practice, with greater uncertainties in near-field situations and at higher frequencies (shorter wavelengths), or areas where large reflecting objects are present. Under optimum measurement conditions, SAR measurement uncertainties of at least ± 2 dB can be expected.



Item	Uncertainty Component	Uncertainty Value	Prob. Dist	Div.	c_i (1g)	c_i (10g)	Std. Unc. (1-g)	Std. Unc. (10-g)	V_i or V_{eff}
Measurement System									
u1	Probe Calibration ($k=1$)	$\pm 5.05\%$	Normal	1	1	1	$\pm 5.05\%$	$\pm 5.05\%$	∞
u2	Probe Isotropy	$\pm 7.6\%$	Rectangular	$\sqrt{3}$	0.7	0.7	$\pm 3.1\%$	$\pm 3.1\%$	∞
u3	Boundary Effect	$\pm 1.0\%$	Rectangular	$\sqrt{3}$	1	1	$\pm 0.6\%$	$\pm 0.6\%$	∞
u4	Linearity	$\pm 4.7\%$	Rectangular	$\sqrt{3}$	1	1	$\pm 2.7\%$	$\pm 2.7\%$	∞
u5	System Detection Limit	$\pm 1.0\%$	Rectangular	$\sqrt{3}$	1	1	$\pm 0.58\%$	$\pm 0.58\%$	∞
u6	Readout Electronics	$\pm 0.3\%$	Normal	1	1	1	$\pm 0.3\%$	$\pm 0.3\%$	∞
u7	Response Time	$\pm 0.8\%$	Rectangular	$\sqrt{3}$	1	1	$\pm 0.5\%$	$\pm 0.5\%$	∞
u8	Integration Time	$\pm 2.6\%$	Rectangular	$\sqrt{3}$	1	1	$\pm 1.5\%$	$\pm 1.5\%$	∞
u9	RF Ambient Conditions	$\pm 0\%$	Rectangular	$\sqrt{3}$	1	1	$\pm 0\%$	$\pm 0\%$	∞
u10	RF Ambient Reflections	$\pm 0\%$	Rectangular	$\sqrt{3}$	1	1	$\pm 0\%$	$\pm 0\%$	∞
u11	Probe Positioner Mechanical Tolerance	$\pm 0.4\%$	Rectangular	$\sqrt{3}$	1	1	$\pm 0.2\%$	$\pm 0.2\%$	∞
u12	Probe Positioning with respect to Phantom Shell	$\pm 2.9\%$	Rectangular	$\sqrt{3}$	1	1	$\pm 1.7\%$	$\pm 1.7\%$	∞
u13	Extrapolation, interpolation and integration Algorithms for Max. SAR Evaluation	$\pm 1.0\%$	Rectangular	$\sqrt{3}$	1	1	$\pm 0.6\%$	$\pm 0.6\%$	∞
Test sample Related									
u14	Test sample Positioning	$\pm 3.6\%$	Normal	1	1	1	$\pm 3.6\%$	$\pm 3.6\%$	89
u15	Device Holder Uncertainty	$\pm 3.5\%$	Normal	1	1	1	$\pm 3.5\%$	$\pm 3.5\%$	5
u16	Output Power Variation - SAR drift measurement	$\pm 5.0\%$	Rectangular	$\sqrt{3}$	1	1	$\pm 2.9\%$	$\pm 2.9\%$	∞
Phantom and Tissue Parameters									
u17	Phantom Uncertainty (shape and thickness tolerances)	$\pm 4.0\%$	Rectangular	$\sqrt{3}$	1	1	$\pm 2.3\%$	$\pm 2.3\%$	∞
u18	Liquid Conductivity - deviation from target values	$\pm 5.0\%$	Rectangular	$\sqrt{3}$	0.64	0.43	$\pm 1.8\%$	$\pm 1.2\%$	∞
u19	Liquid Conductivity - measurement uncertainty	$\pm 1.93\%$	Normal	1	0.64	0.43	$\pm 1.24\%$	$\pm 0.83\%$	69
u20	Liquid Permittivity - deviation from target values	$\pm 5.0\%$	Rectangular	$\sqrt{3}$	0.6	0.49	$\pm 1.7\%$	$\pm 1.4\%$	∞
u21	Liquid Permittivity - measurement uncertainty	$\pm 1.4\%$	Normal	1	0.6	0.49	$\pm 0.84\%$	$\pm 1.69\%$	69
Combined standard uncertainty			RSS				$\pm 9.81\%$	$\pm 9.62\%$	313
Expanded uncertainty (95% CONFIDENCE LEVEL)			$k=2$				$\pm 19.62\%$	$\pm 19.24\%$	

Table 8. Uncertainty Budget of DASYS



9. Measurement Procedure

The measurement procedures are as follows:

1. For WLAN function, engineering testing software installed on Notebook can provide continuous transmitting signal.
2. Measure output power through RF cable and power meter
3. Set scan area, grid size and other setting on the DASY software
4. Find out the largest SAR result on these testing positions of each band
5. Measure SAR results for other channels in worst SAR testing position if the SAR of highest power channel is larger than 0.8 W/kg

According to the test standard, the recommended procedure for assessing the peak spatial-average SAR value consists of the following steps:

1. Power reference measurement
2. Area scan
3. Zoom scan
4. Power drift measurement

9.1 Spatial Peak SAR Evaluation

The procedure for spatial peak SAR evaluation has been implemented according to the test standard. It can be conducted for 1g and 10g, as well as for user-specific masses. The DASY software includes all numerical procedures necessary to evaluate the spatial peak SAR value.

The base for the evaluation is a "cube" measurement. The measured volume must include the 1g and 10g cubes with the highest averaged SAR values. For that purpose, the center of the measured volume is aligned to the interpolated peak SAR value of a previously performed area scan.

The entire evaluation of the spatial peak values is performed within the post-processing engine (SEMCAD). The system always gives the maximum values for the 1g and 10g cubes. The algorithm to find the cube with highest averaged SAR is divided into the following stages

1. Extraction of the measured data (grid and values) from the Zoom Scan
2. Calculation of the SAR value at every measurement point based on all stored data (A/D values and measurement parameters)
3. Generation of a high-resolution mesh within the measured volume
4. Interpolation of all measured values from the measurement grid to the high-resolution grid
5. Extrapolation of the entire 3-D field distribution to the phantom surface over the distance from sensor to surface
6. Calculation of the averaged SAR within masses of 1g and 10g



9.2 Area & Zoom Scan Procedures

First Area Scan is used to locate the approximate location(s) of the local peak SAR value(s). The measurement grid within an Area Scan is defined by the grid extent, grid step size and grid offset. Next, in order to determine the EM field distribution in a three-dimensional spatial extension, Zoom Scan is required. The Zoom Scan measures points and step size follow as below. The Zoom Scan is performed around the highest E-field value to determine the averaged SAR-distribution over 10 g.

Grid Type	Frequency		Step size (mm)			X*Y*Z (Point)	Cube size			Step size		
			X	Y	Z		X	Y	Z	X	Y	Z
uniform grid	≤ 3GHz	≤ 2GHz	≤ 8	≤ 8	≤ 5	5*5*7	32	32	30	8	8	5
		2G - 3G	≤ 5	≤ 5	≤ 5	7*7*7	30	30	30	5	5	5
	3 - 6GHz	3 - 4GHz	≤ 5	≤ 5	≤ 4	7*7*8	30	30	28	5	5	4
		4 - 5GHz	≤ 4	≤ 4	≤ 3	8*8*10	28	28	27	4	4	3
		5 - 6GHz	≤ 4	≤ 4	≤ 2	8*8*12	28	28	22	4	4	2

(Our measure settings are refer KDB Publication 865664 D01v01)

9.3 Volume Scan Procedures

The volume scan is used for assess overlapping SAR distributions for antennas transmitting in different frequency bands. It is equivalent to an oversized zoom scan used in standalone measurements. The measurement volume will be used to enclose all the simultaneous transmitting antennas. For antennas transmitting simultaneously in different frequency bands, the volume scan is measured separately in each frequency band. In order to sum correctly to compute the 1g aggregate SAR, the DUT remain in the same test position for all measurements and all volume scan use the same spatial resolution and grid spacing. When all volume scan were completed, the software, SEMCAD postprocessor can combine and subsequently superpose these measurement data to calculating the multiband SAR.

9.4 SAR Averaged Methods

In DASYS, the interpolation and extrapolation are both based on the modified Quadratic Shepard's method. The interpolation scheme combines a least-square fitted function method and a weighted average method which are the two basic types of computational interpolation and approximation. Extrapolation routines are used to obtain SAR values between the lowest measurement points and the inner phantom surface. The extrapolation distance is determined by the surface detection distance and the probe sensor offset. The uncertainty increases with the extrapolation distance. To keep the uncertainty within 1% for the 1 g and 10 g cubes, the extrapolation distance should not be larger than 5 mm.

9.5 Power Drift Monitoring

All SAR testing is under the DUT install full charged battery and transmit maximum output power. In DASYS measurement software, the power reference measurement and power drift measurement procedures are used for monitoring the power drift of DUT during SAR test. Both these procedures measure the field at a specified reference position before and after the SAR testing. The software will calculate the field difference in dB. If the power drift more than 5%, the SAR will be retested.



10. SAR Test Results Summary

10.1 Head Measurement SAR

Index	Position	Band	Ch.	Data Rate or Sub-Test	SIM	Spacing (mm)	SAR _{1g} (W/Kg)	Power Drift	Source-Time-Avg power (dBm)	Time-Avg Tune-Up	Reported SAR _{1g} (W/Kg)
#1	RC	GSM 850	251	1D1U	1	0	0.413	-0.17	23.37	23.5	0.426
#2	RT	GSM 850	251	1D1U	1	0	0.247	-0.15	23.37	23.5	0.255
#3	LC	GSM 850	251	1D1U	1	0	0.467	0.00	23.37	23.5	0.481
#4	LT	GSM 850	251	1D1U	1	0	0.247	0.02	23.37	23.5	0.255
#5	RC	GPRS 850	251	1D4U	1	0	0.731	0.16	25.29	25.5	0.767
#6	RT	GPRS 850	251	1D4U	1	0	0.437	0.08	25.29	25.5	0.459
#9	LC	GPRS 850	128	1D4U	1	0	0.462	0.05	25.09	25.5	0.508
#7	LC	GPRS 850	251	1D4U	1	0	0.773	0.10	25.29	25.5	0.811
#10	LC	GPRS 850	190	1D4U	1	0	0.680	0.09	25.19	25.5	0.730
#8	LT	GPRS 850	251	1D4U	1	0	0.439	0.05	25.29	25.5	0.461
#11	RC	GSM 1900	512	1D1U	1	0	0.207	0.19	20.37	21.0	0.239
#12	RT	GSM 1900	512	1D1U	1	0	0.104	0.01	20.37	21.0	0.120
#13	LC	GSM 1900	512	1D1U	1	0	0.180	0.01	20.37	21.0	0.208
#14	LT	GSM 1900	512	1D1U	1	0	0.100	-0.05	20.37	21.0	0.116
#15	RC	GPRS 1900	810	1D4U	1	0	0.256	-0.19	22.39	23.0	0.295
#16	RT	GPRS 1900	810	1D4U	1	0	0.116	0.18	22.39	23.0	0.133
#17	LC	GPRS 1900	810	1D4U	1	0	0.213	0.17	22.39	23.0	0.245
#18	LT	GPRS 1900	810	1D4U	1	0	0.112	0.04	22.39	23.0	0.129

- Note: 1. According KDB 447498 D01 V05r02 section 4.1.4, the "Reported" explanation as below:
 "When SAR or MPE is measured at or scaled to the maximum tune-up tolerance limit, the results are referred to as reported."
 2. If the Channel's Reported SAR 1g of maximum conducted power is > 0.8 W/Kg, low, middle and high channel are supposed to be tested.



Index.	Position	Band	Ch.	Data Rate or Sub-Test	SIM	Spacing (mm)	SAR _{1g} (W/Kg)	Power Drift	Burst Avg Power	Max tune-up	Reported SAR _{1g} (W/Kg)
#39	RC	WCDMA Band II	9538	RMC12.2K	1	0	0.298	0.14	22.22	23	0.357
#40	RT	WCDMA Band II	9538	RMC12.2K	1	0	0.134	0.06	22.22	23	0.160
#41	LC	WCDMA Band II	9538	RMC12.2K	1	0	0.272	0.03	22.22	23	0.326
#42	LT	WCDMA Band II	9538	RMC12.2K	1	0	0.130	0.01	22.22	23	0.156
#65	RC	WCDMA Band IV	1413	RMC12.2K	1	0	0.279	-0.03	22.25	23	0.332
#66	RT	WCDMA Band IV	1413	RMC12.2K	1	0	0.121	0.09	22.25	23	0.144
#67	LC	WCDMA Band IV	1413	RMC12.2K	1	0	0.277	-0.09	22.25	23	0.329
#68	LT	WCDMA Band IV	1413	RMC12.2K	1	0	0.107	0.07	22.25	23	0.127
#43	RC	WCDMA Band V	4183	RMC12.2K	1	0	0.348	0.16	22.71	23	0.372
#44	RT	WCDMA Band V	4183	RMC12.2K	1	0	0.218	0.15	22.71	23	0.233
#45	LC	WCDMA Band V	4183	RMC12.2K	1	0	0.382	0.04	22.71	23	0.408
#46	LT	WCDMA Band V	4183	RMC12.2K	1	0	0.213	0.14	22.71	23	0.228

Index.	Position	Band	Ch.	Data Rate or Sub-Test	Side	Spacing (mm)	SAR _{1g} (W/Kg)	Power Drift	Burst Avg Power	Max tune-up	Reported SAR _{1g} (W/Kg)
#57	RC	IEEE 802.11b	1	5.5M	-	0	0.645	-0.14	16.82	17	0.672
#58	RT	IEEE 802.11b	1	5.5M	-	0	0.468	0.02	16.82	17	0.488
#59	LC	IEEE 802.11b	1	5.5M	-	0	0.273	-0.07	16.82	17	0.285
#60	LT	IEEE 802.11b	1	5.5M	-	0	0.289	0.05	16.82	17	0.301

- Note: 1. According KDB 447498 D01 V05r02 section 4.1.4, the "Reported" explanation as below:
 "When SAR or MPE is measured at or scaled to the maximum tune-up tolerance limit, the results are referred to as reported."
 2. If the Channel's Reported SAR 1g of maximum conducted power is > 0.8 W/Kg, low, middle and high channel are supposed to be tested.
 3. HSDPA & HSUPA power are not more than WCDMA 0.25dB and the SAR value of WCDMA <1.2 mW/g therefore HSDPA & HSUPA Stand-alone SAR is not required.
 4. The conducted power of (IEEE 802.11g / 802.11n) are not higher than IEEE 802.11b 0.25dB, (IEEE 802.11g / 802.11n) are not supposed to be tested.



10.2 Body Measurement SAR

Evaluated body SAR refers to Hot-spot mode measurement results.

10.3 Hot-spot mode Measurement SAR

Index.	Position	Band	Ch.	Data Rate or Sub-Test	Side to Phantom	SIM	Spacing (mm)	ASSY.	SAR _{1g} (W/Kg)	Power Drift	Source-Time-Avg power (dBm)	Time-Avg Tune-Up	Reported SAR _{1g} (W/Kg)
#20	Flat	GSM 850	251	1D1U	1	1	10	Headset	0.400	-0.05	23.37	23.5	0.412
#21	Flat		251	1D1U	2	1	10	Headset	0.508	0.06	23.37	23.5	0.523
#27	Flat	GPRS 850	128	1D4U	1	1	10	---	0.661	-0.03	25.09	25.5	0.726
#29	Flat		128	1D4U	2	1	10	---	0.799	0.00	25.09	25.5	0.878
#28	Flat		190	1D4U	1	1	10	---	0.800	-0.04	25.19	25.5	0.859
#30	Flat		190	1D4U	2	1	10	---	0.961	0.08	25.19	25.5	1.032
#22	Flat		251	1D4U	1	1	10	---	0.854	0.07	25.29	25.5	0.896
#23	Flat		251	1D4U	2	1	10	---	0.907	-0.15	25.29	25.5	0.952
#24	Flat		251	1D4U	4	1	10	---	0.129	0.03	25.29	25.5	0.135
#25	Flat		251	1D4U	5	1	10	---	0.605	-0.04	25.29	25.5	0.635
#26	Flat		251	1D4U	6	1	10	---	0.546	-0.05	25.29	25.5	0.573
#31	Flat		GSM 1900	512	1D1U	1	1	10	Headset	0.272	-0.01	20.37	21.0
#32	Flat	512		1D1U	2	1	10	Headset	0.341	-0.05	20.37	21.0	0.394
#33	Flat	GPRS 1900	810	1D4U	1	1	10	---	0.394	-0.08	22.39	23.0	0.453
#34	Flat		810	1D4U	2	1	10	---	0.431	0.08	22.39	23.0	0.496
#35	Flat		810	1D4U	4	1	10	---	0.525	-0.02	22.39	23.0	0.604
#36	Flat		810	1D4U	5	1	10	---	0.102	0.00	22.39	23.0	0.117
#37	Flat		810	1D4U	6	1	10	---	0.130	-0.06	22.39	23.0	0.150

- Note: 1. According KDB 447498 D01 V05r02 section 4.1.4, the "Reported" explanation as below:
 "When SAR or MPE is measured at or scaled to the maximum tune-up tolerance limit, the results are referred to as reported."
 2. If the Channel's Reported SAR 1g of maximum conducted power is > 0.8 W/Kg, low, middle and high channel are supposed to be tested.
 3. For hot-spot mode, the WWAN antenna location to edge >2.5 cm therefore test Side 3 is not required.



Index.	Position	Band	Ch.	Data Rate or Sub-Test	Side to Phantom	SIM	Spacing (mm)	SAR _{1g} (W/Kg)	Power Drift	Burst Avg Power	Max tune-up	Reported SAR _{1g} (W/Kg)
#47	Flat	WCDMA Band II	9538	RMC12.2K	1	1	10	0.504	-0.01	22.22	23	0.603
#48	Flat	WCDMA Band II	9538	RMC12.2K	2	1	10	0.506	0.03	22.22	23	0.606
#49	Flat	WCDMA Band II	9538	RMC12.2K	4	1	10	0.644	0.18	22.22	23	0.771
#50	Flat	WCDMA Band II	9538	RMC12.2K	5	1	10	0.115	-0.10	22.22	23	0.138
#51	Flat	WCDMA Band II	9538	RMC12.2K	6	1	10	0.146	0.11	22.22	23	0.175
#69	Flat	WCDMA Band IV	1413	RMC12.2K	1	1	10	0.371	-0.09	22.25	23	0.441
#70	Flat	WCDMA Band IV	1413	RMC12.2K	2	1	10	0.617	0.00	22.25	23	0.733
#71	Flat	WCDMA Band IV	1413	RMC12.2K	4	1	10	0.442	0.06	22.25	23	0.525
#72	Flat	WCDMA Band IV	1413	RMC12.2K	5	1	10	0.080	0.08	22.25	23	0.095
#73	Flat	WCDMA Band IV	1413	RMC12.2K	6	1	10	0.104	0.02	22.25	23	0.124
#52	Flat	WCDMA Band V	4183	RMC12.2K	1	1	10	0.499	0.00	22.71	23	0.533
#53	Flat	WCDMA Band V	4183	RMC12.2K	2	1	10	0.597	0.02	22.71	23	0.638
#54	Flat	WCDMA Band V	4183	RMC12.2K	4	1	10	0.067	0.07	22.71	23	0.072
#55	Flat	WCDMA Band V	4183	RMC12.2K	5	1	10	0.369	-0.06	22.71	23	0.394
#56	Flat	WCDMA Band V	4183	RMC12.2K	6	1	10	0.328	-0.05	22.71	23	0.351

- Note: 1. According KDB 447498 D01 V05r02 section 4.1.4, the "Reported" explanation as below:
 "When SAR or MPE is measured at or scaled to the maximum tune-up tolerance limit, the results are referred to as reported."
2. If the Channel's Reported SAR 1g of maximum conducted power is > 0.8 W/Kg, low, middle and high channel are supposed to be tested.
 3. For hot-spot mode, the WWAN antenna location to edge >2.5 cm therefore test Side 3 is not required.
 4. HSDPA & HSUPA power are not more than WCDMA 0.25dB and the SAR value of WCDMA <1.2 mW/g therefore HSDPA & HSUPA Stand-alone SAR is not required.



Index.	Position	Band	Ch.	Data Rate or Sub-Test	Side to Phantom	Spacing (mm)	SAR _{1g} (W/Kg)	Power Drift	Burst Avg Power	Max tune-up	Reported SAR _{1g} (W/Kg)
#61	Flat	IEEE 802.11b	1	5.5M	1	---	0.124	0.06	16.82	17.0	0.129
#62	Flat	IEEE 802.11b	1	5.5M	2	---	0.133	0.04	16.82	17.0	0.139
#63	Flat	IEEE 802.11b	1	5.5M	3	---	0.096	0.16	16.82	17.0	0.100
#64	Flat	IEEE 802.11b	1	5.5M	5	---	0.114	-0.01	16.82	17.0	0.119
#74	Flat	Bluetooth v 3.0	78	1M	1	---	0.022	0.19	-1.02	0.5	0.030
#75	Flat	Bluetooth v 3.0	78	1M	2	---	0.032	-0.04	-1.02	0.5	0.050

- Note: 1. According KDB 447498 D01 V05r02 section 4.1.4, the "Reported" explanation as below:
 "When SAR or MPE is measured at or scaled to the maximum tune-up tolerance limit, the results are referred to as reported."
 2. If the Channel's Reported SAR_{1g} of maximum conducted power is > 0.8 W/Kg, low, middle and high channel are supposed to be tested.
 3. The conducted power of (IEEE 802.11g / 802.11n) are not higher than IEEE 802.11b 0.25dB, (IEEE 802.11g / 802.11n) are not supposed to be tested.
 4. For hot-spot mode, the WLAN antenna location to edge >2.5 cm, therefore test Side 4 and Side 6 are not required.

10.4 Extremity Measurement SAR

Evaluated extremity SAR is not available.

10.5 SAR Measurement Variability

Detailed evaluations please refer KDB 865664 on "SAR test reduction according to KDB" section.

Index.	Position	Band	Ch.	Data Rate or Sub-Test	Side to Phantom	SIM	Spacing (mm)	Number of Times	SAR _{1g} (W/Kg)	Power Drift	Source-Time-Avg power (dBm)	Time-Avg Tune-Up	Reported SAR _{1g} (W/Kg)	Max Repeated measurement Ratio
#19	LC	GPRS 850	251	1D4U	---	1	0	1	0.754	0	25.29	25.5	0.791	1.02<1.2
#38	Flat	GPRS 850	190	1D4U	2	1	10	1	0.968	-0.12	25.19	25.5	1.04	1.01<1.2

Note: The original highest measured Reported SAR_{1g} is ≥ 0.8 W/kg, repeat that measurement once.



10.6 Std. C95.1-1999 RF Exposure Limit

Human Exposure	Population Uncontrolled Exposure (W/kg) or (mW/g)	Occupational Controlled Exposure (W/kg) or (mW/g)
Spatial Peak SAR* (head)	1.60	8.00
Spatial Peak SAR** (Whole Body)	0.08	0.40
Spatial Peak SAR*** (Partial-Body)	1.60	8.00
Spatial Peak SAR**** (Hands / Feet / Ankle / Wrist)	4.00	20.00

3. Safety Limits for Partial Body Exposure

Notes :

- * The Spatial Peak value of the SAR averaged over any 1 gram of tissue.
(defined as a tissue volume in the shape of a cube) and over the appropriate averaging time.
- ** The Spatial Average value of the SAR averaged over the whole – body.
- *** The Spatial Average value of the SAR averaged over the partial – body.
- **** The Spatial Peak value of the SAR averaged over any 10 grams of tissue.
(defined as a tissue volume in the shape of a cube) and over the appropriate averaging time.

Population / Uncontrolled Environments : are defined as locations where there is the exposure of individuals who have no knowledge or control of their exposure.

Occupational / Controlled Environments : are defined as locations where there is exposure that may be incurred by persons who are aware of the potential for exposure, (i.e. as a result of employment or occupation).



11. Conclusion

The SAR test values found for the portable mobile phone **Sky Phone LLC Trade Name : SKY DEVICE Model(s) : SKY 4.5D** is below the maximum recommended level of 1.6 W/kg (mW/g).

12. References

- [1] Std. C95.1-1999, "American National Standard safety levels with respect to human exposure to radio frequency electromagnetic fields, 300KHz to 100GHz", New York.
- [2] NCRP, National Council on Radiation Protection and Measurements, "Biological Effects and Exposure Criteria for Radio frequency Electromagnetic Fields", NCRP report NO. 86, 1986.
- [3] T. Schmid, O. Egger, and N. Kuster, "Automatic E-field scanning system for dosimetric assessments", IEEE Transactions on Microwave Theory and Techniques, vol. 44, pp, 105-113, Jan. 1996.
- [4] K. Pokovi^c, T. Schmid, and N. Kuster, "Robust setup for precise calibration of E-field probes in tissue simulating liquids at mobile communications frequency", in ICECOM'97, Dubrovnik, October 15-17, 1997, pp.120-124.
- [5] K. Pokovi^c, T. Schmid, and N. Kuster, "E-field probe with improved isotropy in brain simulating liquids", in Proceedings of the ELMAR, Zadar, Croatia, 23-25 June, 1996, pp.172-175.
- [6] N. Kuster, and Q. Balzano, "Energy absorption mechanism by biological bodies in the near field of dipole antennas above 300MHz", IEEE Transaction on Vehicular Technology, vol. 41, no. 1, Feb. 1992, pp. 17-23.
- [7] Robert J. Renka, "Multivariate Interpolation Of Large Sets Of Scattered Data", University of North Texas ACM Transactions on Mathematical Software, vol. 14, no. 2, June 1988 , pp. 139-148.
- [8] N. Kuster, R. Kastle, T. Schmid, Dosimetric evaluation of mobile communications equipment with known precision, IEEE Transaction on Communications, vol. E80-B, no. 5, May 1997, pp. 645-652.
- [9] Std. C95.3-1991, "IEEE Recommended Practice for the Measurement of Potentially Hazardous Electromagnetic Fields – RF and Microwave, New York: IEEE, Aug. 1992.
- [10] CENELEC CLC/SC111B, European Prestandard (prENV 50166-2), Human Exposure to Electromagnetic Fields High-frequency: 10KHz-300GHz, Jan. 1995.
- [11] IEEE Std 1528™-2013 - IEEE Recommended Practice for Determining the Peak Spatial-Average Specific Absorption Rate (SAR) in the Human Head From Wireless Communications Devices: Measurement Techniques
- [12] IEEE Std 1528a™-2005 (Amendment to IEEE Std 1528™-2013), IEEE Recommended Practice for Determining the Peak Spatial-Average Specific Absorption Rate (SAR) in the Human Head from Wireless Communications Devices: Measurement Techniques

13. SAR Measurement Guidance

- [1] KDB 865664 D01 SAR measurement 100 MHz to 6 GHz v01r03
- [2] KDB 865664 D02 RF Exposure Reporting v01r01
- [3] KDB 447498 D01 General RF Exposure Guidance v05r02
- [4] KDB 248227 D01 SAR meas for 802 11 a b g v01r02.
- [5] KDB 941225 D01 SAR test for 3G devices v02
- [6] KDB 941225 D02 HSPA and 1x Advanced v02r02
- [7] KDB 941225 D03 SAR Test Reduction GSM GPRS EDGE vo1
- [8] KDB 941225 D06 Hotspot SAR v01r01
- [9] KDB 648474 D03 Wireless Chargers Battery Cover v01r02
- [10] KDB 648474 D04 Handset SAR v01r02



Appendix A - System Performance Check

Test Laboratory: A Test Lab Techno Corp.

Date: 2014/7/7 Time: PM 09:38:36

System Performance Check at 835MHz_20140707_Head

DUT: Dipole 835 MHz; Type: D835V2; Serial: D835V2 - SN:4d082

Communication System: UID 0, CW (0); Frequency: 835 MHz; Duty Cycle: 1:1

Medium parameters used: $f = 835 \text{ MHz}$; $\sigma = 0.918 \text{ S/m}$; $\epsilon_r = 43.309$; $\rho = 1000 \text{ kg/m}^3$

Phantom section: Flat Section

Measurement Standard: DASYS5 (IEEE/IEC/ANSI C63.19-2011)

DASY Configuration:

- Area Scan setting - Find Secondary Maximum Within: 2.0dB and with a peak SAR value greater than 0.5 W/Kg
- Probe: EX3DV4 - SN3977; ConvF(9.62, 9.62, 9.62); Calibrated: 2014/2/17;
- Sensor-Surface: 2mm (Mechanical Surface Detection)
- Electronics: DAE4 Sn779; Calibrated: 2014/2/25
- Phantom: SAM with CRP; Type: SAM; Serial: TP-1150 and higher
- Measurement SW: DASYS52, Version 52.8 (7); SEMCAD X Version 14.6.10 (7164)

System Performance Check at 835MHz/Area Scan (61x121x1):

Interpolated grid: $dx=1.500 \text{ mm}$, $dy=1.500 \text{ mm}$

Maximum value of SAR (interpolated) = 3.23 W/kg

System Performance Check at 835MHz/Zoom Scan (7x7x7)/Cube 0:

Measurement grid: $dx=5\text{mm}$, $dy=5\text{mm}$, $dz=5\text{mm}$

Reference Value = 59.527 V/m; Power Drift = -0.13 dB

Peak SAR (extrapolated) = 3.50 W/kg

SAR(1 g) = 2.32 W/kg; SAR(10 g) = 1.51 W/kg

Maximum value of SAR (measured) = 2.95 W/kg

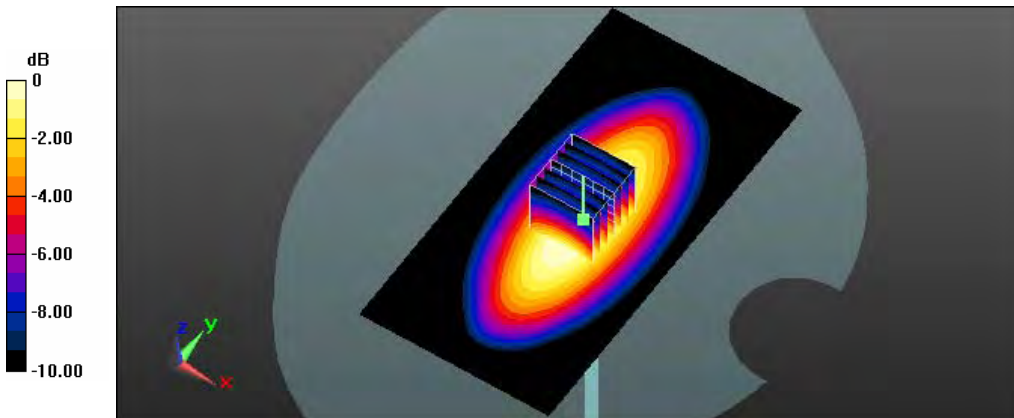

0 dB = 2.95 W/kg = 4.70 dBW/kg

Test Laboratory: A Test Lab Techno Corp.
 Date: 2014/7/8 Time: PM 12:04:31

System Performance Check at 835MHz_20140708_Body

DUT: Dipole 835 MHz; Type: D835V2; Serial: D835V2 - SN:4d082

Communication System: UID 0, CW (0); Frequency: 835 MHz; Duty Cycle: 1:1

Medium parameters used: $f = 835 \text{ MHz}$; $\sigma = 0.99 \text{ S/m}$; $\epsilon_r = 56.434$; $\rho = 1000 \text{ kg/m}^3$

Phantom section: Flat Section

Measurement Standard: DASYS (IEEE/IEC/ANSI C63.19-2011)

DASY Configuration:

- Area Scan setting - Find Secondary Maximum Within: 2.0dB and with a peak SAR value greater than 0.5 W/Kg
- Probe: EX3DV4 - SN3977; ConvF(9.74, 9.74, 9.74); Calibrated: 2014/2/17;
- Sensor-Surface: 2mm (Mechanical Surface Detection)
- Electronics: DAE4 Sn779; Calibrated: 2014/2/25
- Phantom: SAM with CRP; Type: SAM; Serial: TP-1150 and higher
- Measurement SW: DASYS2, Version 52.8 (7); SEMCAD X Version 14.6.10 (7164)

System Performance Check at 835MHz/Area Scan (61x121x1):

Interpolated grid: $dx=1.500 \text{ mm}$, $dy=1.500 \text{ mm}$

Maximum value of SAR (interpolated) = 3.10 W/kg

System Performance Check at 835MHz/Zoom Scan (7x7x7)/Cube 0:

Measurement grid: $dx=5\text{mm}$, $dy=5\text{mm}$, $dz=5\text{mm}$

Reference Value = 56.188 V/m; Power Drift = -0.13 dB

Peak SAR (extrapolated) = 3.63 W/kg

SAR(1 g) = 2.47 W/kg; SAR(10 g) = 1.63 W/kg

Maximum value of SAR (measured) = 3.11 W/kg

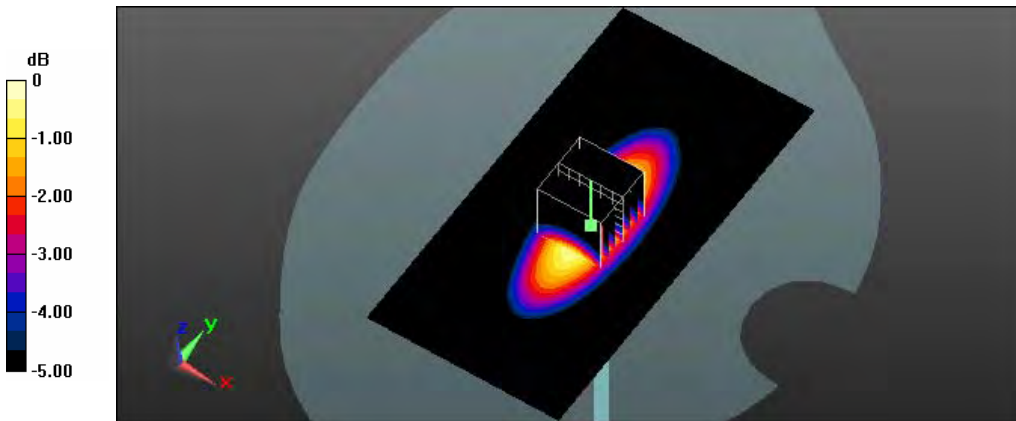

0 dB = 3.11 W/kg = 4.93 dBW/kg

Test Laboratory: A Test Lab Techno Corp.
 Date: 2014/7/9 Time: PM 05:26:57

System Performance Check at 835MHz_20140709_Head

DUT: Dipole 835 MHz; Type: D835V2; Serial: D835V2 - SN:4d082

Communication System: UID 0, CW (0); Frequency: 835 MHz; Duty Cycle: 1:1

Medium parameters used: $f = 835 \text{ MHz}$; $\sigma = 0.918 \text{ S/m}$; $\epsilon_r = 43.309$; $\rho = 1000 \text{ kg/m}^3$

Phantom section: Flat Section

Measurement Standard: DASYS (IEEE/IEC/ANSI C63.19-2011)

DASY Configuration:

- Area Scan setting - Find Secondary Maximum Within: 2.0dB and with a peak SAR value greater than 0.5 W/Kg
- Probe: EX3DV4 - SN3977; ConvF(9.62, 9.62, 9.62); Calibrated: 2014/2/17;
- Sensor-Surface: 2mm (Mechanical Surface Detection)
- Electronics: DAE4 Sn779; Calibrated: 2014/2/25
- Phantom: SAM with CRP; Type: SAM; Serial: TP-1150 and higher
- Measurement SW: DASYS2, Version 52.8 (7); SEMCAD X Version 14.6.10 (7164)

System Performance Check at 835MHz/Area Scan (61x121x1):

Interpolated grid: $dx=1.500 \text{ mm}$, $dy=1.500 \text{ mm}$

Maximum value of SAR (interpolated) = 3.05 W/kg

System Performance Check at 835MHz/Zoom Scan (7x7x7)/Cube 0:

Measurement grid: $dx=5\text{mm}$, $dy=5\text{mm}$, $dz=5\text{mm}$

Reference Value = 58.529 V/m; Power Drift = -0.06 dB

Peak SAR (extrapolated) = 3.62 W/kg

SAR(1 g) = 2.38 W/kg; SAR(10 g) = 1.55 W/kg

Maximum value of SAR (measured) = 3.04 W/kg

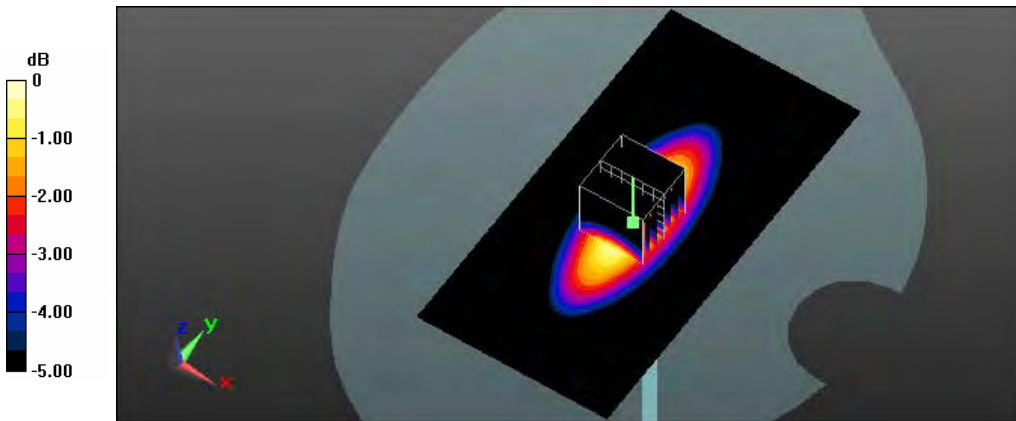

0 dB = 3.04 W/kg = 4.83 dBW/kg

Test Laboratory: A Test Lab Techno Corp.
 Date: 2014/7/12 Time: AM 01:47:32

System Performance Check at 835MHz_20140712_Head

DUT: Dipole 835 MHz; Type: D835V2; Serial: D835V2 - SN:4d082

Communication System: UID 0, CW (0); Frequency: 835 MHz; Duty Cycle: 1:1

Medium parameters used: $f = 835 \text{ MHz}$; $\sigma = 0.918 \text{ S/m}$; $\epsilon_r = 43.309$; $\rho = 1000 \text{ kg/m}^3$

Phantom section: Flat Section

Measurement Standard: DASYS (IEEE/IEC/ANSI C63.19-2011)

DASY Configuration:

- Area Scan setting - Find Secondary Maximum Within: 2.0dB and with a peak SAR value greater than 0.5 W/Kg
- Probe: EX3DV4 - SN3977; ConvF(9.62, 9.62, 9.62); Calibrated: 2014/2/17;
- Sensor-Surface: 2mm (Mechanical Surface Detection)
- Electronics: DAE4 Sn779; Calibrated: 2014/2/25
- Phantom: SAM with CRP; Type: SAM; Serial: TP-1150 and higher
- Measurement SW: DASYS52, Version 52.8 (7); SEMCAD X Version 14.6.10 (7164)

System Performance Check at 835MHz/Area Scan (61x121x1):

Interpolated grid: $dx=1.500 \text{ mm}$, $dy=1.500 \text{ mm}$

Maximum value of SAR (interpolated) = 2.95 W/kg

System Performance Check at 835MHz/Zoom Scan (7x7x7)/Cube 0:

Measurement grid: $dx=5\text{mm}$, $dy=5\text{mm}$, $dz=5\text{mm}$

Reference Value = 58.676 V/m; Power Drift = -0.01 dB

Peak SAR (extrapolated) = 3.51 W/kg

SAR(1 g) = 2.32 W/kg; SAR(10 g) = 1.51 W/kg

Maximum value of SAR (measured) = 2.96 W/kg

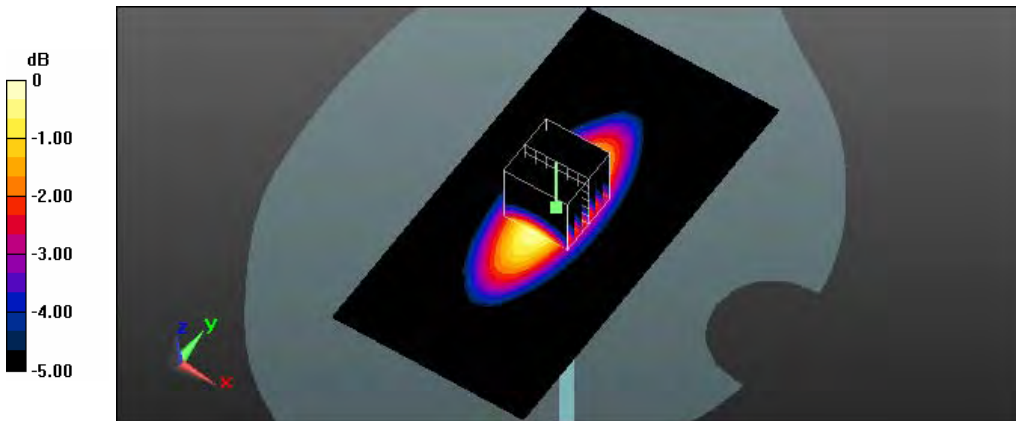

0 dB = 2.96 W/kg = 4.71 dBW/kg

Test Laboratory: A Test Lab Techno Corp.
 Date: 2014/7/16 Time: AM 11:48:28

System Performance Check at 1750MHz_20140716_Head

DUT: Dipole D1750V2_SN1023; Type: D1750V2; Serial: D1750V2 - SN:1023

Communication System: UID 0, CW (0); Frequency: 1750 MHz; Duty Cycle: 1:1

Medium parameters used: $f = 1750 \text{ MHz}$; $\sigma = 1.397 \text{ S/m}$; $\epsilon_r = 41.387$; $\rho = 1000 \text{ kg/m}^3$

Phantom section: Flat Section

Measurement Standard: DASY5 (IEEE/IEC/ANSI C63.19-2011)

DASY Configuration:

- Area Scan setting - Find Secondary Maximum Within: 2.0dB and with a peak SAR value greater than 0.5 W/Kg
- Probe: EX3DV4 - SN3977; ConvF(8.14, 8.14, 8.14); Calibrated: 2014/2/17;
- Sensor-Surface: 2mm (Mechanical Surface Detection)
- Electronics: DAE4 Sn779; Calibrated: 2014/2/25
- Phantom: SAM with CRP; Type: SAM; Serial: TP-1150 and higher
- Measurement SW: DASY52, Version 52.8 (7); SEMCAD X Version 14.6.10 (7164)

System Performance Check at 1750MHz/Area Scan (61x61x1):

Interpolated grid: $dx=1.500 \text{ mm}$, $dy=1.500 \text{ mm}$

Maximum value of SAR (interpolated) = 13.4 W/kg

System Performance Check at 1750MHz/Zoom Scan (7x7x7)/Cube 0:

Measurement grid: $dx=5\text{mm}$, $dy=5\text{mm}$, $dz=5\text{mm}$

Reference Value = 95.008 V/m; Power Drift = 0.07 dB

Peak SAR (extrapolated) = 17.5 W/kg

SAR(1 g) = 9.24 W/kg; SAR(10 g) = 4.73 W/kg

Maximum value of SAR (measured) = 13.5 W/kg

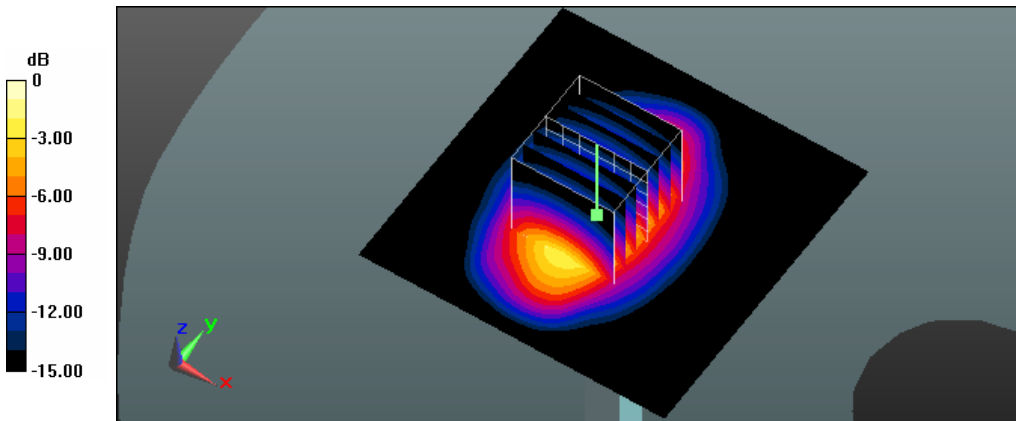

0 dB = 13.5 W/kg = 11.30 dBW/kg

Test Laboratory: A Test Lab Techno Corp.
 Date: 2014/7/16 Time: PM 03:29:18

System Performance Check at 1750MHz_20140716_Body

DUT: Dipole D1750V2_SN1023; Type: D1750V2; Serial: D1750V2 - SN:1023

Communication System: UID 0, CW (0); Frequency: 1750 MHz; Duty Cycle: 1:1

Medium parameters used: $f = 1750 \text{ MHz}$; $\sigma = 1.546 \text{ S/m}$; $\epsilon_r = 52.7$; $\rho = 1000 \text{ kg/m}^3$

Phantom section: Flat Section

Measurement Standard: DASY5 (IEEE/IEC/ANSI C63.19-2011)

DASY Configuration:

- Area Scan setting - Find Secondary Maximum Within: 2.0dB and with a peak SAR value greater than 0.5 W/Kg
- Probe: EX3DV4 - SN3977; ConvF(7.69, 7.69, 7.69); Calibrated: 2014/2/17;
- Sensor-Surface: 2mm (Mechanical Surface Detection)
- Electronics: DAE4 Sn779; Calibrated: 2014/2/25
- Phantom: SAM with CRP; Type: SAM; Serial: TP-1150 and higher
- Measurement SW: DASY52, Version 52.8 (7); SEMCAD X Version 14.6.10 (7164)

System Performance Check at 1750MHz/Area Scan (61x61x1):

Interpolated grid: $dx=1.500 \text{ mm}$, $dy=1.500 \text{ mm}$

Maximum value of SAR (interpolated) = 13.4 W/kg

System Performance Check at 1750MHz/Zoom Scan (7x7x7)/Cube 0:

Measurement grid: $dx=5\text{mm}$, $dy=5\text{mm}$, $dz=5\text{mm}$

Reference Value = 88.714 V/m; Power Drift = 0.19 dB

Peak SAR (extrapolated) = 17.3 W/kg

SAR(1 g) = 9.53 W/kg; SAR(10 g) = 4.92 W/kg

Maximum value of SAR (measured) = 13.7 W/kg

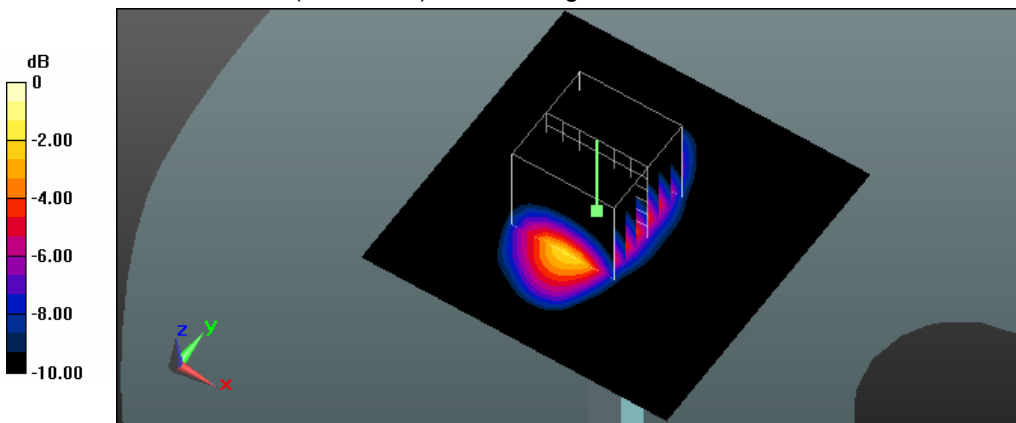

0 dB = 13.7 W/kg = 11.37 dBW/kg

Test Laboratory: A Test Lab Techno Corp.
 Date: 2014/7/10 Time: AM 01:00:36

System Performance Check at 1900MHz_201407010_Head

DUT: Dipole D1900V2_SN5d111; Type: D1900V2; Serial: D1900V2 - SN:5d111

Communication System: UID 0, CW (0); Frequency: 1900 MHz; Duty Cycle: 1:1

Medium parameters used: $f = 1900 \text{ MHz}$; $\sigma = 1.392 \text{ S/m}$; $\epsilon_r = 40.477$; $\rho = 1000 \text{ kg/m}^3$

Phantom section: Flat Section

Measurement Standard: DASYS (IEEE/IEC/ANSI C63.19-2011)

DASY Configuration:

- Area Scan setting - Find Secondary Maximum Within: 2.0dB and with a peak SAR value greater than 0.5 W/Kg
- Probe: EX3DV4 - SN3977; ConvF(7.97, 7.97, 7.97); Calibrated: 2014/2/17;
- Sensor-Surface: 2mm (Mechanical Surface Detection)
- Electronics: DAE4 Sn779; Calibrated: 2014/2/25
- Phantom: SAM with CRP; Type: SAM; Serial: TP-1150 and higher
- Measurement SW: DASYS2, Version 52.8 (7); SEMCAD X Version 14.6.10 (7164)

System Performance Check at 1900MHz/Area Scan (61x61x1):

Interpolated grid: $dx=1.500 \text{ mm}$, $dy=1.500 \text{ mm}$

Maximum value of SAR (interpolated) = 14.2 W/kg

System Performance Check at 1900MHz/Zoom Scan (7x7x7)/Cube 0:

Measurement grid: $dx=5\text{mm}$, $dy=5\text{mm}$, $dz=5\text{mm}$

Reference Value = 90.270 V/m; Power Drift = 0.18 dB

Peak SAR (extrapolated) = 18.9 W/kg

SAR(1 g) = 9.95 W/kg; SAR(10 g) = 5.06 W/kg

Maximum value of SAR (measured) = 14.5 W/kg

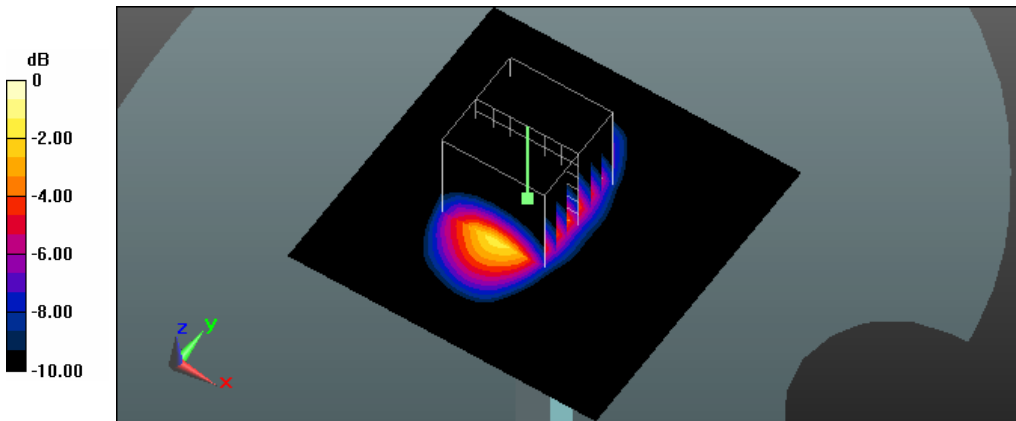

0 dB = 14.5 W/kg = 11.61 dBW/kg

Test Laboratory: A Test Lab Techno Corp.

Date: 2014/7/10 Time: AM 11:47:35

System Performance Check at 1900MHz_201407010_Body

DUT: Dipole D1900V2_SN5d111; Type: D1900V2; Serial: D1900V2 - SN:5d111

Communication System: UID 0, CW (0); Frequency: 1900 MHz; Duty Cycle: 1:1

Medium parameters used: $f = 1900 \text{ MHz}$; $\sigma = 1.475 \text{ S/m}$; $\epsilon_r = 52.463$; $\rho = 1000 \text{ kg/m}^3$

Phantom section: Flat Section

Measurement Standard: DASYS (IEEE/IEC/ANSI C63.19-2011)

DASY Configuration:

- Area Scan setting - Find Secondary Maximum Within: 2.0dB and with a peak SAR value greater than 0.5 W/Kg
- Probe: EX3DV4 - SN3977; ConvF(7.37, 7.37, 7.37); Calibrated: 2014/2/17;
- Sensor-Surface: 2mm (Mechanical Surface Detection)
- Electronics: DAE4 Sn779; Calibrated: 2014/2/25
- Phantom: SAM with CRP; Type: SAM; Serial: TP-1150 and higher
- Measurement SW: DASYS2, Version 52.8 (7); SEMCAD X Version 14.6.10 (7164)

System Performance Check at 1900MHz/Area Scan (61x61x1):

Interpolated grid: $dx=1.500 \text{ mm}$, $dy=1.500 \text{ mm}$

Maximum value of SAR (interpolated) = 14.4 W/kg

System Performance Check at 1900MHz/Zoom Scan (7x7x7)/Cube 0:

Measurement grid: $dx=5\text{mm}$, $dy=5\text{mm}$, $dz=5\text{mm}$

Reference Value = 91.362 V/m; Power Drift = 0.09 dB

Peak SAR (extrapolated) = 19.2 W/kg

SAR(1 g) = 10.3 W/kg; SAR(10 g) = 5.24 W/kg

Maximum value of SAR (measured) = 14.9 W/kg

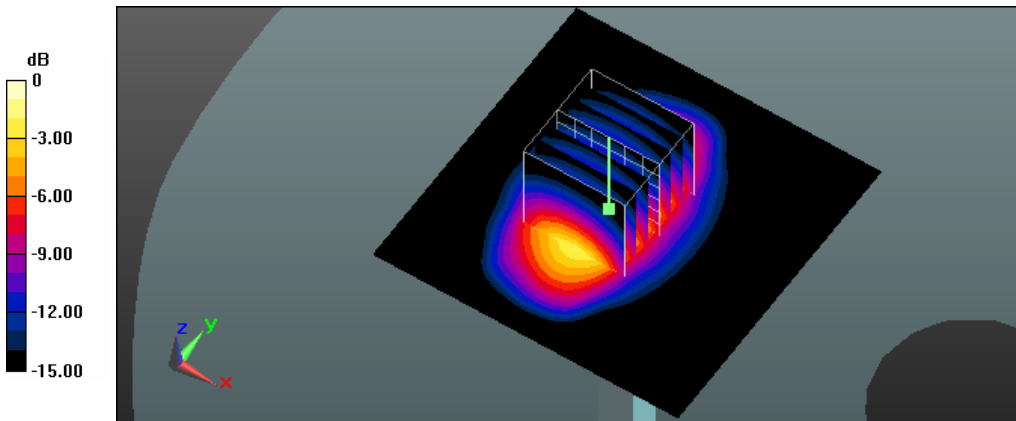

0 dB = 14.9 W/kg = 11.73 dBW/kg

Test Laboratory: A Test Lab Techno Corp.

Date: 2014/7/11 Time: AM 12:02:45

System Performance Check at 1900MHz_201407011_Head

DUT: Dipole D1900V2_SN5d111; Type: D1900V2; Serial: D1900V2 - SN:5d111

Communication System: UID 0, CW (0); Frequency: 1900 MHz; Duty Cycle: 1:1

Medium parameters used: $f = 1900 \text{ MHz}$; $\sigma = 1.392 \text{ S/m}$; $\epsilon_r = 40.477$; $\rho = 1000 \text{ kg/m}^3$

Phantom section: Flat Section

Measurement Standard: DASYS (IEEE/IEC/ANSI C63.19-2011)

DASY Configuration:

- Area Scan setting - Find Secondary Maximum Within: 2.0dB and with a peak SAR value greater than 0.5 W/Kg
- Probe: EX3DV4 - SN3977; ConvF(7.97, 7.97, 7.97); Calibrated: 2014/2/17;
- Sensor-Surface: 2mm (Mechanical Surface Detection)
- Electronics: DAE4 Sn779; Calibrated: 2014/2/25
- Phantom: SAM with CRP; Type: SAM; Serial: TP-1150 and higher
- Measurement SW: DASYS2, Version 52.8 (7); SEMCAD X Version 14.6.10 (7164)

System Performance Check at 1900MHz/Area Scan (61x61x1):

Interpolated grid: $dx=1.500 \text{ mm}$, $dy=1.500 \text{ mm}$

Maximum value of SAR (interpolated) = 13.8 W/kg

System Performance Check at 1900MHz/Zoom Scan (7x7x7)/Cube 0:

Measurement grid: $dx=5\text{mm}$, $dy=5\text{mm}$, $dz=5\text{mm}$

Reference Value = 97.278 V/m; Power Drift = 0.09 dB

Peak SAR (extrapolated) = 18.6 W/kg

SAR(1 g) = 9.94 W/kg; SAR(10 g) = 5.12 W/kg

Maximum value of SAR (measured) = 14.4 W/kg

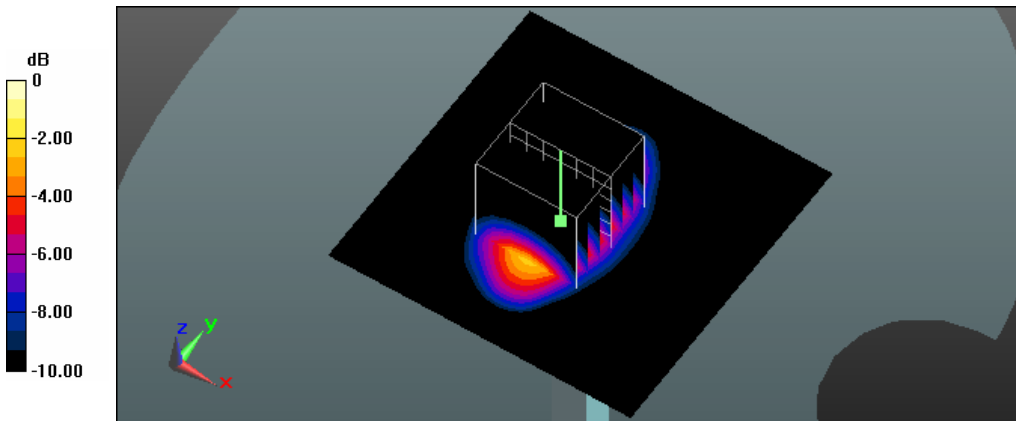

0 dB = 14.4 W/kg = 11.58 dBW/kg

Test Laboratory: A Test Lab Techno Corp.

Date: 2014/7/14 Time: AM 10:00:36

System Performance Check at 1900MHz_20140714_Body

DUT: Dipole D1900V2_SN5d111; Type: D1900V2; Serial: D1900V2 - SN:5d111

Communication System: UID 0, CW (0); Frequency: 1900 MHz; Duty Cycle: 1:1

Medium parameters used: $f = 1900 \text{ MHz}$; $\sigma = 1.475 \text{ S/m}$; $\epsilon_r = 52.463$; $\rho = 1000 \text{ kg/m}^3$

Phantom section: Flat Section

Measurement Standard: DASY5 (IEEE/IEC/ANSI C63.19-2011)

DASY Configuration:

- Area Scan setting - Find Secondary Maximum Within: 2.0dB and with a peak SAR value greater than 0.5 W/Kg
- Probe: EX3DV4 - SN3977; ConvF(7.37, 7.37, 7.37); Calibrated: 2014/2/17;
- Sensor-Surface: 2mm (Mechanical Surface Detection)
- Electronics: DAE4 Sn779; Calibrated: 2014/2/25
- Phantom: SAM with CRP; Type: SAM; Serial: TP-1150 and higher
- Measurement SW: DASY52, Version 52.8 (7); SEMCAD X Version 14.6.10 (7164)

System Performance Check at 1900MHz/Area Scan (61x61x1):

Interpolated grid: $dx=1.500 \text{ mm}$, $dy=1.500 \text{ mm}$

Maximum value of SAR (interpolated) = 14.8 W/kg

System Performance Check at 1900MHz/Zoom Scan (7x7x7)/Cube 0:

Measurement grid: $dx=5\text{mm}$, $dy=5\text{mm}$, $dz=5\text{mm}$

Reference Value = 98.650 V/m; Power Drift = 0.05 dB

Peak SAR (extrapolated) = 19.2 W/kg

SAR(1 g) = 10.4 W/kg; SAR(10 g) = 5.29 W/kg

Maximum value of SAR (measured) = 15.1 W/kg

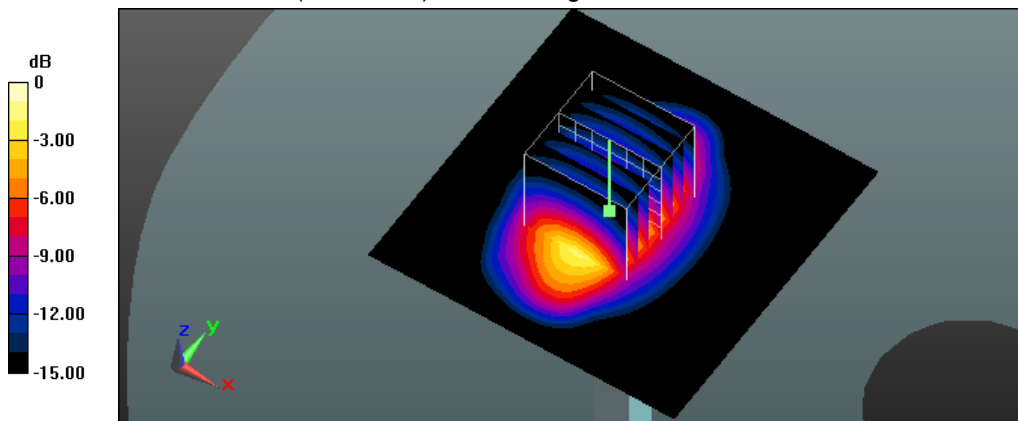

0 dB = 15.1 W/kg = 11.79 dBW/kg

Test Laboratory: A Test Lab Techno Corp.
 Date: 2014/7/11 Time: AM 10:00:42

System Performance Check at 2450MHz_201407011_Body

DUT: Dipole 2450 MHz; Type: D2450V2; Serial: D2450V2 - SN:712

Communication System: UID 0, CW (0); Frequency: 2450 MHz; Duty Cycle: 1:1

Medium parameters used: $f = 2450 \text{ MHz}$; $\sigma = 1.98 \text{ S/m}$; $\epsilon_r = 54.458$; $\rho = 1000 \text{ kg/m}^3$

Phantom section: Flat Section

Measurement Standard: DASY5 (IEEE/IEC/ANSI C63.19-2011)

DASY Configuration:

- Area Scan setting - Find Secondary Maximum Within: 2.0dB and with a peak SAR value greater than 0.5 W/Kg
- Probe: EX3DV4 - SN3977; ConvF(6.97, 6.97, 6.97); Calibrated: 2014/2/17;
- Sensor-Surface: 2mm (Mechanical Surface Detection)
- Electronics: DAE4 Sn779; Calibrated: 2014/2/25
- Phantom: SAM with CRP; Type: SAM; Serial: TP-1150 and higher
- Measurement SW: DASY52, Version 52.8 (7); SEMCAD X Version 14.6.10 (7164)

System Performance Check at 2450MHz/Area Scan (61x61x1):

Interpolated grid: $dx=1.500 \text{ mm}$, $dy=1.500 \text{ mm}$

Maximum value of SAR (interpolated) = 19.4 W/kg

System Performance Check at 2450MHz/Zoom Scan (7x7x7)/Cube 0:

Measurement grid: $dx=5\text{mm}$, $dy=5\text{mm}$, $dz=5\text{mm}$

Reference Value = 94.224 V/m; Power Drift = 0.00 dB

Peak SAR (extrapolated) = 27.6 W/kg

SAR(1 g) = 13.1 W/kg; SAR(10 g) = 5.93 W/kg

Maximum value of SAR (measured) = 20.2 W/kg

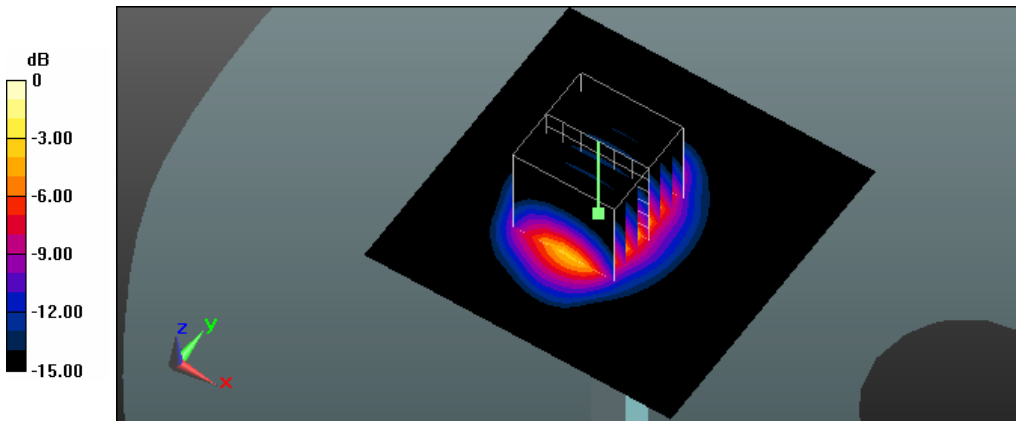

0 dB = 20.2 W/kg = 13.05 dBW/kg

Test Laboratory: A Test Lab Techno Corp.
 Date: 2014/7/11 Time: PM 06:43:17

System Performance Check at 2450MHz_201407011_Head

DUT: Dipole 2450 MHz; Type: D2450V2; Serial: D2450V2 - SN:712

Communication System: UID 0, CW (0); Frequency: 2450 MHz; Duty Cycle: 1:1

Medium parameters used: $f = 2450 \text{ MHz}$; $\sigma = 1.84 \text{ S/m}$; $\epsilon_r = 38.359$; $\rho = 1000 \text{ kg/m}^3$

Phantom section: Flat Section

Measurement Standard: DASY5 (IEEE/IEC/ANSI C63.19-2011)

DASY Configuration:

- Area Scan setting - Find Secondary Maximum Within: 2.0dB and with a peak SAR value greater than 0.5 W/Kg
- Probe: EX3DV4 - SN3977; ConvF(7.24, 7.24, 7.24); Calibrated: 2014/2/17;
- Sensor-Surface: 2mm (Mechanical Surface Detection)
- Electronics: DAE4 Sn779; Calibrated: 2014/2/25
- Phantom: SAM with CRP; Type: SAM; Serial: TP-1150 and higher
- Measurement SW: DASY52, Version 52.8 (7); SEMCAD X Version 14.6.10 (7164)

System Performance Check at 2450MHz/Area Scan (61x61x1):

Interpolated grid: $dx=1.500 \text{ mm}$, $dy=1.500 \text{ mm}$

Maximum value of SAR (interpolated) = 20.3 W/kg

System Performance Check at 2450MHz/Zoom Scan (7x7x7)/Cube 0:

Measurement grid: $dx=5\text{mm}$, $dy=5\text{mm}$, $dz=5\text{mm}$

Reference Value = 98.047 V/m; Power Drift = 0.15 dB

Peak SAR (extrapolated) = 28.2 W/kg

SAR(1 g) = 13.2 W/kg; SAR(10 g) = 5.97 W/kg

Maximum value of SAR (measured) = 20.6 W/kg

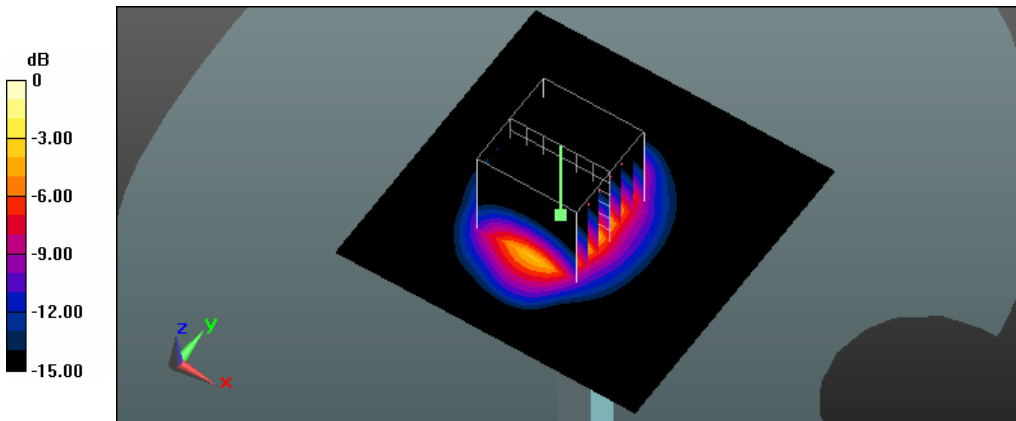

0 dB = 20.6 W/kg = 13.14 dBW/kg



Appendix B - SAR Measurement Data

Test Laboratory: A Test Lab Techno Corp.

Date: 2014/7/8 Time: AM 09:45:26

1_RC_GSM 850 CH251_SIM1

DUT: SKY 4.5D; Type: WCDMA Mobile Phone; Serial: 868817019960135

Communication System: UID 0, GSM850 (0); Frequency: 848.8 MHz; Duty Cycle: 1:8

Medium parameters used: $f = 849$ MHz; $\sigma = 0.943$ S/m; $\epsilon_r = 43.407$; $\rho = 1000$ kg/m³

Phantom section: Right Section

Measurement Standard: DASYS5 (IEEE/IEC/ANSI C63.19-2011)

DASY Configuration:

- Area Scan setting - Find Secondary Maximum Within: 2.0dB and with a peak SAR value greater than 0.5 W/Kg
- Probe: EX3DV4 - SN3977; ConvF(9.62, 9.62, 9.62); Calibrated: 2014/2/17;
- Sensor-Surface: 2mm (Mechanical Surface Detection)
- Electronics: DAE4 Sn779; Calibrated: 2014/2/25
- Phantom: SAM with CRP; Type: SAM; Serial: TP-1150 and higher
- Measurement SW: DASYS52, Version 52.8 (7); SEMCAD X Version 14.6.10 (7164)

Right Cheek/Area Scan (71x121x1):

Interpolated grid: dx=1.500 mm, dy=1.500 mm

Maximum value of SAR (interpolated) = 0.471 W/kg

Right Cheek/Zoom Scan (5x5x7)/Cube 0:

Measurement grid: dx=8mm, dy=8mm, dz=5mm

Reference Value = 4.314 V/m; Power Drift = -0.17 dB

Peak SAR (extrapolated) = 0.503 W/kg

SAR(1 g) = 0.413 W/kg; SAR(10 g) = 0.319 W/kg

Maximum value of SAR (measured) = 0.465 W/kg

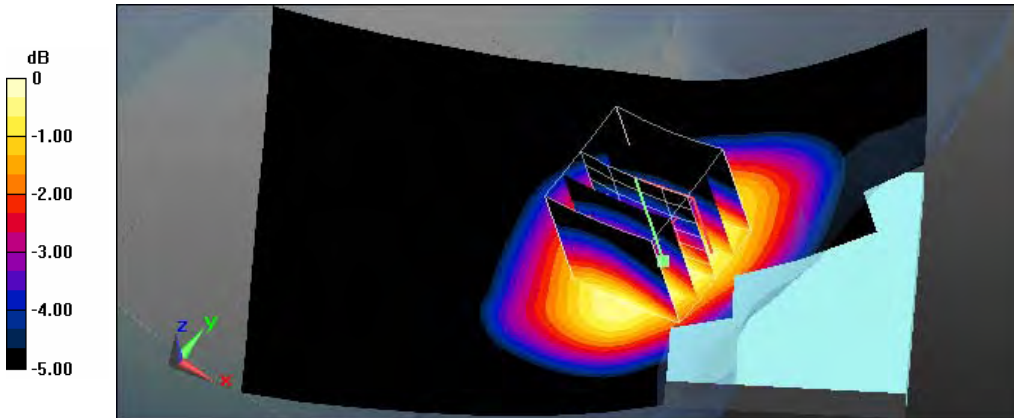

0 dB = 0.465 W/kg = -3.33 dBW/kg

Test Laboratory: A Test Lab Techno Corp.

Date: 2014/7/8 Time: AM 10:06:15

2_RT_GSM 850 CH251_SIM1

DUT: SKY 4.5D; Type: WCDMA Mobile Phone; Serial: 868817019960135

Communication System: UID 0, GSM850 (0); Frequency: 848.8 MHz; Duty Cycle: 1:8

Medium parameters used: $f = 849$ MHz; $\sigma = 0.943$ S/m; $\epsilon_r = 43.407$; $\rho = 1000$ kg/m³

Phantom section: Right Section

Measurement Standard: DASYS5 (IEEE/IEC/ANSI C63.19-2011)

DASY Configuration:

- Area Scan setting - Find Secondary Maximum Within: 2.0dB and with a peak SAR value greater than 0.5 W/Kg
- Probe: EX3DV4 - SN3977; ConvF(9.62, 9.62, 9.62); Calibrated: 2014/2/17;
- Sensor-Surface: 2mm (Mechanical Surface Detection)
- Electronics: DAE4 Sn779; Calibrated: 2014/2/25
- Phantom: SAM with CRP; Type: SAM; Serial: TP-1150 and higher
- Measurement SW: DASYS52, Version 52.8 (7); SEMCAD X Version 14.6.10 (7164)

Right Tilted/Area Scan (71x121x1):

Interpolated grid: dx=1.500 mm, dy=1.500 mm

Maximum value of SAR (interpolated) = 0.283 W/kg

Right Tilted/Zoom Scan (5x5x7)/Cube 0:

Measurement grid: dx=8mm, dy=8mm, dz=5mm

Reference Value = 6.601 V/m; Power Drift = -0.15 dB

Peak SAR (extrapolated) = 0.299 W/kg

SAR(1 g) = 0.247 W/kg; SAR(10 g) = 0.191 W/kg

Maximum value of SAR (measured) = 0.277 W/kg

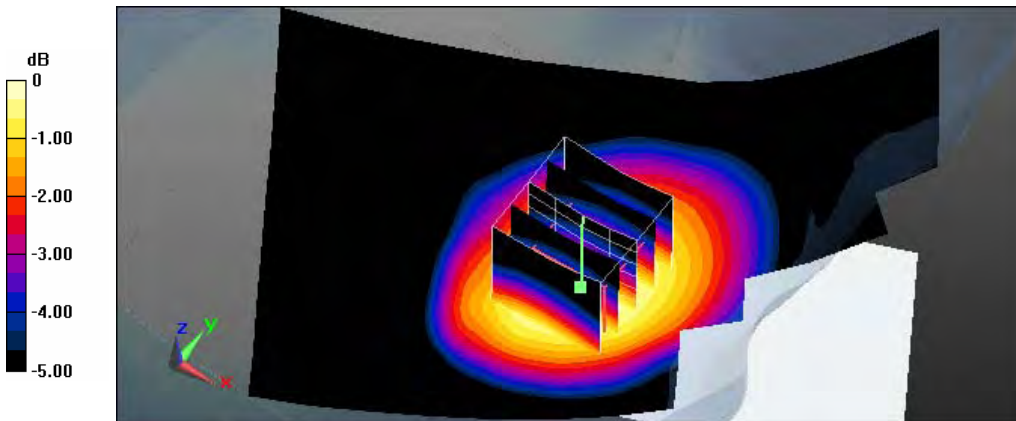

0 dB = 0.277 W/kg = -5.58 dBW/kg

Test Laboratory: A Test Lab Techno Corp.

Date: 2014/7/8 Time: AM 11:06:09

3_LC_GSM 850 CH251_SIM1

DUT: SKY 4.5D; Type: WCDMA Mobile Phone; Serial: 868817019960135

Communication System: UID 0, GSM850 (0); Frequency: 848.8 MHz; Duty Cycle: 1:8

Medium parameters used: $f = 849 \text{ MHz}$; $\sigma = 0.943 \text{ S/m}$; $\epsilon_r = 43.407$; $\rho = 1000 \text{ kg/m}^3$

Phantom section: Left Section

Measurement Standard: DASYS5 (IEEE/IEC/ANSI C63.19-2011)

DASY Configuration:

- Area Scan setting - Find Secondary Maximum Within: 2.0dB and with a peak SAR value greater than 0.5 W/Kg
- Probe: EX3DV4 - SN3977; ConvF(9.62, 9.62, 9.62); Calibrated: 2014/2/17;
- Sensor-Surface: 2mm (Mechanical Surface Detection)
- Electronics: DAE4 Sn779; Calibrated: 2014/2/25
- Phantom: SAM with CRP; Type: SAM; Serial: TP-1150 and higher
- Measurement SW: DASYS52, Version 52.8 (7); SEMCAD X Version 14.6.10 (7164)

Left Cheek/Area Scan (71x121x1):

Interpolated grid: $dx=1.500 \text{ mm}$, $dy=1.500 \text{ mm}$

Maximum value of SAR (interpolated) = 0.533 W/kg

Left Cheek/Zoom Scan (5x5x7)/Cube 0:

Measurement grid: $dx=8\text{mm}$, $dy=8\text{mm}$, $dz=5\text{mm}$

Reference Value = 4.890 V/m; Power Drift = -0.00 dB

Peak SAR (extrapolated) = 0.582 W/kg

SAR(1 g) = 0.467 W/kg; SAR(10 g) = 0.358 W/kg

Maximum value of SAR (measured) = 0.532 W/kg

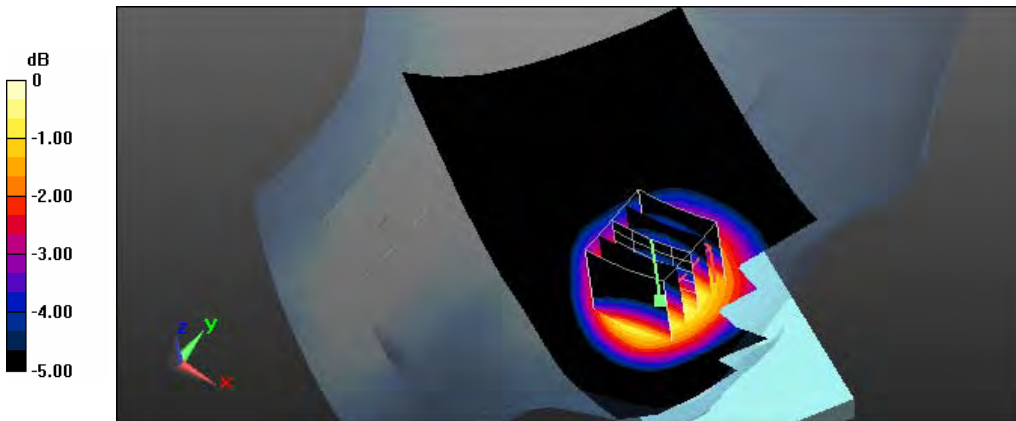

0 dB = 0.532 W/kg = -2.74 dBW/kg

Test Laboratory: A Test Lab Techno Corp.
 Date: 2014/7/8 Time: AM 10:30:54

4_LT_GSM 850 CH251_SIM1

DUT: SKY 4.5D; Type: WCDMA Mobile Phone; Serial: 868817019960135

Communication System: UID 0, GSM850 (0); Frequency: 848.8 MHz; Duty Cycle: 1:8

Medium parameters used: $f = 849 \text{ MHz}$; $\sigma = 0.943 \text{ S/m}$; $\epsilon_r = 43.407$; $\rho = 1000 \text{ kg/m}^3$

Phantom section: Left Section

Measurement Standard: DASYS (IEEE/IEC/ANSI C63.19-2011)

DASY Configuration:

- Area Scan setting - Find Secondary Maximum Within: 2.0dB and with a peak SAR value greater than 0.5 W/Kg
- Probe: EX3DV4 - SN3977; ConvF(9.62, 9.62, 9.62); Calibrated: 2014/2/17;
- Sensor-Surface: 2mm (Mechanical Surface Detection)
- Electronics: DAE4 Sn779; Calibrated: 2014/2/25
- Phantom: SAM with CRP; Type: SAM; Serial: TP-1150 and higher
- Measurement SW: DASYS2, Version 52.8 (7); SEMCAD X Version 14.6.10 (7164)

Left Tilted/Area Scan (71x121x1):

Interpolated grid: $dx=1.500 \text{ mm}$, $dy=1.500 \text{ mm}$

Maximum value of SAR (interpolated) = 0.280 W/kg

Left Tilted/Zoom Scan (5x5x7)/Cube 0:

Measurement grid: $dx=8\text{mm}$, $dy=8\text{mm}$, $dz=5\text{mm}$

Reference Value = 7.660 V/m; Power Drift = 0.02 dB

Peak SAR (extrapolated) = 0.304 W/kg

SAR(1 g) = 0.247 W/kg; SAR(10 g) = 0.192 W/kg

Maximum value of SAR (measured) = 0.276 W/kg

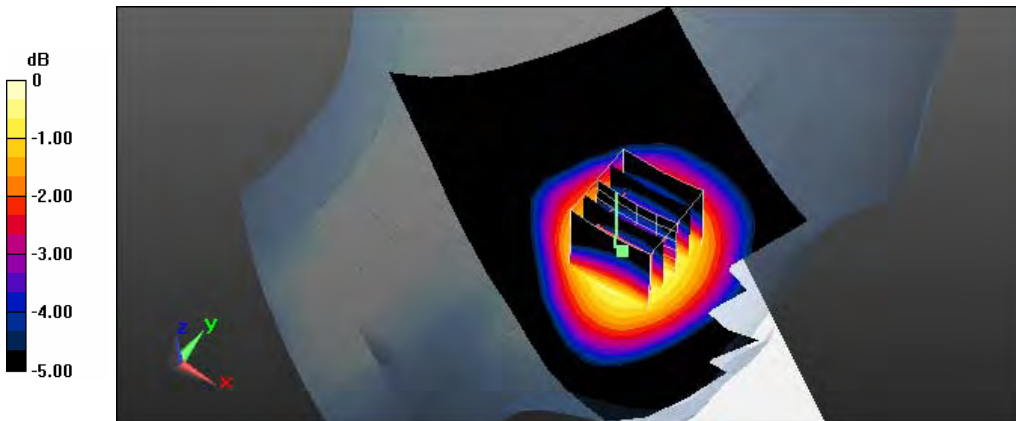

0 dB = 0.276 W/kg = -5.59 dBW/kg

Test Laboratory: A Test Lab Techno Corp.

Date: 2014/7/9 Time: PM 06:15:12

5_RC_GPRS 850 CH251_1D4U_SIM1

DUT: SKY 4.5D; Type: WCDMA Mobile Phone; Serial: 868817019960135

Communication System: UID 0, GPRS 850 (1Down, 4Up) (0); Frequency: 848.8 MHz; Duty Cycle: 1:2

Medium parameters used: $f = 849 \text{ MHz}$; $\sigma = 0.943 \text{ S/m}$; $\epsilon_r = 43.407$; $\rho = 1000 \text{ kg/m}^3$

Phantom section: Right Section

Measurement Standard: DASYS (IEEE/IEC/ANSI C63.19-2011)

DASY Configuration:

- Area Scan setting - Find Secondary Maximum Within: 2.0dB and with a peak SAR value greater than 0.5 W/Kg
- Probe: EX3DV4 - SN3977; ConvF(9.62, 9.62, 9.62); Calibrated: 2014/2/17;
- Sensor-Surface: 2mm (Mechanical Surface Detection)
- Electronics: DAE4 Sn779; Calibrated: 2014/2/25
- Phantom: SAM with CRP; Type: SAM; Serial: TP-1150 and higher
- Measurement SW: DASYS52, Version 52.8 (7); SEMCAD X Version 14.6.10 (7164)

Right Cheek/Area Scan (71x121x1):

Interpolated grid: $dx=1.500 \text{ mm}$, $dy=1.500 \text{ mm}$

Maximum value of SAR (interpolated) = 0.814 W/kg

Right Cheek/Zoom Scan (5x5x7)/Cube 0:

Measurement grid: $dx=8\text{mm}$, $dy=8\text{mm}$, $dz=5\text{mm}$

Reference Value = 6.464 V/m; Power Drift = 0.16 dB

Peak SAR (extrapolated) = 0.920 W/kg

SAR(1 g) = 0.731 W/kg; SAR(10 g) = 0.529 W/kg

Maximum value of SAR (measured) = 0.831 W/kg

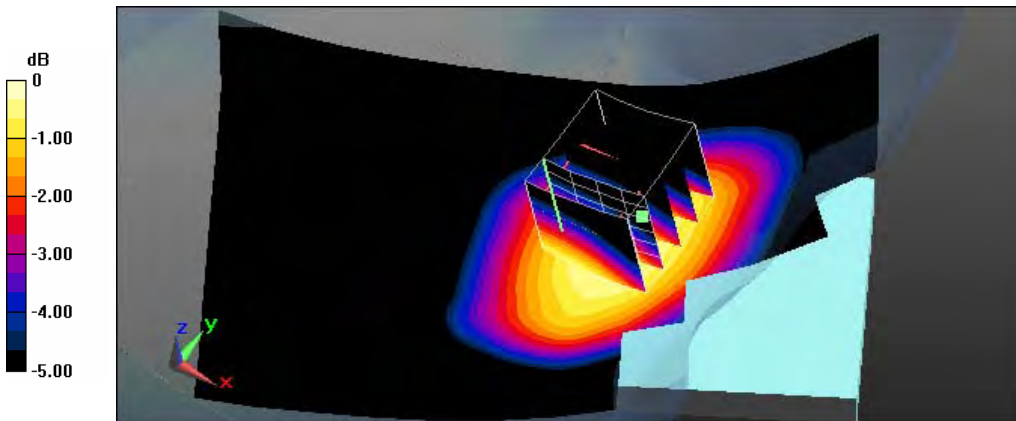

0 dB = 0.831 W/kg = -0.80 dBW/kg

Test Laboratory: A Test Lab Techno Corp.

Date: 2014/7/9 Time: PM 07:27:05

6_RT_GPRS 850 CH251_1D4U_SIM1

DUT: SKY 4.5D; Type: WCDMA Mobile Phone; Serial: 868817019960135

Communication System: UID 0, GPRS 850 (1Down, 4Up) (0); Frequency: 848.8 MHz; Duty Cycle: 1:2

Medium parameters used: $f = 849 \text{ MHz}$; $\sigma = 0.943 \text{ S/m}$; $\epsilon_r = 43.407$; $\rho = 1000 \text{ kg/m}^3$

Phantom section: Right Section

Measurement Standard: DASYS (IEEE/IEC/ANSI C63.19-2011)

DASY Configuration:

- Area Scan setting - Find Secondary Maximum Within: 2.0dB and with a peak SAR value greater than 0.5 W/Kg
- Probe: EX3DV4 - SN3977; ConvF(9.62, 9.62, 9.62); Calibrated: 2014/2/17;
- Sensor-Surface: 2mm (Mechanical Surface Detection)
- Electronics: DAE4 Sn779; Calibrated: 2014/2/25
- Phantom: SAM with CRP; Type: SAM; Serial: TP-1150 and higher
- Measurement SW: DASYS52, Version 52.8 (7); SEMCAD X Version 14.6.10 (7164)

Right Tilted/Area Scan (71x121x1):

Interpolated grid: $dx=1.500 \text{ mm}$, $dy=1.500 \text{ mm}$

Maximum value of SAR (interpolated) = 0.495 W/kg

Right Tilted/Zoom Scan (5x5x7)/Cube 0:

Measurement grid: $dx=8\text{mm}$, $dy=8\text{mm}$, $dz=5\text{mm}$

Reference Value = 14.742 V/m; Power Drift = 0.08 dB

Peak SAR (extrapolated) = 0.545 W/kg

SAR(1 g) = 0.437 W/kg; SAR(10 g) = 0.337 W/kg

Maximum value of SAR (measured) = 0.500 W/kg

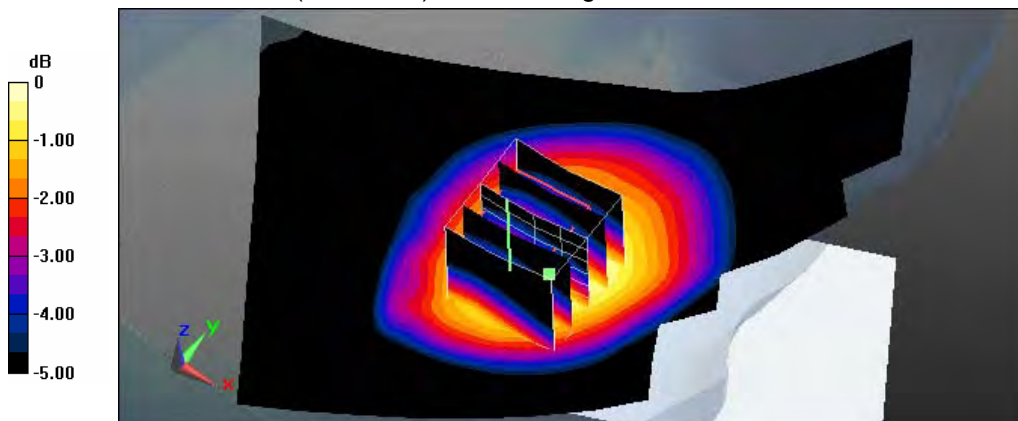

0 dB = 0.500 W/kg = -3.01 dBW/kg

Test Laboratory: A Test Lab Techno Corp.

Date: 2014/7/9 Time: PM 11:04:07

9_LC_GPRS 850 CH128_1D4U_SIM1

DUT: SKY 4.5D; Type: WCDMA Mobile Phone; Serial: 868817019960135

Communication System: UID 0, GPRS 850 (1Down, 4Up) (0); Frequency: 824.2 MHz; Duty Cycle: 1:2

Medium parameters used (interpolated): $f = 824.2$ MHz; $\sigma = 0.895$ S/m; $\epsilon_r = 43.343$; $\rho = 1000$ kg/m³

Phantom section: Left Section

Measurement Standard: DASYS (IEEE/IEC/ANSI C63.19-2011)

DASY Configuration:

- Area Scan setting - Find Secondary Maximum Within: 2.0dB and with a peak SAR value greater than 0.5 W/Kg
- Probe: EX3DV4 - SN3977; ConvF(9.62, 9.62, 9.62); Calibrated: 2014/2/17;
- Sensor-Surface: 2mm (Mechanical Surface Detection)
- Electronics: DAE4 Sn779; Calibrated: 2014/2/25
- Phantom: SAM with CRP; Type: SAM; Serial: TP-1150 and higher
- Measurement SW: DASYS2, Version 52.8 (7); SEMCAD X Version 14.6.10 (7164)

Left Cheek/Area Scan (71x121x1):

Interpolated grid: dx=1.500 mm, dy=1.500 mm

Maximum value of SAR (interpolated) = 0.529 W/kg

Left Cheek/Zoom Scan (5x5x7)/Cube 0:

Measurement grid: dx=8mm, dy=8mm, dz=5mm

Reference Value = 8.190 V/m; Power Drift = 0.05 dB

Peak SAR (extrapolated) = 0.562 W/kg

SAR(1 g) = 0.462 W/kg; SAR(10 g) = 0.359 W/kg

Maximum value of SAR (measured) = 0.517 W/kg

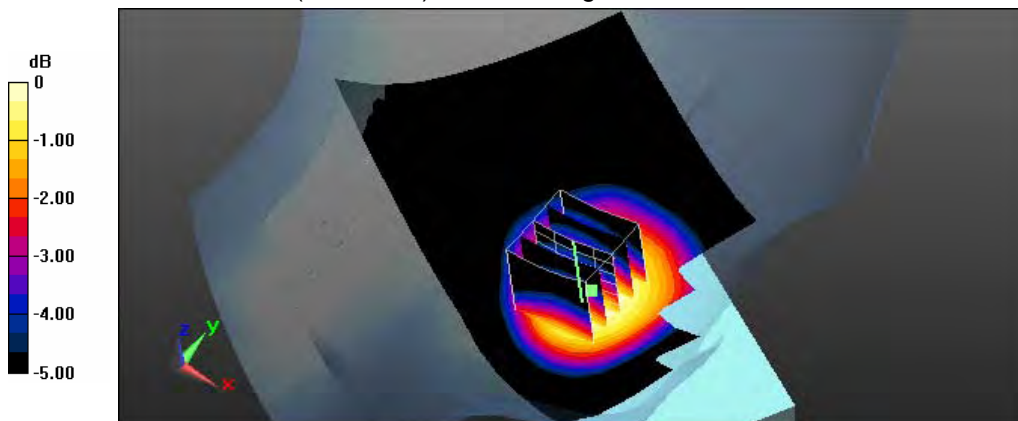

0 dB = 0.517 W/kg = -2.87 dBW/kg

Test Laboratory: A Test Lab Techno Corp.

Date: 2014/7/9 Time: PM 07:53:22

7_LC_GPRS 850 CH251_1D4U_SIM1

DUT: SKY 4.5D; Type: WCDMA Mobile Phone; Serial: 868817019960135

Communication System: UID 0, GPRS 850 (1Down, 4Up) (0); Frequency: 848.8 MHz; Duty Cycle: 1:2

Medium parameters used: $f = 849 \text{ MHz}$; $\sigma = 0.943 \text{ S/m}$; $\epsilon_r = 43.407$; $\rho = 1000 \text{ kg/m}^3$

Phantom section: Left Section

Measurement Standard: DASYS (IEEE/IEC/ANSI C63.19-2011)

DASY Configuration:

- Area Scan setting - Find Secondary Maximum Within: 2.0dB and with a peak SAR value greater than 0.5 W/Kg
- Probe: EX3DV4 - SN3977; ConvF(9.62, 9.62, 9.62); Calibrated: 2014/2/17;
- Sensor-Surface: 2mm (Mechanical Surface Detection)
- Electronics: DAE4 Sn779; Calibrated: 2014/2/25
- Phantom: SAM with CRP; Type: SAM; Serial: TP-1150 and higher
- Measurement SW: DASYS2, Version 52.8 (7); SEMCAD X Version 14.6.10 (7164)

Left Cheek/Area Scan (71x121x1):

Interpolated grid: $dx=1.500 \text{ mm}$, $dy=1.500 \text{ mm}$

Maximum value of SAR (interpolated) = 0.896 W/kg

Left Cheek/Zoom Scan (5x5x7)/Cube 0:

Measurement grid: $dx=8\text{mm}$, $dy=8\text{mm}$, $dz=5\text{mm}$

Reference Value = 10.703 V/m; Power Drift = 0.10 dB

Peak SAR (extrapolated) = 0.957 W/kg

SAR(1 g) = 0.773 W/kg; SAR(10 g) = 0.596 W/kg

Maximum value of SAR (measured) = 0.882 W/kg

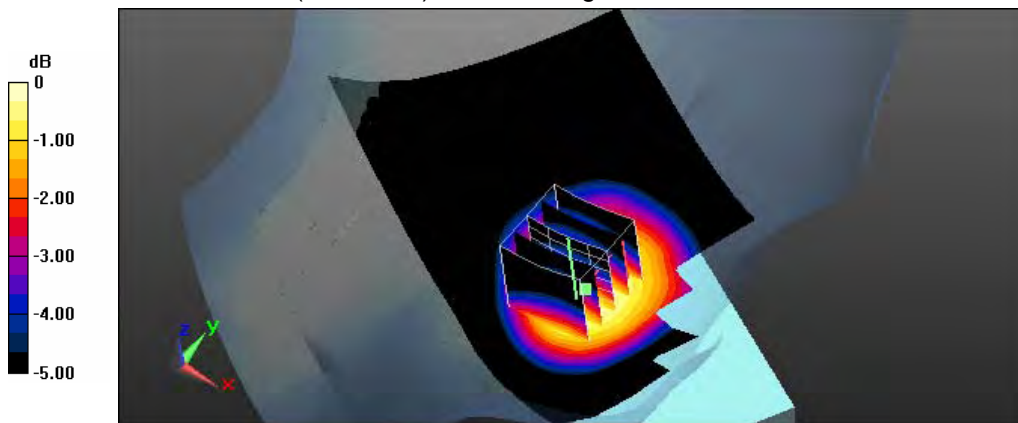

0 dB = 0.882 W/kg = -0.55 dBW/kg

Test Laboratory: A Test Lab Techno Corp.

Date: 2014/7/9 Time: PM 11:24:20

10_LC_GPRS 850 CH190_1D4U_SIM1

DUT: SKY 4.5D; Type: WCDMA Mobile Phone; Serial: 868817019960135

Communication System: UID 0, GPRS 850 (1Down, 4Up) (0); Frequency: 836.6 MHz; Duty Cycle: 1:2

Medium parameters used: $f = 837 \text{ MHz}$; $\sigma = 0.922 \text{ S/m}$; $\epsilon_r = 43.353$; $\rho = 1000 \text{ kg/m}^3$

Phantom section: Left Section

Measurement Standard: DASYS5 (IEEE/IEC/ANSI C63.19-2011)

DASY Configuration:

- Area Scan setting - Find Secondary Maximum Within: 2.0dB and with a peak SAR value greater than 0.5 W/Kg
- Probe: EX3DV4 - SN3977; ConvF(9.62, 9.62, 9.62); Calibrated: 2014/2/17;
- Sensor-Surface: 2mm (Mechanical Surface Detection)
- Electronics: DAE4 Sn779; Calibrated: 2014/2/25
- Phantom: SAM with CRP; Type: SAM; Serial: TP-1150 and higher
- Measurement SW: DASYS52, Version 52.8 (7); SEMCAD X Version 14.6.10 (7164)

Left Cheek/Area Scan (71x121x1):

Interpolated grid: $dx=1.500 \text{ mm}$, $dy=1.500 \text{ mm}$

Maximum value of SAR (interpolated) = 0.776 W/kg

Left Cheek/Zoom Scan (5x5x7)/Cube 0:

Measurement grid: $dx=8\text{mm}$, $dy=8\text{mm}$, $dz=5\text{mm}$

Reference Value = 9.582 V/m; Power Drift = 0.09 dB

Peak SAR (extrapolated) = 0.839 W/kg

SAR(1 g) = 0.680 W/kg; SAR(10 g) = 0.522 W/kg

Maximum value of SAR (measured) = 0.777 W/kg

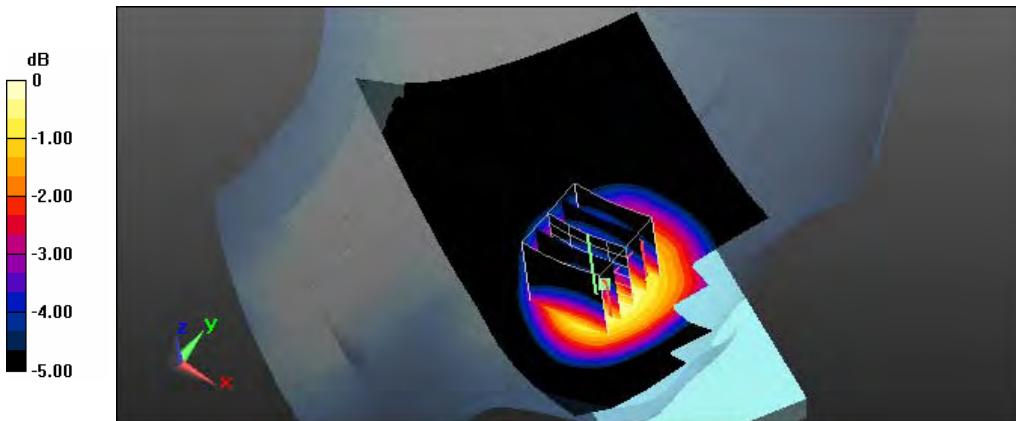

0 dB = 0.777 W/kg = -1.10 dBW/kg

Test Laboratory: A Test Lab Techno Corp.

Date: 2014/7/9 Time: PM 10:42:21

8_LT_GPRS 850 CH251_1D4U_SIM1

DUT: SKY 4.5D; Type: WCDMA Mobile Phone; Serial: 868817019960135

Communication System: UID 0, GPRS 850 (1Down, 4Up) (0); Frequency: 848.8 MHz; Duty Cycle: 1:2

Medium parameters used: $f = 849 \text{ MHz}$; $\sigma = 0.943 \text{ S/m}$; $\epsilon_r = 43.407$; $\rho = 1000 \text{ kg/m}^3$

Phantom section: Left Section

Measurement Standard: DASYS5 (IEEE/IEC/ANSI C63.19-2011)

DASY Configuration:

- Area Scan setting - Find Secondary Maximum Within: 2.0dB and with a peak SAR value greater than 0.5 W/Kg
- Probe: EX3DV4 - SN3977; ConvF(9.62, 9.62, 9.62); Calibrated: 2014/2/17;
- Sensor-Surface: 2mm (Mechanical Surface Detection)
- Electronics: DAE4 Sn779; Calibrated: 2014/2/25
- Phantom: SAM with CRP; Type: SAM; Serial: TP-1150 and higher
- Measurement SW: DASYS52, Version 52.8 (7); SEMCAD X Version 14.6.10 (7164)

Left Tilted/Area Scan (71x121x1):

Interpolated grid: $dx=1.500 \text{ mm}$, $dy=1.500 \text{ mm}$

Maximum value of SAR (interpolated) = 0.492 W/kg

Left Tilted/Zoom Scan (5x5x7)/Cube 0:

Measurement grid: $dx=8\text{mm}$, $dy=8\text{mm}$, $dz=5\text{mm}$

Reference Value = 14.350 V/m; Power Drift = 0.05 dB

Peak SAR (extrapolated) = 0.550 W/kg

SAR(1 g) = 0.439 W/kg; SAR(10 g) = 0.338 W/kg

Maximum value of SAR (measured) = 0.498 W/kg

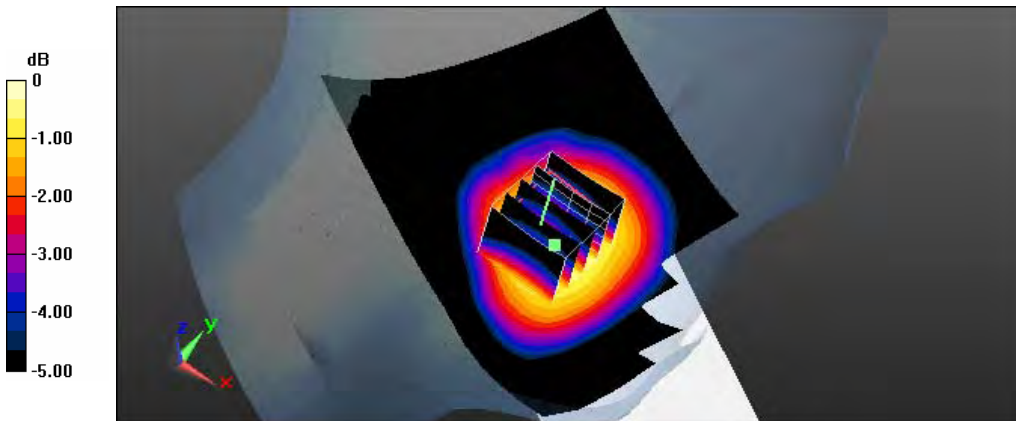

0 dB = 0.498 W/kg = -3.03 dBW/kg

Test Laboratory: A Test Lab Techno Corp.

Date: 2014/7/10 Time: AM 01:32:42

11_RC_PCS CH512_SIM1

DUT: SKY 4.5D; Type: WCDMA Mobile Phone; Serial: 868817019960135

Communication System: UID 0, PCS (0); Frequency: 1850.2 MHz; Duty Cycle: 1:8

Medium parameters used (interpolated): $f = 1850.2$ MHz; $\sigma = 1.344$ S/m; $\epsilon_r = 40.633$; $\rho = 1000$ kg/m³

Phantom section: Right Section

Measurement Standard: DASYS (IEEE/IEC/ANSI C63.19-2011)

DASY Configuration:

- Area Scan setting - Find Secondary Maximum Within: 2.0dB and with a peak SAR value greater than 0.5 W/Kg
- Probe: EX3DV4 - SN3977; ConvF(7.97, 7.97, 7.97); Calibrated: 2014/2/17;
- Sensor-Surface: 2mm (Mechanical Surface Detection)
- Electronics: DAE4 Sn779; Calibrated: 2014/2/25
- Phantom: SAM with CRP; Type: SAM; Serial: TP-1150 and higher
- Measurement SW: DASYS2, Version 52.8 (7); SEMCAD X Version 14.6.10 (7164)

Right Cheek/Area Scan (71x121x1):

Interpolated grid: dx=1.500 mm, dy=1.500 mm

Maximum value of SAR (interpolated) = 0.276 W/kg

Right Cheek/Zoom Scan (5x5x7)/Cube 0:

Measurement grid: dx=8mm, dy=8mm, dz=5mm

Reference Value = 6.664 V/m; Power Drift = 0.19 dB

Peak SAR (extrapolated) = 0.323 W/kg

SAR(1 g) = 0.207 W/kg; SAR(10 g) = 0.127 W/kg

Maximum value of SAR (measured) = 0.261 W/kg

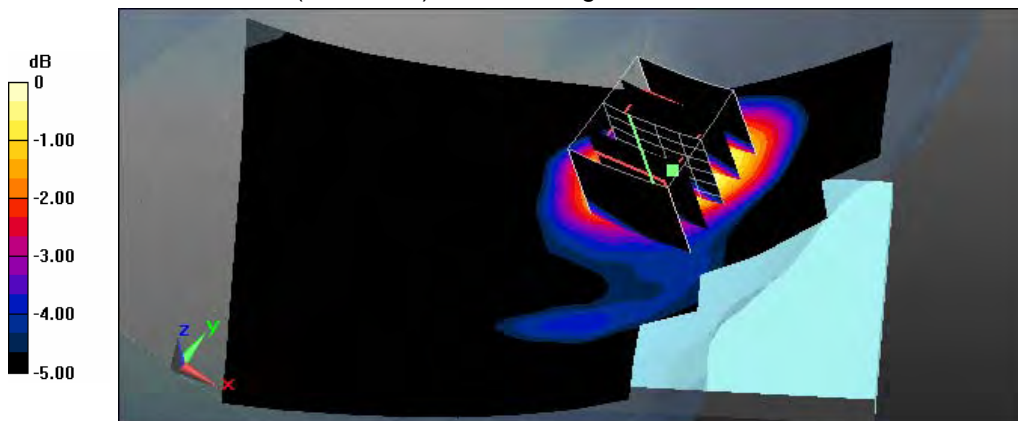

0 dB = 0.261 W/kg = -5.83 dBW/kg

Test Laboratory: A Test Lab Techno Corp.

Date: 2014/7/10 Time: AM 01:54:48

12_RT_PCS CH512_SIM1

DUT: SKY 4.5D; Type: WCDMA Mobile Phone; Serial: 868817019960135

Communication System: UID 0, PCS (0); Frequency: 1850.2 MHz; Duty Cycle: 1:8

Medium parameters used (interpolated): $f = 1850.2$ MHz; $\sigma = 1.344$ S/m; $\epsilon_r = 40.633$; $\rho = 1000$ kg/m³

Phantom section: Right Section

Measurement Standard: DASYS (IEEE/IEC/ANSI C63.19-2011)

DASY Configuration:

- Area Scan setting - Find Secondary Maximum Within: 2.0dB and with a peak SAR value greater than 0.5 W/Kg
- Probe: EX3DV4 - SN3977; ConvF(7.97, 7.97, 7.97); Calibrated: 2014/2/17;
- Sensor-Surface: 2mm (Mechanical Surface Detection)
- Electronics: DAE4 Sn779; Calibrated: 2014/2/25
- Phantom: SAM with CRP; Type: SAM; Serial: TP-1150 and higher
- Measurement SW: DASYS2, Version 52.8 (7); SEMCAD X Version 14.6.10 (7164)

Right Tilted/Area Scan (71x121x1):

Interpolated grid: dx=1.500 mm, dy=1.500 mm

Maximum value of SAR (interpolated) = 0.145 W/kg

Right Tilted/Zoom Scan (5x5x7)/Cube 0:

Measurement grid: dx=8mm, dy=8mm, dz=5mm

Reference Value = 10.147 V/m; Power Drift = 0.01 dB

Peak SAR (extrapolated) = 0.172 W/kg

SAR(1 g) = 0.104 W/kg; SAR(10 g) = 0.060 W/kg

Maximum value of SAR (measured) = 0.141 W/kg

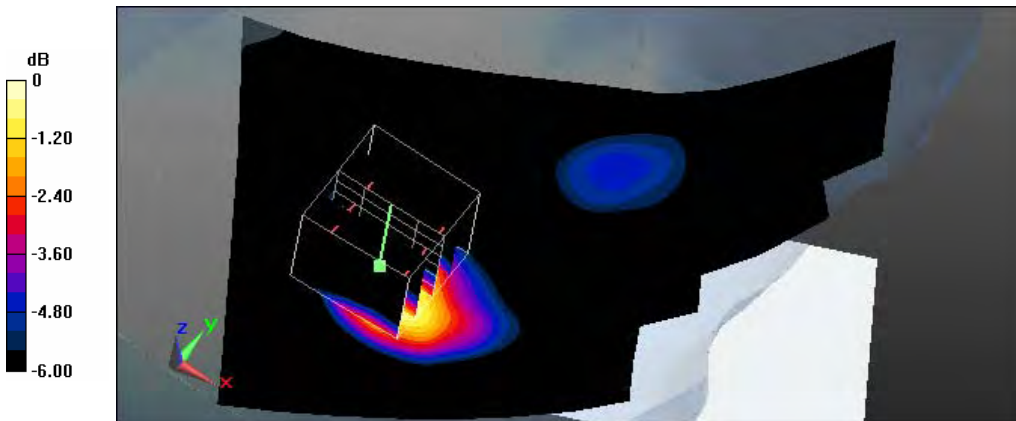

0 dB = 0.141 W/kg = -8.51 dBW/kg

Test Laboratory: A Test Lab Techno Corp.
 Date: 2014/7/10 Time: AM 02:17:24

13_LC_PCS CH512_SIM1

DUT: SKY 4.5D; Type: WCDMA Mobile Phone; Serial: 868817019960135

Communication System: UID 0, PCS (0); Frequency: 1850.2 MHz; Duty Cycle: 1:8

Medium parameters used (interpolated): $f = 1850.2$ MHz; $\sigma = 1.344$ S/m; $\epsilon_r = 40.633$; $\rho = 1000$ kg/m³

Phantom section: Left Section

Measurement Standard: DASYS5 (IEEE/IEC/ANSI C63.19-2011)

DASY Configuration:

- Area Scan setting - Find Secondary Maximum Within: 2.0dB and with a peak SAR value greater than 0.5 W/Kg
- Probe: EX3DV4 - SN3977; ConvF(7.97, 7.97, 7.97); Calibrated: 2014/2/17;
- Sensor-Surface: 2mm (Mechanical Surface Detection)
- Electronics: DAE4 Sn779; Calibrated: 2014/2/25
- Phantom: SAM with CRP; Type: SAM; Serial: TP-1150 and higher
- Measurement SW: DASYS52, Version 52.8 (7); SEMCAD X Version 14.6.10 (7164)

Left Cheek/Area Scan (71x121x1):

Interpolated grid: dx=1.500 mm, dy=1.500 mm

Maximum value of SAR (interpolated) = 0.237 W/kg

Left Cheek/Zoom Scan (5x5x7)/Cube 0:

Measurement grid: dx=8mm, dy=8mm, dz=5mm

Reference Value = 6.687 V/m; Power Drift = 0.01 dB

Peak SAR (extrapolated) = 0.274 W/kg

SAR(1 g) = 0.180 W/kg; SAR(10 g) = 0.113 W/kg

Maximum value of SAR (measured) = 0.228 W/kg

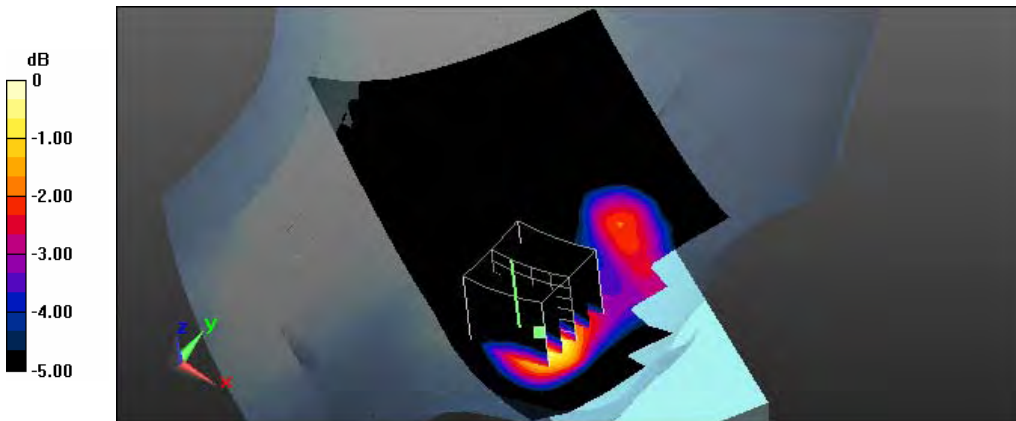

0 dB = 0.228 W/kg = -6.42 dBW/kg

Test Laboratory: A Test Lab Techno Corp.
 Date: 2014/7/10 Time: AM 02:35:52

14_LT_PCS CH512_SIM1

DUT: SKY 4.5D; Type: WCDMA Mobile Phone; Serial: 868817019960135

Communication System: UID 0, PCS (0); Frequency: 1850.2 MHz; Duty Cycle: 1:8

Medium parameters used (interpolated): $f = 1850.2$ MHz; $\sigma = 1.344$ S/m; $\epsilon_r = 40.633$; $\rho = 1000$ kg/m³

Phantom section: Left Section

Measurement Standard: DASYS (IEEE/IEC/ANSI C63.19-2011)

DASY Configuration:

- Area Scan setting - Find Secondary Maximum Within: 2.0dB and with a peak SAR value greater than 0.5 W/Kg
- Probe: EX3DV4 - SN3977; ConvF(7.97, 7.97, 7.97); Calibrated: 2014/2/17;
- Sensor-Surface: 2mm (Mechanical Surface Detection)
- Electronics: DAE4 Sn779; Calibrated: 2014/2/25
- Phantom: SAM with CRP; Type: SAM; Serial: TP-1150 and higher
- Measurement SW: DASYS2, Version 52.8 (7); SEMCAD X Version 14.6.10 (7164)

Left Tilted/Area Scan (71x121x1):

Interpolated grid: dx=1.500 mm, dy=1.500 mm

Maximum value of SAR (interpolated) = 0.144 W/kg

Left Tilted/Zoom Scan (5x5x7)/Cube 0:

Measurement grid: dx=8mm, dy=8mm, dz=5mm

Reference Value = 9.876 V/m; Power Drift = -0.05 dB

Peak SAR (extrapolated) = 0.165 W/kg

SAR(1 g) = 0.100 W/kg; SAR(10 g) = 0.056 W/kg

Maximum value of SAR (measured) = 0.133 W/kg

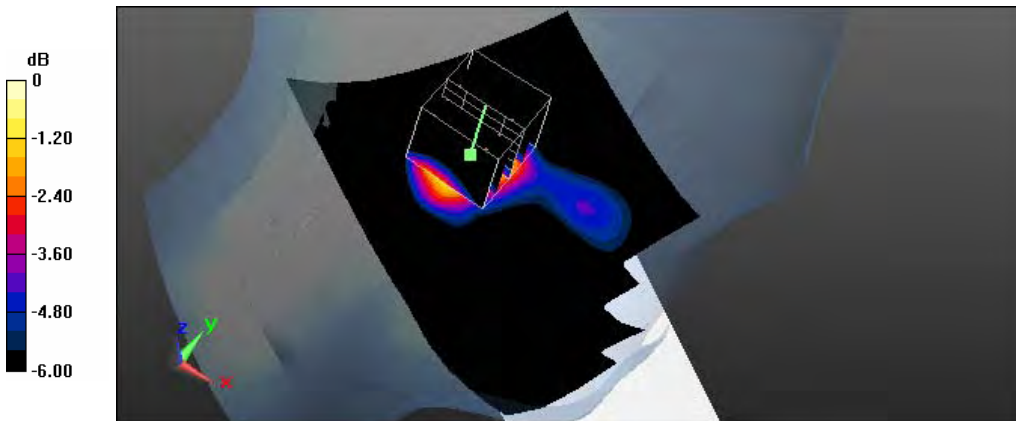

0 dB = 0.133 W/kg = -8.76 dBW/kg

Test Laboratory: A Test Lab Techno Corp.

Date: 2014/7/10 Time: AM 09:25:21

15_RC_GPRS_PCS_CH810_1D4U_SIM1

DUT: SKY 4.5D; Type: WCDMA Mobile Phone; Serial: 868817019960135

Communication System: UID 0, GPRS PCS (1Down,4Up) (0); Frequency: 1909.8 MHz; Duty Cycle: 1:2

Medium parameters used: $f = 1910$ MHz; $\sigma = 1.403$ S/m; $\epsilon_r = 40.436$; $\rho = 1000$ kg/m³

Phantom section: Right Section

Measurement Standard: DASYS5 (IEEE/IEC/ANSI C63.19-2011)

DASY Configuration:

- Area Scan setting - Find Secondary Maximum Within: 2.0dB and with a peak SAR value greater than 0.5 W/Kg
- Probe: EX3DV4 - SN3977; ConvF(7.97, 7.97, 7.97); Calibrated: 2014/2/17;
- Sensor-Surface: 2mm (Mechanical Surface Detection)
- Electronics: DAE4 Sn779; Calibrated: 2014/2/25
- Phantom: SAM with CRP; Type: SAM; Serial: TP-1150 and higher
- Measurement SW: DASYS52, Version 52.8 (7); SEMCAD X Version 14.6.10 (7164)

Right Cheek/Area Scan (71x121x1):

Interpolated grid: dx=1.500 mm, dy=1.500 mm

Maximum value of SAR (interpolated) = 0.334 W/kg

Right Cheek/Zoom Scan (5x5x7)/Cube 0:

Measurement grid: dx=8mm, dy=8mm, dz=5mm

Reference Value = 7.601 V/m; Power Drift = -0.19 dB

Peak SAR (extrapolated) = 0.396 W/kg

SAR(1 g) = 0.256 W/kg; SAR(10 g) = 0.158 W/kg

Maximum value of SAR (measured) = 0.321 W/kg

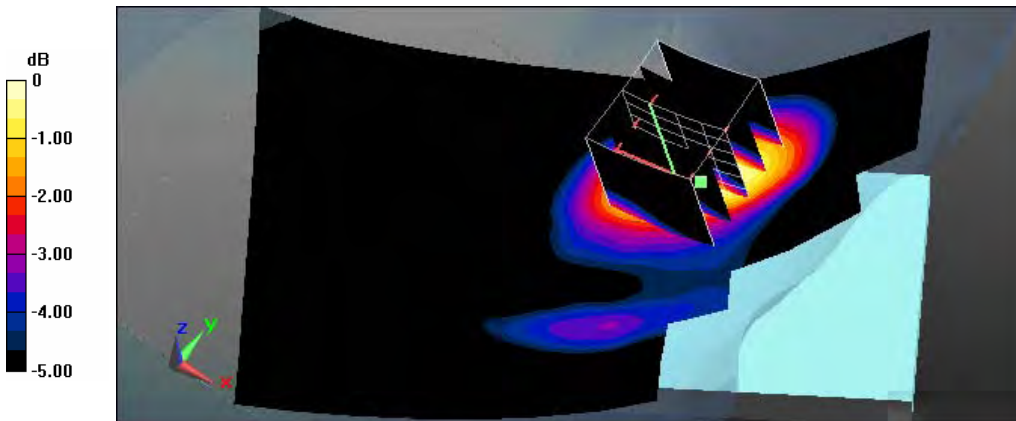

0 dB = 0.321 W/kg = -4.93 dBW/kg

Test Laboratory: A Test Lab Techno Corp.

Date: 2014/7/10 Time: AM 09:45:10

16_RT_GPRS_PCS_CH810_1D4U_SIM1

DUT: SKY 4.5D; Type: WCDMA Mobile Phone; Serial: 868817019960135

Communication System: UID 0, GPRS PCS (1Down,4Up) (0); Frequency: 1909.8 MHz; Duty Cycle: 1:2

Medium parameters used: $f = 1910 \text{ MHz}$; $\sigma = 1.403 \text{ S/m}$; $\epsilon_r = 40.436$; $\rho = 1000 \text{ kg/m}^3$

Phantom section: Right Section

Measurement Standard: DASYS5 (IEEE/IEC/ANSI C63.19-2011)

DASY Configuration:

- Area Scan setting - Find Secondary Maximum Within: 2.0dB and with a peak SAR value greater than 0.5 W/Kg
- Probe: EX3DV4 - SN3977; ConvF(7.97, 7.97, 7.97); Calibrated: 2014/2/17;
- Sensor-Surface: 2mm (Mechanical Surface Detection)
- Electronics: DAE4 Sn779; Calibrated: 2014/2/25
- Phantom: SAM with CRP; Type: SAM; Serial: TP-1150 and higher
- Measurement SW: DASYS52, Version 52.8 (7); SEMCAD X Version 14.6.10 (7164)

Right Tilted/Area Scan (71x121x1):

Interpolated grid: $dx=1.500 \text{ mm}$, $dy=1.500 \text{ mm}$

Maximum value of SAR (interpolated) = 0.153 W/kg

Right Tilted/Zoom Scan (5x5x7)/Cube 0:

Measurement grid: $dx=8\text{mm}$, $dy=8\text{mm}$, $dz=5\text{mm}$

Reference Value = 10.235 V/m; Power Drift = 0.18 dB

Peak SAR (extrapolated) = 0.194 W/kg

SAR(1 g) = 0.116 W/kg; SAR(10 g) = 0.065 W/kg

Maximum value of SAR (measured) = 0.159 W/kg

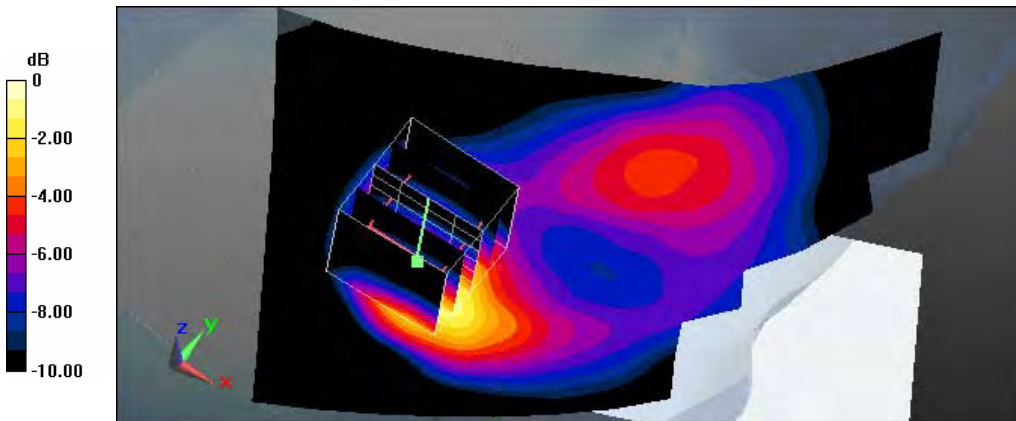

0 dB = 0.159 W/kg = -7.99 dBW/kg

Test Laboratory: A Test Lab Techno Corp.

Date: 2014/7/10 Time: AM 10:07:17

17_LC_GPRS_PCS_CH810_1D4U_SIM1

DUT: SKY 4.5D; Type: WCDMA Mobile Phone; Serial: 868817019960135

Communication System: UID 0, GPRS PCS (1Down,4Up) (0); Frequency: 1909.8 MHz; Duty Cycle: 1:2

Medium parameters used: $f = 1910$ MHz; $\sigma = 1.403$ S/m; $\epsilon_r = 40.436$; $\rho = 1000$ kg/m³

Phantom section: Left Section

Measurement Standard: DASYS5 (IEEE/IEC/ANSI C63.19-2011)

DASY Configuration:

- Area Scan setting - Find Secondary Maximum Within: 2.0dB and with a peak SAR value greater than 0.5 W/Kg
- Probe: EX3DV4 - SN3977; ConvF(7.97, 7.97, 7.97); Calibrated: 2014/2/17;
- Sensor-Surface: 2mm (Mechanical Surface Detection)
- Electronics: DAE4 Sn779; Calibrated: 2014/2/25
- Phantom: SAM with CRP; Type: SAM; Serial: TP-1150 and higher
- Measurement SW: DASYS52, Version 52.8 (7); SEMCAD X Version 14.6.10 (7164)

Left Cheek/Area Scan (71x121x1):

Interpolated grid: dx=1.500 mm, dy=1.500 mm

Maximum value of SAR (interpolated) = 0.285 W/kg

Left Cheek/Zoom Scan (5x5x7)/Cube 0:

Measurement grid: dx=8mm, dy=8mm, dz=5mm

Reference Value = 7.667 V/m; Power Drift = 0.17 dB

Peak SAR (extrapolated) = 0.328 W/kg

SAR(1 g) = 0.213 W/kg; SAR(10 g) = 0.133 W/kg

Maximum value of SAR (measured) = 0.268 W/kg

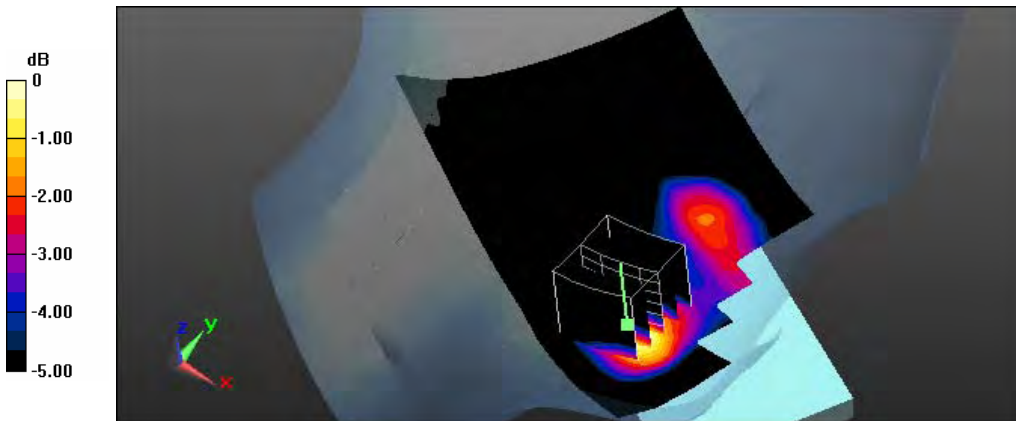

0 dB = 0.268 W/kg = -5.72 dBW/kg

Test Laboratory: A Test Lab Techno Corp.

Date: 2014/7/10 Time: AM 10:32:49

18_LT_GPRS PCS CH810_1D4U_SIM1

DUT: SKY 4.5D; Type: WCDMA Mobile Phone; Serial: 868817019960135

Communication System: UID 0, GPRS PCS (1Down,4Up) (0); Frequency: 1909.8 MHz; Duty Cycle: 1:2

Medium parameters used: $f = 1910 \text{ MHz}$; $\sigma = 1.403 \text{ S/m}$; $\epsilon_r = 40.436$; $\rho = 1000 \text{ kg/m}^3$

Phantom section: Left Section

Measurement Standard: DASYS5 (IEEE/IEC/ANSI C63.19-2011)

DASY Configuration:

- Area Scan setting - Find Secondary Maximum Within: 2.0dB and with a peak SAR value greater than 0.5 W/Kg
- Probe: EX3DV4 - SN3977; ConvF(7.97, 7.97, 7.97); Calibrated: 2014/2/17;
- Sensor-Surface: 2mm (Mechanical Surface Detection)
- Electronics: DAE4 Sn779; Calibrated: 2014/2/25
- Phantom: SAM with CRP; Type: SAM; Serial: TP-1150 and higher
- Measurement SW: DASYS52, Version 52.8 (7); SEMCAD X Version 14.6.10 (7164)

Left Tilted/Area Scan (71x121x1):

Interpolated grid: $dx=1.500 \text{ mm}$, $dy=1.500 \text{ mm}$

Maximum value of SAR (interpolated) = 0.160 W/kg

Left Tilted/Zoom Scan (5x5x7)/Cube 0:

Measurement grid: $dx=8\text{mm}$, $dy=8\text{mm}$, $dz=5\text{mm}$

Reference Value = 10.348 V/m; Power Drift = 0.04 dB

Peak SAR (extrapolated) = 0.183 W/kg

SAR(1 g) = 0.112 W/kg; SAR(10 g) = 0.063 W/kg

Maximum value of SAR (measured) = 0.145 W/kg

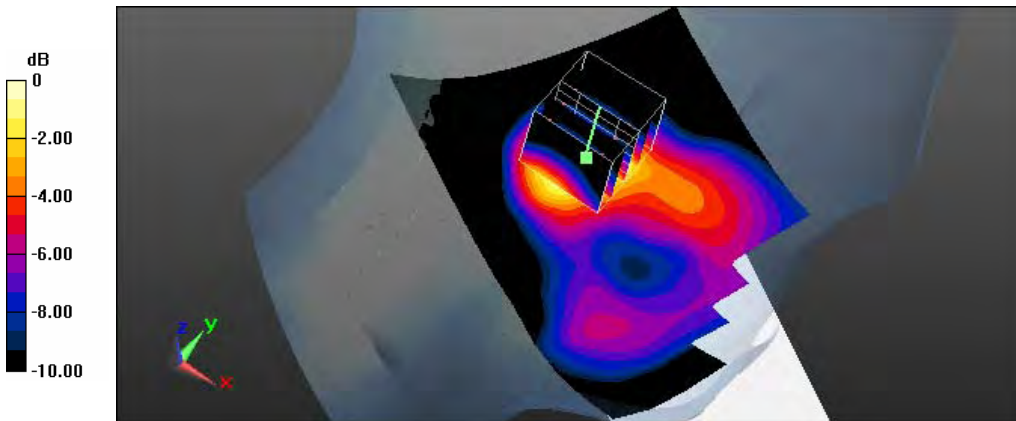

0 dB = 0.145 W/kg = -8.39 dBW/kg

Test Laboratory: A Test Lab Techno Corp.

Date: 2014/7/12 Time: AM 02:25:44

19_LC_GPRS 850 CH251_1D4U_Original #7_SIM1_measurement once

DUT: SKY 4.5D; Type: WCDMA Mobile Phone; Serial: 868817019960135

Communication System: UID 0, GPRS 850 (1Down, 4Up) (0); Frequency: 848.8 MHz; Duty Cycle: 1:2

Medium parameters used: $f = 849 \text{ MHz}$; $\sigma = 0.943 \text{ S/m}$; $\epsilon_r = 43.407$; $\rho = 1000 \text{ kg/m}^3$

Phantom section: Left Section

Measurement Standard: DASYS5 (IEEE/IEC/ANSI C63.19-2011)

DASY Configuration:

- Area Scan setting - Find Secondary Maximum Within: 2.0dB and with a peak SAR value greater than 0.5 W/Kg
- Probe: EX3DV4 - SN3977; ConvF(9.62, 9.62, 9.62); Calibrated: 2014/2/17;
- Sensor-Surface: 2mm (Mechanical Surface Detection)
- Electronics: DAE4 Sn779; Calibrated: 2014/2/25
- Phantom: SAM with CRP; Type: SAM; Serial: TP-1150 and higher
- Measurement SW: DASYS52, Version 52.8 (7); SEMCAD X Version 14.6.10 (7164)

Left Cheek/Area Scan (71x121x1):

Interpolated grid: $dx=1.500 \text{ mm}$, $dy=1.500 \text{ mm}$

Maximum value of SAR (interpolated) = 0.884 W/kg

Left Cheek/Zoom Scan (5x5x7)/Cube 0:

Measurement grid: $dx=8\text{mm}$, $dy=8\text{mm}$, $dz=5\text{mm}$

Reference Value = 8.808 V/m; Power Drift = -0.00 dB

Peak SAR (extrapolated) = 0.933 W/kg

SAR(1 g) = 0.754 W/kg; SAR(10 g) = 0.562 W/kg

Maximum value of SAR (measured) = 0.859 W/kg

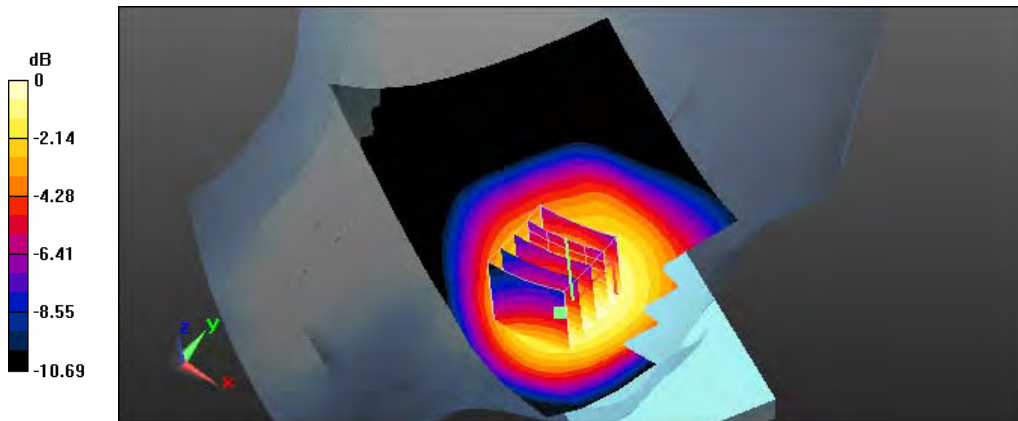

0 dB = 0.859 W/kg = -0.66 dBW/kg

Test Laboratory: A Test Lab Techno Corp.

Date: 2014/7/11 Time: AM 12:52:07

39_RC_WCDMA Band II CH9538_SIM1

DUT: SKY 4.5D; Type: WCDMA Mobile Phone; Serial: 868817019960135

Communication System: UID 0, WCDMA Band II (0); Frequency: 1907.6 MHz; Duty Cycle: 1:1

Medium parameters used: $f = 1908 \text{ MHz}$; $\sigma = 1.4 \text{ S/m}$; $\epsilon_r = 40.448$; $\rho = 1000 \text{ kg/m}^3$

Phantom section: Right Section

Measurement Standard: DASYS5 (IEEE/IEC/ANSI C63.19-2011)

DASY Configuration:

- Area Scan setting - Find Secondary Maximum Within: 2.0dB and with a peak SAR value greater than 0.5 W/Kg
- Probe: EX3DV4 - SN3977; ConvF(7.97, 7.97, 7.97); Calibrated: 2014/2/17;
- Sensor-Surface: 2mm (Mechanical Surface Detection)
- Electronics: DAE4 Sn779; Calibrated: 2014/2/25
- Phantom: SAM with CRP; Type: SAM; Serial: TP-1150 and higher
- Measurement SW: DASYS52, Version 52.8 (7); SEMCAD X Version 14.6.10 (7164)

Right Cheek/Area Scan (71x121x1):

Interpolated grid: $dx=1.500 \text{ mm}$, $dy=1.500 \text{ mm}$

Maximum value of SAR (interpolated) = 0.384 W/kg

Right Cheek/Zoom Scan (5x5x7)/Cube 0:

Measurement grid: $dx=8\text{mm}$, $dy=8\text{mm}$, $dz=5\text{mm}$

Reference Value = 7.775 V/m; Power Drift = 0.14 dB

Peak SAR (extrapolated) = 0.472 W/kg

SAR(1 g) = 0.298 W/kg; SAR(10 g) = 0.180 W/kg

Maximum value of SAR (measured) = 0.388 W/kg

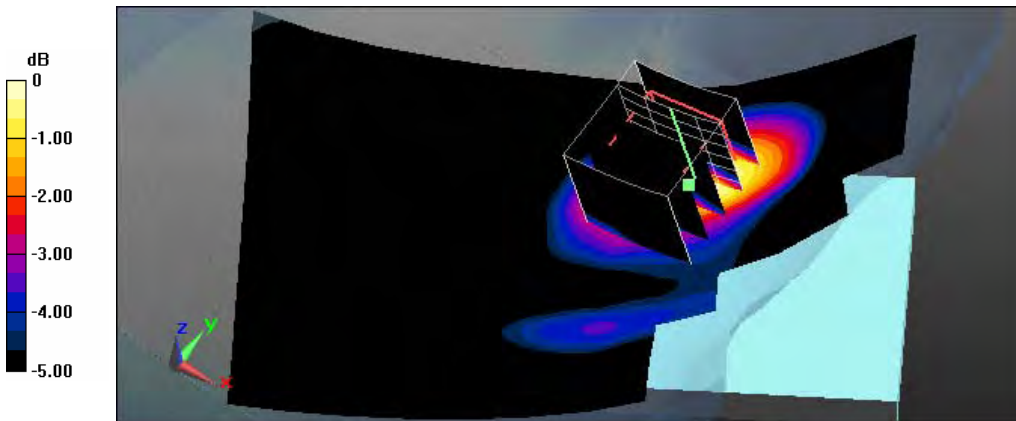

0 dB = 0.388 W/kg = -4.11 dBW/kg

Test Laboratory: A Test Lab Techno Corp.
 Date: 2014/7/11 Time: AM 01:11:00

40_RT_WCDMA Band II CH9538_SIM1

DUT: SKY 4.5D; Type: WCDMA Mobile Phone; Serial: 868817019960135

Communication System: UID 0, WCDMA Band II (0); Frequency: 1907.6 MHz; Duty Cycle: 1:1

Medium parameters used: $f = 1908 \text{ MHz}$; $\sigma = 1.4 \text{ S/m}$; $\epsilon_r = 40.448$; $\rho = 1000 \text{ kg/m}^3$

Phantom section: Right Section

Measurement Standard: DASYS5 (IEEE/IEC/ANSI C63.19-2011)

DASY Configuration:

- Area Scan setting - Find Secondary Maximum Within: 2.0dB and with a peak SAR value greater than 0.5 W/Kg
- Probe: EX3DV4 - SN3977; ConvF(7.97, 7.97, 7.97); Calibrated: 2014/2/17;
- Sensor-Surface: 2mm (Mechanical Surface Detection)
- Electronics: DAE4 Sn779; Calibrated: 2014/2/25
- Phantom: SAM with CRP; Type: SAM; Serial: TP-1150 and higher
- Measurement SW: DASYS52, Version 52.8 (7); SEMCAD X Version 14.6.10 (7164)

Right Tilted/Area Scan (71x121x1):

Interpolated grid: $dx=1.500 \text{ mm}$, $dy=1.500 \text{ mm}$

Maximum value of SAR (interpolated) = 0.183 W/kg

Right Tilted/Zoom Scan (5x5x7)/Cube 0:

Measurement grid: $dx=8\text{mm}$, $dy=8\text{mm}$, $dz=5\text{mm}$

Reference Value = 10.787 V/m; Power Drift = 0.06 dB

Peak SAR (extrapolated) = 0.224 W/kg

SAR(1 g) = 0.134 W/kg; SAR(10 g) = 0.075 W/kg

Maximum value of SAR (measured) = 0.183 W/kg

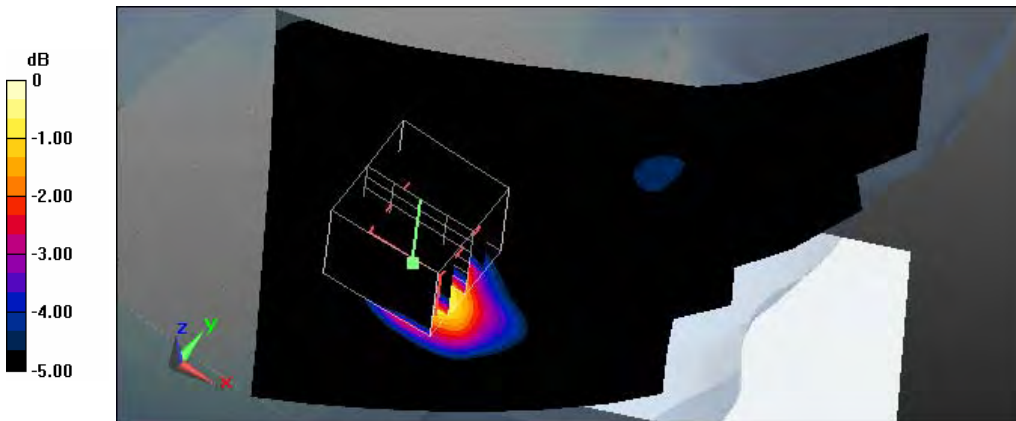

0 dB = 0.183 W/kg = -7.38 dBW/kg

Test Laboratory: A Test Lab Techno Corp.

Date: 2014/7/11 Time: AM 01:36:02

41_LC_WCDMA Band II CH9538_SIM1

DUT: SKY 4.5D; Type: WCDMA Mobile Phone; Serial: 868817019960135

Communication System: UID 0, WCDMA Band II (0); Frequency: 1907.6 MHz; Duty Cycle: 1:1

Medium parameters used: $f = 1908 \text{ MHz}$; $\sigma = 1.4 \text{ S/m}$; $\epsilon_r = 40.448$; $\rho = 1000 \text{ kg/m}^3$

Phantom section: Left Section

Measurement Standard: DASYS (IEEE/IEC/ANSI C63.19-2011)

DASY Configuration:

- Area Scan setting - Find Secondary Maximum Within: 2.0dB and with a peak SAR value greater than 0.5 W/Kg
- Probe: EX3DV4 - SN3977; ConvF(7.97, 7.97, 7.97); Calibrated: 2014/2/17;
- Sensor-Surface: 2mm (Mechanical Surface Detection)
- Electronics: DAE4 Sn779; Calibrated: 2014/2/25
- Phantom: SAM with CRP; Type: SAM; Serial: TP-1150 and higher
- Measurement SW: DASYS2, Version 52.8 (7); SEMCAD X Version 14.6.10 (7164)

Left Cheek/Area Scan (71x121x1):

Interpolated grid: $dx=1.500 \text{ mm}$, $dy=1.500 \text{ mm}$

Maximum value of SAR (interpolated) = 0.346 W/kg

Left Cheek/Zoom Scan (5x5x7)/Cube 0:

Measurement grid: $dx=8\text{mm}$, $dy=8\text{mm}$, $dz=5\text{mm}$

Reference Value = 8.063 V/m; Power Drift = 0.03 dB

Peak SAR (extrapolated) = 0.414 W/kg

SAR(1 g) = 0.272 W/kg; SAR(10 g) = 0.171 W/kg

Maximum value of SAR (measured) = 0.348 W/kg

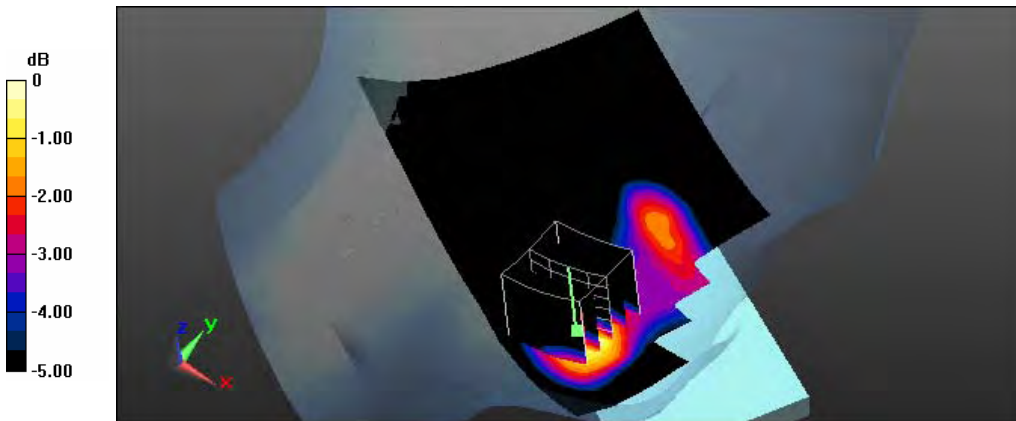

0 dB = 0.348 W/kg = -4.58 dBW/kg

Test Laboratory: A Test Lab Techno Corp.

Date: 2014/7/11 Time: AM 01:57:57

42_LT_WCDMA Band II CH9538_SIM1

DUT: SKY 4.5D; Type: WCDMA Mobile Phone; Serial: 868817019960135

Communication System: UID 0, WCDMA Band II (0); Frequency: 1907.6 MHz; Duty Cycle: 1:1

Medium parameters used: $f = 1908 \text{ MHz}$; $\sigma = 1.4 \text{ S/m}$; $\epsilon_r = 40.448$; $\rho = 1000 \text{ kg/m}^3$

Phantom section: Left Section

Measurement Standard: DASYS (IEEE/IEC/ANSI C63.19-2011)

DASY Configuration:

- Area Scan setting - Find Secondary Maximum Within: 2.0dB and with a peak SAR value greater than 0.5 W/Kg
- Probe: EX3DV4 - SN3977; ConvF(7.97, 7.97, 7.97); Calibrated: 2014/2/17;
- Sensor-Surface: 2mm (Mechanical Surface Detection)
- Electronics: DAE4 Sn779; Calibrated: 2014/2/25
- Phantom: SAM with CRP; Type: SAM; Serial: TP-1150 and higher
- Measurement SW: DASYS2, Version 52.8 (7); SEMCAD X Version 14.6.10 (7164)

Left Tilted/Area Scan (71x121x1):

Interpolated grid: $dx=1.500 \text{ mm}$, $dy=1.500 \text{ mm}$

Maximum value of SAR (interpolated) = 0.186 W/kg

Left Tilted/Zoom Scan (5x5x7)/Cube 0:

Measurement grid: $dx=8\text{mm}$, $dy=8\text{mm}$, $dz=5\text{mm}$

Reference Value = 11.068 V/m; Power Drift = 0.01 dB

Peak SAR (extrapolated) = 0.216 W/kg

SAR(1 g) = 0.130 W/kg; SAR(10 g) = 0.072 W/kg

Maximum value of SAR (measured) = 0.172 W/kg

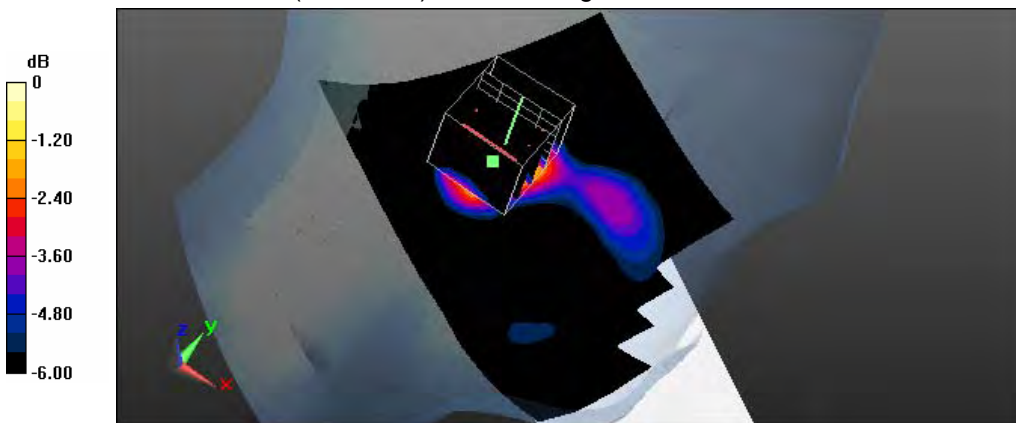

0 dB = 0.172 W/kg = -7.64 dBW/kg

Test Laboratory: A Test Lab Techno Corp.

Date: 2014/7/16 Time: PM 01:30:48

65_RC_WCDMA Band IV CH1413_SIM1

DUT: SKY 4.5D; Type: WCDMA Mobile Phone; Serial: 868817019960135

Communication System: UID 0, WCDMA Band IV (0); Frequency: 1732.6 MHz; Duty Cycle: 1:1

Medium parameters used: $f = 1733 \text{ MHz}$; $\sigma = 1.385 \text{ S/m}$; $\epsilon_r = 41.427$; $\rho = 1000 \text{ kg/m}^3$

Phantom section: Right Section

Measurement Standard: DASYS5 (IEEE/IEC/ANSI C63.19-2011)

DASY Configuration:

- Area Scan setting - Find Secondary Maximum Within: 2.0dB and with a peak SAR value greater than 0.5 W/Kg
- Probe: EX3DV4 - SN3977; ConvF(8.14, 8.14, 8.14); Calibrated: 2014/2/17;
- Sensor-Surface: 2mm (Mechanical Surface Detection)
- Electronics: DAE4 Sn779; Calibrated: 2014/2/25
- Phantom: SAM with CRP; Type: SAM; Serial: TP-1150 and higher
- Measurement SW: DASYS52, Version 52.8 (7); SEMCAD X Version 14.6.10 (7164)

Right Cheek/Area Scan (71x121x1):

Interpolated grid: $dx=1.500 \text{ mm}$, $dy=1.500 \text{ mm}$

Maximum value of SAR (interpolated) = 0.360 W/kg

Right Cheek/Zoom Scan (5x5x7)/Cube 0:

Measurement grid: $dx=8\text{mm}$, $dy=8\text{mm}$, $dz=5\text{mm}$

Reference Value = 7.415 V/m; Power Drift = -0.03 dB

Peak SAR (extrapolated) = 0.439 W/kg

SAR(1 g) = 0.279 W/kg; SAR(10 g) = 0.172 W/kg

Maximum value of SAR (measured) = 0.356 W/kg

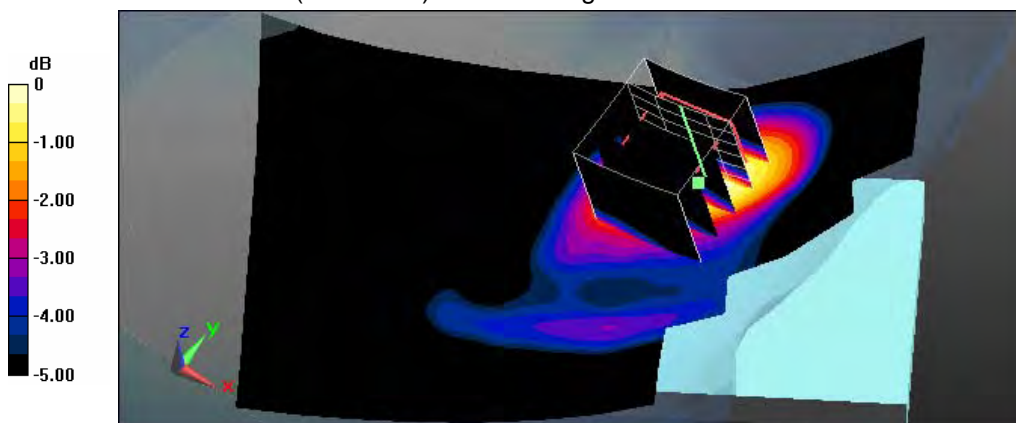

0 dB = 0.356 W/kg = -4.49 dBW/kg

Test Laboratory: A Test Lab Techno Corp.

Date: 2014/7/16 Time: PM 01:50:12

66_RT_WCDMA Band IV CH1413_SIM1

DUT: SKY 4.5D; Type: WCDMA Mobile Phone; Serial: 868817019960135

Communication System: UID 0, WCDMA Band IV (0); Frequency: 1732.6 MHz; Duty Cycle: 1:1

Medium parameters used: $f = 1733 \text{ MHz}$; $\sigma = 1.385 \text{ S/m}$; $\epsilon_r = 41.427$; $\rho = 1000 \text{ kg/m}^3$

Phantom section: Right Section

Measurement Standard: DASYS5 (IEEE/IEC/ANSI C63.19-2011)

DASY Configuration:

- Area Scan setting - Find Secondary Maximum Within: 2.0dB and with a peak SAR value greater than 0.5 W/Kg
- Probe: EX3DV4 - SN3977; ConvF(8.14, 8.14, 8.14); Calibrated: 2014/2/17;
- Sensor-Surface: 2mm (Mechanical Surface Detection)
- Electronics: DAE4 Sn779; Calibrated: 2014/2/25
- Phantom: SAM with CRP; Type: SAM; Serial: TP-1150 and higher
- Measurement SW: DASYS52, Version 52.8 (7); SEMCAD X Version 14.6.10 (7164)

Right Tilted/Area Scan (71x121x1):

Interpolated grid: $dx=1.500 \text{ mm}$, $dy=1.500 \text{ mm}$

Maximum value of SAR (interpolated) = 0.169 W/kg

Right Tilted/Zoom Scan (5x5x7)/Cube 0:

Measurement grid: $dx=8\text{mm}$, $dy=8\text{mm}$, $dz=5\text{mm}$

Reference Value = 9.565 V/m; Power Drift = 0.09 dB

Peak SAR (extrapolated) = 0.192 W/kg

SAR(1 g) = 0.121 W/kg; SAR(10 g) = 0.071 W/kg

Maximum value of SAR (measured) = 0.156 W/kg

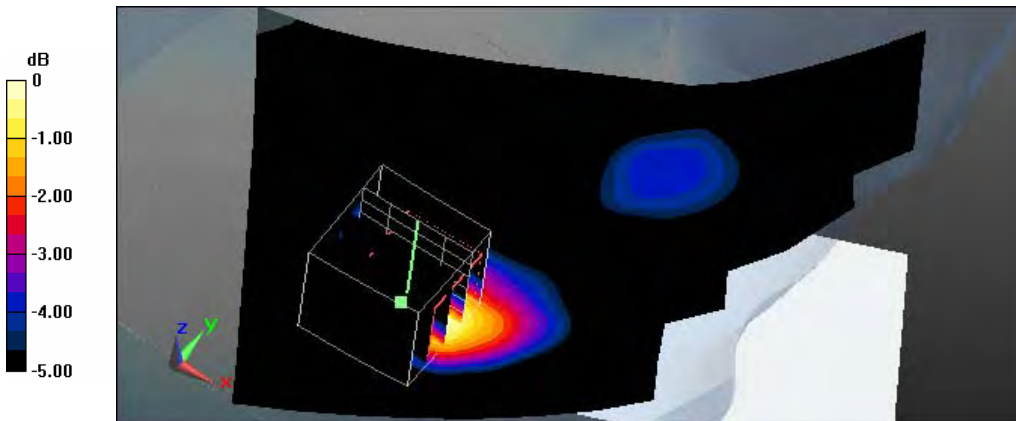

0 dB = 0.156 W/kg = -8.07 dBW/kg

Test Laboratory: A Test Lab Techno Corp.

Date: 2014/7/16 Time: PM 02:22:34

67_LC_WCDMA Band IV CH1413_SIM1

DUT: SKY 4.5D; Type: WCDMA Mobile Phone; Serial: 868817019960135

Communication System: UID 0, WCDMA Band IV (0); Frequency: 1732.6 MHz; Duty Cycle: 1:1

Medium parameters used: $f = 1733 \text{ MHz}$; $\sigma = 1.385 \text{ S/m}$; $\epsilon_r = 41.427$; $\rho = 1000 \text{ kg/m}^3$

Phantom section: Left Section

Measurement Standard: DASYS (IEEE/IEC/ANSI C63.19-2011)

DASY Configuration:

- Area Scan setting - Find Secondary Maximum Within: 2.0dB and with a peak SAR value greater than 0.5 W/Kg
- Probe: EX3DV4 - SN3977; ConvF(8.14, 8.14, 8.14); Calibrated: 2014/2/17;
- Sensor-Surface: 2mm (Mechanical Surface Detection)
- Electronics: DAE4 Sn779; Calibrated: 2014/2/25
- Phantom: SAM with CRP; Type: SAM; Serial: TP-1150 and higher
- Measurement SW: DASYS2, Version 52.8 (7); SEMCAD X Version 14.6.10 (7164)

Left Cheek/Area Scan (71x121x1):

Interpolated grid: $dx=1.500 \text{ mm}$, $dy=1.500 \text{ mm}$

Maximum value of SAR (interpolated) = 0.383 W/kg

Left Cheek/Zoom Scan (5x5x7)/Cube 0:

Measurement grid: $dx=8\text{mm}$, $dy=8\text{mm}$, $dz=5\text{mm}$

Reference Value = 7.374 V/m; Power Drift = -0.09 dB

Peak SAR (extrapolated) = 0.430 W/kg

SAR(1 g) = 0.277 W/kg; SAR(10 g) = 0.171 W/kg

Maximum value of SAR (measured) = 0.349 W/kg

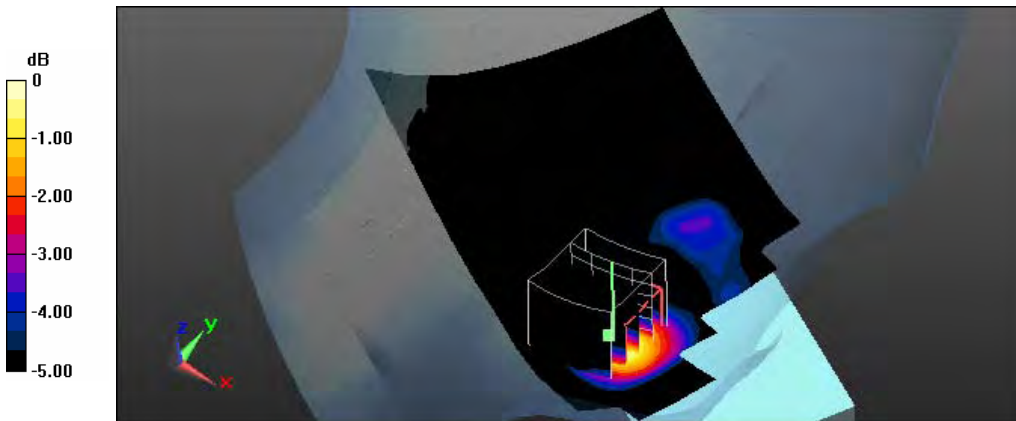

0 dB = 0.349 W/kg = -4.57 dBW/kg

Test Laboratory: A Test Lab Techno Corp.
 Date: 2014/7/16 Time: PM 02:41:10

68_LT_WCDMA Band IV CH1413_SIM1

DUT: SKY 4.5D; Type: WCDMA Mobile Phone; Serial: 868817019960135

Communication System: UID 0, WCDMA Band IV (0); Frequency: 1732.6 MHz; Duty Cycle: 1:1

Medium parameters used: $f = 1733 \text{ MHz}$; $\sigma = 1.385 \text{ S/m}$; $\epsilon_r = 41.427$; $\rho = 1000 \text{ kg/m}^3$

Phantom section: Left Section

Measurement Standard: DASYS (IEEE/IEC/ANSI C63.19-2011)

DASY Configuration:

- Area Scan setting - Find Secondary Maximum Within: 2.0dB and with a peak SAR value greater than 0.5 W/Kg
- Probe: EX3DV4 - SN3977; ConvF(8.14, 8.14, 8.14); Calibrated: 2014/2/17;
- Sensor-Surface: 2mm (Mechanical Surface Detection)
- Electronics: DAE4 Sn779; Calibrated: 2014/2/25
- Phantom: SAM with CRP; Type: SAM; Serial: TP-1150 and higher
- Measurement SW: DASYS2, Version 52.8 (7); SEMCAD X Version 14.6.10 (7164)

Left Tilted/Area Scan (71x121x1):

Interpolated grid: $dx=1.500 \text{ mm}$, $dy=1.500 \text{ mm}$

Maximum value of SAR (interpolated) = 0.147 W/kg

Left Tilted/Zoom Scan (5x5x7)/Cube 0:

Measurement grid: $dx=8\text{mm}$, $dy=8\text{mm}$, $dz=5\text{mm}$

Reference Value = 9.176 V/m; Power Drift = 0.07 dB

Peak SAR (extrapolated) = 0.174 W/kg

SAR(1 g) = 0.107 W/kg; SAR(10 g) = 0.062 W/kg

Maximum value of SAR (measured) = 0.139 W/kg

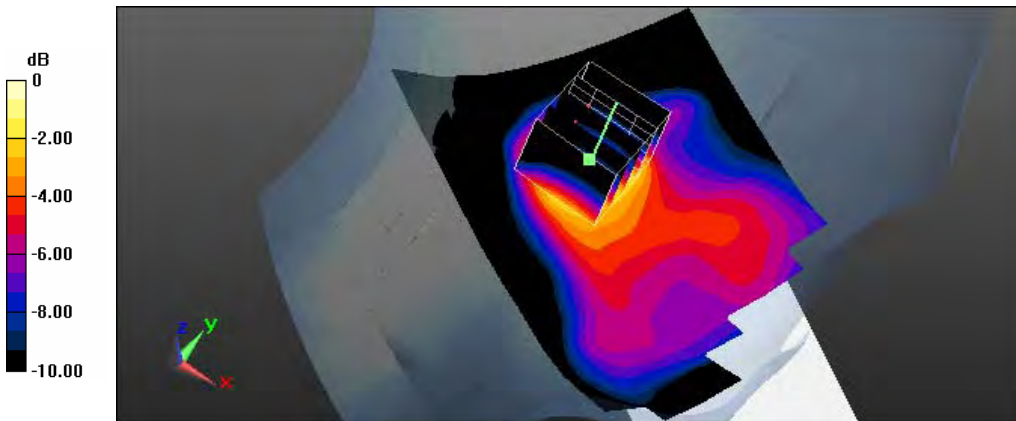

0 dB = 0.139 W/kg = -8.57 dBW/kg

Test Laboratory: A Test Lab Techno Corp.

Date: 2014/7/8 Time: AM 01:13:15

43_RC_WCDMA Band V CH4183_SIM1

DUT: SKY 4.5D; Type: WCDMA Mobile Phone; Serial: 868817019960135

Communication System: UID 0, WCDMA Band V (0); Frequency: 836.6 MHz; Duty Cycle: 1:1

Medium parameters used: $f = 837 \text{ MHz}$; $\sigma = 0.922 \text{ S/m}$; $\epsilon_r = 43.353$; $\rho = 1000 \text{ kg/m}^3$

Phantom section: Right Section

Measurement Standard: DASYS5 (IEEE/IEC/ANSI C63.19-2011)

DASY Configuration:

- Area Scan setting - Find Secondary Maximum Within: 2.0dB and with a peak SAR value greater than 0.5 W/Kg
- Probe: EX3DV4 - SN3977; ConvF(9.62, 9.62, 9.62); Calibrated: 2014/2/17;
- Sensor-Surface: 2mm (Mechanical Surface Detection)
- Electronics: DAE4 Sn779; Calibrated: 2014/2/25
- Phantom: SAM with CRP; Type: SAM; Serial: TP-1150 and higher
- Measurement SW: DASYS52, Version 52.8 (7); SEMCAD X Version 14.6.10 (7164)

Right Cheek/Area Scan (71x121x1):

Interpolated grid: $dx=1.500 \text{ mm}$, $dy=1.500 \text{ mm}$

Maximum value of SAR (interpolated) = 0.398 W/kg

Right Cheek/Zoom Scan (5x5x7)/Cube 0:

Measurement grid: $dx=8\text{mm}$, $dy=8\text{mm}$, $dz=5\text{mm}$

Reference Value = 3.624 V/m; Power Drift = 0.16 dB

Peak SAR (extrapolated) = 0.426 W/kg

SAR(1 g) = 0.348 W/kg; SAR(10 g) = 0.269 W/kg

Maximum value of SAR (measured) = 0.394 W/kg

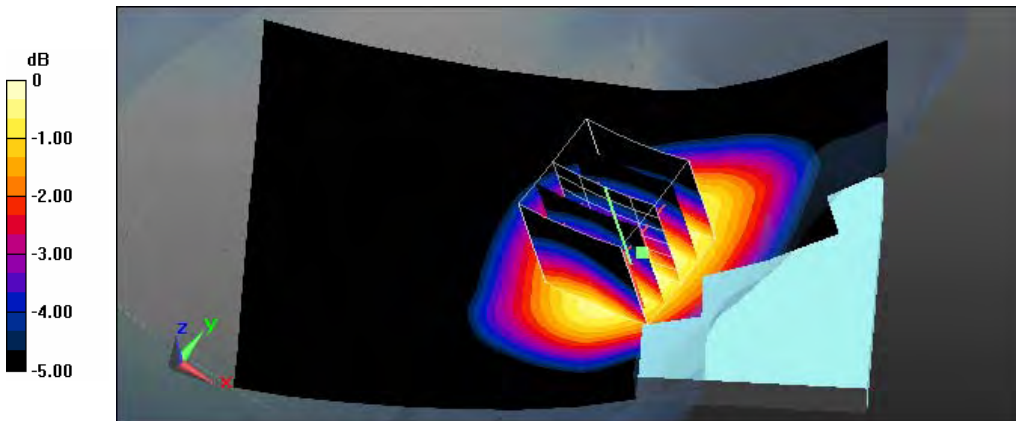

0 dB = 0.394 W/kg = -4.05 dBW/kg

Test Laboratory: A Test Lab Techno Corp.

Date: 2014/7/8 Time: AM 01:32:54

44_RT_WCDMA Band V CH4183_SIM1

DUT: SKY 4.5D; Type: WCDMA Mobile Phone; Serial: 868817019960135

Communication System: UID 0, WCDMA Band V (0); Frequency: 836.6 MHz; Duty Cycle: 1:1

Medium parameters used: $f = 837 \text{ MHz}$; $\sigma = 0.922 \text{ S/m}$; $\epsilon_r = 43.353$; $\rho = 1000 \text{ kg/m}^3$

Phantom section: Right Section

Measurement Standard: DASYS5 (IEEE/IEC/ANSI C63.19-2011)

DASY Configuration:

- Area Scan setting - Find Secondary Maximum Within: 2.0dB and with a peak SAR value greater than 0.5 W/Kg
- Probe: EX3DV4 - SN3977; ConvF(9.62, 9.62, 9.62); Calibrated: 2014/2/17;
- Sensor-Surface: 2mm (Mechanical Surface Detection)
- Electronics: DAE4 Sn779; Calibrated: 2014/2/25
- Phantom: SAM with CRP; Type: SAM; Serial: TP-1150 and higher
- Measurement SW: DASYS52, Version 52.8 (7); SEMCAD X Version 14.6.10 (7164)

Right Tilted/Area Scan (71x121x1):

Interpolated grid: $dx=1.500 \text{ mm}$, $dy=1.500 \text{ mm}$

Maximum value of SAR (interpolated) = 0.245 W/kg

Right Tilted/Zoom Scan (5x5x7)/Cube 0:

Measurement grid: $dx=8\text{mm}$, $dy=8\text{mm}$, $dz=5\text{mm}$

Reference Value = 5.888 V/m; Power Drift = 0.15 dB

Peak SAR (extrapolated) = 0.269 W/kg

SAR(1 g) = 0.218 W/kg; SAR(10 g) = 0.168 W/kg

Maximum value of SAR (measured) = 0.248 W/kg

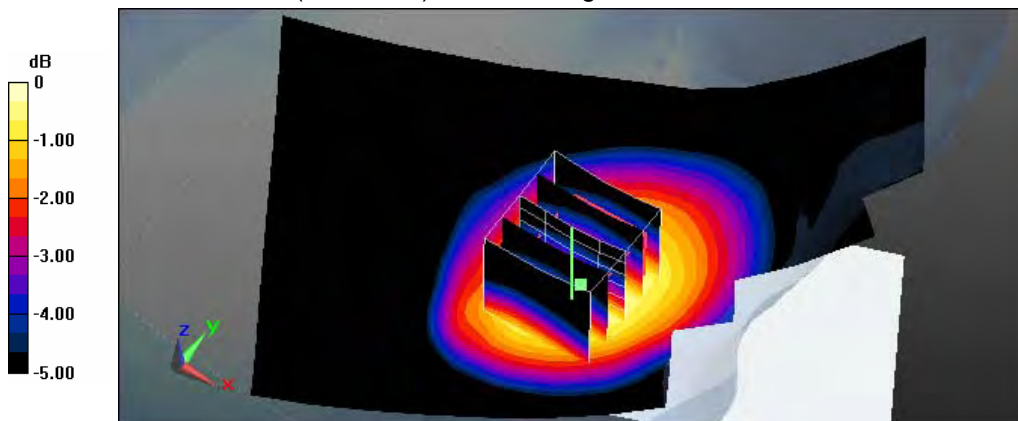

0 dB = 0.248 W/kg = -6.06 dBW/kg

Test Laboratory: A Test Lab Techno Corp.
 Date: 2014/7/8 Time: AM 01:59:07

45_LC_WCDMA Band V CH4183_SIM1

DUT: SKY 4.5D; Type: WCDMA Mobile Phone; Serial: 868817019960135

Communication System: UID 0, WCDMA Band V (0); Frequency: 836.6 MHz; Duty Cycle: 1:1

Medium parameters used: $f = 837 \text{ MHz}$; $\sigma = 0.922 \text{ S/m}$; $\epsilon_r = 43.353$; $\rho = 1000 \text{ kg/m}^3$

Phantom section: Left Section

Measurement Standard: DASYS5 (IEEE/IEC/ANSI C63.19-2011)

DASY Configuration:

- Area Scan setting - Find Secondary Maximum Within: 2.0dB and with a peak SAR value greater than 0.5 W/Kg
- Probe: EX3DV4 - SN3977; ConvF(9.62, 9.62, 9.62); Calibrated: 2014/2/17;
- Sensor-Surface: 2mm (Mechanical Surface Detection)
- Electronics: DAE4 Sn779; Calibrated: 2014/2/25
- Phantom: SAM with CRP; Type: SAM; Serial: TP-1150 and higher
- Measurement SW: DASYS52, Version 52.8 (7); SEMCAD X Version 14.6.10 (7164)

Left Cheek/Area Scan (71x121x1):

Interpolated grid: $dx=1.500 \text{ mm}$, $dy=1.500 \text{ mm}$

Maximum value of SAR (interpolated) = 0.438 W/kg

Left Cheek/Zoom Scan (5x5x7)/Cube 0:

Measurement grid: $dx=8\text{mm}$, $dy=8\text{mm}$, $dz=5\text{mm}$

Reference Value = 5.562 V/m; Power Drift = 0.04 dB

Peak SAR (extrapolated) = 0.469 W/kg

SAR(1 g) = 0.382 W/kg; SAR(10 g) = 0.293 W/kg

Maximum value of SAR (measured) = 0.433 W/kg

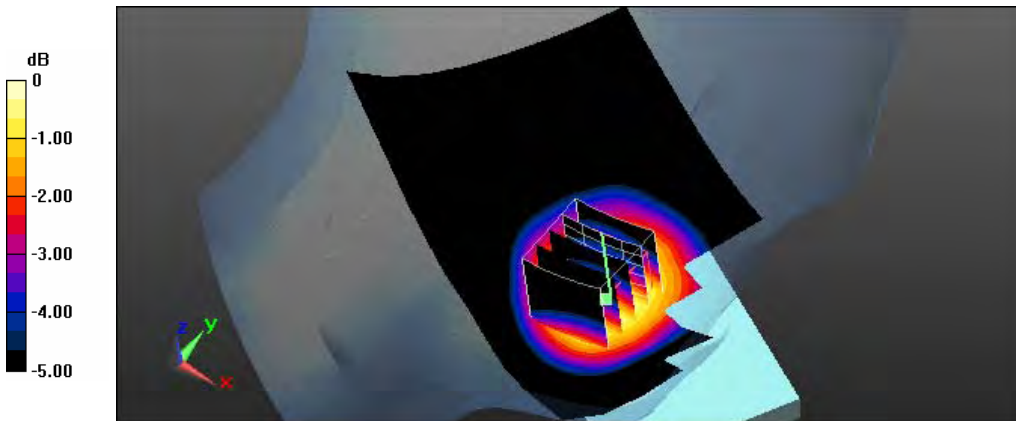

0 dB = 0.433 W/kg = -3.64 dBW/kg

Test Laboratory: A Test Lab Techno Corp.
 Date: 2014/7/8 Time: AM 02:20:22

46_LT_WCDMA Band V CH4183_SIM1

DUT: SKY 4.5D; Type: WCDMA Mobile Phone; Serial: 868817019960135

Communication System: UID 0, WCDMA Band V (0); Frequency: 836.6 MHz; Duty Cycle: 1:1

Medium parameters used: $f = 837 \text{ MHz}$; $\sigma = 0.922 \text{ S/m}$; $\epsilon_r = 43.353$; $\rho = 1000 \text{ kg/m}^3$

Phantom section: Left Section

Measurement Standard: DASYS5 (IEEE/IEC/ANSI C63.19-2011)

DASY Configuration:

- Area Scan setting - Find Secondary Maximum Within: 2.0dB and with a peak SAR value greater than 0.5 W/Kg
- Probe: EX3DV4 - SN3977; ConvF(9.62, 9.62, 9.62); Calibrated: 2014/2/17;
- Sensor-Surface: 2mm (Mechanical Surface Detection)
- Electronics: DAE4 Sn779; Calibrated: 2014/2/25
- Phantom: SAM with CRP; Type: SAM; Serial: TP-1150 and higher
- Measurement SW: DASYS52, Version 52.8 (7); SEMCAD X Version 14.6.10 (7164)

Left Tilted/Area Scan (71x121x1):

Interpolated grid: $dx=1.500 \text{ mm}$, $dy=1.500 \text{ mm}$

Maximum value of SAR (interpolated) = 0.241 W/kg

Left Tilted/Zoom Scan (5x5x7)/Cube 0:

Measurement grid: $dx=8\text{mm}$, $dy=8\text{mm}$, $dz=5\text{mm}$

Reference Value = 7.956 V/m; Power Drift = 0.14 dB

Peak SAR (extrapolated) = 0.263 W/kg

SAR(1 g) = 0.213 W/kg; SAR(10 g) = 0.164 W/kg

Maximum value of SAR (measured) = 0.241 W/kg

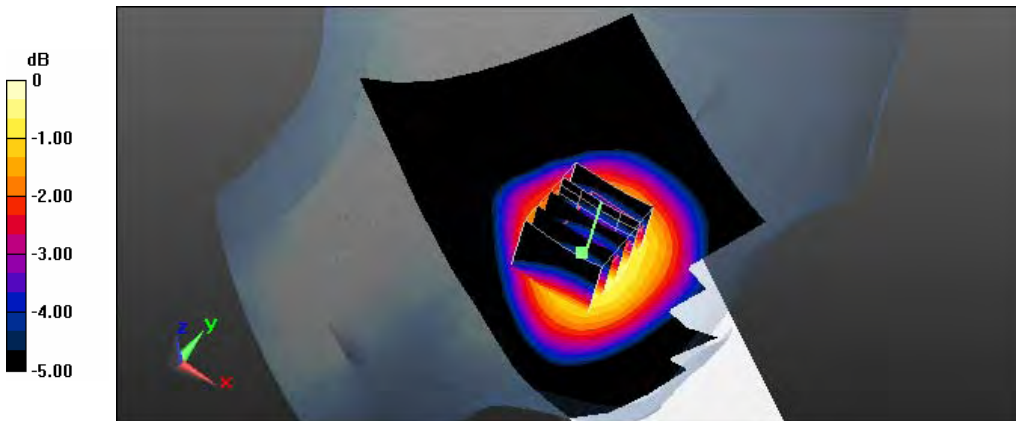

0 dB = 0.241 W/kg = -6.18 dBW/kg

Test Laboratory: A Test Lab Techno Corp.

Date: 2014/7/11 Time: PM 07:24:33

57_RC_802.11b CH1_5.5M

DUT: SKY 4.5D; Type: WCDMA Mobile Phone; Serial: 868817019960135

Communication System: UID 0, IEEE 802.11b (0); Frequency: 2412 MHz; Duty Cycle: 1:1

Medium parameters used: $f = 2412 \text{ MHz}$; $\sigma = 1.792 \text{ S/m}$; $\epsilon_r = 38.418$; $\rho = 1000 \text{ kg/m}^3$

Phantom section: Right Section

Measurement Standard: DASY5 (IEEE/IEC/ANSI C63.19-2011)

DASY Configuration:

- Area Scan setting - Find Secondary Maximum Within: 2.0dB and with a peak SAR value greater than 0.5 W/Kg
- Probe: EX3DV4 - SN3977; ConvF(7.24, 7.24, 7.24); Calibrated: 2014/2/17;
- Sensor-Surface: 2mm (Mechanical Surface Detection)
- Electronics: DAE4 Sn779; Calibrated: 2014/2/25
- Phantom: SAM with CRP; Type: SAM; Serial: TP-1150 and higher
- Measurement SW: DASY52, Version 52.8 (7); SEMCAD X Version 14.6.10 (7164)

Right Cheek/Area Scan (101x181x1):

Interpolated grid: $dx=1.000 \text{ mm}$, $dy=1.000 \text{ mm}$

Maximum value of SAR (interpolated) = 1.11 W/kg

Right Cheek/Zoom Scan (7x7x7)/Cube 0:

Measurement grid: $dx=5\text{mm}$, $dy=5\text{mm}$, $dz=5\text{mm}$

Reference Value = 15.195 V/m; Power Drift = -0.14 dB

Peak SAR (extrapolated) = 1.43 W/kg

SAR(1 g) = 0.645 W/kg; SAR(10 g) = 0.304 W/kg

Maximum value of SAR (measured) = 0.962 W/kg

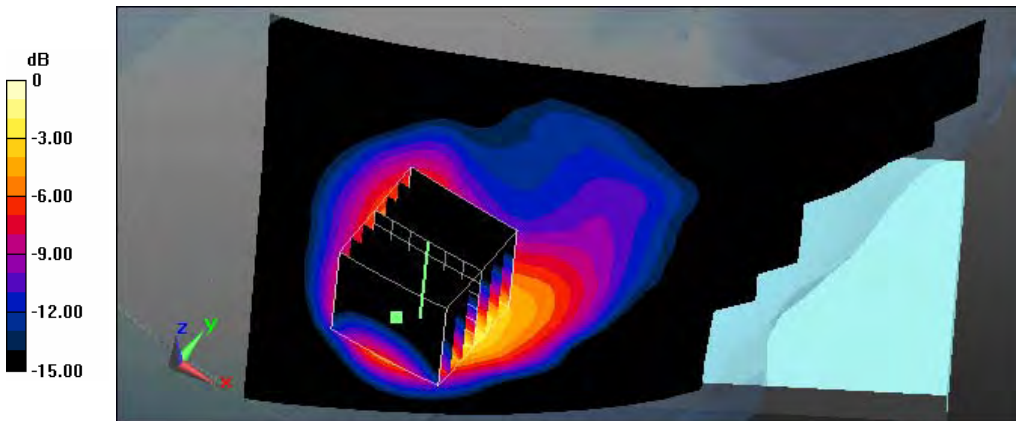

0 dB = 0.962 W/kg = -0.17 dBW/kg

Test Laboratory: A Test Lab Techno Corp.

Date: 2014/7/11 Time: PM 08:32:37

58_RT_802.11b CH1_5.5M

DUT: SKY 4.5D; Type: WCDMA Mobile Phone; Serial: 868817019960135

Communication System: UID 0, IEEE 802.11b (0); Frequency: 2412 MHz; Duty Cycle: 1:1

Medium parameters used: $f = 2412$ MHz; $\sigma = 1.792$ S/m; $\epsilon_r = 38.418$; $\rho = 1000$ kg/m³

Phantom section: Right Section

Measurement Standard: DASYS (IEEE/IEC/ANSI C63.19-2011)

DASY Configuration:

- Area Scan setting - Find Secondary Maximum Within: 2.0dB and with a peak SAR value greater than 0.5 W/Kg
- Probe: EX3DV4 - SN3977; ConvF(7.24, 7.24, 7.24); Calibrated: 2014/2/17;
- Sensor-Surface: 2mm (Mechanical Surface Detection)
- Electronics: DAE4 Sn779; Calibrated: 2014/2/25
- Phantom: SAM with CRP; Type: SAM; Serial: TP-1150 and higher
- Measurement SW: DASYS2, Version 52.8 (7); SEMCAD X Version 14.6.10 (7164)

Right Tilted/Area Scan (101x181x1):

Interpolated grid: dx=1.000 mm, dy=1.000 mm

Maximum value of SAR (interpolated) = 0.794 W/kg

Right Tilted/Zoom Scan (7x7x7)/Cube 0:

Measurement grid: dx=5mm, dy=5mm, dz=5mm

Reference Value = 15.938 V/m; Power Drift = 0.02 dB

Peak SAR (extrapolated) = 1.07 W/kg

SAR(1 g) = 0.468 W/kg; SAR(10 g) = 0.215 W/kg

Maximum value of SAR (measured) = 0.740 W/kg

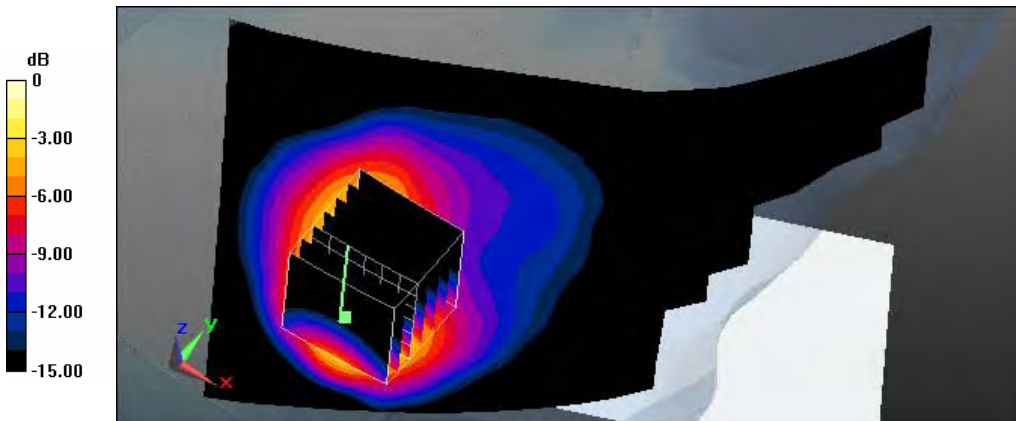

0 dB = 0.740 W/kg = -1.31 dBW/kg

Test Laboratory: A Test Lab Techno Corp.
 Date: 2014/7/11 Time: PM 11:32:52

59_LC_802.11b CH1_5.5M

DUT: SKY 4.5D; Type: WCDMA Mobile Phone; Serial: 868817019960135

Communication System: UID 0, IEEE 802.11b (0); Frequency: 2412 MHz; Duty Cycle: 1:1

Medium parameters used: $f = 2412 \text{ MHz}$; $\sigma = 1.792 \text{ S/m}$; $\epsilon_r = 38.418$; $\rho = 1000 \text{ kg/m}^3$

Phantom section: Left Section

Measurement Standard: DASYS5 (IEEE/IEC/ANSI C63.19-2011)

DASY Configuration:

- Area Scan setting - Find Secondary Maximum Within: 2.0dB and with a peak SAR value greater than 0.5 W/Kg
- Probe: EX3DV4 - SN3977; ConvF(7.24, 7.24, 7.24); Calibrated: 2014/2/17;
- Sensor-Surface: 2mm (Mechanical Surface Detection)
- Electronics: DAE4 Sn779; Calibrated: 2014/2/25
- Phantom: SAM with CRP; Type: SAM; Serial: TP-1150 and higher
- Measurement SW: DASYS52, Version 52.8 (7); SEMCAD X Version 14.6.10 (7164)

Left Cheek/Area Scan (101x181x1):

Interpolated grid: $dx=1.000 \text{ mm}$, $dy=1.000 \text{ mm}$

Maximum value of SAR (interpolated) = 0.403 W/kg

Left Cheek/Zoom Scan (7x7x7)/Cube 0:

Measurement grid: $dx=5\text{mm}$, $dy=5\text{mm}$, $dz=5\text{mm}$

Reference Value = 14.713 V/m; Power Drift = -0.07 dB

Peak SAR (extrapolated) = 0.512 W/kg

SAR(1 g) = 0.273 W/kg; SAR(10 g) = 0.145 W/kg

Maximum value of SAR (measured) = 0.387 W/kg

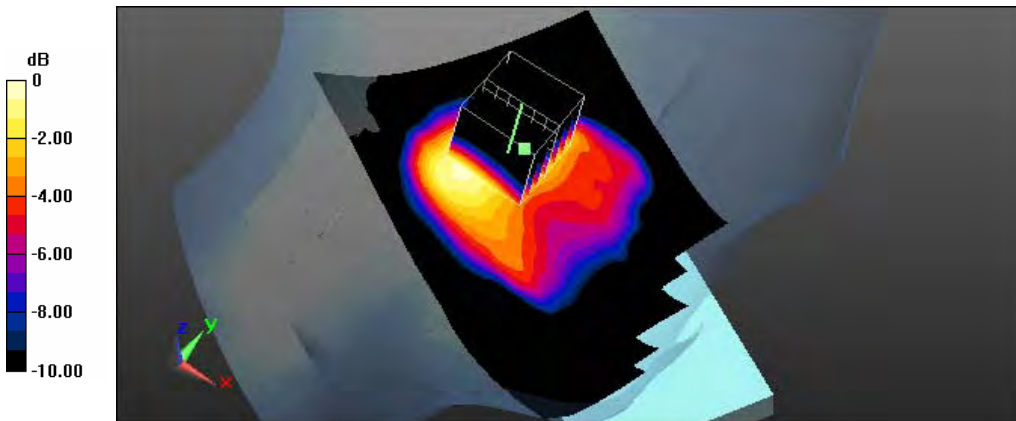

0 dB = 0.387 W/kg = -4.12 dBW/kg

Test Laboratory: A Test Lab Techno Corp.
 Date: 2014/7/12 Time: AM 12:24:43

60_LT_802.11b CH1_5.5M

DUT: SKY 4.5D; Type: WCDMA Mobile Phone; Serial: 868817019960135

Communication System: UID 0, IEEE 802.11b (0); Frequency: 2412 MHz; Duty Cycle: 1:1

Medium parameters used: $f = 2412 \text{ MHz}$; $\sigma = 1.792 \text{ S/m}$; $\epsilon_r = 38.418$; $\rho = 1000 \text{ kg/m}^3$

Phantom section: Left Section

Measurement Standard: DASYS5 (IEEE/IEC/ANSI C63.19-2011)

DASY Configuration:

- Area Scan setting - Find Secondary Maximum Within: 2.0dB and with a peak SAR value greater than 0.5 W/Kg
- Probe: EX3DV4 - SN3977; ConvF(7.24, 7.24, 7.24); Calibrated: 2014/2/17;
- Sensor-Surface: 2mm (Mechanical Surface Detection)
- Electronics: DAE4 Sn779; Calibrated: 2014/2/25
- Phantom: SAM with CRP; Type: SAM; Serial: TP-1150 and higher
- Measurement SW: DASYS52, Version 52.8 (7); SEMCAD X Version 14.6.10 (7164)

Left Tilted/Area Scan (101x181x1):

Interpolated grid: $dx=1.000 \text{ mm}$, $dy=1.000 \text{ mm}$

Maximum value of SAR (interpolated) = 0.435 W/kg

Left Tilted/Zoom Scan (7x7x7)/Cube 0:

Measurement grid: $dx=5\text{mm}$, $dy=5\text{mm}$, $dz=5\text{mm}$

Reference Value = 15.418 V/m; Power Drift = 0.05 dB

Peak SAR (extrapolated) = 0.538 W/kg

SAR(1 g) = 0.289 W/kg; SAR(10 g) = 0.149 W/kg

Maximum value of SAR (measured) = 0.411 W/kg

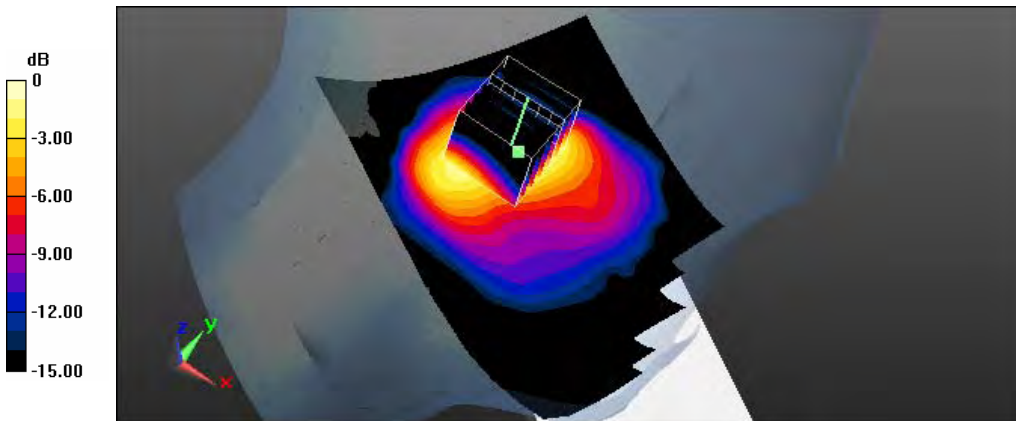

0 dB = 0.411 W/kg = -3.86 dBW/kg

Test Laboratory: A Test Lab Techno Corp.

Date: 2014/7/8 Time: PM 01:46:39

20_Flat_GSM 850 CH251_side1 surface to phantom 10mm_headset_SIM1

DUT: SKY 4.5D; Type: WCDMA Mobile Phone; Serial: 868817019960135

Communication System: UID 0, GSM850 (0); Frequency: 848.8 MHz; Duty Cycle: 1:8

Medium parameters used: $f = 849 \text{ MHz}$; $\sigma = 1.004 \text{ S/m}$; $\epsilon_r = 56.334$; $\rho = 1000 \text{ kg/m}^3$

Phantom section: Flat Section

Measurement Standard: DASYS (IEEE/IEC/ANSI C63.19-2011)

DASY Configuration:

- Area Scan setting - Find Secondary Maximum Within: 2.0dB and with a peak SAR value greater than 0.5 W/Kg
- Probe: EX3DV4 - SN3977; ConvF(9.74, 9.74, 9.74); Calibrated: 2014/2/17;
- Sensor-Surface: 2mm (Mechanical Surface Detection)
- Electronics: DAE4 Sn779; Calibrated: 2014/2/25
- Phantom: SAM with CRP; Type: SAM; Serial: TP-1150 and higher
- Measurement SW: DASYS2, Version 52.8 (7); SEMCAD X Version 14.6.10 (7164)

Flat/Area Scan (71x111x1):

Interpolated grid: $dx=1.500 \text{ mm}$, $dy=1.500 \text{ mm}$

Maximum value of SAR (interpolated) = 0.460 W/kg

Flat/Zoom Scan (5x5x7)/Cube 0:

Measurement grid: $dx=8\text{mm}$, $dy=8\text{mm}$, $dz=5\text{mm}$

Reference Value = 21.583 V/m; Power Drift = -0.05 dB

Peak SAR (extrapolated) = 0.497 W/kg

SAR(1 g) = 0.400 W/kg; SAR(10 g) = 0.310 W/kg

Maximum value of SAR (measured) = 0.455 W/kg

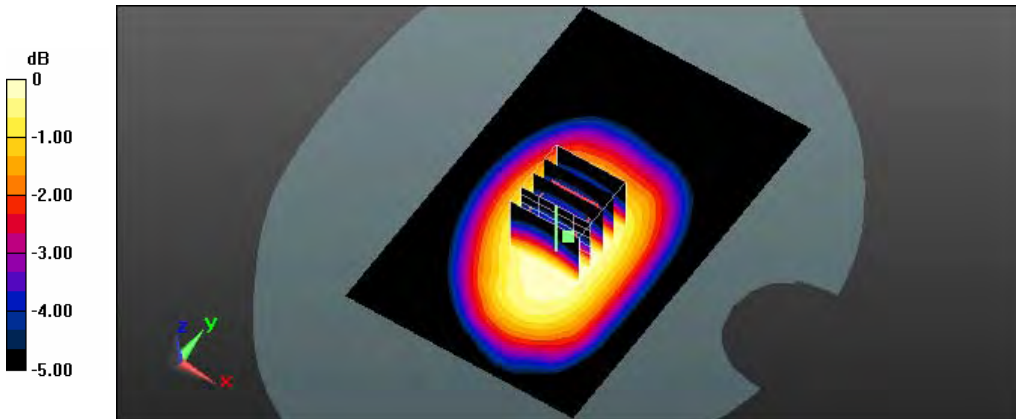

0 dB = 0.455 W/kg = -3.42 dBW/kg

Test Laboratory: A Test Lab Techno Corp.

Date: 2014/7/8 Time: PM 02:11:16

21_Flat_GSM 850 CH251_side2 surface to phantom 10mm_headset_SIM1

DUT: SKY 4.5D; Type: WCDMA Mobile Phone; Serial: 868817019960135

Communication System: UID 0, GSM850 (0); Frequency: 848.8 MHz; Duty Cycle: 1:8

Medium parameters used: $f = 849 \text{ MHz}$; $\sigma = 1.004 \text{ S/m}$; $\epsilon_r = 56.334$; $\rho = 1000 \text{ kg/m}^3$

Phantom section: Flat Section

Measurement Standard: DASY5 (IEEE/IEC/ANSI C63.19-2011)

DASY Configuration:

- Area Scan setting - Find Secondary Maximum Within: 2.0dB and with a peak SAR value greater than 0.5 W/Kg
- Probe: EX3DV4 - SN3977; ConvF(9.74, 9.74, 9.74); Calibrated: 2014/2/17;
- Sensor-Surface: 2mm (Mechanical Surface Detection)
- Electronics: DAE4 Sn779; Calibrated: 2014/2/25
- Phantom: SAM with CRP; Type: SAM; Serial: TP-1150 and higher
- Measurement SW: DASY52, Version 52.8 (7); SEMCAD X Version 14.6.10 (7164)

Flat/Area Scan (71x111x1):

Interpolated grid: $dx=1.500 \text{ mm}$, $dy=1.500 \text{ mm}$

Maximum value of SAR (interpolated) = 0.586 W/kg

Flat/Zoom Scan (5x5x7)/Cube 0:

Measurement grid: $dx=8\text{mm}$, $dy=8\text{mm}$, $dz=5\text{mm}$

Reference Value = 22.952 V/m; Power Drift = 0.06 dB

Peak SAR (extrapolated) = 0.641 W/kg

SAR(1 g) = 0.508 W/kg; SAR(10 g) = 0.383 W/kg

Maximum value of SAR (measured) = 0.582 W/kg

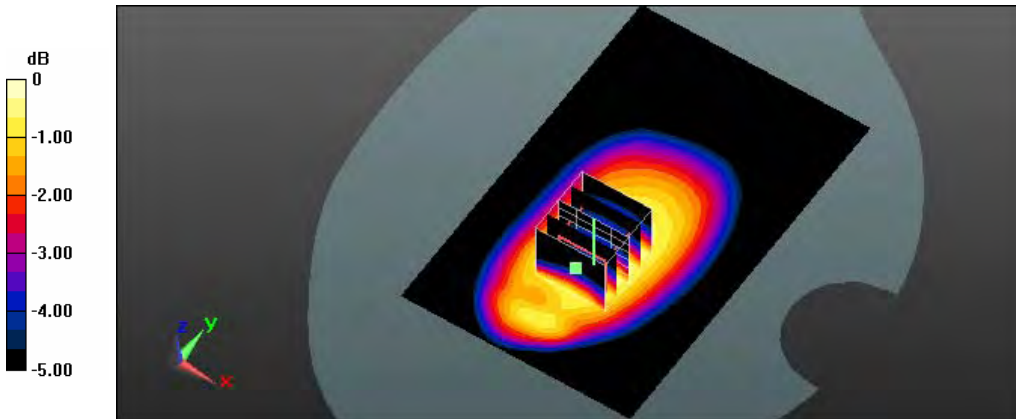

0 dB = 0.582 W/kg = -2.35 dBW/kg

Test Laboratory: A Test Lab Techno Corp.

Date: 2014/7/8 Time: PM 04:33:34

27_Flat_GPRS 850 CH128_1D4U_side1 surface to phantom 10mm_SIM1

DUT: SKY 4.5D; Type: WCDMA Mobile Phone; Serial: 868817019960135

Communication System: UID 0, GPRS 850 (1Down, 4Up) (0); Frequency: 824.2 MHz; Duty Cycle: 1:2

Medium parameters used (interpolated): $f = 824.2$ MHz; $\sigma = 0.978$ S/m; $\epsilon_r = 56.462$; $\rho = 1000$ kg/m³

Phantom section: Flat Section

Measurement Standard: DASYS (IEEE/IEC/ANSI C63.19-2011)

DASY Configuration:

- Area Scan setting - Find Secondary Maximum Within: 2.0dB and with a peak SAR value greater than 0.5 W/Kg
- Probe: EX3DV4 - SN3977; ConvF(9.74, 9.74, 9.74); Calibrated: 2014/2/17;
- Sensor-Surface: 2mm (Mechanical Surface Detection)
- Electronics: DAE4 Sn779; Calibrated: 2014/2/25
- Phantom: SAM with CRP; Type: SAM; Serial: TP-1150 and higher
- Measurement SW: DASYS2, Version 52.8 (7); SEMCAD X Version 14.6.10 (7164)

Flat/Area Scan (71x111x1):

Interpolated grid: dx=1.500 mm, dy=1.500 mm

Maximum value of SAR (interpolated) = 0.764 W/kg

Flat/Zoom Scan (5x5x7)/Cube 0:

Measurement grid: dx=8mm, dy=8mm, dz=5mm

Reference Value = 27.750 V/m; Power Drift = -0.03 dB

Peak SAR (extrapolated) = 0.819 W/kg

SAR(1 g) = 0.661 W/kg; SAR(10 g) = 0.513 W/kg

Maximum value of SAR (measured) = 0.752 W/kg

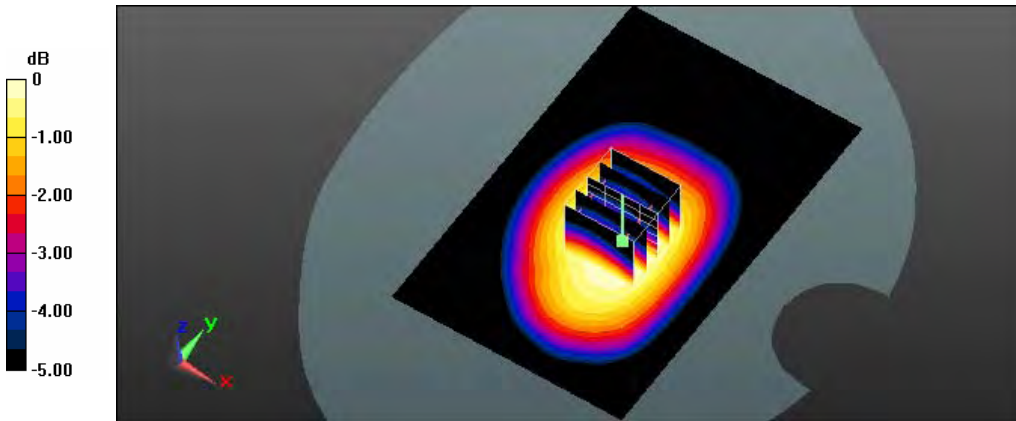

0 dB = 0.752 W/kg = -1.24 dBW/kg

Test Laboratory: A Test Lab Techno Corp.

Date: 2014/7/8 Time: PM 05:14:26

29_Flat_GPRS 850 CH128_1D4U_side2 surface to phantom 10mm_SIM1

DUT: SKY 4.5D; Type: WCDMA Mobile Phone; Serial: 868817019960135

Communication System: UID 0, GPRS 850 (1Down, 4Up) (0); Frequency: 824.2 MHz; Duty Cycle: 1:2

Medium parameters used (interpolated): $f = 824.2 \text{ MHz}$; $\sigma = 0.978 \text{ S/m}$; $\epsilon_r = 56.462$; $\rho = 1000 \text{ kg/m}^3$

Phantom section: Flat Section

Measurement Standard: DASYS (IEEE/IEC/ANSI C63.19-2011)

DASY Configuration:

- Area Scan setting - Find Secondary Maximum Within: 2.0dB and with a peak SAR value greater than 0.5 W/Kg
- Probe: EX3DV4 - SN3977; ConvF(9.74, 9.74, 9.74); Calibrated: 2014/2/17;
- Sensor-Surface: 2mm (Mechanical Surface Detection)
- Electronics: DAE4 Sn779; Calibrated: 2014/2/25
- Phantom: SAM with CRP; Type: SAM; Serial: TP-1150 and higher
- Measurement SW: DASYS2, Version 52.8 (7); SEMCAD X Version 14.6.10 (7164)

Flat/Area Scan (71x111x1):

Interpolated grid: $dx=1.500 \text{ mm}$, $dy=1.500 \text{ mm}$

Maximum value of SAR (interpolated) = 0.930 W/kg

Flat/Zoom Scan (5x5x7)/Cube 0:

Measurement grid: $dx=8\text{mm}$, $dy=8\text{mm}$, $dz=5\text{mm}$

Reference Value = 30.258 V/m; Power Drift = 0.00 dB

Peak SAR (extrapolated) = 0.995 W/kg

SAR(1 g) = 0.799 W/kg; SAR(10 g) = 0.617 W/kg

Maximum value of SAR (measured) = 0.912 W/kg

Flat/Zoom Scan (5x5x7)/Cube 1:

Measurement grid: $dx=8\text{mm}$, $dy=8\text{mm}$, $dz=5\text{mm}$

Reference Value = 30.258 V/m; Power Drift = 0.00 dB

Peak SAR (extrapolated) = 0.855 W/kg

SAR(1 g) = 0.583 W/kg; SAR(10 g) = 0.378 W/kg

Maximum value of SAR (measured) = 0.771 W/kg

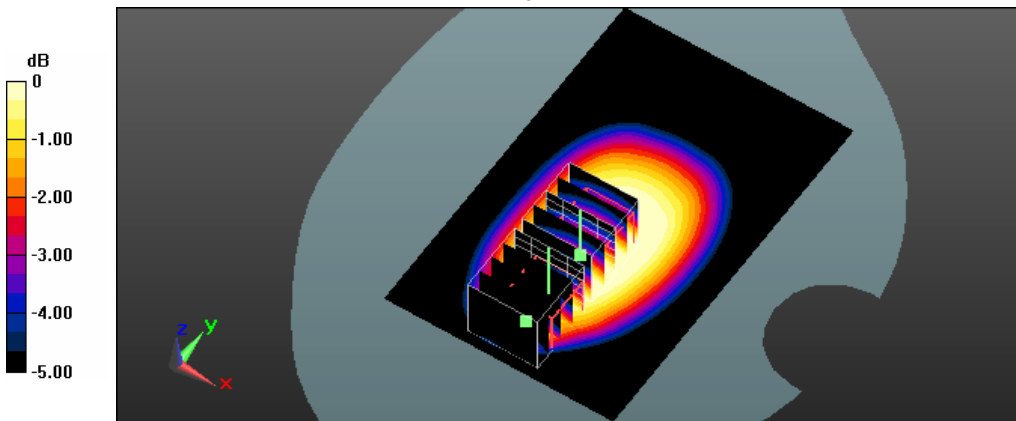

0 dB = 0.771 W/kg = -1.13 dBW/kg

Test Laboratory: A Test Lab Techno Corp.

Date: 2014/7/8 Time: PM 04:52:59

28 Flat_GPRS 850 CH190_1D4U_side1 surface to phantom 10mm_SIM1

DUT: SKY 4.5D; Type: WCDMA Mobile Phone; Serial: 868817019960135

Communication System: UID 0, GPRS 850 (1Down, 4Up) (0); Frequency: 836.6 MHz; Duty Cycle: 1:2

Medium parameters used: $f = 837 \text{ MHz}$; $\sigma = 0.992 \text{ S/m}$; $\epsilon_r = 56.419$; $\rho = 1000 \text{ kg/m}^3$

Phantom section: Flat Section

Measurement Standard: DASYS (IEEE/IEC/ANSI C63.19-2011)

DASY Configuration:

- Area Scan setting - Find Secondary Maximum Within: 2.0dB and with a peak SAR value greater than 0.5 W/Kg
- Probe: EX3DV4 - SN3977; ConvF(9.74, 9.74, 9.74); Calibrated: 2014/2/17;
- Sensor-Surface: 2mm (Mechanical Surface Detection)
- Electronics: DAE4 Sn779; Calibrated: 2014/2/25
- Phantom: SAM with CRP; Type: SAM; Serial: TP-1150 and higher
- Measurement SW: DASYS2, Version 52.8 (7); SEMCAD X Version 14.6.10 (7164)

Flat/Area Scan (71x111x1):

Interpolated grid: $dx=1.500 \text{ mm}$, $dy=1.500 \text{ mm}$

Maximum value of SAR (interpolated) = 0.911 W/kg

Flat/Zoom Scan (5x5x7)/Cube 0:

Measurement grid: $dx=8\text{mm}$, $dy=8\text{mm}$, $dz=5\text{mm}$

Reference Value = 30.616 V/m; Power Drift = -0.04 dB

Peak SAR (extrapolated) = 0.994 W/kg

SAR(1 g) = 0.800 W/kg; SAR(10 g) = 0.621 W/kg

Maximum value of SAR (measured) = 0.902 W/kg

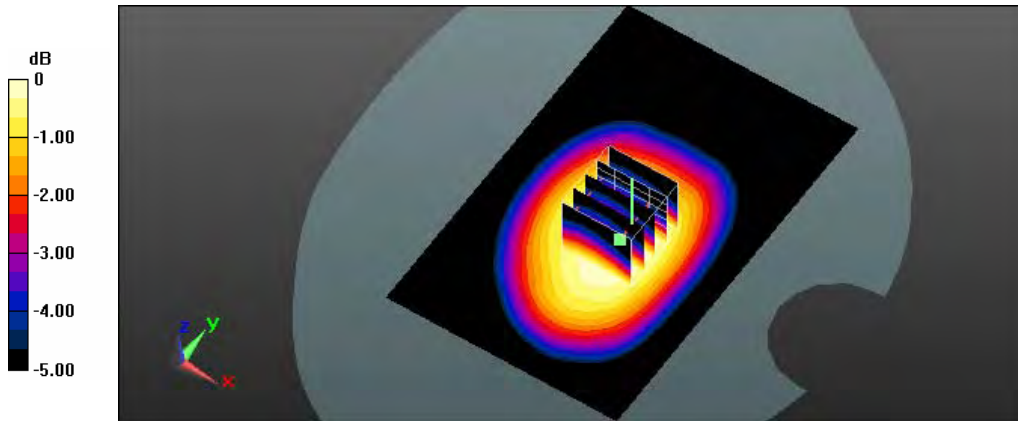

0 dB = 0.902 W/kg = -0.45 dBW/kg

Test Laboratory: A Test Lab Techno Corp.

Date: 2014/7/8 Time: PM 05:49:18

30_Flat_GPRS 850 CH190_1D4U_side2 surface to phantom 10mm_SIM1

DUT: SKY 4.5D; Type: WCDMA Mobile Phone; Serial: 868817019960135

Communication System: UID 0, GPRS 850 (1Down, 4Up) (0); Frequency: 836.6 MHz; Duty Cycle: 1:2

Medium parameters used: $f = 837 \text{ MHz}$; $\sigma = 0.992 \text{ S/m}$; $\epsilon_r = 56.419$; $\rho = 1000 \text{ kg/m}^3$

Phantom section: Flat Section

Measurement Standard: DASYS (IEEE/IEC/ANSI C63.19-2011)

DASY Configuration:

- Area Scan setting - Find Secondary Maximum Within: 2.0dB and with a peak SAR value greater than 0.5 W/Kg
- Probe: EX3DV4 - SN3977; ConvF(9.74, 9.74, 9.74); Calibrated: 2014/2/17;
- Sensor-Surface: 2mm (Mechanical Surface Detection)
- Electronics: DAE4 Sn779; Calibrated: 2014/2/25
- Phantom: SAM with CRP; Type: SAM; Serial: TP-1150 and higher
- Measurement SW: DASYS2, Version 52.8 (7); SEMCAD X Version 14.6.10 (7164)

Flat/Area Scan (71x111x1):

Interpolated grid: $dx=1.500 \text{ mm}$, $dy=1.500 \text{ mm}$

Maximum value of SAR (interpolated) = 1.07 W/kg

Flat/Zoom Scan (5x5x7)/Cube 0:

Measurement grid: $dx=8\text{mm}$, $dy=8\text{mm}$, $dz=5\text{mm}$

Reference Value = 32.763 V/m; Power Drift = 0.08 dB

Peak SAR (extrapolated) = 1.20 W/kg

SAR(1 g) = 0.961 W/kg; SAR(10 g) = 0.734 W/kg

Maximum value of SAR (measured) = 1.10 W/kg

Flat/Zoom Scan (5x5x7)/Cube 1:

Measurement grid: $dx=8\text{mm}$, $dy=8\text{mm}$, $dz=5\text{mm}$

Reference Value = 32.763 V/m; Power Drift = 0.08 dB

Peak SAR (extrapolated) = 1.00 W/kg

SAR(1 g) = 0.680 W/kg; SAR(10 g) = 0.440 W/kg

Maximum value of SAR (measured) = 0.905 W/kg

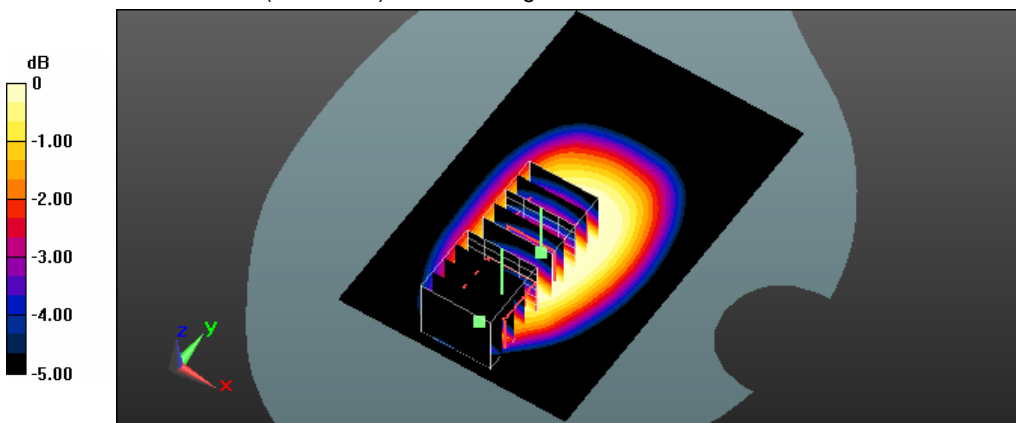

0 dB = 0.905 W/kg = -0.43 dBW/kg

Test Laboratory: A Test Lab Techno Corp.

Date: 2014/7/8 Time: PM 04:11:45

22 Flat_GPRS 850 CH251_1D4U_side1 surface to phantom 10mm_SIM1

DUT: SKY 4.5D; Type: WCDMA Mobile Phone; Serial: 868817019960135

Communication System: UID 0, GPRS 850 (1Down, 4Up) (0); Frequency: 848.8 MHz; Duty Cycle: 1:2

Medium parameters used: $f = 849 \text{ MHz}$; $\sigma = 1.004 \text{ S/m}$; $\epsilon_r = 56.334$; $\rho = 1000 \text{ kg/m}^3$

Phantom section: Flat Section

Measurement Standard: DASYS (IEEE/IEC/ANSI C63.19-2011)

DASY Configuration:

- Area Scan setting - Find Secondary Maximum Within: 2.0dB and with a peak SAR value greater than 0.5 W/Kg
- Probe: EX3DV4 - SN3977; ConvF(9.74, 9.74, 9.74); Calibrated: 2014/2/17;
- Sensor-Surface: 2mm (Mechanical Surface Detection)
- Electronics: DAE4 Sn779; Calibrated: 2014/2/25
- Phantom: SAM with CRP; Type: SAM; Serial: TP-1150 and higher
- Measurement SW: DASYS2, Version 52.8 (7); SEMCAD X Version 14.6.10 (7164)

Flat/Area Scan (71x111x1):

Interpolated grid: $dx=1.500 \text{ mm}$, $dy=1.500 \text{ mm}$

Maximum value of SAR (interpolated) = 0.987 W/kg

Flat/Zoom Scan (5x5x7)/Cube 0:

Measurement grid: $dx=8\text{mm}$, $dy=8\text{mm}$, $dz=5\text{mm}$

Reference Value = 31.364 V/m; Power Drift = 0.07 dB

Peak SAR (extrapolated) = 1.08 W/kg

SAR(1 g) = 0.854 W/kg; SAR(10 g) = 0.660 W/kg

Maximum value of SAR (measured) = 0.975 W/kg

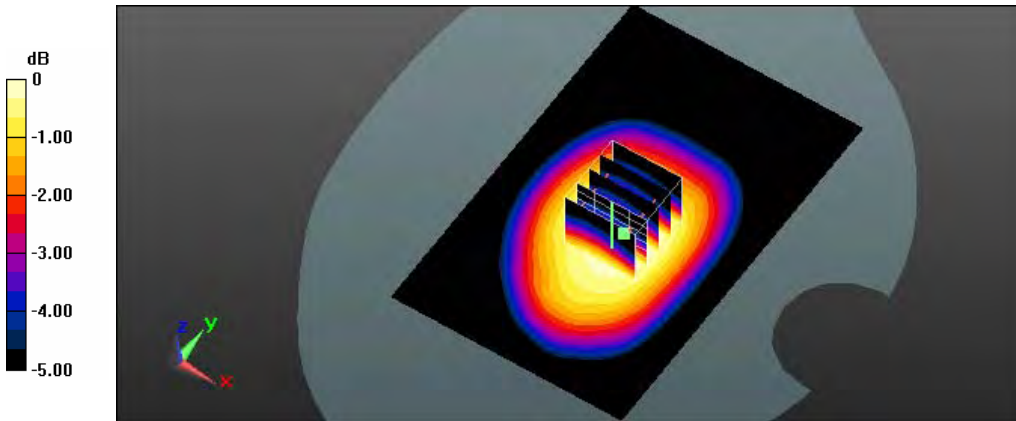

0 dB = 0.975 W/kg = -0.11 dBW/kg

Test Laboratory: A Test Lab Techno Corp.

Date: 2014/7/8 Time: PM 03:41:06

23 Flat GPRS 850 CH251 1D4U_side2 surface to phantom 10mm_SIM1

DUT: SKY 4.5D; Type: WCDMA Mobile Phone; Serial: 868817019960135

Communication System: UID 0, GPRS 850 (1Down, 4Up) (0); Frequency: 848.8 MHz; Duty Cycle: 1:2

Medium parameters used: $f = 849 \text{ MHz}$; $\sigma = 1.004 \text{ S/m}$; $\epsilon_r = 56.334$; $\rho = 1000 \text{ kg/m}^3$

Phantom section: Flat Section

Measurement Standard: DASYS (IEEE/IEC/ANSI C63.19-2011)

DASY Configuration:

- Area Scan setting - Find Secondary Maximum Within: 2.0dB and with a peak SAR value greater than 0.5 W/Kg
- Probe: EX3DV4 - SN3977; ConvF(9.74, 9.74, 9.74); Calibrated: 2014/2/17;
- Sensor-Surface: 2mm (Mechanical Surface Detection)
- Electronics: DAE4 Sn779; Calibrated: 2014/2/25
- Phantom: SAM with CRP; Type: SAM; Serial: TP-1150 and higher
- Measurement SW: DASYS2, Version 52.8 (7); SEMCAD X Version 14.6.10 (7164)

Flat/Area Scan (71x111x1):

Interpolated grid: $dx=1.500 \text{ mm}$, $dy=1.500 \text{ mm}$

Maximum value of SAR (interpolated) = 1.05 W/kg

Flat/Zoom Scan (5x5x7)/Cube 0:

Measurement grid: $dx=8\text{mm}$, $dy=8\text{mm}$, $dz=5\text{mm}$

Reference Value = 32.441 V/m; Power Drift = -0.15 dB

Peak SAR (extrapolated) = 1.15 W/kg

SAR(1 g) = 0.907 W/kg; SAR(10 g) = 0.694 W/kg

Maximum value of SAR (measured) = 1.05 W/kg

Flat/Zoom Scan (5x5x7)/Cube 1:

Measurement grid: $dx=8\text{mm}$, $dy=8\text{mm}$, $dz=5\text{mm}$

Reference Value = 32.441 V/m; Power Drift = -0.15 dB

Peak SAR (extrapolated) = 0.993 W/kg

SAR(1 g) = 0.691 W/kg; SAR(10 g) = 0.441 W/kg

Maximum value of SAR (measured) = 0.898 W/kg

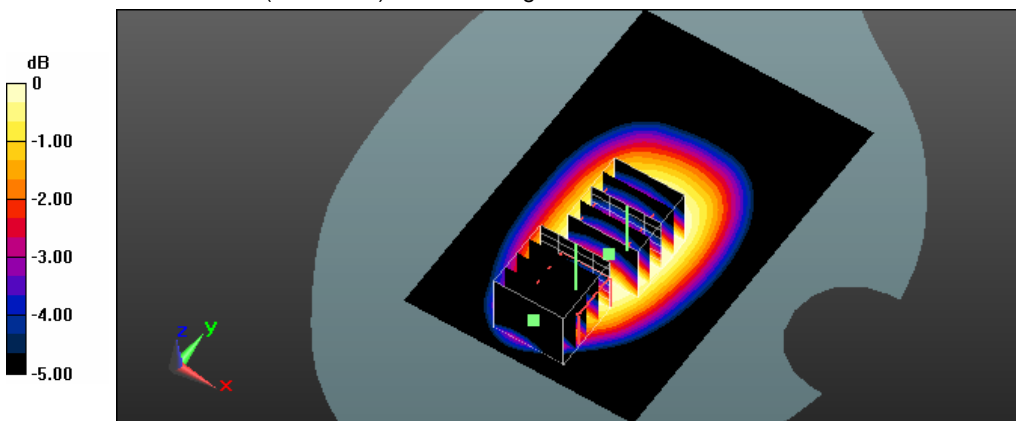

0 dB = 0.898 W/kg = -0.47 dBW/kg

Test Laboratory: A Test Lab Techno Corp.

Date: 2014/7/8 Time: PM 09:30:06

24_Flat_GPRS 850 CH251_1D4U_side4 surface to phantom 10mm_SIM1

DUT: SKY 4.5D; Type: WCDMA Mobile Phone; Serial: 868817019960135

Communication System: UID 0, GPRS 850 (1Down, 4Up) (0); Frequency: 848.8 MHz; Duty Cycle: 1:2

Medium parameters used: $f = 849 \text{ MHz}$; $\sigma = 1.004 \text{ S/m}$; $\epsilon_r = 56.334$; $\rho = 1000 \text{ kg/m}^3$

Phantom section: Flat Section

Measurement Standard: DASYS (IEEE/IEC/ANSI C63.19-2011)

DASY Configuration:

- Area Scan setting - Find Secondary Maximum Within: 2.0dB and with a peak SAR value greater than 0.5 W/Kg
- Probe: EX3DV4 - SN3977; ConvF(9.74, 9.74, 9.74); Calibrated: 2014/2/17;
- Sensor-Surface: 2mm (Mechanical Surface Detection)
- Electronics: DAE4 Sn779; Calibrated: 2014/2/25
- Phantom: SAM with CRP; Type: SAM; Serial: TP-1150 and higher
- Measurement SW: DASYS2, Version 52.8 (7); SEMCAD X Version 14.6.10 (7164)

Flat/Area Scan (51x91x1):

Interpolated grid: $dx=1.500 \text{ mm}$, $dy=1.500 \text{ mm}$

Maximum value of SAR (interpolated) = 0.155 W/kg

Flat/Zoom Scan (5x5x7)/Cube 0:

Measurement grid: $dx=8\text{mm}$, $dy=8\text{mm}$, $dz=5\text{mm}$

Reference Value = 11.604 V/m; Power Drift = 0.03 dB

Peak SAR (extrapolated) = 0.235 W/kg

SAR(1 g) = 0.129 W/kg; SAR(10 g) = 0.071 W/kg

Maximum value of SAR (measured) = 0.171 W/kg

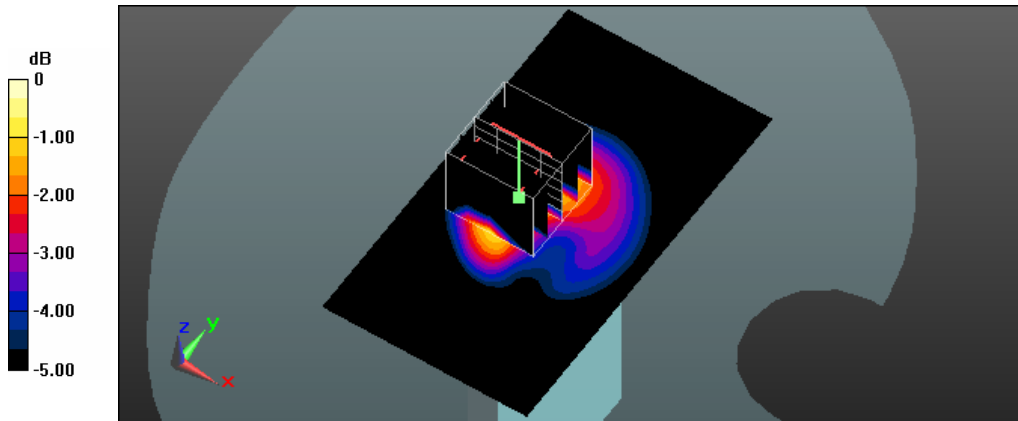

0 dB = 0.171 W/kg = -7.67 dBW/kg

Test Laboratory: A Test Lab Techno Corp.

Date: 2014/7/8 Time: PM 09:48:39

25_Flat_GPRS 850 CH251_1D4U_side5 surface to phantom 10mm_SIM1

DUT: SKY 4.5D; Type: WCDMA Mobile Phone; Serial: 868817019960135

Communication System: UID 0, GPRS 850 (1Down, 4Up) (0); Frequency: 848.8 MHz; Duty Cycle: 1:2

Medium parameters used: $f = 849 \text{ MHz}$; $\sigma = 1.004 \text{ S/m}$; $\epsilon_r = 56.334$; $\rho = 1000 \text{ kg/m}^3$

Phantom section: Flat Section

Measurement Standard: DASYS (IEEE/IEC/ANSI C63.19-2011)

DASY Configuration:

- Area Scan setting - Find Secondary Maximum Within: 2.0dB and with a peak SAR value greater than 0.5 W/Kg
- Probe: EX3DV4 - SN3977; ConvF(9.74, 9.74, 9.74); Calibrated: 2014/2/17;
- Sensor-Surface: 2mm (Mechanical Surface Detection)
- Electronics: DAE4 Sn779; Calibrated: 2014/2/25
- Phantom: SAM with CRP; Type: SAM; Serial: TP-1150 and higher
- Measurement SW: DASYS2, Version 52.8 (7); SEMCAD X Version 14.6.10 (7164)

Flat/Area Scan (51x111x1):

Interpolated grid: $dx=1.500 \text{ mm}$, $dy=1.500 \text{ mm}$

Maximum value of SAR (interpolated) = 0.736 W/kg

Flat/Zoom Scan (5x5x7)/Cube 0:

Measurement grid: $dx=8\text{mm}$, $dy=8\text{mm}$, $dz=5\text{mm}$

Reference Value = 27.076 V/m; Power Drift = -0.04 dB

Peak SAR (extrapolated) = 0.840 W/kg

SAR(1 g) = 0.605 W/kg; SAR(10 g) = 0.423 W/kg

Maximum value of SAR (measured) = 0.735 W/kg

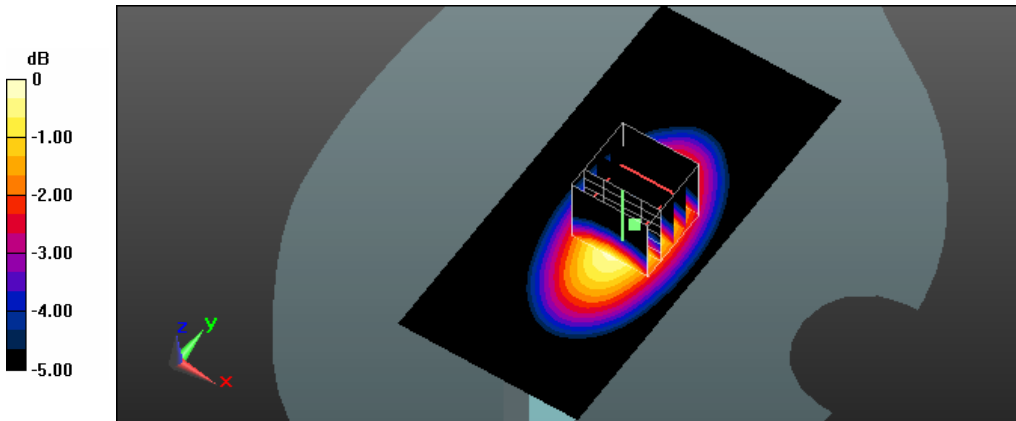

0 dB = 0.735 W/kg = -1.34 dBW/kg

Test Laboratory: A Test Lab Techno Corp.

Date: 2014/7/8 Time: PM 10:41:33

26 Flat_GPRS 850 CH251_1D4U_side6 surface to phantom 10mm_SIM1

DUT: SKY 4.5D; Type: WCDMA Mobile Phone; Serial: 868817019960135

Communication System: UID 0, GPRS 850 (1Down, 4Up) (0); Frequency: 848.8 MHz; Duty Cycle: 1:2

Medium parameters used: $f = 849 \text{ MHz}$; $\sigma = 1.004 \text{ S/m}$; $\epsilon_r = 56.334$; $\rho = 1000 \text{ kg/m}^3$

Phantom section: Flat Section

Measurement Standard: DASY5 (IEEE/IEC/ANSI C63.19-2011)

DASY Configuration:

- Area Scan setting - Find Secondary Maximum Within: 2.0dB and with a peak SAR value greater than 0.5 W/Kg
- Probe: EX3DV4 - SN3977; ConvF(9.74, 9.74, 9.74); Calibrated: 2014/2/17;
- Sensor-Surface: 2mm (Mechanical Surface Detection)
- Electronics: DAE4 Sn779; Calibrated: 2014/2/25
- Phantom: SAM with CRP; Type: SAM; Serial: TP-1150 and higher
- Measurement SW: DASY52, Version 52.8 (7); SEMCAD X Version 14.6.10 (7164)

Flat/Area Scan (51x111x1):

Interpolated grid: $dx=1.500 \text{ mm}$, $dy=1.500 \text{ mm}$

Maximum value of SAR (interpolated) = 0.658 W/kg

Flat/Zoom Scan (5x5x7)/Cube 0:

Measurement grid: $dx=8\text{mm}$, $dy=8\text{mm}$, $dz=5\text{mm}$

Reference Value = 25.101 V/m; Power Drift = -0.05 dB

Peak SAR (extrapolated) = 0.758 W/kg

SAR(1 g) = 0.546 W/kg; SAR(10 g) = 0.379 W/kg

Maximum value of SAR (measured) = 0.666 W/kg

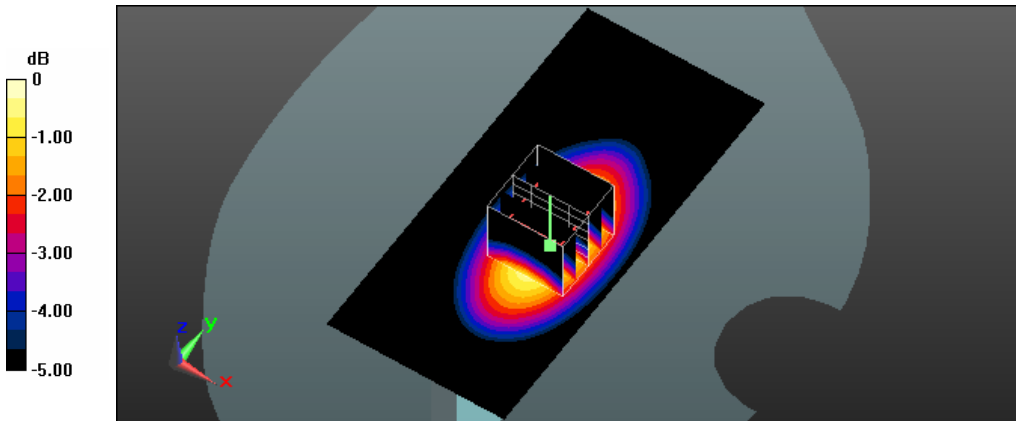

0 dB = 0.666 W/kg = -1.77 dBW/kg

Test Laboratory: A Test Lab Techno Corp.

Date: 2014/7/10 Time: PM 01:42:31

31_Flat_PCS CH512_side1 surface to phantom 10mm_headset_SIM1

DUT: SKY 4.5D; Type: WCDMA Mobile Phone; Serial: 868817019960135

Communication System: UID 0, PCS (0); Frequency: 1850.2 MHz; Duty Cycle: 1:8

Medium parameters used (interpolated): $f = 1850.2 \text{ MHz}$; $\sigma = 1.457 \text{ S/m}$; $\epsilon_r = 52.373$; $\rho = 1000 \text{ kg/m}^3$

Phantom section: Flat Section

Measurement Standard: DASYS (IEEE/IEC/ANSI C63.19-2011)

DASY Configuration:

- Area Scan setting - Find Secondary Maximum Within: 2.0dB and with a peak SAR value greater than 0.5 W/Kg
- Probe: EX3DV4 - SN3977; ConvF(7.37, 7.37, 7.37); Calibrated: 2014/2/17;
- Sensor-Surface: 2mm (Mechanical Surface Detection)
- Electronics: DAE4 Sn779; Calibrated: 2014/2/25
- Phantom: SAM with CRP; Type: SAM; Serial: TP-1150 and higher
- Measurement SW: DASYS2, Version 52.8 (7); SEMCAD X Version 14.6.10 (7164)

Flat/Area Scan (71x111x1):

Interpolated grid: $dx=1.500 \text{ mm}$, $dy=1.500 \text{ mm}$

Maximum value of SAR (interpolated) = 0.386 W/kg

Flat/Zoom Scan (5x5x7)/Cube 0:

Measurement grid: $dx=8\text{mm}$, $dy=8\text{mm}$, $dz=5\text{mm}$

Reference Value = 7.475 V/m; Power Drift = -0.01 dB

Peak SAR (extrapolated) = 0.425 W/kg

SAR(1 g) = 0.272 W/kg; SAR(10 g) = 0.170 W/kg

Maximum value of SAR (measured) = 0.346 W/kg

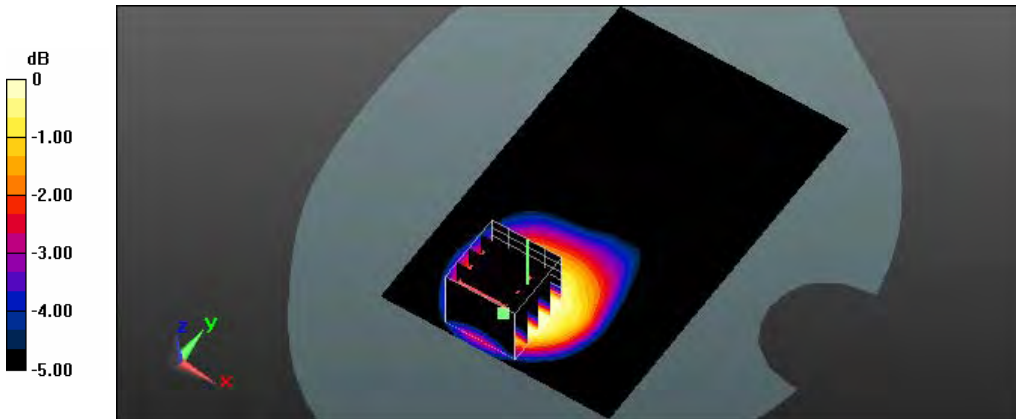

0 dB = 0.346 W/kg = -4.61 dBW/kg

Test Laboratory: A Test Lab Techno Corp.

Date: 2014/7/10 Time: PM 02:03:41

32_Flat_PCS CH512_side2 surface to phantom 10mm_headset_SIM1

DUT: SKY 4.5D; Type: WCDMA Mobile Phone; Serial: 868817019960135

Communication System: UID 0, PCS (0); Frequency: 1850.2 MHz; Duty Cycle: 1:8

Medium parameters used (interpolated): $f = 1850.2 \text{ MHz}$; $\sigma = 1.457 \text{ S/m}$; $\epsilon_r = 52.373$; $\rho = 1000 \text{ kg/m}^3$

Phantom section: Flat Section

Measurement Standard: DASYS (IEEE/IEC/ANSI C63.19-2011)

DASY Configuration:

- Area Scan setting - Find Secondary Maximum Within: 2.0dB and with a peak SAR value greater than 0.5 W/Kg
- Probe: EX3DV4 - SN3977; ConvF(7.37, 7.37, 7.37); Calibrated: 2014/2/17;
- Sensor-Surface: 2mm (Mechanical Surface Detection)
- Electronics: DAE4 Sn779; Calibrated: 2014/2/25
- Phantom: SAM with CRP; Type: SAM; Serial: TP-1150 and higher
- Measurement SW: DASYS2, Version 52.8 (7); SEMCAD X Version 14.6.10 (7164)

Flat/Area Scan (71x111x1):

Interpolated grid: $dx=1.500 \text{ mm}$, $dy=1.500 \text{ mm}$

Maximum value of SAR (interpolated) = 0.444 W/kg

Flat/Zoom Scan (5x5x7)/Cube 0:

Measurement grid: $dx=8\text{mm}$, $dy=8\text{mm}$, $dz=5\text{mm}$

Reference Value = 7.672 V/m; Power Drift = -0.05 dB

Peak SAR (extrapolated) = 0.545 W/kg

SAR(1 g) = 0.341 W/kg; SAR(10 g) = 0.207 W/kg

Maximum value of SAR (measured) = 0.447 W/kg

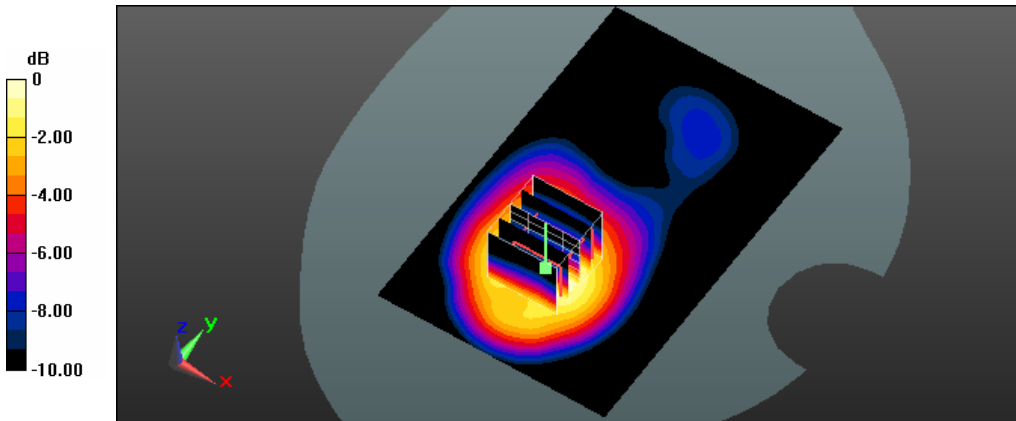

0 dB = 0.447 W/kg = -3.50 dBW/kg

Test Laboratory: A Test Lab Techno Corp.

Date: 2014/7/10 Time: PM 02:33:10

33_Flat_GPRS_PCS_CH810_1D4U_side1 surface to phantom 10mm_SIM1

DUT: SKY 4.5D; Type: WCDMA Mobile Phone; Serial: 868817019960135

Communication System: UID 0, GPRS PCS (1Down,4Up) (0); Frequency: 1909.8 MHz; Duty Cycle: 1:2

Medium parameters used: $f = 1910 \text{ MHz}$; $\sigma = 1.496 \text{ S/m}$; $\epsilon_r = 52.287$; $\rho = 1000 \text{ kg/m}^3$

Phantom section: Flat Section

Measurement Standard: DASYS (IEEE/IEC/ANSI C63.19-2011)

DASY Configuration:

- Area Scan setting - Find Secondary Maximum Within: 2.0dB and with a peak SAR value greater than 0.5 W/Kg
- Probe: EX3DV4 - SN3977; ConvF(7.37, 7.37, 7.37); Calibrated: 2014/2/17;
- Sensor-Surface: 2mm (Mechanical Surface Detection)
- Electronics: DAE4 Sn779; Calibrated: 2014/2/25
- Phantom: SAM with CRP; Type: SAM; Serial: TP-1150 and higher
- Measurement SW: DASYS2, Version 52.8 (7); SEMCAD X Version 14.6.10 (7164)

Flat/Area Scan (71x111x1):

Interpolated grid: $dx=1.500 \text{ mm}$, $dy=1.500 \text{ mm}$

Maximum value of SAR (interpolated) = 0.517 W/kg

Flat/Zoom Scan (5x5x7)/Cube 0:

Measurement grid: $dx=8\text{mm}$, $dy=8\text{mm}$, $dz=5\text{mm}$

Reference Value = 9.903 V/m; Power Drift = -0.08 dB

Peak SAR (extrapolated) = 0.636 W/kg

SAR(1 g) = 0.394 W/kg; SAR(10 g) = 0.236 W/kg

Maximum value of SAR (measured) = 0.501 W/kg

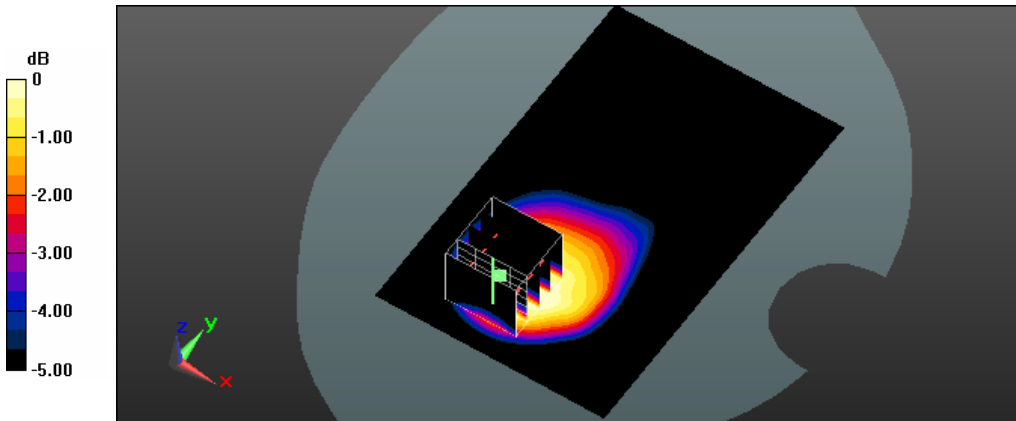

0 dB = 0.501 W/kg = -3.00 dBW/kg

Test Laboratory: A Test Lab Techno Corp.

Date: 2014/7/10 Time: PM 03:02:49

34_Flat_GPRS PCS CH810_1D4U_side2 surface to phantom 10mm_SIM1

DUT: SKY 4.5D; Type: WCDMA Mobile Phone; Serial: 868817019960135

Communication System: UID 0, GPRS PCS (1Down,4Up) (0); Frequency: 1909.8 MHz; Duty Cycle: 1:2

Medium parameters used: $f = 1910$ MHz; $\sigma = 1.496$ S/m; $\epsilon_r = 52.287$; $\rho = 1000$ kg/m³

Phantom section: Flat Section

Measurement Standard: DASYS (IEEE/IEC/ANSI C63.19-2011)

DASY Configuration:

- Area Scan setting - Find Secondary Maximum Within: 2.0dB and with a peak SAR value greater than 0.5 W/Kg
- Probe: EX3DV4 - SN3977; ConvF(7.37, 7.37, 7.37); Calibrated: 2014/2/17;
- Sensor-Surface: 2mm (Mechanical Surface Detection)
- Electronics: DAE4 Sn779; Calibrated: 2014/2/25
- Phantom: SAM with CRP; Type: SAM; Serial: TP-1150 and higher
- Measurement SW: DASYS2, Version 52.8 (7); SEMCAD X Version 14.6.10 (7164)

Flat/Area Scan (71x111x1):

Interpolated grid: dx=1.500 mm, dy=1.500 mm

Maximum value of SAR (interpolated) = 0.570 W/kg

Flat/Zoom Scan (5x5x7)/Cube 0:

Measurement grid: dx=8mm, dy=8mm, dz=5mm

Reference Value = 10.021 V/m; Power Drift = 0.08 dB

Peak SAR (extrapolated) = 0.694 W/kg

SAR(1 g) = 0.431 W/kg; SAR(10 g) = 0.263 W/kg

Maximum value of SAR (measured) = 0.565 W/kg

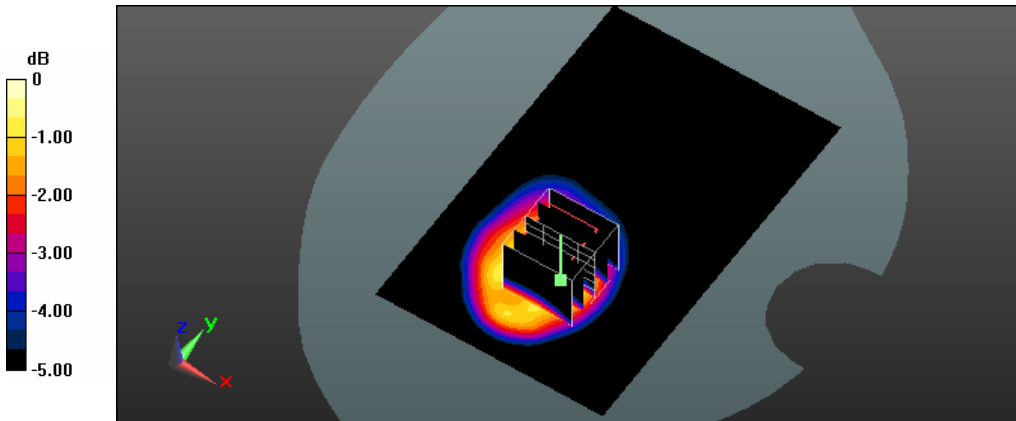

0 dB = 0.565 W/kg = -2.48 dBW/kg

Test Laboratory: A Test Lab Techno Corp.

Date: 2014/7/10 Time: PM 03:25:46

35_Flat_GPRS PCS CH810_1D4U_side4 surface to phantom 10mm_SIM1

DUT: SKY 4.5D; Type: WCDMA Mobile Phone; Serial: 868817019960135

Communication System: UID 0, GPRS PCS (1Down,4Up) (0); Frequency: 1909.8 MHz; Duty Cycle: 1:2

Medium parameters used: $f = 1910 \text{ MHz}$; $\sigma = 1.496 \text{ S/m}$; $\epsilon_r = 52.287$; $\rho = 1000 \text{ kg/m}^3$

Phantom section: Flat Section

Measurement Standard: DASYS (IEEE/IEC/ANSI C63.19-2011)

DASY Configuration:

- Area Scan setting - Find Secondary Maximum Within: 2.0dB and with a peak SAR value greater than 0.5 W/Kg
- Probe: EX3DV4 - SN3977; ConvF(7.37, 7.37, 7.37); Calibrated: 2014/2/17;
- Sensor-Surface: 2mm (Mechanical Surface Detection)
- Electronics: DAE4 Sn779; Calibrated: 2014/2/25
- Phantom: SAM with CRP; Type: SAM; Serial: TP-1150 and higher
- Measurement SW: DASYS2, Version 52.8 (7); SEMCAD X Version 14.6.10 (7164)

Flat/Area Scan (51x91x1):

Interpolated grid: $dx=1.500 \text{ mm}$, $dy=1.500 \text{ mm}$

Maximum value of SAR (interpolated) = 0.733 W/kg

Flat/Zoom Scan (5x5x7)/Cube 0:

Measurement grid: $dx=8\text{mm}$, $dy=8\text{mm}$, $dz=5\text{mm}$

Reference Value = 19.878 V/m; Power Drift = -0.02 dB

Peak SAR (extrapolated) = 0.909 W/kg

SAR(1 g) = 0.525 W/kg; SAR(10 g) = 0.273 W/kg

Maximum value of SAR (measured) = 0.741 W/kg

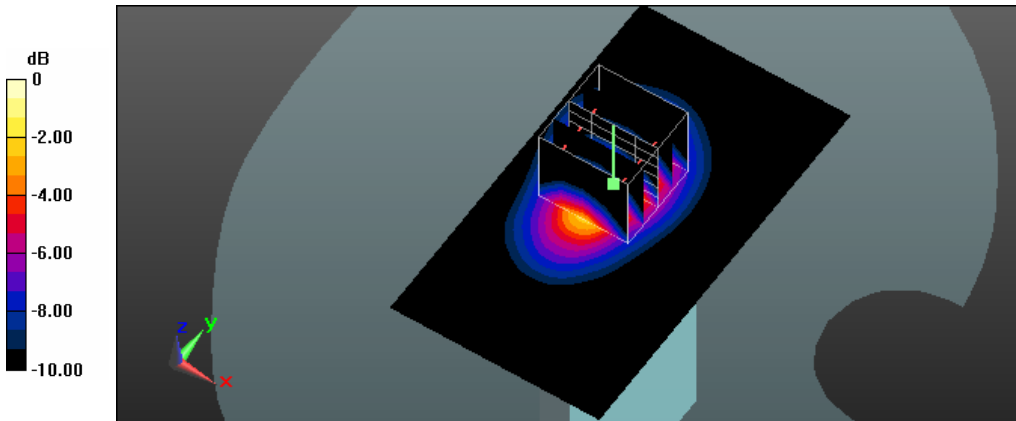

0 dB = 0.741 W/kg = -1.30 dBW/kg

Test Laboratory: A Test Lab Techno Corp.

Date: 2014/7/14 Time: AM 10:36:12

36 Flat_GPRS PCS CH810_1D4U_side5 surface to phantom 10mm_SIM1

DUT: SKY 4.5D; Type: WCDMA Mobile Phone; Serial: 868817019960135

Communication System: UID 0, GPRS PCS (1Down,4Up) (0); Frequency: 1909.8 MHz; Duty Cycle: 1:2

Medium parameters used: $f = 1910 \text{ MHz}$; $\sigma = 1.496 \text{ S/m}$; $\epsilon_r = 52.287$; $\rho = 1000 \text{ kg/m}^3$

Phantom section: Flat Section

Measurement Standard: DASYS (IEEE/IEC/ANSI C63.19-2011)

DASY Configuration:

- Area Scan setting - Find Secondary Maximum Within: 2.0dB and with a peak SAR value greater than 0.5 W/Kg
- Probe: EX3DV4 - SN3977; ConvF(7.37, 7.37, 7.37); Calibrated: 2014/2/17;
- Sensor-Surface: 2mm (Mechanical Surface Detection)
- Electronics: DAE4 Sn779; Calibrated: 2014/2/25
- Phantom: SAM with CRP; Type: SAM; Serial: TP-1150 and higher
- Measurement SW: DASYS2, Version 52.8 (7); SEMCAD X Version 14.6.10 (7164)

Flat/Area Scan (51x111x1):

Interpolated grid: $dx=1.500 \text{ mm}$, $dy=1.500 \text{ mm}$

Maximum value of SAR (interpolated) = 0.133 W/kg

Flat/Zoom Scan (5x5x7)/Cube 0:

Measurement grid: $dx=8\text{mm}$, $dy=8\text{mm}$, $dz=5\text{mm}$

Reference Value = 7.059 V/m; Power Drift = -0.00 dB

Peak SAR (extrapolated) = 0.167 W/kg

SAR(1 g) = 0.102 W/kg; SAR(10 g) = 0.060 W/kg

Maximum value of SAR (measured) = 0.137 W/kg

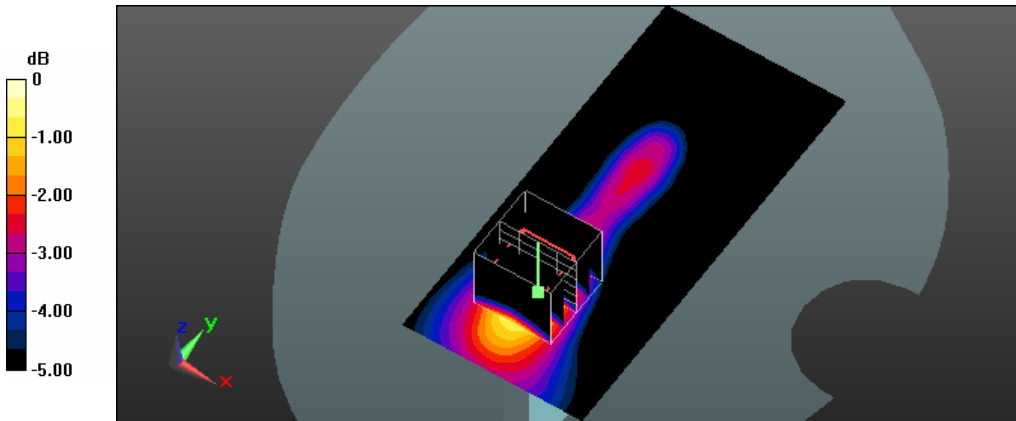

0 dB = 0.137 W/kg = -8.63 dBW/kg

Test Laboratory: A Test Lab Techno Corp.

Date: 2014/7/10 Time: PM 04:07:20

37_Flat_GPRS PCS CH810_1D4U_side6 surface to phantom 10mm_SIM1

DUT: SKY 4.5D; Type: WCDMA Mobile Phone; Serial: 868817019960135

Communication System: UID 0, GPRS PCS (1Down,4Up) (0); Frequency: 1909.8 MHz; Duty Cycle: 1:2

Medium parameters used: $f = 1910 \text{ MHz}$; $\sigma = 1.496 \text{ S/m}$; $\epsilon_r = 52.287$; $\rho = 1000 \text{ kg/m}^3$

Phantom section: Flat Section

Measurement Standard: DASYS (IEEE/IEC/ANSI C63.19-2011)

DASY Configuration:

- Area Scan setting - Find Secondary Maximum Within: 2.0dB and with a peak SAR value greater than 0.5 W/Kg
- Probe: EX3DV4 - SN3977; ConvF(7.37, 7.37, 7.37); Calibrated: 2014/2/17;
- Sensor-Surface: 2mm (Mechanical Surface Detection)
- Electronics: DAE4 Sn779; Calibrated: 2014/2/25
- Phantom: SAM with CRP; Type: SAM; Serial: TP-1150 and higher
- Measurement SW: DASYS2, Version 52.8 (7); SEMCAD X Version 14.6.10 (7164)

Flat/Area Scan (51x111x1):

Interpolated grid: $dx=1.500 \text{ mm}$, $dy=1.500 \text{ mm}$

Maximum value of SAR (interpolated) = 0.177 W/kg

Flat/Zoom Scan (5x5x7)/Cube 0:

Measurement grid: $dx=8\text{mm}$, $dy=8\text{mm}$, $dz=5\text{mm}$

Reference Value = 8.488 V/m; Power Drift = -0.06 dB

Peak SAR (extrapolated) = 0.217 W/kg

SAR(1 g) = 0.130 W/kg; SAR(10 g) = 0.074 W/kg

Maximum value of SAR (measured) = 0.176 W/kg

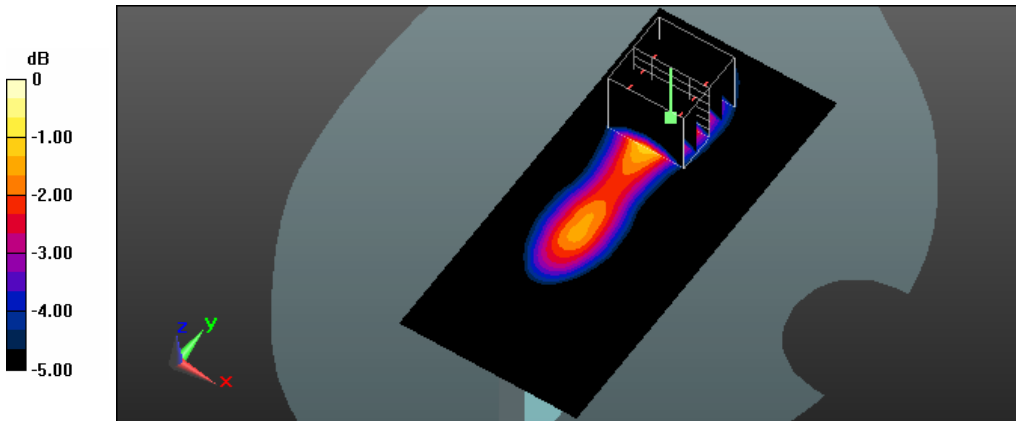

0 dB = 0.176 W/kg = -7.54 dBW/kg

Test Laboratory: A Test Lab Techno Corp.

Date: 2014/7/9 Time: AM 11:50:45

38_Flat_GPRS 850 CH190_1D4U_Original #30_side2 surface to phantom 10mm_SIM1_measurement once

DUT: SKY 4.5D; Type: WCDMA Mobile Phone; Serial: 868817019960135

Communication System: UID 0, GPRS 850 (1Down, 4Up) (0); Frequency: 836.6 MHz; Duty Cycle: 1:2

Medium parameters used: $f = 837 \text{ MHz}$; $\sigma = 0.992 \text{ S/m}$; $\epsilon_r = 56.419$; $\rho = 1000 \text{ kg/m}^3$

Phantom section: Flat Section

Measurement Standard: DASYS (IEEE/IEC/ANSI C63.19-2011)

DASY Configuration:

- Area Scan setting - Find Secondary Maximum Within: 2.0dB and with a peak SAR value greater than 0.5 W/Kg
- Probe: EX3DV4 - SN3977; ConvF(9.74, 9.74, 9.74); Calibrated: 2014/2/17;
- Sensor-Surface: 2mm (Mechanical Surface Detection)
- Electronics: DAE4 Sn779; Calibrated: 2014/2/25
- Phantom: SAM with CRP; Type: SAM; Serial: TP-1150 and higher
- Measurement SW: DASYS2, Version 52.8 (7); SEMCAD X Version 14.6.10 (7164)

Flat/Area Scan (71x111x1):

Interpolated grid: $dx=1.500 \text{ mm}$, $dy=1.500 \text{ mm}$

Maximum value of SAR (interpolated) = 1.12 W/kg

Flat/Zoom Scan (5x5x7)/Cube 0:

Measurement grid: $dx=8\text{mm}$, $dy=8\text{mm}$, $dz=5\text{mm}$

Reference Value = 34.060 V/m; Power Drift = -0.12 dB

Peak SAR (extrapolated) = 1.23 W/kg

SAR(1 g) = 0.968 W/kg; SAR(10 g) = 0.738 W/kg

Maximum value of SAR (measured) = 1.11 W/kg

Flat/Zoom Scan (5x5x7)/Cube 1:

Measurement grid: $dx=8\text{mm}$, $dy=8\text{mm}$, $dz=5\text{mm}$

Reference Value = 34.060 V/m; Power Drift = -0.12 dB

Peak SAR (extrapolated) = 0.920 W/kg

SAR(1 g) = 0.618 W/kg; SAR(10 g) = 0.389 W/kg

Maximum value of SAR (measured) = 0.834 W/kg

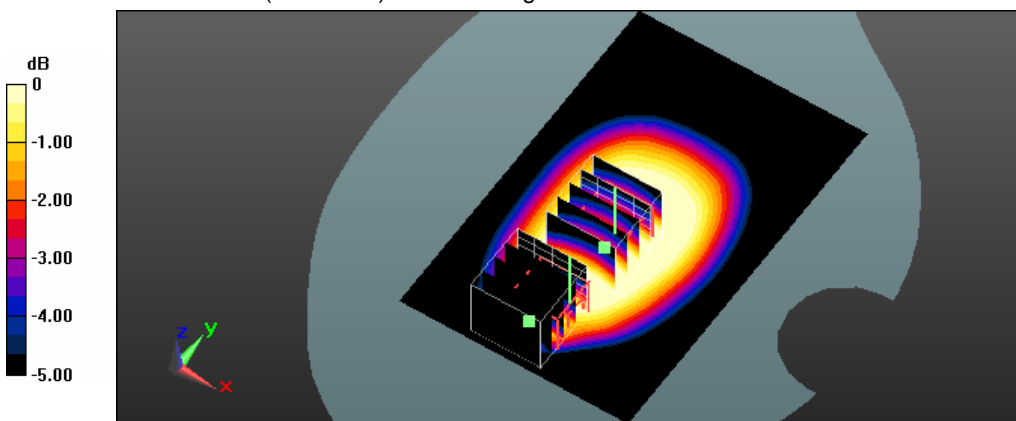

0 dB = 0.834 W/kg = -0.79 dBW/kg

Test Laboratory: A Test Lab Techno Corp.

Date: 2014/7/10 Time: PM 08:08:08

47_Flat_WCDMA Band II CH9538_side1 surface to phantom 10mm_SIM1

DUT: SKY 4.5D; Type: WCDMA Mobile Phone; Serial: 868817019960135

Communication System: UID 0, WCDMA Band II (0); Frequency: 1907.6 MHz; Duty Cycle: 1:1

Medium parameters used: $f = 1908 \text{ MHz}$; $\sigma = 1.491 \text{ S/m}$; $\epsilon_r = 52.317$; $\rho = 1000 \text{ kg/m}^3$

Phantom section: Flat Section

Measurement Standard: DASYS (IEEE/IEC/ANSI C63.19-2011)

DASY Configuration:

- Area Scan setting - Find Secondary Maximum Within: 2.0dB and with a peak SAR value greater than 0.5 W/Kg
- Probe: EX3DV4 - SN3977; ConvF(7.37, 7.37, 7.37); Calibrated: 2014/2/17;
- Sensor-Surface: 2mm (Mechanical Surface Detection)
- Electronics: DAE4 Sn779; Calibrated: 2014/2/25
- Phantom: SAM with CRP; Type: SAM; Serial: TP-1150 and higher
- Measurement SW: DASYS2, Version 52.8 (7); SEMCAD X Version 14.6.10 (7164)

Flat/Area Scan (71x111x1):

Interpolated grid: $dx=1.500 \text{ mm}$, $dy=1.500 \text{ mm}$

Maximum value of SAR (interpolated) = 0.640 W/kg

Flat/Zoom Scan (5x5x7)/Cube 0:

Measurement grid: $dx=8\text{mm}$, $dy=8\text{mm}$, $dz=5\text{mm}$

Reference Value = 9.957 V/m; Power Drift = -0.01 dB

Peak SAR (extrapolated) = 0.809 W/kg

SAR(1 g) = 0.504 W/kg; SAR(10 g) = 0.303 W/kg

Maximum value of SAR (measured) = 0.659 W/kg

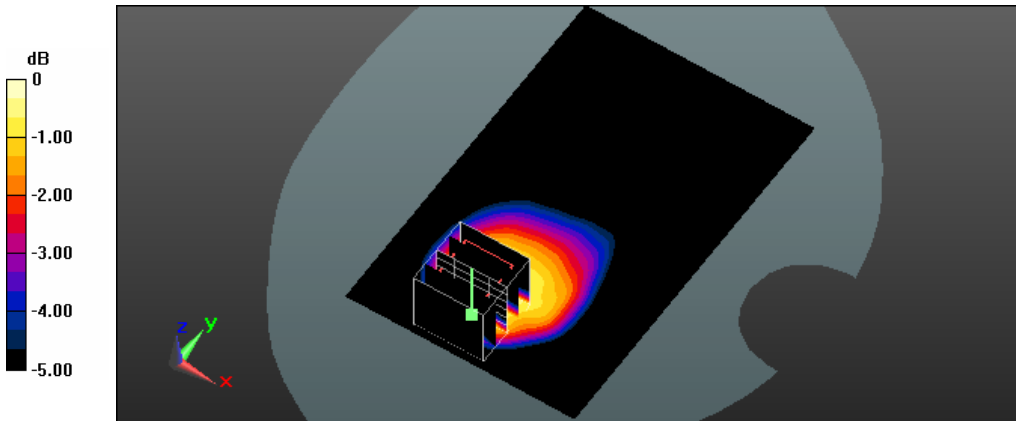

0 dB = 0.659 W/kg = -1.81 dBW/kg

Test Laboratory: A Test Lab Techno Corp.

Date: 2014/7/10 Time: PM 07:39:08

48 Flat_WCDMA Band II CH9538_side2 surface to phantom 10mm_SIM1

DUT: SKY 4.5D; Type: WCDMA Mobile Phone; Serial: 868817019960135

Communication System: UID 0, WCDMA Band II (0); Frequency: 1907.6 MHz; Duty Cycle: 1:1

Medium parameters used: $f = 1908 \text{ MHz}$; $\sigma = 1.491 \text{ S/m}$; $\epsilon_r = 52.317$; $\rho = 1000 \text{ kg/m}^3$

Phantom section: Flat Section

Measurement Standard: DASYS (IEEE/IEC/ANSI C63.19-2011)

DASY Configuration:

- Area Scan setting - Find Secondary Maximum Within: 2.0dB and with a peak SAR value greater than 0.5 W/Kg
- Probe: EX3DV4 - SN3977; ConvF(7.37, 7.37, 7.37); Calibrated: 2014/2/17;
- Sensor-Surface: 2mm (Mechanical Surface Detection)
- Electronics: DAE4 Sn779; Calibrated: 2014/2/25
- Phantom: SAM with CRP; Type: SAM; Serial: TP-1150 and higher
- Measurement SW: DASYS2, Version 52.8 (7); SEMCAD X Version 14.6.10 (7164)

Flat/Area Scan (71x111x1):

Interpolated grid: $dx=1.500 \text{ mm}$, $dy=1.500 \text{ mm}$

Maximum value of SAR (interpolated) = 0.654 W/kg

Flat/Zoom Scan (5x5x7)/Cube 0:

Measurement grid: $dx=8\text{mm}$, $dy=8\text{mm}$, $dz=5\text{mm}$

Reference Value = 10.596 V/m; Power Drift = 0.03 dB

Peak SAR (extrapolated) = 0.805 W/kg

SAR(1 g) = 0.506 W/kg; SAR(10 g) = 0.311 W/kg

Maximum value of SAR (measured) = 0.652 W/kg

Flat/Zoom Scan (5x5x7)/Cube 1:

Measurement grid: $dx=8\text{mm}$, $dy=8\text{mm}$, $dz=5\text{mm}$

Reference Value = 10.596 V/m; Power Drift = 0.03 dB

Peak SAR (extrapolated) = 0.693 W/kg

SAR(1 g) = 0.423 W/kg; SAR(10 g) = 0.266 W/kg

Maximum value of SAR (measured) = 0.565 W/kg

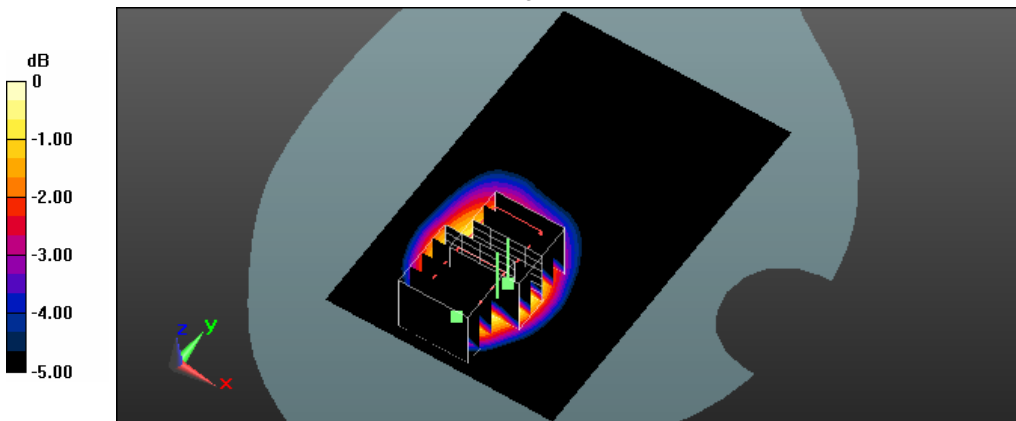

0 dB = 0.565 W/kg = -2.48 dBW/kg

Test Laboratory: A Test Lab Techno Corp.

Date: 2014/7/10 Time: PM 08:34:00

49_Flat_WCDMA Band II CH9538_side4 surface to phantom 10mm_SIM1

DUT: SKY 4.5D; Type: WCDMA Mobile Phone; Serial: 868817019960135

Communication System: UID 0, WCDMA Band II (0); Frequency: 1907.6 MHz; Duty Cycle: 1:1

Medium parameters used: $f = 1908 \text{ MHz}$; $\sigma = 1.491 \text{ S/m}$; $\epsilon_r = 52.317$; $\rho = 1000 \text{ kg/m}^3$

Phantom section: Flat Section

Measurement Standard: DASYS (IEEE/IEC/ANSI C63.19-2011)

DASY Configuration:

- Area Scan setting - Find Secondary Maximum Within: 2.0dB and with a peak SAR value greater than 0.5 W/Kg
- Probe: EX3DV4 - SN3977; ConvF(7.37, 7.37, 7.37); Calibrated: 2014/2/17;
- Sensor-Surface: 2mm (Mechanical Surface Detection)
- Electronics: DAE4 Sn779; Calibrated: 2014/2/25
- Phantom: SAM with CRP; Type: SAM; Serial: TP-1150 and higher
- Measurement SW: DASYS2, Version 52.8 (7); SEMCAD X Version 14.6.10 (7164)

Flat/Area Scan (51x91x1):

Interpolated grid: $dx=1.500 \text{ mm}$, $dy=1.500 \text{ mm}$

Maximum value of SAR (interpolated) = 0.917 W/kg

Flat/Zoom Scan (5x5x7)/Cube 0:

Measurement grid: $dx=8\text{mm}$, $dy=8\text{mm}$, $dz=5\text{mm}$

Reference Value = 21.964 V/m; Power Drift = 0.18 dB

Peak SAR (extrapolated) = 1.12 W/kg

SAR(1 g) = 0.644 W/kg; SAR(10 g) = 0.334 W/kg

Maximum value of SAR (measured) = 0.917 W/kg

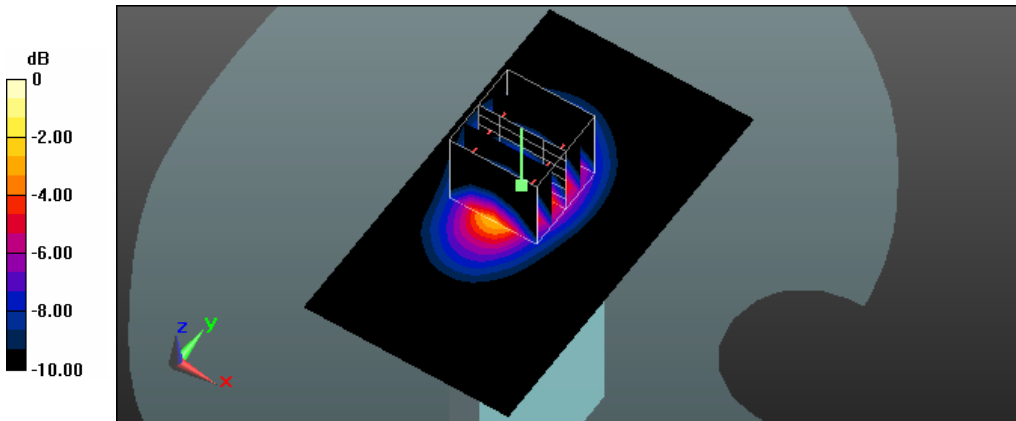

0 dB = 0.917 W/kg = -0.38 dBW/kg

Test Laboratory: A Test Lab Techno Corp.

Date: 2014/7/14 Time: AM 10:58:31

50_Flat_WCDMA BandII CH9538_side5 surface to phantom 10mm_SIM1

DUT: SKY 4.5D; Type: WCDMA Mobile Phone; Serial: 868817019960135

Communication System: UID 0, WCDMA Band II (0); Frequency: 1907.6 MHz; Duty Cycle: 1:1

Medium parameters used: $f = 1908 \text{ MHz}$; $\sigma = 1.491 \text{ S/m}$; $\epsilon_r = 52.317$; $\rho = 1000 \text{ kg/m}^3$

Phantom section: Flat Section

Measurement Standard: DASY5 (IEEE/IEC/ANSI C63.19-2011)

DASY Configuration:

- Area Scan setting - Find Secondary Maximum Within: 2.0dB and with a peak SAR value greater than 0.5 W/Kg
- Probe: EX3DV4 - SN3977; ConvF(7.37, 7.37, 7.37); Calibrated: 2014/2/17;
- Sensor-Surface: 2mm (Mechanical Surface Detection)
- Electronics: DAE4 Sn779; Calibrated: 2014/2/25
- Phantom: SAM with CRP; Type: SAM; Serial: TP-1150 and higher
- Measurement SW: DASY52, Version 52.8 (7); SEMCAD X Version 14.6.10 (7164)

Flat/Area Scan (51x111x1):

Interpolated grid: $dx=1.500 \text{ mm}$, $dy=1.500 \text{ mm}$

Maximum value of SAR (interpolated) = 0.148 W/kg

Flat/Zoom Scan (5x5x7)/Cube 0:

Measurement grid: $dx=8\text{mm}$, $dy=8\text{mm}$, $dz=5\text{mm}$

Reference Value = 7.361 V/m; Power Drift = -0.10 dB

Peak SAR (extrapolated) = 0.186 W/kg

SAR(1 g) = 0.115 W/kg; SAR(10 g) = 0.068 W/kg

Maximum value of SAR (measured) = 0.151 W/kg

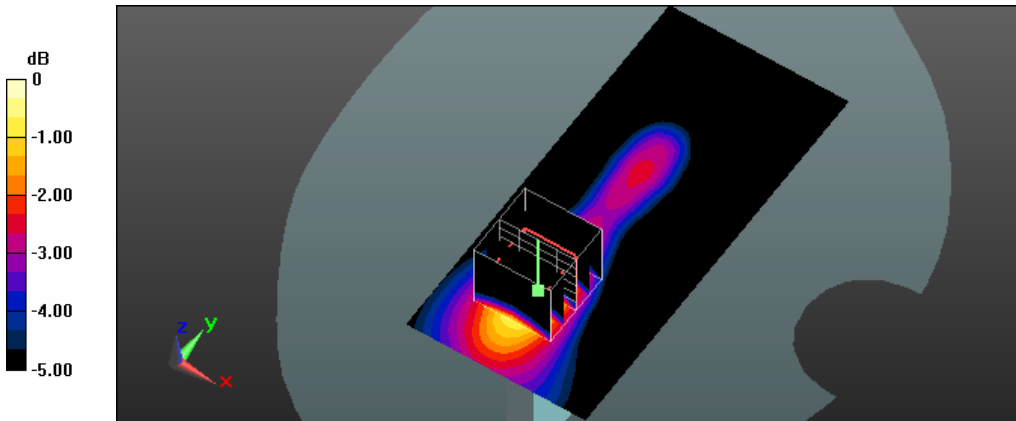

0 dB = 0.151 W/kg = -8.21 dBW/kg

Test Laboratory: A Test Lab Techno Corp.

Date: 2014/7/10 Time: PM 04:33:46

51_Flat_WCDMA Band II CH9538_side6 surface to phantom 10mm_SIM1

DUT: SKY 4.5D; Type: WCDMA Mobile Phone; Serial: 868817019960135

Communication System: UID 0, WCDMA Band II (0); Frequency: 1907.6 MHz; Duty Cycle: 1:1

Medium parameters used: $f = 1908 \text{ MHz}$; $\sigma = 1.491 \text{ S/m}$; $\epsilon_r = 52.317$; $\rho = 1000 \text{ kg/m}^3$

Phantom section: Flat Section

Measurement Standard: DASYS (IEEE/IEC/ANSI C63.19-2011)

DASY Configuration:

- Area Scan setting - Find Secondary Maximum Within: 2.0dB and with a peak SAR value greater than 0.5 W/Kg
- Probe: EX3DV4 - SN3977; ConvF(7.37, 7.37, 7.37); Calibrated: 2014/2/17;
- Sensor-Surface: 2mm (Mechanical Surface Detection)
- Electronics: DAE4 Sn779; Calibrated: 2014/2/25
- Phantom: SAM with CRP; Type: SAM; Serial: TP-1150 and higher
- Measurement SW: DASYS2, Version 52.8 (7); SEMCAD X Version 14.6.10 (7164)

Flat/Area Scan (51x111x1):

Interpolated grid: $dx=1.500 \text{ mm}$, $dy=1.500 \text{ mm}$

Maximum value of SAR (interpolated) = 0.199 W/kg

Flat/Zoom Scan (5x5x7)/Cube 0:

Measurement grid: $dx=8\text{mm}$, $dy=8\text{mm}$, $dz=5\text{mm}$

Reference Value = 8.999 V/m; Power Drift = 0.11 dB

Peak SAR (extrapolated) = 0.246 W/kg

SAR(1 g) = 0.146 W/kg; SAR(10 g) = 0.083 W/kg

Maximum value of SAR (measured) = 0.199 W/kg

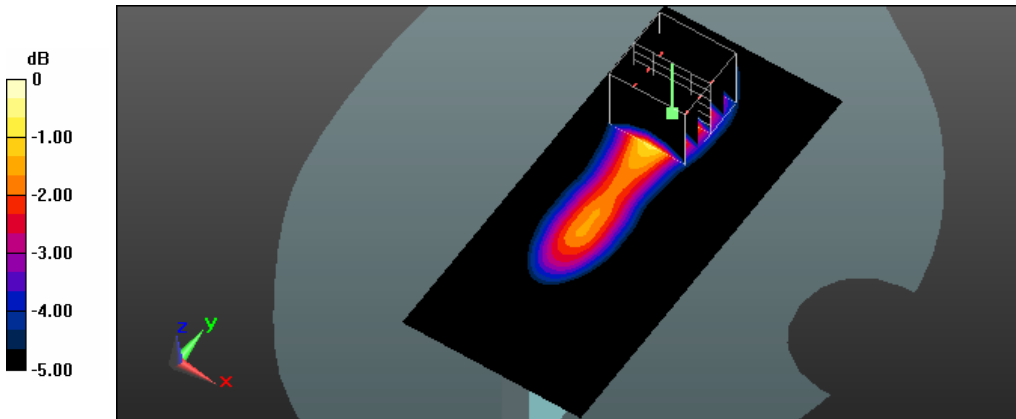

0 dB = 0.199 W/kg = -7.01 dBW/kg

Test Laboratory: A Test Lab Techno Corp.

Date: 2014/7/16 Time: PM 03:58:16

69_Flat_WCDMA Band IV CH1413_side1 surface to phantom 10mm_SIM1

DUT: SKY 4.5D; Type: WCDMA Mobile Phone; Serial: 868817019960135

Communication System: UID 0, WCDMA Band IV (0); Frequency: 1732.6 MHz; Duty Cycle: 1:1

Medium parameters used: $f = 1733 \text{ MHz}$; $\sigma = 1.543 \text{ S/m}$; $\epsilon_r = 52.487$; $\rho = 1000 \text{ kg/m}^3$

Phantom section: Flat Section

Measurement Standard: DASYS (IEEE/IEC/ANSI C63.19-2011)

DASY Configuration:

- Area Scan setting - Find Secondary Maximum Within: 2.0dB and with a peak SAR value greater than 0.5 W/Kg
- Probe: EX3DV4 - SN3977; ConvF(7.69, 7.69, 7.69); Calibrated: 2014/2/17;
- Sensor-Surface: 2mm (Mechanical Surface Detection)
- Electronics: DAE4 Sn779; Calibrated: 2014/2/25
- Phantom: SAM with CRP; Type: SAM; Serial: TP-1150 and higher
- Measurement SW: DASYS2, Version 52.8 (7); SEMCAD X Version 14.6.10 (7164)

Flat/Area Scan (71x111x1):

Interpolated grid: $dx=1.500 \text{ mm}$, $dy=1.500 \text{ mm}$

Maximum value of SAR (interpolated) = 0.492 W/kg

Flat/Zoom Scan (5x5x7)/Cube 0:

Measurement grid: $dx=8\text{mm}$, $dy=8\text{mm}$, $dz=5\text{mm}$

Reference Value = 9.062 V/m; Power Drift = -0.09 dB

Peak SAR (extrapolated) = 0.587 W/kg

SAR(1 g) = 0.371 W/kg; SAR(10 g) = 0.232 W/kg

Maximum value of SAR (measured) = 0.477 W/kg

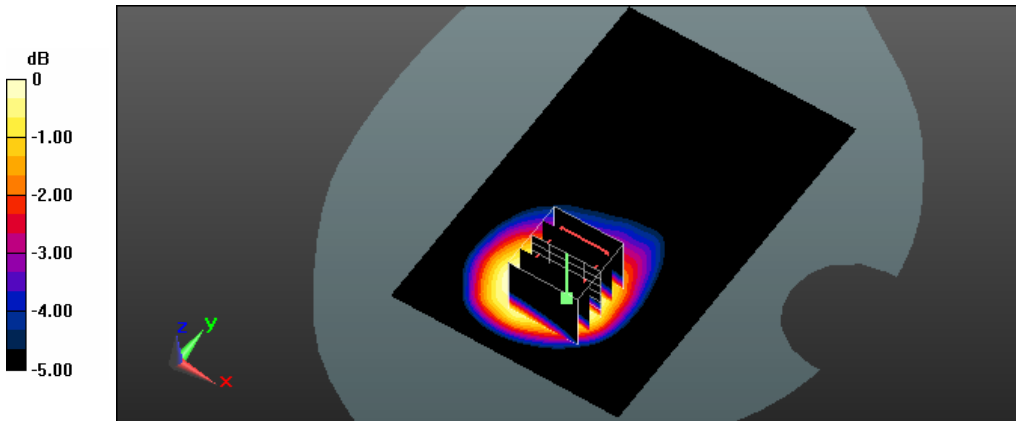

0 dB = 0.477 W/kg = -3.21 dBW/kg

Test Laboratory: A Test Lab Techno Corp.

Date: 2014/7/16 Time: PM 04:20:07

70_Flat_WCDMA Band IV CH1413_side2 surface to phantom 10mm_SIM1

DUT: SKY 4.5D; Type: WCDMA Mobile Phone; Serial: 868817019960135

Communication System: UID 0, WCDMA Band IV (0); Frequency: 1732.6 MHz; Duty Cycle: 1:1

Medium parameters used: $f = 1733 \text{ MHz}$; $\sigma = 1.543 \text{ S/m}$; $\epsilon_r = 52.487$; $\rho = 1000 \text{ kg/m}^3$

Phantom section: Flat Section

Measurement Standard: DASYS (IEEE/IEC/ANSI C63.19-2011)

DASY Configuration:

- Area Scan setting - Find Secondary Maximum Within: 2.0dB and with a peak SAR value greater than 0.5 W/Kg
- Probe: EX3DV4 - SN3977; ConvF(7.69, 7.69, 7.69); Calibrated: 2014/2/17;
- Sensor-Surface: 2mm (Mechanical Surface Detection)
- Electronics: DAE4 Sn779; Calibrated: 2014/2/25
- Phantom: SAM with CRP; Type: SAM; Serial: TP-1150 and higher
- Measurement SW: DASYS2, Version 52.8 (7); SEMCAD X Version 14.6.10 (7164)

Flat/Area Scan (71x111x1):

Interpolated grid: $dx=1.500 \text{ mm}$, $dy=1.500 \text{ mm}$

Maximum value of SAR (interpolated) = 0.809 W/kg

Flat/Zoom Scan (5x5x7)/Cube 0:

Measurement grid: $dx=8\text{mm}$, $dy=8\text{mm}$, $dz=5\text{mm}$

Reference Value = 10.030 V/m; Power Drift = -0.00 dB

Peak SAR (extrapolated) = 0.971 W/kg

SAR(1 g) = 0.617 W/kg; SAR(10 g) = 0.374 W/kg

Maximum value of SAR (measured) = 0.791 W/kg

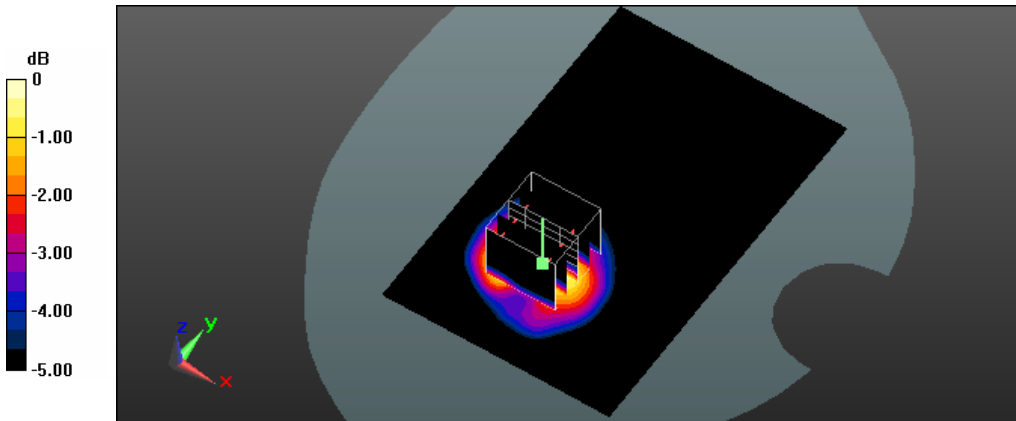

0 dB = 0.791 W/kg = -1.02 dBW/kg

Test Laboratory: A Test Lab Techno Corp.

Date: 2014/7/16 Time: PM 04:45:27

71_Flat_WCDMA Band IV CH1413_side4 surface to phantom 10mm_SIM1

DUT: SKY 4.5D; Type: WCDMA Mobile Phone; Serial: 868817019960135

Communication System: UID 0, WCDMA Band IV (0); Frequency: 1732.6 MHz; Duty Cycle: 1:1

Medium parameters used: $f = 1733 \text{ MHz}$; $\sigma = 1.543 \text{ S/m}$; $\epsilon_r = 52.487$; $\rho = 1000 \text{ kg/m}^3$

Phantom section: Flat Section

Measurement Standard: DASYS (IEEE/IEC/ANSI C63.19-2011)

DASY Configuration:

- Area Scan setting - Find Secondary Maximum Within: 2.0dB and with a peak SAR value greater than 0.5 W/Kg
- Probe: EX3DV4 - SN3977; ConvF(7.69, 7.69, 7.69); Calibrated: 2014/2/17;
- Sensor-Surface: 2mm (Mechanical Surface Detection)
- Electronics: DAE4 Sn779; Calibrated: 2014/2/25
- Phantom: SAM with CRP; Type: SAM; Serial: TP-1150 and higher
- Measurement SW: DASYS2, Version 52.8 (7); SEMCAD X Version 14.6.10 (7164)

Flat/Area Scan (51x91x1):

Interpolated grid: $dx=1.500 \text{ mm}$, $dy=1.500 \text{ mm}$

Maximum value of SAR (interpolated) = 0.595 W/kg

Flat/Zoom Scan (5x5x7)/Cube 0:

Measurement grid: $dx=8\text{mm}$, $dy=8\text{mm}$, $dz=5\text{mm}$

Reference Value = 19.418 V/m; Power Drift = 0.06 dB

Peak SAR (extrapolated) = 0.720 W/kg

SAR(1 g) = 0.442 W/kg; SAR(10 g) = 0.243 W/kg

Maximum value of SAR (measured) = 0.608 W/kg

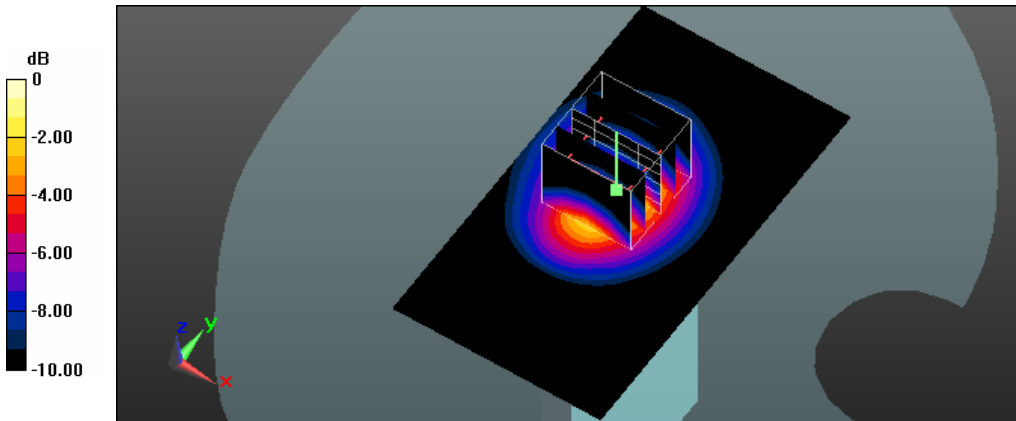

0 dB = 0.608 W/kg = -2.16 dBW/kg

Test Laboratory: A Test Lab Techno Corp.

Date: 2014/7/16 Time: PM 05:05:59

72 Flat_WCDMA Band IV CH1413_side5 surface to phantom 10mm_SIM1

DUT: SKY 4.5D; Type: WCDMA Mobile Phone; Serial: 868817019960135

Communication System: UID 0, WCDMA Band IV (0); Frequency: 1732.6 MHz; Duty Cycle: 1:1

Medium parameters used: $f = 1733 \text{ MHz}$; $\sigma = 1.543 \text{ S/m}$; $\epsilon_r = 52.487$; $\rho = 1000 \text{ kg/m}^3$

Phantom section: Flat Section

Measurement Standard: DASYS (IEEE/IEC/ANSI C63.19-2011)

DASY Configuration:

- Area Scan setting - Find Secondary Maximum Within: 2.0dB and with a peak SAR value greater than 0.5 W/Kg
- Probe: EX3DV4 - SN3977; ConvF(7.69, 7.69, 7.69); Calibrated: 2014/2/17;
- Sensor-Surface: 2mm (Mechanical Surface Detection)
- Electronics: DAE4 Sn779; Calibrated: 2014/2/25
- Phantom: SAM with CRP; Type: SAM; Serial: TP-1150 and higher
- Measurement SW: DASYS2, Version 52.8 (7); SEMCAD X Version 14.6.10 (7164)

Flat/Area Scan (51x111x1):

Interpolated grid: $dx=1.500 \text{ mm}$, $dy=1.500 \text{ mm}$

Maximum value of SAR (interpolated) = 0.103 W/kg

Flat/Zoom Scan (5x5x7)/Cube 0:

Measurement grid: $dx=8\text{mm}$, $dy=8\text{mm}$, $dz=5\text{mm}$

Reference Value = 6.247 V/m; Power Drift = 0.08 dB

Peak SAR (extrapolated) = 0.125 W/kg

SAR(1 g) = 0.080 W/kg; SAR(10 g) = 0.049 W/kg

Maximum value of SAR (measured) = 0.104 W/kg

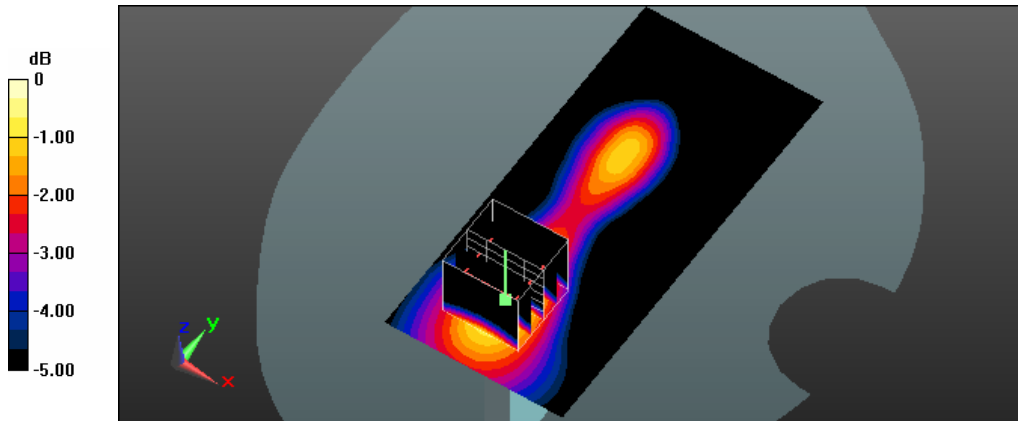

0 dB = 0.104 W/kg = -9.83 dBW/kg

Test Laboratory: A Test Lab Techno Corp.

Date: 2014/7/16 Time: PM 05:26:48

73_Flat_WCDMA Band IV CH1413_side6 surface to phantom 10mm_SIM1

DUT: SKY 4.5D; Type: WCDMA Mobile Phone; Serial: 868817019960135

Communication System: UID 0, WCDMA Band IV (0); Frequency: 1732.6 MHz; Duty Cycle: 1:1

Medium parameters used: $f = 1733 \text{ MHz}$; $\sigma = 1.543 \text{ S/m}$; $\epsilon_r = 52.487$; $\rho = 1000 \text{ kg/m}^3$

Phantom section: Flat Section

Measurement Standard: DASYS (IEEE/IEC/ANSI C63.19-2011)

DASY Configuration:

- Area Scan setting - Find Secondary Maximum Within: 2.0dB and with a peak SAR value greater than 0.5 W/Kg
- Probe: EX3DV4 - SN3977; ConvF(7.69, 7.69, 7.69); Calibrated: 2014/2/17;
- Sensor-Surface: 2mm (Mechanical Surface Detection)
- Electronics: DAE4 Sn779; Calibrated: 2014/2/25
- Phantom: SAM with CRP; Type: SAM; Serial: TP-1150 and higher
- Measurement SW: DASYS2, Version 52.8 (7); SEMCAD X Version 14.6.10 (7164)

Flat/Area Scan (51x111x1):

Interpolated grid: $dx=1.500 \text{ mm}$, $dy=1.500 \text{ mm}$

Maximum value of SAR (interpolated) = 0.140 W/kg

Flat/Zoom Scan (5x5x7)/Cube 0:

Measurement grid: $dx=8\text{mm}$, $dy=8\text{mm}$, $dz=5\text{mm}$

Reference Value = 9.026 V/m; Power Drift = 0.02 dB

Peak SAR (extrapolated) = 0.167 W/kg

SAR(1 g) = 0.104 W/kg; SAR(10 g) = 0.063 W/kg

Maximum value of SAR (measured) = 0.138 W/kg

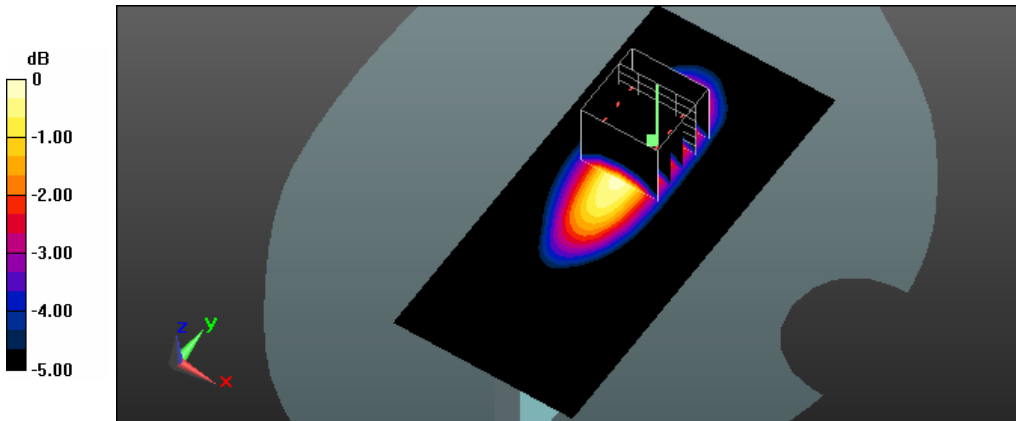

0 dB = 0.138 W/kg = -8.60 dBW/kg

Test Laboratory: A Test Lab Techno Corp.

Date: 2014/7/9 Time: AM 09:33:07

52 Flat_WCDMA Band V CH4183_side 1 surface to phantom 10mm_SIM1

DUT: SKY 4.5D; Type: WCDMA Mobile Phone; Serial: 868817019960135

Communication System: UID 0, WCDMA Band V (0); Frequency: 836.6 MHz; Duty Cycle: 1:1

Medium parameters used: $f = 837 \text{ MHz}$; $\sigma = 0.992 \text{ S/m}$; $\epsilon_r = 56.419$; $\rho = 1000 \text{ kg/m}^3$

Phantom section: Flat Section

Measurement Standard: DASY5 (IEEE/IEC/ANSI C63.19-2011)

DASY Configuration:

- Area Scan setting - Find Secondary Maximum Within: 2.0dB and with a peak SAR value greater than 0.5 W/Kg
- Probe: EX3DV4 - SN3977; ConvF(9.74, 9.74, 9.74); Calibrated: 2014/2/17;
- Sensor-Surface: 2mm (Mechanical Surface Detection)
- Electronics: DAE4 Sn779; Calibrated: 2014/2/25
- Phantom: SAM with CRP; Type: SAM; Serial: TP-1150 and higher
- Measurement SW: DASY52, Version 52.8 (7); SEMCAD X Version 14.6.10 (7164)

Flat/Area Scan (71x111x1):

Interpolated grid: $dx=1.500 \text{ mm}$, $dy=1.500 \text{ mm}$

Maximum value of SAR (interpolated) = 0.564 W/kg

Flat/Zoom Scan (5x5x7)/Cube 0:

Measurement grid: $dx=8\text{mm}$, $dy=8\text{mm}$, $dz=5\text{mm}$

Reference Value = 24.165 V/m; Power Drift = -0.00 dB

Peak SAR (extrapolated) = 0.621 W/kg

SAR(1 g) = 0.499 W/kg; SAR(10 g) = 0.387 W/kg

Maximum value of SAR (measured) = 0.568 W/kg

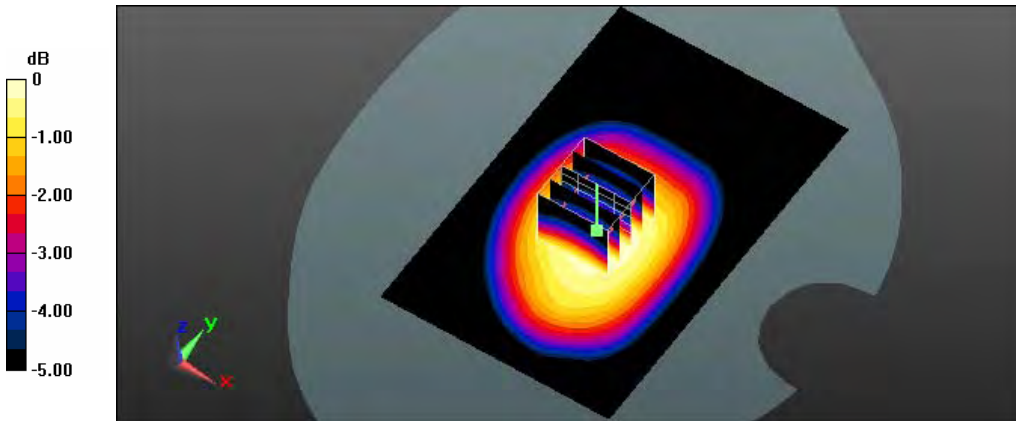

0 dB = 0.568 W/kg = -2.46 dBW/kg

Test Laboratory: A Test Lab Techno Corp.

Date: 2014/7/9 Time: AM 09:54:55

53_Flat_WCDMA Band V CH4183_side 2 surface to phantom 10mm_SIM1

DUT: SKY 4.5D; Type: WCDMA Mobile Phone; Serial: 868817019960135

Communication System: UID 0, WCDMA Band V (0); Frequency: 836.6 MHz; Duty Cycle: 1:1

Medium parameters used: $f = 837 \text{ MHz}$; $\sigma = 0.992 \text{ S/m}$; $\epsilon_r = 56.419$; $\rho = 1000 \text{ kg/m}^3$

Phantom section: Flat Section

Measurement Standard: DASY5 (IEEE/IEC/ANSI C63.19-2011)

DASY Configuration:

- Area Scan setting - Find Secondary Maximum Within: 2.0dB and with a peak SAR value greater than 0.5 W/Kg
- Probe: EX3DV4 - SN3977; ConvF(9.74, 9.74, 9.74); Calibrated: 2014/2/17;
- Sensor-Surface: 2mm (Mechanical Surface Detection)
- Electronics: DAE4 Sn779; Calibrated: 2014/2/25
- Phantom: SAM with CRP; Type: SAM; Serial: TP-1150 and higher
- Measurement SW: DASY52, Version 52.8 (7); SEMCAD X Version 14.6.10 (7164)

Flat/Area Scan (71x111x1):

Interpolated grid: $dx=1.500 \text{ mm}$, $dy=1.500 \text{ mm}$

Maximum value of SAR (interpolated) = 0.684 W/kg

Flat/Zoom Scan (5x5x7)/Cube 0:

Measurement grid: $dx=8\text{mm}$, $dy=8\text{mm}$, $dz=5\text{mm}$

Reference Value = 26.251 V/m; Power Drift = 0.02 dB

Peak SAR (extrapolated) = 0.748 W/kg

SAR(1 g) = 0.597 W/kg; SAR(10 g) = 0.458 W/kg

Maximum value of SAR (measured) = 0.682 W/kg

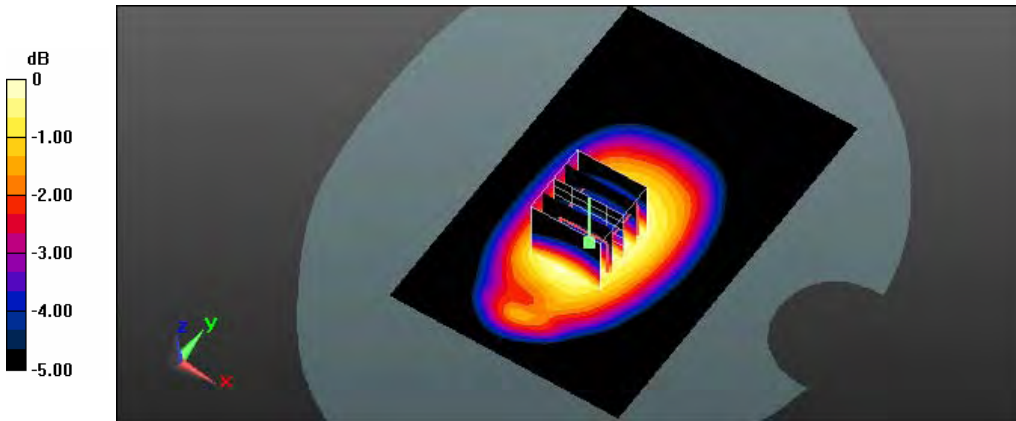

0 dB = 0.682 W/kg = -1.66 dBW/kg

Test Laboratory: A Test Lab Techno Corp.

Date: 2014/7/9 Time: AM 10:50:29

54_Flat_WCDMA Band V CH4183_side 4 surface to phantom 10mm_SIM1

DUT: SKY 4.5D; Type: WCDMA Mobile Phone; Serial: 868817019960135

Communication System: UID 0, WCDMA Band V (0); Frequency: 836.6 MHz; Duty Cycle: 1:1

Medium parameters used: $f = 837 \text{ MHz}$; $\sigma = 0.992 \text{ S/m}$; $\epsilon_r = 56.419$; $\rho = 1000 \text{ kg/m}^3$

Phantom section: Flat Section

Measurement Standard: DASY5 (IEEE/IEC/ANSI C63.19-2011)

DASY Configuration:

- Area Scan setting - Find Secondary Maximum Within: 2.0dB and with a peak SAR value greater than 0.5 W/Kg
- Probe: EX3DV4 - SN3977; ConvF(9.74, 9.74, 9.74); Calibrated: 2014/2/17;
- Sensor-Surface: 2mm (Mechanical Surface Detection)
- Electronics: DAE4 Sn779; Calibrated: 2014/2/25
- Phantom: SAM with CRP; Type: SAM; Serial: TP-1150 and higher
- Measurement SW: DASY52, Version 52.8 (7); SEMCAD X Version 14.6.10 (7164)

Flat/Area Scan (51x91x1):

Interpolated grid: $dx=1.500 \text{ mm}$, $dy=1.500 \text{ mm}$

Maximum value of SAR (interpolated) = 0.0981 W/kg

Flat/Zoom Scan (5x5x7)/Cube 0:

Measurement grid: $dx=8\text{mm}$, $dy=8\text{mm}$, $dz=5\text{mm}$

Reference Value = 9.489 V/m; Power Drift = 0.07 dB

Peak SAR (extrapolated) = 0.126 W/kg

SAR(1 g) = 0.067 W/kg; SAR(10 g) = 0.037 W/kg

Maximum value of SAR (measured) = 0.0970 W/kg

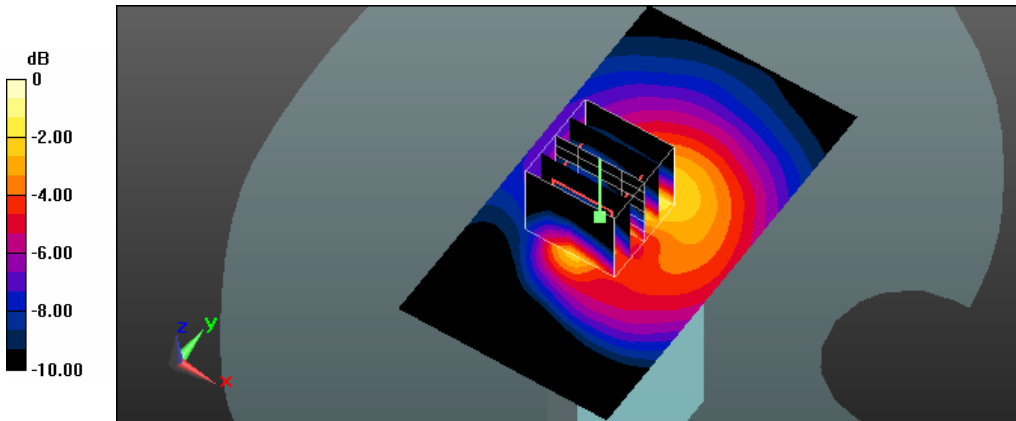

0 dB = 0.0970 W/kg = -10.13 dBW/kg

Test Laboratory: A Test Lab Techno Corp.

Date: 2014/7/9 Time: AM 11:08:12

55_Flat_WCDMA Band V CH4183_side5 surface to phantom 10mm_SIM1

DUT: SKY 4.5D; Type: WCDMA Mobile Phone; Serial: 868817019960135

Communication System: UID 0, WCDMA Band V (0); Frequency: 836.6 MHz; Duty Cycle: 1:1

Medium parameters used: $f = 837 \text{ MHz}$; $\sigma = 0.992 \text{ S/m}$; $\epsilon_r = 56.419$; $\rho = 1000 \text{ kg/m}^3$

Phantom section: Flat Section

Measurement Standard: DASY5 (IEEE/IEC/ANSI C63.19-2011)

DASY Configuration:

- Area Scan setting - Find Secondary Maximum Within: 2.0dB and with a peak SAR value greater than 0.5 W/Kg
- Probe: EX3DV4 - SN3977; ConvF(9.74, 9.74, 9.74); Calibrated: 2014/2/17;
- Sensor-Surface: 2mm (Mechanical Surface Detection)
- Electronics: DAE4 Sn779; Calibrated: 2014/2/25
- Phantom: SAM with CRP; Type: SAM; Serial: TP-1150 and higher
- Measurement SW: DASY52, Version 52.8 (7); SEMCAD X Version 14.6.10 (7164)

Flat/Area Scan (51x111x1):

Interpolated grid: $dx=1.500 \text{ mm}$, $dy=1.500 \text{ mm}$

Maximum value of SAR (interpolated) = 0.449 W/kg

Flat/Zoom Scan (5x5x7)/Cube 0:

Measurement grid: $dx=8\text{mm}$, $dy=8\text{mm}$, $dz=5\text{mm}$

Reference Value = 21.569 V/m; Power Drift = -0.06 dB

Peak SAR (extrapolated) = 0.517 W/kg

SAR(1 g) = 0.369 W/kg; SAR(10 g) = 0.256 W/kg

Maximum value of SAR (measured) = 0.451 W/kg

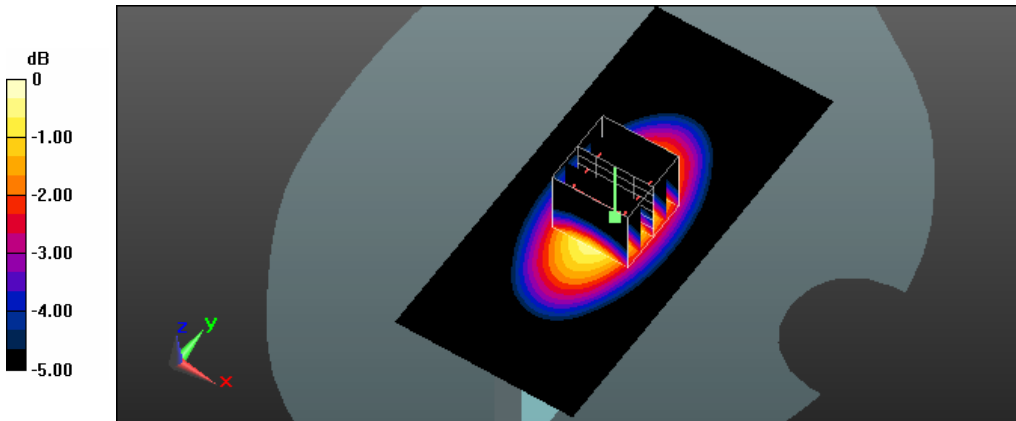

0 dB = 0.451 W/kg = -3.46 dBW/kg

Test Laboratory: A Test Lab Techno Corp.

Date: 2014/7/9 Time: AM 11:28:03

56_Flat_WCDMA Band V CH4183_side 6 surface to phantom 10mm_SIM1

DUT: SKY 4.5D; Type: WCDMA Mobile Phone; Serial: 868817019960135

Communication System: UID 0, WCDMA Band V (0); Frequency: 836.6 MHz; Duty Cycle: 1:1

Medium parameters used: $f = 837 \text{ MHz}$; $\sigma = 0.992 \text{ S/m}$; $\epsilon_r = 56.419$; $\rho = 1000 \text{ kg/m}^3$

Phantom section: Flat Section

Measurement Standard: DASYS (IEEE/IEC/ANSI C63.19-2011)

DASY Configuration:

- Area Scan setting - Find Secondary Maximum Within: 2.0dB and with a peak SAR value greater than 0.5 W/Kg
- Probe: EX3DV4 - SN3977; ConvF(9.74, 9.74, 9.74); Calibrated: 2014/2/17;
- Sensor-Surface: 2mm (Mechanical Surface Detection)
- Electronics: DAE4 Sn779; Calibrated: 2014/2/25
- Phantom: SAM with CRP; Type: SAM; Serial: TP-1150 and higher
- Measurement SW: DASYS2, Version 52.8 (7); SEMCAD X Version 14.6.10 (7164)

Flat/Area Scan (51x111x1):

Interpolated grid: $dx=1.500 \text{ mm}$, $dy=1.500 \text{ mm}$

Maximum value of SAR (interpolated) = 0.399 W/kg

Flat/Zoom Scan (5x5x7)/Cube 0:

Measurement grid: $dx=8\text{mm}$, $dy=8\text{mm}$, $dz=5\text{mm}$

Reference Value = 20.295 V/m; Power Drift = -0.05 dB

Peak SAR (extrapolated) = 0.461 W/kg

SAR(1 g) = 0.328 W/kg; SAR(10 g) = 0.227 W/kg

Maximum value of SAR (measured) = 0.402 W/kg

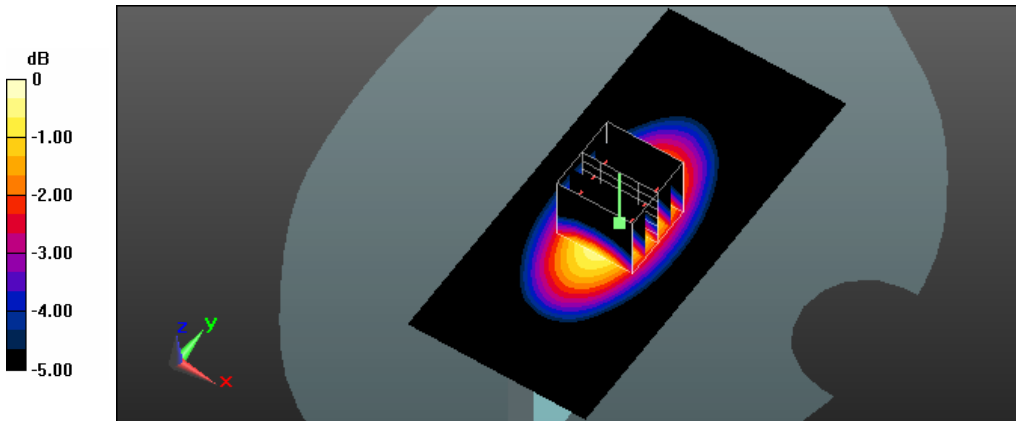

0 dB = 0.402 W/kg = -3.96 dBW/kg

Test Laboratory: A Test Lab Techno Corp.

Date: 2014/7/11 Time: AM 10:57:00

61_Flat_802.11b_CH1_5.5M_side1 surface to phantom 10mm

DUT: SKY 4.5D; Type: WCDMA Mobile Phone; Serial: 868817019960135

Communication System: UID 0, IEEE 802.11b (0); Frequency: 2412 MHz; Duty Cycle: 1:1

Medium parameters used: $f = 2412 \text{ MHz}$; $\sigma = 1.927 \text{ S/m}$; $\epsilon_r = 53.982$; $\rho = 1000 \text{ kg/m}^3$

Phantom section: Flat Section

Measurement Standard: DASYS (IEEE/IEC/ANSI C63.19-2011)

DASY Configuration:

- Area Scan setting - Find Secondary Maximum Within: 2.0dB and with a peak SAR value greater than 0.5 W/Kg
- Probe: EX3DV4 - SN3977; ConvF(6.97, 6.97, 6.97); Calibrated: 2014/2/17;
- Sensor-Surface: 2mm (Mechanical Surface Detection)
- Electronics: DAE4 Sn779; Calibrated: 2014/2/25
- Phantom: SAM with CRP; Type: SAM; Serial: TP-1150 and higher
- Measurement SW: DASYS2, Version 52.8 (7); SEMCAD X Version 14.6.10 (7164)

Flat/Area Scan (101x101x1):

Interpolated grid: $dx=1.000 \text{ mm}$, $dy=1.000 \text{ mm}$

Maximum value of SAR (interpolated) = 0.181 W/kg

Flat/Zoom Scan (7x7x7)/Cube 0:

Measurement grid: $dx=5\text{mm}$, $dy=5\text{mm}$, $dz=5\text{mm}$

Reference Value = 5.297 V/m; Power Drift = 0.06 dB

Peak SAR (extrapolated) = 0.248 W/kg

SAR(1 g) = 0.124 W/kg; SAR(10 g) = 0.063 W/kg

Maximum value of SAR (measured) = 0.180 W/kg

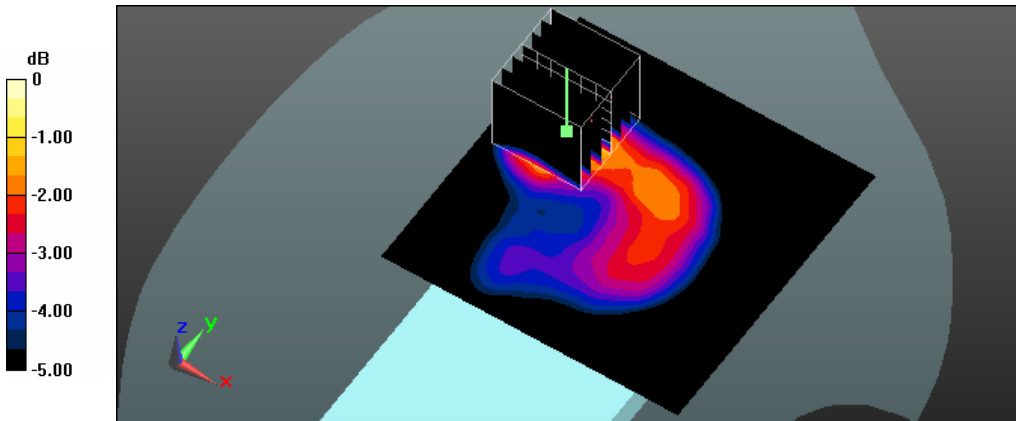

0 dB = 0.180 W/kg = -7.45 dBW/kg

Test Laboratory: A Test Lab Techno Corp.

Date: 2014/7/11 Time: AM 11:26:44

62_Flat_802.11b_CH1_5.5M_side2 surface to phantom 10mm

DUT: SKY 4.5D; Type: WCDMA Mobile Phone; Serial: 868817019960135

Communication System: UID 0, IEEE 802.11b (0); Frequency: 2412 MHz; Duty Cycle: 1:1

Medium parameters used: $f = 2412 \text{ MHz}$; $\sigma = 1.927 \text{ S/m}$; $\epsilon_r = 53.982$; $\rho = 1000 \text{ kg/m}^3$

Phantom section: Flat Section

Measurement Standard: DASYS (IEEE/IEC/ANSI C63.19-2011)

DASY Configuration:

- Area Scan setting - Find Secondary Maximum Within: 2.0dB and with a peak SAR value greater than 0.5 W/Kg
- Probe: EX3DV4 - SN3977; ConvF(6.97, 6.97, 6.97); Calibrated: 2014/2/17;
- Sensor-Surface: 2mm (Mechanical Surface Detection)
- Electronics: DAE4 Sn779; Calibrated: 2014/2/25
- Phantom: SAM with CRP; Type: SAM; Serial: TP-1150 and higher
- Measurement SW: DASYS2, Version 52.8 (7); SEMCAD X Version 14.6.10 (7164)

Flat/Area Scan (101x101x1):

Interpolated grid: $dx=1.000 \text{ mm}$, $dy=1.000 \text{ mm}$

Maximum value of SAR (interpolated) = 0.212 W/kg

Flat/Zoom Scan (7x7x7)/Cube 0:

Measurement grid: $dx=5\text{mm}$, $dy=5\text{mm}$, $dz=5\text{mm}$

Reference Value = 5.540 V/m; Power Drift = 0.04 dB

Peak SAR (extrapolated) = 0.284 W/kg

SAR(1 g) = 0.133 W/kg; SAR(10 g) = 0.061 W/kg

Maximum value of SAR (measured) = 0.204 W/kg

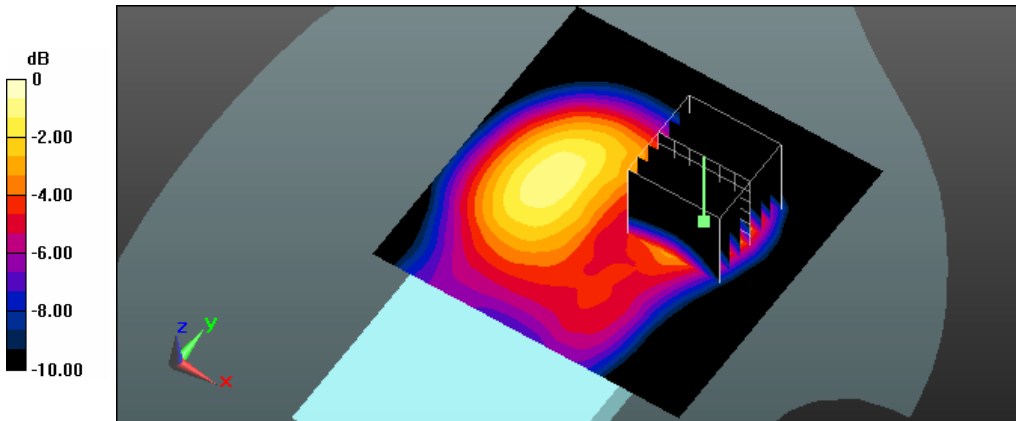

0 dB = 0.204 W/kg = -6.90 dBW/kg

Test Laboratory: A Test Lab Techno Corp.

Date: 2014/7/11 Time: PM 02:30:17

63_Flat_802.11b_CH1_5.5M_side3 surface to phantom 10mm

DUT: SKY 4.5D; Type: WCDMA Mobile Phone; Serial: 868817019960135

Communication System: UID 0, IEEE 802.11b (0); Frequency: 2412 MHz; Duty Cycle: 1:1

Medium parameters used: $f = 2412 \text{ MHz}$; $\sigma = 1.927 \text{ S/m}$; $\epsilon_r = 53.982$; $\rho = 1000 \text{ kg/m}^3$

Phantom section: Flat Section

Measurement Standard: DASY5 (IEEE/IEC/ANSI C63.19-2011)

DASY Configuration:

- Area Scan setting - Find Secondary Maximum Within: 2.0dB and with a peak SAR value greater than 0.5 W/Kg
- Probe: EX3DV4 - SN3977; ConvF(6.97, 6.97, 6.97); Calibrated: 2014/2/17;
- Sensor-Surface: 2mm (Mechanical Surface Detection)
- Electronics: DAE4 Sn779; Calibrated: 2014/2/25
- Phantom: SAM with CRP; Type: SAM; Serial: TP-1150 and higher
- Measurement SW: DASY52, Version 52.8 (7); SEMCAD X Version 14.6.10 (7164)

Flat/Area Scan (71x101x1):

Interpolated grid: $dx=1.000 \text{ mm}$, $dy=1.000 \text{ mm}$

Maximum value of SAR (interpolated) = 0.136 W/kg

Flat/Zoom Scan (7x7x7)/Cube 0:

Measurement grid: $dx=5\text{mm}$, $dy=5\text{mm}$, $dz=5\text{mm}$

Reference Value = 8.242 V/m; Power Drift = 0.16 dB

Peak SAR (extrapolated) = 0.178 W/kg

SAR(1 g) = 0.096 W/kg; SAR(10 g) = 0.051 W/kg

Maximum value of SAR (measured) = 0.136 W/kg

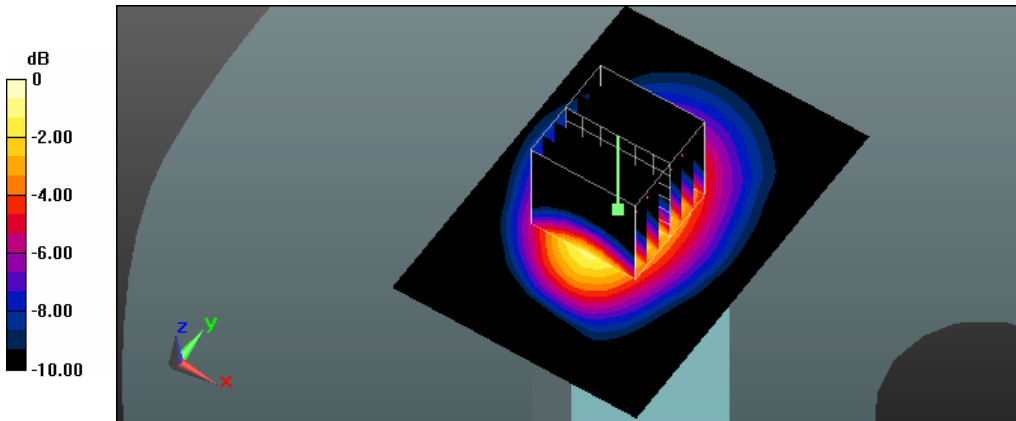

0 dB = 0.136 W/kg = -8.66 dBW/kg

Test Laboratory: A Test Lab Techno Corp.

Date: 2014/7/11 Time: PM 01:59:43

64_Flat_802.11b_CH1_5.5M_side5 surface to phantom 10mm

DUT: SKY 4.5D; Type: WCDMA Mobile Phone; Serial: 868817019960135

Communication System: UID 0, IEEE 802.11b (0); Frequency: 2412 MHz; Duty Cycle: 1:1

Medium parameters used: $f = 2412 \text{ MHz}$; $\sigma = 1.927 \text{ S/m}$; $\epsilon_r = 53.982$; $\rho = 1000 \text{ kg/m}^3$

Phantom section: Flat Section

Measurement Standard: DASY5 (IEEE/IEC/ANSI C63.19-2011)

DASY Configuration:

- Area Scan setting - Find Secondary Maximum Within: 2.0dB and with a peak SAR value greater than 0.5 W/Kg
- Probe: EX3DV4 - SN3977; ConvF(6.97, 6.97, 6.97); Calibrated: 2014/2/17;
- Sensor-Surface: 2mm (Mechanical Surface Detection)
- Electronics: DAE4 Sn779; Calibrated: 2014/2/25
- Phantom: SAM with CRP; Type: SAM; Serial: TP-1150 and higher
- Measurement SW: DASY52, Version 52.8 (7); SEMCAD X Version 14.6.10 (7164)

Flat/Area Scan (71x101x1):

Interpolated grid: $dx=1.000 \text{ mm}$, $dy=1.000 \text{ mm}$

Maximum value of SAR (interpolated) = 0.173 W/kg

Flat/Zoom Scan (7x7x7)/Cube 0:

Measurement grid: $dx=5\text{mm}$, $dy=5\text{mm}$, $dz=5\text{mm}$

Reference Value = 6.372 V/m; Power Drift = -0.01 dB

Peak SAR (extrapolated) = 0.229 W/kg

SAR(1 g) = 0.114 W/kg; SAR(10 g) = 0.055 W/kg

Maximum value of SAR (measured) = 0.167 W/kg

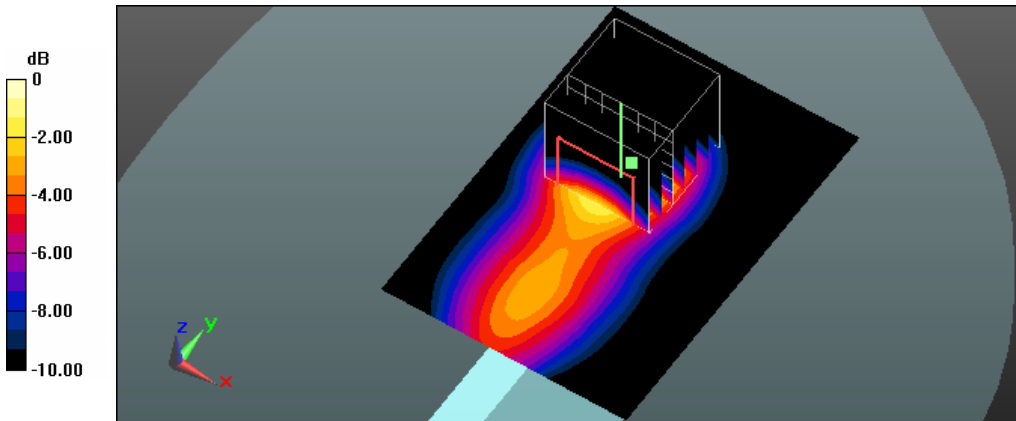

0 dB = 0.167 W/kg = -7.77 dBW/kg

Test Laboratory: A Test Lab Techno Corp.

Date: 2014/7/11 Time: PM 04:57:07

74_Flat_BT3.0_CH78_DH5_1M_side1 surface to phantom 10mm

DUT: SKY 4.5D; Type: WCDMA Mobile Phone; Serial: 868817019960135

Communication System: UID 0, Bluetooth (0); Frequency: 2480 MHz; Duty Cycle: 1:1

Medium parameters used: $f = 2480 \text{ MHz}$; $\sigma = 1.957 \text{ S/m}$; $\epsilon_r = 54.12$; $\rho = 1000 \text{ kg/m}^3$

Phantom section: Flat Section

Measurement Standard: DASY5 (IEEE/IEC/ANSI C63.19-2011)

DASY Configuration:

- Area Scan setting - Find Secondary Maximum Within: 2.0dB and with a peak SAR value greater than 0.5 W/Kg
- Probe: EX3DV4 - SN3977; ConvF(6.97, 6.97, 6.97); Calibrated: 2014/2/17;
- Sensor-Surface: 2mm (Mechanical Surface Detection)
- Electronics: DAE4 Sn779; Calibrated: 2014/2/25
- Phantom: SAM with CRP; Type: SAM; Serial: TP-1150 and higher
- Measurement SW: DASY52, Version 52.8 (7); SEMCAD X Version 14.6.10 (7164)

Flat/Area Scan (101x121x1):

Interpolated grid: $dx=1.000 \text{ mm}$, $dy=1.000 \text{ mm}$

Maximum value of SAR (interpolated) = 0.0669 W/kg

Flat/Zoom Scan (7x7x7)/Cube 0:

Measurement grid: $dx=5\text{mm}$, $dy=5\text{mm}$, $dz=5\text{mm}$

Reference Value = 0 V/m; Power Drift = 0.19 dB

Peak SAR (extrapolated) = 0.0560 W/kg

SAR(1 g) = 0.022 W/kg; SAR(10 g) = 0.00791 W/kg

Maximum value of SAR (measured) = 0.0348 W/kg

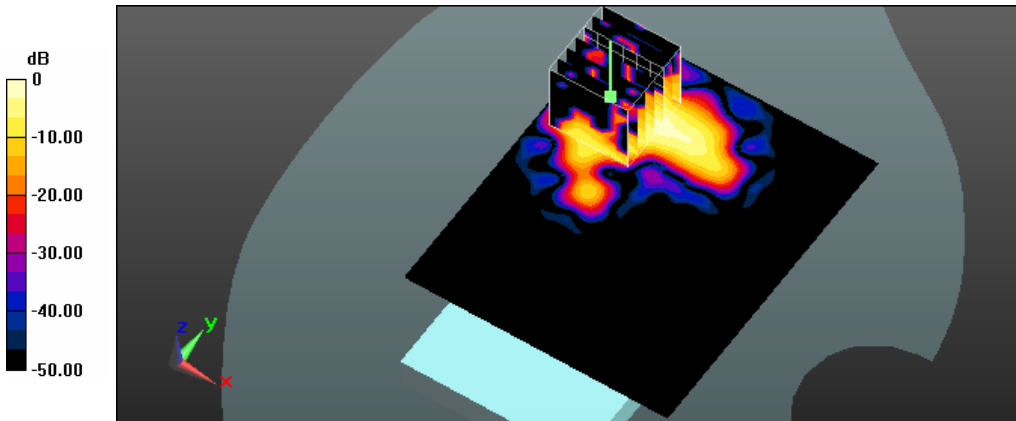

0 dB = 0.0348 W/kg = -14.58 dBW/kg

Test Laboratory: A Test Lab Techno Corp.

Date: 2014/7/11 Time: PM 05:33:19

75_Flat_BT3.0_CH78_DH5_1M_side2 surface to phantom 10mm

DUT: SKY 4.5D; Type: WCDMA Mobile Phone; Serial: 868817019960135

Communication System: UID 0, Bluetooth (0); Frequency: 2480 MHz; Duty Cycle: 1:1

Medium parameters used: $f = 2480 \text{ MHz}$; $\sigma = 1.957 \text{ S/m}$; $\epsilon_r = 54.12$; $\rho = 1000 \text{ kg/m}^3$

Phantom section: Flat Section

Measurement Standard: DASY5 (IEEE/IEC/ANSI C63.19-2011)

DASY Configuration:

- Area Scan setting - Find Secondary Maximum Within: 2.0dB and with a peak SAR value greater than 0.5 W/Kg
- Probe: EX3DV4 - SN3977; ConvF(6.97, 6.97, 6.97); Calibrated: 2014/2/17;
- Sensor-Surface: 2mm (Mechanical Surface Detection)
- Electronics: DAE4 Sn779; Calibrated: 2014/2/25
- Phantom: SAM with CRP; Type: SAM; Serial: TP-1150 and higher
- Measurement SW: DASY52, Version 52.8 (7); SEMCAD X Version 14.6.10 (7164)

Flat/Area Scan (101x121x1):

Interpolated grid: $dx=1.000 \text{ mm}$, $dy=1.000 \text{ mm}$

Maximum value of SAR (interpolated) = 0.0611 W/kg

Flat/Zoom Scan (7x7x7)/Cube 0:

Measurement grid: $dx=5\text{mm}$, $dy=5\text{mm}$, $dz=5\text{mm}$

Reference Value = 0.558 V/m; Power Drift = -0.04 dB

Peak SAR (extrapolated) = 0.0860 W/kg

SAR(1 g) = 0.032 W/kg; SAR(10 g) = 0.00992 W/kg

Maximum value of SAR (measured) = 0.0564 W/kg

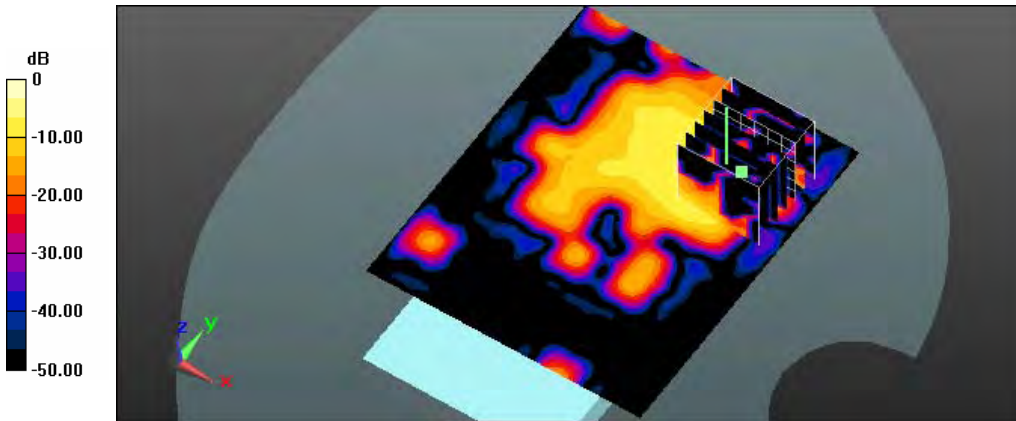

0 dB = 0.0564 W/kg = -12.49 dBW/kg



Appendix C - Calibration

All of the instruments Calibration information are listed below.

- Dipole _ D835V2 SN:4d082 Calibration No.D835V2-4d082_Jul13
- Dipole _ D1750V2 SN:1023 Calibration No.D1750V2-1023_Jun14
- Dipole _ D1900V2 SN:5d111 Calibration No.D1900V2-5d111_Jul13
- Dipole _ D2450V2 SN:712 Calibration No.D2450V2-712_Mar14
- Probe _ EX3DV4 SN:3977 Calibration No.EX3-3977_Feb14
- DAE _ DAE4 SN:779 Calibration No.DAE4-779_Feb14

**Calibration Laboratory of
Schmid & Partner
Engineering AG**
Zeughausstrasse 43, 8004 Zurich, Switzerland



S Schweizerischer Kalibrierdienst
C Service suisse d'étalonnage
S Servizio svizzero di taratura
S Swiss Calibration Service

Accredited by the Swiss Accreditation Service (SAS)
The Swiss Accreditation Service is one of the signatories to the EA
Multilateral Agreement for the recognition of calibration certificates

Accreditation No.: **SCS 108**

Client **ATL (Auden)**

Certificate No: **D835V2-4d082_Jul13**

CALIBRATION CERTIFICATE

Object: **D835V2 - SN: 4d082**

Calibration procedure(s): **QA CAL-05.v9
Calibration procedure for dipole validation kits above 700 MHz**

Calibration date: **July 30, 2013**



This calibration certificate documents the traceability to national standards, which realize the physical units of measurements (SI).
The measurements and the uncertainties with confidence probability are given on the following pages and are part of the certificate.

All calibrations have been conducted in the closed laboratory facility: environment temperature (22 ± 3)°C and humidity < 70%.

Calibration Equipment used (M&TE critical for calibration)

Primary Standards	ID #	Cal Date (Certificate No.)	Scheduled Calibration
Power meter EPM-442A	GB37480704	01-Nov-12 (No. 217-01640)	Oct-13
Power sensor HP 8481A	US37292783	01-Nov-12 (No. 217-01640)	Oct-13
Reference 20 dB Attenuator	SN: 5058 (20k)	04-Apr-13 (No. 217-01736)	Apr-14
Type-N mismatch combination	SN: 5047.3 / 06327	04-Apr-13 (No. 217-01739)	Apr-14
Reference Probe ES3DV3	SN: 3205	28-Dec-12 (No. ES3-3205_Dec12)	Dec-13
DAE4	SN: 601	25-Apr-13 (No. DAE4-601_Apr13)	Apr-14

Secondary Standards	ID #	Check Date (in house)	Scheduled Check
Power sensor HP 8481A	MY41092317	18-Oct-02 (in house check Oct-11)	In house check: Oct-13
RF generator R&S SMT-06	100005	04-Aug-99 (in house check Oct-11)	In house check: Oct-13
Network Analyzer HP 8753E	US37390585 S4206	18-Oct-01 (in house check Oct-12)	In house check: Oct-13

Calibrated by:	Name Claudio Leubler	Function Laboratory Technician	Signature 
Approved by:	Name Katja Pokovic	Function Technical Manager	Signature 

Issued: July 30, 2013

This calibration certificate shall not be reproduced except in full without written approval of the laboratory.

Calibration Laboratory of
 Schmid & Partner
 Engineering AG
 Zeughausstrasse 43, 8004 Zurich, Switzerland



S Schweizerischer Kalibrierdienst
C Service suisse d'étalonnage
S Servizio svizzero di taratura
S Swiss Calibration Service

Accredited by the Swiss Accreditation Service (SAS)
 The Swiss Accreditation Service is one of the signatories to the EA
 Multilateral Agreement for the recognition of calibration certificates

Accreditation No.: **SCS 108**

Glossary:

TSL tissue simulating liquid
 ConvF sensitivity in TSL / NORM x,y,z
 N/A not applicable or not measured

Calibration is Performed According to the Following Standards:

- a) IEEE Std 1528-2003, "IEEE Recommended Practice for Determining the Peak Spatial-Averaged Specific Absorption Rate (SAR) in the Human Head from Wireless Communications Devices: Measurement Techniques", December 2003
- b) IEC 62209-1, "Procedure to measure the Specific Absorption Rate (SAR) for hand-held devices used in close proximity to the ear (frequency range of 300 MHz to 3 GHz)", February 2005
- c) Federal Communications Commission Office of Engineering & Technology (FCC OET), "Evaluating Compliance with FCC Guidelines for Human Exposure to Radiofrequency Electromagnetic Fields; Additional Information for Evaluating Compliance of Mobile and Portable Devices with FCC Limits for Human Exposure to Radiofrequency Emissions", Supplement C (Edition 01-01) to Bulletin 65

Additional Documentation:

- d) DASY4/5 System Handbook

Methods Applied and Interpretation of Parameters:

- *Measurement Conditions:* Further details are available from the Validation Report at the end of the certificate. All figures stated in the certificate are valid at the frequency indicated.
- *Antenna Parameters with TSL:* The dipole is mounted with the spacer to position its feed point exactly below the center marking of the flat phantom section, with the arms oriented parallel to the body axis.
- *Feed Point Impedance and Return Loss:* These parameters are measured with the dipole positioned under the liquid filled phantom. The impedance stated is transformed from the measurement at the SMA connector to the feed point. The Return Loss ensures low reflected power. No uncertainty required.
- *Electrical Delay:* One-way delay between the SMA connector and the antenna feed point. No uncertainty required.
- *SAR measured:* SAR measured at the stated antenna input power.
- *SAR normalized:* SAR as measured, normalized to an input power of 1 W at the antenna connector.
- *SAR for nominal TSL parameters:* The measured TSL parameters are used to calculate the nominal SAR result.

The reported uncertainty of measurement is stated as the standard uncertainty of measurement multiplied by the coverage factor $k=2$, which for a normal distribution corresponds to a coverage probability of approximately 95%.

Measurement Conditions

DASY system configuration, as far as not given on page 1.

DASY Version	DASY5	V52.8.7
Extrapolation	Advanced Extrapolation	
Phantom	Modular Flat Phantom	
Distance Dipole Center - TSL	15 mm	with Spacer
Zoom Scan Resolution	dx, dy, dz = 5 mm	
Frequency	835 MHz ± 1 MHz	

Head TSL parameters

The following parameters and calculations were applied.

	Temperature	Permittivity	Conductivity
Nominal Head TSL parameters	22.0 °C	41.5	0.90 mho/m
Measured Head TSL parameters	(22.0 ± 0.2) °C	41.8 ± 6 %	0.92 mho/m ± 6 %
Head TSL temperature change during test	< 0.5 °C	----	----

SAR result with Head TSL

SAR averaged over 1 cm ³ (1 g) of Head TSL	Condition	
SAR measured	250 mW input power	2.36 W/kg
SAR for nominal Head TSL parameters	normalized to 1W	9.30 W/kg ± 17.0 % (k=2)

SAR averaged over 10 cm ³ (10 g) of Head TSL	condition	
SAR measured	250 mW input power	1.54 W/kg
SAR for nominal Head TSL parameters	normalized to 1W	6.09 W/kg ± 16.5 % (k=2)

Body TSL parameters

The following parameters and calculations were applied.

	Temperature	Permittivity	Conductivity
Nominal Body TSL parameters	22.0 °C	55.2	0.97 mho/m
Measured Body TSL parameters	(22.0 ± 0.2) °C	54.9 ± 6 %	1.00 mho/m ± 6 %
Body TSL temperature change during test	< 0.5 °C	----	----

SAR result with Body TSL

SAR averaged over 1 cm ³ (1 g) of Body TSL	Condition	
SAR measured	250 mW input power	2.42 W/kg
SAR for nominal Body TSL parameters	normalized to 1W	9.45 W/kg ± 17.0 % (k=2)

SAR averaged over 10 cm ³ (10 g) of Body TSL	condition	
SAR measured	250 mW input power	1.59 W/kg
SAR for nominal Body TSL parameters	normalized to 1W	6.24 W/kg ± 16.5 % (k=2)



Appendix

Antenna Parameters with Head TSL

Impedance, transformed to feed point	50.9 Ω - 4.3 $\mu\Omega$
Return Loss	- 27.2 dB

Antenna Parameters with Body TSL

Impedance, transformed to feed point	46.6 Ω - 6.0 $\mu\Omega$
Return Loss	- 23.0 dB

General Antenna Parameters and Design

Electrical Delay (one direction)	1.392 ns
----------------------------------	----------

After long term use with 100W radiated power, only a slight warming of the dipole near the feedpoint can be measured.

The dipole is made of standard semirigid coaxial cable. The center conductor of the feeding line is directly connected to the second arm of the dipole. The antenna is therefore short-circuited for DC-signals. On some of the dipoles, small end caps are added to the dipole arms in order to improve matching when loaded according to the position as explained in the "Measurement Conditions" paragraph. The SAR data are not affected by this change. The overall dipole length is still according to the Standard.

No excessive force must be applied to the dipole arms, because they might bend or the soldered connections near the feedpoint may be damaged.

Additional EUT Data

Manufactured by	SPEAG
Manufactured on	October 17, 2008

DASY5 Validation Report for Head TSL

Date: 30.07.2013

Test Laboratory: SPEAG, Zurich, Switzerland

DUT: Dipole 835 MHz; Type: D835V2; Serial: D835V2 - SN: 4d082

Communication System: UID 0 - CW ; Frequency: 835 MHz
 Medium parameters used: $f = 835 \text{ MHz}$; $\sigma = 0.92 \text{ S/m}$; $\epsilon_r = 41.8$; $\rho = 1000 \text{ kg/m}^3$
 Phantom section: Flat Section
 Measurement Standard: DASY5 (IEEE/IEC/ANSI C63.19-2007)

DASY52 Configuration:

- Probe: ES3DV3 - SN3205; ConvF(6.05, 6.05, 6.05); Calibrated: 28.12.2012;
- Sensor-Surface: 3mm (Mechanical Surface Detection)
- Electronics: DAE4 Sn601; Calibrated: 25.04.2013
- Phantom: Flat Phantom 4.9L; Type: QD000P49AA; Serial: 1001
- DASY52 52.8.7(1137); SEMCAD X 14.6.10(7164)

Dipole Calibration for Head Tissue/Pin=250 mW, d=15mm/Zoom Scan (7x7x7)/Cube 0:

Measurement grid: $dx=5\text{mm}$, $dy=5\text{mm}$, $dz=5\text{mm}$
 Reference Value = 55.929 V/m; Power Drift = 0.01 dB
 Peak SAR (extrapolated) = 3.52 W/kg
SAR(1 g) = 2.36 W/kg; SAR(10 g) = 1.54 W/kg
 Maximum value of SAR (measured) = 2.73 W/kg

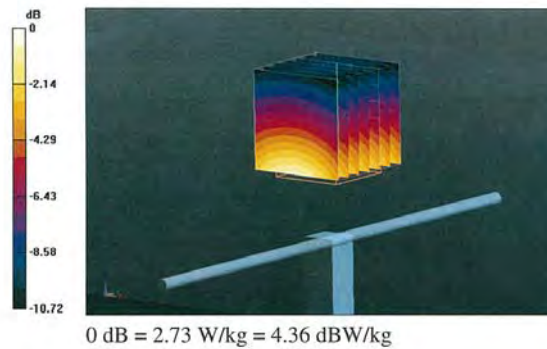

Impedance Measurement Plot for Head TSL

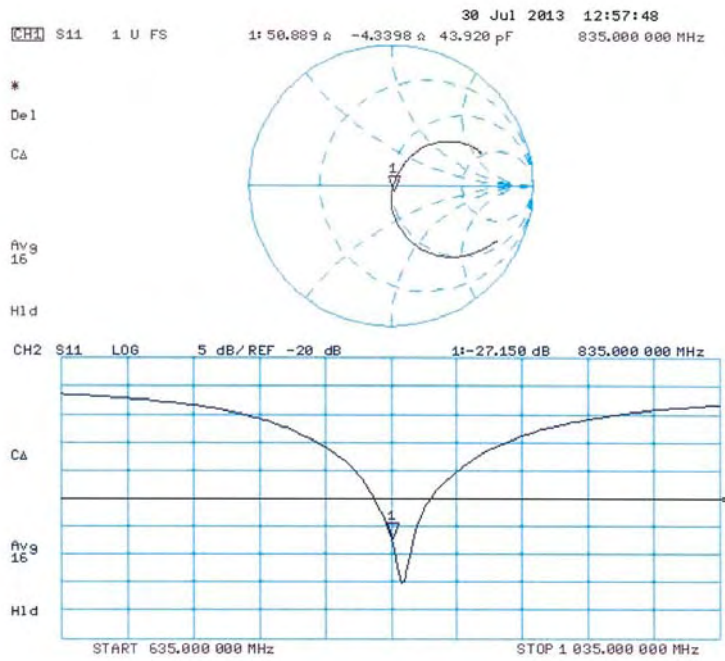

DASY5 Validation Report for Body TSL

Date: 30.07.2013

Test Laboratory: SPEAG, Zurich, Switzerland

DUT: Dipole 835 MHz; Type: D835V2; Serial: D835V2 - SN: 4d082

Communication System: UID 0 - CW ; Frequency: 835 MHz
 Communication System Frame Length in ms: 0
 Medium parameters used: $f = 835 \text{ MHz}$; $\sigma = 1 \text{ S/m}$; $\epsilon_r = 54.9$; $\rho = 1000 \text{ kg/m}^3$
 Phantom section: Flat Section
 Measurement Standard: DASY5 (IEEE/IEC/ANSI C63.19-2007)

DASY52 Configuration:

- Probe: ES3DV3 - SN3205; ConvF(6.04, 6.04, 6.04); Calibrated: 28.12.2012;
- Sensor-Surface: 3mm (Mechanical Surface Detection)
- Electronics: DAE4 Sn601; Calibrated: 25.04.2013
- Phantom: Flat Phantom 4.9L; Type: QD000P49AA; Serial: 1001
- DASY52 52.8.7(1137); SEMCAD X 14.6.10(7164)

Dipole Calibration for Body Tissue/Pin=250 mW, d=15mm/Zoom Scan (7x7x7)/Cube 0:

Measurement grid: dx=5mm, dy=5mm, dz=5mm
 Reference Value = 54.990 V/m; Power Drift = 0.01 dB
 Peak SAR (extrapolated) = 3.52 W/kg
SAR(1 g) = 2.42 W/kg; SAR(10 g) = 1.59 W/kg
 Maximum value of SAR (measured) = 2.82 W/kg

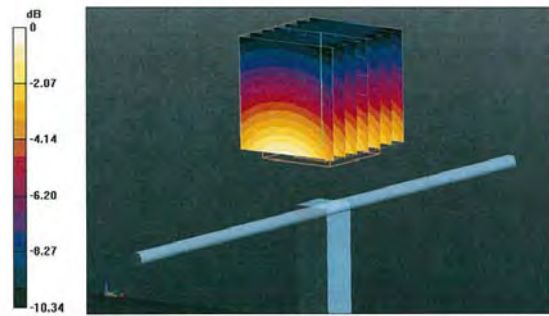

0 dB = 2.82 W/kg = 4.50 dBW/kg

Impedance Measurement Plot for Body TSL

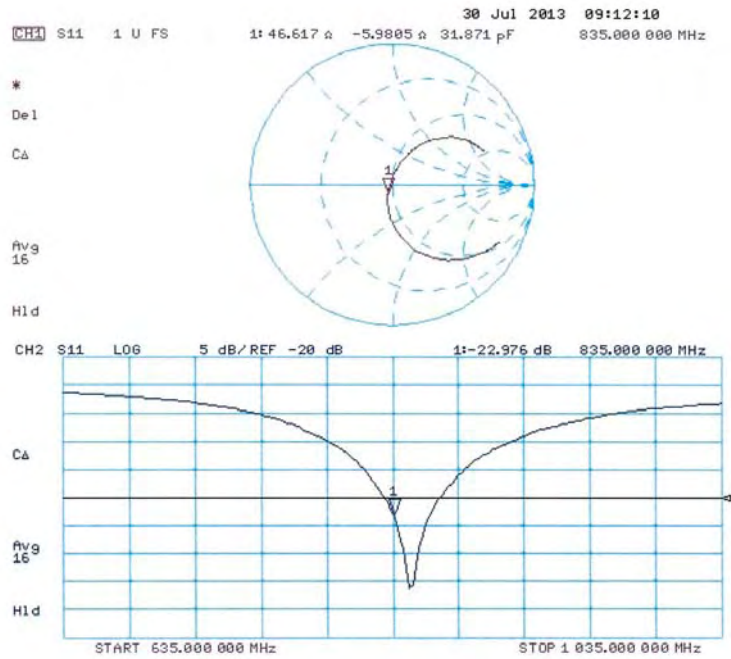

**Calibration Laboratory of
Schmid & Partner
Engineering AG**
Zeughausstrasse 43, 8004 Zurich, Switzerland



S Schweizerischer Kalibrierdienst
S Service suisse d'étalonnage
C Servizio svizzero di taratura
S Swiss Calibration Service

Accredited by the Swiss Accreditation Service (SAS)
The Swiss Accreditation Service is one of the signatories to the EA
Multilateral Agreement for the recognition of calibration certificates

Accreditation No.: **SCS 108**

Client **Auden**

Certificate No: **D1750V2-1023_Jun14**

CALIBRATION CERTIFICATE

Object **D1750V2 - SN: 1023**

Calibration procedure(s) **QA CAL-05.v9
Calibration procedure for dipole validation kits above 700 MHz**

Calibration date: **June 17, 2014**

This calibration certificate documents the traceability to national standards, which realize the physical units of measurements (SI).
The measurements and the uncertainties with confidence probability are given on the following pages and are part of the certificate.

All calibrations have been conducted in the closed laboratory facility: environment temperature (22 ± 3)°C and humidity < 70%.

Calibration Equipment used (M&TE critical for calibration)

Primary Standards	ID #	Cal Date (Certificate No.)	Scheduled Calibration
Power meter EPM-442A	GB37480704	09-Oct-13 (No. 217-01827)	Oct-14
Power sensor HP 8481A	US37292783	09-Oct-13 (No. 217-01827)	Oct-14
Power sensor HP 8481A	MY41092317	09-Oct-13 (No. 217-01828)	Oct-14
Reference 20 dB Attenuator	SN: 5058 (20k)	03-Apr-14 (No. 217-01918)	Apr-15
Type-N mismatch combination	SN: 5047.2 / 06327	03-Apr-14 (No. 217-01921)	Apr-15
Reference Probe ES3DV3	SN: 3205	30-Dec-13 (No. ES3-3205_Dec13)	Dec-14
DAE4	SN: 601	30-Apr-14 (No. DAE4-601_Apr14)	Apr-15
Secondary Standards	ID #	Check Date (in house)	Scheduled Check
RF generator R&S SMT-06	100005	04-Aug-99 (in house check Oct-13)	In house check: Oct-16
Network Analyzer HP 8753E	US37390585 S4206	18-Oct-01 (in house check Oct-13)	In house check: Oct-14

Calibrated by:	Name Leif Klysner	Function Laboratory Technician	Signature 
Approved by:	Katja Pokovic	Technical Manager	

Issued: June 18, 2014

This calibration certificate shall not be reproduced except in full without written approval of the laboratory.

Certificate No: D1750V2-1023_Jun14

Page 1 of 8

Calibration Laboratory of
Schmid & Partner
Engineering AG
Zeughausstrasse 43, 8004 Zurich, Switzerland



S Schweizerischer Kalibrierdienst
C Service suisse d'étalonnage
S Servizio svizzero di taratura
S Swiss Calibration Service

Accredited by the Swiss Accreditation Service (SAS)
The Swiss Accreditation Service is one of the signatories to the EA
Multilateral Agreement for the recognition of calibration certificates

Accreditation No.: **SCS 108**

Glossary:

TSL	tissue simulating liquid
ConvF	sensitivity in TSL / NORM x,y,z
N/A	not applicable or not measured

Calibration is Performed According to the Following Standards:

- IEEE Std 1528-2013, "IEEE Recommended Practice for Determining the Peak Spatial-Averaged Specific Absorption Rate (SAR) in the Human Head from Wireless Communications Devices: Measurement Techniques", June 2013
- IEC 62209-1, "Procedure to measure the Specific Absorption Rate (SAR) for hand-held devices used in close proximity to the ear (frequency range of 300 MHz to 3 GHz)", February 2005
- KDB 865664, "SAR Measurement Requirements for 100 MHz to 6 GHz"

Additional Documentation:

- DASY4/5 System Handbook

Methods Applied and Interpretation of Parameters:

- Measurement Conditions:** Further details are available from the Validation Report at the end of the certificate. All figures stated in the certificate are valid at the frequency indicated.
- Antenna Parameters with TSL:** The dipole is mounted with the spacer to position its feed point exactly below the center marking of the flat phantom section, with the arms oriented parallel to the body axis.
- Feed Point Impedance and Return Loss:** These parameters are measured with the dipole positioned under the liquid filled phantom. The impedance stated is transformed from the measurement at the SMA connector to the feed point. The Return Loss ensures low reflected power. No uncertainty required.
- Electrical Delay:** One-way delay between the SMA connector and the antenna feed point. No uncertainty required.
- SAR measured:** SAR measured at the stated antenna input power.
- SAR normalized:** SAR as measured, normalized to an input power of 1 W at the antenna connector.
- SAR for nominal TSL parameters:** The measured TSL parameters are used to calculate the nominal SAR result.

The reported uncertainty of measurement is stated as the standard uncertainty of measurement multiplied by the coverage factor $k=2$, which for a normal distribution corresponds to a coverage probability of approximately 95%.



Measurement Conditions

DASY system configuration, as far as not given on page 1.

DASY Version	DASY5	V52.8.8
Extrapolation	Advanced Extrapolation	
Phantom	Modular Flat Phantom	
Distance Dipole Center - TSL	10 mm	with Spacer
Zoom Scan Resolution	dx, dy, dz = 5 mm	
Frequency	1750 MHz \pm 1 MHz	

Head TSL parameters

The following parameters and calculations were applied.

	Temperature	Permittivity	Conductivity
Nominal Head TSL parameters	22.0 °C	40.1	1.37 mho/m
Measured Head TSL parameters	(22.0 \pm 0.2) °C	39.3 \pm 6 %	1.37 mho/m \pm 6 %
Head TSL temperature change during test	< 0.5 °C	----	----

SAR result with Head TSL

SAR averaged over 1 cm ³ (1 g) of Head TSL	Condition	
SAR measured	250 mW input power	9.21 W/kg
SAR for nominal Head TSL parameters	normalized to 1W	36.7 W/kg \pm 17.0 % (k=2)

SAR averaged over 10 cm ³ (10 g) of Head TSL	condition	
SAR measured	250 mW input power	4.88 W/kg
SAR for nominal Head TSL parameters	normalized to 1W	19.5 W/kg \pm 16.5 % (k=2)

Body TSL parameters

The following parameters and calculations were applied.

	Temperature	Permittivity	Conductivity
Nominal Body TSL parameters	22.0 °C	53.4	1.49 mho/m
Measured Body TSL parameters	(22.0 \pm 0.2) °C	52.0 \pm 6 %	1.49 mho/m \pm 6 %
Body TSL temperature change during test	< 0.5 °C	----	----

SAR result with Body TSL

SAR averaged over 1 cm ³ (1 g) of Body TSL	Condition	
SAR measured	250 mW input power	9.54 W/kg
SAR for nominal Body TSL parameters	normalized to 1W	37.9 W/kg \pm 17.0 % (k=2)

SAR averaged over 10 cm ³ (10 g) of Body TSL	condition	
SAR measured	250 mW input power	5.12 W/kg
SAR for nominal Body TSL parameters	normalized to 1W	20.4 W/kg \pm 16.5 % (k=2)



Appendix (Additional assessments outside the scope of SCS108)

Antenna Parameters with Head TSL

Impedance, transformed to feed point	51.2 Ω - 0.4 j Ω
Return Loss	- 38.0 dB

Antenna Parameters with Body TSL

Impedance, transformed to feed point	46.4 Ω + 0.4 j Ω
Return Loss	- 28.4 dB

General Antenna Parameters and Design

Electrical Delay (one direction)	1.217 ns
----------------------------------	----------

After long term use with 100W radiated power, only a slight warming of the dipole near the feedpoint can be measured.

The dipole is made of standard semirigid coaxial cable. The center conductor of the feeding line is directly connected to the second arm of the dipole. The antenna is therefore short-circuited for DC-signals. On some of the dipoles, small end caps are added to the dipole arms in order to improve matching when loaded according to the position as explained in the "Measurement Conditions" paragraph. The SAR data are not affected by this change. The overall dipole length is still according to the Standard.

No excessive force must be applied to the dipole arms, because they might bend or the soldered connections near the feedpoint may be damaged.

Additional EUT Data

Manufactured by	SPEAG
Manufactured on	August 20, 2009

DASY5 Validation Report for Head TSL

Date: 17.06.2014

Test Laboratory: SPEAG, Zurich, Switzerland

DUT: Dipole 1750 MHz; Type: D1750V2; Serial: D1750V2 - SN: 1023

Communication System: UID 0 - CW; Frequency: 1750 MHz
 Medium parameters used: $f = 1750 \text{ MHz}$; $\sigma = 1.37 \text{ S/m}$; $\epsilon_r = 39.3$; $\rho = 1000 \text{ kg/m}^3$
 Phantom section: Flat Section
 Measurement Standard: DASY5 (IEEE/IEC/ANSI C63.19-2011)

DASY52 Configuration:

- Probe: ES3DV3 - SN3205; ConvF(5.23, 5.23, 5.23); Calibrated: 30.12.2013;
- Sensor-Surface: 3mm (Mechanical Surface Detection)
- Electronics: DAE4 Sn601; Calibrated: 30.04.2014
- Phantom: Flat Phantom 5.0 (front); Type: QD000P50AA; Serial: 1001
- DASY52 52.8.8(1222); SEMCAD X 14.6.10(7331)

Dipole Calibration for Head Tissue/Pin=250 mW, d=10mm/Zoom Scan (7x7x7)/Cube 0:

Measurement grid: $dx=5\text{mm}$, $dy=5\text{mm}$, $dz=5\text{mm}$
 Reference Value = 94.67 V/m; Power Drift = 0.01 dB
 Peak SAR (extrapolated) = 16.6 W/kg
SAR(1 g) = 9.21 W/kg; SAR(10 g) = 4.88 W/kg
 Maximum value of SAR (measured) = 11.5 W/kg

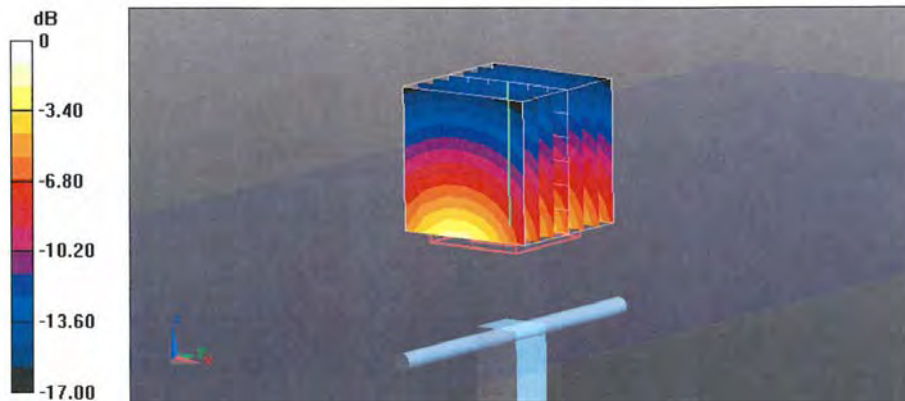

0 dB = 11.5 W/kg = 10.61 dBW/kg



Impedance Measurement Plot for Head TSL

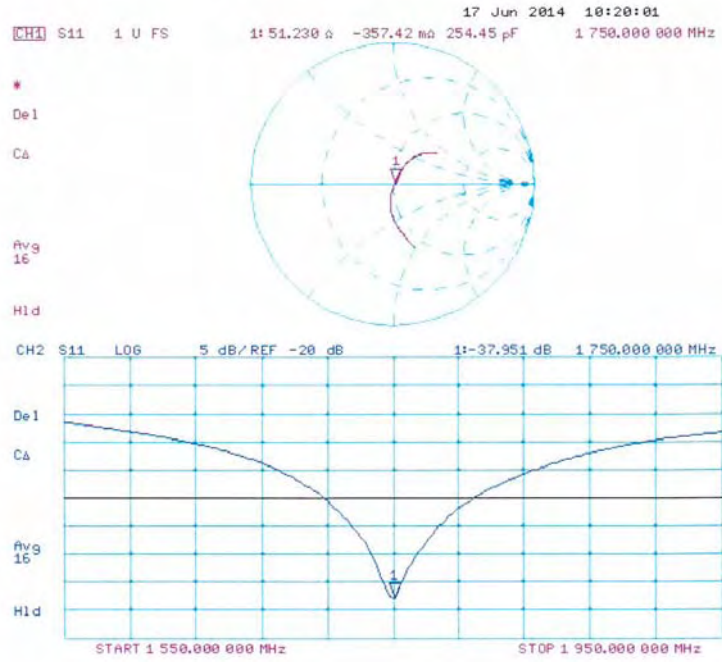

DASY5 Validation Report for Body TSL

Date: 17.06.2014

Test Laboratory: SPEAG, Zurich, Switzerland

DUT: Dipole 1750 MHz; Type: D1750V2; Serial: D1750V2 - SN: 1023

Communication System: UID 0 - CW; Frequency: 1750 MHz
 Medium parameters used: $f = 1750$ MHz; $\sigma = 1.49$ S/m; $\epsilon_r = 52$; $\rho = 1000$ kg/m³
 Phantom section: Flat Section
 Measurement Standard: DASY5 (IEEE/IEC/ANSI C63.19-2011)

DASY52 Configuration:

- Probe: ES3DV3 - SN3205; ConvF(4.89, 4.89, 4.89); Calibrated: 30.12.2013;
- Sensor-Surface: 3mm (Mechanical Surface Detection)
- Electronics: DAE4 Sn601; Calibrated: 30.04.2014
- Phantom: Flat Phantom 5.0 (back); Type: QD000P50AA; Serial: 1002
- DASY52 52.8.8(1222); SEMCAD X 14.6.10(7331)

Dipole Calibration for Body Tissue/Pin=250 mW, d=10mm/Zoom Scan (7x7x7)/Cube 0:

Measurement grid: dx=5mm, dy=5mm, dz=5mm
 Reference Value = 93.68 V/m; Power Drift = 0.01 dB
 Peak SAR (extrapolated) = 16.4 W/kg
SAR(1 g) = 9.54 W/kg; SAR(10 g) = 5.12 W/kg
 Maximum value of SAR (measured) = 12.0 W/kg

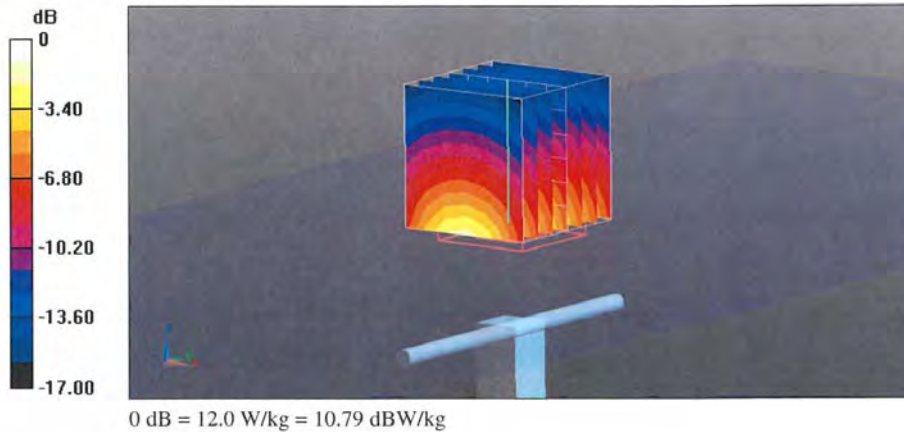



Impedance Measurement Plot for Body TSL

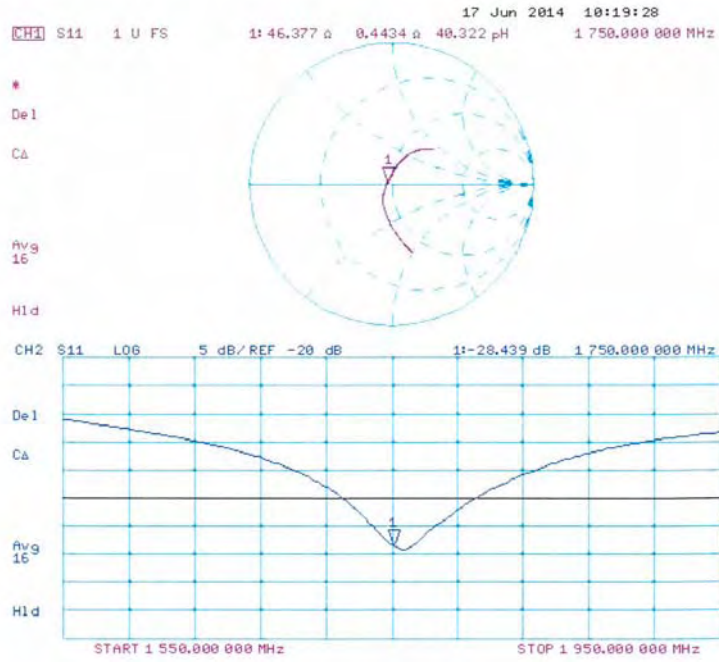



Calibration Laboratory of
 Schmid & Partner
 Engineering AG
 Zeughausstrasse 43, 8004 Zurich, Switzerland



S Schweizerischer Kalibrierdienst
C Service suisse d'étalonnage
S Servizio svizzero di taratura
S Swiss Calibration Service

Accredited by the Swiss Accreditation Service (SAS)
 The Swiss Accreditation Service is one of the signatories to the EA
 Multilateral Agreement for the recognition of calibration certificates

Accreditation No.: **SCS 108**

Client **ATL (Auden)**

Certificate No: **D1900V2-5d111_Jul13**

CALIBRATION CERTIFICATE

Object: **D1900V2 - SN: 5d111**

Calibration procedure(s): **QA CAL-05.v9**
 Calibration procedure for dipole validation kits above 700 MHz

Calibration date: **July 29, 2013**

This calibration certificate documents the traceability to national standards, which realize the physical units of measurements (SI).
 The measurements and the uncertainties with confidence probability are given on the following pages and are part of the certificate.

All calibrations have been conducted in the closed laboratory facility: environment temperature (22 ± 3)°C and humidity < 70%.

Calibration Equipment used (M&TE critical for calibration)

Primary Standards	ID #	Cal Date (Certificate No.)	Scheduled Calibration
Power meter EPM-442A	GB37480704	01-Nov-12 (No. 217-01640)	Oct-13
Power sensor HP 8481A	US37292783	01-Nov-12 (No. 217-01640)	Oct-13
Reference 20 dB Attenuator	SN: 5058 (20k)	04-Apr-13 (No. 217-01736)	Apr-14
Type-N mismatch combination	SN: 5047.3 / 06327	04-Apr-13 (No. 217-01739)	Apr-14
Reference Probe ES3DV3	SN: 3205	28-Dec-12 (No. ES3-3205_Dec12)	Dec-13
DAE4	SN: 601	25-Apr-13 (No. DAE4-601_Apr13)	Apr-14
Secondary Standards	ID #	Check Date (in house)	Scheduled Check
Power sensor HP 8481A	MY41092317	18-Oct-02 (in house check Oct-11)	In house check: Oct-13
RF generator R&S SMT-06	100005	04-Aug-99 (in house check Oct-11)	In house check: Oct-13
Network Analyzer HP 8753E	US37390585 S4206	18-Oct-01 (in house check Oct-12)	In house check: Oct-13

	Name	Function	Signature
Calibrated by:	Israe El-Naouq	Laboratory Technician	
Approved by:	Katja Pokovic	Technical Manager	

Issued: July 30, 2013

This calibration certificate shall not be reproduced except in full without written approval of the laboratory.

Calibration Laboratory of
Schmid & Partner
Engineering AG
Zeughausstrasse 43, 8004 Zurich, Switzerland



S Schweizerischer Kalibrierdienst
C Service suisse d'étalonnage
S Servizio svizzero di taratura
S Swiss Calibration Service

Accredited by the Swiss Accreditation Service (SAS)
The Swiss Accreditation Service is one of the signatories to the EA
Multilateral Agreement for the recognition of calibration certificates

Accreditation No.: **SCS 108**

Glossary:

TSL	tissue simulating liquid
ConvF	sensitivity in TSL / NORM x,y,z
N/A	not applicable or not measured

Calibration is Performed According to the Following Standards:

- IEEE Std 1528-2003, "IEEE Recommended Practice for Determining the Peak Spatial-Averaged Specific Absorption Rate (SAR) in the Human Head from Wireless Communications Devices: Measurement Techniques", December 2003
- IEC 62209-1, "Procedure to measure the Specific Absorption Rate (SAR) for hand-held devices used in close proximity to the ear (frequency range of 300 MHz to 3 GHz)", February 2005
- Federal Communications Commission Office of Engineering & Technology (FCC OET), "Evaluating Compliance with FCC Guidelines for Human Exposure to Radiofrequency Electromagnetic Fields; Additional Information for Evaluating Compliance of Mobile and Portable Devices with FCC Limits for Human Exposure to Radiofrequency Emissions", Supplement C (Edition 01-01) to Bulletin 65

Additional Documentation:

- DASY4/5 System Handbook

Methods Applied and Interpretation of Parameters:

- Measurement Conditions:** Further details are available from the Validation Report at the end of the certificate. All figures stated in the certificate are valid at the frequency indicated.
- Antenna Parameters with TSL:** The dipole is mounted with the spacer to position its feed point exactly below the center marking of the flat phantom section, with the arms oriented parallel to the body axis.
- Feed Point Impedance and Return Loss:** These parameters are measured with the dipole positioned under the liquid filled phantom. The impedance stated is transformed from the measurement at the SMA connector to the feed point. The Return Loss ensures low reflected power. No uncertainty required.
- Electrical Delay:** One-way delay between the SMA connector and the antenna feed point. No uncertainty required.
- SAR measured:** SAR measured at the stated antenna input power.
- SAR normalized:** SAR as measured, normalized to an input power of 1 W at the antenna connector.
- SAR for nominal TSL parameters:** The measured TSL parameters are used to calculate the nominal SAR result.

The reported uncertainty of measurement is stated as the standard uncertainty of measurement multiplied by the coverage factor $k=2$, which for a normal distribution corresponds to a coverage probability of approximately 95%.



Measurement Conditions

DASY system configuration, as far as not given on page 1.

DASY Version	DASY5	V52.8.7
Extrapolation	Advanced Extrapolation	
Phantom	Modular Flat Phantom	
Distance Dipole Center - TSL	10 mm	with Spacer
Zoom Scan Resolution	dx, dy, dz = 5 mm	
Frequency	1900 MHz ± 1 MHz	

Head TSL parameters

The following parameters and calculations were applied.

	Temperature	Permittivity	Conductivity
Nominal Head TSL parameters	22.0 °C	40.0	1.40 mho/m
Measured Head TSL parameters	(22.0 ± 0.2) °C	38.9 ± 6 %	1.36 mho/m ± 6 %
Head TSL temperature change during test	< 0.5 °C	----	----

SAR result with Head TSL

SAR averaged over 1 cm ³ (1 g) of Head TSL	Condition	
SAR measured	250 mW input power	9.97 W/kg
SAR for nominal Head TSL parameters	normalized to 1W	40.3 W/kg ± 17.0 % (k=2)

SAR averaged over 10 cm ³ (10 g) of Head TSL	condition	
SAR measured	250 mW input power	5.23 W/kg
SAR for nominal Head TSL parameters	normalized to 1W	21.1 W/kg ± 16.5 % (k=2)

Body TSL parameters

The following parameters and calculations were applied.

	Temperature	Permittivity	Conductivity
Nominal Body TSL parameters	22.0 °C	53.3	1.52 mho/m
Measured Body TSL parameters	(22.0 ± 0.2) °C	53.4 ± 6 %	1.49 mho/m ± 6 %
Body TSL temperature change during test	< 0.5 °C	----	----

SAR result with Body TSL

SAR averaged over 1 cm ³ (1 g) of Body TSL	Condition	
SAR measured	250 mW input power	9.98 W/kg
SAR for nominal Body TSL parameters	normalized to 1W	40.4 W/kg ± 17.0 % (k=2)

SAR averaged over 10 cm ³ (10 g) of Body TSL	condition	
SAR measured	250 mW input power	5.32 W/kg
SAR for nominal Body TSL parameters	normalized to 1W	21.4 W/kg ± 16.5 % (k=2)



Appendix

Antenna Parameters with Head TSL

Impedance, transformed to feed point	50.1 Ω + 6.1 j Ω
Return Loss	- 24.4 dB

Antenna Parameters with Body TSL

Impedance, transformed to feed point	45.9 Ω + 6.3 j Ω
Return Loss	- 22.2 dB

General Antenna Parameters and Design

Electrical Delay (one direction)	1.201 ns
----------------------------------	----------

After long term use with 100W radiated power, only a slight warming of the dipole near the feedpoint can be measured.

The dipole is made of standard semirigid coaxial cable. The center conductor of the feeding line is directly connected to the second arm of the dipole. The antenna is therefore short-circuited for DC-signals. On some of the dipoles, small end caps are added to the dipole arms in order to improve matching when loaded according to the position as explained in the "Measurement Conditions" paragraph. The SAR data are not affected by this change. The overall dipole length is still according to the Standard.

No excessive force must be applied to the dipole arms, because they might bend or the soldered connections near the feedpoint may be damaged.

Additional EUT Data

Manufactured by	SPEAG
Manufactured on	March 28, 2008

DASY5 Validation Report for Head TSL

Date: 29.07.2013

Test Laboratory: SPEAG, Zurich, Switzerland

DUT: Dipole 1900 MHz; Type: D1900V2; Serial: D1900V2 - SN: 5d111

Communication System: UID 0 - CW; Frequency: 1900 MHz
 Medium parameters used: $f = 1900 \text{ MHz}$; $\sigma = 1.36 \text{ S/m}$; $\epsilon_r = 38.9$; $\rho = 1000 \text{ kg/m}^3$
 Phantom section: Flat Section
 Measurement Standard: DASY5 (IEEE/IEC/ANSI C63.19-2007)

DASY52 Configuration:

- Probe: ES3DV3 - SN3205; ConvF(4.98, 4.98, 4.98); Calibrated: 28.12.2012;
- Sensor-Surface: 3mm (Mechanical Surface Detection)
- Electronics: DAE4 Sn601; Calibrated: 25.04.2013
- Phantom: Flat Phantom 5.0 (front); Type: QD000P50AA; Serial: 1001
- DASY52 52.8.7(1137); SEMCAD X 14.6.10(7164)

Dipole Calibration for Head Tissue/Pin=250 mW, d=10mm/Zoom Scan (7x7x7)/Cube 0:

Measurement grid: $dx=5\text{mm}$, $dy=5\text{mm}$, $dz=5\text{mm}$
 Reference Value = 96.045 V/m; Power Drift = 0.04 dB
 Peak SAR (extrapolated) = 18.1 W/kg
SAR(1 g) = 9.97 W/kg; SAR(10 g) = 5.23 W/kg
 Maximum value of SAR (measured) = 12.4 W/kg



0 dB = 12.4 W/kg = 10.93 dBW/kg

Impedance Measurement Plot for Head TSL

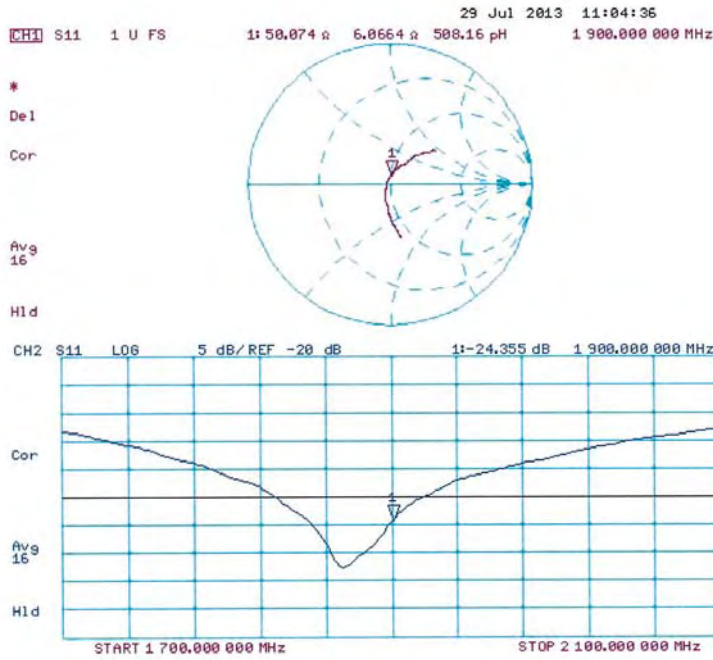

DASY5 Validation Report for Body TSL

Date: 29.07.2013

Test Laboratory: SPEAG, Zurich, Switzerland

DUT: Dipole 1900 MHz; Type: D1900V2; Serial: D1900V2 - SN: 5d111

Communication System: UID 0 - CW; Frequency: 1900 MHz
 Medium parameters used: $f = 1900$ MHz; $\sigma = 1.49$ S/m; $\epsilon_r = 53.4$; $\rho = 1000$ kg/m³
 Phantom section: Flat Section
 Measurement Standard: DASY5 (IEEE/IEC/ANSI C63.19-2007)

DASY52 Configuration:

- Probe: ES3DV3 - SN3205; ConvF(4.6, 4.6, 4.6); Calibrated: 28.12.2012;
- Sensor-Surface: 3mm (Mechanical Surface Detection)
- Electronics: DAE4 Sn601; Calibrated: 25.04.2013
- Phantom: Flat Phantom 5.0 (back); Type: QD000P50AA; Serial: 1002
- DASY52 52.8.7(1137); SEMCAD X 14.6.10(7164)

Dipole Calibration for Body Tissue/Pin=250 mW, d=10mm/Zoom Scan (7x7x7)/Cube 0:

Measurement grid: dx=5mm, dy=5mm, dz=5mm
 Reference Value = 96.045 V/m; Power Drift = 0.02 dB
 Peak SAR (extrapolated) = 17.1 W/kg
SAR(1 g) = 9.98 W/kg; SAR(10 g) = 5.32 W/kg
 Maximum value of SAR (measured) = 12.6 W/kg

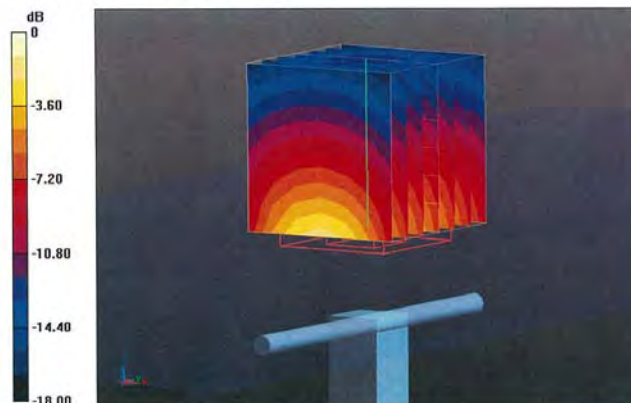

0 dB = 12.6 W/kg = 11.00 dBW/kg

Impedance Measurement Plot for Body TSL

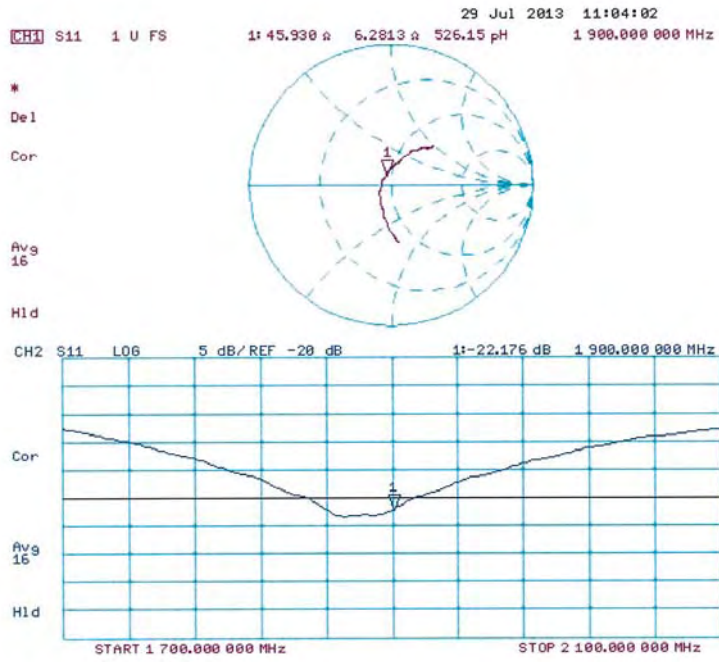



Calibration Laboratory of
Schmid & Partner
Engineering AG
 Zeughausstrasse 43, 8004 Zurich, Switzerland



S Schweizerischer Kalibrierdienst
C Service suisse d'étalonnage
 Servizio svizzero di taratura
S Swiss Calibration Service

Accredited by the Swiss Accreditation Service (SAS)
 The Swiss Accreditation Service is one of the signatories to the EA
 Multilateral Agreement for the recognition of calibration certificates

Accreditation No.: **SCS 108**

Client **ATL (Auden)**

Certificate No.: **D2450V2-712_Mar14**

CALIBRATION CERTIFICATE																																															
Object	D2450V2 - SN: 712																																														
Calibration procedure(s)	QA CAL-05.v9 Calibration procedure for dipole validation kits above 700 MHz																																														
Calibration date:	March 04, 2014																																														
<p>This calibration certificate documents the traceability to national standards, which realize the physical units of measurements (SI). The measurements and the uncertainties with confidence probability are given on the following pages and are part of the certificate.</p> <p>All calibrations have been conducted in the closed laboratory facility: environment temperature (22 ± 3)°C and humidity < 70%.</p> <p>Calibration Equipment used (M&TE critical for calibration)</p> <table border="1"> <thead> <tr> <th>Primary Standards</th> <th>ID #</th> <th>Cal Date (Certificate No.)</th> <th>Scheduled Calibration</th> </tr> </thead> <tbody> <tr> <td>Power meter EPM-442A</td> <td>GB37480704</td> <td>09-Oct-13 (No. 217-01827)</td> <td>Oct-14</td> </tr> <tr> <td>Power sensor HP 8481A</td> <td>US37292783</td> <td>09-Oct-13 (No. 217-01827)</td> <td>Oct-14</td> </tr> <tr> <td>Power sensor HP 8481A</td> <td>MY41092317</td> <td>09-Oct-13 (No. 217-01828)</td> <td>Oct-14</td> </tr> <tr> <td>Reference 20 dB Attenuator</td> <td>SN: 5058 (20k)</td> <td>04-Apr-13 (No. 217-01736)</td> <td>Apr-14</td> </tr> <tr> <td>Type-N mismatch combination</td> <td>SN: 5047.3 / 06327</td> <td>04-Apr-13 (No. 217-01739)</td> <td>Apr-14</td> </tr> <tr> <td>Reference Probe ES3DV3</td> <td>SN: 3205</td> <td>30-Dec-13 (No. ES3-3205_Dec13)</td> <td>Dec-14</td> </tr> <tr> <td>DAE4</td> <td>SN: 601</td> <td>25-Apr-13 (No. DAE4-601_Apr13)</td> <td>Apr-14</td> </tr> </tbody> </table> <table border="1"> <thead> <tr> <th>Secondary Standards</th> <th>ID #</th> <th>Check Date (in house)</th> <th>Scheduled Check</th> </tr> </thead> <tbody> <tr> <td>RF generator R&S SMT-06</td> <td>100005</td> <td>04-Aug-99 (in house check Oct-13)</td> <td>In house check: Oct-16</td> </tr> <tr> <td>Network Analyzer HP 8753E</td> <td>US37390585 S4206</td> <td>18-Oct-01 (in house check Oct-13)</td> <td>In house check: Oct-14</td> </tr> </tbody> </table>				Primary Standards	ID #	Cal Date (Certificate No.)	Scheduled Calibration	Power meter EPM-442A	GB37480704	09-Oct-13 (No. 217-01827)	Oct-14	Power sensor HP 8481A	US37292783	09-Oct-13 (No. 217-01827)	Oct-14	Power sensor HP 8481A	MY41092317	09-Oct-13 (No. 217-01828)	Oct-14	Reference 20 dB Attenuator	SN: 5058 (20k)	04-Apr-13 (No. 217-01736)	Apr-14	Type-N mismatch combination	SN: 5047.3 / 06327	04-Apr-13 (No. 217-01739)	Apr-14	Reference Probe ES3DV3	SN: 3205	30-Dec-13 (No. ES3-3205_Dec13)	Dec-14	DAE4	SN: 601	25-Apr-13 (No. DAE4-601_Apr13)	Apr-14	Secondary Standards	ID #	Check Date (in house)	Scheduled Check	RF generator R&S SMT-06	100005	04-Aug-99 (in house check Oct-13)	In house check: Oct-16	Network Analyzer HP 8753E	US37390585 S4206	18-Oct-01 (in house check Oct-13)	In house check: Oct-14
Primary Standards	ID #	Cal Date (Certificate No.)	Scheduled Calibration																																												
Power meter EPM-442A	GB37480704	09-Oct-13 (No. 217-01827)	Oct-14																																												
Power sensor HP 8481A	US37292783	09-Oct-13 (No. 217-01827)	Oct-14																																												
Power sensor HP 8481A	MY41092317	09-Oct-13 (No. 217-01828)	Oct-14																																												
Reference 20 dB Attenuator	SN: 5058 (20k)	04-Apr-13 (No. 217-01736)	Apr-14																																												
Type-N mismatch combination	SN: 5047.3 / 06327	04-Apr-13 (No. 217-01739)	Apr-14																																												
Reference Probe ES3DV3	SN: 3205	30-Dec-13 (No. ES3-3205_Dec13)	Dec-14																																												
DAE4	SN: 601	25-Apr-13 (No. DAE4-601_Apr13)	Apr-14																																												
Secondary Standards	ID #	Check Date (in house)	Scheduled Check																																												
RF generator R&S SMT-06	100005	04-Aug-99 (in house check Oct-13)	In house check: Oct-16																																												
Network Analyzer HP 8753E	US37390585 S4206	18-Oct-01 (in house check Oct-13)	In house check: Oct-14																																												
Calibrated by:	Name Leif Klysner	Function Laboratory Technician	Signature 																																												
Approved by:	Name Katja Pokovic	Function Technical Manager	Signature 																																												
			Issued: March 4, 2014																																												
This calibration certificate shall not be reproduced except in full without written approval of the laboratory.																																															

Certificate No: D2450V2-712_Mar14

Page 1 of 8

Calibration Laboratory of
Schmid & Partner
Engineering AG
Zeughausstrasse 43, 8004 Zurich, Switzerland



S Schweizerischer Kalibrierdienst
S Service suisse d'étalonnage
C Servizio svizzero di taratura
S Swiss Calibration Service

Accredited by the Swiss Accreditation Service (SAS)
The Swiss Accreditation Service is one of the signatories to the EA
Multilateral Agreement for the recognition of calibration certificates

Accreditation No.: **SCS 108**

Glossary:

TSL tissue simulating liquid
ConvF sensitivity in TSL / NORM x,y,z
N/A not applicable or not measured

Calibration is Performed According to the Following Standards:

- a) IEEE Std 1528-2013, "IEEE Recommended Practice for Determining the Peak Spatial-Averaged Specific Absorption Rate (SAR) in the Human Head from Wireless Communications Devices: Measurement Techniques", June 2013
- b) IEC 62209-1, "Procedure to measure the Specific Absorption Rate (SAR) for hand-held devices used in close proximity to the ear (frequency range of 300 MHz to 3 GHz)", February 2005
- c) KDB 865664, "SAR Measurement Requirements for 100 MHz to 6 GHz"

Additional Documentation:

- d) DASY4/5 System Handbook

Methods Applied and Interpretation of Parameters:

- *Measurement Conditions:* Further details are available from the Validation Report at the end of the certificate. All figures stated in the certificate are valid at the frequency indicated.
- *Antenna Parameters with TSL:* The dipole is mounted with the spacer to position its feed point exactly below the center marking of the flat phantom section, with the arms oriented parallel to the body axis.
- *Feed Point Impedance and Return Loss:* These parameters are measured with the dipole positioned under the liquid filled phantom. The impedance stated is transformed from the measurement at the SMA connector to the feed point. The Return Loss ensures low reflected power. No uncertainty required.
- *Electrical Delay:* One-way delay between the SMA connector and the antenna feed point. No uncertainty required.
- *SAR measured:* SAR measured at the stated antenna input power.
- *SAR normalized:* SAR as measured, normalized to an input power of 1 W at the antenna connector.
- *SAR for nominal TSL parameters:* The measured TSL parameters are used to calculate the nominal SAR result.

The reported uncertainty of measurement is stated as the standard uncertainty of measurement multiplied by the coverage factor $k=2$, which for a normal distribution corresponds to a coverage probability of approximately 95%.



Measurement Conditions

DASY system configuration, as far as not given on page 1.

DASY Version	DASY5	V52.8.7
Extrapolation	Advanced Extrapolation	
Phantom	Modular Flat Phantom	
Distance Dipole Center - TSL	10 mm	with Spacer
Zoom Scan Resolution	dx, dy, dz = 5 mm	
Frequency	2450 MHz \pm 1 MHz	

Head TSL parameters

The following parameters and calculations were applied.

	Temperature	Permittivity	Conductivity
Nominal Head TSL parameters	22.0 °C	39.2	1.80 mho/m
Measured Head TSL parameters	(22.0 \pm 0.2) °C	38.1 \pm 6 %	1.86 mho/m \pm 6 %
Head TSL temperature change during test	< 0.5 °C	----	----

SAR result with Head TSL

SAR averaged over 1 cm ³ (1 g) of Head TSL	Condition	
SAR measured	250 mW input power	13.3 W/kg
SAR for nominal Head TSL parameters	normalized to 1W	52.0 W/kg \pm 17.0 % (k=2)

SAR averaged over 10 cm ³ (10 g) of Head TSL	condition	
SAR measured	250 mW input power	6.16 W/kg
SAR for nominal Head TSL parameters	normalized to 1W	24.3 W/kg \pm 16.5 % (k=2)

Body TSL parameters

The following parameters and calculations were applied.

	Temperature	Permittivity	Conductivity
Nominal Body TSL parameters	22.0 °C	52.7	1.95 mho/m
Measured Body TSL parameters	(22.0 \pm 0.2) °C	50.7 \pm 6 %	2.02 mho/m \pm 6 %
Body TSL temperature change during test	< 0.5 °C	----	----

SAR result with Body TSL

SAR averaged over 1 cm ³ (1 g) of Body TSL	Condition	
SAR measured	250 mW input power	12.9 W/kg
SAR for nominal Body TSL parameters	normalized to 1W	50.3 W/kg \pm 17.0 % (k=2)

SAR averaged over 10 cm ³ (10 g) of Body TSL	condition	
SAR measured	250 mW input power	5.96 W/kg
SAR for nominal Body TSL parameters	normalized to 1W	23.5 W/kg \pm 16.5 % (k=2)



Appendix

Antenna Parameters with Head TSL

Impedance, transformed to feed point	54.7 Ω + 3.2 $j\Omega$
Return Loss	- 25.4 dB

Antenna Parameters with Body TSL

Impedance, transformed to feed point	51.3 Ω + 5.0 $j\Omega$
Return Loss	- 25.9 dB

General Antenna Parameters and Design

Electrical Delay (one direction)	1.150 ns
----------------------------------	----------

After long term use with 100W radiated power, only a slight warming of the dipole near the feedpoint can be measured.

The dipole is made of standard semirigid coaxial cable. The center conductor of the feeding line is directly connected to the second arm of the dipole. The antenna is therefore short-circuited for DC-signals. On some of the dipoles, small end caps are added to the dipole arms in order to improve matching when loaded according to the position as explained in the "Measurement Conditions" paragraph. The SAR data are not affected by this change. The overall dipole length is still according to the Standard.

No excessive force must be applied to the dipole arms, because they might bend or the soldered connections near the feedpoint may be damaged.

Additional EUT Data

Manufactured by	SPEAG
Manufactured on	July 05, 2002

DASY5 Validation Report for Head TSL

Date: 04.03.2014

Test Laboratory: SPEAG, Zurich, Switzerland

DUT: Dipole 2450 MHz; Type: D2450V2; Serial: D2450V2 - SN: 712

Communication System: UID 0 - CW; Frequency: 2450 MHz
 Medium parameters used: $f = 2450$ MHz; $\sigma = 1.86$ S/m; $\epsilon_r = 38.1$; $\rho = 1000$ kg/m³
 Phantom section: Flat Section
 Measurement Standard: DASY5 (IEEE/IEC/ANSI C63.19-2007)

DASY52 Configuration:

- Probe: ES3DV3 - SN3205; ConvF(4.53, 4.53, 4.53); Calibrated: 30.12.2013;
- Sensor-Surface: 3mm (Mechanical Surface Detection)
- Electronics: DAE4 Sn601; Calibrated: 25.04.2013
- Phantom: Flat Phantom 5.0 (front); Type: QD000P50AA; Serial: 1001
- DASY52 52.8.7(1137); SEMCAD X 14.6.10(7164)

Dipole Calibration for Head Tissue/Pin=250 mW, d=10mm/Zoom Scan (7x7x7)/Cube 0:

Measurement grid: dx=5mm, dy=5mm, dz=5mm
 Reference Value = 99.26 V/m; Power Drift = 0.05 dB
 Peak SAR (extrapolated) = 27.5 W/kg
SAR(1 g) = 13.3 W/kg; SAR(10 g) = 6.16 W/kg
 Maximum value of SAR (measured) = 17.0 W/kg

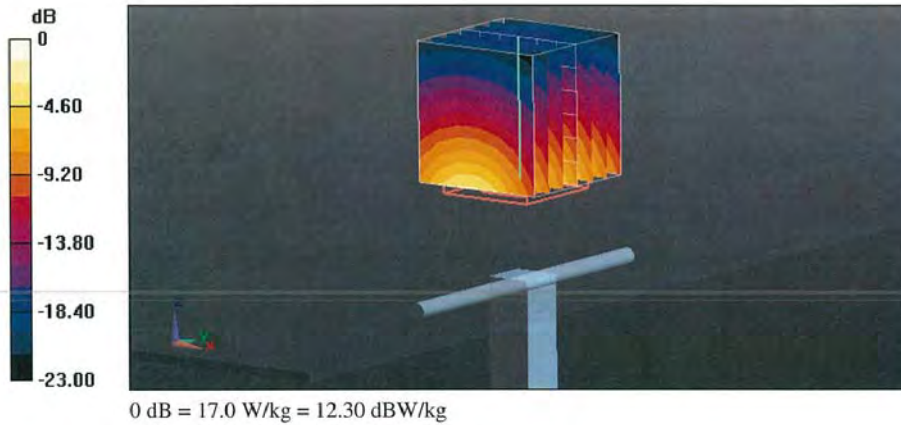



Impedance Measurement Plot for Head TSL

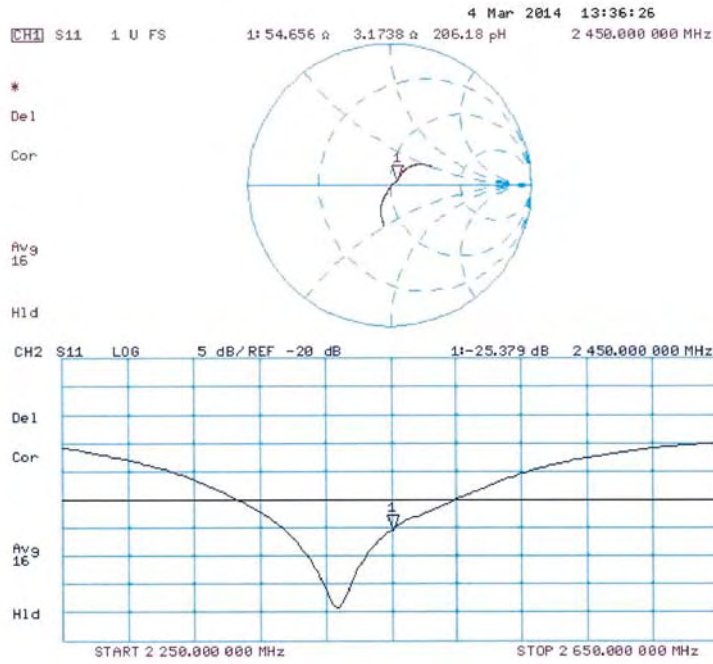

DASY5 Validation Report for Body TSL

Date: 04.03.2014

Test Laboratory: SPEAG, Zurich, Switzerland

DUT: Dipole 2450 MHz; Type: D2450V2; Serial: D2450V2 - SN: 712

Communication System: UID 0 - CW; Frequency: 2450 MHz

Medium parameters used: $f = 2450$ MHz; $\sigma = 2.02$ S/m; $\epsilon_r = 50.7$; $\rho = 1000$ kg/m³

Phantom section: Flat Section

Measurement Standard: DASY5 (IEEE/IEC/ANSI C63.19-2007)

DASY52 Configuration:

- Probe: ES3DV3 - SN3205; ConvF(4.35, 4.35, 4.35); Calibrated: 30.12.2013;
- Sensor-Surface: 3mm (Mechanical Surface Detection)
- Electronics: DAE4 Sn601; Calibrated: 25.04.2013
- Phantom: Flat Phantom 5.0 (back); Type: QD000P50AA; Serial: 1002
- DASY52 52.8.7(1137); SEMCAD X 14.6.10(7164)

Dipole Calibration for Body Tissue/Pin=250 mW, d=10mm/Zoom Scan (7x7x7)/Cube 0:

Measurement grid: dx=5mm, dy=5mm, dz=5mm

Reference Value = 94.771 V/m; Power Drift = 0.01 dB

Peak SAR (extrapolated) = 27.0 W/kg

SAR(1 g) = 12.9 W/kg; SAR(10 g) = 5.96 W/kg

Maximum value of SAR (measured) = 17.1 W/kg

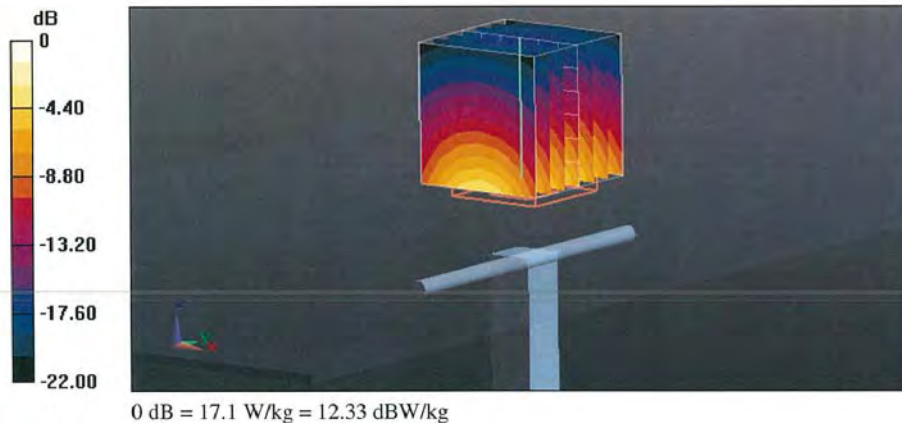



Impedance Measurement Plot for Body TSL

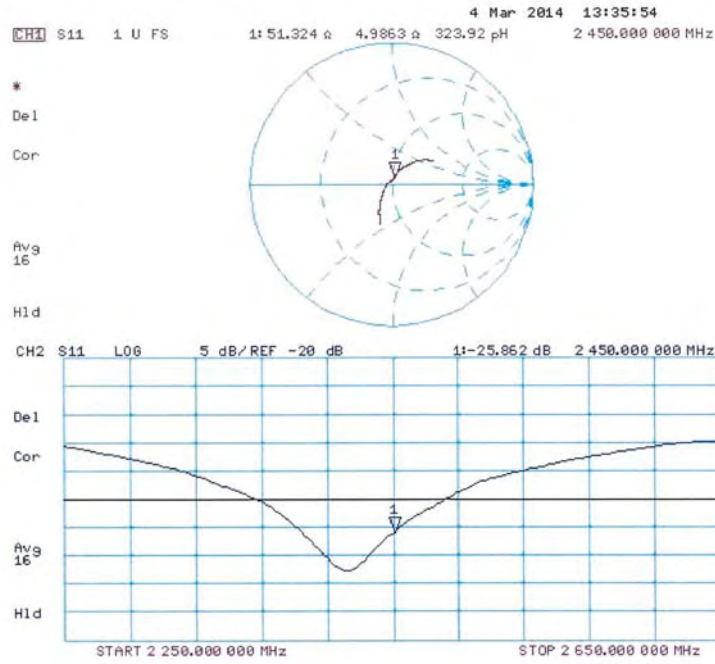

**Calibration Laboratory of
Schmid & Partner
Engineering AG**
Zeughausstrasse 43, 8004 Zurich, Switzerland



S Schweizerischer Kalibrierdienst
C Service suisse d'étalonnage
S Servizio svizzero di taratura
S Swiss Calibration Service

Accredited by the Swiss Accreditation Service (SAS)
The Swiss Accreditation Service is one of the signatories to the EA
Multilateral Agreement for the recognition of calibration certificates

Accreditation No.: **SCS 108**

Client **ATL (Auden)**

Certificate No: **EX3-3977_Feb14**

CALIBRATION CERTIFICATE

Object: **EX3DV4 - SN:3977**

Calibration procedure(s): **QA CAL-01.v9, QA CAL-12.v9, QA CAL-14.v4, QA CAL-23.v5,
QA CAL-25.v6
Calibration procedure for dosimetric E-field probes**



Calibration date: **February 17, 2014**

This calibration certificate documents the traceability to national standards, which realize the physical units of measurements (SI).
The measurements and the uncertainties with confidence probability are given on the following pages and are part of the certificate.

All calibrations have been conducted in the closed laboratory facility: environment temperature (22 ± 3)°C and humidity < 70%.

Calibration Equipment used (M&TE critical for calibration)

Primary Standards	ID	Cal Date (Certificate No.)	Scheduled Calibration
Power meter E4419B	GB41293874	04-Apr-13 (No. 217-01733)	Apr-14
Power sensor E4412A	MY41498087	04-Apr-13 (No. 217-01733)	Apr-14
Reference 3 dB Attenuator	SN: S5054 (3c)	04-Apr-13 (No. 217-01737)	Apr-14
Reference 20 dB Attenuator	SN: S5277 (20x)	04-Apr-13 (No. 217-01735)	Apr-14
Reference 30 dB Attenuator	SN: S5129 (30b)	04-Apr-13 (No. 217-01738)	Apr-14
Reference Probe ES3DV2	SN: 3013	30-Dec-13 (No. ES3-3013_Dec13)	Dec-14
DAE4	SN: 660	13-Dec-13 (No. DAE4-660_Dec13)	Dec-14
Secondary Standards	ID	Check Date (in house)	Scheduled Check
RF generator HP 8648C	US3642U01700	4-Aug-99 (in house check Apr-13)	In house check: Apr-16
Network Analyzer HP 8753E	US37390585	18-Oct-01 (in house check Oct-13)	In house check: Oct-14

	Name	Function	Signature
Calibrated by:	Jeton Kastrati	Laboratory Technician	
Approved by:	Katja Pokovic	Technical Manager	

Issued: February 19, 2014

This calibration certificate shall not be reproduced except in full without written approval of the laboratory.

Calibration Laboratory of
Schmid & Partner
Engineering AG
 Zeughausstrasse 43, 8004 Zurich, Switzerland



S Schweizerischer Kalibrierdienst
C Service suisse d'étalonnage
S Servizio svizzero di taratura
S Swiss Calibration Service

Accredited by the Swiss Accreditation Service (SAS)
 The Swiss Accreditation Service is one of the signatories to the EA
 Multilateral Agreement for the recognition of calibration certificates

Accreditation No.: **SCS 108**

Glossary:

TSL	tissue simulating liquid
NORM _{x,y,z}	sensitivity in free space
ConvF	sensitivity in TSL / NORM _{x,y,z}
DCP	diode compression point
CF	crest factor (1/duty_cycle) of the RF signal
A, B, C, D	modulation dependent linearization parameters
Polarization φ	φ rotation around probe axis
Polarization θ	θ rotation around an axis that is in the plane normal to probe axis (at measurement center), i.e., θ = 0 is normal to probe axis
Connector Angle	information used in DASY system to align probe sensor X to the robot coordinate system

Calibration is Performed According to the Following Standards:

- a) IEEE Std 1528-2013, "IEEE Recommended Practice for Determining the Peak Spatial-Averaged Specific Absorption Rate (SAR) in the Human Head from Wireless Communications Devices: Measurement Techniques", June 2013
- b) IEC 62209-1, "Procedure to measure the Specific Absorption Rate (SAR) for hand-held devices used in close proximity to the ear (frequency range of 300 MHz to 3 GHz)", February 2005

Methods Applied and Interpretation of Parameters:

- *NORM_{x,y,z}*: Assessed for E-field polarization θ = 0 (f ≤ 900 MHz in TEM-cell; f > 1800 MHz: R22 waveguide). *NORM_{x,y,z}* are only intermediate values, i.e., the uncertainties of *NORM_{x,y,z}* does not affect the E²-field uncertainty inside TSL (see below *ConvF*).
- *NORM(f)_{x,y,z}* = *NORM_{x,y,z}* * *frequency_response* (see Frequency Response Chart). This linearization is implemented in DASY4 software versions later than 4.2. The uncertainty of the frequency response is included in the stated uncertainty of *ConvF*.
- *DCP_{x,y,z}*: DCP are numerical linearization parameters assessed based on the data of power sweep with CW signal (no uncertainty required). DCP does not depend on frequency nor media.
- *PAR*: PAR is the Peak to Average Ratio that is not calibrated but determined based on the signal characteristics
- *A_{x,y,z}*; *B_{x,y,z}*; *C_{x,y,z}*; *D_{x,y,z}*; *VR_{x,y,z}*; *A*, *B*, *C*, *D* are numerical linearization parameters assessed based on the data of power sweep for specific modulation signal. The parameters do not depend on frequency nor media. *VR* is the maximum calibration range expressed in RMS voltage across the diode.
- *ConvF and Boundary Effect Parameters*: Assessed in flat phantom using E-field (or Temperature Transfer Standard for f ≤ 800 MHz) and inside waveguide using analytical field distributions based on power measurements for f > 800 MHz. The same setups are used for assessment of the parameters applied for boundary compensation (alpha, depth) of which typical uncertainty values are given. These parameters are used in DASY4 software to improve probe accuracy close to the boundary. The sensitivity in TSL corresponds to *NORM_{x,y,z}* * *ConvF* whereby the uncertainty corresponds to that given for *ConvF*. A frequency dependent *ConvF* is used in DASY version 4.4 and higher which allows extending the validity from ± 50 MHz to ± 100 MHz.
- *Spherical isotropy (3D deviation from isotropy)*: in a field of low gradients realized using a flat phantom exposed by a patch antenna.
- *Sensor Offset*: The sensor offset corresponds to the offset of virtual measurement center from the probe tip (on probe axis). No tolerance required.
- *Connector Angle*: The angle is assessed using the information gained by determining the *NORM_x* (no uncertainty required).



EX3DV4 – SN:3977

February 17, 2014

Probe EX3DV4

SN:3977

Manufactured: November 5, 2013
Calibrated: February 17, 2014

Calibrated for DASY/EASY Systems
(Note: non-compatible with DASY2 system!)



EX3DV4-- SN:3977

February 17, 2014

DASY/EASY - Parameters of Probe: EX3DV4 - SN:3977

Basic Calibration Parameters

	Sensor X	Sensor Y	Sensor Z	Unc (k=2)
Norm ($\mu\text{V}/(\text{V}/\text{m})^2$) ^A	0.54	0.57	0.54	$\pm 10.1 \%$
DCP (mV) ^B	99.5	100.0	99.7	

Modulation Calibration Parameters

UID	Communication System Name		A dB	B dB $\sqrt{\mu\text{V}}$	C	D dB	VR mV	Unc ^E (k=2)
0	CW	X	0.0	0.0	1.0	0.00	133.3	$\pm 3.3 \%$
		Y	0.0	0.0	1.0		134.9	
		Z	0.0	0.0	1.0		146.5	

The reported uncertainty of measurement is stated as the standard uncertainty of measurement multiplied by the coverage factor k=2, which for a normal distribution corresponds to a coverage probability of approximately 95%.

^A The uncertainties of NormX,Y,Z do not affect the E²-field uncertainty inside TSL (see Pages 5 and 6).

^B Numerical linearization parameter: uncertainty not required.

^E Uncertainty is determined using the max. deviation from linear response applying rectangular distribution and is expressed for the square of the field value.



EX3DV4- SN:3977

February 17, 2014

DASY/EASY - Parameters of Probe: EX3DV4 - SN:3977

Calibration Parameter Determined in Head Tissue Simulating Media

f (MHz) ^C	Relative Permittivity ^F	Conductivity (S/m) ^F	ConvF X	ConvF Y	ConvF Z	Alpha ^G	Depth (mm) ^G	Unct. (k=2)
450	43.5	0.87	11.72	11.72	11.72	0.18	1.10	± 13.3 %
750	41.9	0.89	9.98	9.98	9.98	0.36	0.88	± 12.0 %
835	41.5	0.90	9.62	9.62	9.62	0.61	0.69	± 12.0 %
900	41.5	0.97	9.48	9.48	9.48	0.77	0.63	± 12.0 %
1750	40.1	1.37	8.14	8.14	8.14	0.78	0.60	± 12.0 %
1900	40.0	1.40	7.97	7.97	7.97	0.48	0.75	± 12.0 %
2000	40.0	1.40	7.93	7.93	7.93	0.69	0.63	± 12.0 %
2300	39.5	1.67	7.59	7.59	7.59	0.37	0.83	± 12.0 %
2450	39.2	1.80	7.24	7.24	7.24	0.27	1.10	± 12.0 %
2600	39.0	1.96	7.07	7.07	7.07	0.41	0.84	± 12.0 %
5200	36.0	4.66	5.09	5.09	5.09	0.35	1.80	± 13.1 %
5300	35.9	4.76	4.82	4.82	4.82	0.35	1.80	± 13.1 %
5500	35.6	4.96	4.76	4.76	4.76	0.35	1.80	± 13.1 %
5600	35.5	5.07	4.55	4.55	4.55	0.40	1.80	± 13.1 %
5800	35.3	5.27	4.52	4.52	4.52	0.40	1.80	± 13.1 %

^C Frequency validity of ± 100 MHz only applies for DASY v4.4 and higher (see Page 2), else it is restricted to ± 50 MHz. The uncertainty is the RSS of the ConvF uncertainty at calibration frequency and the uncertainty for the indicated frequency band.

^F At frequencies below 3 GHz, the validity of tissue parameters (ϵ and σ) can be relaxed to ± 10% if liquid compensation formula is applied to measured SAR values. At frequencies above 3 GHz, the validity of tissue parameters (ϵ and σ) is restricted to ± 5%. The uncertainty is the RSS of the ConvF uncertainty for indicated target tissue parameters.

^G Alpha/Depth are determined during calibration. SPEAG warrants that the remaining deviation due to the boundary effect after compensation is always less than ± 1% for frequencies below 3 GHz and below ± 2% for frequencies between 3-6 GHz at any distance larger than half the probe tip diameter from the boundary.



EX3DV4- SN:3977

February 17, 2014

DASY/EASY - Parameters of Probe: EX3DV4 - SN:3977

Calibration Parameter Determined in Body Tissue Simulating Media

f (MHz) ^C	Relative Permittivity ^F	Conductivity (S/m) ^F	ConvF X	ConvF Y	ConvF Z	Alpha ^G	Depth (mm) ^G	Unct. (k=2)
450	56.7	0.94	12.47	12.47	12.47	0.11	1.10	± 13.3 %
750	55.5	0.96	9.78	9.78	9.78	0.45	0.86	± 12.0 %
835	55.2	0.97	9.74	9.74	9.74	0.48	0.83	± 12.0 %
900	55.0	1.05	9.46	9.46	9.46	0.41	0.89	± 12.0 %
1750	53.4	1.49	7.69	7.69	7.69	0.41	0.88	± 12.0 %
1900	53.3	1.52	7.37	7.37	7.37	0.34	0.89	± 12.0 %
2000	53.3	1.52	7.41	7.41	7.41	0.24	1.14	± 12.0 %
2300	52.9	1.81	7.12	7.12	7.12	0.66	0.64	± 12.0 %
2450	52.7	1.95	6.97	6.97	6.97	0.80	0.50	± 12.0 %
2600	52.5	2.16	6.68	6.68	6.68	0.80	0.50	± 12.0 %
5200	49.0	5.30	4.50	4.50	4.50	0.45	1.90	± 13.1 %
5300	48.9	5.42	4.28	4.28	4.28	0.45	1.90	± 13.1 %
5500	48.6	5.65	4.02	4.02	4.02	0.45	1.90	± 13.1 %
5600	48.5	5.77	3.87	3.87	3.87	0.45	1.90	± 13.1 %
5800	48.2	6.00	4.12	4.12	4.12	0.50	1.90	± 13.1 %

^C Frequency validity of ± 100 MHz only applies for DASY v4.4 and higher (see Page 2), else it is restricted to ± 50 MHz. The uncertainty is the RSS of the ConvF uncertainty at calibration frequency and the uncertainty for the indicated frequency band.

^F At frequencies below 3 GHz, the validity of tissue parameters (ϵ and σ) can be relaxed to ± 10% if liquid compensation formula is applied to measured SAR values. At frequencies above 3 GHz, the validity of tissue parameters (ϵ and σ) is restricted to ± 5%. The uncertainty is the RSS of the ConvF uncertainty for indicated target tissue parameters.

^G Alpha/Depth are determined during calibration. SPEAG warrants that the remaining deviation due to the boundary effect after compensation is always less than ± 1% for frequencies below 3 GHz and below ± 2% for frequencies between 3-6 GHz at any distance larger than half the probe tip diameter from the boundary.



EX3DV4- SN:3977

February 17, 2014

Frequency Response of E-Field (TEM-Cell:ifi110 EXX, Waveguide: R22)

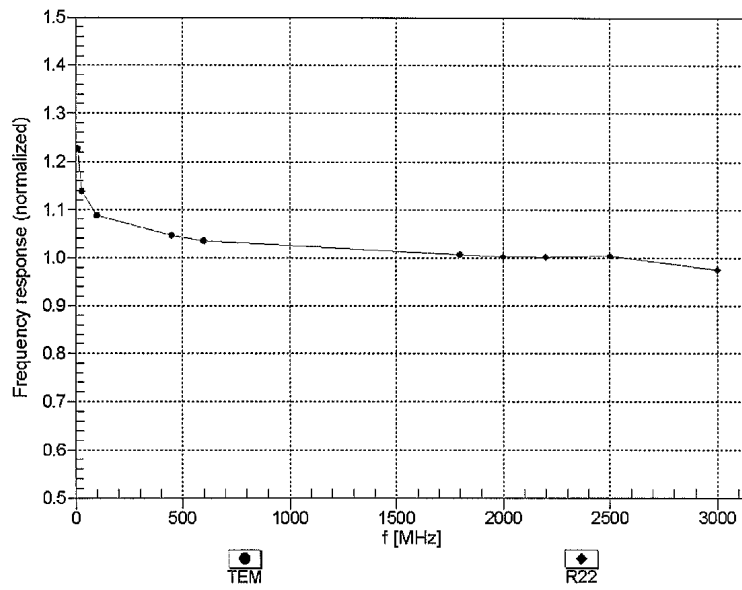

Uncertainty of Frequency Response of E-field: $\pm 6.3\%$ (k=2)

Receiving Pattern (ϕ), $\theta = 0^\circ$

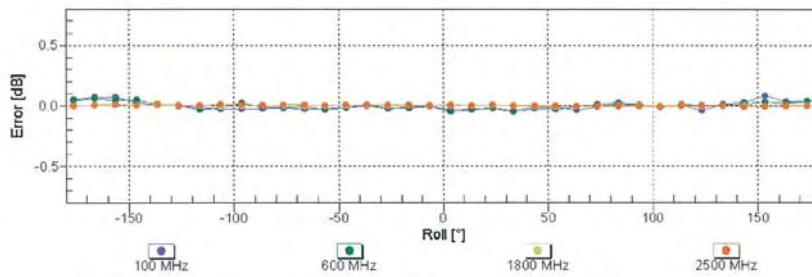
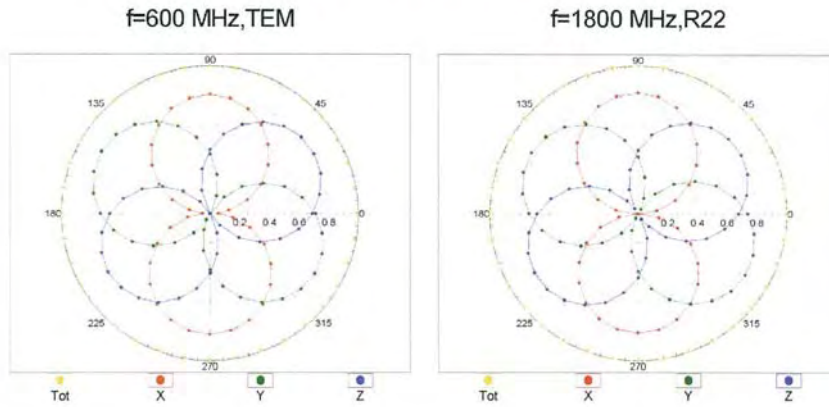

Uncertainty of Axial Isotropy Assessment: $\pm 0.5\%$ ($k=2$)

Dynamic Range f(SAR_{head}) (TEM cell , f_{eval}= 1900 MHz)

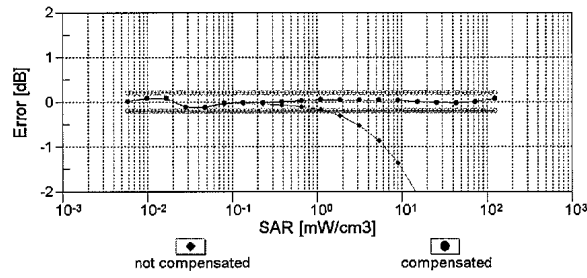
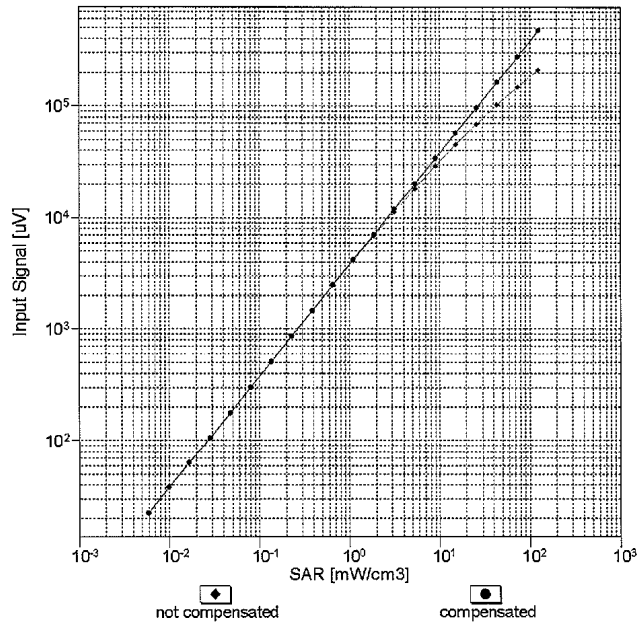

Uncertainty of Linearity Assessment: ± 0.6% (k=2)

Conversion Factor Assessment

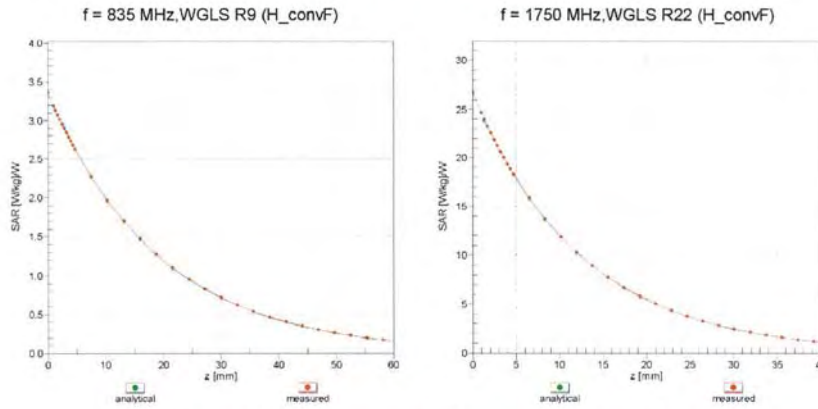

Deviation from Isotropy in Liquid Error (ϕ, θ), f = 900 MHz

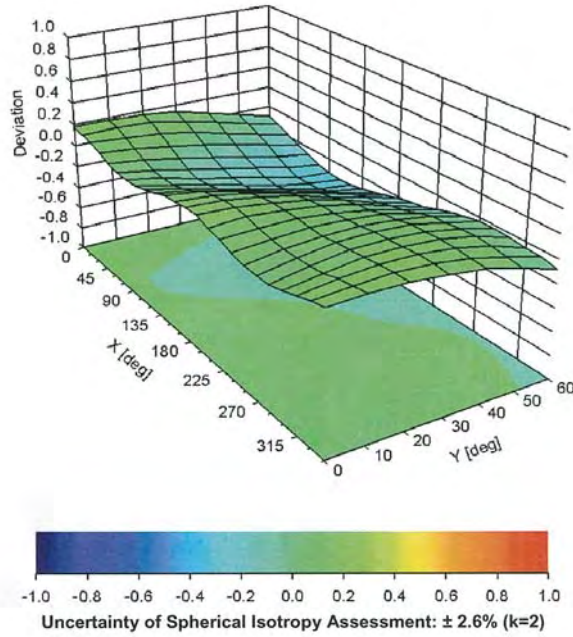



EX3DV4- SN:3977

February 17, 2014

DASY/EASY - Parameters of Probe: EX3DV4 - SN:3977

Other Probe Parameters

Sensor Arrangement	Triangular
Connector Angle (°)	23.6
Mechanical Surface Detection Mode	enabled
Optical Surface Detection Mode	disabled
Probe Overall Length	337 mm
Probe Body Diameter	10 mm
Tip Length	9 mm
Tip Diameter	2.5 mm
Probe Tip to Sensor X Calibration Point	1 mm
Probe Tip to Sensor Y Calibration Point	1 mm
Probe Tip to Sensor Z Calibration Point	1 mm
Recommended Measurement Distance from Surface	2 mm



**Calibration Laboratory of
Schmid & Partner
Engineering AG**
Zeughausstrasse 43, 8004 Zurich, Switzerland



S Schweizerischer Kalibrierdienst
C Service suisse d'étalonnage
S Servizio svizzero di taratura
S Swiss Calibration Service

Accredited by the Swiss Accreditation Service (SAS)
The Swiss Accreditation Service is one of the signatories to the EA
Multilateral Agreement for the recognition of calibration certificates

Accreditation No.: **SCS 108**

Client **ATL (Auden)**

Certificate No: **DAE4-779_Feb14**

CALIBRATION CERTIFICATE

Object: **DAE4 - SD 000 D04 BM - SN: 779**

Calibration procedure(s): **QA CAL-06.v26
Calibration procedure for the data acquisition electronics (DAE)**

Calibration date: **February 25, 2014**

This calibration certificate documents the traceability to national standards, which realize the physical units of measurements (SI). The measurements and the uncertainties with confidence probability are given on the following pages and are part of the certificate.

All calibrations have been conducted in the closed laboratory facility; environment temperature (22 ± 3)°C and humidity < 70%.

Calibration Equipment used (M&TE critical for calibration)

Primary Standards	ID #	Cal Date (Certificate No.)	Scheduled Calibration
Keithley Multimeter Type 2001	SN: 0810278	01-Oct-13 (No:13976)	Oct-14
Secondary Standards	ID #	Check Date (in house)	Scheduled Check
Auto DAE Calibration Unit	SE UWS 053 AA 1001	07-Jan-14 (in house check)	In house check: Jan-15
Calibrator Box V2.1	SE UMS 006 AA 1002	07-Jan-14 (in house check)	In house check: Jan-15

Calibrated by:	Name	Function	Signature
	R.Mayoraz	Technician	<i>R. Mayoraz</i>
Approved by:	Name	Function	Signature
	Fin Bomholt	Deputy Technical Manager	<i>F. Bomholt</i>

Issued: February 25, 2014

This calibration certificate shall not be reproduced except in full without written approval of the laboratory.

Calibration Laboratory of
Schmid & Partner
Engineering AG
Zeughausstrasse 43, 8004 Zurich, Switzerland



S Schweizerischer Kalibrierdienst
C Service suisse d'étalonnage
S Servizio svizzero di taratura
S Swiss Calibration Service

Accredited by the Swiss Accreditation Service (SAS)
The Swiss Accreditation Service is one of the signatories to the EA
Multilateral Agreement for the recognition of calibration certificates

Accreditation No.: **SCS 108**

Glossary

DAE data acquisition electronics
Connector angle information used in DASY system to align probe sensor X to the robot coordinate system.

Methods Applied and Interpretation of Parameters

- *DC Voltage Measurement:* Calibration Factor assessed for use in DASY system by comparison with a calibrated instrument traceable to national standards. The figure given corresponds to the full scale range of the voltmeter in the respective range.
- *Connector angle:* The angle of the connector is assessed measuring the angle mechanically by a tool inserted. Uncertainty is not required.
- The following parameters as documented in the Appendix contain technical information as a result from the performance test and require no uncertainty.
 - *DC Voltage Measurement Linearity:* Verification of the Linearity at +10% and -10% of the nominal calibration voltage. Influence of offset voltage is included in this measurement.
 - *Common mode sensitivity:* Influence of a positive or negative common mode voltage on the differential measurement.
 - *Channel separation:* Influence of a voltage on the neighbor channels not subject to an input voltage.
 - *AD Converter Values with inputs shorted:* Values on the internal AD converter corresponding to zero input voltage
 - *Input Offset Measurement:* Output voltage and statistical results over a large number of zero voltage measurements.
 - *Input Offset Current:* Typical value for information; Maximum channel input offset current, not considering the input resistance.
 - *Input resistance:* Typical value for information: DAE input resistance at the connector, during internal auto-zeroing and during measurement.
 - *Low Battery Alarm Voltage:* Typical value for information. Below this voltage, a battery alarm signal is generated.
 - *Power consumption:* Typical value for information. Supply currents in various operating modes.



DC Voltage Measurement

A/D - Converter Resolution nominal

High Range: 1LSB = 6.1 μ V, full range = -100...+300 mV

Low Range: 1LSB = 61nV, full range = -1.....+3mV

DASY measurement parameters: Auto Zero Time: 3 sec; Measuring time: 3 sec

Calibration Factors	X	Y	Z
High Range	404.515 \pm 0.02% (k=2)	403.757 \pm 0.02% (k=2)	403.978 \pm 0.02% (k=2)
Low Range	3.96916 \pm 1.50% (k=2)	3.98125 \pm 1.50% (k=2)	3.99560 \pm 1.50% (k=2)

Connector Angle

Connector Angle to be used in DASY system	157.5 $^{\circ}$ \pm 1 $^{\circ}$
---	-------------------------------------



Appendix

1. DC Voltage Linearity

High Range	Reading (μV)	Difference (μV)	Error (%)
Channel X + Input	199997.74	1.65	0.00
Channel X + Input	20001.89	1.21	0.01
Channel X - Input	-19997.69	3.10	-0.02
Channel Y + Input	199997.92	2.13	0.00
Channel Y + Input	20001.37	0.80	0.00
Channel Y - Input	-19999.57	1.35	-0.01
Channel Z + Input	199997.09	1.06	0.00
Channel Z + Input	20000.80	0.22	0.00
Channel Z - Input	-19999.23	1.60	-0.01

Low Range	Reading (μV)	Difference (μV)	Error (%)
Channel X + Input	2001.24	0.10	0.01
Channel X + Input	202.08	0.59	0.29
Channel X - Input	-198.10	0.23	-0.11
Channel Y + Input	2001.05	-0.03	-0.00
Channel Y + Input	200.92	-0.52	-0.26
Channel Y - Input	-199.30	-0.92	0.46
Channel Z + Input	2001.25	0.24	0.01
Channel Z + Input	200.66	-0.81	-0.40
Channel Z - Input	-198.77	-0.44	0.22

2. Common mode sensitivity

DASY measurement parameters: Auto Zero Time: 3 sec; Measuring time: 3 sec

	Common mode Input Voltage (mV)	High Range Average Reading (μV)	Low Range Average Reading (μV)
Channel X	200	-3.03	-4.58
	-200	6.11	4.63
Channel Y	200	13.34	13.05
	-200	-15.36	-15.98
Channel Z	200	3.32	2.92
	-200	-3.98	-4.66

3. Channel separation

DASY measurement parameters: Auto Zero Time: 3 sec; Measuring time: 3 sec

	Input Voltage (mV)	Channel X (μV)	Channel Y (μV)	Channel Z (μV)
Channel X	200	-	-1.70	-3.37
Channel Y	200	10.69	-	-1.19
Channel Z	200	7.92	8.10	-



4. AD-Converter Values with inputs shorted

DASY measurement parameters: Auto Zero Time: 3 sec; Measuring time: 3 sec

	High Range (LSB)	Low Range (LSB)
Channel X	15606	14291
Channel Y	15844	15955
Channel Z	16208	16276

5. Input Offset Measurement

DASY measurement parameters: Auto Zero Time: 3 sec; Measuring time: 3 sec

Input 10MΩ

	Average (μV)	min. Offset (μV)	max. Offset (μV)	Std. Deviation (μV)
Channel X	-0.06	-2.42	1.10	0.60
Channel Y	-0.79	-2.62	0.91	0.68
Channel Z	-0.58	-2.53	0.84	0.57

6. Input Offset Current

Nominal Input circuitry offset current on all channels: <25fA

7. Input Resistance (Typical values for information)

	Zeroing (kOhm)	Measuring (MOhm)
Channel X	200	200
Channel Y	200	200
Channel Z	200	200

8. Low Battery Alarm Voltage (Typical values for information)

Typical values	Alarm Level (VDC)
Supply (+ Vcc)	+7.9
Supply (- Vcc)	-7.6

9. Power Consumption (Typical values for information)

Typical values	Switched off (mA)	Stand by (mA)	Transmitting (mA)
Supply (+ Vcc)	+0.01	+6	+14
Supply (- Vcc)	-0.01	-8	-9