



SAR Test Setup Photographs

EUT Side Definition	
Item	Side
1	Side 1
2	Side 2
3	Side 3
4	Side 4
5	Side 5
6	Side 6
	
	

Phantom Position : Right Cheek	EUT side : N/A
Spacing to phantom : 0 mm	Accessory : N/A

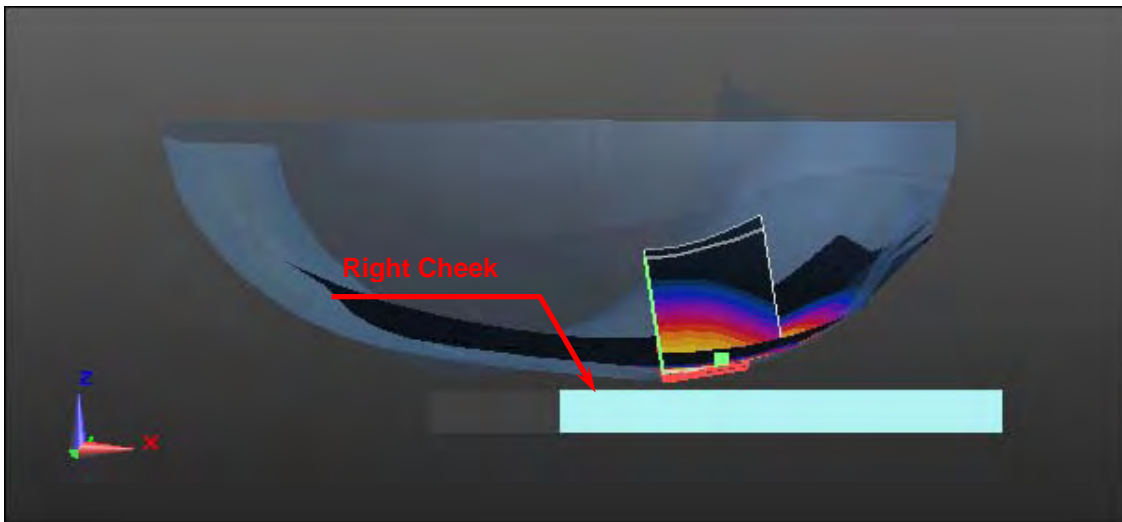
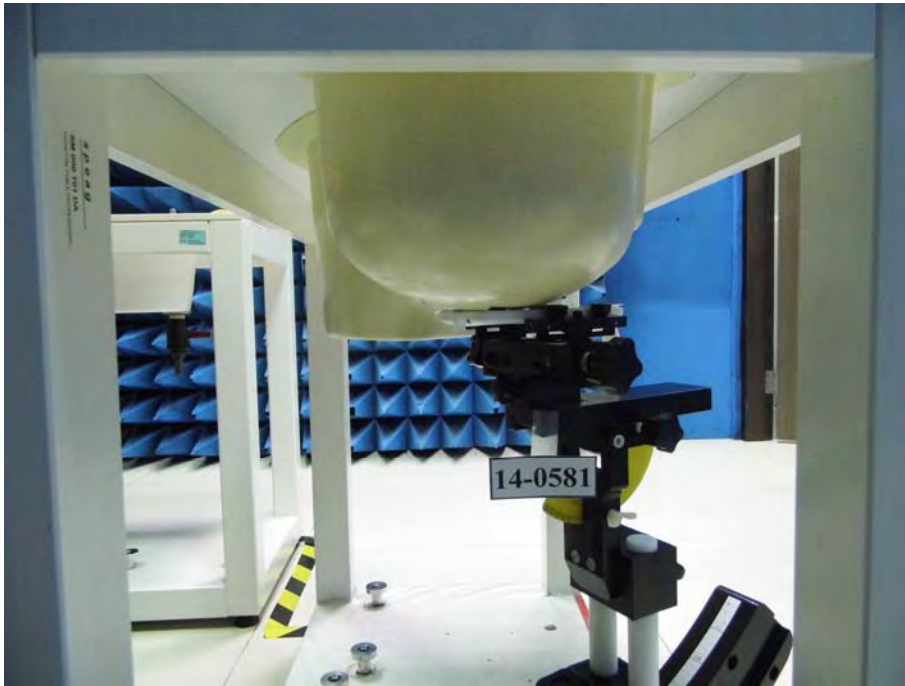

Phantom Position : Right Tilted	EUT side : N/A
Spacing to phantom : 0 mm	Accessory : N/A

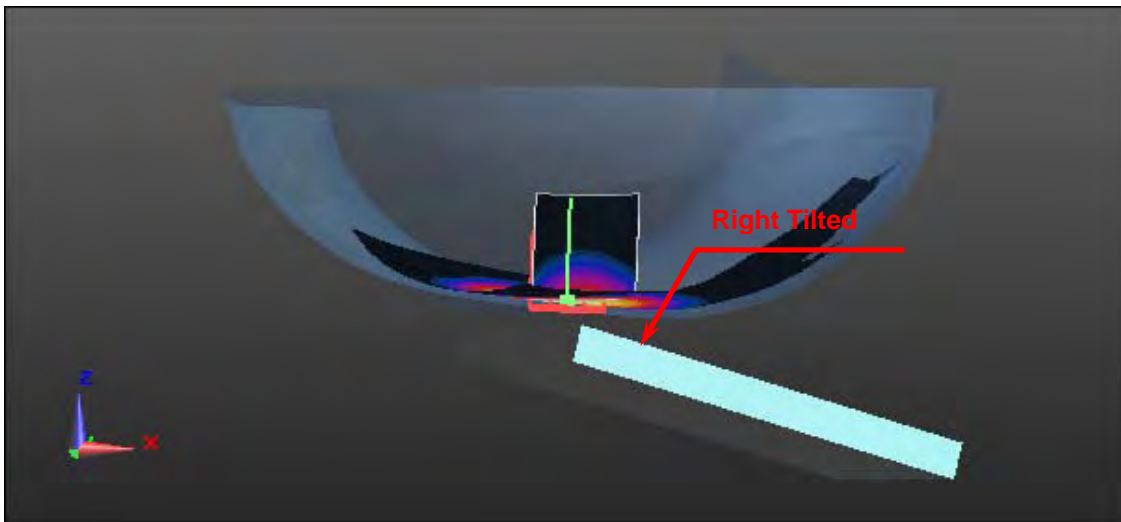
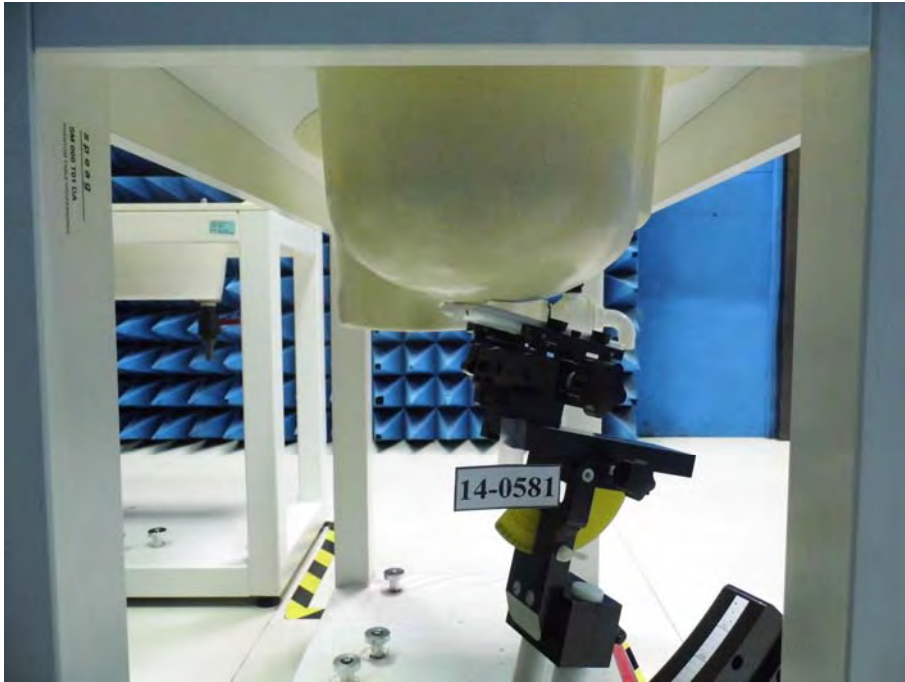

Phantom Position : Left Cheek	EUT side : N/A
Spacing to phantom : 0 mm	Accessory : N/A

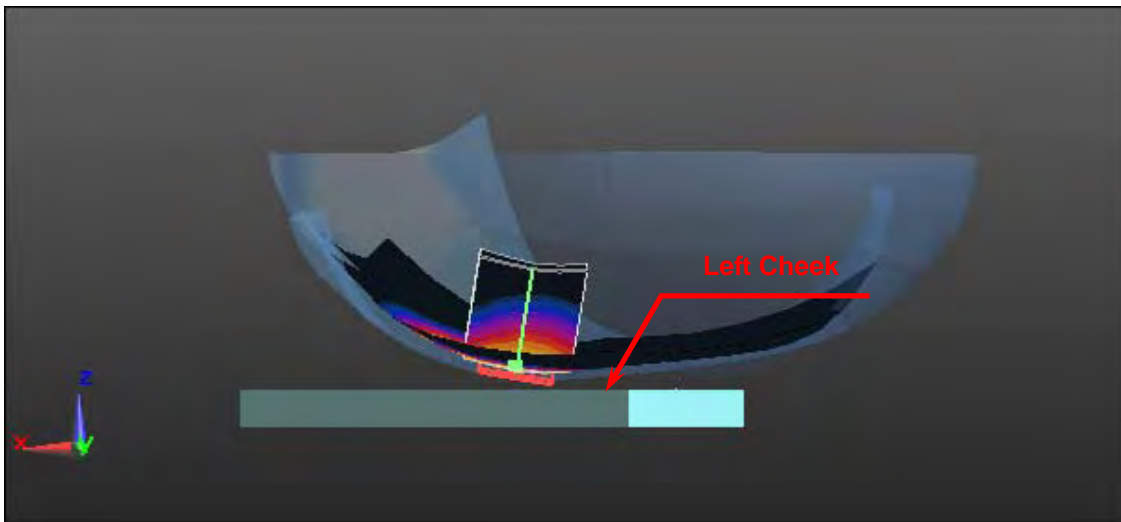

Phantom Position : Left Tilted	EUT side : N/A
Spacing to phantom : 0 mm	Accessory : N/A

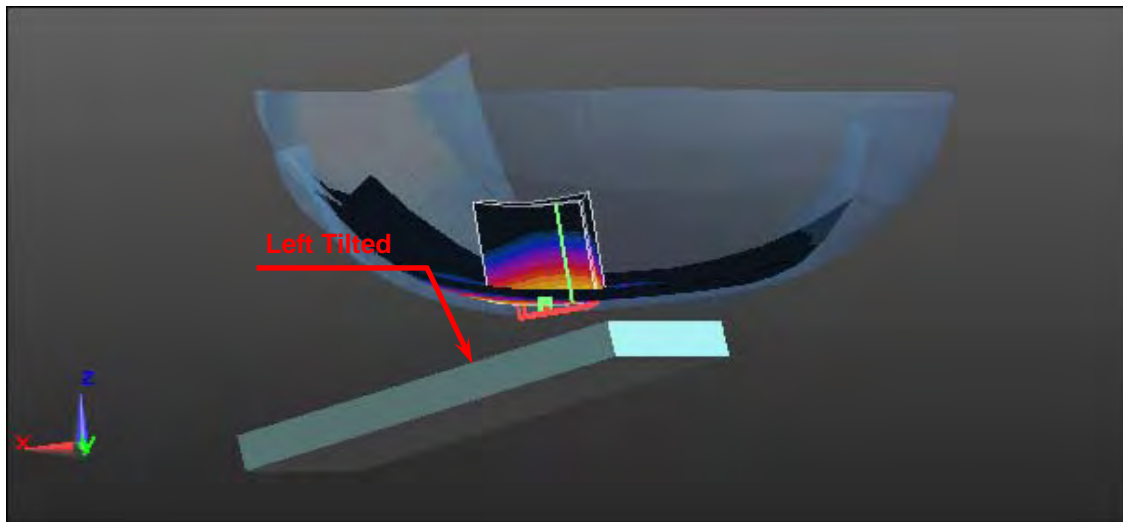
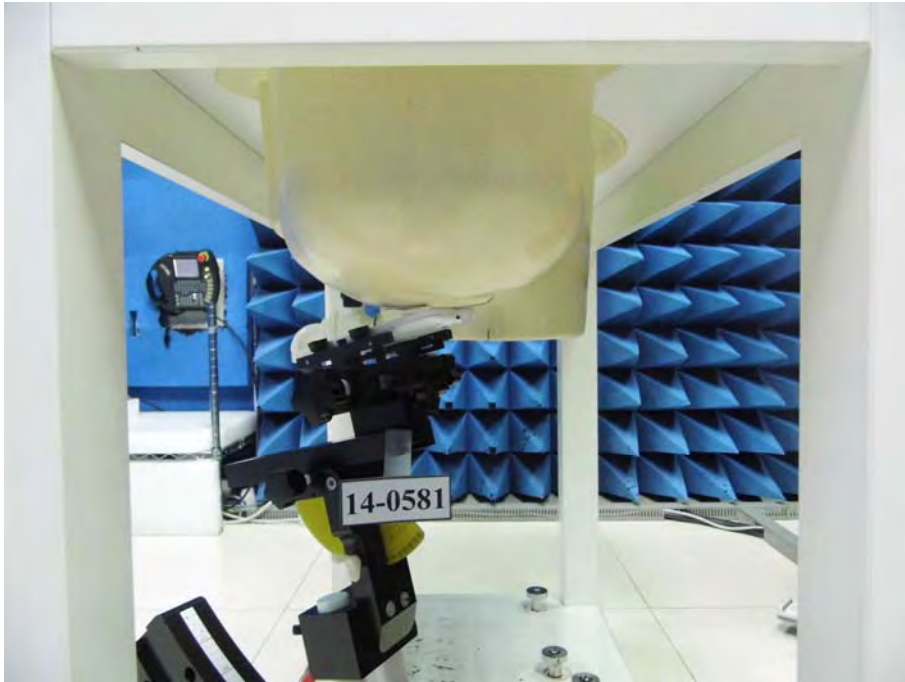

Phantom Position : Flat	EUT side : Side 1
Spacing to phantom : 10 mm	Accessory : N/A

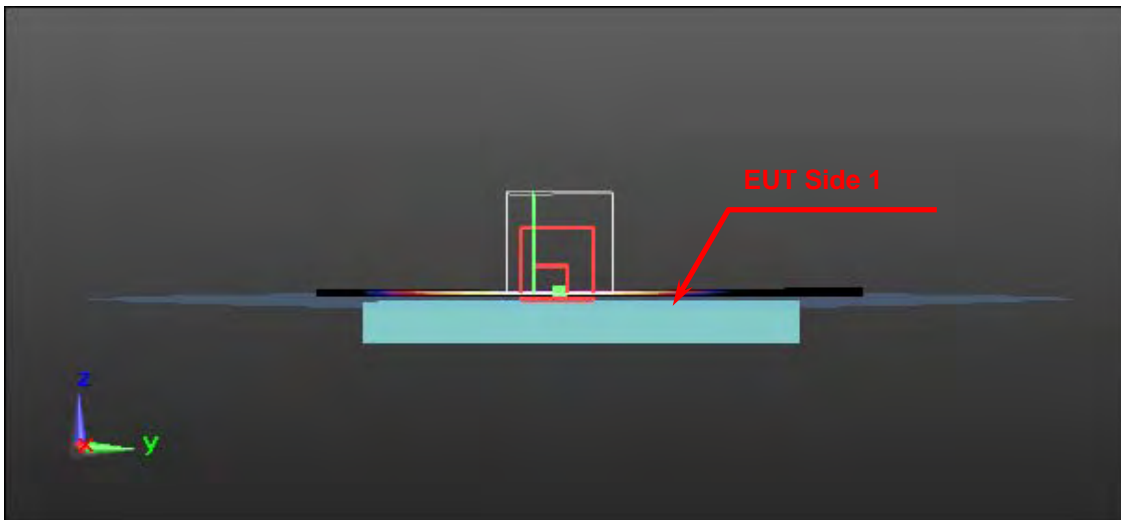

Phantom Position : Flat	EUT side : Side 1
Spacing to phantom : 10 mm	Accessory : Headset

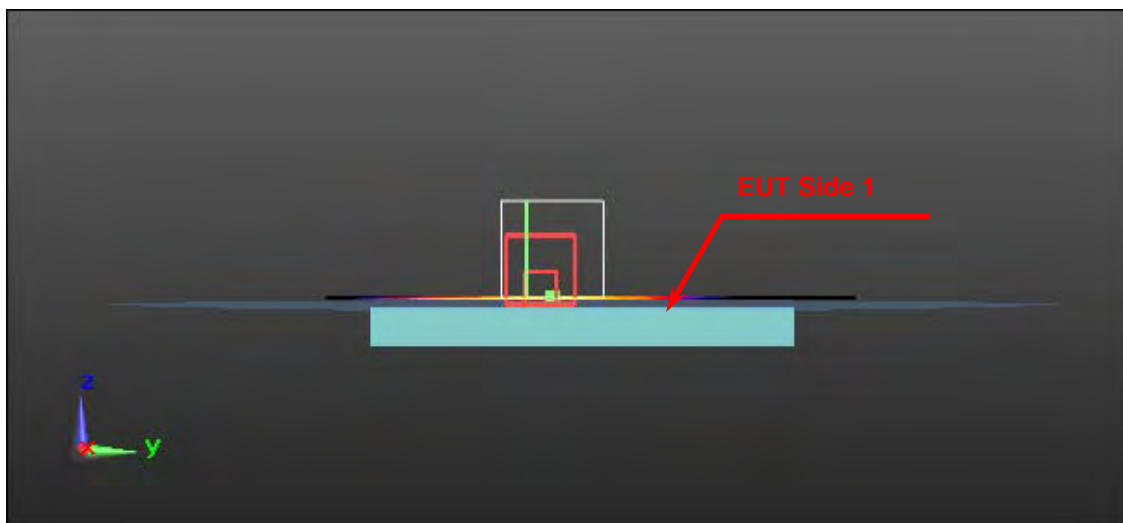

Phantom Position : Flat	EUT side : Side 2
Spacing to phantom : 10 mm	Accessory : N/A

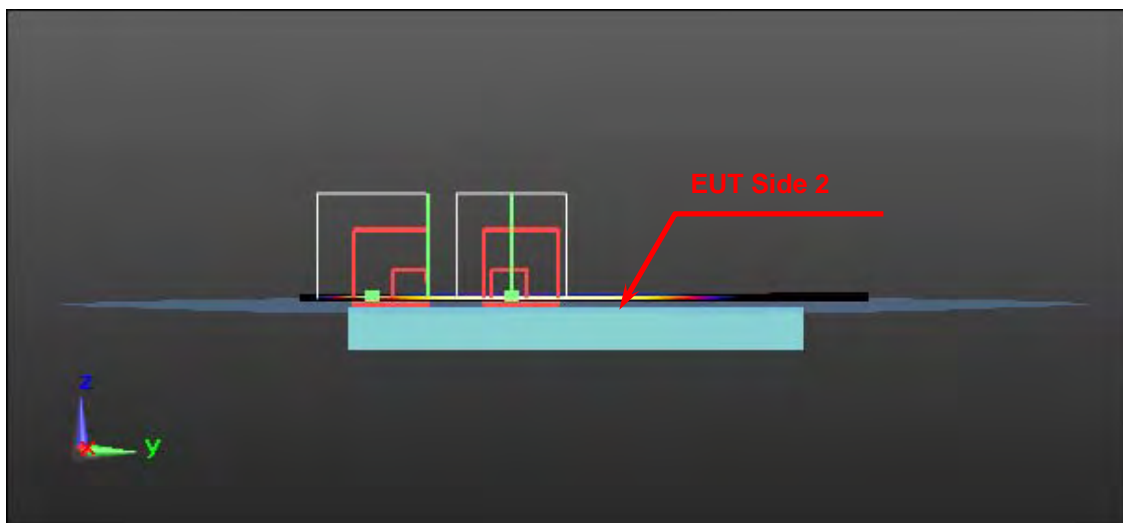

Phantom Position : Flat	EUT side : Side 2
Spacing to phantom : 10 mm	Accessory : Headset

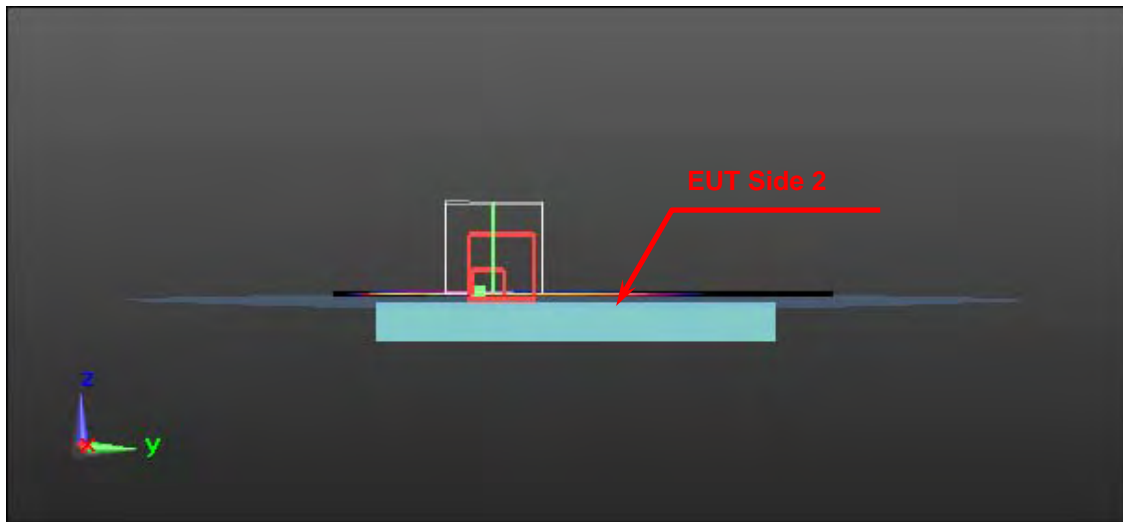

Phantom Position : Flat	EUT side : Side 3
Spacing to phantom : 10 mm	Accessory : N/A

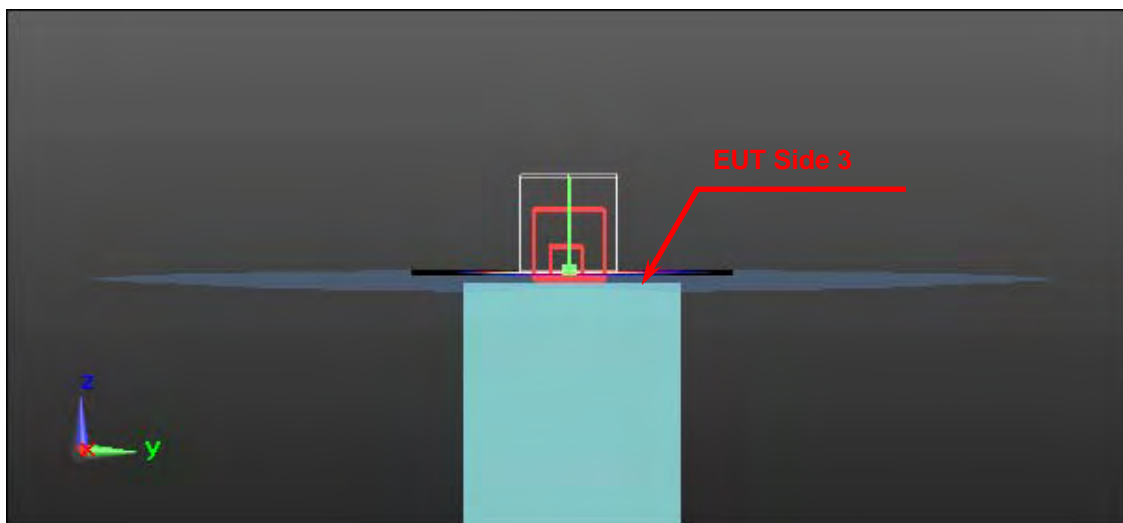
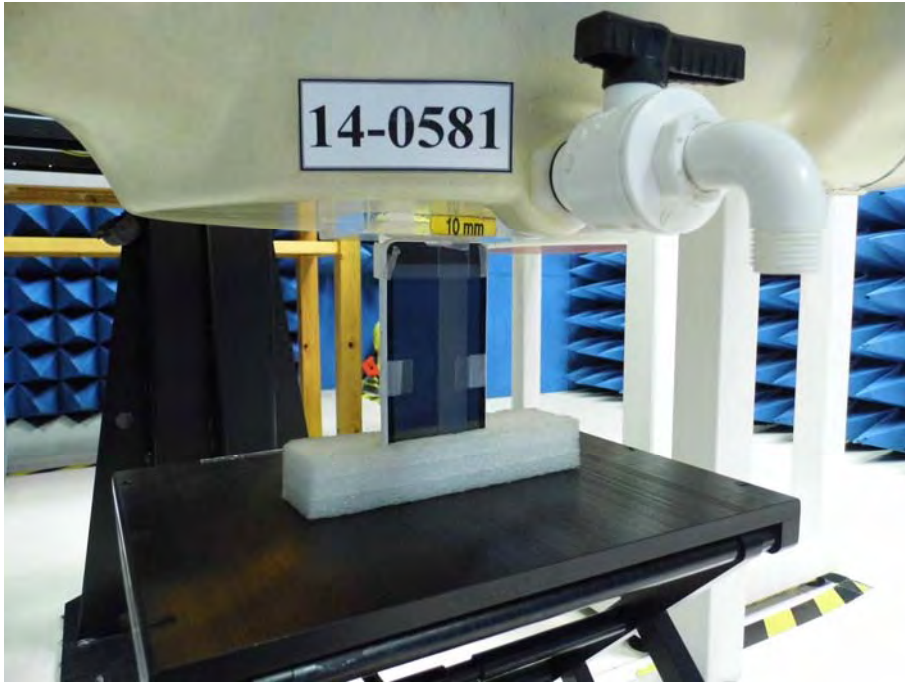

Phantom Position : Flat	EUT side : Side 4
Spacing to phantom : 10 mm	Accessory : N/A

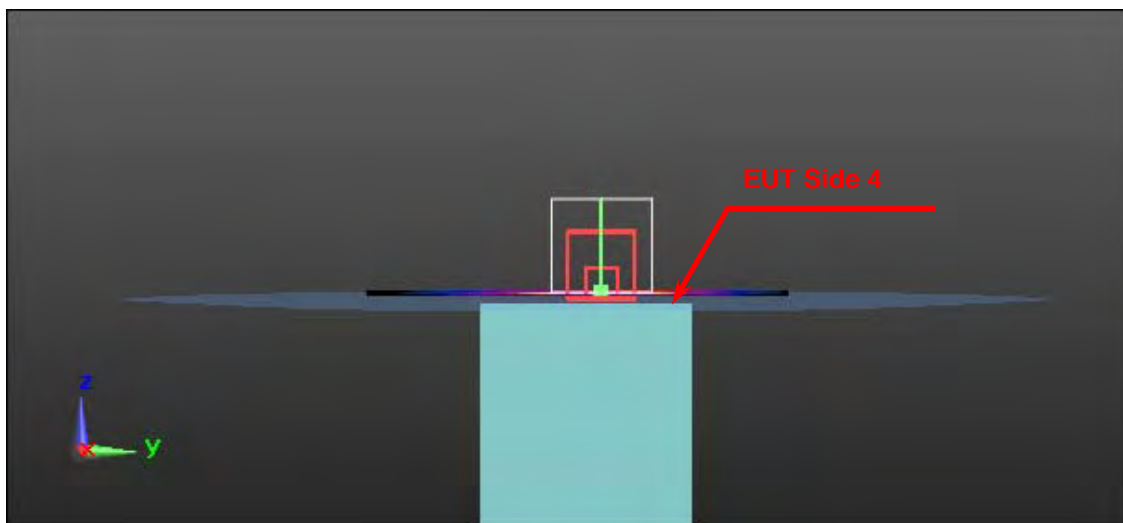
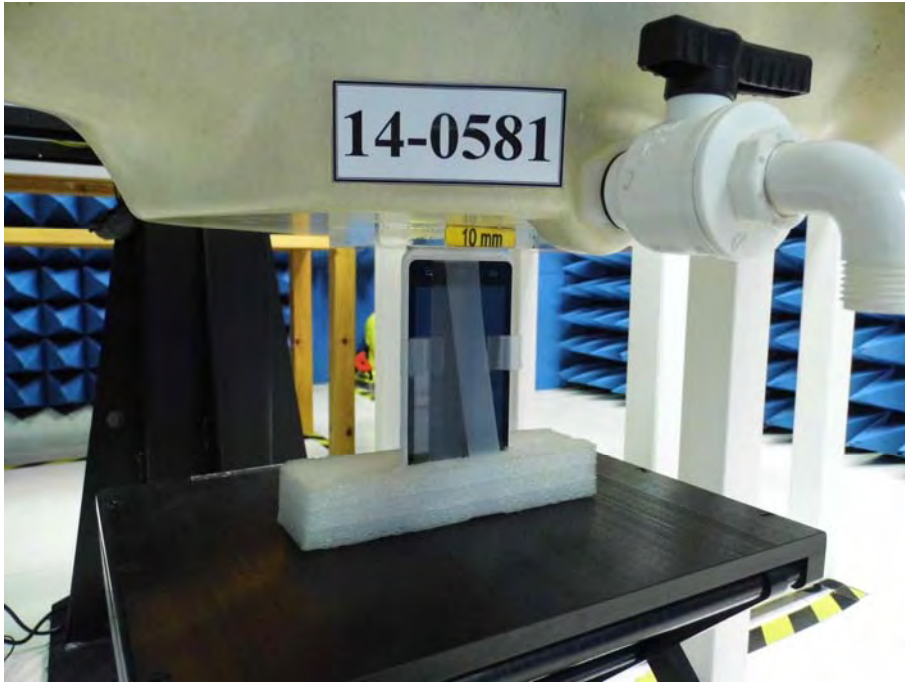

Phantom Position : Flat	EUT side : Side 5
Spacing to phantom : 10 mm	Accessory : N/A

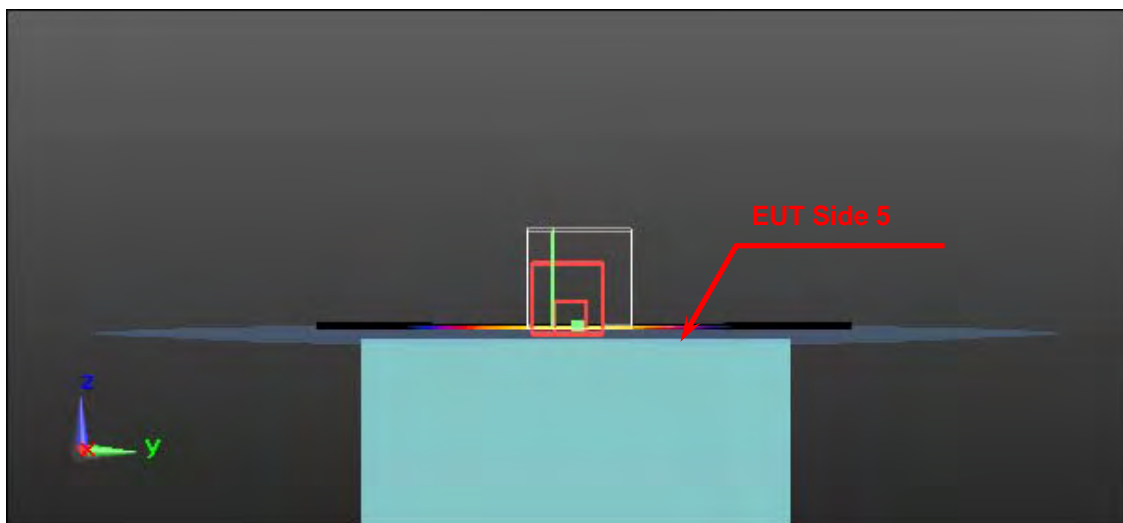
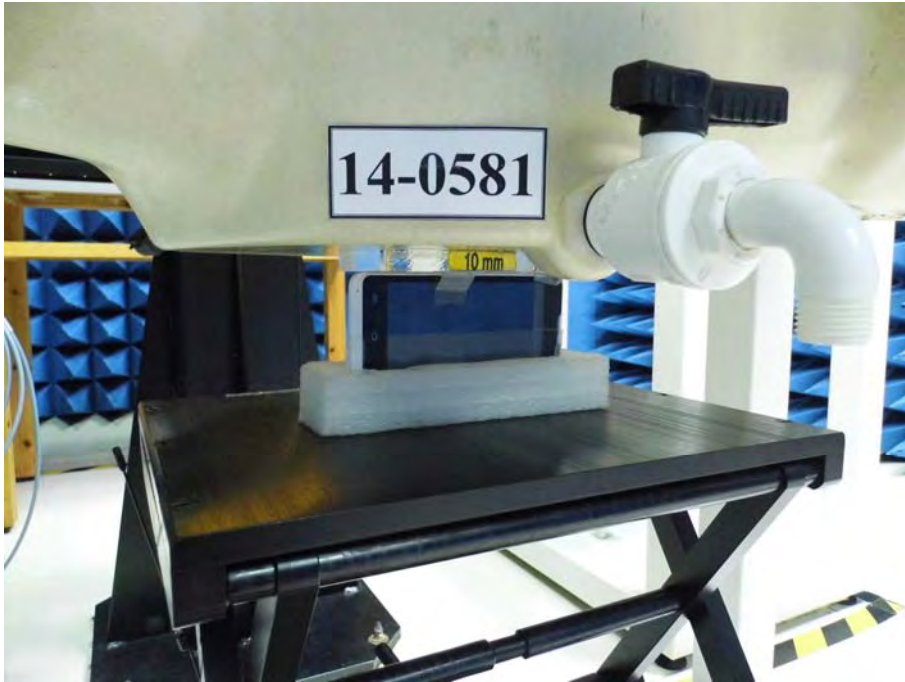

Phantom Position : Flat	EUT side : Side 6
Spacing to phantom : 10 mm	Accessory : N/A

