

S

T

S

L

A

B



RADIO TESTREPORT

Report No: STS1610011F02

Issued for

Sky Phone LLC

1348 Washington Av. Suite 350, Miami Beach, FL 33139
United States

Product Name:	Mobile phone
Brand Name:	SKY DEVICES
Model Name:	ELITE 5.5 OCTA
Series Model:	N/A
FCC ID:	2ABOSELITE55OCTA
Test Standard:	FCC Part 15.247

Any reproduction of this document must be done in full. No single part of this document may be reproduced without permission from STS, All Test Data Presented in this report is only applicable to presented Test sample.

Shenzhen STS Test Services Co., Ltd.
1/F., Building B, Zhuoke Science Park, No.190, Chongqing Road,
Fuyong Street, Bao'an District, Shenzhen, Guangdong, China
TEL: +86-755 3688 6288 FAX: +86-755 3688 6277 E-mail: sts@stsapp.com





TEST RESULT CERTIFICATION

Applicant's name.....: Sky Phone LLC
Address.....: 1348 Washington Av. Suite 350, Miami Beach, FL 33139 United States
Manufacture's Name: Techain
Address.....: No.18, Lane1387 Zhangdong Rd, Pudong, Shanghai, 201203, P.R.C

Product description

Product name.....: Mobile phone
Brand name.....: SKY DEVICES
Model and/or type reference .: ELITE 5.5 OCTA
Standards: FCC Part15.247
Test procedure: ANSI C63.10-2013

This device described above has been tested by STS, and the test results show that the equipment under test (EUT) is in compliance with the FCC requirements. And it is applicable only to the tested sample identified in the report.

This report shall not be reproduced except in full, without the written approval of STS, this document may be altered or revised by STS, personal only, and shall be noted in the revision of the document.

Date of Test.....:
Date (s) of performance of tests : 08 Oct. 2016~18 Oct. 2016
Date of Issue: 19 Oct. 2016
Test Result: Pass

Testing Engineer : [Signature]
(Tony Liu)

Technical Manager : [Signature]
(Vita Li)

Authorized Signatory : [Signature]
(Bovey Yang)





Table of Contents	Page
1. SUMMARY OF TEST RESULTS	6
1.1 TEST FACTORY	7
1.2 MEASUREMENT UNCERTAINTY	7
2. GENERAL INFORMATION	8
2.1 GENERAL DESCRIPTION OF EUT	8
2.2 DESCRIPTION OF TEST MODES	10
2.3 TABLE OF PARAMETERS OF TEXT SOFTWARE SETTING	10
2.4 BLOCK DIGRAM SHOWING THE CONFIGURATION OF SYSTEM TESTED	11
2.5 DESCRIPTION OF SUPPORT UNITS	12
2.6 EQUIPMENTS LIST FOR ALL TEST ITEMS	13
3. EMC EMISSION TEST	14
3.1 CONDUCTED EMISSION MEASUREMENT	14
3.2 RADIATED EMISSION MEASUREMENT	18
4. CONDUCTED SPURIOUS & BAND EDGE EMISSION	29
4.1 REQUIREMENT	29
4.2 TEST PROCEDURE	29
4.3 TEST SETUP	29
4.4 EUT OPERATION CONDITIONS	29
4.5 TEST RESULTS	30
5. NUMBER OF HOPPING CHANNEL	42
5.1 APPLIED PROCEDURES / LIMIT	42
5.2 TEST PROCEDURE	42
5.3 TEST SETUP	42
5.4 EUT OPERATION CONDITIONS	42
5.5 TEST RESULTS	43
6. AVERAGE TIME OF OCCUPANCY	44
6.1 APPLIED PROCEDURES / LIMIT	44
6.2 TEST PROCEDURE	44
6.3 TEST SETUP	44
6.4 EUT OPERATION CONDITIONS	44
6.5 TEST RESULTS	45
7. HOPPING CHANNEL SEPARATION MEASUREMENT	51



Table of Contents	Page
7.1 APPLIED PROCEDURES / LIMIT	51
7.2 TEST PROCEDURE	51
7.3 TEST SETUP	51
7.4 EUT OPERATION CONDITIONS	51
7.5 TEST RESULTS	52
8. BANDWIDTH TEST	58
8.1 APPLIED PROCEDURES / LIMIT	58
8.2 TEST PROCEDURE	58
8.3 TEST SETUP	58
8.4 EUT OPERATION CONDITIONS	58
8.5 TEST RESULTS	59
9. OUTPUT POWER TEST	65
9.1 APPLIED PROCEDURES / LIMIT	65
9.2 TEST PROCEDURE	65
9.3 TEST SETUP	65
9.4 EUT OPERATION CONDITIONS	65
9.5 TEST RESULTS	66
10. ANTENNA REQUIREMENT	67
10.1 STANDARD REQUIREMENT	67
10.2 EUT ANTENNA	67



Revision History

Rev.	Issue Date	Report NO.	Effect Page	Contents
00	19 Oct. 2016	STS1610011F02	ALL	Initial Issue





1. SUMMARY OF TEST RESULTS

Test procedures according to the technical standards:
KDB DA 00-705

FCC Part 15.247, Subpart C			
Standard Section	Test Item	Judgment	Remark
15.207	Conducted Emission	PASS	--
15.247(a)(1)	Hopping Channel Separation	PASS	--
15.247(a)(1)&(b)(1)	Output Power	PASS	--
15.247(c)	Radiated Spurious Emission	PASS	--
15.247(d)	Conducted Spurious & Band Edge Emission	PASS	--
15.247(a)(iii)	Number of Hopping Frequency	PASS	--
15.247(a)(iii)	Dwell Time	PASS	--
15.247(a)(1)	Bandwidth	PASS	--
15.205	Band Edge Emission	PASS	--
15.203	Antenna Requirement	PASS	--

NOTE:

(1) "N/A" denotes test is not applicable in this Test Report

(2) All tests are according to ANSI C63.10-2013



1.1 TEST FACTORY

Shenzhen STS Test Services Co., Ltd.

Add. : 1/F., Building B, Zhuoke Science Park, No.190, Chongqing Road,
Fuyong Street, Bao'an District, Shenzhen, Guangdong, China

CNAS Registration No.: L7649;

FCC Registration No.: 842334; IC Registration No.: 12108A-1

1.2 MEASUREMENT UNCERTAINTY

The reported uncertainty of measurement $y \pm U$, where expanded uncertainty U is based on a standard uncertainty multiplied by a coverage factor of $k=2$, providing a level of confidence of approximately **95 %**.

No.	Item	Uncertainty
1	Conducted Emission (9KHz-150KHz)	$\pm 2.88\text{dB}$
2	Conducted Emission (150KHz-30MHz)	$\pm 2.67\text{dB}$
3	RF power,conducted	$\pm 0.70\text{dB}$
4	Spurious emissions,conducted	$\pm 1.19\text{dB}$
5	All emissions,radiated (9KHz-30MHz)	$\pm 2.45\text{dB}$
6	All emissions,radiated (30MHz-200MHz)	$\pm 2.83\text{dB}$
7	All emissions,radiated (200MHz-1000MHz)	$\pm 2.94\text{dB}$
8	All emissions,radiated(>1G)	$\pm 3.03\text{dB}$
9	Temperature	$\pm 0.5^{\circ}\text{C}$
10	Humidity	$\pm 2\%$



2. GENERAL INFORMATION

2.1 GENERAL DESCRIPTION OF EUT

Equipment	Mobile phone
Trade Name	SKY DEVICES
Model Name	ELITE 5.5 OCTA
Series Model	N/A
Model Difference	N/A
Channel List	Please refer to the Note 2.
Bluetooth	Frequency:2402 – 2480 MHz Modulation: GFSK(1Mbps), $\pi/4$ -DQPSK(2Mbps), 8-DPSK(3Mbps)
Adapter	Input: AC 100-240V, 300mA, 50/60 Hz Output: DC 5V, 1000mA
Battery	Rated Voltage: 3.8V Capacity: 2800mAh
Hardware version number	L93E1
Software version number	Sky_ELITE_OCTA_V01_0926_2016
Connecting I/O Port(s)	Please refer to the User's Manual

Note:

1. For a more detailed features description, please refer to the manufacturer's specifications or the User's Manual.



2.

Channel List					
Channel	Frequency (MHz)	Channel	Frequency (MHz)	Channel	Frequency (MHz)
00	2402	27	2429	54	2456
01	2403	28	2430	55	2457
02	2404	29	2431	56	2458
03	2405	30	2432	57	2459
04	2406	31	2433	58	2460
05	2407	32	2434	59	2461
06	2408	33	2435	60	2462
07	2409	34	2436	61	2463
08	2410	35	2437	62	2464
09	2411	36	2438	63	2465
10	2412	37	2439	64	2466
11	2413	38	2440	65	2467
12	2414	39	2441	66	2468
13	2415	40	2442	67	2469
14	2416	41	2443	68	2470
15	2417	42	2444	69	2471
16	2418	43	2445	70	2472
17	2419	44	2446	71	2473
18	2420	45	2447	72	2474
19	2421	46	2448	73	2475
20	2422	47	2449	74	2476
21	2423	48	2450	75	2477
22	2424	49	2451	76	2478
23	2425	50	2452	77	2479
24	2426	51	2453	78	2480
25	2427	52	2454		
26	2428	53	2455		

3. Table for Filed Antenna

Ant	Brand	Model Name	Antenna Type	Connector	Gain (dBi)	NOTE
1	SKY DEVICES	ELITE 5.5 OCTA	PIFA Antenna	N/A	-2.23	BT Antenna



2.2 DESCRIPTION OF TEST MODES

To investigate the maximum EMI emission characteristics generates from EUT, the test system was pre-scanning tested base on the consideration of following EUT operation mode or test configuration mode which possible have effect on EMI emission level. Each of these EUT operation mode(s) or test configuration mode(s) mentioned above was evaluated respectively.

Worst Mode	Description	Data Rate/Modulation
Mode 1	TX CH00	1Mbps/GFSK
Mode 2	TX CH39	1Mbps/GFSK
Mode 3	TX CH78	1Mbps/GFSK
Mode 4	TX CH00	2 Mbps/ π /4-DQPSK
Mode 5	TX CH39	2 Mbps/ π /4-DQPSK
Mode 6	TX CH78	2 Mbps/ π /4-DQPSK
Mode7	TX CH00	3 Mbps/8-DPSK
Mode 8	TX CH39	3 Mbps/8-DPSK
Mode 9	TX CH78	3 Mbps/8-DPSK

Note:

- (1) The measurements are performed at all Bit Rate of Transmitter, the worst data was reported
- (2) We have be tested for all avaiable U.S. voltage and frequencies(For 120V,50/60Hz and 240V, 50/60Hz) for which the device is capable of operation.

For AC Conducted Emission

Test Case	
AC Conducted Emission	Mode 10 : Keeping BT TX

2.3 TABLE OF PARAMETERS OF TEXT SOFTWARE SETTING

During testing channel & power controlling software provided by the customer was used to control the operating channel as well as the output power level. The RF output power selection is for the setting of RF output power expected by the customer and is going to be fixed on the firmware of the final end product power parameters of FHSS.

Test software Version	Test program: Bluetooth		
Frequency	2402 MHz	2441 MHz	2480 MHz
CSR (Power control software) Parameters(1/2/3Mbps)	Power class: 1 M rate:4:27 2 M rate:11:183 3 Mrate:15:339	Power class: 1 M rate:4:27 2 M rate:11:183 3 Mrate:15:339	Power class: 1 M rate:4:27 2 M rate:11:183 3 Mrate:15:339

2.4 BLOCK DIGRAM SHOWING THE CONFIGURATION OF SYSTEM TESTED

During testing channel & power controlling software provided by the customer was used to control the operating channel as well as the output power level. The RF output power selection is for the setting of RF output power expected by the customer and is going to be fixed on the firmware of the final end product power parameters of FHSS

Radiated Spurious Emission Test

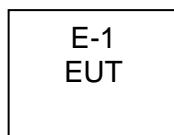

Conducted Emission Test

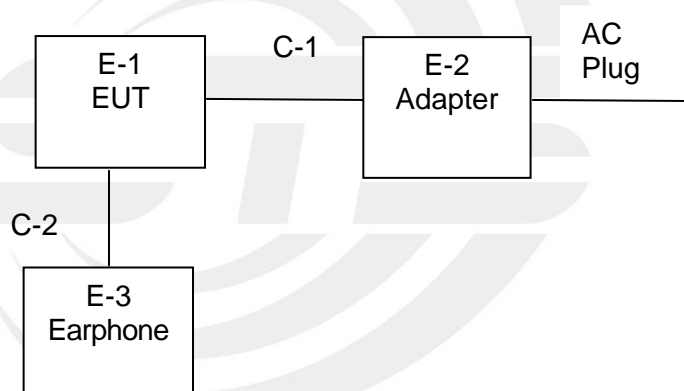



2.5 DESCRIPTION OF SUPPORT UNITS

The EUT has been tested as an independent unit together with other necessary accessories or support units. The following support units or accessories were used to form a representative test configuration during the tests.

Item	Equipment	Mfr/Brand	Model/Type No.	Serial No.	Note
E-1	Mobile phone	SKY DEVICES	ELITE 5.5 OCTA	N/A	EUT
E-2	Adapter	SKY DEVICES	ELITE 5.5 OCTA	N/A	EUT
E-3	Earphone	N/A	N/A	N/A	EUT

Item	Shielded Type	Ferrite Core	Length	Note
C-1	USB Cable shielded line (Charging)	NO	100cm	N/A
C-2	Earphone line	NO	110cm	N/A

Note:

- (1) The support equipment was authorized by Declaration of Confirmation.
- (2) For detachable type I/O cable should be specified the length in cm in 『Length』 column.
- (3) “YES” is means “shielded” “with core”; “NO” is means “unshielded” “without core”.



2.6 EQUIPMENTS LIST FOR ALL TEST ITEMS

Radiation Test equipment

Kind of Equipment	Manufacturer	Type No.	Serial No.	Last calibration	Calibrated until
Spectrum Analyzer	Agilent	E4407B	MY50140340	2015.10.25	2016.10.24
Test Receiver	R&S	ESCI	101427	2015.10.25	2016.10.24
Bilog Antenna	TESEQ	CBL6111D	34678	2015.11.25	2016.11.24
Horn Antenna	Schwarzbeck	BBHA 9120D	9120D-1343	2016.03.06	2017.03.05
Horn Antenna	Schwarzbeck	BBHA 9170	9170-0741	2016.03.06	2017.03.05
50Ω Coaxial Switch	Anritsu	MP59B	6200264416	2016.06.06	2017.06.05
PreAmplifier	Agilent	8449B	60538	2015.10.25	2016.10.24
Loop Antenna	ARA	PLA-1030/B	1029	2016.06.08	2017.06.07
Preamplifier	Agilent	8449B	60538	2015.11.05	2016.11.05
Low frequency cable (9KHz-1GHz)	EM	R01	N/A	N/A	N/A
High frequency cable (1GHz-25GHz)	SCHWARZBECK	AK9515H	SN-96286/96287	N/A	N/A
Semi-anechoic chamber	Changling	966	N/A	2015.10.25	2016.10.24

Conduction Test equipment

Kind of Equipment	Manufacturer	Type No.	Serial No.	Last calibration	Calibrated until
EMI Test Receiver	R&S	ESPI	102086	2015.11.20	2016.11.19
LISN	R&S	ENV216	101242	2015.10.25	2016.10.24
LISN	EMCO	3810/2NM	000-23625	2015.10.25	2016.10.24
Conduction Cable (150KHz-30MHz)	EM	C01	N/A	N/A	N/A
Shielding Room	Changling	854	N/A	2015.10.25	2016.10.24

RF Connected Test

Kind of Equipment	Manufacturer	Type No.	Serial No.	Last calibration	Calibrated until
USB RF power sensor	DARE	RPR3006W	15I00041SNO03	2015.10.25	2016.10.24
Spectrum Analyzer	Agilent	E4407B	MY50140340	2015.10.25	2016.10.24
Signal Analyzer	Agilent	N9020A	MY49100060	2015.11.18	2016.11.17
Temporary Antenna Connector	Murrata	MXHS83QE3000	2085751	2015.10.25	2016.10.24

Note: The temporary antenna connector is soldered on the PCB board in order to perform conducted tests and this temporary antenna connector is listed in the equipment list.



3. EMC EMISSION TEST

3.1 CONDUCTED EMISSION MEASUREMENT

3.1.1 POWER LINE CONDUCTED EMISSION LIMITS

Operating frequency band. In case the emission fall within the restricted band specified on Part 207(a) limit in the table below has to be followed.

FREQUENCY (MHz)	Conducted Emissionlimit (dBuV)	
	Quasi-peak	Average
0.15 -0.5	66 - 56 *	56 - 46 *
0.50 -5.0	56.00	46.00
5.0 -30.0	60.00	50.00

Note:

- (1) The tighter limit applies at the band edges.
- (2) The limit of " * " marked band means the limitation decreases linearly with the logarithm of the frequency in the range.

The following table is the setting of the receiver

Receiver Parameters	Setting
Attenuation	10 dB
Start Frequency	0.15 MHz
Stop Frequency	30 MHz
IF Bandwidth	9 kHz

3.1.2 TEST PROCEDURE

- a. The EUT was 0.8 meters from the horizontal ground plane and 0.4 meters from the vertical ground plane with EUT being connected to the power mains through a line impedance stabilization network (LISN). All other support equipments powered from additional LISN(s). The LISN provide 50 Ohm/ 50uH of coupling impedance for the measuring instrument.
- b. Interconnecting cables that hang closer than 40 cm to the ground plane shall be folded back and forth in the center forming a bundle 30 to 40 cm long.
- c. I/O cables that are not connected to a peripheral shall be bundled in the center. The end of the cable may be terminated, if required, using the correct terminating impedance. The overall length shall not exceed 1 m.
- d. LISN at least 80 cm from nearest part of EUT chassis.
- e. For the actual test configuration, please refer to the related Item –EUT Test Photos.

3.1.3 TEST SETUP

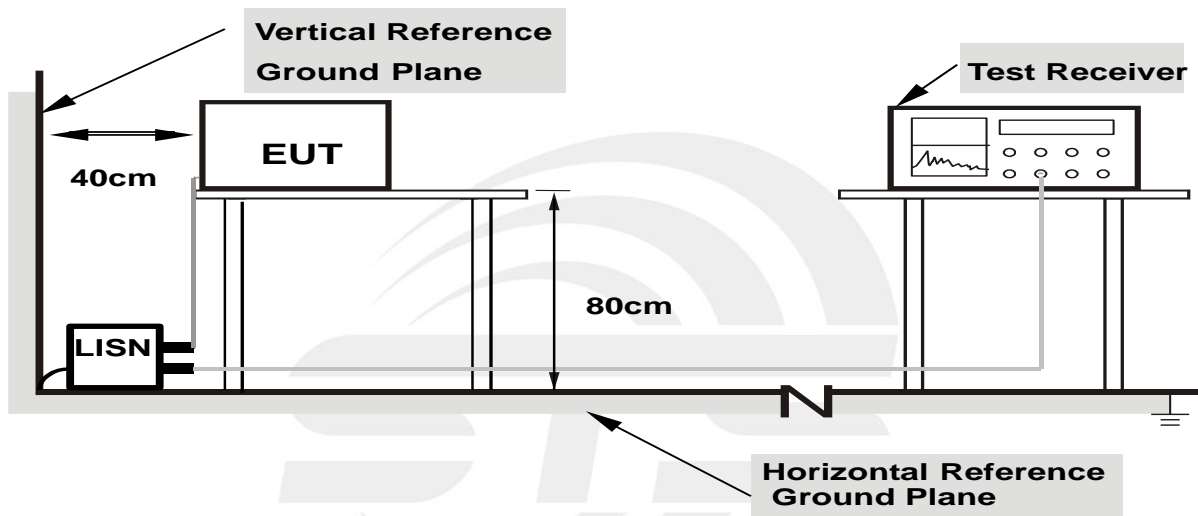

- Note: 1.Support units were connected to second LISN.**
2.Both of LISNs (AMN) are 80 cm from EUT and at least 80 from other units and other metal planes

3.1.4 EUT OPERATING CONDITIONS

The EUT was configured for testing in a typical fashion (as a customer would normally use it). The EUT has been programmed to continuously transmit during test. This operating condition was tested and used to collect the included data.



3.1.5 TEST RESULT

Temperature:	26 °C	Relative Humidity:	54%
Pressure:	1010hPa	Phase:	L
Test Voltage:	AC 120V/60Hz	Test Mode:	Mode 10

Frequency (MHz)	Reading (dBUV)	Correct Factor(dB)	Result (dBUV)	Limit (dBUV)	Margin (dB)	Remark
0.2060	37.46	9.22	46.68	63.37	-16.69	QP
0.2060	14.51	9.22	23.73	53.37	-29.64	AVG
0.2700	32.32	9.16	41.48	61.12	-19.64	QP
0.2700	14.99	9.16	24.15	51.12	-26.97	AVG
0.4140	29.92	9.23	39.15	57.57	-18.42	QP
0.4140	16.38	9.23	25.61	47.57	-21.96	AVG
4.8580	26.43	9.27	35.70	56.00	-20.30	QP
4.8580	8.77	9.27	18.04	46.00	-27.96	AVG
12.9220	27.37	9.42	36.79	60.00	-23.21	QP
12.9220	11.95	9.42	21.37	50.00	-28.63	AVG
27.7100	31.57	10.02	41.59	60.00	-18.41	QP
27.7100	13.27	10.02	23.29	50.00	-26.71	AVG

Remark:

1. All readings are Quasi-Peak and Average values.
2. Margin = Result (Result =Reading + Factor) –Limit

100.0 dBUV

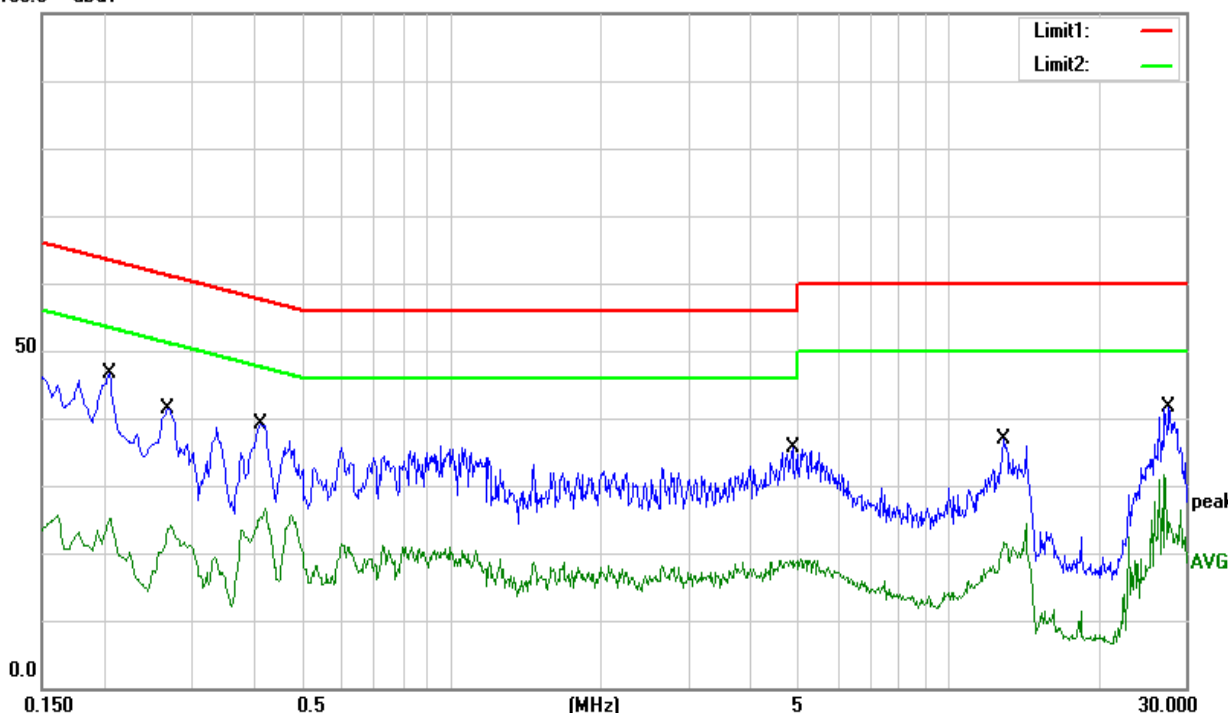



Temperature:	26 °C	Relative Humidity:	54%
Pressure:	1010hPa	Phase:	N
Test Voltage:	AC 120V/60Hz	Test Mode:	Mode 10

Frequency (MHz)	Reading (dBuV)	Correct Factor(dB)	Result (dBuV)	Limit (dBuV)	Margin (dB)	Remark
0.1540	49.43	9.23	58.66	65.78	-7.12	QP
0.1540	30.38	9.23	39.61	55.78	-16.17	AVG
0.1940	42.88	9.23	52.11	63.86	-11.75	QP
0.1940	25.47	9.23	34.70	53.86	-19.16	AVG
0.2460	38.71	9.18	47.89	61.89	-14.00	QP
0.2460	20.47	9.18	29.65	51.89	-22.24	AVG
0.4220	34.55	9.22	43.77	57.41	-13.64	QP
0.4220	22.91	9.22	32.13	47.41	-15.28	AVG
0.9700	32.42	9.25	41.67	56.00	-14.33	QP
0.9700	14.02	9.25	23.27	46.00	-22.73	AVG
27.1580	37.15	10.00	47.15	60.00	-12.85	QP
27.1580	26.30	10.00	36.30	50.00	-13.70	AVG

Remark:

1. All readings are Quasi-Peak and Average values.
2. Margin = Result (Result = Reading + Factor) - Limit

100.0 dBuV

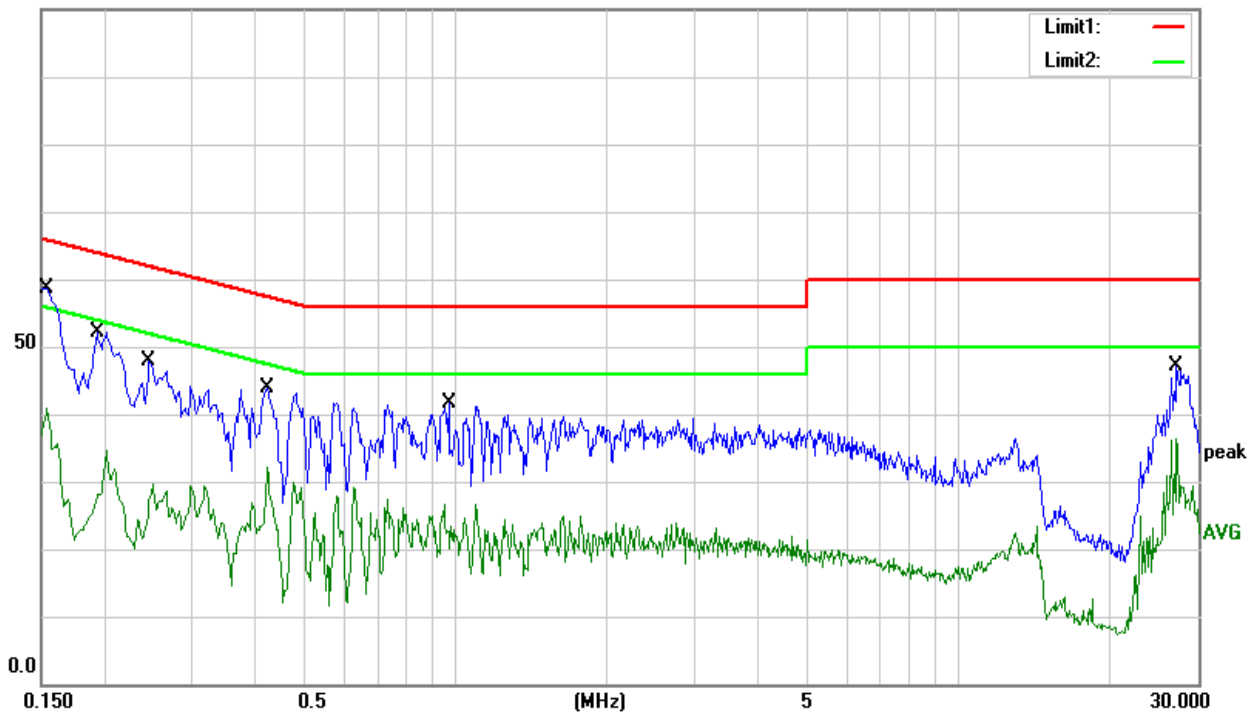



3.2 RADIATED EMISSION MEASUREMENT

3.2.1 RADIATED EMISSION LIMITS

in any 100 kHz bandwidth outside the operating frequency band. In case the emission fall within the restricted band specified on Part15.205(a)&209(a) limit in the table below has to be followed.

LIMITS OF RADIATED EMISSION MEASUREMENT (0.009MHz - 1000MHz)

Frequencies (MHz)	Field Strength (micorvolts/meter)	Measurement Distance (meters)
0.009~0.490	2400/F(KHz)	300
0.490~1.705	24000/F(KHz)	30
1.705~30.0	30	30
30~88	100	3
88~216	150	3
216~960	200	3
Above 960	500	3

LIMITS OF RADIATED EMISSION MEASUREMENT (1GHz-25 GHz)

FREQUENCY (MHz)	Class B (dBuV/m) (at 3M)	
	PEAK	AVERAGE
Above 1000	74	54

Notes:

- (1) The limit for radiated test was performed according to FCC PART 15C.
- (2) The tighter limit applies at the band edges.
- (3) Emission level (dBuV/m)=20log Emission level (uV/m).

For Radiated Emission

Spectrum Parameter	Setting
Attenuation	Auto
Detector	Peak
Start Frequency	1000 MHz(Peak/AV)
Stop Frequency	10 th carrier hamonic(Peak/AV)
RB / VB (emission in restricted band)	PK=1MHz / 1MHz, AV=1 MHz / 10 Hz

For Band edge

Spectrum Parameter	Setting
Detector	Peak
Start/Stop Frequency	Lower Band Edge: 2300 to 2430 MHz Upper Band Edge: 2450 to 2500 MHz
RB / VB (emission in restricted band)	PK=1MHz / 1MHz, AV=1 MHz / 10 Hz



Receiver Parameter	Setting
Attenuation	Auto
Start ~ Stop Frequency	9kHz~90kHz / RB 200Hz for PK & AV
Start ~ Stop Frequency	90kHz~110kHz / RB 200Hz for QP
Start ~ Stop Frequency	110kHz~490kHz / RB 200Hz for PK & AV
Start ~ Stop Frequency	490kHz~30MHz / RB 9kHz for QP
Start ~ Stop Frequency	30MHz~1000MHz / RB 120kHz for QP

3.2.2 TEST PROCEDURE

- The measuring distance of at 3 m shall be used for measurements at frequency 0.009MHz up to 1GHz, and above 1GHz.
- The EUT was placed on the top of a rotating table 0.8 meters (above 1GHz is 1.5 m) above the ground at a 3 meter anechoic chamber test site. The table was rotated 360 degrees to determine the position of the highest radiation.
- The height of the equipment shall be 0.8 m (above 1GHz is 1.5 m); the height of the test antenna shall vary between 1 m to 4 m. horizontal and vertical polarizations of the antenna are set to make the measurement.
- The initial step in collecting conducted emission data is a spectrum analyzer peak detector mode pre-scanning the measurement frequency range. Significant peaks are then marked and then QuasiPeak detector mode re-measured.
- If the Peak Mode measured value compliance with and lower than Quasi Peak Mode Limit, the EUT shall be deemed to meet QP Limits and then no additional QP Mode measurement performed.
- For the actual test configuration, please refer to the related Item –EUT Test Photos.

Note:

Both horizontal and vertical antenna polarities were tested and performed pretest to three orthogonal axis. The worst case emissions were reported

3.2.3 DEVIATION FROM TEST STANDARD

No deviation

3.2.4 TESTSETUP

(A) Radiated Emission Test-Up Frequency Below 30MHz

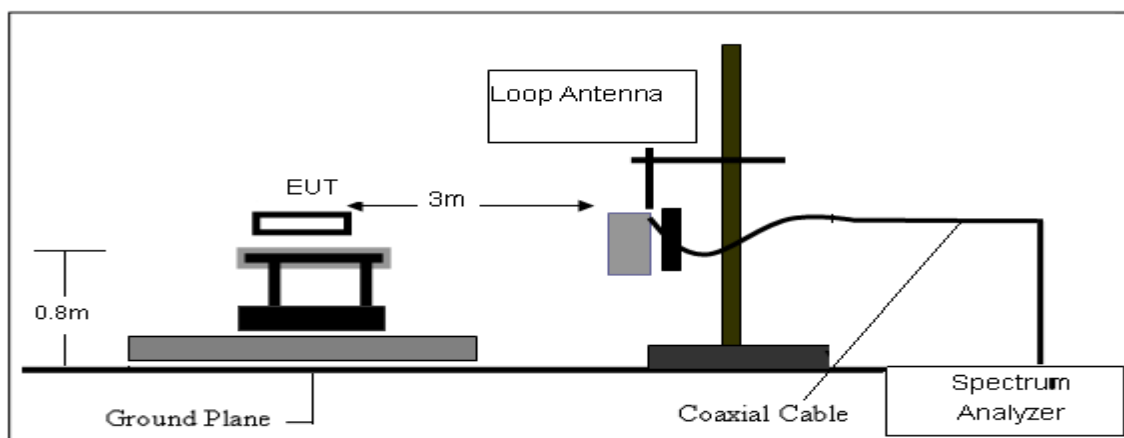

(B) Radiated Emission Test-Up Frequency 30MHz~1GHz

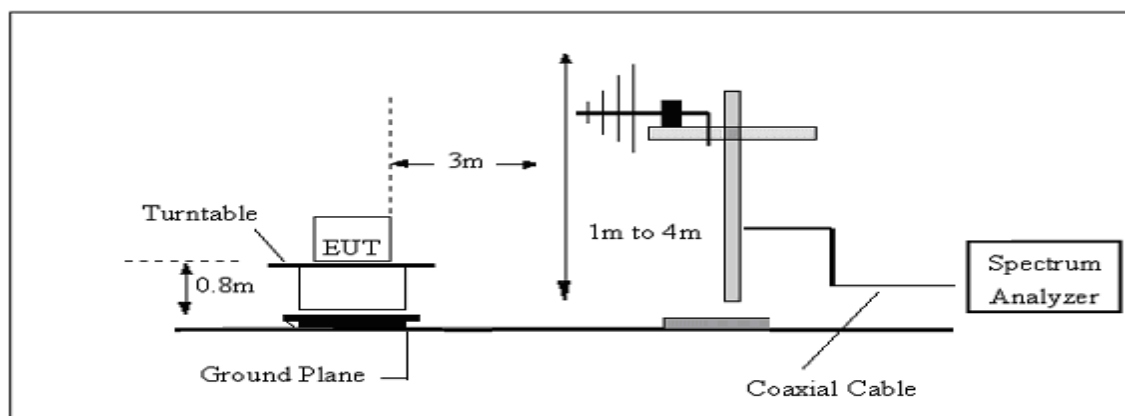

(C) Radiated Emission Test-Up Frequency Above 1GHz

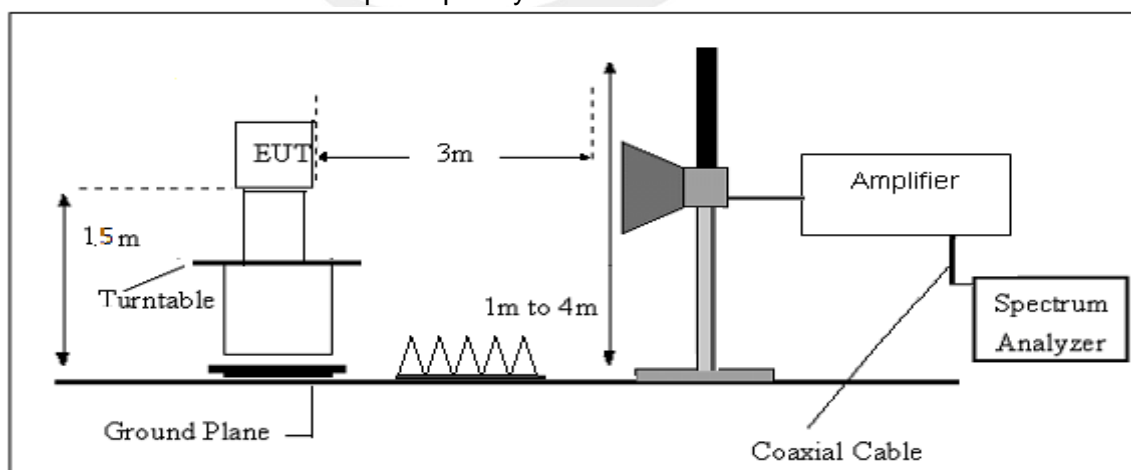

3.2.5 EUT OPERATING CONDITIONS

The EUT tested system was configured as the statements of 2.4 Unless otherwise a special operating condition is specified in the follows during the testing.



3.2.6 TEST RESULTS

(9KHz-30MHz)

Temperature:	26 °C	Relative Humidity:	54%
Pressure:	1010hPa	Test Mode:	TX Mode
Test Voltage:	DC 3.8V from battery		

Freq. (MHz)	Reading (dBuV/m)	Limit (dBuV/m)	Margin (dB)	State P/F	Test Result
--	--	--	--	--	PASS
--	--	--	--	--	PASS

Note:

The amplitude of spurious emissions which are attenuated by more than 20dB below the permissible value has no need to be reported.

Distance extrapolation factor = $40 \log (\text{specific distance}/\text{test distance})$ (dB);

Limit line = specific limits(dBuv) + distance extrapolation factor.

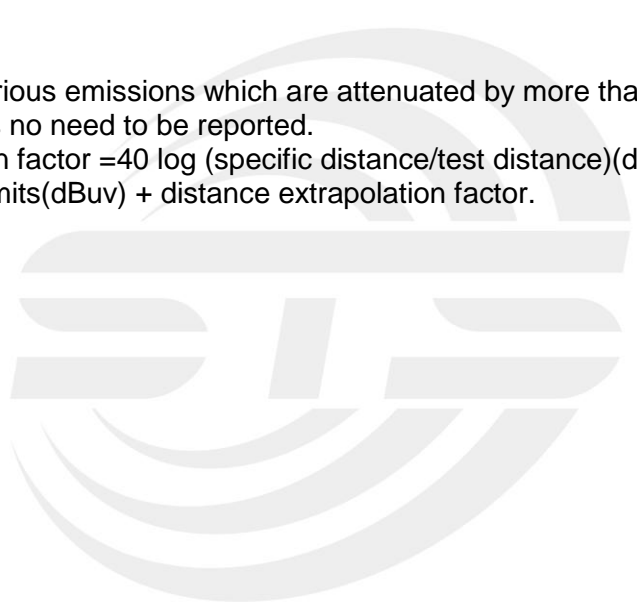



(30MHz-1000MHz)

Temperature:	26 °C	Relative Humidity:	54%
Pressure:	1010hPa	Phase:	Horizontal
Test Voltage:	DC 3.8V from battery	Test Mode:	Mode 1/2/3/4/5/6/7/8/9 (Mode 1-1M worst mode)

Frequency (MHz)	Reading (dBuV)	Correct Factor(dB/m)	Result (dBuV/m)	Limit (dBuV/m)	Margin (dB)	Remark
47.8260	44.38	-20.36	24.02	40.00	-15.98	QP
68.6310	42.60	-24.14	18.46	40.00	-21.54	QP
94.0980	43.09	-19.78	23.31	43.50	-20.19	QP
112.1305	39.08	-18.20	20.88	43.50	-22.62	QP
159.2251	41.68	-18.46	23.22	43.50	-20.28	QP
689.5644	37.19	-5.57	31.62	46.00	-14.38	QP

Remark:

1. Margin = Result (Result =Reading + Factor)–Limit

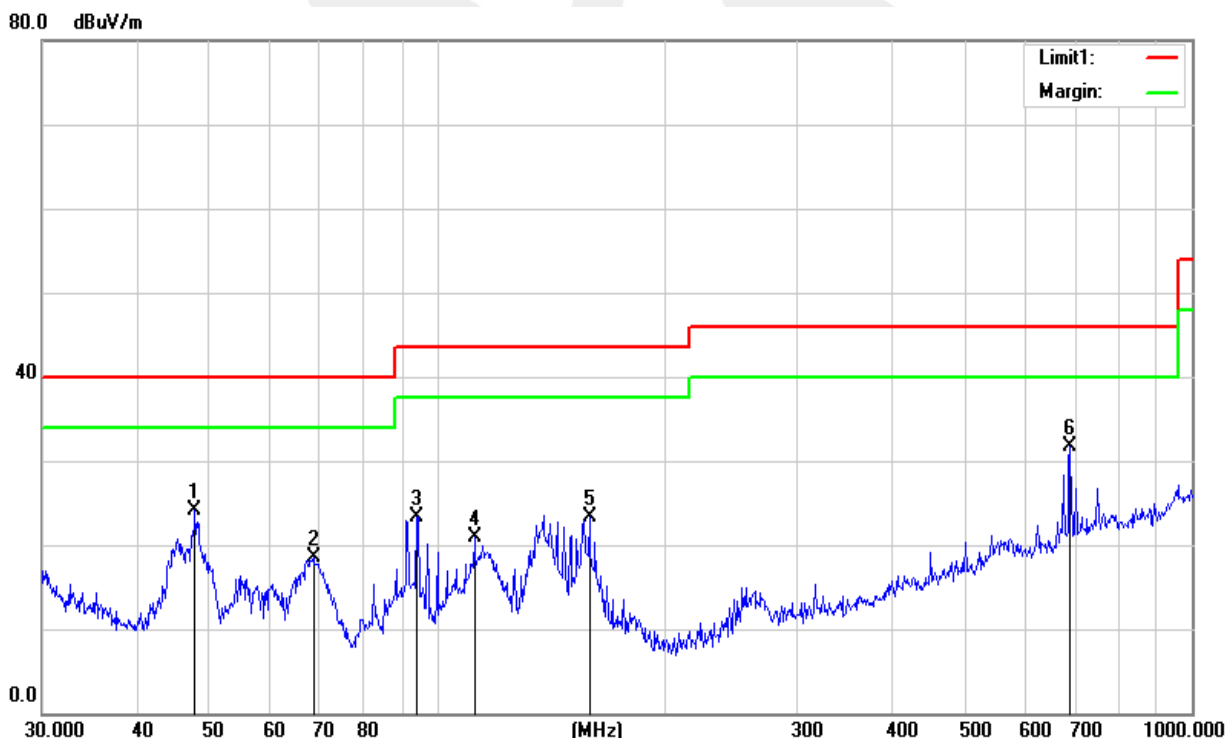



Temperature:	26 °C	Relative Humidity:	54%
Pressure:	1010hPa	Phase:	Vertical
Test Voltage:	DC 3.8V from battery	Test Mode:	Mode 1/2/3/4/5/6/7/8/9 (Mode 1-1M worst mode)

Frequency (MHz)	Reading (dBuV)	Correct Factor(dB/m)	Result (dBuV/m)	Limit (dBuV/m)	Margin (dB)	Remark
94.0980	43.48	-19.78	23.70	43.50	-19.80	QP
114.9170	41.04	-18.02	23.02	43.50	-20.48	QP
136.4598	40.77	-17.52	23.25	43.50	-20.25	QP
181.9202	42.07	-19.60	22.47	43.50	-21.03	QP
375.9385	32.95	-12.73	20.22	46.00	-25.78	QP
952.0937	28.25	-0.36	27.89	46.00	-18.11	QP

Remark:

1. Margin = Result (Result =Reading + Factor)-Limit

80.0 dBuV/m

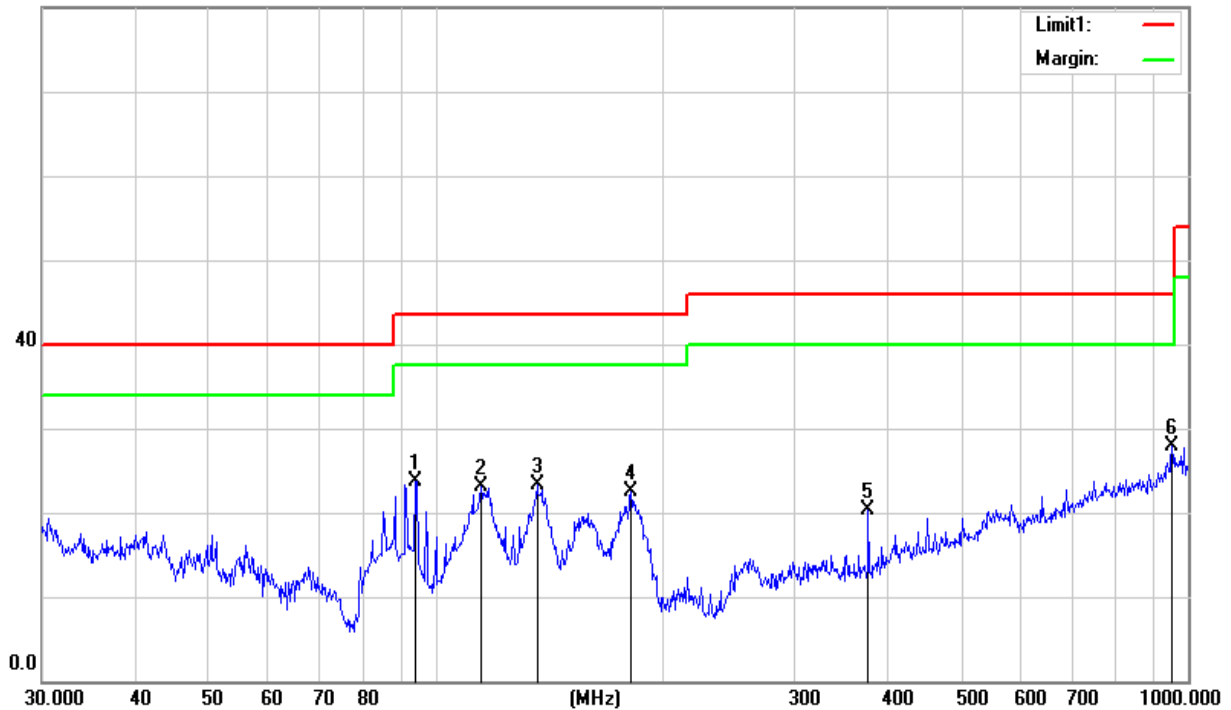



(1GHz~25GHz)

GFSK Low Channel

Meter		Antenna		Orrected	Emission					
Frequency	Reading	Amplifier	Loss	Factor	Factor	Level	Limits	Margin	Detector	
(MHz)	(dBμV)	(dB)	(dB)	(dB/m)	(dB)	(dBμV/m)	(dBμV/m)	(dB)	Type	Comment
Low Channel (2402 MHz)										
3264.81	48.59	44.70	6.70	28.20	-9.80	38.79	74.00	-35.21	PK	Vertical
3264.81	39.75	44.70	6.70	28.20	-9.80	29.95	54.00	-24.05	AV	Vertical
3264.79	49.25	44.70	6.70	28.20	-9.80	39.45	74.00	-34.55	PK	Horizontal
3264.79	38.76	44.70	6.70	28.20	-9.80	28.96	54.00	-25.04	AV	Horizontal
4804.35	58.72	44.20	9.04	31.60	-3.56	55.16	74.00	-18.84	PK	Vertical
4804.35	39.23	44.20	9.04	31.60	-3.56	35.67	54.00	-18.33	AV	Vertical
4804.41	58.97	44.20	9.04	31.60	-3.56	55.41	74.00	-18.59	PK	Horizontal
4804.41	38.82	44.20	9.04	31.60	-3.56	35.26	54.00	-18.74	AV	Horizontal
5359.72	44.96	44.20	9.86	32.00	-2.34	42.62	74.00	-31.38	PK	Vertical
5359.72	37.74	44.20	9.86	32.00	-2.34	35.40	54.00	-18.60	AV	Vertical
5359.85	45.16	44.20	9.86	32.00	-2.34	42.82	74.00	-31.18	PK	Horizontal
5359.85	37.19	44.20	9.86	32.00	-2.34	34.85	54.00	-19.15	AV	Horizontal
7205.79	51.14	43.50	11.40	35.50	3.40	54.54	74.00	-19.46	PK	Vertical
7205.79	33.42	43.50	11.40	35.50	3.40	36.82	54.00	-17.18	AV	Vertical
7205.67	51.57	43.50	11.40	35.50	3.40	54.97	74.00	-19.03	PK	Horizontal
7205.67	32.52	43.50	11.40	35.50	3.40	35.92	54.00	-18.08	AV	Horizontal
11035.87	40.68	43.60	14.30	39.50	10.20	50.88	74.00	-23.12	PK	Vertical
11035.87	30.50	43.60	14.30	39.50	10.20	40.70	54.00	-13.30	AV	Vertical
11036.24	40.58	43.60	14.30	39.50	10.20	50.78	74.00	-23.22	PK	Horizontal
11036.24	30.07	43.60	14.30	39.50	10.20	40.27	54.00	-13.73	AV	Horizontal
13299.34	39.99	42.60	15.90	38.90	12.20	52.19	74.00	-21.81	PK	Vertical
13299.34	28.54	42.60	15.90	38.90	12.20	40.74	54.00	-13.26	AV	Vertical
13299.31	39.83	42.60	15.90	38.90	12.20	52.03	74.00	-21.97	PK	Horizontal
13299.31	29.64	42.60	15.90	38.90	12.20	41.84	54.00	-12.16	AV	Horizontal
15999.66	40.25	42.70	18.00	37.10	12.40	52.65	74.00	-21.35	PK	Vertical
15999.66	28.64	42.70	18.00	37.10	12.40	41.04	54.00	-12.96	AV	Vertical
15999.62	40.10	42.70	18.00	37.10	12.40	52.50	74.00	-21.50	PK	Horizontal
15999.62	29.03	42.70	18.00	37.10	12.40	41.43	54.00	-12.57	AV	Horizontal
17997.79	30.96	42.70	19.40	46.50	23.20	54.16	74.00	-19.84	PK	Vertical
17997.79	19.64	42.70	19.40	46.50	23.20	42.84	54.00	-11.16	AV	Vertical
17997.57	29.85	42.70	19.40	46.50	23.20	53.05	74.00	-20.95	PK	Horizontal
17997.57	17.91	42.70	19.40	46.50	23.20	41.11	54.00	-12.89	AV	Horizontal



GFSK Mid Channel

Meter		Antenna		Corrected		Emission				
Frequency	Reading	Amplifier	Loss	Factor	Factor	Level	Limits	Margin	Detector	
(MHz)	(dBμV)	(dB)	(dB)	(dB/m)	(dB)	(dBμV/m)	(dBμV/m)	(dB)	Type	Comment
Low Channel (2441 MHz)										
3264.72	48.12	44.70	6.70	28.20	-9.80	38.32	74.00	-35.68	PK	Vertical
3264.72	38.06	44.70	6.70	28.20	-9.80	28.26	54.00	-25.74	AV	Vertical
3264.63	48.07	44.70	6.70	28.20	-9.80	38.27	74.00	-35.73	PK	Horizontal
3264.63	37.98	44.70	6.70	28.20	-9.80	28.18	54.00	-25.82	AV	Horizontal
4882.39	59.51	44.20	9.04	31.60	-3.56	55.95	74.00	-18.05	PK	Vertical
4882.39	38.25	44.20	9.04	31.60	-3.56	34.69	54.00	-19.31	AV	Vertical
4882.32	59.05	44.20	9.04	31.60	-3.56	55.49	74.00	-18.51	PK	Horizontal
4882.32	38.41	44.20	9.04	31.60	-3.56	34.85	54.00	-19.15	AV	Horizontal
5359.82	45.81	44.20	9.86	32.00	-2.34	43.47	74.00	-30.53	PK	Vertical
5359.82	37.52	44.20	9.86	32.00	-2.34	35.18	54.00	-18.82	AV	Vertical
5359.70	45.29	44.20	9.86	32.00	-2.34	42.95	74.00	-31.05	PK	Horizontal
5359.70	37.17	44.20	9.86	32.00	-2.34	34.83	54.00	-19.17	AV	Horizontal
7313.76	51.66	43.50	11.40	35.50	3.40	55.06	74.00	-18.94	PK	Vertical
7313.76	33.02	43.50	11.40	35.50	3.40	36.42	54.00	-17.58	AV	Vertical
7313.93	51.12	43.50	11.40	35.50	3.40	54.52	74.00	-19.48	PK	Horizontal
7313.93	33.58	43.50	11.40	35.50	3.40	36.98	54.00	-17.02	AV	Horizontal
9607.94	40.40	43.60	14.30	39.50	10.20	50.60	74.00	-23.40	PK	Vertical
9607.94	31.19	43.60	14.30	39.50	10.20	41.39	54.00	-12.61	AV	Vertical
9608.11	40.64	43.60	14.30	39.50	10.20	50.84	74.00	-23.16	PK	Horizontal
9608.11	30.91	43.60	14.30	39.50	10.20	41.11	54.00	-12.89	AV	Horizontal
13299.38	40.62	42.60	15.90	38.90	12.20	52.82	74.00	-21.18	PK	Vertical
13299.38	28.54	42.60	15.90	38.90	12.20	40.74	54.00	-13.26	AV	Vertical
13299.42	40.31	42.60	15.90	38.90	12.20	52.51	74.00	-21.49	Pk	Horizontal
13299.42	29.26	42.60	15.90	38.90	12.20	41.46	54.00	-12.54	AV	Horizontal
15999.93	40.67	42.70	18.00	37.10	12.40	53.07	74.00	-20.93	PK	Vertical
15999.93	28.64	42.70	18.00	37.10	12.40	41.04	54.00	-12.96	AV	Vertical
15999.60	40.88	42.70	18.00	37.10	12.40	53.28	74.00	-20.72	PK	Horizontal
15999.60	29.08	42.70	18.00	37.10	12.40	41.48	54.00	-12.52	AV	Horizontal
17997.69	30.63	42.70	19.40	46.50	23.20	53.83	74.00	-20.17	PK	Vertical
17997.69	19.49	42.70	19.40	46.50	23.20	42.69	54.00	-11.31	AV	Vertical
17997.62	30.61	42.70	19.40	46.50	23.20	53.81	74.00	-20.19	PK	Horizontal
17997.62	18.64	42.70	19.40	46.50	23.20	41.84	54.00	-12.16	AV	Horizontal



GFSK High Channel

Frequency (MHz)	Meter		Antenna		Corrected		Emission			
	Reading (dBμV)	Amplifier (dB)	Loss (dB)	Factor (dB/m)	Factor (dB)	Level (dBμV/m)	Limits (dBμV/m)	Margin (dB)	Detector Type	Comment
Low Channel (2480 MHz)										
3264.75	48.48	44.70	6.70	28.20	-9.80	38.68	74.00	-35.32	PK	Vertical
3264.75	39.05	44.70	6.70	28.20	-9.80	29.25	54.00	-24.75	AV	Vertical
3264.73	48.03	44.70	6.70	28.20	-9.80	38.23	74.00	-35.77	PK	Horizontal
3264.73	38.85	44.70	6.70	28.20	-9.80	29.05	54.00	-24.95	AV	Horizontal
4960.34	59.25	44.20	9.04	31.60	-3.56	55.69	74.00	-18.31	PK	Vertical
4960.34	38.80	44.20	9.04	31.60	-3.56	35.24	54.00	-18.76	AV	Vertical
4960.45	59.60	44.20	9.04	31.60	-3.56	56.04	74.00	-17.96	PK	Horizontal
4960.45	39.58	44.20	9.04	31.60	-3.56	36.02	54.00	-17.98	AV	Horizontal
5359.64	45.57	44.20	9.86	32.00	-2.34	43.23	74.00	-30.77	PK	Vertical
5359.64	38.09	44.20	9.86	32.00	-2.34	35.75	54.00	-18.25	AV	Vertical
5359.63	45.10	44.20	9.86	32.00	-2.34	42.76	74.00	-31.24	PK	Horizontal
5359.63	38.17	44.20	9.86	32.00	-2.34	35.83	54.00	-18.17	AV	Horizontal
7439.90	51.80	43.50	11.40	35.50	3.40	55.20	74.00	-18.80	PK	Vertical
7439.90	33.71	43.50	11.40	35.50	3.40	37.11	54.00	-16.89	AV	Vertical
7439.72	50.72	43.50	11.40	35.50	3.40	54.12	74.00	-19.88	PK	Horizontal
7439.72	33.72	43.50	11.40	35.50	3.40	37.12	54.00	-16.88	AV	Horizontal
9919.91	40.18	43.60	14.30	39.50	10.20	50.38	74.00	-23.62	PK	Vertical
9919.91	31.06	43.60	14.30	39.50	10.20	41.26	54.00	-12.74	AV	Vertical
9920.00	40.74	43.60	14.30	39.50	10.20	50.94	74.00	-23.06	PK	Horizontal
9920.00	31.05	43.60	14.30	39.50	10.20	41.25	54.00	-12.75	AV	Horizontal
13299.38	40.62	42.70	18.00	37.10	12.40	53.02	74.00	-20.98	PK	Vertical
13299.38	28.54	42.70	18.00	37.10	12.40	40.94	54.00	-13.06	AV	Vertical
13299.30	40.66	42.70	18.00	37.10	12.40	53.06	74.00	-20.94	PK	Horizontal
13299.30	29.36	42.70	18.00	37.10	12.40	41.76	54.00	-12.24	AV	Horizontal
17997.93	30.08	42.70	19.40	46.50	23.20	53.28	74.00	-20.72	PK	Vertical
17997.93	19.41	42.70	19.40	46.50	23.20	42.61	54.00	-11.39	AV	Vertical
17997.72	30.10	42.70	19.40	46.50	23.20	53.30	74.00	-20.70	PK	Horizontal
17997.72	18.68	42.70	19.40	46.50	23.20	41.88	54.00	-12.12	AV	Horizontal

Note:

- 1) Scan with GFSK, π/4-DQPSK, 8DPSK, the worst case is GFSK Mode
- 2) Factor = Antenna Factor + Cable Loss – Pre-amplifier.

Emission Level = Meter Reading + Factor



Band edge

Frequency (MHz)	Meter		Loss (dB)	Antenna		Emission		Margin (dB)	Detector Type	Comment
	Reading (dBμV)	Amplifier (dB)		Factor (dB/m)	Orrected Factor (dB)	Level (dBμV/m)	Limits (dBμV/m)			
GFSK										
2400.00	68.65	43.80	4.91	25.90	-12.99	55.66	74	-18.34	PK	Vertical
2400.00	54.17	43.80	4.91	25.90	-12.99	41.18	54	-12.82	AV	Vertical
2400.00	69.04	43.80	4.91	25.90	-12.99	56.05	74	-17.95	PK	Horizontal
2400.00	52.64	43.80	4.91	25.90	-12.99	39.65	54	-14.35	AV	Horizontal
2483.50	70.29	43.80	5.12	25.90	-12.78	57.51	74	-16.49	PK	Vertical
2483.50	53.07	43.80	5.12	25.90	-12.78	40.29	54	-13.71	AV	Vertical
2483.50	69.41	43.80	5.12	25.90	-12.78	56.63	74	-17.37	PK	Horizontal
2483.50	53.51	43.80	5.12	25.90	-12.78	40.73	54	-13.27	AV	Horizontal
π/4-DQPSK										
2400.00	68.20	43.80	4.91	25.90	-12.99	55.21	74	-18.79	PK	Vertical
2400.00	53.79	43.80	4.91	25.90	-12.99	40.80	54	-13.20	AV	Vertical
2400.00	68.33	43.80	4.91	25.90	-12.99	55.34	74	-18.66	PK	Horizontal
2400.00	52.99	43.80	4.91	25.90	-12.99	40.00	54	-14.00	AV	Horizontal
2483.50	69.19	43.80	5.12	25.90	-12.78	56.41	74	-17.59	PK	Vertical
2483.50	52.19	43.80	5.12	25.90	-12.78	39.41	54	-14.59	AV	Vertical
2483.50	69.48	43.80	5.12	25.90	-12.78	56.70	74	-17.30	PK	Horizontal
2483.50	53.02	43.80	5.12	25.90	-12.78	40.24	54	-13.76	AV	Horizontal
8DPSK										
2400.00	68.01	43.80	4.91	25.90	-12.99	55.02	74	-18.98	PK	Vertical
2400.00	53.33	43.80	4.91	25.90	-12.99	40.34	54	-13.66	AV	Vertical
2400.00	69.19	43.80	4.91	25.90	-12.99	56.20	74	-17.80	PK	Horizontal
2400.00	53.51	43.80	4.91	25.90	-12.99	40.52	54	-13.48	AV	Horizontal
2483.50	70.08	43.80	5.12	25.90	-12.78	57.30	74	-16.70	PK	Vertical
2483.50	52.14	43.80	5.12	25.90	-12.78	39.36	54	-14.64	AV	Vertical
2483.50	69.85	43.80	5.12	25.90	-12.78	57.07	74	-16.93	PK	Horizontal
2483.50	53.20	43.80	5.12	25.90	-12.78	40.42	54	-13.58	AV	Horizontal
<p>Low measurement frequencies is range from 2310 to 2400 MHz, high measurement frequencies is range from 2483.5 to 2500 MHz. Only showthe worst point data of the emissions in the frequency 2310-2400 MHz and 2483.5-2500 MHz.</p>										



Hopping Band edge

Frequency (MHz)	Meter		Antenna		Orrected	Emission		Margin (dB)	Detector Type	Comment
	Reading (dBμV)	Amplifier (dB)	Loss (dB)	Factor (dB/m)	Factor (dB)	Level (dBμV/m)	Limits (dBμV/m)			
GFSK										
2400.00	67.83	43.80	4.91	25.90	-12.99	54.84	74	-19.16	PK	Vertical
2400.00	54.04	43.80	4.91	25.90	-12.99	41.05	54	-12.95	AV	Vertical
2400.00	69.55	43.80	4.91	25.90	-12.99	56.56	74	-17.44	PK	Horizontal
2400.00	53.44	43.80	4.91	25.90	-12.99	40.45	54	-13.55	AV	Horizontal
2483.50	69.40	43.80	5.12	25.90	-12.78	56.62	74	-17.38	PK	Vertical
2483.50	52.72	43.80	5.12	25.90	-12.78	39.94	54	-14.06	AV	Vertical
2483.50	70.21	43.80	5.12	25.90	-12.78	57.43	74	-16.57	PK	Horizontal
2483.50	52.75	43.80	5.12	25.90	-12.78	39.97	54	-14.03	AV	Horizontal
π/4-DQPSK										
2400.00	67.43	43.80	4.91	25.90	-12.99	54.44	74	-19.56	PK	Vertical
2400.00	54.45	43.80	4.91	25.90	-12.99	41.46	54	-12.54	AV	Vertical
2400.00	69.01	43.80	4.91	25.90	-12.99	56.02	74	-17.98	PK	Horizontal
2400.00	53.22	43.80	4.91	25.90	-12.99	40.23	54	-13.77	AV	Horizontal
2483.50	70.40	43.80	5.12	25.90	-12.78	57.62	74	-16.38	PK	Vertical
2483.50	53.45	43.80	5.12	25.90	-12.78	40.67	54	-13.33	AV	Vertical
2483.50	70.36	43.80	5.12	25.90	-12.78	57.58	74	-16.42	PK	Horizontal
2483.50	52.72	43.80	5.12	25.90	-12.78	39.94	54	-14.06	AV	Horizontal
8DPSK										
2400.00	67.68	43.80	4.91	25.90	-12.99	54.69	74	-19.31	PK	Vertical
2400.00	53.62	43.80	4.91	25.90	-12.99	40.63	54	-13.37	AV	Vertical
2400.00	69.65	43.80	4.91	25.90	-12.99	56.66	74	-17.34	PK	Horizontal
2400.00	52.18	43.80	4.91	25.90	-12.99	39.19	54	-14.81	AV	Horizontal
2483.50	69.70	43.80	5.12	25.90	-12.78	56.92	74	-17.08	PK	Vertical
2483.50	52.65	43.80	5.12	25.90	-12.78	39.87	54	-14.13	AV	Vertical
2483.50	70.28	43.80	5.12	25.90	-12.78	57.50	74	-16.50	PK	Horizontal
2483.50	53.18	43.80	5.12	25.90	-12.78	40.40	54	-13.60	AV	Horizontal
<p>Low measurement frequencies is range from 2310 to 2400 MHz,high measurement frequencies is range from 2483.5 to 2500 MHz. Only showthe worst point data of the emissions in the frequency 2310-2400 MHz and 2483.5-2500 MHz.</p>										

4. CONDUCTED SPURIOUS & BAND EDGE EMISSION

4.1 REQUIREMENT

According to FCC section 15.247(d), in any 100kHz bandwidth outside the frequency band in which the spread spectrum or digitally modulated intentional radiator is operating, the radio frequency power that is produced by the intentional radiator shall be at least 20dB below that in the 100kHz bandwidth within the band that contains the highest level of the desired power, based on either an RF conducted or a radiated measurement.

4.2 TEST PROCEDURE

Spectrum Parameter	Setting
Detector	Peak
Start/Stop Frequency	30 MHz to 10th carrier harmonic
RB / VB (emission in restricted band)	100 KHz/300 KHz
Trace-Mode:	Max hold

For Band edge

Spectrum Parameter	Setting
Detector	Peak
Start/Stop Frequency	Lower Band Edge: 2310 – 2404 MHz Upper Band Edge: 2478 – 2500 MHz
RB / VB (emission in restricted band)	100 KHz/300 KHz
Trace-Mode:	Max hold

Remark : Hopping on and Hopping off mode all have been tested, only worst case hopping off is reported.

4.3 TEST SETUP

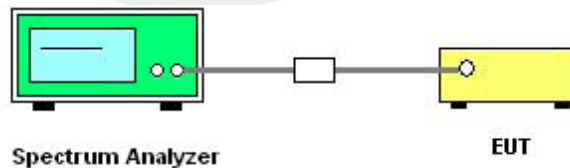

The EUT is coupled to the Spectrum Analyzer; the RF load attached to the EUT antenna terminal is 50Ohm; the path loss as the factor is calibrated to correct the reading. Make the measurement with the spectrum analyzer's resolution bandwidth(RBW) = 100 kHz. In order to make an accurate measurement, set the span greater than RBW.

4.4 EUT OPERATION CONDITIONS

The EUT tested system was configured as the statements of 2.3 Unless otherwise a special operating condition is specified in the follows during the testing.



4.5 TEST RESULTS

Temperature :	25°C	Relative Humidity :	50%
Pressure :	1012 hPa	Test Voltage :	DC 3.8V
Test Mode :	GFSK(1Mbps)-00/39/78 CH		

00 CH

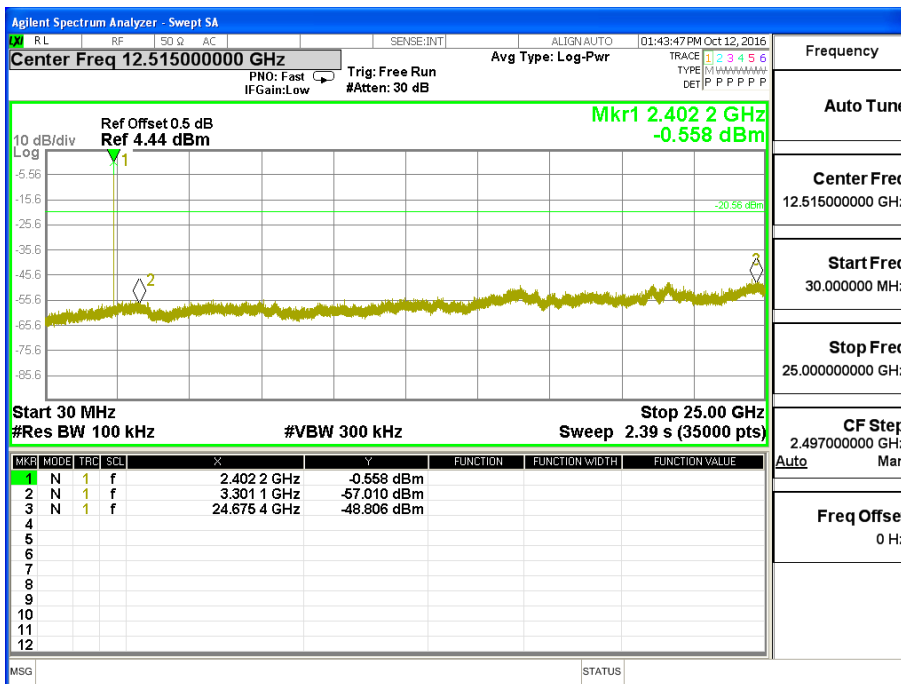

39 CH

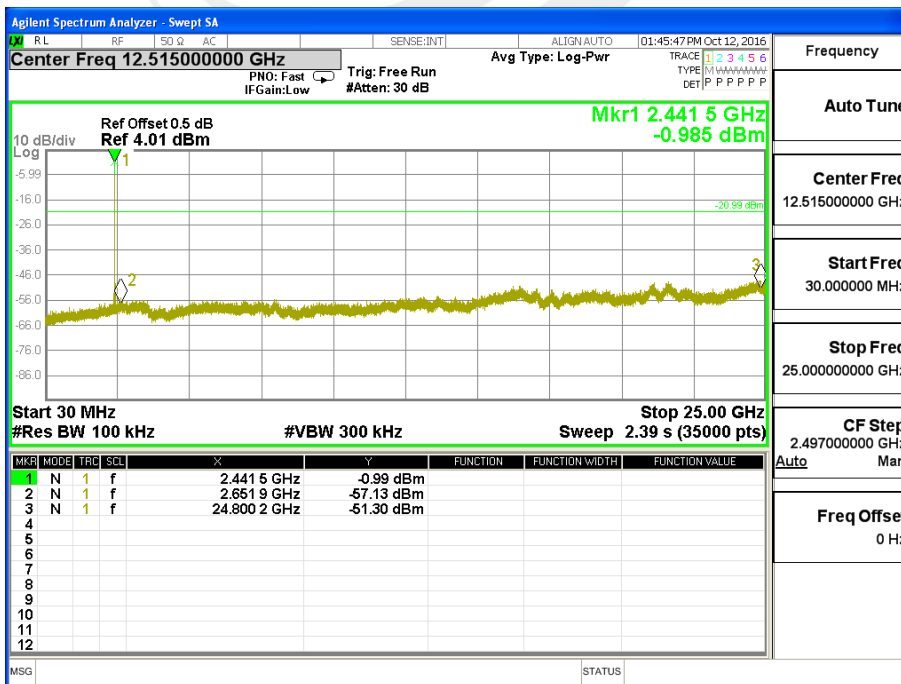



78 CH

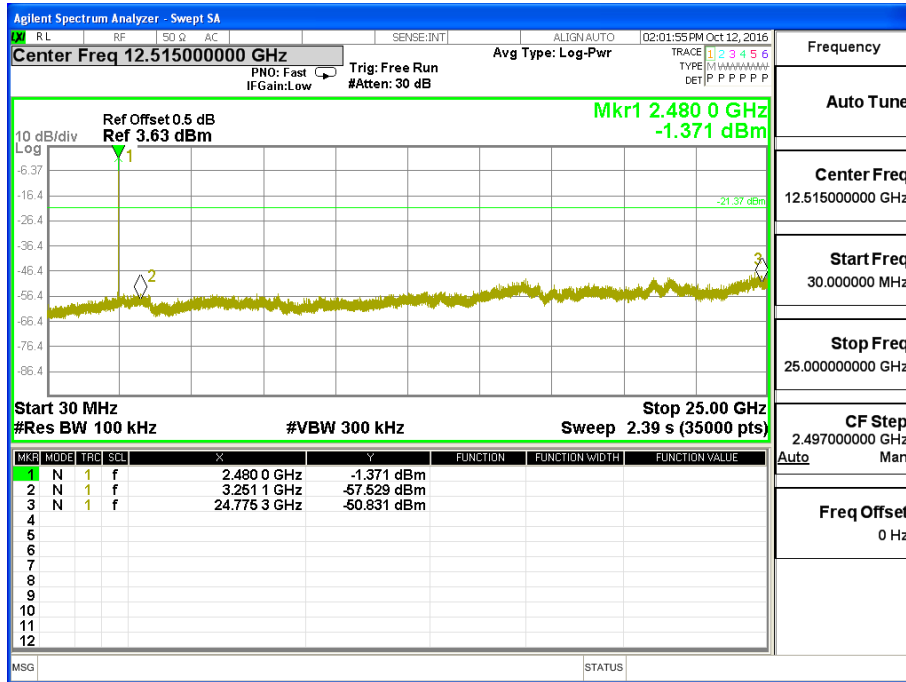



For Band edge

00 CH

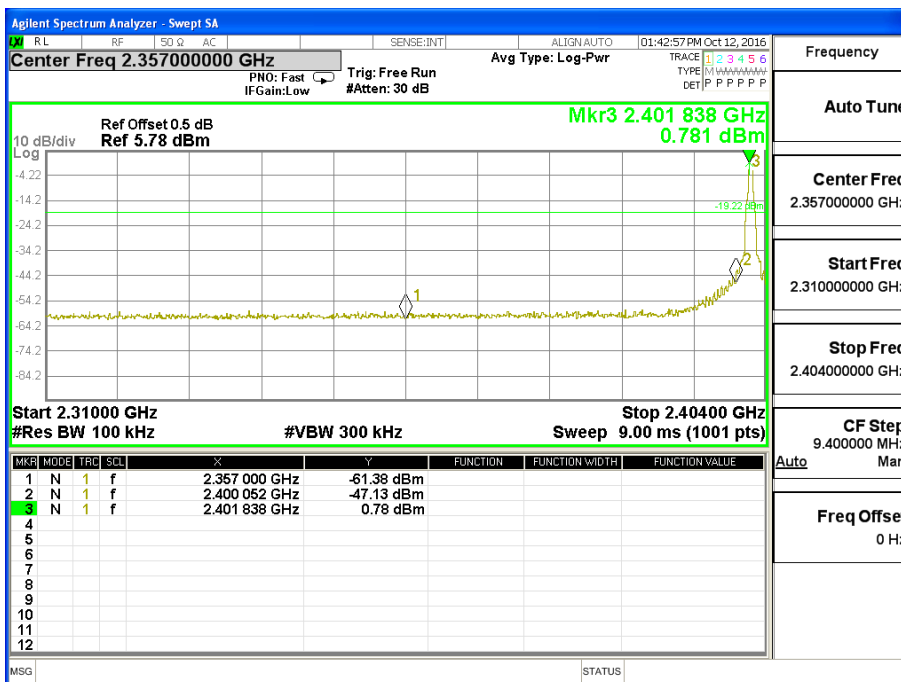

78 CH

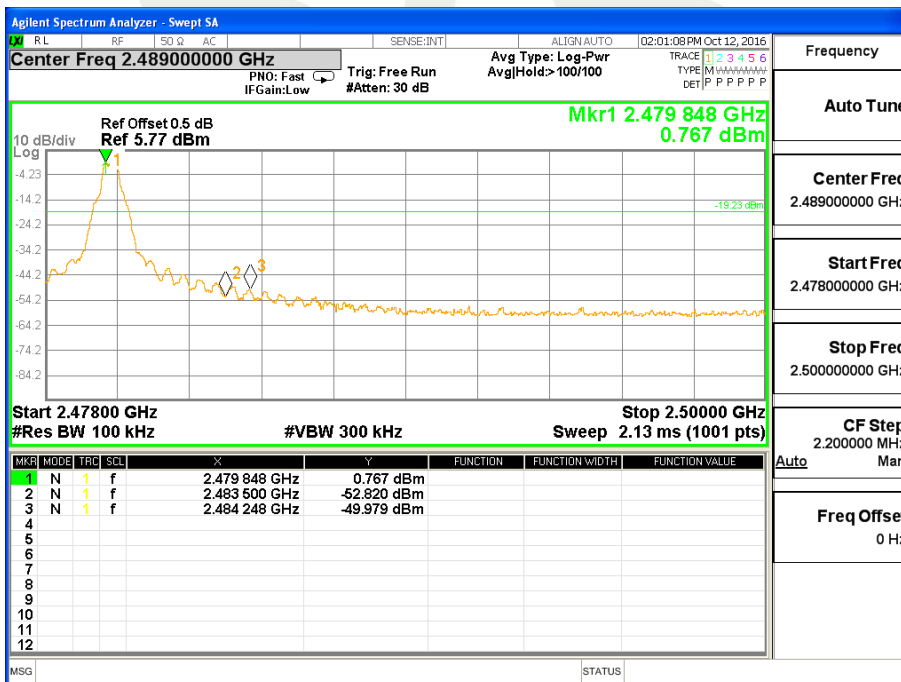



For Hopping Band edge

00 CH

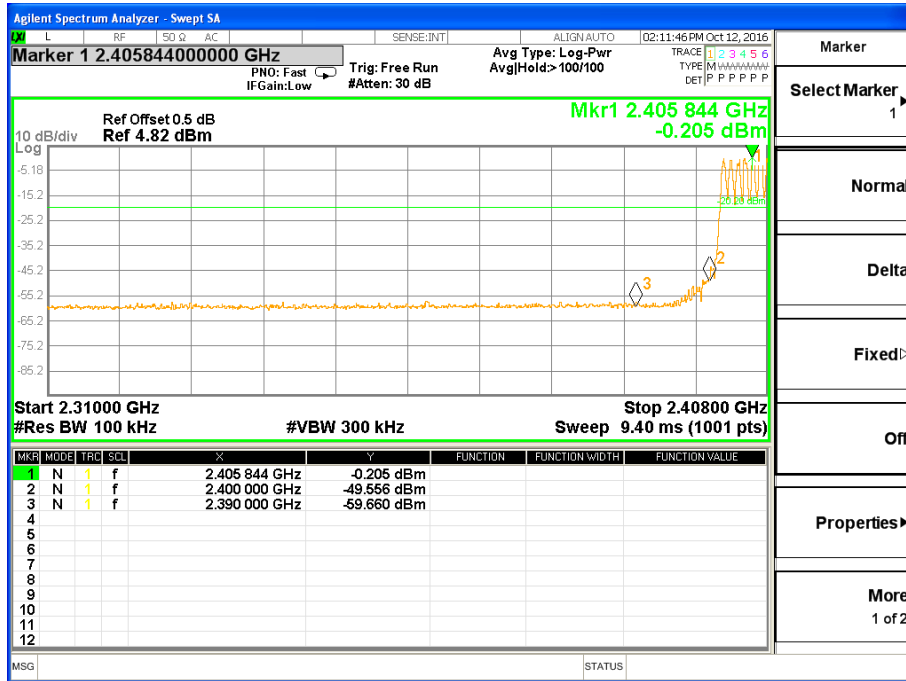

78 CH

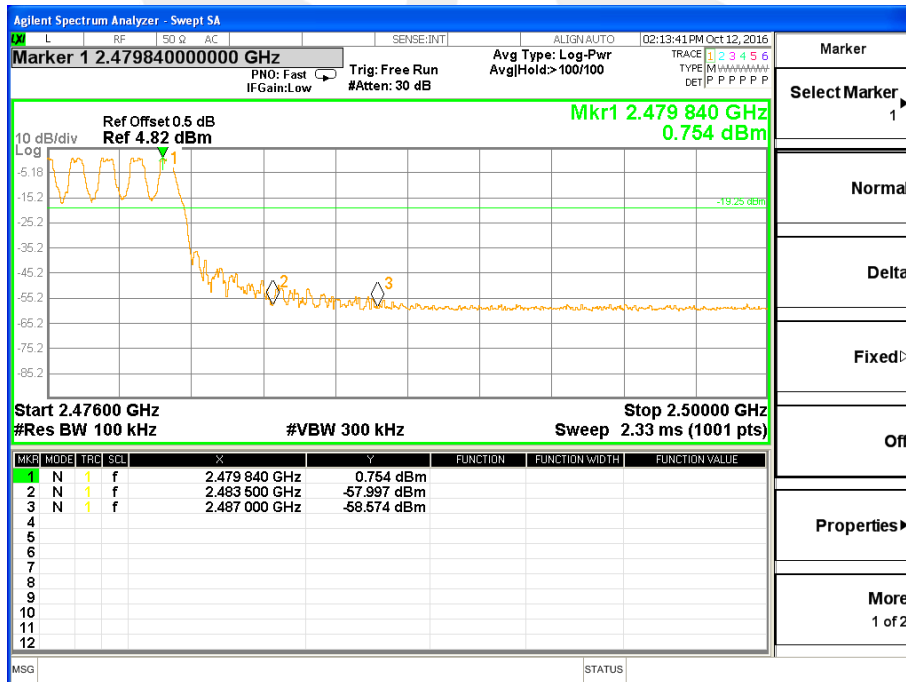



Temperature :	25°C	Relative Humidity :	50%
Pressure :	1012 hPa	Test Voltage :	DC 3.8V
Test Mode :	π/4-DQPSK(2Mbps) -00/39/78 CH		

00 CH

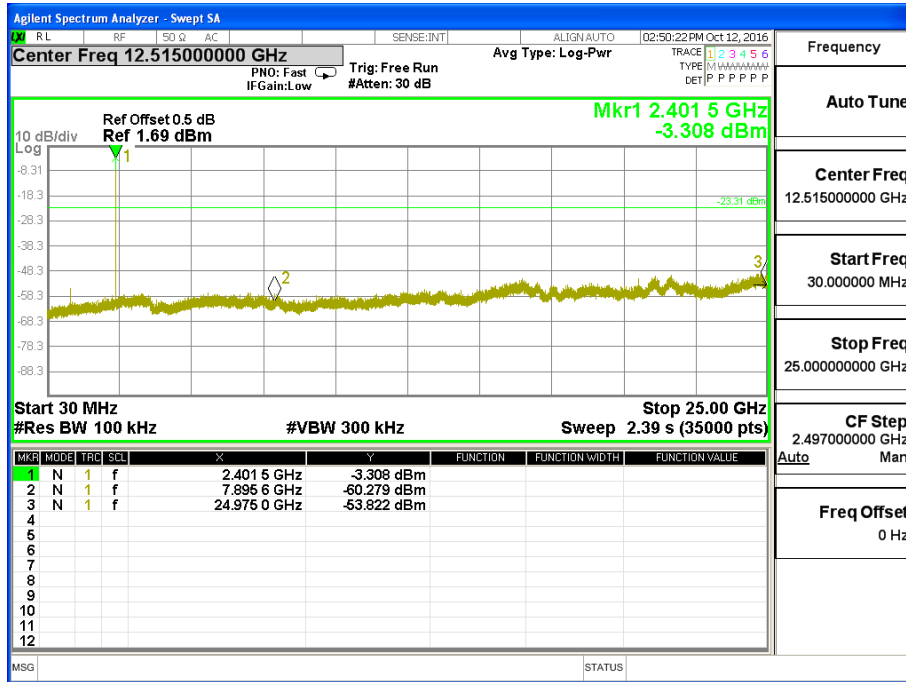

39 CH

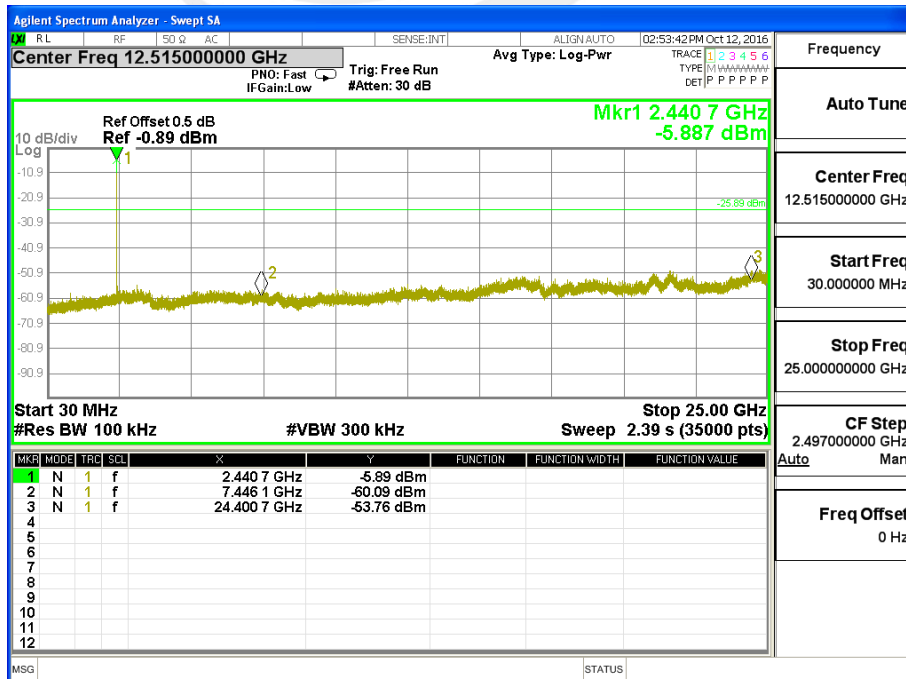



78 CH

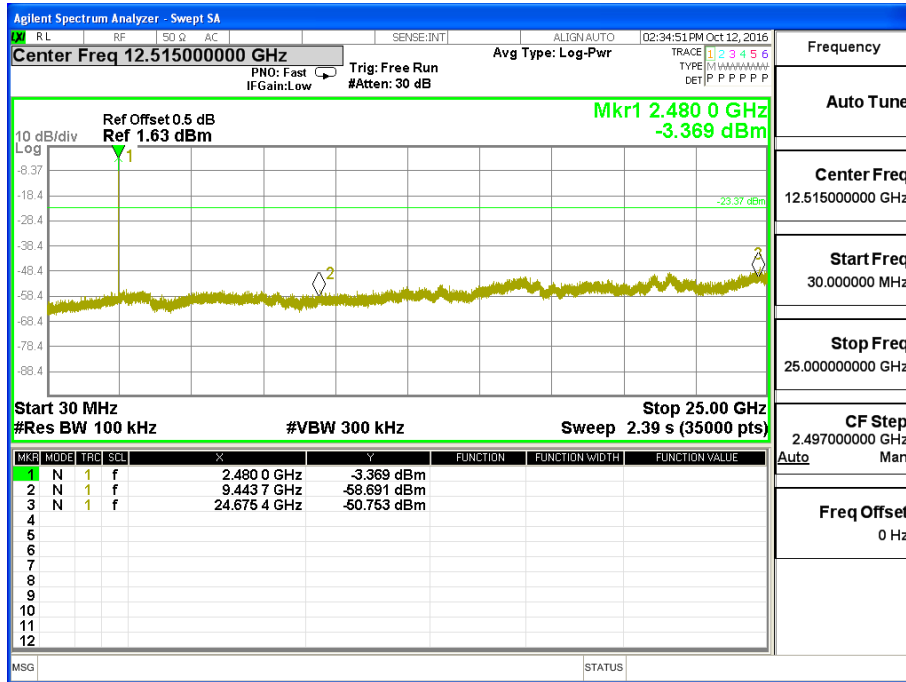



For Band edge

00 CH

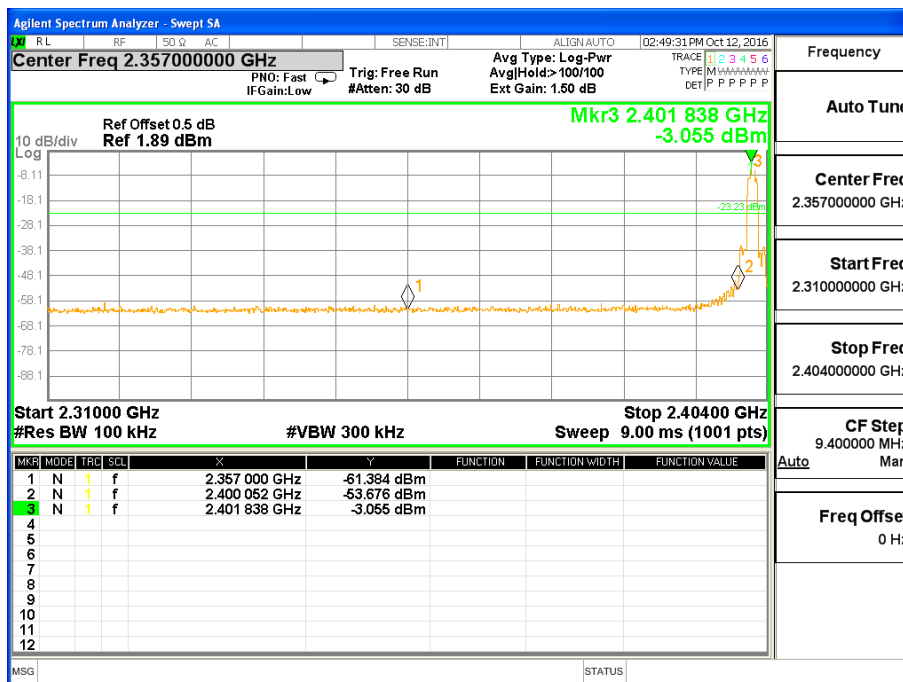

78 CH

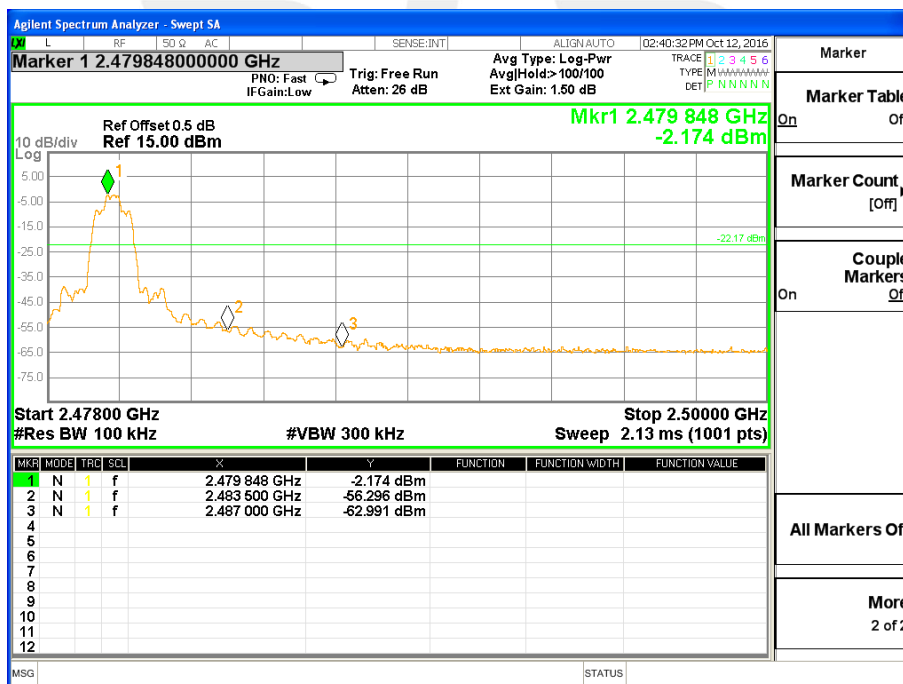



For Hopping Band edge

00 CH

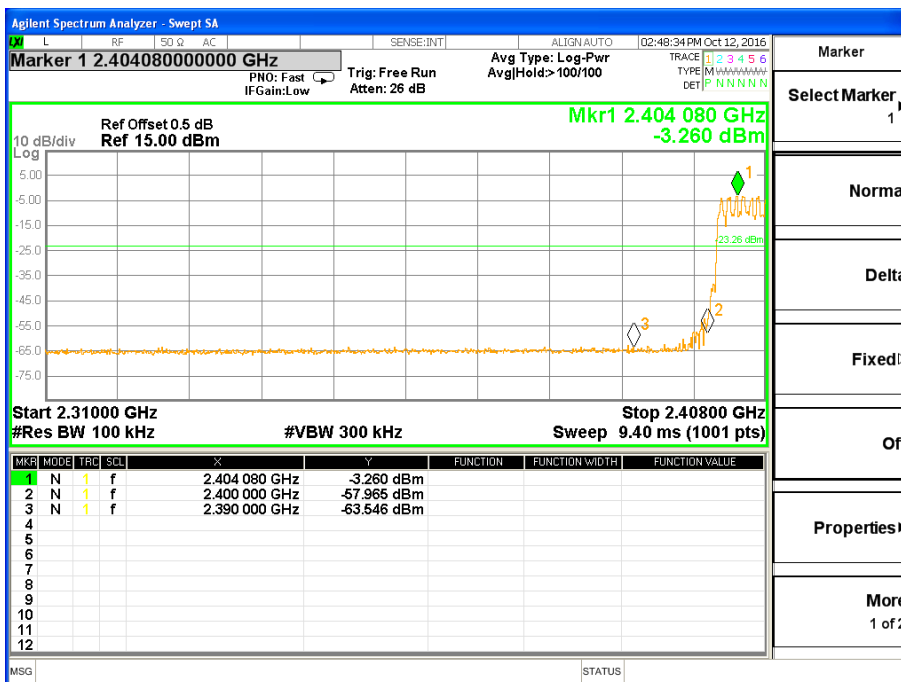

78 CH

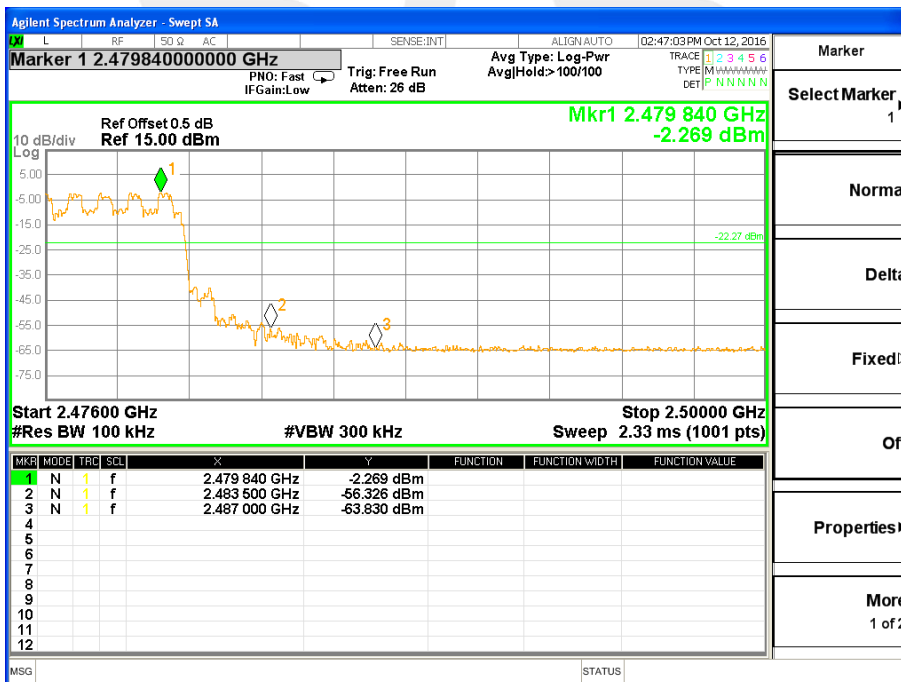



Temperature :	25°C	Relative Humidity :	50%
Pressure :	1012 hPa	Test Voltage :	DC 3.8V
Test Mode :	8-DPSK(3Mbps) -00/39/78 CH		

00 CH

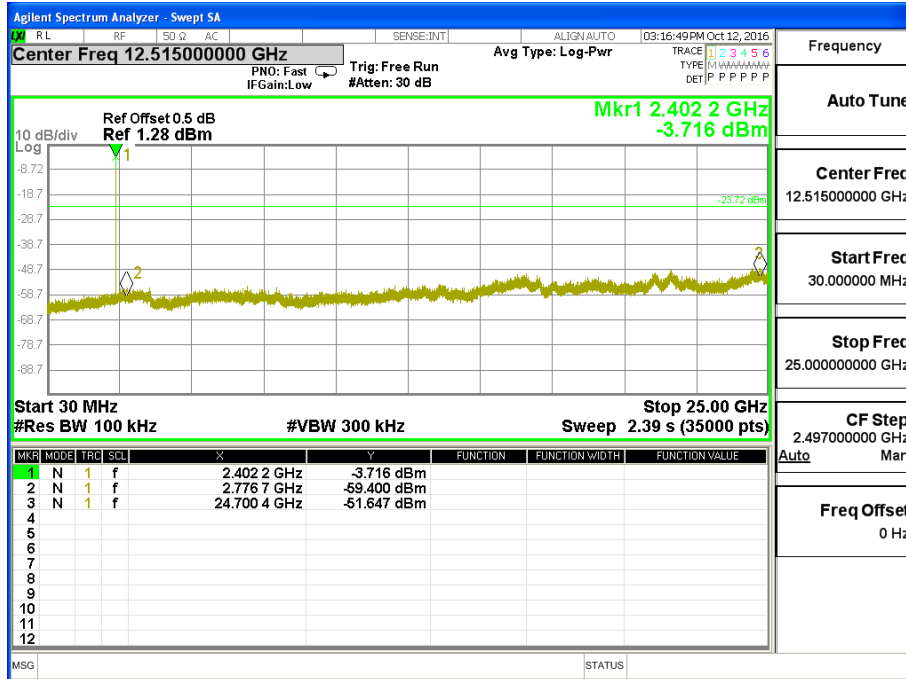

39 CH

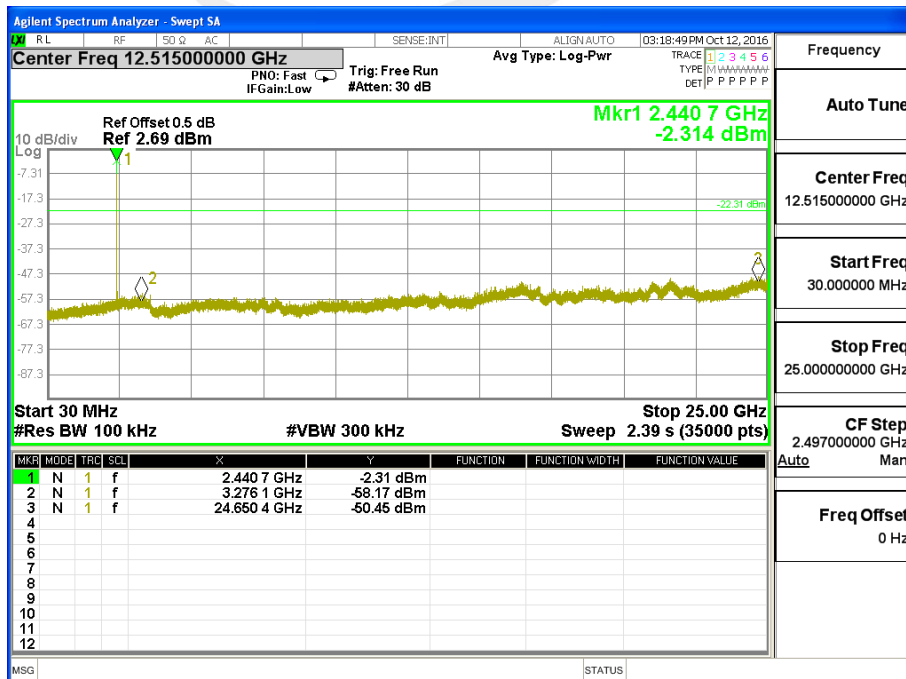



78 CH

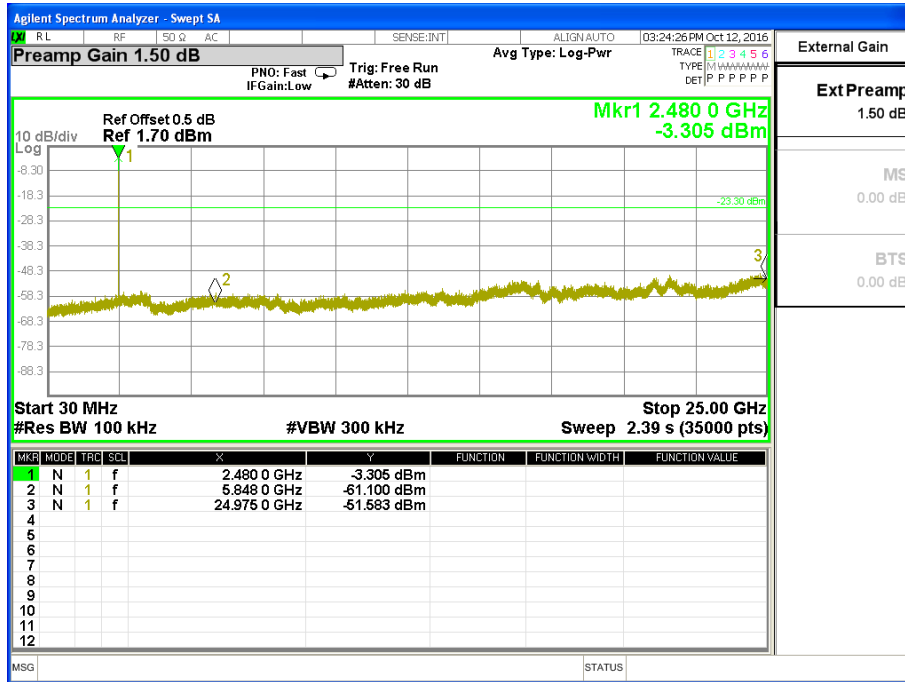



For Band edge

00 CH

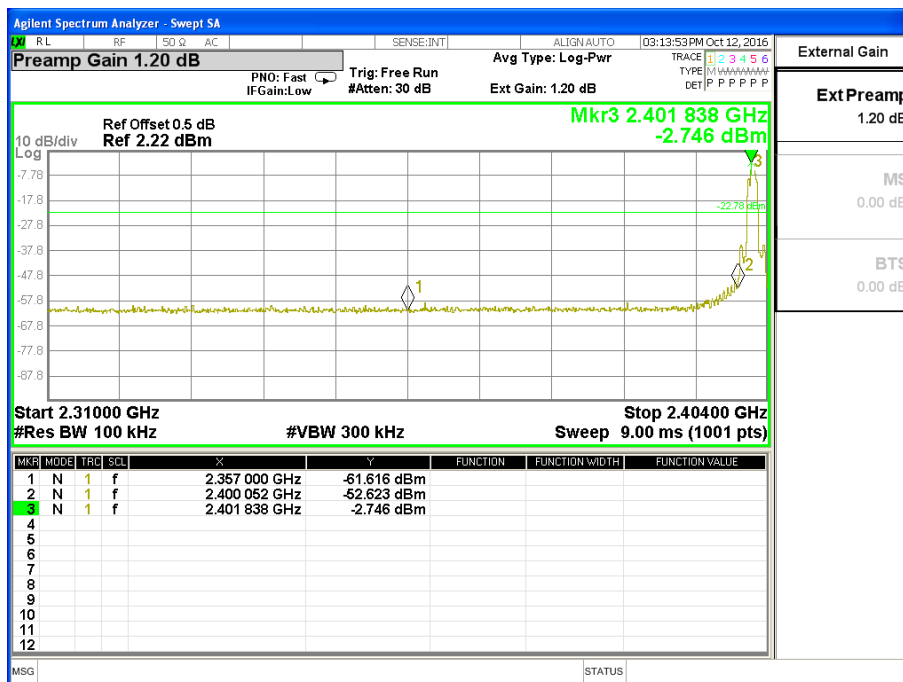

78 CH

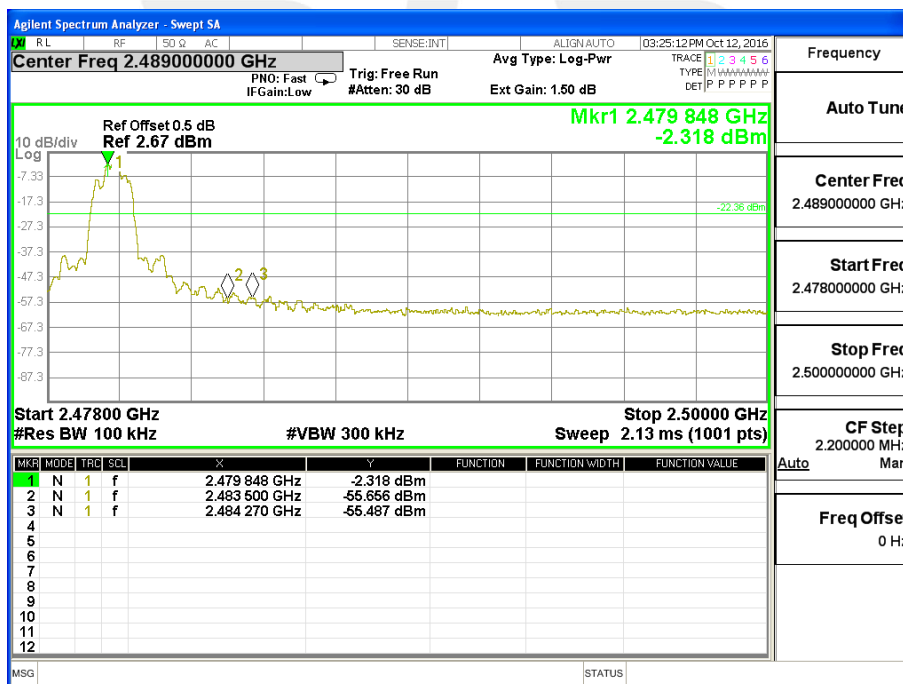



For Hopping Band edge

00 CH

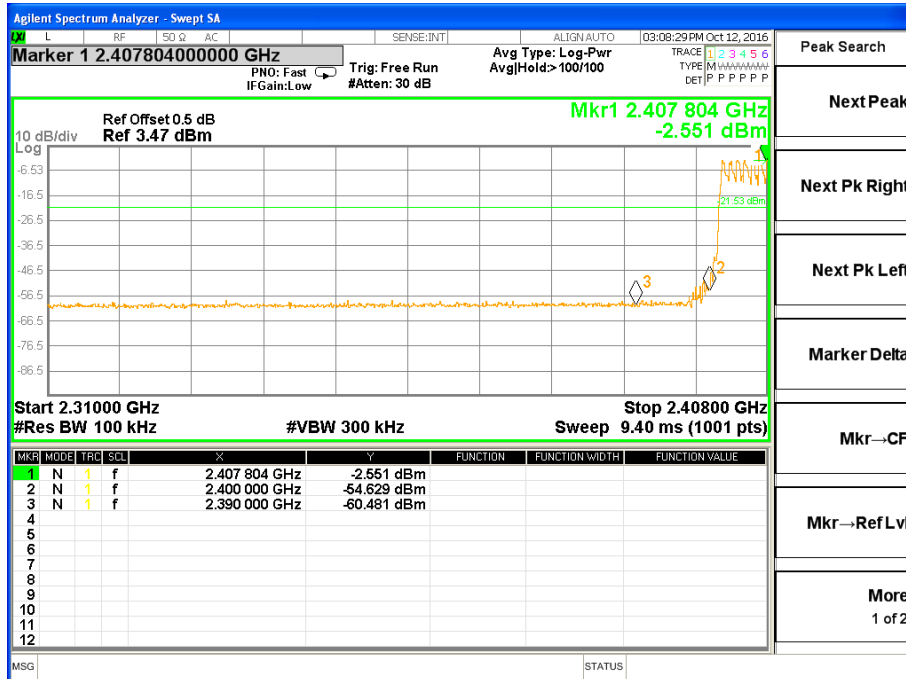

78 CH

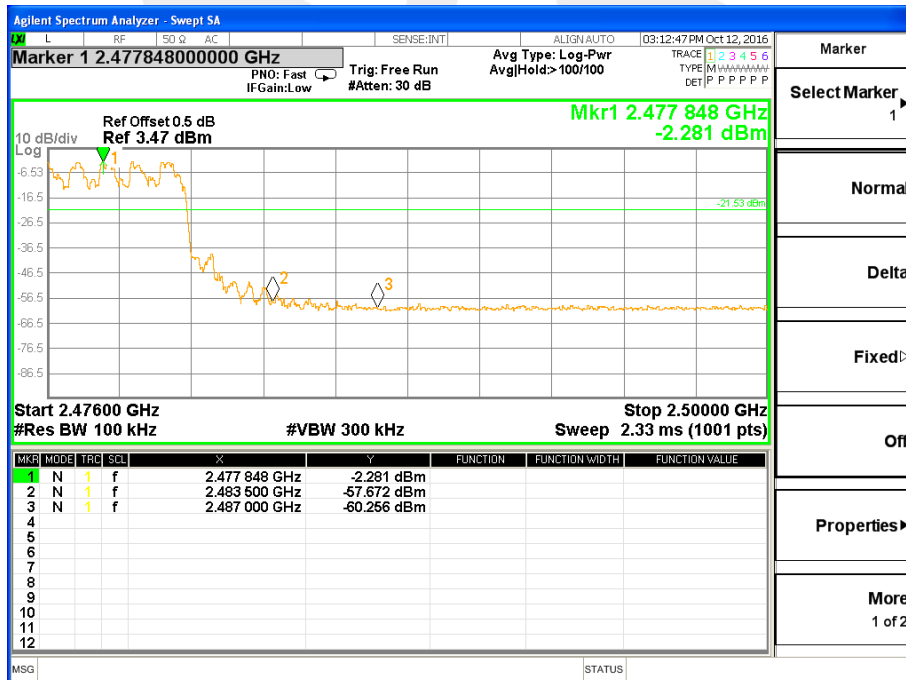



5. NUMBER OF HOPPING CHANNEL

5.1 APPLIED PROCEDURES / LIMIT

FCC Part 15.247, Subpart C				
Section	Test Item	Limit	FrequencyRange (MHz)	Result
15.247 (a)(1)(iii)	Number of Hopping Channel	≥15	2400-2483.5	PASS

Spectrum Parameters	Setting
Attenuation	Auto
Span Frequency	> Operating FrequencyRange
RB	100KHz
VB	100KHz
Detector	Peak
Trace	Max Hold
Sweep Time	Auto

5.2 TEST PROCEDURE

- The EUT was directly connected to the spectrum analyzer and antenna output port as show in the block diagram below,
- Spectrum Setting : RBW= 100KHz, VBW=100KHz, Sweep time = Auto.

5.3 TEST SETUP

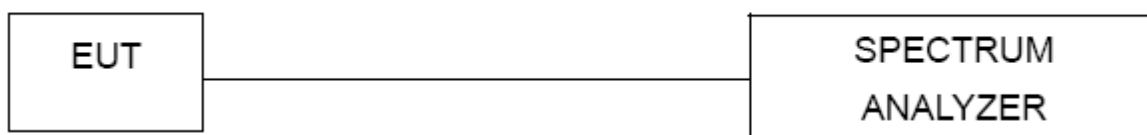

5.4 EUT OPERATION CONDITIONS

The EUT tested system was configured as the statements of 2.4 Unless otherwise a special operating condition is specified in the follows during the testing.



5.5 TEST RESULTS

Temperature :	25°C	Relative Humidity :	60%
Pressure :	1015 hPa	Test Voltage :	DC 3.8V
Test Mode :	Hopping Mode		

Number of Hopping Channel

79

Hopping channel

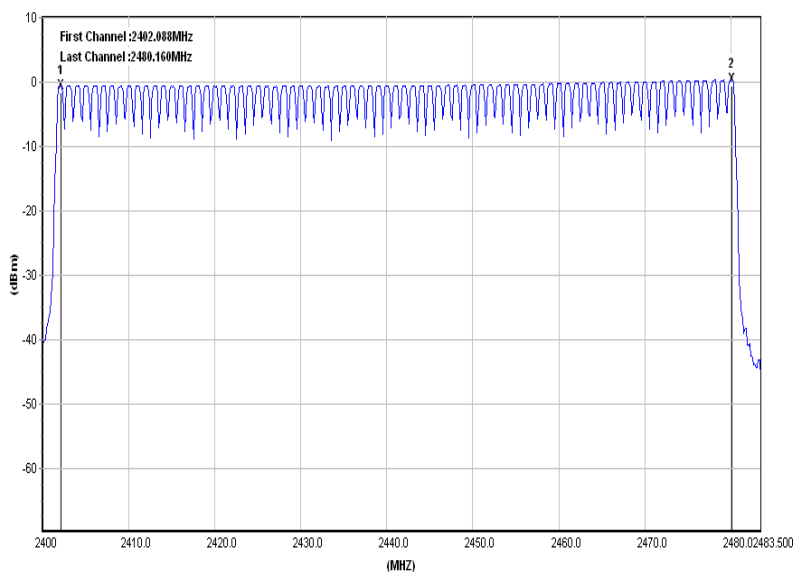



6. AVERAGE TIME OF OCCUPANCY

6.1 APPLIED PROCEDURES / LIMIT

FCC Part 15.247, Subpart C				
Section	Test Item	Limit	FrequencyRange (MHz)	Result
15.247 (a)(1)(iii)	Average Time of Occupancy	0.4sec	2400-2483.5	PASS

6.2 TEST PROCEDURE

- The transmitter output (antenna port) was connected to the spectrum analyzer
- Set RBW =1MHz/VBW =3MHz.
- Use a video trigger with the trigger level set to enable triggering only on full pulses.
- Sweep Time is more than once pulse time.
Set the center frequency on any frequency would be measure and set the frequency span to
- zero span.
- Measure the maximum time duration of one single pulse.
- Set the EUT for DH5, DH3 and DH1 packet transmitting.
- Measure the maximum time duration of one single pulse.
- DH5 Packet permit maximum $1600 / 79 / 6 = 3.37$ hops per second in each channel (5 time slots RX, 1 time slot TX). So the dwell time is the time duration of the pulse times $3.37 \times 31.6 = 106.6$ within 31.6 seconds.
- DH3 Packet permit maximum $1600 / 79 / 4 = 5.06$ hops per second in each channel (3 time slots RX, 1 time slot TX). So the dwell time is the time duration of the pulse times $5.06 \times 31.6 = 160$ within 31.6 seconds.
- DH1 Packet permit maximum $1600 / 79 / 2 = 10.12$ hops per second in each channel (1 time slot RX, 1 time slot TX). So the dwell time is the time duration of the pulse times $10.12 \times 31.6 = 320$ within 31.6 seconds.

6.3 TEST SETUP

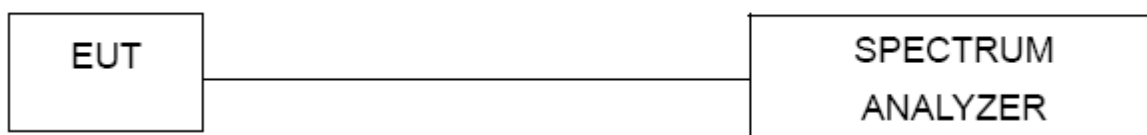

6.4 EUT OPERATION CONDITIONS

The EUT tested system was configured as the statements of 2.4 Unless otherwise a special operating condition is specified in the follows during the testing.



6.5 TEST RESULTS

Temperature :	25°C	Relative Humidity :	50%
Pressure :	1012 hPa	Test Voltage :	DC 3.8V
Test Mode :	GFSK(1Mbps)-DH1/DH3/DH5		

Data Packet	Frequency	Pulse Duration(ms)	Dwell Time(s)	Limits(s)
DH1	2441 MHz	0.370	0.118	0.4
DH3	2441 MHz	1.630	0.261	0.4
DH5	2441 MHz	2.880	0.307	0.4





CH39-DH1

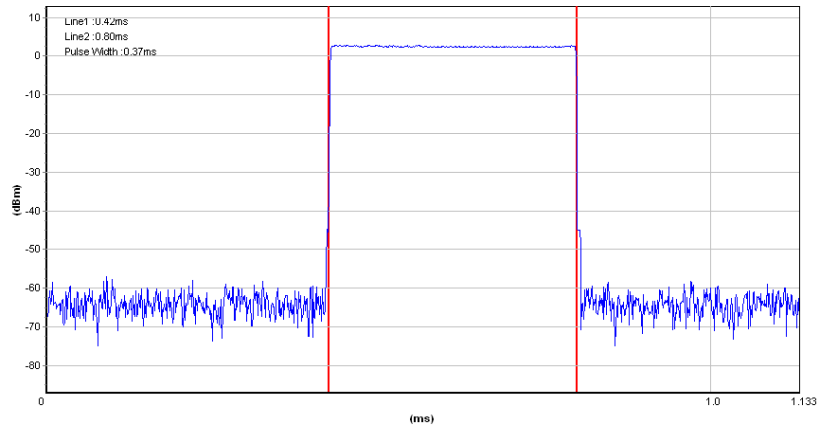

CH39-DH3

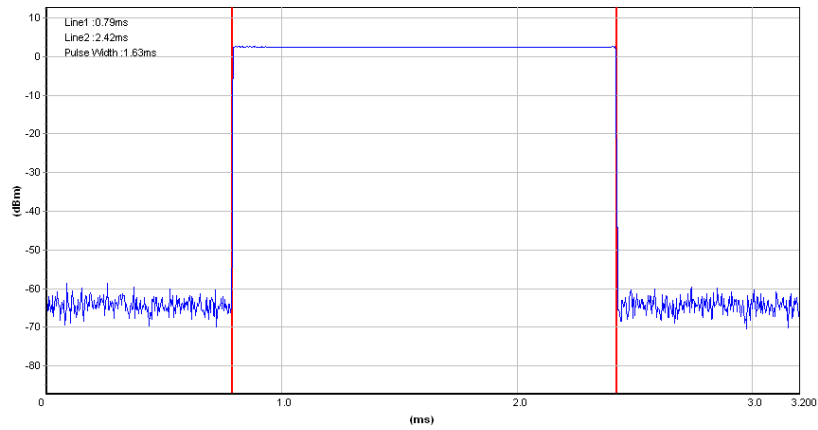

CH39-DH5

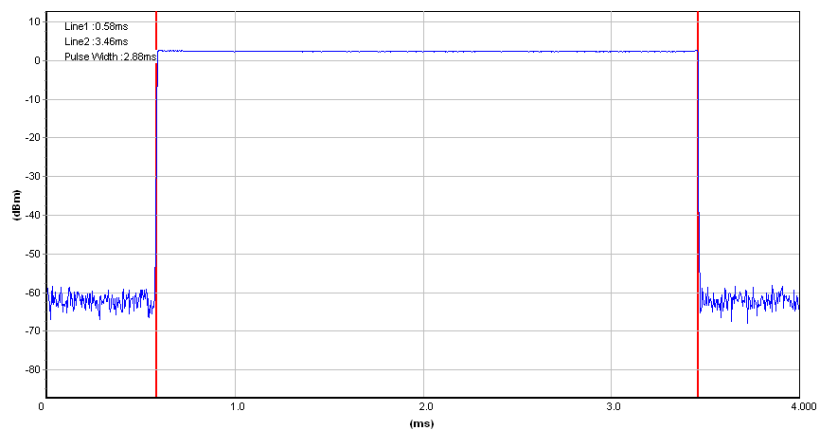



Temperature :	25°C	Relative Humidity :	50%
Pressure :	1012 hPa	Test Voltage :	DC 3.8V
Test Mode :	$\pi/4$ -DQPSK(2Mbps) –2DH1/2DH3/2DH5		

Data Packet	Frequency	Pulse Duration(ms)	Dwell Time(s)	Limits(s)
2DH1	2441 MHz	0.380	0.122	0.4
2DH3	2441 MHz	1.640	0.262	0.4
2DH5	2441 MHz	2.880	0.307	0.4





CH39-2DH1

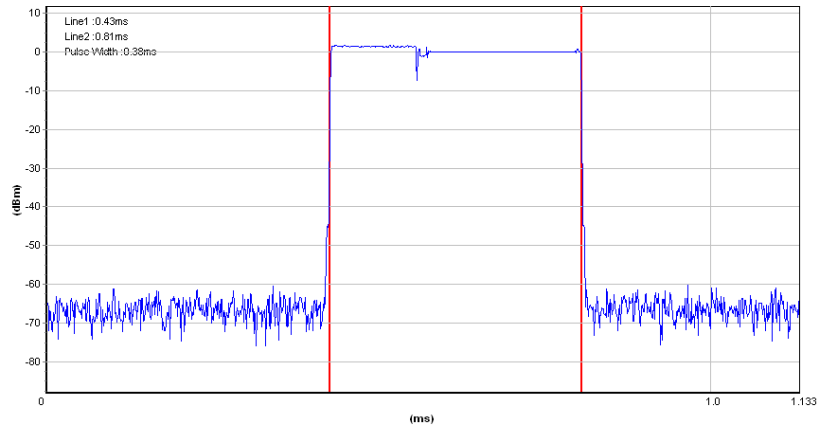

CH39-2DH3

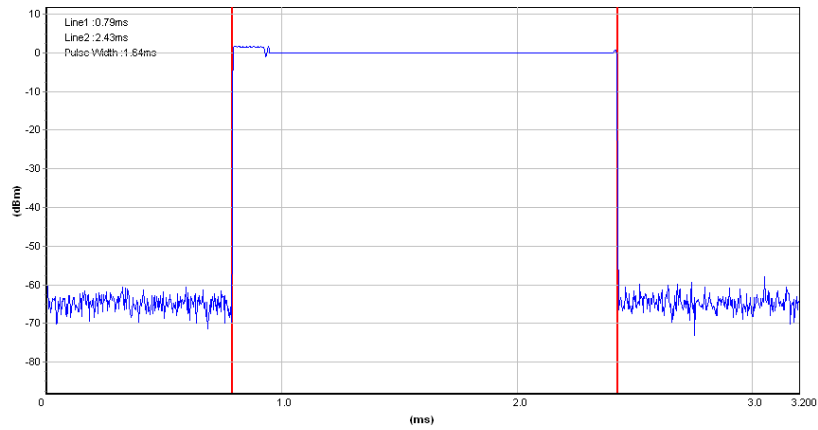

CH39-2DH5

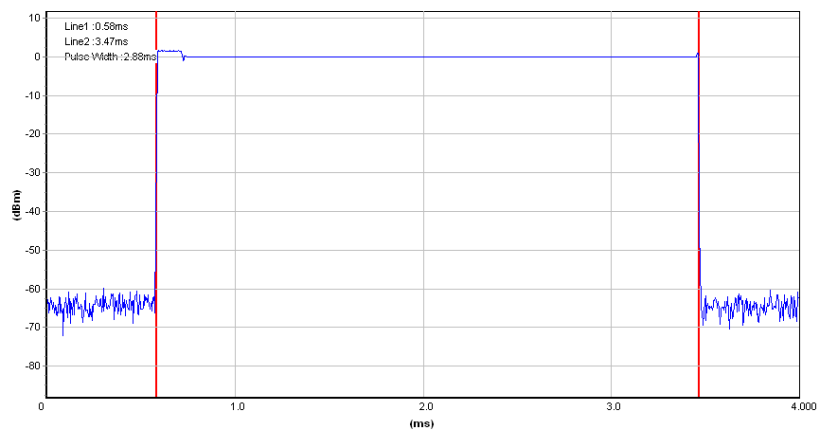



Temperature :	25°C	Relative Humidity :	50%
Pressure :	1012 hPa	Test Voltage :	DC 3.8V
Test Mode :	8DPSK(3Mbps) –3DH1/3DH3/3DH5		

Data Packet	Frequency	Pulse Duration(ms)	Dwell Time(s)	Limits(s)
3DH1	2441 MHz	0.380	0.122	0.4
3DH3	2441 MHz	1.640	0.262	0.4
3DH5	2441 MHz	2.890	0.308	0.4





CH39-3DH1

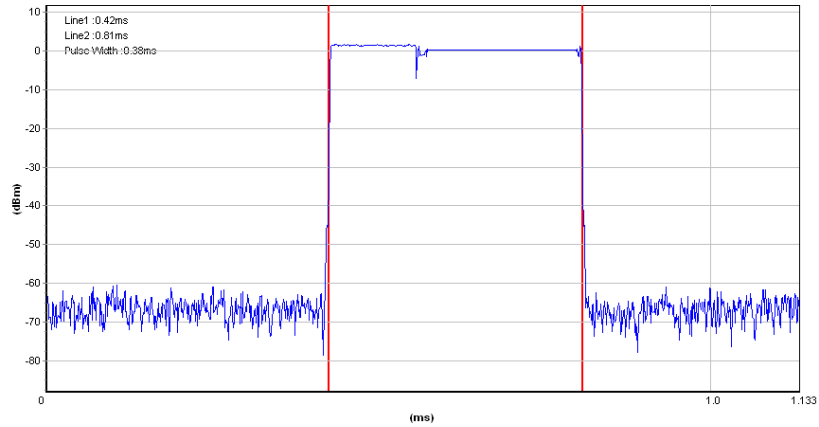

CH39-3DH3

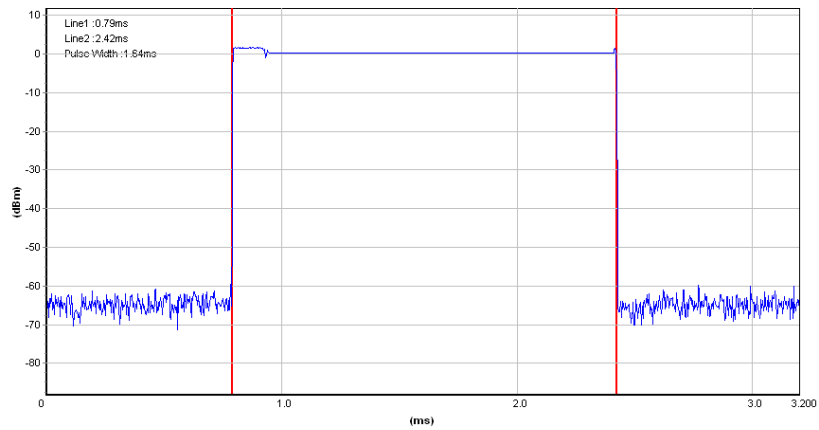

CH39-3DH5

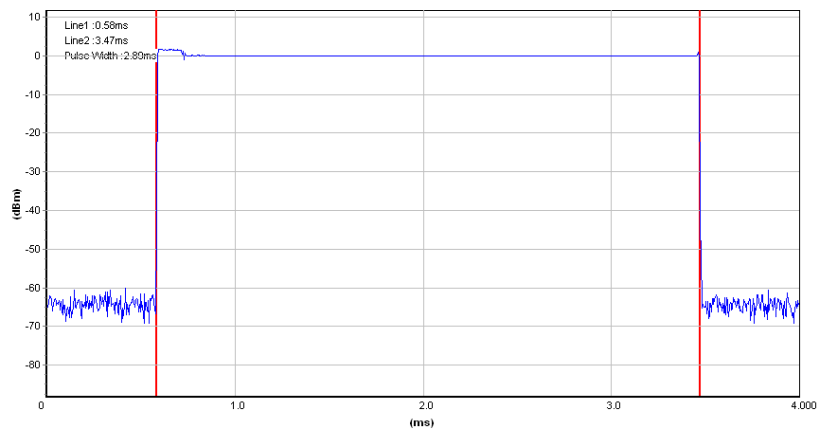

7. HOPPING CHANNEL SEPARATION MEASUREMENT

7.1 APPLIED PROCEDURES / LIMIT

Frequency hopping systems operating in the 2400-2483.5 MHz band may have hopping channel carrier frequencies that are separated by 20 dB bandwidth of the hopping channel, whichever is greater.

Spectrum Parameter	Setting
Attenuation	Auto
Span Frequency	> 20 dB Bandwidth or Channel Separation
RB	30 kHz (20dB Bandwidth) / 30 kHz (Channel Separation)
VB	100 kHz (20dB Bandwidth) / 100 kHz (Channel Separation)
Detector	Peak
Trace	Max Hold
Sweep Time	Auto

7.2 TEST PROCEDURE

- The transmitter output (antenna port) was connected to the spectrum analyser in peak hold mode.
- The resolution bandwidth of 30 kHz and the video bandwidth of 100 kHz were utilised for 20 dB bandwidth measurement.
- The resolution bandwidth of 30 kHz and the video bandwidth of 100 kHz were utilised for channel separation measurement.

7.3 TEST SETUP

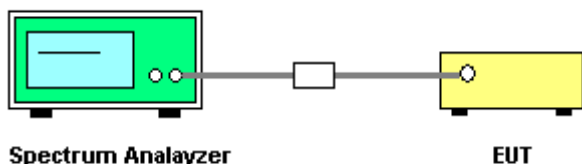

7.4 EUT OPERATION CONDITIONS

The EUT was programmed to be in continuously transmitting mode.



7.5 TEST RESULTS

Temperature :	25°C	Relative Humidity :	50%
Pressure :	1012 hPa	Test Voltage :	DC 3.8V
Test Mode :	CH00 / CH39 /CH78 (GFSK(1Mbps) Mode)		

Frequency	Ch. Separation (MHz)	Limit	Result
2402 MHz	1.000	0.889	Complies
2441 MHz	1.005	0.892	Complies
2480 MHz	0.996	0.890	Complies

For GFSK: Ch. Separation Limits: > 20dB bandwidth

CH00 -1Mbps

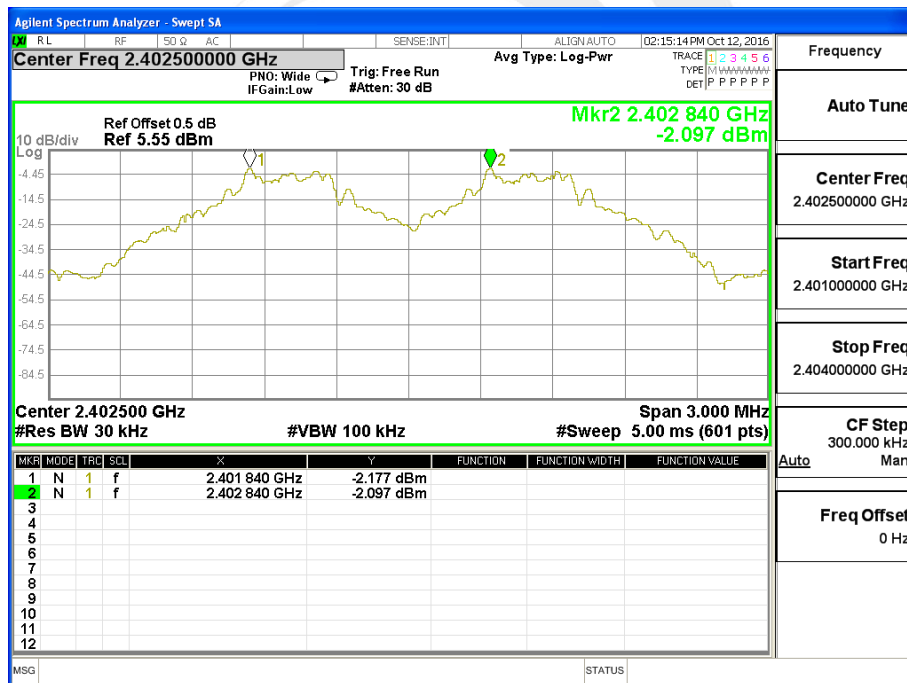



CH39 -1Mbps

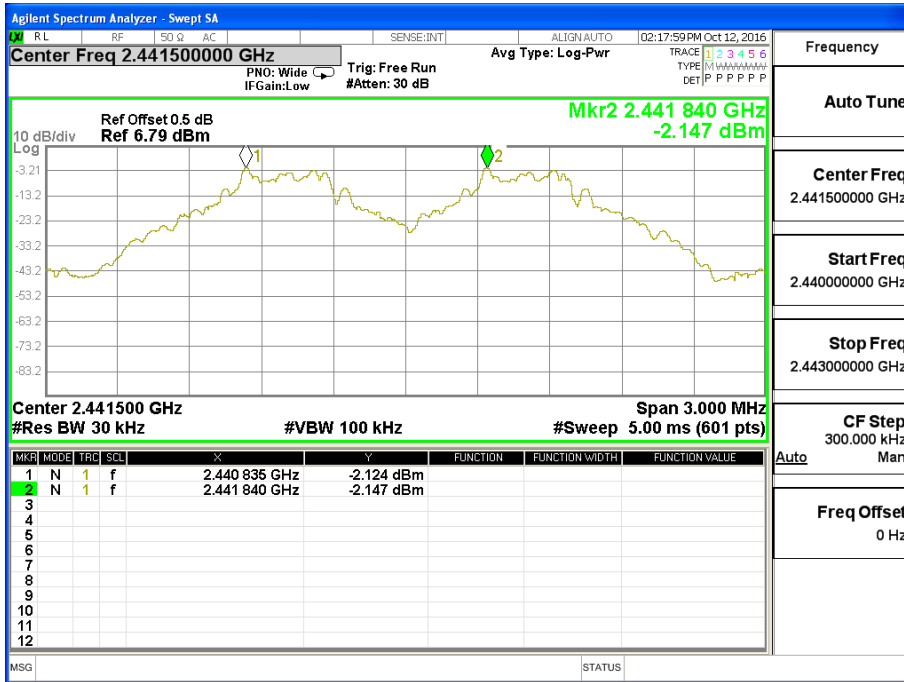

CH78 -1Mbps

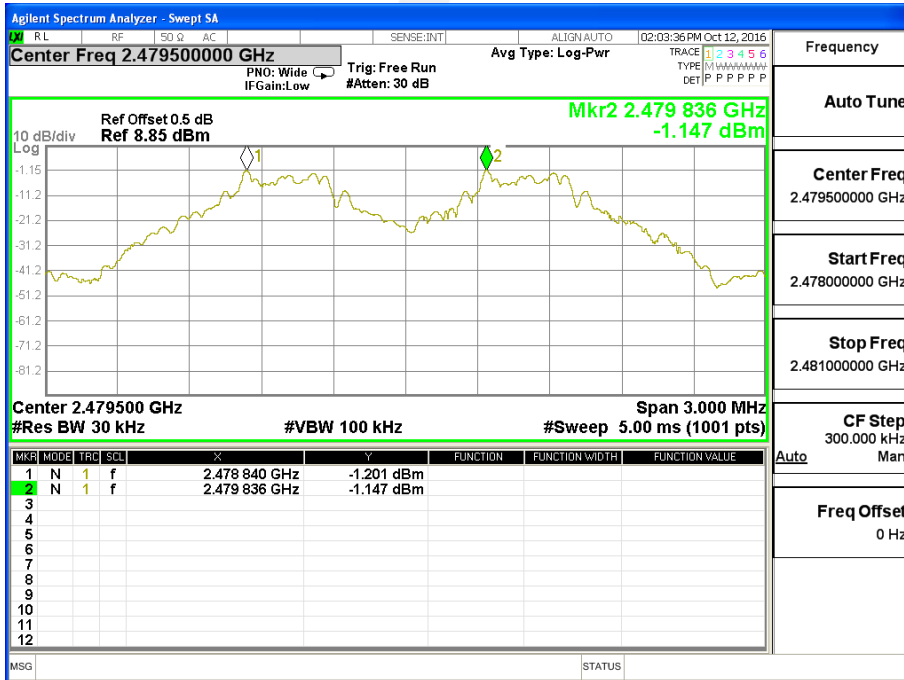



Temperature :	25°C	Relative Humidity :	50%
Pressure :	1012 hPa	Test Voltage :	DC 3.8V
Test Mode :	CH00 / CH39 /CH78 ($\pi/4$ -DQPSK(2Mbps) Mode)		

Frequency	Ch. Separation (MHz)	Limit	Result
2402 MHz	1.005	0.743	Complies
2441 MHz	1.000	0.743	Complies
2480 MHz	1.000	0.743	Complies

For $\pi/4$ -DQPSK(2Mbps): Ch. Separation Limits: > two-thirds 20dB bandwidth

CH00 -2Mbps

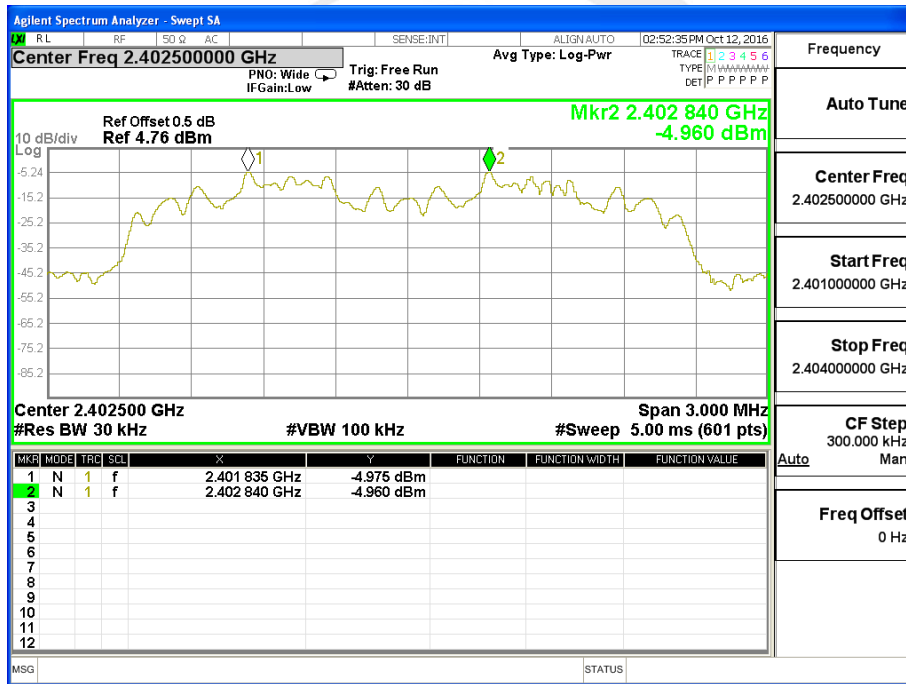



CH39 -2Mbps

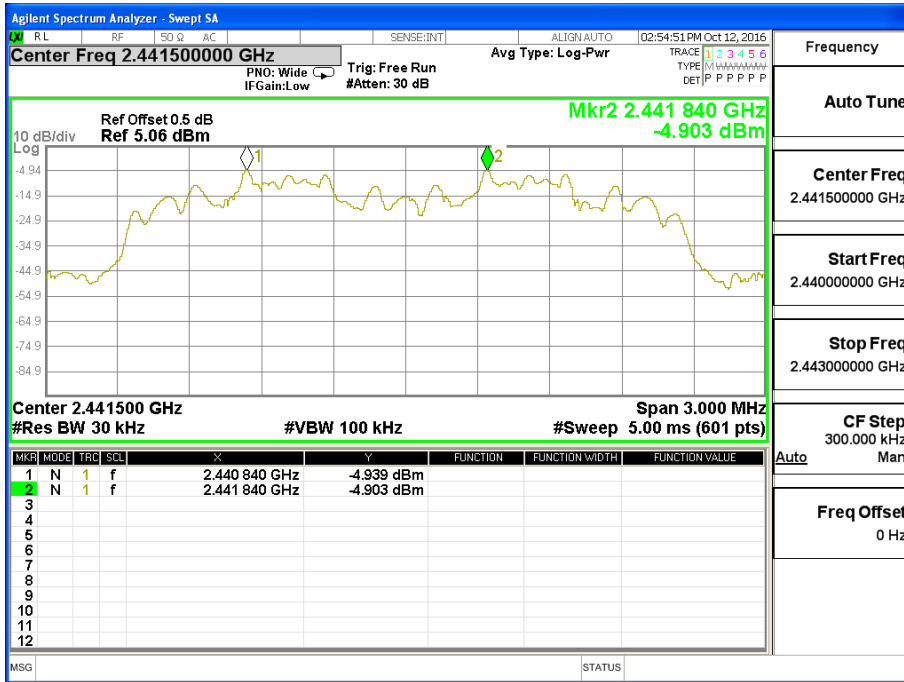

CH78 -2Mbps

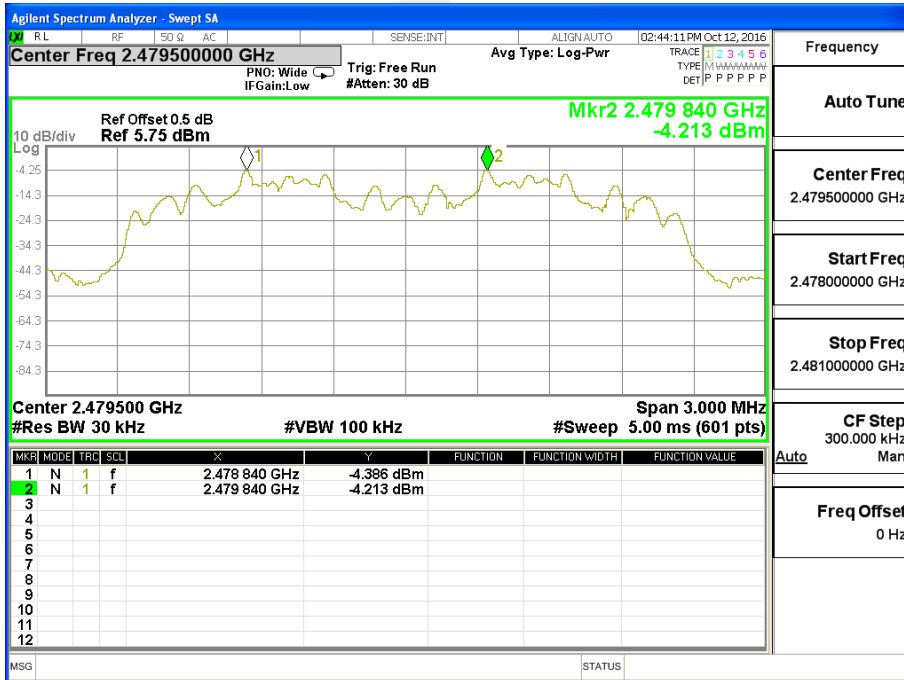



Temperature :	25°C	Relative Humidity :	50%
Pressure :	1012 hPa	Test Voltage :	DC 3.8V
Test Mode :	CH00 / CH39 /CH78 (8-DPSK(3Mbps)Mode)		

Frequency	Ch. Separation (MHz)	Limit	Result
2402 MHz	1.005	0.773	Complies
2441 MHz	1.000	0.774	Complies
2480 MHz	0.995	0.774	Complies

For 8-DPSK(3Mbps):Ch. Separation Limits: > two-thirds 20dB bandwidth

CH00 -3Mbps

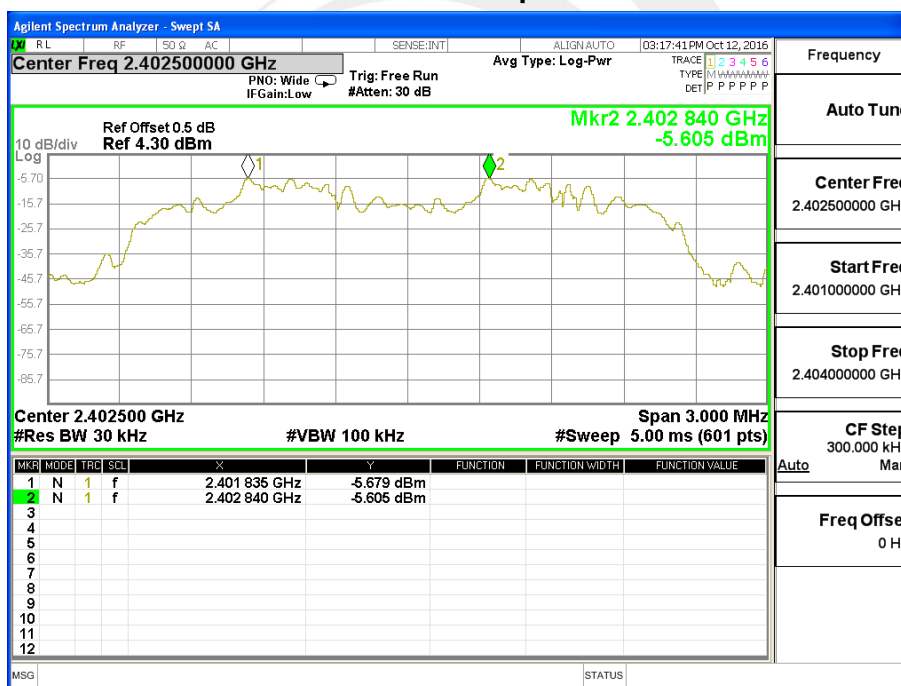



CH39 -3Mbps

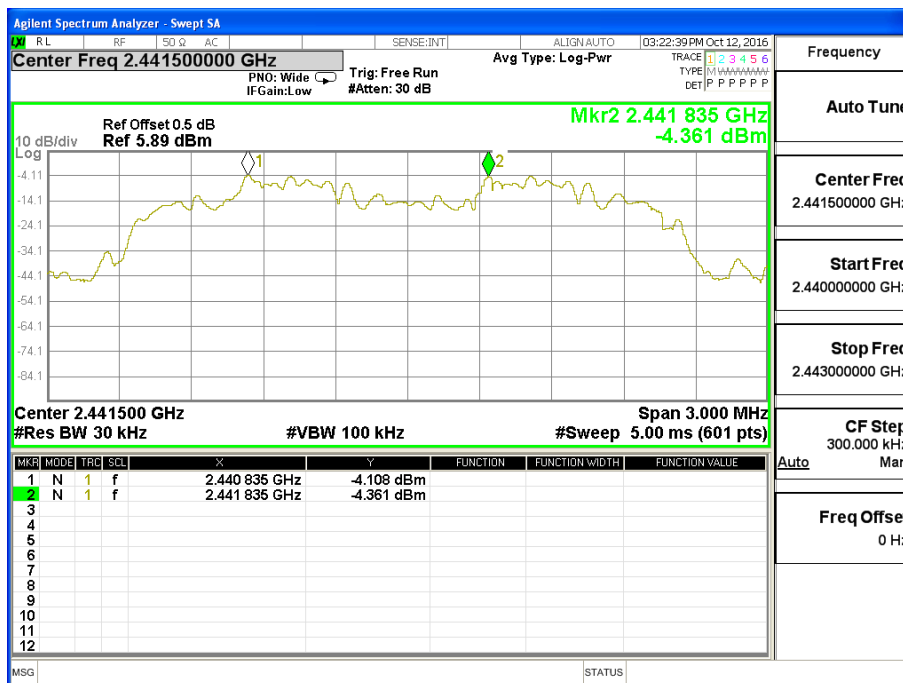

CH78 -3Mbps

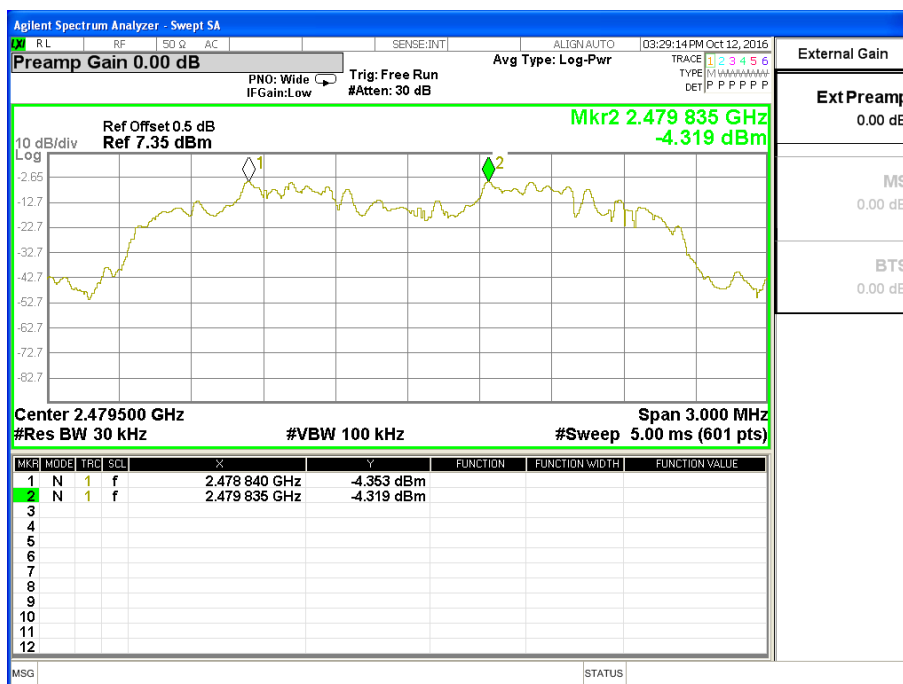



8. BANDWIDTH TEST

8.1 APPLIED PROCEDURES / LIMIT

FCC Part15 15.247,Subpart C				
Section	Test Item	Limit	FrequencyRange (MHz)	Result
15.247 (a)(1)	Bandwidth	(20dB bandwidth)	2400-2483.5	PASS

Spectrum Parameter	Setting
Attenuation	Auto
Span Frequency	> Measurement Bandwidth or Channel Separation
RB	30 kHz (20dB Bandwidth) / 30 kHz (Channel Separation)
VB	100 kHz (20dB Bandwidth) / 100 kHz (Channel Separation)
Detector	Peak
Trace	Max Hold
Sweep Time	Auto

8.2 TEST PROCEDURE

- The EUT was directly connected to the spectrum analyzer and antenna output port as show in the block diagram below,
- Spectrum Setting : RBW= 30KHz, VBW=100KHz, Sweep time = Auto.

8.3 TEST SETUP

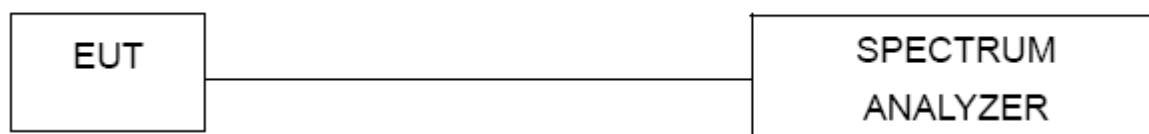

8.4 EUT OPERATION CONDITIONS

The EUT tested system was configured as the statements of 2.4 Unless otherwise a special operating condition is specified in the follows during the testing.



8.5 TEST RESULTS

Temperature :	25°C	Relative Humidity :	50%
Pressure :	1012 hPa	Test Voltage :	DC 3.8V
Test Mode :	GFSK(1Mbps)CH00 / CH39 /C78		

Frequency	20dB Bandwidth (MHz)	Result
2402 MHz	0.889	PASS
2441 MHz	0.892	PASS
2480 MHz	0.890	PASS

CH00 -1Mbps

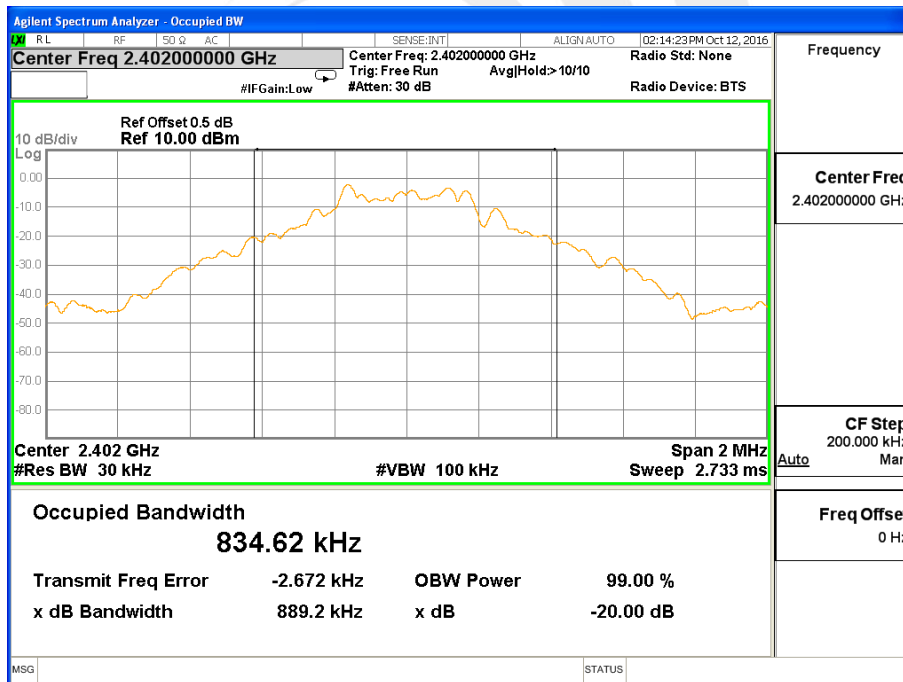



CH39 -1Mbps

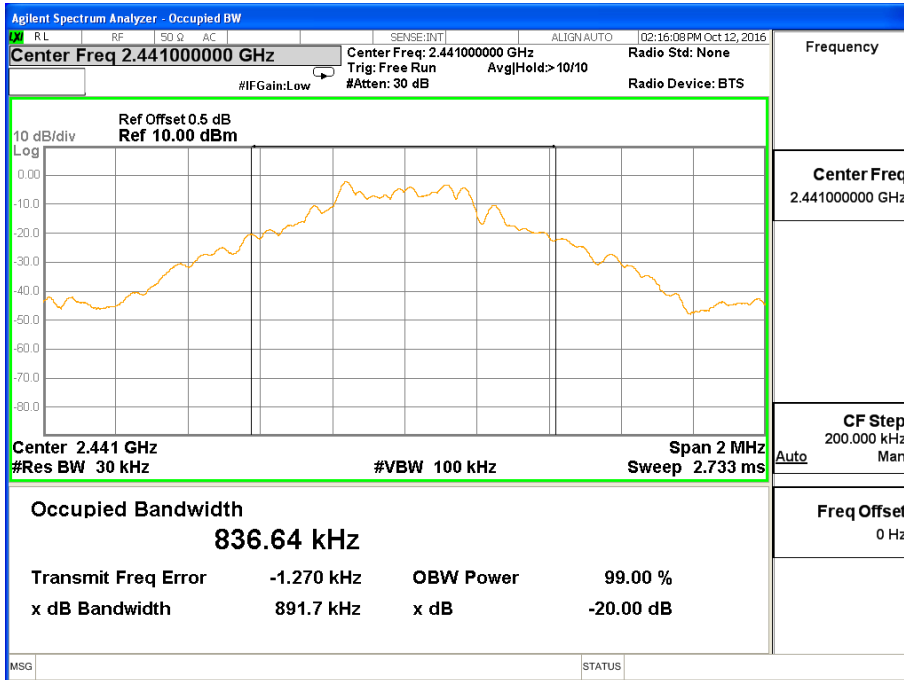

CH78 -1Mbps

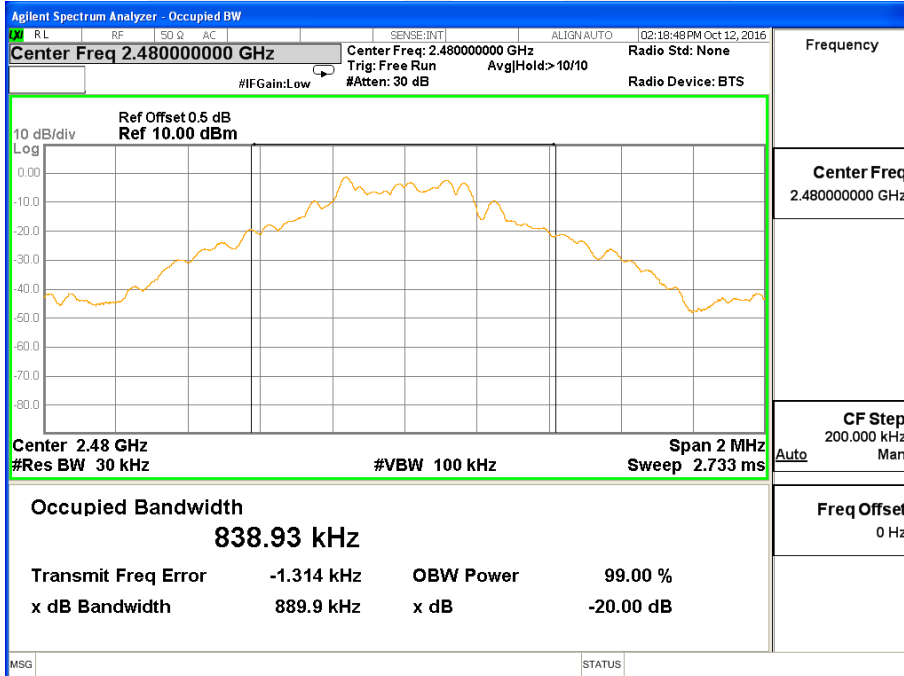



Temperature :	25°C	Relative Humidity :	50%
Pressure :	1012 hPa	Test Voltage :	DC 3.8V
Test Mode :	π/4-DQPSK(2Mbps)CH00 / CH39 /C78		

Frequency	20dB Bandwidth(MHz)	Result
2402 MHz	1.114	PASS
2441 MHz	1.114	PASS
2480 MHz	1.114	PASS

CH00 -2Mbps

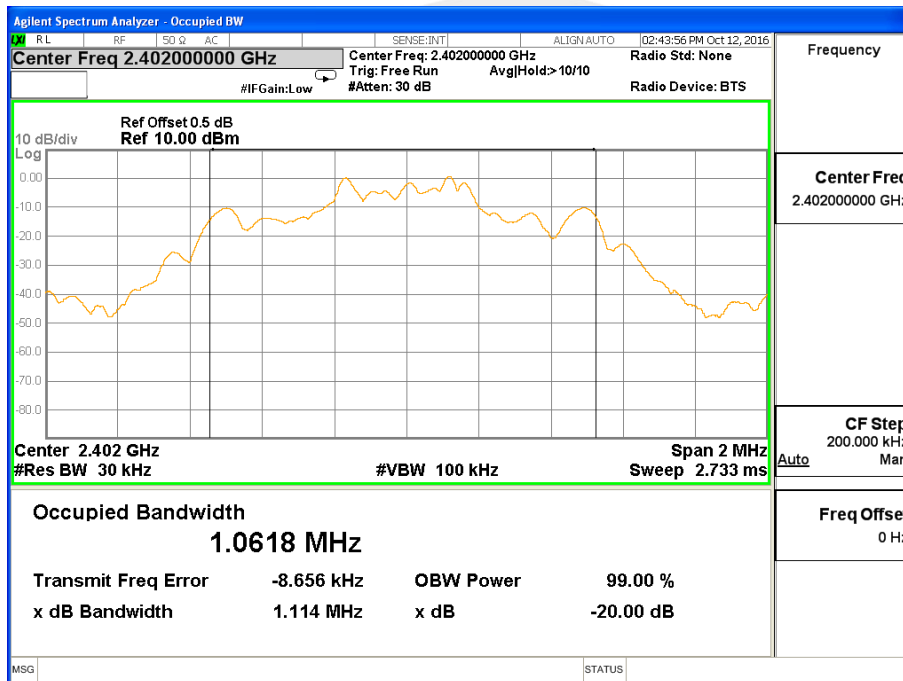



CH39 -2Mbps

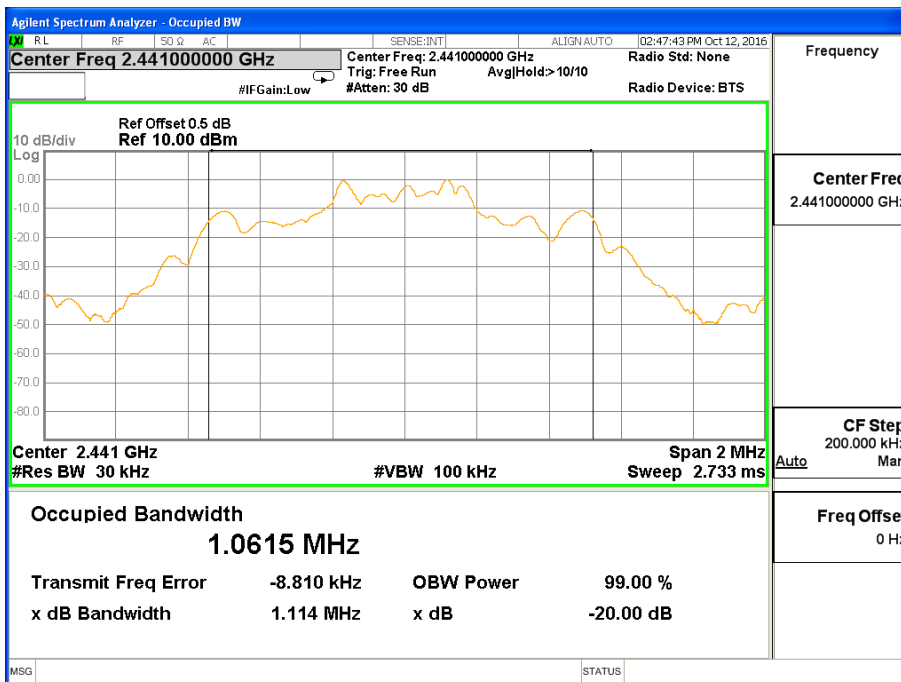

CH78 -2Mbps

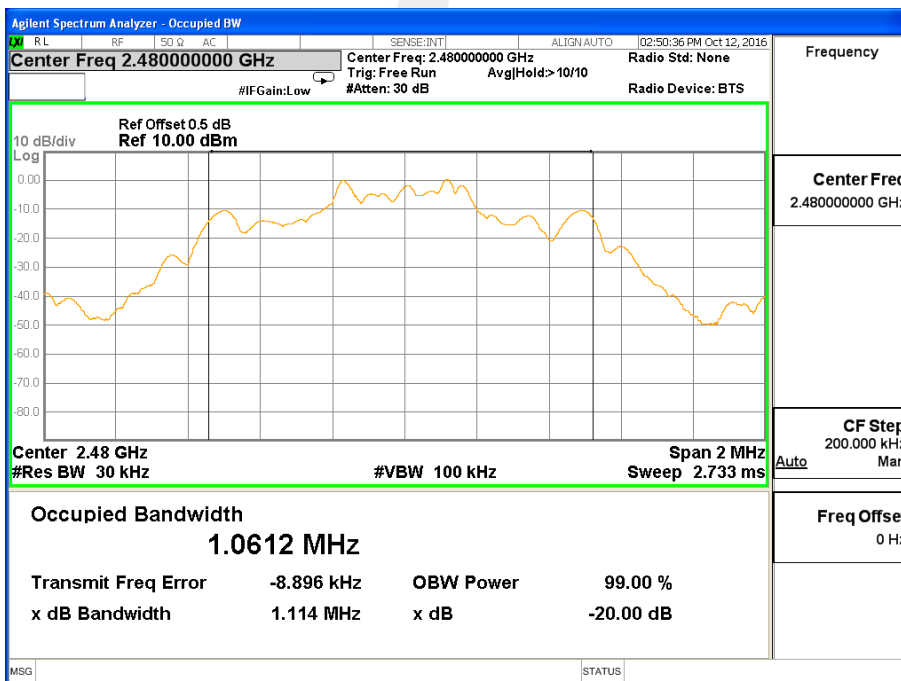



Temperature :	25°C	Relative Humidity :	50%
Pressure :	1012 hPa	Test Voltage :	DC 3.8V
Test Mode :	8DPSK(3Mbps)CH00 / CH39 / CH78		

Frequency	20dB Bandwidth (MHz)	Result
2402 MHz	1.160	PASS
2441 MHz	1.161	PASS
2480 MHz	1.161	PASS

CH00 -3Mbps

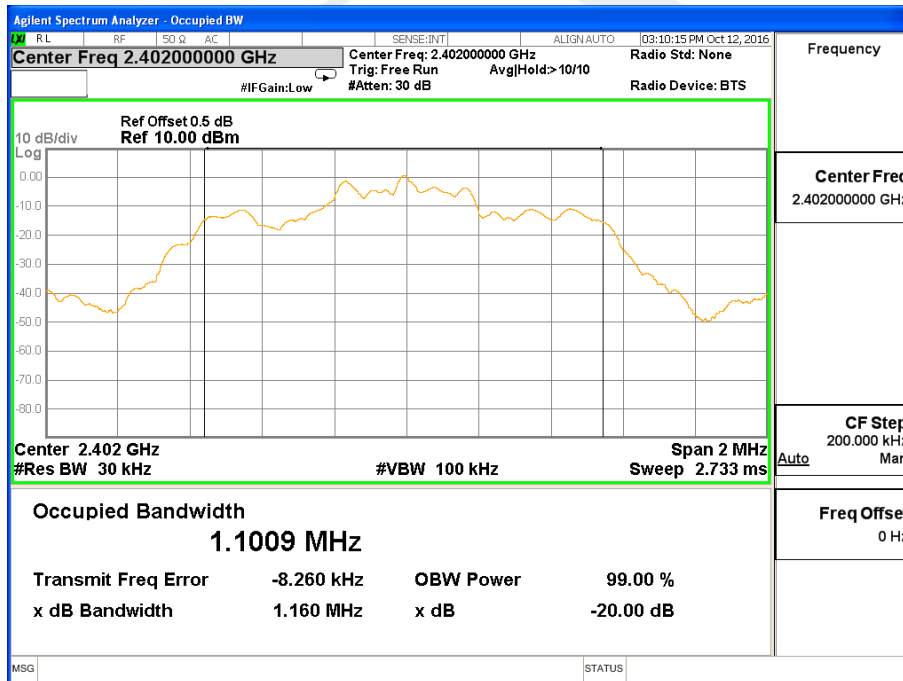



CH39 -3Mbps

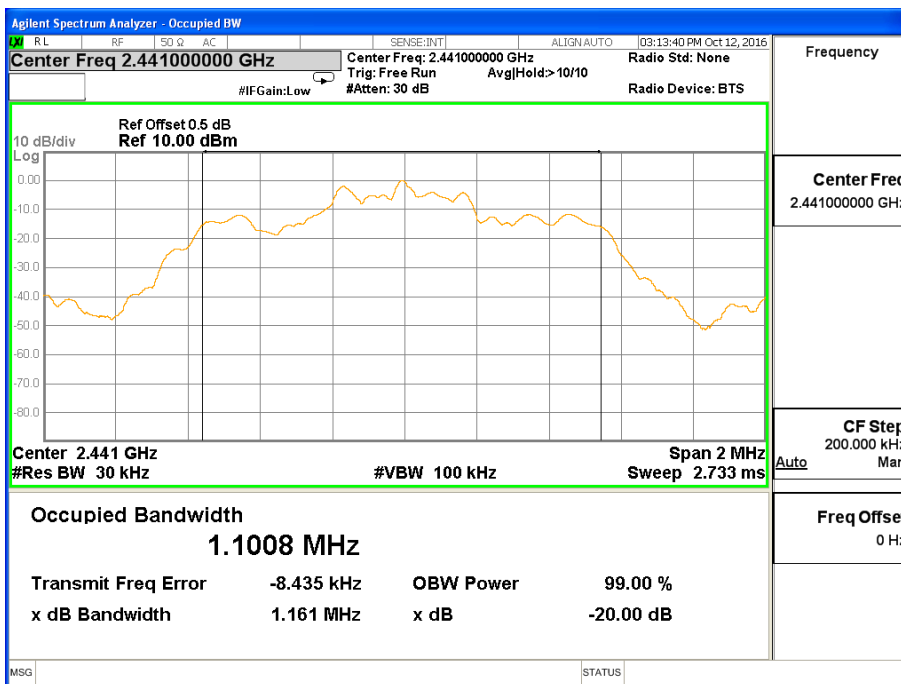

CH78 -3Mbps

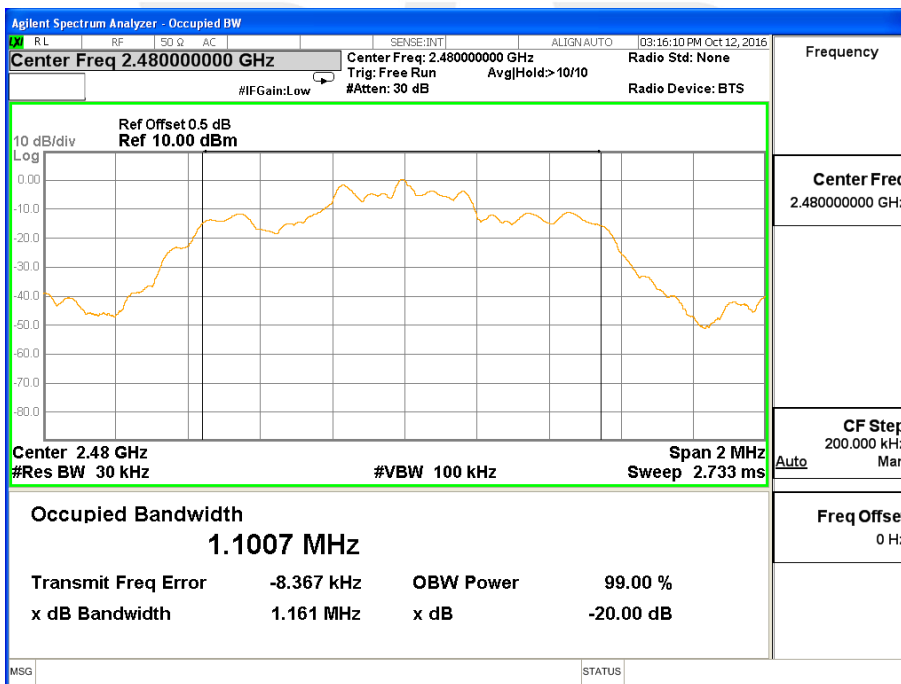



9. OUTPUT POWER TEST

9.1 APPLIED PROCEDURES / LIMIT

FCC Part 15.247, Subpart C				
Section	Test Item	Limit	Frequency Range (MHz)	Result
15.247 (a)(1)&(b)(1)	Output Power	1 W or 0.125W	2400-2483.5	PASS
		if channel separation > 2/3 bandwidth provided the systems operate with an output power no greater than 125 mW (20.96dBm)		

9.2 TEST PROCEDURE

- a. The EUT was directly connected to the Power Sensor & PC

9.3 TEST SETUP



9.4 EUT OPERATION CONDITIONS

The EUT tested system was configured as the statements of 2.4 Unless otherwise a special operating condition is specified in the follows during the testing.



9.5 TEST RESULTS

Temperature :	25°C	Relative Humidity :	60%
Pressure :	1012 hPa	Test Voltage :	DC 3.8V

GFSK(1Mbps)				
Test Channe	Frequency	Conducted Output Power		LIMIT
	(MHz)	Peak (dBm)	AVG (dBm)	dBm
CH00	2402	1.42	-3.67	30
CH39	2441	1.41	-3.68	30
CH78	2480	1.39	-3.70	30

Note : the channel separation > bandwidth

$\pi/4$QPSK(2Mbps)				
Test Channe	Frequency	Conducted Output Power		LIMIT
	(MHz)	Peak (dBm)	AVG (dBm)	dBm
CH00	2402	-1.40	-6.49	20.96
CH39	2441	-1.41	-6.50	20.96
CH78	2480	-1.45	-6.54	20.96

Note : the channel separation >2/3 bandwidth

8-DPSK(3Mbps)				
Test Channe	Frequency	Conducted Output Power		LIMIT
	(MHz)	Peak (dBm)	AVG (dBm)	dBm
CH00	2402	-1.22	-6.31	20.96
CH39	2441	-1.23	-6.32	20.96
CH78	2480	-1.31	-6.40	20.96

Note : the channel separation >2/3 bandwidth



10. ANTENNA REQUIREMENT

10.1 STANDARD REQUIREMENT

15.203 requirement: For intentional device, according to 15.203: an intentional radiator shall be designed to ensure that no antenna other than that furnished by the responsible party shall be used with the device.

10.2 EUT ANTENNA

The EUT antenna is PIFA Antenna. It comply with the standard requirement.





APPENDIX-PHOTOS OF TEST SETUP

Radiated Measurement Photos

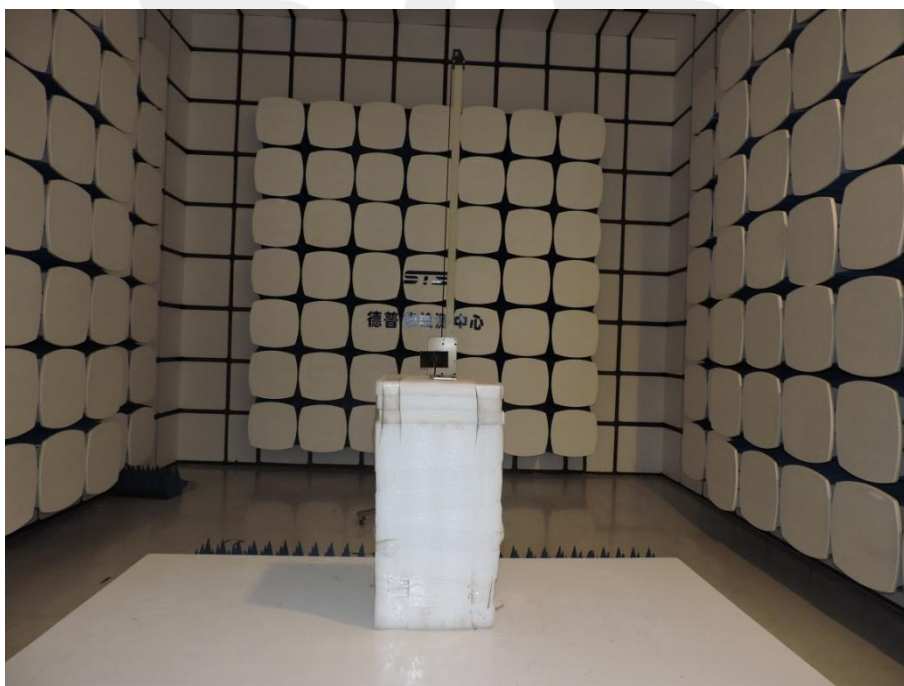
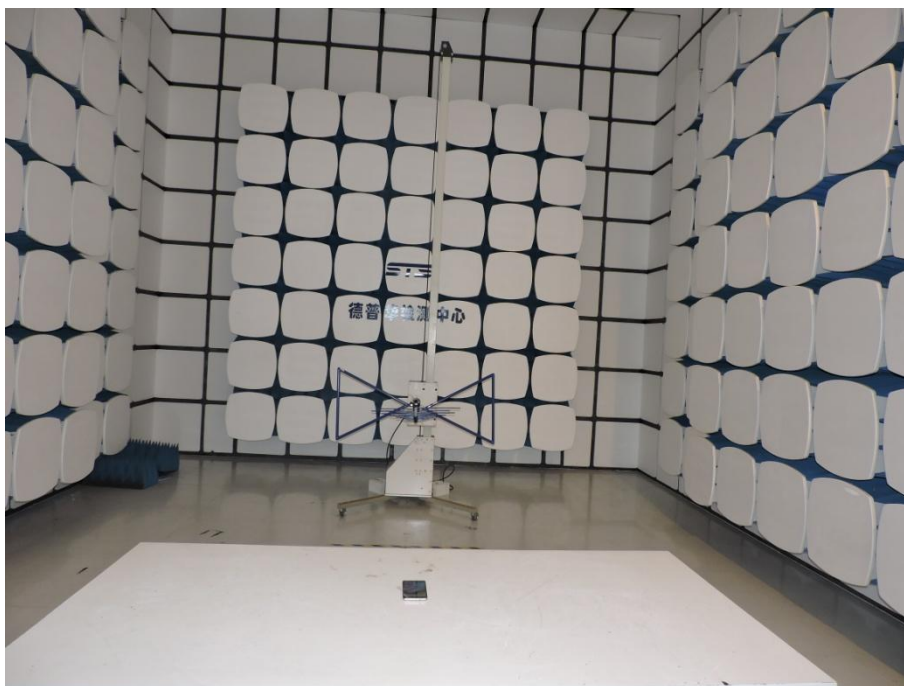



Conducted Measurement Photos

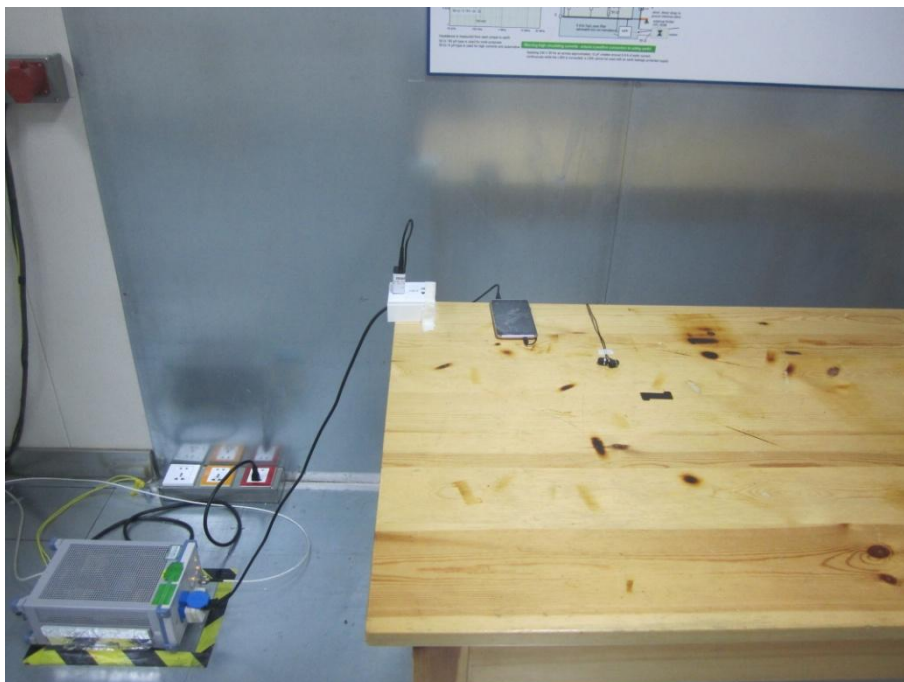

*****END OF THE REPORT*****