

LTE Band 7-20MHz

QPSK

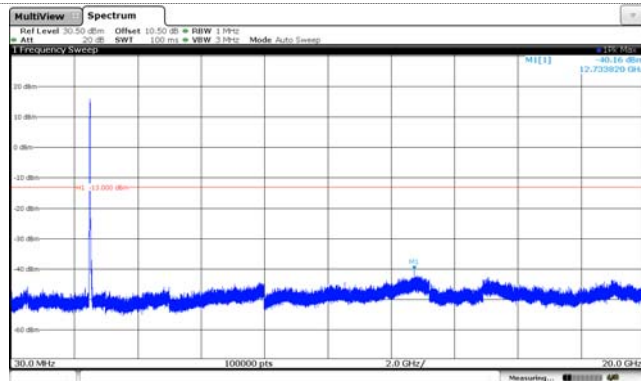

16QAM

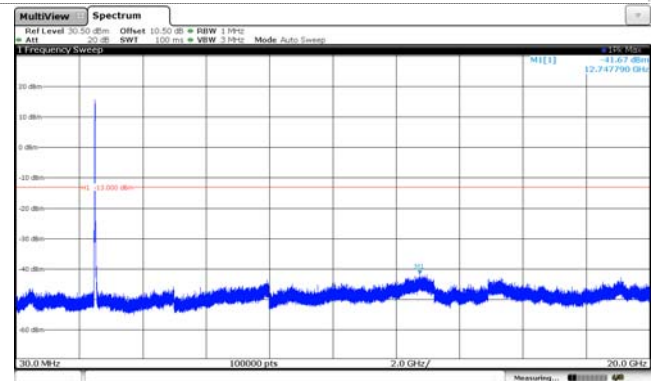

Channel Low

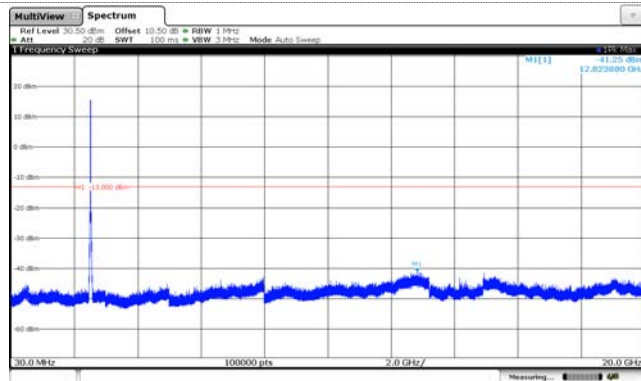

Channel Low

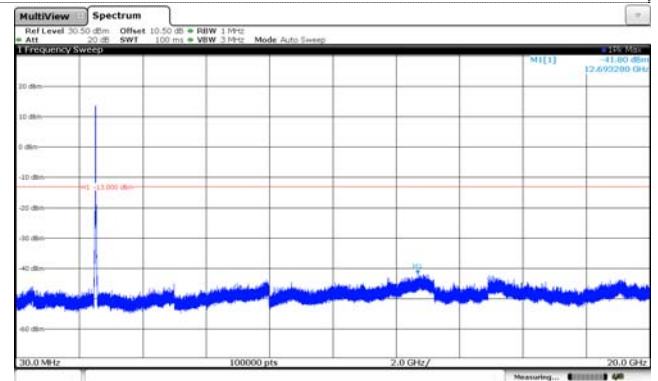

Channel Mid

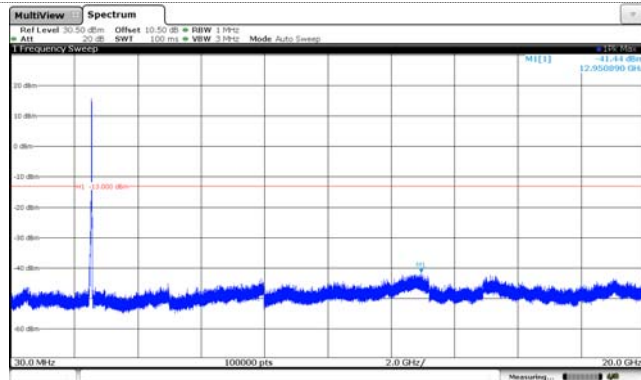

Channel Mid

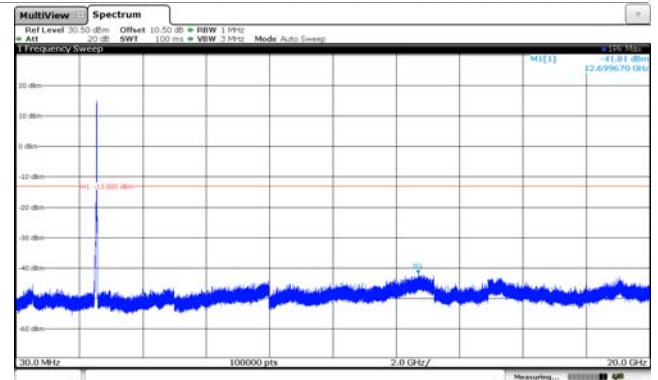

Channel High



Channel High



#### 4.4. Band Edge compliance

##### LIMIT

Part 24.238 and 27.53(h) specify that the power of any emission outside of the authorized operating frequency ranges must be attenuated below the transmitting power (P) by a factor of at least  $43 + 10 \log(P)$  dB.

The specification that emissions shall be attenuated below the transmitter power (P) by at least  $43 + 10 \log(P)$  dB, translates in the relevant power range (1 to 0.001 W) to -13 dBm. At 1 W the specified minimum attenuation becomes 43 dB and relative to a 30 dBm (1 W) carrier becomes a limit of -13 dBm. At 0.001 W (0 dBm) the minimum attenuation is 13 dB, which again yields a limit of -13 dBm. In this way a translation of the specification from relative to absolute terms is carried out.

##### TEST CONFIGURATION

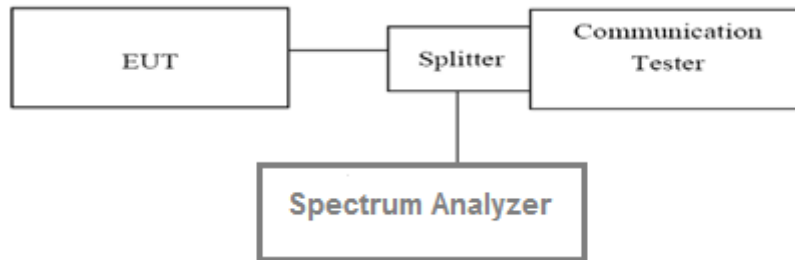

##### TEST PROCEDURE

1. The RF output of the transceiver was connected to a spectrum analyzer through appropriate attenuation.
2. The band edges of low and high channels for the highest RF powers were measured. Set RBW  $\geq$  1% EBW in the 1MHz band immediately outside and adjacent to the band edge.
3. Set spectrum analyzer with RMS detector.

##### TEST RESULTS

LTE Band 2-1.4MHz-QPSK

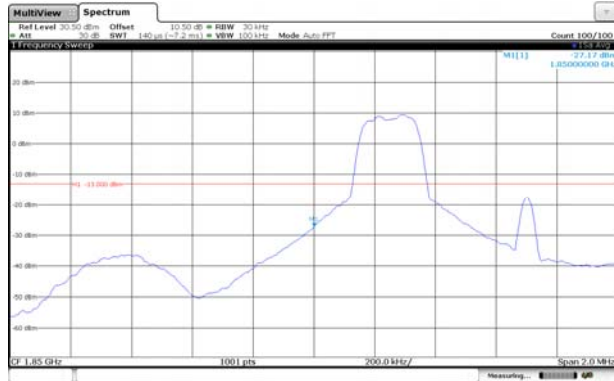

Channel Low-1RB#

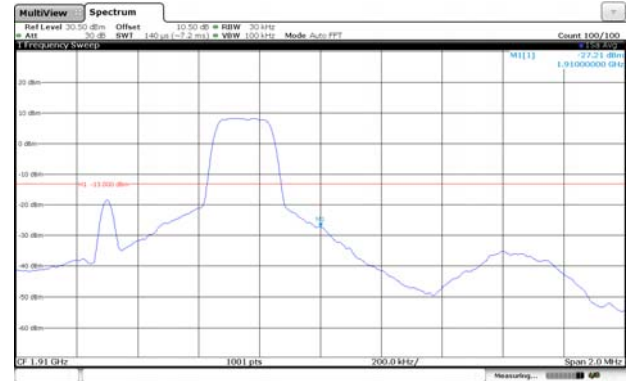

Channel High-1RB#

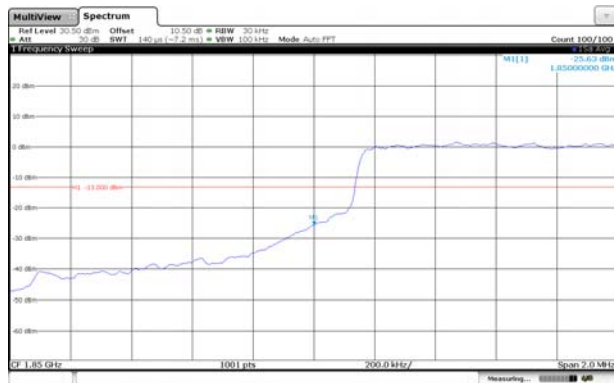

Channel Low-Full RB#

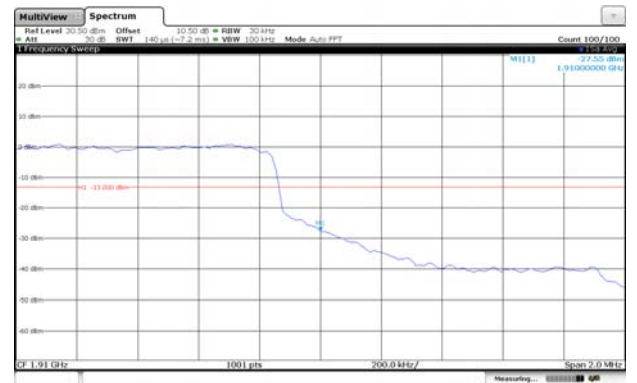

Channel High-Full RB#

LTE Band 2-1.4MHz-16QAM

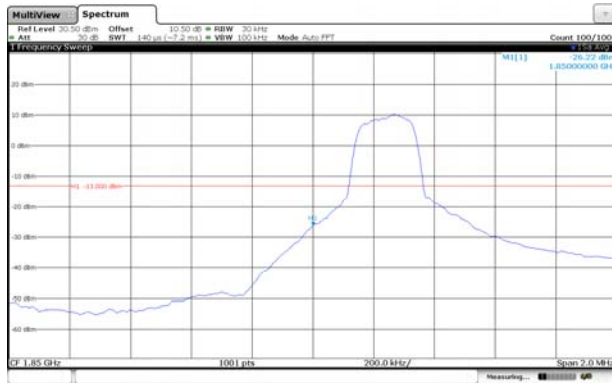

Channel Low-1RB#

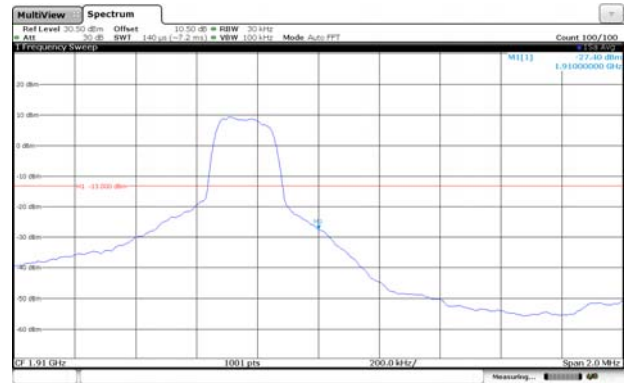

Channel High-1RB#

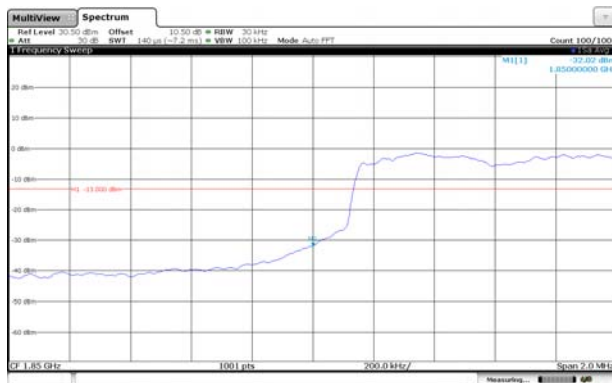

Channel Low-Full RB#

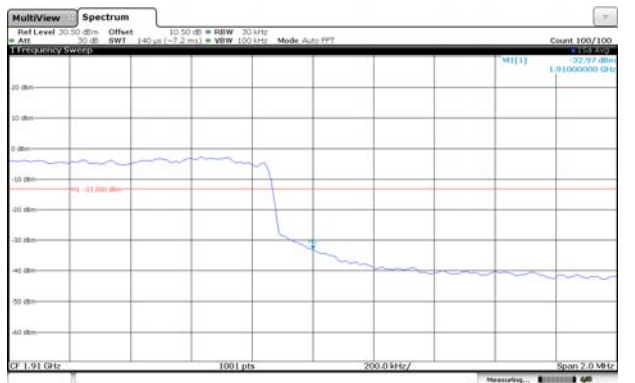

Channel High-Full RB#

LTE Band 2-3MHz-QPSK

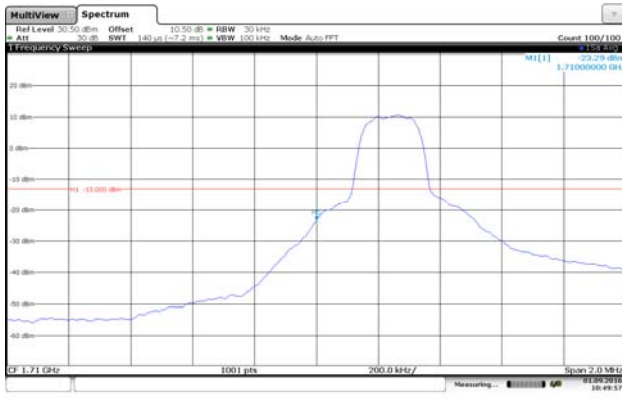

Channel Low-1RB#

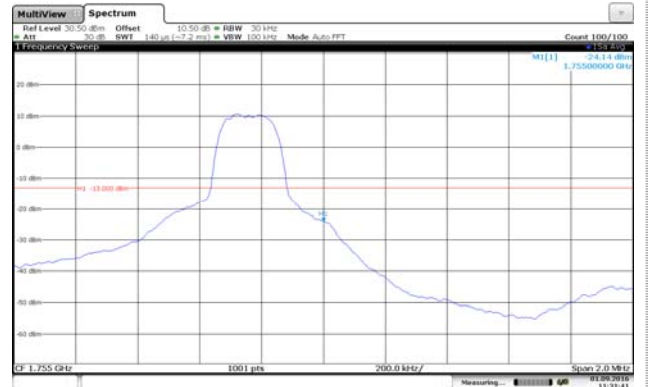

Channel High-1RB#

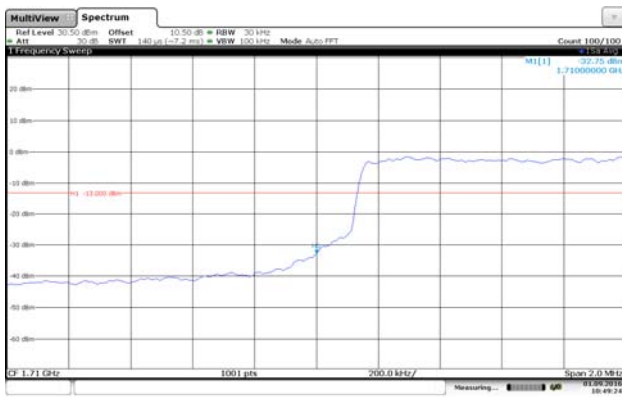

Channel Low-Full RB#

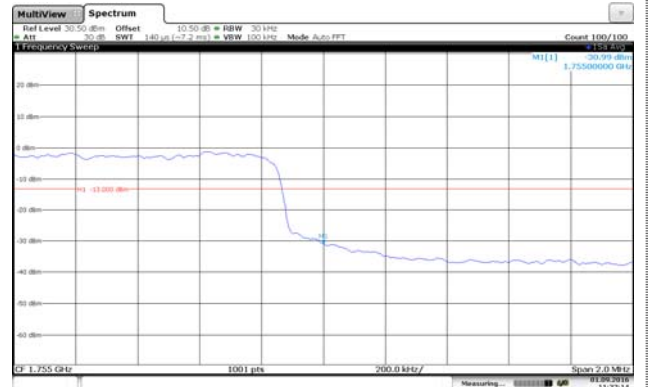

Channel High-Full RB#

LTE Band 2-3MHz-16QAM

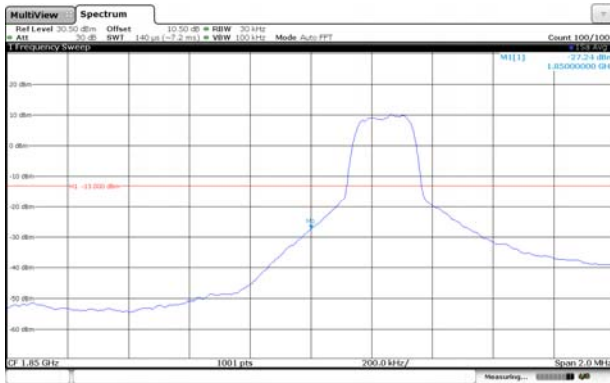

Channel Low-1RB#

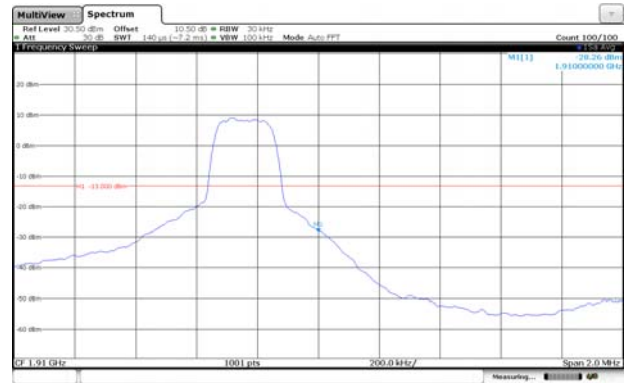

Channel High-1RB#

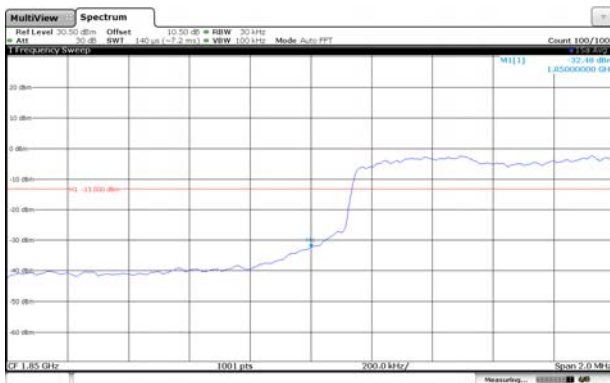

Channel Low-Full RB#

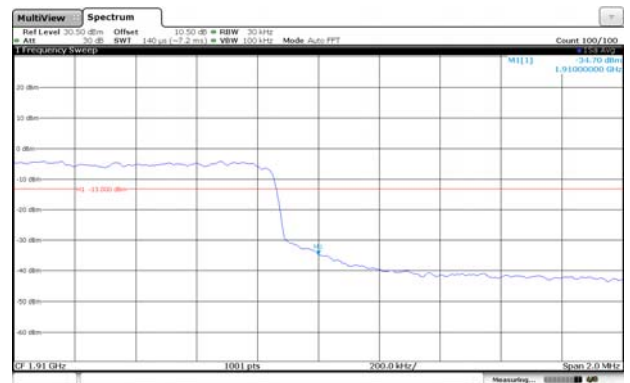

Channel High-Full RB#

LTE Band 2-5MHz-QPSK



Channel Low-1RB#

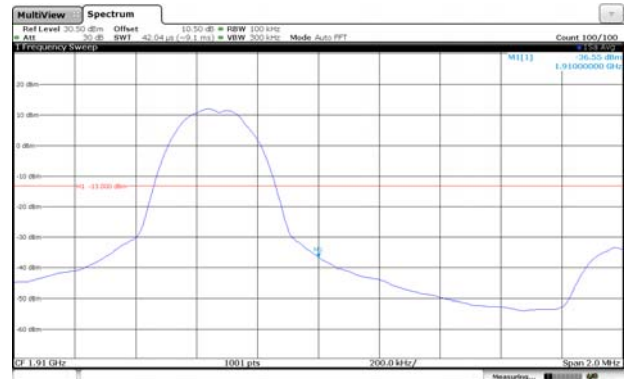

Channel High-1RB#

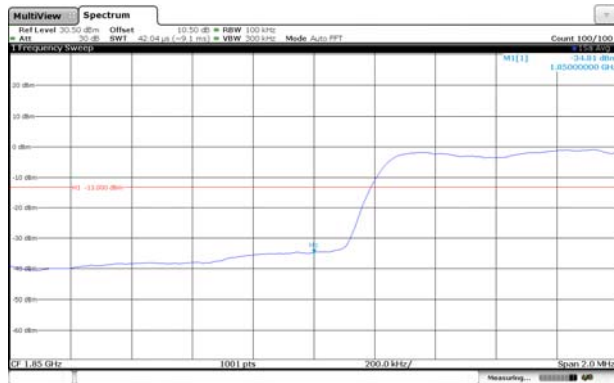

Channel Low-Full RB#

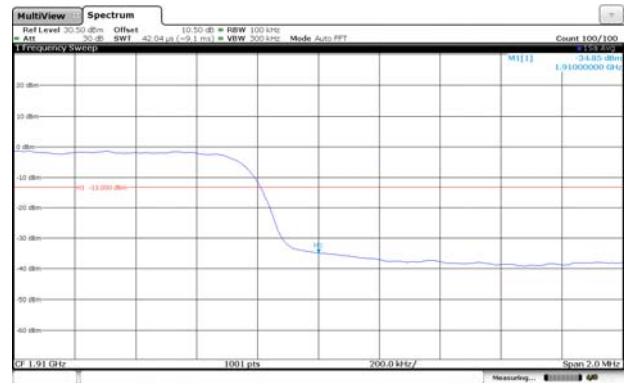

Channel High-Full RB#

LTE Band 2-5MHz-16QAM

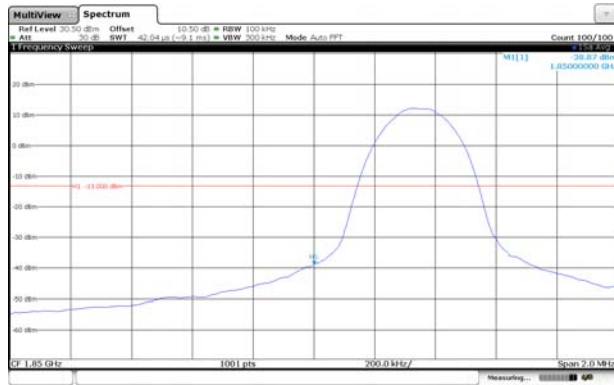

Channel Low-1RB#

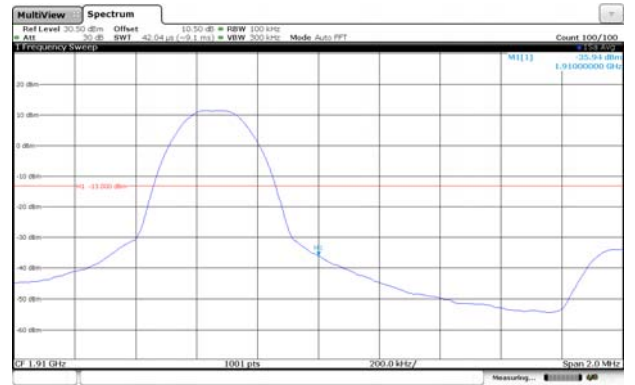

Channel High-1RB#

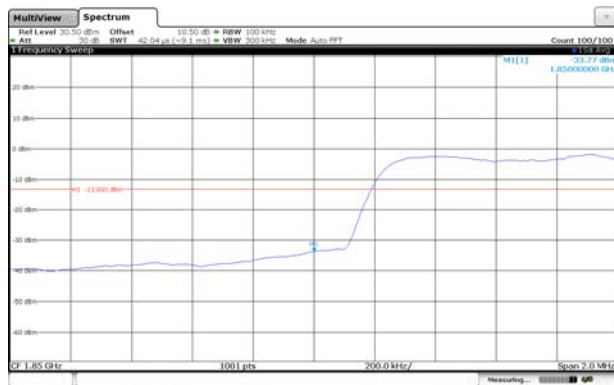

Channel Low-Full RB#

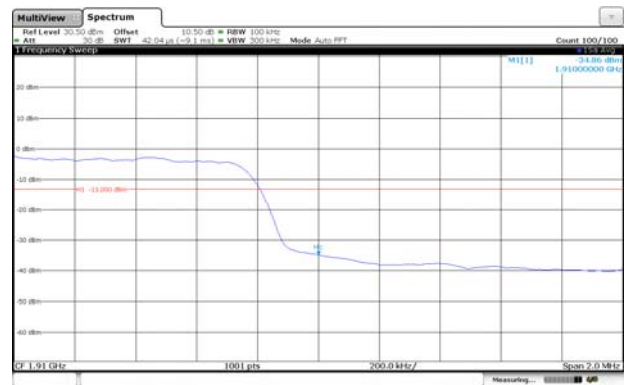

Channel High-Full RB#



LTE Band 2-10MHz-QPSK

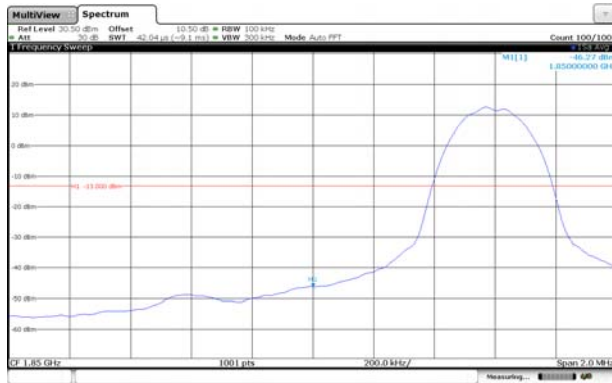

Channel Low-1RB#

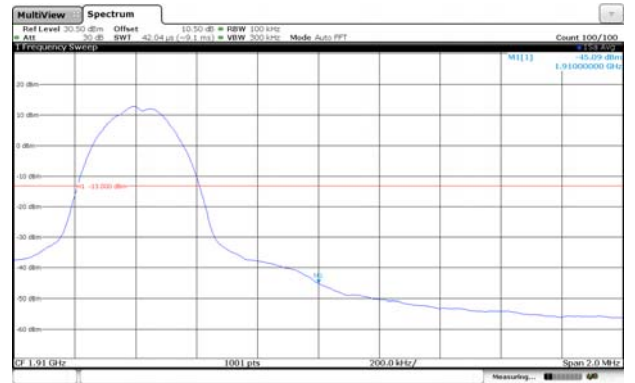

Channel High-1RB#

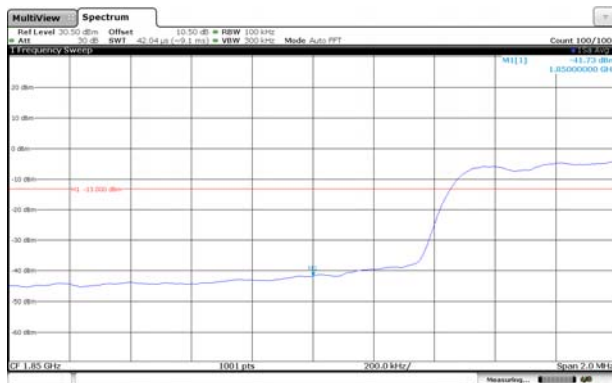

Channel Low-Full RB#

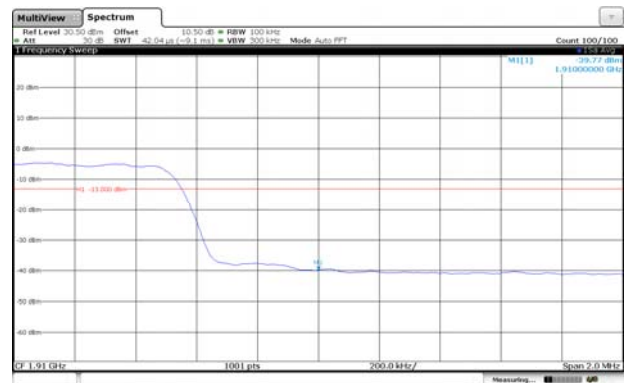

Channel High-Full RB#

LTE Band 2-10MHz-16QAM

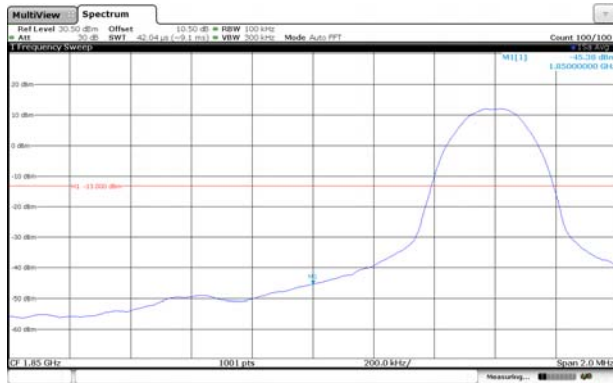

Channel Low-1RB#

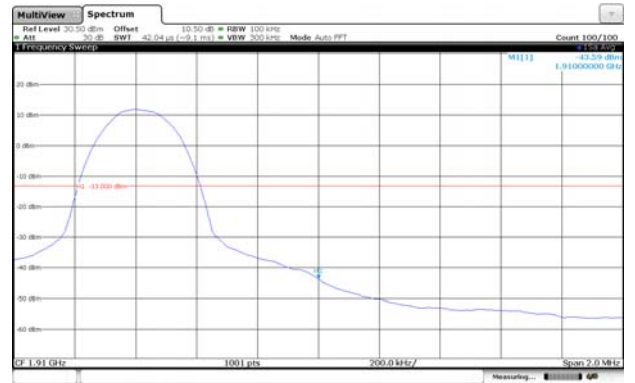

Channel High-1RB#

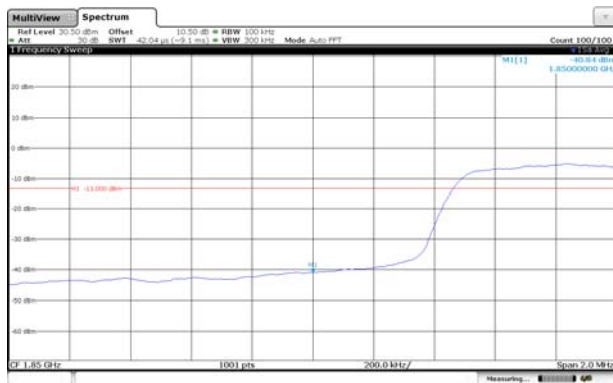

Channel Low-Full RB#

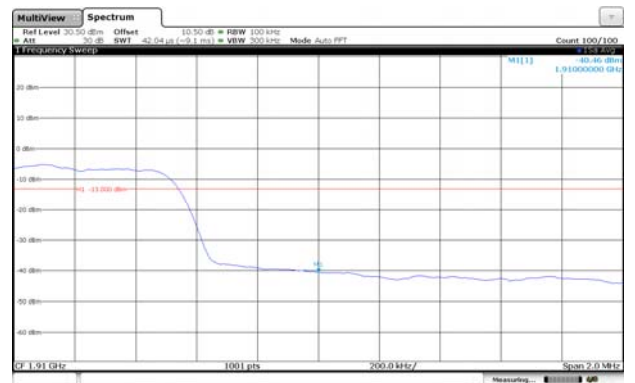

Channel High-Full RB#

LTE Band 2-15MHz-QPSK

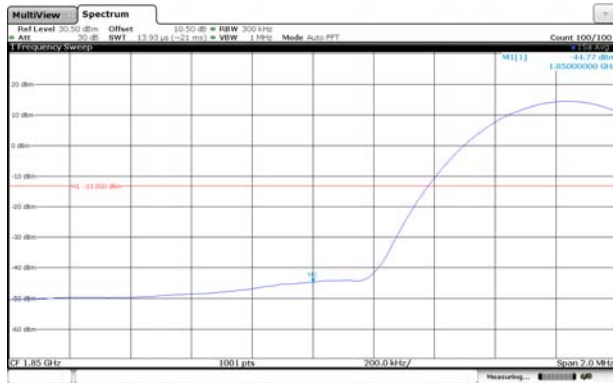

Channel Low-1RB#

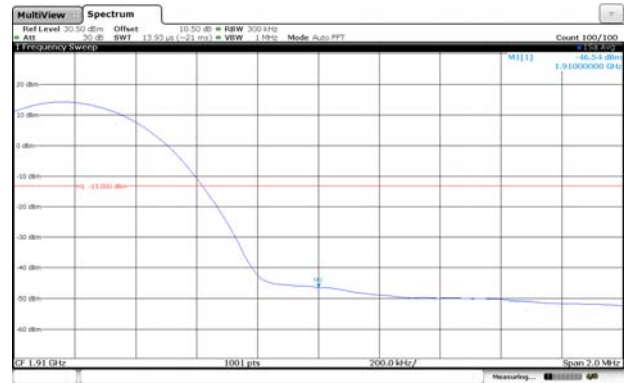

Channel High-1RB#

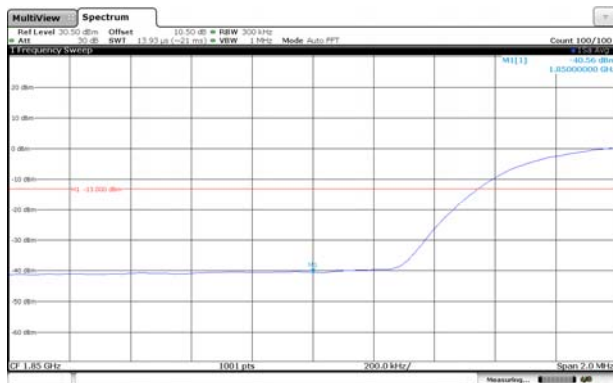

Channel Low-Full RB#

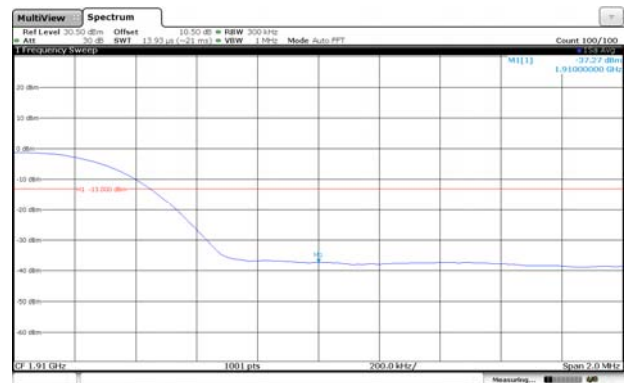

Channel High-Full RB#

LTE Band 2-15MHz-16QAM

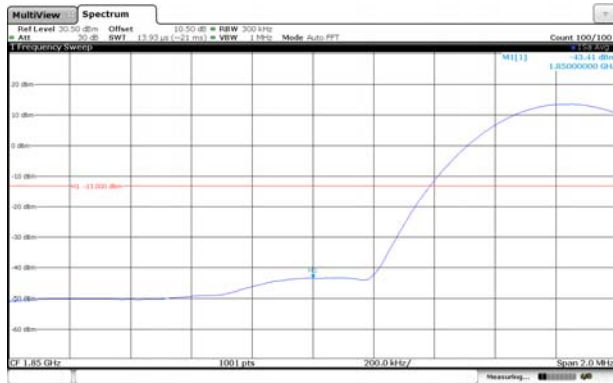

Channel Low-1RB#

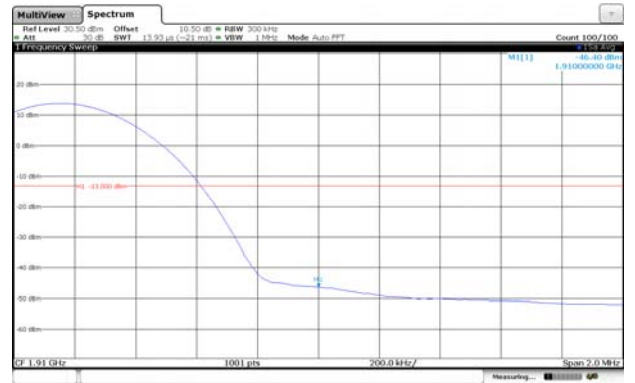

Channel High-1RB#

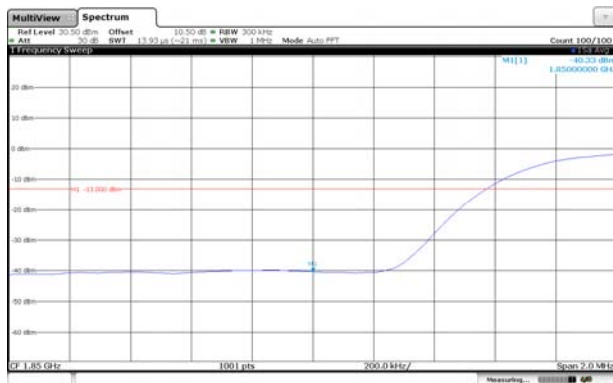

Channel Low-Full RB#

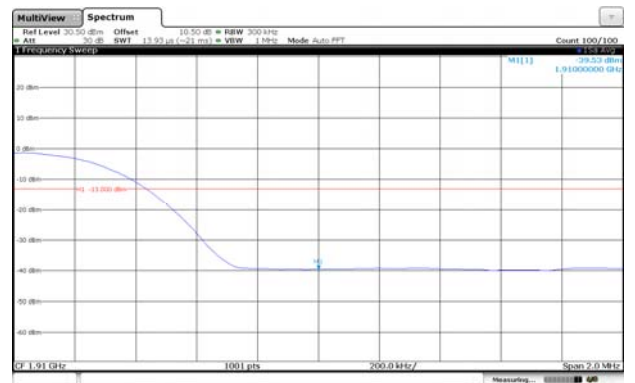

Channel High-Full RB#

LTE Band 2-20MHz-QPSK

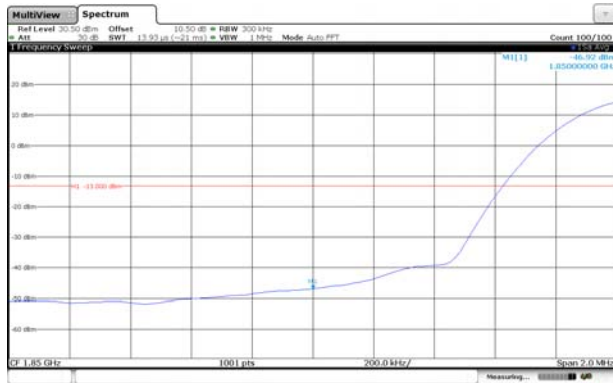

Channel Low-1RB#

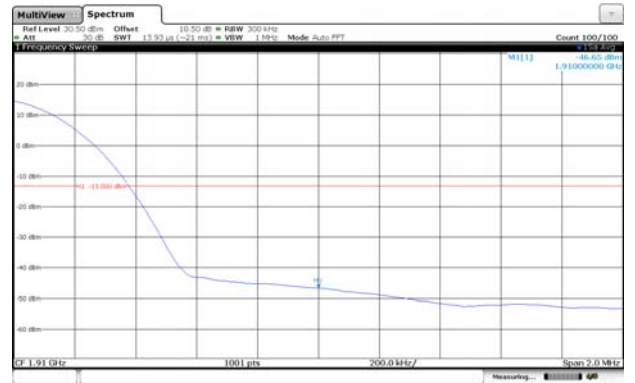

Channel High-1RB#

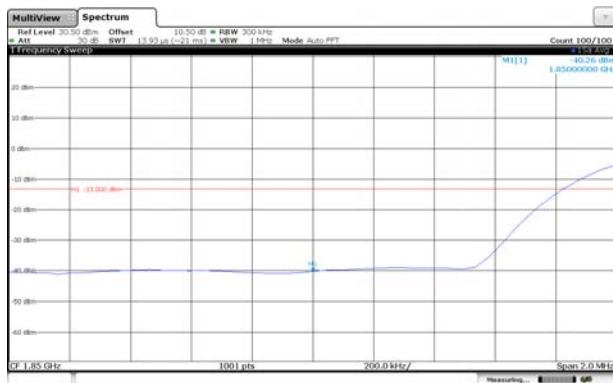

Channel Low-Full RB#

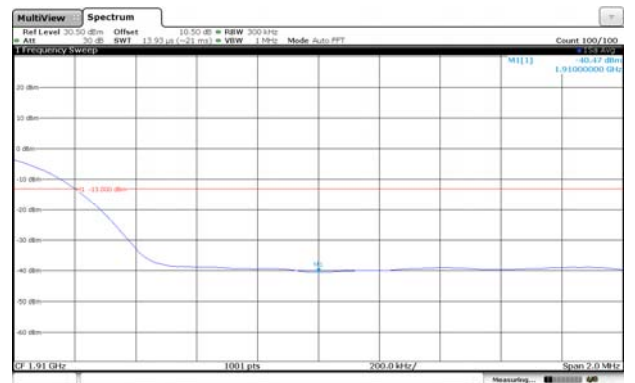

Channel High-Full RB#

LTE Band 2-20MHz-16QAM

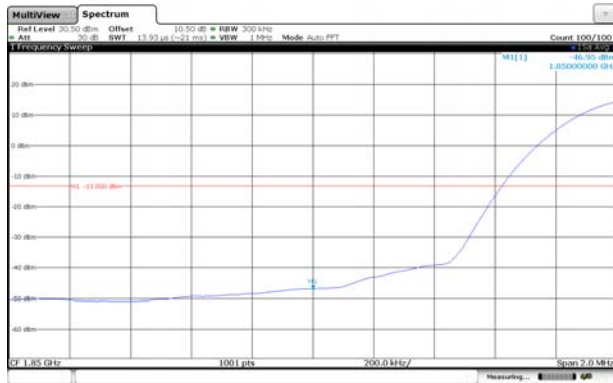

Channel Low-1RB#

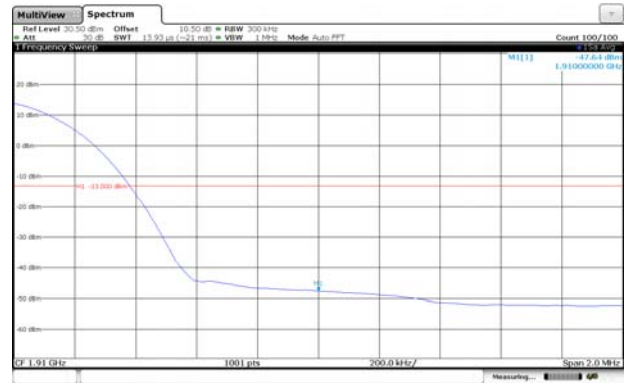

Channel High-1RB#

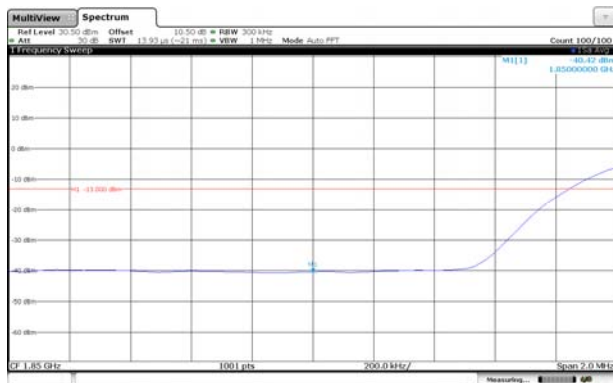

Channel Low-Full RB#

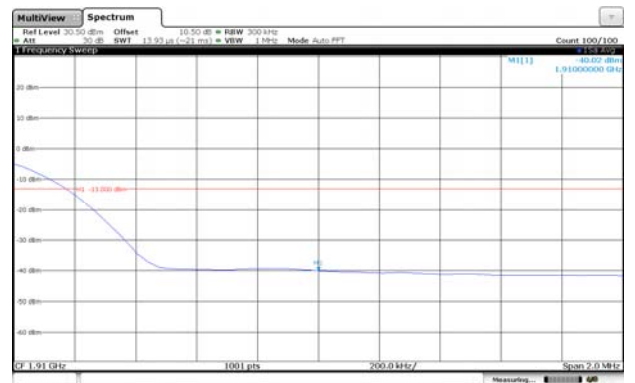

Channel High-Full RB#

LTE Band 4-1.4MHz-QPSK

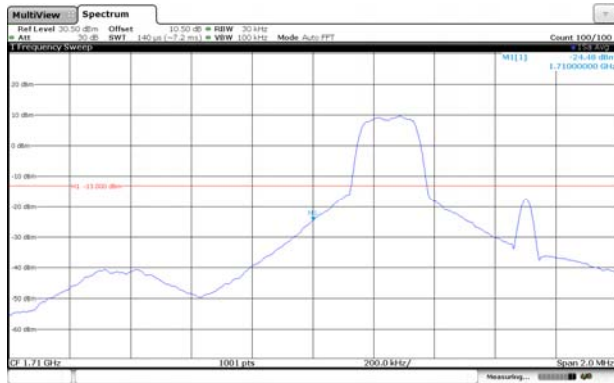

Channel Low-1RB#

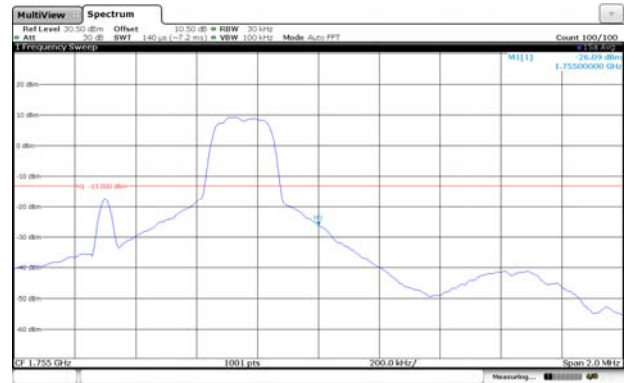

Channel High-1RB#

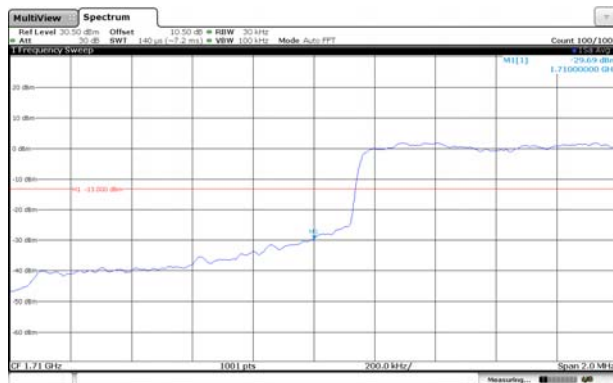

Channel Low-Full RB#

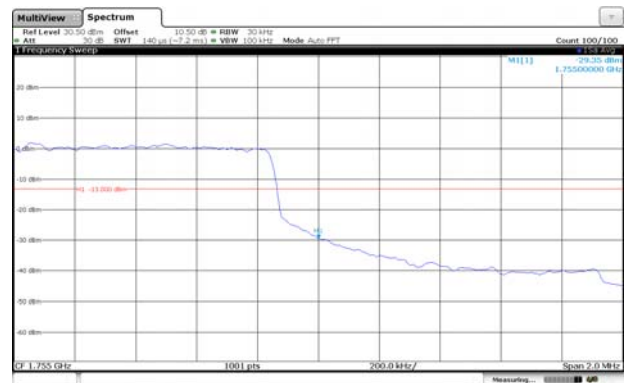

Channel High-Full RB#

LTE Band 4-1.4MHz-16QAM

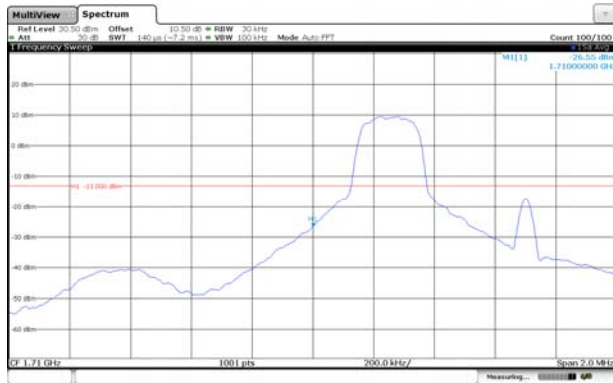

Channel Low-1RB#

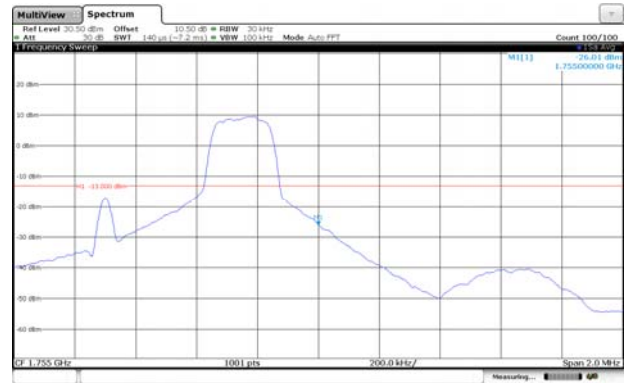

Channel High-1RB#

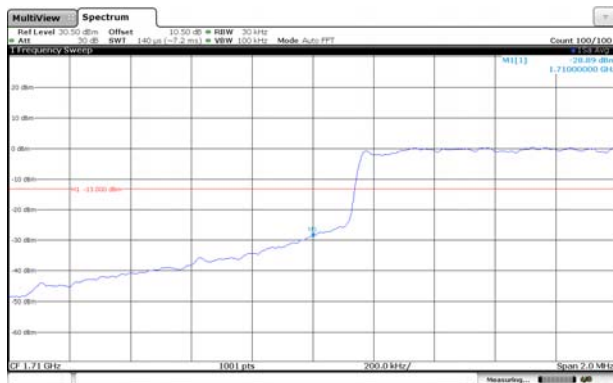

Channel Low-Full RB#

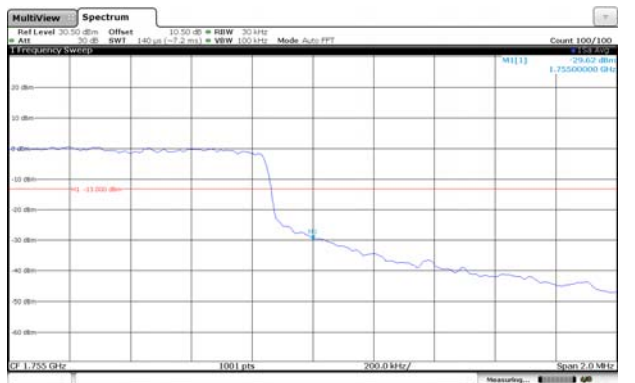

Channel High-Full RB#



LTE Band 4-3MHz-QPSK

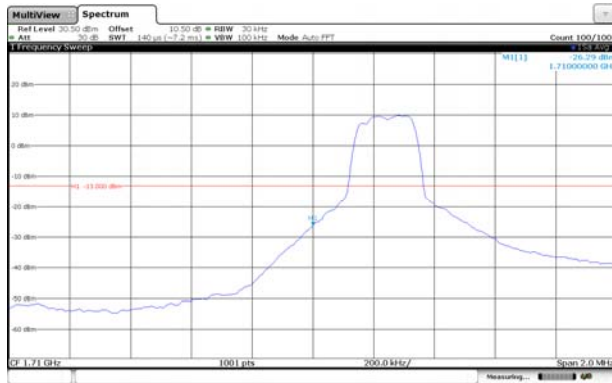

Channel Low-1RB#

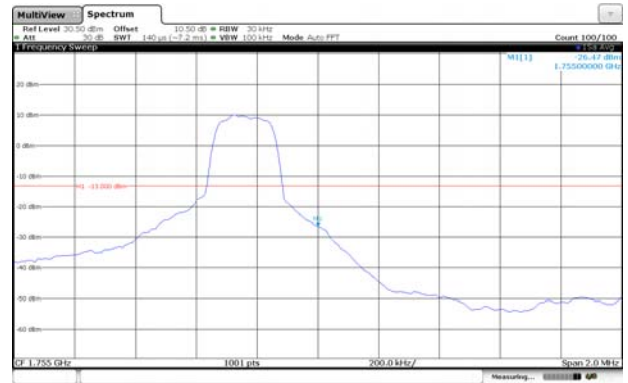

Channel High-1RB#

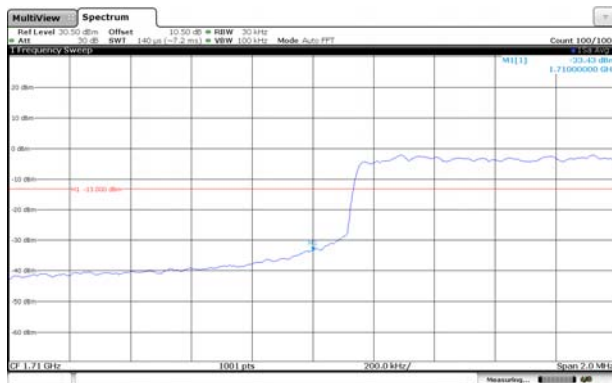

Channel Low-Full RB#

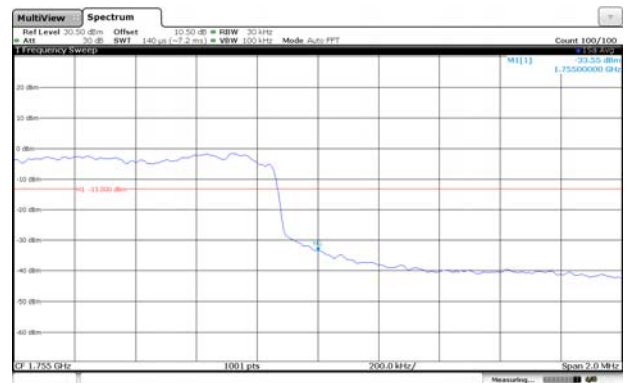

Channel High-Full RB#

LTE Band 4-3MHz-16QAM

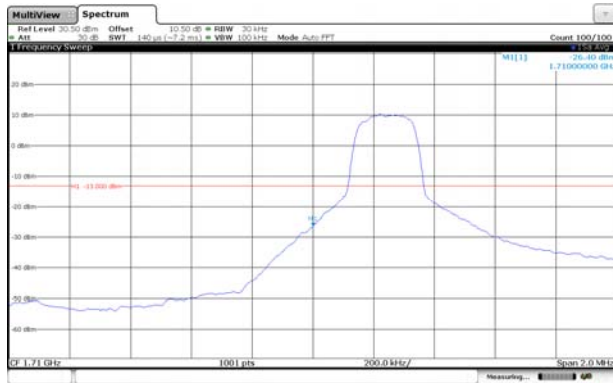

Channel Low-1RB#

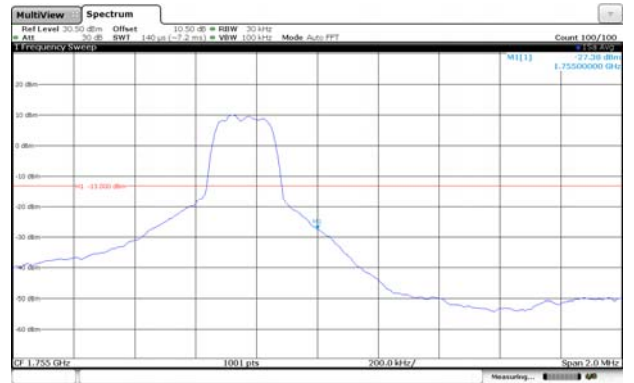

Channel High-1RB#

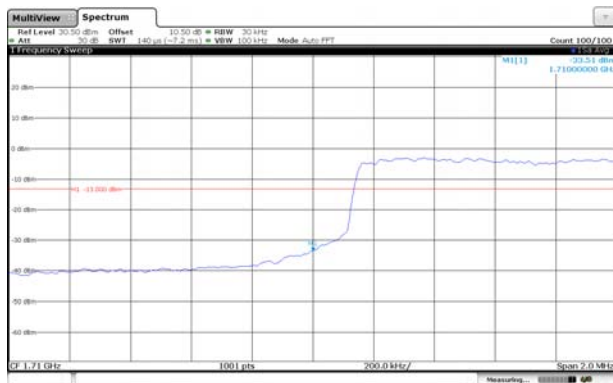

Channel Low-Full RB#

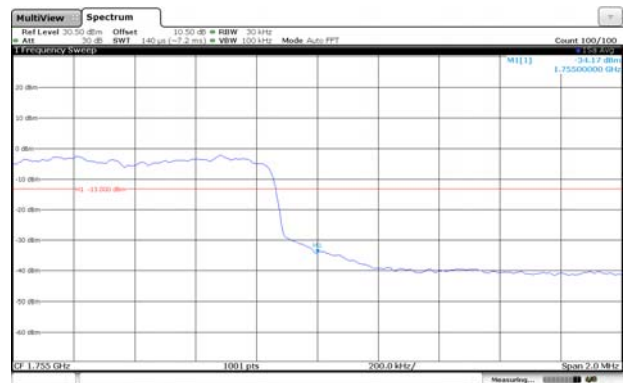

Channel High-Full RB#

LTE Band 4-5MHz-QPSK



Channel Low-1RB#

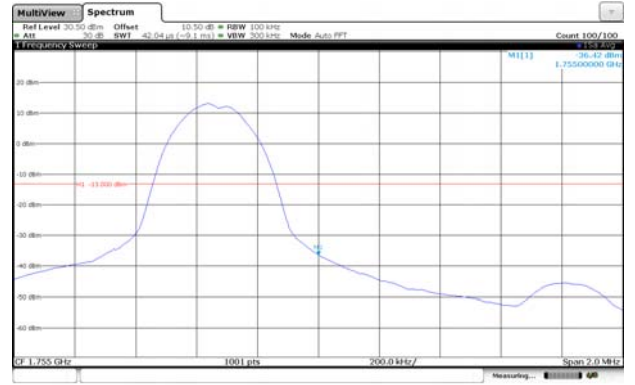

Channel High-1RB#



Channel Low-Full RB#

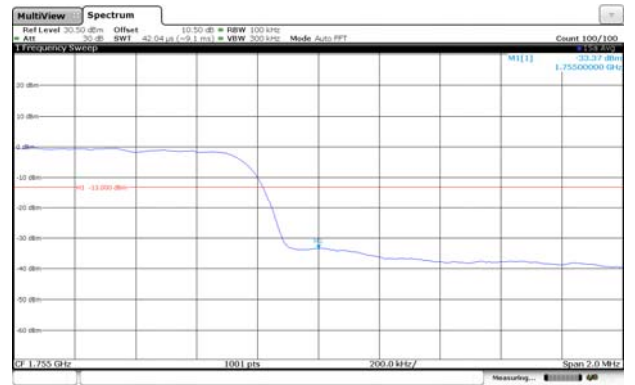

Channel High-Full RB#

LTE Band 4-5MHz-16QAM

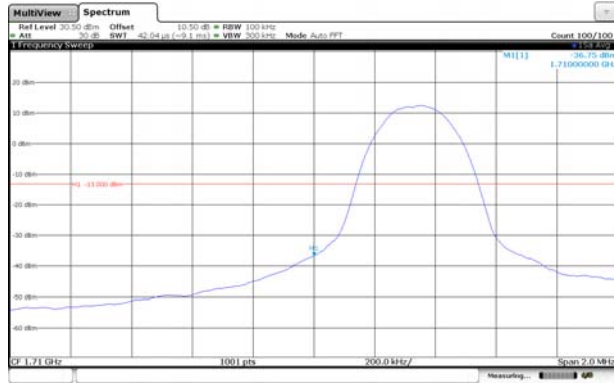

Channel Low-1RB#

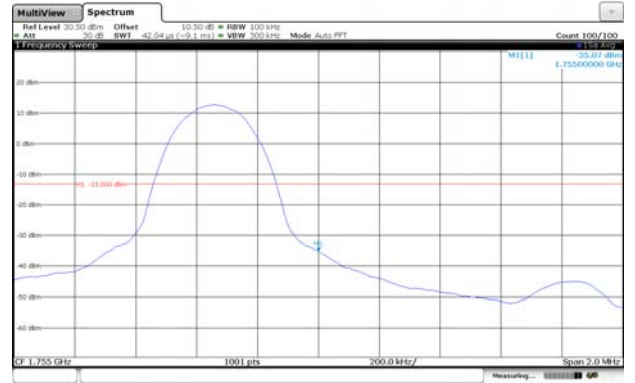

Channel High-1RB#

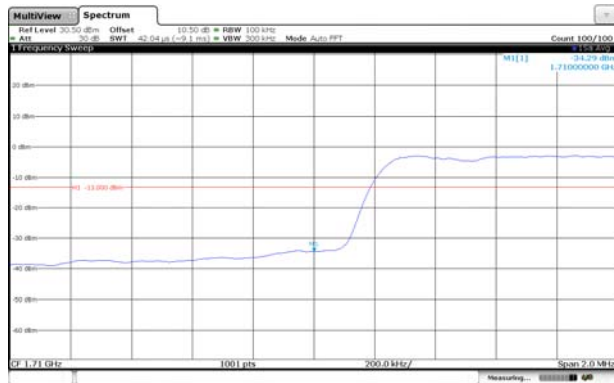

Channel Low-Full RB#

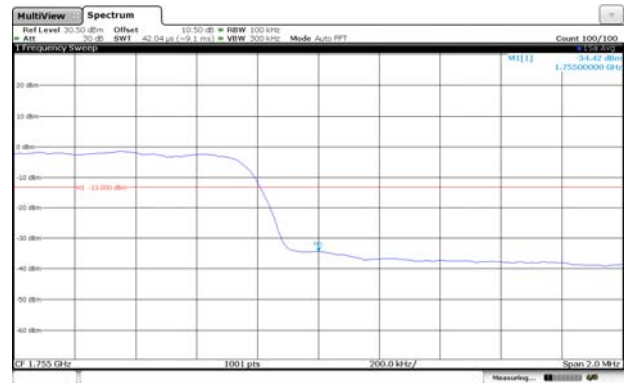

Channel High-Full RB#

LTE Band 4-10MHz-QPSK

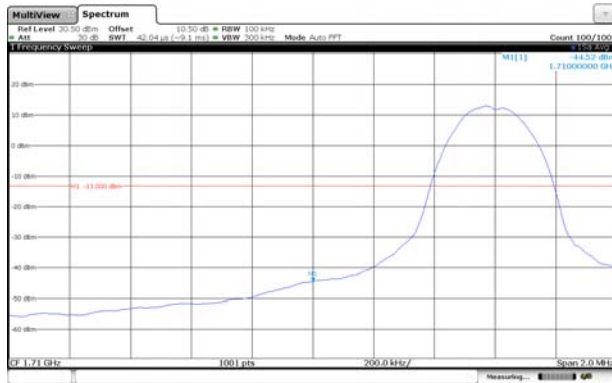

Channel Low-1RB#

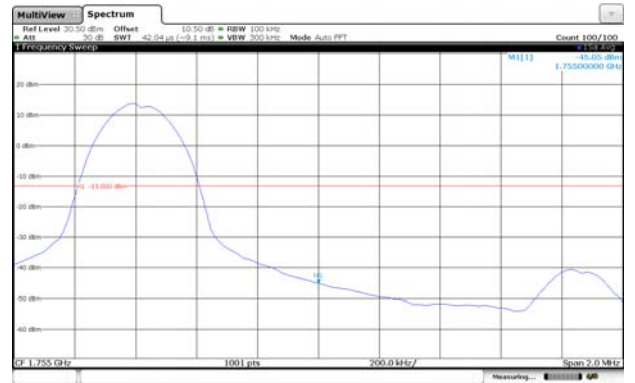

Channel High-1RB#

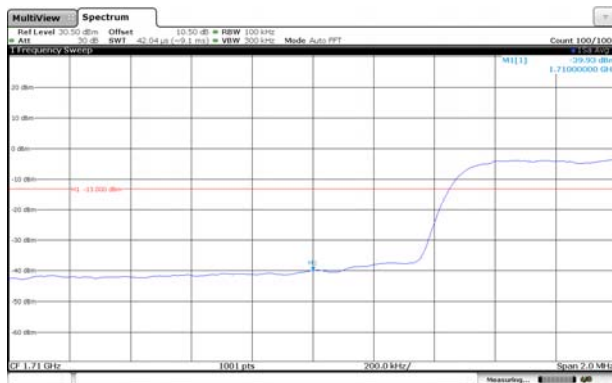

Channel Low-Full RB#

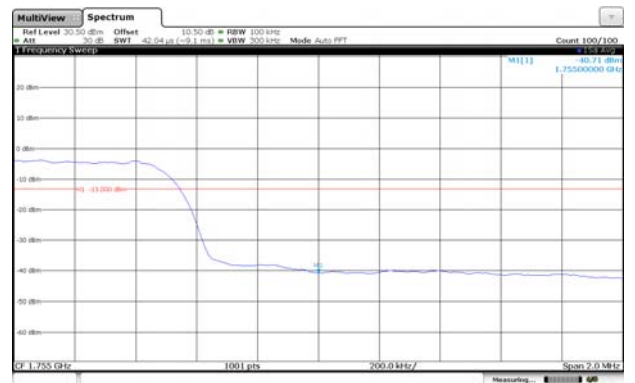

Channel High-Full RB#

LTE Band 4-10MHz-16QAM

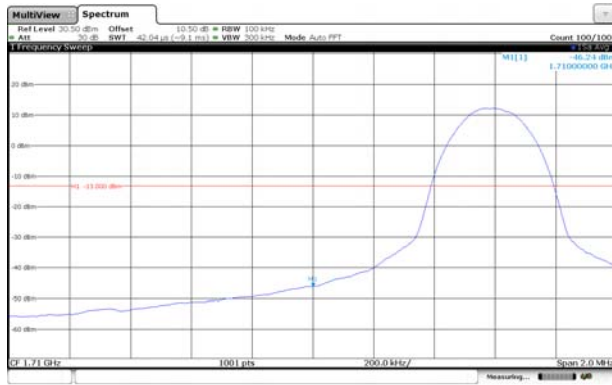

Channel Low-1RB#

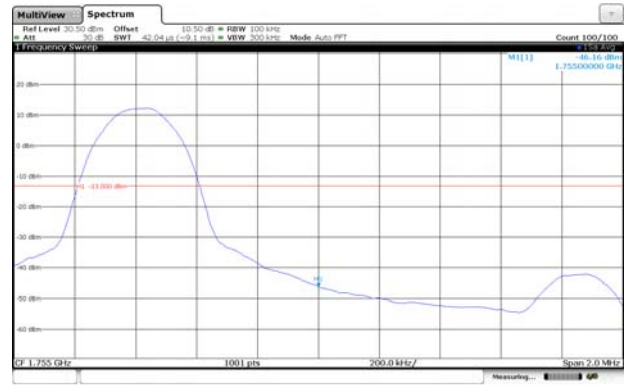

Channel High-1RB#

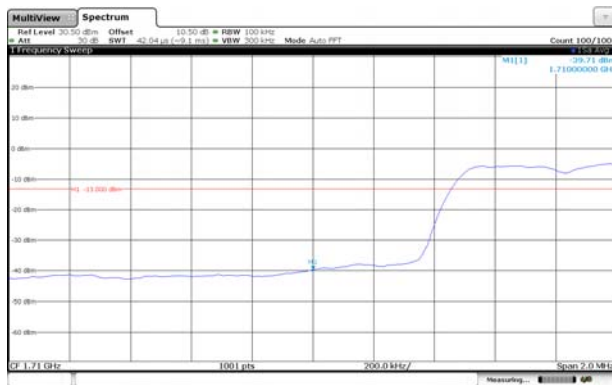

Channel Low-Full RB#

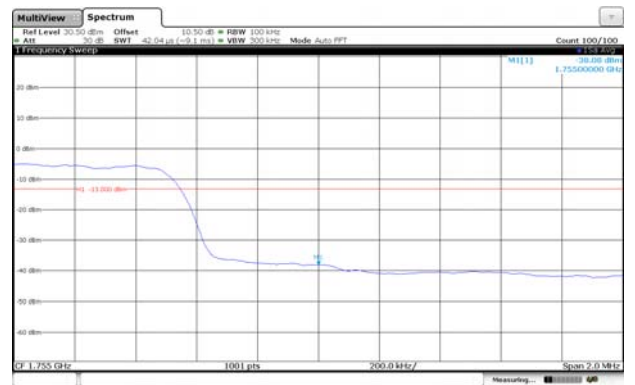

Channel High-Full RB#

LTE Band 4-15MHz-QPSK

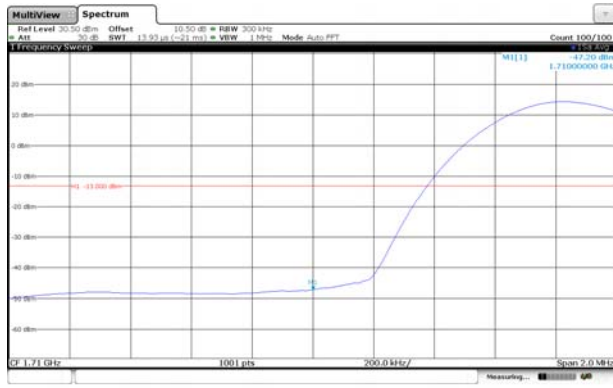

Channel Low-1RB#

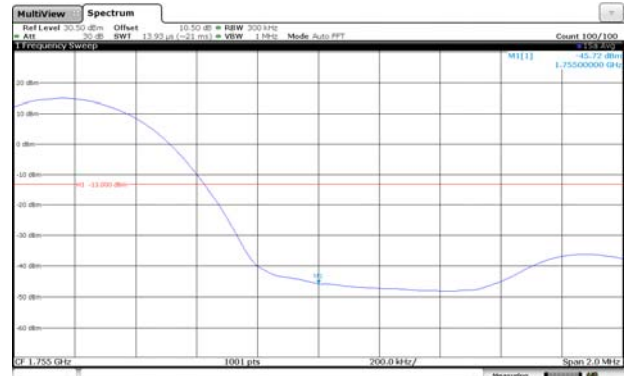

Channel High-1RB#

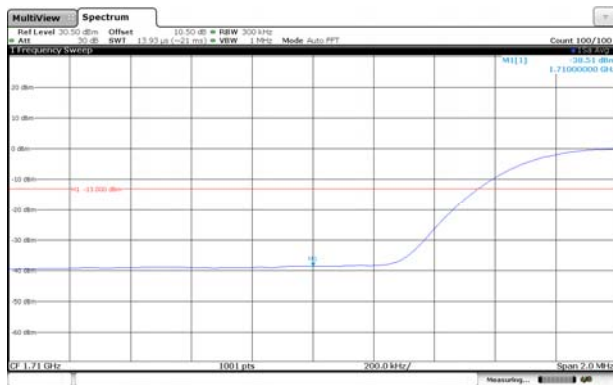

Channel Low-Full RB#

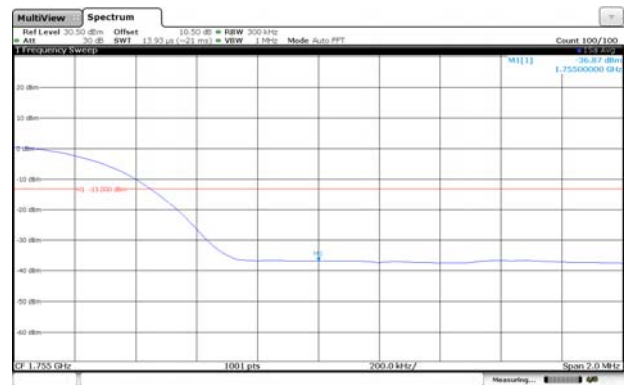

Channel High-Full RB#

LTE Band 4-15MHz-16QAM

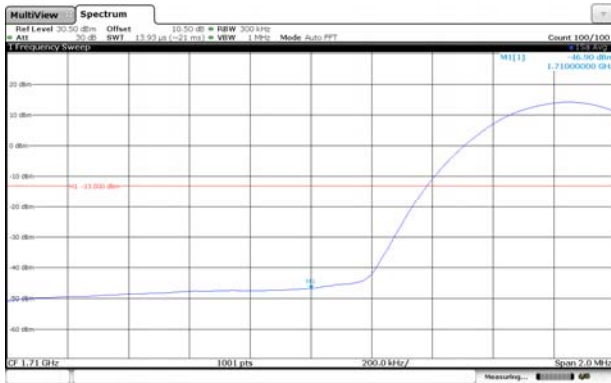

Channel Low-1RB#

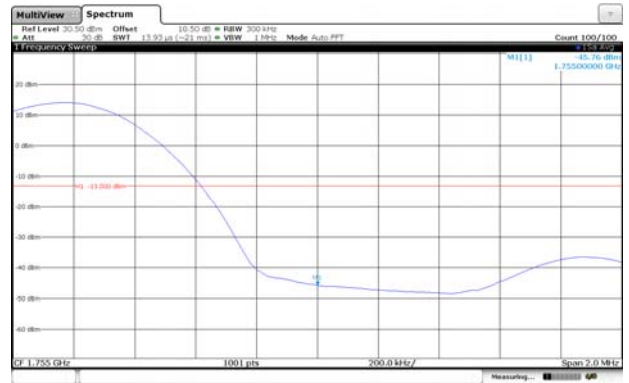

Channel High-1RB#

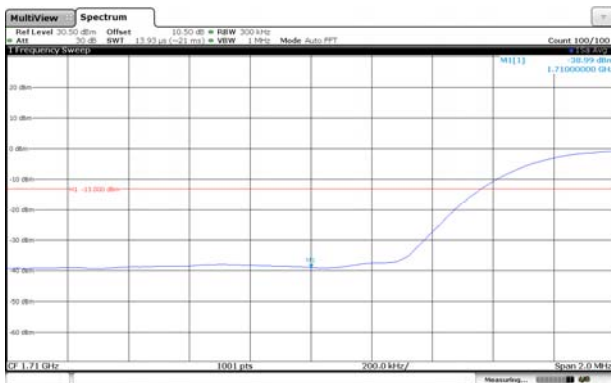

Channel Low-Full RB#

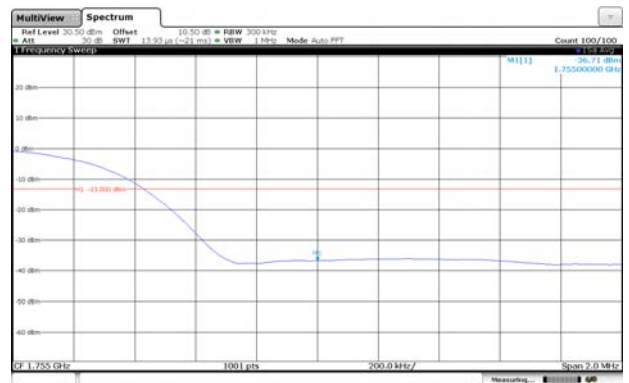

Channel High-Full RB#



LTE Band 4-20MHz-QPSK

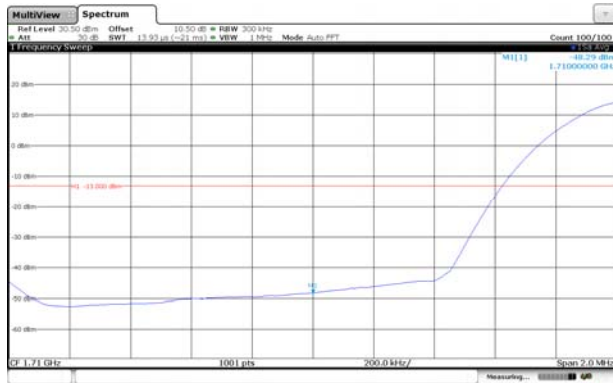

Channel Low-1RB#

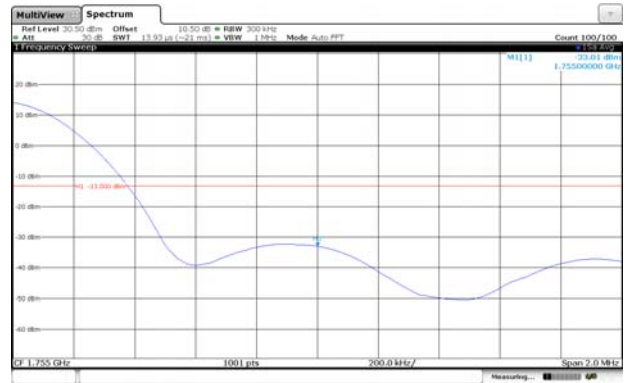

Channel High-1RB#

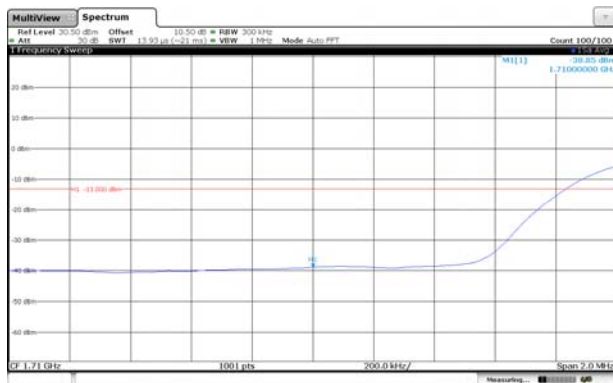

Channel Low-Full RB#

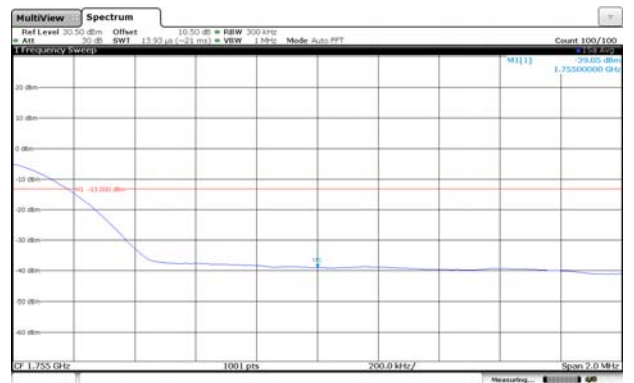

Channel High-Full RB#

LTE Band 4-20MHz-16QAM

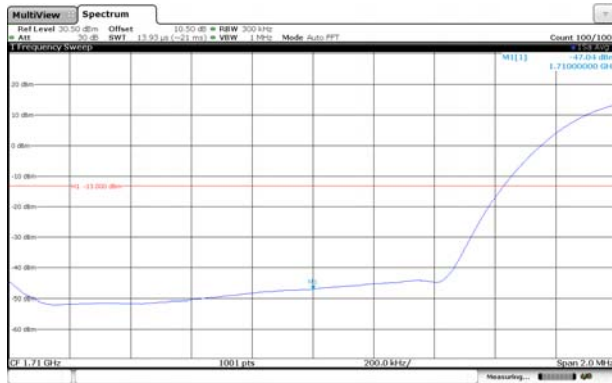

Channel Low-1RB#

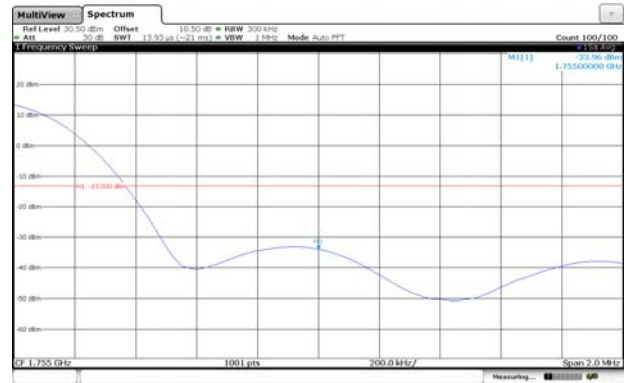

Channel High-1RB#

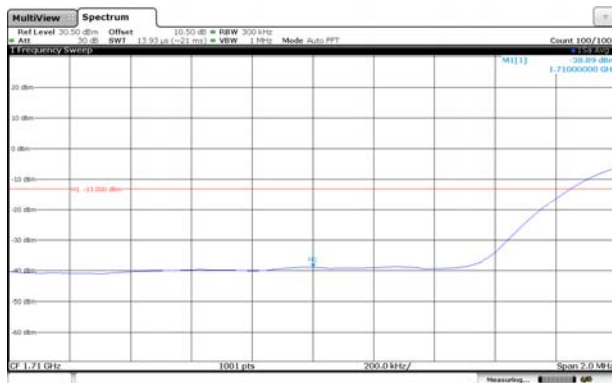

Channel Low-Full RB#

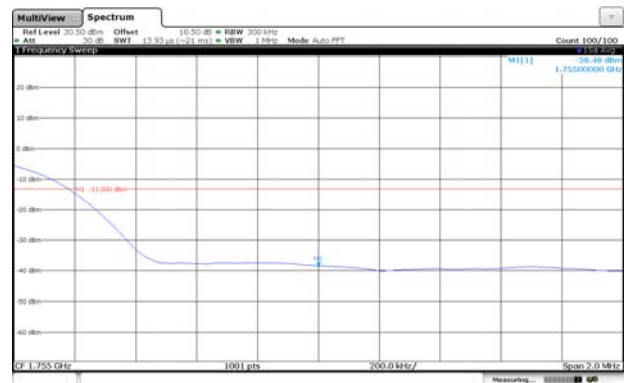

Channel High-Full RB#

LTE Band 7-5MHz-QPSK

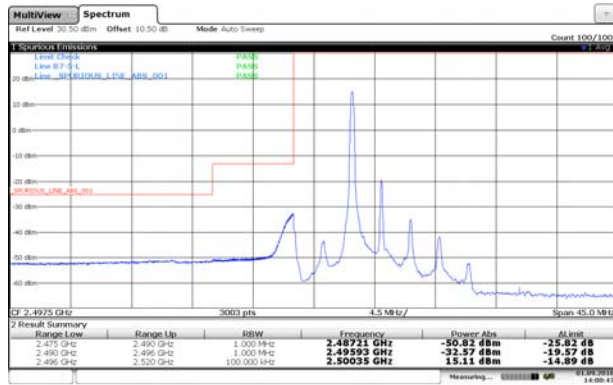

Channel Low-1RB#

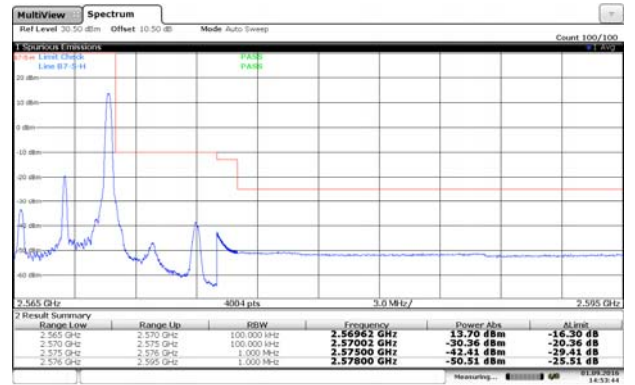

Channel High-1RB#

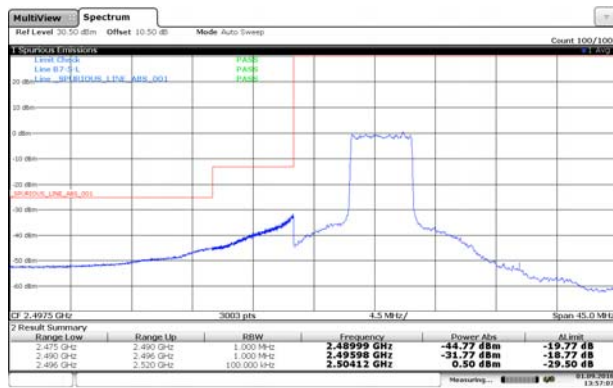

Channel Low-Full RB#

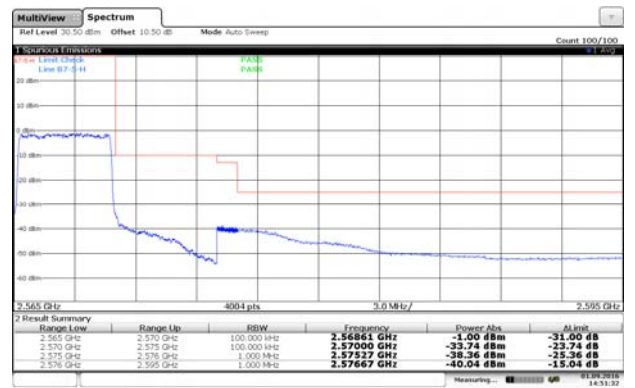

Channel High-Full RB#

LTE Band 7-5MHz-16QAM

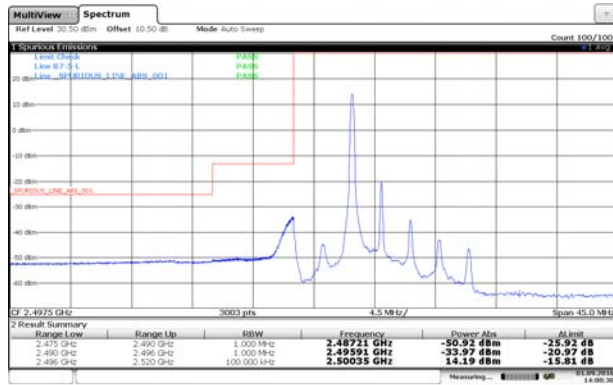

Channel Low-1RB#

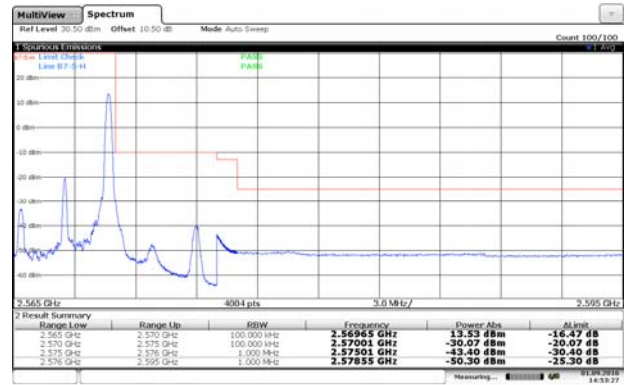

Channel High-1RB#

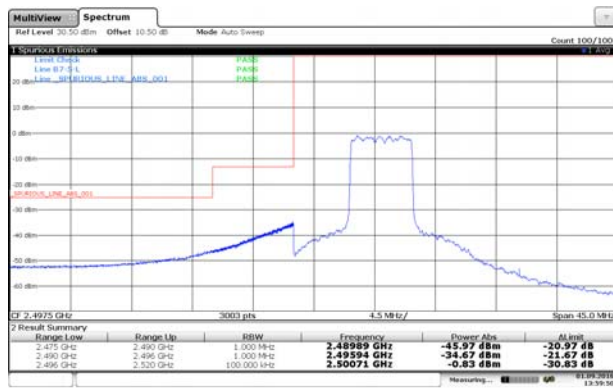

Channel Low-Full RB#

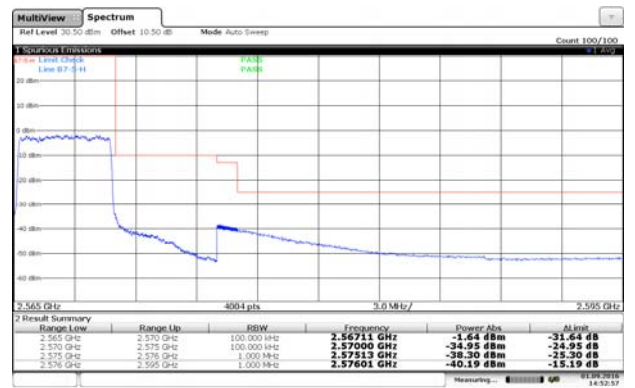

Channel High-Full RB#

LTE Band 7-10MHz-QPSK

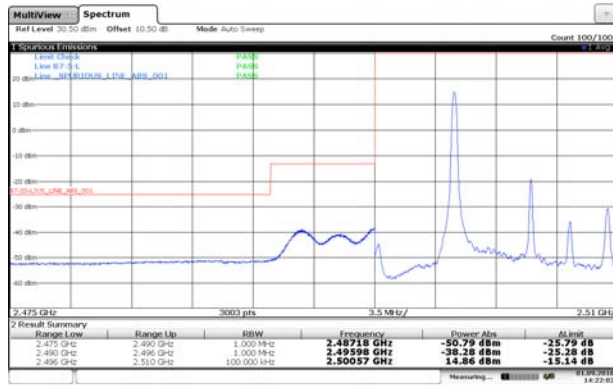

Channel Low-1RB#

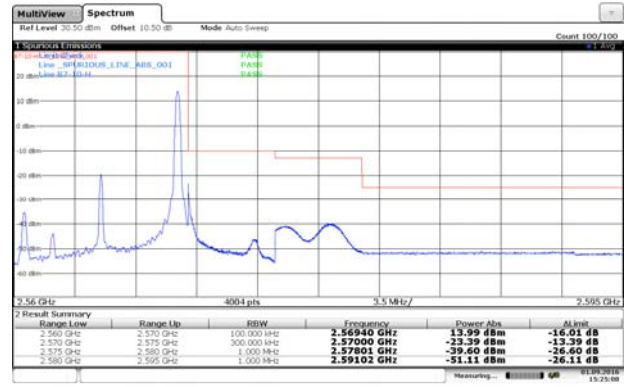

Channel High-1RB#

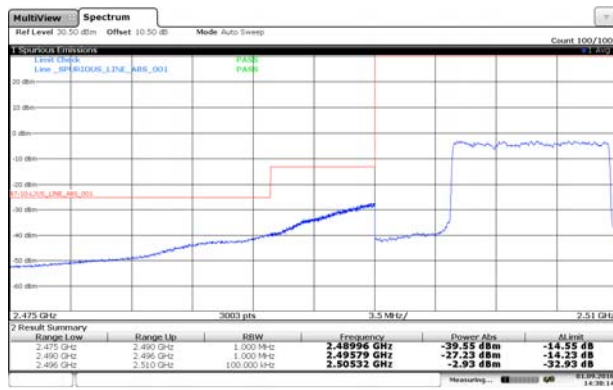

Channel Low-Full RB#

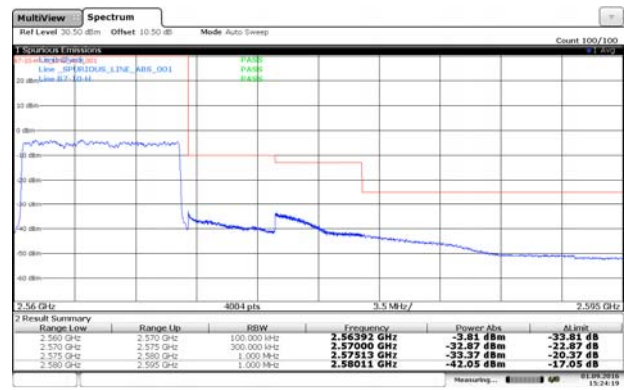

Channel High-Full RB#

LTE Band 7-10MHz-16QAM

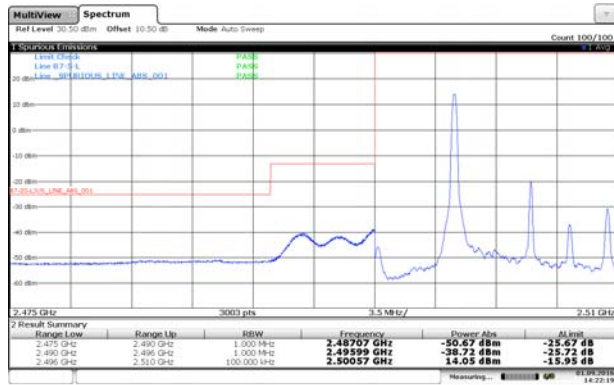

Channel Low-1RB#

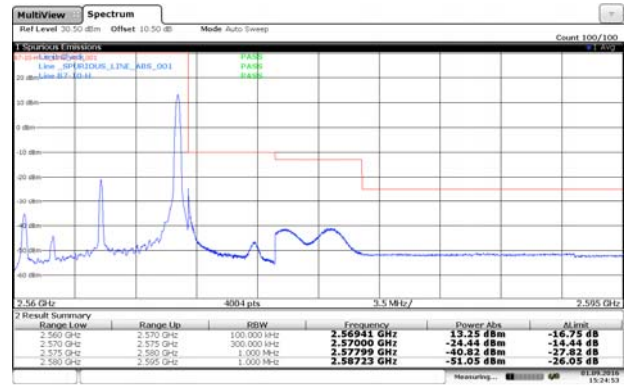

Channel High-1RB#

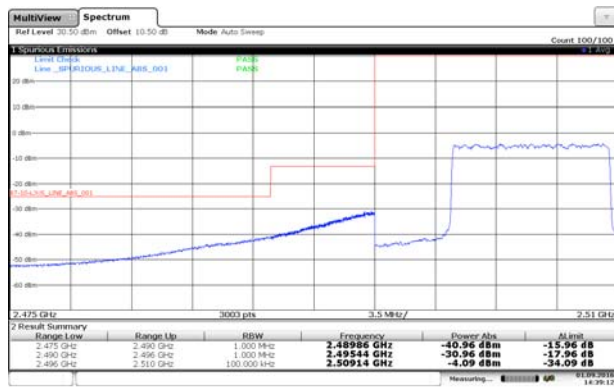

Channel Low-Full RB#

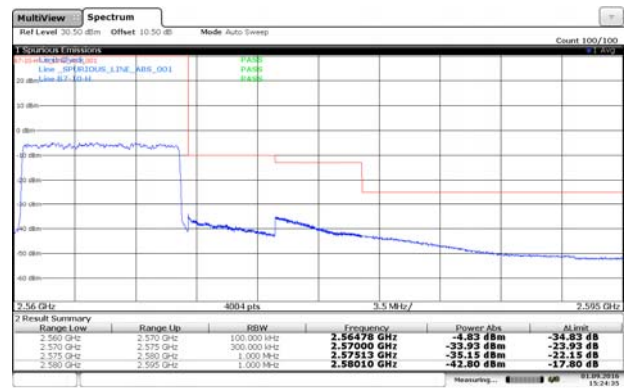

Channel High-Full RB#

LTE Band 7-15MHz-QPSK

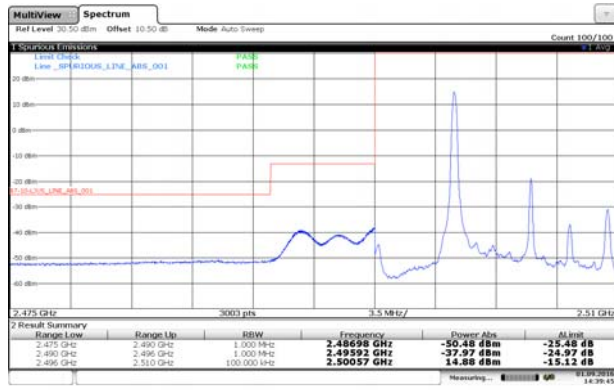

Channel Low-1RB#

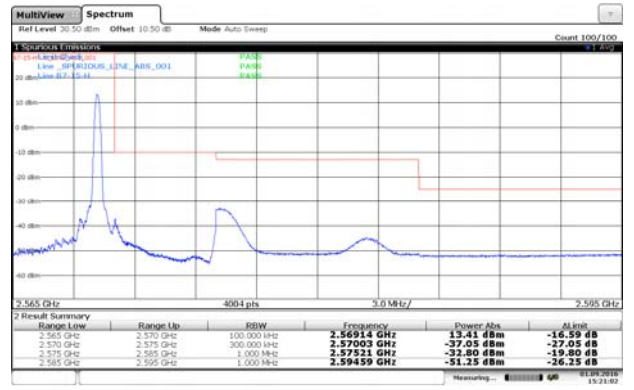

Channel High-1RB#

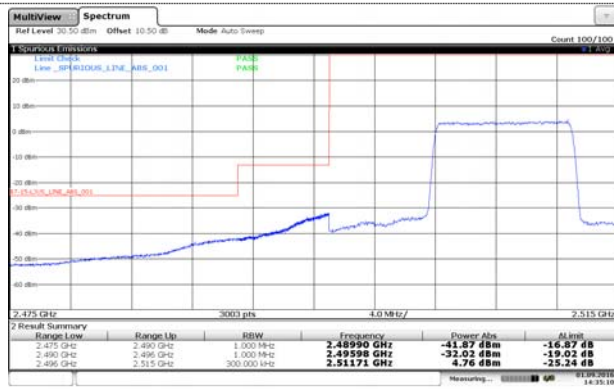

Channel Low-Full RB#

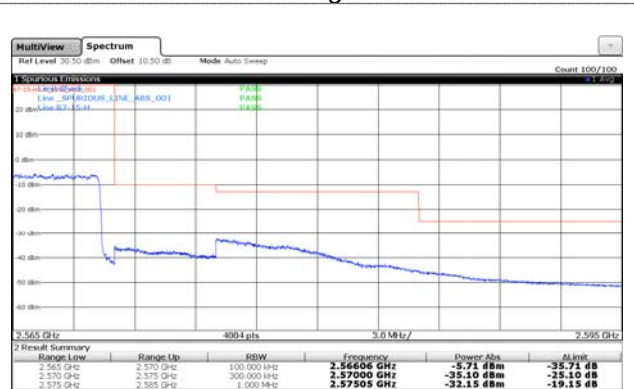

Channel High-Full RB#

LTE Band 7-15MHz-16QAM

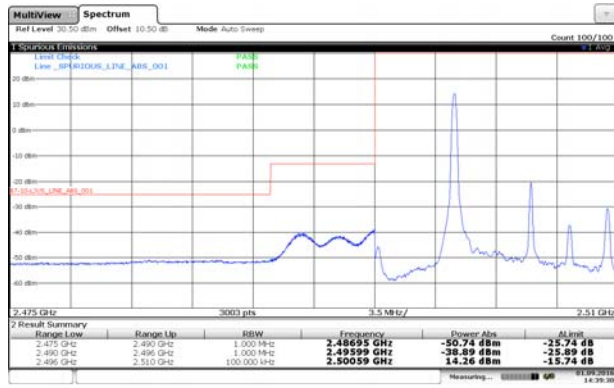

Channel Low-1RB#

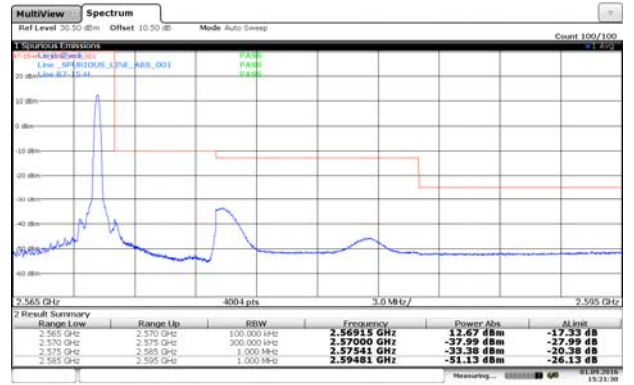

Channel High-1RB#

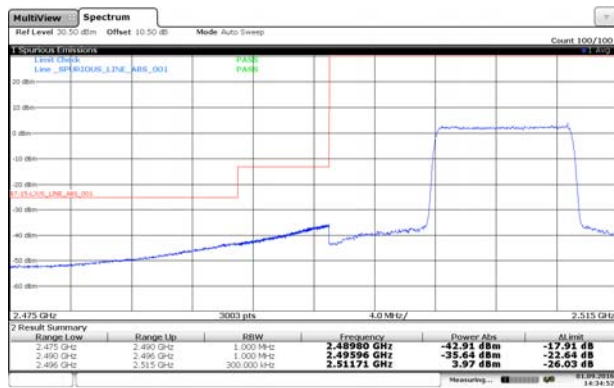

Channel Low-Full RB#

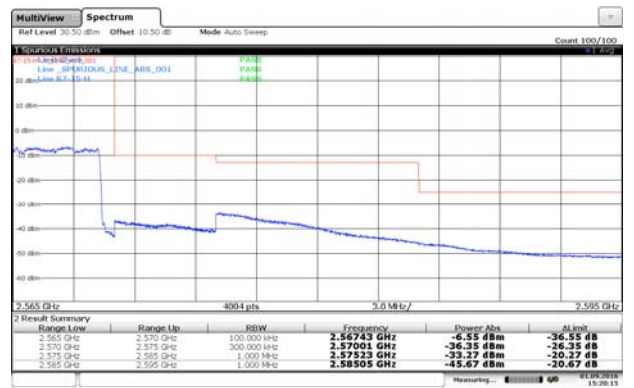

Channel High-Full RB#



LTE Band 7-20MHz-QPSK

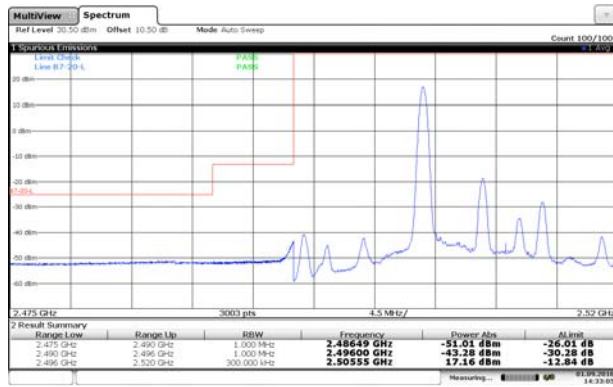

Channel Low-1RB#

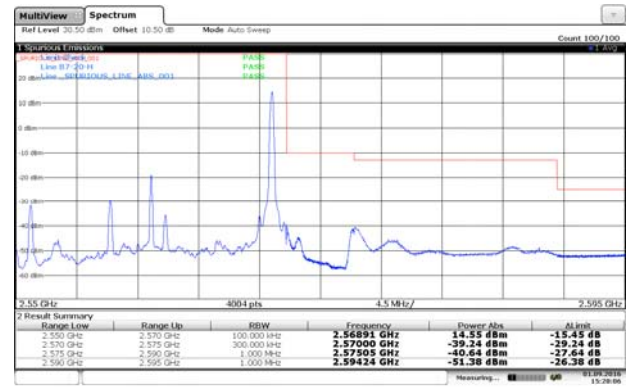

Channel High-1RB#

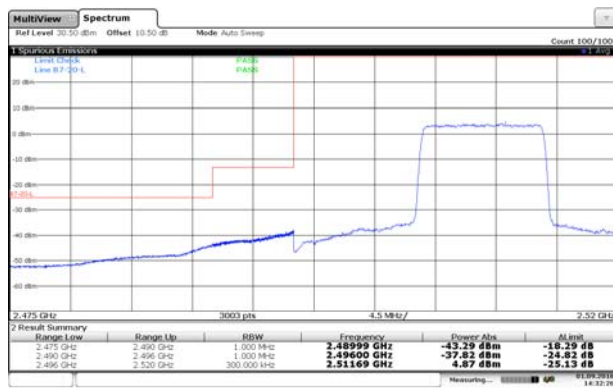

Channel Low-Full RB#



Channel High-Full RB#

LTE Band 7-20MHz-16QAM

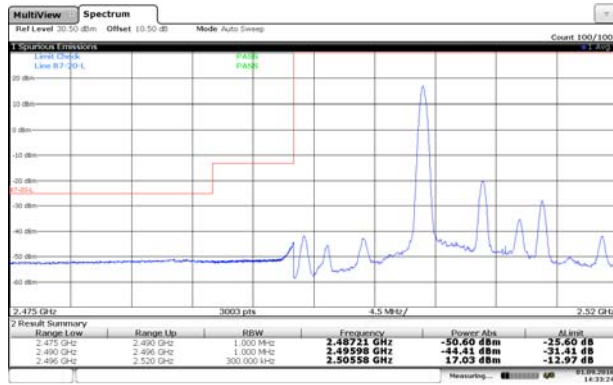

Channel Low-1RB#

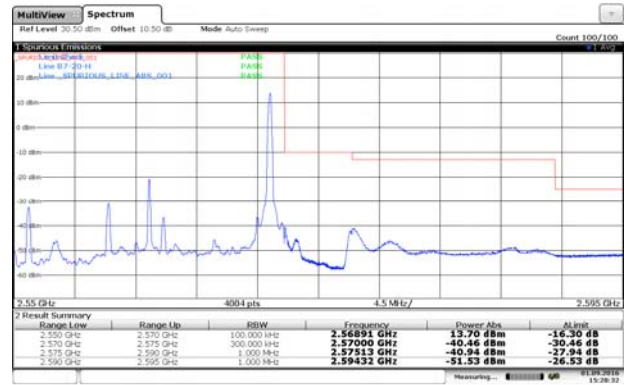

Channel High-1RB#

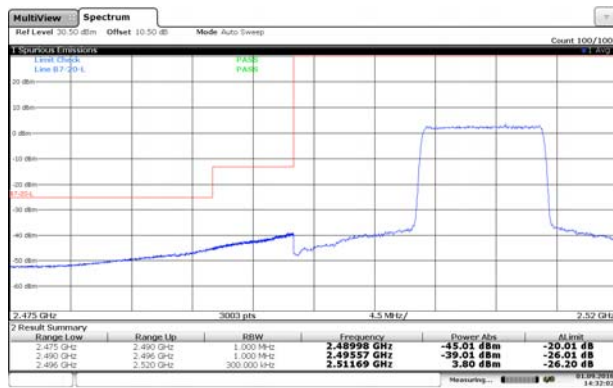

Channel Low-Full RB#

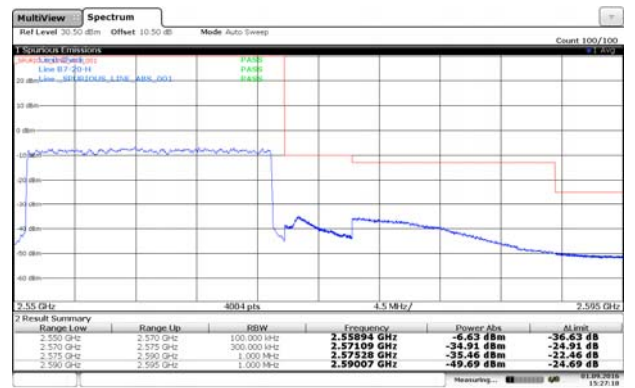

Channel High-Full RB#

## 4.5. Radiated Power Measurement

### LIMIT

LTE Band 2: EIRP <2W, LTE Band 4: EIRP <1W, LTE Band 7: ERP <2W

### TEST CONFIGURATION

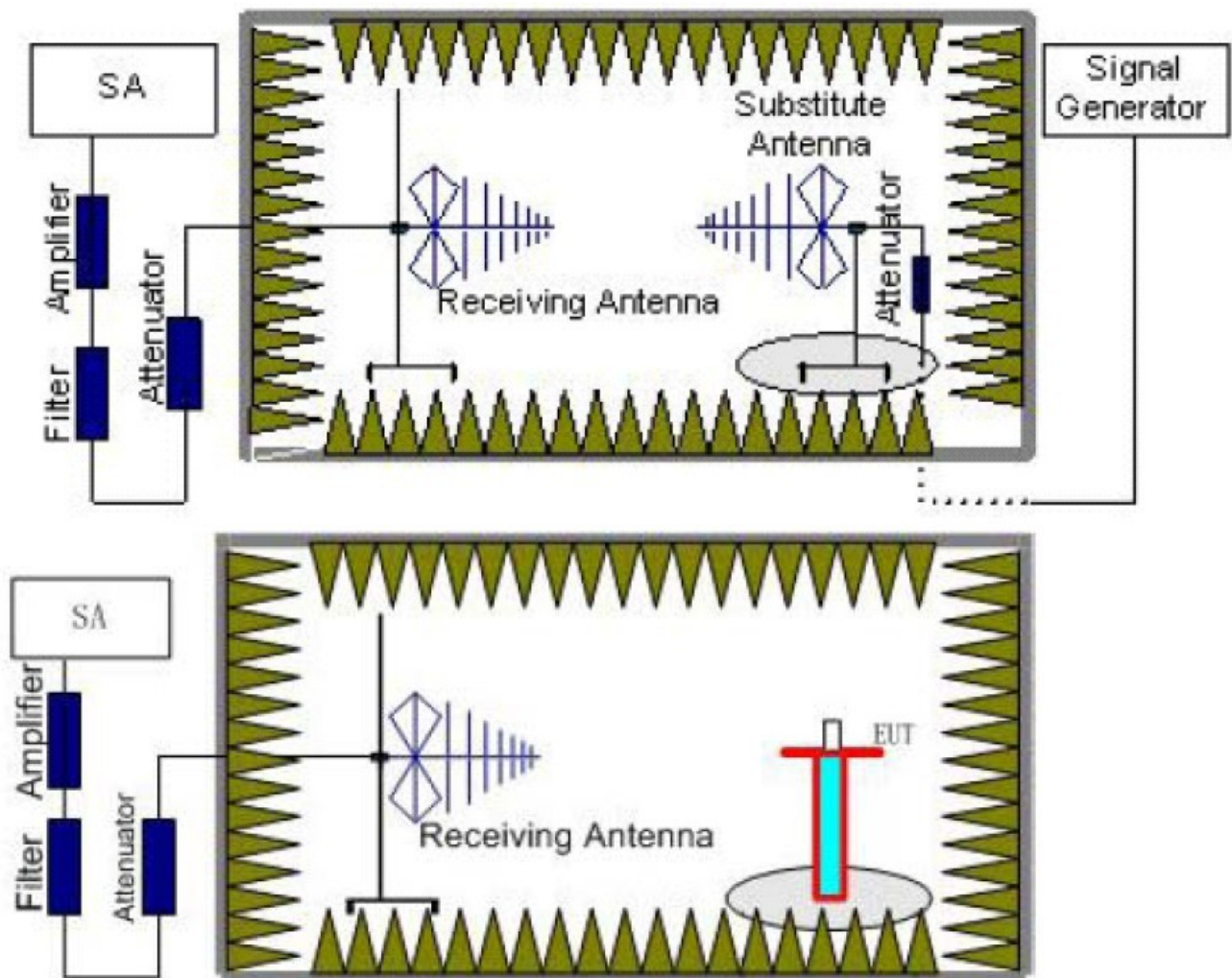

### TEST PROCEDURE

1. EUT was placed on a 1.5 meter high non-conductive stand at a 3 meter test distance from the receive antenna. A receiving antenna was placed on the antenna mast 3 meters from the EUT for emission measurements. The height of receiving antenna is 1.0m. Detected emissions were maximized at each frequency by rotating the EUT through 360° and adjusting the receiving antenna polarization. The radiated emission measurements of all transmit frequencies in three channels (High, Middle, Low) were measured with peak detector.
2. A log-periodic antenna or double-ridged waveguide horn antenna shall be substituted in place of the EUT. The log-periodic antenna will be driven by a signal generator and the level will be adjusted till the same power value on the spectrum analyzer or receiver. The level of the spurious emissions can be calculated through the level of the signal generator, cable loss, the gain of the substitution antenna and the reading of the spectrum analyzer or receiver.
3. The EUT is then put into continuously transmitting mode at its maximum power level during the test. Set Test Receiver or Spectrum RBW=1MHz, VBW=3MHz for above 1GHz and RBW=100kHz, VBW=300kHz for 30MHz to 1GHz,, And the maximum value of the receiver should be recorded as (Pr).
4. The EUT shall be replaced by a substitution antenna. In the chamber, an substitution antenna for the frequency band of interest is placed at the reference point of the chamber. An RF Signal source for the frequency band of interest is connected to the substitution antenna with a cable that has been constructed to not interfere with the radiation pattern of the antenna. A power (PMea) is applied to the input of the substitution antenna, and adjust the level of the signal generator output until the value of the receiver reach the previously recorded (Pr). The power of signal source (PMea) is recorded. The test should be

performed by rotating the test item and adjusting the receiving antenna polarization.

5. A amplifier should be connected to the Signal Source output port. And the cable should be connect between the Amplifier and the Substitution Antenna. The cable loss (Pcl) ,the Substitution Antenna Gain (Ga) and the Amplifier Gain (PAg) should be recorded after test.
6. The measurement results are obtained as described below:  
Power(EIRP)=PMea- PAg - Pcl + Ga  
We used SMF100A micowave signal generator which signal level can up to 33dBm,so we not used power Amplifier for substitution test; The measurement results are amend as described below:  
Power(EIRP)=PMea- Pcl + Ga
7. This value is EIRP since the measurement is calibrated using an antenna of known gain (2.15 dBi) and known input power.  
ERP can be calculated from EIRP by subtracting the gain of the dipole, ERP = EIRP-2.15dBi.

## **TEST RESULTS**

LTE Band 2-1.4MHz					
Modulation	Channel	EIRP (dBm)		Limit (dBm)	Result
		Vertical	Horizontal		
QPSK	Low	18.45	20.66	30	PASS
	Mid	19.02	21.14		
	High	18.36	20.84		
16QAM	Low	18.69	20.73		PASS
	Mid	18.71	21.07		
	High	19.00	20.77		

LTE Band 2-3MHz					
Modulation	Channel	EIRP (dBm)		Limit (dBm)	Result
		Vertical	Horizontal		
QPSK	Low	18.35	20.52	30	PASS
	Mid	18.43	20.19		
	High	18.52	19.76		
16QAM	Low	18.04	20.46		PASS
	Mid	17.97	20.07		
	High	18.55	19.77		

LTE Band 2-5MHz					
Modulation	Channel	EIRP (dBm)		Limit (dBm)	Result
		Vertical	Horizontal		
QPSK	Low	18.74	20.52	30	PASS
	Mid	18.36	20.41		
	High	18.43	20.33		
16QAM	Low	17.94	20.52		PASS
	Mid	17.56	20.41		
	High	19.07	20.47		

LTE Band 2-10MHz					
Modulation	Channel	EIRP (dBm)		Limit (dBm)	Result
		Vertical	Horizontal		
QPSK	Low	18.39	20.36	30	PASS
	Mid	18.94	20.41		
	High	17.69	19.92		
16QAM	Low	18.26	19.73		PASS
	Mid	19.18	20.54		
	High	17.48	19.68		

LTE Band 2-15MHz						
Modulation	Channel	EIRP (dBm)		Limit (dBm)	Result	
		Vertical	Horizontal			
QPSK	Low	18.38	20.15	30	PASS	
	Mid	18.47	20.36			
	High	18.86	20.33			
16QAM	Low	17.87	20.15		30	PASS
	Mid	18.47	20.36			
	High	18.73	20.33			

LTE Band 2-20MHz						
Modulation	Channel	EIRP (dBm)		Limit (dBm)	Result	
		Vertical	Horizontal			
QPSK	Low	17.43	19.65	30	PASS	
	Mid	18.52	20.66			
	High	18.58	20.14			
16QAM	Low	16.95	19.55		30	PASS
	Mid	17.81	20.48			
	High	18.65	20.16			

LTE Band 4-1.4MHz					
Modulation	Channel	EIRP (dBm)		Limit (dBm)	Result
		Vertical	Horizontal		
QPSK	Low	15.43	18.96	30	PASS
	Mid	16.36	19.78		
	High	15.44	18.85		
16QAM	Low	15.76	19.09		PASS
	Mid	15.80	19.66		
	High	16.32	18.73		

LTE Band 4-3MHz					
Modulation	Channel	EIRP (dBm)		Limit (dBm)	Result
		Vertical	Horizontal		
QPSK	Low	15.66	18.84	30	PASS
	Mid	16.98	19.52		
	High	15.75	18.89		
16QAM	Low	15.10	18.72		PASS
	Mid	16.15	19.31		
	High	15.85	18.91		

LTE Band 4-5MHz					
Modulation	Channel	EIRP (dBm)		Limit (dBm)	Result
		Vertical	Horizontal		
QPSK	Low	15.39	19.75	30	PASS
	Mid	15.24	19.67		
	High	15.08	19.76		
16QAM	Low	14.65	19.59		PASS
	Mid	15.98	19.81		
	High	14.49	19.63		

LTE Band 4-10MHz					
Modulation	Channel	EIRP (dBm)		Limit (dBm)	Result
		Vertical	Horizontal		
QPSK	Low	15.76	18.32	30	PASS
	Mid	16.35	19.15		
	High	15.38	18.33		
16QAM	Low	16.24	18.34		PASS
	Mid	16.33	19.13		
	High	16.34	18.31		

LTE Band 4-15MHz						
Modulation	Channel	EIRP (dBm)		Limit (dBm)	Result	
		Vertical	Horizontal			
QPSK	Low	15.82	18.76	30	PASS	
	Mid	15.49	18.52			
	High	16.35	19.08			
16QAM	Low	16.45	18.76		30	PASS
	Mid	15.49	18.52			
	High	16.51	19.08			

LTE Band 4-20MHz						
Modulation	Channel	EIRP (dBm)		Limit (dBm)	Result	
		Vertical	Horizontal			
QPSK	Low	15.34	18.79	30	PASS	
	Mid	15.85	18.47			
	High	15.47	19.32			
16QAM	Low	15.92	18.91		30	PASS
	Mid	16.72	18.69			
	High	14.64	19.14			



LTE Band 7-5MHz						
Modulation	Channel	ERP (dBm)		Limit (dBm)	Result	
		Vertical	Horizontal			
QPSK	Low	19.43	21.33	33.0	PASS	
	Mid	19.25	21.36			
	High	19.36	21.78			
16QAM	Low	19.32	21.42		33.0	PASS
	Mid	19.33	21.28			
	High	18.99	21.86			

LTE Band 7-10MHz						
Modulation	Channel	ERP (dBm)		Limit (dBm)	Result	
		Vertical	Horizontal			
QPSK	Low	19.47	21.85	33.0	PASS	
	Mid	19.27	21.43			
	High	19.35	21.74			
16QAM	Low	19.10	21.77		33.0	PASS
	Mid	18.72	21.29			
	High	19.39	21.75			

LTE Band 7-15MHz						
Modulation	Channel	ERP (dBm)		Limit (dBm)	Result	
		Vertical	Horizontal			
QPSK	Low	18.95	20.25	33.0	PASS	
	Mid	18.76	20.23			
	High	18.74	20.65			
16QAM	Low	18.20	20.41		33.0	PASS
	Mid	19.34	20.10			
	High	19.30	20.77			

LTE Band 7-20MHz						
Modulation	Channel	ERP (dBm)		Limit (dBm)	Result	
		Vertical	Horizontal			
QPSK	Low	18.94	20.25	33.0	PASS	
	Mid	18.37	20.47			
	High	19.36	20.66			
16QAM	Low	19.77	20.61		33.0	PASS
	Mid	18.95	19.97			
	High	20.23	20.89			

## 4.6. Radiated Spurious Emission

### LIMIT

-13dBm

### TEST CONFIGURATION

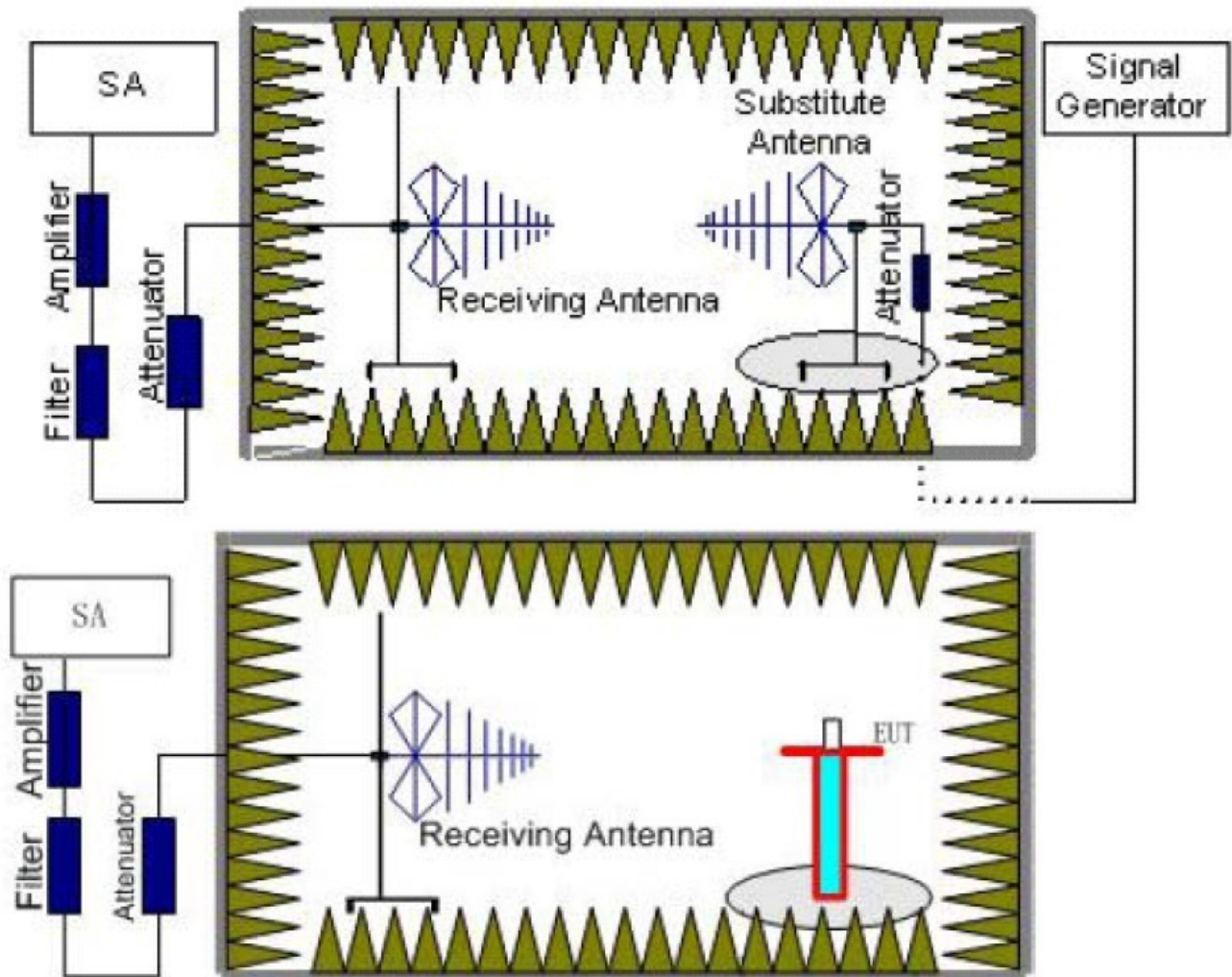

### TEST RESULTS

1. EUT was placed on a 1.5 meter high non-conductive stand at a 3 meter test distance from the receive antenna. A receiving antenna was placed on the antenna mast 3 meters from the EUT for emission measurements. The height of receiving antenna is 1.0m. Detected emissions were maximized at each frequency by rotating the EUT through 360° and adjusting the receiving antenna polarization. The radiated emission measurements of all transmit frequencies in three channels (High, Middle, Low) were measured with peak detector.
2. A log-periodic antenna or double-ridged waveguide horn antenna shall be substituted in place of the EUT. The log-periodic antenna will be driven by a signal generator and the level will be adjusted till the same power value on the spectrum analyzer or receiver. The level of the spurious emissions can be calculated through the level of the signal generator, cable loss, the gain of the substitution antenna and the reading of the spectrum analyzer or receiver.
3. The EUT is then put into continuously transmitting mode at its maximum power level during the test. Set Test Receiver or Spectrum RBW=1MHz, VBW=3MHz for above 1GHz and RBW=100kHz, VBW=300kHz for 30MHz to 1GHz, And the maximum value of the receiver should be recorded as (Pr).
4. The EUT shall be replaced by a substitution antenna. In the chamber, an substitution antenna for the frequency band of interest is placed at the reference point of the chamber. An RF Signal source for the frequency band of interest is connected to the substitution antenna with a cable that has been constructed to not interfere with the radiation pattern of the antenna. A power (PMea) is applied to the input of the substitution antenna, and adjust the level of the signal generator output until the value of the receiver reach the previously recorded (Pr). The power of signal source (PMea) is recorded. The test should be

performed by rotating the test item and adjusting the receiving antenna polarization.

5. A amplifier should be connected to the Signal Source output port. And the cable should be connect between the Amplifier and the Substitution Antenna. The cable loss (Pcl) ,the Substitution Antenna Gain (Ga) and the Amplifier Gain (PAg) should be recorded after test.
6. The measurement results are obtained as described below:  
Power(EIRP)=PMea- PAg - Pcl + Ga  
We used SMF100A micowave signal generator which signal level can up to 33dBm,so we not used power Amplifier for substitution test; The measurement results are amend as described below:  
Power(EIRP)=PMea- Pcl + Ga
7. This value is EIRP since the measurement is calibrated using an antenna of known gain (2.15 dBi) and known input power.  
ERP can be calculated from EIRP by subtracting the gain of the dipole, ERP = EIRP-2.15dBi.

## **TEST RESULTS**

LTE Band 2-1.4MHz					
Channel	Frequency (MHz)	Spurious Emission		Limit (dBm)	Result
		Polarization	Level (dBm)		
Low	3701.4	Vertical	-43.52	-13.00	Pass
	5552.1	V	-44.75		
	7402.8	V	---		
	3701.4	Horizontal	-46.38	-13.00	Pass
	5552.1	H	-47.85		
	7402.8	H	---		
Mid	3760	Vertical	-42.60	-13.00	Pass
	5640	V	-44.94		
	7520	V	---		
	3760	Horizontal	-46.18	-13.00	Pass
	5640	H	-47.65		
	7520	H	---		
High	3818.6	Vertical	-42.94	-13.00	Pass
	5727.9	V	-45.26		
	7637.2	V	---		
	3818.6	Horizontal	-46.24	-13.00	Pass
	5727.9	H	-47.59		
	7637.2	H	---		

Remark :

1. Remark"---" means that the emission level is too low to be measured
2. The emission levels of below 1 GHz are very lower than the limit and not show in test report.

LTE Band 2-3MHz					
Channel	Frequency (MHz)	Spurious Emission		Limit (dBm)	Result
		Polarization	Level (dBm)		
Low	3703	Vertical	-44.39	-13.00	Pass
	5554.5	V	-45.04		
	7406	V	---		
	3703	Horizontal	-43.05	-13.00	Pass
	5554.5	H	-45.32		
	7406	H	---		
Mid	3760	Vertical	-43.27	-13.00	Pass
	5640	V	-46.20		
	7520	V	---		
	3760	Horizontal	-43.46	-13.00	Pass
	5640	H	-46.90		
	7520	H	---		
High	3817	Vertical	-42.26	-13.00	Pass
	5725.5	V	-46.67		
	7634	V	---		
	3817	Horizontal	-43.37	-13.00	Pass
	5725.5	H	-46.90		
	7634	H	---		

Remark :

1. Remark"---" means that the emission level is too low to be measured
2. The emission levels of below 1 GHz are very lower than the limit and not show in test report.

LTE Band 2-5MHz					
Channel	Frequency (MHz)	Spurious Emission		Limit (dBm)	Result
		Polarization	Level (dBm)		
Low	3705	Vertical	-43.45	-13.00	Pass
	5557.5	V	-45.22		
	7410	V	---		
	3705	Horizontal	-42.66	-13.00	Pass
	5557.5	H	-45.38		
	7410	H	---		
Mid	3760	Vertical	-42.79	-13.00	Pass
	5640	V	-45.90		
	7520	V	---		
	3760	Horizontal	-42.26	-13.00	Pass
	5640	H	-45.17		
	7520	H	---		
High	3815	Vertical	-43.53	-13.00	Pass
	5722.5	V	-45.41		
	7630	V	---		
	3815	Horizontal	-44.09	-13.00	Pass
	5722.5	H	-45.53		
	7630	H	---		

Remark :

1. Remark"---" means that the emission level is too low to be measured
2. The emission levels of below 1 GHz are very lower than the limit and not show in test report.

LTE Band 2-10MHz					
Channel	Frequency (MHz)	Spurious Emission		Limit (dBm)	Result
		Polarization	Level (dBm)		
Low	3710	Vertical	-42.89	-13.00	Pass
	5565	V	-45.51		
	7420	V	---		
	3710	Horizontal	-41.54	-13.00	Pass
	5565	H	-45.79		
	7420	H	---		
Mid	3760	Vertical	-41.76	-13.00	Pass
	5640	V	-46.69		
	7520	V	---		
	3760	Horizontal	-40.87	-13.00	Pass
	5640	H	-47.94		
	7520	H	---		
High	3810	Vertical	-38.70	-13.00	Pass
	5715	V	-47.53		
	7620	V	---		
	3810	Horizontal	-37.94	-13.00	Pass
	5715	H	-47.37		
	7620	H	---		

Remark :

1. Remark"---" means that the emission level is too low to be measured
2. The emission levels of below 1 GHz are very lower than the limit and not show in test report.

LTE Band 2-15MHz					
Channel	Frequency (MHz)	Spurious Emission		Limit (dBm)	Result
		Polarization	Level (dBm)		
Low	3705	Vertical	-41.94	-13.00	Pass
	5557.5	V	-45.91		
	7410	V	---		
	3705	Horizontal	-40.16	-13.00	Pass
	5557.5	H	-46.27		
	7410	H	---		
Mid	3760	Vertical	-40.45	-13.00	Pass
	5640	V	-47.46		
	7520	V	---		
	3760	Horizontal	-39.27	-13.00	Pass
	5640	H	-48.01		
	7520	H	---		
High	3815	Vertical	-38.31	-13.00	Pass
	5722.5	V	-47.83		
	7630	V	---		
	3815	Horizontal	-38.56	-13.00	Pass
	5722.5	H	-47.88		
	7630	H	---		

Remark :

1. Remark"---" means that the emission level is too low to be measured
2. The emission levels of below 1 GHz are very lower than the limit and not show in test report.

LTE Band 2-20MHz					
Channel	Frequency (MHz)	Spurious Emission		Limit (dBm)	Result
		Polarization	Level (dBm)		
Low	3720	Vertical	-40.68	-13.00	Pass
	5580	V	-46.35		
	7440	V	---		
	3720	Horizontal	-38.67	-13.00	Pass
	5580	H	-46.76		
	7440	H	---		
Mid	3760	Vertical	-39.00	-13.00	Pass
	5640	V	-48.10		
	7520	V	---		
	3760	Horizontal	-37.67	-13.00	Pass
	5640	H	-49.28		
	7520	H	---		
High	3800	Vertical	-35.62	-13.00	Pass
	5700	V	-48.89		
	7600	V	---		
	3800	Horizontal	-37.04	-13.00	Pass
	5700	H	-49.19		
	7600	H	---		

Remark:

1. Remark"---" means that the emission level is too low to be measured
2. The emission levels of below 1 GHz are very lower than the limit and not show in test report.

LTE Band 4-1.4MHz					
Channel	Frequency (MHz)	Spurious Emission		Limit (dBm)	Result
		Polarization	Level (dBm)		
Low	3421.4	Vertical	-38.47	-13.00	Pass
	5132.1	V	-42.52		
	6842.8	V	---		
	3421.4	Horizontal	-43.36	-13.00	Pass
	5132.1	H	-45.25		
	6842.8	H	---		
Mid	3465	Vertical	-38.31	-13.00	Pass
	5197.5	V	-42.67		
	6930	V	---		
	3465	Horizontal	-43.56	-13.00	Pass
	5197.5	H	-45.41		
	6930	H	---		
High	3508.6	Vertical	-38.05	-13.00	Pass
	5262.9	V	-42.42		
	7017.2	V	---		
	3508.6	Horizontal	-43.60	-13.00	Pass
	5262.9	H	-45.45		
	7017.2	H	---		

Remark :

1. Remark"---" means that the emission level is too low to be measured
2. The emission levels of below 1 GHz are very lower than the limit and not show in test report.

LTE Band 4-3MHz					
Channel	Frequency (MHz)	Spurious Emission		Limit (dBm)	Result
		Polarization	Level (dBm)		
Low	3423	Vertical	-37.77	-13.00	Pass
	5134.5	V	-42.93		
	6846	V	---		
	3423	Horizontal	-43.97	-13.00	Pass
	5134.5	H	-45.63		
	6846	H	---		
Mid	3465	Vertical	-37.47	-13.00	Pass
	5197.5	V	-42.64		
	6930	V	---		
	3465	Horizontal	-43.64	-13.00	Pass
	5197.5	H	-45.90		
	6930	H	---		
High	3507	Vertical	-37.92	-13.00	Pass
	5260.5	V	-42.22		
	7014	V	---		
	3423	Horizontal	-43.82	-13.00	Pass
	5134.5	H	-45.73		
	6846	H	---		

Remark :

1. Remark"---" means that the emission level is too low to be measured
2. The emission levels of below 1 GHz are very lower than the limit and not show in test report.

LTE Band 4-5MHz					
Channel	Frequency (MHz)	Spurious Emission		Limit (dBm)	Result
		Polarization	Level (dBm)		
Low	3425	Vertical	-36.47	-13.00	Pass
	5137.5	V	-43.10		
	6850	V	---		
	3425	Horizontal	-44.00	-13.00	Pass
	5137.5	H	-45.89		
	6850	H	---		
Mid	3465	Vertical	-36.33	-13.00	Pass
	5197.5	V	-42.98		
	6930	V	-		
	3465	Horizontal	-43.71	-13.00	Pass
	5197.5	H	-45.66		
	6930	H	---		
High	3505	Vertical	-36.73	-13.00	Pass
	5257.5	V	-43.34		
	7010	V	-		
	3505	Horizontal	-43.83	-13.00	Pass
	5257.5	H	-45.77		
	7010	H	---		

## Remark:

1. Remark"---" means that the emission level is too low to be measured
2. The emission levels of below 1 GHz are very lower than the limit and not show in test report.

LTE Band 4-10MHz					
Channel	Frequency (MHz)	Spurious Emission		Limit (dBm)	Result
		Polarization	Level (dBm)		
Low	3430	Vertical	-35.91	-13.00	Pass
	5145	V	-43.40		
	6860	V	---		
	3430	Horizontal	-43.41	-13.00	Pass
	5145	H	-45.42		
	6860	H	---		
Mid	3465	Vertical	-36.13	-13.00	Pass
	5197.5	V	-43.61		
	6930	V	---		
	3465	Horizontal	-43.09	-13.00	Pass
	5197.5	H	-45.16		
	6930	H	-		
High	3500	Vertical	-36.58	-13.00	Pass
	5250	V	-44.02		
	7000	V	-		
	3500	Horizontal	-42.93	-13.00	Pass
	5250	H	-45.00		
	7000	H	---		

## Remark :

1. Remark"---" means that the emission level is too low to be measured
2. The emission levels of below 1 GHz are very lower than the limit and not show in test report.



LTE Band 4-15MHz					
Channel	Frequency (MHz)	Spurious Emission		Limit (dBm)	Result
		Polarization	Level (dBm)		
Low	3435	Vertical	-34.95	-13.00	Pass
	5152.5	V	-43.79		
	6870	V	---		
	3435	Horizontal	-43.32	-13.00	Pass
	5152.5	H	-44.64		
	6870	H	---		
Mid	3465	Vertical	-35.25	-13.00	Pass
	5197.5	V	-44.07		
	6930	V	---		
	3465	Horizontal	-43.77	-13.00	Pass
	5197.5	H	-45.00		
	6930	H	---		
High	3490	Vertical	-34.62	-13.00	Pass
	5235	V	-43.49		
	6980	V	---		
	3490	Horizontal	-43.72	-13.00	Pass
	5235	H	-44.95		
	6980	H	---		

Remark :

1. Remark"---" means that the emission level is too low to be measured
2. The emission levels of below 1 GHz are very lower than the limit and not show in test report.

LTE Band 4-20MHz					
Channel	Frequency (MHz)	Spurious Emission		Limit (dBm)	Result
		Polarization	Level (dBm)		
Low	3440	Vertical	-33.70	-13.00	Pass
	5160	V	-43.93		
	6880	V	---		
	3440	Horizontal	-43.30	-13.00	Pass
	5160	H	-45.30		
	6880	H	---		
Mid	3465	Vertical	-33.39	-13.00	Pass
	5197.5	V	-44.39		
	6930	V	---		
	3465	Horizontal	-43.75	-13.00	Pass
	5197.5	H	-44.94		
	6930	H	---		
High	3490	Vertical	-32.75	-13.00	Pass
	5235	V	-44.73		
	6980	V	---		
	3490	Horizontal	-42.99	-13.00	Pass
	5235	H	-45.01		
	6980	H	---		

Remark:

1. Remark"---" means that the emission level is too low to be measured
2. The emission levels of below 1 GHz are very lower than the limit and not show in test report.

LTE Band 7-5MHz					
Channel	Frequency (MHz)	Spurious Emission		Limit (dBm)	Result
		Polarization	Level (dBm)		
Low	5005	Vertical	-37.47	-13.00	Pass
	7507.5	V	-43.58		
	10010	V	---		
	5005	Horizontal	-43.14	-13.00	Pass
	7507.5	H	-46.67		
	10010	H	---		
Mid	5070	Vertical	-37.15	-13.00	Pass
	7605	V	-43.28		
	10140	V	---		
	5070	Horizontal	-42.81	-13.00	Pass
	7605	H	-46.40		
	10140	H	---		
High	5135	Vertical	-37.61	-13.00	Pass
	7702.5	V	-43.70		
	10270	V	-		
	5135	Horizontal	-42.99	-13.00	Pass
	7702.5	H	-46.57		
	10270	H	---		

Remark:

1. Remark"---" means that the emission level is too low to be measured
2. The emission levels of below 1 GHz are very lower than the limit and not show in test report.

LTE Band 7-10MHz					
Channel	Frequency (MHz)	Spurious Emission		Limit (dBm)	Result
		Polarization	Level (dBm)		
Low	5010	Vertical	-37.58	-13.00	Pass
	7515	V	-43.47		
	10020	V	---		
	5010	Horizontal	-43.63	-13.00	Pass
	7515	H	-46.78		
	10020	H	---		
Mid	5070	Vertical	-37.97	-13.00	Pass
	7605	V	-43.81		
	10140	V	---		
	5070	Horizontal	-43.47	-13.00	Pass
	7605	H	-46.90		
	10140	H	---		
High	5130	Vertical	-38.51	-13.00	Pass
	7695	V	-44.69		
	10260	V	---		
	5130	Horizontal	-44.36	-13.00	Pass
	7695	H	-47.74		
	10260	H	---		

Remark:

1. Remark"---" means that the emission level is too low to be measured
2. The emission levels of below 1 GHz are very lower than the limit and not show in test report.

LTE Band 7-15MHz					
Channel	Frequency (MHz)	Spurious Emission		Limit (dBm)	Result
		Polarization	Level (dBm)		
Low	5015	Vertical	-37.63	-13.00	Pass
	7522.5	V	-43.42		
	10030	V	---		
	5015	Horizontal	-43.81	-13.00	Pass
	7522.5	H	-46.82		
	10030	H	---		
Mid	5070	Vertical	-37.77	-13.00	Pass
	7605	V	-43.55		
	10140	V	---		
	5070	Horizontal	-43.55	-13.00	Pass
	7605	H	-44.44		
	10140	H	---		
High	5125	Vertical	-38.66	-13.00	Pass
	7687.5	V	-45.03		
	10250	V	---		
	5125	Horizontal	-44.05	-13.00	Pass
	7687.5	H	-44.92		
	10250	H	---		

## Remark:

1. Remark"---" means that the emission level is too low to be measured
2. The emission levels of below 1 GHz are very lower than the limit and not show in test report.

LTE Band 7-20MHz					
Channel	Frequency (MHz)	Spurious Emission		Limit (dBm)	Result
		Polarization	Level (dBm)		
Low	5015	Vertical	-37.54	-13.00	Pass
	7522.5	V	-43.51		
	10030	V	---		
	5015	Horizontal	-43.44	-13.00	Pass
	7522.5	H	-46.74		
	10030	H	---		
Mid	5070	Vertical	-37.24	-13.00	Pass
	7605	V	-43.25		
	10140	V	---		
	5070	Horizontal	-44.30	-13.00	Pass
	7605	H	-46.89		
	10140	H	---		
High	5125	Vertical	-37.51	-13.00	Pass
	7687.5	V	-43.01		
	10250	V	-		
	5125	Horizontal	-44.24	-13.00	Pass
	7687.5	H	-46.95		
	10250	H	---		

## Remark:

1. Remark"---" means that the emission level is too low to be measured
2. The emission levels of below 1 GHz are very lower than the limit and not show in test report.

## 4.7. Frequency stability V.S. Temperature measurement

### LIMIT

2.5ppm

### TEST CONFIGURATION

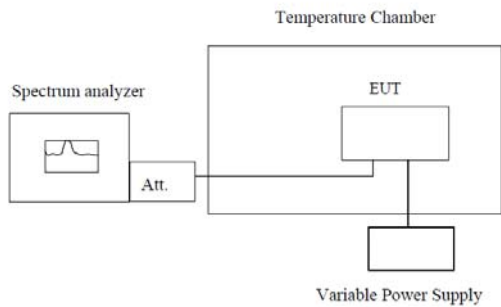

**Note :** Measurement setup for testing on Antenna connector

### TEST PROCEDURE

1. The equipment under test was connected to an external DC power supply and input rated voltage.
2. RF output was connected to a frequency counter or spectrum analyzer via feed through attenuators.
3. The EUT was placed inside the temperature chamber.
4. Set the spectrum analyzer RBW low enough to obtain the desired frequency resolution and measure EUT 25°C operating frequency as reference frequency.
5. Turn EUT off and set the chamber temperature to -30°C. After the temperature stabilized for approximately 30 minutes recorded the frequency.
6. Repeat step measure with 10°C increased per stage until the highest temperature of +50°C reached.

### TEST RESULTS

#### Worst case

Reference Frequency: LTE Band 2 Middle channel=1880MHz,20MHz Bandwidth					
Power supplied (Vdc)	Temperature (°C)	Frequency error		Limit (ppm)	Result
		Hz	ppm		
3.80	-30	18	0.0096	2.5	Pass
	-20	23	0.0122		
	-10	21	0.0112		
	0	24	0.0128		
	10	19	0.0101		
	20	17	0.0090		
	30	19	0.0101		
	40	22	0.0117		
	50	24	0.0128		
Reference Frequency: LTE Band 4 Middle channel=1732.5MHz,20MHz Bandwidth					
Power supplied (Vdc)	Temperature (°C)	Frequency error		Limit (ppm)	Result
		Hz	ppm		
3.80	-30	24	0.0139	2.5	Pass
	-20	29	0.0167		
	-10	23	0.0133		
	0	21	0.0121		
	10	17	0.0098		
	20	19	0.0110		
	30	22	0.0127		
	40	26	0.0150		
	50	28	0.0162		
Reference Frequency: LTE Band 7 Middle channel=2535MHz,20MHz Bandwidth					
Power supplied (Vdc)	Temperature (°C)	Frequency error		Limit (ppm)	Result
		Hz	ppm		
3.80	-30	22	0.0087	2.5	Pass
	-20	20	0.0079		
	-10	19	0.0075		
	0	23	0.0091		
	10	22	0.0087		
	20	21	0.0083		
	30	29	0.0114		
	40	27	0.0107		
	50	25	0.0099		

### 4.8. Frequency stability V.S. Voltage measurement

**LIMIT**

2.5ppm

**TEST CONFIGURATION**

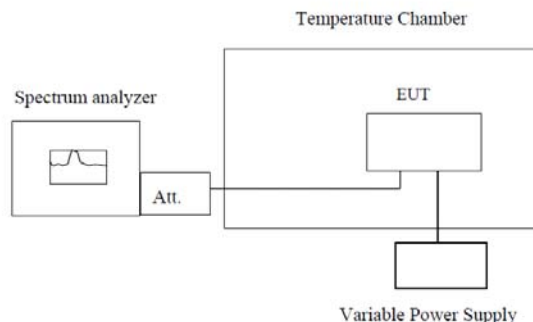

Note : Measurement setup for testing on Antenna connector

**TEST PROCEDURE**

1. Set chamber temperature to 25°C. Use a variable DC power source to power the EUT and set the voltage to rated voltage.
2. Set the spectrum analyzer RBW low enough to obtain the desired frequency resolution and recorded the frequency.
3. Reduce the input voltage to specified extreme voltage variation (+/- 15%) and endpoint, record the maximum frequency change.

**TEST RESULTS**

**Worst case**

Reference Frequency: LTE Band 2 Middle channel=1880MHz,20MHz Bandwidth					
Temperature (°C)	Power supplied (Vdc)	Frequency error		Limit (ppm)	Result
		Hz	ppm		
25	4.35	19	0.0101	2.5	Pass
	3.80	17	0.0090		
	3.60	21	0.0112		
Reference Frequency: LTE Band 4 Middle channel=1732.5MHz,20MHz Bandwidth					
Temperature (°C)	Power supplied (Vdc)	Frequency error		Limit (ppm)	Result
		Hz	ppm		
25	4.35	18	0.0104	2.5	Pass
	3.80	19	0.0110		
	3.60	20	0.0115		
Reference Frequency: LTE Band 7 Middle channel=2535MHz,20MHz Bandwidth					
Temperature (°C)	Power supplied (Vdc)	Frequency error		Limit (ppm)	Result
		Hz	ppm		
25	4.35	22	0.0087	2.5	Pass
	3.80	21	0.0083		
	3.60	23	0.0091		

### 4.9. Peak-Average Ratio

**LIMIT**

13dB

**TEST CONFIGURATION**

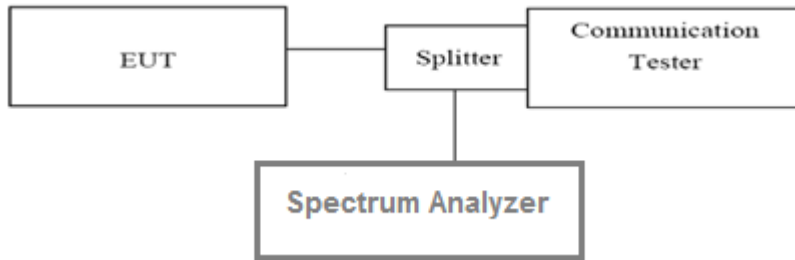

**TEST PROCEDURE**

According with KDB 971168

1. The signal analyzer' s CCDF measurement profile is enabled
2. Frequency = carrier center frequency
3. Measurement BW > Emission bandwidth of signal
4. The signal analyzer was set to collect one million samples to generate the CCDF curve
5. The measurement interval was set depending on the type of signal analyzed. For continuous signals(>98% duty cycle), the measurement interval was set to 1ms. For burst transmissions, the spectrum analyzer is set to use an internal " RF Burst" trigger that is synced with an incoming pulse and the measurement interval is set to less than the duration of the " on time" of one burst to ensure that energy is only captured during a time in which the transmitter is operating at maximum power

**TEST RESULTS**

**Worst case**

LTE Band 2-20MHz						
Modulation	QPSK		16QAM		Limit(dB)	Result
Channel	1RB#	Full RB#	1RB#	Full RB#		
Low	7.08	7.16	7.1	7.15	13	Pass
Mid	7.09	7.13	7.14	7.12	13	Pass
High	7.05	7.11	7.12	1.17	13	Pass

LTE Band 4-20MHz						
Modulation	QPSK		16QAM		Limit(dB)	Result
Channel	1RB#	Full RB#	1RB#	Full RB#		
Low	6.11	6.17	6.16	6.15	13	Pass
Mid	6.19	6.2	6.18	6.21	13	Pass
High	6.16	6.29	6.19	6.24	13	Pass

LTE Band 7-20MHz						
Modulation	QPSK		16QAM		Limit(dB)	Result
Channel	1RB#	Full RB#	1RB#	Full RB#		
Low	5.49	5.53	5.48	5.52	13	Pass
Mid	5.59	5.49	5.47	5.51	13	Pass
High	5.61	5.63	5.62	5.65	13	Pass

## 5. Test Setup Photos of the EUT

Radiated emission:





## **6. External and Internal Photos of the EUT**

Reference to the test report No. TRE1608017801

.....End of Report.....