



FCC&IC TEST REPORT

FCC ID: 2ABNA-P9IIHH, IC: 11648A-P9IIHH

On Behalf of

**Guangzhou Geoelectron Science & Technology Company
Limited**

P9II Handheld

Model No.: P9II PRO, P9II STD

Prepared for : Guangzhou Geoelectron Science & Technology Company Limited
Address : No.704, 7/F, Building C, No.7, Cai Pin Road, Science City, Luogang
District, Guangzhou, China

Prepared By : Shenzhen Alpha Product Testing Co., Ltd.
Address : Building i, No.2, Lixin Road, Fuyong Street, Bao'an District, 518103,
Shenzhen, Guangdong, China

Report Number : T1881637 21
Date of Receipt : October 23, 2018
Date of Test : October 23, 2018-December 27, 2018
Date of Report : February 04, 2019
Version Number : REV0

TABLE OF CONTENTS

Description	Page
1. Summary of Standards And Results-----	6
1.1. Description of Standards and Results -----	6
2. General Information -----	7
2.1. Description of Device (EUT)-----	7
2.2. Accessories of Device (EUT) -----	8
2.3. Tested Supporting System Details -----	8
2.4. Block Diagram of connection between EUT and simulators -----	8
2.5. Test Mode Description -----	8
2.6. Test Conditions -----	8
2.7. Test Facility -----	9
2.8. Measurement Uncertainty -----	9
2.9. Test Equipment List -----	10
3. Spurious Emission -----	12
3.1. Test Limits -----	12
3.2. Test Procedure -----	15
3.3. Test Setup -----	15
3.4. Test Results -----	16
4. Power Line Conducted Emission-----	21
4.1. Test Limits -----	21
4.2. Test Procedure -----	21
4.3. Test Setup -----	21
4.4. Test Results -----	22
5. Conducted Maximum Output Power -----	24
5.1. Test limits -----	24
5.2. Test Procedure -----	24
5.3. Test Setup -----	24
5.4. Test Results -----	24
6. Peak Power Spectral Density-----	25
6.1. Test limits -----	25
6.2. Test Procedure -----	25
6.3. Test Setup -----	25
6.4. Test Results -----	25
7. Bandwidth-----	27
7.1. Test limits -----	27
7.2. Test Procedure -----	27
7.3. Test Setup -----	27
7.4. Test Results -----	27
8. Band Edge Check-----	29
8.1. Test limits -----	29
8.2. Test Procedure -----	29
8.3. Test Setup -----	29
8.4. Test Results -----	29
9. Frequency stability -----	33
9.1. Test limit -----	33
9.2. Test Procedure -----	33

- 9.3. Test Setup ----- 33
- 9.4. Test Results ----- 33
- 10. Antenna Requirement ----- 35**
- 10.1. Standard Requirement ----- 35
- 10.2. Antenna Connected Construction----- 35
- 10.3. Results ----- 35

TEST REPORT DECLARATION

Applicant : Guangzhou Geoelectron Science & Technology Company Limited
 Address : No.704, 7/F, Building C, No.7, Cai Pin Road, Science City, Luogang District, Guangzhou, China
 Manufacturer : Guangzhou Geoelectron Science & Technology Company Limited
 Address : No.704, 7/F, Building C, No.7, Cai Pin Road, Science City, Luogang District, Guangzhou, China
 EUT Description : P9II Handheld
 (A) Model No. : P9II PRO, P9II STD
 (B) Trademark : N/A

Measurement Standard Used:

FCC Rules and Regulations Part 15 Subpart C Section 15.247,
RSS-247 Issue 2, RSS-Gen Issue 5, ANSI C63.10:2013, CISPR 16-1-4:2010

The device described above is tested by Shenzhen Alpha Product Testing Co., Ltd. to determine the maximum emission levels emanating from the device. The maximum emission levels are compared to the FCC Part 15 Subpart C limits both conducted and radiated emissions. The test results are contained in this test report and Shenzhen Alpha Product Testing Co., Ltd. is assumed of full responsibility for the accuracy and completeness of these tests.

After the test, our opinion is that EUT compliance with the requirement of the above standards.

This report applies to above tested sample only. This report shall not be reproduced in parts without written approval of Shenzhen Alpha Product Testing Co., Ltd.

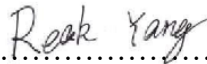
Tested by (name + signature).....: Reak Yang
 Project Engineer 

Approved by (name + signature).....: Simple Guan
 Project Manager 

Date of issue..... : February 04, 2019

Revision History

Revision	Issue Date	Revisions	Revised By
00	February 04, 2019	Initial released Issue	Simple Guan

1. SUMMARY OF STANDARDS AND RESULTS

1.1. Description of Standards and Results

The EUT have been tested according to the applicable standards as referenced below:

Test Item	Standards Paragraph	Result
Conducted Emission	FCC Part 15: 15.207 RSS-GEN(8.8) ANSI C63.10 :2013	P
6dB Bandwidth	FCC PART 15:15.247(a)(2) RSS-247(5.2 a) ANSI C63.10 :2013	P
Output Power	FCC Part 15: 15.247(b)(3) RSS-247(5.4 d) ANSI C63.10 :2013	P
Radiated Spurious Emission	FCC Part 15: 15.209 FCC Part 15: 15.247(d) RSS-Gen(8.9), RSS-247(5.5) ANSI C63.10 :2013	P
Conducted Spurious & Band Edge Emission	FCC Part 15: 15.247(d) RSS-Gen(8.9), RSS-247(5.5) ANSI C63.10 :2013	P
Power Spectral Density	FCC PART 15:15.247(e) RSS-247(5.2 b) ANSI C63.10 :2013	P
Radiated Band Edge Emission	FCC Part 15: 15.247(d) RSS-GEN(6.13) ANSI C63.10 :2013	P
Frequency stability	RSS-GEN(6.11)	P
Antenna Requirement	FCC Part 15: 15.203 RSS-GEN(6.8)	P
Note:	1. P is an abbreviation for Pass. 2. F is an abbreviation for Fail. 3. N/A is an abbreviation for Not Applicable.	

2. GENERAL INFORMATION

2.1. Description of Device (EUT)

Description/PMN : P9II Handheld

Model
Number/HVIN(s) : P9II PRO, P9II STD

Diff. : They are all the same, except that P9II PRO with M8T GPS receiver, P9II STD without M8T GPS receiver, the result of this report belongs to P9II PRO.

Trademark : N/A

Test Voltage : DC 7.2V from battery, DC 15V For Charging

Bluetooth Version : Bluetooth 4.1 BLE

Operation
frequency : 2402-2480MHz

Channel No. : 40 Channels

Modulation type : GFSK

Antenna Type : Internal antenna, Maximum Gain is 1.56dBi for BT

Software version : V1.0

Hardware
Version/FVIN : V1.3

Remark: The worst-case simultaneous transmission configuration was evaluated with no non-compliance found. Results in this report are only for Bluetooth 4.1 BLE function, and there is no other transmitter involved.

2.2. Accessories of Device (EUT)

Accessories1	:	USB-PD Chager
Manufacturer	:	Kuantech (Cambodia) Corpration Limited
Model	:	KSA-45P-45W D5
Input	:	AC 100-240V, 50/60Hz, 1.5A
Output	:	DC 5V/3A, DC 9V/3A, DC 12V/3A, DC 15V/3A, DC 20V/2.25A, DC 3.3-16V/3A Max., 45W Max.

2.3. Tested Supporting System Details

No.	Description	Manufacturer	Model	Serial Number	Certification or DOC
1.	Notebook	ACER	ZQT	N/A	DOC

2.4. Block Diagram of connection between EUT and simulators

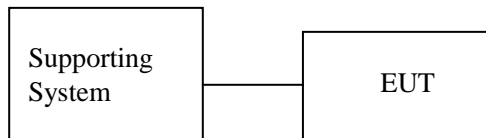

2.5. Test Mode Description

Tested mode, channel, and data rate information		
Mode	Channel	Frequency (MHz)
GFSK	Low :CH1	2402
	Middle: CH20	2440
	High: CH40	2480

2.6. Test Conditions

Items	Required	Actual
Temperature range:	15-35°C	27°C
Humidity range:	25-75%	56%
Pressure range:	86-106kPa	98kPa

2.7. Test Facility

Shenzhen Alpha Product Testing Co., Ltd
 Building i, No.2, Lixin Road, Fuyong Street, Bao'an District, 518103,
 Shenzhen, Guangdong, China

June 21, 2018 File on Federal Communication Commission
 Registration Number: 293961
 Designation Number: CN1236

July 25, 2017 Certificated by IC
 Registration Number: 12135A

2.8. Measurement Uncertainty

(95% confidence levels, k=2)

Item	Uncertainty
Uncertainty for Power point Conducted Emissions Test	2.74dB
Uncertainty for Radiation Emission test in 3m chamber (below 30MHz)	2.13 dB(Polarize: V)
	2.57dB(Polarize: H)
Uncertainty for Radiation Emission test in 3m chamber (30MHz to 1GHz)	3.77dB(Polarize: V)
	3.80dB(Polarize: H)
Uncertainty for Radiation Emission test in 3m chamber (1GHz to 25GHz)	4.16dB(Polarize: H)
	4.13dB(Polarize: V)
Uncertainty for radio frequency	5.4×10^{-8}
Uncertainty for conducted RF Power	0.37dB
Uncertainty for temperature	0.2°C
Uncertainty for humidity	1%
Uncertainty for DC and low frequency voltages	0.06%

2.9. Test Equipment List

Equipment	Manufacture	Model No.	Serial No.	Last cal.	Cal Interval
3m Semi-Anechoic	ETS-LINDGR EN	N/A	SEL0017	2018.09.21	1Year
Receiver	R&S	ESCI	1166.5950K03-101 1	2018.09.21	1Year
Receiver	R&S	ESCI	101202	2018.09.21	1Year
Bilog Antenna	Schwarzbeck	VULB 9168	VULB9168-438	2018.04.13	2Year
Horn Antenna	EMCO	3115	640201028-06	2018.04.13	2Year
Active Loop Antenna	Beijing Daze	ZN30900A	SEL0097	2018.04.13	2Year
Cable	Resenberger	N/A	No.1	2018.09.21	1Year
Cable	SCHWARZBE CK	N/A	No.2	2018.09.21	1Year
Cable	SCHWARZBE CK	N/A	No.3	2018.09.21	1Year
Pre-amplifier	Schwarzbeck	BBV9743	9743-019	2018.09.21	1Year
Pre-amplifier	R&S	AFS33-1800265 0-30-8P-44	SEL0080	2018.09.21	1Year
Temperature controller	Terchy	MHQ	120	2018.09.21	1Year
Power divider	Anritsu	K240C	020346	2018.09.21	1 Year
Signal Generator	HP	83732B	VS3449051	2018.09.21	1 Year
Power Meter	Agilent	E9300A	MY41496625	2018.09.21	1Year
L.I.S.N.#1	Schwarzbeck	NSLK8126	8126466	2018.09.21	1Year

L.I.S.N.#2	ROHDE&SCH WARZ	ENV216	101043	2018.09.21	1 Year
20db Attenuator	ICPROBING	IATS1	82347	2018.09.21	1 Year
Horn Antenna	SCHWARZBE CK	BBHA 9170	BBHA 9170294	2018.04.13	2 Year
Temperature Chamber	Gongwen	GDS-250	080943	2018.09.11	1 Year
Switching Mode Power Supply	JUNKE	JK12010S	20140927-6	2018.09.11	1 Year

3. SPURIOUS EMISSION

3.1. Test Limits

All the emissions appearing within 15.205 restricted frequency bands shall not exceed the limits shown in 15.209, all the other emissions shall be at least 20dB below the fundamental emissions, or comply with 15.209 limits.

15.205 Restricted frequency band

MHz	MHz	MHz	GHz
0.090 - 0.110	16.42 - 16.423	399.9 - 410	4.5 - 5.15
¹ 0.495 - 0.505	16.69475 - 16.69525	608 - 614	5.35 - 5.46
2.1735 - 2.1905	16.80425 - 16.80475	960 - 1240	7.25 - 7.75
4.125 - 4.128	25.5 - 25.67	1300 - 1427	8.025 - 8.5
4.17725 - 4.17775	37.5 - 38.25	1435 - 1626.5	9.0 - 9.2
4.20725 - 4.20775	73 - 74.6	1645.5 - 1646.5	9.3 - 9.5
6.215 - 6.218	74.8 - 75.2	1660 - 1710	10.6 - 12.7
6.26775 - 6.26825	108 - 121.94	1718.8 - 1722.2	13.25 - 13.4
6.31175 - 6.31225	123 - 138	2200 - 2300	14.47 - 14.5
8.291 - 8.294	149.9 - 150.05	2310 - 2390	15.35 - 16.2
8.362 - 8.366	156.52475 - 156.52525	2483.5 - 2500	17.7 - 21.4
8.37625 - 8.38675	156.7 - 156.9	2690 - 2900	22.01 - 23.12
8.41425 - 8.41475	162.0125 - 167.17	3260 - 3267	23.6 - 24.0
12.29 - 12.293	167.72 - 173.2	3332 - 3339	31.2 - 31.8
12.51975 - 12.52025	240 - 285	3345.8 - 3358	36.43 - 36.5
12.57675 - 12.57725	322 - 335.4	3600 - 4400	(²)

RSS-GEN Restricted frequency band

Table 7 – Restricted frequency bands ^{Note 1}

MHz	MHz	GHz
0.090 - 0.110	149.9 - 150.05	9.0 - 9.2
0.495 - 0.505	156.52475 - 156.52525	9.3 - 9.5
2.1735 - 2.1905	156.7 - 156.9	10.6 - 12.7
3.020 - 3.026	162.0125 - 167.17	13.25 - 13.4
4.125 - 4.128	167.72 - 173.2	14.47 - 14.5
4.17725 - 4.17775	240 - 285	15.35 - 16.2
4.20725 - 4.20775	322 - 335.4	17.7 - 21.4

5.677 - 5.683	399.9 - 410	22.01 - 23.12
6.215 - 6.218	608 - 614	23.6 - 24.0
6.26775 - 6.26825	960 - 1427	31.2 - 31.8
6.31175 - 6.31225	1435 - 1626.5	36.43 - 36.5
8.291 - 8.294	1645.5 - 1646.5	Above 38.6
8.362 - 8.366	1660 - 1710	
8.37625 - 8.38675	1718.8 - 1722.2	
8.41425 - 8.41475	2200 - 2300	
12.29 - 12.293	2310 - 2390	
12.51975 - 12.52025	2483.5 - 2500	
12.57675 - 12.57725	2655 - 2900	
13.36 - 13.41	3260 – 3267	
16.42 - 16.423	3332 - 3339	
16.69475 - 16.69525	3345.8 - 3358	
16.80425 - 16.80475	3500 - 4400	
25.5 - 25.67	4500 - 5150	
37.5 - 38.25	5350 - 5460	
73 - 74.6	7250 - 7750	
74.8 - 75.2	8025 – 8500	
108 – 138		

Note 1: Certain frequency bands listed in table 7 and in bands above 38.6 GHz are designated for licence-exempt applications. These frequency bands and the requirements that apply to related devices are set out in the 200 and 300 series of RSSs.

15.209 Limit

FREQUENCY MHz	DISTANCE Meters	FIELD STRENGTHS LIMIT	
		$\mu\text{V}/\text{m}$	$\text{dB}(\mu\text{V})/\text{m}$
0.009-0.490	300	$2400/\text{F}(\text{KHz})$	/
0.490-1.705	30	$24000/\text{F}(\text{KHz})$	/
1.705-30	30	30	29.5
30 ~ 88	3	100	40.0
88 ~ 216	3	150	43.5
216 ~ 960	3	200	46.0
960 ~ 1000	3	500	54.0
Above 1000	3	74.0 $\text{dB}(\mu\text{V})/\text{m}$ (Peak) 54.0 $\text{dB}(\mu\text{V})/\text{m}$ (Average)	
Note 1: The peak limit is 20 dB higher than the average limit			
Note 2: Peak limit applies (AVG limit + 20 dB) as well as RSS-247 Section 5.5			

Harmonic emissions limits comply with below 54 $\text{dB}\mu\text{V}/\text{m}$ at 3m. Other emissions radiated outside of the specified frequency bands, except for harmonics, shall be attenuated by at least 50 dB below the level of the fundamental or comply with the radiated emissions limits specified in section 15.209(a) limit in the table below has to be followed.

Table 5 – General field strength limits at frequencies above 30 MHz

Frequency (MHz)	Field strength ($\mu\text{V}/\text{m}$ at 3 m)
30 – 88	100
88 – 216	150
216 – 960	200
Above 960	500

Table 6 – General field strength limits at frequencies below 30 MHz

Frequency	Magnetic field strength (H-Field) ($\mu\text{A}/\text{m}$)	Measurement distance (m)
9 - 490 kHz ^{Note 1}	$6.37/\text{F}$ (F in kHz)	300
490 - 1705 kHz	$63.7/\text{F}$ (F in kHz)	30
1.705 - 30 MHz	0.08	30

Note 1: The emission limits for the ranges 9-90 kHz and 110-490 kHz are based on measurements employing a linear average detector.

3.2. Test Procedure

The measuring distance of 3m shall be used for measurements at frequency up to 1GHz and above 1GHz. The EUT was placed on a rotating 0.8 m high above ground for below 1GHz and 1.5m high for above 1GHz testing, The table was rotated 360 degrees to determine the position of the highest radiation.

The Test antenna shall vary between 1m and 4m, Both Horizontal and Vertical antenna are set of make measurement.

The initial step in collecting radiated emission data is a spectrum analyzer Peak detector mode pre-scanning the measurement frequency range. Significant Peaks are then marked. and then Quasi Peak Detector mode premeasured.

If Peak value comply with QP limit Below 1GHz, the EUT deemed to comply with QP limit. But the Peak value and average value both need to comply with applicable limit above 1GHz.

For the actual test configuration, please see the test setup photo.

3.3. Test Setup

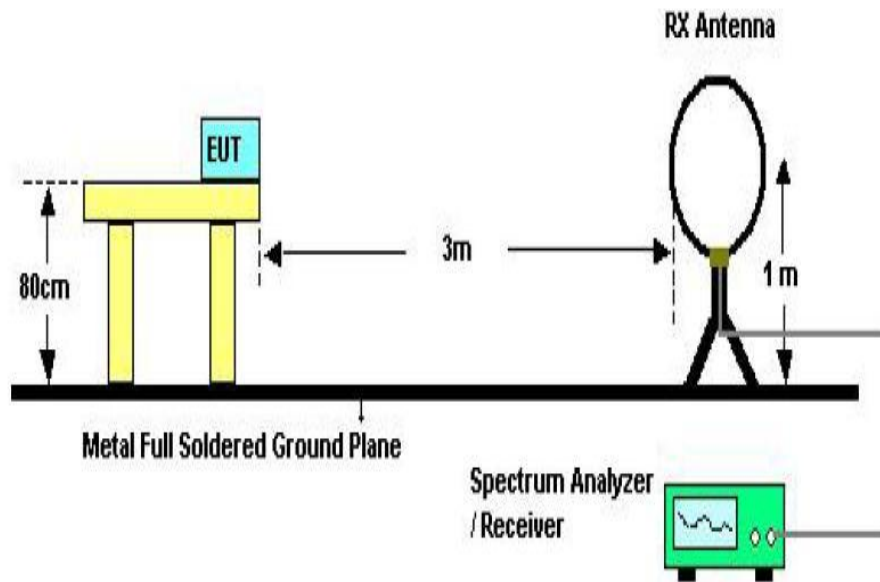

Below 30MHz Test Setup

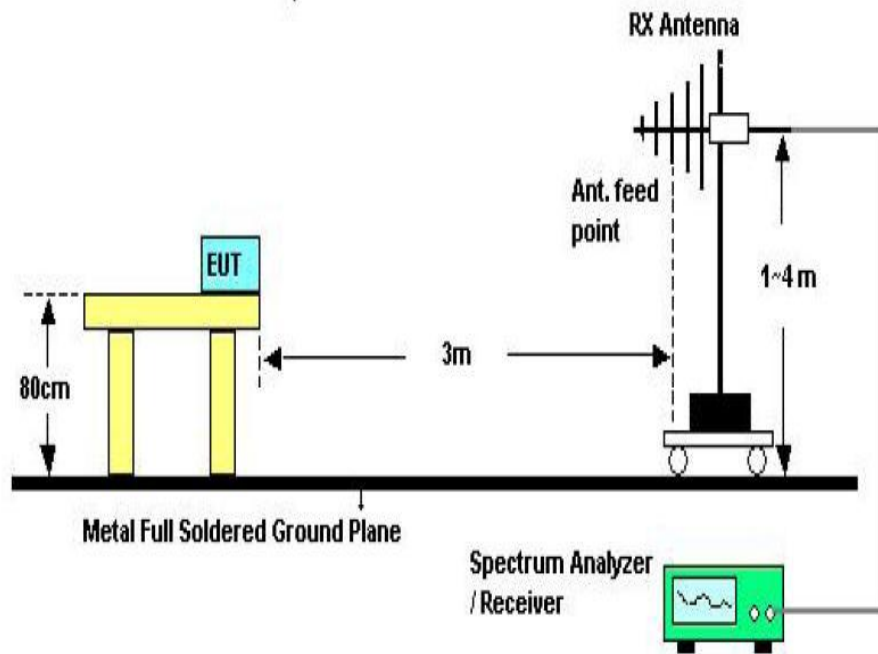

Above 30MHz Test Setup

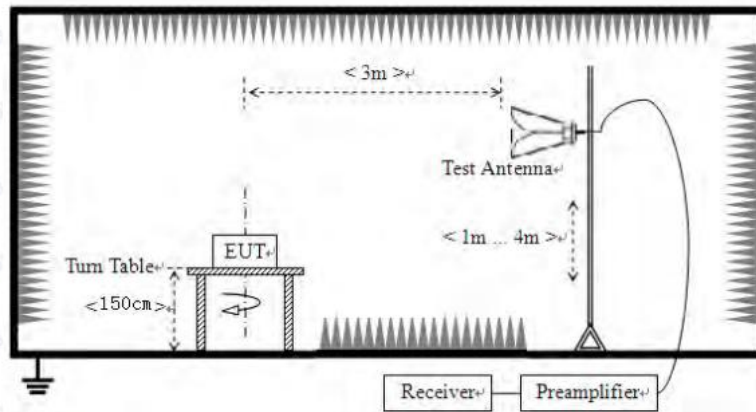

Above 1GHz Test Setup

3.4. Test Results

Test Condition

Continual Transmitting in maximum power.

9KHz~150KHz	RBW200Hz	VBW1KHz
150KHz~30MHz	RBW9KHz	VBW 30KHz
30MHz~1GHz	RBW120KHz	VBW 300KHz
Above1GHz	RBW1MHz	VBW 3MHz

We have scanned from 9 kHz to the 10th harmonic of the EUT.

Detailed information please see the following page.

From 9KHz to 30MHz: Conclusion: PASS

Note: 1.The amplitude of spurious emissions which are attenuated by more than 20dB below the permissible value has no need to be reported.

2.Only show the test data of the worst Channel in this report.

From 30MHz to 1000MHz: Conclusion: PASS
 Vertical:

Radiated Emission Measurement

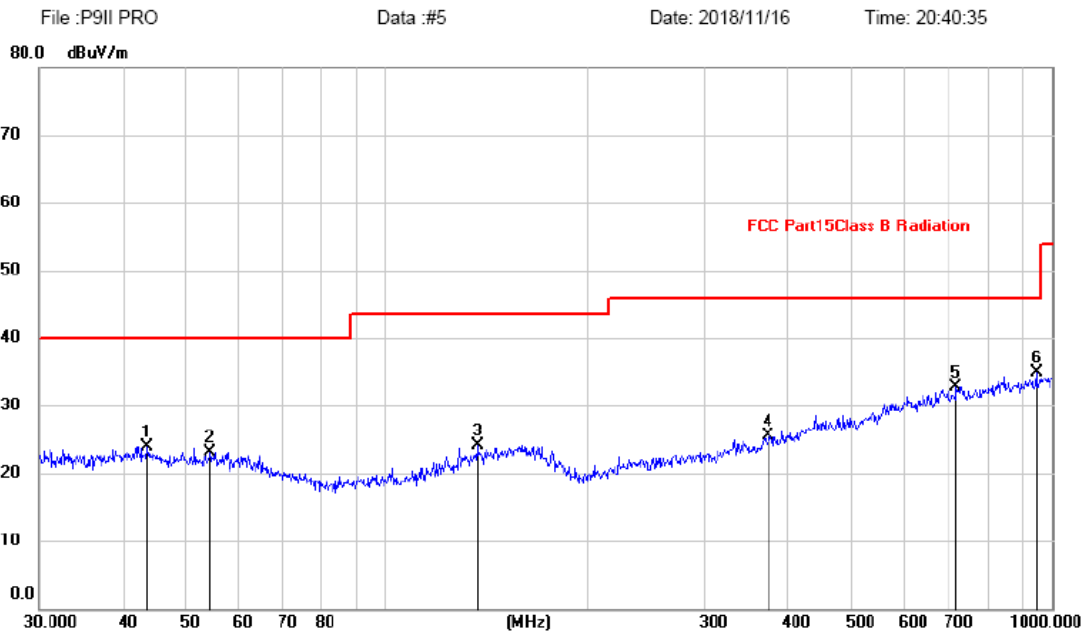

No.	Mk.	Freq.	Reading Level	Correct Factor	Measurement	Limit	Margin	Antenna Height	Table Degree
		MHz	dBuV	dB	dBuV/m	dBuV/m	dB	m	degree
1		43.5056	10.03	13.90	23.93	40.00	-16.07	1-4	0-360
2		54.4515	9.81	13.35	23.16	40.00	-16.84	1-4	0-360
3		136.4598	10.48	13.61	24.09	43.50	-19.41	1-4	0-360
4		374.6225	10.26	15.28	25.54	46.00	-20.46	1-4	0-360
5		716.6820	11.67	20.96	32.63	46.00	-13.37	1-4	0-360
6	*	945.4400	11.65	23.31	34.96	46.00	-11.04	1-4	0-360

Note:1. *:Maximum data; x:Over limit; !:over margin.

2.Measurement=Reading Level+Correct Factor; Correct Factor=Antenna Factor+Cable Loss.

Horizontal:

Radiated Emission Measurement

File :P9II PRO

Data :#6

Date: 2018/11/16

Time: 20:41:49

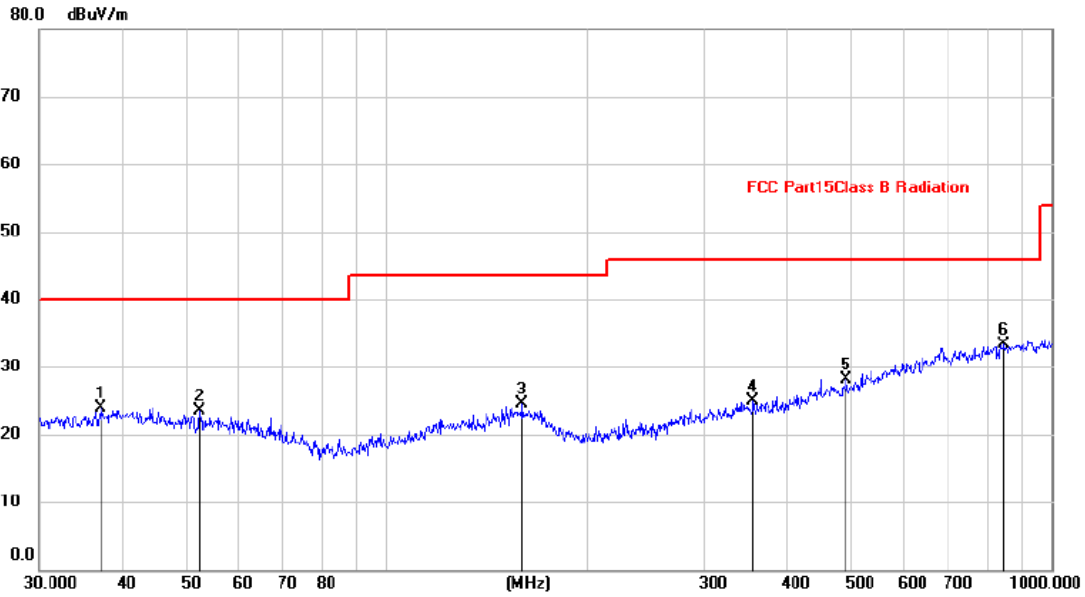

No.	Mk.	Freq. MHz	Reading Level dBuV	Correct Factor dB	Measure- ment dBuV/m	Limit dBuV/m	Margin dB	Detector	Antenna Height m	Table Degree
1		37.2854	10.03	13.82	23.85	40.00	-16.15	peak	1-4	0-360
2		52.3912	9.86	13.55	23.41	40.00	-16.59	peak	1-4	0-360
3		159.7844	9.87	14.58	24.45	43.50	-19.05	peak	1-4	0-360
4		355.4273	10.36	14.46	24.82	46.00	-21.18	peak	1-4	0-360
5		490.7447	10.70	17.39	28.09	46.00	-17.91	peak	1-4	0-360
6	*	848.0563	10.54	22.68	33.22	46.00	-12.78	peak	1-4	0-360

Note:1. *:Maximum data; x:Over limit; !:over margin.

2.Measurement=Reading Level+Correct Factor; Correct Factor=Antenna Factor+Cable Loss.

Notes: Above is below 1GHz test data. This report only shall the worst case mode for TX 2402MHz.

From 1G-25GHz

Test Mode: TX Low									
Freq (MHz)	Read Level (dBuV/m)	Polar (H/V)	Antenna Factor (dB/m)	Cable loss(dB)	Amp Factor (dB)	Result (dBuV/m)	Limit (dBuV/m)	Margin (dB)	Remark
4804	43.09	V	33.95	10.18	34.26	52.96	74	-21.04	PK
4804	31.55	V	33.95	10.18	34.26	41.42	54	-12.58	AV
7206	/	/	/	/	/	/	/	/	/
9608	/	/	/	/	/	/	/	/	/
4804	43.61	H	33.95	10.18	34.26	53.48	74	-20.52	PK
4804	31.66	H	33.95	10.18	34.26	41.53	54	-12.47	AV
7206	/	/	/	/	/	/	/	/	/
9608	/	/	/	/	/	/	/	/	/
Test Mode: TX Mid									
4880	43.29	V	33.93	10.2	34.25	53.17	74	-20.83	PK
4880	30.42	V	33.93	10.2	34.25	40.30	54	-13.70	AV
7320	/	/	/	/	/	/	/	/	/
9760	/	/	/	/	/	/	/	/	/
4880	43.71	H	33.93	10.2	34.29	53.55	74	-20.45	PK
4880	32.97	H	33.93	10.2	34.29	42.81	54	-11.19	AV
7320	/	/	/	/	/	/	/	/	/
9760	/	/	/	/	/	/	/	/	/
Test Mode: TX High									
4960	42.04	V	33.98	10.22	34.25	51.99	74	-22.01	PK
4960	32.54	V	33.98	10.22	34.25	42.49	54	-11.51	AV
7440	/	/	/	/	/	/	/	/	/
9920	/	/	/	/	/	/	/	/	/
4960	42.69	H	33.98	10.22	34.25	52.64	74	-21.36	PK
4960	31.69	H	33.98	10.22	34.25	41.64	54	-12.36	AV
7440	/	/	/	/	/	/	/	/	/
9920	/	/	/	/	/	/	/	/	/
Note:									
1, Result = Read level + Antenna factor + cable loss-Amp factor									
2, All the other emissions not reported were too low to read and deemed to comply with FCC limit.									

4. POWER LINE CONDUCTED EMISSION

4.1. Test Limits

Frequency MHz	Limits dB(μ V)	
	Quasi-peak Level	Average Level
0.15 -0.50	66 -56*	56 - 46*
0.50 -5.00	56	46
5.00 -30.00	60	50

- Notes: 1. *Decreasing linearly with logarithm of frequency.
 2. The lower limit shall apply at the transition frequencies.
 3. The limit decreases in line with the logarithm of the frequency in rang of 0.15 to 0.50 MHz.

4.2. Test Procedure

The EUT is put on the plane 0.8m high above the ground by insulating support and is connected to the power mains through a line impedance stabilization network (L.I.S.N.). This provides a 50ohm coupling impedance for the EUT system. Please refer the block diagram of the test setup and photographs. Both sides of AC lines are checked to find out the maximum conducted emission. In order to find the maximum emission levels, the relative positions of equipment and all of the interface cables shall be changed according to ANSI ANSI C63.10:2013 on Conducted Emission Measurement.

The bandwidth of test receiver is set at 9 kHz.

4.3. Test Setup

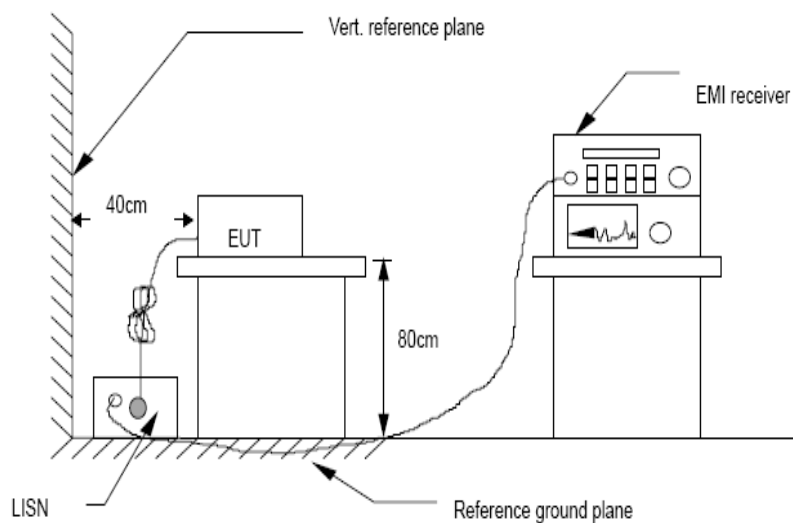

4.4. Test Results

Line:

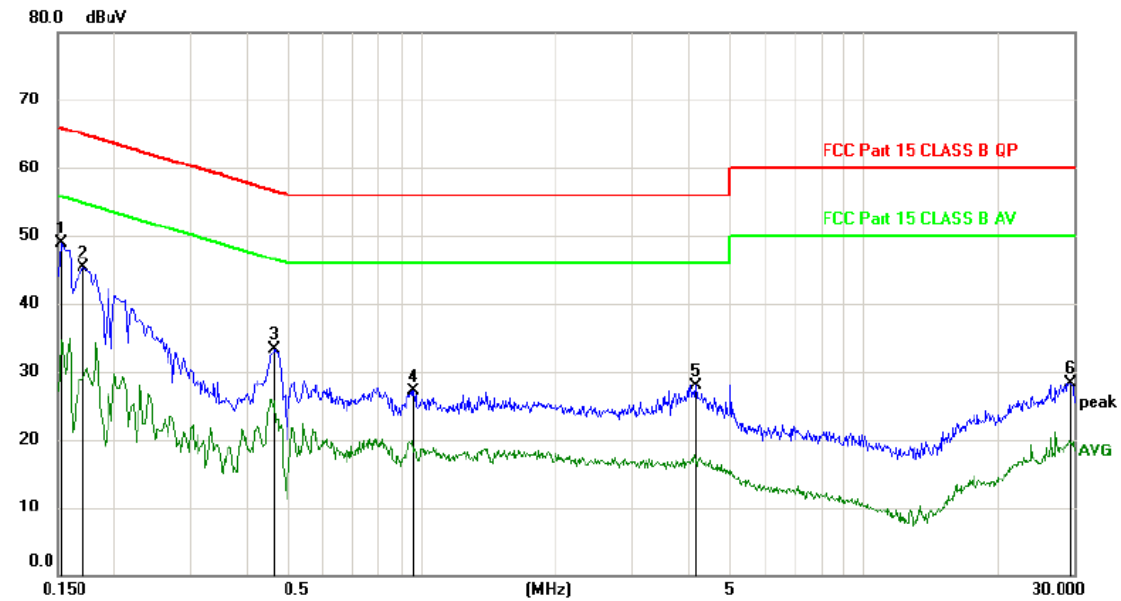

No.	Mk.	Freq. MHz	Reading Level dBuV	Correct Factor dB	Measure- ment dBuV	Limit dBuV	Margin dB	Detector	Comment
1	*	0.1530	48.81	0.13	48.94	65.84	-16.90	peak	
2		0.1710	45.26	0.13	45.39	64.91	-19.52	peak	
3		0.4650	33.22	0.13	33.35	56.60	-23.25	peak	
4		0.9600	26.89	0.14	27.03	56.00	-28.97	peak	
5		4.1610	27.67	0.21	27.88	56.00	-28.12	peak	
6		29.5770	27.20	1.16	28.36	60.00	-31.64	peak	

*:Maximum data x:Over limit !:over margin

Note: Measurement=Reading Level+Correc Factor. Factor=(LISN or ISN or PLC or Current Probe)Factor+Cable

Neutral:

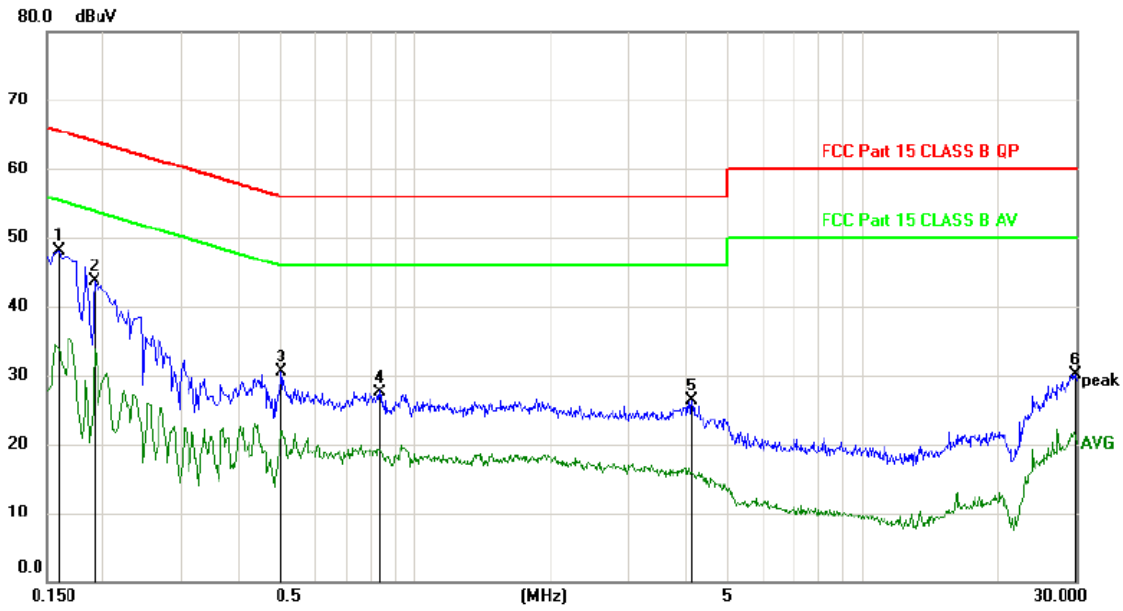

No.	Mk.	Freq. MHz	Reading Level dBuV	Correct Factor dB	Measure- ment dBuV	Limit dBuV	Margin dB	Detector	Comment
1	*	0.1590	47.91	0.13	48.04	65.52	-17.48	peak	
2		0.1920	43.52	0.13	43.65	63.95	-20.30	peak	
3		0.5010	30.30	0.13	30.43	56.00	-25.57	peak	
4		0.8310	27.47	0.13	27.60	56.00	-28.40	peak	
5		4.1490	26.13	0.21	26.34	56.00	-29.66	peak	
6		29.8980	28.94	1.17	30.11	60.00	-29.89	peak	

*:Maximum data x:Over limit !:over margin

Note: Measurement=Reading Level+Correc Factor. Factor=(LISN or ISN or PLC or Current Probe)Factor+Cable

Remark: All modes have been tested, and only worst data of GFSK mode, Channel 2402MHz (AC 120V/ 60Hz) was listed in this report.

5. CONDUCTED MAXIMUM OUTPUT POWER

5.1. Test limits

Please refer section RSS-247 & 15.247.

5.2. Test Procedure

Details see the KDB558074 D01 Meas Guidance V05

5.2.1 Place the EUT on the table and set it in transmitting mode.

5.2.2 Measure out each mode and each bands peak output power of EUT.

Note: The cable loss and attenuator loss were offset into measure device as amplitude offset.

5.3. Test Setup

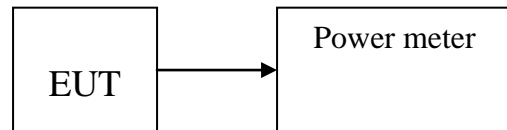

5.4. Test Results

Channel	Frequency (MHz)	PK Output Power (dBm)	PK Output Power (mW)	Limit (dBm)
CH1	2402	-1.716	0.674	30
CH20	2440	-0.529	0.885	30
CH40	2480	-2.382	0.578	30
Conclusion: PASS				

6. PEAK POWER SPECTRAL DENSITY

6.1. Test limits

6.1.1 Please refer section RSS-247 & 15.247.

6.1.2 For direct sequence systems, the peak power spectral density conducted from the intentional radiator to the antenna shall not be greater than 8dBm in any 3kHz band during any time interval of continuous transmission.

6.1.3 The direct sequence operating of the hybrid system, with the frequency hopping operation turned off, shall comply with the power density requirements of paragraph (d) of this section.

6.2. Test Procedure

Details see the KDB558074 D01 Meas Guidance V05

6.2.1 Place the EUT on the table and set it in transmitting mode.

6.2.2 Remove the antenna from the EUT and then connect a low loss RF cable from the antenna port to the spectrum analyzer.

6.2.3 Set the spectrum analyzer as RBW = 3kHz(Set the RBW to: $3 \text{ kHz} \leq \text{RBW} \leq 100 \text{ kHz}$.),
VBW = 10kHz(Set the VBW $\geq 3 \times \text{RBW}$), span $\geq 1.5 \times \text{DTS bandwidth}$., detail see the test plot.

6.2.4 Record the max reading.

6.2.5 Repeat the above procedure until the measurements for all frequencies are completed.

6.3. Test Setup

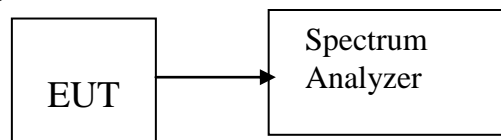

6.4. Test Results

Channel	Frequency (MHz)	Power Spectral Density (dBm)	Limit (dBm)	Result
CH1	2402	-8.119	8	PASS
CH20	2440	-6.613	8	PASS
CH40	2480	-8.288	8	PASS
Conclusion: PASS				

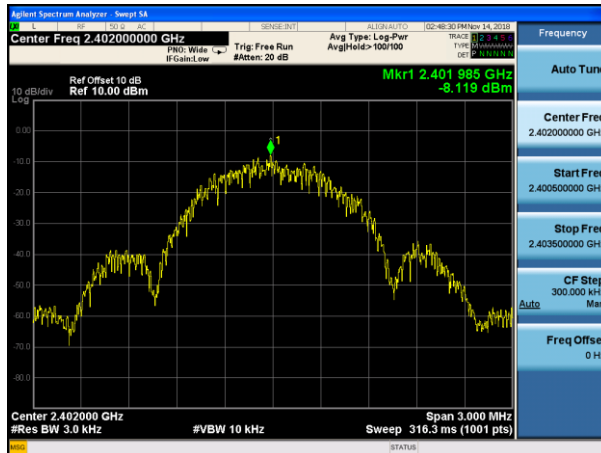

Low

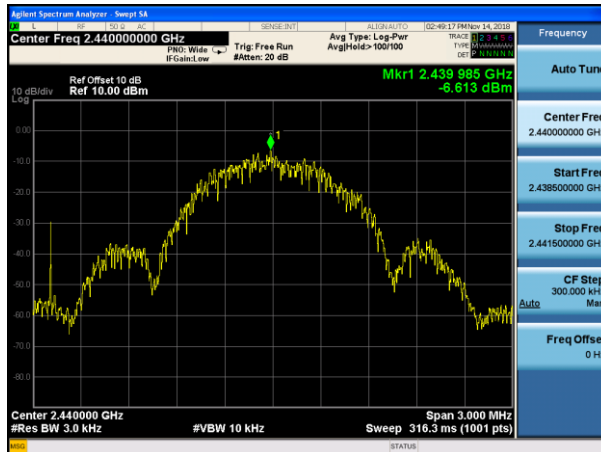

Midd

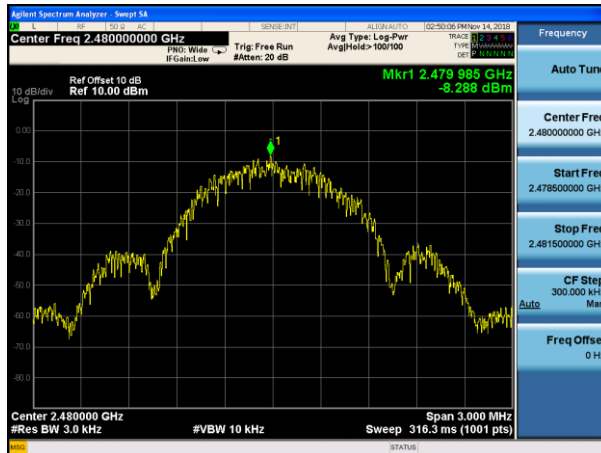

High

7. BANDWIDTH

7.1. Test limits

Please refer section RSS-247 & 15.247

For direct sequence systems, the minimum 6dB bandwidth shall be at least 500 kHz.

7.2. Test Procedure

Details see the KDB558074 D01 Meas Guidance V05

a) The bandwidth is measured at an amplitude level reduced 6dB from the reference level. The reference level is the level of the highest amplitude signal observed from the transmitter at the fundamental frequency. Once the reference level is established, the equipment is conditioned with typical modulating signal to produce the worst-case (i.e. the widest) bandwidth.

b) The test receiver set RBW = 100kHz, VBW $\geq 3 \cdot$ RBW = 300kHz, Sweep time set auto, detail see the test plot.

7.3. Test Setup

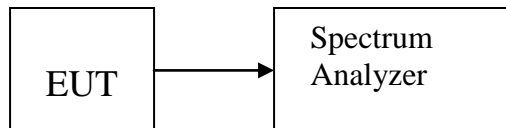

7.4. Test Results

Channel	Frequency (MHz)	99% Bandwidth (MHz)	6dB Bandwidth (MHz)	Limit (MHz)	Result
CH1	2402	1.0870	0.677	0.5	PASS
CH20	2440	1.0855	0.681	0.5	PASS
CH40	2480	1.0867	0.678	0.5	PASS



Low



Mid



High

8. BAND EDGE CHECK

8.1. Test limits

Please refer section RSS-GEN&15.247.

8.2. Test Procedure

Details see the KDB558074 D01 Meas Guidance V05

8.2.1 Put the EUT on a 1.5m high table, power on the EUT. Emissions were scanned and measured rotating the EUT to 360 degrees, Find the maximum Emission

8.2.2 Check the spurious emissions out of band.

8.2.3 RBW 1MHz ,VBW 3MHz ,peak detector for peak value , RBW 1MHz ,VBW 3MHz ,RMS detector for AV value.

8.3. Test Setup

Same as 3.3 above 1GHz.

8.4. Test Results

Radiated Method:

Polarization: Vertical

Test Mode:

GFSK-Low

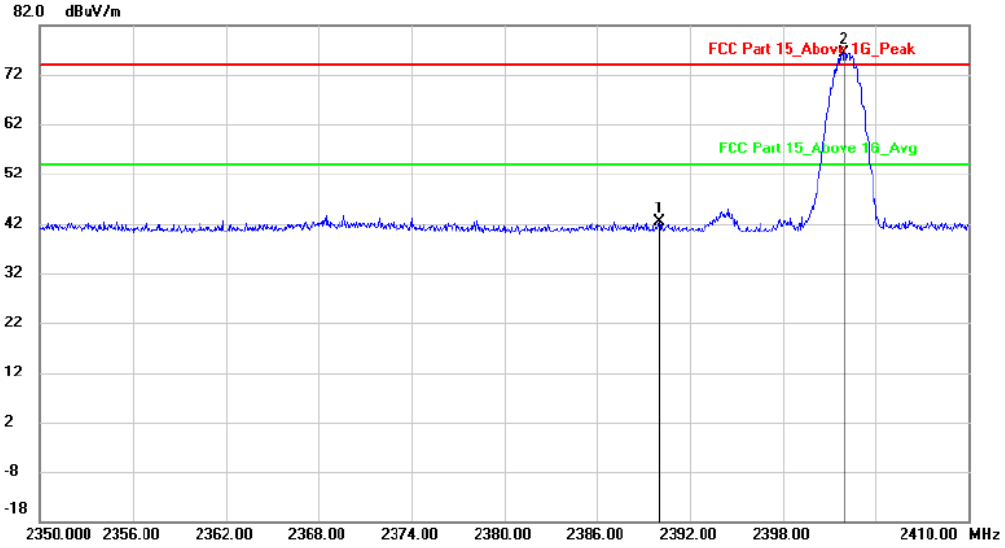

No.	Mk.	Freq.	Reading Level	Correct Factor	Measurement	Limit	Margin	Antenna Height	Table Degree	
		MHz	dBuV	dB	dBuV/m	dBuV/m	dB	cm	degree	Comment
1		2390.000	45.67	-3.40	42.27	74.00	-31.73			peak
2	*	2401.960	79.90	-3.41	76.49	74.00	2.49			peak

Polarization: Horizontal

Test Mode:

GFSK-Low

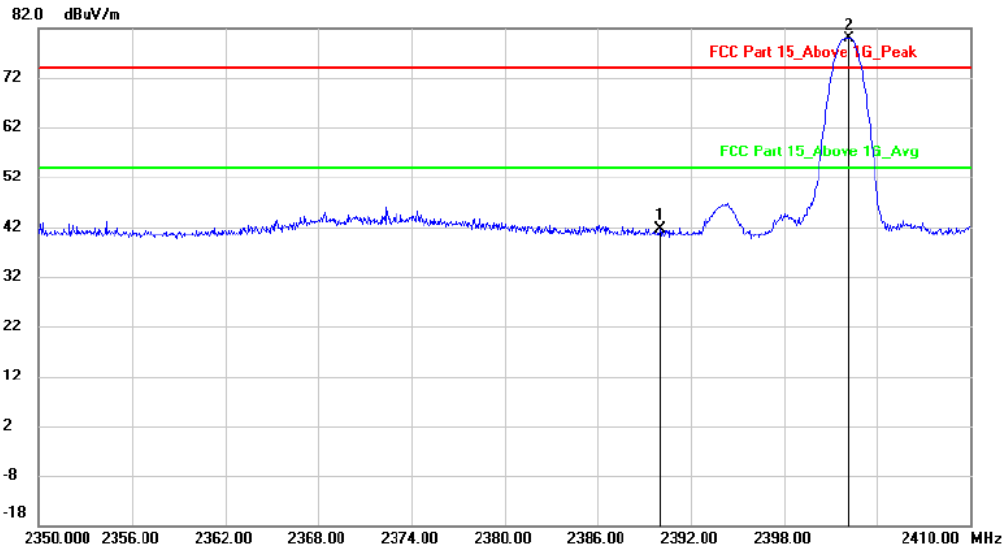

No.	Mk.	Freq.	Reading Level	Correct Factor	Measurement	Limit	Margin	Antenna Height	Table Degree	
		MHz	dBuV	dB	dBuV/m	dBuV/m	dB	cm	degree	Comment
1		2390.000	45.12	-3.40	41.72	74.00	-32.28			peak
2	*	2402.200	83.38	-3.41	79.97	74.00	5.97			peak

Polarization: Vertical Test Mode: GFSK-High

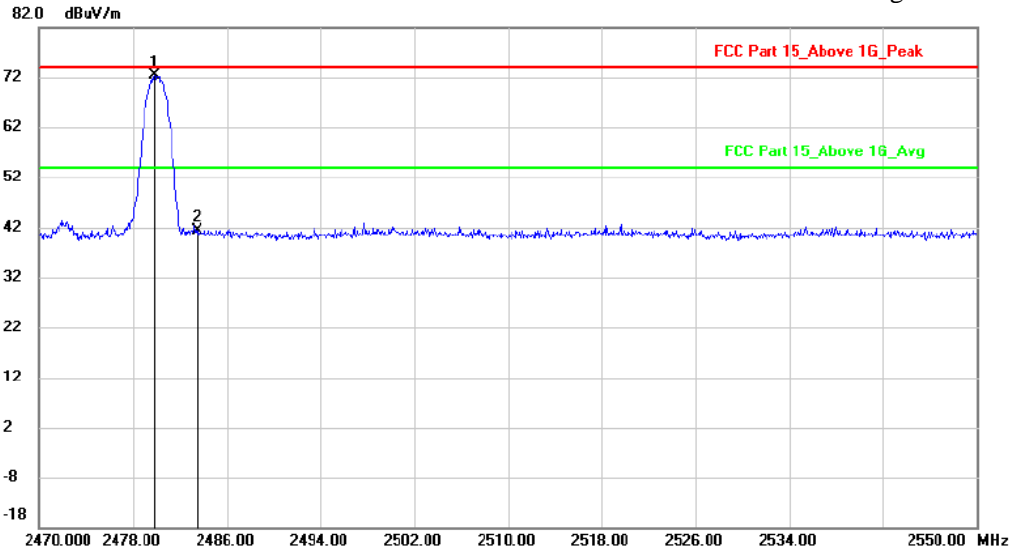

No.	Mk.	Freq.	Reading Level	Correct Factor	Measurement	Limit	Margin	Antenna Height	Table Degree
		MHz	dBuV	dB	dBuV/m	dBuV/m	dB	cm	degree
1	*	2479.840	75.64	-3.38	72.26	74.00	-1.74	peak	
2		2483.500	44.81	-3.38	41.43	74.00	-32.57	peak	

Polarization: Horizontal Test Mode: GFSK-High

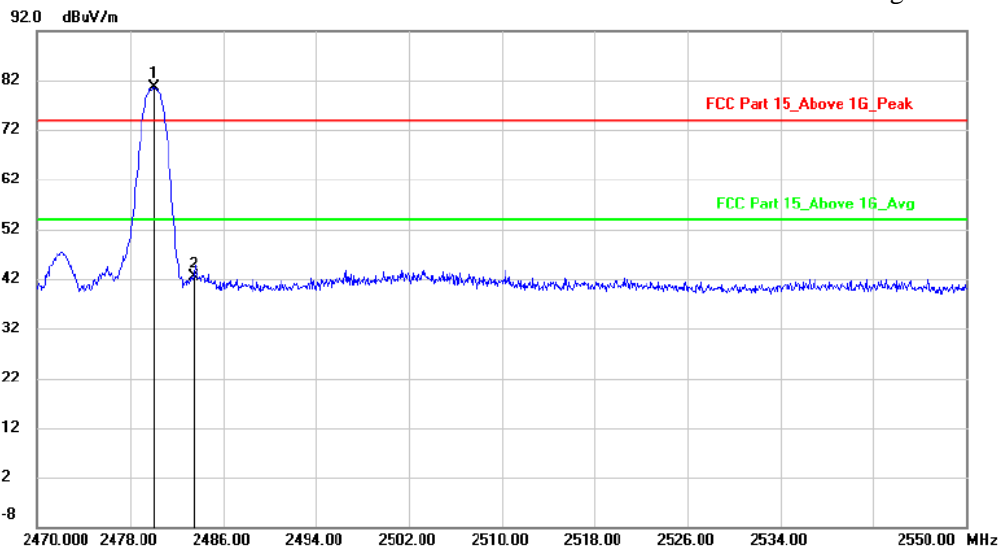

No.	Mk.	Freq.	Reading Level	Correct Factor	Measurement	Limit	Margin	Antenna Height	Table Degree
		MHz	dBuV	dB	dBuV/m	dBuV/m	dB	cm	degree
1	*	2480.080	83.91	-3.38	80.53	74.00	6.53	peak	
2		2483.500	45.80	-3.38	42.42	74.00	-31.58	peak	

Conducted Method:
GFSK

Lowest channel

Highest channel

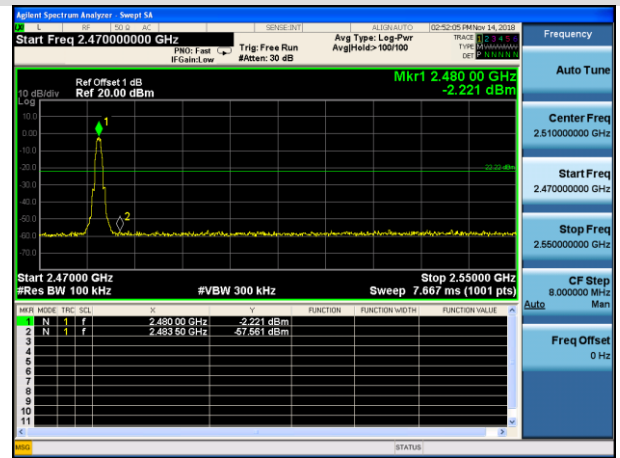
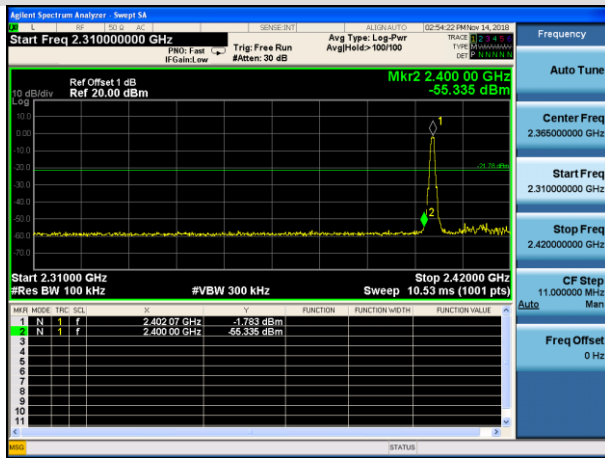

9. FREQUENCY STABILITY

9.1. Test limit

Please refer section RSS-Gen.

Regulation RSS-Gen If the frequency stability of the licence-exempt radio apparatus is not specified in the applicable RSS, the fundamental emissions of the radio apparatus should be kept within at least the central 80% of its permitted operating frequency band in order to minimize the possibility of out-of-band operation. In addition, its occupied bandwidth shall be entirely outside the restricted bands and the prohibited TV bands of 54-72 MHz, 76-88 MHz, 174-216 MHz, and 470-602 MHz, unless otherwise indicated.

9.2. Test Procedure

The following equipment are installed on the emission measurement to meet the commission requirements and operating regulations in a manner which tends to maximize its emission characteristics in normal application.

9.3. Test Setup

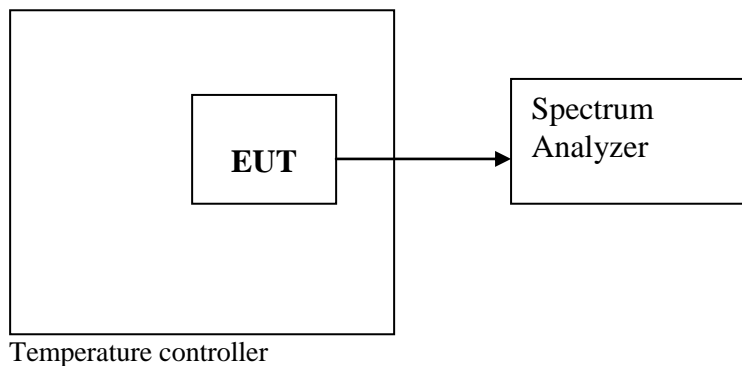

9.4. Test Results

PASS.

Detailed information please see the following page.

Assigned Frequency(MHz): 2402MHz				
Voltage	Temperature	Measured Frequency (MHz)	Frequency stability(MHz)	Limit(MHz)
Low DC 6.1V	+20°C	2401.989	-0.011	±0.020
Normal DC 7.2V	-20°C	2401.992	-0.008	±0.020
	-10°C	2401.992	-0.008	±0.020
	0°C	2401.995	-0.005	±0.020
	+10°C	2401.992	-0.008	±0.020
	+20°C	2402.003	0.003	±0.020
	+30°C	2401.996	-0.004	±0.020
	+40°C	2401.991	-0.009	±0.020
	+50°C	2401.994	-0.006	±0.020
High DC 8.3V	+20°C	2401.995	-0.005	±0.020

10. ANTENNA REQUIREMENT

10.1. Standard Requirement

An intentional radiator shall be designed to ensure that no antenna other than that furnished by the responsible party shall be used with the device. The use of a permanently attached antenna or of an antenna that uses a unique coupling to the intentional radiator shall be considered sufficient to comply with the provisions of this Section. The manufacturer may design the unit so that a broken antenna can be replaced by the user, but the use of a standard antenna jack or electrical connector is prohibited.

10.2. Antenna Connected Construction

The antenna is Internal antenna and no consideration of replacement. Please see EUT photo for details.

10.3. Results

The EUT antenna is Internal Antenna. It comply with the standard requirement.

-----THE END OF REPORT-----