

FCC Report (WIFI)

Applicant: ShenZhen RF-STAR Technology CO.,LTD
Address of Applicant: 2F,BLDG.8,Zone A,BaoAn Internet Industry Base, BaoYuan Road,XiXiang, BaoAn DIST, ShenZhen, China
Manufacturer: ShenZhen RF-STAR Technology CO.,LTD
Address of Manufacturer: 2F,BLDG.8,Zone A,BaoAn Internet Industry Base, BaoYuan Road,XiXiang, BaoAn DIST, ShenZhen, China

Equipment Under Test (EUT)

Product Name: Wi-Fi module
Model No.: RF-WM-3220B1
FCC ID: 2ABN2-RS3220B1
Applicable standards: FCC CFR Title 47 Part 15 Subpart C Section 15.247
Date of sample receipt: July 17, 2018
Date of Test: July 17, 2018-Aug 14, 2018
Date of report issued: Aug 14, 2018
Test Result : PASS *

* In the configuration tested, the EUT complied with the standards specified above.

Authorized Signature:



Robinson Lo
Laboratory Manager

This results shown in this test report refer only to the sample(s) tested, this test report cannot be reproduced, except in full, without prior written permission of the company. The report would be invalid without specific stamp of test institute and the signatures of compiler and approver.

2 Version

Version No.	Date	Description
00	July 31, 2018	Original
01	Aug 14, 2018	Update page 6, 7, 12, 13, 14, 15, 16

Prepared By:

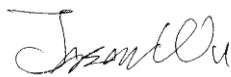

Date:

Aug 14, 2018

Project Engineer

Check By:

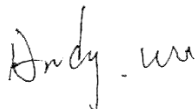

Date:

Aug 14, 2018

Reviewer

3 Contents

	Page
1 COVER PAGE	1
2 VERSION	2
3 CONTENTS	3
4 TEST SUMMARY	4
5 GENERAL INFORMATION	5
5.1 GENERAL DESCRIPTION OF EUT	5
5.2 TEST MODE	7
5.3 DESCRIPTION OF SUPPORT UNITS	7
5.4 TEST FACILITY	7
5.5 TEST LOCATION	7
6 TEST INSTRUMENTS LIST	8
7 TEST RESULTS AND MEASUREMENT DATA	10
7.1 ANTENNA REQUIREMENT	10
7.2 CONDUCTED PEAK OUTPUT POWER	11
7.3 CHANNEL BANDWIDTH	12
7.4 POWER SPECTRAL DENSITY	16
7.5 BAND EDGES	20
7.5.1 Conducted Emission Method	20
7.5.2 Radiated Emission Method	23
7.6 SPURIOUS EMISSION	27
7.6.1 Conducted Emission Method	27
7.6.2 Radiated Emission Method	31
8 TEST SETUP PHOTO	45
9 EUT CONSTRUCTIONAL DETAILS	46

4 Test Summary

Test Item	Section in CFR 47	Result
Antenna requirement	15.203/15.247 (c)	Pass
AC Power Line Conducted Emission	15.207	N/A
Conducted Peak Output Power	15.247 (b)(3)	Pass
Channel Bandwidth	15.247 (a)(2)	Pass
Power Spectral Density	15.247 (e)	Pass
Band Edge	15.247(d)	Pass
Spurious Emission	15.205/15.209	Pass

Remark: Test according to ANSI C63.10:2013.

Pass: The EUT complies with the essential requirements in the standard.

N/A: Not applicable.

Measurement Uncertainty

Test Item	Frequency Range	Measurement Uncertainty	Notes
Radiated Emission	9kHz ~ 30MHz	± 4.34dB	(1)
Radiated Emission	30MHz ~ 1000MHz	± 4.24dB	(1)
Radiated Emission	1GHz ~ 26.5GHz	± 4.68dB	(1)
AC Power Line Conducted Emission	0.15MHz ~ 30MHz	± 3.45dB	(1)

Note (1): The measurement uncertainty is for coverage factor of k=2 and a level of confidence of 95%.

5 General Information

5.1 General Description of EUT

Product Name:	Wi-Fi module
Model No.:	RF-WM-3220B1
Serial No.:	W280719M-0158
Test sample(s) ID:	GTS201808000035-1
Sample(s) Status	Engineer sample
Channel numbers:	802.11b/802.11g /802.11n(HT20): 11
Channel separation:	5MHz
Modulation technology:	802.11b: Direct Sequence Spread Spectrum (DSSS) 802.11g/802.11n(H20) Orthogonal Frequency Division Multiplexing (OFDM)
Antenna Type:	Chip Antenna
Antenna gain:	0dBi(declare by applicant)
Power supply:	DC 3.3V

Operation Frequency each of channel							
Channel	Frequency	Channel	Frequency	Channel	Frequency	Channel	Frequency
1	2412MHz	4	2427MHz	7	2442MHz	10	2457MHz
2	2417MHz	5	2432MHz	8	2447MHz	11	2462MHz
3	2422MHz	6	2437MHz	9	2452MHz	X	

Note:

In section 15.31(m), regards to the operating frequency range over 10 MHz, the Lowest frequency, the middle frequency, and the highest frequency of channel were selected to perform the test, and the selected channel see below:

Test channel	Frequency (MHz)
	802.11b/802.11g/802.11n(HT20)
Lowest channel	2412MHz
Middle channel	2437MHz
Highest channel	2462MHz

5.2 Test mode

Transmitting mode	Keep the EUT in continuously transmitting mode
<i>Remark: During the test, the duty cycle >98%, the test voltage was tuned from 85% to 115% of the nominal rated supply voltage, and found that the worst case was under the nominal rated supply condition. So the report just shows that condition's data.</i>	

We have verified the construction and function in typical operation. All the test modes were carried out with the EUT in transmitting operation, which was shown in this test report and defined as follows:			
Pre-scan all kind of data rate in lowest channel, and found the follow list which it was worst case.			
Mode	802.11b	802.11g	802.11n(HT20)
Data rate	1Mbps	6Mbps	6.5Mbps

5.3 Description of Support Units

Manufacturer	Description	Model	Serial Number
Apple	PC	A1278	C1MN99ERDTY3
ASW	USB to TTL	PL2303	N/A

5.4 Test Facility

<p>The test facility is recognized, certified, or accredited by the following organizations:</p> <ul style="list-style-type: none"> • FCC —Registration No.: 381383 Global United Technology Services Co., Ltd., Shenzhen EMC Laboratory has been registered and fully described in a report filed with the (FCC) Federal Communications Commission. The acceptance letter from the FCC is maintained in files. Registration 381383, January 08, 2018. • Industry Canada (IC) —Registration No.: 9079A-2 The 3m Semi-anechoic chamber of Global United Technology Services Co., Ltd. has been registered by Certification and Engineering Bureau of Industry Canada for radio equipment testing with Registration No.: 9079A-2, August 15, 2016.
--

5.5 Test Location

All tests were performed at:
<p>Global United Technology Services Co., Ltd. Address: No. 301-309, 3/F., Jinyuan Business Building, No.2, Laodong Industrial Zone, Xixiang Road, Baoan District, Shenzhen, Guangdong, China 518102 Tel: 0755-27798480 Fax: 0755-27798960</p>

6 Test Instruments list

Radiated Emission:						
Item	Test Equipment	Manufacturer	Model No.	Inventory No.	Cal.Date (mm-dd-yy)	Cal.Due date (mm-dd-yy)
1	3m Semi- Anechoic Chamber	ZhongYu Electron	9.2(L)*6.2(W)* 6.4(H)	GTS250	July. 03 2015	July. 02 2020
2	Control Room	ZhongYu Electron	6.2(L)*2.5(W)* 2.4(H)	GTS251	N/A	N/A
3	EMI Test Receiver	Rohde & Schwarz	ESU26	GTS203	June. 27 2018	June. 26 2019
4	BiConiLog Antenna	SCHWARZBECK MESS-ELEKTRONIK	VULB9163	GTS214	June. 27 2018	June. 26 2019
5	Double -ridged waveguide horn	SCHWARZBECK MESS-ELEKTRONIK	BBHA 9120 D	GTS208	June. 27 2018	June. 26 2019
6	Horn Antenna	ETS-LINDGREN	3160	GTS217	June. 27 2018	June. 26 2019
7	EMI Test Software	AUDIX	E3	N/A	N/A	N/A
8	Coaxial Cable	GTS	N/A	GTS213	June. 27 2018	June. 26 2019
9	Coaxial Cable	GTS	N/A	GTS211	June. 27 2018	June. 26 2019
10	Coaxial cable	GTS	N/A	GTS210	June. 27 2018	June. 26 2019
11	Coaxial Cable	GTS	N/A	GTS212	June. 27 2018	June. 26 2019
12	Amplifier(100kHz-3GHz)	HP	8347A	GTS204	June. 27 2018	June. 26 2019
13	Amplifier(2GHz-20GHz)	HP	84722A	GTS206	June. 27 2018	June. 26 2019
14	Amplifier (18-26GHz)	Rohde & Schwarz	AFS33-18002 650-30-8P-44	GTS218	June. 27 2018	June. 26 2019
15	Band filter	Amindeon	82346	GTS219	June. 27 2018	June. 26 2019
16	Power Meter	Anritsu	ML2495A	GTS540	June. 27 2018	June. 26 2019
17	Power Sensor	Anritsu	MA2411B	GTS541	June. 27 2018	June. 26 2019
18	Wideband Radio Communication Tester	Rohde & Schwarz	CMW500	GTS575	June. 27 2018	June. 26 2019
19	Splitter	Agilent	11636B	GTS237	June. 27 2018	June. 26 2019
20	Loop Antenna	ZHINAN	ZN30900A	GTS534	June. 27 2018	June. 26 2019

RF Conducted Test:						
Item	Test Equipment	Manufacturer	Model No.	Serial No.	Cal.Date (mm-dd-yy)	Cal.Due date (mm-dd-yy)
1	MXA Signal Analyzer	Agilent	N9020A	GTS566	June. 27 2018	June. 26 2019
2	EMI Test Receiver	R&S	ESCI 7	GTS552	June. 27 2018	June. 26 2019
3	Spectrum Analyzer	Agilent	E4440A	GTS533	June. 27 2018	June. 26 2019
4	MXG vector Signal Generator	Agilent	N5182A	GTS567	June. 27 2018	June. 26 2019
5	ESG Analog Signal Generator	Agilent	E4428C	GTS568	June. 27 2018	June. 26 2019
6	USB RF Power Sensor	DARE	RPR3006W	GTS569	June. 27 2018	June. 26 2019
7	RF Switch Box	Shongyi	RFSW3003328	GTS571	June. 27 2018	June. 26 2019
8	EMI Test Receiver	R&S	ESCI 7	GTS552	June. 27 2018	June. 26 2019
9	Programmable Constant Temp & Humi Test Chamber	WEWON	WHTH-150L-40-880	GTS572	June. 27 2018	June. 26 2019

General used equipment:						
Item	Test Equipment	Manufacturer	Model No.	Inventory No.	Cal.Date (mm-dd-yy)	Cal.Due date (mm-dd-yy)
1	Humidity/ Temperature Indicator	KTJ	TA328	GTS243	June. 27 2018	June. 26 2019
2	Barometer	ChangChun	DYM3	GTS255	June. 27 2018	June. 26 2019

7 Test results and Measurement Data

7.1 Antenna requirement

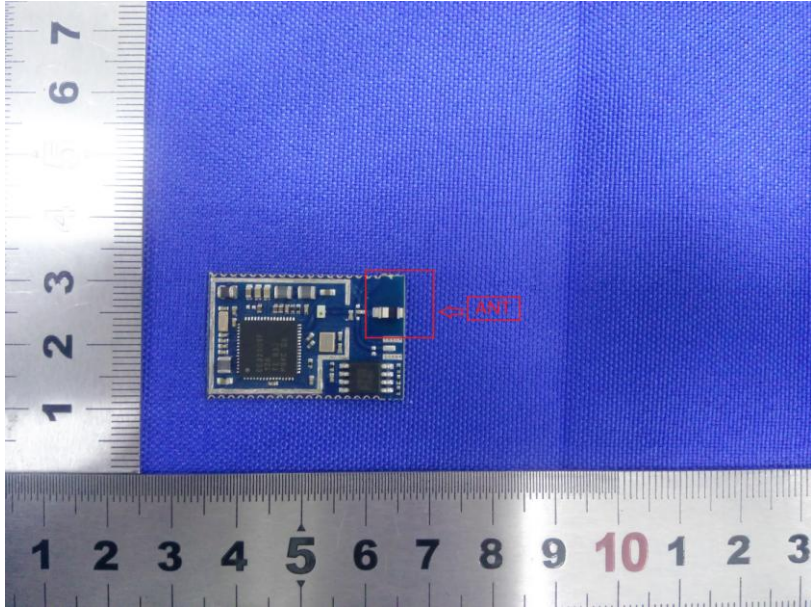
Standard requirement:	FCC Part15 C Section 15.203 /247(c)
<p>15.203 requirement: An intentional radiator shall be designed to ensure that no antenna other than that furnished by the responsible party shall be used with the device. The use of a permanently attached antenna or of an antenna that uses a unique coupling to the intentional radiator, the manufacturer may design the unit so that a broken antenna can be replaced by the user, but the use of a standard antenna jack or electrical connector is prohibited.</p> <p>15.247(c) (1)(i) requirement: (i) Systems operating in the 2400-2483.5 MHz band that is used exclusively for fixed. Point-to-point operations may employ transmitting antennas with directional gain greater than 6dBi provided the maximum conducted output power of the intentional radiator is reduced by 1 dB for every 3 dB that the directional gain of the antenna exceeds 6dBi.</p>	
EUT Antenna:	
<p><i>The antenna is Chip Antenna, the best case gain of the antenna is 0dBi</i></p> 	

7.2 Conducted Peak Output Power

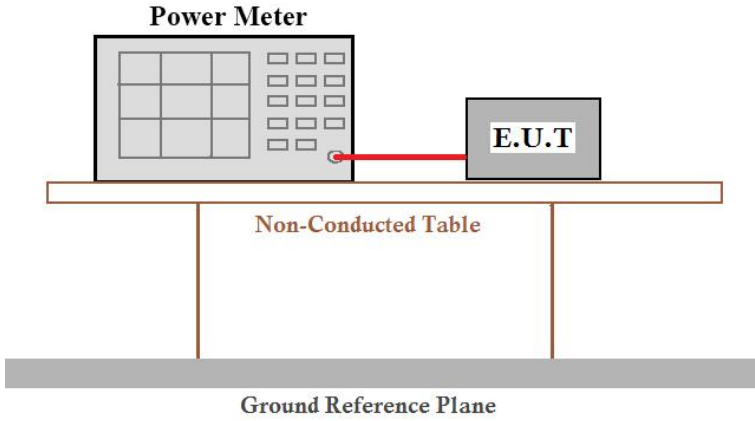
Test Requirement:	FCC Part15 C Section 15.247 (b)(3)
Test Method:	KDB558074 D01 DTS Meas Guidance V04
Limit:	30dBm
Test setup:	 <p>The diagram illustrates the test setup. A Power Meter is connected to an E.U.T. (Equipment Under Test) via a red cable. Both are placed on a Non-Conducted Table, which is supported by two legs. Below the table is a Ground Reference Plane.</p>
Test Instruments:	Refer to section 6.0 for details
Test mode:	Refer to section 5.2 for details
Test results:	Pass

Measurement Data

Test CH	Peak Output Power (dBm)			Limit(dBm)	Result
	802.11b	802.11g	802.11n(HT20)		
Lowest	14.97	11.46	11.45	30.00	Pass
Middle	15.56	14.70	13.96		
Highest	15.57	12.36	12.33		

7.3 Channel Bandwidth

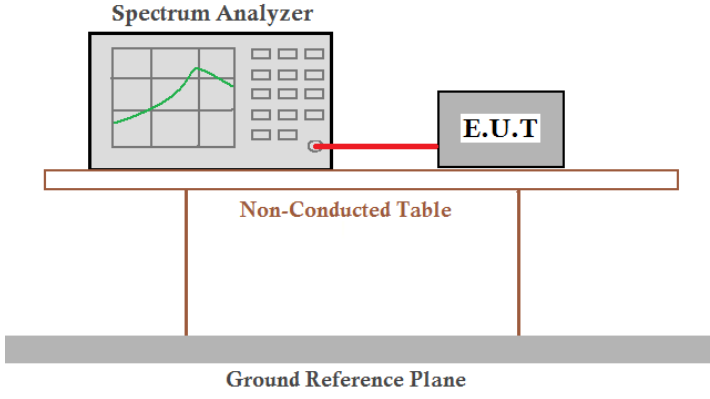
Test Requirement:	FCC Part15 C Section 15.247 (a)(2)
Test Method:	KDB558074 D01 DTS Meas Guidance V04
Limit:	>500KHz
Test setup:	 <p>The diagram illustrates the test setup. A Spectrum Analyzer is connected to an E.U.T. (Equipment Under Test) via a red cable. Both are placed on a Non-Conducted Table, which is supported by a Ground Reference Plane.</p>
Test Instruments:	Refer to section 6.0 for details
Test mode:	Refer to section 5.2 for details
Test results:	Pass

Measurement Data

Test CH	6dB Emission Bandwidth (MHz)			Limit(kHz)	Result
	802.11b	802.11g	802.11n(H20)		
Lowest	10.24	15.36	15.36	>500	Pass
Middle	10.08	15.52	15.28		
Highest	10.08	15.36	15.28		

Test plot as follows:

Test mode:802.11b
6dBEBW

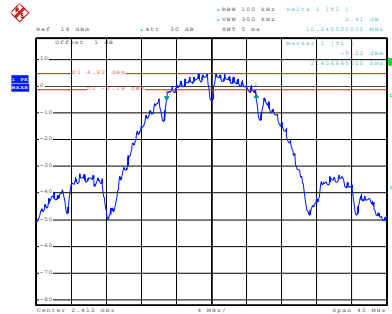

Date: 27.JUL.2018 09:45:12

Lowest channel

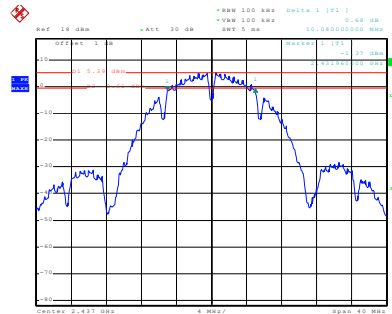

Date: 27.JUL.2018 09:47:55

Middle channel

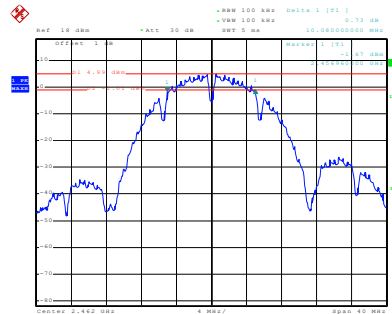

Date: 27.JUL.2018 09:50:23

Highest channel

Test mode:802.11g

6dBEBW

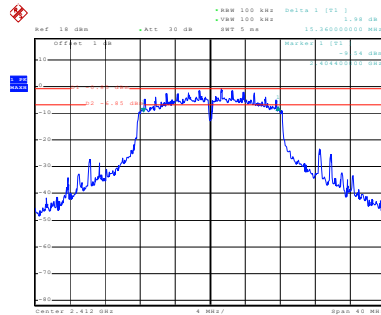

Date: 27.JUL.2018 09:55:55

Lowest channel

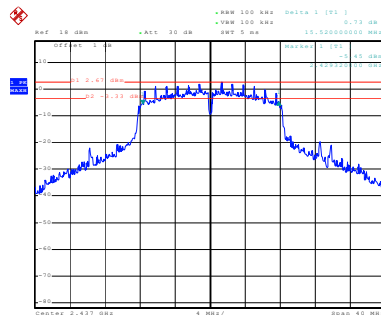

Date: 27.JUL.2018 09:58:38

Middle channel

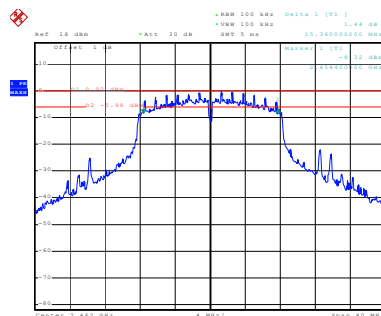

Date: 27.JUL.2018 10:04:19

Highest channel

Test mode:802.11n(HT20)

6dBEBW

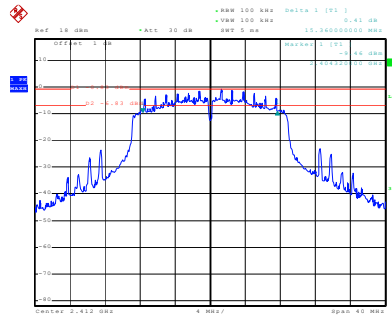

Date: 27.JUL.2018 10:10:04

Lowest channel

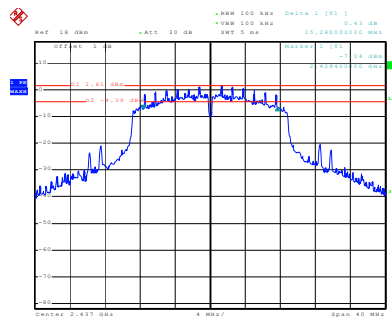

Date: 27.JUL.2018 10:16:31

Middle channel

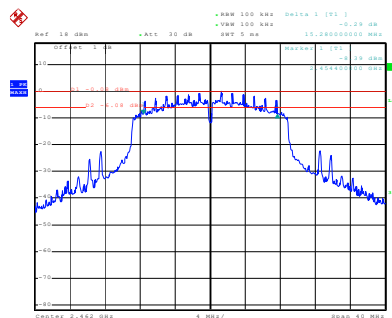

Date: 27.JUL.2018 10:26:23

Highest channel

7.4 Power Spectral Density

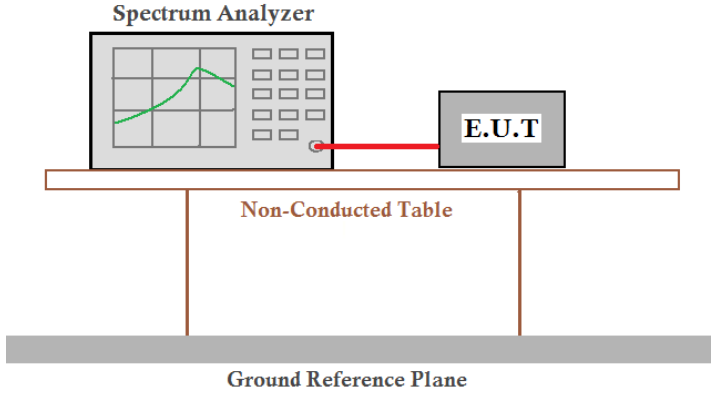
Test Requirement:	FCC Part15 C Section 15.247 (e)
Test Method:	KDB558074 D01 DTS Meas Guidance V04
Limit:	8dBm/3KHz
Test setup:	 <p>The diagram shows a Spectrum Analyzer and an E.U.T. connected by a red cable. They are positioned on a table labeled 'Non-Conducted Table'. Below the table is a 'Ground Reference Plane'.</p>
Test Instruments:	Refer to section 6.0 for details
Test mode:	Refer to section 5.2 for details
Test results:	Pass

Measurement Data

Test CH	Power Spectral Density (dBm)			Limit (dBm/3KHz)	Result
	802.11b	802.11g	802.11n(HT20)		
Lowest	-10.63	-16.32	-16.45	8.00	Pass
Middle	-10.11	-12.89	-13.97		
Highest	-10.48	-15.50	-15.58		

Remark:

Power Spectral Density (dBm/3kHz)=PSD value(RBW=100kHz)-10log(100kHz/3kHz)

Test plot as follows:

Test mode:	802.11b
------------	---------

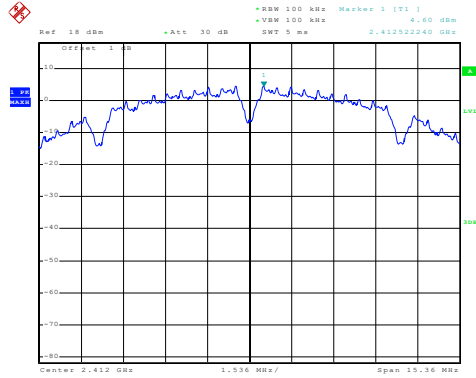

Date: 27.JUL.2018 09:46:33

Lowest channel

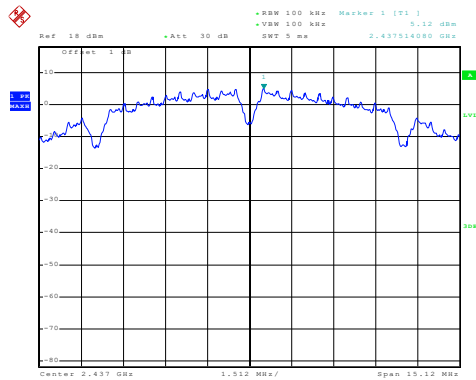

Date: 27.JUL.2018 09:48:55

Middle channel

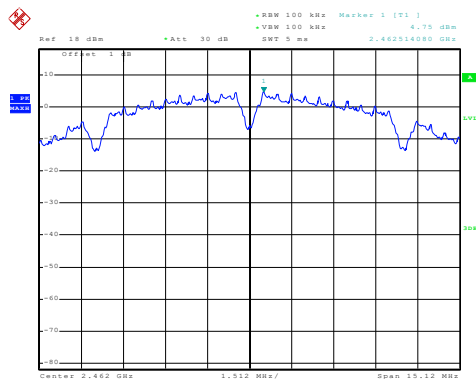

Date: 27.JUL.2018 09:51:12

Highest channel

Test mode: 802.11g

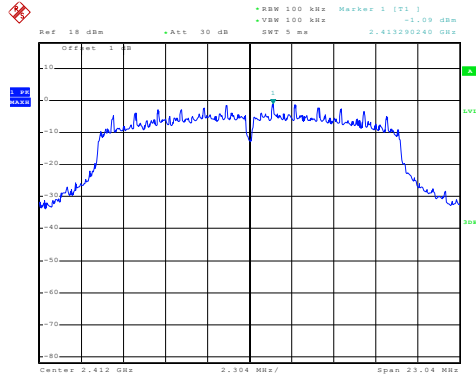

Date: 27.JUL.2018 09:57:02

Lowest channel

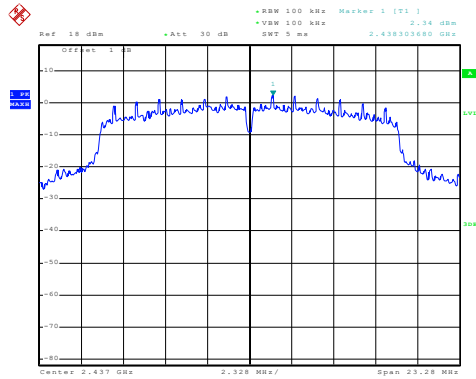

Date: 27.JUL.2018 10:00:53

Middle channel

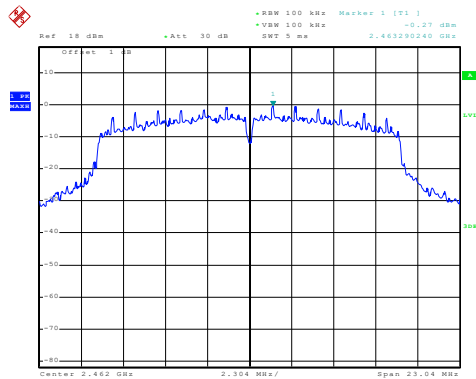

Date: 27.JUL.2018 10:06:42

Highest channel

Test mode: 802.11n(HT20)

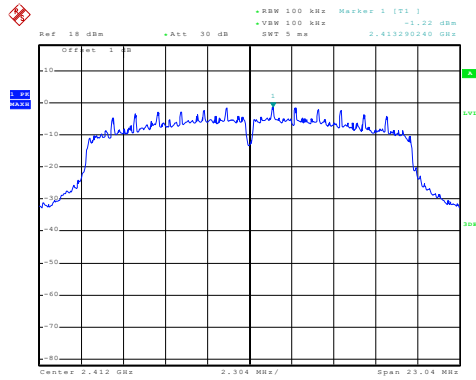

Date: 27.JUL.2018 10:17:40

Lowest channel

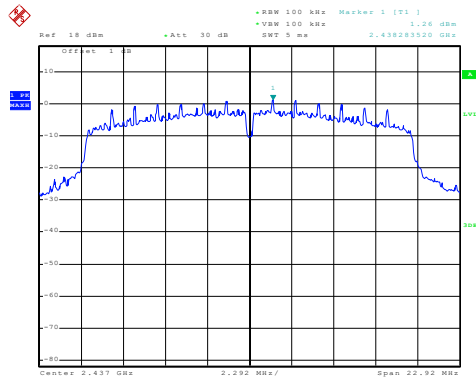

Date: 27.JUL.2018 10:20:03

Middle channel

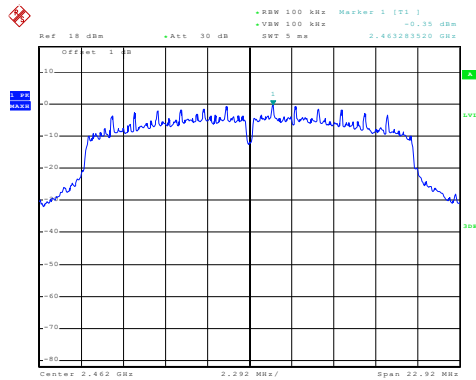

Date: 27.JUL.2018 10:27:44

Highest channel

7.5 Band edges

7.5.1 Conducted Emission Method

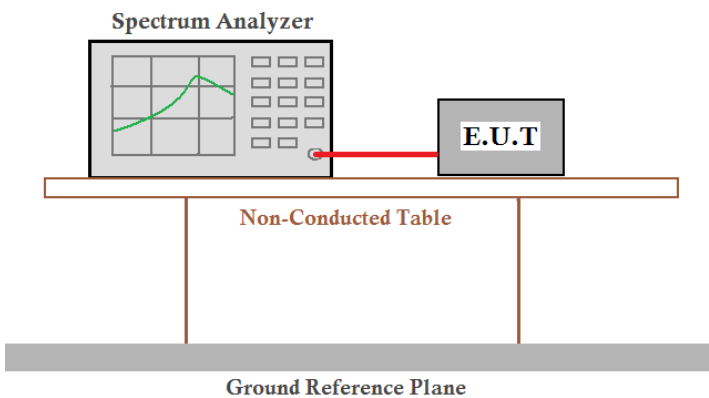
Test Requirement:	FCC Part15 C Section 15.247 (d)
Test Method:	KDB558074 D01 DTS Meas Guidance V04
Limit:	In any 100 kHz bandwidth outside the frequency band in which the spread spectrum intentional radiator is operating, the radio frequency power that is produced by the intentional radiator shall be at least 20 dB below that in the 100 kHz bandwidth within the band that contains the highest level of the desired power, based on either an RF conducted or a radiated measurement.
Test setup:	 <p>The diagram illustrates the test setup. A Spectrum Analyzer is connected to an E.U.T. (Equipment Under Test) via a red cable. Both are placed on a Non-Conducted Table, which is supported by two vertical legs. Below the table is a Ground Reference Plane, represented by a thick grey bar.</p>
Test Instruments:	Refer to section 6.0 for details
Test mode:	Refer to section 5.2 for details
Test results:	Pass

Test plot as follows:

Test mode:	802.11b
------------	---------

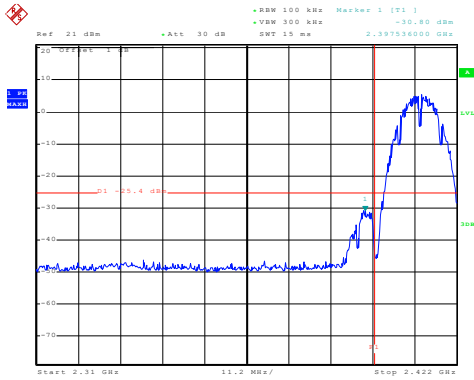

Date: 27.JUL.2018 11:23:00

Lowest channel

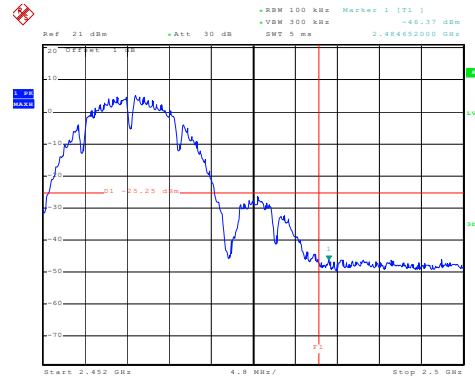

Date: 27.JUL.2018 11:26:35

Highest channel

Test mode:	802.11g
------------	---------

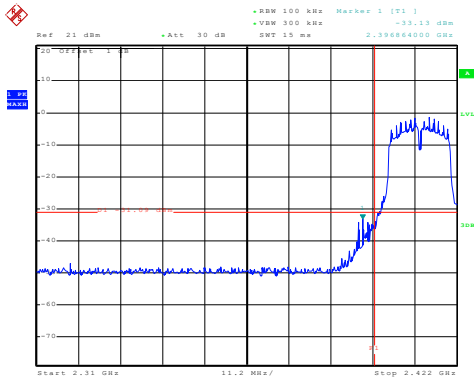

Date: 27.JUL.2018 11:23:48

Lowest channel

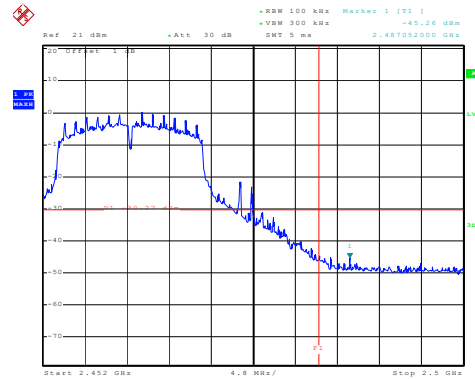

Date: 27.JUL.2018 11:26:00

Highest channel

Test mode: 802.11n(HT20)

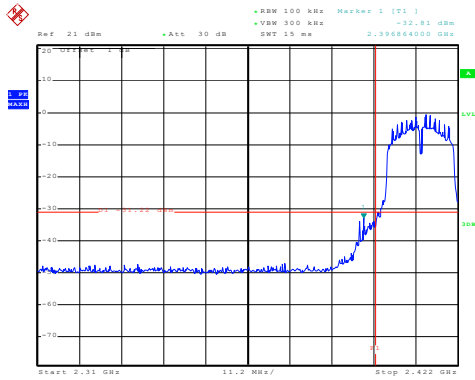

Date: 27. III. 2018 11:24:40

Lowest channel

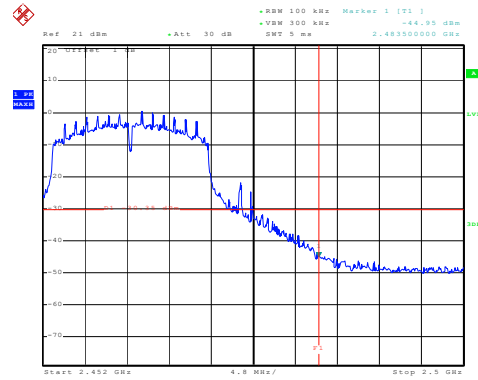

Date: 27. III. 2018 11:25:00

Highest channel

7.5.2 Radiated Emission Method

Test Requirement:	FCC Part15 C Section 15.209 and 15.205			
Test Method:	ANSI C63.10:2013			
Test Frequency Range:	All of the restrict bands were tested, only the worst band's (2310MHz to 2390MHz, 2483.5MHz to 2500MHz) data was showed.			
Test site:	Measurement Distance: 3m			
Receiver setup:	Frequency	Detector	RBW	VBW
	Above 1GHz	Peak	1MHz	3MHz
		Average	1MHz	3MHz
Limit:	Frequency	Limit (dBuV/m @3m)		Value
	Above 1GHz	54.00		Average
		74.00		Peak
Test setup:				
Test Procedure:	<ol style="list-style-type: none"> 1. The EUT was placed on the top of a rotating table 1.5 meters above the ground at a 3 meter camber. The table was rotated 360 degrees to determine the position of the highest radiation. 2. The EUT was set 3 meters away from the interference-receiving antenna, which was mounted on the top of a variable-height antenna tower. 3. The antenna height is varied from one meter to four meters above the ground to determine the maximum value of the field strength. Both horizontal and vertical polarizations of the antenna are set to make the measurement. 4. For each suspected emission, the EUT was arranged to its worst case and then the antenna was tuned to heights from 1 meter to 4 meters and the rota table was turned from 0 degrees to 360 degrees to find the maximum reading. 5. The test-receiver system was set to Peak Detect Function and Specified Bandwidth with Maximum Hold Mode. 6. If the emission level of the EUT in peak mode was 10dB lower than the limit specified, then testing could be stopped and the peak values of the EUT would be reported. Otherwise the emissions that did not have 10dB margin would be re-tested one by one using peak, quasi-peak or average method as specified and then reported in a data sheet. 7. The radiation measurements are performed in X, Y, Z axis positioning. And found the Y axis positioning which it is worse case, only the test worst case mode is recorded in the report. 			

Test Instruments:	Refer to section 6.0 for details
Test mode:	Refer to section 5.2 for details
Test results:	Pass

Measurement data:

Remark: The pre-test were performed on lowest, middle and highest frequencies, only the worst case's (lowest and highest frequencies) data was showed.

Test mode:	802.11b	Test channel:	Lowest
------------	---------	---------------	--------

Peak value:

Frequency (MHz)	Read Level (dBuV)	Correct factor (dB/m)	Level (dBuV/m)	Limit Line (dBuV/m)	Over Limit (dB)	Polarization
2310.00	54.36	-16.65	37.71	74.00	-36.29	Horizontal
2390.00	53.14	-16.28	36.86	74.00	-37.14	Horizontal
2310.00	54.29	-16.65	37.64	74.00	-36.36	Vertical
2390.00	54.03	-16.28	37.75	74.00	-36.25	Vertical

Average value:

Frequency (MHz)	Read Level (dBuV)	Correct factor (dB/m)	Level (dBuV/m)	Limit Line (dBuV/m)	Over Limit (dB)	Polarization
2310.00	42.78	-16.65	26.13	54.00	-27.87	Horizontal
2390.00	44.36	-16.28	28.08	54.00	-25.92	Horizontal
2310.00	45.15	-16.65	28.50	54.00	-25.50	Vertical
2390.00	43.82	-16.28	27.54	54.00	-26.46	Vertical

Test channel:	Highest
---------------	---------

Peak value:

Frequency (MHz)	Read Level (dBuV)	Correct factor (dB/m)	Level (dBuV/m)	Limit Line (dBuV/m)	Over Limit (dB)	Polarization
2483.50	58.26	-15.45	42.81	74.00	-31.19	Horizontal
2500.00	54.03	-15.32	38.71	74.00	-35.29	Horizontal
2483.50	57.83	-15.45	42.38	74.00	-31.62	Vertical
2500.00	53.46	-15.32	38.14	74.00	-35.86	Vertical

Average value:

Frequency (MHz)	Read Level (dBuV)	Correct factor (dB/m)	Level (dBuV/m)	Limit Line (dBuV/m)	Over Limit (dB)	Polarization
2483.50	47.29	-15.45	31.84	54.00	-22.16	Horizontal
2500.00	45.12	-15.32	29.80	54.00	-24.20	Horizontal
2483.50	48.23	-15.45	32.78	54.00	-21.22	Vertical
2500.00	44.07	-15.32	28.75	54.00	-25.25	Vertical

Remark:

- Final Level = Receiver Read level + Correct factor

2. The emission levels of other frequencies are very lower than the limit and not show in test report.
3. Correct factor= Antenna Factor + Cable Loss – Preamplifier Factor

Test mode:	802.11g	Test channel:	Lowest
------------	---------	---------------	--------

Peak value:

Frequency (MHz)	Read Level (dBuV)	Correct factor (dB/m)	Level (dBuV/m)	Limit Line (dBuV/m)	Over Limit (dB)	Polarization
2310.00	54.36	-16.65	37.71	74.00	-36.29	Horizontal
2390.00	53.81	-16.28	37.53	74.00	-36.47	Horizontal
2310.00	54.13	-16.65	37.48	74.00	-36.52	Vertical
2390.00	54.01	-16.28	37.73	74.00	-36.27	Vertical

Average value:

Frequency (MHz)	Read Level (dBuV)	Correct factor (dB/m)	Level (dBuV/m)	Limit Line (dBuV/m)	Over Limit (dB)	Polarization
2310.00	44.36	-16.65	27.71	54.00	-26.29	Horizontal
2390.00	43.15	-16.28	26.87	54.00	-27.13	Horizontal
2310.00	45.08	-16.65	28.43	54.00	-25.57	Vertical
2390.00	44.69	-16.28	28.41	54.00	-25.59	Vertical

Test mode:	802.11g	Test channel:	Highest
------------	---------	---------------	---------

Peak value:

Frequency (MHz)	Read Level (dBuV)	Correct factor (dB/m)	Level (dBuV/m)	Limit Line (dBuV/m)	Over Limit (dB)	Polarization
2483.50	58.34	-15.45	42.89	74.00	-31.11	Horizontal
2500.00	53.73	-15.32	38.41	74.00	-35.59	Horizontal
2483.50	57.74	-15.45	42.29	74.00	-31.71	Vertical
2500.00	53.19	-15.32	37.87	74.00	-36.13	Vertical

Average value:

Frequency (MHz)	Read Level (dBuV)	Correct factor (dB/m)	Level (dBuV/m)	Limit Line (dBuV/m)	Over Limit (dB)	Polarization
2483.50	45.19	-15.45	29.74	54.00	-24.26	Horizontal
2500.00	44.03	-15.32	28.71	54.00	-25.29	Horizontal
2483.50	45.36	-15.45	29.91	54.00	-24.09	Vertical
2500.00	44.18	-15.32	28.86	54.00	-25.14	Vertical

Remark:

1. Final Level = Receiver Read level + Correct factor
2. The emission levels of other frequencies are very lower than the limit and not show in test report.
3. Correct factor = Antenna Factor + Cable Loss – Preamplifier Factor

Test mode:	802.11n(HT20)	Test channel:	Lowest
------------	---------------	---------------	--------

Peak value:

Frequency (MHz)	Read Level (dBUV)	Correct factor (dB/m)	Level (dBUV/m)	Limit Line (dBUV/m)	Over Limit (dB)	Polarization
2310.00	54.69	-16.65	38.04	74.00	-35.96	Horizontal
2390.00	53.29	-16.28	37.01	74.00	-36.99	Horizontal
2310.00	54.81	-16.65	38.16	74.00	-35.84	Vertical
2390.00	52.73	-16.28	36.45	74.00	-37.55	Vertical

Average value:

Frequency (MHz)	Read Level (dBUV)	Correct factor (dB/m)	Level (dBUV/m)	Limit Line (dBUV/m)	Over Limit (dB)	Polarization
2310.00	46.01	-16.65	29.36	54.00	-24.64	Horizontal
2390.00	44.28	-16.28	28.00	54.00	-26.00	Horizontal
2310.00	45.16	-16.65	28.51	54.00	-25.49	Vertical
2390.00	43.37	-16.28	27.09	54.00	-26.91	Vertical

Test mode:	802.11n(HT20)	Test channel:	Highest
------------	---------------	---------------	---------

Peak value:

Frequency (MHz)	Read Level (dBUV)	Correct factor (dB/m)	Level (dBUV/m)	Limit Line (dBUV/m)	Over Limit (dB)	Polarization
2483.50	57.82	-15.45	42.37	74.00	-31.63	Horizontal
2500.00	54.01	-15.32	38.69	74.00	-35.31	Horizontal
2483.50	57.43	-15.45	41.98	74.00	-32.02	Vertical
2500.00	53.31	-15.32	37.99	74.00	-36.01	Vertical

Average value:

Frequency (MHz)	Read Level (dBUV)	Correct factor (dB/m)	Level (dBUV/m)	Limit Line (dBUV/m)	Over Limit (dB)	Polarization
2483.50	46.65	-15.45	31.20	54.00	-22.80	Horizontal
2500.00	44.19	-15.32	28.87	54.00	-25.13	Horizontal
2483.50	45.13	-15.45	29.68	54.00	-24.32	Vertical
2500.00	44.82	-15.32	29.50	54.00	-24.50	Vertical

Remark:

1. Final Level = Receiver Read level + Correct factor
2. The emission levels of other frequencies are very lower than the limit and not show in test report.
3. Correct factor = Antenna Factor + Cable Loss - Pre-amplifier Factor

7.6 Spurious Emission

7.6.1 Conducted Emission Method

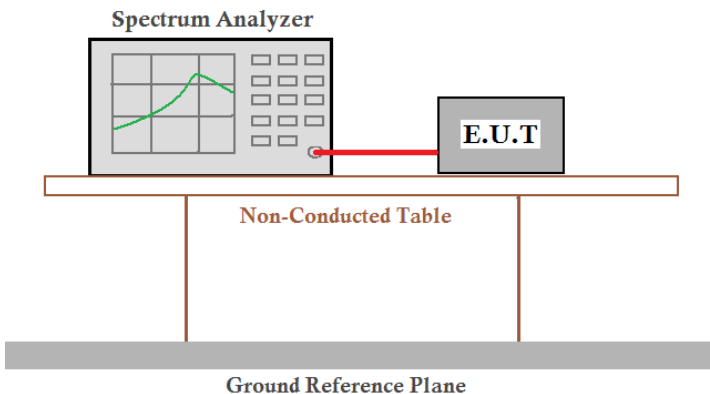
Test Requirement:	FCC Part15 C Section 15.247 (d)
Test Method:	KDB558074 D01 DTS Meas Guidance V04
Limit:	In any 100 kHz bandwidth outside the frequency band in which the spread spectrum intentional radiator is operating, the radio frequency power that is produced by the intentional radiator shall be at least 20 dB below that in the 100 kHz bandwidth within the band that contains the highest level of the desired power, based on either an RF conducted or a radiated measurement.
Test setup:	 <p>The diagram illustrates the test setup. A Spectrum Analyzer is connected to an E.U.T. (Equipment Under Test) via a red cable. Both are placed on a Non-Conducted Table, which is supported by a Ground Reference Plane.</p>
Test Instruments:	Refer to section 6.0 for details
Test mode:	Refer to section 5.2 for details
Test results:	Pass

Test plot as follows:

Test mode:	802.11b
Lowest channel	

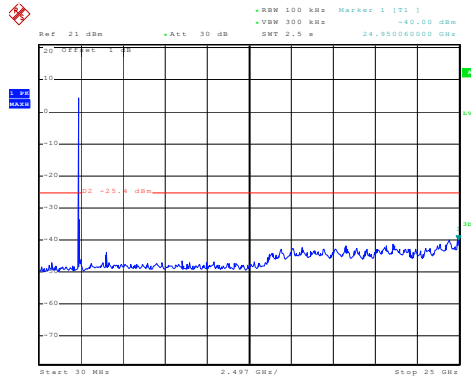

Date: 27.JUL.2018 11:28:14

30MHz~25GHz

Middle channel

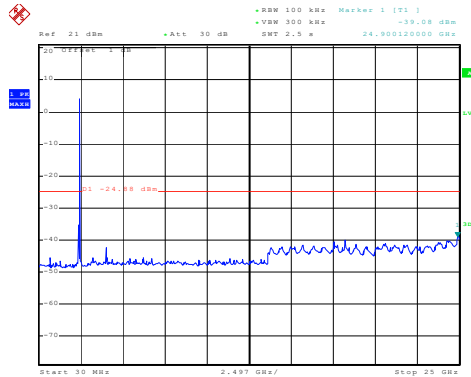

Date: 27.JUL.2018 11:37:54

30MHz~25GHz

Highest channel

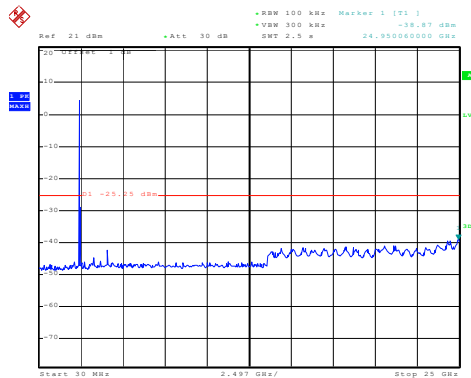

Date: 27.JUL.2018 11:47:13

30MHz~25GHz

Test mode:	802.11g
Lowest channel	

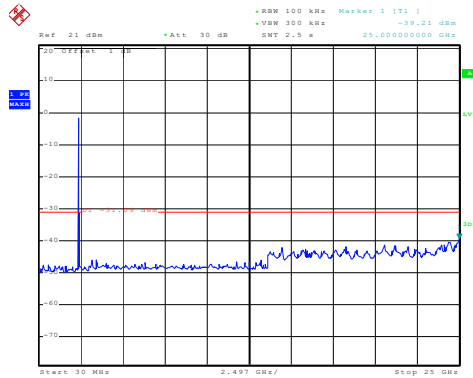

Date: 27.JUL.2018 11:48:14

30MHz~25GHz

Middle channel

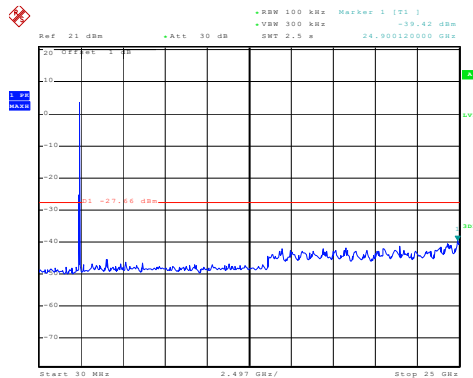

Date: 27.JUL.2018 11:49:07

30MHz~25GHz

Highest channel

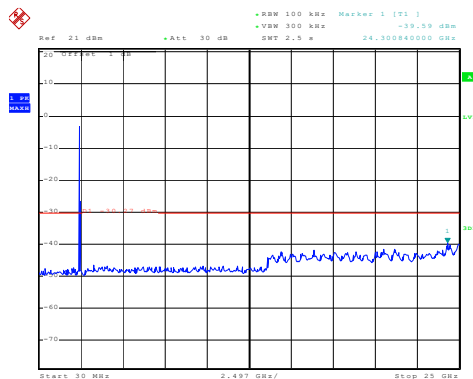

Date: 27.JUL.2018 11:50:12

30MHz~25GHz

Test mode:	802.11n(HT20)
Lowest channel	

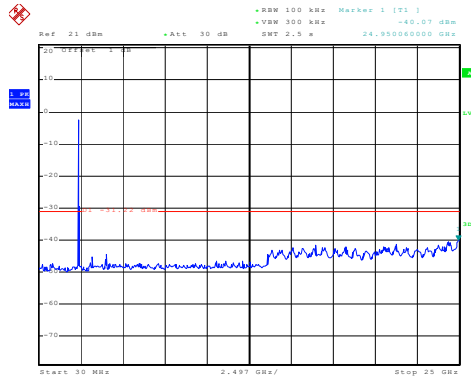

Date: 27.JUL.2018 11:52:41

30MHz~25GHz

Middle channel

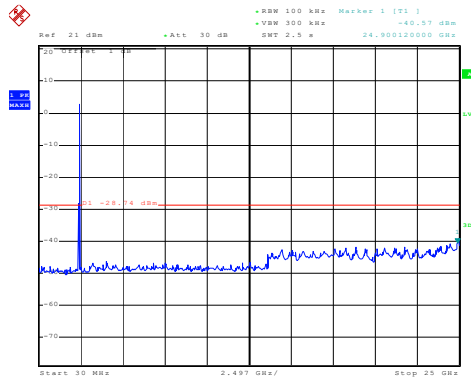

Date: 27.JUL.2018 11:51:43

30MHz~25GHz

Highest channel

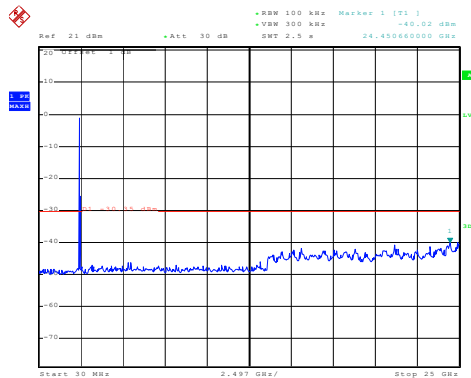

Date: 27.JUL.2018 11:51:04

30MHz~25GHz

7.6.2 Radiated Emission Method

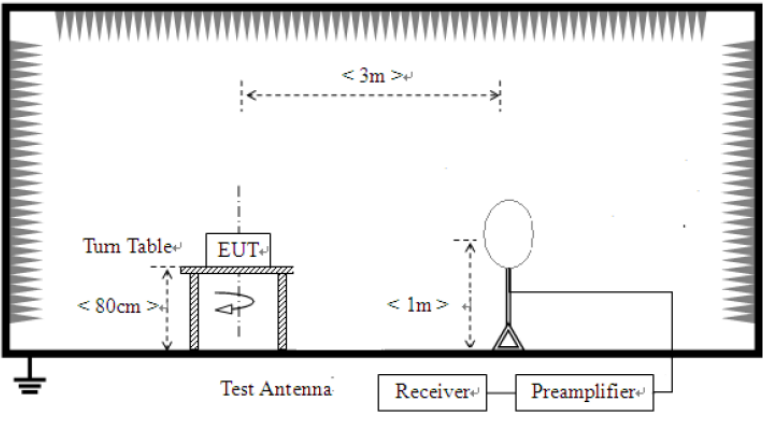
Test Requirement:	FCC Part15 C Section 15.209				
Test Method:	ANSI C63.10:2013				
Test Frequency Range:	9kHz to 25GHz				
Test site:	Measurement Distance: 3m				
Receiver setup:	Frequency	Detector	RBW	VBW	Value
	9KHz-150KHz	Quasi-peak	200Hz	600Hz	Quasi-peak
	150KHz-30MHz	Quasi-peak	9KHz	30KHz	Quasi-peak
	30MHz-1GHz	Quasi-peak	100KHz	300KHz	Quasi-peak
	Above 1GHz	Peak	1MHz	3MHz	Peak
Peak		1MHz	10Hz	Average	
Limit:	Frequency	Limit (uV/m)	Value	Measurement Distance	
	0.009MHz-0.490MHz	2400/F(KHz)	QP	300m	
	0.490MHz-1.705MHz	24000/F(KHz)	QP	300m	
	1.705MHz-30MHz	30	QP	30m	
	30MHz-88MHz	100	QP	3m	
	88MHz-216MHz	150	QP		
	216MHz-960MHz	200	QP		
	960MHz-1GHz	500	QP		
	Above 1GHz	500	Average		
		5000	Peak		
Test setup:	For radiated emissions from 9kHz to 30MHz				
	 <p>The diagram illustrates the test setup for radiated emissions from 9kHz to 30MHz. It shows a Turn Table with an EUT (Equipment Under Test) on top, positioned at a distance of less than 80cm from the center. A Test Antenna is placed at a distance of less than 1m from the EUT. The measurement distance is less than 3m. The antenna is connected to a Receiver and a Preamplifier.</p>				
	For radiated emissions from 30MHz to 1GHz				

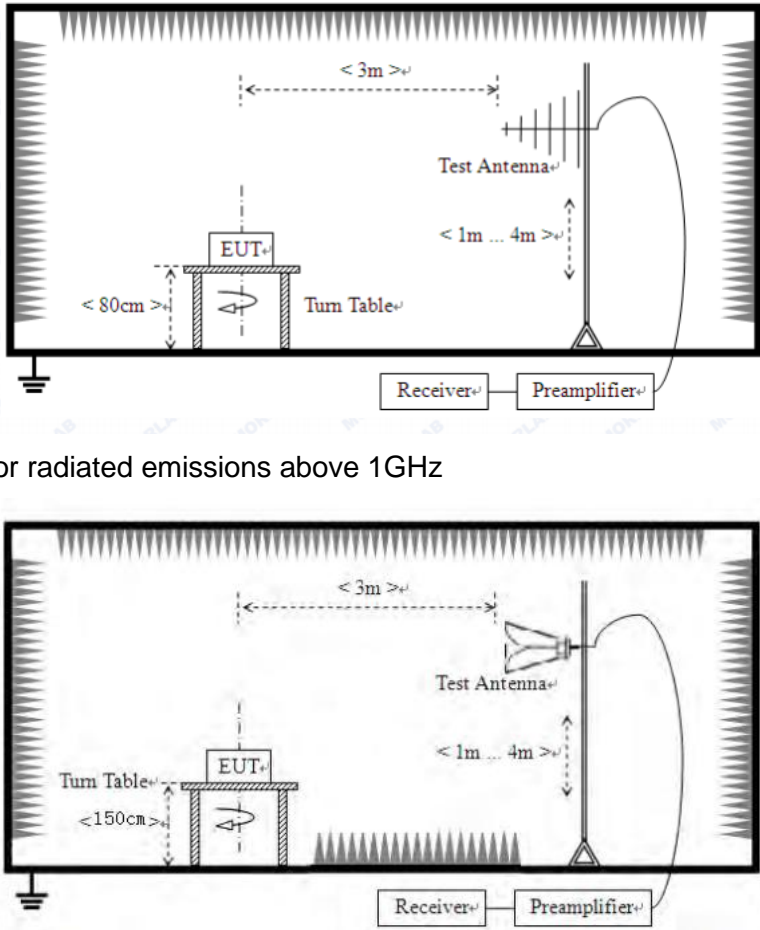
	 <p>For radiated emissions above 1GHz</p>
<p>Test Procedure:</p>	<ol style="list-style-type: none"> 1. The EUT was placed on the top of a rotating table (0.8m for below 1G and 1.5m for above 1G) above the ground at a 3 meter camber. The table was rotated 360 degrees to determine the position of the highest radiation. 2. The EUT was set 3 meters away from the interference-receiving antenna, which was mounted on the top of a variable-height antenna tower. 3. The antenna height is varied from one meter to four meters above the ground to determine the maximum value of the field strength. Both horizontal and vertical polarizations of the antenna are set to make the measurement. 4. For each suspected emission, the EUT was arranged to its worst case and then the antenna was tuned to heights from 1 meter to 4 meters and the rota table was turned from 0 degrees to 360 degrees to find the maximum reading. 5. The test-receiver system was set to Peak Detect Function and Specified Bandwidth with Maximum Hold Mode. 6. If the emission level of the EUT in peak mode was 10dB lower than the limit specified, then testing could be stopped and the peak values of the EUT would be reported. Otherwise the emissions that did not have

	10dB margin would be re-tested one by one using peak, quasi-peak or average method as specified and then reported in a data sheet.
Test Instruments:	Refer to section 6.0 for details
Test mode:	Refer to section 5.2 for details
Test results:	Pass
Test voltage:	AC120V 60Hz

Remark:

Pre-scan all kind of the place mode (X-axis, Y-axis, Z-axis), and found the Y-axis which it is worse case.

Measurement data:

■ **9kHz~30MHz**

The low frequency, which started from 9 kHz to 30 MHz, was pre-scanned and the result which was 20 dB lower than the limit line per 15.31(o) was not reported.

■ Below 1GHz

Mode:	Transmitting mode	Polarization:	Horizontal
Temp./Hum.(%RH):	26°C/56%RH		

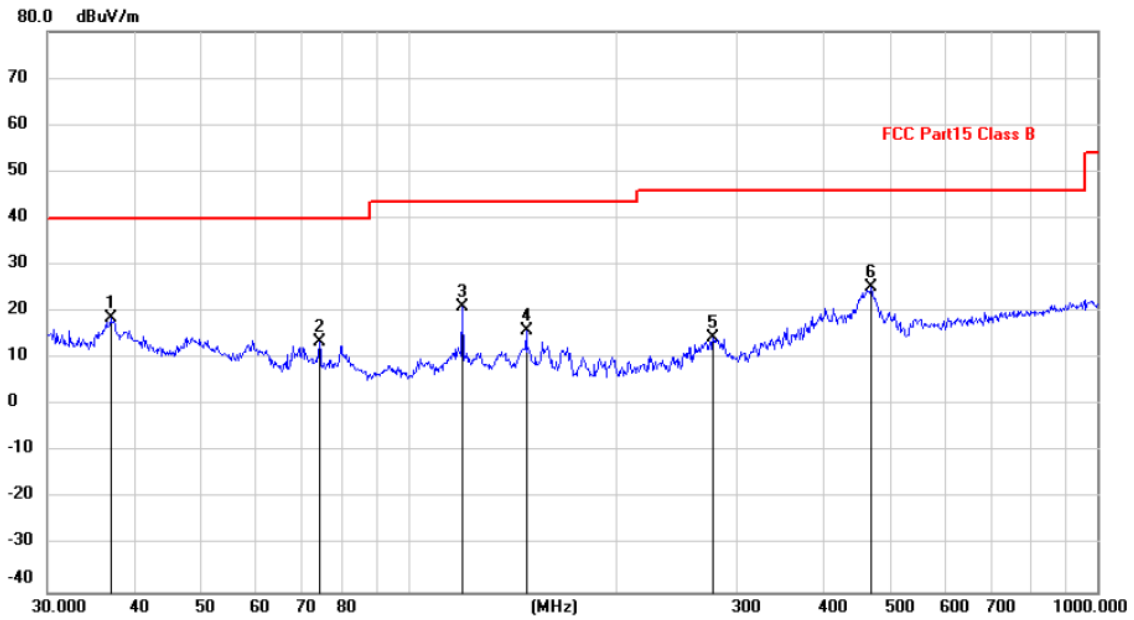

No.	Mk.	Freq. MHz	Reading Level dBuV	Correct Factor dB	Measure- ment dBuV/m	Limit dBuV/m	Over dB	Detector
1		37.0248	51.77	-33.19	18.58	40.00	-21.42	QP
2		74.3954	51.77	-38.10	13.67	40.00	-26.33	QP
3		119.8555	57.59	-36.51	21.08	43.50	-22.42	QP
4		148.4410	50.67	-34.72	15.95	43.50	-27.55	QP
5		277.0935	49.89	-35.56	14.33	46.00	-31.67	QP
6	*	470.5231	55.92	-30.80	25.12	46.00	-20.88	QP

Mode:	Transmitting mode	Polarization:	Vertical
Temp./Hum.(%RH):	26°C/56%RH		

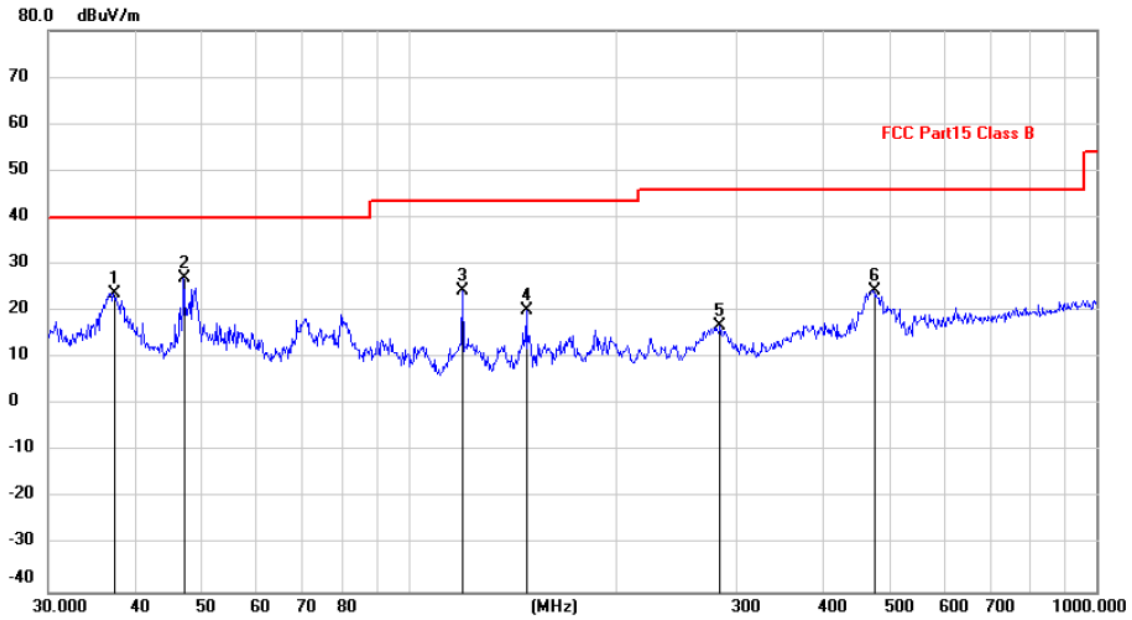

No.	Mk.	Freq. MHz	Reading Level dBuV	Correct Factor dB	Measure- ment dBuV/m	Limit dBuV/m	Over dB	Detector
1		37.2855	56.99	-33.19	23.80	40.00	-16.20	QP
2	*	47.1599	60.90	-33.97	26.93	40.00	-13.07	QP
3		119.8556	60.83	-36.51	24.32	43.50	-19.18	QP
4		148.4410	54.79	-34.72	20.07	43.50	-23.43	QP
5		283.9791	52.36	-35.38	16.98	46.00	-29.02	QP
6		473.8347	54.97	-30.75	24.22	46.00	-21.78	QP

■ Above 1GHz

Test mode:	802.11b	Test channel:	Lowest
------------	---------	---------------	--------

Peak value:

Frequency (MHz)	Read Level (dBuV)	Correct factor (dB/m)	Level (dBuV/m)	Limit Line (dBuV/m)	Over Limit (dB)	Polarization
4824.00	53.68	-9.61	44.07	74.00	-29.93	Vertical
7236.00	52.43	-3.23	49.20	74.00	-24.80	Vertical
9648.00	51.57	-3.18	48.39	74.00	-25.61	Vertical
12060.00	*			74.00		Vertical
14472.00	*			74.00		Vertical
4824.00	53.51	-9.61	43.90	74.00	-30.10	Horizontal
7236.00	52.16	-3.23	48.93	74.00	-25.07	Horizontal
9648.00	51.38	-3.18	48.20	74.00	-25.80	Horizontal
12060.00				74.00		Horizontal
14472.00	*			74.00		Horizontal

Average value:

Frequency (MHz)	Read Level (dBuV)	Correct factor (dB/m)	Level (dBuV/m)	Limit Line (dBuV/m)	Over Limit (dB)	Polarization
4824.00	44.16	-9.61	34.55	54.00	-19.45	Vertical
7236.00	43.69	-3.23	40.46	54.00	-13.54	Vertical
9648.00	43.08	-3.18	39.90	54.00	-14.10	Vertical
12060.00	*			54.00		Vertical
14472.00	*			54.00		Vertical
4824.00	44.18	-9.61	34.57	54.00	-19.43	Horizontal
7236.00	43.06	-3.23	39.83	54.00	-14.17	Horizontal
9648.00	42.19	-3.18	39.01	54.00	-14.99	Horizontal
12060.00	*			54.00		Horizontal
14472.00	*			54.00		Horizontal

Remark:

1. *Final Level = Receiver Read level + Correct factor*
2. *"**", means this data is the too weak instrument of signal is unable to test.*
3. *Correct factor = Antenna Factor + Cable Loss – Preamplifier Factor*

Test mode:	802.11b	Test channel:	Middle
------------	---------	---------------	--------

Peak value:

Frequency (MHz)	Read Level (dBuV)	Correct factor (dB/m)	Level (dBuV/m)	Limit Line (dBuV/m)	Over Limit (dB)	Polarization
4874.00	54.36	-9.59	44.77	74.00	-29.23	Vertical
7311.00	53.48	-3.21	50.27	74.00	-23.73	Vertical
9748.00	54.01	-3.17	50.84	74.00	-23.16	Vertical
12185.00	*			74.00		Vertical
14622.00	*			74.00		Vertical
4874.00	53.69	-9.59	44.10	74.00	-29.90	Horizontal
7311.00	54.18	-3.21	50.97	74.00	-23.03	Horizontal
9748.00	53.22	-3.17	50.05	74.00	-23.95	Horizontal
12185.00	*			74.00		Horizontal
14622.00	*			74.00		Horizontal

Average value:

Frequency (MHz)	Read Level (dBuV)	Correct factor (dB/m)	Level (dBuV/m)	Limit Line (dBuV/m)	Over Limit (dB)	Polarization
4874.00	46.83	-9.59	37.24	54.00	-16.76	Vertical
7311.00	47.41	-3.21	44.20	54.00	-9.80	Vertical
9748.00	45.57	-3.17	42.40	54.00	-11.60	Vertical
12185.00	*			54.00		Vertical
14622.00	*			54.00		Vertical
4874.00	45.42	-9.59	35.83	54.00	-18.17	Horizontal
7311.00	44.85	-3.21	41.64	54.00	-12.36	Horizontal
9748.00	43.61	-3.17	40.44	54.00	-13.56	Horizontal
12185.00	*			54.00		Horizontal
14622.00	*			54.00		Horizontal

1. Remark:

2. 1. Final Level = Receiver Read level + Correct factor
3. 2. “*”, means this data is the too weak instrument of signal is unable to test.
4. 3. Correct factor = Antenna Factor + Cable Loss – Preamplifier Factor
5. .

Test mode:	802.11b	Test channel:	Highest
------------	---------	---------------	---------

Peak value:

Frequency (MHz)	Read Level (dBuV)	Correct factor (dB/m)	Level (dBuV/m)	Limit Line (dBuV/m)	Over Limit (dB)	Polarization
4924.00	54.36	-9.57	44.79	74.00	-29.21	Vertical
7386.00	53.29	-3.20	50.09	74.00	-23.91	Vertical
9848.00	52.14	-3.16	48.98	74.00	-25.02	Vertical
12310.00	*			74.00		Vertical
14772.00	*			74.00		Vertical
4924.00	53.86	-9.57	44.29	74.00	-29.71	Horizontal
7386.00	54.01	-3.20	50.81	74.00	-23.19	Horizontal
9848.00	53.33	-3.16	50.17	74.00	-23.83	Horizontal
12310.00	*			74.00		Horizontal
14772.00	*			74.00		Horizontal

Average value:

Frequency (MHz)	Read Level (dBuV)	Correct factor (dB/m)	Level (dBuV/m)	Limit Line (dBuV/m)	Over Limit (dB)	Polarization
4924.00	43.96	-9.57	34.39	54.00	-19.61	Vertical
7386.00	45.32	-3.20	42.12	54.00	-11.88	Vertical
9848.00	44.65	-3.16	41.49	54.00	-12.51	Vertical
12310.00	*			54.00		Vertical
14772.00	*			54.00		Vertical
4924.00	45.13	-9.57	35.56	54.00	-18.44	Horizontal
7386.00	44.47	-3.20	41.27	54.00	-12.73	Horizontal
9848.00	43.63	-3.16	40.47	54.00	-13.53	Horizontal
12310.00	*			54.00		Horizontal
14772.00	*			54.00		Horizontal

Remark:

1. Final Level = Receiver Read level + Correct factor
2. “*”, means this data is the too weak instrument of signal is unable to test.
3. Correct factor = Antenna Factor + Cable Loss – Preamplifier Factor

Test mode:	802.11g	Test channel:	lowest
------------	---------	---------------	--------

Peak value:

Frequency (MHz)	Read Level (dBuV)	Correct factor (dB/m)	Level (dBuV/m)	Limit Line (dBuV/m)	Over Limit (dB)	Polarization
4824.00	54.15	-9.61	44.54	74.00	-29.46	Vertical
7236.00	53.69	-3.23	50.46	74.00	-23.54	Vertical
9648.00	52.28	-3.18	49.10	74.00	-24.90	Vertical
12060.00	*			74.00		Vertical
14472.00	*			74.00		Vertical
4824.00	53.81	-9.61	44.20	74.00	-29.80	Horizontal
7236.00	52.54	-3.23	49.31	74.00	-24.69	Horizontal
9648.00	53.33	-3.18	50.15	74.00	-23.85	Horizontal
12060.00	*			74.00		Horizontal
14472.00	*			74.00		Horizontal

Average value:

Frequency (MHz)	Read Level (dBuV)	Correct factor (dB/m)	Level (dBuV/m)	Limit Line (dBuV/m)	Over Limit (dB)	Polarization
4824.00	45.20	-9.61	35.59	54.00	-18.41	Vertical
7236.00	43.13	-3.23	39.90	54.00	-14.10	Vertical
9648.00	42.84	-3.18	39.66	54.00	-14.34	Vertical
12060.00	*			54.00		Vertical
14472.00	*			54.00		Vertical
4824.00	44.26	-9.61	34.65	54.00	-19.35	Horizontal
7236.00	43.36	-3.23	40.13	54.00	-13.87	Horizontal
9648.00	42.17	-3.18	38.99	54.00	-15.01	Horizontal
12060.00	*			54.00		Horizontal
14472.00	*			54.00		Horizontal

Remark:

1. Final Level = Receiver Read level + Correct factor
2. "*", means this data is the too weak instrument of signal is unable to test.
3. Correct factor = Antenna Factor + Cable Loss – Preamplifier Factor

Test mode:	802.11g	Test channel:	Middle
------------	---------	---------------	--------

Peak value:

Frequency (MHz)	Read Level (dBuV)	Correct factor (dB/m)	Level (dBuV/m)	Limit Line (dBuV/m)	Over Limit (dB)	Polarization
4874.00	53.33	-9.59	43.74	74.00	-30.26	Vertical
7311.00	52.51	-3.21	49.30	74.00	-24.70	Vertical
9748.00	54.06	-3.17	50.89	74.00	-23.11	Vertical
12185.00	*			74.00		Vertical
14622.00	*			74.00		Vertical
4874.00	54.47	-9.59	44.88	74.00	-29.12	Horizontal
7311.00	53.36	-3.21	50.15	74.00	-23.85	Horizontal
9748.00	52.53	-3.17	49.36	74.00	-24.64	Horizontal
12185.00	*			74.00		Horizontal
14622.00	*			74.00		Horizontal

Average value:

Frequency (MHz)	Read Level (dBuV)	Correct factor (dB/m)	Level (dBuV/m)	Limit Line (dBuV/m)	Over Limit (dB)	Polarization
4874.00	48.15	-9.59	38.56	54.00	-15.44	Vertical
7311.00	48.57	-3.21	45.36	54.00	-8.64	Vertical
9748.00	47.16	-3.17	43.99	54.00	-10.01	Vertical
12185.00	*			54.00		Vertical
14622.00	*			54.00		Vertical
4874.00	49.61	-9.59	40.02	54.00	-13.98	Horizontal
7311.00	48.84	-3.21	45.63	54.00	-8.37	Horizontal
9748.00	47.65	-3.17	44.48	54.00	-9.52	Horizontal
12185.00	*			54.00		Horizontal
14622.00	*			54.00		Horizontal

Remark:

1. *Final Level = Receiver Read level + Correct factor*
2. *"*" , means this data is the too weak instrument of signal is unable to test.*
3. *Correct factor = Antenna Factor + Cable Loss – Preamplifier Factor*

Test mode:	802.11g	Test channel:	Highest
------------	---------	---------------	---------

Peak value:

Frequency (MHz)	Read Level (dBuV)	Correct factor (dB/m)	Level (dBuV/m)	Limit Line (dBuV/m)	Over Limit (dB)	Polarization
4924.00	54.25	-9.57	44.68	74.00	-29.32	Vertical
7386.00	53.72	-3.20	50.52	74.00	-23.48	Vertical
9848.00	52.03	-3.16	48.87	74.00	-25.13	Vertical
12310.00	*			74.00		Vertical
14772.00	*			74.00		Vertical
4924.00	53.82	-9.57	44.25	74.00	-29.75	Horizontal
7386.00	54.76	-3.20	51.56	74.00	-22.44	Horizontal
9848.00	53.44	-3.16	50.28	74.00	-23.72	Horizontal
12310.00	*			74.00		Horizontal
14772.00	*			74.00		Horizontal

Average value:

Frequency (MHz)	Read Level (dBuV)	Correct factor (dB/m)	Level (dBuV/m)	Limit Line (dBuV/m)	Over Limit (dB)	Polarization
4924.00	44.15	-9.57	34.58	54.00	-19.42	Vertical
7386.00	43.57	-3.20	40.37	54.00	-13.63	Vertical
9848.00	42.16	-3.16	39.00	54.00	-15.00	Vertical
12310.00	*			54.00		Vertical
14772.00	*			54.00		Vertical
4924.00	43.61	-9.57	34.04	54.00	-19.96	Horizontal
7386.00	44.84	-3.20	41.64	54.00	-12.36	Horizontal
9848.00	42.65	-3.16	39.49	54.00	-14.51	Horizontal
12310.00	*			54.00		Horizontal
14772.00	*			54.00		Horizontal

Remark:

1. *Final Level = Receiver Read level + Correct factor*
2. *"**", means this data is the too weak instrument of signal is unable to test.*
3. *Correct factor = Antenna Factor + Cable Loss – Preamplifier Factor*

Test mode:	802.11n(HT20)	Test channel:	Lowest
------------	---------------	---------------	--------

Peak value:

Frequency (MHz)	Read Level (dBuV)	Correct factor (dB/m)	Level (dBuV/m)	Limit Line (dBuV/m)	Over Limit (dB)	Polarization
4824.00	53.25	-9.61	43.64	74.00	-30.36	Vertical
7236.00	52.72	-3.23	49.49	74.00	-24.51	Vertical
9648.00	54.03	-3.18	50.85	74.00	-23.15	Vertical
12060.00	*			74.00		Vertical
14472.00	*			74.00		Vertical
4824.00	53.82	-9.61	44.21	74.00	-29.79	Horizontal
7236.00	52.76	-3.23	49.53	74.00	-24.47	Horizontal
9648.00	51.44	-3.18	48.26	74.00	-25.74	Horizontal
12060.00	*			74.00		Horizontal
14472.00	*			74.00		Horizontal

Average value:

Frequency (MHz)	Read Level (dBuV)	Correct factor (dB/m)	Level (dBuV/m)	Limit Line (dBuV/m)	Over Limit (dB)	Polarization
4824.00	43.15	-9.61	33.54	54.00	-20.46	Vertical
7236.00	41.57	-3.23	38.34	54.00	-15.66	Vertical
9648.00	44.16	-3.18	40.98	54.00	-13.02	Vertical
12060.00	*			54.00		Vertical
14472.00	*			54.00		Vertical
4824.00	42.61	-9.61	33.00	54.00	-21.00	Horizontal
7236.00	44.84	-3.23	41.61	54.00	-12.39	Horizontal
9648.00	45.65	-3.18	42.47	54.00	-11.53	Horizontal
12060.00	*			54.00		Horizontal
14472.00	*			54.00		Horizontal

Remark:

1. *Final Level = Receiver Read level + Correct factor*
2. *"*" , means this data is the too weak instrument of signal is unable to test.*
3. *Correct factor = Antenna Factor + Cable Loss – Preamplifier Factor*

Test mode:	802.11n(HT20)	Test channel:	Middle
------------	---------------	---------------	--------

Peak value:

Frequency (MHz)	Read Level (dBuV)	Correct factor (dB/m)	Level (dBuV/m)	Limit Line (dBuV/m)	Over Limit (dB)	Polarization
4874.00	53.37	-9.59	43.78	74.00	-30.22	Vertical
7311.00	52.57	-3.21	49.36	74.00	-24.64	Vertical
9748.00	43.19	-3.17	40.02	74.00	-33.98	Vertical
12185.00	*			74.00		Vertical
14622.00	*			74.00		Vertical
4874.00	52.17	-9.59	42.58	74.00	-31.42	Horizontal
7311.00	52.04	-3.21	48.83	74.00	-25.17	Horizontal
9748.00	53.39	-3.17	50.22	74.00	-23.78	Horizontal
12185.00	*			74.00		Horizontal
14622.00	*			74.00		Horizontal

Average value:

Frequency (MHz)	Read Level (dBuV)	Correct factor (dB/m)	Level (dBuV/m)	Limit Line (dBuV/m)	Over Limit (dB)	Polarization
4874.00	43.11	-9.59	33.52	54.00	-20.48	Vertical
7311.00	42.83	-3.21	39.62	54.00	-14.38	Vertical
9748.00	43.07	-3.17	39.90	54.00	-14.10	Vertical
12185.00	*			54.00		Vertical
14622.00	*			54.00		Vertical
4874.00	43.32	-9.59	33.73	54.00	-20.27	Horizontal
7311.00	42.28	-3.21	39.07	54.00	-14.93	Horizontal
9748.00	42.27	-3.17	39.10	54.00	-14.90	Horizontal
12185.00	*			54.00		Horizontal
14622.00	*			54.00		Horizontal

Remark:

1. *Final Level = Receiver Read level + Correct factor*
2. *“*”*, means this data is the too weak instrument of signal is unable to test.
3. *Correct factor = Antenna Factor + Cable Loss – Preamplifier Factor*

Test mode:	802.11n(HT20)	Test channel:	Highest
------------	---------------	---------------	---------

Peak value:

Frequency (MHz)	Read Level (dBuV)	Correct factor (dB/m)	Level (dBuV/m)	Limit Line (dBuV/m)	Over Limit (dB)	Polarization
4924.00	54.26	-9.57	44.69	74.00	-29.31	Vertical
7386.00	53.26	-3.20	50.06	74.00	-23.94	Vertical
9848.00	52.18	-3.16	49.02	74.00	-24.98	Vertical
12310.00	*			74.00		Vertical
14772.00	*			74.00		Vertical
4924.00	53.26	-9.57	43.69	74.00	-30.31	Horizontal
7386.00	52.17	-3.20	48.97	74.00	-25.03	Horizontal
9848.00	51.26	-3.16	48.10	74.00	-25.90	Horizontal
12310.00	*			74.00		Horizontal
14772.00	*			74.00		Horizontal

Average value:

Frequency (MHz)	Read Level (dBuV)	Correct factor (dB/m)	Level (dBuV/m)	Limit Line (dBuV/m)	Over Limit (dB)	Polarization
4924.00	43.36	-9.57	33.79	54.00	-20.21	Vertical
7386.00	42.57	-3.20	39.37	54.00	-14.63	Vertical
9848.00	41.69	-3.16	38.53	54.00	-15.47	Vertical
12310.00	*			54.00		Vertical
14772.00	*			54.00		Vertical
4924.00	43.55	-9.57	33.98	54.00	-20.02	Horizontal
7386.00	43.03	-3.20	39.83	54.00	-14.17	Horizontal
9848.00	42.74	-3.16	39.58	54.00	-14.42	Horizontal
12310.00	*			54.00		Horizontal
14772.00	*			54.00		Horizontal

Remark:

- 1 Final Level = Receiver Read level + Correct factor
- 2 "*", means this data is the too weak instrument of signal is unable to test.
- 3 Correct factor = Antenna Factor + Cable Loss – Preamplifier Factor

8 Test Setup Photo

Radiated Emission

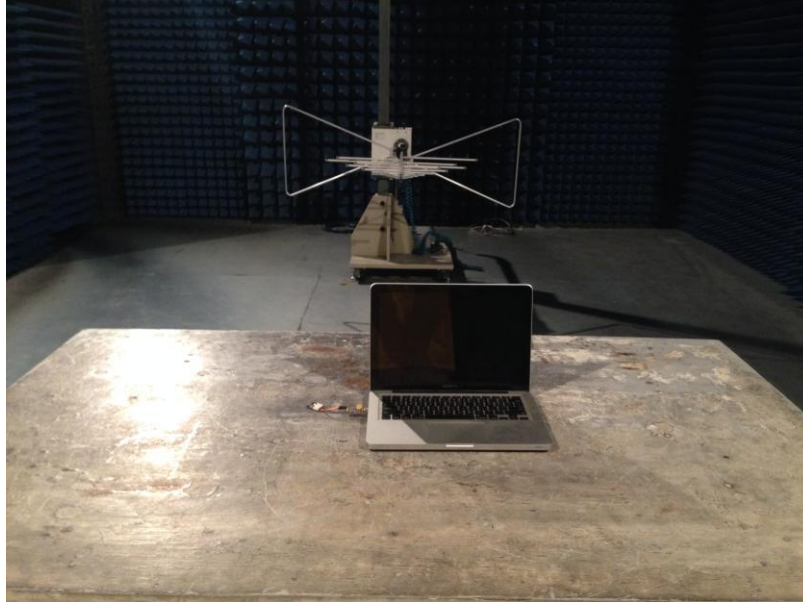

9 EUT Constructional Details

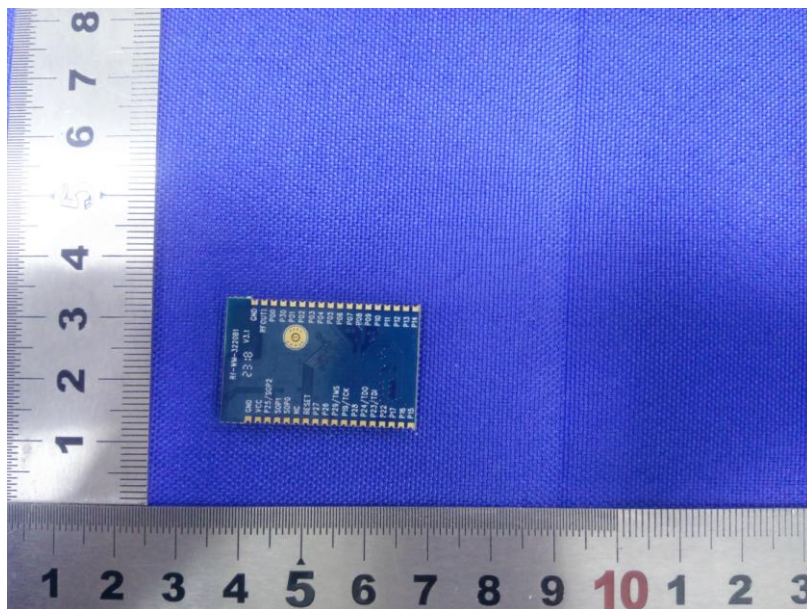
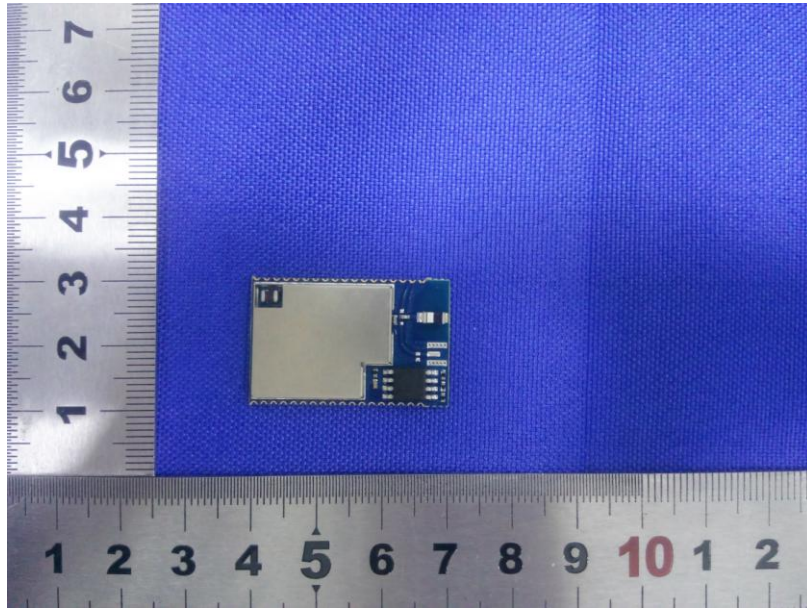

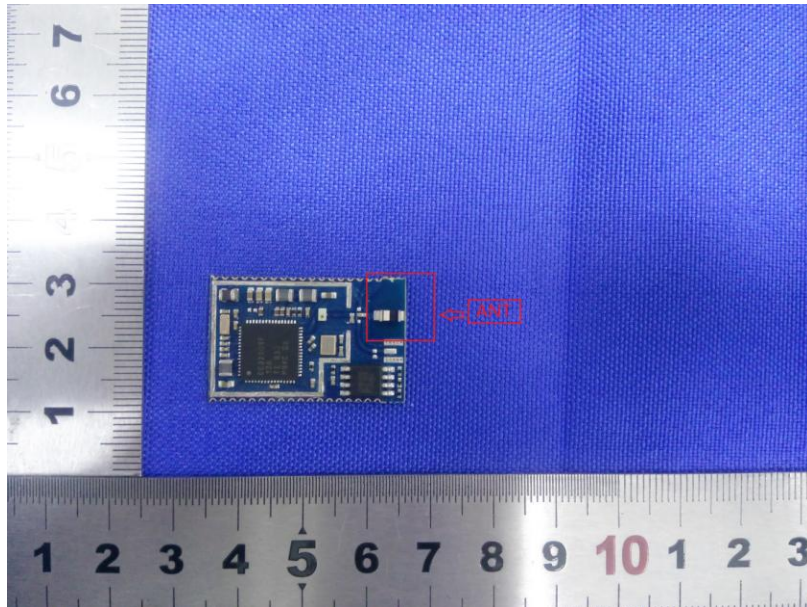
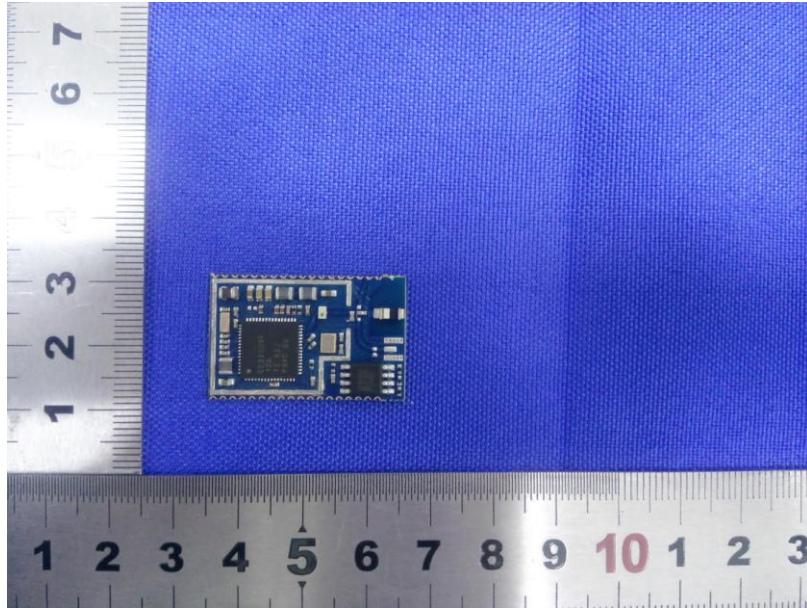

-----End-----