

DFS Test Report

Report No.: RFBCKS-WTW-P23110556A-1

FCC ID: 2ABLKGS5229XX

Test Model: u6txg GS5229XG

Series Model: u6t GS5229E

Received Date: 2023/11/18

Test Date: 2024/2/15 ~ 2024/3/5

Issued Date: 2024/3/29

Applicant: Calix Inc.

Address: 1035 N. McDowell Blvd. Petaluma, CA94954 U.S.A.

Issued By: Bureau Veritas Consumer Products Services (H.K.) Ltd., Taoyuan Branch
Hsin Chu Laboratory

Lab Address: E-2, No.1, Li Hsin 1st Road, Hsinchu Science Park, Hsinchu City 300,
Taiwan

Test Location: E-2, No.1, Li Hsin 1st Road, Hsinchu Science Park, Hsinchu City 300,
Taiwan

**FCC Registration /
Designation Number:** 723255 / TW2022



This report is governed by, and incorporates by reference, the Conditions of Testing as posted at the date of issuance of this report at <http://www.bureauveritas.com/home/about-us/our-business/cps/about-us/terms-conditions/> and is intended for your exclusive use. Any copying or replication of this report to or for any other person or entity, or use of our name or trademark, is permitted only with our prior written permission. This report sets forth our findings solely with respect to the test samples identified herein. The results set forth in this report are not indicative or representative of the quality or characteristics of the lot from which a test sample was taken or any similar or identical product unless specifically and expressly noted. Our report includes all of the tests requested by you and the results thereof based upon the information that you provided to us. Measurement uncertainty is only provided upon request for accredited tests. Statements of conformity are based on simple acceptance criteria without taking measurement uncertainty into account, unless otherwise requested in writing. You have 60 days from date of issuance of this report to notify us of any material error or omission caused by our negligence or if you require measurement uncertainty; provided, however, that such notice shall be in writing and shall specifically address the issue you wish to raise. A failure to raise such issue within the prescribed time shall constitute your unqualified acceptance of the completeness of this report, the tests conducted and the correctness of the report contents.

Table of Contents

Release Control Record	3
1 Certificate of Conformity	4
2 EUT Information	5
2.1 Operating Frequency Bands and Mode of EUT.....	5
2.2 EUT Software and Firmware Version.....	5
2.3 Description of Available Antennas to the EUT.....	6
2.4 EUT Maximum and Minimum Conducted Power.....	7
2.5 EUT Maximum and Minimum EIRP Power.....	7
2.6 Transmit Power Control (TPC).....	8
2.7 Statement of Manufacturer.....	8
3 U-NII DFS Rule Requirements	9
3.1 Working Modes and Required Test Items.....	9
3.2 Test Limits and Radar Signal Parameters.....	10
4 Test and Support Equipment List	13
4.1 Test Instruments.....	13
4.2 Description of Support Units.....	13
5 Test Procedure	14
5.1 DFS Measurement System.....	14
5.2 Calibration of DFS Detection Threshold Level.....	15
5.3 Deviation from Test Standard.....	15
5.4 Radiated Test Setup Configuration.....	16
6 Test Results	17
6.1 Summary of Test Results.....	17
6.2 Test Results.....	18
6.2.1 Test Mode: Device Operating In Master Mode.....	18
6.2.2 U-NII Detection Bandwidth.....	23
6.2.3 Channel Availability Check Time.....	33
6.2.4 Channel Closing Transmission and Channel Move Time.....	35
6.2.5 Non- Occupancy Period.....	71
7 Information of the Testing Laboratories	73
APPENDIX-A	74



Release Control Record

Issue No.	Description	Date Issued
RFBCKS-WTW-P23110556A-1	Original release.	2024/3/29

1 Certificate of Conformity

Product: GigaSpire BLAST u6t

Brand: Calix

Test Model: u6txg GS5229XG

Series Model: u6t GS5229E

Sample Status: Engineering sample

Applicant: Calix Inc.

Test Date: 2024/2/15 ~ 2024/3/5

Standards: FCC Part 15, Subpart E (Section 15.407)

References Test Guidance: KDB 905462 D02 UNII DFS Compliance Procedures New Rules v02

The above equipment has been tested by **Bureau Veritas Consumer Products Services (H.K.) Ltd., Taoyuan Branch**, and found compliance with the requirement of the above standards. The test record, data evaluation & Equipment Under Test (EUT) configurations represented herein are true and accurate accounts of the measurements of the sample's EMC characteristics under the conditions specified in this report.

Prepared by : Phoenix Huang , **Date:** 2024/3/29
Phoenix Huang / Specialist

Approved by : May Chen , **Date:** 2024/3/29
May Chen / Manager

2 EUT Information

2.1 Operating Frequency Bands and Mode of EUT

Table 1: Operating Frequency Bands and Mode of EUT

Operational Mode	Operating Frequency Range	
	5250~5350MHz	5470~5725MHz
Master	✓	✓
Repeater	✓	✓

2.2 EUT Software and Firmware Version

Table 2: The EUT Software/Firmware Version

No.	Product	Model No.	Software/Firmware Version
1	GigaSpire BLAST u6t	u6t GS5229E	24.2.0.0

2.3 Description of Available Antennas to the EUT

Table 3: Antenna List

1. The antenna information is listed as below.

Antenna No.	RF Chain No.	Antenna Net Gain (dBi)	Frequency Range (GHz)	Antenna Type	Connector Type
2G1	Chain 0	3.69	2.4~2.4835	Dipole	ipex(MHF)
2G2	Chain 1	3.63	2.4~2.4835	Dipole	ipex(MHF)
5G1	Chain 0	3.96	5.15~5.25	Dipole	ipex(MHF)
		3.96	5.25~5.35		
		3.90	5.47~5.725		
		3.06	5.725~5.85		
5G2	Chain 1	4.63	5.15~5.25	Dipole	ipex(MHF)
		4.28	5.25~5.35		
		5.02	5.47~5.725		
		4.27	5.725~5.85		
5G3	Chain 2	3.06	5.15~5.25	Dipole	ipex(MHF)
		2.25	5.25~5.35		
		1.91	5.47~5.725		
		3.57	5.725~5.85		
5G4	Chain 3	3.18	5.15~5.25	Dipole	ipex(MHF)
		3.45	5.25~5.35		
		4.60	5.47~5.725		
		3.72	5.725~5.85		

2. The directional gain table:

Frequency Range (GHz)	Directional Antenna Gain (dBi)	Antenna Type	Connector Type
2.4~2.4835	5.84	Dipole	ipex(MHF)
5.15 ~ 5.25	6.11	Dipole	ipex(MHF)
5.25 ~ 5.35	5.43	Dipole	ipex(MHF)
5.47 ~ 5.725	6.89	Dipole	ipex(MHF)
5.725 ~ 5.85	4.94	Dipole	ipex(MHF)

3. Detail antenna specification please refer to antenna datasheet and/or antenna measurement report.

2.4 EUT Maximum and Minimum Conducted Power

Table 4: The Measured Conducted Output Power

CDD Mode

Frequency Band (MHz)	MAX. Power		MIN. Power	
	Output Power (mW)	Output Power (dBm)	Output Power (mW)	Output Power (dBm)
5250~5350	238.502	23.77	59.841	17.77
5470~5725	236.863	23.74	59.429	17.74

Beamforming Mode

Frequency Band (MHz)	MAX. Power		MIN. Power	
	Output Power (mW)	Output Power (dBm)	Output Power (mW)	Output Power (dBm)
5250~5350	238.502	23.77	59.841	17.77
5470~5725	189.874	22.78	47.643	16.78

2.5 EUT Maximum and Minimum EIRP Power

Table 5: The EIRP Output Power List

CDD Mode

Frequency Band (MHz)	MAX. EIRP Power		MIN. EIRP Power	
	Output Power (mW)	Output Power (dBm)	Output Power (mW)	Output Power (dBm)
5250~5350	638.987	28.05	160.325	22.05
5470~5725	752.484	28.76	188.799	22.76

Beamforming Mode

Frequency Band (MHz)	MAX. EIRP Power		MIN. EIRP Power	
	Output Power (mW)	Output Power (dBm)	Output Power (mW)	Output Power (dBm)
5250~5350	832.707	29.2	208.930	23.2
5470~5725	927.824	29.67	232.809	23.67

2.6 Transmit Power Control (TPC)

U-NII devices operating in the 5.25-5.35 GHz band and the 5.47-5.725 GHz band shall employ a TPC mechanism. The U-NII device is required to have the capability to operate at least 6 dB below the mean EIRP value of 30 dBm. A TPC mechanism is not required for systems with an e.i.r.p. of less than 500 mW.

Applicable	EIRP	FCC 15.407 (h)(1)
√	>500mW	The TPC mechanism is required for system with an EIRP of above 500mW
	<500mW	The TPC mechanism is not required for system with an EIRP of less 500mW

The UUT can adjust a transmitter's output power based on the signal level present at the receiver. TPC is auto controlled by software.

2.7 Statement of Manufacturer

Manufacturer statement confirming that information regarding the parameters of the detected Radar Waveforms is not available to the end user.

3 U-NII DFS Rule Requirements

3.1 Working Modes and Required Test Items

The manufacturer shall state whether the UUT is capable of operating as a Master and/or a Client. If the UUT is capable of operating in more than one operating mode then each operating mode shall be tested separately. See tables 6 and 7 for the applicability of DFS requirements for each of the operational modes.

Table 6: Applicability of DFS Requirements Prior to Use a Channel

Requirement	Operational Mode		
	Master	Client without radar detection	Client with radar detection
Non-Occupancy Period	✓	✓ note	✓
DFS Detection Threshold	✓	Not required	✓
Channel Availability Check Time	✓	Not required	Not required
U-NII Detection Bandwidth	✓	Not required	✓

Note: Per KDB 905462 D03 UNII Clients Without Radar Detection New Rules v01r02 section (b)(5/6), If the client moves with the master, the device is considered compliant if nothing appears in the client non-occupancy period test. For devices that shut down (rather than moving channels), no beacons should appear. An analyzer plot that contains a single 30-minute sweep on the original channel.

Table 7: Applicability of DFS Requirements during Normal Operation

Requirement	Operational Mode	
	Master or Client with radar detection	Client without radar detection
DFS Detection Threshold	✓	Not required
Channel Closing Transmission Time	✓	✓
Channel Move Time	✓	✓
U-NII Detection Bandwidth	✓	Not required

Additional requirements for devices with multiple bandwidth modes	Master or Client with radar detection	Client without radar detection
U-NII Detection Bandwidth and Statistical Performance Check	All BW modes must be tested	Not required
Channel Move Time and Channel Closing Transmission Time	Test using widest BW mode available	Test using the widest BW mode available for the link
All other tests	Any single BW mode	Not required

Note: Frequencies selected for statistical performance check (Section 7.8.4) should include several frequencies within the radar detection bandwidth and frequencies near the edge of the radar detection bandwidth. For 802.11 devices it is suggested to select frequencies in each of the bonded 20 MHz channels and the channel center frequency.

3.2 Test Limits and Radar Signal Parameters

Detection Threshold Values

Table 8: DFS Detection Thresholds for Master Devices and Client Devices with Radar Detection

Maximum Transmit Power	Value (See Notes 1, 2, and 3)
EIRP \geq 200 milliwatt	-64 dBm
EIRP < 200 milliwatt and power spectral density < 10 dBm/MHz	-62 dBm
EIRP < 200 milliwatt that do not meet the power spectral density requirement	-64 dBm

Note 1: This is the level at the input of the receiver assuming a 0 dBi receive antenna.

Note 2: Throughout these test procedures an additional 1 dB has been added to the amplitude of the test transmission waveforms to account for variations in measurement equipment. This will ensure that the test signal is at or above the detection threshold level to trigger a DFS response.

Note 3: EIRP is based on the highest antenna gain. For MIMO devices refer to KDB Publication 662911 D01.

Table 9: DFS Response Requirement Values

Parameter	Value
Non-occupancy period	Minimum 30 minutes
Channel Availability Check Time	60 seconds
Channel Move Time	10 seconds See Note 1.
Channel Closing Transmission Time	200 milliseconds + an aggregate of 60 milliseconds over remaining 10 second period. See Notes 1 and 2.
U-NII Detection Bandwidth	Minimum 100% of the U-NII 99% transmission power bandwidth. See Note 3

Note 1: Channel Move Time and the Channel Closing Transmission Time should be performed with Radar Type 0. The measurement timing begins at the end of the Radar Type 0 burst.

Note 2: The Channel Closing Transmission Time is comprised of 200 milliseconds starting at the beginning of the Channel Move Time plus any additional intermittent control signals required to facilitate a Channel move (an aggregate of 60 milliseconds) during the remainder of the 10 second period. The aggregate duration of control signals will not count quiet periods in between transmissions.

Note 3: During the U-NII Detection Bandwidth detection test, radar type 0 should be used. For each frequency step the minimum percentage of detection is 90 percent. Measurements are performed with no data traffic.

Parameters of DFS Test Signals

Step intervals of 0.1 microsecond for Pulse Width, 1 microsecond for PRI, 1 MHz for chirp width and 1 for the number of pulses will be utilized for the random determination of specific test waveforms.

Table 10: Short Pulse Radar Test Waveforms

Radar Type	Pulse Width (μsec)	PRI (μsec)	Number of Pulses	Minimum Percentage of Successful Detection	Minimum Number of Trials
0	1	1428	18	See Note 1	See Note 1
1	1	Test A 15 unique PRI values randomly selected from the list of 23 PRI values	Roundup $\left\{ \left(\frac{1}{360} \right) \cdot \left(\frac{19 \cdot 10^6}{\text{PRI}_{\mu\text{sec}}} \right) \right\}$	60%	30
		15 unique PRI values randomly selected within the range of 518~3066 μ sec with a minimum of 1 μ sec, excluding PRI values selected in Test A			
2	1-5	150-230	23-29	60%	30
3	6-10	200-500	16-18	60%	30
4	11-20	200-500	12-16	60%	30
Aggregate (Radar Types 1-4)				80%	120
Note 1: Short Pulse Radar Type 0 should be used for the detection bandwidth test, channel move time, and channel closing time tests.					

Table 11: Long Pulse Radar Test Waveform

Radar Type	Pulse Width (μsec)	Chirp Width (MHz)	PRI (μsec)	Number of Pulses Per Burst	Number of Bursts	Minimum Percentage of Successful Detection	Minimum Number of Trials
5	50-100	5-20	1000-2000	1-3	8-20	80%	30

Three subsets of trials will be performed with a minimum of ten trials per subset. The subset of trials differ in where the Long Pulse Type 5 Signal is tuned in frequency.

- a) the Channel center frequency
- b) tuned frequencies such that 90% of the Long Pulse Type 5 frequency modulation is within the low edge of the UUT Occupied Bandwidth
- c) tuned frequencies such that 90% of the Long Pulse Type 5 frequency modulation is within the high edge of the UUT Occupied Bandwidth

It include 10 trails for every subset, the formula as below,

For subset case 1: the center frequency of the signal generator will remain fixed at the center of the UUT Channel.

For subset case 2: to retain 90% frequency overlap between the radar signal and the UUT Occupied Bandwidth, the center frequency of the signal generator will vary for each of the ten trials in subset case 2. The center frequency of the signal generator for each trial is calculated by:

$$FL+(0.4*Chirp\ Width\ [in\ MHz])$$

For subset case 3: to retain 90% frequency overlap between the radar signal and the UUT Occupied Bandwidth, the center frequency of the signal generator will vary for each of the ten trials in subset case 3. The center frequency of the signal generator for each trial is calculated by:

$$FH-(0.4*Chirp\ Width\ [in\ MHz])$$

Table 12: Frequency Hopping Radar Test Waveform

Radar Type	Pulse Width (μsec)	PRI (μsec)	Pulses per Hop	Hopping Rate (kHz)	Hopping Sequence Length (msec)	Minimum Percentage of Successful Detection	Minimum Number of Trials
6	1	333	9	0.333	300	70%	30

4 Test and Support Equipment List

4.1 Test Instruments

Table 13: Test Instruments List

Description & Manufacturer	Model No.	Serial No.	Calibrated Date	Calibrated Until
EMI Test Receiver R&S	ESR7	102026	2023/4/6	2024/4/5
MXG Vector Signal Generator Keysight	N5182B	MY53052700	2023/7/17	2024/7/16
Horn Antenna FT-RF	HA-07M18G-NF	0000220091110	2023/11/12	2024/11/11
Programmable Step Attenuator Agilent	8496H-002	MY42143989	2023/11/3	2024/11/2

Notes:

1. The calibration interval of the all test instruments are 12 months and the calibrations are traceable to NML/ROC and NIST/USA.
2. The test was performed in DFS-2 room.
3. Tested Date: 2024/2/15 ~ 2024/3/5

4.2 Description of Support Units

Table 14: Support Unit Information

No.	Product	Brand	Model No.	FCC ID	Spec
1	GigaSpire BLAST u6t	Calix	u6txg GS5229XG	2ABLKGS5229XX	-

NOTE: This device was functioned as a Master Client device during the DFS test.

Table 15: Software/Firmware Information

No.	Product	Model No.	Software/Firmware Version
1	GigaSpire BLAST u6t	u6txg GS5229XG	24.2.0.0

5 Test Procedure

5.1 DFS Measurement System

A complete DFS Measurement System consists of two subsystems: (1) the Radar Signal Generating system and (2) the Traffic Monitoring system. The control PC is necessary for generating the Radar waveforms in Table 10, 11 and 12. The traffic monitoring subsystem is specified to the type of unit under test (UUT).

Radiated Setup Configuration of DFS Measurement System

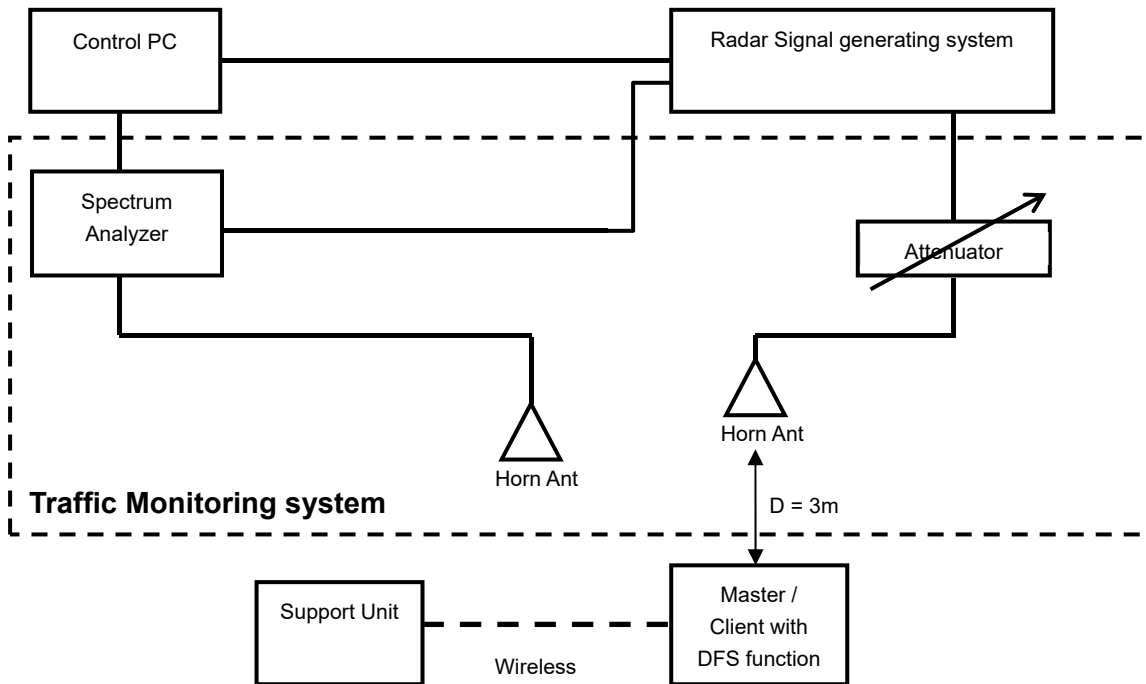

Channel Loading

System testing will be performed with channel-loading using means appropriate to the data types that are used by the unlicensed device. The following requirements apply:

a)	The data file must be of a type that is typical for the device (i.e., MPEG-2, MPEG-4, WAV, MP3, MP4, AVI, etc.) and must generally be transmitting in a streaming mode.	
b)	Software to ping the client is permitted to simulate data transfer but must have random ping intervals.	
c)	Timing plots are required with calculations demonstrating a minimum channel loading of approximately 17% or greater.	✓
d)	Unicast or Multicast protocols are preferable but other protocols may be used. The appropriate protocol used must be described in the test procedures.	

5.2 Calibration of DFS Detection Threshold Level

The measured channel is chosen from the operating channels of the UUT within the 5250-5350 MHz or 5470-5725 MHz and using the all bandwidth mode available for the link. The radar signal was the same as transmitted channels, and injected into the antenna of AP (master) or Client Device with Radar Detection, measured the channel closing transmission time and channel move time.

Radiated setup configuration of Calibration of DFS Detection Threshold Level

The radar signal generate system is generating waveform pattern of radar types. The amplitude of the radar signal generator system is adjusted to yield a level of -64 dBm as measured on the spectrum analyzer.

The interference detection threshold level is lower than -64 dBm hence it provides margin to the limit.

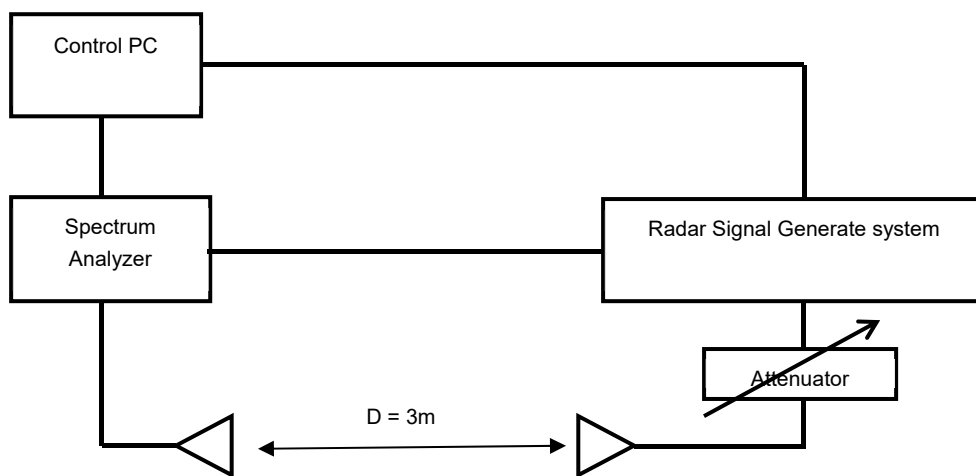

5.3 Deviation from Test Standard

No deviation.

5.4 Radiated Test Setup Configuration

Master mode

The EUT is a U-NII Device operating in Master mode. The radar test signals are injected into the Master Device.

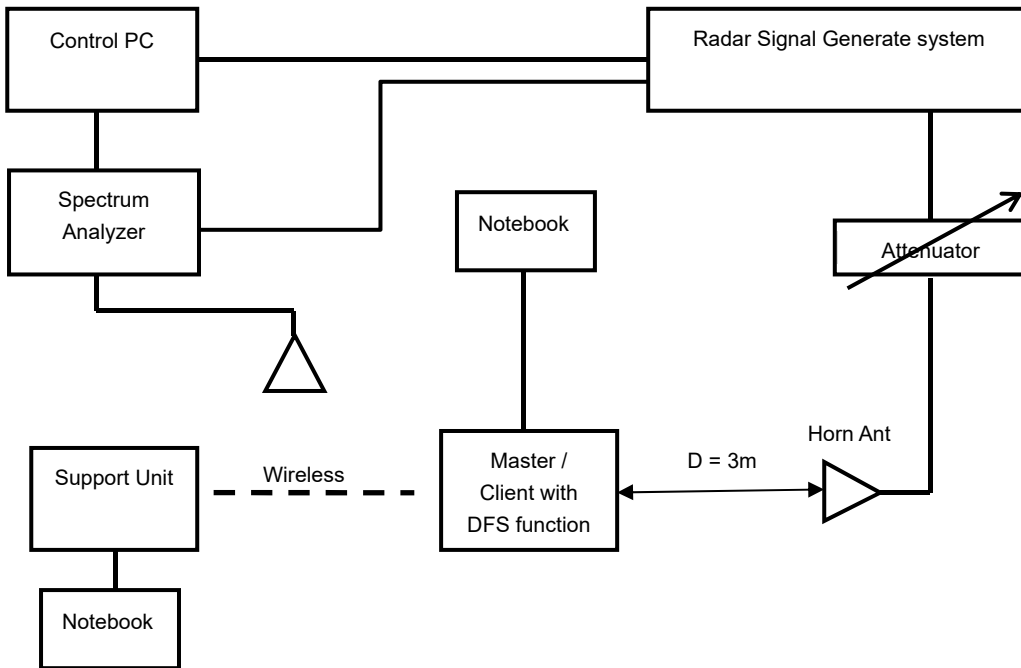

Note: The UUT main beam of the antenna is directly toward the radar emitter during testing.

6 Test Results

6.1 Summary of Test Results

Clause	Test Parameter	Remarks	Pass/Fail
15.407	DFS Detection Threshold	Applicable	Pass
15.407	Channel Availability Check Time	Applicable	Pass
15.407	Channel Move Time	Applicable	Pass
15.407	Channel Closing Transmission Time	Applicable	Pass
15.407	Non- Occupancy Period	Applicable	Pass
15.407	U-NII Detection Bandwidth and Statistical Performance Check	Applicable	Pass

Note:

1. Determining compliance based on the results of the compliance measurement, not taking into account measurement instrumentation uncertainty.
2. Repeater mode, only Statistical Performance Check (KDB 905462 Section 7.8.4) on one of the radar types is required to perform.
3. This device does not support "802.11ax Channel Puncturing" function.

6.2 Test Results

6.2.1 Test Mode: Device Operating In Master Mode

The radar test waveforms are injected into the Master.
 This test was investigated for different bandwidth (20 MHz , 40 MHz , 80 MHz and 80+80 MHz).
 The following plots was done on 80+80 MHz as a representative.

DFS Detection Threshold

For detection threshold level of -64 dBm, the tested level is lower than required level for 1 dB, hence it provides margin to the limit.

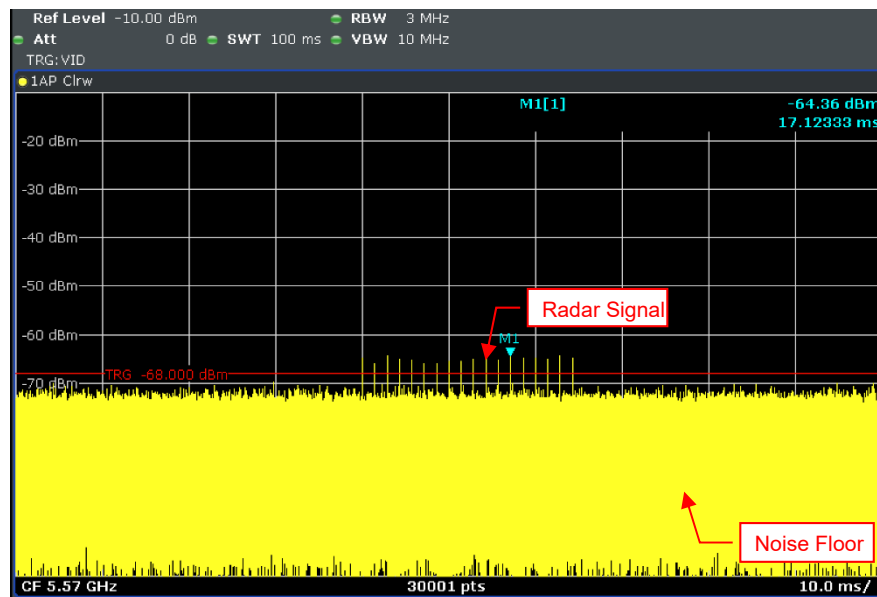

Radar Signal 0

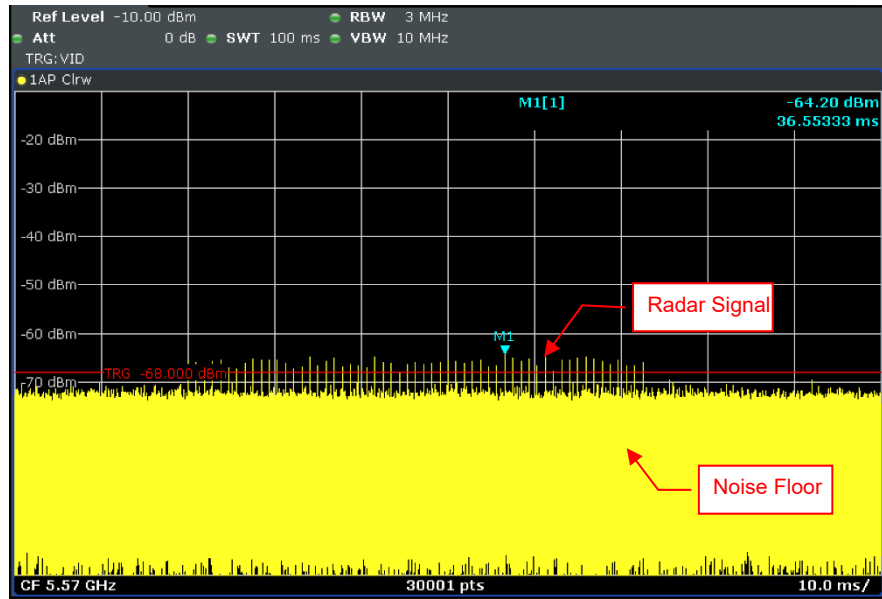

Radar Signal 1 (Test A)

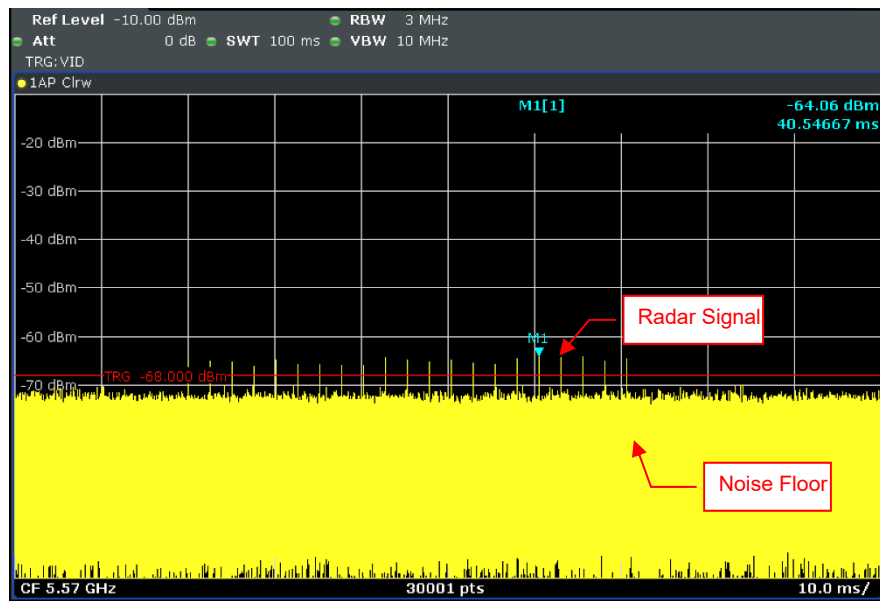

Radar Signal 1 (Test B)

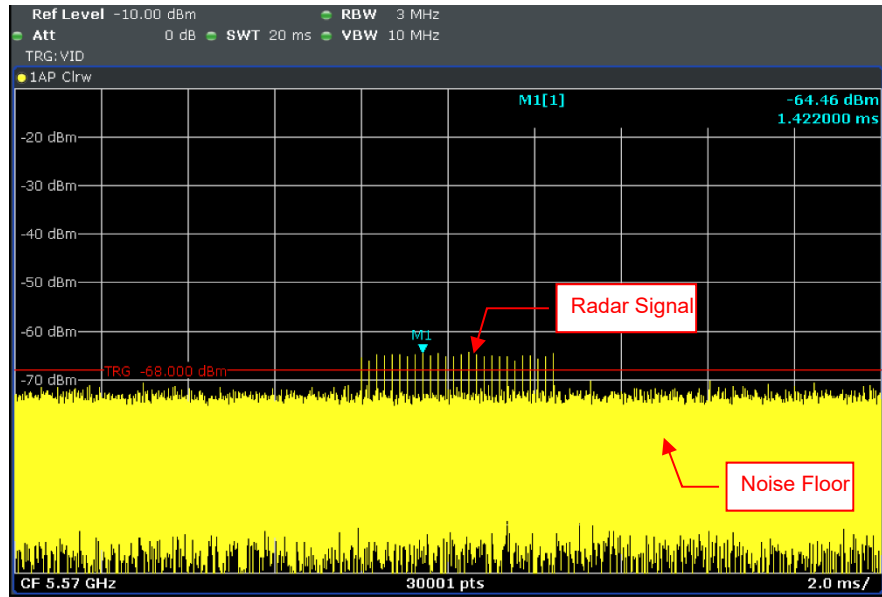

Radar Signal 2

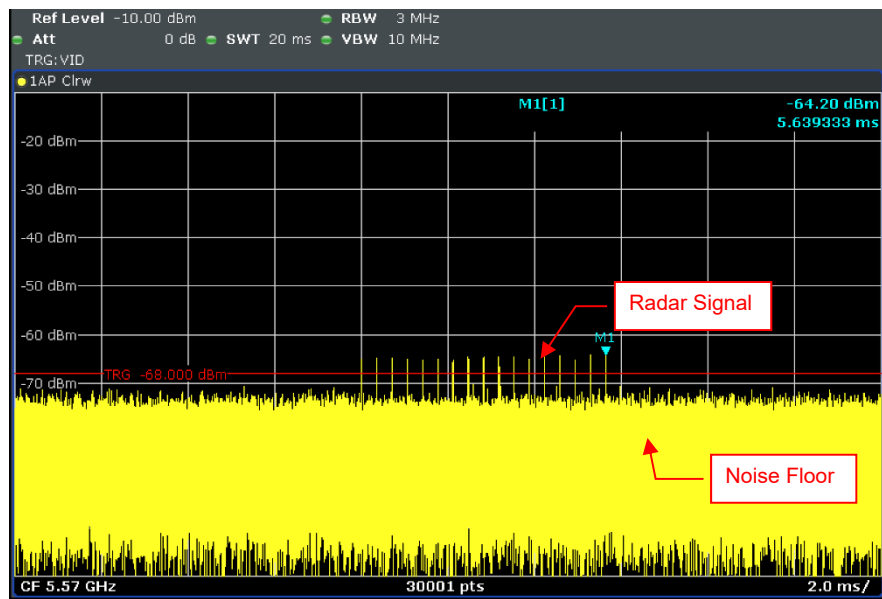

Radar Signal 3

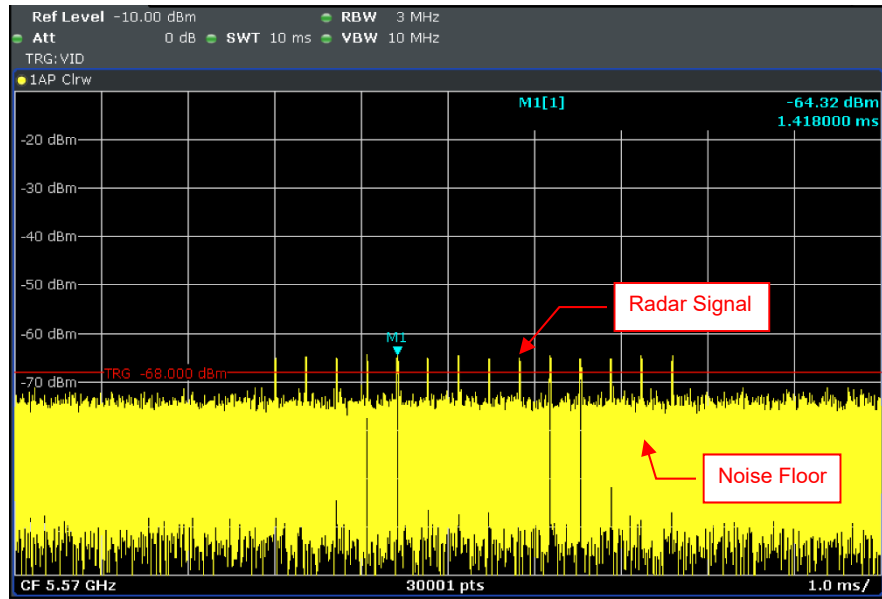

Single Burst of Radar Signal 4

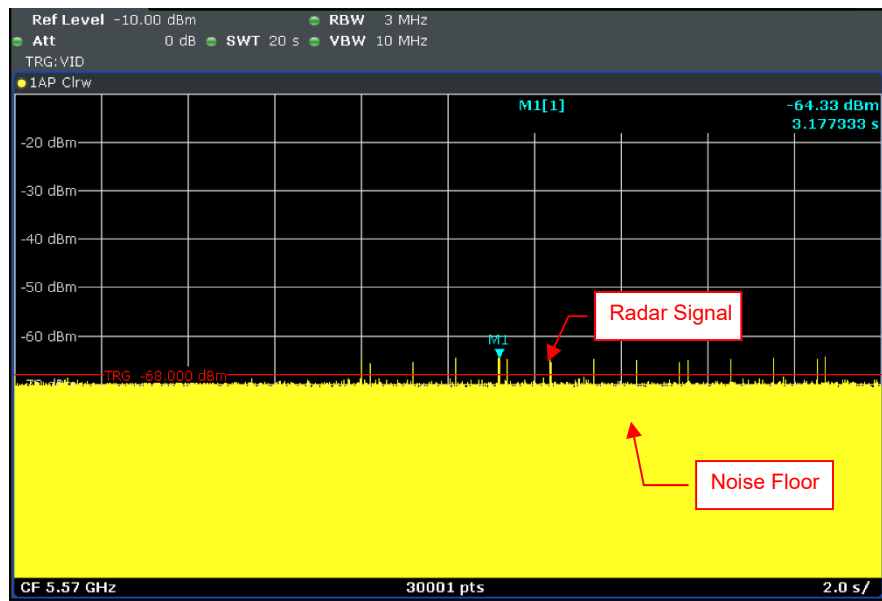

Radar Signal 5

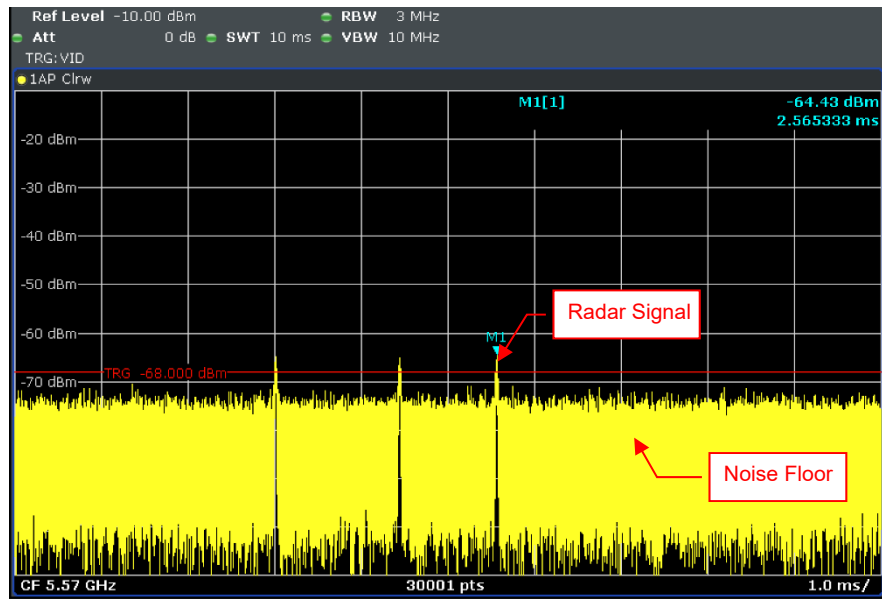

Single Burst of Radar Signal 5

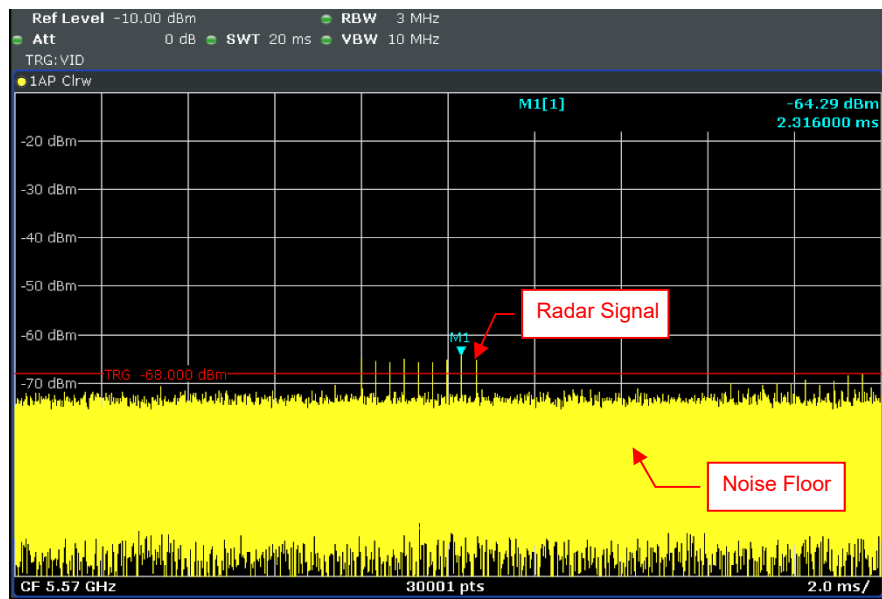

Radar Signal 6

6.2.2 U-NII Detection Bandwidth

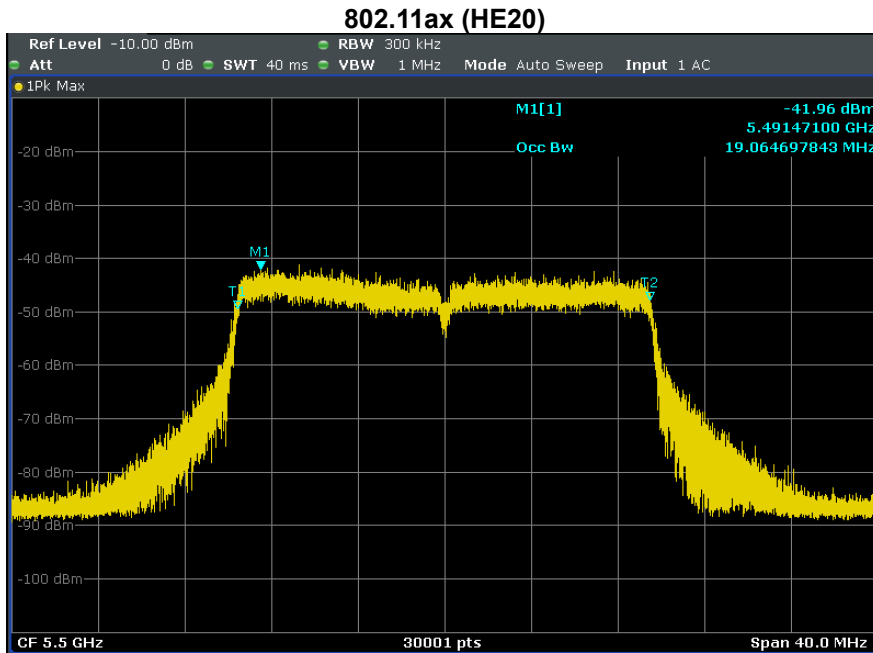

U-NII 99% Channel bandwidth

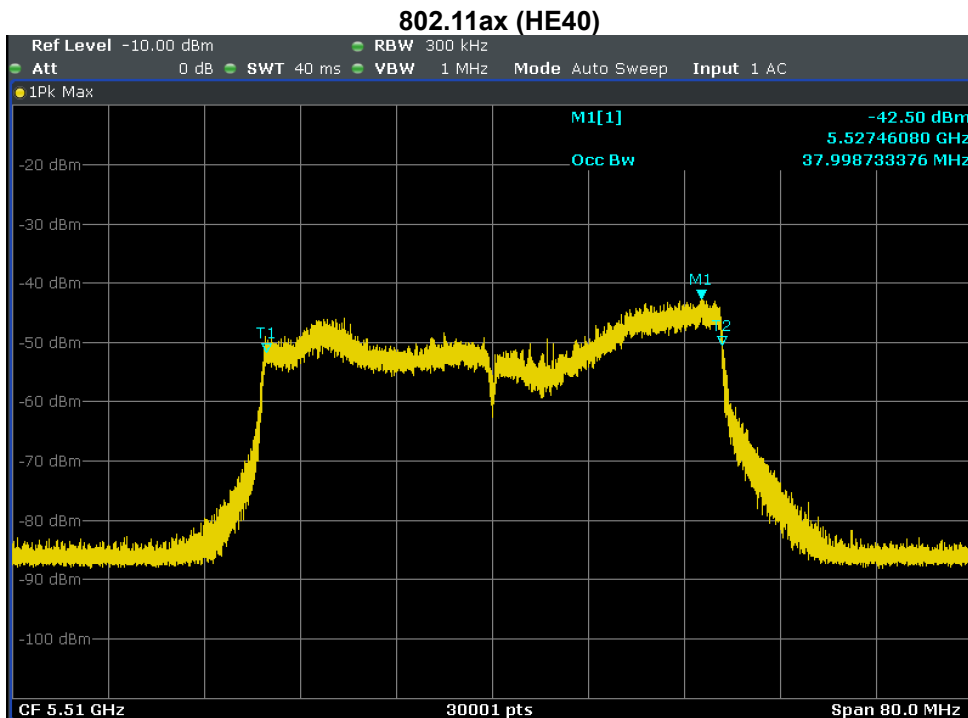

U-NII 99% Channel bandwidth

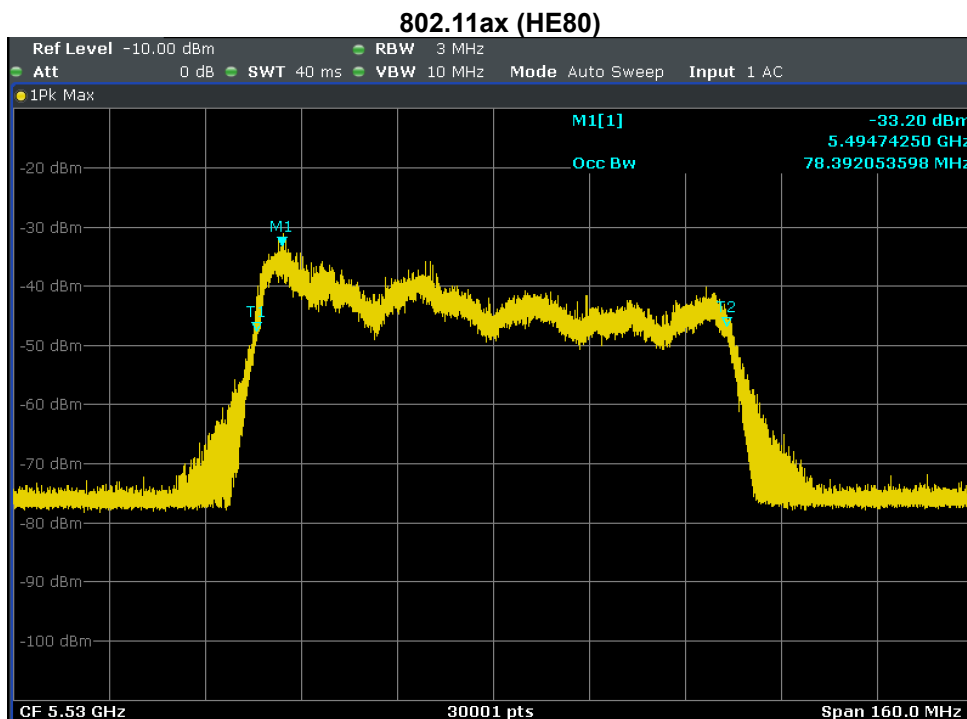

U-NII 99% Channel bandwidth

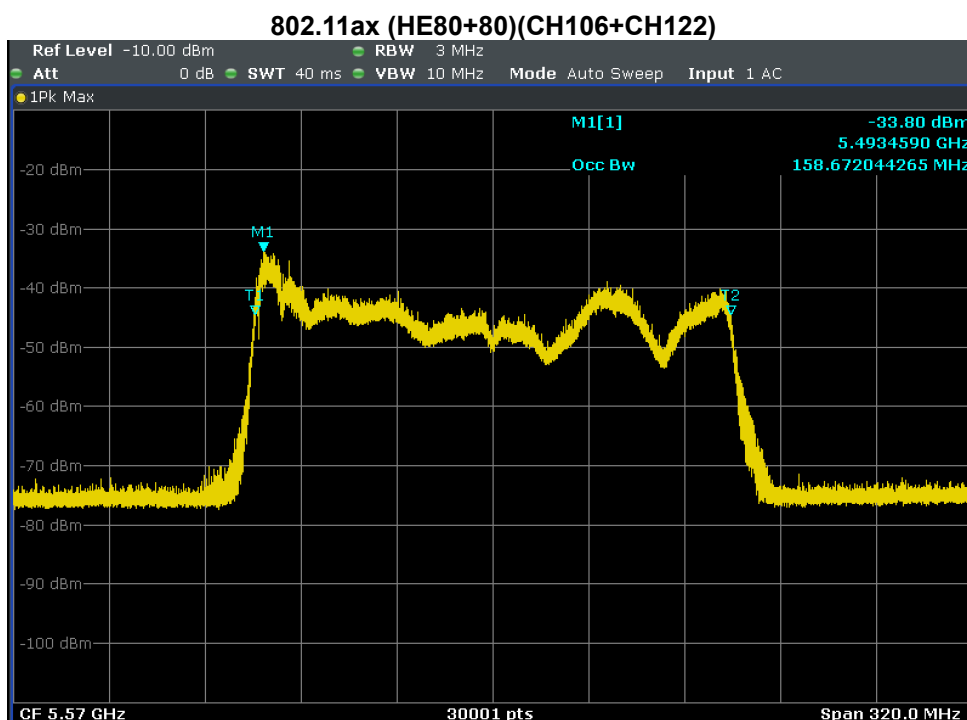

U-NII 99% Channel bandwidth



Detection Bandwidth Test - **802.11ax (HE20)**

Radar Type 0

EUT Frequency: 5500MHz

EUT 99% Power bandwidth: 19.064 MHz

Detection bandwidth limit (100% of EUT 99% Power bandwidth): 19.064 MHz

Detection bandwidth (5510(FH) – 5490(FL)) : 20 MHz

Test Result : PASS

Radar Frequency (MHz)	Trial Number / Detection										Detection Rate (%)
	1	2	3	4	5	6	7	8	9	10	
5490 (FL)	No	Yes	Yes	Yes	Yes	Yes	Yes	Yes	Yes	Yes	90
5491	Yes	Yes	Yes	Yes	Yes	Yes	Yes	Yes	Yes	Yes	100
5492	Yes	Yes	Yes	Yes	Yes	Yes	Yes	Yes	Yes	Yes	100
5493	Yes	Yes	Yes	Yes	Yes	Yes	Yes	Yes	Yes	Yes	100
5494	Yes	Yes	Yes	Yes	Yes	Yes	Yes	Yes	Yes	Yes	100
5495	Yes	Yes	Yes	Yes	Yes	Yes	Yes	Yes	Yes	Yes	100
5496	Yes	Yes	Yes	Yes	Yes	Yes	Yes	Yes	Yes	Yes	100
5497	Yes	Yes	Yes	Yes	Yes	Yes	Yes	Yes	Yes	Yes	100
5498	Yes	Yes	Yes	Yes	Yes	Yes	Yes	Yes	Yes	Yes	100
5499	Yes	Yes	Yes	Yes	Yes	Yes	Yes	Yes	Yes	Yes	100
5500	Yes	Yes	Yes	Yes	Yes	Yes	Yes	Yes	Yes	Yes	100
5501	Yes	Yes	Yes	Yes	Yes	Yes	Yes	Yes	Yes	Yes	100
5502	Yes	Yes	Yes	Yes	Yes	Yes	Yes	Yes	Yes	Yes	100
5503	Yes	Yes	Yes	Yes	Yes	Yes	Yes	Yes	Yes	Yes	100
5504	Yes	Yes	Yes	Yes	Yes	Yes	Yes	Yes	Yes	Yes	100
5505	Yes	Yes	Yes	Yes	Yes	Yes	Yes	Yes	Yes	Yes	100
5506	Yes	Yes	Yes	Yes	Yes	Yes	Yes	Yes	Yes	Yes	100
5507	Yes	Yes	Yes	Yes	Yes	Yes	Yes	Yes	Yes	Yes	100
5508	Yes	Yes	Yes	Yes	Yes	Yes	Yes	Yes	Yes	Yes	100
5509	Yes	Yes	Yes	Yes	Yes	Yes	Yes	Yes	Yes	Yes	100
5510 (FH)	Yes	Yes	Yes	Yes	Yes	Yes	Yes	Yes	Yes	No	90



Detection Bandwidth Test - **802.11ax (HE40)**
 Radar Type 0
 EUT Frequency: 5510 MHz
 EUT 99% Power bandwidth: 37.998 MHz
 Detection bandwidth limit (100% of EUT 99% Power bandwidth): 37.998 MHz
 Detection bandwidth (5529(FH) – 5491(FL)) : 38 MHz
 Test Result : PASS

Radar Frequency (MHz)	Trial Number / Detection										Detection Rate (%)
	1	2	3	4	5	6	7	8	9	10	
5491 (FL)	Yes	Yes	Yes	Yes	Yes	Yes	Yes	Yes	Yes	Yes	100
5492	Yes	Yes	Yes	Yes	Yes	Yes	Yes	Yes	Yes	Yes	100
5493	Yes	Yes	Yes	Yes	Yes	Yes	Yes	Yes	Yes	Yes	100
5494	Yes	Yes	Yes	Yes	Yes	Yes	Yes	Yes	Yes	Yes	100
5495	Yes	Yes	Yes	Yes	Yes	Yes	Yes	Yes	Yes	Yes	100
5496	Yes	Yes	Yes	Yes	Yes	Yes	Yes	Yes	Yes	Yes	100
5497	Yes	Yes	Yes	Yes	Yes	Yes	Yes	Yes	Yes	Yes	100
5498	Yes	Yes	Yes	Yes	Yes	Yes	Yes	Yes	Yes	Yes	100
5499	Yes	Yes	Yes	Yes	Yes	Yes	Yes	Yes	Yes	Yes	100
5500	Yes	Yes	Yes	Yes	Yes	Yes	Yes	Yes	Yes	Yes	100
5501	Yes	Yes	Yes	Yes	Yes	Yes	Yes	Yes	Yes	Yes	100
5502	Yes	Yes	Yes	Yes	Yes	Yes	Yes	Yes	Yes	Yes	100
5503	Yes	Yes	Yes	Yes	Yes	Yes	Yes	Yes	Yes	Yes	100
5504	Yes	Yes	Yes	Yes	Yes	Yes	Yes	Yes	Yes	Yes	100
5505	Yes	Yes	Yes	Yes	Yes	Yes	Yes	Yes	Yes	Yes	100
5506	Yes	Yes	Yes	Yes	Yes	Yes	Yes	Yes	Yes	Yes	100
5507	Yes	Yes	Yes	Yes	Yes	Yes	Yes	Yes	Yes	Yes	100
5508	Yes	Yes	Yes	Yes	Yes	Yes	Yes	Yes	Yes	Yes	100
5509	Yes	Yes	Yes	Yes	Yes	Yes	Yes	Yes	Yes	Yes	100
5510	Yes	Yes	Yes	Yes	Yes	Yes	Yes	Yes	Yes	Yes	100
5511	Yes	Yes	Yes	Yes	Yes	Yes	Yes	Yes	Yes	Yes	100
5512	Yes	Yes	Yes	Yes	Yes	Yes	Yes	Yes	Yes	Yes	100
5513	Yes	Yes	Yes	Yes	Yes	Yes	Yes	Yes	Yes	Yes	100
5514	Yes	Yes	Yes	Yes	Yes	Yes	Yes	Yes	Yes	Yes	100
5515	Yes	Yes	Yes	Yes	Yes	Yes	Yes	Yes	Yes	Yes	100
5516	Yes	Yes	Yes	Yes	Yes	Yes	Yes	Yes	Yes	Yes	100
5517	Yes	Yes	Yes	Yes	Yes	Yes	Yes	Yes	Yes	Yes	100
5518	Yes	Yes	Yes	Yes	Yes	Yes	Yes	Yes	Yes	Yes	100
5519	Yes	Yes	Yes	Yes	Yes	Yes	Yes	Yes	Yes	Yes	100
5520	Yes	Yes	Yes	Yes	Yes	Yes	Yes	Yes	Yes	Yes	100
5521	Yes	Yes	Yes	Yes	Yes	Yes	Yes	Yes	Yes	Yes	100
5522	Yes	Yes	Yes	Yes	Yes	Yes	Yes	Yes	Yes	Yes	100
5523	Yes	Yes	Yes	Yes	Yes	Yes	Yes	Yes	Yes	Yes	100
5524	Yes	Yes	Yes	Yes	Yes	Yes	Yes	Yes	Yes	Yes	100
5525	Yes	Yes	Yes	Yes	Yes	Yes	Yes	Yes	Yes	Yes	100
5526	Yes	Yes	Yes	Yes	Yes	Yes	Yes	Yes	Yes	Yes	100
5527	Yes	Yes	Yes	Yes	Yes	Yes	Yes	Yes	Yes	Yes	100
5528	Yes	Yes	Yes	Yes	Yes	Yes	Yes	Yes	Yes	Yes	100
5529 (FH)	Yes	Yes	Yes	Yes	Yes	Yes	Yes	Yes	Yes	Yes	100



Detection Bandwidth Test - **802.11ax (HE80)**
 Radar Type 0
 EUT Frequency: 5530 MHz
 EUT 99% Power bandwidth: 78.392 MHz
 Detection bandwidth limit (100% of EUT 99% Power bandwidth): 78.392 MHz
 Detection bandwidth (5570(FH) – 5490(FL)) : 80 MHz
 Test Result : PASS

Radar Frequency (MHz)	Trial Number / Detection										Detection Rate (%)
	1	2	3	4	5	6	7	8	9	10	
5490 (FL)	Yes	Yes	Yes	Yes	Yes	Yes	Yes	Yes	Yes	Yes	100
5491	Yes	Yes	Yes	Yes	Yes	Yes	Yes	Yes	Yes	Yes	100
5492	Yes	Yes	Yes	Yes	Yes	Yes	Yes	Yes	Yes	Yes	100
5493	Yes	Yes	Yes	Yes	Yes	Yes	Yes	Yes	Yes	Yes	100
5494	Yes	Yes	Yes	Yes	Yes	Yes	Yes	Yes	Yes	Yes	100
5495	Yes	Yes	Yes	Yes	Yes	Yes	Yes	Yes	Yes	Yes	100
5496	Yes	Yes	Yes	Yes	Yes	Yes	Yes	Yes	Yes	Yes	100
5497	Yes	Yes	Yes	Yes	Yes	Yes	Yes	Yes	Yes	Yes	100
5498	Yes	Yes	Yes	Yes	Yes	Yes	Yes	Yes	Yes	Yes	100
5499	Yes	Yes	Yes	Yes	Yes	Yes	Yes	Yes	Yes	Yes	100
5500	Yes	Yes	Yes	Yes	Yes	Yes	Yes	Yes	Yes	Yes	100
5501	Yes	Yes	Yes	Yes	Yes	Yes	Yes	Yes	Yes	Yes	100
5502	Yes	Yes	Yes	Yes	Yes	Yes	Yes	Yes	Yes	Yes	100
5503	Yes	Yes	Yes	Yes	Yes	Yes	Yes	Yes	Yes	Yes	100
5504	Yes	Yes	Yes	Yes	Yes	Yes	Yes	Yes	Yes	Yes	100
5505	Yes	Yes	Yes	Yes	Yes	Yes	Yes	Yes	Yes	Yes	100
5506	Yes	Yes	Yes	Yes	Yes	Yes	Yes	Yes	Yes	Yes	100
5507	Yes	Yes	Yes	Yes	Yes	Yes	Yes	Yes	Yes	Yes	100
5508	Yes	Yes	Yes	Yes	Yes	Yes	Yes	Yes	Yes	Yes	100
5509	Yes	Yes	Yes	Yes	Yes	Yes	Yes	Yes	Yes	Yes	100
5510	Yes	Yes	Yes	Yes	Yes	Yes	Yes	Yes	Yes	Yes	100
5511	Yes	Yes	No	Yes	Yes	Yes	Yes	Yes	Yes	Yes	90
5512	Yes	Yes	Yes	Yes	Yes	Yes	Yes	Yes	Yes	Yes	100
5513	Yes	Yes	Yes	Yes	Yes	Yes	Yes	Yes	Yes	Yes	100
5514	Yes	Yes	Yes	Yes	Yes	Yes	Yes	Yes	Yes	Yes	100
5515	Yes	Yes	Yes	Yes	Yes	Yes	Yes	Yes	Yes	Yes	100
5516	Yes	Yes	Yes	Yes	Yes	Yes	Yes	Yes	Yes	Yes	100
5517	Yes	Yes	Yes	Yes	Yes	Yes	Yes	Yes	Yes	Yes	100
5518	Yes	Yes	Yes	Yes	Yes	Yes	Yes	Yes	Yes	Yes	100
5519	Yes	Yes	Yes	Yes	Yes	Yes	Yes	Yes	Yes	Yes	100
5520	Yes	Yes	Yes	Yes	Yes	Yes	Yes	Yes	Yes	Yes	100
5521	Yes	Yes	Yes	Yes	Yes	Yes	Yes	Yes	Yes	Yes	100
5522	Yes	Yes	Yes	Yes	Yes	Yes	Yes	Yes	Yes	Yes	100
5523	Yes	Yes	Yes	Yes	Yes	Yes	Yes	Yes	Yes	Yes	100
5524	Yes	Yes	Yes	Yes	Yes	Yes	Yes	Yes	Yes	Yes	100
5525	Yes	Yes	Yes	Yes	Yes	Yes	Yes	Yes	Yes	Yes	100
5526	Yes	Yes	Yes	Yes	Yes	Yes	Yes	Yes	Yes	Yes	100
5527	Yes	Yes	Yes	Yes	Yes	Yes	Yes	Yes	Yes	Yes	100
5528	Yes	Yes	Yes	Yes	Yes	Yes	Yes	Yes	Yes	Yes	100
5529	Yes	Yes	Yes	Yes	Yes	Yes	Yes	Yes	Yes	Yes	100
5530	Yes	Yes	Yes	Yes	Yes	Yes	Yes	Yes	Yes	Yes	100
5531	Yes	Yes	Yes	Yes	Yes	Yes	Yes	Yes	Yes	Yes	100
5532	Yes	Yes	Yes	Yes	Yes	Yes	Yes	Yes	Yes	Yes	100
5533	Yes	Yes	Yes	Yes	Yes	Yes	Yes	Yes	Yes	Yes	100
5534	Yes	Yes	Yes	Yes	Yes	Yes	Yes	Yes	Yes	Yes	100



5535	Yes	Yes	Yes	Yes	Yes	Yes	Yes	Yes	Yes	Yes	100
5536	Yes	Yes	Yes	Yes	Yes	Yes	Yes	Yes	Yes	Yes	100
5537	Yes	Yes	Yes	Yes	Yes	Yes	Yes	Yes	Yes	Yes	100
5538	Yes	Yes	Yes	Yes	Yes	Yes	Yes	Yes	Yes	Yes	100
5539	Yes	Yes	Yes	Yes	Yes	Yes	Yes	Yes	Yes	Yes	100
5540	Yes	Yes	Yes	Yes	Yes	Yes	Yes	Yes	Yes	Yes	100
5541	Yes	Yes	Yes	Yes	Yes	Yes	Yes	Yes	Yes	Yes	100
5542	Yes	Yes	Yes	Yes	Yes	Yes	Yes	Yes	Yes	Yes	100
5543	Yes	Yes	Yes	Yes	Yes	Yes	Yes	Yes	Yes	Yes	100
5544	Yes	Yes	Yes	Yes	Yes	Yes	Yes	Yes	Yes	Yes	100
5545	Yes	Yes	Yes	Yes	Yes	Yes	Yes	Yes	Yes	Yes	100
5546	Yes	Yes	Yes	Yes	Yes	Yes	Yes	Yes	Yes	Yes	100
5547	Yes	Yes	Yes	Yes	Yes	Yes	Yes	Yes	Yes	Yes	100
5548	Yes	Yes	Yes	Yes	Yes	Yes	Yes	Yes	Yes	Yes	100
5549	Yes	Yes	Yes	Yes	Yes	Yes	Yes	Yes	Yes	Yes	100
5550	Yes	Yes	Yes	Yes	Yes	Yes	Yes	Yes	Yes	Yes	100
5551	Yes	Yes	Yes	Yes	Yes	Yes	Yes	Yes	Yes	Yes	100
5552	Yes	Yes	Yes	Yes	Yes	Yes	Yes	Yes	Yes	Yes	100
5553	Yes	Yes	Yes	Yes	Yes	Yes	Yes	Yes	Yes	Yes	100
5554	Yes	Yes	Yes	Yes	Yes	Yes	Yes	Yes	Yes	Yes	100
5555	Yes	Yes	Yes	Yes	Yes	Yes	Yes	Yes	Yes	Yes	100
5556	Yes	Yes	Yes	Yes	Yes	Yes	Yes	Yes	Yes	Yes	100
5557	Yes	Yes	Yes	Yes	Yes	Yes	Yes	Yes	Yes	Yes	100
5558	Yes	Yes	Yes	Yes	Yes	Yes	Yes	Yes	Yes	Yes	100
5559	Yes	Yes	Yes	Yes	Yes	Yes	Yes	Yes	Yes	Yes	100
5560	Yes	Yes	Yes	Yes	Yes	Yes	Yes	Yes	Yes	Yes	100
5561	Yes	Yes	Yes	Yes	Yes	Yes	Yes	Yes	Yes	Yes	100
5562	Yes	Yes	Yes	Yes	Yes	Yes	Yes	Yes	Yes	Yes	100
5563	Yes	Yes	Yes	Yes	Yes	Yes	Yes	Yes	Yes	Yes	100
5564	Yes	Yes	Yes	Yes	Yes	Yes	Yes	Yes	Yes	Yes	100
5565	Yes	Yes	Yes	Yes	Yes	Yes	Yes	Yes	Yes	Yes	100
5566	Yes	Yes	Yes	Yes	Yes	Yes	Yes	Yes	Yes	Yes	100
5567	Yes	Yes	Yes	Yes	Yes	Yes	Yes	Yes	Yes	Yes	100
5568	Yes	Yes	Yes	Yes	Yes	Yes	Yes	Yes	Yes	Yes	100
5569	Yes	Yes	Yes	Yes	Yes	Yes	Yes	Yes	Yes	Yes	100
5570 (FH)	Yes	Yes	Yes	Yes	Yes	Yes	Yes	Yes	Yes	Yes	100



Detection Bandwidth Test - 802.11ax (HE80+80)(CH106+CH122)

Radar Type 0

EUT Frequency: 5570 MHz

EUT 99% Power bandwidth: 158.672 MHz

Detection bandwidth limit (100% of EUT 99% Power bandwidth): 158.672 MHz

Detection bandwidth (5650(FH) – 5490(FL)) : 160 MHz

Test Result : PASS

Radar Frequency (MHz)	Trial Number / Detection										Detection Rate (%)
	1	2	3	4	5	6	7	8	9	10	
5490 (FL)	Yes	Yes	Yes	Yes	Yes	Yes	Yes	Yes	Yes	Yes	100
5491	Yes	Yes	Yes	Yes	Yes	Yes	Yes	Yes	Yes	Yes	100
5492	Yes	Yes	Yes	Yes	Yes	Yes	Yes	Yes	Yes	Yes	100
5493	Yes	Yes	Yes	Yes	Yes	Yes	Yes	Yes	Yes	Yes	100
5494	Yes	Yes	Yes	Yes	Yes	Yes	Yes	Yes	Yes	Yes	100
5495	Yes	Yes	Yes	Yes	Yes	Yes	Yes	Yes	Yes	Yes	100
5496	Yes	Yes	Yes	Yes	Yes	Yes	Yes	Yes	Yes	Yes	100
5497	Yes	Yes	Yes	Yes	Yes	Yes	Yes	Yes	Yes	Yes	100
5498	Yes	Yes	Yes	Yes	Yes	Yes	Yes	Yes	Yes	Yes	100
5499	Yes	Yes	Yes	Yes	Yes	Yes	Yes	Yes	Yes	Yes	100
5500	Yes	Yes	Yes	Yes	Yes	Yes	Yes	Yes	Yes	Yes	100
5501	Yes	Yes	Yes	Yes	Yes	Yes	Yes	Yes	Yes	Yes	100
5502	Yes	Yes	Yes	Yes	Yes	Yes	Yes	Yes	Yes	Yes	100
5503	Yes	Yes	Yes	Yes	Yes	Yes	Yes	Yes	Yes	Yes	100
5504	Yes	Yes	Yes	Yes	Yes	Yes	Yes	Yes	Yes	Yes	100
5505	Yes	Yes	Yes	Yes	Yes	Yes	Yes	Yes	Yes	Yes	100
5506	Yes	Yes	Yes	Yes	Yes	Yes	Yes	Yes	Yes	Yes	100
5507	Yes	Yes	Yes	Yes	Yes	Yes	Yes	Yes	Yes	Yes	100
5508	Yes	Yes	Yes	Yes	Yes	Yes	Yes	Yes	Yes	Yes	100
5509	Yes	Yes	Yes	Yes	Yes	Yes	Yes	Yes	Yes	Yes	100
5510	Yes	Yes	Yes	Yes	Yes	Yes	Yes	Yes	Yes	Yes	100
5511	Yes	Yes	Yes	Yes	Yes	Yes	Yes	Yes	Yes	Yes	100
5512	Yes	Yes	Yes	Yes	Yes	Yes	Yes	Yes	Yes	Yes	100
5513	Yes	Yes	Yes	Yes	Yes	Yes	Yes	Yes	Yes	Yes	100
5514	Yes	Yes	Yes	Yes	Yes	Yes	Yes	Yes	Yes	Yes	100
5515	Yes	Yes	Yes	Yes	Yes	Yes	Yes	Yes	Yes	Yes	100
5516	Yes	Yes	Yes	Yes	Yes	Yes	Yes	Yes	Yes	Yes	100
5517	Yes	Yes	Yes	Yes	Yes	Yes	Yes	Yes	Yes	Yes	100
5518	Yes	Yes	Yes	Yes	Yes	Yes	Yes	Yes	Yes	Yes	100
5519	Yes	Yes	Yes	Yes	Yes	Yes	Yes	Yes	Yes	Yes	100
5520	Yes	Yes	Yes	Yes	Yes	Yes	Yes	Yes	Yes	Yes	100
5521	Yes	Yes	Yes	Yes	Yes	Yes	Yes	Yes	Yes	Yes	100
5522	Yes	Yes	Yes	Yes	Yes	Yes	Yes	Yes	Yes	Yes	100
5523	Yes	Yes	Yes	Yes	Yes	Yes	Yes	Yes	Yes	Yes	100
5524	Yes	Yes	Yes	Yes	Yes	Yes	Yes	Yes	Yes	Yes	100
5525	Yes	Yes	Yes	Yes	Yes	Yes	Yes	Yes	Yes	Yes	100
5526	Yes	Yes	Yes	Yes	Yes	Yes	Yes	Yes	Yes	Yes	100
5527	Yes	Yes	Yes	Yes	Yes	Yes	Yes	Yes	Yes	Yes	100
5528	Yes	Yes	Yes	Yes	Yes	Yes	Yes	Yes	Yes	Yes	100
5529	Yes	Yes	Yes	Yes	Yes	Yes	Yes	Yes	Yes	Yes	100
5530	Yes	Yes	Yes	Yes	Yes	Yes	Yes	Yes	Yes	Yes	100
5531	Yes	Yes	Yes	Yes	Yes	Yes	Yes	Yes	Yes	Yes	100
5532	Yes	Yes	Yes	Yes	Yes	Yes	Yes	Yes	Yes	Yes	100
5533	Yes	Yes	Yes	Yes	Yes	Yes	Yes	Yes	Yes	Yes	100
5534	Yes	Yes	Yes	Yes	Yes	Yes	Yes	Yes	Yes	Yes	100



5590	Yes	Yes	Yes	Yes	Yes	Yes	Yes	Yes	Yes	Yes	100
5591	Yes	Yes	Yes	Yes	Yes	Yes	Yes	Yes	Yes	Yes	100
5592	Yes	Yes	Yes	Yes	Yes	Yes	Yes	Yes	Yes	Yes	100
5593	Yes	Yes	Yes	Yes	Yes	Yes	Yes	Yes	Yes	Yes	100
5594	Yes	Yes	Yes	Yes	Yes	Yes	Yes	Yes	Yes	Yes	100
5595	Yes	Yes	Yes	Yes	Yes	Yes	Yes	Yes	Yes	Yes	100
5596	Yes	Yes	Yes	Yes	Yes	Yes	Yes	Yes	Yes	Yes	100
5597	Yes	Yes	Yes	Yes	Yes	Yes	Yes	Yes	Yes	Yes	100
5598	Yes	Yes	Yes	Yes	Yes	Yes	Yes	Yes	Yes	Yes	100
5599	Yes	Yes	Yes	Yes	Yes	Yes	Yes	Yes	Yes	Yes	100
5600	Yes	Yes	Yes	Yes	Yes	Yes	Yes	Yes	Yes	Yes	100
5601	Yes	Yes	Yes	Yes	Yes	Yes	Yes	Yes	Yes	Yes	100
5602	Yes	Yes	Yes	Yes	Yes	Yes	Yes	Yes	Yes	Yes	100
5603	Yes	Yes	Yes	Yes	Yes	Yes	Yes	Yes	Yes	Yes	100
5604	Yes	Yes	Yes	Yes	Yes	Yes	Yes	Yes	Yes	Yes	100
5605	Yes	Yes	Yes	Yes	Yes	Yes	Yes	Yes	Yes	Yes	100
5606	Yes	Yes	Yes	Yes	Yes	Yes	Yes	Yes	Yes	Yes	100
5607	Yes	Yes	Yes	Yes	Yes	Yes	Yes	Yes	Yes	Yes	100
5608	Yes	Yes	Yes	Yes	Yes	Yes	Yes	Yes	Yes	Yes	100
5609	Yes	Yes	Yes	Yes	Yes	Yes	Yes	Yes	Yes	Yes	100
5610	Yes	Yes	Yes	Yes	Yes	Yes	Yes	Yes	Yes	Yes	100
5611	Yes	Yes	Yes	Yes	Yes	Yes	Yes	Yes	Yes	Yes	100
5612	Yes	Yes	Yes	Yes	Yes	Yes	Yes	Yes	Yes	Yes	100
5613	Yes	Yes	Yes	Yes	Yes	Yes	Yes	Yes	Yes	Yes	100
5614	Yes	Yes	Yes	Yes	Yes	Yes	Yes	Yes	Yes	Yes	100
5615	Yes	Yes	Yes	Yes	Yes	Yes	Yes	Yes	Yes	Yes	100
5616	Yes	Yes	Yes	Yes	Yes	Yes	Yes	Yes	Yes	Yes	100
5617	Yes	Yes	Yes	Yes	Yes	Yes	Yes	Yes	Yes	Yes	100
5618	Yes	Yes	Yes	Yes	Yes	Yes	Yes	Yes	Yes	Yes	100
5619	Yes	Yes	Yes	Yes	Yes	Yes	Yes	Yes	Yes	Yes	100
5620	Yes	Yes	Yes	Yes	Yes	Yes	Yes	Yes	Yes	Yes	100
5621	Yes	Yes	Yes	Yes	Yes	Yes	Yes	Yes	Yes	Yes	100
5622	Yes	Yes	Yes	Yes	Yes	Yes	Yes	Yes	Yes	Yes	100
5623	Yes	Yes	Yes	Yes	Yes	Yes	Yes	Yes	Yes	Yes	100
5624	Yes	Yes	Yes	Yes	Yes	Yes	Yes	Yes	Yes	Yes	100
5625	Yes	Yes	Yes	Yes	Yes	Yes	Yes	Yes	Yes	Yes	100
5626	Yes	Yes	Yes	Yes	Yes	Yes	Yes	Yes	Yes	Yes	100
5627	Yes	Yes	Yes	Yes	Yes	Yes	Yes	Yes	Yes	Yes	100
5628	Yes	Yes	Yes	Yes	Yes	Yes	Yes	Yes	Yes	Yes	100
5629	Yes	Yes	Yes	Yes	Yes	Yes	Yes	Yes	Yes	Yes	100
5630	Yes	Yes	Yes	Yes	Yes	Yes	Yes	Yes	Yes	Yes	100
5631	Yes	Yes	Yes	Yes	Yes	Yes	Yes	Yes	Yes	Yes	100
5632	Yes	Yes	Yes	Yes	Yes	Yes	Yes	Yes	Yes	Yes	100
5633	Yes	Yes	Yes	Yes	Yes	Yes	Yes	Yes	Yes	Yes	100
5634	Yes	Yes	Yes	Yes	Yes	Yes	Yes	Yes	Yes	Yes	100
5635	Yes	Yes	Yes	Yes	Yes	Yes	Yes	Yes	Yes	Yes	100
5636	Yes	Yes	Yes	Yes	Yes	Yes	Yes	Yes	Yes	Yes	100
5637	Yes	Yes	Yes	Yes	Yes	Yes	Yes	Yes	Yes	Yes	100
5638	Yes	Yes	Yes	Yes	Yes	Yes	Yes	Yes	Yes	Yes	100
5639	Yes	Yes	Yes	Yes	Yes	Yes	Yes	Yes	Yes	Yes	100
5640	Yes	Yes	Yes	Yes	Yes	Yes	Yes	Yes	Yes	Yes	100
5641	Yes	No	Yes	Yes	Yes	Yes	Yes	Yes	Yes	Yes	90
5642	Yes	No	Yes	Yes	Yes	Yes	Yes	Yes	Yes	Yes	90
5643	Yes	Yes	Yes	Yes	Yes	Yes	Yes	Yes	Yes	No	90
5644	Yes	Yes	Yes	Yes	Yes	Yes	Yes	Yes	Yes	Yes	100



5645	Yes	Yes	Yes	Yes	Yes	Yes	Yes	Yes	Yes	Yes	100
5646	Yes	Yes	Yes	Yes	Yes	Yes	Yes	Yes	Yes	Yes	100
5647	Yes	Yes	Yes	Yes	Yes	Yes	Yes	Yes	Yes	Yes	100
5648	Yes	Yes	Yes	Yes	Yes	Yes	Yes	Yes	Yes	Yes	100
5649	Yes	Yes	Yes	Yes	Yes	Yes	Yes	Yes	Yes	Yes	100
5650 (FH)	Yes	Yes	Yes	Yes	Yes	Yes	Yes	Yes	Yes	Yes	100

6.2.3 Channel Availability Check Time

If the EUT successfully detected the radar burst, it should be observed as the EUT has no transmissions occurred until the EUT starts transmitting on another channel.

Timing of Radar Signal	Observation	
	EUT	Spectrum Analyzer
Within 1 to 6 second	Detected	No transmissions
Within 54 to 60 second	Detected	No transmissions

Initial Channel Availability Check Time

Channel Availability Check

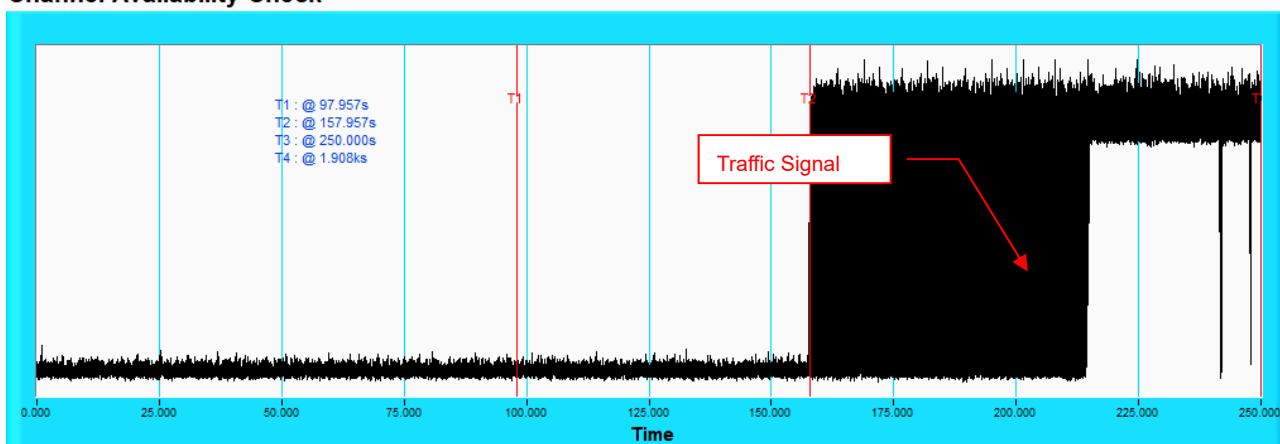

NOTE: T1 denotes the end of power-up time period is 97.957th second. T2 denotes the end of Channel Availability Check time is 157.957th second. Channel Availability Check time is equal to (T2 – T1) 60 seconds.

Radar Burst at the Beginning of the Channel Availability Check Time

Channel Availability Check

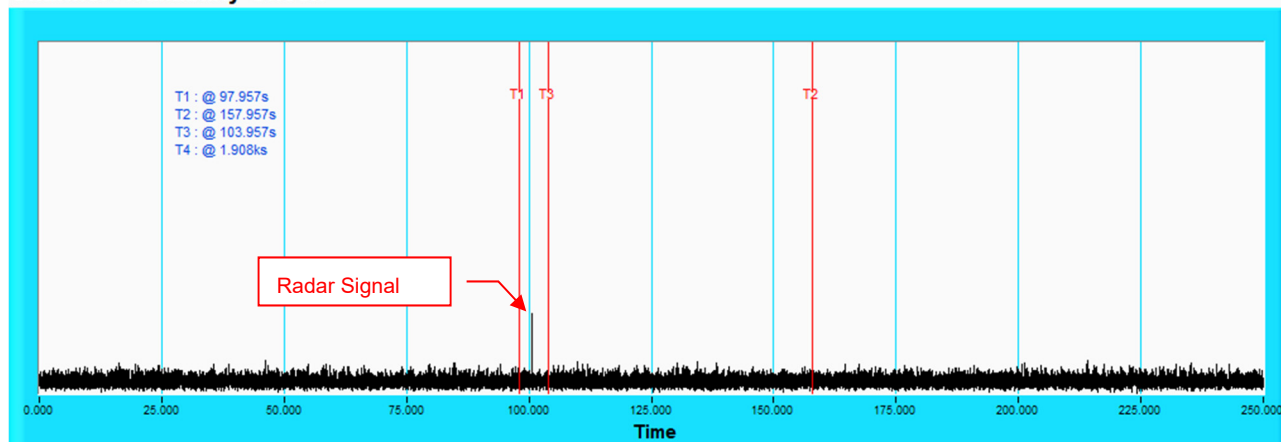

NOTE: T1 denotes the end of power up time period is 97.957th second. T3 denotes 103.957th second and the radar burst was commenced within a 6 second window starting from the end of power-up sequence. T2 denotes the 157.957th second.

Radar Burst at the End of the Channel Availability Check Time

Channel Availability Check

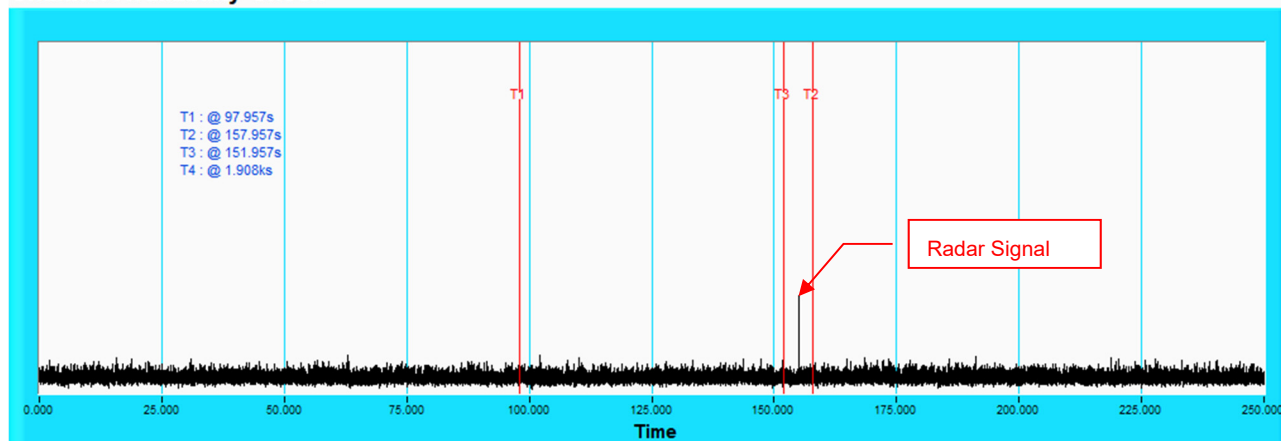

NOTE: T1 denotes the end of power up time period is 97.957th second. T3 denotes 151.957th second and the radar burst was commenced within 54th second to 60th second window starting from the end of power-up sequence. T2 denotes the 157.957th second.



6.2.4 Channel Closing Transmission and Channel Move Time

Wireless Traffic Loading

802.11ax (HE20)

Duty Cycle

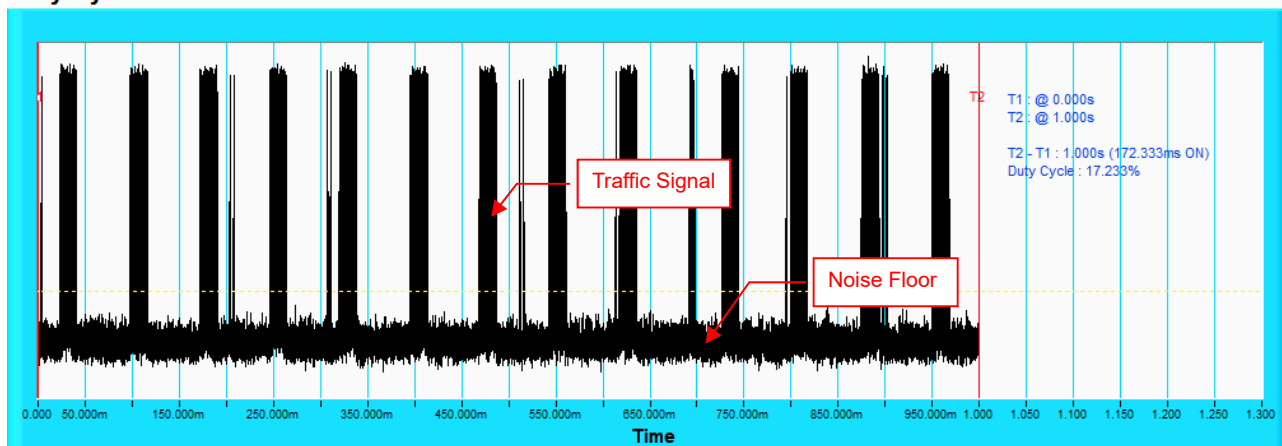

802.11ax (HE40)

Duty Cycle

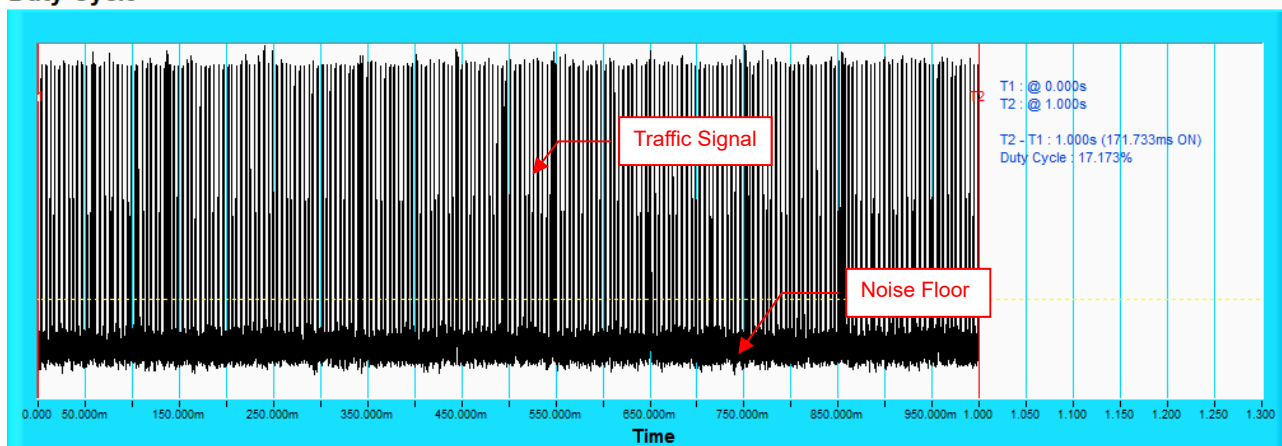

802.11ax (HE80)

Duty Cycle

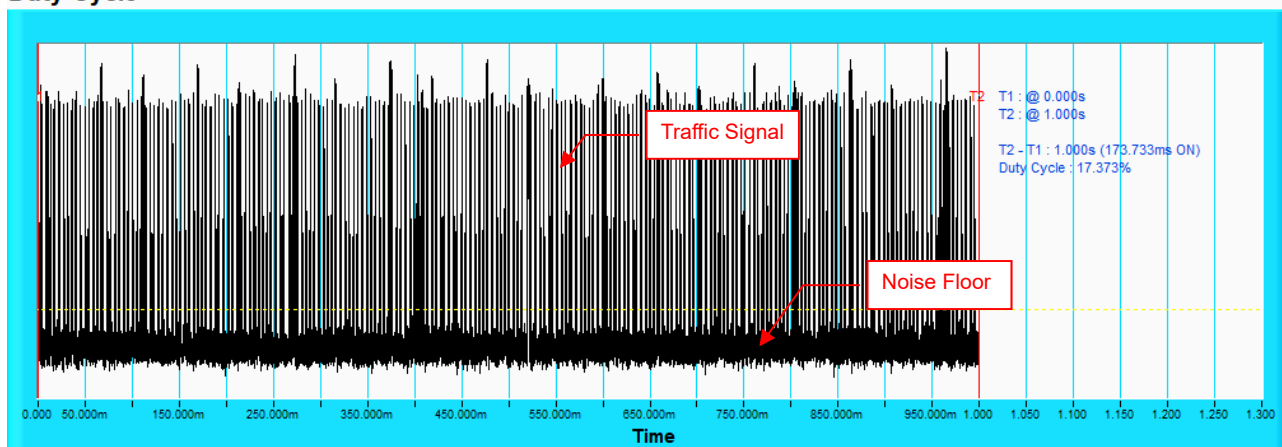



802.11ax (HE80+80)

Duty Cycle

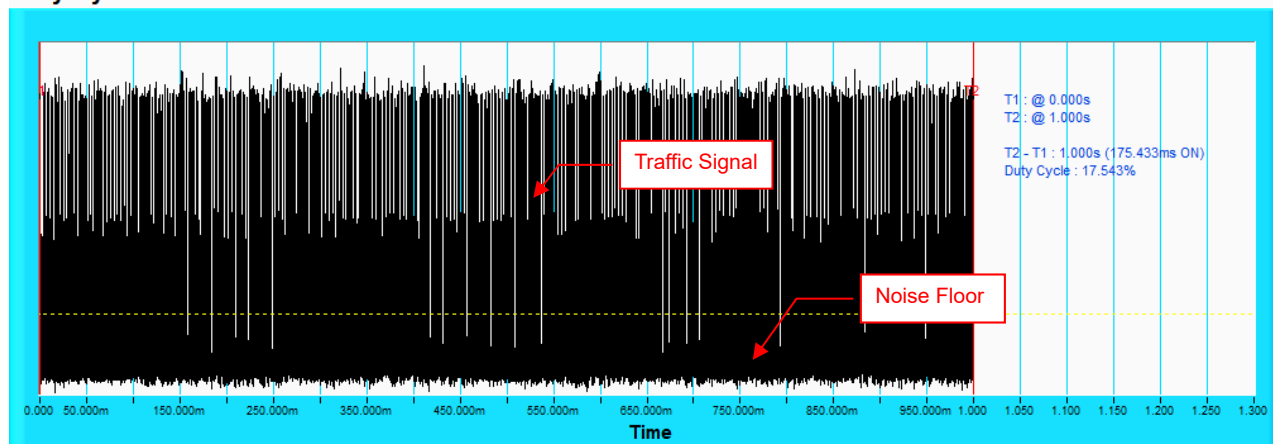



802.11ax (HE20)

Table 1: Short Pulse Radar Test Waveforms

Radar Type	Pulse Width (μsec)	PRI (μsec)	Number of Pulses	Number of Trials(Times)	Percentage of Successful Detection (%)
1	1	Test A 15 unique PRI values randomly selected from the list of 23 PRI values	Roundup $\left\{ \left(\frac{1}{360} \right) \cdot \left(\frac{19 \cdot 10^6}{\text{PRI}_{\mu\text{sec}}} \right) \right\}$	30	96.6
		15 unique PRI values randomly selected within the range of 518~3066 μ sec with a minimum of 1 μ sec, excluding PRI values selected in Test A			
2	1-5	150-230	23-29	30	93.3
3	6-10	200-500	16-18	30	90.0
4	11-20	200-500	12-16	30	83.3
Aggregate (Radar Types 1-4)				120	90.8

Table 2: Long Pulse Radar Test Waveform

Radar Type	Pulse Width (μsec)	Chirp Width (MHz)	PRI (μsec)	Number of Pulses per Burst	Number of Bursts	Number of Trials(Times)	Percentage of Successful Detection (%)
5	50-100	5-20	1000-2000	1-3	8-20	30	90.0

Table 3: Frequency Hopping Radar Test Waveform

Radar Type	Pulse Width (μsec)	PRI (μsec)	Pulses per Hop	Hopping Rate (kHz)	Hopping Sequence Length (msec)	Number of Trials(Times)	Percentage of Successful Detection (%)
6	1	333	9	0.333	300	30	93.3



802.11ax (HE40)

Table 1: Short Pulse Radar Test Waveforms

Radar Type	Pulse Width (μsec)	PRI (μsec)	Number of Pulses	Number of Trials(Times)	Percentage of Successful Detection (%)
1	1	Test A 15 unique PRI values randomly selected from the list of 23 PRI values	Roundup $\left\{ \left(\frac{1}{360} \right) \cdot \left(\frac{19 \cdot 10^6}{\text{PRI}_{\mu\text{sec}}} \right) \right\}$	30	93.3
		15 unique PRI values randomly selected within the range of 518~3066 μ sec with a minimum of 1 μ sec, excluding PRI values selected in Test A			
2	1-5	150-230	23-29	30	93.3
3	6-10	200-500	16-18	30	90.0
4	11-20	200-500	12-16	30	86.6
Aggregate (Radar Types 1-4)				120	90.8

Table 2: Long Pulse Radar Test Waveform

Radar Type	Pulse Width (μsec)	Chirp Width (MHz)	PRI (μsec)	Number of Pulses per Burst	Number of Bursts	Number of Trials(Times)	Percentage of Successful Detection (%)
5	50-100	5-20	1000-2000	1-3	8-20	30	93.3

Table 3: Frequency Hopping Radar Test Waveform

Radar Type	Pulse Width (μsec)	PRI (μsec)	Pulses per Hop	Hopping Rate (kHz)	Hopping Sequence Length (msec)	Number of Trials(Times)	Percentage of Successful Detection (%)
6	1	333	9	0.333	300	30	93.3



802.11ax (HE80)

Table 1: Short Pulse Radar Test Waveforms

Radar Type	Pulse Width (μsec)	PRI (μsec)	Number of Pulses	Number of Trials(Times)	Percentage of Successful Detection (%)
1	1	Test A 15 unique PRI values randomly selected from the list of 23 PRI values	Roundup $\left\{ \left(\frac{1}{360} \right) \cdot \left(\frac{19 \cdot 10^6}{\text{PRI}_{\mu\text{sec}}} \right) \right\}$	30	93.3
		15 unique PRI values randomly selected within the range of 518~3066 μ sec with a minimum of 1 μ sec, excluding PRI values selected in Test A			
2	1-5	150-230	23-29	30	93.3
3	6-10	200-500	16-18	30	86.6
4	11-20	200-500	12-16	30	96.6
Aggregate (Radar Types 1-4)				120	92.4

Table 2: Long Pulse Radar Test Waveform

Radar Type	Pulse Width (μsec)	Chirp Width (MHz)	PRI (μsec)	Number of Pulses per Burst	Number of Bursts	Number of Trials(Times)	Percentage of Successful Detection (%)
5	50-100	5-20	1000-2000	1-3	8-20	30	93.3

Table 3: Frequency Hopping Radar Test Waveform

Radar Type	Pulse Width (μsec)	PRI (μsec)	Pulses per Hop	Hopping Rate (kHz)	Hopping Sequence Length (msec)	Number of Trials(Times)	Percentage of Successful Detection (%)
6	1	333	9	0.333	300	30	96.6



802.11ax (HE80+80)(CH106+CH122)

Table 1: Short Pulse Radar Test Waveforms

Radar Type	Pulse Width (μsec)	PRI (μsec)	Number of Pulses	Number of Trials(Times)	Percentage of Successful Detection (%)
1	1	Test A 15 unique PRI values randomly selected from the list of 23 PRI values	Roundup $\left\{ \begin{matrix} \left(\frac{1}{360} \right) \cdot \\ \left(\frac{19 \cdot 10^6}{\text{PRI}_{\mu\text{sec}}} \right) \end{matrix} \right\}$	30	96.6
		15 unique PRI values randomly selected within the range of 518~3066 μ sec with a minimum of 1 μ sec, excluding PRI values selected in Test A			
2	1-5	150-230	23-29	30	96.6
3	6-10	200-500	16-18	30	86.6
4	11-20	200-500	12-16	30	80.0
Aggregate (Radar Types 1-4)				120	89.9

Table 2: Long Pulse Radar Test Waveform

Radar Type	Pulse Width (μsec)	Chirp Width (MHz)	PRI (μsec)	Number of Pulses per Burst	Number of Bursts	Number of Trials(Times)	Percentage of Successful Detection (%)
5	50-100	5-20	1000-2000	1-3	8-20	30	96.6

Table 3: Frequency Hopping Radar Test Waveform

Radar Type	Pulse Width (μsec)	PRI (μsec)	Pulses per Hop	Hopping Rate (kHz)	Hopping Sequence Length (msec)	Number of Trials(Times)	Percentage of Successful Detection (%)
6	1	333	9	0.333	300	30	93.3

802.11ax (HE80+80)

Radar signal 0

Channel Closing Transmission Time & Channel Move Time

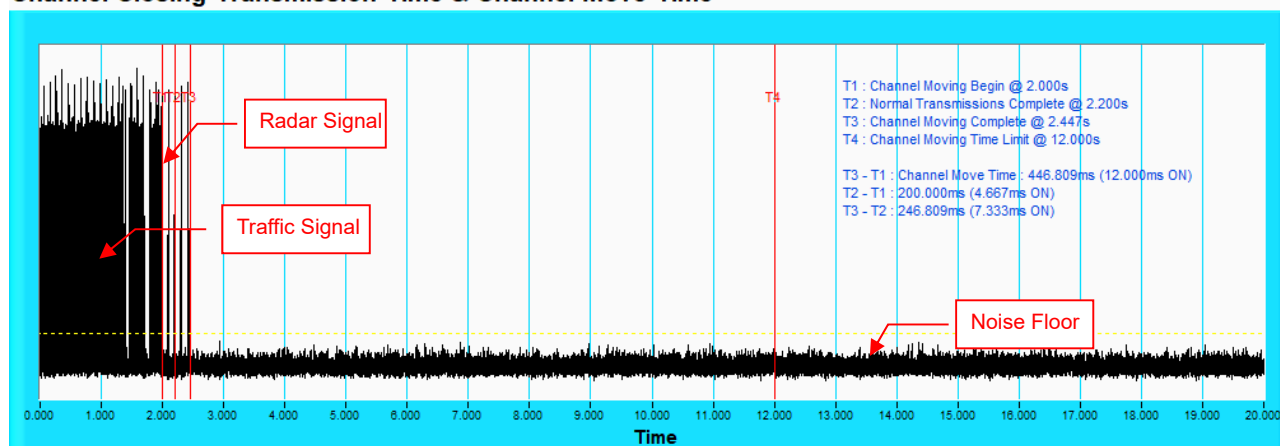

NOTE: T1 denotes the start of Channel Move Time upon the end of the last Radar burst. T2 denotes the data transmission time of 200 ms from T1. T3 denotes the end of Channel Move Time. T4 denotes the 10 second from T1 to observe the aggregate duration of transmissions.

Channel Closing Transmission Time & Channel Move Time

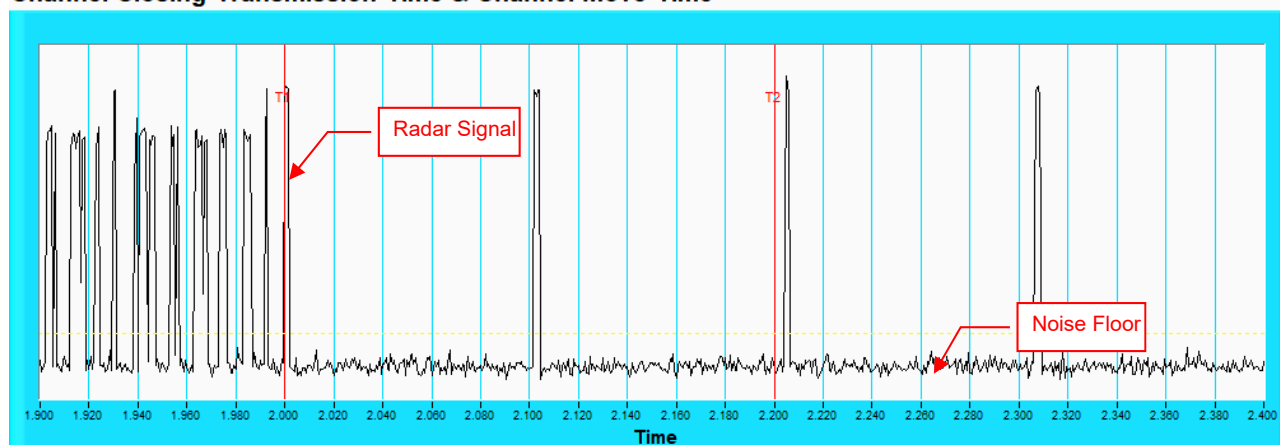

NOTE: Zoom in of the first 500 ms after radar signal applied.

Radar signal 1

Channel Closing Transmission Time & Channel Move Time

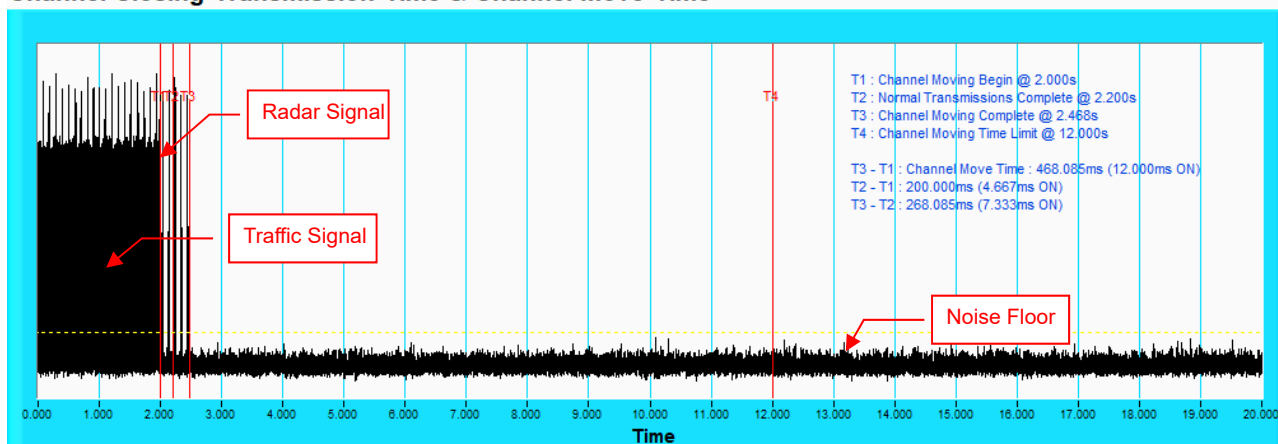

NOTE: T1 denotes the start of Channel Move Time upon the end of the last Radar burst. T2 denotes the data transmission time of 200 ms from T1. T3 denotes the end of Channel Move Time. T4 denotes the 10 second from T1 to observe the aggregate duration of transmissions.

Channel Closing Transmission Time & Channel Move Time

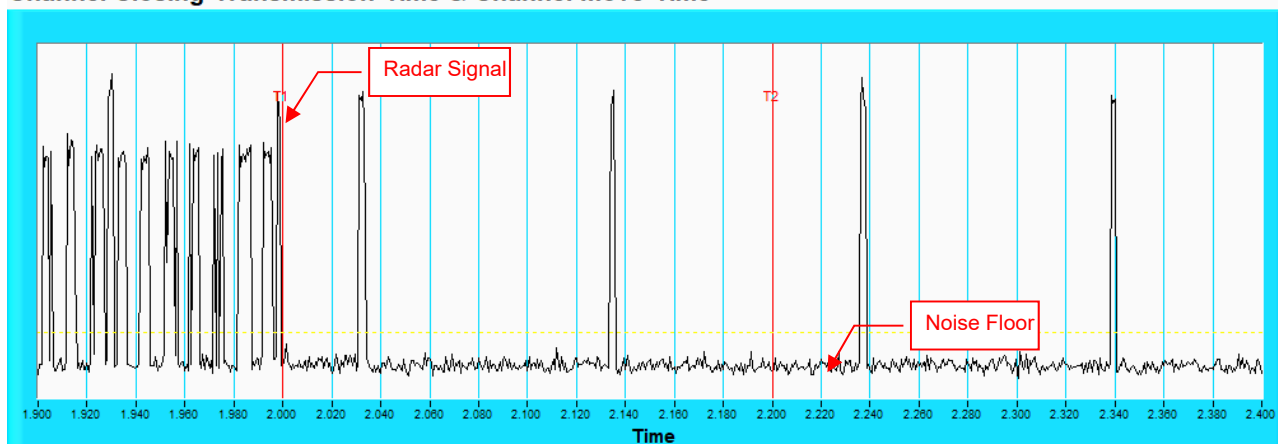

NOTE: Zoom in of the first 500 ms after radar signal applied.

Radar signal 2

Channel Closing Transmission Time & Channel Move Time

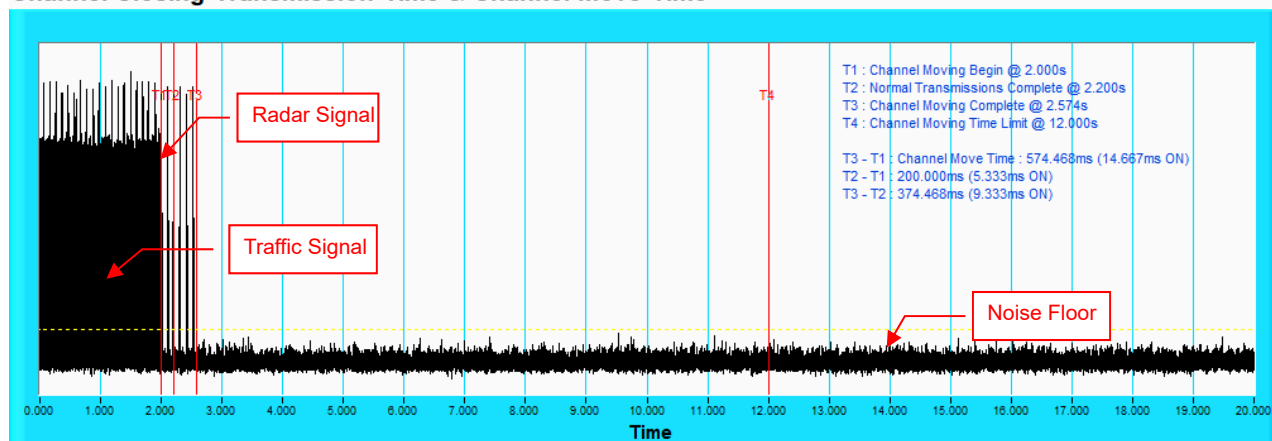

NOTE: T1 denotes the start of Channel Move Time upon the end of the last Radar burst. T2 denotes the data transmission time of 200 ms from T1. T3 denotes the end of Channel Move Time. T4 denotes the 10 second from T1 to observe the aggregate duration of transmissions.

Channel Closing Transmission Time & Channel Move Time

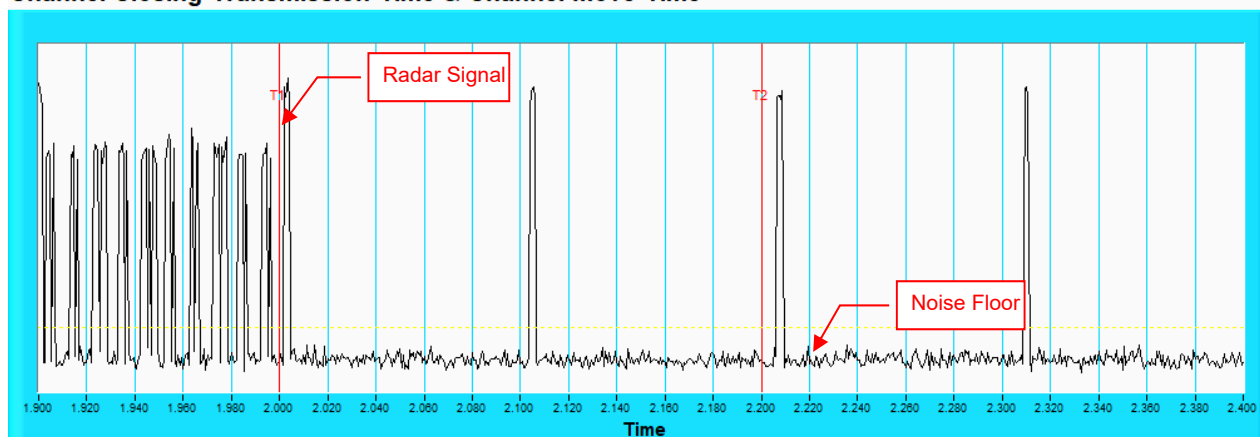

NOTE: Zoom in of the first 500 ms after radar signal applied.

Radar signal 3

Channel Closing Transmission Time & Channel Move Time

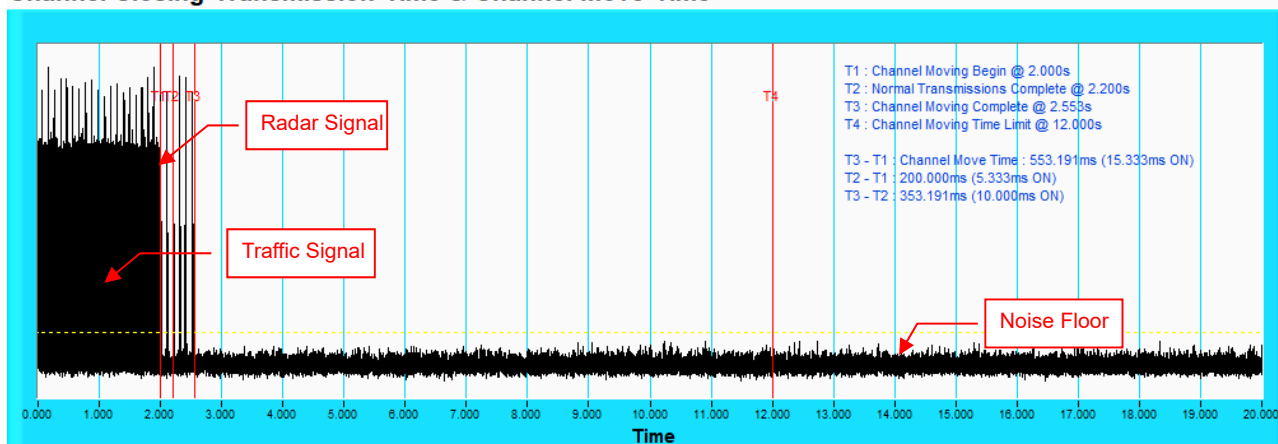

NOTE: T1 denotes the start of Channel Move Time upon the end of the last Radar burst. T2 denotes the data transmission time of 200 ms from T1. T3 denotes the end of Channel Move Time. T4 denotes the 10 second from T1 to observe the aggregate duration of transmissions.

Channel Closing Transmission Time & Channel Move Time

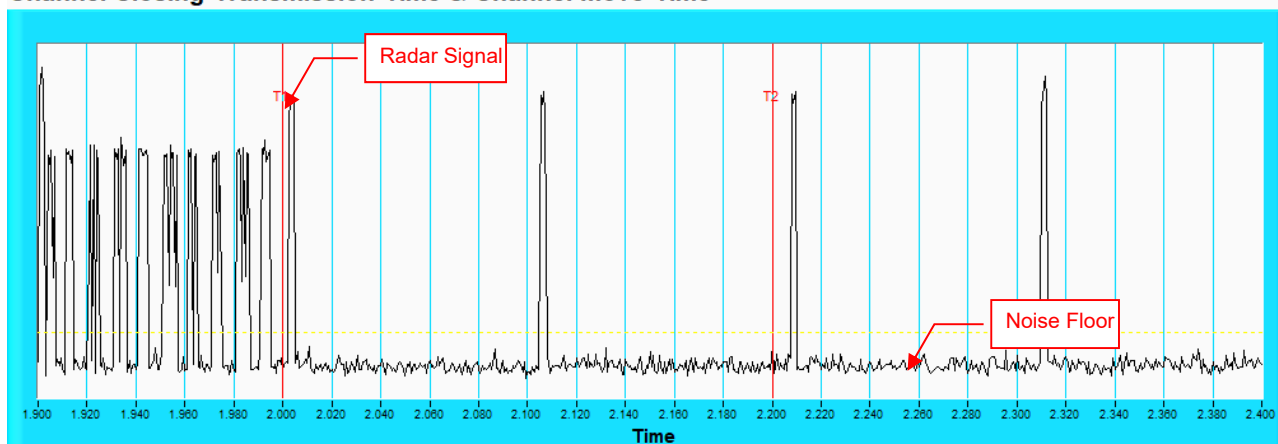

NOTE: Zoom in of the first 500 ms after radar signal applied.

Radar signal 4

Channel Closing Transmission Time & Channel Move Time

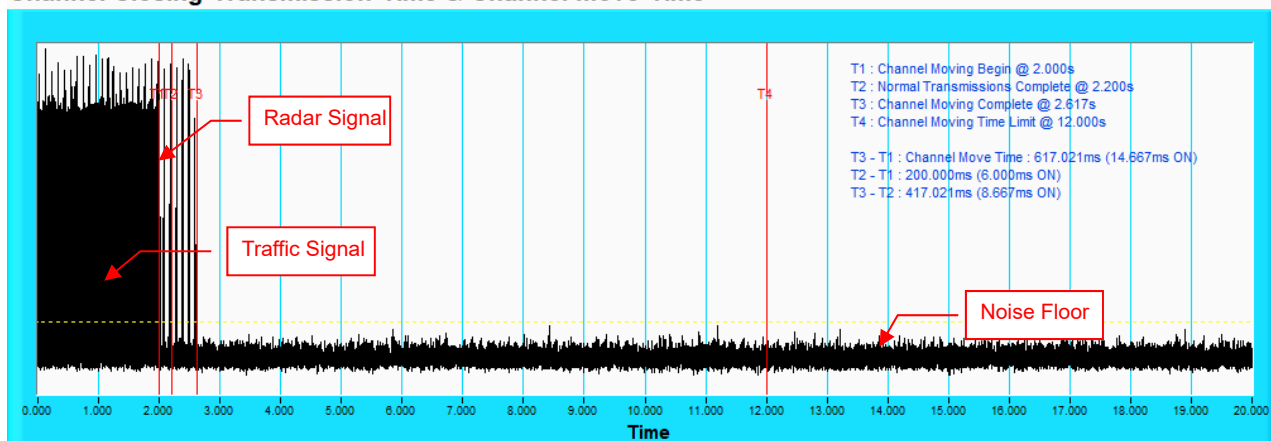

NOTE: T1 denotes the start of Channel Move Time upon the end of the last Radar burst. T2 denotes the data transmission time of 200 ms from T1. T3 denotes the end of Channel Move Time. T4 denotes the 10 second from T1 to observe the aggregate duration of transmissions.

Channel Closing Transmission Time & Channel Move Time

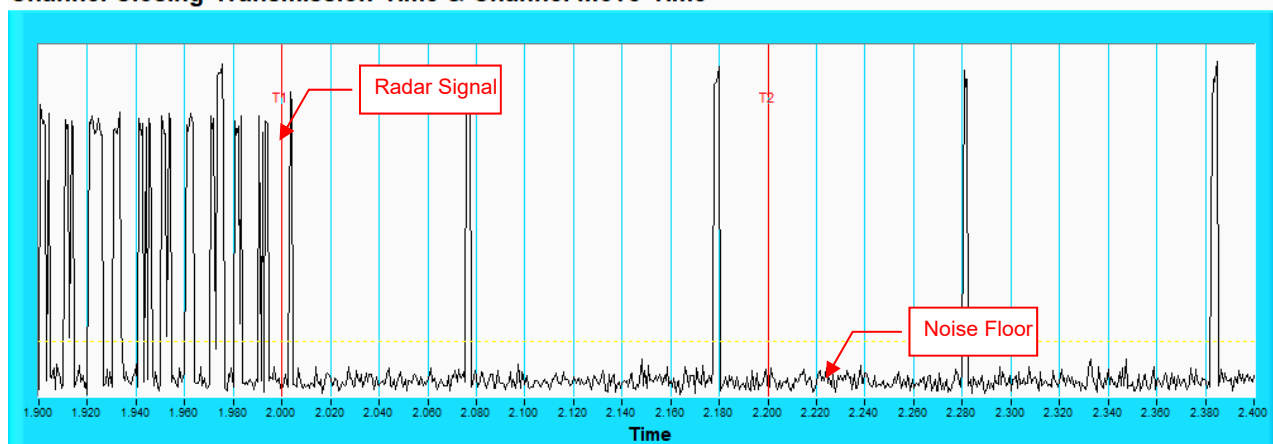

NOTE: Zoom in of the first 500 ms after radar signal applied.



802.11ax (HE20)

Type 1 Radar Statistical Performances

Trial #	Test Frequency (MHz)	Pulse Repetition Frequency Number (1 to 23)	Pulse Repetition Frequency (pps)	Pulses per Burst	Pulse Repetition Interval (µsec)	Detection
1	5500	5	1672.2	89	598	Yes
2	5506	21	1089.3	58	918	Yes
3	5500	14	1285.3	68	778	Yes
4	5501	23	326.2	18	3066	Yes
5	5501	10	1432.7	76	698	Yes
6	5505	13	1319.3	70	758	Yes
7	5496	16	1222.5	65	818	Yes
8	5495	15	1253.1	67	798	Yes
9	5503	11	1392.8	74	718	Yes
10	5494	3	1792.1	95	558	Yes
11	5507	22	1066.1	57	938	Yes
12	5494	7	1567.4	83	638	Yes
13	5500	17	1193.3	63	838	Yes
14	5503	18	1165.6	62	858	Yes
15	5495	9	1474.9	78	678	Yes
16	5503	-	1524.4	81	656	Yes
17	5499	-	749.6	40	1334	Yes
18	5505	-	1811.6	96	552	Yes
19	5498	-	660.5	35	1514	Yes
20	5495	-	364.2	20	2746	Yes
21	5502	-	960.6	51	1041	Yes
22	5498	-	344.1	19	2906	Yes
23	5498	-	421.2	23	2374	Yes
24	5503	-	751.3	40	1331	Yes
25	5503	-	513.3	28	1948	Yes
26	5494	-	1026.7	55	974	Yes
27	5498	-	409.3	22	2443	No
28	5507	-	557.4	30	1794	Yes
29	5492	-	874.1	47	1144	Yes
30	5502	-	473.5	25	2112	Yes

Detection Rate : 96.6%

Note. " - " : 15 unique PRI values randomly selected within the range of 518-3066 µsec, with a minimum increment of 1µsec, excluding PRI values selected in Test A



802.11ax (HE20)

Type 2 Radar Statistical Performances

Trial #	Test Frequency (MHz)	Pulses per Burst	Pulse Width(us)	PRI(us)	Detection
1	5500	28	4.2	228	Yes
2	5505	24	1.6	202	Yes
3	5504	24	1.9	193	Yes
4	5503	29	4.6	189	Yes
5	5499	26	3	167	Yes
6	5506	25	2.6	180	Yes
7	5498	23	1.4	165	No
8	5494	29	5	190	Yes
9	5497	23	1.2	168	Yes
10	5505	26	3	224	Yes
11	5498	27	3.9	187	Yes
12	5501	29	5	171	Yes
13	5504	28	4.3	223	Yes
14	5499	26	2.9	216	Yes
15	5499	26	2.9	219	Yes
16	5503	27	3.6	169	Yes
17	5506	25	2.5	199	Yes
18	5505	26	3	151	Yes
19	5497	25	2.4	198	Yes
20	5502	29	5	207	Yes
21	5504	23	1.5	162	Yes
22	5499	29	5	161	No
23	5502	24	1.8	194	Yes
24	5495	28	4.1	178	Yes
25	5505	24	1.6	170	Yes
26	5498	27	3.4	195	Yes
27	5504	25	2.7	212	Yes
28	5504	24	1.7	196	Yes
29	5503	26	2.8	217	Yes
30	5497	24	1.8	183	Yes

Detection Rate : 93.3%



802.11ax (HE20)

Type 3 Radar Statistical Performances

Trial #	Test Frequency (MHz)	Pulses per Burst	Pulse Width(us)	PRI(us)	Detection
1	5500	18	9.2	258	No
2	5501	16	6.6	493	Yes
3	5495	16	6.9	359	Yes
4	5496	18	9.6	397	Yes
5	5504	17	8	355	Yes
6	5495	17	7.6	428	Yes
7	5498	16	6.4	271	Yes
8	5504	18	10	371	Yes
9	5500	16	6.2	430	No
10	5496	17	8	272	Yes
11	5494	18	8.9	202	Yes
12	5503	18	10	264	No
13	5498	18	9.3	207	Yes
14	5499	17	7.9	456	Yes
15	5504	17	7.9	291	Yes
16	5503	17	8.6	411	Yes
17	5503	17	7.5	368	Yes
18	5502	17	8	241	Yes
19	5500	17	7.4	467	Yes
20	5500	18	10	339	Yes
21	5500	16	6.5	500	Yes
22	5508	18	10	358	Yes
23	5502	16	6.8	251	Yes
24	5503	18	9.1	230	Yes
25	5498	16	6.6	285	Yes
26	5500	17	8.4	426	Yes
27	5503	17	7.7	350	Yes
28	5498	16	6.7	434	Yes
29	5507	17	7.8	491	Yes
30	5494	16	6.8	438	Yes

Detection Rate : 90%



802.11ax (HE20)

Type 4 Radar Statistical Performances

Trial #	Test Frequency (MHz)	Pulses per Burst	Pulse Width(us)	PRI(us)	Detection
1	5500	15	18.1	258	Yes
2	5504	12	12.3	493	No
3	5499	13	13.2	359	No
4	5500	16	19.1	397	No
5	5507	14	15.4	355	Yes
6	5499	14	14.6	428	Yes
7	5498	12	11.9	271	Yes
8	5495	16	19.9	371	No
9	5495	12	11.6	430	Yes
10	5502	14	15.4	272	No
11	5502	15	17.4	202	Yes
12	5500	16	19.9	264	Yes
13	5497	16	18.4	207	Yes
14	5502	14	15.3	456	Yes
15	5505	14	15.3	291	Yes
16	5505	15	16.8	411	Yes
17	5506	13	14.3	368	Yes
18	5499	14	15.5	241	Yes
19	5503	13	14.2	467	Yes
20	5506	16	20	339	Yes
21	5506	12	12.2	500	Yes
22	5499	16	19.9	358	Yes
23	5501	13	12.9	251	Yes
24	5502	15	17.9	230	Yes
25	5494	12	12.3	285	Yes
26	5498	15	16.5	426	Yes
27	5497	14	14.8	350	Yes
28	5493	12	12.6	434	Yes
29	5504	14	15.1	491	Yes
30	5501	13	12.9	438	Yes

Detection Rate : 83.3%



802.11ax (HE20)

Type 5 Radar Statistical Performances				
Trial #	Minimum Chirp Width(MHz)	Chirp Center Frequency(MHz)	Test Signal Name	Detection
1	7	5500	LP_Signal_01	Yes
2	15	5500	LP_Signal_02	Yes
3	16	5500	LP_Signal_03	Yes
4	18	5500	LP_Signal_04	Yes
5	8	5500	LP_Signal_05	Yes
6	5	5500	LP_Signal_06	Yes
7	18	5500	LP_Signal_07	Yes
8	12	5500	LP_Signal_08	Yes
9	12	5500	LP_Signal_09	Yes
10	15	5500	LP_Signal_10	Yes
11	5	5492	LP_Signal_11	Yes
12	6	5492	LP_Signal_12	Yes
13	11	5494	LP_Signal_13	Yes
14	18	5497	LP_Signal_14	Yes
15	20	5498	LP_Signal_15	Yes
16	13	5495	LP_Signal_16	Yes
17	9	5494	LP_Signal_17	Yes
18	11	5494	LP_Signal_18	Yes
19	8	5493	LP_Signal_19	No
20	5	5492	LP_Signal_20	Yes
21	12	5505	LP_Signal_21	Yes
22	17	5503	LP_Signal_22	Yes
23	10	5506	LP_Signal_23	Yes
24	5	5508	LP_Signal_24	Yes
25	15	5504	LP_Signal_25	No
26	11	5506	LP_Signal_26	Yes
27	7	5507	LP_Signal_27	No
28	6	5508	LP_Signal_28	Yes
29	6	5508	LP_Signal_29	Yes
30	8	5507	LP_Signal_30	Yes

Detection Rate : 90%

Note: The Long Pulse Radar pattern shown in Appendix A.1



802.11ax (HE20)

Type 6 Radar Statistical Performances					
Trial #	Pulses per Burst	Pulse Width(us)	PRI(us)	Hopping Frequency Sequence Name	Detection
1	9	1	333.3	HOP_FREQ_SEQ_01	Yes
2	9	1	333.3	HOP_FREQ_SEQ_02	Yes
3	9	1	333.3	HOP_FREQ_SEQ_03	Yes
4	9	1	333.3	HOP_FREQ_SEQ_04	Yes
5	9	1	333.3	HOP_FREQ_SEQ_05	Yes
6	9	1	333.3	HOP_FREQ_SEQ_06	Yes
7	9	1	333.3	HOP_FREQ_SEQ_07	Yes
8	9	1	333.3	HOP_FREQ_SEQ_08	Yes
9	9	1	333.3	HOP_FREQ_SEQ_09	Yes
10	9	1	333.3	HOP_FREQ_SEQ_10	Yes
11	9	1	333.3	HOP_FREQ_SEQ_11	Yes
12	9	1	333.3	HOP_FREQ_SEQ_12	Yes
13	9	1	333.3	HOP_FREQ_SEQ_13	Yes
14	9	1	333.3	HOP_FREQ_SEQ_14	Yes
15	9	1	333.3	HOP_FREQ_SEQ_15	Yes
16	9	1	333.3	HOP_FREQ_SEQ_16	Yes
17	9	1	333.3	HOP_FREQ_SEQ_17	Yes
18	9	1	333.3	HOP_FREQ_SEQ_18	Yes
19	9	1	333.3	HOP_FREQ_SEQ_19	Yes
20	9	1	333.3	HOP_FREQ_SEQ_20	Yes
21	9	1	333.3	HOP_FREQ_SEQ_21	Yes
22	9	1	333.3	HOP_FREQ_SEQ_22	Yes
23	9	1	333.3	HOP_FREQ_SEQ_23	Yes
24	9	1	333.3	HOP_FREQ_SEQ_24	Yes
25	9	1	333.3	HOP_FREQ_SEQ_25	Yes
26	9	1	333.3	HOP_FREQ_SEQ_26	No
27	9	1	333.3	HOP_FREQ_SEQ_27	Yes
28	9	1	333.3	HOP_FREQ_SEQ_28	Yes
29	9	1	333.3	HOP_FREQ_SEQ_29	Yes
30	9	1	333.3	HOP_FREQ_SEQ_30	No

Detection Rate : 93.3%

Note: The Frequency Hopping Radar pattern shown in Appendix A.2



802.11ax (HE40)

Type 1 Radar Statistical Performances

Trial #	Test Frequency (MHz)	Pulse Repetition Frequency Number (1 to 23)	Pulse Repetition Frequency (pps)	Pulses per Burst	Pulse Repetition Interval (µsec)	Detection
1	5510	5	1672.2	89	598	Yes
2	5520	21	1089.3	58	918	Yes
3	5500	14	1285.3	68	778	Yes
4	5520	23	326.2	18	3066	Yes
5	5514	10	1432.7	76	698	Yes
6	5520	13	1319.3	70	758	Yes
7	5507	16	1222.5	65	818	Yes
8	5502	15	1253.1	67	798	Yes
9	5510	11	1392.8	74	718	Yes
10	5496	3	1792.1	95	558	Yes
11	5502	22	1066.1	57	938	Yes
12	5507	7	1567.4	83	638	Yes
13	5500	17	1193.3	63	838	Yes
14	5495	18	1165.6	62	858	Yes
15	5522	9	1474.9	78	678	No
16	5501	-	1524.4	81	656	Yes
17	5520	-	749.6	40	1334	Yes
18	5499	-	1811.6	96	552	Yes
19	5513	-	660.5	35	1514	Yes
20	5510	-	364.2	20	2746	Yes
21	5524	-	960.6	51	1041	Yes
22	5522	-	344.1	19	2906	Yes
23	5508	-	421.2	23	2374	Yes
24	5510	-	751.3	40	1331	Yes
25	5512	-	513.3	28	1948	Yes
26	5497	-	1026.7	55	974	No
27	5517	-	409.3	22	2443	Yes
28	5524	-	557.4	30	1794	Yes
29	5515	-	874.1	47	1144	Yes
30	5520	-	473.5	25	2112	Yes

Detection Rate : 93.3%

Note. " - " : 15 unique PRI values randomly selected within the range of 518-3066 µsec, with a minimum increment of 1µsec, excluding PRI values selected in Test A



802.11ax (HE40)

Type 2 Radar Statistical Performances

Trial #	Test Frequency (MHz)	Pulses per Burst	Pulse Width(us)	PRI(us)	Detection
1	5510	28	4.2	228	Yes
2	5520	24	1.6	202	Yes
3	5500	24	1.9	193	Yes
4	5512	29	4.6	189	Yes
5	5495	26	3	167	Yes
6	5517	25	2.6	180	Yes
7	5503	23	1.4	165	Yes
8	5518	29	5	190	Yes
9	5511	23	1.2	168	Yes
10	5501	26	3	224	Yes
11	5502	27	3.9	187	No
12	5495	29	5	171	No
13	5505	28	4.3	223	Yes
14	5502	26	2.9	216	Yes
15	5514	26	2.9	219	Yes
16	5503	27	3.6	169	Yes
17	5504	25	2.5	199	Yes
18	5511	26	3	151	Yes
19	5510	25	2.4	198	Yes
20	5506	29	5	207	Yes
21	5524	23	1.5	162	Yes
22	5521	29	5	161	Yes
23	5508	24	1.8	194	Yes
24	5497	28	4.1	178	Yes
25	5502	24	1.6	170	Yes
26	5499	27	3.4	195	Yes
27	5515	25	2.7	212	Yes
28	5499	24	1.7	196	Yes
29	5518	26	2.8	217	Yes
30	5507	24	1.8	183	Yes

Detection Rate : 93.3%



802.11ax (HE40)

Type 3 Radar Statistical Performances

Trial #	Test Frequency (MHz)	Pulses per Burst	Pulse Width(us)	PRI(us)	Detection
1	5510	18	9.2	258	Yes
2	5520	16	6.6	493	Yes
3	5500	16	6.9	359	Yes
4	5512	18	9.6	397	Yes
5	5521	17	8	355	Yes
6	5516	17	7.6	428	Yes
7	5518	16	6.4	271	Yes
8	5499	18	10	371	Yes
9	5498	16	6.2	430	Yes
10	5504	17	8	272	Yes
11	5508	18	8.9	202	Yes
12	5516	18	10	264	Yes
13	5525	18	9.3	207	Yes
14	5515	17	7.9	456	Yes
15	5507	17	7.9	291	Yes
16	5497	17	8.6	411	Yes
17	5499	17	7.5	368	No
18	5503	17	8	241	Yes
19	5507	17	7.4	467	Yes
20	5497	18	10	339	Yes
21	5524	16	6.5	500	Yes
22	5513	18	10	358	Yes
23	5500	16	6.8	251	Yes
24	5500	18	9.1	230	Yes
25	5518	16	6.6	285	No
26	5519	17	8.4	426	Yes
27	5514	17	7.7	350	Yes
28	5516	16	6.7	434	No
29	5517	17	7.8	491	Yes
30	5525	16	6.8	438	Yes

Detection Rate : 90%



802.11ax (HE40)

Type 4 Radar Statistical Performances

Trial #	Test Frequency (MHz)	Pulses per Burst	Pulse Width(us)	PRI(us)	Detection
1	5510	15	18.1	258	Yes
2	5520	12	12.3	493	Yes
3	5500	13	13.2	359	Yes
4	5520	16	19.1	397	Yes
5	5521	14	15.4	355	Yes
6	5521	14	14.6	428	Yes
7	5522	12	11.9	271	Yes
8	5503	16	19.9	371	Yes
9	5508	12	11.6	430	Yes
10	5519	14	15.4	272	Yes
11	5514	15	17.4	202	Yes
12	5523	16	19.9	264	No
13	5508	16	18.4	207	Yes
14	5515	14	15.3	456	Yes
15	5509	14	15.3	291	No
16	5523	15	16.8	411	Yes
17	5519	13	14.3	368	Yes
18	5503	14	15.5	241	Yes
19	5512	13	14.2	467	Yes
20	5515	16	20	339	Yes
21	5513	12	12.2	500	Yes
22	5516	16	19.9	358	Yes
23	5499	13	12.9	251	Yes
24	5521	15	17.9	230	Yes
25	5514	12	12.3	285	Yes
26	5498	15	16.5	426	Yes
27	5511	14	14.8	350	No
28	5499	12	12.6	434	Yes
29	5497	14	15.1	491	Yes
30	5510	13	12.9	438	No

Detection Rate : 86.6%



802.11ax (HE40)

Type 5 Radar Statistical Performances

Trial #	Minimum Chirp Width(MHz)	Chirp Center Frequency(MHz)	Test Signal Name	Detection
1	8	5510	LP_Signal_01	Yes
2	9	5510	LP_Signal_02	Yes
3	7	5510	LP_Signal_03	Yes
4	9	5510	LP_Signal_04	Yes
5	7	5510	LP_Signal_05	Yes
6	17	5510	LP_Signal_06	Yes
7	17	5510	LP_Signal_07	Yes
8	12	5510	LP_Signal_08	Yes
9	16	5510	LP_Signal_09	Yes
10	11	5510	LP_Signal_10	Yes
11	12	5496	LP_Signal_11	No
12	15	5497	LP_Signal_12	Yes
13	17	5498	LP_Signal_13	Yes
14	19	5499	LP_Signal_14	Yes
15	11	5495	LP_Signal_15	Yes
16	17	5498	LP_Signal_16	Yes
17	6	5493	LP_Signal_17	Yes
18	15	5497	LP_Signal_18	Yes
19	9	5495	LP_Signal_19	Yes
20	18	5498	LP_Signal_20	Yes
21	16	5523	LP_Signal_21	Yes
22	8	5526	LP_Signal_22	Yes
23	16	5523	LP_Signal_23	No
24	16	5523	LP_Signal_24	Yes
25	18	5522	LP_Signal_25	Yes
26	15	5523	LP_Signal_26	Yes
27	18	5522	LP_Signal_27	Yes
28	10	5525	LP_Signal_28	Yes
29	14	5523	LP_Signal_29	Yes
30	17	5522	LP_Signal_30	Yes

Detection Rate : 93.3%

Note: The Long Pulse Radar pattern shown in Appendix A.1



802.11ax (HE40)

Type 6 Radar Statistical Performances

Trial #	Pulses per Burst	Pulse Width(us)	PRI(us)	Hopping Frequency Sequence Name	Detection
1	9	1	333.3	HOP_FREQ_SEQ_01	Yes
2	9	1	333.3	HOP_FREQ_SEQ_02	Yes
3	9	1	333.3	HOP_FREQ_SEQ_03	Yes
4	9	1	333.3	HOP_FREQ_SEQ_04	No
5	9	1	333.3	HOP_FREQ_SEQ_05	Yes
6	9	1	333.3	HOP_FREQ_SEQ_06	Yes
7	9	1	333.3	HOP_FREQ_SEQ_07	Yes
8	9	1	333.3	HOP_FREQ_SEQ_08	Yes
9	9	1	333.3	HOP_FREQ_SEQ_09	Yes
10	9	1	333.3	HOP_FREQ_SEQ_10	Yes
11	9	1	333.3	HOP_FREQ_SEQ_11	Yes
12	9	1	333.3	HOP_FREQ_SEQ_12	Yes
13	9	1	333.3	HOP_FREQ_SEQ_13	Yes
14	9	1	333.3	HOP_FREQ_SEQ_14	Yes
15	9	1	333.3	HOP_FREQ_SEQ_15	Yes
16	9	1	333.3	HOP_FREQ_SEQ_16	Yes
17	9	1	333.3	HOP_FREQ_SEQ_17	Yes
18	9	1	333.3	HOP_FREQ_SEQ_18	No
19	9	1	333.3	HOP_FREQ_SEQ_19	Yes
20	9	1	333.3	HOP_FREQ_SEQ_20	Yes
21	9	1	333.3	HOP_FREQ_SEQ_21	Yes
22	9	1	333.3	HOP_FREQ_SEQ_22	Yes
23	9	1	333.3	HOP_FREQ_SEQ_23	Yes
24	9	1	333.3	HOP_FREQ_SEQ_24	Yes
25	9	1	333.3	HOP_FREQ_SEQ_25	Yes
26	9	1	333.3	HOP_FREQ_SEQ_26	Yes
27	9	1	333.3	HOP_FREQ_SEQ_27	Yes
28	9	1	333.3	HOP_FREQ_SEQ_28	Yes
29	9	1	333.3	HOP_FREQ_SEQ_29	Yes
30	9	1	333.3	HOP_FREQ_SEQ_30	Yes

Detection Rate : 93.3%

Note: The Frequency Hopping Radar pattern shown in Appendix A.2



802.11ax (HE80)

Type 1 Radar Statistical Performances

Trial #	Test Frequency (MHz)	Pulse Repetition Frequency Number (1 to 23)	Pulse Repetition Frequency (pps)	Pulses per Burst	Pulse Repetition Interval (µsec)	Detection
1	5530	5	1672.2	89	598	Yes
2	5540	21	1089.3	58	918	Yes
3	5560	14	1285.3	68	778	Yes
4	5520	23	326.2	18	3066	Yes
5	5500	10	1432.7	76	698	Yes
6	5504	13	1319.3	70	758	Yes
7	5535	16	1222.5	65	818	Yes
8	5543	15	1253.1	67	798	Yes
9	5529	11	1392.8	74	718	Yes
10	5517	3	1792.1	95	558	Yes
11	5536	22	1066.1	57	938	Yes
12	5518	7	1567.4	83	638	Yes
13	5518	17	1193.3	63	838	Yes
14	5541	18	1165.6	62	858	Yes
15	5525	9	1474.9	78	678	Yes
16	5514	-	1524.4	81	656	Yes
17	5519	-	749.6	40	1334	Yes
18	5529	-	1811.6	96	552	Yes
19	5505	-	660.5	35	1514	No
20	5544	-	364.2	20	2746	Yes
21	5555	-	960.6	51	1041	Yes
22	5519	-	344.1	19	2906	Yes
23	5519	-	421.2	23	2374	Yes
24	5509	-	751.3	40	1331	Yes
25	5523	-	513.3	28	1948	Yes
26	5520	-	1026.7	55	974	No
27	5503	-	409.3	22	2443	Yes
28	5510	-	557.4	30	1794	Yes
29	5516	-	874.1	47	1144	Yes
30	5554	-	473.5	25	2112	Yes

Detection Rate : 93.3%

Note. " - " : 15 unique PRI values randomly selected within the range of 518-3066 µsec, with a minimum increment of 1µsec, excluding PRI values selected in Test A

802.11ax (HE80)

Type 2 Radar Statistical Performances					
Trial #	Test Frequency (MHz)	Pulses per Burst	Pulse Width(us)	PRI(us)	Detection
1	5530	28	4.2	228	Yes
2	5540	24	1.6	202	Yes
3	5560	24	1.9	193	Yes
4	5520	29	4.6	189	No
5	5500	26	3	167	Yes
6	5547	25	2.6	180	Yes
7	5520	23	1.4	165	Yes
8	5508	29	5	190	Yes
9	5545	23	1.2	168	Yes
10	5555	26	3	224	Yes
11	5508	27	3.9	187	Yes
12	5522	29	5	171	Yes
13	5542	28	4.3	223	No
14	5520	26	2.9	216	Yes
15	5518	26	2.9	219	Yes
16	5524	27	3.6	169	Yes
17	5531	25	2.5	199	Yes
18	5545	26	3	151	Yes
19	5552	25	2.4	198	Yes
20	5516	29	5	207	Yes
21	5539	23	1.5	162	Yes
22	5535	29	5	161	Yes
23	5522	24	1.8	194	Yes
24	5523	28	4.1	178	Yes
25	5555	24	1.6	170	Yes
26	5502	27	3.4	195	Yes
27	5521	25	2.7	212	Yes
28	5502	24	1.7	196	Yes
29	5507	26	2.8	217	Yes
30	5526	24	1.8	183	Yes

Detection Rate : 93.3%



802.11ax (HE80)

Type 3 Radar Statistical Performances

Trial #	Test Frequency (MHz)	Pulses per Burst	Pulse Width(us)	PRI(us)	Detection
1	5530	18	9.2	258	Yes
2	5540	16	6.6	493	Yes
3	5560	16	6.9	359	Yes
4	5520	18	9.6	397	Yes
5	5500	17	8	355	No
6	5549	17	7.6	428	Yes
7	5560	16	6.4	271	Yes
8	5539	18	10	371	Yes
9	5500	16	6.2	430	Yes
10	5519	17	8	272	Yes
11	5505	18	8.9	202	Yes
12	5511	18	10	264	Yes
13	5560	18	9.3	207	Yes
14	5525	17	7.9	456	Yes
15	5533	17	7.9	291	Yes
16	5557	17	8.6	411	Yes
17	5520	17	7.5	368	No
18	5521	17	8	241	Yes
19	5525	17	7.4	467	Yes
20	5511	18	10	339	Yes
21	5554	16	6.5	500	Yes
22	5500	18	10	358	Yes
23	5507	16	6.8	251	Yes
24	5503	18	9.1	230	Yes
25	5529	16	6.6	285	No
26	5551	17	8.4	426	Yes
27	5527	17	7.7	350	No
28	5535	16	6.7	434	Yes
29	5533	17	7.8	491	Yes
30	5537	16	6.8	438	Yes

Detection Rate : 86.6%



802.11ax (HE80)

Type 4 Radar Statistical Performances

Trial #	Test Frequency (MHz)	Pulses per Burst	Pulse Width(us)	PRI(us)	Detection
1	5530	15	18.1	258	Yes
2	5540	12	12.3	493	Yes
3	5560	13	13.2	359	Yes
4	5520	16	19.1	397	Yes
5	5500	14	15.4	355	Yes
6	5504	14	14.6	428	Yes
7	5560	12	11.9	271	Yes
8	5511	16	19.9	371	No
9	5510	12	11.6	430	Yes
10	5502	14	15.4	272	Yes
11	5514	15	17.4	202	Yes
12	5534	16	19.9	264	Yes
13	5525	16	18.4	207	Yes
14	5524	14	15.3	456	Yes
15	5529	14	15.3	291	Yes
16	5528	15	16.8	411	Yes
17	5524	13	14.3	368	Yes
18	5556	14	15.5	241	Yes
19	5521	13	14.2	467	Yes
20	5539	16	20	339	Yes
21	5516	12	12.2	500	Yes
22	5546	16	19.9	358	Yes
23	5511	13	12.9	251	Yes
24	5550	15	17.9	230	Yes
25	5513	12	12.3	285	Yes
26	5501	15	16.5	426	Yes
27	5522	14	14.8	350	Yes
28	5511	12	12.6	434	Yes
29	5500	14	15.1	491	Yes
30	5541	13	12.9	438	Yes

Detection Rate : 96.6%



802.11ax (HE80)

Type 5 Radar Statistical Performances				
Trial #	Minimum Chirp Width(MHz)	Chirp Center Frequency(MHz)	Test Signal Name	Detection
1	9	5530	LP_Signal_01	No
2	18	5530	LP_Signal_02	Yes
3	13	5530	LP_Signal_03	Yes
4	15	5530	LP_Signal_04	Yes
5	5	5530	LP_Signal_05	Yes
6	13	5530	LP_Signal_06	Yes
7	15	5530	LP_Signal_07	Yes
8	12	5530	LP_Signal_08	Yes
9	20	5530	LP_Signal_09	Yes
10	6	5530	LP_Signal_10	Yes
11	20	5498	LP_Signal_11	Yes
12	8	5493	LP_Signal_12	Yes
13	7	5493	LP_Signal_13	Yes
14	20	5498	LP_Signal_14	Yes
15	17	5497	LP_Signal_15	Yes
16	5	5492	LP_Signal_16	Yes
17	20	5498	LP_Signal_17	Yes
18	19	5498	LP_Signal_18	Yes
19	10	5494	LP_Signal_19	Yes
20	14	5496	LP_Signal_20	Yes
21	5	5568	LP_Signal_21	Yes
22	16	5564	LP_Signal_22	No
23	5	5568	LP_Signal_23	Yes
24	11	5566	LP_Signal_24	Yes
25	5	5568	LP_Signal_25	Yes
26	20	5562	LP_Signal_26	Yes
27	14	5564	LP_Signal_27	Yes
28	13	5565	LP_Signal_28	Yes
29	7	5567	LP_Signal_29	Yes
30	11	5566	LP_Signal_30	Yes

Detection Rate : 93.3%

Note: The Long Pulse Radar pattern shown in Appendix A.1



802.11ax (HE80)

Type 6 Radar Statistical Performances

Trial #	Pulses per Burst	Pulse Width(us)	PRI(us)	Hopping Frequency Sequence Name	Detection
1	9	1	333.3	HOP_FREQ_SEQ_01	Yes
2	9	1	333.3	HOP_FREQ_SEQ_02	Yes
3	9	1	333.3	HOP_FREQ_SEQ_03	Yes
4	9	1	333.3	HOP_FREQ_SEQ_04	Yes
5	9	1	333.3	HOP_FREQ_SEQ_05	Yes
6	9	1	333.3	HOP_FREQ_SEQ_06	Yes
7	9	1	333.3	HOP_FREQ_SEQ_07	Yes
8	9	1	333.3	HOP_FREQ_SEQ_08	Yes
9	9	1	333.3	HOP_FREQ_SEQ_09	Yes
10	9	1	333.3	HOP_FREQ_SEQ_10	Yes
11	9	1	333.3	HOP_FREQ_SEQ_11	Yes
12	9	1	333.3	HOP_FREQ_SEQ_12	Yes
13	9	1	333.3	HOP_FREQ_SEQ_13	Yes
14	9	1	333.3	HOP_FREQ_SEQ_14	Yes
15	9	1	333.3	HOP_FREQ_SEQ_15	Yes
16	9	1	333.3	HOP_FREQ_SEQ_16	Yes
17	9	1	333.3	HOP_FREQ_SEQ_17	Yes
18	9	1	333.3	HOP_FREQ_SEQ_18	Yes
19	9	1	333.3	HOP_FREQ_SEQ_19	Yes
20	9	1	333.3	HOP_FREQ_SEQ_20	Yes
21	9	1	333.3	HOP_FREQ_SEQ_21	Yes
22	9	1	333.3	HOP_FREQ_SEQ_22	Yes
23	9	1	333.3	HOP_FREQ_SEQ_23	Yes
24	9	1	333.3	HOP_FREQ_SEQ_24	Yes
25	9	1	333.3	HOP_FREQ_SEQ_25	Yes
26	9	1	333.3	HOP_FREQ_SEQ_26	Yes
27	9	1	333.3	HOP_FREQ_SEQ_27	Yes
28	9	1	333.3	HOP_FREQ_SEQ_28	No
29	9	1	333.3	HOP_FREQ_SEQ_29	Yes
30	9	1	333.3	HOP_FREQ_SEQ_30	Yes

Detection Rate : 96.6%

Note: The Frequency Hopping Radar pattern shown in Appendix A.2



802.11ax (HE80+80)(CH106+CH122)

Type 1 Radar Statistical Performances

Trial #	Test Frequency (MHz)	Pulse Repetition Frequency Number (1 to 23)	Pulse Repetition Frequency (pps)	Pulses per Burst	Pulse Repetition Interval (μ sec)	Detection
1	5570	5	1672.2	89	598	Yes
2	5580	21	1089.3	58	918	Yes
3	5640	14	1285.3	68	778	Yes
4	5560	23	326.2	18	3066	Yes
5	5500	10	1432.7	76	698	Yes
6	5559	13	1319.3	70	758	Yes
7	5591	16	1222.5	65	818	No
8	5511	15	1253.1	67	798	Yes
9	5564	11	1392.8	74	718	Yes
10	5509	3	1792.1	95	558	Yes
11	5571	22	1066.1	57	938	Yes
12	5564	7	1567.4	83	638	Yes
13	5627	17	1193.3	63	838	Yes
14	5517	18	1165.6	62	858	Yes
15	5628	9	1474.9	78	678	Yes
16	5616	-	1524.4	81	656	Yes
17	5521	-	749.6	40	1334	Yes
18	5516	-	1811.6	96	552	Yes
19	5557	-	660.5	35	1514	Yes
20	5596	-	364.2	20	2746	Yes
21	5507	-	960.6	51	1041	Yes
22	5611	-	344.1	19	2906	Yes
23	5528	-	421.2	23	2374	Yes
24	5579	-	751.3	40	1331	Yes
25	5618	-	513.3	28	1948	Yes
26	5565	-	1026.7	55	974	Yes
27	5519	-	409.3	22	2443	Yes
28	5525	-	557.4	30	1794	Yes
29	5528	-	874.1	47	1144	Yes
30	5524	-	473.5	25	2112	Yes

Detection Rate : 96.6%

Note. " - " : 15 unique PRI values randomly selected within the range of 518-3066 μ sec, with a minimum increment of 1 μ sec, excluding PRI values selected in Test A

802.11ax (HE80+80)(CH106+CH122)

Type 2 Radar Statistical Performances

Trial #	Test Frequency (MHz)	Pulses per Burst	Pulse Width(us)	PRI(us)	Detection
1	5570	28	4.2	228	Yes
2	5580	24	1.6	202	Yes
3	5640	24	1.9	193	Yes
4	5560	29	4.6	189	Yes
5	5500	26	3	167	Yes
6	5552	25	2.6	180	Yes
7	5546	23	1.4	165	Yes
8	5552	29	5	190	Yes
9	5539	23	1.2	168	Yes
10	5571	26	3	224	Yes
11	5536	27	3.9	187	Yes
12	5587	29	5	171	Yes
13	5633	28	4.3	223	Yes
14	5579	26	2.9	216	Yes
15	5515	26	2.9	219	Yes
16	5558	27	3.6	169	Yes
17	5520	25	2.5	199	Yes
18	5513	26	3	151	Yes
19	5574	25	2.4	198	Yes
20	5510	29	5	207	Yes
21	5545	23	1.5	162	Yes
22	5543	29	5	161	Yes
23	5617	24	1.8	194	Yes
24	5571	28	4.1	178	Yes
25	5592	24	1.6	170	Yes
26	5605	27	3.4	195	No
27	5555	25	2.7	212	Yes
28	5550	24	1.7	196	Yes
29	5561	26	2.8	217	Yes
30	5569	24	1.8	183	Yes
Detection Rate : 96.6%					



802.11ax (HE80+80)(CH106+CH122)

Type 3 Radar Statistical Performances

Trial #	Test Frequency (MHz)	Pulses per Burst	Pulse Width(us)	PRI(us)	Detection
1	5570	18	9.2	258	Yes
2	5580	16	6.6	493	Yes
3	5640	16	6.9	359	No
4	5560	18	9.6	397	Yes
5	5500	17	8	355	Yes
6	5582	17	7.6	428	Yes
7	5547	16	6.4	271	Yes
8	5606	18	10	371	Yes
9	5593	16	6.2	430	Yes
10	5527	17	8	272	Yes
11	5576	18	8.9	202	Yes
12	5526	18	10	264	Yes
13	5508	18	9.3	207	No
14	5515	17	7.9	456	Yes
15	5605	17	7.9	291	Yes
16	5513	17	8.6	411	Yes
17	5627	17	7.5	368	Yes
18	5508	17	8	241	Yes
19	5544	17	7.4	467	Yes
20	5547	18	10	339	Yes
21	5617	16	6.5	500	Yes
22	5571	18	10	358	Yes
23	5588	16	6.8	251	Yes
24	5555	18	9.1	230	Yes
25	5539	16	6.6	285	Yes
26	5624	17	8.4	426	Yes
27	5571	17	7.7	350	No
28	5599	16	6.7	434	No
29	5540	17	7.8	491	Yes
30	5621	16	6.8	438	Yes

Detection Rate : 86.6%



802.11ax (HE80+80)(CH106+CH122)

Type 4 Radar Statistical Performances

Trial #	Test Frequency (MHz)	Pulses per Burst	Pulse Width(us)	PRI(us)	Detection
1	5570	15	18.1	258	Yes
2	5580	12	12.3	493	Yes
3	5640	13	13.2	359	Yes
4	5560	16	19.1	397	Yes
5	5500	14	15.4	355	Yes
6	5601	14	14.6	428	Yes
7	5630	12	11.9	271	Yes
8	5522	16	19.9	371	Yes
9	5547	12	11.6	430	Yes
10	5597	14	15.4	272	Yes
11	5511	15	17.4	202	No
12	5507	16	19.9	264	Yes
13	5606	16	18.4	207	Yes
14	5520	14	15.3	456	Yes
15	5545	14	15.3	291	Yes
16	5545	15	16.8	411	Yes
17	5626	13	14.3	368	No
18	5596	14	15.5	241	Yes
19	5604	13	14.2	467	No
20	5539	16	20	339	Yes
21	5625	12	12.2	500	Yes
22	5629	16	19.9	358	Yes
23	5510	13	12.9	251	No
24	5560	15	17.9	230	Yes
25	5615	12	12.3	285	No
26	5555	15	16.5	426	Yes
27	5597	14	14.8	350	Yes
28	5573	12	12.6	434	No
29	5610	14	15.1	491	Yes
30	5616	13	12.9	438	Yes

Detection Rate : 80%



802.11ax (HE80+80)(CH106+CH122)

Type 5 Radar Statistical Performances

Trial #	Minimum Chirp Width(MHz)	Chirp Center Frequency(MHz)	Test Signal Name	Detection
1	17	5570	LP_Signal_01	No
2	7	5570	LP_Signal_02	Yes
3	8	5570	LP_Signal_03	Yes
4	19	5570	LP_Signal_04	Yes
5	12	5570	LP_Signal_05	Yes
6	11	5570	LP_Signal_06	Yes
7	6	5570	LP_Signal_07	Yes
8	20	5570	LP_Signal_08	Yes
9	6	5570	LP_Signal_09	Yes
10	12	5570	LP_Signal_10	Yes
11	16	5496	LP_Signal_11	Yes
12	20	5498	LP_Signal_12	Yes
13	18	5497	LP_Signal_13	Yes
14	12	5495	LP_Signal_14	Yes
15	12	5495	LP_Signal_15	Yes
16	15	5496	LP_Signal_16	Yes
17	10	5494	LP_Signal_17	Yes
18	12	5495	LP_Signal_18	Yes
19	10	5494	LP_Signal_19	Yes
20	20	5498	LP_Signal_20	Yes
21	7	5647	LP_Signal_21	Yes
22	20	5642	LP_Signal_22	Yes
23	8	5647	LP_Signal_23	Yes
24	17	5643	LP_Signal_24	Yes
25	7	5647	LP_Signal_25	Yes
26	14	5644	LP_Signal_26	Yes
27	11	5646	LP_Signal_27	Yes
28	7	5647	LP_Signal_28	Yes
29	12	5645	LP_Signal_29	Yes
30	8	5647	LP_Signal_30	Yes

Detection Rate : 96.6%

Note: The Long Pulse Radar pattern shown in Appendix A.1



802.11ax (HE80+80)(CH106+CH122)

Type 6 Radar Statistical Performances

Trial #	Pulses per Burst	Pulse Width(us)	PRI(us)	Hopping Frequency Sequence Name	Detection
1	9	1	333.3	HOP_FREQ_SEQ_01	Yes
2	9	1	333.3	HOP_FREQ_SEQ_02	Yes
3	9	1	333.3	HOP_FREQ_SEQ_03	Yes
4	9	1	333.3	HOP_FREQ_SEQ_04	Yes
5	9	1	333.3	HOP_FREQ_SEQ_05	Yes
6	9	1	333.3	HOP_FREQ_SEQ_06	Yes
7	9	1	333.3	HOP_FREQ_SEQ_07	Yes
8	9	1	333.3	HOP_FREQ_SEQ_08	Yes
9	9	1	333.3	HOP_FREQ_SEQ_09	Yes
10	9	1	333.3	HOP_FREQ_SEQ_10	Yes
11	9	1	333.3	HOP_FREQ_SEQ_11	Yes
12	9	1	333.3	HOP_FREQ_SEQ_12	Yes
13	9	1	333.3	HOP_FREQ_SEQ_13	Yes
14	9	1	333.3	HOP_FREQ_SEQ_14	Yes
15	9	1	333.3	HOP_FREQ_SEQ_15	Yes
16	9	1	333.3	HOP_FREQ_SEQ_16	Yes
17	9	1	333.3	HOP_FREQ_SEQ_17	Yes
18	9	1	333.3	HOP_FREQ_SEQ_18	Yes
19	9	1	333.3	HOP_FREQ_SEQ_19	Yes
20	9	1	333.3	HOP_FREQ_SEQ_20	No
21	9	1	333.3	HOP_FREQ_SEQ_21	No
22	9	1	333.3	HOP_FREQ_SEQ_22	Yes
23	9	1	333.3	HOP_FREQ_SEQ_23	Yes
24	9	1	333.3	HOP_FREQ_SEQ_24	Yes
25	9	1	333.3	HOP_FREQ_SEQ_25	Yes
26	9	1	333.3	HOP_FREQ_SEQ_26	Yes
27	9	1	333.3	HOP_FREQ_SEQ_27	Yes
28	9	1	333.3	HOP_FREQ_SEQ_28	Yes
29	9	1	333.3	HOP_FREQ_SEQ_29	Yes
30	9	1	333.3	HOP_FREQ_SEQ_30	Yes

Detection Rate : 93.3%

Note: The Frequency Hopping Radar pattern shown in Appendix A.2



Repeater mode

802.11ax (HE80+80)(CH106+CH122)

Type 4 Radar Statistical Performances

Trial #	Test Frequency (MHz)	Pulses per Burst	Pulse Width(us)	PRI(us)	Detection
1	5570	15	18.1	258	Yes
2	5580	12	12.3	493	Yes
3	5640	13	13.2	359	Yes
4	5560	16	19.1	397	Yes
5	5500	14	15.4	355	Yes
6	5608	14	14.6	428	Yes
7	5562	12	11.9	271	No
8	5519	16	19.9	371	No
9	5583	12	11.6	430	Yes
10	5512	14	15.4	272	Yes
11	5586	15	17.4	202	Yes
12	5516	16	19.9	264	Yes
13	5547	16	18.4	207	No
14	5528	14	15.3	456	Yes
15	5551	14	15.3	291	Yes
16	5606	15	16.8	411	Yes
17	5632	13	14.3	368	Yes
18	5575	14	15.5	241	Yes
19	5588	13	14.2	467	Yes
20	5622	16	20	339	Yes
21	5529	12	12.2	500	Yes
22	5537	16	19.9	358	Yes
23	5597	13	12.9	251	Yes
24	5550	15	17.9	230	Yes
25	5630	12	12.3	285	Yes
26	5572	15	16.5	426	Yes
27	5575	14	14.8	350	Yes
28	5628	12	12.6	434	Yes
29	5609	14	15.1	491	Yes
30	5601	13	12.9	438	Yes

Detection Rate : 90%

6.2.5 Non- Occupancy Period

1) Test results demonstrating an associated client link is established with the master on a test frequency.

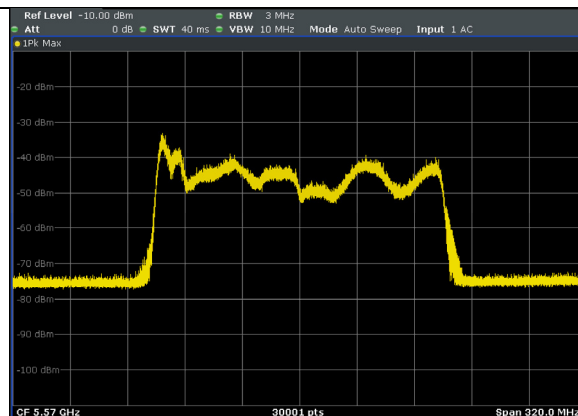

EUT (master) links with Client on 5570MHz

2) The master and DFS-certified client device are associated, and system testing will be performed with channel-loading for a non-occupancy period test.

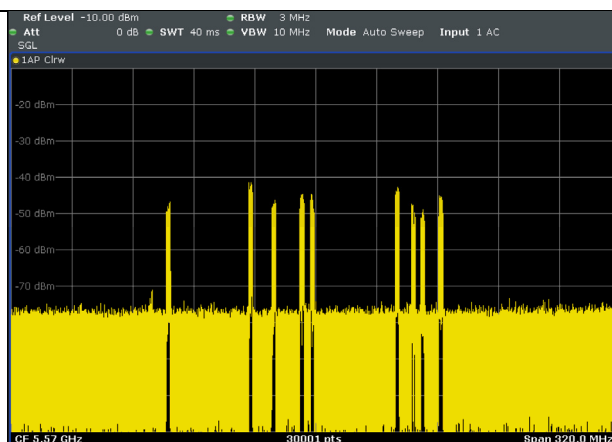

Client performed with channel-loading via master.

3). The device transmits one type of radar as specified in the DFS Order.

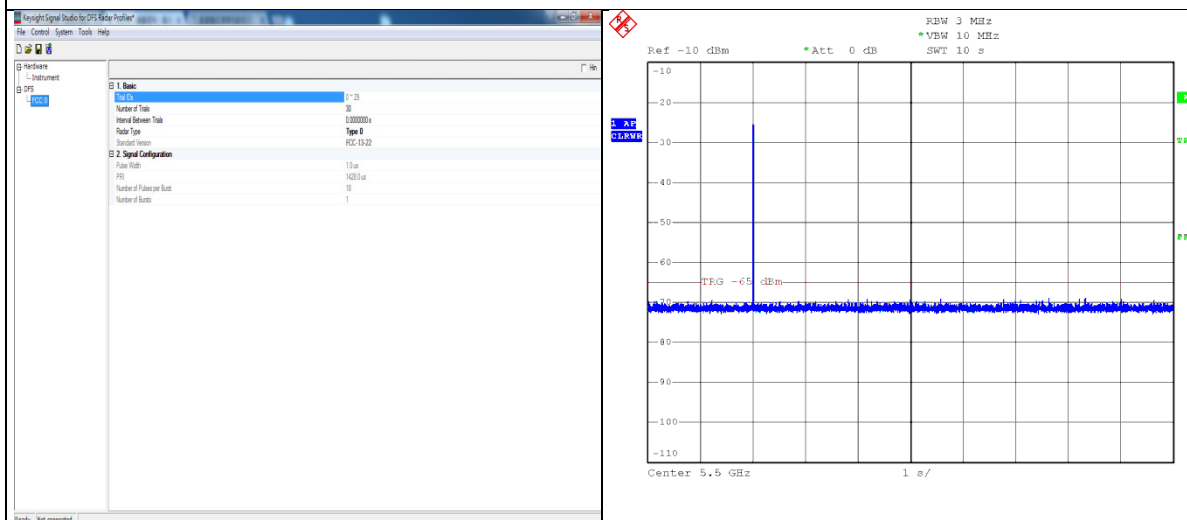

Radar 0 is used to test during DFS testing.

4) The test frequency has been monitored to ensure no transmission of any type has occurred for 30 minutes;

Note: If the client moves with the master, the device is considered compliant if nothing appears in the client non-occupancy period test. For devices that shut down (rather than moving channels), no beacons should appear;

5) An analyzer plot that contains a single 30-minute sweep on the original test frequency.

Non - Occupancy Period

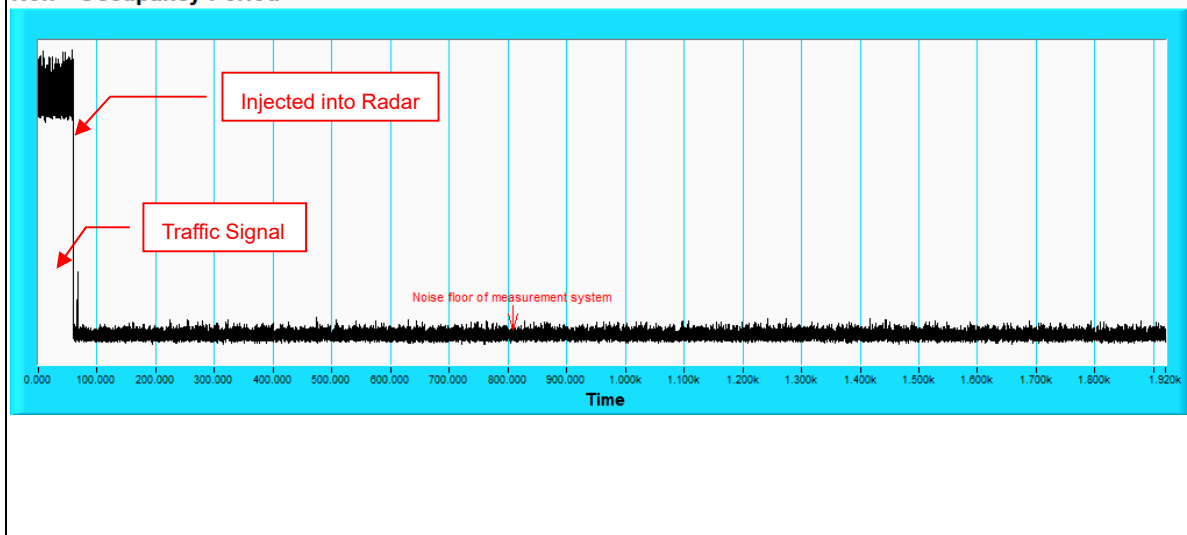

7 Information of the Testing Laboratories

We, Bureau Veritas Consumer Products Services (H.K.) Ltd., Taoyuan Branch, were founded in 1988 to provide our best service in EMC, Radio, Telecom and Safety consultation. Our laboratories are accredited and approved according to ISO/IEC 17025.

If you have any comments, please feel free to contact us at the following:

Lin Kou EMC/RF Lab:

Tel: 886-2-26052180

Fax: 886-2-26051924

Hsin Chu EMC/RF/Telecom Lab:

Tel: 886-3-6668565

Fax: 886-3-6668323

Hwa Ya EMC/RF/Safety Lab:

Tel: 886-3-3183232

Fax: 886-3-3270892

Email: service.adt@tw.bureauveritas.com

Web Site: www.bureauveritas-adt.com

The address and road map of all our labs can be found in our web site also.

APPENDIX-A

RADAR TEST SIGNAL

A.1 The Long Pulse Radar Pattern

802.11ax (HE20)

Long Pulse Radar Test Signal						
Test Signal Name: LP_Signal_01						
Number of Bursts in Trial: 10						
Burst	Pulses per Burst	Chirp (MHz)	Pulse Width(us)	PRI-1 (us)	PRI-2 (us)	PRI-3 (us)
1	1	7	58.7	1765	-	-
2	3	7	84.3	1452	1398	1571
3	3	7	87.4	1358	1377	1111
4	3	7	91.4	1554	1036	1662
5	1	7	61.8	1828	-	-
6	1	7	51.8	1621	-	-
7	3	7	93.4	1063	1317	1923
8	2	7	73.8	1804	1156	-
9	2	7	72.6	1935	1079	-
10	2	7	82.5	1049	1478	-
11	-	-	-	-	-	-
12	-	-	-	-	-	-
13	-	-	-	-	-	-
14	-	-	-	-	-	-
15	-	-	-	-	-	-
16	-	-	-	-	-	-
17	-	-	-	-	-	-
18	-	-	-	-	-	-
19	-	-	-	-	-	-
20	-	-	-	-	-	-



Long Pulse Radar Test Signal

Test Signal Name: LP_Signal_02

Number of Bursts in Trial: 16

Burst	Pulses per Burst	Chirp (MHz)	Pulse Width(us)	PRI-1 (us)	PRI-2 (us)	PRI-3 (us)
1	1	15	51.3	1713	-	-
2	1	15	54	1485	-	-
3	2	15	69.1	1043	1750	-
4	3	15	93.8	1665	1844	1155
5	3	15	99.1	1505	1825	1538
6	2	15	76	1866	1508	-
7	1	15	63.5	1889	-	-
8	2	15	69.8	1024	1578	-
9	1	15	60.9	1067	-	-
10	1	15	52.9	1162	-	-
11	2	15	73.7	1211	1581	-
12	3	15	87.8	1516	1753	1473
13	2	15	68.6	1029	1730	-
14	1	15	50.9	1930	-	-
15	2	15	83	1675	1303	-
16	2	15	69.5	1296	1410	-
17						
18						
19						
20						



Long Pulse Radar Test Signal

Test Signal Name: LP_Signal_03

Number of Bursts in Trial: 17

Burst	Pulses per Burst	Chirp (MHz)	Pulse Width(us)	PRI-1 (us)	PRI-2 (us)	PRI-3 (us)
1	1	16	56.4	1603	-	-
2	1	16	53.9	1545	-	-
3	1	16	53.5	1943	-	-
4	1	16	59.4	1206	-	-
5	2	16	78.5	1305	1969	-
6	3	16	86.1	1355	1823	1948
7	2	16	67	1788	1958	-
8	2	16	74.5	1213	1124	-
9	2	16	81.3	1215	1366	-
10	2	16	81.5	1429	1293	-
11	2	16	79.9	1345	1990	-
12	1	16	50.5	1996	-	-
13	3	16	88.4	1871	1121	1723
14	1	16	65.7	1964	-	-
15	3	16	93	1962	1265	1267
16	1	16	63.6	1020	-	-
17	2	16	78.1	1737	1422	-
18						
19						
20						



Long Pulse Radar Test Signal

Test Signal Name: LP_Signal_04

Number of Bursts in Trial: 18

Burst	Pulses per Burst	Chirp (MHz)	Pulse Width(us)	PRI-1 (us)	PRI-2 (us)	PRI-3 (us)
1	2	18	76.8	1105	1462	-
2	2	18	72.6	1668	1188	-
3	2	18	70.4	1321	1820	-
4	1	18	57	1683	-	-
5	3	18	88.6	1721	1611	1967
6	1	18	55	1594	-	-
7	3	18	93.3	1624	1678	1625
8	3	18	86.7	1720	1540	1349
9	3	18	86.7	1816	1617	1754
10	1	18	57.7	1382	-	-
11	2	18	78.1	1561	1416	-
12	1	18	59.9	1734	-	-
13	2	18	71	1677	1220	-
14	1	18	65.7	1497	-	-
15	3	18	86.4	1957	1088	1054
16	1	18	58.3	1104	-	-
17	3	18	92.3	1589	1800	1189
18	3	18	95.4	1147	1801	1748
19						
20						



Long Pulse Radar Test Signal

Test Signal Name: LP_Signal_05

Number of Bursts in Trial: 11

Burst	Pulses per Burst	Chirp (MHz)	Pulse Width(us)	PRI-1 (us)	PRI-2 (us)	PRI-3 (us)
1	3	8	89.4	1574	1736	1023
2	2	8	70.2	1655	1500	-
3	1	8	63.2	1445	-	-
4	1	8	53.9	1098	-	-
5	1	8	65.2	1918	-	-
6	3	8	87.1	1453	1658	1236
7	3	8	94.6	1896	1154	1456
8	1	8	62.4	1646	-	-
9	2	8	67.6	1600	1439	-
10	3	8	96.2	1629	1909	1879
11	1	8	62.9	1793	-	-
12						
13						
14						
15						
16						
17						
18						
19						
20						



Long Pulse Radar Test Signal

Test Signal Name: LP_Signal_06

Number of Bursts in Trial: 8

Burst	Pulses per Burst	Chirp (MHz)	Pulse Width(us)	PRI-1 (us)	PRI-2 (us)	PRI-3 (us)
1	2	5	81.4	1413	1565	-
2	3	5	95.3	1774	1131	1995
3	1	5	60	1160	-	-
4	1	5	60.1	1922	-	-
5	1	5	59.6	1069	-	-
6	3	5	91.8	1259	1810	1477
7	2	5	78.4	1763	1487	-
8	1	5	62.6	1122	-	-
9						
10						
11						
12						
13						
14						
15						
16						
17						
18						
19						
20						



Long Pulse Radar Test Signal

Test Signal Name: LP_Signal_07

Number of Bursts in Trial: 19

Burst	Pulses per Burst	Chirp (MHz)	Pulse Width(us)	PRI-1 (us)	PRI-2 (us)	PRI-3 (us)
1	1	18	62.4	1000	-	-
2	2	18	67.9	1925	1039	-
3	3	18	99	1890	1228	1326
4	1	18	60.3	1210	-	-
5	2	18	72.7	1688	1548	-
6	3	18	91.9	1988	1503	1201
7	2	18	78.3	1309	1198	-
8	3	18	88.9	1080	1399	1115
9	1	18	64.5	1087	-	-
10	1	18	60.3	1133	-	-
11	1	18	65.8	1579	-	-
12	3	18	93.5	1619	1682	1758
13	3	18	92.2	1533	1842	1979
14	3	18	96.2	1672	1744	1971
15	2	18	70.3	1414	1692	-
16	1	18	53.5	1706	-	-
17	3	18	93.4	1870	1242	1395
18	1	18	64.9	1438	-	-
19	2	18	72.9	1239	1817	-
20						



Long Pulse Radar Test Signal

Test Signal Name: LP_Signal_08

Number of Bursts in Trial: 14

Burst	Pulses per Burst	Chirp (MHz)	Pulse Width(us)	PRI-1 (us)	PRI-2 (us)	PRI-3 (us)
1	1	12	57.3	1698	-	-
2	2	12	83.3	1700	1427	-
3	1	12	62.5	1952	-	-
4	2	12	76.1	1612	1397	-
5	3	12	87.5	1139	1901	1400
6	3	12	97.1	1352	1798	1636
7	2	12	73.8	1496	1536	-
8	1	12	55.2	1357	-	-
9	1	12	62.5	1811	-	-
10	2	12	68.1	1251	1843	-
11	3	12	99.9	1819	1057	1017
12	1	12	61.3	1342	-	-
13	2	12	73.9	1725	1872	-
14	1	12	58	1747	-	-
15						
16						
17						
18						
19						
20						



Long Pulse Radar Test Signal

Test Signal Name: LP_Signal_09

Number of Bursts in Trial: 13

Burst	Pulses per Burst	Chirp (MHz)	Pulse Width(us)	PRI-1 (us)	PRI-2 (us)	PRI-3 (us)
1	3	12	95.8	1465	1975	1904
2	2	12	79.9	1764	1174	-
3	2	12	77.4	1235	1584	-
4	3	12	90.4	1114	1974	1027
5	1	12	59.9	1126	-	-
6	3	12	90.5	1275	1985	1845
7	1	12	62	1062	-	-
8	3	12	87	1463	1587	1887
9	3	12	98.3	1586	1187	1651
10	2	12	80.1	1277	1881	-
11	1	12	52.1	1330	-	-
12	1	12	51.7	1333	-	-
13	1	12	52.7	1867	-	-
14						
15						
16						
17						
18						
19						
20						



Long Pulse Radar Test Signal

Test Signal Name: LP_Signal_10

Number of Bursts in Trial: 16

Burst	Pulses per Burst	Chirp (MHz)	Pulse Width(us)	PRI-1 (us)	PRI-2 (us)	PRI-3 (us)
1	2	15	70.7	1934	1731	-
2	3	15	85.3	1179	1751	1711
3	2	15	75	1034	1261	-
4	1	15	56.4	1954	-	-
5	2	15	66.7	1243	1090	-
6	3	15	94.8	1224	1970	1214
7	2	15	68.8	1701	1280	-
8	2	15	71	1563	1537	-
9	2	15	79.4	1525	1389	-
10	3	15	100	1717	1498	1740
11	3	15	91.9	1295	1037	1829
12	1	15	61.5	1949	-	-
13	1	15	63.2	1596	-	-
14	3	15	99	1254	1919	1073
15	3	15	86.6	1606	1849	1202
16	1	15	65.8	1635	-	-
17						
18						
19						
20						

Long Pulse Radar Test Signal

Test Signal Name: LP_Signal_11

Number of Bursts in Trial: 8

Burst	Pulses per Burst	Chirp (MHz)	Pulse Width(us)	PRI-1 (us)	PRI-2 (us)	PRI-3 (us)
1	2	5	70.7	1897	1749	-
2	1	5	64.6	1965	-	-
3	3	5	99	1012	1045	1772
4	3	5	91.9	1583	1466	1549
5	3	5	85.5	1420	1780	1459
6	3	5	96.5	1530	1924	1835
7	1	5	66.2	1550	-	-
8	3	5	92.9	1929	1335	1883
9						
10						
11						
12						
13						
14						
15						
16						
17						
18						
19						
20						

Long Pulse Radar Test Signal

Test Signal Name: LP_Signal_12

Number of Bursts in Trial: 9

Burst	Pulses per Burst	Chirp (MHz)	Pulse Width(us)	PRI-1 (us)	PRI-2 (us)	PRI-3 (us)
1	1	6	63.1	1642	-	-
2	3	6	83.5	1005	1981	1250
3	2	6	74.5	1914	1474	-
4	1	6	60.9	1430	-	-
5	2	6	70.4	1680	1542	-
6	3	6	85.1	1048	1127	1393
7	2	6	82.4	1605	1282	-
8	2	6	74	1108	1691	-
9	3	6	85.7	1486	1976	1212
10						
11						
12						
13						
14						
15						
16						
17						
18						
19						
20						



Long Pulse Radar Test Signal

Test Signal Name: LP_Signal_13

Number of Bursts in Trial: 12

Burst	Pulses per Burst	Chirp (MHz)	Pulse Width(us)	PRI-1 (us)	PRI-2 (us)	PRI-3 (us)
1	3	11	94.4	1385	1336	1376
2	1	11	53	1805	-	-
3	2	11	70	1248	1558	-
4	3	11	87.6	1403	1170	1315
5	1	11	61.7	1042	-	-
6	2	11	83.2	1100	1535	-
7	1	11	66.6	1038	-	-
8	1	11	55.1	1423	-	-
9	3	11	87	1789	1306	1643
10	1	11	66.4	1409	-	-
11	2	11	80	1319	1094	-
12	3	11	85.6	1891	1291	1529
13						
14						
15						
16						
17						
18						
19						
20						



Long Pulse Radar Test Signal

Test Signal Name: LP_Signal_14

Number of Bursts in Trial: 19

Burst	Pulses per Burst	Chirp (MHz)	Pulse Width(us)	PRI-1 (us)	PRI-2 (us)	PRI-3 (us)
1	2	18	78.9	1613	1263	-
2	3	18	96.7	1627	1432	1986
3	3	18	91.5	1472	1759	1784
4	2	18	75.4	1274	1795	-
5	2	18	71.1	1968	1444	-
6	2	18	77.5	1588	1441	-
7	1	18	65.4	1710	-	-
8	1	18	53.1	1419	-	-
9	1	18	59.9	1518	-	-
10	2	18	67.3	1195	1168	-
11	2	18	74.2	1386	1216	-
12	2	18	69	1557	1132	-
13	2	18	82.1	1987	1186	-
14	3	18	93.3	1365	1032	1728
15	2	18	83.3	1103	1568	-
16	2	18	70.3	1699	1281	-
17	1	18	57.9	1285	-	-
18	1	18	50.6	1850	-	-
19	3	18	94.3	1479	1218	1733
20						



Long Pulse Radar Test Signal

Test Signal Name: LP_Signal_15

Number of Bursts in Trial: 20

Burst	Pulses per Burst	Chirp (MHz)	Pulse Width(us)	PRI-1 (us)	PRI-2 (us)	PRI-3 (us)
1	2	20	67.5	1434	1117	-
2	2	20	67.8	1567	1773	-
3	2	20	75.9	1846	1362	-
4	2	20	68.9	1237	1818	-
5	3	20	96	1339	1796	1852
6	1	20	66.6	1289	-	-
7	2	20	78.3	1862	1856	-
8	1	20	58.9	1412	-	-
9	2	20	81.5	1113	1591	-
10	2	20	82.4	1059	1861	-
11	3	20	86.8	1797	1163	1320
12	3	20	98.5	1268	1300	1868
13	2	20	80.1	1086	1482	-
14	3	20	86.3	1860	1407	1998
15	1	20	57.2	1241	-	-
16	3	20	84.3	1808	1873	1628
17	3	20	86.8	1258	1302	1978
18	2	20	83	1690	1378	-
19	3	20	85.6	1327	1956	1311
20	3	20	99.4	1112	1815	1262



Long Pulse Radar Test Signal

Test Signal Name: LP_Signal_16

Number of Bursts in Trial: 14

Burst	Pulses per Burst	Chirp (MHz)	Pulse Width(us)	PRI-1 (us)	PRI-2 (us)	PRI-3 (us)
1	1	13	57.5	1379	-	-
2	2	13	67	1551	1620	-
3	2	13	70.9	1939	1083	-
4	2	13	75.7	1332	1476	-
5	2	13	77.1	1840	1010	-
6	2	13	78.8	1371	1618	-
7	1	13	51	1494	-	-
8	1	13	55.4	1794	-	-
9	2	13	68.5	1590	1266	-
10	3	13	100	1484	1314	1428
11	3	13	96.4	1363	1361	1292
12	3	13	97.2	1694	1480	1446
13	3	13	86.4	1447	1227	1102
14	2	13	72.1	1184	1638	-
15						
16						
17						
18						
19						
20						



Long Pulse Radar Test Signal

Test Signal Name: LP_Signal_17

Number of Bursts in Trial: 11

Burst	Pulses per Burst	Chirp (MHz)	Pulse Width(us)	PRI-1 (us)	PRI-2 (us)	PRI-3 (us)
1	1	9	62.4	1329	-	-
2	2	9	67.8	1364	1937	-
3	1	9	53	1790	-	-
4	2	9	77.8	1546	1906	-
5	3	9	95.6	1145	1743	1499
6	1	9	58.8	1199	-	-
7	3	9	92.8	1424	1408	1381
8	2	9	68.5	1340	1972	-
9	3	9	84	1607	1663	1270
10	2	9	70.8	1468	1760	-
11	2	9	73.1	1869	1515	-
12						
13						
14						
15						
16						
17						
18						
19						
20						



Long Pulse Radar Test Signal

Test Signal Name: LP_Signal_18

Number of Bursts in Trial: 13

Burst	Pulses per Burst	Chirp (MHz)	Pulse Width(us)	PRI-1 (us)	PRI-2 (us)	PRI-3 (us)
1	2	11	68.8	1504	1973	-
2	3	11	94.2	1920	1299	1467
3	2	11	82.7	1003	1351	-
4	2	11	74.8	1597	1457	-
5	1	11	58.9	1874	-	-
6	3	11	96.5	1838	1708	1328
7	3	11	87.3	1405	1271	1687
8	2	11	72.4	1200	1433	-
9	1	11	51.3	1475	-	-
10	3	11	86.8	1159	1652	1942
11	1	11	50.4	1056	-	-
12	3	11	97	1884	1876	1415
13	1	11	50.1	1519	-	-
14						
15						
16						
17						
18						
19						
20						



Long Pulse Radar Test Signal

Test Signal Name: LP_Signal_19

Number of Bursts in Trial: 10

Burst	Pulses per Burst	Chirp (MHz)	Pulse Width(us)	PRI-1 (us)	PRI-2 (us)	PRI-3 (us)
1	3	8	91.9	1301	1337	1645
2	2	8	67.2	1983	1040	-
3	1	8	65.5	1671	-	-
4	2	8	72.8	1489	1016	-
5	3	8	90.5	1552	1180	1064
6	2	8	81.6	1807	1853	-
7	3	8	86	1312	1905	1278
8	3	8	89.6	1152	1068	1832
9	1	8	62.1	1119	-	-
10	1	8	58	1234	-	-
11						
12						
13						
14						
15						
16						
17						
18						
19						
20						



Long Pulse Radar Test Signal

Test Signal Name: LP_Signal_20

Number of Bursts in Trial: 8

Burst	Pulses per Burst	Chirp (MHz)	Pulse Width(us)	PRI-1 (us)	PRI-2 (us)	PRI-3 (us)
1	2	5	73.8	1071	1915	-
2	3	5	89.5	1294	1450	1025
3	2	5	81.2	1144	1146	-
4	1	5	59	1041	-	-
5	3	5	87.5	1096	1941	1018
6	2	5	76.7	1667	1947	-
7	1	5	56.5	1573	-	-
8	3	5	89	1033	1391	1304
9						
10						
11						
12						
13						
14						
15						
16						
17						
18						
19						
20						



Long Pulse Radar Test Signal

Test Signal Name: LP_Signal_21

Number of Bursts in Trial: 14

Burst	Pulses per Burst	Chirp (MHz)	Pulse Width(us)	PRI-1 (us)	PRI-2 (us)	PRI-3 (us)
1	2	12	83.1	1762	1058	-
2	1	12	50	1739	-	-
3	1	12	52.6	1055	-	-
4	1	12	58.2	1704	-	-
5	3	12	84.6	1226	1177	1886
6	2	12	68.3	1269	1851	-
7	2	12	80.6	1814	1074	-
8	1	12	59.5	1009	-	-
9	1	12	53.4	1417	-	-
10	1	12	59.1	1431	-	-
11	2	12	74.8	1002	1394	-
12	3	12	85	1670	1755	1158
13	3	12	85.3	1307	1560	1078
14	1	12	61.9	1197	-	-
15						
16						
17						
18						
19						
20						



Long Pulse Radar Test Signal

Test Signal Name: LP_Signal_22

Number of Bursts in Trial: 17

Burst	Pulses per Burst	Chirp (MHz)	Pulse Width(us)	PRI-1 (us)	PRI-2 (us)	PRI-3 (us)
1	2	17	70.8	1022	1015	-
2	1	17	52.9	1483	-	-
3	3	17	86	1524	1308	1287
4	2	17	78.4	1821	1406	-
5	3	17	93.3	1991	1966	1290
6	2	17	70	1858	1471	-
7	2	17	78.1	1507	1705	-
8	1	17	52.4	1060	-	-
9	3	17	84.8	1859	1839	1993
10	3	17	83.5	1150	1492	1443
11	1	17	56.7	1208	-	-
12	3	17	86.2	1674	1125	1053
13	1	17	58.8	1436	-	-
14	3	17	85.4	1686	1509	1577
15	2	17	77.7	1297	1298	-
16	3	17	87.4	1649	1894	1075
17	3	17	99.8	1185	1167	1616
18						
19						
20						



Long Pulse Radar Test Signal

Test Signal Name: LP_Signal_23

Number of Bursts in Trial: 12

Burst	Pulses per Burst	Chirp (MHz)	Pulse Width(us)	PRI-1 (us)	PRI-2 (us)	PRI-3 (us)
1	3	10	95.7	1353	1813	1028
2	3	10	94.9	1735	1994	1084
3	3	10	97.9	1354	1792	1418
4	2	10	67.4	1348	1008	-
5	3	10	96.9	1916	1425	1283
6	3	10	97.6	1384	1050	1569
7	3	10	83.6	1231	1219	1194
8	2	10	82.6	1128	1346	-
9	3	10	97.2	1142	1769	1173
10	3	10	92.3	1181	1164	1458
11	2	10	80.9	1222	1756	-
12	2	10	78.1	1190	1999	-
13						
14						
15						
16						
17						
18						
19						
20						



Long Pulse Radar Test Signal

Test Signal Name: LP_Signal_24

Number of Bursts in Trial: 8

Burst	Pulses per Burst	Chirp (MHz)	Pulse Width(us)	PRI-1 (us)	PRI-2 (us)	PRI-3 (us)
1	2	5	76.9	1564	1767	-
2	1	5	64.7	1437	-	-
3	2	5	77.1	1046	1944	-
4	2	5	72.7	1440	1374	-
5	1	5	61.9	1035	-	-
6	2	5	68.6	1205	1892	-
7	2	5	78.3	1047	1273	-
8	2	5	73.1	1426	1863	-
9						
10						
11						
12						
13						
14						
15						
16						
17						
18						
19						
20						



Long Pulse Radar Test Signal

Test Signal Name: LP_Signal_25

Number of Bursts in Trial: 16

Burst	Pulses per Burst	Chirp (MHz)	Pulse Width(us)	PRI-1 (us)	PRI-2 (us)	PRI-3 (us)
1	1	15	59.1	1718	-	-
2	3	15	83.5	1070	1129	1318
3	3	15	86.5	1176	1253	1442
4	1	15	60.8	1209	-	-
5	2	15	80.7	2000	1360	-
6	1	15	65.2	1101	-	-
7	2	15	69.1	1511	1030	-
8	1	15	51.5	1161	-	-
9	3	15	98.5	1061	1951	1812
10	1	15	59.5	1325	-	-
11	3	15	95.3	1284	1650	1169
12	2	15	81.8	1460	1077	-
13	1	15	66	1149	-	-
14	1	15	59.3	1373	-	-
15	2	15	79.2	1836	1534	-
16	3	15	90.2	1455	1738	1490
17						
18						
19						
20						



Long Pulse Radar Test Signal

Test Signal Name: LP_Signal_26

Number of Bursts in Trial: 13

Burst	Pulses per Burst	Chirp (MHz)	Pulse Width(us)	PRI-1 (us)	PRI-2 (us)	PRI-3 (us)
1	3	11	87.5	1343	1331	1313
2	3	11	94.6	1448	1543	1803
3	2	11	73.9	1722	1514	-
4	1	11	55.4	1506	-	-
5	1	11	52.3	1960	-	-
6	3	11	95.8	1240	1380	1252
7	3	11	96.1	1372	1411	1908
8	2	11	77.8	1885	1593	-
9	3	11	97.2	1021	1614	1633
10	2	11	74.3	1582	1097	-
11	1	11	57.9	1031	-	-
12	2	11	68.8	1927	1936	-
13	2	11	79.6	1857	1470	-
14						
15						
16						
17						
18						
19						
20						



Long Pulse Radar Test Signal

Test Signal Name: LP_Signal_27

Number of Bursts in Trial: 9

Burst	Pulses per Burst	Chirp (MHz)	Pulse Width(us)	PRI-1 (us)	PRI-2 (us)	PRI-3 (us)
1	1	7	63.4	1595	-	-
2	3	7	97	1451	1660	1562
3	2	7	66.7	1116	1544	-
4	3	7	99.5	1553	1526	1768
5	1	7	64.3	1107	-	-
6	3	7	90.7	1992	1626	1899
7	1	7	62.1	1630	-	-
8	1	7	58.3	1676	-	-
9	3	7	87	1726	1696	1464
10						
11						
12						
13						
14						
15						
16						
17						
18						
19						
20						



Long Pulse Radar Test Signal

Test Signal Name: LP_Signal_28

Number of Bursts in Trial: 9

Burst	Pulses per Burst	Chirp (MHz)	Pulse Width(us)	PRI-1 (us)	PRI-2 (us)	PRI-3 (us)
1	3	6	86.8	1673	1383	1653
2	2	6	81.7	1841	1911	-
3	2	6	78.4	1900	1229	-
4	2	6	82.1	1527	1072	-
5	3	6	84.1	1893	1742	1491
6	3	6	87.7	1247	1341	1955
7	3	6	97	1559	1685	1572
8	3	6	99.1	1641	1727	1848
9	1	6	62	1245	-	-
10						
11						
12						
13						
14						
15						
16						
17						
18						
19						
20						



Long Pulse Radar Test Signal

Test Signal Name: LP_Signal_29

Number of Bursts in Trial: 8

Burst	Pulses per Burst	Chirp (MHz)	Pulse Width(us)	PRI-1 (us)	PRI-2 (us)	PRI-3 (us)
1	2	6	67.5	1193	1182	-
2	3	6	85.6	1221	1741	1338
3	3	6	86.9	1580	1775	1809
4	3	6	85.3	1082	1854	1095
5	2	6	67.3	1898	1977	-
6	3	6	94.8	1791	1350	1230
7	2	6	72.9	1681	1323	-
8	2	6	70.7	1709	1123	-
9						
10						
11						
12						
13						
14						
15						
16						
17						
18						
19						



Long Pulse Radar Test Signal

Test Signal Name: LP_Signal_30

Number of Bursts in Trial: 10

Burst	Pulses per Burst	Chirp (MHz)	Pulse Width(us)	PRI-1 (us)	PRI-2 (us)	PRI-3 (us)
1	1	8	63.3	1044	-	-
2	3	8	87.4	1945	1602	1203
3	1	8	58.7	1556	-	-
4	1	8	63.6	1598	-	-
5	1	8	56.3	1110	-	-
6	1	8	57.2	1878	-	-
7	1	8	50.3	1659	-	-
8	2	8	71.9	1143	1724	-
9	3	8	85.1	1404	1715	1449
10	1	8	62.5	1276	-	-
11						
12						
13						
14						
15						
16						
17						
18						
19						
20						



802.11ax (HE40)

Long Pulse Radar Test Signal

Test Signal Name: LP_Signal_01

Number of Bursts in Trial: 10

Burst	Pulses per Burst	Chirp (MHz)	Pulse Width(us)	PRI-1 (us)	PRI-2 (us)	PRI-3 (us)
1	1	8	61	1508	-	-
2	1	8	63.6	1149	-	-
3	1	8	57.3	1174	-	-
4	1	8	62.7	1924	-	-
5	1	8	56.9	1099	-	-
6	3	8	89.3	1882	1626	1569
7	3	8	88.2	1622	1087	1261
8	2	8	74	1476	1252	-
9	3	8	85	1392	1977	1489
10	2	8	69.3	1713	1390	-
11						
12						
13						
14						
15						
16						
17						
18						
19						
20						



Long Pulse Radar Test Signal

Test Signal Name: LP_Signal_02

Number of Bursts in Trial: 11

Burst	Pulses per Burst	Chirp (MHz)	Pulse Width(us)	PRI-1 (us)	PRI-2 (us)	PRI-3 (us)
1	2	9	75	1435	1931	-
2	2	9	82.2	1022	1332	-
3	3	9	87.9	1633	1301	1902
4	3	9	95.8	1534	1407	1056
5	2	9	69.1	1373	1496	-
6	3	9	88.5	1729	1167	1215
7	1	9	55.5	1471	-	-
8	2	9	81.8	1105	1414	-
9	1	9	63.6	1477	-	-
10	3	9	91.7	1699	1306	1956
11	3	9	87	1759	1086	1966
12						
13						
14						
15						
16						
17						
18						
19						
20						



Long Pulse Radar Test Signal

Test Signal Name: LP_Signal_03

Number of Bursts in Trial: 9

Burst	Pulses per Burst	Chirp (MHz)	Pulse Width(us)	PRI-1 (us)	PRI-2 (us)	PRI-3 (us)
1	1	7	62.2	1023	-	-
2	3	7	85.5	1408	1788	1881
3	3	7	85.9	1081	1109	1008
4	3	7	92.8	1300	1770	1859
5	3	7	83.8	1429	1771	1126
6	3	7	92.5	1275	1820	1728
7	1	7	65.9	1570	-	-
8	2	7	81.2	1449	1379	-
9	3	7	90	1360	1094	1783
10						
11						
12						
13						
14						
15						
16						
17						
18						
19						
20						



Long Pulse Radar Test Signal

Test Signal Name: LP_Signal_04

Number of Bursts in Trial: 11

Burst	Pulses per Burst	Chirp (MHz)	Pulse Width(us)	PRI-1 (us)	PRI-2 (us)	PRI-3 (us)
1	1	9	65.4	1287	-	-
2	1	9	62.4	1816	-	-
3	1	9	57.2	1012	-	-
4	2	9	77	1267	1084	-
5	1	9	66.2	1734	-	-
6	3	9	85.8	1172	1189	1621
7	1	9	62.7	1863	-	-
8	2	9	68.7	1127	1494	-
9	1	9	55.5	2000	-	-
10	2	9	72.5	1528	1264	-
11	2	9	69.7	1741	1682	-
12						
13						
14						
15						
16						
17						
18						
19						
20						



Long Pulse Radar Test Signal

Test Signal Name: LP_Signal_05

Number of Bursts in Trial: 9

Burst	Pulses per Burst	Chirp (MHz)	Pulse Width(us)	PRI-1 (us)	PRI-2 (us)	PRI-3 (us)
1	3	7	91.4	1652	1611	1190
2	3	7	85.3	1645	1604	1677
3	3	7	88.2	1481	1442	1892
4	2	7	75.3	1840	1665	-
5	1	7	58.4	1080	-	-
6	3	7	91.1	1400	1005	1594
7	3	7	90.1	1520	1350	1743
8	1	7	64.8	1216	-	-
9	1	7	56.4	1289	-	-
10						
11						
12						
13						
14						
15						
16						
17						
18						
19						
20						



Long Pulse Radar Test Signal

Test Signal Name: LP_Signal_06

Number of Bursts in Trial: 18

Burst	Pulses per Burst	Chirp (MHz)	Pulse Width(us)	PRI-1 (us)	PRI-2 (us)	PRI-3 (us)
1	3	17	98.3	1687	1598	1810
2	2	17	81.7	1161	1034	-
3	2	17	80.4	1072	1200	-
4	3	17	98.5	1595	1185	1640
5	2	17	80	1933	1697	-
6	3	17	98.8	1846	1358	1171
7	2	17	78.1	1663	1845	-
8	2	17	71.4	1253	1985	-
9	2	17	69.9	1552	1198	-
10	2	17	73.1	1996	1187	-
11	3	17	96.8	1710	2000	1466
12	2	17	72.2	1616	1177	-
13	3	17	92.8	1374	1737	1605
14	3	17	95.1	1643	1669	1849
15	1	17	53.8	1707	-	-
16	1	17	62.6	1638	-	-
17	2	17	75	1750	1349	-
18	1	17	60.8	1942	-	-
19						
20						

Long Pulse Radar Test Signal

Test Signal Name: LP_Signal_07

Number of Bursts in Trial: 17

Burst	Pulses per Burst	Chirp (MHz)	Pulse Width(us)	PRI-1 (us)	PRI-2 (us)	PRI-3 (us)
1	2	17	79.5	1151	1873	-
2	2	17	83.3	1036	1704	-
3	2	17	75.8	1299	1027	-
4	3	17	86.8	1965	1954	1078
5	2	17	76.2	1013	1887	-
6	3	17	91.2	1271	1895	1720
7	2	17	71.9	1334	1237	-
8	3	17	95.6	1689	1058	1202
9	2	17	77	1974	1389	-
10	3	17	97.4	1847	1719	1664
11	1	17	60.6	1599	-	-
12	3	17	84.4	1953	1361	1480
13	3	17	92.7	1580	1475	1548
14	1	17	52.3	1347	-	-
15	1	17	51.1	1774	-	-
16	2	17	74.7	1653	1844	-
17	3	17	91.7	1521	1964	1436
18						
19						
20						



Long Pulse Radar Test Signal

Test Signal Name: LP_Signal_08

Number of Bursts in Trial: 14

Burst	Pulses per Burst	Chirp (MHz)	Pulse Width(us)	PRI-1 (us)	PRI-2 (us)	PRI-3 (us)
1	3	12	83.8	1307	1557	1911
2	2	12	82	1915	1884	-
3	1	12	58.7	1195	-	-
4	3	12	97.1	1317	1568	1454
5	2	12	67.5	1193	1499	-
6	1	12	57.7	1543	-	-
7	3	12	91.4	1343	1245	1315
8	3	12	98.9	1779	1044	1046
9	2	12	82.4	1125	1756	-
10	2	12	75.7	1959	1917	-
11	3	12	97.6	1660	1501	1453
12	3	12	98.7	1427	1411	1782
13	3	12	90.3	1452	1324	1701
14	3	12	84.3	1448	1900	1516
15						
16						
17						
18						
19						
20						



Long Pulse Radar Test Signal

Test Signal Name: LP_Signal_09

Number of Bursts in Trial: 17

Burst	Pulses per Burst	Chirp (MHz)	Pulse Width(us)	PRI-1 (us)	PRI-2 (us)	PRI-3 (us)
1	1	16	62.7	1909	-	-
2	3	16	83.5	1363	1613	1206
3	2	16	80.3	1438	1514	-
4	1	16	60.5	1395	-	-
5	2	16	81.6	1803	1205	-
6	2	16	80.7	1362	1251	-
7	1	16	61.5	1224	-	-
8	1	16	55.4	1703	-	-
9	3	16	89.3	1108	1866	1394
10	2	16	76.6	1043	1666	-
11	3	16	84.4	1183	1019	1321
12	2	16	71.7	1869	1331	-
13	2	16	80.8	1148	1727	-
14	1	16	60.8	1493	-	-
15	3	16	85.6	1865	1738	1642
16	2	16	80.4	1297	1890	-
17	3	16	94.5	1500	1242	1310
18						
19						
20						

Long Pulse Radar Test Signal

Test Signal Name: LP_Signal_10

Number of Bursts in Trial: 13

Burst	Pulses per Burst	Chirp (MHz)	Pulse Width(us)	PRI-1 (us)	PRI-2 (us)	PRI-3 (us)
1	2	11	71.1	1812	1555	-
2	2	11	68	1225	1592	-
3	1	11	53.3	1450	-	-
4	2	11	70.1	1627	1197	-
5	2	11	80.6	1545	1905	-
6	1	11	66.2	1768	-	-
7	1	11	63.8	1304	-	-
8	1	11	62	1433	-	-
9	2	11	75.6	1531	1107	-
10	3	11	84.5	1366	1670	1563
11	3	11	88	1425	1342	1879
12	3	11	93.9	1864	1180	1066
13	1	11	65.5	1620	-	-
14						
15						
16						
17						
18						
19						
20						



Long Pulse Radar Test Signal

Test Signal Name: LP_Signal_11

Number of Bursts in Trial: 14

Burst	Pulses per Burst	Chirp (MHz)	Pulse Width(us)	PRI-1 (us)	PRI-2 (us)	PRI-3 (us)
1	2	12	74.4	1619	1405	-
2	3	12	97	1277	1145	1992
3	3	12	86.7	1134	1074	1843
4	1	12	63	1814	-	-
5	3	12	97.9	1744	1117	1549
6	1	12	50.8	1212	-	-
7	1	12	62.4	1910	-	-
8	3	12	91.8	1135	1824	1155
9	2	12	69.6	1249	1130	-
10	3	12	94.1	1885	1968	1588
11	2	12	80.2	1447	1384	-
12	2	12	78.3	1927	1539	-
13	3	12	92.8	1851	1491	1809
14	2	12	82.1	1128	1226	-
15						
16						
17						
18						
19						
20						



Long Pulse Radar Test Signal

Test Signal Name: LP_Signal_12

Number of Bursts in Trial: 16

Burst	Pulses per Burst	Chirp (MHz)	Pulse Width(us)	PRI-1 (us)	PRI-2 (us)	PRI-3 (us)
1	1	15	62.6	1376	-	-
2	3	15	95.8	1415	1488	1975
3	2	15	76.9	1063	1772	-
4	2	15	80.6	1661	1711	-
5	1	15	63.3	1270	-	-
6	1	15	52	1455	-	-
7	2	15	81.2	1377	1589	-
8	2	15	76.4	1564	1629	-
9	2	15	80.6	1822	1510	-
10	3	15	87	1723	1787	1146
11	1	15	64.2	1925	-	-
12	2	15	82.1	1674	1995	-
13	2	15	67.2	1529	1538	-
14	1	15	66.4	1355	-	-
15	3	15	98.6	1637	1867	1519
16	1	15	55.9	1830	-	-
17						
18						
19						
20						



Long Pulse Radar Test Signal

Test Signal Name: LP_Signal_13

Number of Bursts in Trial: 17

Burst	Pulses per Burst	Chirp (MHz)	Pulse Width(us)	PRI-1 (us)	PRI-2 (us)	PRI-3 (us)
1	3	17	96.2	1346	1827	1861
2	2	17	73.5	1141	1685	-
3	1	17	61.6	1541	-	-
4	2	17	73.7	1222	1004	-
5	1	17	52.1	1749	-	-
6	3	17	87.4	1231	1671	1124
7	3	17	85.1	1998	1991	1780
8	2	17	67.7	1755	1351	-
9	1	17	62.9	1116	-	-
10	3	17	84.7	1614	1007	1250
11	2	17	68	1196	1850	-
12	1	17	52.6	1051	-	-
13	1	17	51.4	1364	-	-
14	2	17	74	1733	1957	-
15	2	17	73.2	1244	1630	-
16	3	17	91.9	1213	1035	1880
17	3	17	87.9	1133	1111	1667
18						
19						
20						

Long Pulse Radar Test Signal

Test Signal Name: LP_Signal_14

Number of Bursts in Trial: 19

Burst	Pulses per Burst	Chirp (MHz)	Pulse Width(us)	PRI-1 (us)	PRI-2 (us)	PRI-3 (us)
1	3	19	84.1	1359	1095	1769
2	1	19	51.2	1967	-	-
3	1	19	66.2	1987	-	-
4	3	19	98.7	1947	1837	1490
5	1	19	53.9	1860	-	-
6	2	19	74.7	1526	1504	-
7	3	19	91.8	1893	1989	1944
8	3	19	84.3	1785	1877	1218
9	3	19	98	1527	1383	1055
10	1	19	66.4	1852	-	-
11	3	19	99.8	1020	1639	1891
12	3	19	98.9	1556	1441	1356
13	1	19	65.7	1015	-	-
14	3	19	83.7	1648	1090	1296
15	3	19	96	1898	1952	1571
16	3	19	93.3	1963	1762	1422
17	1	19	63.6	1576	-	-
18	3	19	97.9	1140	1804	1440
19	1	19	56.6	1016	-	-
20						



Long Pulse Radar Test Signal

Test Signal Name: LP_Signal_15

Number of Bursts in Trial: 12

Burst	Pulses per Burst	Chirp (MHz)	Pulse Width(us)	PRI-1 (us)	PRI-2 (us)	PRI-3 (us)
1	1	11	66.6	1265	-	-
2	2	11	69	1178	1853	-
3	2	11	80	1106	1969	-
4	2	11	75.2	1886	1104	-
5	1	11	60.7	1908	-	-
6	1	11	59.2	1834	-	-
7	2	11	67.6	1322	1958	-
8	2	11	78.6	1607	1833	-
9	3	11	84.1	1823	1721	1431
10	2	11	78.6	1751	1445	-
11	2	11	75	1609	1795	-
12	1	11	56.5	1577	-	-
13						
14						
15						
16						
17						
18						
19						
20						



Long Pulse Radar Test Signal

Test Signal Name: LP_Signal_16

Number of Bursts in Trial: 18

Burst	Pulses per Burst	Chirp (MHz)	Pulse Width(us)	PRI-1 (us)	PRI-2 (us)	PRI-3 (us)
1	1	17	63.7	1294	-	-
2	2	17	72.3	1632	1413	-
3	3	17	94.3	1165	1451	1045
4	2	17	83.1	1097	1936	-
5	1	17	65.2	1247	-	-
6	2	17	82.4	1562	1811	-
7	1	17	57.3	1067	-	-
8	3	17	92.3	1186	1610	1458
9	3	17	98.8	1428	1482	1945
10	2	17	69.8	1484	1182	-
11	3	17	89.5	1175	1600	1385
12	1	17	54.1	1139	-	-
13	2	17	71	1524	1815	-
14	3	17	85.4	1344	1011	1625
15	2	17	68.8	1298	1581	-
16	3	17	97.2	1654	1434	1410
17	1	17	51	1093	-	-
18	2	17	72	1112	1474	-
19						
20						



Long Pulse Radar Test Signal

Test Signal Name: LP_Signal_17

Number of Bursts in Trial: 9

Burst	Pulses per Burst	Chirp (MHz)	Pulse Width(us)	PRI-1 (us)	PRI-2 (us)	PRI-3 (us)
1	1	6	59.4	1238	-	-
2	3	6	87.9	1662	1048	1725
3	2	6	76.2	1028	1257	-
4	1	6	66.5	1464	-	-
5	2	6	75.2	1918	1462	-
6	2	6	68.8	1578	1951	-
7	1	6	54.1	1986	-	-
8	2	6	76	1432	1790	-
9	1	6	55.5	1353	-	-
10						
11						
12						
13						
14						
15						
16						
17						
18						
19						
20						



Long Pulse Radar Test Signal

Test Signal Name: LP_Signal_18

Number of Bursts in Trial: 16

Burst	Pulses per Burst	Chirp (MHz)	Pulse Width(us)	PRI-1 (us)	PRI-2 (us)	PRI-3 (us)
1	3	15	89.5	1658	1765	1387
2	3	15	86.3	1209	1617	1705
3	3	15	96.2	1523	1032	1650
4	1	15	57.7	1070	-	-
5	1	15	55.7	1156	-	-
6	2	15	73	1525	1495	-
7	1	15	59.8	1731	-	-
8	3	15	86	1050	1188	1345
9	2	15	76.5	1380	1288	-
10	2	15	71.4	1089	1311	-
11	1	15	50.5	1984	-	-
12	2	15	80.7	1096	1021	-
13	1	15	60.8	1615	-	-
14	1	15	56.2	1706	-	-
15	1	15	55.5	1848	-	-
16	1	15	57.9	1684	-	-
17						
18						
19						
20						



Long Pulse Radar Test Signal

Test Signal Name: LP_Signal_19

Number of Bursts in Trial: 11

Burst	Pulses per Burst	Chirp (MHz)	Pulse Width(us)	PRI-1 (us)	PRI-2 (us)	PRI-3 (us)
1	3	9	96.8	1941	1870	1430
2	2	9	79.6	1517	1584	-
3	2	9	75.8	1817	1181	-
4	1	9	54.1	1305	-	-
5	2	9	75.4	1553	1129	-
6	3	9	90.4	1904	1978	1724
7	2	9	70.5	1208	1176	-
8	2	9	77.6	1894	1921	-
9	1	9	62	1460	-	-
10	2	9	69.1	1354	1443	-
11	3	9	87.1	1807	1040	1439
12						
13						
14						
15						
16						
17						
18						
19						
20						



Long Pulse Radar Test Signal

Test Signal Name: LP_Signal_20

Number of Bursts in Trial: 18

Burst	Pulses per Burst	Chirp (MHz)	Pulse Width(us)	PRI-1 (us)	PRI-2 (us)	PRI-3 (us)
1	2	18	80.4	1230	1672	-
2	3	18	97.3	1325	1715	1009
3	3	18	97.1	1388	1137	1502
4	2	18	75.4	1136	1688	-
5	2	18	79	1014	1049	-
6	3	18	89.3	1279	1401	1047
7	2	18	76.8	1602	1203	-
8	2	18	67.9	1585	1115	-
9	1	18	56	1132	-	-
10	1	18	52.6	1290	-	-
11	1	18	62	1386	-	-
12	3	18	83.7	1284	1276	1680
13	2	18	81.2	1550	1446	-
14	1	18	61.1	1341	-	-
15	3	18	99.4	1497	1485	1767
16	3	18	92.3	1919	1403	1981
17	2	18	75.7	1634	1509	-
18	1	18	50.4	1166	-	-
19						
20						



Long Pulse Radar Test Signal

Test Signal Name: LP_Signal_21

Number of Bursts in Trial: 17

Burst	Pulses per Burst	Chirp (MHz)	Pulse Width(us)	PRI-1 (us)	PRI-2 (us)	PRI-3 (us)
1	3	16	91.3	1747	1138	1467
2	3	16	98.6	1872	1255	1854
3	2	16	81.6	1031	1735	-
4	2	16	70.6	1513	1718	-
5	1	16	58.5	1612	-	-
6	2	16	78.5	1419	1835	-
7	3	16	89.3	1260	1939	1838
8	2	16	78.3	1683	1593	-
9	2	16	71.8	1053	1314	-
10	2	16	80.2	1030	1832	-
11	3	16	99.2	1566	1536	1572
12	1	16	65.8	1858	-	-
13	2	16	68.5	1201	1702	-
14	3	16	95.8	1686	1234	1668
15	3	16	86.6	1378	1098	1337
16	3	16	85.9	1318	1800	1673
17	2	16	79.5	1406	1391	-
18						
19						
20						



Long Pulse Radar Test Signal

Test Signal Name: LP_Signal_22

Number of Bursts in Trial: 11

Burst	Pulses per Burst	Chirp (MHz)	Pulse Width(us)	PRI-1 (us)	PRI-2 (us)	PRI-3 (us)
1	3	8	88.8	1152	1076	1263
2	2	8	79.4	1657	1623	-
3	3	8	96	1808	1316	1147
4	2	8	71.6	1930	1042	-
5	3	8	91.5	1748	1248	1223
6	3	8	84.1	1159	1295	1544
7	3	8	88.4	1716	1560	1950
8	3	8	99.6	1901	1121	1303
9	1	8	55.3	1157	-	-
10	3	8	84.7	1340	1268	1586
11	3	8	95.9	1194	1693	1144
12						
13						
14						
15						
16						
17						
18						
19						
20						



Long Pulse Radar Test Signal

Test Signal Name: LP_Signal_23

Number of Bursts in Trial: 17

Burst	Pulses per Burst	Chirp (MHz)	Pulse Width(us)	PRI-1 (us)	PRI-2 (us)	PRI-3 (us)
1	3	16	94.7	1062	1628	1922
2	3	16	93.1	1082	1948	1365
3	2	16	76.1	1114	1937	-
4	3	16	98.1	1913	1828	1712
5	3	16	94.8	1871	1457	1402
6	2	16	77.2	1855	1730	-
7	2	16	70.8	1191	1164	-
8	2	16	70.5	1786	1052	-
9	1	16	55.5	1960	-	-
10	1	16	59.8	1259	-	-
11	3	16	88.7	1091	1971	1404
12	2	16	68.6	1101	1239	-
13	3	16	86.2	1659	1463	1876
14	1	16	50.6	1940	-	-
15	2	16	67.4	1281	1676	-
16	3	16	96.7	1150	1928	1179
17	2	16	68.8	1367	1926	-
18						
19						
20						



Long Pulse Radar Test Signal

Test Signal Name: LP_Signal_24

Number of Bursts in Trial: 17

Burst	Pulses per Burst	Chirp (MHz)	Pulse Width(us)	PRI-1 (us)	PRI-2 (us)	PRI-3 (us)
1	3	16	90.2	1935	1079	1478
2	3	16	84.2	1757	1982	1606
3	1	16	66.3	1162	-	-
4	3	16	97.2	1976	1479	1302
5	3	16	95.3	1118	1818	1829
6	2	16	81.7	1426	1122	-
7	1	16	60.5	1309	-	-
8	1	16	62.8	1059	-	-
9	2	16	79.7	1077	1029	-
10	2	16	78.9	1970	1483	-
11	3	16	99.8	1472	1262	1313
12	1	16	64.5	1006	-	-
13	3	16	93.2	1717	1778	1169
14	2	16	71	1003	1899	-
15	1	16	53.2	1826	-	-
16	3	16	93.8	1819	1217	1232
17	3	16	93.5	1839	1221	1437
18						
19						
20						



Long Pulse Radar Test Signal

Test Signal Name: LP_Signal_25

Number of Bursts in Trial: 19

Burst	Pulses per Burst	Chirp (MHz)	Pulse Width(us)	PRI-1 (us)	PRI-2 (us)	PRI-3 (us)
1	3	18	83.6	1590	1646	1773
2	2	18	78.8	1532	1417	-
3	1	18	54.1	1739	-	-
4	1	18	51	1219	-	-
5	2	18	71.1	1857	1796	-
6	3	18	91.4	1883	1025	1603
7	2	18	74.9	1068	1983	-
8	1	18	66	1745	-	-
9	2	18	80.4	1211	1761	-
10	2	18	69.7	1558	1393	-
11	1	18	50.1	1997	-	-
12	1	18	60.8	1207	-	-
13	1	18	59.8	1017	-	-
14	2	18	70.9	1170	1754	-
15	2	18	74.1	1100	1369	-
16	3	18	87.4	1308	1327	1214
17	2	18	69.6	1060	1143	-
18	1	18	59.3	1547	-	-
19	2	18	71.1	1018	1912	-
20						



Long Pulse Radar Test Signal

Test Signal Name: LP_Signal_26

Number of Bursts in Trial: 16

Burst	Pulses per Burst	Chirp (MHz)	Pulse Width(us)	PRI-1 (us)	PRI-2 (us)	PRI-3 (us)
1	2	15	68.3	1085	1505	-
2	3	15	98.8	1700	1371	1522
3	3	15	99.5	1897	1103	1348
4	1	15	61.4	1120	-	-
5	1	15	65.5	1235	-	-
6	3	15	85.2	1789	1740	1649
7	1	15	65	1168	-	-
8	3	15	98.3	1291	1962	1326
9	2	15	71	1797	1540	-
10	1	15	56	1368	-	-
11	1	15	62.3	1282	-	-
12	3	15	88.8	1794	1409	1591
13	3	15	85.4	1791	1906	1518
14	2	15	74.9	1999	1473	-
15	3	15	92.8	1333	1554	1932
16	2	15	67	1511	1889	-
17						
18						
19						
20						



Long Pulse Radar Test Signal

Test Signal Name: LP_Signal_27

Number of Bursts in Trial: 19

Burst	Pulses per Burst	Chirp (MHz)	Pulse Width(us)	PRI-1 (us)	PRI-2 (us)	PRI-3 (us)
1	3	18	88.7	1601	1038	1083
2	3	18	92.6	1565	1537	1692
3	2	18	67.7	1696	1920	-
4	2	18	69.1	1227	1929	-
5	3	18	92.8	1412	1352	1631
6	3	18	91.4	1836	1608	1596
7	2	18	81.1	1486	1862	-
8	1	18	64.8	1533	-	-
9	1	18	61.9	1714	-	-
10	1	18	60.3	1293	-	-
11	1	18	52	1980	-	-
12	2	18	69.9	1233	1792	-
13	1	18	57.9	1173	-	-
14	2	18	75.6	1559	1057	-
15	2	18	77.2	1375	1801	-
16	2	18	73.6	1990	1142	-
17	1	18	61.7	1037	-	-
18	2	18	82.1	1736	1573	-
19	2	18	75.4	1372	1766	-
20						



Long Pulse Radar Test Signal

Test Signal Name: LP_Signal_28

Number of Bursts in Trial: 12

Burst	Pulses per Burst	Chirp (MHz)	Pulse Width(us)	PRI-1 (us)	PRI-2 (us)	PRI-3 (us)
1	3	10	94.7	1329	1955	1420
2	3	10	84.2	1184	1507	1266
3	2	10	67.3	1163	1784	-
4	3	10	88.6	1597	1973	1708
5	1	10	65.9	1236	-	-
6	1	10	56	1694	-	-
7	3	10	93.1	1821	1903	1283
8	1	10	53.9	1075	-	-
9	1	10	60	1856	-	-
10	2	10	68	1258	1328	-
11	2	10	80.9	1624	1695	-
12	1	10	64.8	1644	-	-
13						
14						
15						
16						
17						
18						
19						
20						



Long Pulse Radar Test Signal

Test Signal Name: LP_Signal_29

Number of Bursts in Trial: 16

Burst	Pulses per Burst	Chirp (MHz)	Pulse Width(us)	PRI-1 (us)	PRI-2 (us)	PRI-3 (us)
1	3	14	85.9	1370	1000	1154
2	2	14	67.1	1256	1753	-
3	1	14	53.8	1776	-	-
4	3	14	85.5	1655	1961	1399
5	3	14	94.8	1583	1102	1726
6	1	14	51.9	1357	-	-
7	3	14	90.2	1806	1979	1220
8	2	14	78.4	1923	1542	-
9	2	14	77	1061	1498	-
10	2	14	67.6	1071	1681	-
11	3	14	84.6	1416	1988	1764
12	3	14	99.5	1825	1722	1875
13	1	14	55.1	1470	-	-
14	2	14	83.1	1054	1946	-
15	3	14	95.2	1746	1618	1424
16	3	14	90.4	1709	1065	1069
17						
18						
19						



Long Pulse Radar Test Signal

Test Signal Name: LP_Signal_30

Number of Bursts in Trial: 18

Burst	Pulses per Burst	Chirp (MHz)	Pulse Width(us)	PRI-1 (us)	PRI-2 (us)	PRI-3 (us)
1	3	17	95.4	1574	1546	1798
2	2	17	78.8	1243	1775	-
3	3	17	88.8	1246	1842	1423
4	2	17	77	1199	1949	-
5	1	17	53.2	1073	-	-
6	3	17	99.5	1943	1229	1320
7	3	17	98.1	1907	1092	1119
8	2	17	82.9	1272	1254	-
9	2	17	71.3	1396	1192	-
10	1	17	54	1273	-	-
11	1	17	51.7	1278	-	-
12	1	17	63.1	1001	-	-
13	3	17	99.8	1690	1158	1656
14	3	17	87.5	1010	1330	1292
15	2	17	71	1934	1635	-
16	3	17	96.9	1285	1972	1228
17	2	17	81.1	1459	1503	-
18	3	17	95.6	1878	1418	1752
19						
20						



802.11ax (HE80)

Long Pulse Radar Test Signal

Test Signal Name: LP_Signal_01

Number of Bursts in Trial: 11

Burst	Pulses per Burst	Chirp (MHz)	Pulse Width(us)	PRI-1 (us)	PRI-2 (us)	PRI-3 (us)
1	1	9	63.2	1251	-	-
2	3	9	93	1099	1203	1528
3	2	9	77.2	1842	1132	-
4	3	9	84.1	1139	1584	1206
5	1	9	52	1514	-	-
6	2	9	76.6	1696	1078	-
7	2	9	83	1188	1467	-
8	2	9	74.1	1282	1923	-
9	3	9	97.4	1521	1847	1791
10	1	9	56.1	1558	-	-
11	3	9	98.7	1315	1204	1306
12						
13						
14						
15						
16						
17						
18						
19						
20						



Long Pulse Radar Test Signal

Test Signal Name: LP_Signal_02

Number of Bursts in Trial: 19

Burst	Pulses per Burst	Chirp (MHz)	Pulse Width(us)	PRI-1 (us)	PRI-2 (us)	PRI-3 (us)
1	1	18	60.2	1801	-	-
2	1	18	56.5	1403	-	-
3	3	18	97.8	1719	1959	1990
4	3	18	89.1	1916	1920	1723
5	1	18	50.9	1175	-	-
6	3	18	97.6	1053	1186	1250
7	3	18	93.8	1138	1234	1548
8	1	18	66.3	1699	-	-
9	2	18	80.4	1405	1177	-
10	1	18	50.2	1575	-	-
11	3	18	86.8	1319	1339	1393
12	1	18	52.4	1085	-	-
13	2	18	70.8	1861	1355	-
14	1	18	52.6	1999	-	-
15	3	18	98.2	1742	1522	1609
16	2	18	78.4	1300	1573	-
17	2	18	77.9	1899	1729	-
18	1	18	58.8	1692	-	-
19	2	18	70.5	1668	1182	-
20						



Long Pulse Radar Test Signal

Test Signal Name: LP_Signal_03

Number of Bursts in Trial: 15

Burst	Pulses per Burst	Chirp (MHz)	Pulse Width(us)	PRI-1 (us)	PRI-2 (us)	PRI-3 (us)
1	1	13	52.3	1596	-	-
2	3	13	88.8	1292	1975	1156
3	3	13	97.5	1388	1281	1285
4	2	13	79.5	1036	1287	-
5	1	13	51.1	1299	-	-
6	3	13	90.2	1345	1623	1163
7	3	13	95.6	1280	1240	1715
8	3	13	86.9	1010	1887	1098
9	2	13	72.7	1066	1561	-
10	2	13	79.2	1174	1983	-
11	3	13	96.5	1655	1446	1932
12	2	13	69.2	1241	1507	-
13	3	13	92.6	1858	1284	1006
14	3	13	99.5	1811	1981	1346
15	2	13	78	1183	1258	-
16						
17						
18						
19						
20						



Long Pulse Radar Test Signal

Test Signal Name: LP_Signal_04

Number of Bursts in Trial: 16

Burst	Pulses per Burst	Chirp (MHz)	Pulse Width(us)	PRI-1 (us)	PRI-2 (us)	PRI-3 (us)
1	3	15	96.5	1057	1829	1321
2	2	15	75.1	1700	1650	-
3	3	15	91.7	1152	1273	1367
4	2	15	74.6	1912	1014	-
5	2	15	69.7	1935	1783	-
6	1	15	59.9	1084	-	-
7	2	15	76.8	1733	1675	-
8	1	15	53.1	1245	-	-
9	2	15	68.9	1756	1195	-
10	1	15	50	1142	-	-
11	2	15	76.4	1608	1048	-
12	3	15	90.6	1782	1443	1061
13	1	15	56.3	1870	-	-
14	2	15	81.4	1354	1395	-
15	1	15	53.9	1480	-	-
16	3	15	98.2	1896	1785	1005
17						
18						
19						
20						



Long Pulse Radar Test Signal

Test Signal Name: LP_Signal_05

Number of Bursts in Trial: 8

Burst	Pulses per Burst	Chirp (MHz)	Pulse Width(us)	PRI-1 (us)	PRI-2 (us)	PRI-3 (us)
1	1	5	55	1081	-	-
2	1	5	65.3	1524	-	-
3	2	5	76.9	1929	1493	-
4	1	5	53.8	1476	-	-
5	1	5	59.9	1333	-	-
6	1	5	62.8	1749	-	-
7	2	5	77.1	1119	1565	-
8	3	5	96.7	1331	1746	1176
9						
10						
11						
12						
13						
14						
15						
16						
17						
18						
19						
20						



Long Pulse Radar Test Signal

Test Signal Name: LP_Signal_06

Number of Bursts in Trial: 14

Burst	Pulses per Burst	Chirp (MHz)	Pulse Width(us)	PRI-1 (us)	PRI-2 (us)	PRI-3 (us)
1	3	13	99	1503	1924	1407
2	1	13	55.4	1682	-	-
3	1	13	60.7	1063	-	-
4	2	13	71.1	1917	1474	-
5	3	13	87.1	1344	1541	1257
6	3	13	83.9	1589	1537	1598
7	2	13	81.1	1880	1889	-
8	3	13	94.3	1269	1231	1930
9	1	13	52.9	1955	-	-
10	3	13	92.8	1815	1856	1199
11	1	13	56.1	1914	-	-
12	2	13	73	1253	1448	-
13	3	13	86.8	1276	1043	1972
14	1	13	53.3	1289	-	-
15						
16						
17						
18						
19						
20						



Long Pulse Radar Test Signal

Test Signal Name: LP_Signal_07

Number of Bursts in Trial: 16

Burst	Pulses per Burst	Chirp (MHz)	Pulse Width(us)	PRI-1 (us)	PRI-2 (us)	PRI-3 (us)
1	3	15	89.2	1520	1813	1948
2	1	15	60.5	1326	-	-
3	2	15	75.6	1427	1795	-
4	3	15	85.7	1356	1944	1166
5	2	15	78.5	1050	1838	-
6	2	15	79.5	1205	1219	-
7	2	15	74.7	1404	1931	-
8	3	15	99.6	1515	1248	1803
9	3	15	89.2	1109	1167	1107
10	1	15	55.4	1442	-	-
11	2	15	68.7	1429	1894	-
12	2	15	81	1684	1374	-
13	3	15	91.5	1252	1992	1029
14	1	15	53.8	1591	-	-
15	1	15	65.7	1525	-	-
16	3	15	95.7	1892	1128	1239
17						
18						
19						
20						



Long Pulse Radar Test Signal

Test Signal Name: LP_Signal_08

Number of Bursts in Trial: 14

Burst	Pulses per Burst	Chirp (MHz)	Pulse Width(us)	PRI-1 (us)	PRI-2 (us)	PRI-3 (us)
1	2	12	68.1	1789	1765	-
2	3	12	83.7	1271	1288	1233
3	3	12	98.1	1421	1034	1044
4	3	12	95.1	1114	1657	1027
5	2	12	75.7	1263	1090	-
6	1	12	64.2	1901	-	-
7	3	12	99.3	1327	1320	1606
8	1	12	55.6	1074	-	-
9	1	12	66	1527	-	-
10	3	12	85	1621	1464	1482
11	2	12	68.9	1970	1883	-
12	2	12	82.1	1351	1469	-
13	3	12	87.7	1841	1640	1009
14	1	12	63.5	1599	-	-
15						
16						
17						
18						
19						
20						



Long Pulse Radar Test Signal

Test Signal Name: LP_Signal_09

Number of Bursts in Trial: 20

Burst	Pulses per Burst	Chirp (MHz)	Pulse Width(us)	PRI-1 (us)	PRI-2 (us)	PRI-3 (us)
1	2	20	75.3	1881	1127	-
2	2	20	81	1274	1648	-
3	1	20	61.4	1077	-	-
4	1	20	51.7	1570	-	-
5	2	20	76.2	1478	1019	-
6	1	20	66.3	1501	-	-
7	2	20	78.2	1626	1818	-
8	2	20	74.3	1123	1201	-
9	3	20	84.3	1165	1144	1809
10	3	20	97.6	1335	1753	1453
11	2	20	71.9	1153	1939	-
12	3	20	99.4	1900	1069	1389
13	1	20	66.2	1516	-	-
14	1	20	55.2	1502	-	-
15	1	20	52.4	1745	-	-
16	1	20	56	1193	-	-
17	3	20	92.5	1585	1534	1304
18	2	20	77.3	1747	1730	-
19	2	20	78.6	1015	1202	-
20	1	20	57.2	1382	-	-



Long Pulse Radar Test Signal

Test Signal Name: LP_Signal_10

Number of Bursts in Trial: 9

Burst	Pulses per Burst	Chirp (MHz)	Pulse Width(us)	PRI-1 (us)	PRI-2 (us)	PRI-3 (us)
1	2	6	74.7	1508	1788	-
2	2	6	72.4	1718	1439	-
3	2	6	74.9	1097	1455	-
4	3	6	91.8	1602	1799	1376
5	2	6	77.7	1823	1748	-
6	2	6	74.9	1922	1672	-
7	1	6	61.3	1903	-	-
8	2	6	69.9	1089	1772	-
9	2	6	69.6	1008	1134	-
10						
11						
12						
13						
14						
15						
16						
17						
18						
19						
20						



Long Pulse Radar Test Signal

Test Signal Name: LP_Signal_11

Number of Bursts in Trial: 20

Burst	Pulses per Burst	Chirp (MHz)	Pulse Width(us)	PRI-1 (us)	PRI-2 (us)	PRI-3 (us)
1	3	20	93.6	1370	1793	1594
2	1	20	60.5	1093	-	-
3	3	20	92.6	1607	1991	1504
4	1	20	61.9	1773	-	-
5	2	20	75.7	1659	1151	-
6	2	20	80.1	1353	1419	-
7	3	20	87.8	1001	1291	1396
8	2	20	69.6	1651	1819	-
9	3	20	89.7	1764	1338	1254
10	2	20	77.7	1634	1641	-
11	3	20	99.4	1064	1432	1627
12	2	20	67.4	1418	1874	-
13	3	20	93.9	1178	1519	1909
14	3	20	99.5	1362	1192	1977
15	1	20	50.4	1771	-	-
16	2	20	73.1	1848	1550	-
17	2	20	76.3	1888	1787	-
18	3	20	98.1	1740	1721	1638
19	3	20	94	1832	1593	1461
20	1	20	53.2	1218	-	-



Long Pulse Radar Test Signal

Test Signal Name: LP_Signal_12

Number of Bursts in Trial: 10

Burst	Pulses per Burst	Chirp (MHz)	Pulse Width(us)	PRI-1 (us)	PRI-2 (us)	PRI-3 (us)
1	1	8	59.9	1968	-	-
2	3	8	92.6	1072	1399	1032
3	3	8	91.7	1988	1458	1428
4	1	8	53.5	1686	-	-
5	2	8	80.4	1490	1347	-
6	3	8	88.9	1459	1698	1083
7	1	8	52.9	1485	-	-
8	1	8	56	1039	-	-
9	2	8	69.7	1549	1755	-
10	2	8	74	1279	1140	-
11						
12						
13						
14						
15						
16						
17						
18						
19						
20						



Long Pulse Radar Test Signal

Test Signal Name: LP_Signal_13

Number of Bursts in Trial: 9

Burst	Pulses per Burst	Chirp (MHz)	Pulse Width(us)	PRI-1 (us)	PRI-2 (us)	PRI-3 (us)
1	1	7	51.3	1489	-	-
2	1	7	54.9	1149	-	-
3	1	7	58.3	1605	-	-
4	1	7	54.6	1316	-	-
5	3	7	90.8	1154	1226	1247
6	3	7	87	1578	1643	1375
7	2	7	79.3	1677	1041	-
8	3	7	87.4	1631	1586	1323
9	3	7	90.6	1361	1466	1411
10						
11						
12						
13						
14						
15						
16						
17						
18						
19						
20						



Long Pulse Radar Test Signal

Test Signal Name: LP_Signal_14

Number of Bursts in Trial: 20

Burst	Pulses per Burst	Chirp (MHz)	Pulse Width(us)	PRI-1 (us)	PRI-2 (us)	PRI-3 (us)
1	2	20	75.2	1744	1145	-
2	1	20	64.6	1971	-	-
3	3	20	86.5	1532	1301	1031
4	1	20	52.7	1028	-	-
5	3	20	99.7	1040	1486	1451
6	2	20	79.2	1488	1702	-
7	3	20	89.9	1553	1984	1492
8	2	20	80.8	1869	1511	-
9	2	20	73	1437	1030	-
10	2	20	74.5	1208	1734	-
11	2	20	68.6	1400	1013	-
12	1	20	51.3	1816	-	-
13	2	20	76.8	1087	1674	-
14	2	20	67.4	1845	1665	-
15	1	20	66.6	1844	-	-
16	1	20	59.7	1135	-	-
17	1	20	51	1088	-	-
18	2	20	68.9	1661	1024	-
19	3	20	89.1	1497	1915	1170
20	2	20	81.6	1921	1877	-

Long Pulse Radar Test Signal

Test Signal Name: LP_Signal_15

Number of Bursts in Trial: 18

Burst	Pulses per Burst	Chirp (MHz)	Pulse Width(us)	PRI-1 (us)	PRI-2 (us)	PRI-3 (us)
1	3	17	86.8	1854	1969	1825
2	2	17	77.1	1895	1473	-
3	2	17	81.8	1905	1615	-
4	3	17	99.9	1401	1025	1979
5	1	17	65.7	1652	-	-
6	2	17	76.3	1572	1408	-
7	3	17	94.5	1543	1430	1465
8	1	17	59.1	1802	-	-
9	3	17	89.3	1710	1212	1950
10	1	17	58.6	1897	-	-
11	1	17	63.5	1735	-	-
12	3	17	93.9	1129	1168	1383
13	3	17	89	1775	1689	1708
14	1	17	57.5	1047	-	-
15	2	17	68.7	1853	1904	-
16	3	17	88.7	1539	1761	1120
17	2	17	73.4	1259	1445	-
18	3	17	89.8	1058	1484	1189
19						
20						



Long Pulse Radar Test Signal

Test Signal Name: LP_Signal_16

Number of Bursts in Trial: 8

Burst	Pulses per Burst	Chirp (MHz)	Pulse Width(us)	PRI-1 (us)	PRI-2 (us)	PRI-3 (us)
1	3	5	92.1	1774	1390	1720
2	2	5	74.3	1852	1910	-
3	3	5	90.5	1094	1663	1191
4	1	5	58	1704	-	-
5	2	5	79.9	1592	1409	-
6	2	5	81.5	1566	1051	-
7	1	5	51.1	1691	-	-
8	2	5	72.7	1833	1583	-
9						
10						
11						
12						
13						
14						
15						
16						
17						
18						
19						
20						



Long Pulse Radar Test Signal

Test Signal Name: LP_Signal_17

Number of Bursts in Trial: 20

Burst	Pulses per Burst	Chirp (MHz)	Pulse Width(us)	PRI-1 (us)	PRI-2 (us)	PRI-3 (us)
1	2	20	74.5	1544	1805	-
2	3	20	87.5	1460	1664	1807
3	3	20	91.7	1886	1249	1849
4	3	20	94.9	1884	1717	1431
5	3	20	89.7	1000	1283	1213
6	2	20	68.1	1601	1349	-
7	3	20	90.3	1666	1369	1328
8	1	20	55.8	1878	-	-
9	1	20	53.7	1512	-	-
10	3	20	98.1	1161	1875	1580
11	2	20	82.9	1555	1111	-
12	3	20	86.6	1311	1637	1307
13	3	20	87.1	1857	1963	1947
14	2	20	73.3	1122	1873	-
15	3	20	84.8	1998	1743	1941
16	2	20	80.7	1831	1557	-
17	3	20	91.6	1420	1738	1470
18	1	20	64.3	1225	-	-
19	1	20	60.9	1309	-	-
20	2	20	74.8	1197	1617	-



Long Pulse Radar Test Signal

Test Signal Name: LP_Signal_18

Number of Bursts in Trial: 19

Burst	Pulses per Burst	Chirp (MHz)	Pulse Width(us)	PRI-1 (us)	PRI-2 (us)	PRI-3 (us)
1	1	19	62.4	1636	-	-
2	2	19	69.3	1002	1054	-
3	3	19	98.7	1360	1974	1441
4	2	19	78	1851	1244	-
5	3	19	86.3	1918	1310	1406
6	1	19	61.2	1426	-	-
7	2	19	76.8	1386	1997	-
8	1	19	64.8	1436	-	-
9	3	19	91.1	1928	1938	1576
10	2	19	78.8	1007	1817	-
11	3	19	97.3	1447	1117	1313
12	1	19	50.2	1982	-	-
13	3	19	98.8	1101	1517	1976
14	3	19	93	1255	1112	1468
15	1	19	51.7	1936	-	-
16	1	19	56.9	1554	-	-
17	2	19	67.5	1456	1925	-
18	3	19	94.4	1866	1758	1978
19	2	19	69	1371	1732	-
20						



Long Pulse Radar Test Signal

Test Signal Name: LP_Signal_19

Number of Bursts in Trial: 12

Burst	Pulses per Burst	Chirp (MHz)	Pulse Width(us)	PRI-1 (us)	PRI-2 (us)	PRI-3 (us)
1	2	10	70.9	1736	1367	-
2	1	10	62.4	1193	-	-
3	1	10	61.8	1596	-	-
4	1	10	52.6	1646	-	-
5	2	10	78.9	1049	1639	-
6	1	10	63.9	1679	-	-
7	3	10	98.5	1627	1731	1442
8	3	10	92	1294	1547	1119
9	1	10	65.8	1386	-	-
10	2	10	77.7	1987	1964	-
11	1	10	54.6	1553	-	-
12	2	10	77.7	1171	1413	-
13						
14						
15						
16						
17						
18						
19						
20						



Long Pulse Radar Test Signal

Test Signal Name: LP_Signal_20

Number of Bursts in Trial: 15

Burst	Pulses per Burst	Chirp (MHz)	Pulse Width(us)	PRI-1 (us)	PRI-2 (us)	PRI-3 (us)
1	1	14	65.6	1479	-	-
2	2	14	70.6	1075	1317	-
3	2	14	76.3	1949	1961	-
4	1	14	60.2	1653	-	-
5	1	14	55.2	1359	-	-
6	3	14	88.8	1110	1158	1076
7	1	14	63.6	1046	-	-
8	1	14	58.5	1229	-	-
9	2	14	78.5	1391	1590	-
10	3	14	91.3	1126	1108	1872
11	2	14	75.5	1697	1893	-
12	1	14	64.7	1221	-	-
13	2	14	74.9	1444	1911	-
14	1	14	50.8	1506	-	-
15	2	14	82.6	1582	1185	-
16						
17						
18						
19						
20						



Long Pulse Radar Test Signal

Test Signal Name: LP_Signal_21

Number of Bursts in Trial: 08

Burst	Pulses per Burst	Chirp (MHz)	Pulse Width(us)	PRI-1 (us)	PRI-2 (us)	PRI-3 (us)
1	3	5	87.9	1834	1951	1104
2	3	5	94.1	1762	1716	1410
3	2	5	71.5	1294	1750	-
4	2	5	77.8	1706	1337	-
5	1	5	63.2	1784	-	-
6	3	5	97.2	1552	1564	1216
7	3	5	95.4	1402	1336	1017
8	1	5	65.6	1068	-	-
9						
10						
11						
12						
13						
14						
15						
16						
17						
18						
19						
20						



Long Pulse Radar Test Signal

Test Signal Name: LP_Signal_22

Number of Bursts in Trial: 17

Burst	Pulses per Burst	Chirp (MHz)	Pulse Width(us)	PRI-1 (us)	PRI-2 (us)	PRI-3 (us)
1	2	16	71.2	1358	1100	-
2	2	16	79.3	1224	1475	-
3	1	16	65.5	1681	-	-
4	2	16	78.1	1827	1322	-
5	2	16	72.2	1164	1821	-
6	3	16	99.5	1115	1752	1800
7	1	16	58.5	1806	-	-
8	1	16	58	1065	-	-
9	2	16	75.2	1846	1246	-
10	2	16	81.3	1171	1956	-
11	1	16	62.3	1646	-	-
12	2	16	81.6	1342	1628	-
13	2	16	79.7	1020	1937	-
14	2	16	72.4	1797	1669	-
15	2	16	82.8	1341	1116	-
16	3	16	96.6	1049	1890	1533
17	2	16	68.1	1481	1070	-
18						
19						
20						



Long Pulse Radar Test Signal

Test Signal Name: LP_Signal_23

Number of Bursts in Trial: 08

Burst	Pulses per Burst	Chirp (MHz)	Pulse Width(us)	PRI-1 (us)	PRI-2 (us)	PRI-3 (us)
1	1	5	53.8	1709	-	-
2	3	5	85.9	1768	1645	1563
3	3	5	90.5	1676	1055	1597
4	1	5	54.1	1425	-	-
5	2	5	78.2	1348	1952	-
6	2	5	68.4	1169	1760	-
7	2	5	78.9	1776	1620	-
8	2	5	69.8	1662	1381	-
9						
10						
11						-
12						-
13						
14						
15						
16						
17						
18						
19						
20						



Long Pulse Radar Test Signal

Test Signal Name: LP_Signal_24

Number of Bursts in Trial: 13

Burst	Pulses per Burst	Chirp (MHz)	Pulse Width(us)	PRI-1 (us)	PRI-2 (us)	PRI-3 (us)
1	2	11	73.2	1690	1966	-
2	3	11	99.1	1707	1220	1763
3	1	11	58.6	1647	-	-
4	3	11	97.3	1926	1499	1529
5	1	11	61.7	1434	-	-
6	3	11	96.6	1727	1600	1804
7	2	11	69.2	1042	1023	-
8	2	11	70.3	1898	1701	-
9	1	11	54.9	1256	-	-
10	1	11	55.1	1986	-	-
11	2	11	81	1736	1477	-
12	3	11	89.8	1372	1724	1571
13	1	11	60.7	1958	-	-
14						
15						
16						
17						
18						
19						
20						



Long Pulse Radar Test Signal

Test Signal Name: LP_Signal_25

Number of Bursts in Trial: 08

Burst	Pulses per Burst	Chirp (MHz)	Pulse Width(us)	PRI-1 (us)	PRI-2 (us)	PRI-3 (us)
1	3	5	91.4	1673	1060	1196
2	1	5	59.1	1639	-	-
3	2	5	70	1303	1822	-
4	2	5	83.2	1778	1215	-
5	1	5	50.2	1433	-	-
6	3	5	83.4	1695	1106	1885
7	1	5	62.5	1946	-	-
8	2	5	69.3	1622	1731	-
9						
10						
11						
12						
13						
14						
15						
16						
17						
18						
19						
20						



Long Pulse Radar Test Signal

Test Signal Name: LP_Signal_26

Number of Bursts in Trial: 20

Burst	Pulses per Burst	Chirp (MHz)	Pulse Width(us)	PRI-1 (us)	PRI-2 (us)	PRI-3 (us)
1	1	20	52.9	1509	-	-
2	1	20	65.4	1714	-	-
3	1	20	61.3	1907	-	-
4	2	20	75	1136	1618	-
5	1	20	59.7	1919	-	-
6	1	20	59.4	1942	-	-
7	1	20	61.3	1850	-	-
8	1	20	54.8	1859	-	-
9	1	20	61.4	1624	-	-
10	3	20	93.1	1162	1649	1368
11	1	20	60.8	1312	-	-
12	3	20	86.6	1180	1828	1397
13	1	20	58.2	1860	-	-
14	3	20	99.1	1394	1275	1722
15	1	20	50.4	1423	-	-
16	3	20	99.9	1227	1343	1867
17	1	20	60.8	1879	-	-
18	1	20	63.5	1003	-	-
19	3	20	84.8	1613	1703	1685
20	3	20	93.2	1222	1194	1567



Long Pulse Radar Test Signal

Test Signal Name: LP_Signal_27

Number of Bursts in Trial: 15

Burst	Pulses per Burst	Chirp (MHz)	Pulse Width(us)	PRI-1 (us)	PRI-2 (us)	PRI-3 (us)
1	1	14	61.3	1190	-	-
2	2	14	74.7	1633	1062	-
3	2	14	67.3	1022	1147	-
4	1	14	51.7	1352	-	-
5	1	14	56.7	1413	-	-
6	1	14	57.3	1642	-	-
7	1	14	62.4	1658	-	-
8	2	14	76.7	1902	1121	-
9	2	14	70.5	1546	1513	-
10	2	14	70.9	1644	1505	-
11	2	14	77.9	1518	1004	-
12	3	14	85.1	1155	2000	1330
13	1	14	66.3	1876	-	-
14	1	14	50.5	1018	-	-
15	2	14	70.2	1814	1035	-
16						
17						
18						
19						
20						



Long Pulse Radar Test Signal

Test Signal Name: LP_Signal_28

Number of Bursts in Trial: 15

Burst	Pulses per Burst	Chirp (MHz)	Pulse Width(us)	PRI-1 (us)	PRI-2 (us)	PRI-3 (us)
1	3	13	83.6	1207	1133	1542
2	3	13	97.4	1540	1026	1906
3	2	13	72.2	1688	1933	-
4	1	13	52	1610	-	-
5	3	13	87.1	1863	1210	1236
6	1	13	57.9	1272	-	-
7	1	13	65.4	1577	-	-
8	3	13	93.6	1214	1412	1835
9	1	13	62.1	1463	-	-
10	2	13	70.1	1705	1989	-
11	1	13	53.1	1262	-	-
12	1	13	52.5	1318	-	-
13	3	13	92.4	1340	1364	1780
14	1	13	58.6	1293	-	-
15	2	13	70.2	1332	1993	-
16						
17						
18						
19						
20						



Long Pulse Radar Test Signal

Test Signal Name: LP_Signal_29

Number of Bursts in Trial: 10

Burst	Pulses per Burst	Chirp (MHz)	Pulse Width(us)	PRI-1 (us)	PRI-2 (us)	PRI-3 (us)
1	2	7	72.4	1495	1679	-
2	3	7	86.8	1296	1683	1836
3	3	7	98.7	1667	1767	1305
4	2	7	69.4	1855	1611	-
5	1	7	57.9	1157	-	-
6	2	7	78.2	1927	1759	-
7	3	7	98.1	1105	1995	1547
8	1	7	59.5	1726	-	-
9	2	7	68.3	1741	1325	-
10	1	7	52.3	1500	-	-
11						
12						
13						
14						
15						
16						
17						
18						
19						



Long Pulse Radar Test Signal

Test Signal Name: LP_Signal_30

Number of Bursts in Trial: 13

Burst	Pulses per Burst	Chirp (MHz)	Pulse Width(us)	PRI-1 (us)	PRI-2 (us)	PRI-3 (us)
1	3	11	97	1181	1440	1980
2	3	11	84.6	1562	1184	1779
3	3	11	84.4	1452	1350	1868
4	3	11	90.5	1678	1228	1223
5	1	11	65.1	1943	-	-
6	2	11	75.8	1130	1498	-
7	2	11	70.2	1994	1712	-
8	1	11	57.7	1960	-	-
9	2	11	78.8	1953	1379	-
10	2	11	66.8	1131	1366	-
11	1	11	52.5	1560	-	-
12	3	11	88.7	1278	1957	1934
13	1	11	61.4	1016	-	-
14						
15						
16						
17						
18						
19						
20						

802.11ax (HE80+80)

Long Pulse Radar Test Signal

Test Signal Name: LP_Signal_01

Number of Bursts in Trial: 18

Burst	Pulses per Burst	Chirp (MHz)	Pulse Width(us)	PRI-1 (us)	PRI-2 (us)	PRI-3 (us)
1	3	17	89.4	1750	1823	1091
2	1	17	57.6	1831	-	-
3	1	17	62.1	1839	-	-
4	3	17	94.8	1258	1771	1217
5	2	17	74.7	1246	1854	-
6	2	17	70.3	1286	1132	-
7	1	17	55.3	1409	-	-
8	3	17	99.3	1879	1810	1391
9	1	17	53.5	1673	-	-
10	2	17	74.6	1448	1969	-
11	3	17	85.5	1999	1087	1140
12	3	17	99.3	1602	1435	1376
13	3	17	91	1211	1374	1783
14	2	17	73.s8	1924	1124	-
15	2	17	74.1	1641	1247	-
16	2	17	82.2	1904	1345	-
17	2	17	68.6	1168	1844	-
18	2	17	74.8	1444	1778	-
19						
20						



Long Pulse Radar Test Signal

Test Signal Name: LP_Signal_02

Number of Bursts in Trial: 9

Burst	Pulses per Burst	Chirp (MHz)	Pulse Width(us)	PRI-1 (us)	PRI-2 (us)	PRI-3 (us)
1	2	7	67.7	1691	1157	-
2	3	7	99.8	1097	1766	1178
3	1	7	56.9	1188	-	-
4	3	7	99.1	1208	1655	1974
5	1	7	60.8	1480	-	-
6	3	7	88.3	1272	1863	1474
7	1	7	57.5	1911	-	-
8	2	7	80.3	1455	1881	-
9	2	7	71.4	1137	1241	-
10						
11						
12						
13						
14						
15						
16						
17						
18						
19						
20						



Long Pulse Radar Test Signal

Test Signal Name: LP_Signal_03

Number of Bursts in Trial: 11

Burst	Pulses per Burst	Chirp (MHz)	Pulse Width(us)	PRI-1 (us)	PRI-2 (us)	PRI-3 (us)
1	1	8	58.9	1295	-	-
2	2	8	72.6	1375	1213	-
3	1	8	60.7	1039	-	-
4	2	8	70.8	1230	1064	-
5	1	8	51.9	1025	-	-
6	2	8	67.5	1895	1802	-
7	2	8	80.8	1550	1533	-
8	2	8	68.6	1525	1221	-
9	3	8	92.4	1651	1985	1505
10	3	8	87	1671	1451	1643
11	2	8	70.9	1439	1724	-
12						
13						
14						
15						
16						
17						
18						
19						
20						



Long Pulse Radar Test Signal

Test Signal Name: LP_Signal_04

Number of Bursts in Trial: 19

Burst	Pulses per Burst	Chirp (MHz)	Pulse Width(us)	PRI-1 (us)	PRI-2 (us)	PRI-3 (us)
1	2	19	81.2	1922	1020	-
2	1	19	57.6	1677	-	-
3	3	19	84.9	1073	1244	1949
4	2	19	83.1	1935	1174	-
5	2	19	71.1	1542	1560	-
6	1	19	55.1	1790	-	-
7	1	19	54.4	1396	-	-
8	3	19	90.6	1035	1886	1980
9	3	19	92.2	1950	1759	1163
10	3	19	92.5	1108	1661	1358
11	2	19	79.5	1441	1957	-
12	2	19	76.3	1259	1876	-
13	1	19	65.7	1880	-	-
14	3	19	99.4	1971	1493	1004
15	3	19	89.5	1238	1700	1581
16	2	19	79.1	1906	1546	-
17	1	19	60	1019	-	-
18	3	19	90.3	1808	1034	1199
19	3	19	96.8	1869	1993	1967
20						



Long Pulse Radar Test Signal

Test Signal Name: LP_Signal_05

Number of Bursts in Trial: 14

Burst	Pulses per Burst	Chirp (MHz)	Pulse Width(us)	PRI-1 (us)	PRI-2 (us)	PRI-3 (us)
1	2	12	73.8	1686	1255	-
2	3	12	87.2	1201	1621	1693
3	3	12	94.4	1503	1529	1431
4	3	12	99	1308	1366	1481
5	3	12	96.5	1318	1418	1452
6	2	12	76.6	1695	1170	-
7	3	12	92.8	1304	1113	1835
8	1	12	53.8	1068	-	-
9	3	12	83.6	1384	1593	1212
10	2	12	81.8	1395	1768	-
11	1	12	60.2	1129	-	-
12	1	12	55.1	1045	-	-
13	2	12	81.8	1984	1703	-
14	3	12	95.3	1992	1828	1932
15						
16						
17						
18						
19						
20						



Long Pulse Radar Test Signal

Test Signal Name: LP_Signal_06

Number of Bursts in Trial: 13

Burst	Pulses per Burst	Chirp (MHz)	Pulse Width(us)	PRI-1 (us)	PRI-2 (us)	PRI-3 (us)
1	3	11	97.7	1350	1354	1424
2	3	11	93.6	1779	1273	1540
3	1	11	60	1065	-	-
4	1	11	64.8	1956	-	-
5	2	11	73.9	1390	1794	-
6	2	11	77.9	1670	1206	-
7	1	11	55.7	1942	-	-
8	3	11	83.9	1105	1853	1440
9	2	11	66.9	1819	1281	-
10	3	11	88.2	1734	1361	1371
11	2	11	79	1400	1522	-
12	2	11	79.4	1516	1031	-
13	3	11	96.4	1328	1845	1833
14						
15						
16						
17						
18						
19						
20						

Long Pulse Radar Test Signal

Test Signal Name: LP_Signal_07

Number of Bursts in Trial: 9

Burst	Pulses per Burst	Chirp (MHz)	Pulse Width(us)	PRI-1 (us)	PRI-2 (us)	PRI-3 (us)
1	3	6	95.1	1436	1883	1146
2	2	6	71.5	1669	1952	-
3	1	6	62.5	1309	-	-
4	3	6	88.5	1797	1846	1528
5	2	6	70.7	1976	1714	-
6	2	6	78.3	1943	1873	-
7	3	6	95.6	1763	1887	1977
8	1	6	63.1	1434	-	-
9	3	6	83.7	1069	1236	1277
10						
11						
12						
13						
14						
15						
16						
17						
18						
19						
20						



Long Pulse Radar Test Signal

Test Signal Name: LP_Signal_08

Number of Bursts in Trial: 20

Burst	Pulses per Burst	Chirp (MHz)	Pulse Width(us)	PRI-1 (us)	PRI-2 (us)	PRI-3 (us)
1	3	20	86.9	1257	1010	1287
2	1	20	58.7	1628	-	-
3	3	20	88.4	1800	1214	1234
4	1	20	56.4	1340	-	-
5	2	20	78.4	1792	1243	-
6	1	20	51.3	1416	-	-
7	2	20	70.8	1645	1975	-
8	1	20	58.8	1755	-	-
9	2	20	82	1476	1356	-
10	3	20	87.3	1650	1941	1834
11	3	20	97.8	1898	1608	1523
12	2	20	81.1	1696	1870	-
13	2	20	68.1	1652	1323	-
14	1	20	55.7	1814	-	-
15	2	20	79.4	1078	1527	-
16	1	20	64.2	1667	-	-
17	3	20	86.2	1052	1038	1690
18	1	20	62.3	1494	-	-
19	3	20	91.1	1885	1460	1013
20	3	20	89.9	1603	1592	1239



Long Pulse Radar Test Signal

Test Signal Name: LP_Signal_09

Number of Bursts in Trial: 8

Burst	Pulses per Burst	Chirp (MHz)	Pulse Width(us)	PRI-1 (us)	PRI-2 (us)	PRI-3 (us)
1	2	6	70.2	1773	1471	-
2	1	6	56.2	1180	-	-
3	2	6	69.9	1042	1393	-
4	2	6	67	1569	1594	-
5	2	6	80.3	1292	1588	-
6	3	6	97.8	1338	1678	1114
7	2	6	82.3	1803	1185	-
8	2	6	71.1	1564	1164	-
9						
10						
11						
12						
13						
14						
15						
16						
17						
18						
19						
20						



Long Pulse Radar Test Signal

Test Signal Name: LP_Signal_10

Number of Bursts in Trial: 14

Burst	Pulses per Burst	Chirp (MHz)	Pulse Width(us)	PRI-1 (us)	PRI-2 (us)	PRI-3 (us)
1	3	12	93.3	1781	1456	1265
2	3	12	89.5	1276	1002	1998
3	2	12	76.9	1607	1538	-
4	3	12	86.2	1261	1890	1231
5	2	12	82.1	1559	1369	-
6	1	12	63.9	1752	-	-
7	1	12	56.7	1225	-	-
8	1	12	51.3	1183	-	-
9	2	12	76.5	1498	1486	-
10	2	12	67.4	1235	1381	-
11	3	12	99.6	1582	1629	1177
12	1	12	54.4	1983	-	-
13	1	12	63.1	1953	-	-
14	1	12	58.1	1075	-	-
15						
16						
17						
18						
19						
20						



Long Pulse Radar Test Signal

Test Signal Name: LP_Signal_11

Number of Bursts in Trial: 17

Burst	Pulses per Burst	Chirp (MHz)	Pulse Width(us)	PRI-1 (us)	PRI-2 (us)	PRI-3 (us)
1	1	16	56.2	1389	-	-
2	3	16	91.7	1227	1497	1722
3	2	16	81.7	1437	1561	-
4	1	16	65.2	1001	-	-
5	2	16	76.9	1649	1267	-
6	1	16	65.7	1962	-	-
7	2	16	83.1	1242	1536	-
8	2	16	74.3	1972	1030	-
9	3	16	84.6	1148	1675	1683
10	1	16	66	1398	-	-
11	1	16	54.4	1368	-	-
12	2	16	73.2	1692	1156	-
13	1	16	63.5	1508	-	-
14	2	16	80.7	1506	1426	-
15	3	16	88.8	1939	1738	1841
16	2	16	71.3	1430	1705	-
17	2	16	76.2	1182	1708	-
18						
19						
20						



Long Pulse Radar Test Signal

Test Signal Name: LP_Signal_12

Number of Bursts in Trial: 20

Burst	Pulses per Burst	Chirp (MHz)	Pulse Width(us)	PRI-1 (us)	PRI-2 (us)	PRI-3 (us)
1	2	20	80.6	1716	1419	-
2	2	20	69	1197	1349	-
3	3	20	99.8	1300	1756	1712
4	1	20	65.5	1028	-	-
5	3	20	92.5	1857	1534	1544
6	1	20	60.4	1640	-	-
7	1	20	61.5	1761	-	-
8	3	20	99	1457	1908	1599
9	1	20	54.1	1487	-	-
10	3	20	99.1	1720	1314	1945
11	2	20	78	1155	1829	-
12	3	20	87.8	1812	1617	1159
13	2	20	68.8	1458	1438	-
14	1	20	62.7	1672	-	-
15	3	20	86.7	1618	1422	1224
16	2	20	76.8	1056	1934	-
17	1	20	62	1006	-	-
18	1	20	50	1884	-	-
19	2	20	78.2	1330	1630	-
20	3	20	85.3	1464	1955	1960



Long Pulse Radar Test Signal

Test Signal Name: LP_Signal_13

Number of Bursts in Trial: 18

Burst	Pulses per Burst	Chirp (MHz)	Pulse Width(us)	PRI-1 (us)	PRI-2 (us)	PRI-3 (us)
1	1	18	65	1066	-	-
2	2	18	70.8	1929	1636	-
3	1	18	66.5	1094	-	-
4	3	18	88	1855	1252	1111
5	2	18	69	1290	1859	-
6	1	18	54.9	1551	-	-
7	1	18	60.8	2000	-	-
8	2	18	81.8	1585	1864	-
9	1	18	58.8	1130	-	-
10	1	18	50.4	1169	-	-
11	2	18	76	1325	1445	-
12	1	18	62.6	1530	-	-
13	1	18	55.1	1851	-	-
14	3	18	91.2	1181	1302	1966
15	2	18	68.9	1348	1355	-
16	3	18	85.4	1537	1758	1109
17	1	18	63.4	1011	-	-
18	3	18	92.7	1122	1333	1584
19						
20						



Long Pulse Radar Test Signal

Test Signal Name: LP_Signal_14

Number of Bursts in Trial: 14

Burst	Pulses per Burst	Chirp (MHz)	Pulse Width(us)	PRI-1 (us)	PRI-2 (us)	PRI-3 (us)
1	1	12	63.7	1830	-	-
2	2	12	81.3	1110	1746	-
3	2	12	70.2	1334	1187	-
4	1	12	66.3	1587	-	-
5	2	12	72.8	1578	1745	-
6	2	12	66.7	1694	1931	-
7	1	12	55.1	1284	-	-
8	3	12	86.5	1089	1490	1762
9	1	12	65.7	1084	-	-
10	1	12	53.2	1268	-	-
11	2	12	67.8	1625	1411	-
12	3	12	96.5	1576	1799	1233
13	1	12	51.4	1373	-	-
14	2	12	80.7	1098	1849	-
15						
16						
17						
18						
19						
20						



Long Pulse Radar Test Signal

Test Signal Name: LP_Signal_15

Number of Bursts in Trial: 14

Burst	Pulses per Burst	Chirp (MHz)	Pulse Width(us)	PRI-1 (us)	PRI-2 (us)	PRI-3 (us)
1	1	12	60.5	1668	-	-
2	3	12	86	1786	1666	1266
3	1	12	61.2	1228	-	-
4	1	12	59.8	1204	-	-
5	1	12	52.5	1021	-	-
6	1	12	61.7	1634	-	-
7	3	12	96.5	1741	1875	1296
8	3	12	87.6	1093	1250	1172
9	3	12	99.6	1215	1813	1820
10	2	12	79.7	1327	1512	-
11	3	12	90.2	1589	1145	1082
12	1	12	53.7	1136	-	-
13	2	12	73	1706	1526	-
14	1	12	65.4	1420	-	-
15						
16						
17						
18						
19						
20						



Long Pulse Radar Test Signal

Test Signal Name: LP_Signal_16

Number of Bursts in Trial: 16

Burst	Pulses per Burst	Chirp (MHz)	Pulse Width(us)	PRI-1 (us)	PRI-2 (us)	PRI-3 (us)
1	2	15	82.6	1347	1485	-
2	2	15	77.6	1312	1500	-
3	3	15	93.8	1062	1005	1749
4	1	15	51.3	1809	-	-
5	1	15	63.4	1699	-	-
6	2	15	69.4	1606	1219	-
7	3	15	86.3	1102	1878	1728
8	3	15	97	1192	1858	1772
9	1	15	65.1	1363	-	-
10	3	15	98.8	1083	1567	1961
11	3	15	98.1	1473	1271	1263
12	3	15	99.9	1780	1871	1249
13	2	15	82.9	1785	1081	-
14	2	15	82.5	1501	1921	-
15	3	15	89.2	1767	1357	1479
16	1	15	57.5	1891	-	-
17						
18						
19						
20						



Long Pulse Radar Test Signal

Test Signal Name: LP_Signal_17

Number of Bursts in Trial: 12

Burst	Pulses per Burst	Chirp (MHz)	Pulse Width(us)	PRI-1 (us)	PRI-2 (us)	PRI-3 (us)
1	1	10	63.9	1331	-	-
2	1	10	62.4	1897	-	-
3	3	10	99.1	1769	1832	1647
4	3	10	95.4	1991	1085	1937
5	1	10	52	1029	-	-
6	2	10	69.1	1637	1611	-
7	2	10	80	1447	1685	-
8	1	10	59.1	1635	-	-
9	2	10	82.8	1134	1080	-
10	1	10	51.6	1138	-	-
11	3	10	96.2	1165	1754	1269
12	2	10	76.1	1406	1818	-
13						
14						
15						
16						
17						
18						
19						
20						



Long Pulse Radar Test Signal

Test Signal Name: LP_Signal_18

Number of Bursts in Trial: 14

Burst	Pulses per Burst	Chirp (MHz)	Pulse Width(us)	PRI-1 (us)	PRI-2 (us)	PRI-3 (us)
1	2	12	81.7	1946	1868	-
2	3	12	90.5	1414	1453	1305
3	2	12	76.2	2000	1852	-
4	2	12	69.1	1351	1071	-
5	3	12	93.7	1865	1196	1782
6	3	12	89.7	1429	1948	1402
7	1	12	53.9	1070	-	-
8	3	12	88.2	1632	1940	1689
9	1	12	59.4	1733	-	-
10	1	12	66.4	1285	-	-
11	2	12	83	1321	1591	-
12	2	12	82	1912	1012	-
13	3	12	94.4	1698	1784	1303
14	1	12	63.6	1175	-	-
15						
16						
17						
18						
19						
20						



Long Pulse Radar Test Signal

Test Signal Name: LP_Signal_19

Number of Bursts in Trial: 12

Burst	Pulses per Burst	Chirp (MHz)	Pulse Width(us)	PRI-1 (us)	PRI-2 (us)	PRI-3 (us)
1	2	10	70.9	1736	1367	-
2	1	10	62.4	1193	-	-
3	1	10	61.8	1596	-	-
4	1	10	52.6	1646	-	-
5	2	10	78.9	1049	1639	-
6	1	10	63.9	1679	-	-
7	3	10	98.5	1627	1731	1442
8	3	10	92	1294	1547	1119
9	1	10	65.8	1386	-	-
10	2	10	77.7	1987	1964	-
11	1	10	54.6	1553	-	-
12	2	10	77.7	1171	1413	-
13						
14						
15						
16						
17						
18						
19						
20						



Long Pulse Radar Test Signal

Test Signal Name: LP_Signal_20

Number of Bursts in Trial: 20

Burst	Pulses per Burst	Chirp (MHz)	Pulse Width(us)	PRI-1 (us)	PRI-2 (us)	PRI-3 (us)
1	1	20	63.4	1899	-	-
2	1	20	63.5	1633	-	-
3	3	20	97.6	1815	1198	1488
4	3	20	84.7	1626	1026	1326
5	2	20	68.5	1469	1684	-
6	1	20	61.8	1408	-	-
7	2	20	73.2	1735	1125	-
8	1	20	60.2	1468	-	-
9	1	20	65.2	1519	-	-
10	2	20	74.6	1954	1654	-
11	2	20	72.6	1394	1096	-
12	2	20	78.9	1343	1843	-
13	1	20	56.2	1003	-	-
14	3	20	93.2	1433	1299	1324
15	2	20	78.6	1404	1539	-
16	1	20	50.9	1570	-	-
17	3	20	98.2	1346	1179	1510
18	3	20	97.5	1616	1360	1710
19	2	20	79.5	1822	1721	-
20	2	20	67	1554	1237	-



Long Pulse Radar Test Signal

Test Signal Name: LP_Signal_21

Number of Bursts in Trial: 9

Burst	Pulses per Burst	Chirp (MHz)	Pulse Width(us)	PRI-1 (us)	PRI-2 (us)	PRI-3 (us)
1	1	7	51	1893	-	-
2	3	7	88.5	1270	1664	1623
3	3	7	98.2	1979	1826	1128
4	2	7	67.5	1417	1586	-
5	3	7	97.4	1642	1121	1770
6	2	7	80.2	1816	1060	-
7	2	7	72.8	1619	1203	-
8	2	7	82.2	1499	1848	-
9	2	7	77.6	1562	1573	-
10						
11						
12						
13						
14						
15						
16						
17						
18						
19						
20						



Long Pulse Radar Test Signal

Test Signal Name: LP_Signal_22

Number of Bursts in Trial: 20

Burst	Pulses per Burst	Chirp (MHz)	Pulse Width(us)	PRI-1 (us)	PRI-2 (us)	PRI-3 (us)
1	3	20	89.8	1742	1968	1036
2	2	20	74.7	1850	1306	-
3	3	20	98.5	1123	1336	1791
4	1	20	64.4	1740	-	-
5	1	20	66	1000	-	-
6	2	20	76.3	1521	1928	-
7	3	20	90.4	1764	1383	1726
8	3	20	90.6	1896	1653	1697
9	2	20	74.8	1995	1938	-
10	3	20	98	1251	1520	1725
11	2	20	71.2	1775	1240	-
12	1	20	58.8	1195	-	-
13	3	20	84.1	1475	1472	1590
14	3	20	98.4	1274	1282	1918
15	3	20	96.4	1131	1739	1009
16	3	20	89.9	1484	1283	1412
17	2	20	82.9	1729	1571	-
18	3	20	96.5	1978	1478	1555
19	3	20	85.7	1872	1737	1847
20	3	20	85.4	1387	1151	1531

Long Pulse Radar Test Signal

Test Signal Name: LP_Signal_23

Number of Bursts in Trial: 10

Burst	Pulses per Burst	Chirp (MHz)	Pulse Width(us)	PRI-1 (us)	PRI-2 (us)	PRI-3 (us)
1	3	8	97.6	1568	1676	1023
2	3	8	93.9	1407	1682	1209
3	2	8	68.3	1807	1365	-
4	3	8	98.3	1107	1882	1524
5	3	8	87.6	1557	1342	1910
6	2	8	76.6	1033	1048	-
7	2	8	74.9	1101	1443	-
8	1	8	65.3	1341	-	-
9	2	8	80	1220	1015	-
10	3	8	87.4	1765	1316	1377
11						
12						
13						
14						
15						
16						
17						
18						
19						
20						



Long Pulse Radar Test Signal

Test Signal Name: LP_Signal_24

Number of Bursts in Trial: 17

Burst	Pulses per Burst	Chirp (MHz)	Pulse Width(us)	PRI-1 (us)	PRI-2 (us)	PRI-3 (us)
1	3	17	88.4	1279	1317	1150
2	3	17	89.1	1288	1660	1789
3	3	17	91	1385	1988	1461
4	2	17	82.6	1915	1059	-
5	2	17	75.5	1662	1982	-
6	3	17	99.9	1222	1796	1717
7	2	17	74.1	1877	1917	-
8	1	17	64.5	1380	-	-
9	3	17	90.3	1032	1613	1191
10	2	17	66.9	1158	1930	-
11	3	17	88.2	1753	1399	1507
12	1	17	60.4	1307	-	-
13	2	17	73.3	1152	1543	-
14	3	17	99.6	1207	1491	1297
15	1	17	58.2	1024	-	-
16	1	17	58.2	1925	-	-
17	2	17	66.9	1994	1090	-
18						
19						
20						



Long Pulse Radar Test Signal

Test Signal Name: LP_Signal_25

Number of Bursts in Trial: 9

Burst	Pulses per Burst	Chirp (MHz)	Pulse Width(us)	PRI-1 (us)	PRI-2 (us)	PRI-3 (us)
1	3	7	90.1	1465	1459	1862
2	1	7	51.8	1730	-	-
3	2	7	77.7	1874	1388	-
4	1	7	64.4	1401	-	-
5	3	7	83.7	1517	1861	1612
6	3	7	87.1	1981	1161	1541
7	3	7	96.9	1143	1757	1115
8	2	7	80.1	1232	1574	-
9	3	7	95.9	1051	1202	1344
10						
11						
12						
13						
14						
15						
16						
17						
18						
19						
20						



Long Pulse Radar Test Signal

Test Signal Name: LP_Signal_26

Number of Bursts in Trial: 15

Burst	Pulses per Burst	Chirp (MHz)	Pulse Width(us)	PRI-1 (us)	PRI-2 (us)	PRI-3 (us)
1	1	14	56.4	1379	-	-
2	1	14	50.2	1827	-	-
3	2	14	76.8	1189	1788	-
4	3	14	89.4	1713	1774	1743
5	1	14	51.3	1926	-	-
6	2	14	75	1958	1194	-
7	1	14	60.5	1631	-	-
8	3	14	87.5	1483	1825	1329
9	1	14	59.6	1495	-	-
10	2	14	82.2	1604	1421	-
11	2	14	67.8	1139	1482	-
12	1	14	51.5	1018	-	-
13	2	14	72.9	1135	1332	-
14	3	14	96.5	1116	1291	1665
15	1	14	65.7	1256	-	-
16						
17						
18						
19						
20						



Long Pulse Radar Test Signal

Test Signal Name: LP_Signal_27

Number of Bursts in Trial: 13

Burst	Pulses per Burst	Chirp (MHz)	Pulse Width(us)	PRI-1 (us)	PRI-2 (us)	PRI-3 (us)
1	2	11	68.4	1210	1254	-
2	1	11	56.2	1106	-	-
3	2	11	68.7	1989	1167	-
4	3	11	97.2	1963	1037	1860
5	3	11	87.1	1120	1335	1563
6	2	11	70.6	1298	1502	-
7	2	11	68.7	1747	1446	-
8	3	11	90	1315	1072	1226
9	2	11	79.4	1577	1311	-
10	1	11	59.6	1176	-	-
11	3	11	84.9	1027	1727	1260
12	1	11	63.5	1605	-	-
13	1	11	52.3	1702	-	-
14						
15						
16						
17						
18						
19						
20						



Long Pulse Radar Test Signal

Test Signal Name: LP_Signal_28

Number of Bursts in Trial: 10

Burst	Pulses per Burst	Chirp (MHz)	Pulse Width(us)	PRI-1 (us)	PRI-2 (us)	PRI-3 (us)
1	2	7	72.9	1622	1104	-
2	1	7	54.6	1609	-	-
3	1	7	51.9	1707	-	-
4	3	7	94.2	1173	1515	1688
5	1	7	52.5	1077	-	-
6	2	7	79.6	1054	1245	-
7	3	7	93.5	1575	1141	1046
8	2	7	73.9	1718	1638	-
9	3	7	87.7	1126	1462	1310
10	1	7	50.8	1154	-	-
11						
12						
13						
14						
15						
16						
17						
18						
19						
20						

Long Pulse Radar Test Signal

Test Signal Name: LP_Signal_29

Number of Bursts in Trial: 13

Burst	Pulses per Burst	Chirp (MHz)	Pulse Width(us)	PRI-1 (us)	PRI-2 (us)	PRI-3 (us)
1	1	12	65.6	1074	-	-
2	1	12	63.2	1477	-	-
3	3	12	99.9	1053	1805	1657
4	3	12	85.8	1293	1680	1184
5	3	12	90	1200	1511	1127
6	2	12	76.1	1017	1133	-
7	3	12	90.4	1043	1088	1362
8	1	12	65.4	1610	-	-
9	2	12	67.1	1824	1410	-
10	1	12	55.3	1278	-	-
11	1	12	61.9	1403	-	-
12	3	12	96.1	1923	1216	1744
13	2	12	77.5	1558	1253	-
14						
15						
16						
17						
18						
19						



Long Pulse Radar Test Signal

Test Signal Name: LP_Signal_30

Number of Bursts in Trial: 10

Burst	Pulses per Burst	Chirp (MHz)	Pulse Width(us)	PRI-1 (us)	PRI-2 (us)	PRI-3 (us)
1	2	8	68.4	1190	1907	-
2	3	8	99.7	1996	1806	1079
3	3	8	93	1777	1092	1337
4	2	8	75.3	1548	1583	-
5	3	8	87.7	1715	1889	1470
6	1	8	60.2	1008	-	-
7	3	8	97.5	1658	1514	1748
8	2	8	79.7	1532	1793	-
9	1	8	66.4	1014	-	-
10	1	8	61.4	1322	-	-
11						
12						
13						
14						
15						
16						
17						
18						
19						
20						



A.2 The Frequency Hopping Radar pattern

Hopping Frequency Sequence Name: HOP_FREQ_SEQ_01

Frequency (MHz)	0	1	2	3	4
0	5385	5718	5545	5371	5537
5	5323	5519	5588	5621	5549
10	5327	5659	5489	5570	5584
15	5336	5311	5303	5647	5458
20	5612	5354	5716	5479	5348
25	5438	5337	5335	5574	5601
30	5265	5713	5577	5653	5715
35	5307	5432	5674	5562	5506
40	5306	5258	5345	5631	5632
45	5514	5320	5568	5696	5628
50	5602	5428	5708	5378	5349
55	5413	5273	5446	5333	5531
60	5264	5367	5534	5339	5332
65	5561	5580	5624	5251	5459
70	5563	5391	5402	5701	5259
75	5618	5573	5538	5271	5364
80	5328	5353	5252	5496	5670
85	5684	5305	5269	5463	5520
90	5597	5719	5325	5539	5639
95	5550	5678	5465	5552	5664

Hopping Frequency Sequence Name: HOP_FREQ_SEQ_02

Frequency (MHz)	0	1	2	3	4
0	5543	5482	5481	5435	5282
5	5365	5541	5566	5309	5281
10	5636	5448	5530	5290	5605
15	5424	5438	5406	5692	5650
20	5620	5423	5279	5471	5321
25	5704	5664	5538	5678	5635
30	5307	5699	5534	5393	5489
35	5505	5474	5358	5695	5572
40	5428	5286	5396	5629	5346
45	5437	5626	5274	5418	5381
50	5604	5284	5467	5550	5357
55	5461	5400	5426	5253	5710
60	5399	5639	5484	5623	5350
65	5675	5398	5298	5283	5680
70	5720	5718	5422	5514	5705
75	5711	5708	5568	5277	5359
80	5272	5464	5651	5305	5580
85	5684	5312	5459	5715	5402
90	5337	5601	5370	5445	5649
95	5472	5654	5660	5672	5420



Hopping Frequency Sequence Name: HOP_FREQ_SEQ_03

Frequency (MHz)	0	1	2	3	4
0	5323	5721	5417	5596	5599
5	5504	5466	5641	5472	5585
10	5567	5712	5571	5485	5626
15	5415	5565	5509	5262	5367
20	5628	5589	5695	5560	5294
25	5592	5613	5266	5404	5669
30	5446	5588	5491	5511	5325
35	5381	5629	5434	5609	5411
40	5608	5699	5636	5275	5658
45	5520	5587	5327	5683	5257
50	5305	5335	5556	5373	5679
55	5552	5616	5547	5584	5528
60	5389	5704	5471	5310	5569
65	5648	5624	5605	5553	5483
70	5467	5706	5649	5490	5664
75	5680	5542	5689	5488	5678
80	5533	5523	5677	5281	5651
85	5719	5543	5409	5330	5657
90	5405	5690	5436	5694	5715
95	5425	5526	5644	5575	5377

Hopping Frequency Sequence Name: HOP_FREQ_SEQ_04

Frequency (MHz)	0	1	2	3	4
0	5578	5582	5353	5282	5344
5	5546	5488	5716	5635	5317
10	5498	5501	5612	5583	5647
15	5503	5692	5515	5685	5559
20	5539	5658	5636	5552	5267
25	5480	5465	5469	5508	5703
30	5574	5448	5251	5415	5523
35	5277	5569	5522	5587	5620
40	5347	5691	5637	5401	5623
45	5638	5603	5645	5380	5570
50	5608	5481	5386	5671	5265
55	5686	5331	5366	5555	5657
60	5554	5271	5400	5611	5374
65	5573	5373	5340	5445	5286
70	5314	5346	5466	5649	5591
75	5588	5670	5590	5495	5674
80	5476	5561	5601	5517	5284
85	5333	5318	5479	5419	5257
90	5510	5542	5572	5678	5672
95	5375	5621	5410	5504	5500



Hopping Frequency Sequence Name: HOP_FREQ_SEQ_05

Frequency (MHz)	0	1	2	3	4
0	5358	5346	5289	5443	5661
5	5588	5413	5316	5701	5524
10	5332	5290	5653	5303	5668
15	5591	5722	5618	5255	5276
20	5547	5349	5674	5641	5715
25	5271	5414	5672	5612	5262
30	5530	5463	5405	5466	5567
35	5343	5416	5660	5318	5362
40	5534	5299	5575	5544	5620
45	5511	5686	5703	5433	5360
50	5484	5657	5437	5356	5494
55	5470	5453	5640	5521	5563
60	5526	5311	5719	5691	5707
65	5558	5522	5409	5647	5467
70	5708	5300	5347	5345	5582
75	5711	5256	5651	5420	5326
80	5570	5279	5671	5457	5403
85	5566	5696	5385	5335	5581
90	5675	5260	5324	5407	5361
95	5431	5274	5535	5440	5551

Hopping Frequency Sequence Name: HOP_FREQ_SEQ_06

Frequency (MHz)	0	1	2	3	4
0	5613	5585	5700	5604	5406
5	5630	5435	5391	5389	5353
10	5263	5554	5694	5498	5689
15	5679	5374	5721	5300	5468
20	5555	5418	5615	5633	5688
25	5634	5266	5303	5716	5296
30	5669	5352	5362	5681	5341
35	5541	5458	5276	5589	5515
40	5448	5500	5382	5513	5309
45	5714	5440	5598	5294	5664
50	5722	5358	5488	5445	5695
55	5414	5641	5594	5711	5497
60	5409	5636	5539	5360	5504
65	5398	5471	5510	5270	5305
70	5286	5449	5671	5321	5490
75	5356	5302	5632	5672	5339
80	5351	5443	5621	5668	5457
85	5342	5626	5413	5350	5289
90	5354	5425	5330	5441	5540
95	5291	5590	5575	5338	5530



Hopping Frequency Sequence Name: HOP_FREQ_SEQ_07

Frequency (MHz)	0	1	2	3	4
0	5296	5349	5636	5290	5723
5	5294	5457	5466	5552	5560
10	5669	5440	5260	5693	5710
15	5670	5501	5345	5660	5584
20	5556	5722	5661	5425	5593
25	5506	5330	5711	5338	5319
30	5324	5493	5361	5597	5367
35	5482	5668	5459	5339	5562
40	5451	5549	5272	5578	5377
45	5442	5512	5614	5534	5539
50	5518	5261	5354	5548	5426
55	5676	5371	5569	5574	5581
60	5283	5450	5599	5420	5384
65	5689	5402	5474	5369	5452
70	5423	5297	5500	5362	5476
75	5445	5613	5449	5607	5306
80	5568	5683	5360	5659	5589
85	5508	5340	5602	5590	5336
90	5378	5503	5649	5308	5645
95	5559	5412	5413	5563	5307

Hopping Frequency Sequence Name: HOP_FREQ_SEQ_08

Frequency (MHz)	0	1	2	3	4
0	5551	5588	5572	5451	5468
5	5336	5382	5541	5715	5292
10	5503	5704	5398	5413	5256
15	5283	5628	5452	5293	5377
20	5474	5653	5497	5714	5634
25	5313	5542	5709	5546	5364
30	5278	5702	5276	5539	5267
35	5656	5261	5458	5443	5373
40	5645	5314	5708	5676	5558
45	5460	5305	5495	5399	5490
50	5710	5590	5623	5341	5680
55	5502	5616	5342	5601	5264
60	5678	5584	5396	5422	5369
65	5420	5424	5672	5351	5355
70	5455	5272	5273	5459	5331
75	5499	5491	5594	5701	5559
80	5388	5674	5565	5403	5263
85	5501	5649	5700	5658	5294
90	5375	5416	5280	5412	5385
95	5661	5543	5609	5391	5615



Hopping Frequency Sequence Name: HOP_FREQ_SEQ_09

Frequency (MHz)	0	1	2	3	4
0	5331	5352	5508	5612	5310
5	5378	5404	5616	5403	5596
10	5434	5493	5439	5511	5277
15	5371	5658	5458	5338	5666
20	5482	5344	5535	5328	5704
25	5579	5394	5437	5650	5398
30	5417	5591	5708	5279	5419
35	5379	5303	5646	5549	5287
40	5589	5253	5705	5457	5441
45	5543	5266	5548	5664	5366
50	5411	5641	5334	5639	5527
55	5255	5456	5709	5692	5313
60	5429	5568	5607	5410	5623
65	5318	5359	5256	5564	5629
70	5715	5341	5555	5724	5321
75	5678	5619	5634	5575	5478
80	5572	5644	5363	5432	5562
85	5598	5263	5440	5526	5345
90	5711	5445	5349	5645	5295
95	5280	5624	5507	5273	5718

Hopping Frequency Sequence Name: HOP_FREQ_SEQ_10

Frequency (MHz)	0	1	2	3	4
0	5586	5591	5444	5676	5530
5	5420	5329	5691	5469	5328
10	5268	5282	5480	5706	5298
15	5459	5310	5561	5383	5393
20	5413	5476	5320	5677	5467
25	5343	5640	5279	5432	5577
30	5665	5494	5668	5674	5442
35	5262	5345	5274	5428	5433
40	5643	5697	5702	5437	5421
45	5626	5324	5601	5551	5620
50	5587	5692	5423	5365	5471
55	5346	5410	5424	5511	5284
60	5384	5594	5513	5439	5333
65	5385	5446	5267	5395	5466
70	5359	5335	5312	5327	5558
75	5445	5700	5280	5647	5264
80	5302	5653	5633	5682	5425
85	5527	5495	5559	5318	5641
90	5575	5512	5491	5299	5434
95	5610	5451	5404	5456	5608



Hopping Frequency Sequence Name: HOP_FREQ_SEQ_11

Frequency (MHz)	0	1	2	3	4
0	5269	5355	5380	5362	5372
5	5559	5351	5291	5632	5535
10	5674	5546	5521	5426	5319
15	5450	5437	5664	5331	5575
20	5401	5579	5417	5409	5650
25	5670	5271	5383	5466	5501
30	5622	5612	5345	5397	5581
35	5353	5713	5524	5687	5267
40	5516	5462	5321	5366	5709
45	5382	5654	5341	5496	5288
50	5268	5512	5663	5318	5534
55	5364	5614	5330	5633	5513
60	5284	5458	5634	5647	5691
65	5431	5298	5629	5613	5481
70	5410	5658	5294	5714	5616
75	5384	5348	5317	5681	5655
80	5556	5544	5599	5635	5704
85	5359	5350	5547	5254	5300
90	5457	5320	5312	5416	5473
95	5390	5592	5400	5609	5449

Hopping Frequency Sequence Name: HOP_FREQ_SEQ_12

Frequency (MHz)	0	1	2	3	4
0	5524	5594	5316	5523	5592
5	5601	5276	5366	5320	5267
10	5605	5432	5562	5621	5340
15	5538	5564	5292	5376	5409
20	5270	5455	5401	5623	5522
25	5474	5584	5500	5543	5355
30	5579	5352	5692	5720	5444
35	5509	5677	5581	5599	5519
40	5318	5673	5381	5317	5343
45	5610	5703	5372	5464	5319
50	5486	5262	5722	5329	5527
55	5604	5642	5449	5578	5460
60	5374	5470	5640	5370	5508
65	5521	5416	5553	5396	5661
70	5555	5488	5504	5491	5615
75	5662	5330	5462	5283	5718
80	5544	5598	5324	5304	5452
85	5465	5463	5354	5669	5525
90	5587	5445	5576	5298	5588
95	5552	5550	5466	5417	5566



Hopping Frequency Sequence Name: HOP_FREQ_SEQ_13

Frequency (MHz)	0	1	2	3	4
0	5304	5358	5252	5684	5434
5	5643	5298	5441	5483	5571
10	5439	5696	5603	5341	5361
15	5626	5691	5395	5421	5484
20	5320	5339	5396	5490	5596
25	5509	5471	5677	5688	5534
30	5682	5536	5567	5271	5415
35	5287	5535	5305	5355	5612
40	5420	5457	5370	5315	5602
45	5400	5401	5663	5493	5723
50	5543	5690	5309	5584	5435
55	5272	5519	5346	5575	5674
60	5614	5445	5410	5383	5671
65	5589	5406	5340	5316	5694
70	5625	5382	5286	5531	5632
75	5527	5537	5440	5718	5447
80	5306	5453	5525	5380	5658
85	5516	5667	5258	5568	5630
90	5566	5291	5551	5634	5604
95	5500	5657	5470	5655	5273

Hopping Frequency Sequence Name: HOP_FREQ_SEQ_14

Frequency (MHz)	0	1	2	3	4
0	5559	5597	5663	5370	5654
5	5685	5698	5516	5549	5303
10	5485	5644	5439	5382	5714
15	5721	5401	5466	5676	5328
20	5505	5337	5482	5569	5300
25	5323	5405	5317	5568	5724
30	5705	5493	5307	5520	5710
35	5426	5626	5673	5605	5526
40	5356	5387	5395	5610	5312
45	5434	5341	5483	5459	5716
50	5380	5502	5719	5421	5510
55	5528	5623	5701	5709	5640
60	5546	5304	5390	5339	5684
65	5266	5494	5538	5345	5550
70	5683	5497	5319	5368	5289
75	5694	5507	5591	5329	5647
80	5680	5577	5691	5453	5499
85	5611	5450	5720	5350	5621
90	5708	5632	5309	5470	5320
95	5572	5325	5336	5646	5555



Hopping Frequency Sequence Name: HOP_FREQ_SEQ_15

Frequency (MHz)	0	1	2	3	4
0	5339	5361	5599	5531	5496
5	5349	5720	5591	5712	5510
10	5301	5274	5685	5634	5403
15	5705	5373	5504	5414	5393
20	5336	5574	5375	5571	5542
25	5663	5272	5608	5421	5602
30	5291	5691	5450	5425	5672
35	5530	5565	5469	5283	5440
40	5670	5470	5333	5309	5363
45	5699	5566	5420	5294	5645
50	5378	5472	5490	5558	5424
55	5459	5457	5432	5646	5607
60	5687	5695	5487	5381	5382
65	5478	5678	5391	5451	5389
70	5543	5483	5550	5298	5292
75	5251	5371	5563	5280	5300
80	5529	5447	5350	5636	5681
85	5328	5500	5263	5589	5290
90	5485	5578	5359	5693	5638
95	5610	5625	5467	5331	5386

Hopping Frequency Sequence Name: HOP_FREQ_SEQ_16

Frequency (MHz)	0	1	2	3	4
0	5497	5600	5535	5692	5716
5	5391	5645	5666	5400	5339
10	5610	5538	5348	5354	5424
15	5318	5500	5607	5459	5585
20	5722	5265	5316	5563	5515
25	5454	5599	5714	5622	5539
30	5430	5580	5407	5640	5446
35	5253	5704	5436	5451	5509
40	5553	5649	5518	5403	5292
45	5679	5478	5347	5532	5254
50	5596	5523	5579	5631	5319
55	5427	5512	5517	5656	5586
60	5634	5377	5433	5255	5421
65	5417	5592	5273	5481	5560
70	5437	5392	5412	5394	5623
75	5673	5536	5367	5444	5635
80	5644	5520	5465	5314	5488
85	5650	5584	5296	5277	5665
90	5706	5462	5310	5489	5274
95	5315	5350	5694	5591	5344



Hopping Frequency Sequence Name: HOP_FREQ_SEQ_17

Frequency (MHz)	0	1	2	3	4
0	5277	5364	5471	5281	5558
5	5433	5667	5266	5563	5546
10	5541	5424	5389	5549	5445
15	5406	5627	5710	5504	5399
20	5255	5334	5257	5652	5488
25	5342	5548	5442	5251	5573
30	5472	5469	5380	5598	5271
35	5521	5536	5589	5365	5348
40	5258	5587	5283	5400	5599
45	5659	5322	5508	5297	5574
50	5668	5454	5641	5615	5466
55	5707	5475	5362	5715	5324
60	5310	5259	5676	5719	5385
65	5356	5640	5284	5632	5423
70	5395	5619	5338	5468	5614
75	5435	5537	5520	5686	5317
80	5531	5655	5441	5452	5631
85	5417	5704	5333	5268	5513
90	5340	5590	5330	5360	5401
95	5294	5720	5690	5289	5592

Hopping Frequency Sequence Name: HOP_FREQ_SEQ_18

Frequency (MHz)	0	1	2	3	4
0	5532	5603	5407	5442	5303
5	5572	5592	5341	5629	5278
10	5472	5688	5430	5269	5466
15	5494	5279	5338	5549	5591
20	5263	5500	5295	5644	5461
25	5705	5400	5645	5355	5607
30	5514	5455	5321	5595	5372
35	5271	5410	5612	5429	5364
40	5284	5525	5523	5397	5528
45	5639	5340	5594	5356	5684
50	5384	5473	5625	5379	5655
55	5585	5328	5420	5422	5294
60	5333	5369	5489	5267	5714
65	5657	5622	5445	5334	5392
70	5634	5435	5562	5326	5409
75	5495	5468	5314	5427	5486
80	5555	5583	5501	5652	5573
85	5695	5647	5631	5259	5667
90	5332	5676	5319	5286	5506
95	5505	5693	5717	5510	5311



Hopping Frequency Sequence Name: HOP_FREQ_SEQ_19

Frequency (MHz)	0	1	2	3	4
0	5312	5464	5343	5603	5620
5	5614	5416	5317	5582	5306
10	5477	5471	5367	5487	5485
15	5309	5344	5497	5308	5649
20	5569	5711	5258	5434	5496
25	5252	5373	5459	5641	5653
30	5278	5713	5524	5566	5549
35	5703	5700	5517	5290	5598
40	5424	5463	5288	5394	5360
45	5619	5423	5555	5409	5474
50	5260	5676	5468	5478	5432
55	5516	5374	5612	5491	5682
60	5401	5276	5546	5483	5665
65	5268	5283	5428	5466	5327
70	5365	5398	5492	5498	5386
75	5455	5675	5251	5579	5429
80	5431	5354	5384	5403	5338
85	5534	5576	5273	5704	5670
90	5699	5301	5502	5522	5328
95	5355	5280	5631	5625	5323

Hopping Frequency Sequence Name: HOP_FREQ_SEQ_20

Frequency (MHz)	0	1	2	3	4
0	5470	5703	5279	5289	5365
5	5656	5539	5491	5480	5314
10	5712	5266	5512	5562	5508
15	5573	5436	5447	5542	5500
20	5657	5260	5652	5250	5407
25	5384	5676	5576	5660	5675
30	5695	5708	5710	5453	5298
35	5591	5416	5496	5670	5679
40	5437	5507	5401	5431	5391
45	5599	5506	5613	5462	5361
50	5611	5350	5252	5557	5301
55	5376	5704	5328	5327	5310
60	5653	5530	5441	5254	5378
65	5309	5469	5707	5367	5597
70	5546	5567	5478	5598	5641
75	5345	5424	5320	5297	5560
80	5681	5444	5610	5451	5466
85	5335	5515	5690	5619	5509
90	5324	5307	5524	5360	5705
95	5713	5631	5410	5264	5529



Hopping Frequency Sequence Name: HOP_FREQ_SEQ_21

Frequency (MHz)	0	1	2	3	4
0	5250	5467	5690	5450	5682
5	5698	5561	5566	5643	5521
10	5546	5530	5553	5282	5529
15	5661	5563	5550	5587	5692
20	5665	5329	5593	5339	5380
25	5650	5528	5289	5709	5262
30	5694	5667	5668	5584	5255
35	5507	5389	5445	5276	5687
40	5671	5485	5693	5579	5589
45	5515	5626	5390	5526	5303
50	5646	5599	5417	5517	5604
55	5624	5659	5606	5674	5685
60	5707	5557	5292	5656	5403
65	5508	5392	5349	5639	5464
70	5601	5393	5717	5304	5296
75	5440	5541	5361	5554	5391
80	5615	5332	5437	5357	5275
85	5336	5474	5278	5555	5722
90	5525	5711	5272	5644	5265
95	5459	5465	5723	5427	5486

Hopping Frequency Sequence Name: HOP_FREQ_SEQ_22

Frequency (MHz)	0	1	2	3	4
0	5505	5706	5626	5611	5427
5	5362	5486	5641	5709	5350
10	5477	5416	5594	5550	5274
15	5690	5653	5535	5409	5576
20	5495	5631	5331	5353	5538
25	5410	5393	5268	5401	5583
30	5624	5408	5699	5404	5394
35	5598	5660	5604	5590	5295
40	5277	5436	5482	5525	5462
45	5672	5632	5568	5513	5266
50	5702	5354	5357	5325	5642
55	5605	5711	5707	5423	5595
60	5313	5296	5619	5517	5533
65	5503	5493	5342	5718	5284
70	5627	5547	5701	5717	5693
75	5263	5265	5463	5522	5613
80	5664	5647	5304	5689	5329
85	5574	5340	5713	5431	5328
90	5542	5339	5684	5526	5476
95	5520	5422	5368	5446	5650



Hopping Frequency Sequence Name: HOP_FREQ_SEQ_23

Frequency (MHz)	0	1	2	3	4
0	5285	5470	5562	5297	5269
5	5404	5508	5716	5397	5557
10	5408	5680	5635	5672	5571
15	5265	5342	5281	5580	5601
20	5584	5661	5572	5420	5326
25	5329	5613	5497	5302	5443
30	5569	5581	5526	5376	5602
35	5533	5689	5456	5276	5518
40	5378	5690	5579	5479	5454
45	5442	5280	5621	5303	5617
50	5403	5405	5446	5623	5489
55	5696	5665	5325	5620	5469
60	5461	5546	5694	5554	5550
65	5430	5704	5566	5697	5612
70	5583	5629	5503	5390	5677
75	5428	5468	5277	5294	5718
80	5298	5307	5283	5380	5345
85	5386	5493	5575	5313	5320
90	5347	5638	5266	5270	5471
95	5693	5535	5384	5662	5664

Hopping Frequency Sequence Name: HOP_FREQ_SEQ_24

Frequency (MHz)	0	1	2	3	4
0	5540	5709	5498	5458	5489
5	5446	5433	5316	5560	5289
10	5717	5469	5298	5295	5592
15	5353	5372	5287	5625	5318
20	5255	5513	5412	5299	5692
25	5656	5341	5698	5336	5485
30	5538	5266	5422	5575	5305
35	5252	5526	5432	5365	5461
40	5531	5344	5476	5286	5363
45	5273	5577	5665	5493	5579
50	5456	5535	5409	5619	5515
55	5439	5440	5474	5626	5606
60	5278	5282	5492	5517	5503
65	5414	5285	5708	5477	5519
70	5329	5415	5548	5581	5703
75	5675	5484	5642	5312	5684
80	5340	5701	5718	5455	5261
85	5650	5334	5545	5351	5655
90	5668	5495	5510	5630	5297
95	5693	5704	5464	5268	5683



Hopping Frequency Sequence Name: HOP_FREQ_SEQ_25

Frequency (MHz)	0	1	2	3	4
0	5698	5473	5531	5522	5331
5	5488	5455	5391	5723	5593
10	5648	5258	5339	5490	5613
15	5441	5499	5390	5670	5607
20	5503	5421	5551	5501	5272
25	5580	5605	5544	5327	5370
30	5527	5347	5495	5481	5302
35	5620	5714	5493	5679	5443
40	5641	5469	5584	5690	5402
45	5446	5709	5630	5280	5507
50	5624	5269	5597	5573	5705
55	5411	5603	5316	5585	5583
60	5438	5718	5549	5353	5592
65	5716	5511	5646	5505	5332
70	5264	5524	5615	5453	5348
75	5343	5465	5419	5325	5699
80	5500	5684	5621	5394	5435
85	5288	5283	5710	5357	5689
90	5550	5685	5378	5591	5683
95	5369	5662	5363	5420	5502

Hopping Frequency Sequence Name: HOP_FREQ_SEQ_26

Frequency (MHz)	0	1	2	3	4
0	5478	5712	5467	5683	5551
5	5627	5380	5466	5411	5325
10	5579	5522	5685	5634	5529
15	5626	5493	5618	5324	5511
20	5490	5492	5720	5371	5457
25	5650	5431	5404	5666	5333
30	5452	5696	5440	5378	5584
35	5416	5357	5518	5724	5407
40	5349	5567	5619	5382	5292
45	5342	5623	5456	5558	5713
50	5470	5699	5310	5527	5420
55	5455	5257	5481	5496	5417
60	5506	5541	5498	5389	5327
65	5692	5718	5588	5335	5491
70	5500	5574	5422	5486	5446
75	5435	5721	5388	5563	5695
80	5501	5524	5711	5284	5483
85	5717	5273	5578	5400	5363
90	5723	5616	5641	5265	5362
95	5489	5565	5472	5482	5458



Hopping Frequency Sequence Name: HOP_FREQ_SEQ_27

Frequency (MHz)	0	1	2	3	4
0	5258	5476	5403	5369	5393
5	5669	5402	5541	5477	5532
10	5413	5408	5421	5405	5655
15	5520	5278	5596	5663	5516
20	5519	5656	5433	5582	5693
25	5259	5406	5378	5535	5438
30	5708	5697	5409	5339	5703
35	5638	5420	5675	5687	5607
40	5271	5454	5332	5345	5492
45	5564	5451	5362	5709	5350
50	5261	5499	5632	5609	5424
55	5293	5546	5498	5384	5610
60	5274	5256	5386	5646	5538
65	5724	5427	5267	5447	5328
70	5634	5495	5412	5574	5435
75	5340	5533	5294	5491	5351
80	5545	5502	5552	5626	5692
85	5696	5524	5553	5722	5344
90	5448	5521	5301	5565	5466
95	5660	5250	5658	5320	5346

Hopping Frequency Sequence Name: HOP_FREQ_SEQ_28

Frequency (MHz)	0	1	2	3	4
0	5513	5715	5339	5530	5613
5	5711	5327	5616	5640	5264
10	5344	5672	5462	5600	5676
15	5608	5405	5699	5708	5430
20	5250	5471	5574	5666	5525
25	5258	5581	5639	5472	5275
30	5586	5366	5554	5477	5458
35	5559	5291	5580	5285	5282
40	5293	5512	5283	5257	5561
45	5380	5720	5317	5311	5314
50	5494	5278	5333	5660	5591
55	5490	5686	5338	5325	5568
60	5702	5515	5336	5483	5653
65	5633	5373	5565	5396	5364
70	5369	5673	5298	5484	5560
75	5438	5664	5355	5492	5263
80	5611	5675	5505	5603	5558
85	5619	5689	5592	5416	5427
90	5307	5439	5316	5722	5294
95	5596	5255	5694	5262	5375



Hopping Frequency Sequence Name: HOP_FREQ_SEQ_29

Frequency (MHz)	0	1	2	3	4
0	5671	5479	5275	5691	5455
5	5278	5349	5328	5568	5461
10	5503	5698	5697	5696	5435
15	5705	5425	5438	5416	5412
20	5663	5639	5413	5585	5309
25	5365	5506	5414	5572	5323
30	5294	5629	5382	5376	5607
35	5595	5497	5558	5687	5700
40	5400	5369	5367	5284	5509
45	5711	5602	5337	5302	5292
50	5515	5387	5673	5644	5501
55	5428	5485	5556	5319	5291
60	5345	5676	5565	5576	5653
65	5546	5538	5513	5331	5451
70	5707	5256	5721	5486	5380
75	5668	5539	5308	5374	5589
80	5611	5330	5334	5270	5631
85	5281	5298	5542	5420	5478
90	5359	5371	5692	5430	5411
95	5280	5405	5306	5601	5646

Hopping Frequency Sequence Name: HOP_FREQ_SEQ_30

Frequency (MHz)	0	1	2	3	4
0	5451	5718	5686	5377	5675
5	5417	5274	5291	5491	5300
10	5584	5250	5544	5418	5309
15	5562	5333	5701	5617	5446
20	5485	5353	5655	5612	5679
25	5534	5512	5469	5540	5456
30	5461	5280	5509	5403	5476
35	5362	5473	5647	5688	5585
40	5678	5634	5262	5555	5616
45	5680	5483	5427	5323	5646
50	5505	5685	5287	5691	5615
55	5281	5490	5721	5608	5644
60	5676	5666	5470	5317	5382
65	5492	5294	5339	5411	5360
70	5379	5629	5541	5265	5307
75	5410	5579	5376	5389	5467
80	5632	5303	5320	5472	5437
85	5586	5331	5330	5273	5251
90	5624	5252	5315	5517	5484
95	5665	5716	5383	5395	5653

--- END ---