

## FCC Test Report (DFS Band)

**Report No.:** RF180611E01C-7

**FCC ID:** 2ABLK-GS2026

**Test Model:** GS2026E

**Received Date:** Oct. 30, 2018

**Test Date:** Nov. 21 to Dec. 04, 2018

**Issued Date:** Mar. 14, 2019

**Applicant:** Calix Inc.

**Address:** 1035 N. McDowell Blvd. Petaluma, CA 94954 U.S.A.

**Issued By:** Bureau Veritas Consumer Products Services (H.K.) Ltd., Taoyuan Branch  
Hsin Chu Laboratory

**Lab Address:** E-2, No.1, Li Hsin 1st Road, Hsinchu Science Park, Hsinchu City 300,  
Taiwan R.O.C.

**Test Location:** E-2, No.1, Li Hsin 1st Road, Hsinchu Science Park, Hsinchu City 300,  
Taiwan R.O.C.

**FCC Registration /  
Designation Number:** 723255 / TW2022



This report is for your exclusive use. Any copying or replication of this report to or for any other person or entity, or use of our name or trademark, is permitted only with our prior written permission. This report sets forth our findings solely with respect to the test samples identified herein. The results set forth in this report are not indicative or representative of the quality or characteristics of the lot from which a test sample was taken or any similar or identical product specifically and expressly noted. Our report includes all of the tests requested by you and the results thereof based upon the information that you provided to us. You have 60 days from date of issuance of this report to notify us of any material error or omission caused by our negligence, provided, however, that such notice shall be in writing and shall specifically address the issue you wish to raise. A failure to raise such issue within the prescribed time shall constitute your unqualified acceptance of the completeness of this report, the tests conducted and the correctness of the report contents. Unless specific mention, the uncertainty of measurement has been explicitly taken into account to declare the compliance or non-compliance to the specification. The report must not be used by the client to claim product certification, approval, or endorsement by TAF or any government agencies.

## Table of Contents

<b>Release Control Record</b> .....	<b>4</b>
<b>1 Certificate of Conformity</b> .....	<b>5</b>
<b>2 Summary of Test Results</b> .....	<b>6</b>
2.1 Measurement Uncertainty.....	6
2.2 Modification Record.....	6
<b>3 General Information</b> .....	<b>7</b>
3.1 General Description of EUT (DFS Band).....	7
3.2 Description of Test Modes.....	12
3.2.1 Test Mode Applicability and Tested Channel Detail.....	14
3.3 Duty Cycle of Test Signal.....	17
3.4 Description of Support Units.....	19
3.4.1 Configuration of System under Test.....	20
3.5 General Description of Applied Standard.....	21
<b>4 Test Types and Results</b> .....	<b>22</b>
4.1 Radiated Emission and Bandedge Measurement.....	22
4.1.1 Limits of Radiated Emission and Bandedge Measurement.....	22
4.1.2 Test Instruments.....	23
4.1.3 Test Procedure.....	24
4.1.4 Deviation from Test Standard.....	24
4.1.5 Test Setup.....	25
4.1.6 EUT Operating Condition.....	26
4.1.7 Test Results.....	27
4.2 Conducted Emission Measurement.....	56
4.2.1 Limits of Conducted Emission Measurement.....	56
4.2.2 Test Instruments.....	56
4.2.3 Test Procedure.....	57
4.2.4 Deviation from Test Standard.....	57
4.2.5 Test Setup.....	57
4.2.6 EUT Operating Condition.....	57
4.2.7 Test Results.....	58
4.3 Transmit Power Measurement.....	60
4.3.1 Limits of Transmit Power Measurement.....	60
4.3.2 Test Setup.....	61
4.3.3 Test Instruments.....	61
4.3.4 Test Procedure.....	61
4.3.5 Deviation from Test Standard.....	62
4.3.6 EUT Operating Condition.....	62
4.3.7 Test Results.....	63
4.4 Occupied Bandwidth Measurement.....	97
4.4.1 Test Setup.....	97
4.4.2 Test Instruments.....	97
4.4.3 Test Procedure.....	97
4.4.4 Test Results.....	98
4.5 Peak Power Spectral Density Measurement.....	101
4.5.1 Limits of Peak Power Spectral Density Measurement.....	101
4.5.2 Test Setup.....	101
4.5.3 Test Instruments.....	101
4.5.4 Test Procedure.....	101
4.5.5 Deviation from Test Standard.....	101
4.5.6 EUT Operating Condition.....	101
4.5.7 Test Results.....	102
4.6 Frequency Stability Measurement.....	115
4.6.1 Limits of Frequency Stability Measurement.....	115

4.6.2	Test Setup.....	115
4.6.3	Test Instruments .....	115
4.6.4	Test Procedure .....	115
4.6.5	Deviation from Test Standard .....	115
4.6.6	EUT Operating Condition .....	115
4.6.7	Test Results .....	116
4.7	6dB Bandwidth Measurement.....	117
4.7.1	Limits of 6dB Bandwidth Measurement.....	117
4.7.2	Test Setup.....	117
4.7.3	Test Instruments .....	117
4.7.4	Test Procedure .....	117
4.7.5	Deviation from Test Standard .....	117
4.7.6	EUT Operating Condition .....	117
4.7.7	Test Results .....	118
<b>5</b>	<b>Pictures of Test Arrangements.....</b>	<b>120</b>
	<b>Appendix – Information of the Testing Laboratories .....</b>	<b>121</b>

### Release Control Record

Issue No.	Description	Date Issued
RF180611E01C-7	Original release.	Mar. 14, 2019

## 1 Certificate of Conformity

**Product:** GigaSpire  
**Brand:** Calix  
**Test Model:** GS2026E  
**Sample Status:** MASS-PRODUCTION  
**Applicant:** Calix Inc.  
**Test Date:** Nov. 21 to Dec. 04, 2018  
**Standard:** 47 CFR FCC Part 15, Subpart E (Section 15.407)  
ANSI C63.10: 2013

The above equipment has been tested by **Bureau Veritas Consumer Products Services (H.K.) Ltd., Taoyuan Branch**, and found compliance with the requirement of the above standards. The test record, data evaluation & Equipment Under Test (EUT) configurations represented herein are true and accurate accounts of the measurements of the sample's EMC characteristics under the conditions specified in this report.

**Prepared by :** Mary Ko , **Date:** Mar. 14, 2019  
Mary Ko / Specialist

**Approved by :** May Chen , **Date:** Mar. 14, 2019  
May Chen / Manager

## 2 Summary of Test Results

47 CFR FCC Part 15, Subpart E (Section 15.407)			
FCC Clause	Test Item	Result	Remarks
15.407(b)(6)	AC Power Conducted Emissions	Pass	Meet the requirement of limit. Minimum passing margin is -3.00dB at 0.39609MHz.
15.407(b) (1/2/3/4(i/ii)/6)	Radiated Emissions & Band Edge Measurement*	Pass	Meet the requirement of limit. Minimum passing margin is -3.2dB at 37.78MHz.
15.407(a)(1/2/3)	Max Average Transmit Power	Pass	Meet the requirement of limit.
---	Occupied Bandwidth Measurement	-	Reference only.
15.407(a)(1/2/3)	Peak Power Spectral Density	Pass	Meet the requirement of limit.
15.407(e)	6dB bandwidth	Pass	Meet the requirement of limit. (U-NII-3 Band only)
15.407(g)	Frequency Stability	Pass	Meet the requirement of limit.
15.203	Antenna Requirement	Pass	Antenna connector is i-pex(MHF) not a standard connector.

### 2.1 Measurement Uncertainty

Where relevant, the following measurement uncertainty levels have been estimated for tests performed on the EUT as specified in CISPR 16-4-2:

Measurement	Frequency	Expanded Uncertainty (k=2) (±)
Conducted Emissions at mains ports	150kHz ~ 30MHz	1.84 dB
Radiated Emissions up to 1 GHz	30MHz ~ 1GHz	5.33 dB
Radiated Emissions above 1 GHz	1GHz ~ 6GHz	5.08 dB
	6GHz ~ 18GHz	4.98 dB
	18GHz ~ 40GHz	5.19 dB

### 2.2 Modification Record

There were no modifications required for compliance.

### 3 General Information

#### 3.1 General Description of EUT (DFS Band)

Product	GigaSpire
Brand	Calix
Test Model	GS2026E
Status of EUT	MASS-PRODUCTION
Power Supply Rating	12Vdc from adapter
Modulation Type	64QAM, 16QAM, QPSK, BPSK for OFDM 256QAM for OFDM in 11ac mode and VHT (20/40) mode in 2.4GHz 1024QAM for OFDMA in 11ax HE mode
Modulation Technology	OFDM,OFDMA
Transfer Rate	802.11a: up to 54Mbps 802.11n: up to 600Mbps 802.11ac: up to 3466.7Mbps 802.11ax: up to 4803.9Mbps
Operating Frequency	5.26 ~ 5.32GHz, 5.50 ~ 5.72GHz
Number of Channel	802.11a, 802.11n (HT20), 802.11ac (VHT20), 802.11ax (HE20): 16 802.11n (HT40), 802.11ac (VHT40), 802.11ax (HE40): 8 802.11ac (VHT80), 802.11ax (HE80): 4 802.11ac (VHT80+80), 802.11ax (HE80+80): 14 sets
Output Power	<b>5.26 ~ 5.32GHz</b> <b>Non-Beamforming Mode:</b> 99.27mW <b>Beamforming Mode:</b> 99.27mW <b>5.5 ~ 5.72GHz</b> <b>Non-Beamforming Mode:</b> 103.136mW <b>Beamforming Mode:</b> 103.136mW
Antenna Type	Refer to Note
Antenna Connector	Refer to Note
Accessory Device	Adapter x 1
Data Cable Supplied	NA

Note:

- This report is prepared for FCC II change. The difference compared with the Report No.: RF180611E01C-1 design changed is as the following:
  - ◆ Added DFS band <5.26~ 5.32GHz, 5.50 ~ 5.72GHz>.
- According to above conditions, all test items need to be performed. And all data was verified to meet the requirements.
- There are WLAN, Bluetooth, Zigbee and Z-wave technology used for the EUT. The EUT has below radios as following table:

Radio 1	Radio 2	Radio 3	Radio 4	Radio 5
WLAN - 4TX (2.4GHz+5GHz)	WLAN - 4TX (5GHz)	Bluetooth	Zigbee	Z-wave

Note: For WLAN- 5GHz based on Radio 1 + 2 operating at same time.

- Simultaneously transmission condition.

Condition	Technology				
1	WLAN 2.4GHz	WLAN 5GHz	Bluetooth	Zigbee	Z-wave

**Note:** The emission of the simultaneous operation has been evaluated and no non-compliance was found.

5. The EUT must be supplied with a power adapter as following table:

Brand	Model No.	Spec.
Frecom	F60-120500SPA	Input: 100-240Vac, 1.6A, 50/60Hz AC input cable: Unshielded, 1.0m Output: 12V, 5A DC output cable: Unshielded, 1.5m
		Input: 100-240Vac, 1.6A, 50/60Hz AC input cable: Unshielded, 1.5m Output: 12V, 5A DC output cable: Unshielded, 1.5m

Note: In the original, from the above spec., the radiated emissions worse case was found in **AC input cable: Unshielded, 1.0m**. Therefore only the test data of the mode was recorded in this report.

6. The antennas provided to the EUT, please refer to the following table:

WLAN Directional gain table			
Frequency range (GHz)	Directional Antenna Gain (dBi)	Antenna Type	Antenna Connector
2.4 ~ 2.4835	7.41	Dipole	i-pex(MHF)
5.18 ~ 5.24	9.7		
5.26 ~ 5.32	9.9		
5.50 ~ 5.70	9.83		
5.745 ~ 5.825	10.27		

#### Bluetooth antenna spec.

Antenna Net Gain (dBi)	Frequency range (GHz)	Antenna Type	Antenna Connector
3.04	2.4~2.5	PIFA	None

#### Zigbee antenna spec.

Antenna Net Gain (dBi)	Frequency range (GHz)	Antenna Type	Antenna Connector
3.29	2.4~2.5	MONOPOLE	None

#### Z-wave antenna spec.

Antenna Net Gain (dBi)	Frequency range (MHz)	Antenna Type	Antenna Connector
2.76	850~920	PIFA	None

Note: More detailed information, please refer to operating description.



7. The EUT incorporates a MIMO function:

2.4GHz Band			
MODULATION MODE	DATA RATE (MCS)	TX & RX CONFIGURATION	
802.11b	1 ~ 11Mbps	4TX	4RX
802.11g	6 ~ 54Mbps	4TX	4RX
802.11n (HT20)	MCS 0~7	4TX	4RX
	MCS 8~15	4TX	4RX
	MCS 16~23	4TX	4RX
	MCS 24~31	4TX	4RX
802.11n (HT40)	MCS 0~7	4TX	4RX
	MCS 8~15	4TX	4RX
	MCS 16~23	4TX	4RX
	MCS 24~31	4TX	4RX
VHT20	MCS0~8 Nss=1	4TX	4RX
	MCS0~8 Nss=2	4TX	4RX
	MCS0~9 Nss=3	4TX	4RX
	MCS0~8 Nss=4	4TX	4RX
VHT40	MCS0~9 Nss=1	4TX	4RX
	MCS0~9 Nss=2	4TX	4RX
	MCS0~9 Nss=3	4TX	4RX
	MCS0~9 Nss=4	4TX	4RX
802.11ax (HE20)	MCS0~11 Nss=1	4TX	4RX
	MCS0~11 Nss=2	4TX	4RX
	MCS0~11 Nss=3	4TX	4RX
	MCS0~11 Nss=4	4TX	4RX
802.11ax (HE40)	MCS0~11 Nss=1	4TX	4RX
	MCS0~11 Nss=2	4TX	4RX
	MCS0~11 Nss=3	4TX	4RX
	MCS0~11 Nss=4	4TX	4RX
5GHz Band (Radio 1 + 2)			
MODULATION MODE	DATA RATE (MCS)	TX & RX CONFIGURATION	
802.11a	6 ~ 54Mbps	8TX	8RX
802.11n (HT20)	MCS 0~7	8TX	8RX
	MCS 8~15	8TX	8RX
	MCS 16~23	8TX	8RX
	MCS 24~31	8TX	8RX
802.11n (HT40)	MCS 0~7	8TX	8RX
	MCS 8~15	8TX	8RX
	MCS 16~23	8TX	8RX
	MCS 24~31	8TX	8RX

<b>802.11ac (VHT20)</b>	MCS0~8 Nss=1	8TX	8RX
	MCS0~8 Nss=2	8TX	8RX
	MCS0~9 Nss=3	8TX	8RX
	MCS0~8 Nss=4	8TX	8RX
	MCS0~8 Nss=5	8TX	8RX
	MCS0~9 Nss=6	8TX	8RX
	MCS0~8 Nss=7	8TX	8RX
	MCS0~8 Nss=8	8TX	8RX
<b>802.11ac (VHT40)</b>	MCS0~9 Nss=1	8TX	8RX
	MCS0~9 Nss=2	8TX	8RX
	MCS0~9 Nss=3	8TX	8RX
	MCS0~9 Nss=4	8TX	8RX
	MCS0~9 Nss=5	8TX	8RX
	MCS0~9 Nss=6	8TX	8RX
	MCS0~9 Nss=7	8TX	8RX
	MCS0~9 Nss=8	8TX	8RX
<b>802.11ac (VHT80)</b>	MCS0~9 Nss=1	8TX	8RX
	MCS0~9 Nss=2	8TX	8RX
	MCS0~9 Nss=3	8TX	8RX
	MCS0~9 Nss=4	8TX	8RX
	MCS0~9 Nss=5	8TX	8RX
	MCS0~8 Nss=6	8TX	8RX
	MCS 0~9 Nss=7	8TX	8RX
	MCS0~9 Nss=8	8TX	8RX
<b>802.11ac (VHT80+80)</b>	MCS0~9 Nss=1	4TX+4TX	4RX+4RX
	MCS0~9 Nss=2	4TX+4TX	4RX+4RX
	MCS0~9 Nss=3	4TX+4TX	4RX+4RX
	MCS0~9 Nss=4	4TX+4TX	4RX+4RX
<b>802.11ax (HE20)</b>	MCS0~11 Nss=1	8TX	8RX
	MCS0~11 Nss=2	8TX	8RX
	MCS0~11 Nss=3	8TX	8RX
	MCS0~11 Nss=4	8TX	8RX
	MCS0~11 Nss=5	8TX	8RX
	MCS0~11 Nss=6	8TX	8RX
	MCS0~11 Nss=7	8TX	8RX
	MCS0~11 Nss=8	8TX	8RX
<b>802.11ax (HE40)</b>	MCS0~11 Nss=1	8TX	8RX
	MCS0~11 Nss=2	8TX	8RX
	MCS0~11 Nss=3	8TX	8RX
	MCS0~11 Nss=4	8TX	8RX
	MCS0~11 Nss=5	8TX	8RX
	MCS0~11 Nss=6	8TX	8RX
	MCS0~11 Nss=7	8TX	8RX
	MCS0~11 Nss=8	8TX	8RX

<b>802.11ax (HE80)</b>	MCS0~11 Nss=1	8TX	8RX
	MCS0~11 Nss=2	8TX	8RX
	MCS0~11 Nss=3	8TX	8RX
	MCS0~11 Nss=4	8TX	8RX
	MCS0~11 Nss=5	8TX	8RX
	MCS0~11 Nss=6	8TX	8RX
	MCS0~11 Nss=7	8TX	8RX
	MCS0~11 Nss=8	8TX	8RX
<b>802.11ax (HE80+80)</b>	MCS0~11 Nss=1	4TX+4TX	4RX+4RX
	MCS0~11 Nss=2	4TX+4TX	4RX+4RX
	MCS0~11 Nss=3	4TX+4TX	4RX+4RX
	MCS0~11 Nss=4	4TX+4TX	4RX+4RX

Note:

1. All of modulation mode support beamforming function except 802.11a/b/g modulation mode.
2. The EUT support Beamforming and non-beamforming mode, therefore both mode were investigated and the worst case scenario was identified. The worst case data were presented in test report.
3. The modulation and bandwidth are similar for 802.11n mode for 20MHz (40MHz) and 802.11ac/ax mode for 20MHz (40MHz/80MHz), therefore investigated worst case to representative mode in test report. (Final test mode refer section 3.2.1)
8. This device can support different category application which switched by access point mode and client mode by software.
9. The above EUT information is declared by manufacturer and for more detailed features description, please refers to the manufacturer's specifications or user's manual.

### 3.2 Description of Test Modes

#### FOR 5260 ~ 5320MHz

4 channels are provided for 802.11a, 802.11n (HT20), 802.11ac (VHT20), 802.11ax (HE20):

Channel	Frequency	Channel	Frequency
52	5260 MHz	60	5300 MHz
56	5280 MHz	64	5320 MHz

2 channels are provided for 802.11n (HT40), 802.11ac (VHT40), 802.11ax (HE40):

Channel	Frequency	Channel	Frequency
54	5270 MHz	62	5310 MHz

1 channel is provided for 802.11ac (VHT80), 802.11ax (HE80):

Channel	Frequency
58	5290 MHz

#### FOR 5500 ~ 5720MHz

12 channels are provided for 802.11a, 802.11n (HT20), 802.11ac (VHT20), 802.11ax (HE20):

Channel	Frequency	Channel	Frequency
100	5500 MHz	124	5620 MHz
104	5520 MHz	128	5640 MHz
108	5540 MHz	132	5660 MHz
112	5560 MHz	136	5680 MHz
116	5580 MHz	140	5700 MHz
120	5600 MHz	144	5720 MHz

6 channels are provided for 802.11n (HT40), 802.11ac (VHT40), 802.11ax (HE40):

Channel	Frequency	Channel	Frequency
102	5510 MHz	126	5630 MHz
110	5550 MHz	134	5670 MHz
118	5590 MHz	142	5710 MHz

3 channels are provided for 802.11ac (VHT80), 802.11ax (HE80):

Channel	Frequency	Channel	Frequency
106	5530 MHz	138	5690 MHz
122	5610 MHz		

**For simultaneous transmission:**

14 sets are provided for 802.11ac (VHT80+80), 802.11ax (HE80+80):

Channel	Frequency	Channel	Frequency
42+58	5210 MHz + 5290 MHz	58+155	5290 MHz + 5775 MHz
42+106	5210 MHz + 5530 MHz	106+122	5530 MHz + 5610 MHz
42+122	5210 MHz + 5610 MHz	106+138	5530 MHz + 5690 MHz
42+138	5210 MHz + 5690 MHz	106+155	5530 MHz + 5775 MHz
58+106	5290 MHz + 5530 MHz	122+138	5610 MHz + 5690 MHz
58+122	5290 MHz + 5610 MHz	122+155	5610 MHz + 5775 MHz
58+138	5290 MHz + 5690 MHz	138+155	5690 MHz + 5775 MHz

### 3.2.1 Test Mode Applicability and Tested Channel Detail

EUT Configure Mode	Applicable To				Description
	RE $\geq$ 1G	RE $<$ 1G	PLC	APCM	
-	√	√	√	√	-

Where **RE $\geq$ 1G**: Radiated Emission above 1GHz  
**RE $<$ 1G**: Radiated Emission below 1GHz  
**PLC**: Power Line Conducted Emission  
**APCM**: Antenna Port Conducted Measurement

#### Radiated Emission Test (Above 1GHz):

- Pre-Scan has been conducted to determine the worst-case mode from all possible combinations between available modulations, data rates and antenna ports (if EUT with antenna diversity architecture).
- Following channel(s) was (were) selected for the final test as listed below.

Non-Beamforming Mode						
Mode	FREQ. Band (MHz)	Available Channel	Tested Channel	Modulation Technology	Modulation Type	Data Rate Parameter
802.11a	5260-5320	52 to 64	52, 60, 64	OFDM	BPSK	6Mb/s
802.11ax (HE20)		52 to 64	52, 60, 64	OFDMA	BPSK	MCS0
802.11ax (HE40)		54 to 62	54, 62	OFDMA	BPSK	MCS0
802.11ax (HE80)		58	58	OFDMA	BPSK	MCS0
802.11a	5500-5720	100 to 144	100, 116, 140, 144	OFDM	BPSK	6Mb/s
802.11ax (HE20)		100 to 144	100, 116, 140, 144	OFDMA	BPSK	MCS0
802.11ax (HE40)		102 to 142	102, 110, 134, 142	OFDMA	BPSK	MCS0
802.11ax (HE80)		106 to 138	106, 122, 138	OFDMA	BPSK	MCS0
802.11ax (HE80+80)	5260-5320 5500-5720	42 to 155	58+106, 106+122, 106+138	OFDMA	BPSK	MCS0

#### Radiated Emission Test (Below 1GHz):

- Pre-Scan has been conducted to determine the worst-case mode from all possible combinations between available modulations, data rates and antenna ports (if EUT with antenna diversity architecture).
- Following channel(s) was (were) selected for the final test as listed below.

Non-Beamforming Mode						
Mode	FREQ. Band (MHz)	Available Channel	Tested Channel	Modulation Technology	Modulation Type	Data Rate (Mbps)
802.11ax (HE20)	5260-5320 5500-5720	52 to 64 100 to 144	140	OFDMA	BPSK	MCS0

### Power Line Conducted Emission Test:

- Pre-Scan has been conducted to determine the worst-case mode from all possible combinations between available modulations, data rates and antenna ports (if EUT with antenna diversity architecture).
- Following channel(s) was (were) selected for the final test as listed below.

Non-Beamforming Mode						
Mode	FREQ. Band (MHz)	Available Channel	Tested Channel	Modulation Technology	Modulation Type	Data Rate (Mbps)
802.11ax (HE20)	5260-5320 5500-5720	52 to 64 100 to 144	140	OFDMA	BPSK	MCS0

### Antenna Port Conducted Measurement:

- This item includes all test value of each mode, but only includes spectrum plot of worst value of each mode.
- Pre-Scan has been conducted to determine the worst-case mode from all possible combinations between available modulations, data rates and antenna ports (if EUT with antenna diversity architecture).
- Following channel(s) was (were) selected for the final test as listed below.

Non-Beamforming Mode						
Mode	FREQ. Band (MHz)	Available Channel	Tested Channel	Modulation Technology	Modulation Type	Data Rate Parameter
802.11a	5260-5320	52 to 64	52, 60, 64	OFDM	BPSK	6Mb/s
802.11ac (VHT20)		52 to 64	52, 60, 64	OFDM	BPSK	MCS0
802.11ac (VHT40)		54 to 62	54, 62	OFDM	BPSK	MCS0
802.11ac (VHT80)		58	58	OFDM	BPSK	MCS0
802.11ax (HE20)		52 to 64	52, 60, 64	OFDMA	BPSK	MCS0
802.11ax (HE40)		54 to 62	54, 62	OFDMA	BPSK	MCS0
802.11ax (HE80)		58	58	OFDMA	BPSK	MCS0
802.11a	5500-5720	100 to 144	100, 116, 140, 144	OFDM	BPSK	6Mb/s
802.11ac (VHT20)		100 to 144	100, 116, 140, 144	OFDM	BPSK	MCS0
802.11ac (VHT40)		102 to 142	102, 110, 134, 142	OFDM	BPSK	MCS0
802.11ac (VHT80)		106 to 138	106, 122, 138	OFDM	BPSK	MCS0
802.11ax (HE20)		100 to 144	100, 116, 140, 144	OFDMA	BPSK	MCS0
802.11ax (HE40)		102 to 142	102, 110, 134, 142	OFDMA	BPSK	MCS0
802.11ax (HE80)		106 to 138	106, 122, 138	OFDMA	BPSK	MCS0
802.11ac (VHT80+80)	5260-5320 5500-5720	42 to 155	58+106, 106+122, 106+138	OFDM	BPSK	MCS0
802.11ax (HE80+80)	5260-5320 5500-5720	42 to 155	58+106, 106+122, 106+138	OFDMA	BPSK	MCS0

**Beamforming Mode (output power only)**

Mode	FREQ. Band (MHz)	Available Channel	Tested Channel	Modulation Technology	Modulation Type	Data Rate Parameter
802.11ac (VHT20)	5260-5320	52 to 64	52, 60, 64	OFDM	BPSK	MCS0
802.11ac (VHT40)		54 to 62	54, 62	OFDM	BPSK	MCS0
802.11ac (VHT80)		58	58	OFDM	BPSK	MCS0
802.11ax (HE20)		52 to 64	52, 60, 64	OFDMA	BPSK	MCS0
802.11ax (HE40)		54 to 62	54, 62	OFDMA	BPSK	MCS0
802.11ax (HE80)		58	58	OFDMA	BPSK	MCS0
802.11ac (VHT20)	5500-5720	100 to 144	100, 116, 140, 144	OFDM	BPSK	MCS0
802.11ac (VHT40)		102 to 142	102, 110, 134, 142	OFDM	BPSK	MCS0
802.11ac (VHT80)		106 to 138	106, 122, 138	OFDM	BPSK	MCS0
802.11ax (HE20)		100 to 144	100, 116, 140, 144	OFDMA	BPSK	MCS0
802.11ax (HE40)		102 to 142	102, 110, 134, 142	OFDMA	BPSK	MCS0
802.11ax (HE80)		106 to 138	106, 122, 138	OFDMA	BPSK	MCS0
802.11ac (VHT80+80)	5260-5320 5500-5720	42 to 155	58+106, 106+122, 106+138	OFDM	BPSK	MCS0
802.11ax (HE80+80)	5260-5320 5500-5720	42 to 155	58+106, 106+122, 106+138	OFDMA	BPSK	MCS0

**Test Condition:**

Applicable To	Environmental Conditions	Input Power	Tested By
RE $\geq$ 1G	23deg. C, 67%RH	120Vac, 60Hz	Rey Chen
RE $<$ 1G	23deg. C, 68%RH	120Vac, 60Hz	Frank Chuang
PLC	25deg. C, 75%RH	120Vac, 60Hz	Andy Ho
APCM	25deg. C, 60%RH	120Vac, 60Hz	Jyunchun Lin



### 3.3 Duty Cycle of Test Signal

If duty cycle of test signal is < 98%, duty factor shall be considered.

**802.11a:** Duty cycle = 1.432 ms/1.615 ms = 0.887, Duty factor =  $10 * \log(1/0.887) = 0.52$

**802.11ac (VHT20):** Duty cycle = 5.42 ms/5.63 ms = 0.963, Duty factor =  $10 * \log(1/0.963) = 0.17$

**802.11ac (VHT40):** Duty cycle = 5.42 ms/5.62 ms = 0.964, Duty factor =  $10 * \log(1/0.964) = 0.16$

**802.11ac (VHT80):** Duty cycle = 5.418 ms/5.618 ms = 0.964, Duty factor =  $10 * \log(1/0.964) = 0.16$

**802.11ac (VHT80+80):** Duty cycle = 5.422 ms/5.627 ms = 0.964, Duty factor =  $10 * \log(1/0.964) = 0.16$

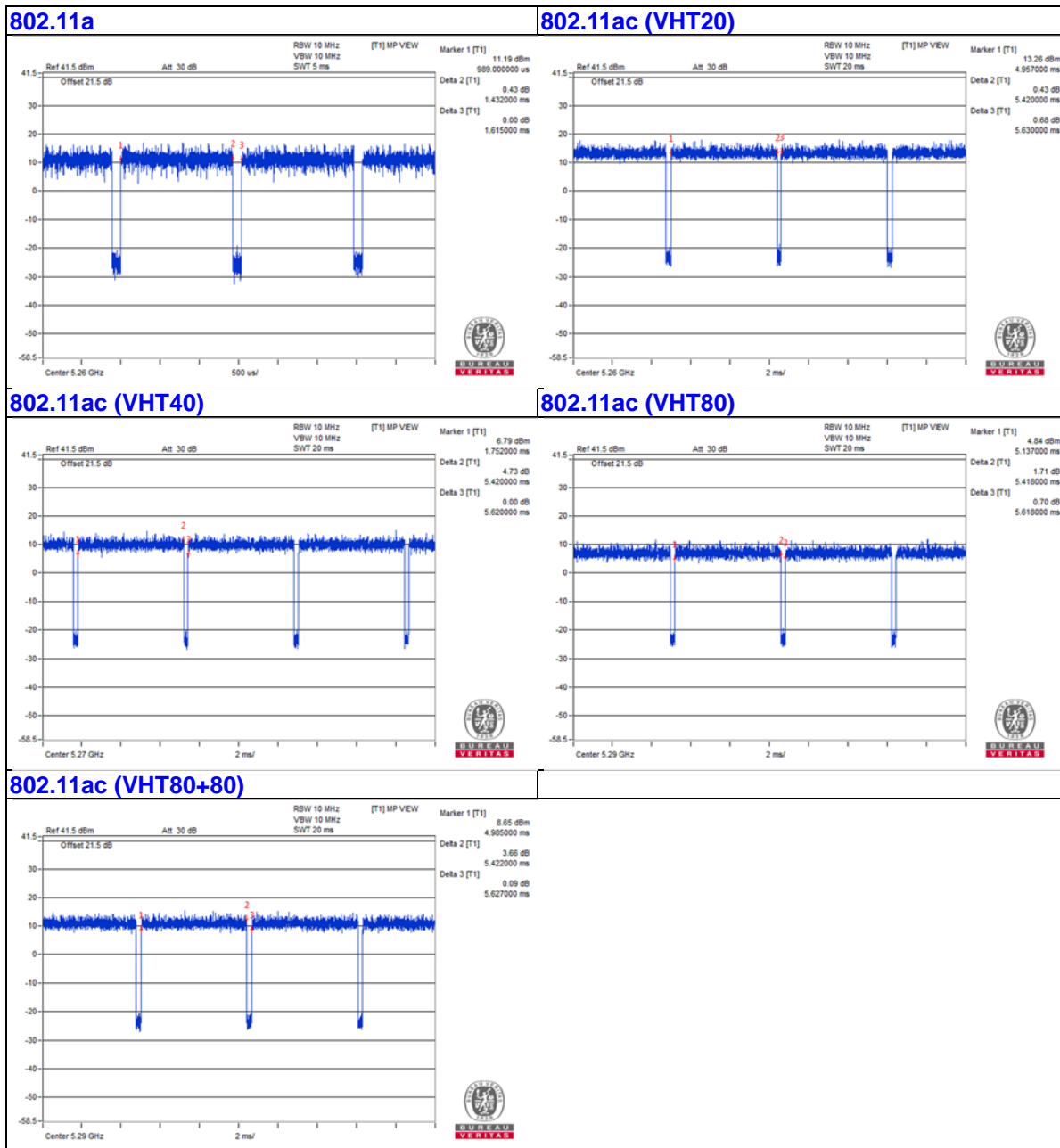

**802.11ax (HE20):** Duty cycle = 5.443 ms/5.65 ms = 0.963, Duty factor =  $10 * \log( 1/0.963) = 0.16$

**802.11ax (HE40):** Duty cycle = 5.438 ms/5.668 ms = 0.959, Duty factor =  $10 * \log( 1/0.959) = 0.18$

**802.11ax (HE80):** Duty cycle = 5.438 ms/5.638 ms = 0.965, Duty factor =  $10 * \log( 1/0.965) = 0.16$

**802.11ax (HE80+80):** Duty cycle = 5.437ms/5.644 ms = 0.963, Duty factor =  $10 * \log( 1/0.963) = 0.16$

**802.11ax (HE20)**

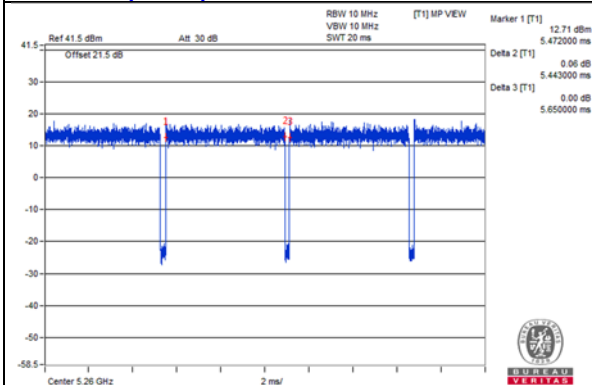

**802.11ax (HE40)**

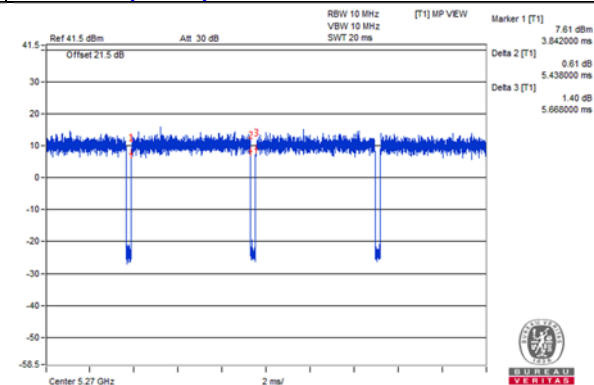

**802.11ax (HE80)**

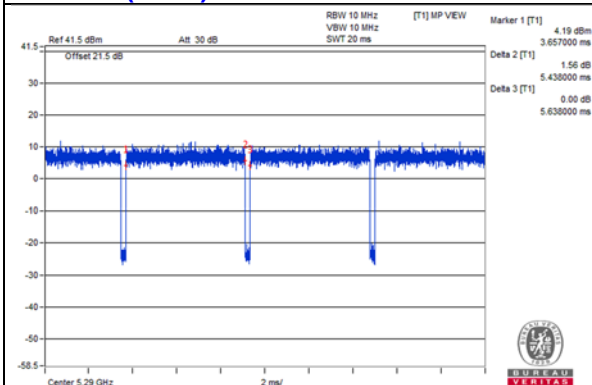

**802.11ax (HE80+80)**

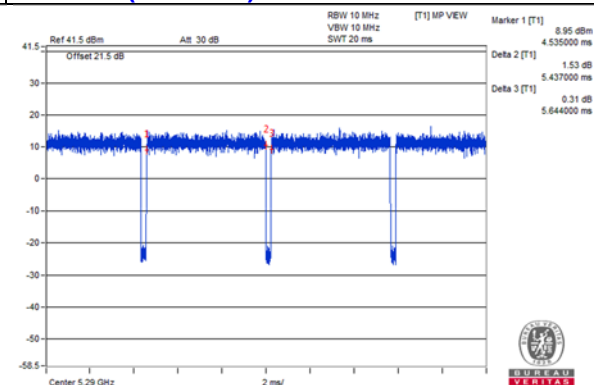

### 3.4 Description of Support Units

The EUT has been tested as an independent unit together with other necessary accessories or support units. The following support units or accessories were used to form a representative test configuration during the tests.

ID	Product	Brand	Model No.	Serial No.	FCC ID	Remarks
A.	Laptop	DELL	E5430	HYV4VY1	FCC DoC	Provided by Lab
B.	Laptop	DELL	E6420	B92T3R1	FCC DoC	Provided by Lab
C.	Earphone	Apple	NA	NA	NA	Provided by Lab
D.	USB 3.0 Disk	Transcend	16GB	NA	NA	Provided by Lab

Note:

1. All power cords of the above support units are non-shielded (1.8m).

ID	Descriptions	Qty.	Length (m)	Shielding (Yes/No)	Cores (Qty.)	Remarks
1.	DC Cable	1	1.5	No	0	Supplied by client
2.	AC Cable	1	1.0	No	0	Supplied by client
3.	RJ-45 Cable	1	10	No	0	Provided by Lab
4.	RJ-45 Cable	1	10	No	0	Provided by Lab
5.	Audio Cable	1	1.2	No	0	Provided by Lab

### 3.4.1 Configuration of System under Test

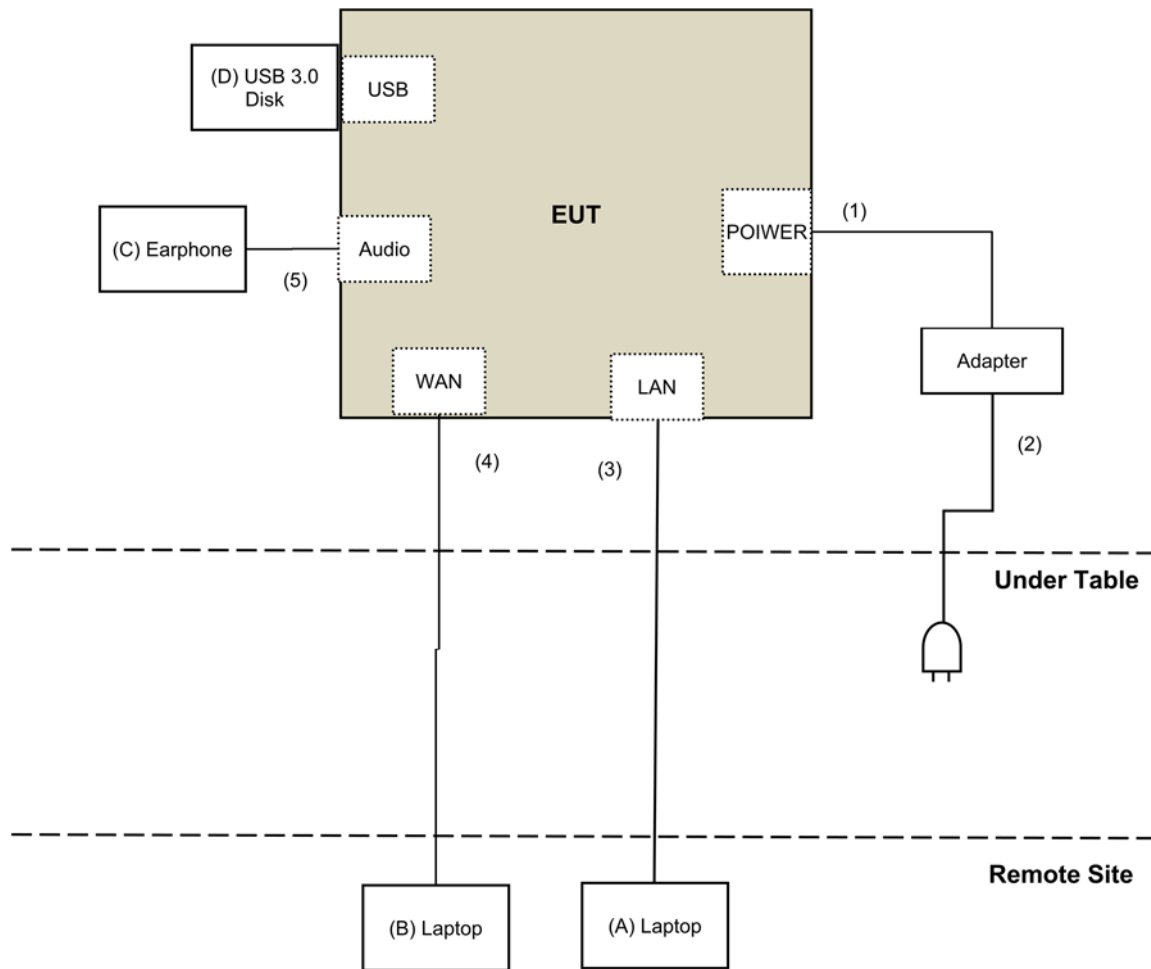

### 3.5 General Description of Applied Standard

The EUT is a RF Product. According to the specifications of the manufacturer, it must comply with the requirements of the following standards:

**FCC Part 15, Subpart E (15.407)**

**KDB 789033 D02 General UNII Test Procedure New Rules v02r01**

**KDB 662911 D01 Multiple Transmitter Output v02r01**

**ANSI C63.10-2013**

All test items have been performed and recorded as per the above standards.

## 4 Test Types and Results

### 4.1 Radiated Emission and Bandedge Measurement

#### 4.1.1 Limits of Radiated Emission and Bandedge Measurement

Radiated emissions which fall in the restricted bands must comply with the radiated emission limits specified as below table.

Frequencies (MHz)	Field Strength (microvolts/meter)	Measurement Distance (meters)
0.009 ~ 0.490	2400/F(kHz)	300
0.490 ~ 1.705	24000/F(kHz)	30
1.705 ~ 30.0	30	30
30 ~ 88	100	3
88 ~ 216	150	3
216 ~ 960	200	3
Above 960	500	3

#### NOTE:

- The lower limit shall apply at the transition frequencies.
- Emission level (dBuV/m) = 20 log Emission level (uV/m).
- For frequencies above 1000MHz, the field strength limits are based on average detector, however, the peak field strength of any emission shall not exceed the maximum permitted average limits, specified above by more than 20dB under any condition of modulation.

Limits of unwanted emission out of the restricted bands

Applicable To		Limit	
789033 D02 General UNII Test Procedure New Rules v02r01		Field Strength at 3m	
		PK:74 (dBuV/m)	AV:54 (dBuV/m)
Frequency Band	Applicable To	EIRP Limit	Equivalent Field Strength at 3m
5150~5250 MHz	15.407(b)(1)	PK:-27 (dBm/MHz)	PK:68.2(dBuV/m)
5250~5350 MHz	15.407(b)(2)		
5470~5725 MHz	15.407(b)(3)		
5725~5850 MHz	<input type="checkbox"/> 15.407(b)(4)(i)	PK:-27 (dBm/MHz) <sup>*1</sup> PK:10 (dBm/MHz) <sup>*2</sup> PK:15.6 (dBm/MHz) <sup>*3</sup> PK:27 (dBm/MHz) <sup>*4</sup>	PK: 68.2(dBuV/m) <sup>*1</sup> PK:105.2 (dBuV/m) <sup>*2</sup> PK: 110.8(dBuV/m) <sup>*3</sup> PK:122.2 (dBuV/m) <sup>*4</sup>
	<input type="checkbox"/> 15.407(b)(4)(ii)	Emission limits in section 15.247(d)	
*1 beyond 75 MHz or more above of the band edge.		*2 below the band edge increasing linearly to 10 dBm/MHz at 25 MHz above.	
*3 below the band edge increasing linearly to a level of 15.6 dBm/MHz at 5 MHz above.		*4 from 5 MHz above or below the band edge increasing linearly to a level of 27 dBm/MHz at the band edge.	

#### Note:

The following formula is used to convert the equipment isotropic radiated power (eirp) to field strength:

$$E = \frac{1000000\sqrt{30P}}{3} \mu\text{V/m, where } P \text{ is the eirp (Watts).}$$

## 4.1.2 Test Instruments

DESCRIPTION & MANUFACTURER	MODEL NO.	SERIAL NO.	CALIBRATED DATE	CALIBRATED UNTIL
Test Receiver Agilent	N9038A	MY50010156	July 12, 2018	July 11, 2019
Pre-Amplifier EMCI	EMC001340	980142	Feb. 09, 2018	Feb. 08, 2019
Loop Antenna(*) Electro-Metrics	EM-6879	264	Dec. 16, 2016	Dec. 15, 2018
RF Cable	NA	LOOPCAB-001	Jan. 15, 2018	Jan. 14, 2019
RF Cable	NA	LOOPCAB-002	Jan. 15, 2018	Jan. 14, 2019
Pre-Amplifier Mini-Circuits	ZFL-1000VH2B	AMP-ZFL-05	May 05, 2018	May 04, 2019
Trilog Broadband Antenna SCHWARZBECK	VULB 9168	9168-361	Nov. 22, 2018	Nov. 21, 2019
RF Cable	8D	966-3-1	Mar. 20, 2018	Mar. 19, 2019
RF Cable	8D	966-3-2	Mar. 20, 2018	Mar. 19, 2019
RF Cable	8D	966-3-3	Mar. 20, 2018	Mar. 19, 2019
Fixed attenuator Mini-Circuits	UNAT-5+	PAD-3m-3-01	Sep. 27, 2018	Sep. 26, 2019
Horn_Antenna SCHWARZBECK	BBHA9120-D	9120D-406	Dec. 12, 2017	Dec. 11, 2018
Pre-Amplifier EMCI	EMC12630SE	980384	Jan. 29, 2018	Jan. 28, 2019
RF Cable	EMC104-SM-SM-1200	160922	Jan. 29, 2018	Jan. 28, 2019
RF Cable	EMC104-SM-SM-2000	150317	Jan. 29, 2018	Jan. 28, 2019
RF Cable	EMC104-SM-SM-5000	150322	Jan. 29, 2018	Jan. 28, 2019
Spectrum Analyzer Keysight	N9030A	MY54490679	July 23, 2018	July 22, 2019
Pre-Amplifier EMCI	EMC184045SE	980386	Jan. 29, 2018	Jan. 28, 2019
Horn_Antenna SCHWARZBECK	BBHA 9170	BBHA9170608	Dec. 14, 2017	Dec. 13, 2018
RF Cable	EMC102-KM-KM-1200	160924	Jan. 29, 2018	Jan. 28, 2019
Software	ADT_Radiated_V8.7.08	NA	NA	NA
Antenna Tower & Turn Table Max-Full	MF-7802	MF780208406	NA	NA
Boresight Antenna Fixture	FBA-01	FBA-SIP01	NA	NA
Spectrum Analyzer R&S	FSV40	100964	June 20, 2018	June 19, 2019
Power meter Anritsu	ML2495A	1014008	May 09, 2018	May 08, 2019
Power sensor Anritsu	MA2411B	0917122	May 09, 2018	May 08, 2019
AC Power Source Extech Electronics	6205	1440452	NA	NA
Temperature & Humidity Chamber Giant Force	GTH-150-40-SP-AR	MAA0812-008	Jan. 10, 2018	Jan. 09, 2019
True RMS Clamp Meter FLUKE	325	31130711WS	May 22, 2018	May 21, 2019

**Note:**

1. The calibration interval of the above test instruments is 12 months and the calibrations are traceable to NML/ROC and NIST/USA.
2. \*The calibration interval of the above test instruments is 24 months and the calibrations are traceable to NML/ROC and NIST/USA.
3. The test was performed in 966 Chamber No. 3.
4. Loop antenna was used for all emissions below 30 MHz.
5. Tested Date: Nov. 26 to Dec. 04, 2018

#### 4.1.3 Test Procedure

##### **For Radiated emission below 30MHz**

- a. The EUT was placed on the top of a rotating table 0.8 meters above the ground at a 3 meter chamber room. The table was rotated 360 degrees to determine the position of the highest radiation.
- b. The EUT was set 3 meters away from the interference-receiving antenna, which was mounted on the top of a variable-height antenna tower.
- c. Parallel, perpendicular, and ground-parallel orientations of the antenna are set to make the measurement.
- d. For each suspected emission, the EUT was arranged to its worst case and the rotatable table was turned from 0 degrees to 360 degrees to find the maximum reading.
- e. The test-receiver system was set to Quasi-Peak Detect Function and Specified Bandwidth with Maximum Hold Mode.

##### **Note:**

1. The resolution bandwidth and video bandwidth of test receiver/spectrum analyzer is 9kHz at frequency below 30MHz.

##### **For Radiated emission above 30MHz**

- a. The EUT was placed on the top of a rotating table 0.8 meters (for 30MHz ~ 1GHz) / 1.5 meters (for above 1GHz) above the ground at 3 meter chamber room for test. The table was rotated 360 degrees to determine the position of the highest radiation.
- b. The EUT was set 3 meters away from the interference-receiving antenna, which was mounted on the top of a variable-height antenna tower.
- c. The height of antenna is varied from one meter to four meters above the ground to determine the maximum value of the field strength. Both horizontal and vertical polarizations of the antenna are set to make the measurement.
- d. For each suspected emission, the EUT was arranged to its worst case and then the antenna was tuned to heights from 1 meter to 4 meters and the rotatable table was turned from 0 degrees to 360 degrees to find the maximum reading.
- e. The test-receiver system was set to quasi-peak detect function and specified bandwidth with maximum hold mode when the test frequency is below 1 GHz.
- f. The test-receiver system was set to peak and average detects function and specified bandwidth with maximum hold mode when the test frequency is above 1 GHz. If the peak reading value also meets average limit, measurement with the average detector is unnecessary.

##### **Note:**

1. The resolution bandwidth and video bandwidth of test receiver/spectrum analyzer is 120kHz for Quasi-peak detection (QP) at frequency below 1GHz.
2. The resolution bandwidth of test receiver/spectrum analyzer is 1 MHz and the video bandwidth is 3 MHz for Peak detection (PK) at frequency above 1GHz.
3. The resolution bandwidth of test receiver/spectrum analyzer is 1MHz and the video bandwidth is  $\geq 1/T$  (Duty cycle < 98%) or 10Hz (Duty cycle  $\geq 98\%$ ) for Average detection (AV) at frequency above 1GHz.
4. All modes of operation were investigated and the worst-case emissions are reported.

#### 4.1.4 Deviation from Test Standard

No deviation.



#### 4.1.5 Test Setup

##### For Radiated emission below 30MHz

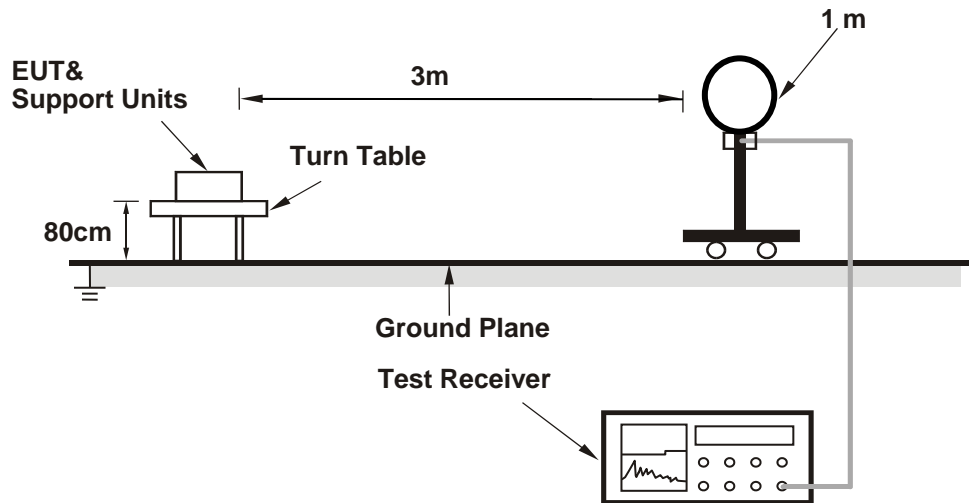

##### For Radiated emission 30MHz to 1GHz

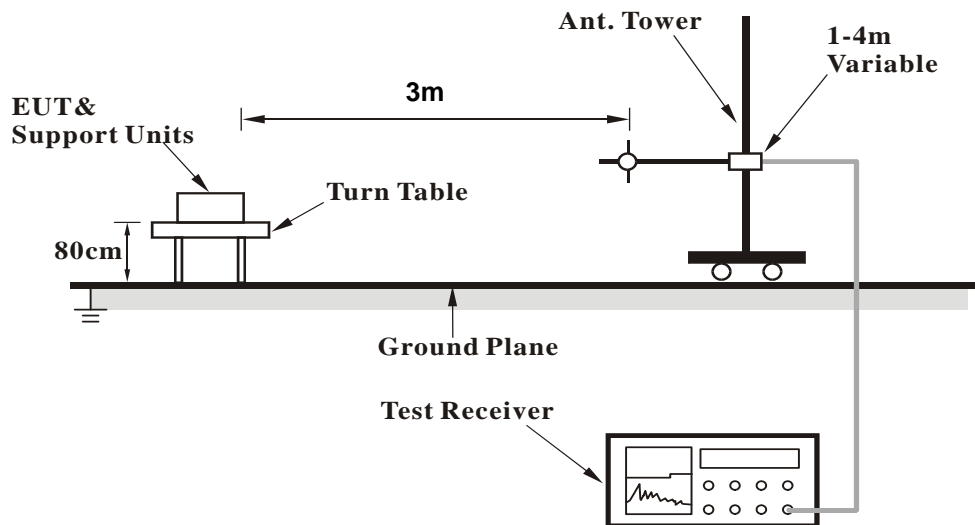

### For Radiated emission above 1GHz

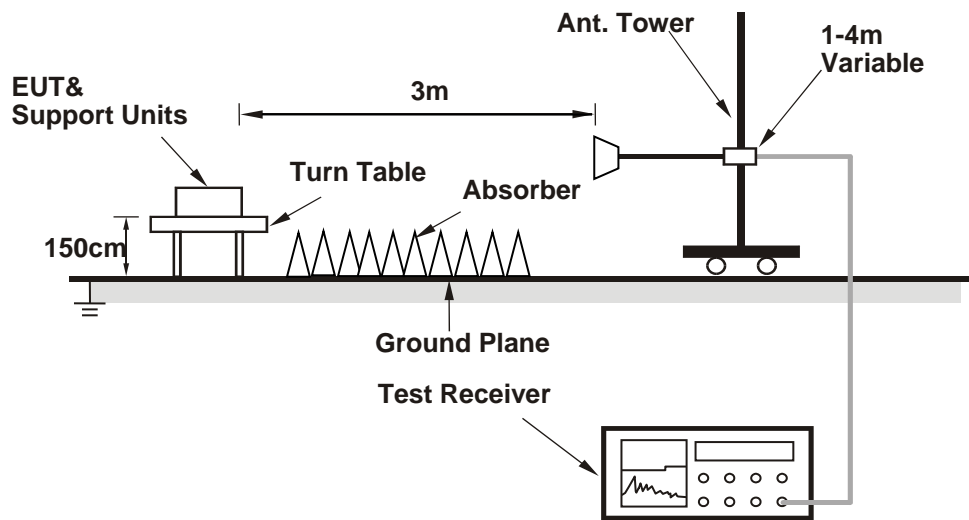

For the actual test configuration, please refer to the attached file (Test Setup Photo).

#### 4.1.6 EUT Operating Condition

- a. Connected the EUT with the Notebook Computer which is placed on remote site.
- b. Controlling software (QSPR (5.0-00148)) has been activated to set the EUT on specific status.

#### 4.1.7 Test Results

#### Above 1GHz Data:

#### 802.11a

<b>CHANNEL</b>	TX Channel 52	<b>DETECTOR FUNCTION</b>	Peak (PK)
<b>FREQUENCY RANGE</b>	1GHz ~ 40GHz		Average (AV)

ANTENNA POLARITY & TEST DISTANCE: HORIZONTAL AT 3 M								
NO.	FREQ. (MHz)	EMISSION LEVEL (dBuV/m)	LIMIT (dBuV/m)	MARGIN (dB)	ANTENNA HEIGHT (m)	TABLE ANGLE (Degree)	RAW VALUE (dBuV)	CORRECTION FACTOR (dB/m)
1	5150.00	55.3 PK	74.0	-18.7	2.67 H	304	52.7	2.6
2	5150.00	42.3 AV	54.0	-11.7	2.67 H	304	39.7	2.6
3	*5260.00	109.2 PK			2.67 H	304	107.1	2.1
4	*5260.00	97.2 AV			2.67 H	304	95.1	2.1
5	#10520.00	38.4 PK	68.2	-29.8	1.63 H	354	26.0	12.4
6	15780.00	48.7 PK	74.0	-25.3	1.74 H	260	37.2	11.5
7	15780.00	36.3 AV	54.0	-17.7	1.74 H	260	24.8	11.5
ANTENNA POLARITY & TEST DISTANCE: VERTICAL AT 3 M								
NO.	FREQ. (MHz)	EMISSION LEVEL (dBuV/m)	LIMIT (dBuV/m)	MARGIN (dB)	ANTENNA HEIGHT (m)	TABLE ANGLE (Degree)	RAW VALUE (dBuV)	CORRECTION FACTOR (dB/m)
1	5150.00	54.5 PK	74.0	-19.5	1.86 V	352	51.9	2.6
2	5150.00	40.3 AV	54.0	-13.7	1.86 V	352	37.7	2.6
3	*5260.00	107.6 PK			1.86 V	352	105.5	2.1
4	*5260.00	95.9 AV			1.86 V	352	93.8	2.1
5	#10520.00	41.4 PK	68.2	-26.8	1.62 V	201	29.0	12.4
6	15780.00	42.8 PK	74.0	-31.2	2.02 V	219	31.3	11.5
7	15780.00	31.9 AV	54.0	-22.1	2.02 V	219	20.4	11.5

#### REMARKS:

1. Emission Level(dBuV/m) = Raw Value(dBuV) + Correction Factor(dB/m)
2. Correction Factor(dB/m) = Antenna Factor(dB/m) + Cable Factor(dB) – Pre-Amplifier Factor(dB)
3. The other emission levels were very low against the limit.
4. Margin value = Emission Level – Limit value
5. " \* ": Fundamental frequency.
6. " # ": The radiated frequency is out of the restricted band.

<b>CHANNEL</b>	TX Channel 60	<b>DETECTOR FUNCTION</b>	Peak (PK)
<b>FREQUENCY RANGE</b>	1GHz ~ 40GHz		Average (AV)

**ANTENNA POLARITY & TEST DISTANCE: HORIZONTAL AT 3 M**

NO.	FREQ. (MHz)	EMISSION LEVEL (dBuV/m)	LIMIT (dBuV/m)	MARGIN (dB)	ANTENNA HEIGHT (m)	TABLE ANGLE (Degree)	RAW VALUE (dBuV)	CORRECTION FACTOR (dB/m)
1	*5300.00	109.5 PK			2.67 H	334	107.3	2.2
2	*5300.00	97.5 AV			2.67 H	334	95.3	2.2
3	10600.00	38.4 PK	74.0	-35.6	1.64 H	342	26.7	11.7
4	10600.00	36.2 AV	54.0	-17.8	1.64 H	342	24.5	11.7
5	15900.00	48.6 PK	74.0	-25.4	1.68 H	248	37.4	11.2
6	15900.00	35.9 AV	54.0	-18.1	1.68 H	248	24.7	11.2

**ANTENNA POLARITY & TEST DISTANCE: VERTICAL AT 3 M**

NO.	FREQ. (MHz)	EMISSION LEVEL (dBuV/m)	LIMIT (dBuV/m)	MARGIN (dB)	ANTENNA HEIGHT (m)	TABLE ANGLE (Degree)	RAW VALUE (dBuV)	CORRECTION FACTOR (dB/m)
1	*5300.00	107.9 PK			1.88 V	360	105.7	2.2
2	*5300.00	96.2 AV			1.88 V	360	94.0	2.2
3	10600.00	41.3 PK	74.0	-32.7	1.57 V	212	29.6	11.7
4	10600.00	31.2 AV	54.0	-22.8	1.57 V	212	19.5	11.7
5	15900.00	43.2 PK	74.0	-30.8	2.02 V	234	32.0	11.2
6	15900.00	32.2 AV	54.0	-21.8	2.02 V	234	21.0	11.2

**REMARKS:**

1. Emission Level(dBuV/m) = Raw Value(dBuV) + Correction Factor(dB/m)
2. Correction Factor(dB/m) = Antenna Factor(dB/m) + Cable Factor(dB) – Pre-Amplifier Factor(dB)
3. The other emission levels were very low against the limit.
4. Margin value = Emission Level – Limit value
5. " \* ": Fundamental frequency.

<b>CHANNEL</b>	TX Channel 64	<b>DETECTOR FUNCTION</b>	Peak (PK)
<b>FREQUENCY RANGE</b>	1GHz ~ 40GHz		Average (AV)

**ANTENNA POLARITY & TEST DISTANCE: HORIZONTAL AT 3 M**

NO.	FREQ. (MHz)	EMISSION LEVEL (dBuV/m)	LIMIT (dBuV/m)	MARGIN (dB)	ANTENNA HEIGHT (m)	TABLE ANGLE (Degree)	RAW VALUE (dBuV)	CORRECTION FACTOR (dB/m)
1	*5320.00	110.1 PK			2.64 H	308	107.8	2.3
2	*5320.00	98.3 AV			2.64 H	308	96.0	2.3
3	5350.00	51.9 PK	74.0	-22.1	2.64 H	308	49.6	2.3
4	5350.00	41.0 AV	54.0	-13.0	2.64 H	308	38.7	2.3
5	10640.00	38.9 PK	74.0	-35.1	1.67 H	334	27.2	11.7
6	10640.00	36.6 AV	54.0	-17.4	1.67 H	334	24.9	11.7
7	15960.00	48.1 PK	74.0	-25.9	1.64 H	250	36.7	11.4
8	15960.00	35.4 AV	54.0	-18.6	1.64 H	250	24.0	11.4

**ANTENNA POLARITY & TEST DISTANCE: VERTICAL AT 3 M**

NO.	FREQ. (MHz)	EMISSION LEVEL (dBuV/m)	LIMIT (dBuV/m)	MARGIN (dB)	ANTENNA HEIGHT (m)	TABLE ANGLE (Degree)	RAW VALUE (dBuV)	CORRECTION FACTOR (dB/m)
1	*5320.00	108.5 PK			1.95 V	356	106.2	2.3
2	*5320.00	97.0 AV			1.95 V	356	94.7	2.3
3	5350.00	43.2 PK	74.0	-30.8	1.95 V	356	40.9	2.3
4	5350.00	33.9 AV	54.0	-20.1	1.95 V	356	31.6	2.3
5	10640.00	41.5 PK	74.0	-32.5	1.58 V	198	29.8	11.7
6	10640.00	31.6 AV	54.0	-22.4	1.58 V	198	19.9	11.7
7	15960.00	43.7 PK	74.0	-30.3	2.04 V	236	32.3	11.4
8	15960.00	32.6 AV	54.0	-21.4	2.04 V	236	21.2	11.4

**REMARKS:**

1. Emission Level(dBuV/m) = Raw Value(dBuV) + Correction Factor(dB/m)
2. Correction Factor(dB/m) = Antenna Factor(dB/m) + Cable Factor(dB) – Pre-Amplifier Factor(dB)
3. The other emission levels were very low against the limit.
4. Margin value = Emission Level – Limit value
5. " \* ": Fundamental frequency.

<b>CHANNEL</b>	TX Channel 100	<b>DETECTOR FUNCTION</b>	Peak (PK)
<b>FREQUENCY RANGE</b>	1GHz ~ 40GHz		Average (AV)

**ANTENNA POLARITY & TEST DISTANCE: HORIZONTAL AT 3 M**

NO.	FREQ. (MHz)	EMISSION LEVEL (dBuV/m)	LIMIT (dBuV/m)	MARGIN (dB)	ANTENNA HEIGHT (m)	TABLE ANGLE (Degree)	RAW VALUE (dBuV)	CORRECTION FACTOR (dB/m)
1	#5470.00	54.3 PK	68.2	-13.9	2.69 H	334	51.7	2.6
2	*5500.00	110.3 PK			2.69 H	334	107.8	2.5
3	*5500.00	98.3 AV			2.69 H	334	95.8	2.5
4	11000.00	37.8 PK	74.0	-36.2	1.66 H	340	25.6	12.2
5	11000.00	35.8 AV	54.0	-18.2	1.66 H	340	23.6	12.2
6	#16500.00	48.6 PK	68.2	-19.6	1.66 H	260	34.9	13.7

**ANTENNA POLARITY & TEST DISTANCE: VERTICAL AT 3 M**

NO.	FREQ. (MHz)	EMISSION LEVEL (dBuV/m)	LIMIT (dBuV/m)	MARGIN (dB)	ANTENNA HEIGHT (m)	TABLE ANGLE (Degree)	RAW VALUE (dBuV)	CORRECTION FACTOR (dB/m)
1	#5470.00	54.7 PK	68.2	-13.5	1.88 V	355	52.1	2.6
2	*5500.00	108.7 PK			1.88 V	355	106.2	2.5
3	*5500.00	97.0 AV			1.88 V	355	94.5	2.5
4	11000.00	41.3 PK	74.0	-32.7	1.60 V	227	29.1	12.2
5	11000.00	30.9 AV	54.0	-23.1	1.60 V	227	18.7	12.2
6	#16500.00	43.5 PK	68.2	-24.7	2.04 V	230	29.8	13.7

**REMARKS:**

1. Emission Level(dBuV/m) = Raw Value(dBuV) + Correction Factor(dB/m)
2. Correction Factor(dB/m) = Antenna Factor(dB/m) + Cable Factor(dB) – Pre-Amplifier Factor(dB)
3. The other emission levels were very low against the limit.
4. Margin value = Emission Level – Limit value
5. " \* ": Fundamental frequency.
6. " # ": The radiated frequency is out of the restricted band.

<b>CHANNEL</b>	TX Channel 116	<b>DETECTOR FUNCTION</b>	Peak (PK)
<b>FREQUENCY RANGE</b>	1GHz ~ 40GHz		Average (AV)

**ANTENNA POLARITY & TEST DISTANCE: HORIZONTAL AT 3 M**

NO.	FREQ. (MHz)	EMISSION LEVEL (dBuV/m)	LIMIT (dBuV/m)	MARGIN (dB)	ANTENNA HEIGHT (m)	TABLE ANGLE (Degree)	RAW VALUE (dBuV)	CORRECTION FACTOR (dB/m)
1	*5580.00	110.3 PK			2.68 H	306	107.5	2.8
2	*5580.00	98.1 AV			2.68 H	306	95.3	2.8
3	11160.00	38.6 PK	74.0	-35.4	1.69 H	356	26.6	12.0
4	11160.00	36.2 AV	54.0	-17.8	1.69 H	356	24.2	12.0
5	#16740.00	48.8 PK	68.2	-19.4	1.64 H	247	34.6	14.2

**ANTENNA POLARITY & TEST DISTANCE: VERTICAL AT 3 M**

NO.	FREQ. (MHz)	EMISSION LEVEL (dBuV/m)	LIMIT (dBuV/m)	MARGIN (dB)	ANTENNA HEIGHT (m)	TABLE ANGLE (Degree)	RAW VALUE (dBuV)	CORRECTION FACTOR (dB/m)
1	*5580.00	108.7 PK			1.86 V	344	105.9	2.8
2	*5580.00	96.8 AV			1.86 V	344	94.0	2.8
3	11160.00	41.3 PK	74.0	-32.7	1.51 V	208	29.3	12.0
4	11160.00	31.0 AV	54.0	-23.0	1.51 V	208	19.0	12.0
5	#16740.00	43.5 PK	68.2	-24.7	2.03 V	233	29.3	14.2

**REMARKS:**

1. Emission Level(dBuV/m) = Raw Value(dBuV) + Correction Factor(dB/m)
2. Correction Factor(dB/m) = Antenna Factor(dB/m) + Cable Factor(dB) – Pre-Amplifier Factor(dB)
3. The other emission levels were very low against the limit.
4. Margin value = Emission Level – Limit value
5. " \* ": Fundamental frequency.
6. " # ": The radiated frequency is out of the restricted band.

<b>CHANNEL</b>	TX Channel 140	<b>DETECTOR FUNCTION</b>	Peak (PK)
<b>FREQUENCY RANGE</b>	1GHz ~ 40GHz		Average (AV)

**ANTENNA POLARITY & TEST DISTANCE: HORIZONTAL AT 3 M**

NO.	FREQ. (MHz)	EMISSION LEVEL (dBuV/m)	LIMIT (dBuV/m)	MARGIN (dB)	ANTENNA HEIGHT (m)	TABLE ANGLE (Degree)	RAW VALUE (dBuV)	CORRECTION FACTOR (dB/m)
1	*5700.00	110.1 PK			2.70 H	326	107.2	2.9
2	*5700.00	98.4 AV			2.70 H	326	95.5	2.9
3	#5725.00	51.4 PK	68.2	-16.8	2.70 H	326	48.5	2.9
4	11400.00	38.5 PK	74.0	-35.5	1.66 H	339	25.5	13.0
5	11400.00	36.1 AV	54.0	-17.9	1.66 H	339	23.1	13.0
6	#17100.00	48.5 PK	68.2	-19.7	1.73 H	241	32.4	16.1

**ANTENNA POLARITY & TEST DISTANCE: VERTICAL AT 3 M**

NO.	FREQ. (MHz)	EMISSION LEVEL (dBuV/m)	LIMIT (dBuV/m)	MARGIN (dB)	ANTENNA HEIGHT (m)	TABLE ANGLE (Degree)	RAW VALUE (dBuV)	CORRECTION FACTOR (dB/m)
1	*5700.00	108.5 PK			1.93 V	356	105.6	2.9
2	*5700.00	97.1 AV			1.93 V	356	94.2	2.9
3	#5725.00	43.4 PK	68.2	-24.8	1.93 V	356	40.5	2.9
4	11400.00	41.1 PK	74.0	-32.9	1.54 V	221	28.1	13.0
5	11400.00	31.0 AV	54.0	-23.0	1.54 V	221	18.0	13.0
6	#17100.00	43.4 PK	68.2	-24.8	1.96 V	241	27.3	16.1

**REMARKS:**

1. Emission Level(dBuV/m) = Raw Value(dBuV) + Correction Factor(dB/m)
2. Correction Factor(dB/m) = Antenna Factor(dB/m) + Cable Factor(dB) – Pre-Amplifier Factor(dB)
3. The other emission levels were very low against the limit.
4. Margin value = Emission Level – Limit value
5. " \* ": Fundamental frequency.
6. " # ": The radiated frequency is out of the restricted band.



<b>CHANNEL</b>	TX Channel 144	<b>DETECTOR FUNCTION</b>	Peak (PK)
<b>FREQUENCY RANGE</b>	1GHz ~ 40GHz		Average (AV)

**ANTENNA POLARITY & TEST DISTANCE: HORIZONTAL AT 3 M**

NO.	FREQ. (MHz)	EMISSION LEVEL (dBuV/m)	LIMIT (dBuV/m)	MARGIN (dB)	ANTENNA HEIGHT (m)	TABLE ANGLE (Degree)	RAW VALUE (dBuV)	CORRECTION FACTOR (dB/m)
1	#5470.00	54.8 PK	68.2	-13.4	2.71 H	307	52.2	2.6
2	*5720.00	110.1 PK			2.71 H	307	107.2	2.9
3	*5720.00	97.9 AV			2.71 H	307	95.0	2.9
4	#5850.00	50.9 PK	68.2	-17.3	2.71 H	307	47.6	3.3
5	11440.00	38.2 PK	74.0	-35.8	1.59 H	336	25.5	12.7
6	11440.00	36.2 AV	54.0	-17.8	1.59 H	336	23.5	12.7
7	#17160.00	48.8 PK	68.2	-19.4	1.65 H	234	33.2	15.6

**ANTENNA POLARITY & TEST DISTANCE: VERTICAL AT 3 M**

NO.	FREQ. (MHz)	EMISSION LEVEL (dBuV/m)	LIMIT (dBuV/m)	MARGIN (dB)	ANTENNA HEIGHT (m)	TABLE ANGLE (Degree)	RAW VALUE (dBuV)	CORRECTION FACTOR (dB/m)
1	#5470.00	54.5 PK	68.2	-13.7	1.96 V	356	51.9	2.6
2	*5720.00	108.5 PK			1.96 V	356	105.6	2.9
3	*5720.00	96.6 AV			1.96 V	356	93.7	2.9
4	#5850.00	43.3 PK	68.2	-24.9	1.96 V	356	40.0	3.3
5	11440.00	41.4 PK	74.0	-32.6	1.55 V	207	28.7	12.7
6	11440.00	31.4 AV	54.0	-22.6	1.55 V	207	18.7	12.7
7	#17160.00	43.2 PK	68.2	-25.0	2.01 V	236	27.6	15.6

**REMARKS:**

1. Emission Level(dBuV/m) = Raw Value(dBuV) + Correction Factor(dB/m)
2. Correction Factor(dB/m) = Antenna Factor(dB/m) + Cable Factor(dB) – Pre-Amplifier Factor(dB)
3. The other emission levels were very low against the limit.
4. Margin value = Emission Level – Limit value
5. " \* ": Fundamental frequency.
6. " # ": The radiated frequency is out of the restricted band.

**802.11ax (HE20)**

<b>CHANNEL</b>	TX Channel 52	<b>DETECTOR FUNCTION</b>	Peak (PK)
<b>FREQUENCY RANGE</b>	1GHz ~ 40GHz		Average (AV)

ANTENNA POLARITY & TEST DISTANCE: HORIZONTAL AT 3 M								
NO.	FREQ. (MHz)	EMISSION LEVEL (dBuV/m)	LIMIT (dBuV/m)	MARGIN (dB)	ANTENNA HEIGHT (m)	TABLE ANGLE (Degree)	RAW VALUE (dBuV)	CORRECTION FACTOR (dB/m)
1	5150.00	55.5 PK	74.0	-18.5	2.11 H	183	52.9	2.6
2	5150.00	42.4 AV	54.0	-11.6	2.11 H	183	39.8	2.6
3	*5260.00	113.1 PK			2.11 H	183	111.0	2.1
4	*5260.00	100.9 AV			2.11 H	183	98.8	2.1
5	#10520.00	38.4 PK	68.2	-29.8	1.61 H	343	26.0	12.4
6	15780.00	48.7 PK	74.0	-25.3	1.65 H	247	37.2	11.5
7	15780.00	36.1 AV	54.0	-17.9	1.65 H	247	24.6	11.5

ANTENNA POLARITY & TEST DISTANCE: VERTICAL AT 3 M								
NO.	FREQ. (MHz)	EMISSION LEVEL (dBuV/m)	LIMIT (dBuV/m)	MARGIN (dB)	ANTENNA HEIGHT (m)	TABLE ANGLE (Degree)	RAW VALUE (dBuV)	CORRECTION FACTOR (dB/m)
1	5150.00	54.4 PK	74.0	-19.6	1.94 V	343	51.8	2.6
2	5150.00	40.2 AV	54.0	-13.8	1.94 V	343	37.6	2.6
3	*5260.00	111.5 PK			1.94 V	343	109.4	2.1
4	*5260.00	99.6 AV			1.94 V	343	97.5	2.1
5	#10520.00	40.6 PK	68.2	-27.6	1.62 V	222	28.2	12.4
6	15780.00	43.3 PK	74.0	-30.7	2.07 V	222	31.8	11.5
7	15780.00	32.1 AV	54.0	-21.9	2.07 V	222	20.6	11.5

**REMARKS:**

1. Emission Level(dBuV/m) = Raw Value(dBuV) + Correction Factor(dB/m)
2. Correction Factor(dB/m) = Antenna Factor(dB/m) + Cable Factor(dB) – Pre-Amplifier Factor(dB)
3. The other emission levels were very low against the limit.
4. Margin value = Emission Level – Limit value
5. " \* ": Fundamental frequency.
6. " # ": The radiated frequency is out of the restricted band.

<b>CHANNEL</b>	TX Channel 60	<b>DETECTOR FUNCTION</b>	Peak (PK)
<b>FREQUENCY RANGE</b>	1GHz ~ 40GHz		Average (AV)

**ANTENNA POLARITY & TEST DISTANCE: HORIZONTAL AT 3 M**

NO.	FREQ. (MHz)	EMISSION LEVEL (dBuV/m)	LIMIT (dBuV/m)	MARGIN (dB)	ANTENNA HEIGHT (m)	TABLE ANGLE (Degree)	RAW VALUE (dBuV)	CORRECTION FACTOR (dB/m)
1	*5300.00	112.5 PK			2.10 H	177	110.3	2.2
2	*5300.00	100.6 AV			2.10 H	177	98.4	2.2
3	10600.00	38.7 PK	74.0	-35.3	1.64 H	331	27.0	11.7
4	10600.00	36.5 AV	54.0	-17.5	1.64 H	331	24.8	11.7
5	15900.00	48.2 PK	74.0	-25.8	1.71 H	241	37.0	11.2
6	15900.00	35.7 AV	54.0	-18.3	1.71 H	241	24.5	11.2

**ANTENNA POLARITY & TEST DISTANCE: VERTICAL AT 3 M**

NO.	FREQ. (MHz)	EMISSION LEVEL (dBuV/m)	LIMIT (dBuV/m)	MARGIN (dB)	ANTENNA HEIGHT (m)	TABLE ANGLE (Degree)	RAW VALUE (dBuV)	CORRECTION FACTOR (dB/m)
1	*5300.00	110.9 PK			1.95 V	360	108.7	2.2
2	*5300.00	99.3 AV			1.95 V	360	97.1	2.2
3	10600.00	40.9 PK	74.0	-33.1	1.57 V	201	29.2	11.7
4	10600.00	30.8 AV	54.0	-23.2	1.57 V	201	19.1	11.7
5	15900.00	43.2 PK	74.0	-30.8	2.06 V	238	32.0	11.2
6	15900.00	32.1 AV	54.0	-21.9	2.06 V	238	20.9	11.2

**REMARKS:**

1. Emission Level(dBuV/m) = Raw Value(dBuV) + Correction Factor(dB/m)
2. Correction Factor(dB/m) = Antenna Factor(dB/m) + Cable Factor(dB) – Pre-Amplifier Factor(dB)
3. The other emission levels were very low against the limit.
4. Margin value = Emission Level – Limit value
5. " \* ": Fundamental frequency.

<b>CHANNEL</b>	TX Channel 64	<b>DETECTOR FUNCTION</b>	Peak (PK)
<b>FREQUENCY RANGE</b>	1GHz ~ 40GHz		Average (AV)

**ANTENNA POLARITY & TEST DISTANCE: HORIZONTAL AT 3 M**

NO.	FREQ. (MHz)	EMISSION LEVEL (dBuV/m)	LIMIT (dBuV/m)	MARGIN (dB)	ANTENNA HEIGHT (m)	TABLE ANGLE (Degree)	RAW VALUE (dBuV)	CORRECTION FACTOR (dB/m)
1	*5320.00	113.0 PK			2.08 H	183	110.7	2.3
2	*5320.00	100.9 AV			2.08 H	183	98.6	2.3
3	5350.00	52.0 PK	74.0	-22.0	2.08 H	183	49.7	2.3
4	5350.00	41.4 AV	54.0	-12.6	2.08 H	183	39.1	2.3
5	10640.00	38.5 PK	74.0	-35.5	1.65 H	354	26.8	11.7
6	10640.00	36.3 AV	54.0	-17.7	1.65 H	354	24.6	11.7
7	15960.00	49.0 PK	74.0	-25.0	1.67 H	258	37.6	11.4
8	15960.00	36.1 AV	54.0	-17.9	1.67 H	258	24.7	11.4

**ANTENNA POLARITY & TEST DISTANCE: VERTICAL AT 3 M**

NO.	FREQ. (MHz)	EMISSION LEVEL (dBuV/m)	LIMIT (dBuV/m)	MARGIN (dB)	ANTENNA HEIGHT (m)	TABLE ANGLE (Degree)	RAW VALUE (dBuV)	CORRECTION FACTOR (dB/m)
1	*5320.00	111.4 PK			1.90 V	360	109.1	2.3
2	*5320.00	99.6 AV			1.90 V	360	97.3	2.3
3	5350.00	43.4 PK	74.0	-30.6	1.90 V	360	41.1	2.3
4	5350.00	33.9 AV	54.0	-20.1	1.90 V	360	31.6	2.3
5	10640.00	41.0 PK	74.0	-33.0	1.58 V	208	29.3	11.7
6	10640.00	31.1 AV	54.0	-22.9	1.58 V	208	19.4	11.7
7	15960.00	43.4 PK	74.0	-30.6	2.00 V	243	32.0	11.4
8	15960.00	32.4 AV	54.0	-21.6	2.00 V	243	21.0	11.4

**REMARKS:**

1. Emission Level(dBuV/m) = Raw Value(dBuV) + Correction Factor(dB/m)
2. Correction Factor(dB/m) = Antenna Factor(dB/m) + Cable Factor(dB) – Pre-Amplifier Factor(dB)
3. The other emission levels were very low against the limit.
4. Margin value = Emission Level – Limit value
5. " \* ": Fundamental frequency.

<b>CHANNEL</b>	TX Channel 100	<b>DETECTOR FUNCTION</b>	Peak (PK)
<b>FREQUENCY RANGE</b>	1GHz ~ 40GHz		Average (AV)

**ANTENNA POLARITY & TEST DISTANCE: HORIZONTAL AT 3 M**

NO.	FREQ. (MHz)	EMISSION LEVEL (dBuV/m)	LIMIT (dBuV/m)	MARGIN (dB)	ANTENNA HEIGHT (m)	TABLE ANGLE (Degree)	RAW VALUE (dBuV)	CORRECTION FACTOR (dB/m)
1	#5470.00	55.0 PK	68.2	-13.2	2.12 H	182	52.4	2.6
2	*5500.00	112.2 PK			2.12 H	182	109.7	2.5
3	*5500.00	100.4 AV			2.12 H	182	97.9	2.5
4	11000.00	38.5 PK	74.0	-35.5	1.60 H	331	26.3	12.2
5	11000.00	36.3 AV	54.0	-17.7	1.60 H	331	24.1	12.2
6	#16500.00	48.5 PK	68.2	-19.7	1.66 H	240	34.8	13.7

**ANTENNA POLARITY & TEST DISTANCE: VERTICAL AT 3 M**

NO.	FREQ. (MHz)	EMISSION LEVEL (dBuV/m)	LIMIT (dBuV/m)	MARGIN (dB)	ANTENNA HEIGHT (m)	TABLE ANGLE (Degree)	RAW VALUE (dBuV)	CORRECTION FACTOR (dB/m)
1	#5470.00	54.3 PK	68.2	-13.9	1.91 V	347	51.7	2.6
2	*5500.00	110.6 PK			1.91 V	347	108.1	2.5
3	*5500.00	99.1 AV			1.91 V	347	96.6	2.5
4	11000.00	41.1 PK	74.0	-32.9	1.58 V	209	28.9	12.2
5	11000.00	31.1 AV	54.0	-22.9	1.58 V	209	18.9	12.2
6	#16500.00	42.8 PK	68.2	-25.4	2.05 V	222	29.1	13.7

**REMARKS:**

1. Emission Level(dBuV/m) = Raw Value(dBuV) + Correction Factor(dB/m)
2. Correction Factor(dB/m) = Antenna Factor(dB/m) + Cable Factor(dB) – Pre-Amplifier Factor(dB)
3. The other emission levels were very low against the limit.
4. Margin value = Emission Level – Limit value
5. " \* ": Fundamental frequency.
6. " # ": The radiated frequency is out of the restricted band.

<b>CHANNEL</b>	TX Channel 116	<b>DETECTOR FUNCTION</b>	Peak (PK)
<b>FREQUENCY RANGE</b>	1GHz ~ 40GHz		Average (AV)

**ANTENNA POLARITY & TEST DISTANCE: HORIZONTAL AT 3 M**

NO.	FREQ. (MHz)	EMISSION LEVEL (dBuV/m)	LIMIT (dBuV/m)	MARGIN (dB)	ANTENNA HEIGHT (m)	TABLE ANGLE (Degree)	RAW VALUE (dBuV)	CORRECTION FACTOR (dB/m)
1	*5580.00	112.4 PK			2.08 H	180	109.6	2.8
2	*5580.00	100.5 AV			2.08 H	180	97.7	2.8
3	11160.00	38.0 PK	74.0	-36.0	1.61 H	339	26.0	12.0
4	11160.00	35.7 AV	54.0	-18.3	1.61 H	339	23.7	12.0
5	#16740.00	48.3 PK	68.2	-19.9	1.70 H	247	34.1	14.2

**ANTENNA POLARITY & TEST DISTANCE: VERTICAL AT 3 M**

NO.	FREQ. (MHz)	EMISSION LEVEL (dBuV/m)	LIMIT (dBuV/m)	MARGIN (dB)	ANTENNA HEIGHT (m)	TABLE ANGLE (Degree)	RAW VALUE (dBuV)	CORRECTION FACTOR (dB/m)
1	*5580.00	110.8 PK			1.93 V	360	108.0	2.8
2	*5580.00	99.2 AV			1.93 V	360	96.4	2.8
3	11160.00	41.4 PK	74.0	-32.6	1.59 V	209	29.4	12.0
4	11160.00	31.1 AV	54.0	-22.9	1.59 V	209	19.1	12.0
5	#16740.00	43.6 PK	68.2	-24.6	1.99 V	227	29.4	14.2

**REMARKS:**

1. Emission Level(dBuV/m) = Raw Value(dBuV) + Correction Factor(dB/m)
2. Correction Factor(dB/m) = Antenna Factor(dB/m) + Cable Factor(dB) – Pre-Amplifier Factor(dB)
3. The other emission levels were very low against the limit.
4. Margin value = Emission Level – Limit value
5. " \* ": Fundamental frequency.
6. " # ": The radiated frequency is out of the restricted band.

<b>CHANNEL</b>	TX Channel 140	<b>DETECTOR FUNCTION</b>	Peak (PK)
<b>FREQUENCY RANGE</b>	1GHz ~ 40GHz		Average (AV)

**ANTENNA POLARITY & TEST DISTANCE: HORIZONTAL AT 3 M**

NO.	FREQ. (MHz)	EMISSION LEVEL (dBuV/m)	LIMIT (dBuV/m)	MARGIN (dB)	ANTENNA HEIGHT (m)	TABLE ANGLE (Degree)	RAW VALUE (dBuV)	CORRECTION FACTOR (dB/m)
1	*5700.00	112.9 PK			2.14 H	162	110.0	2.9
2	*5700.00	101.1 AV			2.14 H	162	98.2	2.9
3	#5725.00	52.0 PK	68.2	-16.2	2.14 H	162	49.1	2.9
4	11400.00	38.3 PK	74.0	-35.7	1.68 H	353	25.3	13.0
5	11400.00	36.0 AV	54.0	-18.0	1.68 H	353	23.0	13.0
6	#17100.00	48.5 PK	68.2	-19.7	1.68 H	258	32.4	16.1

**ANTENNA POLARITY & TEST DISTANCE: VERTICAL AT 3 M**

NO.	FREQ. (MHz)	EMISSION LEVEL (dBuV/m)	LIMIT (dBuV/m)	MARGIN (dB)	ANTENNA HEIGHT (m)	TABLE ANGLE (Degree)	RAW VALUE (dBuV)	CORRECTION FACTOR (dB/m)
1	*5700.00	111.3 PK			1.94 V	360	108.4	2.9
2	*5700.00	99.8 AV			1.94 V	360	96.9	2.9
3	#5725.00	43.1 PK	68.2	-25.1	1.94 V	360	40.2	2.9
4	11400.00	41.4 PK	74.0	-32.6	1.67 V	182	28.4	13.0
5	11400.00	31.4 AV	54.0	-22.6	1.67 V	182	18.4	13.0
6	#17100.00	44.1 PK	68.2	-24.1	2.04 V	222	28.0	16.1

**REMARKS:**

1. Emission Level(dBuV/m) = Raw Value(dBuV) + Correction Factor(dB/m)
2. Correction Factor(dB/m) = Antenna Factor(dB/m) + Cable Factor(dB) – Pre-Amplifier Factor(dB)
3. The other emission levels were very low against the limit.
4. Margin value = Emission Level – Limit value
5. " \* ": Fundamental frequency.
6. " # ": The radiated frequency is out of the restricted band.

<b>CHANNEL</b>	TX Channel 144	<b>DETECTOR FUNCTION</b>	Peak (PK)
<b>FREQUENCY RANGE</b>	1GHz ~ 40GHz		Average (AV)

**ANTENNA POLARITY & TEST DISTANCE: HORIZONTAL AT 3 M**

NO.	FREQ. (MHz)	EMISSION LEVEL (dBuV/m)	LIMIT (dBuV/m)	MARGIN (dB)	ANTENNA HEIGHT (m)	TABLE ANGLE (Degree)	RAW VALUE (dBuV)	CORRECTION FACTOR (dB/m)
1	#5470.00	55.0 PK	68.2	-13.2	2.06 H	158	52.4	2.6
2	*5720.00	112.7 PK			2.06 H	158	109.8	2.9
3	*5720.00	100.9 AV			2.06 H	158	98.0	2.9
4	#5850.00	51.6 PK	68.2	-16.6	2.06 H	158	48.3	3.3
5	11440.00	38.5 PK	74.0	-35.5	1.68 H	351	25.8	12.7
6	11440.00	36.5 AV	54.0	-17.5	1.68 H	351	23.8	12.7
7	#17160.00	49.2 PK	68.2	-19.0	1.67 H	256	33.6	15.6

**ANTENNA POLARITY & TEST DISTANCE: VERTICAL AT 3 M**

NO.	FREQ. (MHz)	EMISSION LEVEL (dBuV/m)	LIMIT (dBuV/m)	MARGIN (dB)	ANTENNA HEIGHT (m)	TABLE ANGLE (Degree)	RAW VALUE (dBuV)	CORRECTION FACTOR (dB/m)
1	#5470.00	54.7 PK	68.2	-13.5	1.95 V	356	52.1	2.6
2	*5720.00	111.1 PK			1.95 V	356	108.2	2.9
3	*5720.00	99.6 AV			1.95 V	356	96.7	2.9
4	#5850.00	43.6 PK	68.2	-24.6	1.95 V	356	40.3	3.3
5	11440.00	41.7 PK	74.0	-32.3	1.62 V	197	29.0	12.7
6	11440.00	31.4 AV	54.0	-22.6	1.62 V	197	18.7	12.7
7	#17160.00	43.8 PK	68.2	-24.4	2.00 V	219	28.2	15.6

**REMARKS:**

1. Emission Level(dBuV/m) = Raw Value(dBuV) + Correction Factor(dB/m)
2. Correction Factor(dB/m) = Antenna Factor(dB/m) + Cable Factor(dB) – Pre-Amplifier Factor(dB)
3. The other emission levels were very low against the limit.
4. Margin value = Emission Level – Limit value
5. " \* ": Fundamental frequency.
6. " # ": The radiated frequency is out of the restricted band.



**802.11ax (HE40)**

<b>CHANNEL</b>	TX Channel 54	<b>DETECTOR FUNCTION</b>	Peak (PK)
<b>FREQUENCY RANGE</b>	1GHz ~ 40GHz		Average (AV)

**ANTENNA POLARITY & TEST DISTANCE: HORIZONTAL AT 3 M**

NO.	FREQ. (MHz)	EMISSION LEVEL (dBuV/m)	LIMIT (dBuV/m)	MARGIN (dB)	ANTENNA HEIGHT (m)	TABLE ANGLE (Degree)	RAW VALUE (dBuV)	CORRECTION FACTOR (dB/m)
1	5150.00	54.7 PK	74.0	-19.3	2.66 H	313	52.1	2.6
2	5150.00	41.8 AV	54.0	-12.2	2.66 H	313	39.2	2.6
3	*5270.00	110.3 PK			2.66 H	313	108.2	2.1
4	*5270.00	98.2 AV			2.66 H	313	96.1	2.1
5	#10540.00	38.9 PK	68.2	-29.3	1.60 H	348	26.7	12.2
6	15810.00	48.2 PK	74.0	-25.8	1.73 H	237	36.9	11.3
7	15810.00	35.6 AV	54.0	-18.4	1.73 H	237	24.3	11.3

**ANTENNA POLARITY & TEST DISTANCE: VERTICAL AT 3 M**

NO.	FREQ. (MHz)	EMISSION LEVEL (dBuV/m)	LIMIT (dBuV/m)	MARGIN (dB)	ANTENNA HEIGHT (m)	TABLE ANGLE (Degree)	RAW VALUE (dBuV)	CORRECTION FACTOR (dB/m)
1	5150.00	54.3 PK	74.0	-19.7	2.02 V	357	51.7	2.6
2	5150.00	40.1 AV	54.0	-13.9	2.02 V	357	37.5	2.6
3	*5270.00	108.7 PK			2.02 V	357	106.6	2.1
4	*5270.00	96.9 AV			2.02 V	357	94.8	2.1
5	#10540.00	41.3 PK	68.2	-26.9	1.51 V	224	29.1	12.2
6	15810.00	43.1 PK	74.0	-30.9	2.01 V	229	31.8	11.3
7	15810.00	32.2 AV	54.0	-21.8	2.01 V	229	20.9	11.3

**REMARKS:**

1. Emission Level(dBuV/m) = Raw Value(dBuV) + Correction Factor(dB/m)
2. Correction Factor(dB/m) = Antenna Factor(dB/m) + Cable Factor(dB) – Pre-Amplifier Factor(dB)
3. The other emission levels were very low against the limit.
4. Margin value = Emission Level – Limit value
5. " \* ": Fundamental frequency.
6. " # ": The radiated frequency is out of the restricted band.

<b>CHANNEL</b>	TX Channel 62	<b>DETECTOR FUNCTION</b>	Peak (PK)
<b>FREQUENCY RANGE</b>	1GHz ~ 40GHz		Average (AV)

**ANTENNA POLARITY & TEST DISTANCE: HORIZONTAL AT 3 M**

NO.	FREQ. (MHz)	EMISSION LEVEL (dBuV/m)	LIMIT (dBuV/m)	MARGIN (dB)	ANTENNA HEIGHT (m)	TABLE ANGLE (Degree)	RAW VALUE (dBuV)	CORRECTION FACTOR (dB/m)
1	*5310.00	109.5 PK			2.70 H	310	107.3	2.2
2	*5310.00	97.5 AV			2.70 H	310	95.3	2.2
3	5350.00	52.1 PK	74.0	-21.9	2.70 H	310	49.8	2.3
4	5350.00	41.4 AV	54.0	-12.6	2.70 H	310	39.1	2.3
5	10620.00	38.6 PK	74.0	-35.4	1.61 H	332	26.9	11.7
6	10620.00	36.3 AV	54.0	-17.7	1.61 H	332	24.6	11.7
7	15930.00	48.7 PK	74.0	-25.3	1.73 H	264	37.5	11.2
8	15930.00	35.7 AV	54.0	-18.3	1.73 H	264	24.5	11.2

**ANTENNA POLARITY & TEST DISTANCE: VERTICAL AT 3 M**

NO.	FREQ. (MHz)	EMISSION LEVEL (dBuV/m)	LIMIT (dBuV/m)	MARGIN (dB)	ANTENNA HEIGHT (m)	TABLE ANGLE (Degree)	RAW VALUE (dBuV)	CORRECTION FACTOR (dB/m)
1	*5310.00	107.9 PK			2.00 V	357	105.7	2.2
2	*5310.00	96.2 AV			2.00 V	357	94.0	2.2
3	5350.00	43.2 PK	74.0	-30.8	2.00 V	357	40.9	2.3
4	5350.00	34.1 AV	54.0	-19.9	2.00 V	357	31.8	2.3
5	10620.00	41.8 PK	74.0	-32.2	1.57 V	205	30.1	11.7
6	10620.00	31.6 AV	54.0	-22.4	1.57 V	205	19.9	11.7
7	15930.00	43.0 PK	74.0	-31.0	2.03 V	231	31.8	11.2
8	15930.00	32.1 AV	54.0	-21.9	2.03 V	231	20.9	11.2

**REMARKS:**

1. Emission Level(dBuV/m) = Raw Value(dBuV) + Correction Factor(dB/m)
2. Correction Factor(dB/m) = Antenna Factor(dB/m) + Cable Factor(dB) – Pre-Amplifier Factor(dB)
3. The other emission levels were very low against the limit.
4. Margin value = Emission Level – Limit value
5. " \* ": Fundamental frequency.

<b>CHANNEL</b>	TX Channel 102	<b>DETECTOR FUNCTION</b>	Peak (PK)
<b>FREQUENCY RANGE</b>	1GHz ~ 40GHz		Average (AV)

**ANTENNA POLARITY & TEST DISTANCE: HORIZONTAL AT 3 M**

NO.	FREQ. (MHz)	EMISSION LEVEL (dBuV/m)	LIMIT (dBuV/m)	MARGIN (dB)	ANTENNA HEIGHT (m)	TABLE ANGLE (Degree)	RAW VALUE (dBuV)	CORRECTION FACTOR (dB/m)
1	#5470.00	54.3 PK	68.2	-13.9	2.64 H	314	51.7	2.6
2	*5510.00	109.3 PK			2.64 H	314	106.8	2.5
3	*5510.00	97.5 AV			2.64 H	314	95.0	2.5
4	11020.00	38.0 PK	74.0	-36.0	1.59 H	337	25.7	12.3
5	11020.00	35.8 AV	54.0	-18.2	1.59 H	337	23.5	12.3
6	#16530.00	48.7 PK	68.2	-19.5	1.65 H	239	34.8	13.9

**ANTENNA POLARITY & TEST DISTANCE: VERTICAL AT 3 M**

NO.	FREQ. (MHz)	EMISSION LEVEL (dBuV/m)	LIMIT (dBuV/m)	MARGIN (dB)	ANTENNA HEIGHT (m)	TABLE ANGLE (Degree)	RAW VALUE (dBuV)	CORRECTION FACTOR (dB/m)
1	#5470.00	54.1 PK	68.2	-14.1	1.92 V	354	51.5	2.6
2	*5510.00	107.7 PK			1.92 V	354	105.2	2.5
3	*5510.00	96.2 AV			1.92 V	354	93.7	2.5
4	11020.00	40.9 PK	74.0	-33.1	1.57 V	203	28.6	12.3
5	11020.00	30.9 AV	54.0	-23.1	1.57 V	203	18.6	12.3
6	#16530.00	43.0 PK	68.2	-25.2	1.98 V	235	29.1	13.9

**REMARKS:**

1. Emission Level(dBuV/m) = Raw Value(dBuV) + Correction Factor(dB/m)
2. Correction Factor(dB/m) = Antenna Factor(dB/m) + Cable Factor(dB) – Pre-Amplifier Factor(dB)
3. The other emission levels were very low against the limit.
4. Margin value = Emission Level – Limit value
5. " \* ": Fundamental frequency.
6. " # ": The radiated frequency is out of the restricted band.

<b>CHANNEL</b>	TX Channel 110	<b>DETECTOR FUNCTION</b>	Peak (PK)
<b>FREQUENCY RANGE</b>	1GHz ~ 40GHz		Average (AV)

**ANTENNA POLARITY & TEST DISTANCE: HORIZONTAL AT 3 M**

NO.	FREQ. (MHz)	EMISSION LEVEL (dBuV/m)	LIMIT (dBuV/m)	MARGIN (dB)	ANTENNA HEIGHT (m)	TABLE ANGLE (Degree)	RAW VALUE (dBuV)	CORRECTION FACTOR (dB/m)
1	*5550.00	110.2 PK			2.62 H	316	107.5	2.7
2	*5550.00	98.2 AV			2.62 H	316	95.5	2.7
3	11100.00	38.5 PK	74.0	-35.5	1.69 H	337	26.4	12.1
4	11100.00	36.2 AV	54.0	-17.8	1.69 H	337	24.1	12.1
5	#16650.00	48.8 PK	68.2	-19.4	1.65 H	235	34.6	14.2

**ANTENNA POLARITY & TEST DISTANCE: VERTICAL AT 3 M**

NO.	FREQ. (MHz)	EMISSION LEVEL (dBuV/m)	LIMIT (dBuV/m)	MARGIN (dB)	ANTENNA HEIGHT (m)	TABLE ANGLE (Degree)	RAW VALUE (dBuV)	CORRECTION FACTOR (dB/m)
1	*5550.00	108.6 PK			1.95 V	346	105.9	2.7
2	*5550.00	96.9 AV			1.95 V	346	94.2	2.7
3	11100.00	41.4 PK	74.0	-32.6	1.61 V	218	29.3	12.1
4	11100.00	31.2 AV	54.0	-22.8	1.61 V	218	19.1	12.1
5	#16650.00	43.4 PK	68.2	-24.8	2.08 V	223	29.2	14.2

**REMARKS:**

1. Emission Level(dBuV/m) = Raw Value(dBuV) + Correction Factor(dB/m)
2. Correction Factor(dB/m) = Antenna Factor(dB/m) + Cable Factor(dB) – Pre-Amplifier Factor(dB)
3. The other emission levels were very low against the limit.
4. Margin value = Emission Level – Limit value
5. " \* ": Fundamental frequency.
6. " # ": The radiated frequency is out of the restricted band.

<b>CHANNEL</b>	TX Channel 134	<b>DETECTOR FUNCTION</b>	Peak (PK)
<b>FREQUENCY RANGE</b>	1GHz ~ 40GHz		Average (AV)

**ANTENNA POLARITY & TEST DISTANCE: HORIZONTAL AT 3 M**

NO.	FREQ. (MHz)	EMISSION LEVEL (dBuV/m)	LIMIT (dBuV/m)	MARGIN (dB)	ANTENNA HEIGHT (m)	TABLE ANGLE (Degree)	RAW VALUE (dBuV)	CORRECTION FACTOR (dB/m)
1	*5670.00	109.7 PK			2.63 H	331	106.8	2.9
2	*5670.00	97.6 AV			2.63 H	331	94.7	2.9
3	#5725.00	52.5 PK	68.2	-15.7	2.63 H	331	49.6	2.9
4	11340.00	38.0 PK	74.0	-36.0	1.60 H	329	25.1	12.9
5	11340.00	35.8 AV	54.0	-18.2	1.60 H	329	22.9	12.9
6	#17010.00	48.7 PK	68.2	-19.5	1.66 H	248	32.9	15.8

**ANTENNA POLARITY & TEST DISTANCE: VERTICAL AT 3 M**

NO.	FREQ. (MHz)	EMISSION LEVEL (dBuV/m)	LIMIT (dBuV/m)	MARGIN (dB)	ANTENNA HEIGHT (m)	TABLE ANGLE (Degree)	RAW VALUE (dBuV)	CORRECTION FACTOR (dB/m)
1	*5670.00	108.1 PK			1.95 V	350	105.2	2.9
2	*5670.00	96.3 AV			1.95 V	350	93.4	2.9
3	#5725.00	43.8 PK	68.2	-24.4	1.95 V	350	40.9	2.9
4	11340.00	41.4 PK	74.0	-32.6	1.55 V	207	28.5	12.9
5	11340.00	31.4 AV	54.0	-22.6	1.55 V	207	18.5	12.9
6	#17010.00	42.7 PK	68.2	-25.5	2.06 V	233	26.9	15.8

**REMARKS:**

1. Emission Level(dBuV/m) = Raw Value(dBuV) + Correction Factor(dB/m)
2. Correction Factor(dB/m) = Antenna Factor(dB/m) + Cable Factor(dB) – Pre-Amplifier Factor(dB)
3. The other emission levels were very low against the limit.
4. Margin value = Emission Level – Limit value
5. " \* ": Fundamental frequency.
6. " # ": The radiated frequency is out of the restricted band.

<b>CHANNEL</b>	TX Channel 142	<b>DETECTOR FUNCTION</b>	Peak (PK)
<b>FREQUENCY RANGE</b>	1GHz ~ 40GHz		Average (AV)

**ANTENNA POLARITY & TEST DISTANCE: HORIZONTAL AT 3 M**

NO.	FREQ. (MHz)	EMISSION LEVEL (dBuV/m)	LIMIT (dBuV/m)	MARGIN (dB)	ANTENNA HEIGHT (m)	TABLE ANGLE (Degree)	RAW VALUE (dBuV)	CORRECTION FACTOR (dB/m)
1	#5470.00	54.7 PK	68.2	-13.5	2.66 H	322	52.1	2.6
2	*5710.00	109.8 PK			2.66 H	322	106.8	3.0
3	*5710.00	97.9 AV			2.66 H	322	94.9	3.0
4	#5850.00	52.4 PK	68.2	-15.8	2.66 H	322	49.1	3.3
5	11420.00	38.6 PK	74.0	-35.4	1.59 H	334	25.7	12.9
6	11420.00	36.3 AV	54.0	-17.7	1.59 H	334	23.4	12.9
7	#17130.00	48.0 PK	68.2	-20.2	1.69 H	244	32.2	15.8

**ANTENNA POLARITY & TEST DISTANCE: VERTICAL AT 3 M**

NO.	FREQ. (MHz)	EMISSION LEVEL (dBuV/m)	LIMIT (dBuV/m)	MARGIN (dB)	ANTENNA HEIGHT (m)	TABLE ANGLE (Degree)	RAW VALUE (dBuV)	CORRECTION FACTOR (dB/m)
1	#5470.00	54.7 PK	68.2	-13.5	1.96 V	353	52.1	2.6
2	*5710.00	108.2 PK			1.96 V	353	105.2	3.0
3	*5710.00	96.6 AV			1.96 V	353	93.6	3.0
4	#5850.00	44.0 PK	68.2	-24.2	1.96 V	353	40.7	3.3
5	11420.00	41.7 PK	74.0	-32.3	1.56 V	213	28.8	12.9
6	11420.00	31.6 AV	54.0	-22.4	1.56 V	213	18.7	12.9
7	#17130.00	43.3 PK	68.2	-24.9	2.06 V	240	27.5	15.8

**REMARKS:**

- Emission Level(dBuV/m) = Raw Value(dBuV) + Correction Factor(dB/m)
- Correction Factor(dB/m) = Antenna Factor(dB/m) + Cable Factor(dB) – Pre-Amplifier Factor(dB)
- The other emission levels were very low against the limit.
- Margin value = Emission Level – Limit value
- " \* ": Fundamental frequency.
- " # ": The radiated frequency is out of the restricted band.

**802.11ax (HE80)**

<b>CHANNEL</b>	TX Channel 58	<b>DETECTOR FUNCTION</b>	Peak (PK)
<b>FREQUENCY RANGE</b>	1GHz ~ 40GHz		Average (AV)

**ANTENNA POLARITY & TEST DISTANCE: HORIZONTAL AT 3 M**

NO.	FREQ. (MHz)	EMISSION LEVEL (dBuV/m)	LIMIT (dBuV/m)	MARGIN (dB)	ANTENNA HEIGHT (m)	TABLE ANGLE (Degree)	RAW VALUE (dBuV)	CORRECTION FACTOR (dB/m)
1	5150.00	49.8 PK	74.0	-24.2	1.62 H	321	47.2	2.6
2	5150.00	38.8 AV	54.0	-15.2	1.62 H	321	36.2	2.6
3	*5290.00	108.0 PK			1.62 H	321	105.9	2.1
4	*5290.00	96.1 AV			1.62 H	321	94.0	2.1
5	5350.00	55.9 PK	74.0	-18.1	1.62 H	321	53.6	2.3
6	5350.00	44.6 AV	54.0	-9.4	1.62 H	321	42.3	2.3
7	#10580.00	38.8 PK	68.2	-29.4	1.67 H	348	27.0	11.8
8	15870.00	48.8 PK	74.0	-25.2	1.73 H	237	37.6	11.2
9	15870.00	36.3 AV	54.0	-17.7	1.73 H	237	25.1	11.2

**ANTENNA POLARITY & TEST DISTANCE: VERTICAL AT 3 M**

NO.	FREQ. (MHz)	EMISSION LEVEL (dBuV/m)	LIMIT (dBuV/m)	MARGIN (dB)	ANTENNA HEIGHT (m)	TABLE ANGLE (Degree)	RAW VALUE (dBuV)	CORRECTION FACTOR (dB/m)
1	5150.00	49.3 PK	74.0	-24.7	3.56 V	334	46.7	2.6
2	5150.00	37.0 AV	54.0	-17.0	3.56 V	334	34.4	2.6
3	*5290.00	106.4 PK			3.56 V	334	104.3	2.1
4	*5290.00	94.8 AV			3.56 V	334	92.7	2.1
5	5350.00	54.5 PK	74.0	-19.5	3.56 V	334	52.2	2.3
6	5350.00	39.7 AV	54.0	-14.3	3.56 V	334	37.4	2.3
7	#10580.00	41.1 PK	68.2	-27.1	1.60 V	198	29.3	11.8
8	15870.00	42.8 PK	74.0	-31.2	2.01 V	227	31.6	11.2
9	15870.00	32.0 AV	54.0	-22.0	2.01 V	227	20.8	11.2

**REMARKS:**

1. Emission Level(dBuV/m) = Raw Value(dBuV) + Correction Factor(dB/m)
2. Correction Factor(dB/m) = Antenna Factor(dB/m) + Cable Factor(dB) – Pre-Amplifier Factor(dB)
3. The other emission levels were very low against the limit.
4. Margin value = Emission Level – Limit value
5. " \* ": Fundamental frequency.
6. " # ": The radiated frequency is out of the restricted band.

<b>CHANNEL</b>	TX Channel 106	<b>DETECTOR FUNCTION</b>	Peak (PK)
<b>FREQUENCY RANGE</b>	1GHz ~ 40GHz		Average (AV)

**ANTENNA POLARITY & TEST DISTANCE: HORIZONTAL AT 3 M**

NO.	FREQ. (MHz)	EMISSION LEVEL (dBuV/m)	LIMIT (dBuV/m)	MARGIN (dB)	ANTENNA HEIGHT (m)	TABLE ANGLE (Degree)	RAW VALUE (dBuV)	CORRECTION FACTOR (dB/m)
1	5460.00	51.8 PK	74.0	-22.2	1.43 H	326	49.2	2.6
2	5460.00	39.8 AV	54.0	-14.2	1.43 H	326	37.2	2.6
3	#5470.00	53.9 PK	68.2	-14.3	1.43 H	326	51.3	2.6
4	*5530.00	106.6 PK			1.43 H	326	104.0	2.6
5	*5530.00	95.6 AV			1.43 H	326	93.0	2.6
6	#5725.00	49.8 PK	68.2	-18.4	1.43 H	326	46.9	2.9
7	11060.00	37.7 PK	74.0	-36.3	1.66 H	329	25.6	12.1
8	11060.00	35.7 AV	54.0	-18.3	1.66 H	329	23.6	12.1
9	#16590.00	48.1 PK	68.2	-20.1	1.71 H	258	33.9	14.2

**ANTENNA POLARITY & TEST DISTANCE: VERTICAL AT 3 M**

NO.	FREQ. (MHz)	EMISSION LEVEL (dBuV/m)	LIMIT (dBuV/m)	MARGIN (dB)	ANTENNA HEIGHT (m)	TABLE ANGLE (Degree)	RAW VALUE (dBuV)	CORRECTION FACTOR (dB/m)
1	5460.00	51.3 PK	74.0	-22.7	2.99 V	346	48.7	2.6
2	5460.00	38.0 AV	54.0	-16.0	2.99 V	346	35.4	2.6
3	#5470.00	53.4 PK	68.2	-14.8	2.99 V	346	50.8	2.6
4	*5530.00	105.0 PK			2.99 V	346	102.4	2.6
5	*5530.00	94.3 AV			2.99 V	346	91.7	2.6
6	#5725.00	48.4 PK	68.2	-19.8	2.99 V	346	45.5	2.9
7	11060.00	41.3 PK	74.0	-32.7	1.60 V	219	29.2	12.1
8	11060.00	31.2 AV	54.0	-22.8	1.60 V	219	19.1	12.1
9	#16590.00	43.0 PK	68.2	-25.2	2.01 V	229	28.8	14.2

**REMARKS:**

1. Emission Level(dBuV/m) = Raw Value(dBuV) + Correction Factor(dB/m)
2. Correction Factor(dB/m) = Antenna Factor(dB/m) + Cable Factor(dB) – Pre-Amplifier Factor(dB)
3. The other emission levels were very low against the limit.
4. Margin value = Emission Level – Limit value
5. " \* ": Fundamental frequency.
6. " # ": The radiated frequency is out of the restricted band.



<b>CHANNEL</b>	TX Channel 122	<b>DETECTOR FUNCTION</b>	Peak (PK)
<b>FREQUENCY RANGE</b>	1GHz ~ 40GHz		Average (AV)

**ANTENNA POLARITY & TEST DISTANCE: HORIZONTAL AT 3 M**

NO.	FREQ. (MHz)	EMISSION LEVEL (dBuV/m)	LIMIT (dBuV/m)	MARGIN (dB)	ANTENNA HEIGHT (m)	TABLE ANGLE (Degree)	RAW VALUE (dBuV)	CORRECTION FACTOR (dB/m)
1	*5610.00	106.9 PK			1.40 H	316	104.1	2.8
2	*5610.00	96.1 AV			1.40 H	316	93.3	2.8
3	#5725.00	54.7 PK	68.2	-13.5	1.40 H	316	51.8	2.9
4	11220.00	38.7 PK	74.0	-35.3	1.59 H	340	26.4	12.3
5	11220.00	36.5 AV	54.0	-17.5	1.59 H	340	24.2	12.3
6	#16830.00	49.0 PK	68.2	-19.2	1.70 H	252	34.4	14.6

**ANTENNA POLARITY & TEST DISTANCE: VERTICAL AT 3 M**

NO.	FREQ. (MHz)	EMISSION LEVEL (dBuV/m)	LIMIT (dBuV/m)	MARGIN (dB)	ANTENNA HEIGHT (m)	TABLE ANGLE (Degree)	RAW VALUE (dBuV)	CORRECTION FACTOR (dB/m)
1	*5610.00	105.3 PK			3.01 V	351	102.5	2.8
2	*5610.00	94.8 AV			3.01 V	351	92.0	2.8
3	#5725.00	48.4 PK	68.2	-19.8	3.01 V	351	45.5	2.9
4	11220.00	41.2 PK	74.0	-32.8	1.57 V	200	28.9	12.3
5	11220.00	31.1 AV	54.0	-22.9	1.57 V	200	18.8	12.3
6	#16830.00	42.9 PK	68.2	-25.3	1.98 V	241	28.3	14.6

**REMARKS:**

1. Emission Level(dBuV/m) = Raw Value(dBuV) + Correction Factor(dB/m)
2. Correction Factor(dB/m) = Antenna Factor(dB/m) + Cable Factor(dB) – Pre-Amplifier Factor(dB)
3. The other emission levels were very low against the limit.
4. Margin value = Emission Level – Limit value
5. " \* ": Fundamental frequency.
6. " # ": The radiated frequency is out of the restricted band.

<b>CHANNEL</b>	TX Channel 138	<b>DETECTOR FUNCTION</b>	Peak (PK)
<b>FREQUENCY RANGE</b>	1GHz ~ 40GHz		Average (AV)

**ANTENNA POLARITY & TEST DISTANCE: HORIZONTAL AT 3 M**

NO.	FREQ. (MHz)	EMISSION LEVEL (dBuV/m)	LIMIT (dBuV/m)	MARGIN (dB)	ANTENNA HEIGHT (m)	TABLE ANGLE (Degree)	RAW VALUE (dBuV)	CORRECTION FACTOR (dB/m)
1	#5470.00	55.1 PK	68.2	-13.1	1.38 H	312	52.5	2.6
2	*5690.00	107.0 PK			1.38 H	312	104.1	2.9
3	*5690.00	95.8 AV			1.38 H	312	92.9	2.9
4	#5850.00	55.0 PK	68.2	-13.2	1.38 H	312	51.7	3.3
5	11380.00	38.3 PK	74.0	-35.7	1.59 H	332	25.4	12.9
6	11380.00	35.9 AV	54.0	-18.1	1.59 H	332	23.0	12.9
7	#17070.00	49.0 PK	68.2	-19.2	1.74 H	251	32.9	16.1

**ANTENNA POLARITY & TEST DISTANCE: VERTICAL AT 3 M**

NO.	FREQ. (MHz)	EMISSION LEVEL (dBuV/m)	LIMIT (dBuV/m)	MARGIN (dB)	ANTENNA HEIGHT (m)	TABLE ANGLE (Degree)	RAW VALUE (dBuV)	CORRECTION FACTOR (dB/m)
1	#5470.00	57.8 PK	68.2	-10.4	3.01 V	345	55.2	2.6
2	*5690.00	105.4 PK			3.01 V	345	102.5	2.9
3	*5690.00	94.5 AV			3.01 V	345	91.6	2.9
4	#5850.00	48.1 PK	68.2	-20.1	3.01 V	345	44.8	3.3
5	11380.00	41.5 PK	74.0	-32.5	1.58 V	200	28.6	12.9
6	11380.00	31.6 AV	54.0	-22.4	1.58 V	200	18.7	12.9
7	#17070.00	42.9 PK	68.2	-25.3	2.00 V	233	26.8	16.1

**REMARKS:**

- Emission Level(dBuV/m) = Raw Value(dBuV) + Correction Factor(dB/m)
- Correction Factor(dB/m) = Antenna Factor(dB/m) + Cable Factor(dB) – Pre-Amplifier Factor(dB)
- The other emission levels were very low against the limit.
- Margin value = Emission Level – Limit value
- " \* ": Fundamental frequency.
- " # ": The radiated frequency is out of the restricted band.

**802.11ax (HE80+80)**

<b>CHANNEL</b>	TX Channel 58+106	<b>DETECTOR FUNCTION</b>	Peak (PK) Average (AV)
<b>FREQUENCY RANGE</b>	1GHz ~ 40GHz		

**ANTENNA POLARITY & TEST DISTANCE: HORIZONTAL AT 3 M**

NO.	FREQ. (MHz)	EMISSION LEVEL (dBuV/m)	LIMIT (dBuV/m)	MARGIN (dB)	ANTENNA HEIGHT (m)	TABLE ANGLE (Degree)	RAW VALUE (dBuV)	CORRECTION FACTOR (dB/m)
1	5150.00	55.7 PK	74.0	-18.3	1.44 H	347	53.1	2.6
2	5150.00	45.0 AV	54.0	-9.0	1.44 H	347	42.4	2.6
3	*5290.00	107.3 PK			1.44 H	347	105.2	2.1
4	*5290.00	96.0 AV			1.44 H	347	93.9	2.1
5	5350.00	58.7 PK	74.0	-15.3	1.44 H	347	56.4	2.3
6	5350.00	46.1 AV	54.0	-7.9	1.44 H	347	43.8	2.3
7	5460.00	47.8 PK	74.0	-26.2	1.45 H	337	45.2	2.6
8	5460.00	38.5 AV	54.0	-15.5	1.45 H	337	35.9	2.6
9	#5470.00	54.2 PK	68.2	-14.0	1.45 H	337	51.6	2.6
10	*5530.00	107.9 PK			1.45 H	337	105.3	2.6
11	*5530.00	96.5 AV			1.45 H	337	93.9	2.6
12	#5725.00	51.1 PK	68.2	-17.1	1.45 H	337	48.2	2.9
13	#10580.00	44.0 PK	68.2	-24.2	1.57 H	336	32.2	11.8
14	11060.00	44.0 PK	74.0	-30.0	1.59 H	338	31.9	12.1
15	11060.00	39.9 AV	54.0	-14.1	1.59 H	338	27.8	12.1
16	15870.00	53.0 PK	74.0	-21.0	1.74 H	248	41.8	11.2
17	15870.00	40.1 AV	54.0	-13.9	1.74 H	248	28.9	11.2
18	#16590.00	53.6 PK	68.2	-14.6	1.77 H	243	39.4	14.2

**ANTENNA POLARITY & TEST DISTANCE: VERTICAL AT 3 M**

NO.	FREQ. (MHz)	EMISSION LEVEL (dBuV/m)	LIMIT (dBuV/m)	MARGIN (dB)	ANTENNA HEIGHT (m)	TABLE ANGLE (Degree)	RAW VALUE (dBuV)	CORRECTION FACTOR (dB/m)
1	5150.00	48.6 PK	74.0	-25.4	3.04 V	9	46.0	2.6
2	5150.00	38.8 AV	54.0	-15.2	3.04 V	9	36.2	2.6
3	*5290.00	106.8 PK			3.04 V	9	104.7	2.1
4	*5290.00	95.6 AV			3.04 V	9	93.5	2.1
5	5350.00	57.9 PK	74.0	-16.1	3.04 V	9	55.6	2.3
6	5350.00	44.2 AV	54.0	-9.8	3.04 V	9	41.9	2.3
7	5460.00	46.3 PK	74.0	-27.7	3.08 V	15	43.7	2.6
8	5460.00	35.4 AV	54.0	-18.6	3.08 V	15	32.8	2.6
9	#5470.00	53.8 PK	68.2	-14.4	3.08 V	360	51.2	2.6
10	*5530.00	106.6 PK			3.08 V	15	104.0	2.6
11	*5530.00	95.6 AV			3.08 V	15	93.0	2.6
12	#5725.00	49.5 PK	68.2	-18.7	3.08 V	15	46.6	2.9
13	#10580.00	44.9 PK	68.2	-23.3	1.62 V	179	33.1	11.8
14	11060.00	45.3 PK	74.0	-28.7	1.59 V	200	33.2	12.1
15	11060.00	35.0 AV	54.0	-19.0	1.59 V	200	22.9	12.1
16	15870.00	47.1 PK	74.0	-26.9	2.04 V	267	35.9	11.2
17	15870.00	35.5 AV	54.0	-18.5	2.04 V	267	24.3	11.2
18	#16590.00	46.9 PK	68.2	-21.3	2.01 V	272	32.7	14.2

**REMARKS:**

- Emission Level(dBuV/m) = Raw Value(dBuV) + Correction Factor(dB/m)
- Correction Factor(dB/m) = Antenna Factor(dB/m) + Cable Factor(dB) – Pre-Amplifier Factor(dB)
- The other emission levels were very low against the limit.
- Margin value = Emission Level – Limit value
- " \* ": Fundamental frequency.
- " # ": The radiated frequency is out of the restricted band.

<b>CHANNEL</b>	TX Channel 106+122	<b>DETECTOR FUNCTION</b>	Peak (PK)
<b>FREQUENCY RANGE</b>	1GHz ~ 40GHz		Average (AV)

**ANTENNA POLARITY & TEST DISTANCE: HORIZONTAL AT 3 M**

NO.	FREQ. (MHz)	EMISSION LEVEL (dBuV/m)	LIMIT (dBuV/m)	MARGIN (dB)	ANTENNA HEIGHT (m)	TABLE ANGLE (Degree)	RAW VALUE (dBuV)	CORRECTION FACTOR (dB/m)
1	5460.00	46.9 PK	74.0	-27.1	1.50 H	359	44.3	2.6
2	5460.00	37.7 AV	54.0	-16.3	1.50 H	359	35.1	2.6
3	#5470.00	53.7 PK	68.2	-14.5	1.50 H	359	51.1	2.6
4	*5530.00	105.3 PK			1.50 H	359	102.7	2.6
5	*5530.00	93.9 AV			1.50 H	359	91.3	2.6
6	*5610.00	105.3 PK			1.54 H	357	102.5	2.8
7	*5610.00	94.3 AV			1.54 H	357	91.5	2.8
8	#5725.00	50.8 PK	68.2	-17.4	1.50 H	359	47.9	2.9
9	11060.00	44.4 PK	74.0	-29.6	1.64 H	357	32.3	12.1
10	11060.00	40.6 AV	54.0	-13.4	1.64 H	357	28.5	12.1
11	11220.00	43.5 PK	74.0	-30.5	1.58 H	349	31.2	12.3
12	11220.00	39.7 AV	54.0	-14.3	1.58 H	349	27.4	12.3
13	#16590.00	52.7 PK	68.2	-15.5	1.77 H	243	38.5	14.2

**ANTENNA POLARITY & TEST DISTANCE: VERTICAL AT 3 M**

NO.	FREQ. (MHz)	EMISSION LEVEL (dBuV/m)	LIMIT (dBuV/m)	MARGIN (dB)	ANTENNA HEIGHT (m)	TABLE ANGLE (Degree)	RAW VALUE (dBuV)	CORRECTION FACTOR (dB/m)
1	5460.00	45.6 PK	74.0	-28.4	3.00 V	355	43.0	2.6
2	5460.00	34.7 AV	54.0	-19.3	3.00 V	355	32.1	2.6
3	#5470.00	52.1 PK	68.2	-16.1	3.00 V	355	49.5	2.6
4	*5530.00	104.5 PK			3.00 V	355	101.9	2.6
5	*5530.00	93.3 AV			3.00 V	355	90.7	2.6
6	*5610.00	104.8 PK			3.05 V	13	102.0	2.8
7	*5610.00	93.7 AV			3.05 V	13	90.9	2.8
8	#5725.00	48.1 PK	68.2	-20.1	3.00 V	355	45.2	2.9
9	11060.00	45.8 PK	74.0	-28.2	1.67 V	196	33.7	12.1
10	11060.00	35.6 AV	54.0	-18.4	1.67 V	196	23.5	12.1
11	11220.00	45.6 PK	74.0	-28.4	1.64 V	184	33.3	12.3
12	11220.00	35.3 AV	54.0	-18.7	1.64 V	184	23.0	12.3
13	#16590.00	47.5 PK	68.2	-20.7	1.98 V	274	33.3	14.2

**REMARKS:**

1. Emission Level(dBuV/m) = Raw Value(dBuV) + Correction Factor(dB/m)
2. Correction Factor(dB/m) = Antenna Factor(dB/m) + Cable Factor(dB) – Pre-Amplifier Factor(dB)
3. The other emission levels were very low against the limit.
4. Margin value = Emission Level – Limit value
5. " \* ": Fundamental frequency.
6. " # ": The radiated frequency is out of the restricted band.

<b>CHANNEL</b>	TX Channel 106+138	<b>DETECTOR FUNCTION</b>	Peak (PK)
<b>FREQUENCY RANGE</b>	1GHz ~ 40GHz		Average (AV)

**ANTENNA POLARITY & TEST DISTANCE: HORIZONTAL AT 3 M**

NO.	FREQ. (MHz)	EMISSION LEVEL (dBuV/m)	LIMIT (dBuV/m)	MARGIN (dB)	ANTENNA HEIGHT (m)	TABLE ANGLE (Degree)	RAW VALUE (dBuV)	CORRECTION FACTOR (dB/m)
1	5460.00	47.2 PK	74.0	-26.8	1.44 H	11	44.6	2.6
2	5460.00	38.1 AV	54.0	-15.9	1.44 H	11	35.5	2.6
3	#5470.00	54.7 PK	68.2	-13.5	1.43 H	4	52.1	2.6
4	*5530.00	107.4 PK			1.44 H	11	104.8	2.6
5	*5530.00	94.4 AV			1.44 H	11	91.8	2.6
6	*5690.00	105.2 PK			1.43 H	4	102.3	2.9
7	*5690.00	93.8 AV			1.43 H	4	90.9	2.9
8	#5725.00	50.9 PK	68.2	-17.3	1.44 H	11	48.0	2.9
9	#5850.00	55.3 PK	68.2	-12.9	1.43 H	4	52.0	3.3
10	11060.00	44.9 PK	74.0	-29.1	1.61 H	354	32.8	12.1
11	11060.00	40.6 AV	54.0	-13.4	1.61 H	354	28.5	12.1
12	11380.00	44.4 PK	74.0	-29.6	1.59 H	345	31.5	12.9
13	11380.00	40.4 AV	54.0	-13.6	1.59 H	345	27.5	12.9
14	#16590.00	52.8 PK	68.2	-15.4	1.78 H	263	38.6	14.2
15	#17070.00	53.3 PK	68.2	-14.9	1.75 H	203	37.2	16.1

**ANTENNA POLARITY & TEST DISTANCE: VERTICAL AT 3 M**

NO.	FREQ. (MHz)	EMISSION LEVEL (dBuV/m)	LIMIT (dBuV/m)	MARGIN (dB)	ANTENNA HEIGHT (m)	TABLE ANGLE (Degree)	RAW VALUE (dBuV)	CORRECTION FACTOR (dB/m)
1	5460.00	45.3 PK	74.0	-28.7	3.05 V	353	42.7	2.6
2	5460.00	34.3 AV	54.0	-19.7	3.05 V	353	31.7	2.6
3	#5470.00	52.2 PK	68.2	-16.0	3.05 V	353	49.6	2.6
4	*5530.00	106.8 PK			3.05 V	353	104.2	2.6
5	*5530.00	93.6 AV			3.05 V	353	91.0	2.6
6	*5690.00	104.8 PK			2.98 V	353	101.9	2.9
7	*5690.00	93.4 AV			2.98 V	353	90.5	2.9
8	#5725.00	48.6 PK	68.2	-19.6	3.05 V	353	45.7	2.9
9	#5850.00	48.5 PK	68.2	-19.7	2.98 V	353	45.2	3.3
10	11060.00	45.8 PK	74.0	-28.2	1.65 V	201	33.7	12.1
11	11060.00	35.5 AV	54.0	-18.5	1.65 V	201	23.4	12.1
12	11380.00	45.2 PK	74.0	-28.8	1.74 V	214	32.3	12.9
13	11380.00	35.4 AV	54.0	-18.6	1.74 V	214	22.5	12.9
14	#16590.00	47.2 PK	68.2	-21.0	2.07 V	263	33.0	14.2
15	#17070.00	46.8 PK	68.2	-21.4	2.02 V	264	30.7	16.1

**REMARKS:**

1. Emission Level(dBuV/m) = Raw Value(dBuV) + Correction Factor(dB/m)
2. Correction Factor(dB/m) = Antenna Factor(dB/m) + Cable Factor(dB) – Pre-Amplifier Factor(dB)
3. The other emission levels were very low against the limit.
4. Margin value = Emission Level – Limit value
5. " \* ": Fundamental frequency.
6. " # ": The radiated frequency is out of the restricted band.

Below 1GHz Data:

802.11ax (HE20)

<b>CHANNEL</b>	TX Channel 140	<b>DETECTOR FUNCTION</b>	Quasi-Peak (QP)
<b>FREQUENCY RANGE</b>	9kHz ~ 1GHz		

**ANTENNA POLARITY & TEST DISTANCE: HORIZONTAL AT 3 M**

NO.	FREQ. (MHz)	EMISSION LEVEL (dBuV/m)	LIMIT (dBuV/m)	MARGIN (dB)	ANTENNA HEIGHT (m)	TABLE ANGLE (Degree)	RAW VALUE (dBuV)	CORRECTION FACTOR (dB/m)
1	84.15	33.3 QP	40.0	-6.7	1.00 H	146	46.7	-13.4
2	119.41	38.2 QP	43.5	-5.3	1.00 H	123	47.9	-9.7
3	137.26	37.8 QP	43.5	-5.7	1.50 H	323	46.1	-8.3
4	180.14	34.4 QP	43.5	-9.1	2.00 H	71	43.7	-9.3
5	249.21	39.1 QP	46.0	-6.9	1.00 H	160	48.2	-9.1
6	318.97	37.5 QP	46.0	-8.5	1.50 H	224	43.7	-6.2

**REMARKS:**

1. Emission Level(dBuV/m) = Raw Value(dBuV) + Correction Factor(dB/m)
2. Correction Factor(dB/m) = Antenna Factor(dB/m) + Cable Factor(dB) – Pre-Amplifier Factor(dB)
3. Margin value = Emission Level – Limit value
4. The emission levels were very low against the limit of frequency range 9kHz~30MHz: the amplitude of spurious emissions attenuated more than 20 dB below the permissible value to be report.

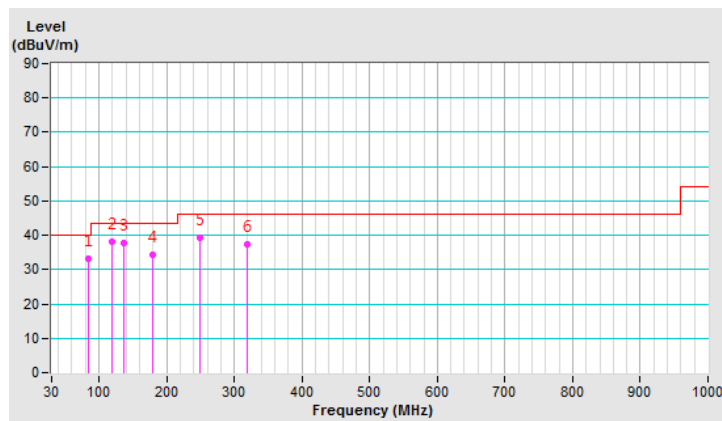

<b>CHANNEL</b>	TX Channel 140	<b>DETECTOR FUNCTION</b>	Quasi-Peak (QP)
<b>FREQUENCY RANGE</b>	9kHz ~ 1GHz		

**ANTENNA POLARITY & TEST DISTANCE: VERTICAL AT 3 M**

NO.	FREQ. (MHz)	EMISSION LEVEL (dBuV/m)	LIMIT (dBuV/m)	MARGIN (dB)	ANTENNA HEIGHT (m)	TABLE ANGLE (Degree)	RAW VALUE (dBuV)	CORRECTION FACTOR (dB/m)
1	37.78	36.8 QP	40.0	-3.2	1.50 V	20	45.3	-8.5
2	123.38	38.3 QP	43.5	-5.2	1.00 V	126	47.7	-9.4
3	132.96	38.1 QP	43.5	-5.4	1.50 V	121	46.9	-8.8
4	247.33	37.1 QP	46.0	-8.9	1.00 V	237	46.2	-9.1
5	288.63	42.4 QP	46.0	-3.6	2.00 V	203	49.7	-7.3
6	358.69	42.1 QP	46.0	-3.9	1.50 V	137	47.6	-5.5

**REMARKS:**

1. Emission Level(dBuV/m) = Raw Value(dBuV) + Correction Factor(dB/m)
2. Correction Factor(dB/m) = Antenna Factor(dB/m) + Cable Factor(dB) – Pre-Amplifier Factor(dB)
3. Margin value = Emission Level – Limit value
4. The emission levels were very low against the limit of frequency range 9kHz~30MHz: the amplitude of spurious emissions attenuated more than 20 dB below the permissible value to be report.

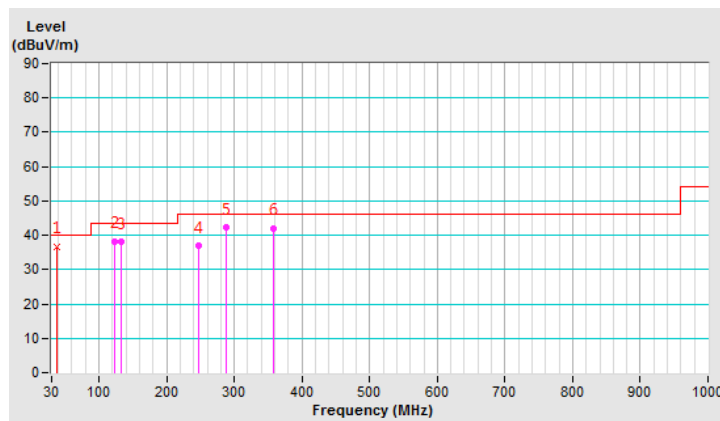

## 4.2 Conducted Emission Measurement

### 4.2.1 Limits of Conducted Emission Measurement

Frequency (MHz)	Conducted Limit (dBuV)	
	Quasi-peak	Average
0.15 - 0.5	66 - 56	56 - 46
0.50 - 5.0	56	46
5.0 - 30.0	60	50

Note: 1. The lower limit shall apply at the transition frequencies.

2. The limit decreases in line with the logarithm of the frequency in the range of 0.15 to 0.50MHz.

### 4.2.2 Test Instruments

DESCRIPTION & MANUFACTURER	MODEL NO.	SERIAL NO.	CALIBRATED DATE	CALIBRATED UNTIL
Test Receiver R&S	ESCS 30	847124/029	Oct. 24, 2018	Oct. 23, 2019
Line-Impedance Stabilization Network (for EUT) R&S	ESH3-Z5	848773/004	Oct. 22, 2018	Oct. 21, 2019
Line-Impedance Stabilization Network (for Peripheral) R&S	ENV216	100072	June 04, 2018	June 03, 2019
50 ohms Terminator	N/A	3	Oct. 22, 2018	Oct. 21, 2019
RF Cable	5D-FB	COCCAB-001	Sep. 28, 2018	Sep. 27, 2019
Fixed attenuator EMCI	STI02-2200-10	003	Mar. 16, 2018	Mar. 15, 2019
Software BVADT	BVADT_Cond_ V7.3.7.4	NA	NA	NA

**Note:**

1. The calibration interval of the above test instruments are 12 months and the calibrations are traceable to NML/ROC and NIST/USA.
2. The test was performed in Conduction 1.
- 3 Tested Date: Nov. 21, 2018



#### 4.2.3 Test Procedure

- The EUT was placed 0.4 meters from the conducting wall of the shielded room with EUT being connected to the power mains through a line impedance stabilization network (LISN). Other support units were connected to the power mains through another LISN. The two LISNs provide 50 ohm/ 50uH of coupling impedance for the measuring instrument.
- Both lines of the power mains connected to the EUT were checked for maximum conducted interference.
- The frequency range from 150kHz to 30MHz was searched. Emission levels under (Limit - 20dB) was not recorded.

**Note:** All modes of operation were investigated and the worst-case emissions are reported.

#### 4.2.4 Deviation from Test Standard

No deviation.

#### 4.2.5 Test Setup

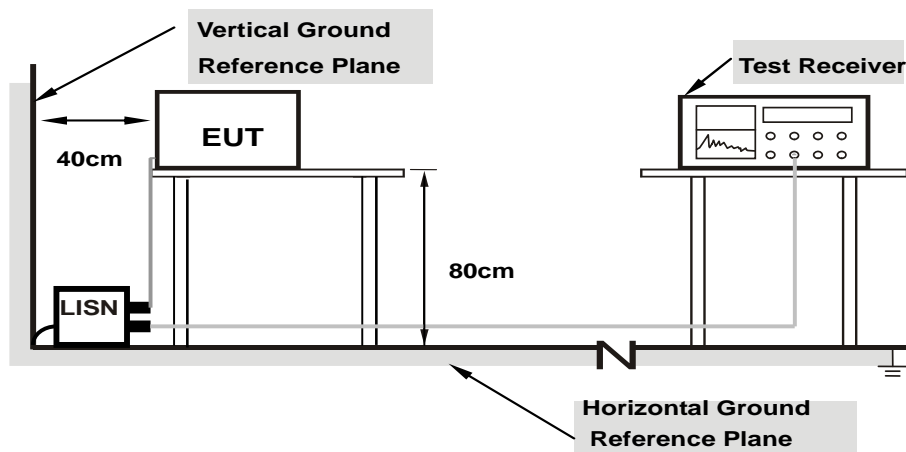

**Note: 1.Support units were connected to second LISN.**

For the actual test configuration, please refer to the attached file (Test Setup Photo).

#### 4.2.6 EUT Operating Condition

Same as 4.1.6.

#### 4.2.7 Test Results

Phase	Line (L)	Detector Function	Quasi-Peak (QP) / Average (AV)
-------	----------	-------------------	--------------------------------

No	Freq. [MHz]	Corr.	Reading Value		Emission Level		Limit		Margin	
		Factor	[dB (uV)]		[dB (uV)]		[dB (uV)]		(dB)	
	(dB)	Q.P.	AV.	Q.P.	AV.	Q.P.	AV.	Q.P.	AV.	
1	0.15000	10.02	35.79	20.26	45.81	30.28	66.00	56.00	-20.19	-25.72
<b>2</b>	<b>0.39609</b>	<b>10.07</b>	<b>39.29</b>	<b>34.86</b>	<b>49.36</b>	<b>44.93</b>	<b>57.93</b>	<b>47.93</b>	<b>-8.57</b>	<b>-3.00</b>
3	0.60703	10.08	27.24	17.80	37.32	27.88	56.00	46.00	-18.68	-18.12
4	1.20313	10.12	26.48	18.27	36.60	28.39	56.00	46.00	-19.40	-17.61
5	2.35156	10.18	22.13	14.31	32.31	24.49	56.00	46.00	-23.69	-21.51
6	24.71094	11.14	13.68	8.56	24.82	19.70	60.00	50.00	-35.18	-30.30

#### Remarks:

1. Q.P. and AV. are abbreviations of quasi-peak and average individually.
2. The emission levels of other frequencies were very low against the limit.
3. Margin value = Emission level – Limit value
4. Correction factor = Insertion loss + Cable loss
5. Emission Level = Correction Factor + Reading Value

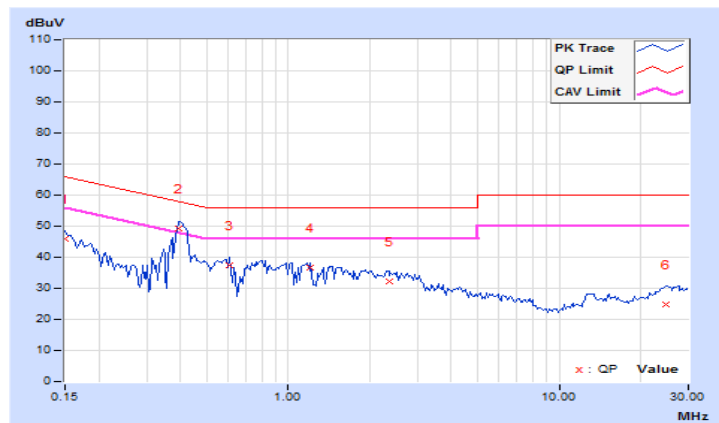

Phase	Neutral (N)	Detector Function	Quasi-Peak (QP) / Average (AV)
-------	-------------	-------------------	--------------------------------

No	Freq. [MHz]	Corr.	Reading Value		Emission Level		Limit		Margin	
		Factor	[dB (uV)]		[dB (uV)]		[dB (uV)]		(dB)	
	(dB)	Q.P.	AV.	Q.P.	AV.	Q.P.	AV.	Q.P.	AV.	
1	0.15000	9.93	34.90	19.20	44.83	29.13	66.00	56.00	-21.17	-26.87
2	0.40000	9.96	37.54	28.96	47.50	38.92	57.85	47.85	-10.35	-8.93
3	0.60703	9.97	25.99	16.67	35.96	26.64	56.00	46.00	-20.04	-19.36
4	0.79453	9.98	26.37	17.81	36.35	27.79	56.00	46.00	-19.65	-18.21
5	2.80859	10.07	20.06	11.75	30.13	21.82	56.00	46.00	-25.87	-24.18
6	13.90234	10.57	9.84	2.92	20.41	13.49	60.00	50.00	-39.59	-36.51

**Remarks:**

1. Q.P. and AV. are abbreviations of quasi-peak and average individually.
2. The emission levels of other frequencies were very low against the limit.
3. Margin value = Emission level – Limit value
4. Correction factor = Insertion loss + Cable loss
5. Emission Level = Correction Factor + Reading Value

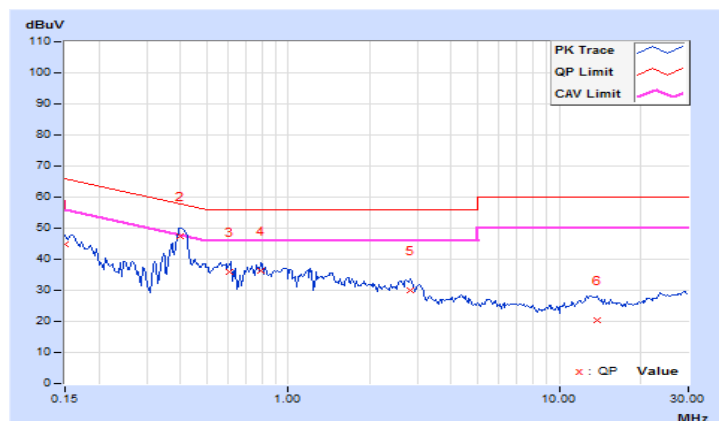

### 4.3 Transmit Power Measurement

#### 4.3.1 Limits of Transmit Power Measurement

Operation Band	EUT Category		Limit
U-NII-1		Outdoor Access Point	1 Watt (30 dBm) (Max. e.i.r.p $\leq$ 125mW(21 dBm) at any elevation angle above 30 degrees as measured from the horizon)
		Fixed point-to-point Access Point	1 Watt (30 dBm)
		Indoor Access Point	1 Watt (30 dBm)
		Client device	250mW (24 dBm)
U-NII-2A		√	250mW (24 dBm) or 11 dBm+10 log B*
U-NII-2C		√	250mW (24 dBm) or 11 dBm+10 log B*
U-NII-3		√	1 Watt (30 dBm)

\*B is the 26 dB emission bandwidth in megahertz

Per KDB 662911 Method of conducted output power measurement on IEEE 802.11 devices,

Array Gain = 0 dB (i.e., no array gain) for  $N_{ANT} \leq 4$ ;

Array Gain = 0 dB (i.e., no array gain) for channel widths  $\geq 40$  MHz for any  $N_{ANT}$ ;

Array Gain =  $5 \log(N_{ANT}/N_{SS})$  dB or 3 dB, whichever is less for 20-MHz channel widths with  $N_{ANT} \geq 5$ .

For power measurements on all other devices: Array Gain =  $10 \log(N_{ANT}/N_{SS})$  dB.

#### 4.3.2 Test Setup

##### FOR POWER OUTPUT MEASUREMENT

For channel straddling 5725MHz:

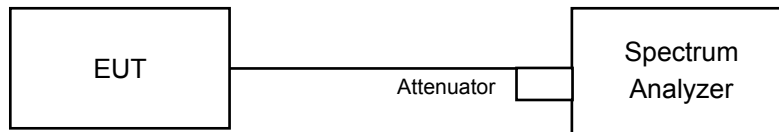

For other channels:

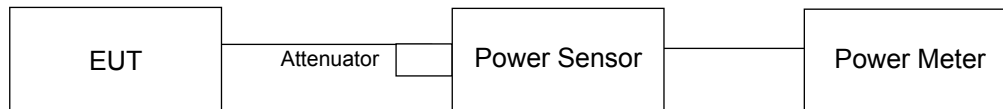

##### FOR 26dB OCCUPIED BANDWIDTH

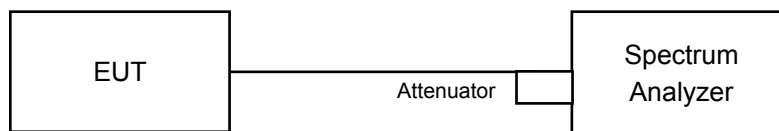

#### 4.3.3 Test Instruments

Refer to section 4.1.2 to get information of above instrument.

#### 4.3.4 Test Procedure

##### FOR POWER OUTPUT MEASUREMENT

For other channels:

Method PM is used to perform output power measurement, trigger and gating function of wide band power meter is enabled to measure max output power of TX on burst. Duty factor is not added to measured value.

**For channel straddling 5725MHz:**

Follow FCC KDB 789033 UNII test procedure:

Method SA-2

1. Set span to encompass the emission bandwidth (EBW) of the signal.
2. Set RBW =1MHz.
3. Set the VBW  $\geq 3 \times$  RBW.
4. Number of points in sweep  $\geq 2$  Span / RBW.
5. Sweep time = auto.
6. Detector = RMS.
7. Trace average at least 100 traces in power averaging mode
8. Compute power by integrating the spectrum across the 26 dB EBW of the signal.
9. Duty factor need added to measured value (duty cycle < 98 percent).

##### FOR 26dB OCCUPIED BANDWIDTH

1. Set RBW = approximately 1% of the emission bandwidth.
2. Set the VBW > RBW.
3. Detector = Peak.
4. Trace mode = max hold.
5. Measure the maximum width of the emission that is 26 dB down from the peak of the emission. Compare this with the RBW setting of the analyzer. Readjust RBW and repeat measurement as needed until the RBW/EBW ratio is approximately 1%.

#### 4.3.5 Deviation from Test Standard

No deviation.

#### 4.3.6 EUT Operating Condition

The software provided by client to enable the EUT under transmission condition continuously at lowest, middle and highest channel frequencies individually.

### 4.3.7 Test Results

#### Non-Beamforming Mode

#### 802.11a

Chan.	Freq. (MHz)	Maximum Conducted Power (dBm)								Total Power (mW)	Total Power (dBm)	Limit (dBm)	Pass / Fail
		Chain 0	Chain 1	Chain 2	Chain 3	Chain 4	Chain 5	Chain 6	Chain 7				
52	5260	10.19	10.07	10.73	10.90	10.41	10.92	10.78	11.01	92.678	19.67	20.10	Pass
60	5300	10.17	10.11	10.81	10.92	10.43	10.89	10.83	11.07	93.281	19.70	20.10	Pass
64	5320	10.16	10.12	10.83	10.86	10.41	10.81	10.85	11.12	93.096	19.69	20.10	Pass
100	5500	10.18	10.13	10.89	10.96	10.27	10.65	10.71	11.09	92.36	19.65	20.17	Pass
116	5580	10.10	10.09	11.11	11.03	10.2	10.85	10.77	11.11	93.516	19.71	20.17	Pass
140	5700	10.17	10.15	11.18	11.11	10.26	10.9	10.82	11.16	94.844	19.77	20.17	Pass
*144 (U-NII-2C Band)	5720	4.63	4.55	5.71	6.13	4.82	5.34	5.36	5.73	30.689	14.87	19.02	Pass
*144 (U-NII-3 Band)	5720	-0.76	0.28	0.20	-0.52	0.3	-1.46	0.16	-0.63	8.491	9.29	25.73	Pass

Note: \* Test was performed in accordance with Measurement follow FCC KDB 789033 UNII test procedure Method SA-2 and use spectrum analyzer test.

1. For U-NII-2A: Directional gain is 9.9dBi > 6dBi, so the power limit shall be reduced to "Determined Conducted Limit-(9.9-6)".
2. For U-NII-2C: Directional gain is 9.83dB > 6dBi, so the power limit shall be reduced to "Determined Conducted Limit-(9.83-6)".
3. For U-NII-3: Directional gain is 10.27dB > 6dBi, so the power limit shall be reduced to 30-(10.27-6) = 25.73dBm.

The Total Power for the straddle channel:

Chan.	Chan. Freq. (MHz)	Average Power (mW)	Average Power (dBm)
144	5720	39.18	15.93

Note: The total power was calculated through formula and record the value for reference only.

#### 26dB OCCUPIED BANDWIDTH

Channel	Frequency (MHz)	26dBc Bandwidth (MHz)							
		Chain 0	Chain 1	Chain 2	Chain 3	Chain 4	Chain 5	Chain 6	Chain 7
52	5260	21.13	21.22	20.91	20.90	20.63	22.77	22.44	21.10
60	5300	21.28	22.02	20.78	21.07	20.71	22.33	22.38	21.24
64	5320	21.19	22.23	20.90	20.74	20.64	21.97	21.95	20.74
100	5500	21.24	21.41	20.68	20.74	20.63	22.30	22.17	20.74
116	5580	20.85	21.91	20.73	20.72	20.60	23.11	21.44	21.10
140	5700	20.78	21.76	20.78	20.96	20.94	22.41	22.20	21.14
144 (U-NII-2C Band)	5720	16.00	15.93	15.34	15.67	15.44	16.20	16.13	15.66

Note: For U-NII-2A, U-NII-2C Band output power limitation is determined based on 26dBc bandwidth.

Power Limit = 11dBm + 10logB < U-NII-2A, U-NII-2C >

Channel Number	Freq.(MHz)	Min. B(MHz)	Determined Conducted Limit (dBm)
52	5260	20.63	24.14 > 24
60	5300	20.71	24.16 > 24
64	5320	20.64	24.14 > 24
100	5500	20.63	24.14 > 24
116	5580	20.60	24.13 > 24
140	5700	20.78	24.17 > 24
144 (U-NII-2C Band)	5720	15.34	22.85 < 24



### 802.11ac (VHT20)

Chan.	Freq. (MHz)	Maximum Conducted Power (dBm)								Total Power (mW)	Total Power (dBm)	Limit (dBm)	Pass / Fail
		Chain 0	Chain 1	Chain 2	Chain 3	Chain 4	Chain 5	Chain 6	Chain 7				
52	5260	10.32	10.17	10.89	11.01	10.52	11.07	10.85	11.21	95.497	19.80	20.10	Pass
60	5300	10.29	10.11	10.79	10.92	10.45	10.98	10.81	11.11	93.887	19.73	20.10	Pass
64	5320	10.13	10.12	10.71	10.73	10.45	11.18	10.92	11.31	94.284	19.74	20.10	Pass
100	5500	10.22	10.21	10.75	10.79	10.42	11.22	10.98	11.35	95.331	19.79	20.17	Pass
116	5580	10.17	10.16	10.79	10.74	10.52	11.18	10.85	11.31	94.704	19.76	20.17	Pass
140	5700	10.31	10.19	10.83	10.85	10.61	11.31	10.9	11.42	96.654	19.85	20.17	Pass
*144 (U-NII-2C Band)	5720	5.38	5.59	6.38	6.15	6.05	5.82	6.3	6.65	33.527	15.25	18.91	Pass
*144 (U-NII-3 Band)	5720	-1.11	-1.94	-0.89	-0.42	-0.4	0.37	-1.17	0.18	7.2129	8.58	25.73	Pass

Note: \* Test was performed in accordance with Measurement follow FCC KDB 789033 UNII test procedure Method SA-2 and use spectrum analyzer test.

1. For U-NII-2A: Directional gain is 9.9dBi > 6dBi, so the power limit shall be reduced to "Determined Conducted Limit-(9.9-6)".
2. For U-NII-2C: Directional gain is 9.83dB > 6dBi, so the power limit shall be reduced to "Determined Conducted Limit-(9.83-6)".
3. For U-NII-3: Directional gain is 10.27dB > 6dBi, so the power limit shall be reduced to 30-(10.27-6) = 25.73dBm.

The Total Power for the straddle channel:

Chan.	Chan. Freq. (MHz)	Average Power (mW)	Average Power (dBm)
144	5720	40.7399	16.1

Note: The total power was calculated through formula and record the value for reference only.

### 26dB OCCUPIED BANDWIDTH

Channel	Frequency (MHz)	26dBc Bandwidth (MHz)							
		Chain 0	Chain 1	Chain 2	Chain 3	Chain 4	Chain 5	Chain 6	Chain 7
52	5260	20.80	20.56	20.80	20.46	20.65	20.55	20.40	20.39
60	5300	20.92	20.73	20.67	20.71	20.57	20.60	20.71	20.04
64	5320	20.60	20.74	20.83	20.53	20.38	20.94	20.06	20.01
100	5500	20.12	20.55	20.51	20.92	20.43	21.23	20.67	20.18
116	5580	20.34	20.03	20.43	20.64	20.66	21.04	21.13	20.41
140	5700	20.83	20.79	20.35	20.68	20.58	20.95	20.38	20.07
144 (U-NII-2C Band)	5720	15.12	15.45	15.34	15.38	15.31	15.45	15.32	14.94

Note: For U-NII-2A, U-NII-2C Band output power limitation is determined based on 26dBc bandwidth.

Power Limit = 11dBm + 10logB < U-NII-2A, U-NII-2C >

Channel Number	Freq.(MHz)	Min. B(MHz)	Determined Conducted Limit (dBm)
52	5260	20.39	24.09 > 24
60	5300	20.04	24.01 > 24
64	5320	20.01	24.01 > 24
100	5500	20.12	24.03 > 24
116	5580	20.03	24.01 > 24
140	5700	20.07	24.02 > 24
144 (U-NII-2C Band)	5720	14.94	22.74 < 24

### 802.11ac (VHT40)

Chan.	Freq. (MHz)	Maximum Conducted Power (dBm)								Total Power (mW)	Total Power (dBm)	Limit (dBm)	Pass / Fail
		Chain 0	Chain 1	Chain 2	Chain 3	Chain 4	Chain 5	Chain 6	Chain 7				
54	5270	10.31	10.21	10.91	11.11	10.62	11.11	10.92	11.35	96.931	19.86	20.10	Pass
62	5310	10.41	10.32	10.75	11.08	10.75	11.08	10.85	11.21	96.546	19.85	20.10	Pass
102	5510	10.26	10.25	10.83	11.17	10.85	11.17	10.99	11.01	96.84	19.86	20.17	Pass
110	5550	10.21	10.20	10.79	11.03	10.95	11.21	10.91	11.11	96.54	19.85	20.17	Pass
134	5670	10.15	10.11	10.85	11.02	10.88	11.09	10.95	11.16	96.023	19.82	20.17	Pass
*142 (U-NII-2C Band)	5710	6.29	6.24	6.68	6.98	6.79	7.22	6.43	6.98	38.925	15.90	20.17	Pass
*142 (U-NII-3 Band)	5710	-5.08	-4.60	-5.34	-4.57	-2.88	-3.62	-3.65	-3.17	3.2786	5.16	25.73	Pass

Note: \* Test was performed in accordance with Measurement follow FCC KDB 789033 UNII test procedure Method SA-2 and use spectrum analyzer test.

1. For U-NII-2A: Directional gain is 9.9dBi > 6dBi, so the power limit shall be reduced to "Determined Conducted Limit-(9.9-6)".
2. For U-NII-2C: Directional gain is 9.83dB > 6dBi, so the power limit shall be reduced to "Determined Conducted Limit-(9.83-6)".
3. For U-NII-3: Directional gain is 10.27dB > 6dBi, so the power limit shall be reduced to 30-(10.27-6) = 25.73dBm.

The Total Power for the straddle channel:

Chan.	Chan. Freq. (MHz)	Average Power (mW)	Average Power (dBm)
142	5710	42.2036	16.25

Note: The total power was calculated through formula and record the value for reference only.

### 26dB OCCUPIED BANDWIDTH

Channel	Frequency (MHz)	26dBc Bandwidth (MHz)							
		Chain 0	Chain 1	Chain 2	Chain 3	Chain 4	Chain 5	Chain 6	Chain 7
54	5270	41.57	41.90	42.12	41.33	41.91	41.36	41.13	40.82
62	5310	41.47	41.64	41.48	41.63	41.37	41.58	40.97	41.41
102	5510	41.31	41.85	41.61	41.64	41.86	41.39	40.96	40.70
110	5550	41.21	40.86	42.01	42.03	41.62	41.27	41.48	41.14
134	5670	41.34	41.59	41.72	41.61	41.47	41.52	41.27	41.34
142 (U-NII-2C Band)	5710	35.83	35.93	36.03	35.60	35.73	35.49	35.73	35.55

Note: For U-NII-2A, U-NII-2C Band output power limitation is determined based on 26dBc bandwidth.

Power Limit = 11dBm + 10logB < U-NII-2A, U-NII-2C >

Channel Number	Freq.(MHz)	Min. B(MHz)	Determined Conducted Limit (dBm)
54	5270	40.82	27.1 > 24
62	5310	40.97	27.12 > 24
102	5510	40.70	27.09 > 24
110	5550	40.86	27.11 > 24
134	5670	41.27	27.15 > 24
142 (U-NII-2C Band)	5710	35.49	26.5 > 24

### 802.11ac (VHT80)

Chan.	Freq. (MHz)	Maximum Conducted Power (dBm)								Total Power (mW)	Total Power (dBm)	Limit (dBm)	Pass / Fail
		Chain 0	Chain 1	Chain 2	Chain 3	Chain 4	Chain 5	Chain 6	Chain 7				
58	5290	10.27	10.16	10.42	10.95	11.2	11.02	11.01	10.98	95.457	19.80	20.10	Pass
106	5530	10.21	10.11	10.31	10.85	11.11	10.96	10.9	10.87	93.56	19.71	20.17	Pass
122	5610	10.27	10.23	10.36	10.92	11.2	11.15	11.02	10.81	95.321	19.79	20.17	Pass
*138 (U-NII-2C Band)	5690	6.52	6.53	6.64	7.29	7.34	7.39	7.41	7.88	43.037	16.34	20.17	Pass
*138 (U-NII-3 Band)	5690	-7.91	-7.79	-7.11	-7.59	-7.81	-7.45	-7.52	-7.92	1.4317	1.56	25.73	Pass

Note: \* Test was performed in accordance with Measurement follow FCC KDB 789033 UNII test procedure Method SA-2 and use spectrum analyzer test.

1. For U-NII-2A: Directional gain is 9.9dBi > 6dBi, so the power limit shall be reduced to "Determined Conducted Limit-(9.9-6)".
2. For U-NII-2C: Directional gain is 9.83dB > 6dBi, so the power limit shall be reduced to "Determined Conducted Limit-(9.83-6)".
3. For U-NII-3: Directional gain is 10.27dB > 6dBi, so the power limit shall be reduced to 30-(10.27-6) = 25.73dBm.

The Total Power for the straddle channel:

Chan.	Chan. Freq. (MHz)	Average Power (mW)	Average Power (dBm)
138	5690	44.4687	16.48

Note: The total power was calculated through formula and record the value for reference only.

### 26dB OCCUPIED BANDWIDTH

Channel	Frequency (MHz)	26dBc Bandwidth (MHz)							
		Chain 0	Chain 1	Chain 2	Chain 3	Chain 4	Chain 5	Chain 6	Chain 7
58	5290	82.15	83.03	82.13	82.66	82.12	81.88	81.75	82.38
106	5530	81.66	82.52	82.23	82.31	82.28	82.24	81.91	81.76
122	5610	81.96	82.37	82.71	82.43	82.42	82.13	81.99	81.26
138 (U-NII-2C Band)	5690	75.99	76.34	76.28	76.24	75.96	76.14	75.78	75.73

Note: For U-NII-2A, U-NII-2C Band output power limitation is determined based on 26dBc bandwidth.

Power Limit = 11dBm + 10logB < U-NII-2A, U-NII-2C >			
Channel Number	Freq.(MHz)	Min. B(MHz)	Determined Conducted Limit (dBm)
58	5290	81.75	30.12 > 24
106	5530	81.66	30.12 > 24
122	5610	81.26	30.09 > 24
138 (U-NII-2C Band)	5690	75.73	29.79 > 24

### 802.11ac (VHT80+80)

Chan.	Freq. (MHz)	Maximum Conducted Power (dBm)								Total Power (mW)	Total Power (dBm)	Limit (dBm)	Pass / Fail
		Chain 0	Chain 1	Chain 2	Chain 3	Chain 4	Chain 5	Chain 6	Chain 7				
58+106	5290	13.56	13.62	13.74	13.11	-	-	-	-	89.837	19.53	20.10	Pass
	5530	-	-	-	-	14.11	14.01	14.16	13.96	101.89	20.08	20.17	Pass
106+122	5530	11.68	10.81	11.38	10.56	-	-	-	-	100.292	20.01	20.17	Pass
	5610	-	-	-	-	10.58	10.69	10.75	11.26				Pass
106+*138 (UNII-2C Band)+*138 (UNII-3 Band)	5530	11.68	10.81	11.38	10.56	-	-	-	-	72.499	18.60	20.17	Pass
	5690	-	-	-	-	6.98	6.7	6.93	7.21				Pass
	5690	-	-	-	-	-7.18	-9.03	-9.58	-8.44	0.591	-2.28	25.73	Pass

Note: \* Test was performed in accordance with Measurement follow FCC KDB 789033 UNII test procedure Method SA-2 and use spectrum analyzer test.

1. For U-NII-2A: Directional gain is 9.9dBi > 6dBi, so the power limit shall be reduced to "Determined Conducted Limit-(9.9-6)".
2. For U-NII-2C: Directional gain is 9.83dB > 6dBi, so the power limit shall be reduced to "Determined Conducted Limit-(9.83-6)".
3. For U-NII-3: Directional gain is 10.27dB > 6dBi, so the power limit shall be reduced to 30-(10.27-6) = 25.73dBm.

The Total Power for the straddle channel:

Chan.	Chan. Freq. (MHz)	Average Power (mW)	Average Power (dBm)
106+138	5690	21.2	13.26

Note: The total power was calculated through formula and record the value for reference only.

### 26dB OCCUPIED BANDWIDTH

Channel	Frequency (MHz)	26dBc Bandwidth (MHz)							
		Chain 0	Chain 1	Chain 2	Chain 3	Chain 4	Chain 5	Chain 6	Chain 7
58+106	5290	81.60	81.88	82.53	82.89	-	-	-	-
	5530	-	-	-	-	81.46	81.85	81.60	81.69
106+122	5530	81.97	81.81	82.02	82.66	-	-	-	-
	5610	-	-	-	-	81.81	82.08	82.20	81.42
106 +138 (UNII-2C Band)	5530	81.97	81.81	82.02	82.66	-	-	-	-
	5690	-	-	-	-	75.79	76.14	75.69	76.41

Note: For U-NII-2A, U-NII-2C Band output power limitation is determined based on 26dBc bandwidth.

Power Limit = 11dBm + 10logB < U-NII-2A, U-NII-2C >			
Channel Number	Freq.(MHz)	Min. B(MHz)	Determined Conducted Limit (dBm)
58+106	5290	81.60	30.11 > 24
	5530	81.46	30.1 > 24
106+122	5530	81.81	30.12 > 24
	5610	81.42	30.1 > 24
106+138 (UNII-2C Band)	5530	81.81	30.12 > 24
	5690	75.69	29.79 > 24

### 802.11ax (HE20)

Chan.	Freq. (MHz)	Maximum Conducted Power (dBm)								Total Power (mW)	Total Power (dBm)	Limit (dBm)	Pass / Fail
		Chain 0	Chain 1	Chain 2	Chain 3	Chain 4	Chain 5	Chain 6	Chain 7				
52	5260	10.32	10.21	10.89	11.01	10.56	11.08	10.86	11.21	95.755	19.81	20.10	Pass
60	5300	10.31	10.18	10.79	10.98	10.52	10.95	10.81	11.12	94.399	19.75	20.10	Pass
64	5320	10.33	10.26	10.81	11.00	10.61	11.12	10.85	11.16	95.72	19.81	20.10	Pass
100	5500	10.31	10.27	10.75	11.11	10.82	11.06	10.91	11.15	96.384	19.84	20.17	Pass
116	5580	10.39	10.35	10.83	11.25	10.95	11.25	11.2	11.21	99.396	19.97	20.17	Pass
140	5700	10.41	10.39	10.95	11.31	11.03	11.2	11.41	11.35	101.236	20.05	20.17	Pass
*144 (U-NII-2C Band)	5720	5.54	5.46	6.81	6.60	6.15	6.14	6.2	6.63	34.741	15.41	19.08	Pass
*144 (U-NII-3 Band)	5720	-0.49	0.94	0.48	0.91	1.37	1.29	1.91	0.34	10.2095	10.09	25.73	Pass

Note: \* Test was performed in accordance with Measurement follow FCC KDB 789033 UNII test procedure Method SA-2 and use spectrum analyzer test.

1. For U-NII-2A: Directional gain is 9.9dBi > 6dBi, so the power limit shall be reduced to "Determined Conducted Limit-(9.9-6)".
2. For U-NII-2C: Directional gain is 9.83dB > 6dBi, so the power limit shall be reduced to "Determined Conducted Limit-(9.83-6)".
3. For U-NII-3: Directional gain is 10.27dB > 6dBi, so the power limit shall be reduced to 30-(10.27-6) = 25.73dBm.

The Total Power for the straddle channel:

Chan.	Chan. Freq. (MHz)	Average Power (mW)	Average Power (dBm)
144	5720	44.9505	16.53

Note: The total power was calculated through formula and record the value for reference only.

### 26dB OCCUPIED BANDWIDTH

Channel	Frequency (MHz)	26dBc Bandwidth (MHz)							
		Chain 0	Chain 1	Chain 2	Chain 3	Chain 4	Chain 5	Chain 6	Chain 7
52	5260	21.21	21.26	21.34	21.15	21.35	21.42	20.81	21.13
60	5300	21.41	21.10	21.11	21.13	21.25	21.41	21.25	21.66
64	5320	21.29	21.09	21.42	21.12	21.72	21.31	20.96	21.47
100	5500	21.34	22.00	21.26	21.19	21.14	21.22	21.17	21.39
116	5580	21.24	21.56	21.85	21.07	21.79	21.59	21.44	21.33
140	5700	21.01	21.06	21.28	20.97	21.31	21.23	21.42	21.52
144 (U-NII-2C Band)	5720	15.74	15.71	15.94	15.74	15.81	15.86	15.61	15.53

Note: For U-NII-2A, U-NII-2C Band output power limitation is determined based on 26dBc bandwidth.



Power Limit = 11dBm + 10logB < U-NII-2A, U-NII-2C >

Channel Number	Freq.(MHz)	Min. B(MHz)	Determined Conducted Limit (dBm)
52	5260	20.81	24.18 > 24
60	5300	21.10	24.24 > 24
64	5320	20.96	24.21 > 24
100	5500	21.14	24.25 > 24
116	5580	21.07	24.23 > 24
140	5700	20.97	24.21 > 24
144 (U-NII-2C Band)	5720	15.53	22.91 < 24

### 802.11ax (HE40)

Chan.	Freq. (MHz)	Maximum Conducted Power (dBm)								Total Power (mW)	Total Power (dBm)	Limit (dBm)	Pass / Fail
		Chain 0	Chain 1	Chain 2	Chain 3	Chain 4	Chain 5	Chain 6	Chain 7				
54	5270	10.46	10.31	11.05	11.21	10.71	11.21	11.05	11.38	99.27	19.97	20.10	Pass
62	5310	10.41	10.46	10.81	11.19	10.84	11.19	10.95	11.31	98.562	19.94	20.10	Pass
102	5510	10.30	10.29	10.85	11.12	10.85	11.21	10.99	11.08	97.268	19.88	20.17	Pass
110	5550	10.27	10.27	10.82	11.08	10.95	11.24	10.95	11.06	97.141	19.87	20.17	Pass
134	5670	10.41	10.39	10.95	11.31	11.03	11.2	11.41	11.35	101.236	20.05	20.17	Pass
*142 (U-NII-2C Band)	5710	6.77	6.58	7.14	6.69	7.08	7.6	6.91	6.8	41.38	16.17	20.17	Pass
*142 (U-NII-3 Band)	5710	-5.10	-6.01	-2.45	-3.46	-2.61	-2.79	-4.22	-4.32	3.5458	5.50	25.73	Pass

Note: \* Test was performed in accordance with Measurement follow FCC KDB 789033 UNII test procedure Method SA-2 and use spectrum analyzer test.

1. For U-NII-2A: Directional gain is 9.9dBi > 6dBi, so the power limit shall be reduced to "Determined Conducted Limit-(9.9-6)".
2. For U-NII-2C: Directional gain is 9.83dB > 6dBi, so the power limit shall be reduced to "Determined Conducted Limit-(9.83-6)".
3. For U-NII-3: Directional gain is 10.27dB > 6dBi, so the power limit shall be reduced to 30-(10.27-6) = 25.73dBm.

The Total Power for the straddle channel:

Chan.	Chan. Freq. (MHz)	Average Power (mW)	Average Power (dBm)
142	5710	44.9258	16.52

Note: The total power was calculated through formula and record the value for reference only.

### 26dB OCCUPIED BANDWIDTH

Channel	Frequency (MHz)	26dBc Bandwidth (MHz)							
		Chain 0	Chain 1	Chain 2	Chain 3	Chain 4	Chain 5	Chain 6	Chain 7
54	5270	42.16	42.45	42.54	42.11	42.35	42.62	42.48	42.26
62	5310	42.46	41.86	42.99	42.18	42.74	42.62	42.40	42.21
102	5510	42.74	41.83	42.21	42.24	42.49	42.39	42.39	42.51
110	5550	42.59	41.76	42.40	42.31	42.48	42.66	41.97	42.41
134	5670	41.93	41.74	42.10	42.23	42.11	42.13	41.92	42.54
142 (U-NII-2C Band)	5710	36.42	36.28	36.35	36.39	36.41	36.11	36.27	36.10

Note: For U-NII-2A, U-NII-2C Band output power limitation is determined based on 26dBc bandwidth.

Power Limit = 11dBm + 10logB < U-NII-2A, U-NII-2C >

Channel Number	Freq.(MHz)	Min. B(MHz)	Determined Conducted Limit (dBm)
54	5270	42.11	27.24 > 24
62	5310	41.86	27.21 > 24
102	5510	41.83	27.21 > 24
110	5550	41.76	27.2 > 24
134	5670	41.74	27.2 > 24
142 (U-NII-2C Band)	5710	36.10	26.57 > 24

### 802.11ax (HE80)

Chan.	Freq. (MHz)	Maximum Conducted Power (dBm)								Total Power (mW)	Total Power (dBm)	Limit (dBm)	Pass / Fail
		Chain 0	Chain 1	Chain 2	Chain 3	Chain 4	Chain 5	Chain 6	Chain 7				
58	5290	10.32	10.21	10.42	10.95	11.12	11.08	11.05	10.95	95.666	19.81	20.10	Pass
106	5530	10.26	10.12	10.35	10.86	11.11	10.96	10.88	10.86	93.748	19.72	20.17	Pass
122	5610	10.33	10.21	10.41	11.02	11.21	11.11	11.02	10.95	96.14	19.83	20.17	Pass
*138 (U-NII-2C Band)	5690	7.06	6.72	6.77	7.43	7.51	7.23	7.87	7	43.673	16.40	20.17	Pass
*138 (U-NII-3 Band)	5690	-8.60	-5.51	-8.19	-8.24	-7.44	-7.41	-6.02	-6.89	1.594	2.02	25.73	Pass

Note: \* Test was performed in accordance with Measurement follow FCC KDB 789033 UNII test procedure Method SA-2 and use spectrum analyzer test.

1. For U-NII-2A: Directional gain is 9.9dBi > 6dBi, so the power limit shall be reduced to "Determined Conducted Limit-(9.9-6)".
2. For U-NII-2C: Directional gain is 9.83dB > 6dBi, so the power limit shall be reduced to "Determined Conducted Limit-(9.83-6)".
3. For U-NII-3: Directional gain is 10.27dB > 6dBi, so the power limit shall be reduced to 30-(10.27-6) = 25.73dBm.

The Total Power for the straddle channel:

Chan.	Chan. Freq. (MHz)	Average Power (mW)	Average Power (dBm)
138	5690	45.267	16.56

Note: The total power was calculated through formula and record the value for reference only.

### 26dB OCCUPIED BANDWIDTH

Channel	Frequency (MHz)	26dBc Bandwidth (MHz)							
		Chain 0	Chain 1	Chain 2	Chain 3	Chain 4	Chain 5	Chain 6	Chain 7
58	5290	82.81	82.91	82.50	82.65	82.52	82.39	82.60	82.44
106	5530	83.27	82.30	82.68	83.27	82.97	82.53	82.51	82.77
122	5610	83.20	82.56	82.96	82.90	82.64	83.04	82.72	83.01
138 (U-NII-2C Band)	5690	75.78	76.39	76.28	76.53	76.64	76.57	76.11	76.45

Note: For U-NII-2A, U-NII-2C Band output power limitation is determined based on 26dBc bandwidth.

Power Limit = 11dBm + 10logB < U-NII-2A, U-NII-2C >			
Channel Number	Freq.(MHz)	Min. B(MHz)	Determined Conducted Limit (dBm)
58	5290	82.39	30.15 > 24
106	5530	82.30	30.15 > 24
122	5610	82.56	30.16 > 24
138 (U-NII-2C Band)	5690	75.78	29.79 > 24

### 802.11ax (HE80+80)

Chan.	Freq. (MHz)	Maximum Conducted Power (dBm)								Total Power (mW)	Total Power (dBm)	Limit (dBm)	Pass / Fail
		Chain 0	Chain 1	Chain 2	Chain 3	Chain 4	Chain 5	Chain 6	Chain 7				
58+106	5290	13.89	13.81	13.93	13.28	-	-	-	-	94.533	19.76	20.10	Pass
	5530	-	-	-	-	14.13	14.15	14.21	13.96	103.136	20.13	20.17	Pass
106+122	5530	11.84	11.01	11.56	10.72	-	-	-	-	101.148	20.05	20.17	Pass
	5610	-	-	-	-	10.51	10.49	10.71	11.11				Pass
106+*138 (UNII-2C Band)+*138 (UNII-3 Band)	5530	11.84	11.01	11.56	10.75	-	-	-	-	76.607	18.84	20.17	Pass
	5690	-	-	-	-	7.15	6.67	7.49	7.95				Pass
	5690	-	-	-	-	-7.2	-8.91	-6.38	-5.11	0.89	-0.51	25.73	Pass

Note: \* Test was performed in accordance with Measurement follow FCC KDB 789033 UNII test procedure Method SA-2 and use spectrum analyzer test.

1. For U-NII-2A: Directional gain is 9.9dBi > 6dBi, so the power limit shall be reduced to  $24-(9.9-6) = 20.10$ dBm.
2. For U-NII-2C: Directional gain is 9.83dB > 6dBi, so the power limit shall be reduced to  $24-(9.83-6) = 20.17$ dBm.
3. For U-NII-3: Directional gain is 10.27dB > 6dBi, so the power limit shall be reduced to  $30-(10.27-6) = 25.73$ dBm.

The Total Power for the straddle channel:

Chan.	Chan. Freq. (MHz)	Average Power (mW)	Average Power (dBm)
106+138	5690	23.396	13.69

Note: The total power was calculated through formula and record the value for reference only.

### 26dB OCCUPIED BANDWIDTH

Channel	Frequency (MHz)	26dBc Bandwidth (MHz)							
		Chain 0	Chain 1	Chain 2	Chain 3	Chain 4	Chain 5	Chain 6	Chain 7
58+106	5290	82.70	82.81	82.78	82.91	-	-	-	-
	5530	-	-	-	-	82.20	83.02	82.31	82.54
106+122	5530	82.76	82.54	82.76	82.99	-	-	-	-
	5610	-	-	-	-	83.17	83.48	82.89	82.71
106 +138 (UNII-2C Band)	5530	82.76	82.54	82.76	82.99	-	-	-	-
	5690	-	-	-	-	76.54	76.38	76.38	76.27

Note: For U-NII-2A, U-NII-2C Band output power limitation is determined based on 26dBc bandwidth.

Power Limit = 11dBm + 10logB < U-NII-2A, U-NII-2C >			
Channel Number	Freq.(MHz)	Min. B(MHz)	Determined Conducted Limit (dBm)
58+106	5290	82.70	30.17 > 24
	5530	82.20	30.14 > 24
106+122	5530	82.54	30.16 > 24
	5610	82.71	30.17 > 24
106+138 (UNII-2C Band)	5530	82.54	30.16 > 24
	5690	76.27	29.82 > 24

Spectrum Plot of Worst Value

802.11a\_Chain 2 / CH144 (U-NII-2C)

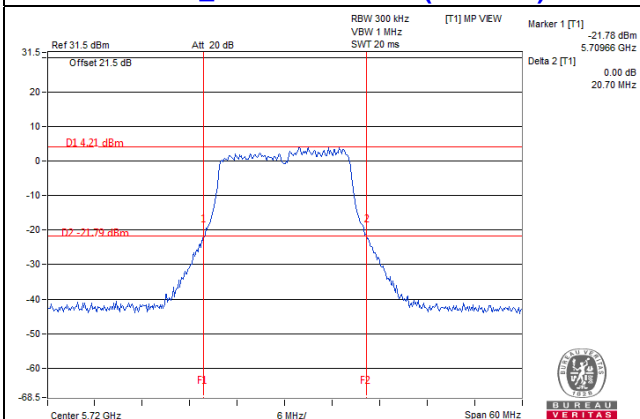

802.11ac (VHT20)\_Chain 7 / CH144 (U-NII-2C)

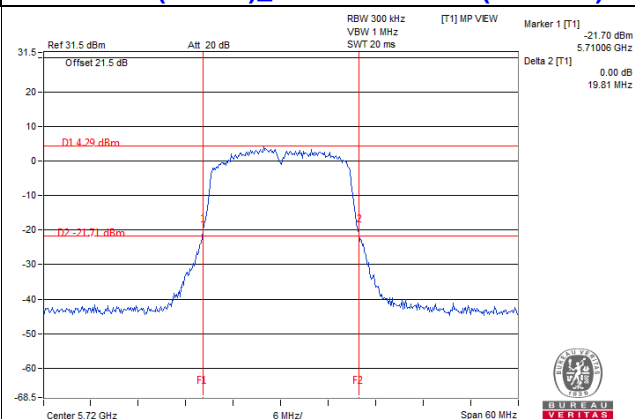

8802.11ac (VHT40)\_Chain 5 / CH142 (U-NII-2C)

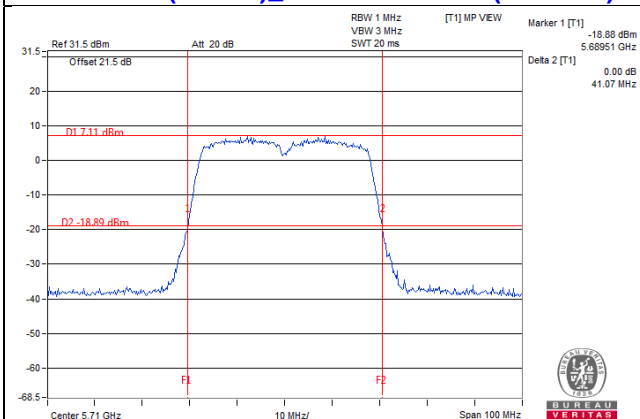

802.11ac (VHT80)\_Chain 7 / CH138 (U-NII-2C)

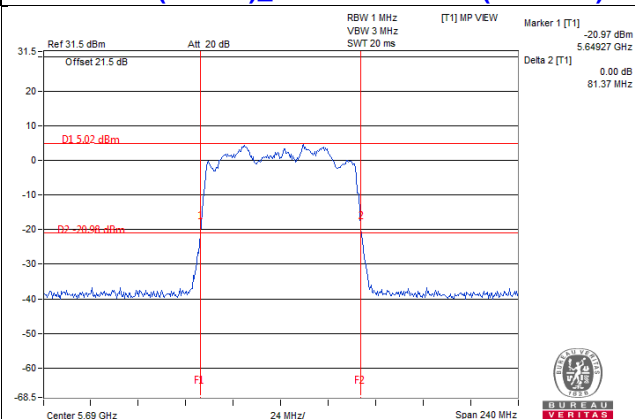

802.11ac (VHT80+80)\_Chain 6 / CH138 (U-NII-2C)

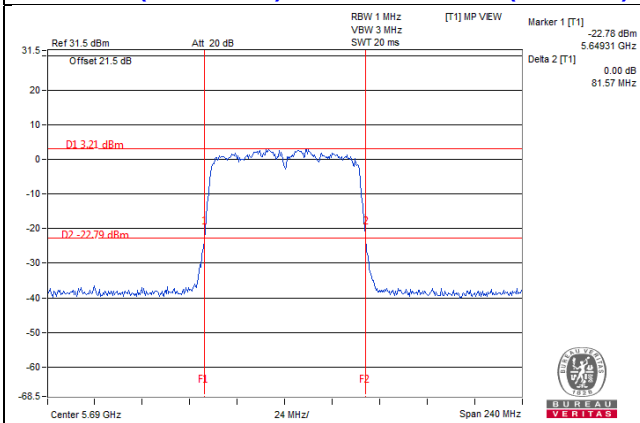

Note:

- For CH144 (U-NII-2C) = 5725MHz - Marker 1
- For CH142 (U-NII-2C) = 5725MHz - Marker 1
- For CH138 (U-NII-2C) = 5725MHz - Marker 1

**Spectrum Plot of Worst Value**

**802.11ax (HE20)\_Chain 7 / CH144 (U-NII-2C)**

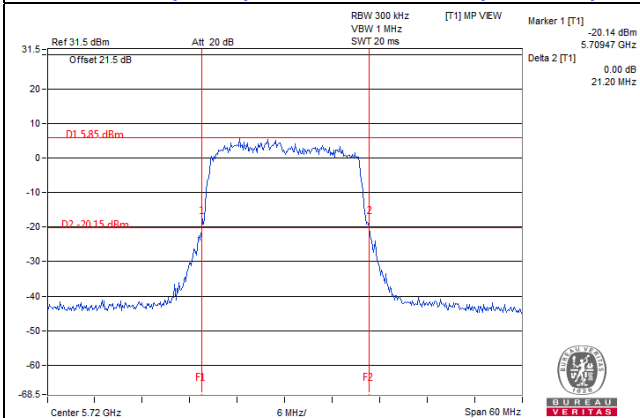

**802.11ax (HE40)\_Chain 7 / CH142 (U-NII-2C)**

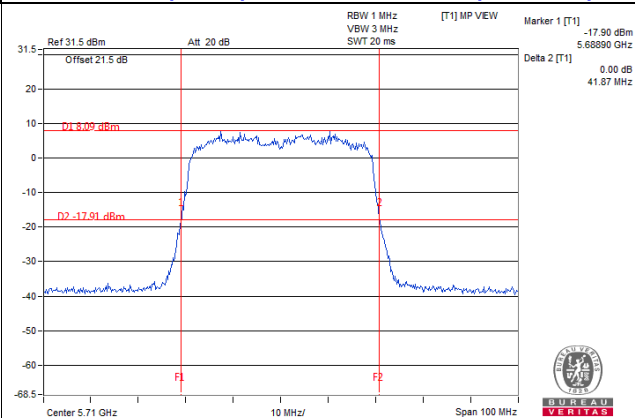

**802.11ax (HE80)\_Chain 0 / CH138 (U-NII-2C)**

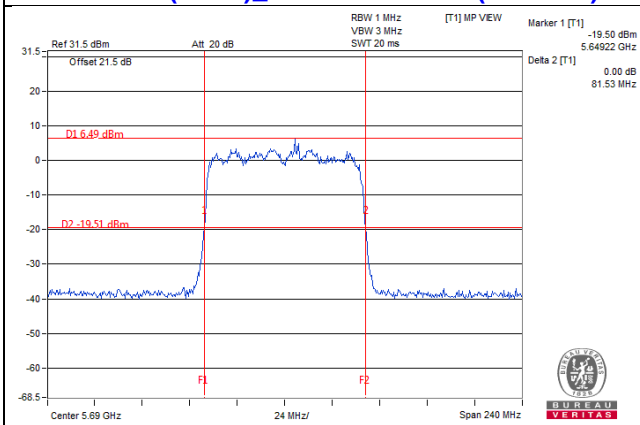

**802.11ax (HE80+80)\_Chain 7 / CH138 (U-NII-2C)**

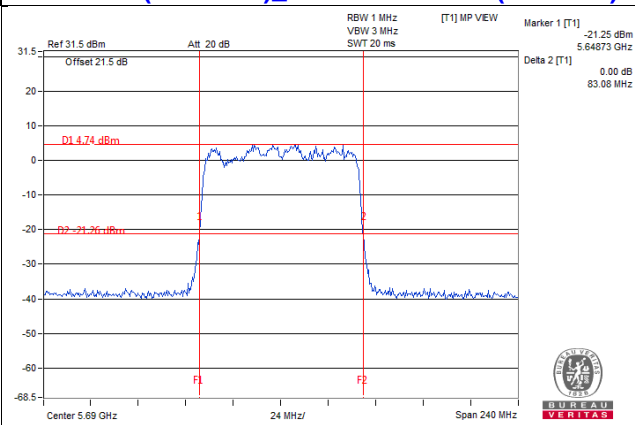

**Note:**

- For CH144 (U-NII-2C) = 5725MHz - Marker 1
- For CH142 (U-NII-2C) = 5725MHz - Marker 1
- For CH138 (U-NII-2C) = 5725MHz - Marker 1



## Beamforming Mode

### 802.11ac (VHT20)

Chan.	Freq. (MHz)	Maximum Conducted Power (dBm)								Total Power (mW)	Total Power (dBm)	Limit (dBm)	Pass / Fail
		Chain 0	Chain 1	Chain 2	Chain 3	Chain 4	Chain 5	Chain 6	Chain 7				
52	5260	10.32	10.17	10.89	11.01	10.52	11.07	10.85	11.21	95.497	19.80	20.10	Pass
60	5300	10.29	10.11	10.79	10.92	10.45	10.98	10.81	11.11	93.887	19.73	20.10	Pass
64	5320	10.13	10.12	10.71	10.73	10.45	11.18	10.92	11.31	94.284	19.74	20.10	Pass
100	5500	10.22	10.21	10.75	10.79	10.42	11.22	10.98	11.35	95.331	19.79	20.17	Pass
116	5580	10.17	10.16	10.79	10.74	10.52	11.18	10.85	11.31	94.704	19.76	20.17	Pass
140	5700	10.31	10.19	10.83	10.85	10.61	11.31	10.9	11.42	96.654	19.85	20.17	Pass
*144 (U-NII-2C Band)	5720	5.38	5.59	6.38	6.15	6.05	5.82	6.3	6.65	33.527	15.25	18.91	Pass
*144 (U-NII-3 Band)	5720	-1.11	-1.94	-0.89	-0.42	-0.4	0.37	-1.17	0.18	7.2129	8.58	25.73	Pass

Note: \* Test was performed in accordance with Measurement follow FCC KDB 789033 UNII test procedure Method SA-2 and use spectrum analyzer test.

1. For U-NII-2A: Directional gain is 9.9dBi > 6dBi, so the power limit shall be reduced to "Determined Conducted Limit-(9.9-6)".
2. For U-NII-2C: Directional gain is 9.83dB > 6dBi, so the power limit shall be reduced to "Determined Conducted Limit-(9.83-6)".
3. For U-NII-3: Directional gain is 10.27dB > 6dBi, so the power limit shall be reduced to 30-(10.27-6) = 25.73dBm.

The Total Power for the straddle channel:

Chan.	Chan. Freq. (MHz)	Average Power (mW)	Average Power (dBm)
144	5720	40.7399	16.1

Note: The total power was calculated through formula and record the value for reference only.

### 26dB OCCUPIED BANDWIDTH

Channel	Frequency (MHz)	26dBc Bandwidth (MHz)							
		Chain 0	Chain 1	Chain 2	Chain 3	Chain 4	Chain 5	Chain 6	Chain 7
52	5260	20.80	20.56	20.80	20.46	20.65	20.55	20.40	20.39
60	5300	20.92	20.73	20.67	20.71	20.57	20.60	20.71	20.04
64	5320	20.60	20.74	20.83	20.53	20.38	20.94	20.06	20.01
100	5500	20.12	20.55	20.51	20.92	20.43	21.23	20.67	20.18
116	5580	20.34	20.03	20.43	20.64	20.66	21.04	21.13	20.41
140	5700	20.83	20.79	20.35	20.68	20.58	20.95	20.38	20.07
144 (U-NII-2C Band)	5720	15.12	15.45	15.34	15.38	15.31	15.45	15.32	14.94

Note: For U-NII-2A, U-NII-2C Band output power limitation is determined based on 26dBc bandwidth.

Power Limit = 11dBm + 10logB < U-NII-2A, U-NII-2C >

Channel Number	Freq.(MHz)	Min. B(MHz)	Determined Conducted Limit (dBm)
52	5260	20.39	24.09 > 24
60	5300	20.04	24.01 > 24
64	5320	20.01	24.01 > 24
100	5500	20.12	24.03 > 24
116	5580	20.03	24.01 > 24
140	5700	20.07	24.02 > 24
144 (U-NII-2C Band)	5720	14.94	22.74 < 24

### 802.11ac (VHT40)

Chan.	Freq. (MHz)	Maximum Conducted Power (dBm)								Total Power (mW)	Total Power (dBm)	Limit (dBm)	Pass / Fail
		Chain 0	Chain 1	Chain 2	Chain 3	Chain 4	Chain 5	Chain 6	Chain 7				
54	5270	10.31	10.21	10.91	11.11	10.62	11.11	10.92	11.35	96.931	19.86	20.10	Pass
62	5310	10.41	10.32	10.75	11.08	10.75	11.08	10.85	11.21	96.546	19.85	20.10	Pass
102	5510	10.26	10.25	10.83	11.17	10.85	11.17	10.99	11.01	96.84	19.86	20.17	Pass
110	5550	10.21	10.20	10.79	11.03	10.95	11.21	10.91	11.11	96.54	19.85	20.17	Pass
134	5670	10.15	10.11	10.85	11.02	10.88	11.09	10.95	11.16	96.023	19.82	20.17	Pass
*142 (U-NII-2C Band)	5710	6.29	6.24	6.68	6.98	6.79	7.22	6.43	6.98	38.925	15.90	20.17	Pass
*142 (U-NII-3 Band)	5710	-5.08	-4.60	-5.34	-4.57	-2.88	-3.62	-3.65	-3.17	3.2786	5.16	25.73	Pass

Note: \* Test was performed in accordance with Measurement follow FCC KDB 789033 UNII test procedure Method SA-2 and use spectrum analyzer test.

1. For U-NII-2A: Directional gain is 9.9dBi > 6dBi, so the power limit shall be reduced to "Determined Conducted Limit-(9.9-6)".
2. For U-NII-2C: Directional gain is 9.83dB > 6dBi, so the power limit shall be reduced to "Determined Conducted Limit-(9.83-6)".
3. For U-NII-3: Directional gain is 10.27dB > 6dBi, so the power limit shall be reduced to 30-(10.27-6) = 25.73dBm.

The Total Power for the straddle channel:

Chan.	Chan. Freq. (MHz)	Average Power (mW)	Average Power (dBm)
142	5710	42.2036	16.25

Note: The total power was calculated through formula and record the value for reference only.

### 26dB OCCUPIED BANDWIDTH

Channel	Frequency (MHz)	26dBc Bandwidth (MHz)							
		Chain 0	Chain 1	Chain 2	Chain 3	Chain 4	Chain 5	Chain 6	Chain 7
54	5270	41.57	41.90	42.12	41.33	41.91	41.36	41.13	40.82
62	5310	41.47	41.64	41.48	41.63	41.37	41.58	40.97	41.41
102	5510	41.31	41.85	41.61	41.64	41.86	41.39	40.96	40.70
110	5550	41.21	40.86	42.01	42.03	41.62	41.27	41.48	41.14
134	5670	41.34	41.59	41.72	41.61	41.47	41.52	41.27	41.34
142 (U-NII-2C Band)	5710	35.83	35.93	36.03	35.60	35.73	35.49	35.73	35.55

Note: For U-NII-2A, U-NII-2C Band output power limitation is determined based on 26dBc bandwidth.

Power Limit = 11dBm + 10logB < U-NII-2A, U-NII-2C >

Channel Number	Freq.(MHz)	Min. B(MHz)	Determined Conducted Limit (dBm)
54	5270	40.82	27.1 > 24
62	5310	40.97	27.12 > 24
102	5510	40.70	27.09 > 24
110	5550	40.86	27.11 > 24
134	5670	41.27	27.15 > 24
142 (U-NII-2C Band)	5710	35.49	26.5 > 24

### 802.11ac (VHT80)

Chan.	Freq. (MHz)	Maximum Conducted Power (dBm)								Total Power (mW)	Total Power (dBm)	Limit (dBm)	Pass / Fail
		Chain 0	Chain 1	Chain 2	Chain 3	Chain 4	Chain 5	Chain 6	Chain 7				
58	5290	10.27	10.16	10.42	10.95	11.2	11.02	11.01	10.98	95.457	19.80	20.10	Pass
106	5530	10.21	10.11	10.31	10.85	11.11	10.96	10.9	10.87	93.56	19.71	20.17	Pass
122	5610	10.27	10.23	10.36	10.92	11.2	11.15	11.02	10.81	95.321	19.79	20.17	Pass
*138 (U-NII-2C Band)	5690	6.52	6.53	6.64	7.29	7.34	7.39	7.41	7.88	43.037	16.34	20.17	Pass
*138 (U-NII-3 Band)	5690	-7.91	-7.79	-7.11	-7.59	-7.81	-7.45	-7.52	-7.92	1.4317	1.56	25.73	Pass

Note: \* Test was performed in accordance with Measurement follow FCC KDB 789033 UNII test procedure Method SA-2 and use spectrum analyzer test.

1. For U-NII-2A: Directional gain is 9.9dBi > 6dBi, so the power limit shall be reduced to "Determined Conducted Limit-(9.9-6)".
2. For U-NII-2C: Directional gain is 9.83dB > 6dBi, so the power limit shall be reduced to "Determined Conducted Limit-(9.83-6)".
3. For U-NII-3: Directional gain is 10.27dB > 6dBi, so the power limit shall be reduced to 30-(10.27-6) = 25.73dBm.

The Total Power for the straddle channel:

Chan.	Chan. Freq. (MHz)	Average Power (mW)	Average Power (dBm)
138	5690	44.4687	16.48

Note: The total power was calculated through formula and record the value for reference only.

### 26dB OCCUPIED BANDWIDTH

Channel	Frequency (MHz)	26dBc Bandwidth (MHz)							
		Chain 0	Chain 1	Chain 2	Chain 3	Chain 4	Chain 5	Chain 6	Chain 7
58	5290	82.15	83.03	82.13	82.66	82.12	81.88	81.75	82.38
106	5530	81.66	82.52	82.23	82.31	82.28	82.24	81.91	81.76
122	5610	81.96	82.37	82.71	82.43	82.42	82.13	81.99	81.26
138 (U-NII-2C Band)	5690	75.99	76.34	76.28	76.24	75.96	76.14	75.78	75.73

Note: For U-NII-2A, U-NII-2C Band output power limitation is determined based on 26dBc bandwidth.

Power Limit = 11dBm + 10logB < U-NII-2A, U-NII-2C >			
Channel Number	Freq.(MHz)	Min. B(MHz)	Determined Conducted Limit (dBm)
58	5290	81.75	30.12 > 24
106	5530	81.66	30.12 > 24
122	5610	81.26	30.09 > 24
138 (U-NII-2C Band)	5690	75.73	29.79 > 24

### 802.11ac (VHT80+80)

Chan.	Freq. (MHz)	Maximum Conducted Power (dBm)								Total Power (mW)	Total Power (dBm)	Limit (dBm)	Pass / Fail
		Chain 0	Chain 1	Chain 2	Chain 3	Chain 4	Chain 5	Chain 6	Chain 7				
58+106	5290	13.56	13.62	13.74	13.11	-	-	-	-	89.837	19.53	20.10	Pass
	5530	-	-	-	-	14.11	14.01	14.16	13.96	101.89	20.08	20.17	Pass
106+122	5530	11.68	10.81	11.38	10.56	-	-	-	-	100.292	20.01	20.17	Pass
	5610	-	-	-	-	10.58	10.69	10.75	11.26				Pass
106+*138 (UNII-2C Band)+*138 (UNII-3 Band)	5530	11.68	10.81	11.38	10.56	-	-	-	-	72.499	18.60	20.17	Pass
	5690	-	-	-	-	6.98	6.7	6.93	7.21				Pass
	5690	-	-	-	-	-7.18	-9.03	-9.58	-8.44	0.591	-2.28	25.73	Pass

Note: \* Test was performed in accordance with Measurement follow FCC KDB 789033 UNII test procedure Method SA-2 and use spectrum analyzer test.

1. For U-NII-2A: Directional gain is 9.9dBi > 6dBi, so the power limit shall be reduced to "Determined Conducted Limit-(9.9-6)".
2. For U-NII-2C: Directional gain is 9.83dB > 6dBi, so the power limit shall be reduced to "Determined Conducted Limit-(9.83-6)".
3. For U-NII-3: Directional gain is 10.27dB > 6dBi, so the power limit shall be reduced to 30-(10.27-6) = 25.73dBm.

The Total Power for the straddle channel:

Chan.	Chan. Freq. (MHz)	Average Power (mW)	Average Power (dBm)
106+138	5690	21.2	13.26

Note: The total power was calculated through formula and record the value for reference only.

### 26dB OCCUPIED BANDWIDTH

Channel	Frequency (MHz)	26dBc Bandwidth (MHz)							
		Chain 0	Chain 1	Chain 2	Chain 3	Chain 4	Chain 5	Chain 6	Chain 7
58+106	5290	81.60	81.88	82.53	82.89	-	-	-	-
	5530	-	-	-	-	81.46	81.85	81.60	81.69
106+122	5530	81.97	81.81	82.02	82.66	-	-	-	-
	5610	-	-	-	-	81.81	82.08	82.20	81.42
106 +138 (UNII-2C Band)	5530	81.97	81.81	82.02	82.66	-	-	-	-
	5690	-	-	-	-	75.79	76.14	75.69	76.41

Note: For U-NII-2A, U-NII-2C Band output power limitation is determined based on 26dBc bandwidth.

Power Limit = 11dBm + 10logB < U-NII-2A, U-NII-2C >			
Channel Number	Freq.(MHz)	Min. B(MHz)	Determined Conducted Limit (dBm)
58+106	5290	81.60	30.11 > 24
	5530	81.46	30.1 > 24
106+122	5530	81.81	30.12 > 24
	5610	81.42	30.1 > 24
106+138 (UNII-2C Band)	5530	81.81	30.12 > 24
	5690	75.69	29.79 > 24

### 802.11ax (HE20)

Chan.	Freq. (MHz)	Maximum Conducted Power (dBm)								Total Power (mW)	Total Power (dBm)	Limit (dBm)	Pass / Fail
		Chain 0	Chain 1	Chain 2	Chain 3	Chain 4	Chain 5	Chain 6	Chain 7				
52	5260	10.32	10.21	10.89	11.01	10.56	11.08	10.86	11.21	95.755	19.81	20.10	Pass
60	5300	10.31	10.18	10.79	10.98	10.52	10.95	10.81	11.12	94.399	19.75	20.10	Pass
64	5320	10.33	10.26	10.81	11.00	10.61	11.12	10.85	11.16	95.72	19.81	20.10	Pass
100	5500	10.31	10.27	10.75	11.11	10.82	11.06	10.91	11.15	96.384	19.84	20.17	Pass
116	5580	10.39	10.35	10.83	11.25	10.95	11.25	11.2	11.21	99.396	19.97	20.17	Pass
140	5700	10.41	10.39	10.95	11.31	11.03	11.2	11.41	11.35	101.236	20.05	20.17	Pass
*144 (U-NII-2C Band)	5720	5.54	5.46	6.81	6.60	6.15	6.14	6.2	6.63	34.741	15.41	19.08	Pass
*144 (U-NII-3 Band)	5720	-0.49	0.94	0.48	0.91	1.37	1.29	1.91	0.34	10.2095	10.09	25.73	Pass

Note: \* Test was performed in accordance with Measurement follow FCC KDB 789033 UNII test procedure Method SA-2 and use spectrum analyzer test.

1. For U-NII-2A: Directional gain is 9.9dBi > 6dBi, so the power limit shall be reduced to "Determined Conducted Limit-(9.9-6)".
2. For U-NII-2C: Directional gain is 9.83dB > 6dBi, so the power limit shall be reduced to "Determined Conducted Limit-(9.83-6)".
3. For U-NII-3: Directional gain is 10.27dB > 6dBi, so the power limit shall be reduced to 30-(10.27-6) = 25.73dBm.

The Total Power for the straddle channel:

Chan.	Chan. Freq. (MHz)	Average Power (mW)	Average Power (dBm)
144	5720	44.9505	16.53

Note: The total power was calculated through formula and record the value for reference only.

### 26dB OCCUPIED BANDWIDTH

Channel	Frequency (MHz)	26dBc Bandwidth (MHz)							
		Chain 0	Chain 1	Chain 2	Chain 3	Chain 4	Chain 5	Chain 6	Chain 7
52	5260	21.21	21.26	21.34	21.15	21.35	21.42	20.81	21.13
60	5300	21.41	21.10	21.11	21.13	21.25	21.41	21.25	21.66
64	5320	21.29	21.09	21.42	21.12	21.72	21.31	20.96	21.47
100	5500	21.34	22.00	21.26	21.19	21.14	21.22	21.17	21.39
116	5580	21.24	21.56	21.85	21.07	21.79	21.59	21.44	21.33
140	5700	21.01	21.06	21.28	20.97	21.31	21.23	21.42	21.52
144 (U-NII-2C Band)	5720	15.74	15.71	15.94	15.74	15.81	15.86	15.61	15.53

Note: For U-NII-2A, U-NII-2C Band output power limitation is determined based on 26dBc bandwidth.



Power Limit = 11dBm + 10logB < U-NII-2A, U-NII-2C >

Channel Number	Freq.(MHz)	Min. B(MHz)	Determined Conducted Limit (dBm)
52	5260	20.81	24.18 > 24
60	5300	21.10	24.24 > 24
64	5320	20.96	24.21 > 24
100	5500	21.14	24.25 > 24
116	5580	21.07	24.23 > 24
140	5700	20.97	24.21 > 24
144 (U-NII-2C Band)	5720	15.53	22.91 < 24

### 802.11ax (HE40)

Chan.	Freq. (MHz)	Maximum Conducted Power (dBm)								Total Power (mW)	Total Power (dBm)	Limit (dBm)	Pass / Fail
		Chain 0	Chain 1	Chain 2	Chain 3	Chain 4	Chain 5	Chain 6	Chain 7				
54	5270	10.46	10.31	11.05	11.21	10.71	11.21	11.05	11.38	99.27	19.97	20.10	Pass
62	5310	10.41	10.46	10.81	11.19	10.84	11.19	10.95	11.31	98.562	19.94	20.10	Pass
102	5510	10.30	10.29	10.85	11.12	10.85	11.21	10.99	11.08	97.268	19.88	20.17	Pass
110	5550	10.27	10.27	10.82	11.08	10.95	11.24	10.95	11.06	97.141	19.87	20.17	Pass
134	5670	10.41	10.39	10.95	11.31	11.03	11.2	11.41	11.35	101.236	20.05	20.17	Pass
*142 (U-NII-2C Band)	5710	6.77	6.58	7.14	6.69	7.08	7.6	6.91	6.8	41.38	16.17	20.17	Pass
*142 (U-NII-3 Band)	5710	-5.10	-6.01	-2.45	-3.46	-2.61	-2.79	-4.22	-4.32	3.5458	5.50	25.73	Pass

Note: \* Test was performed in accordance with Measurement follow FCC KDB 789033 UNII test procedure Method SA-2 and use spectrum analyzer test.

1. For U-NII-2A: Directional gain is 9.9dBi > 6dBi, so the power limit shall be reduced to "Determined Conducted Limit-(9.9-6)".
2. For U-NII-2C: Directional gain is 9.83dB > 6dBi, so the power limit shall be reduced to "Determined Conducted Limit-(9.83-6)".
3. For U-NII-3: Directional gain is 10.27dB > 6dBi, so the power limit shall be reduced to 30-(10.27-6) = 25.73dBm.

The Total Power for the straddle channel:

Chan.	Chan. Freq. (MHz)	Average Power (mW)	Average Power (dBm)
142	5710	44.9258	16.52

Note: The total power was calculated through formula and record the value for reference only.

### 26dB OCCUPIED BANDWIDTH

Channel	Frequency (MHz)	26dBc Bandwidth (MHz)							
		Chain 0	Chain 1	Chain 2	Chain 3	Chain 4	Chain 5	Chain 6	Chain 7
54	5270	42.16	42.45	42.54	42.11	42.35	42.62	42.48	42.26
62	5310	42.46	41.86	42.99	42.18	42.74	42.62	42.40	42.21
102	5510	42.74	41.83	42.21	42.24	42.49	42.39	42.39	42.51
110	5550	42.59	41.76	42.40	42.31	42.48	42.66	41.97	42.41
134	5670	41.93	41.74	42.10	42.23	42.11	42.13	41.92	42.54
142 (U-NII-2C Band)	5710	36.42	36.28	36.35	36.39	36.41	36.11	36.27	36.10

Note: For U-NII-2A, U-NII-2C Band output power limitation is determined based on 26dBc bandwidth.

Power Limit = 11dBm + 10logB < U-NII-2A, U-NII-2C >

Channel Number	Freq.(MHz)	Min. B(MHz)	Determined Conducted Limit (dBm)
54	5270	42.11	27.24 > 24
62	5310	41.86	27.21 > 24
102	5510	41.83	27.21 > 24
110	5550	41.76	27.2 > 24
134	5670	41.74	27.2 > 24
142 (U-NII-2C Band)	5710	36.10	26.57 > 24

### 802.11ax (HE80)

Chan.	Freq. (MHz)	Maximum Conducted Power (dBm)								Total Power (mW)	Total Power (dBm)	Limit (dBm)	Pass / Fail
		Chain 0	Chain 1	Chain 2	Chain 3	Chain 4	Chain 5	Chain 6	Chain 7				
58	5290	10.32	10.21	10.42	10.95	11.12	11.08	11.05	10.95	95.666	19.81	20.10	Pass
106	5530	10.26	10.12	10.35	10.86	11.11	10.96	10.88	10.86	93.748	19.72	20.17	Pass
122	5610	10.33	10.21	10.41	11.02	11.21	11.11	11.02	10.95	96.14	19.83	20.17	Pass
*138 (U-NII-2C Band)	5690	7.06	6.72	6.77	7.43	7.51	7.23	7.87	7	43.673	16.40	20.17	Pass
*138 (U-NII-3 Band)	5690	-8.60	-5.51	-8.19	-8.24	-7.44	-7.41	-6.02	-6.89	1.594	2.02	25.73	Pass

Note: \* Test was performed in accordance with Measurement follow FCC KDB 789033 UNII test procedure Method SA-2 and use spectrum analyzer test.

1. For U-NII-2A: Directional gain is 9.9dBi > 6dBi, so the power limit shall be reduced to "Determined Conducted Limit-(9.9-6)".
2. For U-NII-2C: Directional gain is 9.83dB > 6dBi, so the power limit shall be reduced to "Determined Conducted Limit-(9.83-6)".
3. For U-NII-3: Directional gain is 10.27dB > 6dBi, so the power limit shall be reduced to 30-(10.27-6) = 25.73dBm.

The Total Power for the straddle channel:

Chan.	Chan. Freq. (MHz)	Average Power (mW)	Average Power (dBm)
138	5690	45.267	16.56

Note: The total power was calculated through formula and record the value for reference only.

### 26dB OCCUPIED BANDWIDTH

Channel	Frequency (MHz)	26dBc Bandwidth (MHz)							
		Chain 0	Chain 1	Chain 2	Chain 3	Chain 4	Chain 5	Chain 6	Chain 7
58	5290	82.81	82.91	82.50	82.65	82.52	82.39	82.60	82.44
106	5530	83.27	82.30	82.68	83.27	82.97	82.53	82.51	82.77
122	5610	83.20	82.56	82.96	82.90	82.64	83.04	82.72	83.01
138 (U-NII-2C Band)	5690	75.78	76.39	76.28	76.53	76.64	76.57	76.11	76.45

Note: For U-NII-2A, U-NII-2C Band output power limitation is determined based on 26dBc bandwidth.

Power Limit = 11dBm + 10logB < U-NII-2A, U-NII-2C >			
Channel Number	Freq.(MHz)	Min. B(MHz)	Determined Conducted Limit (dBm)
58	5290	82.39	30.15 > 24
106	5530	82.30	30.15 > 24
122	5610	82.56	30.16 > 24
138 (U-NII-2C Band)	5690	75.78	29.79 > 24

### 802.11ax (HE80+80)

Chan.	Freq. (MHz)	Maximum Conducted Power (dBm)								Total Power (mW)	Total Power (dBm)	Limit (dBm)	Pass / Fail
		Chain 0	Chain 1	Chain 2	Chain 3	Chain 4	Chain 5	Chain 6	Chain 7				
58+106	5290	13.89	13.81	13.93	13.28	-	-	-	-	94.533	19.76	20.10	Pass
	5530	-	-	-	-	14.13	14.15	14.21	13.96	103.136	20.13	20.17	Pass
106+122	5530	11.84	11.01	11.56	10.72	-	-	-	-	101.148	20.05	20.17	Pass
	5610	-	-	-	-	10.51	10.49	10.71	11.11				Pass
106+*138 (UNII-2C Band)+*138 (UNII-3 Band)	5530	11.84	11.01	11.56	10.75	-	-	-	-	76.607	18.84	20.17	Pass
	5690	-	-	-	-	7.15	6.67	7.49	7.95				Pass
	5690	-	-	-	-	-7.2	-8.91	-6.38	-5.11	0.89	-0.51	25.73	Pass

Note: \* Test was performed in accordance with Measurement follow FCC KDB 789033 UNII test procedure Method SA-2 and use spectrum analyzer test.

1. For U-NII-2A: Directional gain is 9.9dBi > 6dBi, so the power limit shall be reduced to  $24-(9.9-6) = 20.10$ dBm.
2. For U-NII-2C: Directional gain is 9.83dB > 6dBi, so the power limit shall be reduced to  $24-(9.83-6) = 20.17$ dBm.
3. For U-NII-3: Directional gain is 10.27dB > 6dBi, so the power limit shall be reduced to  $30-(10.27-6) = 25.73$ dBm.

The Total Power for the straddle channel:

Chan.	Chan. Freq. (MHz)	Average Power (mW)	Average Power (dBm)
106+138	5690	23.396	13.69

Note: The total power was calculated through formula and record the value for reference only.

### 26dB OCCUPIED BANDWIDTH

Channel	Frequency (MHz)	26dBc Bandwidth (MHz)							
		Chain 0	Chain 1	Chain 2	Chain 3	Chain 4	Chain 5	Chain 6	Chain 7
58+106	5290	82.70	82.81	82.78	82.91	-	-	-	-
	5530	-	-	-	-	82.20	83.02	82.31	82.54
106+122	5530	82.76	82.54	82.76	82.99	-	-	-	-
	5610	-	-	-	-	83.17	83.48	82.89	82.71
106 +138 (UNII-2C Band)	5530	82.76	82.54	82.76	82.99	-	-	-	-
	5690	-	-	-	-	76.54	76.38	76.38	76.27

Note: For U-NII-2A, U-NII-2C Band output power limitation is determined based on 26dBc bandwidth.

Power Limit = 11dBm + 10logB < U-NII-2A, U-NII-2C >			
Channel Number	Freq.(MHz)	Min. B(MHz)	Determined Conducted Limit (dBm)
58+106	5290	82.70	30.17 > 24
	5530	82.20	30.14 > 24
106+122	5530	82.54	30.16 > 24
	5610	82.71	30.17 > 24
106+138 (UNII-2C Band)	5530	82.54	30.16 > 24
	5690	76.27	29.82 > 24

Spectrum Plot of Worst Value

802.11ac (VHT20)\_Chain 7 / CH144 (U-NII-2C)

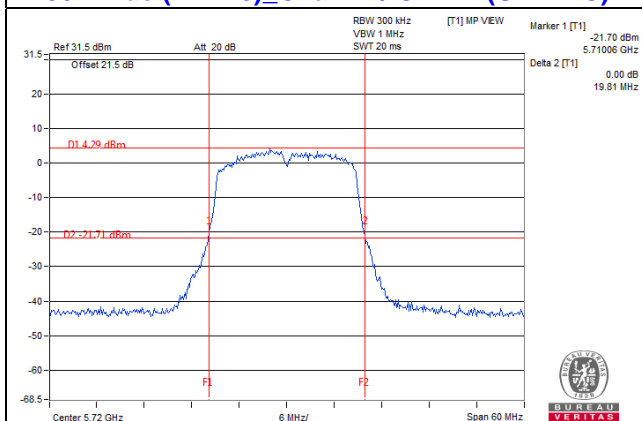

8802.11ac (VHT40)\_Chain 5 / CH142 (U-NII-2C)

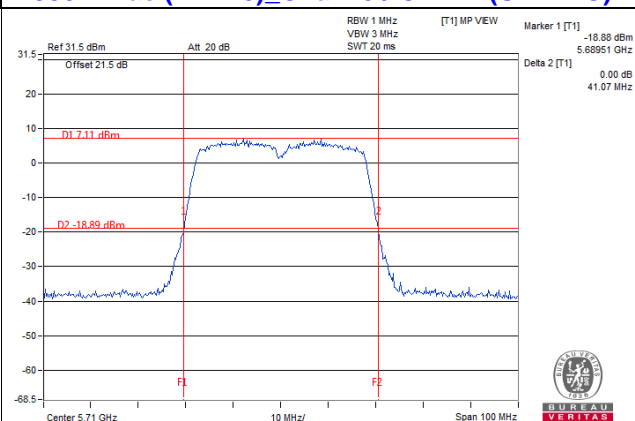

802.11ac (VHT80)\_Chain 7 / CH138 (U-NII-2C)

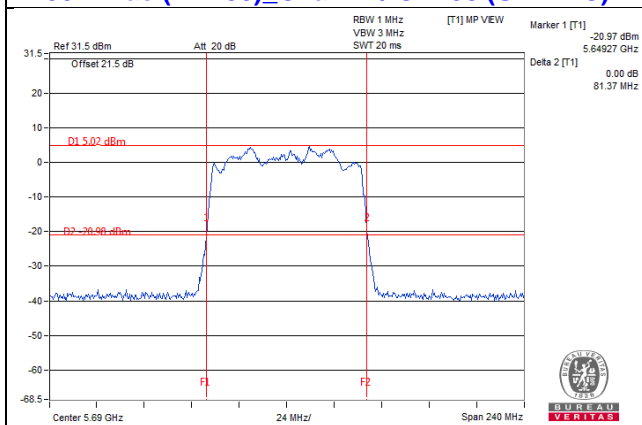

802.11ac (VHT80+80)\_Chain 6 / CH138 (U-NII-2C)

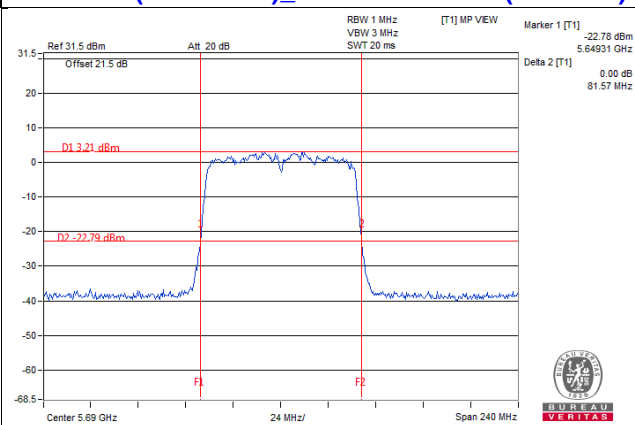

Note:

- For CH144 (U-NII-2C) = 5725MHz - Marker 1
- For CH142 (U-NII-2C) = 5725MHz - Marker 1
- For CH138 (U-NII-2C) = 5725MHz - Marker 1

Spectrum Plot of Worst Value

802.11ax (HE20)\_Chain 7 / CH144 (U-NII-2C)

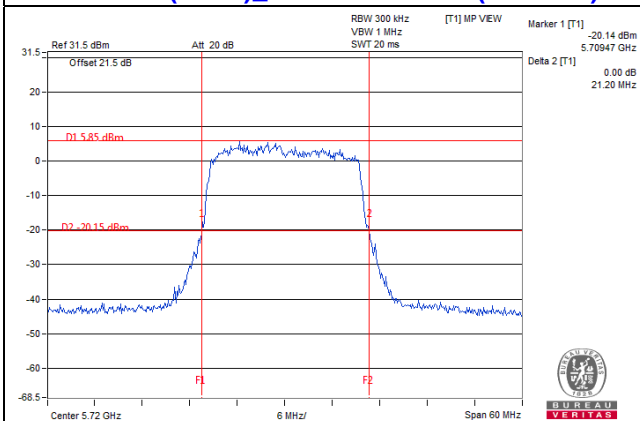

802.11ax (HE40)\_Chain 7 / CH142 (U-NII-2C)

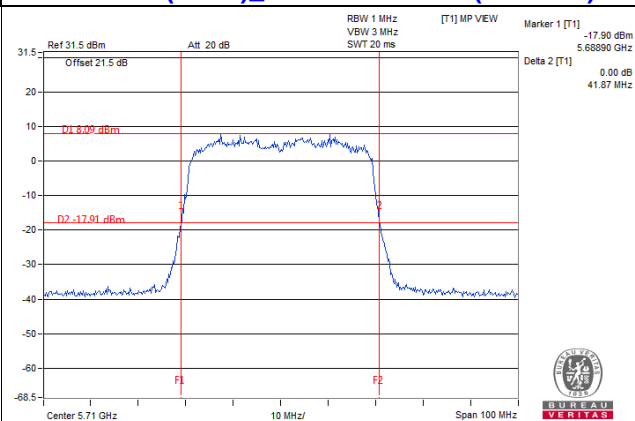

802.11ax (HE80)\_Chain 0 / CH138 (U-NII-2C)

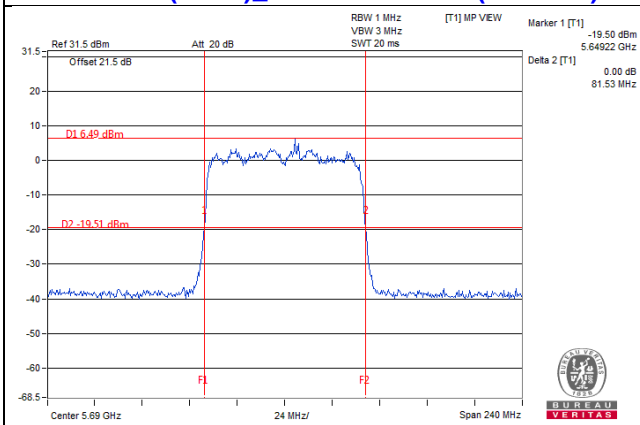

802.11ax (HE80+80)\_Chain 7 / CH138 (U-NII-2C)

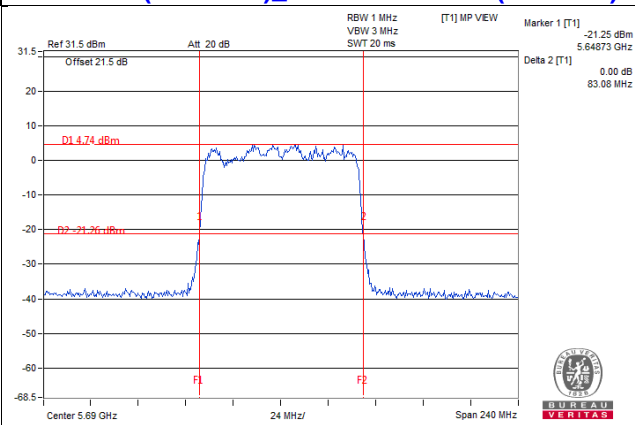

Note:

- For CH144 (U-NII-2C) = 5725MHz - Marker 1
- For CH142 (U-NII-2C) = 5725MHz - Marker 1
- For CH138 (U-NII-2C) = 5725MHz - Marker 1



## 4.4 Occupied Bandwidth Measurement

### 4.4.1 Test Setup

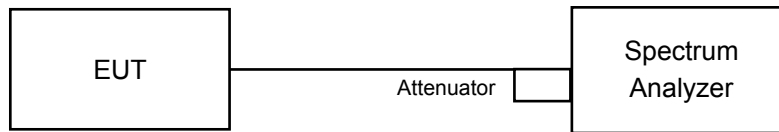

### 4.4.2 Test Instruments

Refer to section 4.1.2 to get information of above instrument.

### 4.4.3 Test Procedure

The transmitter output was connected to the spectrum analyzer through an attenuator. The bandwidth of the fundamental frequency was measured by spectrum analyzer with resolution bandwidth in the range of 1% to 5% of the anticipated emission bandwidth, and a video bandwidth at least 3x the resolution bandwidth and set the detector to SAMPLE. The width of a frequency band such that, below the lower and above the upper frequency limits, the mean powers emitted are each equal to a specified percentage 0.5 %of the total mean power of a given emission.

#### 4.4.4 Test Results

#### Non-Beamforming Mode

#### 802.11a

Channel	Channel Frequency (MHz)	Occupied Bandwidth (MHz)							
		Chain 0	Chain 1	Chain 2	Chain 3	Chain 4	Chain 5	Chain 6	Chain 7
52	5260	16.80	16.68	16.68	16.80	16.56	16.80	16.80	16.80
60	5300	16.68	16.56	16.80	16.68	16.56	16.80	16.92	16.68
64	5320	16.56	16.80	16.68	16.80	16.80	16.80	16.92	16.80
100	5500	16.68	16.68	16.80	16.80	16.56	16.80	16.80	16.68
116	5580	16.80	16.80	16.68	16.80	16.80	16.80	16.80	16.92
140	5700	16.56	16.92	16.68	16.68	16.80	16.80	16.92	16.80
144 (UNII-2C Band)	5720	13.40	13.52	13.40	13.52	13.40	13.52	13.64	13.52
144 (UNII-3 Band)	5720	3.40	3.28	3.28	3.16	3.28	3.28	3.28	3.28

#### 802.11ax (HE20)

Channel	Channel Frequency (MHz)	Occupied Bandwidth (MHz)							
		Chain 0	Chain 1	Chain 2	Chain 3	Chain 4	Chain 5	Chain 6	Chain 7
52	5260	18.96	18.96	18.96	18.96	18.96	18.96	18.84	18.96
60	5300	18.96	18.96	18.96	18.84	18.96	18.84	18.96	19.08
64	5320	18.96	18.96	18.96	19.08	18.96	18.96	18.84	18.96
100	5500	19.08	19.08	18.96	19.08	18.84	18.84	18.96	19.08
116	5580	18.96	18.96	19.08	18.96	18.96	18.96	19.08	18.96
140	5700	18.84	18.84	19.20	18.96	18.96	18.96	18.96	18.96
144 (UNII-2C Band)	5720	14.60	14.60	14.60	14.60	14.60	14.60	14.60	14.60
144 (UNII-3 Band)	5720	4.36	4.48	4.36	4.36	4.36	4.36	4.48	4.36

#### 802.11ax (HE40)

Channel	Channel Frequency (MHz)	Occupied Bandwidth (MHz)							
		Chain 0	Chain 1	Chain 2	Chain 3	Chain 4	Chain 5	Chain 6	Chain 7
54	5270	38.16	38.16	38.16	38.16	38.16	38.16	38.16	38.40
62	5310	38.40	37.92	38.40	38.16	37.92	38.16	38.16	38.16
102	5510	38.16	37.68	38.16	37.68	38.16	37.92	38.16	38.16
110	5550	37.92	37.68	37.92	38.16	37.92	37.92	37.92	38.16
134	5670	38.16	37.68	37.92	38.16	38.16	37.92	37.92	38.16
142 (UNII-2C Band)	5710	34.00	34.20	34.40	34.20	34.20	34.20	34.00	34.00
142 (UNII-3 Band)	5710	3.80	3.60	4.00	3.80	3.80	3.80	3.80	3.80

**802.11ax (HE80)**

Channel	Channel Frequency (MHz)	Occupied Bandwidth (MHz)							
		Chain 0	Chain 1	Chain 2	Chain 3	Chain 4	Chain 5	Chain 6	Chain 7
58	5290	77.28	77.76	77.28	77.28	77.28	77.28	77.28	77.28
106	5530	77.28	77.28	77.28	77.28	77.28	77.28	77.28	77.28
122	5610	77.28	77.28	77.28	77.28	77.76	77.28	76.80	77.28
138 (UNII-2C Band)	5690	73.88	73.88	73.40	73.88	73.88	73.88	73.88	73.88
138 (UNII-3 Band)	5690	2.92	3.40	3.40	3.40	3.40	2.92	3.40	3.40

**802.11ax (HE80+80)**

Channel	Channel Frequency (MHz)	Occupied Bandwidth (MHz)							
		Chain 0	Chain 1	Chain 2	Chain 3	Chain 4	Chain 5	Chain 6	Chain 7
58+106	5290	77.28	77.28	77.28	76.80	-	-	-	-
	5530	-	-	-	-	77.28	77.28	77.28	77.28
106+122	5530	77.28	76.80	77.28	76.80	-	-	-	-
	5610	-	-	-	-	77.28	76.80	77.76	77.76
106 + 138 (UNII-2C Band) + 138 (UNII-3 Band)	5530	77.28	76.80	77.28	76.80	-	-	-	-
	5690	-	-	-	-	73.88	73.88	73.88	73.88
	5690	-	-	-	-	3.40	2.92	3.40	3.40

**Spectrum Plot of Worst Value**

**802.11a\_Chain 1 / CH140**

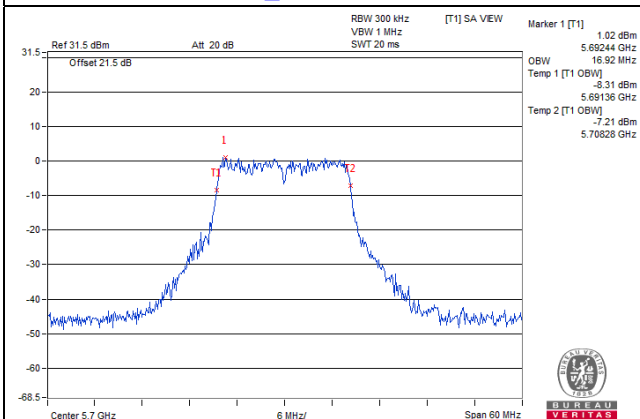

**802.11ax (HE20)\_Chain 2 / CH140**

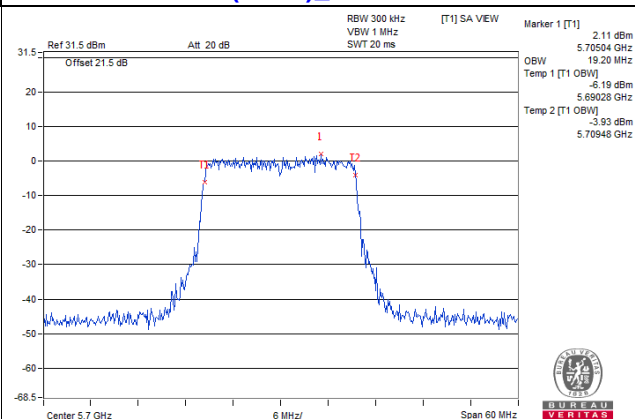

**802.11ax (HE40)\_Chain 0 / CH62**

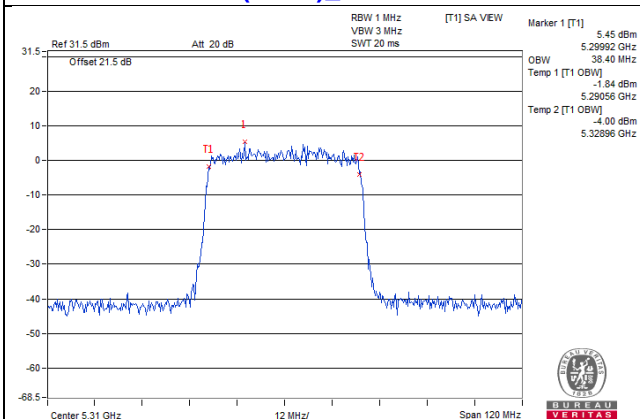

**802.11ax (HE80)\_Chain 1 / CH58**

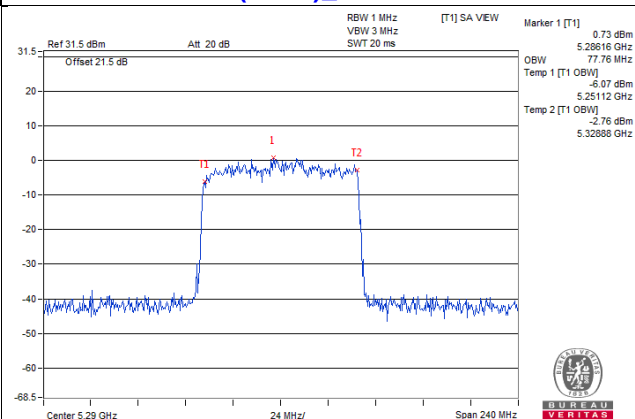

**802.11ax (HE80+80)\_Chain 7 / CH122**

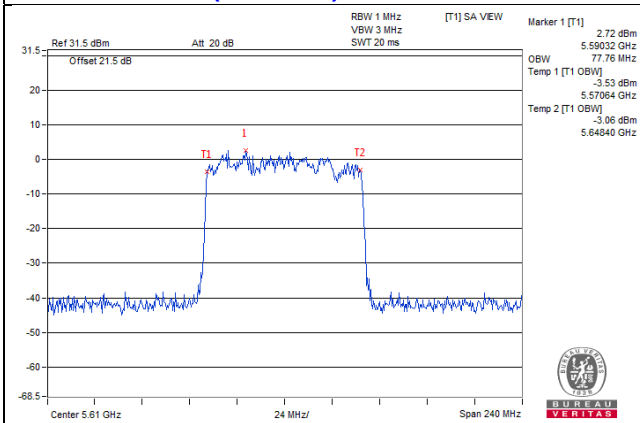

## 4.5 Peak Power Spectral Density Measurement

### 4.5.1 Limits of Peak Power Spectral Density Measurement

Operation Band	EUT Category		Limit
U-NII-1		Outdoor Access Point	17dBm/ MHz
		Fixed point-to-point Access Point	
		Indoor Access Point	
		Client device	11dBm/ MHz
U-NII-2A	√		11dBm/ MHz
U-NII-2C	√		11dBm/ MHz
U-NII-3	√		30dBm/ 500kHz

### 4.5.2 Test Setup

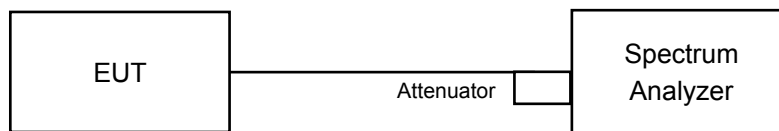

### 4.5.3 Test Instruments

Refer to section 4.1.2 to get information of above instrument.

### 4.5.4 Test Procedure

Using method SA-2

1. Set span to encompass the entire emission bandwidth (EBW) of the signal.
2. Set RBW = 1 MHz, Set VBW ≥ 3 MHz, Detector = RMS
3. Sweep time = auto, trigger set to "free run".
4. Trace average at least 100 traces in power averaging mode.
5. Record the max value and add 10 log (1/duty cycle)

### 4.5.5 Deviation from Test Standard

No deviation.

### 4.5.6 EUT Operating Condition

Same as Item 4.3.6.

#### 4.5.7 Test Results

#### Non-Beamforming Mode

#### For U-NII-2A, UNII-2C:

#### 802.11a

Chan.	Freq. (MHz)	PSD W/O Duty Factor (dBm)								Duty Factor (dB)	Total PSD With Duty Factor (dBm)	Max. Limit (dBm/MHz)	Pass / Fail
		Chain 0	Chain 1	Chain 2	Chain 3	Chain 4	Chain 5	Chain 6	Chain 7				
52	5260	-4.00	-3.79	-2.97	-3.50	-4.39	-4.21	-5.04	-3.30	0.52	5.17	7.10	Pass
60	5300	-3.67	-3.76	-3.74	-2.98	-4.05	-3.95	-2.94	-3.58	0.52	5.46	7.10	Pass
64	5320	-5.04	-5.30	-5.34	-4.25	-3.26	-4.08	-2.17	-4.20	0.52	4.95	7.10	Pass
100	5500	-4.12	-3.94	-2.90	-3.37	-3.10	-3.14	-4.09	-2.48	0.52	5.67	7.17	Pass
116	5580	-5.16	-4.98	-3.76	-5.97	-3.84	-5.40	-2.25	-1.99	0.52	5.09	7.17	Pass
140	5700	-3.45	-3.22	-3.98	-3.37	-3.55	-3.02	-2.84	-4.79	0.52	5.54	7.17	Pass
144 (UNII-2C Band)	5720	-4.90	-4.09	-3.81	-3.75	-3.78	-6.79	-3.34	-3.43	0.52	4.91	7.17	Pass

- Note: 1. Method a) of power density measurement of KDB 662911 is using for calculating total power density. Total power density is summing entire spectra across corresponding frequency bins on the various outputs by computer.
2. For U-NII-2A: Directional gain is 9.9dBi > 6dBi, so the power limit shall be reduced to 11-(9.9-6) = 7.10dBm.
3. For U-NII-2C: Directional gain is 9.83dB > 6dBi, so the power limit shall be reduced to 11-(9.83-6) = 7.17dBm.
4. Refer to section 3.3 for duty cycle spectrum plot.

#### 802.11ac (VHT20)

Chan.	Freq. (MHz)	PSD W/O Duty Factor (dBm)								Duty Factor (dB)	Total PSD With Duty Factor (dBm)	Max. Limit (dBm/MHz)	Pass / Fail
		Chain 0	Chain 1	Chain 2	Chain 3	Chain 4	Chain 5	Chain 6	Chain 7				
52	5260	-3.28	-3.01	-3.02	-2.95	-4.53	-2.38	-2.03	-2.77	0.17	6.09	7.10	Pass
60	5300	-4.67	-3.97	-4.79	-3.35	-3.22	-3.47	-3.20	-3.89	0.17	5.25	7.10	Pass
64	5320	-4.03	-6.11	-3.76	-4.65	-3.49	-5.34	-4.49	-0.99	0.17	5.18	7.10	Pass
100	5500	-2.95	-2.11	-3.43	-3.17	-5.08	-5.39	-3.39	-1.55	0.17	5.82	7.17	Pass
116	5580	-4.92	-4.12	-4.22	-3.94	-2.93	-2.17	-2.78	-2.71	0.17	5.65	7.17	Pass
140	5700	-3.51	-5.47	-2.58	-4.68	-3.43	-4.22	-2.74	-1.11	0.17	5.75	7.17	Pass
144 (UNII-2C Band)	5720	-3.27	-4.05	-2.28	-5.08	-2.54	-3.91	-4.05	-1.52	0.17	5.83	7.17	Pass

- Note: 1. Method a) of power density measurement of KDB 662911 is using for calculating total power density. Total power density is summing entire spectra across corresponding frequency bins on the various outputs by computer.
2. For U-NII-2A: Directional gain is 9.9dBi > 6dBi, so the power limit shall be reduced to 11-(9.9-6) = 7.10dBm.
3. For U-NII-2C: Directional gain is 9.83dB > 6dBi, so the power limit shall be reduced to 11-(9.83-6) = 7.17dBm.
4. Refer to section 3.3 for duty cycle spectrum plot.

### 802.11ac (VHT40)

Chan.	Freq. (MHz)	PSD W/O Duty Factor (dBm)								Duty Factor (dB)	Total PSD With Duty Factor (dBm)	Max. Limit (dBm/MHz)	Pass / Fail
		Chain 0	Chain 1	Chain 2	Chain 3	Chain 4	Chain 5	Chain 6	Chain 7				
54	5270	-5.97	-7.09	-7.07	-7.33	-7.98	-6.45	-10.05	-4.75	0.16	2.17	7.10	Pass
62	5310	-6.86	-6.88	-6.15	-5.69	-5.91	-5.60	-7.17	-4.38	0.16	3.04	7.10	Pass
102	5510	-6.73	-8.41	-7.97	-7.08	-7.86	-6.87	-6.43	-3.81	0.16	2.37	7.17	Pass
110	5550	-7.25	-4.57	-7.20	-8.46	-9.23	-6.62	-8.11	-3.19	0.16	2.65	7.17	Pass
134	5670	-6.86	-6.85	-7.03	-7.94	-7.36	-6.22	-6.51	-4.38	0.16	2.51	7.17	Pass
142 (UNII-2C Band)	5710	-5.91	-6.18	-5.54	-6.24	-4.89	-5.19	-7.79	-4.63	0.16	3.33	7.17	Pass

- Note: 1. Method a) of power density measurement of KDB 662911 is using for calculating total power density. Total power density is summing entire spectra across corresponding frequency bins on the various outputs by computer.
2. For U-NII-2A: Directional gain is 9.9dBi > 6dBi, so the power limit shall be reduced to  $11-(9.9-6) = 7.10\text{dBm}$ .
3. For U-NII-2C: Directional gain is 9.83dB > 6dBi, so the power limit shall be reduced to  $11-(9.83-6) = 7.17\text{dBm}$ .
4. Refer to section 3.3 for duty cycle spectrum plot.

### 802.11ac (VHT80)

Chan.	Freq. (MHz)	PSD W/O Duty Factor (dBm)								Duty Factor (dB)	Total PSD With Duty Factor (dBm)	Max. Limit (dBm/MHz)	Pass / Fail
		Chain 0	Chain 1	Chain 2	Chain 3	Chain 4	Chain 5	Chain 6	Chain 7				
58	5290	-9.85	-9.59	-9.36	-9.53	-8.36	-8.91	-10.25	-9.39	0.16	-0.34	7.10	Pass
106	5530	-10.50	-10.52	-10.95	-9.19	-9.42	-9.79	-8.81	-7.96	0.16	-0.51	7.17	Pass
122	5610	-8.43	-9.93	-11.51	-8.74	-9.97	-8.77	-8.94	-7.87	0.16	-0.12	7.17	Pass
138 (UNII-2C Band)	5690	-10.67	-10.17	-9.74	-9.93	-8.54	-8.04	-8.73	-8.41	0.16	-0.16	7.17	Pass

- Note: 1. Method a) of power density measurement of KDB 662911 is using for calculating total power density. Total power density is summing entire spectra across corresponding frequency bins on the various outputs by computer.
2. For U-NII-2A: Directional gain is 9.9dBi > 6dBi, so the power limit shall be reduced to  $11-(9.9-6) = 7.10\text{dBm}$ .
3. For U-NII-2C: Directional gain is 9.83dB > 6dBi, so the power limit shall be reduced to  $11-(9.83-6) = 7.17\text{dBm}$ .
4. Refer to section 3.3 for duty cycle spectrum plot.

**802.11ac (VHT80+80)**

Chan.	Freq. (MHz)	PSD W/O Duty Factor (dBm)								Duty Factor (dB)	Total PSD With Duty Factor (dBm)	Max. Limit (dBm/MHz)	Pass / Fail
		Chain 0	Chain 1	Chain 2	Chain 3	Chain 4	Chain 5	Chain 6	Chain 7				
58+106	5290	-6.85	-6.63	-6.80	-6.76	-	-	-	-	0.16	-0.74	7.10	Pass
	5530	-	-	-	-	-6.38	-7.31	-5.01	-4.66	0.16	0.31	7.17	Pass
106+122	5530	-9.00	-10.80	-10.25	-9.69	-	-	-	-	0.16	-3.86	7.17	Pass
	5610	-	-	-	-	-10.41	-10.19	-11.76	-7.93	0.16	-3.83	7.17	Pass
106+138 (UNII-2C Band) +138 (UNII-3 Band)	5530	-9.00	-10.80	-10.25	-9.69	-	-	-	-	0.16	-3.86	7.17	Pass
	5690	-	-	-	-	-8.91	-8.82	-9.88	-7.53	0.16	-2.68	7.17	Pass
	5690	Test results refer to U-NII-3 data											

- Note: 1. Method a) of power density measurement of KDB 662911 is using for calculating total power density. Total power density is summing entire spectra across corresponding frequency bins on the various outputs by computer.
2. For U-NII-2A: Directional gain is 9.9dBi > 6dBi, so the power limit shall be reduced to  $11-(9.9-6) = 7.10\text{dBm}$ .
3. For U-NII-2C: Directional gain is 9.83dB > 6dBi, so the power limit shall be reduced to  $11-(9.83-6) = 7.17\text{dBm}$ .
4. Refer to section 3.3 for duty cycle spectrum plot.



### 802.11ax (HE20)

Chan.	Freq. (MHz)	PSD W/O Duty Factor (dBm)								Duty Factor (dB)	Total PSD With Duty Factor (dBm)	Max. Limit (dBm/MHz)	Pass / Fail
		Chain 0	Chain 1	Chain 2	Chain 3	Chain 4	Chain 5	Chain 6	Chain 7				
52	5260	-4.66	-4.77	-3.49	-2.95	-4.72	-3.15	-3.11	-2.24	0.16	5.49	7.10	Pass
60	5300	-3.35	-4.82	-3.45	-2.00	-4.14	-3.93	-5.60	-3.32	0.16	5.32	7.10	Pass
64	5320	-5.73	-4.69	-3.65	-3.16	-3.58	-4.50	-4.25	-2.38	0.16	5.14	7.10	Pass
100	5500	-4.82	-5.24	-4.31	-3.48	-3.04	-4.61	-5.02	-1.93	0.16	5.11	7.17	Pass
116	5580	-6.18	-4.53	-3.74	-2.73	-4.17	-2.82	-3.83	-2.44	0.16	5.36	7.17	Pass
140	5700	-4.08	-2.40	-3.56	-4.23	-3.21	-3.23	-3.04	-3.60	0.16	5.65	7.17	Pass
144 (UNII-2C Band)	5720	-4.37	-7.67	-2.39	-2.69	-2.80	-2.89	-4.33	-2.73	0.16	5.55	7.17	Pass

- Note: 1. Method a) of power density measurement of KDB 662911 is using for calculating total power density. Total power density is summing entire spectra across corresponding frequency bins on the various outputs by computer.
2. For U-NII-2A: Directional gain is 9.9dBi > 6dBi, so the power limit shall be reduced to  $11-(9.9-6) = 7.10$ dBm.
3. For U-NII-2C: Directional gain is 9.83dB > 6dBi, so the power limit shall be reduced to  $11-(9.83-6) = 7.17$ dBm.
4. Refer to section 3.3 for duty cycle spectrum plot.

### 802.11ax (HE40)

Chan.	Freq. (MHz)	PSD W/O Duty Factor (dBm)								Duty Factor (dB)	Total PSD With Duty Factor (dBm)	Max. Limit (dBm/MHz)	Pass / Fail
		Chain 0	Chain 1	Chain 2	Chain 3	Chain 4	Chain 5	Chain 6	Chain 7				
54	5270	-7.53	-8.95	-7.61	-6.14	-6.57	-7.90	-5.39	-5.52	0.18	2.23	7.10	Pass
62	5310	-6.74	-6.49	-5.73	-5.70	-5.54	-5.66	-5.76	-6.32	0.18	3.06	7.10	Pass
102	5510	-7.72	-7.20	-7.28	-5.90	-8.11	-6.50	-7.29	-5.51	0.18	2.17	7.17	Pass
110	5550	-7.15	-7.68	-6.60	-6.89	-5.50	-6.47	-5.65	-6.82	0.18	2.49	7.17	Pass
134	5670	-7.66	-6.90	-6.83	-7.02	-7.97	-6.97	-6.70	-6.16	0.18	2.04	7.17	Pass
142 (UNII-2C Band)	5710	-6.40	-6.62	-6.70	-6.47	-4.96	-5.14	-5.37	-5.91	0.18	3.14	7.17	Pass

- Note: 1. Method a) of power density measurement of KDB 662911 is using for calculating total power density. Total power density is summing entire spectra across corresponding frequency bins on the various outputs by computer.
2. For U-NII-2A: Directional gain is 9.9dBi > 6dBi, so the power limit shall be reduced to  $11-(9.9-6) = 7.10$ dBm.
3. For U-NII-2C: Directional gain is 9.83dB > 6dBi, so the power limit shall be reduced to  $11-(9.83-6) = 7.17$ dBm.
4. Refer to section 3.3 for duty cycle spectrum plot.

### 802.11ax (HE80)

Chan.	Freq. (MHz)	PSD W/O Duty Factor (dBm)								Duty Factor (dB)	Total PSD With Duty Factor (dBm)	Max. Limit (dBm/MHz)	Pass / Fail
		Chain 0	Chain 1	Chain 2	Chain 3	Chain 4	Chain 5	Chain 6	Chain 7				
58	5290	-10.16	-10.24	-10.05	-10.32	-9.39	-9.30	-8.19	-10.51	0.16	-0.68	7.10	Pass
106	5530	-11.58	-10.66	-10.08	-9.46	-8.80	-8.81	-9.06	-10.65	0.16	-0.75	7.17	Pass
122	5610	-9.13	-8.66	-10.24	-8.56	-9.86	-9.31	-9.02	-11.40	0.16	-0.41	7.17	Pass
138 (UNII-2C Band)	5690	-9.46	-11.11	-9.32	-8.42	-7.96	-9.43	-8.02	-9.06	0.16	0.03	7.17	Pass

- Note: 1. Method a) of power density measurement of KDB 662911 is using for calculating total power density. Total power density is summing entire spectra across corresponding frequency bins on the various outputs by computer.
2. For U-NII-2A: Directional gain is 9.9dBi > 6dBi, so the power limit shall be reduced to 11-(9.9-6) = 7.10dBm.
3. For U-NII-2C: Directional gain is 9.83dB > 6dBi, so the power limit shall be reduced to 11-(9.83-6) = 7.17dBm.
4. Refer to section 3.3 for duty cycle spectrum plot.

### 802.11ax (HE80+80)

Chan.	Freq. (MHz)	PSD W/O Duty Factor (dBm)								Duty Factor (dB)	Total PSD With Duty Factor (dBm)	Max. Limit (dBm/MHz)	Pass / Fail
		Chain 0	Chain 1	Chain 2	Chain 3	Chain 4	Chain 5	Chain 6	Chain 7				
58+106	5290	-6.74	-6.47	-6.52	-6.79	-	-	-	-	0.16	-0.61	7.10	Pass
	5530	-	-	-	-	-5.74	-6.60	-4.36	-10.46	0.16	-0.26	7.17	Pass
106+122	5530	-9.90	-10.21	-8.61	-9.71	-	-	-	-	0.16	-3.54	7.17	Pass
	5610	-	-	-	-	-11.47	-10.11	-9.97	-8.17	0.16	-3.75	7.17	Pass
106+138 (UNII-2C Band)	5530	-9.90	-10.21	-8.61	-9.71	-	-	-	-	0.16	-3.54	7.17	Pass
	5690	-	-	-	-	-8.51	-9.09	-9.79	-7.87	0.16	-2.74	7.17	Pass
+138 (UNII-3 Band)	5690	Test results refer to U-NII-3 data											

- Note: 1. Method a) of power density measurement of KDB 662911 is using for calculating total power density. Total power density is summing entire spectra across corresponding frequency bins on the various outputs by computer.
2. For U-NII-2A: Directional gain is 9.9dBi > 6dBi, so the power limit shall be reduced to 11-(9.9-6) = 7.10dBm.
3. For U-NII-2C: Directional gain is 9.83dB > 6dBi, so the power limit shall be reduced to 11-(9.83-6) = 7.17dBm.
4. Refer to section 3.3 for duty cycle spectrum plot.

Spectrum Plot of Worst Value

802.11a\_Chain 7 / CH116

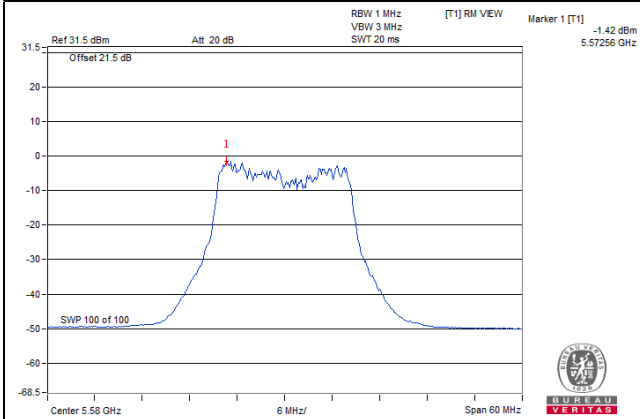

802.11ac (VHT20)\_Chain 7 / CH64

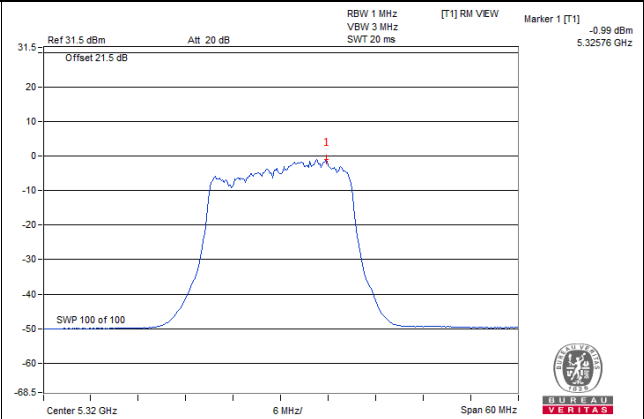

802.11ac (VHT40)\_Chain 7 / CH110

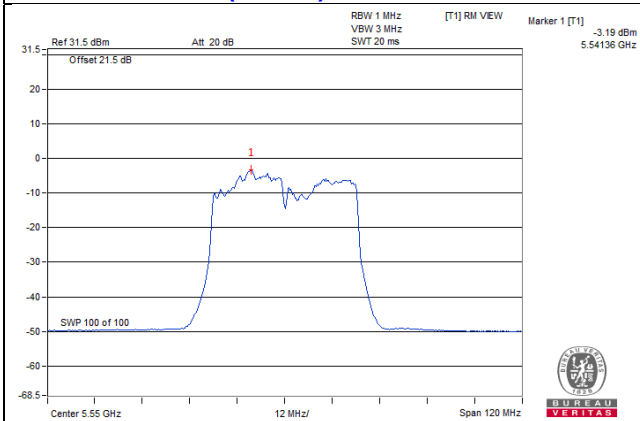

802.11ac (VHT80)\_Chain 7 / CH122

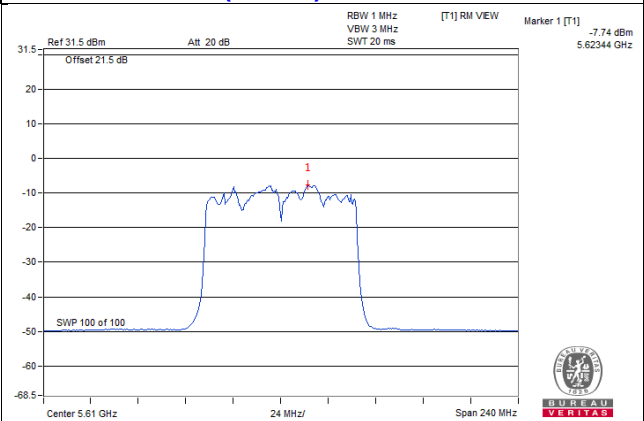

802.11ac (VHT80+80)\_Chain 7 / CH106

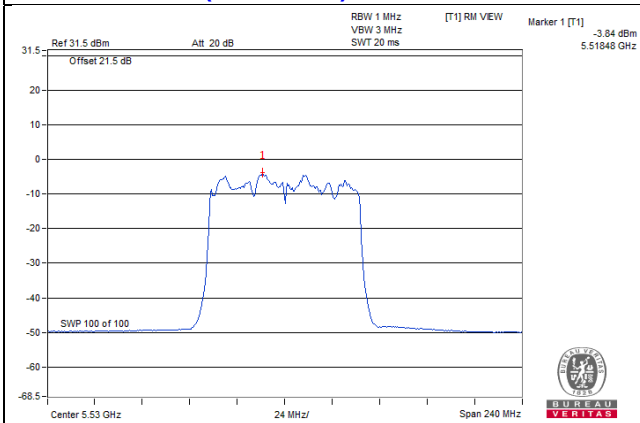

Spectrum Plot of Worst Value

802.11ax (HE20)\_Chain 7 / CH100

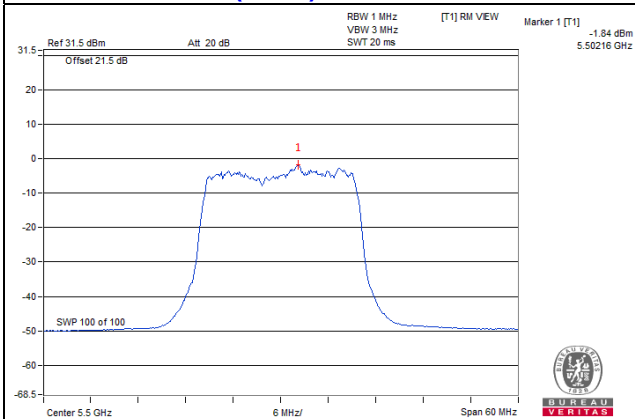

802.11ax (HE40)\_Chain 4 / CH142 (UNII-2C Band)

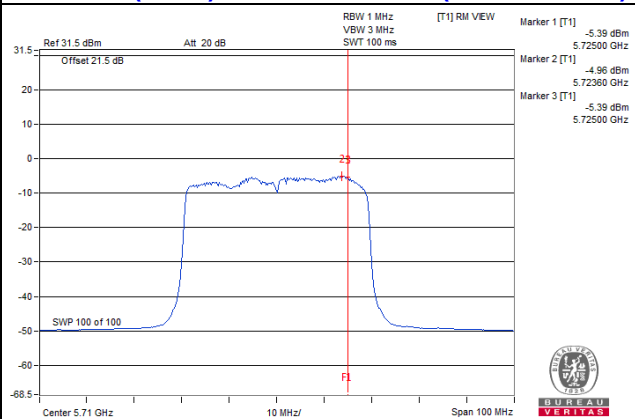

802.11ax (HE80)\_Chain 4 / CH138 (UNII-2C Band)

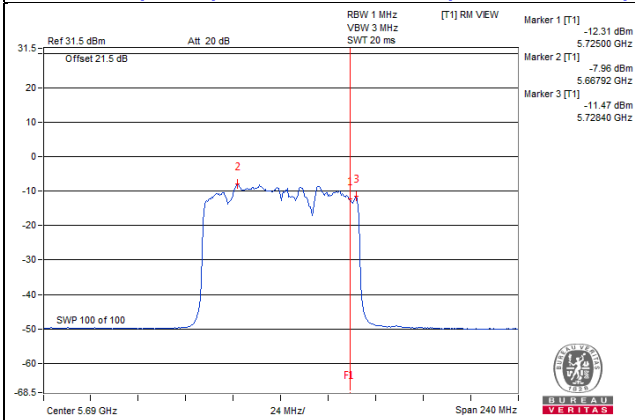

802.11ax (HE80+80)\_Chain 6 / CH106

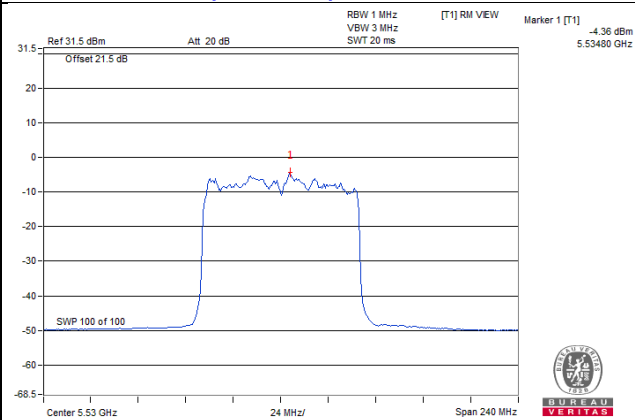

**For U-NII-3:**

**802.11a**

Chan.	Freq. (MHz)	PSD W/O Duty Factor (dBm/300kHz)								Duty Factor (dB)	Total PSD With Duty Factor		Total PSD With Duty Factor (dBm/500kHz)	Limit (dBm/500kHz)	Pass /Fail
		Chain 0	Chain 1	Chain 2	Chain 3	Chain 4	Chain 5	Chain 6	Chain 7		mW/300kHz	dBm/300kHz			
144 (UNII-3 Band)	5720	-13.87	-11.53	-12.27	-14.02	-15.94	-13.51	-11.62	-15.34	0.52	0.37839	-4.22	-2.00	25.73	Pass

- Note: 1. Method b) Measure and sum spectral maxima across the outputs of KDB 662911 is using for calculating total power density.  
 2. Directional gain is 10.27dBi > 6dBi, so the power limit shall be reduced to 30-(10.27-6) = 25.73dBm.  
 3. Refer to section 3.3 for duty cycle spectrum plot.

**802.11ac (VHT20)**

Chan.	Freq. (MHz)	PSD W/O Duty Factor (dBm/300kHz)								Duty Factor (dB)	Total PSD With Duty Factor		Total PSD With Duty Factor (dBm/500kHz)	Limit (dBm/500kHz)	Pass /Fail
		Chain 0	Chain 1	Chain 2	Chain 3	Chain 4	Chain 5	Chain 6	Chain 7		mW/300kHz	dBm/300kHz			
144 (UNII-3 Band)	5720	-14.08	-16.34	-13.96	-14.22	-13.55	-12.32	-12.41	-12.20	0.17	0.36077	-4.43	-2.21	25.73	Pass

- Note: 1. Method b) Measure and sum spectral maxima across the outputs of KDB 662911 is using for calculating total power density.  
 2. Directional gain is 10.27dBi > 6dBi, so the power limit shall be reduced to 30-(10.27-6) = 25.73dBm.  
 3. Refer to section 3.3 for duty cycle spectrum plot.

**802.11ac (VHT40)**

Chan.	Freq. (MHz)	PSD W/O Duty Factor (dBm/300kHz)								Duty Factor (dB)	Total PSD With Duty Factor		Total PSD With Duty Factor (dBm/500kHz)	Limit (dBm/500kHz)	Pass /Fail
		Chain 0	Chain 1	Chain 2	Chain 3	Chain 4	Chain 5	Chain 6	Chain 7		mW/300kHz	dBm/300kHz			
142 (UNII-3 Band)	5710	-17.25	-16.49	-17.46	-15.11	-15.81	-14.67	-15.32	-16.41	0.16	0.20265	-6.93	-4.71	25.73	Pass

- Note: 1. Method b) Measure and sum spectral maxima across the outputs of KDB 662911 is using for calculating total power density.  
 2. Directional gain is 10.27dBi > 6dBi, so the power limit shall be reduced to 30-(10.27-6) = 25.73dBm.  
 3. Refer to section 3.3 for duty cycle spectrum plot.

### 802.11ac (VHT80)

Chan.	Freq. (MHz)	PSD W/O Duty Factor (dBm/300kHz)								Duty Factor (dB)	Total PSD With Duty Factor		Total PSD With Duty Factor (dBm/500kHz)	Limit (dBm/ 500kHz)	Pass /Fail
		Chain 0	Chain 1	Chain 2	Chain 3	Chain 4	Chain 5	Chain 6	Chain 7		mW/ 300kHz	dBm/ 300kHz			
138 (UNII-3 Band)	5690	-21.17	-21.95	-21.17	-21.31	-21.18	-20.50	-20.98	-21.15	0.16	0.06124	-12.13	-9.91	25.73	Pass

- Note: 1. Method b) Measure and sum spectral maxima across the outputs of KDB 662911 is using for calculating total power density.
2. Directional gain is 10.27dBi > 6dBi, so the power limit shall be reduced to 30-(10.27-6) = 25.73dBm.
3. Refer to section 3.3 for duty cycle spectrum plot.

### 802.11ac (VHT80+80)

Chan.	Freq. (MHz)	PSD W/O Duty Factor (dBm/300kHz)								Duty Factor (dB)	Total PSD With Duty Factor		Total PSD With Duty Factor (dBm/500kHz)	Limit (dBm/ 500kHz)	Pass /Fail
		Chain 0	Chain 1	Chain 2	Chain 3	Chain 4	Chain 5	Chain 6	Chain 7		mW/ 300kHz	dBm/ 300kHz			
106+ 138 (UNII-2C Band) +138 (UNII-3 Band)	5530	Test results refer to U_NII-2C data													
	5690	Test results refer to U_NII-2C data													
	5690	-	-	-	-	-21.26	-21.55	-21.50	-19.96	0.16	0.03165	-15.00	-12.78	25.73	Pass

- Note: 1. Method b) Measure and sum spectral maxima across the outputs of KDB 662911 is using for calculating total power density.
2. Directional gain is 10.27dBi > 6dBi, so the power limit shall be reduced to 30-(10.27-6) = 25.73dBm.
3. Refer to section 3.3 for duty cycle spectrum plot.

### 802.11ax (HE20)

Chan.	Freq. (MHz)	PSD W/O Duty Factor (dBm/300kHz)								Duty Factor (dB)	Total PSD With Duty Factor		Total PSD With Duty Factor (dBm/500kHz)	Limit (dBm/500kHz)	Pass /Fail
		Chain 0	Chain 1	Chain 2	Chain 3	Chain 4	Chain 5	Chain 6	Chain 7		mW/300kHz	dBm/300kHz			
144 (UNII-3 Band)	5720	-13.93	-11.63	-12.96	-12.94	-13.16	-13.21	-14.21	-13.35	0.16	0.39079	-4.08	-1.86	25.73	Pass

- Note: 1. Method b) Measure and sum spectral maxima across the outputs of KDB 662911 is using for calculating total power density.
2. Directional gain is 10.27dBi > 6dBi, so the power limit shall be reduced to  $30-(10.27-6) = 25.73\text{dBm}$ .
3. Refer to section 3.3 for duty cycle spectrum plot.

### 802.11ax (HE40)

Chan.	Freq. (MHz)	PSD W/O Duty Factor (dBm/300kHz)								Duty Factor (dB)	Total PSD With Duty Factor		Total PSD With Duty Factor (dBm/500kHz)	Limit (dBm/500kHz)	Pass /Fail
		Chain 0	Chain 1	Chain 2	Chain 3	Chain 4	Chain 5	Chain 6	Chain 7		mW/300kHz	dBm/300kHz			
142 (UNII-3 Band)	5710	-16.37	-19.22	-15.52	-15.81	-14.16	-15.46	-16.33	-17.04	0.18	0.1992	-7.01	-4.79	25.73	Pass

- Note: 1. Method b) Measure and sum spectral maxima across the outputs of KDB 662911 is using for calculating total power density.
2. Directional gain is 10.27dBi > 6dBi, so the power limit shall be reduced to  $30-(10.27-6) = 25.73\text{dBm}$ .
3. Refer to section 3.3 for duty cycle spectrum plot.

### 802.11ax (HE80)

Chan.	Freq. (MHz)	PSD W/O Duty Factor (dBm/300kHz)								Duty Factor (dB)	Total PSD With Duty Factor		Total PSD With Duty Factor (dBm/500kHz)	Limit (dBm/500kHz)	Pass /Fail
		Chain 0	Chain 1	Chain 2	Chain 3	Chain 4	Chain 5	Chain 6	Chain 7		mW/300kHz	dBm/300kHz			
138 (UNII-3 Band)	5690	-20.46	-19.16	-21.14	-20.90	-21.23	-20.71	-20.15	-19.48	0.16	0.07391	-11.31	-9.09	25.73	Pass

- Note: 1. Method b) Measure and sum spectral maxima across the outputs of KDB 662911 is using for calculating total power density.
2. Directional gain is 10.27dBi > 6dBi, so the power limit shall be reduced to  $30-(10.27-6) = 25.73\text{dBm}$ .
3. Refer to section 3.3 for duty cycle spectrum plot.

### 802.11ax (HE80+80)

Chan.	Freq. (MHz)	PSD W/O Duty Factor (dBm/300kHz)								Duty Factor (dB)	Total PSD With Duty Factor		Total PSD With Duty Factor (dBm/500kHz)	Limit (dBm/ 500kHz)	Pass /Fail
		Chain 0	Chain 1	Chain 2	Chain 3	Chain 4	Chain 5	Chain 6	Chain 7		mW/ 300kHz	dBm/ 300kHz			
106+ 138 (UNII-2C Band) +138 (UNII-3 Band)	5530	Test results refer to U_NII-2C data													
	5690	Test results refer to U_NII-2C data													
	5690	-	-	-	-	-20.01	-20.97	-19.12	-18.68	0.16	0.04377	-13.59	-11.37	25.73	Pass

- Note: 1. Method b) Measure and sum spectral maxima across the outputs of KDB 662911 is using for calculating total power density.
2. Directional gain is 10.27dBi > 6dBi, so the power limit shall be reduced to 30-(10.27-6) = 25.73dBm.
3. Refer to section 3.3 for duty cycle spectrum plot.



### Spectrum Plot of Worst Value

**802.11a\_Chain 1 / CH144 (UNII-3 Band)**

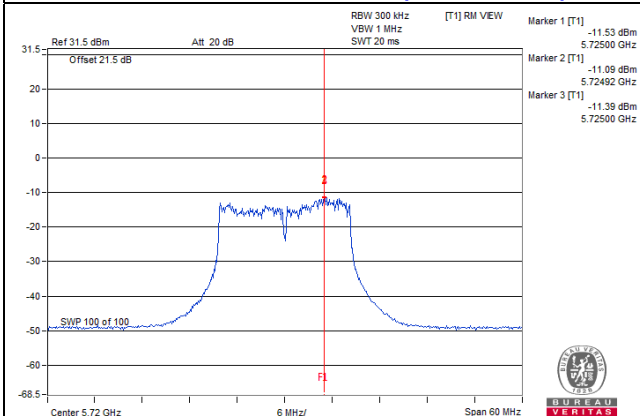

**802.11ac (VHT20)\_Chain 7 / CH144 (UNII-3 Band)**

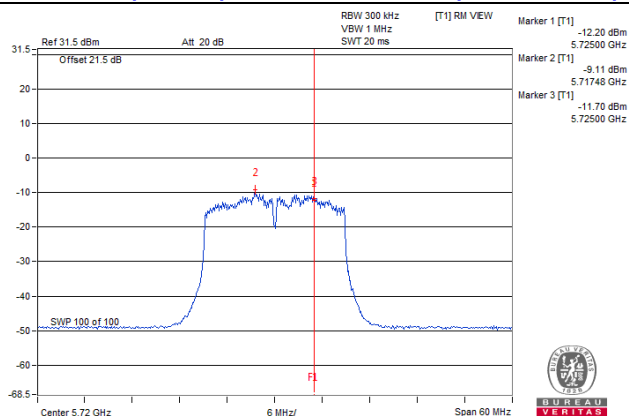

**802.11ac (VHT40)\_Chain 5 / CH142 (UNII-3 Band)**

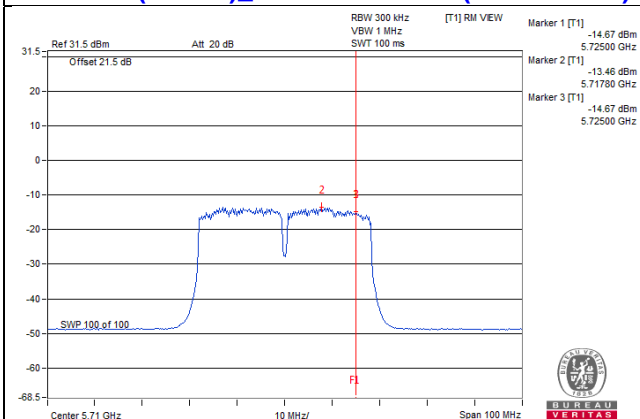

**802.11ac (VHT80)\_Chain 5 / CH138 (UNII-3 Band)**

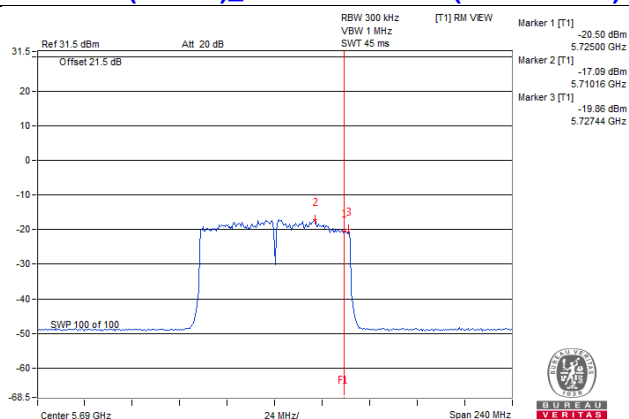

**802.11ac (VHT80+80)  
Chain 7 / CH138 (UNII-2C Band)**

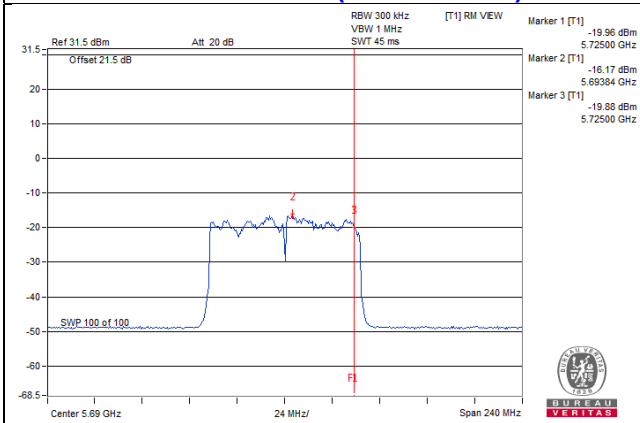

Spectrum Plot of Worst Value

802.11ax (HE20)\_Chain 1 / CH144 (UNII-3 Band)

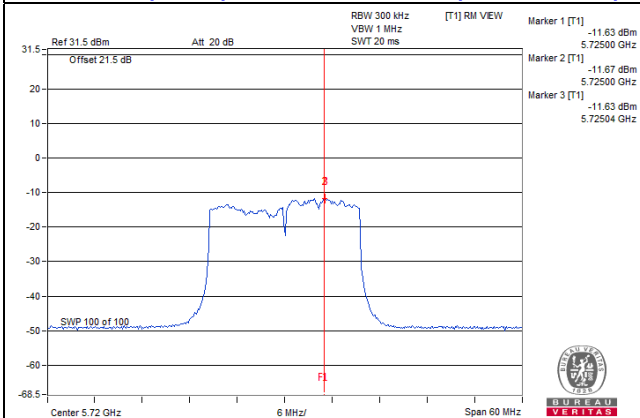

802.11ax (HE40)\_Chain 4 / CH142 (UNII-3 Band)

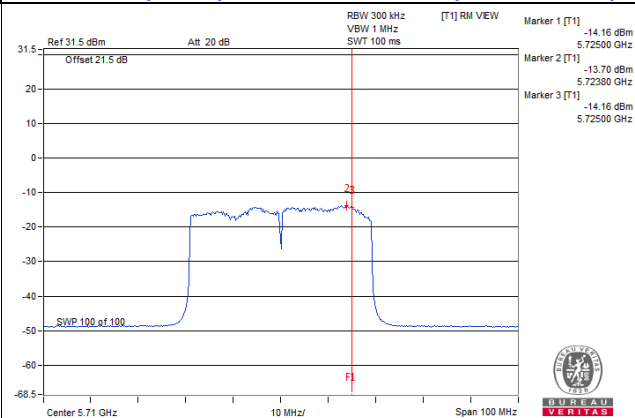

802.11ax (HE80)\_Chain 1 / CH138 (UNII-3 Band)

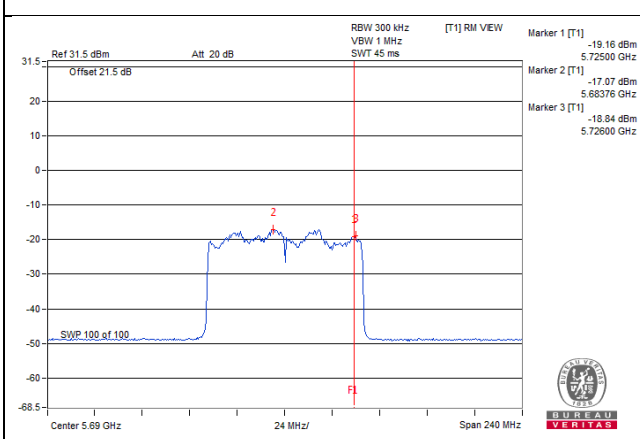

802.11ax (HE80+80)  
Chain 7 / CH138 (UNII-2C Band)

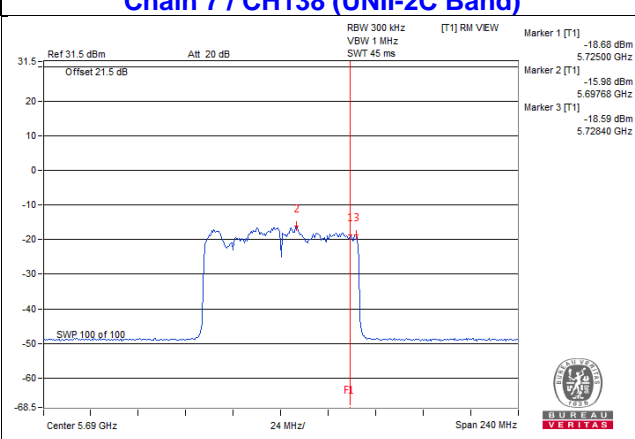

## 4.6 Frequency Stability Measurement

### 4.6.1 Limits of Frequency Stability Measurement

The frequency of the carrier signal shall be maintained within band of operation

### 4.6.2 Test Setup

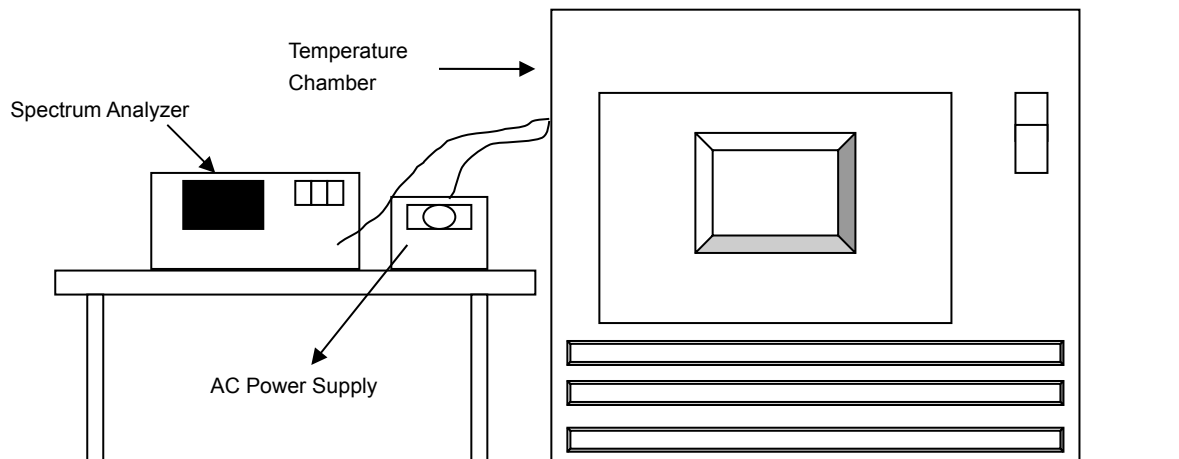

### 4.6.3 Test Instruments

Refer to section 4.1.2 to get information of above instrument.

### 4.6.4 Test Procedure

- The EUT was placed inside the environmental test chamber and powered by nominal AC voltage.
- Turn the EUT on and couple its output to a spectrum analyzer.
- Turn the EUT off and set the chamber to the highest temperature specified.
- Allow sufficient time (approximately 30 min) for the temperature of the chamber to stabilize, turn the EUT on and measure the operating frequency after 2, 5, and 10 Minutes.
- Repeat step 2 and 3 with the temperature chamber set to the lowest temperature.
- The test chamber was allowed to stabilize at +20 degree C for a minimum of 30 Minutes. The supply voltage was then adjusted on the EUT from 85% to 115% and the frequency record.

### 4.6.5 Deviation from Test Standard

No deviation.

### 4.6.6 EUT Operating Condition

Set the EUT transmit at un-modulation mode to test frequency stability.

## 4.6.7 Test Results

Frequency Stability Versus Temp.									
Operating Frequency: 5260 MHz									
TEMP. (°C)	Power Supply (Vac)	0 Minute		2 Minutes		5 Minutes		10 Minutes	
		Measured Frequency (MHz)	Pass/Fail	Measured Frequency (MHz)	Pass/Fail	Measured Frequency (MHz)	Pass/Fail	Measured Frequency (MHz)	Pass/Fail
50	120	5260.0085	Pass	5260.008	Pass	5260.0083	Pass	5260.0091	Pass
40	120	5260.0132	Pass	5260.0114	Pass	5260.0139	Pass	5260.0144	Pass
30	120	5259.9888	Pass	5259.992	Pass	5259.9913	Pass	5259.9884	Pass
20	120	5259.9835	Pass	5259.9844	Pass	5259.9825	Pass	5259.983	Pass
10	120	5259.9996	Pass	5259.9985	Pass	5259.9984	Pass	5259.9969	Pass
0	120	5259.9735	Pass	5259.9757	Pass	5259.9738	Pass	5259.9758	Pass
-10	120	5260.0161	Pass	5260.012	Pass	5260.0146	Pass	5260.011	Pass
-20	120	5259.9792	Pass	5259.98	Pass	5259.9817	Pass	5259.9818	Pass
-30	120	5260.0026	Pass	5260.0028	Pass	5259.9986	Pass	5259.9996	Pass

Frequency Stability Versus Voltage									
Operating Frequency: 5260 MHz									
TEMP. (°C)	Power Supply (Vac)	0 Minute		2 Minutes		5 Minutes		10 Minutes	
		Measured Frequency (MHz)	Pass/Fail	Measured Frequency (MHz)	Pass/Fail	Measured Frequency (MHz)	Pass/Fail	Measured Frequency (MHz)	Pass/Fail
20	138	5259.9832	Pass	5259.9854	Pass	5259.9829	Pass	5259.9828	Pass
	120	5259.9835	Pass	5259.9844	Pass	5259.9825	Pass	5259.983	Pass
	102	5259.9832	Pass	5259.9853	Pass	5259.9829	Pass	5259.9833	Pass

## 4.7 6dB Bandwidth Measurement

### 4.7.1 Limits of 6dB Bandwidth Measurement

The minimum of 6dB Bandwidth Measurement is 0.5MHz.

### 4.7.2 Test Setup

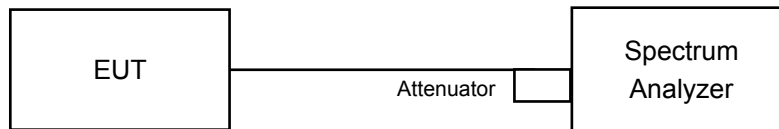

### 4.7.3 Test Instruments

Refer to section 4.1.2 to get information of above instrument.

### 4.7.4 Test Procedure

#### MEASUREMENT PROCEDURE REF

- a. Set resolution bandwidth (RBW) = 100kHz
- b. Set the video bandwidth (VBW)  $\geq 3 \times$  RBW, Detector = Peak.
- c. Trace mode = max hold.
- d. Sweep = auto couple.
- e. Measure the maximum width of the emission that is constrained by the frequencies associated with the two amplitude points (upper and lower) that are attenuated by 6 dB relative to the maximum level measured in the fundamental emission

### 4.7.5 Deviation from Test Standard

No deviation.

### 4.7.6 EUT Operating Condition

The software provided by client to enable the EUT under transmission condition continuously at lowest, middle and highest channel frequencies individually.

#### 4.7.7 Test Results

#### Non-Beamforming Mode

#### 802.11a

Channel	Frequency (MHz)	6dB Bandwidth (MHz)								Minimum Limit (MHz)	Pass / Fail
		Chain 0	Chain 1	Chain 2	Chain 3	Chain 4	Chain 5	Chain 6	Chain 7		
144 (UNII-3 Band)	5720	3.14	3.12	3.16	3.14	3.16	3.12	3.14	3.10	0.5	Pass

Note: The 6dB bandwidth above 5725MHz = Marker 1 + Delta 2 - 5725MHz

#### 802.11ax (HE20)

Channel	Frequency (MHz)	6dB Bandwidth (MHz)								Minimum Limit (MHz)	Pass / Fail
		Chain 0	Chain 1	Chain 2	Chain 3	Chain 4	Chain 5	Chain 6	Chain 7		
144 (UNII-3 Band)	5720	3.78	4.22	4.24	4.33	4.46	4.45	4.27	4.10	0.5	Pass

Note: The 6dB bandwidth above 5725MHz = Marker 1 + Delta 2 - 5725MHz

#### 802.11ax (HE40)

Channel	Frequency (MHz)	6dB Bandwidth (MHz)								Minimum Limit (MHz)	Pass / Fail
		Chain 0	Chain 1	Chain 2	Chain 3	Chain 4	Chain 5	Chain 6	Chain 7		
142 (UNII-3 Band)	5710	0.35	2.58	3.90	4.03	3.44	3.71	3.61	3.72	0.5	Pass

Note: The 6dB bandwidth above 5725MHz = Marker 1 + Delta 2 - 5725MHz

#### 802.11ax (HE80)

Channel	Frequency (MHz)	6dB Bandwidth (MHz)								Minimum Limit (MHz)	Pass / Fail
		Chain 0	Chain 1	Chain 2	Chain 3	Chain 4	Chain 5	Chain 6	Chain 7		
138 (UNII-3 Band)	5690	4.86	3.70	2.83	3.46	2.74	3.42	1.36	2.53	0.5	Pass

Note: The 6dB bandwidth above 5725MHz = Marker 1 + Delta 2 - 5725MHz

#### 802.11ax (HE80+80)

Channel	Frequency (MHz)	6dB Bandwidth (MHz)								Minimum Limit (MHz)	Pass / Fail
		Chain 0	Chain 1	Chain 2	Chain 3	Chain 4	Chain 5	Chain 6	Chain 7		
106+ 138 (UNII-2C Band) +138 (UNII-3 Band)	5530	-									
	5690	-									
	5690	-	-	-	-	3.86	1.43	3.04	3.82	0.5	Pass

Note: The 6dB bandwidth above 5725MHz = Marker 1 + Delta 2 - 5725MHz

**Spectrum Plot of Worst Value**

**802.11a / Chain 7 - CH144 (UNII-3 Band)**

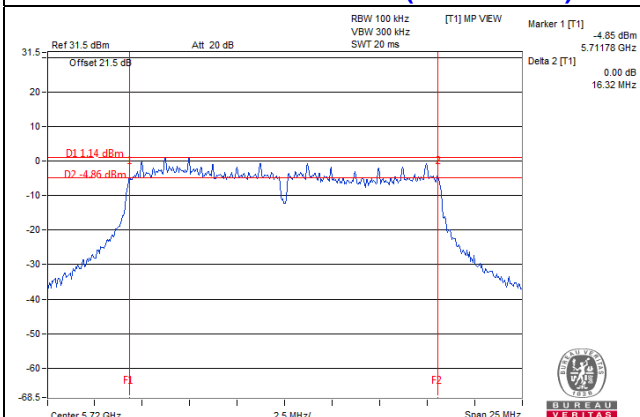

**802.11ax (HE20) / Chain 0 - CH144 (UNII-3 Band)**

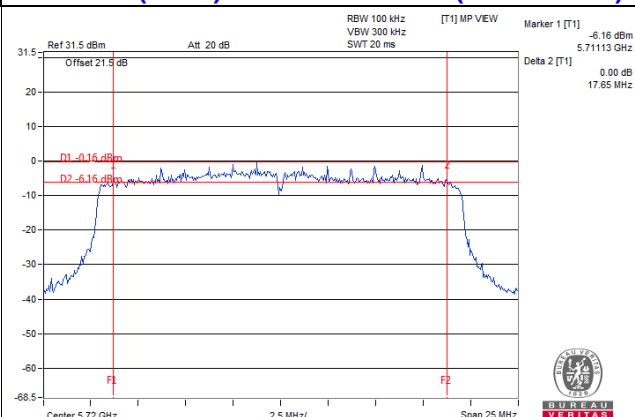

**802.11ax (HE40) / Chain 0 - CH142 (UNII-3 Band)**

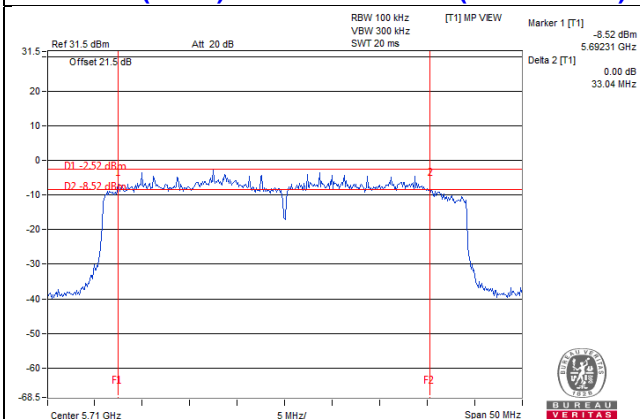

**802.11ax (HE80) / Chain 6 - CH138 (UNII-3 Band)**

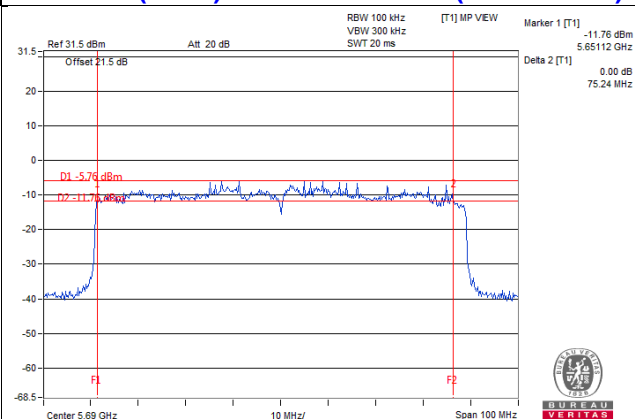

**802.11ax (HE80+80) / Chain 5 - CH138 (UNII-3 Band)**

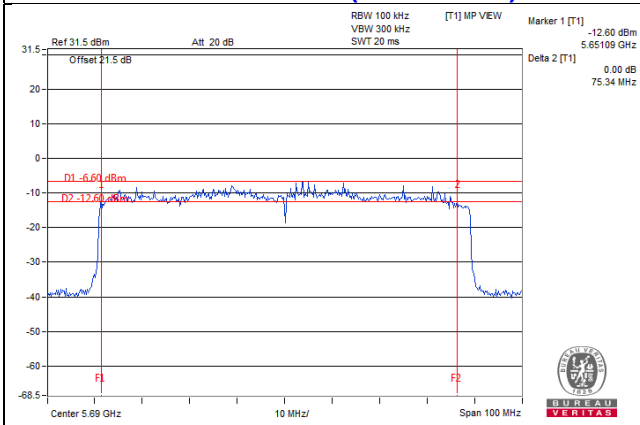

## 5 Pictures of Test Arrangements

Please refer to the attached file (Test Setup Photo).



## Appendix – Information of the Testing Laboratories

We, Bureau Veritas Consumer Products Services (H.K.) Ltd., Taoyuan Branch, were founded in 1988 to provide our best service in EMC, Radio, Telecom and Safety consultation. Our laboratories are FCC recognized accredited test firms and accredited according to ISO/IEC 17025.

If you have any comments, please feel free to contact us at the following:

**Linkou EMC/RF Lab**

Tel: 886-2-26052180

Fax: 886-2-26051924

**Hsin Chu EMC/RF/Telecom Lab**

Tel: 886-3-6668565

Fax: 886-3-6668323

**Hwa Ya EMC/RF/Safety Lab**

Tel: 886-3-3183232

Fax: 886-3-3270892

**Email:** [service.adt@tw.bureauveritas.com](mailto:service.adt@tw.bureauveritas.com)

**Web Site:** [www.bureauveritas-adt.com](http://www.bureauveritas-adt.com)

The address and road map of all our labs can be found in our web site also.

--- END ---