

FCC Test Report (WLAN)

Report No.: RF180611E01-1

FCC ID: 2ABLK-GS2026

Test Model: GS2026E

Received Date: June 08, 2018

Test Date: June 16 to 28, 2018

Issued Date: July 12, 2018

Applicant: Calix Inc.

Address: 1035 N. McDowell Blvd. Petaluma, CA 94954 U.S.A.

Issued By: Bureau Veritas Consumer Products Services (H.K.) Ltd., Taoyuan Branch
Hsin Chu Laboratory

Lab Address: E-2, No.1, Li Hsin 1st Road, Hsinchu Science Park, Hsinchu City 300,
Taiwan R.O.C.

Test Location: E-2, No.1, Li Hsin 1st Road, Hsinchu Science Park, Hsinchu City 300,
Taiwan R.O.C.

**FCC Registration /
Designation Number:** 723255 / TW2022



This report is for your exclusive use. Any copying or replication of this report to or for any other person or entity, or use of our name or trademark, is permitted only with our prior written permission. This report sets forth our findings solely with respect to the test samples identified herein. The results set forth in this report are not indicative or representative of the quality or characteristics of the lot from which a test sample was taken or any similar or identical product unless specifically and expressly noted. Our report includes all of the tests requested by you and the results thereof based upon the information that you provided to us. You have 60 days from date of issuance of this report to notify us of any material error or omission caused by our negligence, provided, however, that such notice shall be in writing and shall specifically address the issue you wish to raise. A failure to raise such issue within the prescribed time shall constitute your unqualified acceptance of the completeness of this report, the tests conducted and the correctness of the report contents. Unless specific mention, the uncertainty of measurement has been explicitly taken into account to declare the compliance or non-compliance to the specification. The report must not be used by the client to claim product certification, approval, or endorsement by TAF or any government agencies.

Table of Contents

Release Control Record	4
1 Certificate of Conformity	5
2 Summary of Test Results	6
2.1 Measurement Uncertainty	6
2.2 Modification Record	6
3 General Information	7
3.1 General Description of EUT (WLAN)	7
3.2 Description of Test Modes	12
3.2.1 Test Mode Applicability and Tested Channel Detail	13
3.3 Duty Cycle of Test Signal	15
3.4 Description of Support Units	17
3.4.1 Configuration of System under Test	18
3.5 General Description of Applied Standard	19
4 Test Types and Results	20
4.1 Radiated Emission and Bandedge Measurement	20
4.1.1 Limits of Radiated Emission and Bandedge Measurement	20
4.1.2 Test Instruments	21
4.1.3 Test Procedure	22
4.1.4 Deviation from Test Standard	22
4.1.5 Test Setup	23
4.1.6 EUT Operating Condition	24
4.1.7 Test Results	25
4.2 Conducted Emission Measurement	60
4.2.1 Limits of Conducted Emission Measurement	60
4.2.2 Test Instruments	60
4.2.3 Test Procedure	61
4.2.4 Deviation from Test Standard	61
4.2.5 Test Setup	61
4.2.6 EUT Operating Condition	61
4.2.7 Test Results	62
4.3 Transmit Power Measurement	64
4.3.1 Limits of Transmit Power Measurement	64
4.3.2 Test Setup	64
4.3.3 Test Instruments	64
4.3.4 Test Procedure	64
4.3.5 Deviation from Test Standard	64
4.3.6 EUT Operating Condition	64
4.3.7 Test Result	65
4.4 Occupied Bandwidth Measurement	69
4.4.1 Test Setup	69
4.4.2 Test Instruments	69
4.4.3 Test Procedure	69
4.4.4 Test Results	70
4.5 Peak Power Spectral Density Measurement	92
4.5.1 Limits of Peak Power Spectral Density Measurement	92
4.5.2 Test Setup	92
4.5.3 Test Instruments	92
4.5.4 Test Procedure	92
4.5.5 Deviation from Test Standard	92
4.5.6 EUT Operating Condition	92
4.5.7 Test Results	93
4.6 Frequency Stability Measurement	105
4.6.1 Limits of Frequency Stability Measurement	105

4.6.2	Test Setup.....	105
4.6.3	Test Instruments	105
4.6.4	Test Procedure	105
4.6.5	Deviation from Test Standard	105
4.6.6	EUT Operating Condition	105
4.6.7	Test Results	106
4.7	6dB Bandwidth Measurement	107
4.7.1	Limits of 6dB Bandwidth Measurement.....	107
4.7.2	Test Setup.....	107
4.7.3	Test Instruments	107
4.7.4	Test Procedure	107
4.7.5	Deviation from Test Standard	107
4.7.6	EUT Operating Condition	107
4.7.7	Test Results	108
5	Pictures of Test Arrangements.....	112
	Annex A- Radiated Out of Band Emission (OOBE) Measurement (For U-NII-3 band)	113
	Appendix – Information on the Testing Laboratories	122

Release Control Record

Issue No.	Description	Date Issued
RF180611E01-1	Original release.	July 12, 2018

1 Certificate of Conformity

Product: GigaSpire

Brand: Calix

Test Model: GS2026E

Sample Status: MASS-PRODUCTION

Applicant: Calix Inc.

Test Date: June 16 to 28, 2018

Standard: 47 CFR FCC Part 15, Subpart E (Section 15.407)
ANSI C63.10: 2013

The above equipment has been tested by **Bureau Veritas Consumer Products Services (H.K.) Ltd., Taoyuan Branch**, and found compliance with the requirement of the above standards. The test record, data evaluation & Equipment Under Test (EUT) configurations represented herein are true and accurate accounts of the measurements of the sample's EMC characteristics under the conditions specified in this report.

Prepared by :

Mary Ko

Date: July 12, 2018

Mary Ko / Specialist

Approved by :

May Chen

Date: July 12, 2018

May Chen / Manager

2 Summary of Test Results

47 CFR FCC Part 15, Subpart E (Section 15.407)

FCC Clause	Test Item	Result	Remarks
15.407(b)(6)	AC Power Conducted Emissions	Pass	Meet the requirement of limit. Minimum passing margin is -12.19dB at 0.41953MHz.
15.407(b) (1/2/3/4(i/ii)/6)	Radiated Emissions & Band Edge Measurement*	Pass	Meet the requirement of limit. Minimum passing margin is -0.1dB at 5458.00MHz.
15.407(a)(1/2/3)	Max Average Transmit Power	Pass	Meet the requirement of limit.
---	Occupied Bandwidth Measurement	-	Reference only.
15.407(a)(1/2/3)	Peak Power Spectral Density	Pass	Meet the requirement of limit.
15.407(e)	6dB bandwidth	Pass	Meet the requirement of limit. (U-NII-3 Band only)
15.407(g)	Frequency Stability	Pass	Meet the requirement of limit.
15.203	Antenna Requirement	Pass	Antenna connector is i-pex(MHF) not a standard connector.

*For U-NII-3 band compliance with rule part 15.407(b)(4)(i), the OOB test plots were recorded in Annex A.

2.1 Measurement Uncertainty

Where relevant, the following measurement uncertainty levels have been estimated for tests performed on the EUT as specified in CISPR 16-4-2:

Measurement	Frequency	Expanded Uncertainty (k=2) (±)
Conducted Emissions at mains ports	150kHz ~ 30MHz	1.84 dB
Radiated Emissions up to 1 GHz	30MHz ~ 1GHz	5.33 dB
Radiated Emissions above 1 GHz	1GHz ~ 6GHz	5.10 dB
	6GHz ~ 18GHz	4.85 dB
	18GHz ~ 40GHz	5.24 dB

2.2 Modification Record

There were no modifications required for compliance.

3 General Information

3.1 General Description of EUT (WLAN)

Product	GigaSpire
Brand	Calix
Test Model	GS2026E
Status of EUT	MASS-PRODUCTION
Power Supply Rating	12Vdc from adapter
Modulation Type	CCK, DQPSK, DBPSK for DSSS 64QAM, 16QAM, QPSK, BPSK for OFDM 256QAM for OFDM in 11ac mode and VHT (20/40) mode in 2.4GHz 1024QAM for OFDMA in 11ax HE mode
Modulation Technology	DSSS,OFDM,OFDMA
Transfer Rate	802.11b: up to 11Mbps 802.11a/g: up to 54Mbps 802.11n: up to 600Mbps 802.11ac: up to 1733.3Mbps 802.11ax: up to 4803.9Mbps
Operating Frequency	2.4GHz: 2.412 ~ 2.462GHz 5GHz: 5.18GHz ~ 5.24GHz, 5.745GHz ~ 5.825GHz
Number of Channel	2.4GHz: 802.11b, 802.11g, 802.11n (HT20), VHT20, 802.11ax (HE20): 11 802.11n (HT40), VHT40, 802.11ax (HE40): 7 5GHz: 802.11a, 802.11n (HT20), 802.11ac (VHT20), 802.11ax (HE20): 9 802.11n (HT40), 802.11ac (VHT40), 802.11ax (HE40): 4 802.11ac (VHT80), 802.11ax (HE80): 2 802.11ac (VHT80+80), 802.11ax (HE80+80): 1 set
Output Power	2.4GHz: 777.345mW 5.18 ~ 5.24GHz: 421.247mW 5.745 ~ 5.825GHz: 367.716mW
Antenna Type	Refer to Note
Antenna Connector	Refer to Note
Accessory Device	Adapter x 1
Data Cable Supplied	NA

Note:

- There are WLAN, Bluetooth, Zigbee and Z-wave technology used for the EUT. The EUT has below radios as following table:

Radio 1	Radio 2	Radio 3	Radio 4	Radio 5
WLAN - 4TX (2.4GHz+5GHz)	WLAN - 4TX (5GHz)	Bluetooth	Zigbee	Z-wave

Note: For WLAN- 5GHz based on Radio 1 + 2 operating at same time.

- Simultaneously transmission condition.

Condition	Technology				
1	WLAN 2.4GHz	WLAN 5GHz	Bluetooth	Zigbee	Z-wave

Note: The emission of the simultaneous operation has been evaluated and no non-compliance was found.

3. The EUT must be supplied with a power adapter as following table:

Brand	Model No.	Spec.
Frecom	F60-120500SPA	Input: 100-240Vac, 1.6A, 50/60Hz AC input cable: Unshielded, 1.0m Output: 12V, 5A DC output cable: Unshielded, 1.5m
		Input: 100-240Vac, 1.6A, 50/60Hz AC input cable: Unshielded, 1.5m Output: 12V, 5A DC output cable: Unshielded, 1.5m

Note: From the above spec., the radiated emissions worse case was found in **AC input cable: Unshielded, 1.0m**. Therefore only the test data of the mode was recorded in this report.

4. The antennas provided to the EUT, please refer to the following table:

WLAN Directional gain table			
Frequency range (GHz)	Directional Antenna Gain (dBi)	Antenna Type	Antenna Connector
2.4 ~ 2.4835	7.41	Dipole	i-pex(MHF)
5.18 ~ 5.24	9.7		
5.26 ~ 5.32	9.9		
5.50 ~ 5.70	9.83		
5.745 ~ 5.825	10.27		
Bluetooth antenna spec.			
Antenna Net Gain (dBi)	Frequency range (GHz)	Antenna Type	Antenna Connector
3.04	2.4~2.5	PIFA	None
Zigbee antenna spec.			
Antenna Net Gain (dBi)	Frequency range (GHz)	Antenna Type	Antenna Connector
3.29	2.4~2.5	MONOPOLE	None
Z-wave antenna spec.			
Antenna Net Gain (dBi)	Frequency range (MHz)	Antenna Type	Antenna Connector
2.76	850~920	PIFA	None

Note: More detailed information, please refer to operating description.

5. The EUT incorporates a MIMO function:

2.4GHz Band			
MODULATION MODE	DATA RATE (MCS)	TX & RX CONFIGURATION	
802.11b	1 ~ 11Mbps	4TX	4RX
802.11g	6 ~ 54Mbps	4TX	4RX
802.11n (HT20)	MCS 0~7	4TX	4RX
	MCS 8~15	4TX	4RX
	MCS 16~23	4TX	4RX
	MCS 24~31	4TX	4RX
802.11n (HT40)	MCS 0~7	4TX	4RX
	MCS 8~15	4TX	4RX
	MCS 16~23	4TX	4RX
	MCS 24~31	4TX	4RX
VHT20	MCS0~8 Nss=1	4TX	4RX
	MCS0~8 Nss=2	4TX	4RX
	MCS0~9 Nss=3	4TX	4RX
	MCS0~8 Nss=4	4TX	4RX
VHT40	MCS0~9 Nss=1	4TX	4RX
	MCS0~9 Nss=2	4TX	4RX
	MCS0~9 Nss=3	4TX	4RX
	MCS0~9 Nss=4	4TX	4RX
802.11ax (HE20)	MCS0~11 Nss=1	4TX	4RX
	MCS0~11 Nss=2	4TX	4RX
	MCS0~11 Nss=3	4TX	4RX
	MCS0~11 Nss=4	4TX	4RX
802.11 ax (HE40)	MCS0~11 Nss=1	4TX	4RX
	MCS0~11 Nss=2	4TX	4RX
	MCS0~11 Nss=3	4TX	4RX
	MCS0~11 Nss=4	4TX	4RX

5GHz Band (Radio 1 + 2)			
MODULATION MODE	DATA RATE (MCS)	TX & RX CONFIGURATION	
802.11a	6 ~ 54Mbps	8TX	8RX
802.11n (HT20)	MCS 0~7	8TX	8RX
	MCS 8~15	8TX	8RX
	MCS 16~23	8TX	8RX
	MCS 24~31	8TX	8RX
802.11n (HT40)	MCS 0~7	8TX	8RX
	MCS 8~15	8TX	8RX
	MCS 16~23	8TX	8RX
	MCS 24~31	8TX	8RX
802.11ac (VHT20)	MCS0~8 Nss=1	8TX	8RX
	MCS0~8 Nss=2	8TX	8RX
	MCS0~9 Nss=3	8TX	8RX
	MCS0~8 Nss=4	8TX	8RX
	MCS0~8 Nss=5	8TX	8RX
	MCS0~9 Nss=6	8TX	8RX
	MCS0~8 Nss=7	8TX	8RX
	MCS0~8 Nss=8	8TX	8RX
802.11ac (VHT40)	MCS0~9 Nss=1	8TX	8RX
	MCS0~9 Nss=2	8TX	8RX
	MCS0~9 Nss=3	8TX	8RX
	MCS0~9 Nss=4	8TX	8RX
	MCS0~9 Nss=5	8TX	8RX
	MCS0~9 Nss=6	8TX	8RX
	MCS0~9 Nss=7	8TX	8RX
	MCS0~9 Nss=8	8TX	8RX
802.11ac (VHT80)	MCS0~9 Nss=1	8TX	8RX
	MCS0~9 Nss=2	8TX	8RX
	MCS0~5 / 7~9 Nss=3	8TX	8RX
	MCS0~9 Nss=4	8TX	8RX
	MCS0~9 Nss=5	8TX	8RX
	MCS0~8 Nss=6	8TX	8RX
	MCS 0~5 / 7~9 Nss=7	8TX	8RX
	MCS0~9 Nss=8	8TX	8RX

802.11ac (VHT80+80)	MCS0~9 Nss=1	8TX	8RX
	MCS0~9 Nss=2	8TX	8RX
	MCS0~8 Nss=3	8TX	8RX
	MCS0~9 Nss=4	8TX	8RX
	MCS0~9 Nss=5	8TX	8RX
	MCS0~9 Nss=6	8TX	8RX
	MCS0~9 Nss=7	8TX	8RX
	MCS0~9 Nss=8	8TX	8RX
802.11ax (HE20)	MCS0~11 Nss=1	8TX	8RX
	MCS0~11 Nss=2	8TX	8RX
	MCS0~11 Nss=3	8TX	8RX
	MCS0~11 Nss=4	8TX	8RX
	MCS0~11 Nss=5	8TX	8RX
	MCS0~11 Nss=6	8TX	8RX
	MCS0~11 Nss=7	8TX	8RX
	MCS0~11 Nss=8	8TX	8RX
802.11ax (HE40)	MCS0~11 Nss=1	8TX	8RX
	MCS0~11 Nss=2	8TX	8RX
	MCS0~11 Nss=3	8TX	8RX
	MCS0~11 Nss=4	8TX	8RX
	MCS0~11 Nss=5	8TX	8RX
	MCS0~11 Nss=6	8TX	8RX
	MCS0~11 Nss=7	8TX	8RX
	MCS0~11 Nss=8	8TX	8RX
802.11ax (HE80)	MCS0~11 Nss=1	8TX	8RX
	MCS0~11 Nss=2	8TX	8RX
	MCS0~11 Nss=3	8TX	8RX
	MCS0~11 Nss=4	8TX	8RX
	MCS0~11 Nss=5	8TX	8RX
	MCS0~11 Nss=6	8TX	8RX
	MCS0~11 Nss=7	8TX	8RX
	MCS0~11 Nss=8	8TX	8RX
802.11ax (HE80+80)	MCS0~11 Nss=1	8TX	8RX
	MCS0~11 Nss=2	8TX	8RX
	MCS0~11 Nss=3	8TX	8RX
	MCS0~11 Nss=4	8TX	8RX
	MCS0~11 Nss=5	8TX	8RX
	MCS0~11 Nss=6	8TX	8RX
	MCS0~11 Nss=7	8TX	8RX
	MCS0~11 Nss=8	8TX	8RX

Note:

1. All of modulation mode support beamforming function except 2.4GHz & 802.11a/ax modulation mode.
2. The EUT support Beamforming and non-beamforming mode, therefore both mode were investigated and the worst case scenario was identified. The worst case data were presented in test report.
3. The modulation and bandwidth are similar for 802.11n mode for 20MHz (40MHz) and 802.11ac mode for 20MHz (40MHz), therefore investigated worst case to representative mode in test report. (Final test mode refer section 3.2.1)
6. The above EUT information is declared by manufacturer and for more detailed features description, please refers to the manufacturer's specifications or user's manual.

3.2 Description of Test Modes

For 5180 ~ 5240MHz

4 channels are provided for 802.11a, 802.11n (HT20), 802.11ac (VHT20), 802.11ax (HE20):

Channel	Frequency	Channel	Frequency
36	5180 MHz	44	5220 MHz
40	5200 MHz	48	5240 MHz

2 channels are provided for 802.11n (HT40), 802.11ac (VHT40), 802.11ax (HE40):

Channel	Frequency	Channel	Frequency
38	5190 MHz	46	5230 MHz

1 channel is provided for 802.11ac (VHT80), 802.11ax (VHT80):

Channel	Frequency
42	5210 MHz

For 5745 ~ 5825MHz:

5 channels are provided for 802.11a, 802.11n (HT20), 802.11ac (VHT20), 802.11ax (HE20):

Channel	Frequency	Channel	Frequency
149	5745 MHz	161	5805 MHz
153	5765 MHz	165	5825 MHz
157	5785 MHz		

2 channels are provided for 802.11n (HT40), 802.11ac (VHT40), 802.11ax (HE40):

Channel	Frequency	Channel	Frequency
151	5755 MHz	159	5795 MHz

1 channel is provided for 802.11ac (VHT80), 802.11ax (HE80):

Channel	Frequency
155	5775 MHz

For simultaneous transmission:

1 set is provided for 802.11ac (VHT80+80), 802.11ax (HE80+80):

Channel	Frequency
42+155	5210 MHz + 5775 MHz

Note: The transmission is for noncontiguous transmission using two nonadjacent 80MHz channels.

3.2.1 Test Mode Applicability and Tested Channel Detail

EUT Configure Mode	Applicable To				Description
	RE \geq 1G	RE<1G	PLC	APCM	
-	√	√	√	√	-

Where **RE \geq 1G**: Radiated Emission above 1GHz **RE<1G**: Radiated Emission below 1GHz
PLC: Power Line Conducted Emission **APCM**: Antenna Port Conducted Measurement

Radiated Emission Test (Above 1GHz):

- Pre-Scan has been conducted to determine the worst-case mode from all possible combinations between available modulations, data rates and antenna ports (if EUT with antenna diversity architecture).
- Following channel(s) was (were) selected for the final test as listed below.

Non-Beamforming Mode						
Mode	FREQ. Band (MHz)	Available Channel	Tested Channel	Modulation Technology	Modulation Type	Data Rate Parameter
802.11a	5180-5240	36 to 48	36, 40, 48	OFDM	BPSK	6Mb/s
802.11ac (VHT20)		36 to 48	36, 40, 48	OFDM	BPSK	MCS0
802.11ac (VHT40)		38 to 46	38, 46	OFDM	BPSK	MCS0
802.11ac (VHT80)		42	42	OFDM	BPSK	MCS0
802.11ax (HE20)		36 to 48	36, 40, 48	OFDMA	BPSK	MCS0
802.11ax (HE40)		38 to 46	38, 46	OFDMA	BPSK	MCS0
802.11ax (HE80)		42	42	OFDMA	BPSK	MCS0
802.11a	5745-5825	149 to 165	149, 157, 165	OFDM	BPSK	6Mb/s
802.11ac (VHT20)		149 to 165	149, 157, 165	OFDM	BPSK	MCS0
802.11ac (VHT40)		151 to 159	151, 159	OFDM	BPSK	MCS0
802.11ac (VHT80)		155	155	OFDM	BPSK	MCS0
802.11ax (HE20)		149 to 165	149, 157, 165	OFDMA	BPSK	MCS0
802.11ax (HE40)		151 to 159	151, 159	OFDMA	BPSK	MCS0
802.11ax (HE80)		155	155	OFDMA	BPSK	MCS0
802.11ac (VHT80+80)	5180-5240 5745-5825	42 + 155	42 + 155	OFDM	BPSK	MCS0
802.11ax (HE80+80)	5180-5240 5745-5825	42 + 155	42 + 155	OFDMA	BPSK	MCS0

Radiated Emission Test (Below 1GHz):

- Pre-Scan has been conducted to determine the worst-case mode from all possible combinations between available modulations, data rates and antenna ports (if EUT with antenna diversity architecture).
- Following channel(s) was (were) selected for the final test as listed below.

Non-Beamforming Mode						
Mode	FREQ. Band (MHz)	Available Channel	Tested Channel	Modulation Technology	Modulation Type	Data Rate Parameter
802.11ax (HE20)	5180-5240 5745-5825	36 to 48 149 to 165	48	OFDMA	BPSK	MCS0

Power Line Conducted Emission Test:

- Pre-Scan has been conducted to determine the worst-case mode from all possible combinations between available modulations, data rates and antenna ports (if EUT with antenna diversity architecture).
- Following channel(s) was (were) selected for the final test as listed below.

Non-Beamforming Mode						
Mode	FREQ. Band (MHz)	Available Channel	Tested Channel	Modulation Technology	Modulation Type	Data Rate Parameter
802.11ax (HE20)	5180-5240 5745-5825	36 to 48 149 to 165	48	OFDMA	BPSK	MCS0

Antenna Port Conducted Measurement:

- This item includes all test value of each mode, but only includes spectrum plot of worst value of each mode.
- Pre-Scan has been conducted to determine the worst-case mode from all possible combinations between available modulations, data rates and antenna ports (if EUT with antenna diversity architecture).
- Following channel(s) was (were) selected for the final test as listed below.

Non-Beamforming Mode						
Mode	FREQ. Band (MHz)	Available Channel	Tested Channel	Modulation Technology	Modulation Type	Data Rate Parameter
802.11a	5180-5240	36 to 48	36, 40, 48	OFDM	BPSK	6Mb/s
802.11ac (VHT20)		36 to 48	36, 40, 48	OFDM	BPSK	MCS0
802.11ac (VHT40)		38 to 46	38, 46	OFDM	BPSK	MCS0
802.11ac (VHT80)		42	42	OFDM	BPSK	MCS0
802.11ax (HE20)		36 to 48	36, 40, 48	OFDMA	BPSK	MCS0
802.11ax (HE40)		38 to 46	38, 46	OFDMA	BPSK	MCS0
802.11ax (HE80)		42	42	OFDMA	BPSK	MCS0
802.11a	5745-5825	149 to 165	149, 157, 165	OFDM	BPSK	6Mb/s
802.11ac (VHT20)		149 to 165	149, 157, 165	OFDM	BPSK	MCS0
802.11ac (VHT40)		151 to 159	151, 159	OFDM	BPSK	MCS0
802.11ac (VHT80)		155	155	OFDM	BPSK	MCS0
802.11ax (HE20)		149 to 165	149, 157, 165	OFDMA	BPSK	MCS0
802.11ax (HE40)		151 to 159	151, 159	OFDMA	BPSK	MCS0
802.11ax (HE80)		155	155	OFDMA	BPSK	MCS0
802.11ac (VHT80+80)	5180-5240 5745-5825	42 + 155	42 + 155	OFDM	BPSK	MCS0
802.11ax (HE80+80)	5180-5240 5745-5825	42 + 155	42 + 155	OFDMA	BPSK	MCS0

Test Condition:

Applicable To	Environmental Conditions	Input Power	Tested By
RE \geq 1G	23deg. C, 67%RH	120Vac, 60Hz	Eason Tseng
RE $<$ 1G	21deg. C, 64%RH	120Vac, 60Hz	Robert Cheng
PLC	23deg. C, 75%RH	120Vac, 60Hz	Andy Ho
APCM	25deg. C, 60%RH	120Vac, 60Hz	Jyunchun Lin

3.3 Duty Cycle of Test Signal

If duty cycle of test signal is < 98%, duty factor shall be considered.

802.11a: Duty cycle = 1.432 ms/1.615 ms = 0.887, Duty factor = $10 * \log(1/0.887) = 0.52$

802.11ac (VHT20): Duty cycle = 5.42 ms/5.63 ms = 0.963, Duty factor = $10 * \log(1/0.963) = 0.17$

802.11ac (VHT40): Duty cycle = 5.42 ms/5.62 ms = 0.964, Duty factor = $10 * \log(1/0.964) = 0.16$

802.11ac (VHT80): Duty cycle = 5.418 ms/5.618 ms = 0.964, Duty factor = $10 * \log(1/0.964) = 0.16$

802.11ac (VHT80+80): Duty cycle = 5.422/5.627 = 0.964, Duty factor = $10 * \log(1/0.964) = 0.16$

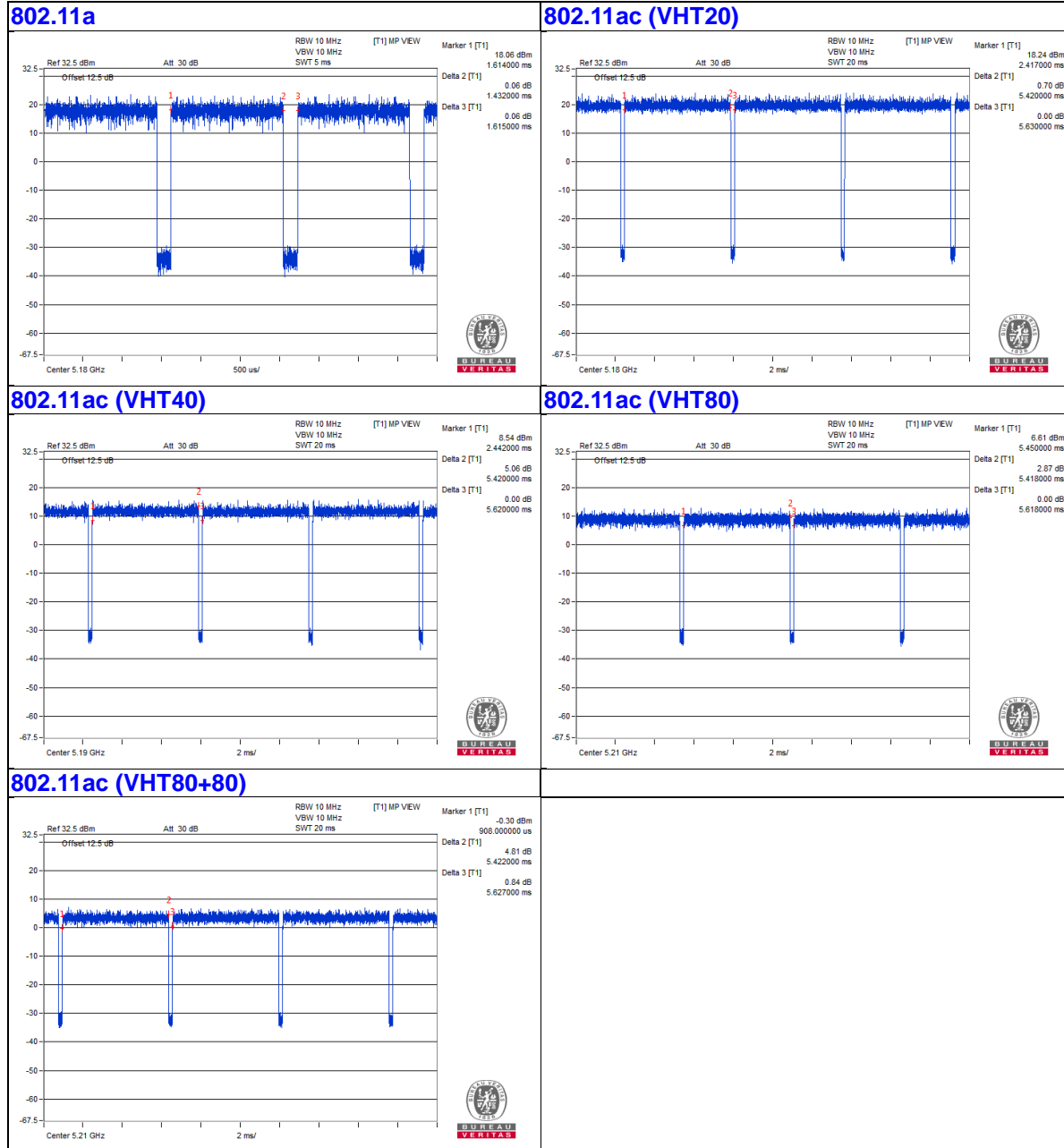

802.11ax (HE20): Duty cycle = 5.443 ms/5.65 ms = 0.963, Duty factor = $10 * \log(1/0.963) = 0.16$
802.11ax (HE40): Duty cycle = 5.438 ms/5.668 ms = 0.959, Duty factor = $10 * \log(1/0.959) = 0.18$
802.11ax (HE80): Duty cycle = 5.438 ms/5.638 ms = 0.965, Duty factor = $10 * \log(1/0.965) = 0.16$
802.11ax (HE80+80): Duty cycle = 5.437/5.644 = 0.963, Duty factor = $10 * \log(1/0.963) = 0.16$

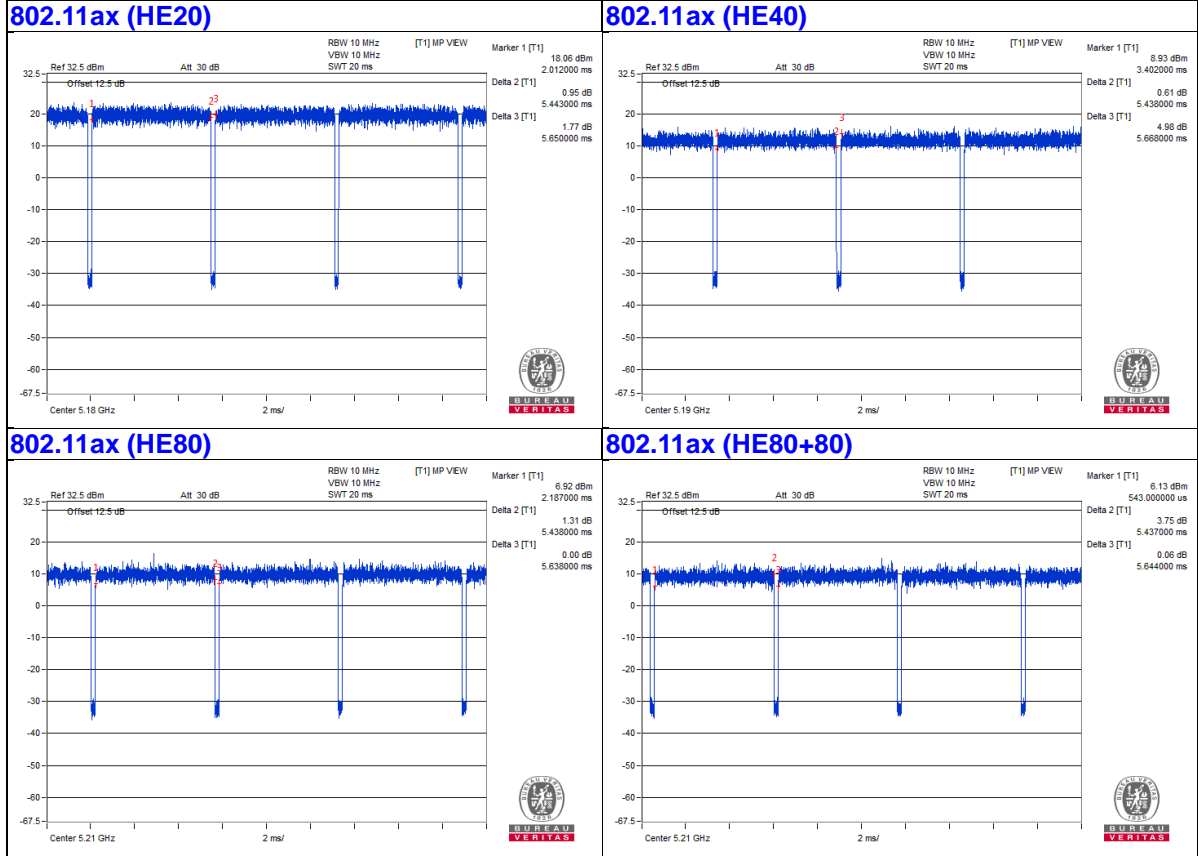

3.4 Description of Support Units

The EUT has been tested as an independent unit together with other necessary accessories or support units. The following support units or accessories were used to form a representative test configuration during the tests.

ID	Product	Brand	Model No.	Serial No.	FCC ID	Remarks
A.	Laptop	DELL	E5430	HYV4VY1	FCC DoC	Provided by Lab
B.	Laptop	DELL	E6420	B92T3R1	FCC DoC	Provided by Lab
C.	Earphone	Apple	NA	NA	NA	Provided by Lab
D.	USB 3.0 Disk	Transcend	16GB	NA	NA	Provided by Lab

Note:

1. All power cords of the above support units are non-shielded (1.8m).

ID	Descriptions	Qty.	Length (m)	Shielding (Yes/No)	Cores (Qty.)	Remarks
1.	DC Cable	1	1.5	No	0	Supplied by client
2.	AC Cable	1	1.0	No	0	Supplied by client
3.	RJ-45 Cable	1	10	No	0	Provided by Lab
4.	RJ-45 Cable	1	10	No	0	Provided by Lab
5.	Audio Cable	1	1.2	No	0	Provided by Lab

3.4.1 Configuration of System under Test

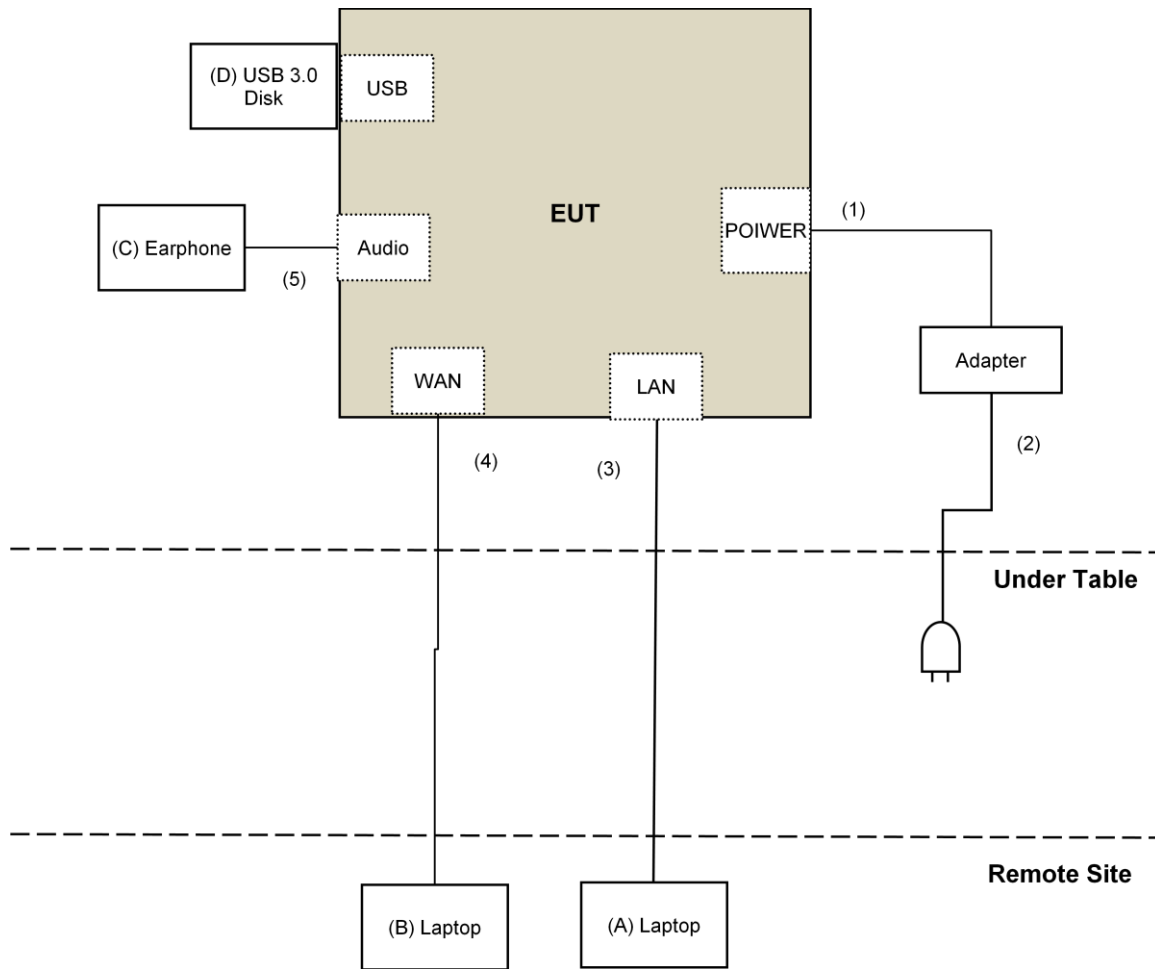

3.5 General Description of Applied Standard

The EUT is a RF Product. According to the specifications of the manufacturer, it must comply with the requirements of the following standards:

FCC Part 15, Subpart E (15.407)
KDB 789033 D02 General UNII Test Procedure New Rules v02r01
KDB 662911 D01 Multiple Transmitter Output v02r01
ANSI C63.10-2013

All test items have been performed and recorded as per the above standards.

4 Test Types and Results

4.1 Radiated Emission and Bandedge Measurement

4.1.1 Limits of Radiated Emission and Bandedge Measurement

Radiated emissions which fall in the restricted bands must comply with the radiated emission limits specified as below table.

Frequencies (MHz)	Field Strength (microvolts/meter)	Measurement Distance (meters)
0.009 ~ 0.490	2400/F(kHz)	300
0.490 ~ 1.705	24000/F(kHz)	30
1.705 ~ 30.0	30	30
30 ~ 88	100	3
88 ~ 216	150	3
216 ~ 960	200	3
Above 960	500	3

NOTE:

- The lower limit shall apply at the transition frequencies.
- Emission level (dBuV/m) = 20 log Emission level (uV/m).
- For frequencies above 1000MHz, the field strength limits are based on average detector, however, the peak field strength of any emission shall not exceed the maximum permitted average limits, specified above by more than 20dB under any condition of modulation.

Limits of unwanted emission out of the restricted bands

Applicable To		Limit	
789033 D02 General UNII Test Procedure New Rules v02r01		Field Strength at 3m	
		PK:74 (dBuV/m)	AV:54 (dBuV/m)
Frequency Band	Applicable To	EIRP Limit	Equivalent Field Strength at 3m
5150~5250 MHz	15.407(b)(1)	PK:-27 (dBm/MHz)	PK:68.2(dBμV/m)
5250~5350 MHz	15.407(b)(2)		
5470~5725 MHz	15.407(b)(3)		
5725~5850 MHz	<input checked="" type="checkbox"/> 15.407(b)(4)(i)	PK:-27 (dBm/MHz) ^{*1} PK:10 (dBm/MHz) ^{*2} PK:15.6 (dBm/MHz) ^{*3} PK:27 (dBm/MHz) ^{*4}	PK: 68.2(dBμV/m) ^{*1} PK:105.2 (dBμV/m) ^{*2} PK: 110.8(dBμV/m) ^{*3} PK:122.2 (dBμV/m) ^{*4}
	<input type="checkbox"/> 15.407(b)(4)(ii)	Emission limits in section 15.247(d)	
^{*1} beyond 75 MHz or more above of the band edge.		^{*2} below the band edge increasing linearly to 10 dBm/MHz at 25 MHz above.	
^{*3} below the band edge increasing linearly to a level of 15.6 dBm/MHz at 5 MHz above.		^{*4} from 5 MHz above or below the band edge increasing linearly to a level of 27 dBm/MHz at the band edge.	

Note:

The following formula is used to convert the equipment isotropic radiated power (eirp) to field strength:

$$E = \frac{1000000\sqrt{30P}}{3} \mu\text{V/m, where P is the eirp (Watts).}$$

4.1.2 Test Instruments

DESCRIPTION & MANUFACTURER	MODEL NO.	SERIAL NO.	CALIBRATED DATE	CALIBRATED UNTIL
Test Receiver Keysight	N9038A	MY54450088	July 08, 2017	July 07, 2018
Pre-Amplifier EMCI	EMC001340	980142	Feb. 09, 2018	Feb. 08, 2019
Loop Antenna ^(*) Electro-Metrics	EM-6879	264	Dec. 16, 2016	Dec. 15, 2018
RF Cable	NA	LOOPCAB-001 LOOPCAB-002	Jan. 15, 2018	Jan. 14, 2019
Pre-Amplifier Mini-Circuits	ZFL-1000VH2B	AMP-ZFL-01	Nov. 09, 2017	Nov. 08, 2018
Trilog Broadband Antenna SCHWARZBECK	VULB 9168	9168-406	Nov. 29, 2017	Nov. 28, 2018
RF Cable	8D	966-4-1 966-4-2 966-4-3	Mar. 21, 2018	Mar. 20, 2019
Fixed attenuator Mini-Circuits	UNAT-5+	PAD-3m-4-01	Oct. 03, 2017	Oct. 02, 2018
Horn_Antenna SCHWARZBECK	BBHA 9120D	9120D-783	Dec. 12, 2017	Dec. 11, 2018
Pre-Amplifier EMCI	EMC12630SE	980385	Jan. 29, 2018	Jan. 28, 2019
RF Cable	EMC104-SM-SM-1200 EMC104-SM-SM-2000 EMC104-SM-SM-5000	160923 150318 150321	Jan. 29, 2018	Jan. 28, 2019
Pre-Amplifier EMCI	EMC184045SE	980387	Jan. 29, 2018	Jan. 28, 2019
Horn_Antenna SCHWARZBECK	BBHA 9170	BBHA9170608	Dec. 14, 2017	Dec. 13, 2018
RF Cable	EMC102-KM-KM-1200	160925	Jan. 29, 2018	Jan. 28, 2019
Software	ADT_Radiated_V8.7.08	NA	NA	NA
Boresight Antenna Tower & Turn Table Max-Full	MF-7802BS	MF780208530	NA	NA
Spectrum Analyzer R&S	FSV40	100964	June 20, 2018	June 19, 2019
Power meter Anritsu	ML2495A	1014008	May 09, 2018	May 08, 2019
Power sensor Anritsu	MA2411B	0917122	May 09, 2018	May 08, 2019
AC Power Source Extech Electronics	6205	1440452	NA	NA
Temperature & Humidity Chamber Giant Force	GTH-150-40-SP-AR	MAA0812-008	Jan. 10, 2018	Jan. 09, 2019
True RMS Clamp Meter FLUKE	325	31130711WS	May 22, 2018	May 21, 2019

Note:

1. The calibration interval of the above test instruments is 12 months and the calibrations are traceable to NML/ROC and NIST/USA.
2. *The calibration interval of the above test instruments is 24 months and the calibrations are traceable to NML/ROC and NIST/USA.
3. The test was performed in 966 Chamber No. 4.
4. The CANADA Site Registration No. is 20331-2
5. Loop antenna was used for all emissions below 30 MHz.
6. Tested Date: June 21 to 28, 2018

4.1.3 Test Procedure

For Radiated emission below 30MHz

- a. The EUT was placed on the top of a rotating table 0.8 meters above the ground at a 3 meter chamber room. The table was rotated 360 degrees to determine the position of the highest radiation.
- b. The EUT was set 3 meters away from the interference-receiving antenna, which was mounted on the top of a variable-height antenna tower.
- c. Parallel, perpendicular, and ground-parallel orientations of the antenna are set to make the measurement.
- d. For each suspected emission, the EUT was arranged to its worst case and the rotatable table was turned from 0 degrees to 360 degrees to find the maximum reading.
- e. The test-receiver system was set to Quasi-Peak Detect Function and Specified Bandwidth with Maximum Hold Mode.

NOTE:

1. The resolution bandwidth and video bandwidth of test receiver/spectrum analyzer is 9kHz at frequency below 30MHz.

For Radiated emission above 30MHz

- a. The EUT was placed on the top of a rotating table 0.8 meters (for 30MHz ~ 1GHz) / 1.5 meters (for above 1GHz) above the ground at 3 meter chamber room for test. The table was rotated 360 degrees to determine the position of the highest radiation.
- b. The EUT was set 3 meters away from the interference-receiving antenna, which was mounted on the top of a variable-height antenna tower.
- c. The height of antenna is varied from one meter to four meters above the ground to determine the maximum value of the field strength. Both horizontal and vertical polarizations of the antenna are set to make the measurement.
- d. For each suspected emission, the EUT was arranged to its worst case and then the antenna was tuned to heights from 1 meter to 4 meters and the rotatable table was turned from 0 degrees to 360 degrees to find the maximum reading.
- e. The test-receiver system was set to quasi-peak detect function and specified bandwidth with maximum hold mode when the test frequency is below 1 GHz.
- f. The test-receiver system was set to peak and average detects function and specified bandwidth with maximum hold mode when the test frequency is above 1 GHz. If the peak reading value also meets average limit, measurement with the average detector is unnecessary.

Note:

1. The resolution bandwidth and video bandwidth of test receiver/spectrum analyzer is 120kHz for Quasi-peak detection (QP) at frequency below 1GHz.
2. The resolution bandwidth of test receiver/spectrum analyzer is 1 MHz and the video bandwidth is 3 MHz for Peak detection (PK) at frequency above 1GHz.
3. The resolution bandwidth of test receiver/spectrum analyzer is 1MHz and the video bandwidth is $\geq 1/T$ (Duty cycle < 98%) or 10Hz (Duty cycle $\geq 98\%$) for Average detection (AV) at frequency above 1GHz.
4. All modes of operation were investigated and the worst-case emissions are reported.

4.1.4 Deviation from Test Standard

No deviation.

4.1.5 Test Setup

For Radiated emission below 30MHz

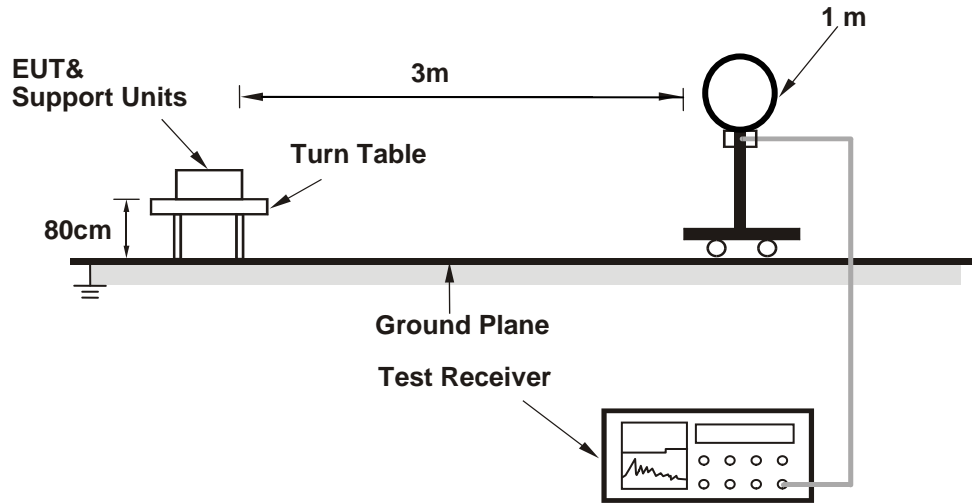

For Radiated emission 30MHz to 1GHz

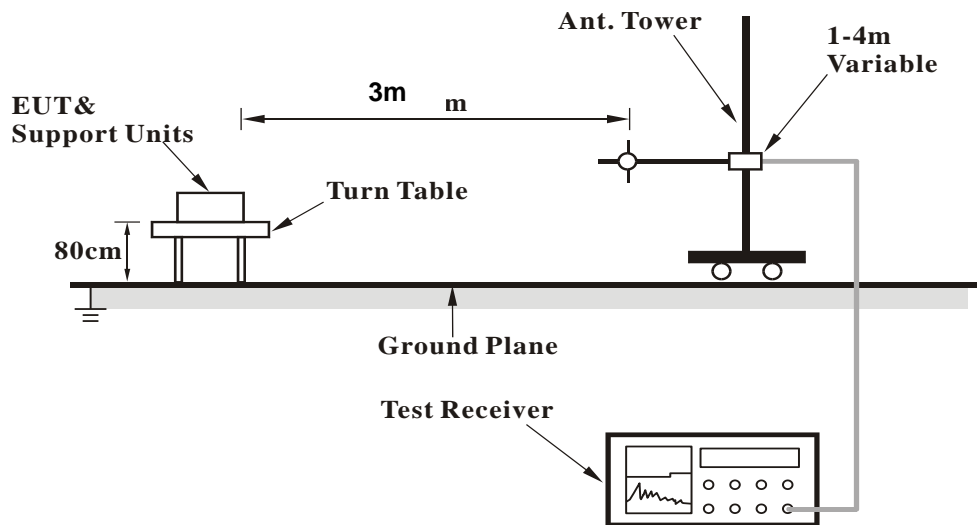

For Radiated emission above 1GHz

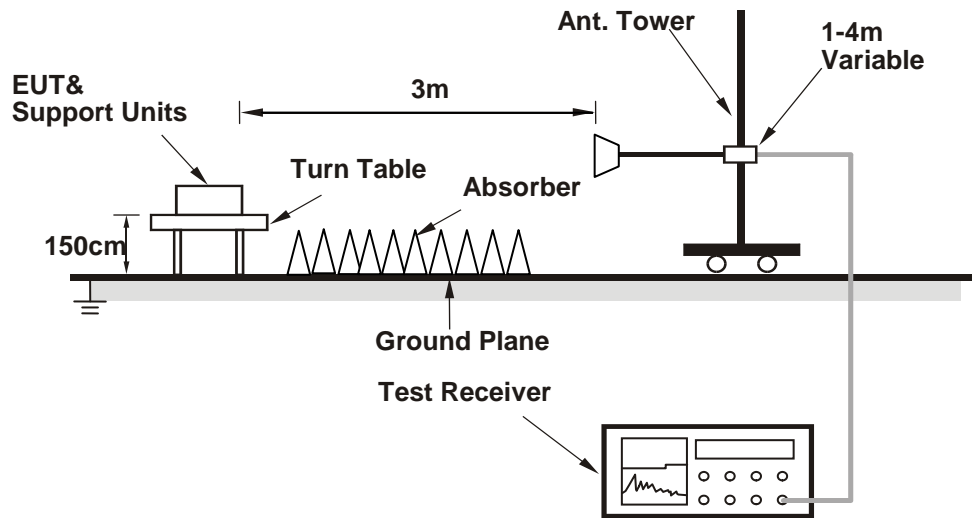

For the actual test configuration, please refer to the attached file (Test Setup Photo).

4.1.6 EUT Operating Condition

- a. Connected the EUT with the Notebook Computer which is placed on remote site.
- b. Controlling software (QSPR (5.0-00148)) has been activated to set the EUT on specific status.

4.1.7 Test Results

Above 1GHz Data:

802.11a

CHANNEL	TX Channel 36	DETECTOR FUNCTION	Peak (PK)
FREQUENCY RANGE	1GHz ~ 40GHz		Average (AV)

ANTENNA POLARITY & TEST DISTANCE: HORIZONTAL AT 3 M

NO.	FREQ. (MHz)	EMISSION LEVEL (dBuV/m)	LIMIT (dBuV/m)	MARGIN (dB)	ANTENNA HEIGHT (m)	TABLE ANGLE (Degree)	RAW VALUE (dBuV)	CORRECTION FACTOR (dB/m)
1	5150.00	59.3 PK	74.0	-14.7	2.75 H	310	56.3	3.0
2	5150.00	45.0 AV	54.0	-9.0	2.75 H	310	42.0	3.0
3	*5180.00	114.3 PK			2.75 H	310	111.5	2.8
4	*5180.00	104.5 AV			2.75 H	310	101.7	2.8
5	#10360.00	45.8 PK	74.0	-28.2	3.57 H	155	33.4	12.4
6	#10360.00	35.6 AV	54.0	-18.4	3.57 H	155	23.2	12.4
7	15540.00	48.6 PK	74.0	-25.4	1.26 H	107	35.8	12.8
8	15540.00	37.6 AV	54.0	-16.4	1.26 H	107	24.8	12.8

ANTENNA POLARITY & TEST DISTANCE: VERTICAL AT 3 M

NO.	FREQ. (MHz)	EMISSION LEVEL (dBuV/m)	LIMIT (dBuV/m)	MARGIN (dB)	ANTENNA HEIGHT (m)	TABLE ANGLE (Degree)	RAW VALUE (dBuV)	CORRECTION FACTOR (dB/m)
1	5150.00	62.1 PK	74.0	-11.9	1.97 V	202	59.1	3.0
2	5150.00	48.1 AV	54.0	-5.9	1.97 V	202	45.1	3.0
3	*5180.00	117.1 PK			1.97 V	202	114.3	2.8
4	*5180.00	108.5 AV			1.97 V	202	105.7	2.8
5	#10360.00	45.3 PK	74.0	-28.7	2.07 V	79	32.9	12.4
6	#10360.00	35.3 AV	54.0	-18.7	2.07 V	79	22.9	12.4
7	15540.00	47.7 PK	74.0	-26.3	1.73 V	170	34.9	12.8
8	15540.00	36.8 AV	54.0	-17.2	1.73 V	170	24.0	12.8

REMARKS:

1. Emission Level(dBuV/m) = Raw Value(dBuV) + Correction Factor(dB/m)
2. Correction Factor(dB/m) = Antenna Factor(dB/m) + Cable Factor(dB) – Pre-Amplifier Factor(dB)
3. The other emission levels were very low against the limit.
4. Margin value = Emission Level – Limit value
5. " * ": Fundamental frequency.
6. " # ": The radiated frequency is out of the restricted band.

CHANNEL	TX Channel 40	DETECTOR FUNCTION	Peak (PK)
FREQUENCY RANGE	1GHz ~ 40GHz		Average (AV)

ANTENNA POLARITY & TEST DISTANCE: HORIZONTAL AT 3 M								
NO.	FREQ. (MHz)	EMISSION LEVEL (dBuV/m)	LIMIT (dBuV/m)	MARGIN (dB)	ANTENNA HEIGHT (m)	TABLE ANGLE (Degree)	RAW VALUE (dBuV)	CORRECTION FACTOR (dB/m)
1	*5200.00	114.2 PK			3.24 H	339	111.5	2.7
2	*5200.00	104.6 AV			3.24 H	339	101.9	2.7
3	#10400.00	45.6 PK	74.0	-28.4	3.57 H	149	33.1	12.5
4	#10400.00	35.3 AV	54.0	-18.7	3.57 H	149	22.8	12.5
5	15600.00	48.3 PK	74.0	-25.7	1.24 H	118	35.5	12.8
6	15600.00	37.5 AV	54.0	-16.5	1.24 H	118	24.7	12.8

ANTENNA POLARITY & TEST DISTANCE: VERTICAL AT 3 M								
NO.	FREQ. (MHz)	EMISSION LEVEL (dBuV/m)	LIMIT (dBuV/m)	MARGIN (dB)	ANTENNA HEIGHT (m)	TABLE ANGLE (Degree)	RAW VALUE (dBuV)	CORRECTION FACTOR (dB/m)
1	*5200.00	116.9 PK			2.44 V	344	114.2	2.7
2	*5200.00	108.2 AV			2.44 V	344	105.5	2.7
3	#10400.00	45.2 PK	74.0	-28.8	2.06 V	69	32.7	12.5
4	#10400.00	35.1 AV	54.0	-18.9	2.06 V	69	22.6	12.5
5	15600.00	48.2 PK	74.0	-25.8	1.72 V	162	35.4	12.8
6	15600.00	37.1 AV	54.0	-16.9	1.72 V	162	24.3	12.8

REMARKS:

1. Emission Level(dBuV/m) = Raw Value(dBuV) + Correction Factor(dB/m)
2. Correction Factor(dB/m) = Antenna Factor(dB/m) + Cable Factor(dB) – Pre-Amplifier Factor(dB)
3. The other emission levels were very low against the limit.
4. Margin value = Emission Level – Limit value
5. " * ": Fundamental frequency.
6. " # ": The radiated frequency is out of the restricted band.

CHANNEL	TX Channel 48	DETECTOR FUNCTION	Peak (PK)
FREQUENCY RANGE	1GHz ~ 40GHz		Average (AV)

ANTENNA POLARITY & TEST DISTANCE: HORIZONTAL AT 3 M								
NO.	FREQ. (MHz)	EMISSION LEVEL (dBuV/m)	LIMIT (dBuV/m)	MARGIN (dB)	ANTENNA HEIGHT (m)	TABLE ANGLE (Degree)	RAW VALUE (dBuV)	CORRECTION FACTOR (dB/m)
1	*5240.00	114.5 PK			3.28 H	350	112.0	2.5
2	*5240.00	104.7 AV			3.28 H	350	102.2	2.5
3	5350.00	48.5 PK	74.0	-25.5	3.28 H	350	45.9	2.6
4	5350.00	38.6 AV	54.0	-15.4	3.28 H	350	36.0	2.6
5	#10480.00	45.8 PK	74.0	-28.2	3.57 H	148	32.8	13.0
6	#10480.00	35.7 AV	54.0	-18.3	3.57 H	148	22.7	13.0
7	15720.00	48.1 PK	74.0	-25.9	1.21 H	107	35.7	12.4
8	15720.00	37.3 AV	54.0	-16.7	1.21 H	107	24.9	12.4

ANTENNA POLARITY & TEST DISTANCE: VERTICAL AT 3 M								
NO.	FREQ. (MHz)	EMISSION LEVEL (dBuV/m)	LIMIT (dBuV/m)	MARGIN (dB)	ANTENNA HEIGHT (m)	TABLE ANGLE (Degree)	RAW VALUE (dBuV)	CORRECTION FACTOR (dB/m)
1	*5240.00	117.4 PK			2.29 V	196	114.9	2.5
2	*5240.00	108.6 AV			2.29 V	196	106.1	2.5
3	5350.00	52.4 PK	74.0	-21.6	2.29 V	196	49.8	2.6
4	5350.00	42.1 AV	54.0	-11.9	2.29 V	196	39.5	2.6
5	#10480.00	45.2 PK	74.0	-28.8	2.05 V	61	32.2	13.0
6	#10480.00	35.3 AV	54.0	-18.7	2.05 V	61	22.3	13.0
7	15720.00	48.2 PK	74.0	-25.8	1.71 V	167	35.8	12.4
8	15720.00	37.1 AV	54.0	-16.9	1.71 V	167	24.7	12.4

REMARKS:

1. Emission Level(dBuV/m) = Raw Value(dBuV) + Correction Factor(dB/m)
2. Correction Factor(dB/m) = Antenna Factor(dB/m) + Cable Factor(dB) – Pre-Amplifier Factor(dB)
3. The other emission levels were very low against the limit.
4. Margin value = Emission Level – Limit value
5. " * ": Fundamental frequency.
6. " # ": The radiated frequency is out of the restricted band.

CHANNEL	TX Channel 149	DETECTOR FUNCTION	Peak (PK)
FREQUENCY RANGE	1GHz ~ 40GHz		Average (AV)

ANTENNA POLARITY & TEST DISTANCE: HORIZONTAL AT 3 M

NO.	FREQ. (MHz)	EMISSION LEVEL (dBuV/m)	LIMIT (dBuV/m)	MARGIN (dB)	ANTENNA HEIGHT (m)	TABLE ANGLE (Degree)	RAW VALUE (dBuV)	CORRECTION FACTOR (dB/m)
1	5408.00	63.9 PK	74.0	-10.1	1.20 H	163	61.1	2.8
2	5408.00	51.9 AV	54.0	-2.1	1.20 H	163	49.1	2.8
3	#5550.00	56.4 PK	74.0	-17.6	1.28 H	144	53.4	3.0
4	#5550.00	45.0 AV	54.0	-9.0	1.28 H	144	42.0	3.0
5	*5745.00	118.7 PK			1.28 H	162	115.4	3.3
6	*5745.00	110.6 AV			1.28 H	162	107.3	3.3
7	11490.00	59.0 PK	74.0	-15.0	1.77 H	171	45.6	13.4
8	11490.00	47.4 AV	54.0	-6.6	1.77 H	171	34.0	13.4
9	#17235.00	53.6 PK	74.0	-20.4	1.51 H	128	36.9	16.7
10	#17235.00	43.2 AV	54.0	-10.8	1.51 H	128	26.5	16.7

ANTENNA POLARITY & TEST DISTANCE: VERTICAL AT 3 M

NO.	FREQ. (MHz)	EMISSION LEVEL (dBuV/m)	LIMIT (dBuV/m)	MARGIN (dB)	ANTENNA HEIGHT (m)	TABLE ANGLE (Degree)	RAW VALUE (dBuV)	CORRECTION FACTOR (dB/m)
1	5408.00	64.6 PK	74.0	-9.4	1.83 V	114	61.8	2.8
2	5408.00	53.8 AV	54.0	-0.2	1.83 V	114	51.0	2.8
3	#5550.00	58.7 PK	74.0	-15.3	1.55 V	307	55.7	3.0
4	#5550.00	47.8 AV	54.0	-6.2	1.55 V	307	44.8	3.0
5	*5745.00	121.6 PK			1.55 V	307	118.3	3.3
6	*5745.00	111.8 AV			1.55 V	307	108.5	3.3
7	11490.00	57.7 PK	74.0	-16.3	2.34 V	97	44.3	13.4
8	11490.00	46.1 AV	54.0	-7.9	2.34 V	97	32.7	13.4
9	#17235.00	52.7 PK	74.0	-21.3	1.99 V	322	36.0	16.7
10	#17235.00	41.9 AV	54.0	-12.1	1.99 V	322	25.2	16.7

REMARKS:

1. Emission Level(dBuV/m) = Raw Value(dBuV) + Correction Factor(dB/m)
2. Correction Factor(dB/m) = Antenna Factor(dB/m) + Cable Factor(dB) – Pre-Amplifier Factor(dB)
3. The other emission levels were very low against the limit.
4. Margin value = Emission Level – Limit value
5. " * ": Fundamental frequency.
6. " # ": The radiated frequency is out of the restricted band.

CHANNEL	TX Channel 157	DETECTOR FUNCTION	Peak (PK)
FREQUENCY RANGE	1GHz ~ 40GHz		Average (AV)

ANTENNA POLARITY & TEST DISTANCE: HORIZONTAL AT 3 M								
NO.	FREQ. (MHz)	EMISSION LEVEL (dBuV/m)	LIMIT (dBuV/m)	MARGIN (dB)	ANTENNA HEIGHT (m)	TABLE ANGLE (Degree)	RAW VALUE (dBuV)	CORRECTION FACTOR (dB/m)
1	5453.00	59.4 PK	74.0	-14.6	2.11 H	162	56.5	2.9
2	5453.00	48.4 AV	54.0	-5.6	2.11 H	162	45.5	2.9
3	#5550.00	52.2 PK	74.0	-21.8	1.33 H	171	49.2	3.0
4	#5550.00	41.3 AV	54.0	-12.7	1.33 H	171	38.3	3.0
5	*5785.00	119.4 PK			1.33 H	171	116.1	3.3
6	*5785.00	110.9 AV			1.33 H	171	107.6	3.3
7	#6025.00	54.2 PK	74.0	-19.8	2.11 H	162	50.4	3.8
8	#6025.00	42.6 AV	54.0	-11.4	2.11 H	162	38.8	3.8
9	11570.00	58.8 PK	74.0	-15.2	1.72 H	162	45.4	13.4
10	11570.00	47.4 AV	54.0	-6.6	1.72 H	162	34.0	13.4
11	#17355.00	53.4 PK	74.0	-20.6	1.47 H	135	36.1	17.3
12	#17355.00	42.8 AV	54.0	-11.2	1.47 H	135	25.5	17.3

ANTENNA POLARITY & TEST DISTANCE: VERTICAL AT 3 M								
NO.	FREQ. (MHz)	EMISSION LEVEL (dBuV/m)	LIMIT (dBuV/m)	MARGIN (dB)	ANTENNA HEIGHT (m)	TABLE ANGLE (Degree)	RAW VALUE (dBuV)	CORRECTION FACTOR (dB/m)
1	5453.00	64.4 PK	74.0	-9.6	1.65 V	360	61.5	2.9
2	5453.00	53.7 AV	54.0	-0.3	1.65 V	360	50.8	2.9
3	#5550.00	57.5 PK	74.0	-16.5	1.89 V	301	54.5	3.0
4	#5550.00	46.3 AV	54.0	-7.7	1.89 V	301	43.3	3.0
5	*5785.00	121.7 PK			1.89 V	301	118.4	3.3
6	*5785.00	111.9 AV			1.89 V	301	108.6	3.3
7	#6025.00	57.5 PK	74.0	-16.5	1.65 V	360	53.7	3.8
8	#6025.00	45.1 AV	54.0	-8.9	1.65 V	360	41.3	3.8
9	11570.00	58.6 PK	74.0	-15.4	2.30 V	121	45.2	13.4
10	11570.00	46.7 AV	54.0	-7.3	2.30 V	121	33.3	13.4
11	#17355.00	52.3 PK	74.0	-21.7	2.00 V	305	35.0	17.3
12	#17355.00	41.3 AV	54.0	-12.7	2.00 V	305	24.0	17.3

REMARKS:

1. Emission Level(dBuV/m) = Raw Value(dBuV) + Correction Factor(dB/m)
2. Correction Factor(dB/m) = Antenna Factor(dB/m) + Cable Factor(dB) – Pre-Amplifier Factor(dB)
3. The other emission levels were very low against the limit.
4. Margin value = Emission Level – Limit value
5. " * ": Fundamental frequency.
6. " # ": The radiated frequency is out of the restricted band.

CHANNEL	TX Channel 165	DETECTOR FUNCTION	Peak (PK)
FREQUENCY RANGE	1GHz ~ 40GHz		Average (AV)

ANTENNA POLARITY & TEST DISTANCE: HORIZONTAL AT 3 M								
NO.	FREQ. (MHz)	EMISSION LEVEL (dBuV/m)	LIMIT (dBuV/m)	MARGIN (dB)	ANTENNA HEIGHT (m)	TABLE ANGLE (Degree)	RAW VALUE (dBuV)	CORRECTION FACTOR (dB/m)
1	#5498.00	63.9 PK	74.0	-10.1	1.21 H	160	61.0	2.9
2	#5498.00	51.8 AV	54.0	-2.2	1.21 H	160	48.9	2.9
3	#5550.00	55.8 PK	74.0	-18.2	1.31 H	178	52.8	3.0
4	#5550.00	44.4 AV	54.0	-9.6	1.31 H	178	41.4	3.0
5	*5825.00	118.9 PK			1.27 H	173	115.4	3.5
6	*5825.00	110.1 AV			1.27 H	173	106.6	3.5
7	#6025.00	56.2 PK	74.0	-17.8	1.26 H	158	52.4	3.8
8	#6025.00	44.6 AV	54.0	-9.4	1.26 H	158	40.8	3.8
9	11650.00	59.2 PK	74.0	-14.8	1.76 H	164	45.9	13.3
10	11650.00	47.7 AV	54.0	-6.3	1.76 H	164	34.4	13.3
11	#17475.00	53.8 PK	74.0	-20.2	1.49 H	123	35.6	18.2
12	#17475.00	43.1 AV	54.0	-10.9	1.49 H	123	24.9	18.2

ANTENNA POLARITY & TEST DISTANCE: VERTICAL AT 3 M								
NO.	FREQ. (MHz)	EMISSION LEVEL (dBuV/m)	LIMIT (dBuV/m)	MARGIN (dB)	ANTENNA HEIGHT (m)	TABLE ANGLE (Degree)	RAW VALUE (dBuV)	CORRECTION FACTOR (dB/m)
1	#5498.00	65.1 PK	74.0	-8.9	1.57 V	125	62.2	2.9
2	#5498.00	53.6 AV	54.0	-0.4	1.57 V	125	50.7	2.9
3	#5550.00	58.3 PK	74.0	-15.7	1.52 V	298	55.3	3.0
4	#5550.00	47.4 AV	54.0	-6.6	1.52 V	298	44.4	3.0
5	*5825.00	121.4 PK			1.52 V	298	117.9	3.5
6	*5825.00	111.3 AV			1.52 V	298	107.8	3.5
7	#6025.00	59.2 PK	74.0	-14.8	1.57 V	125	55.4	3.8
8	#6025.00	47.4 AV	54.0	-6.6	1.57 V	125	43.6	3.8
9	11650.00	57.9 PK	74.0	-16.1	2.33 V	107	44.6	13.3
10	11650.00	46.3 AV	54.0	-7.7	2.33 V	107	33.0	13.3
11	#17475.00	52.8 PK	74.0	-21.2	2.01 V	312	34.6	18.2
12	#17475.00	41.7 AV	54.0	-12.3	2.01 V	312	23.5	18.2

REMARKS:

1. Emission Level(dBuV/m) = Raw Value(dBuV) + Correction Factor(dB/m)
2. Correction Factor(dB/m) = Antenna Factor(dB/m) + Cable Factor(dB) – Pre-Amplifier Factor(dB)
3. The other emission levels were very low against the limit.
4. Margin value = Emission Level – Limit value
5. " * ": Fundamental frequency.
6. " # ": The radiated frequency is out of the restricted band.

802.11ac (VHT20)

CHANNEL	TX Channel 36	DETECTOR FUNCTION	Peak (PK)
FREQUENCY RANGE	1GHz ~ 40GHz		Average (AV)

ANTENNA POLARITY & TEST DISTANCE: HORIZONTAL AT 3 M								
NO.	FREQ. (MHz)	EMISSION LEVEL (dBuV/m)	LIMIT (dBuV/m)	MARGIN (dB)	ANTENNA HEIGHT (m)	TABLE ANGLE (Degree)	RAW VALUE (dBuV)	CORRECTION FACTOR (dB/m)
1	5150.00	59.0 PK	74.0	-15.0	2.72 H	325	56.0	3.0
2	5150.00	44.7 AV	54.0	-9.3	2.72 H	325	41.7	3.0
3	*5180.00	114.0 PK			2.72 H	325	111.2	2.8
4	*5180.00	104.5 AV			2.72 H	325	101.7	2.8
5	#10360.00	45.4 PK	74.0	-28.6	3.57 H	136	33.0	12.4
6	#10360.00	34.8 AV	54.0	-19.2	3.57 H	136	22.4	12.4
7	15540.00	48.2 PK	74.0	-25.8	1.28 H	122	35.4	12.8
8	15540.00	37.4 AV	54.0	-16.6	1.28 H	122	24.6	12.8

ANTENNA POLARITY & TEST DISTANCE: VERTICAL AT 3 M								
NO.	FREQ. (MHz)	EMISSION LEVEL (dBuV/m)	LIMIT (dBuV/m)	MARGIN (dB)	ANTENNA HEIGHT (m)	TABLE ANGLE (Degree)	RAW VALUE (dBuV)	CORRECTION FACTOR (dB/m)
1	5150.00	62.1 PK	74.0	-11.9	1.66 V	80	59.1	3.0
2	5150.00	48.3 AV	54.0	-5.7	1.66 V	80	45.3	3.0
3	*5180.00	117.8 PK			1.66 V	80	115.0	2.8
4	*5180.00	108.9 AV			1.66 V	80	106.1	2.8
5	#10360.00	45.3 PK	74.0	-28.7	2.09 V	82	32.9	12.4
6	#10360.00	35.1 AV	54.0	-18.9	2.09 V	82	22.7	12.4
7	15540.00	47.6 PK	74.0	-26.4	1.67 V	164	34.8	12.8
8	15540.00	36.8 AV	54.0	-17.2	1.67 V	164	24.0	12.8

REMARKS:

1. Emission Level(dBuV/m) = Raw Value(dBuV) + Correction Factor(dB/m)
2. Correction Factor(dB/m) = Antenna Factor(dB/m) + Cable Factor(dB) – Pre-Amplifier Factor(dB)
3. The other emission levels were very low against the limit.
4. Margin value = Emission Level – Limit value
5. " * ": Fundamental frequency.
6. " # ": The radiated frequency is out of the restricted band.

CHANNEL	TX Channel 40	DETECTOR FUNCTION	Peak (PK)
FREQUENCY RANGE	1GHz ~ 40GHz		Average (AV)

ANTENNA POLARITY & TEST DISTANCE: HORIZONTAL AT 3 M								
NO.	FREQ. (MHz)	EMISSION LEVEL (dBuV/m)	LIMIT (dBuV/m)	MARGIN (dB)	ANTENNA HEIGHT (m)	TABLE ANGLE (Degree)	RAW VALUE (dBuV)	CORRECTION FACTOR (dB/m)
1	*5200.00	114.2 PK			2.71 H	312	111.5	2.7
2	*5200.00	104.5 AV			2.71 H	312	101.8	2.7
3	#10400.00	45.8 PK	74.0	-28.2	3.56 H	150	33.3	12.5
4	#10400.00	35.5 AV	54.0	-18.5	3.56 H	150	23.0	12.5
5	15600.00	48.4 PK	74.0	-25.6	1.22 H	112	35.6	12.8
6	15600.00	37.7 AV	54.0	-16.3	1.22 H	112	24.9	12.8

ANTENNA POLARITY & TEST DISTANCE: VERTICAL AT 3 M								
NO.	FREQ. (MHz)	EMISSION LEVEL (dBuV/m)	LIMIT (dBuV/m)	MARGIN (dB)	ANTENNA HEIGHT (m)	TABLE ANGLE (Degree)	RAW VALUE (dBuV)	CORRECTION FACTOR (dB/m)
1	*5200.00	117.5 PK			1.01 V	197	114.8	2.7
2	*5200.00	108.8 AV			1.01 V	197	106.1	2.7
3	#10400.00	44.8 PK	74.0	-29.2	2.06 V	82	32.3	12.5
4	#10400.00	34.7 AV	54.0	-19.3	2.06 V	82	22.2	12.5
5	15600.00	48.3 PK	74.0	-25.7	1.69 V	160	35.5	12.8
6	15600.00	37.1 AV	54.0	-16.9	1.69 V	160	24.3	12.8

REMARKS:

1. Emission Level(dBuV/m) = Raw Value(dBuV) + Correction Factor(dB/m)
2. Correction Factor(dB/m) = Antenna Factor(dB/m) + Cable Factor(dB) – Pre-Amplifier Factor(dB)
3. The other emission levels were very low against the limit.
4. Margin value = Emission Level – Limit value
5. " * ": Fundamental frequency.
6. " # ": The radiated frequency is out of the restricted band.

CHANNEL	TX Channel 48	DETECTOR FUNCTION	Peak (PK)
FREQUENCY RANGE	1GHz ~ 40GHz		Average (AV)

ANTENNA POLARITY & TEST DISTANCE: HORIZONTAL AT 3 M								
NO.	FREQ. (MHz)	EMISSION LEVEL (dBuV/m)	LIMIT (dBuV/m)	MARGIN (dB)	ANTENNA HEIGHT (m)	TABLE ANGLE (Degree)	RAW VALUE (dBuV)	CORRECTION FACTOR (dB/m)
1	*5240.00	114.5 PK			2.74 H	310	112.0	2.5
2	*5240.00	104.8 AV			2.74 H	310	102.3	2.5
3	5350.00	49.0 PK	74.0	-25.0	2.74 H	310	46.4	2.6
4	5350.00	39.0 AV	54.0	-15.0	2.74 H	310	36.4	2.6
5	#10480.00	46.2 PK	74.0	-27.8	3.62 H	141	33.2	13.0
6	#10480.00	35.6 AV	54.0	-18.4	3.62 H	141	22.6	13.0
7	15720.00	48.7 PK	74.0	-25.3	1.21 H	110	36.3	12.4
8	15720.00	38.0 AV	54.0	-16.0	1.21 H	110	25.6	12.4

ANTENNA POLARITY & TEST DISTANCE: VERTICAL AT 3 M								
NO.	FREQ. (MHz)	EMISSION LEVEL (dBuV/m)	LIMIT (dBuV/m)	MARGIN (dB)	ANTENNA HEIGHT (m)	TABLE ANGLE (Degree)	RAW VALUE (dBuV)	CORRECTION FACTOR (dB/m)
1	*5240.00	117.6 PK			1.33 V	206	115.1	2.5
2	*5240.00	108.8 AV			1.33 V	206	106.3	2.5
3	5350.00	52.5 PK	74.0	-21.5	1.33 V	206	49.9	2.6
4	5350.00	42.3 AV	54.0	-11.7	1.33 V	206	39.7	2.6
5	#10480.00	45.1 PK	74.0	-28.9	2.07 V	82	32.1	13.0
6	#10480.00	35.0 AV	54.0	-19.0	2.07 V	82	22.0	13.0
7	15720.00	48.6 PK	74.0	-25.4	1.68 V	162	36.2	12.4
8	15720.00	37.2 AV	54.0	-16.8	1.68 V	162	24.8	12.4

REMARKS:

1. Emission Level(dBuV/m) = Raw Value(dBuV) + Correction Factor(dB/m)
2. Correction Factor(dB/m) = Antenna Factor(dB/m) + Cable Factor(dB) – Pre-Amplifier Factor(dB)
3. The other emission levels were very low against the limit.
4. Margin value = Emission Level – Limit value
5. " * ": Fundamental frequency.
6. " # ": The radiated frequency is out of the restricted band.

CHANNEL	TX Channel 149	DETECTOR FUNCTION	Peak (PK)
FREQUENCY RANGE	1GHz ~ 40GHz		Average (AV)

ANTENNA POLARITY & TEST DISTANCE: HORIZONTAL AT 3 M								
NO.	FREQ. (MHz)	EMISSION LEVEL (dBuV/m)	LIMIT (dBuV/m)	MARGIN (dB)	ANTENNA HEIGHT (m)	TABLE ANGLE (Degree)	RAW VALUE (dBuV)	CORRECTION FACTOR (dB/m)
1	5453.00	63.3 PK	74.0	-10.7	1.32 H	153	60.4	2.9
2	5453.00	51.5 AV	54.0	-2.5	1.32 H	153	48.6	2.9
3	#5550.00	59.7 PK	74.0	-14.3	1.31 H	199	56.7	3.0
4	#5550.00	47.3 AV	54.0	-6.7	1.31 H	199	44.3	3.0
5	*5745.00	117.3 PK			1.28 H	164	114.0	3.3
6	*5745.00	108.3 AV			1.28 H	164	105.0	3.3
7	11490.00	58.7 PK	74.0	-15.3	1.71 H	157	45.3	13.4
8	11490.00	47.5 AV	54.0	-6.5	1.71 H	157	34.1	13.4
9	#17235.00	53.9 PK	74.0	-20.1	1.54 H	138	37.2	16.7
10	#17235.00	43.2 AV	54.0	-10.8	1.54 H	138	26.5	16.7

ANTENNA POLARITY & TEST DISTANCE: VERTICAL AT 3 M								
NO.	FREQ. (MHz)	EMISSION LEVEL (dBuV/m)	LIMIT (dBuV/m)	MARGIN (dB)	ANTENNA HEIGHT (m)	TABLE ANGLE (Degree)	RAW VALUE (dBuV)	CORRECTION FACTOR (dB/m)
1	5453.00	64.8 PK	74.0	-9.2	1.58 V	120	61.9	2.9
2	5453.00	53.6 AV	54.0	-0.4	1.58 V	120	50.7	2.9
3	#5550.00	57.4 PK	74.0	-16.6	2.71 V	338	54.4	3.0
4	#5550.00	46.5 AV	54.0	-7.5	2.71 V	338	43.5	3.0
5	*5745.00	119.4 PK			2.71 V	338	116.1	3.3
6	*5745.00	111.1 AV			2.71 V	338	107.8	3.3
7	11490.00	57.7 PK	74.0	-16.3	2.30 V	96	44.3	13.4
8	11490.00	46.0 AV	54.0	-8.0	2.30 V	96	32.6	13.4
9	#17235.00	52.8 PK	74.0	-21.2	2.06 V	325	36.1	16.7
10	#17235.00	41.4 AV	54.0	-12.6	2.06 V	325	24.7	16.7

REMARKS:

1. Emission Level(dBuV/m) = Raw Value(dBuV) + Correction Factor(dB/m)
2. Correction Factor(dB/m) = Antenna Factor(dB/m) + Cable Factor(dB) – Pre-Amplifier Factor(dB)
3. The other emission levels were very low against the limit.
4. Margin value = Emission Level – Limit value
5. " * ": Fundamental frequency.
6. " # ": The radiated frequency is out of the restricted band.

CHANNEL	TX Channel 157	DETECTOR FUNCTION	Peak (PK)
FREQUENCY RANGE	1GHz ~ 40GHz		Average (AV)

ANTENNA POLARITY & TEST DISTANCE: HORIZONTAL AT 3 M								
NO.	FREQ. (MHz)	EMISSION LEVEL (dBuV/m)	LIMIT (dBuV/m)	MARGIN (dB)	ANTENNA HEIGHT (m)	TABLE ANGLE (Degree)	RAW VALUE (dBuV)	CORRECTION FACTOR (dB/m)
1	5453.00	63.7 PK	74.0	-10.3	1.31 H	159	60.8	2.9
2	5453.00	51.7 AV	54.0	-2.3	1.31 H	159	48.8	2.9
3	#5550.00	51.5 PK	74.0	-22.5	1.33 H	166	48.5	3.0
4	#5550.00	39.9 AV	54.0	-14.1	1.33 H	166	36.9	3.0
5	*5785.00	116.9 PK			1.30 H	165	113.6	3.3
6	*5785.00	108.1 AV			1.30 H	165	104.8	3.3
7	#6025.00	60.3 PK	74.0	-13.7	1.26 H	198	56.5	3.8
8	#6025.00	47.6 AV	54.0	-6.4	1.26 H	198	43.8	3.8
9	11570.00	59.0 PK	74.0	-15.0	1.72 H	163	45.6	13.4
10	11570.00	47.4 AV	54.0	-6.6	1.72 H	163	34.0	13.4
11	#17355.00	53.5 PK	74.0	-20.5	1.50 H	129	36.2	17.3
12	#17355.00	43.0 AV	54.0	-11.0	1.50 H	129	25.7	17.3

ANTENNA POLARITY & TEST DISTANCE: VERTICAL AT 3 M								
NO.	FREQ. (MHz)	EMISSION LEVEL (dBuV/m)	LIMIT (dBuV/m)	MARGIN (dB)	ANTENNA HEIGHT (m)	TABLE ANGLE (Degree)	RAW VALUE (dBuV)	CORRECTION FACTOR (dB/m)
1	5453.00	64.1 PK	74.0	-9.9	1.79 V	108	61.2	2.9
2	5453.00	53.5 AV	54.0	-0.5	1.79 V	108	50.6	2.9
3	#5550.00	56.1 PK	74.0	-17.9	1.71 V	344	53.1	3.0
4	#5550.00	45.8 AV	54.0	-8.2	1.71 V	344	42.8	3.0
5	*5785.00	118.9 PK			1.71 V	344	115.6	3.3
6	*5785.00	110.7 AV			1.71 V	344	107.4	3.3
7	#6025.00	58.2 PK	74.0	-15.8	1.79 V	108	54.4	3.8
8	#6025.00	47.1 AV	54.0	-6.9	1.79 V	108	43.3	3.8
9	11570.00	57.8 PK	74.0	-16.2	2.30 V	117	44.4	13.4
10	11570.00	46.2 AV	54.0	-7.8	2.30 V	117	32.8	13.4
11	#17355.00	52.4 PK	74.0	-21.6	2.02 V	297	35.1	17.3
12	#17355.00	41.3 AV	54.0	-12.7	2.02 V	297	24.0	17.3

REMARKS:

1. Emission Level(dBuV/m) = Raw Value(dBuV) + Correction Factor(dB/m)
2. Correction Factor(dB/m) = Antenna Factor(dB/m) + Cable Factor(dB) – Pre-Amplifier Factor(dB)
3. The other emission levels were very low against the limit.
4. Margin value = Emission Level – Limit value
5. " * ": Fundamental frequency.
6. " # ": The radiated frequency is out of the restricted band.

CHANNEL	TX Channel 165	DETECTOR FUNCTION	Peak (PK)
FREQUENCY RANGE	1GHz ~ 40GHz		Average (AV)

ANTENNA POLARITY & TEST DISTANCE: HORIZONTAL AT 3 M								
NO.	FREQ. (MHz)	EMISSION LEVEL (dBuV/m)	LIMIT (dBuV/m)	MARGIN (dB)	ANTENNA HEIGHT (m)	TABLE ANGLE (Degree)	RAW VALUE (dBuV)	CORRECTION FACTOR (dB/m)
1	#5498.00	63.9 PK	74.0	-10.1	1.29 H	166	61.0	2.9
2	#5498.00	52.0 AV	54.0	-2.0	1.29 H	166	49.1	2.9
3	#5550.00	51.3 PK	74.0	-22.7	1.22 H	187	48.3	3.0
4	#5550.00	39.5 AV	54.0	-14.5	1.22 H	187	36.5	3.0
5	*5825.00	116.6 PK			1.37 H	168	113.1	3.5
6	*5825.00	107.9 AV			1.37 H	168	104.4	3.5
7	#6025.00	56.7 PK	74.0	-17.3	1.27 H	184	52.9	3.8
8	#6025.00	45.4 AV	54.0	-8.6	1.27 H	184	41.6	3.8
9	11650.00	59.0 PK	74.0	-15.0	1.71 H	167	45.7	13.3
10	11650.00	47.5 AV	54.0	-6.5	1.71 H	167	34.2	13.3
11	#17475.00	53.8 PK	74.0	-20.2	1.47 H	128	35.6	18.2
12	#17475.00	43.4 AV	54.0	-10.6	1.47 H	128	25.2	18.2

ANTENNA POLARITY & TEST DISTANCE: VERTICAL AT 3 M								
NO.	FREQ. (MHz)	EMISSION LEVEL (dBuV/m)	LIMIT (dBuV/m)	MARGIN (dB)	ANTENNA HEIGHT (m)	TABLE ANGLE (Degree)	RAW VALUE (dBuV)	CORRECTION FACTOR (dB/m)
1	#5498.00	64.1 PK	74.0	-9.9	1.48 V	125	61.2	2.9
2	#5498.00	53.5 AV	54.0	-0.5	1.48 V	125	50.6	2.9
3	#5550.00	56.1 PK	74.0	-17.9	1.89 V	303	53.1	3.0
4	#5550.00	45.7 AV	54.0	-8.3	1.89 V	303	42.7	3.0
5	*5825.00	118.7 PK			1.89 V	303	115.2	3.5
6	*5825.00	110.5 AV			1.89 V	303	107.0	3.5
7	#6025.00	58.2 PK	74.0	-15.8	1.48 V	125	54.4	3.8
8	#6025.00	47.1 AV	54.0	-6.9	1.48 V	125	43.3	3.8
9	11650.00	57.7 PK	74.0	-16.3	2.31 V	106	44.4	13.3
10	11650.00	46.1 AV	54.0	-7.9	2.31 V	106	32.8	13.3
11	#17475.00	53.4 PK	74.0	-20.6	2.05 V	320	35.2	18.2
12	#17475.00	42.0 AV	54.0	-12.0	2.05 V	320	23.8	18.2

REMARKS:

1. Emission Level(dBuV/m) = Raw Value(dBuV) + Correction Factor(dB/m)
2. Correction Factor(dB/m) = Antenna Factor(dB/m) + Cable Factor(dB) – Pre-Amplifier Factor(dB)
3. The other emission levels were very low against the limit.
4. Margin value = Emission Level – Limit value
5. " * ": Fundamental frequency.
6. " # ": The radiated frequency is out of the restricted band.

802.11ac (VHT40)

CHANNEL	TX Channel 38	DETECTOR FUNCTION	Peak (PK)
FREQUENCY RANGE	1GHz ~ 40GHz		Average (AV)

ANTENNA POLARITY & TEST DISTANCE: HORIZONTAL AT 3 M								
NO.	FREQ. (MHz)	EMISSION LEVEL (dBuV/m)	LIMIT (dBuV/m)	MARGIN (dB)	ANTENNA HEIGHT (m)	TABLE ANGLE (Degree)	RAW VALUE (dBuV)	CORRECTION FACTOR (dB/m)
1	5150.00	64.0 PK	74.0	-10.0	2.81 H	318	61.0	3.0
2	5150.00	51.1 AV	54.0	-2.9	2.81 H	318	48.1	3.0
3	*5190.00	106.2 PK			2.81 H	318	103.4	2.8
4	*5190.00	96.1 AV			2.81 H	318	93.3	2.8
5	5350.00	50.8 PK	74.0	-23.2	2.81 H	318	48.2	2.6
6	5350.00	39.0 AV	54.0	-15.0	2.81 H	318	36.4	2.6
7	#10380.00	45.4 PK	74.0	-28.6	3.55 H	147	33.0	12.4
8	#10380.00	35.2 AV	54.0	-18.8	3.55 H	147	22.8	12.4
9	15570.00	48.7 PK	74.0	-25.3	1.23 H	121	35.9	12.8
10	15570.00	37.7 AV	54.0	-16.3	1.23 H	121	24.9	12.8

ANTENNA POLARITY & TEST DISTANCE: VERTICAL AT 3 M								
NO.	FREQ. (MHz)	EMISSION LEVEL (dBuV/m)	LIMIT (dBuV/m)	MARGIN (dB)	ANTENNA HEIGHT (m)	TABLE ANGLE (Degree)	RAW VALUE (dBuV)	CORRECTION FACTOR (dB/m)
1	5150.00	67.1 PK	74.0	-6.9	1.99 V	77	64.1	3.0
2	5150.00	53.6 AV	54.0	-0.4	1.99 V	77	50.6	3.0
3	*5190.00	110.3 PK			1.99 V	77	107.5	2.8
4	*5190.00	100.5 AV			1.99 V	77	97.7	2.8
5	5350.00	51.4 PK	74.0	-22.6	1.99 V	77	48.8	2.6
6	5350.00	39.7 AV	54.0	-14.3	1.99 V	77	37.1	2.6
7	#10380.00	45.3 PK	74.0	-28.7	2.09 V	56	32.9	12.4
8	#10380.00	34.9 AV	54.0	-19.1	2.09 V	56	22.5	12.4
9	15570.00	48.5 PK	74.0	-25.5	1.77 V	164	35.7	12.8
10	15570.00	37.4 AV	54.0	-16.6	1.77 V	164	24.6	12.8

REMARKS:

1. Emission Level(dBuV/m) = Raw Value(dBuV) + Correction Factor(dB/m)
2. Correction Factor(dB/m) = Antenna Factor(dB/m) + Cable Factor(dB) – Pre-Amplifier Factor(dB)
3. The other emission levels were very low against the limit.
4. Margin value = Emission Level – Limit value
5. " * ": Fundamental frequency.
6. " # ": The radiated frequency is out of the restricted band.

CHANNEL	TX Channel 46	DETECTOR FUNCTION	Peak (PK)
FREQUENCY RANGE	1GHz ~ 40GHz		Average (AV)

ANTENNA POLARITY & TEST DISTANCE: HORIZONTAL AT 3 M								
NO.	FREQ. (MHz)	EMISSION LEVEL (dBuV/m)	LIMIT (dBuV/m)	MARGIN (dB)	ANTENNA HEIGHT (m)	TABLE ANGLE (Degree)	RAW VALUE (dBuV)	CORRECTION FACTOR (dB/m)
1	*5230.00	110.2 PK			2.78 H	298	107.7	2.5
2	*5230.00	101.6 AV			2.78 H	298	99.1	2.5
3	5350.00	52.0 PK	74.0	-22.0	2.78 H	298	49.4	2.6
4	5350.00	41.6 AV	54.0	-12.4	2.78 H	298	39.0	2.6
5	#10460.00	45.7 PK	74.0	-28.3	3.55 H	138	32.8	12.9
6	#10460.00	35.5 AV	54.0	-18.5	3.55 H	138	22.6	12.9
7	15690.00	48.9 PK	74.0	-25.1	1.26 H	128	36.5	12.4
8	15690.00	38.0 AV	54.0	-16.0	1.26 H	128	25.6	12.4

ANTENNA POLARITY & TEST DISTANCE: VERTICAL AT 3 M								
NO.	FREQ. (MHz)	EMISSION LEVEL (dBuV/m)	LIMIT (dBuV/m)	MARGIN (dB)	ANTENNA HEIGHT (m)	TABLE ANGLE (Degree)	RAW VALUE (dBuV)	CORRECTION FACTOR (dB/m)
1	*5230.00	114.7 PK			2.22 V	205	112.2	2.5
2	*5230.00	105.1 AV			2.22 V	205	102.6	2.5
3	5350.00	55.1 PK	74.0	-18.9	2.22 V	205	52.5	2.6
4	5350.00	44.8 AV	54.0	-9.2	2.22 V	205	42.2	2.6
5	#10460.00	45.1 PK	74.0	-28.9	2.11 V	73	32.2	12.9
6	#10460.00	34.7 AV	54.0	-19.3	2.11 V	73	21.8	12.9
7	15690.00	47.9 PK	74.0	-26.1	1.78 V	155	35.5	12.4
8	15690.00	36.9 AV	54.0	-17.1	1.78 V	155	24.5	12.4

REMARKS:

1. Emission Level(dBuV/m) = Raw Value(dBuV) + Correction Factor(dB/m)
2. Correction Factor(dB/m) = Antenna Factor(dB/m) + Cable Factor(dB) – Pre-Amplifier Factor(dB)
3. The other emission levels were very low against the limit.
4. Margin value = Emission Level – Limit value
5. " * ": Fundamental frequency.
6. " # ": The radiated frequency is out of the restricted band.

CHANNEL	TX Channel 151	DETECTOR FUNCTION	Peak (PK)
FREQUENCY RANGE	1GHz ~ 40GHz		Average (AV)

ANTENNA POLARITY & TEST DISTANCE: HORIZONTAL AT 3 M								
NO.	FREQ. (MHz)	EMISSION LEVEL (dBuV/m)	LIMIT (dBuV/m)	MARGIN (dB)	ANTENNA HEIGHT (m)	TABLE ANGLE (Degree)	RAW VALUE (dBuV)	CORRECTION FACTOR (dB/m)
1	5419.00	63.8 PK	74.0	-10.2	1.28 H	163	61.0	2.8
2	5419.00	51.6 AV	54.0	-2.4	1.28 H	163	48.8	2.8
3	#5550.00	51.9 PK	74.0	-22.1	1.30 H	163	48.9	3.0
4	#5550.00	40.1 AV	54.0	-13.9	1.30 H	163	37.1	3.0
5	*5755.00	109.4 PK			1.30 H	161	106.1	3.3
6	*5755.00	100.8 AV			1.30 H	161	97.5	3.3
7	#6025.00	60.3 PK	74.0	-13.7	1.25 H	184	56.5	3.8
8	#6025.00	47.6 AV	54.0	-6.4	1.25 H	184	43.8	3.8
9	11510.00	46.2 PK	74.0	-27.8	1.75 H	170	32.8	13.4
10	11510.00	36.1 AV	54.0	-17.9	1.75 H	170	22.7	13.4
11	#17265.00	49.2 PK	74.0	-24.8	1.53 H	123	32.4	16.8
12	#17265.00	38.3 AV	54.0	-15.7	1.53 H	123	21.5	16.8

ANTENNA POLARITY & TEST DISTANCE: VERTICAL AT 3 M								
NO.	FREQ. (MHz)	EMISSION LEVEL (dBuV/m)	LIMIT (dBuV/m)	MARGIN (dB)	ANTENNA HEIGHT (m)	TABLE ANGLE (Degree)	RAW VALUE (dBuV)	CORRECTION FACTOR (dB/m)
1	5419.00	62.7 PK	74.0	-11.3	1.69 V	284	59.9	2.8
2	5419.00	53.7 AV	54.0	-0.3	1.69 V	284	50.9	2.8
3	#5550.00	53.6 PK	74.0	-20.4	1.01 V	106	50.6	3.0
4	#5550.00	42.4 AV	54.0	-11.6	1.01 V	106	39.4	3.0
5	*5755.00	111.5 PK			1.01 V	106	108.2	3.3
6	*5755.00	101.9 AV			1.01 V	106	98.6	3.3
7	#6025.00	61.7 PK	74.0	-12.3	1.69 V	284	57.9	3.8
8	#6025.00	48.9 AV	54.0	-5.1	1.69 V	284	45.1	3.8
9	11510.00	45.9 PK	74.0	-28.1	2.31 V	95	32.5	13.4
10	11510.00	35.8 AV	54.0	-18.2	2.31 V	95	22.4	13.4
11	#17265.00	49.0 PK	74.0	-25.0	2.04 V	316	32.2	16.8
12	#17265.00	38.1 AV	54.0	-15.9	2.04 V	316	21.3	16.8

REMARKS:

1. Emission Level(dBuV/m) = Raw Value(dBuV) + Correction Factor(dB/m)
2. Correction Factor(dB/m) = Antenna Factor(dB/m) + Cable Factor(dB) – Pre-Amplifier Factor(dB)
3. The other emission levels were very low against the limit.
4. Margin value = Emission Level – Limit value
5. " * ": Fundamental frequency.
6. " # ": The radiated frequency is out of the restricted band.

CHANNEL	TX Channel 159	DETECTOR FUNCTION	Peak (PK)
FREQUENCY RANGE	1GHz ~ 40GHz		Average (AV)

ANTENNA POLARITY & TEST DISTANCE: HORIZONTAL AT 3 M								
NO.	FREQ. (MHz)	EMISSION LEVEL (dBuV/m)	LIMIT (dBuV/m)	MARGIN (dB)	ANTENNA HEIGHT (m)	TABLE ANGLE (Degree)	RAW VALUE (dBuV)	CORRECTION FACTOR (dB/m)
1	5458.00	63.8 PK	74.0	-10.2	1.30 H	155	60.9	2.9
2	5458.00	51.6 AV	54.0	-2.4	1.30 H	155	48.7	2.9
3	#5550.00	51.5 PK	74.0	-22.5	1.22 H	168	48.5	3.0
4	#5550.00	39.8 AV	54.0	-14.2	1.22 H	168	36.8	3.0
5	*5795.00	99.1 PK			1.35 H	162	95.8	3.3
6	*5795.00	98.8 AV			1.35 H	162	95.5	3.3
7	11590.00	46.2 PK	74.0	-27.8	1.75 H	156	32.8	13.4
8	11590.00	36.0 AV	54.0	-18.0	1.75 H	156	22.6	13.4
9	#17385.00	49.6 PK	74.0	-24.4	1.53 H	127	32.1	17.5
10	#17385.00	38.7 AV	54.0	-15.3	1.53 H	127	21.2	17.5

ANTENNA POLARITY & TEST DISTANCE: VERTICAL AT 3 M								
NO.	FREQ. (MHz)	EMISSION LEVEL (dBuV/m)	LIMIT (dBuV/m)	MARGIN (dB)	ANTENNA HEIGHT (m)	TABLE ANGLE (Degree)	RAW VALUE (dBuV)	CORRECTION FACTOR (dB/m)
1	5458.00	57.9 PK	74.0	-16.1	1.99 V	281	55.0	2.9
2	5458.00	53.9 AV	54.0	-0.1	1.99 V	281	51.0	2.9
3	#5550.00	51.9 PK	74.0	-22.1	2.20 V	281	48.9	3.0
4	#5550.00	40.4 AV	54.0	-13.6	2.20 V	281	37.4	3.0
5	*5795.00	99.4 PK			2.20 V	281	96.1	3.3
6	*5795.00	99.4 AV			2.20 V	281	96.1	3.3
7	11590.00	46.3 PK	74.0	-27.7	2.28 V	82	32.9	13.4
8	11590.00	36.0 AV	54.0	-18.0	2.28 V	82	22.6	13.4
9	#17385.00	48.6 PK	74.0	-25.4	2.08 V	326	31.1	17.5
10	#17385.00	37.7 AV	54.0	-16.3	2.08 V	326	20.2	17.5

REMARKS:

1. Emission Level(dBuV/m) = Raw Value(dBuV) + Correction Factor(dB/m)
2. Correction Factor(dB/m) = Antenna Factor(dB/m) + Cable Factor(dB) – Pre-Amplifier Factor(dB)
3. The other emission levels were very low against the limit.
4. Margin value = Emission Level – Limit value
5. " * ": Fundamental frequency.
6. " # ": The radiated frequency is out of the restricted band.

802.11ac (VHT80)

CHANNEL	TX Channel 42	DETECTOR FUNCTION	Peak (PK)
FREQUENCY RANGE	1GHz ~ 40GHz		Average (AV)

ANTENNA POLARITY & TEST DISTANCE: HORIZONTAL AT 3 M								
NO.	FREQ. (MHz)	EMISSION LEVEL (dBuV/m)	LIMIT (dBuV/m)	MARGIN (dB)	ANTENNA HEIGHT (m)	TABLE ANGLE (Degree)	RAW VALUE (dBuV)	CORRECTION FACTOR (dB/m)
1	5150.00	63.7 PK	74.0	-10.3	2.71 H	318	60.7	3.0
2	5150.00	51.8 AV	54.0	-2.2	2.71 H	318	48.8	3.0
3	*5210.00	104.2 PK			2.71 H	318	101.5	2.7
4	*5210.00	93.0 AV			2.71 H	318	90.3	2.7
5	5350.00	51.8 PK	74.0	-22.2	2.71 H	318	49.2	2.6
6	5350.00	39.0 AV	54.0	-15.0	2.71 H	318	36.4	2.6
7	#10420.00	45.8 PK	74.0	-28.2	3.60 H	147	33.2	12.6
8	#10420.00	35.7 AV	54.0	-18.3	3.60 H	147	23.1	12.6
9	15630.00	48.3 PK	74.0	-25.7	1.25 H	126	35.6	12.7
10	15630.00	37.3 AV	54.0	-16.7	1.25 H	126	24.6	12.7

ANTENNA POLARITY & TEST DISTANCE: VERTICAL AT 3 M								
NO.	FREQ. (MHz)	EMISSION LEVEL (dBuV/m)	LIMIT (dBuV/m)	MARGIN (dB)	ANTENNA HEIGHT (m)	TABLE ANGLE (Degree)	RAW VALUE (dBuV)	CORRECTION FACTOR (dB/m)
1	5150.00	66.9 PK	74.0	-7.1	2.21 V	126	63.9	3.0
2	5150.00	53.7 AV	54.0	-0.3	2.21 V	126	50.7	3.0
3	*5210.00	106.6 PK			2.21 V	126	103.9	2.7
4	*5210.00	96.9 AV			2.21 V	126	94.2	2.7
5	5350.00	51.9 PK	74.0	-22.1	2.21 V	126	49.3	2.6
6	5350.00	39.4 AV	54.0	-14.6	2.21 V	126	36.8	2.6
7	#10420.00	45.8 PK	74.0	-28.2	2.12 V	88	33.2	12.6
8	#10420.00	35.2 AV	54.0	-18.8	2.12 V	88	22.6	12.6
9	15630.00	48.3 PK	74.0	-25.7	1.80 V	171	35.6	12.7
10	15630.00	37.0 AV	54.0	-17.0	1.80 V	171	24.3	12.7

REMARKS:

1. Emission Level(dBuV/m) = Raw Value(dBuV) + Correction Factor(dB/m)
2. Correction Factor(dB/m) = Antenna Factor(dB/m) + Cable Factor(dB) – Pre-Amplifier Factor(dB)
3. The other emission levels were very low against the limit.
4. Margin value = Emission Level – Limit value
5. " * ": Fundamental frequency.
6. " # ": The radiated frequency is out of the restricted band.

CHANNEL	TX Channel 155	DETECTOR FUNCTION	Peak (PK)
FREQUENCY RANGE	1GHz ~ 40GHz		Average (AV)

ANTENNA POLARITY & TEST DISTANCE: HORIZONTAL AT 3 M								
NO.	FREQ. (MHz)	EMISSION LEVEL (dBuV/m)	LIMIT (dBuV/m)	MARGIN (dB)	ANTENNA HEIGHT (m)	TABLE ANGLE (Degree)	RAW VALUE (dBuV)	CORRECTION FACTOR (dB/m)
1	5438.00	63.7 PK	74.0	-10.3	1.27 H	162	60.8	2.9
2	5438.00	51.7 AV	54.0	-2.3	1.27 H	162	48.8	2.9
3	#5550.00	51.5 PK	74.0	-22.5	1.26 H	174	48.5	3.0
4	#5550.00	39.8 AV	54.0	-14.2	1.26 H	174	36.8	3.0
5	*5775.00	104.6 PK			1.33 H	176	101.2	3.4
6	*5775.00	93.5 AV			1.33 H	176	90.1	3.4
7	11550.00	45.8 PK	74.0	-28.2	1.81 H	162	32.5	13.3
8	11550.00	35.9 AV	54.0	-18.1	1.81 H	162	22.6	13.3
9	#17325.00	49.5 PK	74.0	-24.5	1.51 H	111	32.4	17.1
10	#17325.00	38.7 AV	54.0	-15.3	1.51 H	111	21.6	17.1

ANTENNA POLARITY & TEST DISTANCE: VERTICAL AT 3 M								
NO.	FREQ. (MHz)	EMISSION LEVEL (dBuV/m)	LIMIT (dBuV/m)	MARGIN (dB)	ANTENNA HEIGHT (m)	TABLE ANGLE (Degree)	RAW VALUE (dBuV)	CORRECTION FACTOR (dB/m)
1	5438.00	62.9 PK	74.0	-11.1	1.80 V	233	60.0	2.9
2	5438.00	53.7 AV	54.0	-0.3	1.80 V	233	50.8	2.9
3	#5550.00	52.1 PK	74.0	-21.9	2.25 V	147	49.1	3.0
4	#5550.00	40.8 AV	54.0	-13.2	2.25 V	147	37.8	3.0
5	*5775.00	107.2 PK			2.25 V	147	103.8	3.4
6	*5775.00	97.1 AV			2.25 V	147	93.7	3.4
7	11550.00	45.7 PK	74.0	-28.3	2.28 V	84	32.4	13.3
8	11550.00	35.6 AV	54.0	-18.4	2.28 V	84	22.3	13.3
9	#17325.00	48.9 PK	74.0	-25.1	2.05 V	319	31.8	17.1
10	#17325.00	38.1 AV	54.0	-15.9	2.05 V	319	21.0	17.1

REMARKS:

1. Emission Level(dBuV/m) = Raw Value(dBuV) + Correction Factor(dB/m)
2. Correction Factor(dB/m) = Antenna Factor(dB/m) + Cable Factor(dB) – Pre-Amplifier Factor(dB)
3. The other emission levels were very low against the limit.
4. Margin value = Emission Level – Limit value
5. " * ": Fundamental frequency.
6. " # ": The radiated frequency is out of the restricted band.

802.11ac (VHT80+80)

CHANNEL	TX Channel 42+155	DETECTOR FUNCTION	Peak (PK) Average (AV)
FREQUENCY RANGE	1GHz ~ 40GHz		

ANTENNA POLARITY & TEST DISTANCE: HORIZONTAL AT 3 M								
NO.	FREQ. (MHz)	EMISSION LEVEL (dBuV/m)	LIMIT (dBuV/m)	MARGIN (dB)	ANTENNA HEIGHT (m)	TABLE ANGLE (Degree)	RAW VALUE (dBuV)	CORRECTION FACTOR (dB/m)
1	5150.00	58.8 PK	74.0	-15.2	1.64 H	114	55.8	3.0
2	5150.00	46.5 AV	54.0	-7.5	1.64 H	114	43.5	3.0
3	*5210.00	104.1 PK			1.64 H	114	101.4	2.7
4	*5210.00	94.5 AV			1.64 H	114	91.8	2.7
5	5350.00	56.2 PK	74.0	-17.8	1.64 H	114	53.6	2.6
6	5350.00	43.5 AV	54.0	-10.5	1.64 H	114	40.9	2.6
7	5419.00	64.0 PK	74.0	-10.0	1.21 H	172	61.2	2.8
8	5419.00	52.1 AV	54.0	-1.9	1.21 H	172	49.3	2.8
9	#5550.00	56.1 PK	74.0	-17.9	1.28 H	180	53.1	3.0
10	#5550.00	44.7 AV	54.0	-9.3	1.28 H	180	41.7	3.0
11	*5775.00	100.5 PK			1.36 H	172	97.1	3.4
12	*5775.00	91.1 AV			1.36 H	172	87.7	3.4
13	#6025.00	55.5 PK	74.0	-18.5	1.31 H	166	51.7	3.8
14	#6025.00	44.2 AV	54.0	-9.8	1.31 H	166	40.4	3.8
15	#10420.00	45.9 PK	74.0	-28.1	3.54 H	137	33.3	12.6
16	#10420.00	35.7 AV	54.0	-18.3	3.54 H	137	23.1	12.6
17	11550.00	46.0 PK	74.0	-28.0	1.70 H	185	32.7	13.3
18	11550.00	35.7 AV	54.0	-18.3	1.70 H	185	22.4	13.3
19	15630.00	48.3 PK	74.0	-25.7	1.26 H	118	35.6	12.7
20	15630.00	37.6 AV	54.0	-16.4	1.26 H	118	24.9	12.7
21	#17325.00	49.5 PK	74.0	-24.5	1.53 H	122	32.4	17.1
22	#17325.00	38.4 AV	54.0	-15.6	1.53 H	122	21.3	17.1

ANTENNA POLARITY & TEST DISTANCE: VERTICAL AT 3 M								
NO.	FREQ. (MHz)	EMISSION LEVEL (dBuV/m)	LIMIT (dBuV/m)	MARGIN (dB)	ANTENNA HEIGHT (m)	TABLE ANGLE (Degree)	RAW VALUE (dBuV)	CORRECTION FACTOR (dB/m)
1	5150.00	65.4 PK	74.0	-8.6	1.64 V	94	62.4	3.0
2	5150.00	50.2 AV	54.0	-3.8	1.64 V	94	47.2	3.0
3	*5210.00	104.8 PK			1.64 V	94	102.1	2.7
4	*5210.00	94.5 AV			1.64 V	94	91.8	2.7
5	5350.00	55.1 PK	74.0	-18.9	1.64 V	94	52.5	2.6
6	5350.00	43.2 AV	54.0	-10.8	1.64 V	94	40.6	2.6
7	5419.00	65.4 PK	74.0	-8.6	1.34 V	120	62.6	2.8
8	5419.00	53.6 AV	54.0	-0.4	1.34 V	120	50.8	2.8
9	#5550.00	51.6 PK	74.0	-22.4	1.34 V	107	48.6	3.0
10	#5550.00	40.4 AV	54.0	-13.6	1.34 V	107	37.4	3.0
11	*5775.00	102.5 PK			1.34 V	107	99.1	3.4
12	*5775.00	93.5 AV			1.34 V	107	90.1	3.4
13	#6025.00	61.5 PK	74.0	-12.5	1.34 V	120	57.7	3.8
14	#6025.00	49.4 AV	54.0	-4.6	1.34 V	120	45.6	3.8
15	#10420.00	45.0 PK	74.0	-29.0	2.10 V	68	32.4	12.6
16	#10420.00	34.3 AV	54.0	-19.7	2.10 V	68	21.7	12.6
17	11550.00	46.1 PK	74.0	-27.9	2.29 V	108	32.8	13.3
18	11550.00	36.1 AV	54.0	-17.9	2.29 V	108	22.8	13.3
19	15630.00	48.2 PK	74.0	-25.8	1.80 V	145	35.5	12.7
20	15630.00	37.0 AV	54.0	-17.0	1.80 V	145	24.3	12.7
21	#17325.00	48.8 PK	74.0	-25.2	2.05 V	303	31.7	17.1
22	#17325.00	38.2 AV	54.0	-15.8	2.05 V	303	21.1	17.1

REMARKS:

1. Emission Level(dBuV/m) = Raw Value(dBuV) + Correction Factor(dB/m)
2. Correction Factor(dB/m) = Antenna Factor(dB/m) + Cable Factor(dB) – Pre-Amplifier Factor(dB)
3. The other emission levels were very low against the limit.
4. Margin value = Emission Level – Limit value
5. " * ": Fundamental frequency.
6. " # ": The radiated frequency is out of the restricted band.

802.11ax (HE20)

CHANNEL	TX Channel 36	DETECTOR FUNCTION	Peak (PK)
FREQUENCY RANGE	1GHz ~ 40GHz		Average (AV)

ANTENNA POLARITY & TEST DISTANCE: HORIZONTAL AT 3 M								
NO.	FREQ. (MHz)	EMISSION LEVEL (dBuV/m)	LIMIT (dBuV/m)	MARGIN (dB)	ANTENNA HEIGHT (m)	TABLE ANGLE (Degree)	RAW VALUE (dBuV)	CORRECTION FACTOR (dB/m)
1	5150.00	59.2 PK	74.0	-14.8	1.68 H	287	56.2	3.0
2	5150.00	45.0 AV	54.0	-9.0	1.68 H	287	42.0	3.0
3	*5180.00	115.4 PK			1.68 H	287	112.6	2.8
4	*5180.00	105.5 AV			1.68 H	287	102.7	2.8
5	#10360.00	45.3 PK	74.0	-28.7	3.54 H	133	32.9	12.4
6	#10360.00	35.5 AV	54.0	-18.5	3.54 H	133	23.1	12.4
7	15540.00	47.8 PK	74.0	-26.2	1.21 H	109	35.0	12.8
8	15540.00	36.9 AV	54.0	-17.1	1.21 H	109	24.1	12.8

ANTENNA POLARITY & TEST DISTANCE: VERTICAL AT 3 M								
NO.	FREQ. (MHz)	EMISSION LEVEL (dBuV/m)	LIMIT (dBuV/m)	MARGIN (dB)	ANTENNA HEIGHT (m)	TABLE ANGLE (Degree)	RAW VALUE (dBuV)	CORRECTION FACTOR (dB/m)
1	5150.00	59.2 PK	74.0	-14.8	1.75 V	351	56.2	3.0
2	5150.00	45.9 AV	54.0	-8.1	1.75 V	351	42.9	3.0
3	*5180.00	120.2 PK			1.75 V	351	117.4	2.8
4	*5180.00	107.9 AV			1.75 V	351	105.1	2.8
5	#5540.00	47.8 PK	74.0	-26.2	1.95 V	248	44.8	3.0
6	#5540.00	36.8 AV	54.0	-17.2	1.95 V	248	33.8	3.0
7	#10360.00	45.3 PK	74.0	-28.7	1.67 V	222	32.9	12.4
8	#10360.00	35.3 AV	54.0	-18.7	1.67 V	222	22.9	12.4

REMARKS:

1. Emission Level(dBuV/m) = Raw Value(dBuV) + Correction Factor(dB/m)
2. Correction Factor(dB/m) = Antenna Factor(dB/m) + Cable Factor(dB) – Pre-Amplifier Factor(dB)
3. The other emission levels were very low against the limit.
4. Margin value = Emission Level – Limit value
5. " * ": Fundamental frequency.
6. " # ": The radiated frequency is out of the restricted band.

CHANNEL	TX Channel 40	DETECTOR FUNCTION	Peak (PK)
FREQUENCY RANGE	1GHz ~ 40GHz		Average (AV)

ANTENNA POLARITY & TEST DISTANCE: HORIZONTAL AT 3 M								
NO.	FREQ. (MHz)	EMISSION LEVEL (dBuV/m)	LIMIT (dBuV/m)	MARGIN (dB)	ANTENNA HEIGHT (m)	TABLE ANGLE (Degree)	RAW VALUE (dBuV)	CORRECTION FACTOR (dB/m)
1	5150.00	50.7 PK	74.0	-23.3	1.64 H	281	47.7	3.0
2	5150.00	39.4 AV	54.0	-14.6	1.64 H	281	36.4	3.0
3	*5200.00	115.8 PK			1.64 H	281	113.1	2.7
4	*5200.00	105.9 AV			1.64 H	281	103.2	2.7
5	5350.00	53.5 PK	74.0	-20.5	1.64 H	281	50.9	2.6
6	5350.00	42.0 AV	54.0	-12.0	1.64 H	281	39.4	2.6
7	#10400.00	43.8 PK	74.0	-30.2	1.94 H	360	31.3	12.5
8	#10400.00	39.9 AV	54.0	-14.1	1.94 H	360	27.4	12.5
9	15600.00	41.7 PK	74.0	-32.3	2.71 H	136	28.9	12.8
10	15600.00	31.2 AV	54.0	-22.8	2.71 H	136	18.4	12.8

ANTENNA POLARITY & TEST DISTANCE: VERTICAL AT 3 M								
NO.	FREQ. (MHz)	EMISSION LEVEL (dBuV/m)	LIMIT (dBuV/m)	MARGIN (dB)	ANTENNA HEIGHT (m)	TABLE ANGLE (Degree)	RAW VALUE (dBuV)	CORRECTION FACTOR (dB/m)
1	5150.00	52.6 PK	74.0	-21.4	2.19 V	120	49.6	3.0
2	5150.00	41.7 AV	54.0	-12.3	2.19 V	120	38.7	3.0
3	*5200.00	117.9 PK			1.93 V	334	115.2	2.7
4	*5200.00	107.3 AV			1.93 V	334	104.6	2.7
5	5350.00	55.6 PK	74.0	-18.4	2.19 V	120	53.0	2.6
6	5350.00	43.6 AV	54.0	-10.4	2.19 V	120	41.0	2.6
7	#10400.00	45.8 PK	74.0	-28.2	1.65 V	230	33.3	12.5
8	#10400.00	35.6 AV	54.0	-18.4	1.65 V	230	23.1	12.5
9	15600.00	47.6 PK	74.0	-26.4	1.98 V	242	34.8	12.8
10	15600.00	36.7 AV	54.0	-17.3	1.98 V	242	23.9	12.8

REMARKS:

1. Emission Level(dBuV/m) = Raw Value(dBuV) + Correction Factor(dB/m)
2. Correction Factor(dB/m) = Antenna Factor(dB/m) + Cable Factor(dB) – Pre-Amplifier Factor(dB)
3. The other emission levels were very low against the limit.
4. Margin value = Emission Level – Limit value
5. " * ": Fundamental frequency.
6. " # ": The radiated frequency is out of the restricted band.

CHANNEL	TX Channel 48	DETECTOR FUNCTION	Peak (PK)
FREQUENCY RANGE	1GHz ~ 40GHz		Average (AV)

ANTENNA POLARITY & TEST DISTANCE: HORIZONTAL AT 3 M								
NO.	FREQ. (MHz)	EMISSION LEVEL (dBuV/m)	LIMIT (dBuV/m)	MARGIN (dB)	ANTENNA HEIGHT (m)	TABLE ANGLE (Degree)	RAW VALUE (dBuV)	CORRECTION FACTOR (dB/m)
1	*5240.00	115.5 PK			1.63 H	280	113.0	2.5
2	*5240.00	105.7 AV			1.63 H	280	103.2	2.5
3	5350.00	48.2 PK	74.0	-25.8	1.63 H	280	45.6	2.6
4	5350.00	38.4 AV	54.0	-15.6	1.63 H	280	35.8	2.6
5	#10480.00	45.8 PK	74.0	-28.2	3.60 H	133	32.8	13.0
6	#10480.00	35.9 AV	54.0	-18.1	3.60 H	133	22.9	13.0
7	15720.00	48.5 PK	74.0	-25.5	1.17 H	119	36.1	12.4
8	15720.00	37.7 AV	54.0	-16.3	1.17 H	119	25.3	12.4

ANTENNA POLARITY & TEST DISTANCE: VERTICAL AT 3 M								
NO.	FREQ. (MHz)	EMISSION LEVEL (dBuV/m)	LIMIT (dBuV/m)	MARGIN (dB)	ANTENNA HEIGHT (m)	TABLE ANGLE (Degree)	RAW VALUE (dBuV)	CORRECTION FACTOR (dB/m)
1	*5240.00	118.3 PK			1.61 V	218	115.8	2.5
2	*5240.00	107.2 AV			1.61 V	218	104.7	2.5
3	5350.00	55.7 PK	74.0	-18.3	1.61 V	218	53.1	2.6
4	5350.00	44.8 AV	54.0	-9.2	1.61 V	218	42.2	2.6
5	#10480.00	45.8 PK	74.0	-28.2	1.62 V	230	32.8	13.0
6	#10480.00	35.4 AV	54.0	-18.6	1.62 V	230	22.4	13.0
7	15720.00	47.9 PK	74.0	-26.1	2.00 V	251	35.5	12.4
8	15720.00	36.9 AV	54.0	-17.1	2.00 V	251	24.5	12.4

REMARKS:

1. Emission Level(dBuV/m) = Raw Value(dBuV) + Correction Factor(dB/m)
2. Correction Factor(dB/m) = Antenna Factor(dB/m) + Cable Factor(dB) – Pre-Amplifier Factor(dB)
3. The other emission levels were very low against the limit.
4. Margin value = Emission Level – Limit value
5. " * ": Fundamental frequency.
6. " # ": The radiated frequency is out of the restricted band.

CHANNEL	TX Channel 149	DETECTOR FUNCTION	Peak (PK)
FREQUENCY RANGE	1GHz ~ 40GHz		Average (AV)

ANTENNA POLARITY & TEST DISTANCE: HORIZONTAL AT 3 M								
NO.	FREQ. (MHz)	EMISSION LEVEL (dBuV/m)	LIMIT (dBuV/m)	MARGIN (dB)	ANTENNA HEIGHT (m)	TABLE ANGLE (Degree)	RAW VALUE (dBuV)	CORRECTION FACTOR (dB/m)
1	5408.00	56.4 PK	74.0	-17.6	1.24 H	186	53.6	2.8
2	5408.00	45.4 AV	54.0	-8.6	1.24 H	186	42.6	2.8
3	#5550.00	52.3 PK	74.0	-21.7	1.22 H	215	49.3	3.0
4	#5550.00	40.4 AV	54.0	-13.6	1.22 H	215	37.4	3.0
5	*5745.00	116.3 PK			1.28 H	153	113.0	3.3
6	*5745.00	104.2 AV			1.28 H	153	100.9	3.3
7	11490.00	44.2 PK	74.0	-29.8	1.63 H	354	30.8	13.4
8	11490.00	39.9 AV	54.0	-14.1	1.63 H	354	26.5	13.4
9	#17235.00	53.2 PK	74.0	-20.8	1.76 H	234	36.5	16.7
10	#17235.00	40.3 AV	54.0	-13.7	1.76 H	234	23.6	16.7

ANTENNA POLARITY & TEST DISTANCE: VERTICAL AT 3 M								
NO.	FREQ. (MHz)	EMISSION LEVEL (dBuV/m)	LIMIT (dBuV/m)	MARGIN (dB)	ANTENNA HEIGHT (m)	TABLE ANGLE (Degree)	RAW VALUE (dBuV)	CORRECTION FACTOR (dB/m)
1	5408.00	60.3 PK	74.0	-13.7	1.64 V	108	57.5	2.8
2	5408.00	49.0 AV	54.0	-5.0	1.64 V	108	46.2	2.8
3	#5550.00	54.3 PK	74.0	-19.7	1.71 V	110	51.3	3.0
4	#5550.00	43.1 AV	54.0	-10.9	1.71 V	110	40.1	3.0
5	*5745.00	119.8 PK			1.51 V	260	116.5	3.3
6	*5745.00	107.8 AV			1.51 V	260	104.5	3.3
7	11490.00	46.7 PK	74.0	-27.3	3.16 V	293	33.3	13.4
8	11490.00	37.3 AV	54.0	-16.7	3.16 V	293	23.9	13.4
9	#17235.00	50.8 PK	74.0	-23.2	2.67 V	270	34.1	16.7
10	#17235.00	39.3 AV	54.0	-14.7	2.67 V	270	22.6	16.7

REMARKS:

1. Emission Level(dBuV/m) = Raw Value(dBuV) + Correction Factor(dB/m)
2. Correction Factor(dB/m) = Antenna Factor(dB/m) + Cable Factor(dB) – Pre-Amplifier Factor(dB)
3. The other emission levels were very low against the limit.
4. Margin value = Emission Level – Limit value
5. " * ": Fundamental frequency.
6. " # ": The radiated frequency is out of the restricted band.

CHANNEL	TX Channel 157	DETECTOR FUNCTION	Peak (PK)
FREQUENCY RANGE	1GHz ~ 40GHz		Average (AV)

ANTENNA POLARITY & TEST DISTANCE: HORIZONTAL AT 3 M

NO.	FREQ. (MHz)	EMISSION LEVEL (dBuV/m)	LIMIT (dBuV/m)	MARGIN (dB)	ANTENNA HEIGHT (m)	TABLE ANGLE (Degree)	RAW VALUE (dBuV)	CORRECTION FACTOR (dB/m)
1	#5467.00	56.5 PK	74.0	-17.5	1.27 H	201	53.6	2.9
2	#5467.00	45.7 AV	54.0	-8.3	1.27 H	201	42.8	2.9
3	*5785.00	116.8 PK			1.22 H	168	113.5	3.3
4	*5785.00	104.3 AV			1.22 H	168	101.0	3.3
5	#6025.00	51.8 PK	74.0	-22.2	1.27 H	201	48.0	3.8
6	#6025.00	40.1 AV	54.0	-13.9	1.27 H	201	36.3	3.8
7	11570.00	44.2 PK	74.0	-29.8	1.60 H	355	30.8	13.4
8	11570.00	39.7 AV	54.0	-14.3	1.60 H	355	26.3	13.4
9	#17355.00	52.7 PK	74.0	-21.3	1.77 H	222	35.4	17.3
10	#17355.00	39.8 AV	54.0	-14.2	1.77 H	222	22.5	17.3

ANTENNA POLARITY & TEST DISTANCE: VERTICAL AT 3 M

NO.	FREQ. (MHz)	EMISSION LEVEL (dBuV/m)	LIMIT (dBuV/m)	MARGIN (dB)	ANTENNA HEIGHT (m)	TABLE ANGLE (Degree)	RAW VALUE (dBuV)	CORRECTION FACTOR (dB/m)
1	#5467.00	59.9 PK	74.0	-14.1	1.67 V	105	57.0	2.9
2	#5467.00	48.6 AV	54.0	-5.4	1.67 V	105	45.7	2.9
3	*5785.00	120.4 PK			1.68 V	293	117.1	3.3
4	*5785.00	108.1 AV			1.68 V	293	104.8	3.3
5	#6025.00	54.7 PK	74.0	-19.3	1.67 V	105	50.9	3.8
6	#6025.00	43.4 AV	54.0	-10.6	1.67 V	105	39.6	3.8
7	11570.00	46.7 PK	74.0	-27.3	3.18 V	279	33.3	13.4
8	11570.00	37.5 AV	54.0	-16.5	3.18 V	279	24.1	13.4
9	#17355.00	50.6 PK	74.0	-23.4	2.67 V	277	33.3	17.3
10	#17355.00	38.9 AV	54.0	-15.1	2.67 V	277	21.6	17.3

REMARKS:

1. Emission Level(dBuV/m) = Raw Value(dBuV) + Correction Factor(dB/m)
2. Correction Factor(dB/m) = Antenna Factor(dB/m) + Cable Factor(dB) – Pre-Amplifier Factor(dB)
3. The other emission levels were very low against the limit.
4. Margin value = Emission Level – Limit value
5. " * ": Fundamental frequency.
6. " # ": The radiated frequency is out of the restricted band.

CHANNEL	TX Channel 165	DETECTOR FUNCTION	Peak (PK)
FREQUENCY RANGE	1GHz ~ 40GHz		Average (AV)

ANTENNA POLARITY & TEST DISTANCE: HORIZONTAL AT 3 M								
NO.	FREQ. (MHz)	EMISSION LEVEL (dBuV/m)	LIMIT (dBuV/m)	MARGIN (dB)	ANTENNA HEIGHT (m)	TABLE ANGLE (Degree)	RAW VALUE (dBuV)	CORRECTION FACTOR (dB/m)
1	#5498.00	56.9 PK	74.0	-17.1	1.27 H	206	54.0	2.9
2	#5498.00	46.2 AV	54.0	-7.8	1.27 H	206	43.3	2.9
3	*5825.00	116.1 PK			1.23 H	161	112.6	3.5
4	*5825.00	103.9 AV			1.23 H	161	100.4	3.5
5	#6025.00	52.0 PK	74.0	-22.0	1.22 H	202	48.2	3.8
6	#6025.00	40.3 AV	54.0	-13.7	1.22 H	202	36.5	3.8
7	11650.00	44.8 PK	74.0	-29.2	1.55 H	343	31.5	13.3
8	11650.00	40.2 AV	54.0	-13.8	1.55 H	343	26.9	13.3
9	#17475.00	53.4 PK	74.0	-20.6	1.73 H	234	35.2	18.2
10	#17475.00	40.2 AV	54.0	-13.8	1.73 H	234	22.0	18.2

ANTENNA POLARITY & TEST DISTANCE: VERTICAL AT 3 M								
NO.	FREQ. (MHz)	EMISSION LEVEL (dBuV/m)	LIMIT (dBuV/m)	MARGIN (dB)	ANTENNA HEIGHT (m)	TABLE ANGLE (Degree)	RAW VALUE (dBuV)	CORRECTION FACTOR (dB/m)
1	#5498.00	59.7 PK	74.0	-14.3	1.60 V	93	56.8	2.9
2	#5498.00	48.7 AV	54.0	-5.3	1.60 V	93	45.8	2.9
3	*5825.00	120.2 PK			1.75 V	119	116.7	3.5
4	*5825.00	107.9 AV			1.75 V	119	104.4	3.5
5	#6025.00	54.4 PK	74.0	-19.6	1.65 V	113	50.6	3.8
6	#6025.00	43.3 AV	54.0	-10.7	1.65 V	113	39.5	3.8
7	11650.00	46.4 PK	74.0	-27.6	3.19 V	273	33.1	13.3
8	11650.00	37.2 AV	54.0	-16.8	3.19 V	273	23.9	13.3
9	#17475.00	50.1 PK	74.0	-23.9	2.67 V	287	31.9	18.2
10	#17475.00	38.4 AV	54.0	-15.6	2.67 V	287	20.2	18.2

REMARKS:

1. Emission Level(dBuV/m) = Raw Value(dBuV) + Correction Factor(dB/m)
2. Correction Factor(dB/m) = Antenna Factor(dB/m) + Cable Factor(dB) – Pre-Amplifier Factor(dB)
3. The other emission levels were very low against the limit.
4. Margin value = Emission Level – Limit value
5. " * ": Fundamental frequency.
6. " # ": The radiated frequency is out of the restricted band.

802.11ax (HE40)

CHANNEL	TX Channel 38	DETECTOR FUNCTION	Peak (PK)
FREQUENCY RANGE	1GHz ~ 40GHz		Average (AV)

ANTENNA POLARITY & TEST DISTANCE: HORIZONTAL AT 3 M								
NO.	FREQ. (MHz)	EMISSION LEVEL (dBuV/m)	LIMIT (dBuV/m)	MARGIN (dB)	ANTENNA HEIGHT (m)	TABLE ANGLE (Degree)	RAW VALUE (dBuV)	CORRECTION FACTOR (dB/m)
1	5150.00	63.6 PK	74.0	-10.4	1.17 H	168	60.6	3.0
2	5150.00	50.8 AV	54.0	-3.2	1.17 H	168	47.8	3.0
3	*5190.00	102.1 PK			1.17 H	168	99.3	2.8
4	*5190.00	91.4 AV			1.17 H	168	88.6	2.8
5	5350.00	51.0 PK	74.0	-23.0	1.00 H	0	48.4	2.6
6	5350.00	39.2 AV	54.0	-14.8	1.00 H	0	36.6	2.6
7	#10380.00	45.2 PK	74.0	-28.8	3.56 H	133	32.8	12.4
8	#10380.00	35.0 AV	54.0	-19.0	3.56 H	133	22.6	12.4
9	15570.00	48.2 PK	74.0	-25.8	1.17 H	105	35.4	12.8
10	15570.00	37.3 AV	54.0	-16.7	1.17 H	105	24.5	12.8

ANTENNA POLARITY & TEST DISTANCE: VERTICAL AT 3 M								
NO.	FREQ. (MHz)	EMISSION LEVEL (dBuV/m)	LIMIT (dBuV/m)	MARGIN (dB)	ANTENNA HEIGHT (m)	TABLE ANGLE (Degree)	RAW VALUE (dBuV)	CORRECTION FACTOR (dB/m)
1	5150.00	64.1 PK	74.0	-9.9	1.63 V	69	61.1	3.0
2	5150.00	53.6 AV	54.0	-0.4	1.63 V	69	50.6	3.0
3	*5190.00	106.1 PK			1.63 V	69	103.3	2.8
4	*5190.00	95.9 AV			1.63 V	69	93.1	2.8
5	5350.00	52.9 PK	74.0	-21.1	1.63 V	69	50.3	2.6
6	5350.00	40.9 AV	54.0	-13.1	1.63 V	69	38.3	2.6
7	#10380.00	45.6 PK	74.0	-28.4	2.06 V	51	33.2	12.4
8	#10380.00	35.2 AV	54.0	-18.8	2.06 V	51	22.8	12.4
9	15570.00	48.6 PK	74.0	-25.4	1.83 V	163	35.8	12.8
10	15570.00	37.5 AV	54.0	-16.5	1.83 V	163	24.7	12.8

REMARKS:

1. Emission Level(dBuV/m) = Raw Value(dBuV) + Correction Factor(dB/m)
2. Correction Factor(dB/m) = Antenna Factor(dB/m) + Cable Factor(dB) – Pre-Amplifier Factor(dB)
3. The other emission levels were very low against the limit.
4. Margin value = Emission Level – Limit value
5. " * ": Fundamental frequency.
6. " # ": The radiated frequency is out of the restricted band.

CHANNEL	TX Channel 46	DETECTOR FUNCTION	Peak (PK)
FREQUENCY RANGE	1GHz ~ 40GHz		Average (AV)

ANTENNA POLARITY & TEST DISTANCE: HORIZONTAL AT 3 M								
NO.	FREQ. (MHz)	EMISSION LEVEL (dBuV/m)	LIMIT (dBuV/m)	MARGIN (dB)	ANTENNA HEIGHT (m)	TABLE ANGLE (Degree)	RAW VALUE (dBuV)	CORRECTION FACTOR (dB/m)
1	*5230.00	110.8 PK			1.28 H	175	108.3	2.5
2	*5230.00	101.2 AV			1.28 H	175	98.7	2.5
3	5350.00	52.3 PK	74.0	-21.7	1.28 H	175	49.7	2.6
4	5350.00	42.1 AV	54.0	-11.9	1.28 H	175	39.5	2.6
5	#10460.00	45.6 PK	74.0	-28.4	3.60 H	140	32.7	12.9
6	#10460.00	35.2 AV	54.0	-18.8	3.60 H	140	22.3	12.9
7	15690.00	49.3 PK	74.0	-24.7	1.29 H	118	36.9	12.4
8	15690.00	38.0 AV	54.0	-16.0	1.29 H	118	25.6	12.4

ANTENNA POLARITY & TEST DISTANCE: VERTICAL AT 3 M								
NO.	FREQ. (MHz)	EMISSION LEVEL (dBuV/m)	LIMIT (dBuV/m)	MARGIN (dB)	ANTENNA HEIGHT (m)	TABLE ANGLE (Degree)	RAW VALUE (dBuV)	CORRECTION FACTOR (dB/m)
1	*5230.00	115.0 PK			1.94 V	220	112.5	2.5
2	*5230.00	105.3 AV			1.94 V	220	102.8	2.5
3	5350.00	55.3 PK	74.0	-18.7	1.94 V	220	52.7	2.6
4	5350.00	45.2 AV	54.0	-8.8	1.94 V	220	42.6	2.6
5	#10460.00	45.5 PK	74.0	-28.5	2.06 V	53	32.6	12.9
6	#10460.00	34.9 AV	54.0	-19.1	2.06 V	53	22.0	12.9
7	15690.00	48.8 PK	74.0	-25.2	1.73 V	166	36.4	12.4
8	15690.00	37.7 AV	54.0	-16.3	1.73 V	166	25.3	12.4

REMARKS:

1. Emission Level(dBuV/m) = Raw Value(dBuV) + Correction Factor(dB/m)
2. Correction Factor(dB/m) = Antenna Factor(dB/m) + Cable Factor(dB) – Pre-Amplifier Factor(dB)
3. The other emission levels were very low against the limit.
4. Margin value = Emission Level – Limit value
5. " * ": Fundamental frequency.
6. " # ": The radiated frequency is out of the restricted band.

CHANNEL	TX Channel 151	DETECTOR FUNCTION	Peak (PK)
FREQUENCY RANGE	1GHz ~ 40GHz		Average (AV)

ANTENNA POLARITY & TEST DISTANCE: HORIZONTAL AT 3 M								
NO.	FREQ. (MHz)	EMISSION LEVEL (dBuV/m)	LIMIT (dBuV/m)	MARGIN (dB)	ANTENNA HEIGHT (m)	TABLE ANGLE (Degree)	RAW VALUE (dBuV)	CORRECTION FACTOR (dB/m)
1	5418.00	63.2 PK	74.0	-10.8	1.24 H	165	60.4	2.8
2	5418.00	51.2 AV	54.0	-2.8	1.24 H	165	48.4	2.8
3	*5755.00	109.5 PK			1.27 H	182	106.2	3.3
4	*5755.00	97.4 AV			1.27 H	182	94.1	3.3
5	#6025.00	60.1 PK	74.0	-13.9	1.29 H	188	56.3	3.8
6	#6025.00	47.4 AV	54.0	-6.6	1.29 H	188	43.6	3.8
7	11510.00	46.1 PK	74.0	-27.9	1.76 H	157	32.7	13.4
8	11510.00	36.2 AV	54.0	-17.8	1.76 H	157	22.8	13.4
9	#17265.00	48.7 PK	74.0	-25.3	1.58 H	131	31.9	16.8
10	#17265.00	37.8 AV	54.0	-16.2	1.58 H	131	21.0	16.8

ANTENNA POLARITY & TEST DISTANCE: VERTICAL AT 3 M								
NO.	FREQ. (MHz)	EMISSION LEVEL (dBuV/m)	LIMIT (dBuV/m)	MARGIN (dB)	ANTENNA HEIGHT (m)	TABLE ANGLE (Degree)	RAW VALUE (dBuV)	CORRECTION FACTOR (dB/m)
1	5418.00	64.2 PK	74.0	-9.8	1.87 V	208	61.4	2.8
2	5418.00	53.8 AV	54.0	-0.2	1.87 V	208	51.0	2.8
3	*5755.00	111.4 PK			1.48 V	359	108.1	3.3
4	*5755.00	99.4 AV			1.48 V	359	96.1	3.3
5	#6025.00	56.8 PK	74.0	-17.2	1.87 V	208	53.0	3.8
6	#6025.00	48.2 AV	54.0	-5.8	1.87 V	208	44.4	3.8
7	11510.00	45.6 PK	74.0	-28.4	2.31 V	85	32.2	13.4
8	11510.00	35.7 AV	54.0	-18.3	2.31 V	85	22.3	13.4
9	#17265.00	49.3 PK	74.0	-24.7	2.01 V	316	32.5	16.8
10	#17265.00	38.5 AV	54.0	-15.5	2.01 V	316	21.7	16.8

REMARKS:

1. Emission Level(dBuV/m) = Raw Value(dBuV) + Correction Factor(dB/m)
2. Correction Factor(dB/m) = Antenna Factor(dB/m) + Cable Factor(dB) – Pre-Amplifier Factor(dB)
3. The other emission levels were very low against the limit.
4. Margin value = Emission Level – Limit value
5. " * ": Fundamental frequency.
6. " # ": The radiated frequency is out of the restricted band.

CHANNEL	TX Channel 159	DETECTOR FUNCTION	Peak (PK)
FREQUENCY RANGE	1GHz ~ 40GHz		Average (AV)

ANTENNA POLARITY & TEST DISTANCE: HORIZONTAL AT 3 M								
NO.	FREQ. (MHz)	EMISSION LEVEL (dBuV/m)	LIMIT (dBuV/m)	MARGIN (dB)	ANTENNA HEIGHT (m)	TABLE ANGLE (Degree)	RAW VALUE (dBuV)	CORRECTION FACTOR (dB/m)
1	5458.00	64.3 PK	74.0	-9.7	1.27 H	151	61.4	2.9
2	5458.00	51.9 AV	54.0	-2.1	1.27 H	151	49.0	2.9
3	*5795.00	110.4 PK			3.05 H	277	107.1	3.3
4	*5795.00	97.8 AV			3.05 H	277	94.5	3.3
5	#6025.00	59.5 PK	74.0	-14.5	1.28 H	177	55.7	3.8
6	#6025.00	47.1 AV	54.0	-6.9	1.28 H	177	43.3	3.8
7	11590.00	46.5 PK	74.0	-27.5	1.71 H	179	33.1	13.4
8	11590.00	36.3 AV	54.0	-17.7	1.71 H	179	22.9	13.4
9	#17385.00	49.4 PK	74.0	-24.6	1.50 H	115	31.9	17.5
10	#17385.00	38.8 AV	54.0	-15.2	1.50 H	115	21.3	17.5

ANTENNA POLARITY & TEST DISTANCE: VERTICAL AT 3 M								
NO.	FREQ. (MHz)	EMISSION LEVEL (dBuV/m)	LIMIT (dBuV/m)	MARGIN (dB)	ANTENNA HEIGHT (m)	TABLE ANGLE (Degree)	RAW VALUE (dBuV)	CORRECTION FACTOR (dB/m)
1	5458.00	63.7 PK	74.0	-10.3	1.46 V	353	60.8	2.9
2	5458.00	53.6 AV	54.0	-0.4	1.46 V	353	50.7	2.9
3	*5795.00	111.9 PK			1.81 V	347	108.6	3.3
4	*5795.00	99.7 AV			1.81 V	347	96.4	3.3
5	#6025.00	57.4 PK	74.0	-16.6	1.46 V	353	53.6	3.8
6	#6025.00	50.9 AV	54.0	-3.1	1.46 V	353	47.1	3.8
7	11590.00	45.9 PK	74.0	-28.1	2.31 V	106	32.5	13.4
8	11590.00	35.5 AV	54.0	-18.5	2.31 V	106	22.1	13.4
9	#17385.00	49.4 PK	74.0	-24.6	2.04 V	300	31.9	17.5
10	#17385.00	38.6 AV	54.0	-15.4	2.04 V	300	21.1	17.5

REMARKS:

1. Emission Level(dBuV/m) = Raw Value(dBuV) + Correction Factor(dB/m)
2. Correction Factor(dB/m) = Antenna Factor(dB/m) + Cable Factor(dB) – Pre-Amplifier Factor(dB)
3. The other emission levels were very low against the limit.
4. Margin value = Emission Level – Limit value
5. " * ": Fundamental frequency.
6. " # ": The radiated frequency is out of the restricted band.

802.11ax (HE80)

CHANNEL	TX Channel 42	DETECTOR FUNCTION	Peak (PK)
FREQUENCY RANGE	1GHz ~ 40GHz		Average (AV)

ANTENNA POLARITY & TEST DISTANCE: HORIZONTAL AT 3 M

NO.	FREQ. (MHz)	EMISSION LEVEL (dBuV/m)	LIMIT (dBuV/m)	MARGIN (dB)	ANTENNA HEIGHT (m)	TABLE ANGLE (Degree)	RAW VALUE (dBuV)	CORRECTION FACTOR (dB/m)
1	5150.00	64.5 PK	74.0	-9.5	2.67 H	320	61.5	3.0
2	5150.00	47.0 AV	54.0	-7.0	2.67 H	320	44.0	3.0
3	*5210.00	104.2 PK			1.20 H	171	101.5	2.7
4	*5210.00	93.1 AV			1.20 H	171	90.4	2.7
5	5350.00	51.8 PK	74.0	-22.2	2.76 H	324	49.2	2.6
6	5350.00	38.7 AV	54.0	-15.3	2.76 H	324	36.1	2.6
7	#10420.00	45.7 PK	74.0	-28.3	3.54 H	160	33.1	12.6
8	#10420.00	35.2 AV	54.0	-18.8	3.54 H	160	22.6	12.6
9	15630.00	48.6 PK	74.0	-25.4	1.23 H	131	35.9	12.7
10	15630.00	37.8 AV	54.0	-16.2	1.23 H	131	25.1	12.7

ANTENNA POLARITY & TEST DISTANCE: VERTICAL AT 3 M

NO.	FREQ. (MHz)	EMISSION LEVEL (dBuV/m)	LIMIT (dBuV/m)	MARGIN (dB)	ANTENNA HEIGHT (m)	TABLE ANGLE (Degree)	RAW VALUE (dBuV)	CORRECTION FACTOR (dB/m)
1	5150.00	66.4 PK	74.0	-7.6	1.51 V	187	63.4	3.0
2	5150.00	49.1 AV	54.0	-4.9	1.51 V	187	46.1	3.0
3	*5210.00	107.9 PK			1.51 V	187	105.2	2.7
4	*5210.00	96.8 AV			1.51 V	187	94.1	2.7
5	5350.00	56.4 PK	74.0	-17.6	1.51 V	187	53.8	2.6
6	5350.00	41.1 AV	54.0	-12.9	1.51 V	187	38.5	2.6
7	#10420.00	45.6 PK	74.0	-28.4	2.12 V	52	33.0	12.6
8	#10420.00	35.3 AV	54.0	-18.7	2.12 V	52	22.7	12.6
9	15630.00	48.2 PK	74.0	-25.8	1.78 V	154	35.5	12.7
10	15630.00	37.2 AV	54.0	-16.8	1.78 V	154	24.5	12.7

REMARKS:

1. Emission Level(dBuV/m) = Raw Value(dBuV) + Correction Factor(dB/m)
2. Correction Factor(dB/m) = Antenna Factor(dB/m) + Cable Factor(dB) – Pre-Amplifier Factor(dB)
3. The other emission levels were very low against the limit.
4. Margin value = Emission Level – Limit value
5. " * ": Fundamental frequency.
6. " # ": The radiated frequency is out of the restricted band.

CHANNEL	TX Channel 155	DETECTOR FUNCTION	Peak (PK)
FREQUENCY RANGE	1GHz ~ 40GHz		Average (AV)

ANTENNA POLARITY & TEST DISTANCE: HORIZONTAL AT 3 M								
NO.	FREQ. (MHz)	EMISSION LEVEL (dBuV/m)	LIMIT (dBuV/m)	MARGIN (dB)	ANTENNA HEIGHT (m)	TABLE ANGLE (Degree)	RAW VALUE (dBuV)	CORRECTION FACTOR (dB/m)
1	5438.00	63.8 PK	74.0	-10.2	1.28 H	160	60.9	2.9
2	5438.00	51.9 AV	54.0	-2.1	1.28 H	160	49.0	2.9
3	*5775.00	105.4 PK			1.66 H	238	102.0	3.4
4	*5775.00	94.5 AV			1.66 H	238	91.1	3.4
5	11550.00	46.3 PK	74.0	-27.7	1.74 H	170	33.0	13.3
6	11550.00	36.2 AV	54.0	-17.8	1.74 H	170	22.9	13.3
7	#17325.00	49.3 PK	74.0	-24.7	1.53 H	118	32.2	17.1
8	#17325.00	38.2 AV	54.0	-15.8	1.53 H	118	21.1	17.1

ANTENNA POLARITY & TEST DISTANCE: VERTICAL AT 3 M								
NO.	FREQ. (MHz)	EMISSION LEVEL (dBuV/m)	LIMIT (dBuV/m)	MARGIN (dB)	ANTENNA HEIGHT (m)	TABLE ANGLE (Degree)	RAW VALUE (dBuV)	CORRECTION FACTOR (dB/m)
1	5438.00	64.9 PK	74.0	-9.1	1.50 V	110	62.0	2.9
2	5438.00	53.6 AV	54.0	-0.4	1.50 V	110	50.7	2.9
3	*5775.00	108.2 PK			1.69 V	360	104.8	3.4
4	*5775.00	97.2 AV			1.69 V	360	93.8	3.4
5	11550.00	45.8 PK	74.0	-28.2	2.33 V	91	32.5	13.3
6	11550.00	35.8 AV	54.0	-18.2	2.33 V	91	22.5	13.3
7	#17325.00	48.4 PK	74.0	-25.6	2.02 V	321	31.3	17.1
8	#17325.00	37.6 AV	54.0	-16.4	2.02 V	321	20.5	17.1

REMARKS:

1. Emission Level(dBuV/m) = Raw Value(dBuV) + Correction Factor(dB/m)
2. Correction Factor(dB/m) = Antenna Factor(dB/m) + Cable Factor(dB) – Pre-Amplifier Factor(dB)
3. The other emission levels were very low against the limit.
4. Margin value = Emission Level – Limit value
5. " * ": Fundamental frequency.
6. " # ": The radiated frequency is out of the restricted band.

802.11ax (HE80+80)

CHANNEL	TX Channel 42+155	DETECTOR FUNCTION	Peak (PK)
FREQUENCY RANGE	1GHz ~ 40GHz		Average (AV)

ANTENNA POLARITY & TEST DISTANCE: HORIZONTAL AT 3 M								
NO.	FREQ. (MHz)	EMISSION LEVEL (dBuV/m)	LIMIT (dBuV/m)	MARGIN (dB)	ANTENNA HEIGHT (m)	TABLE ANGLE (Degree)	RAW VALUE (dBuV)	CORRECTION FACTOR (dB/m)
1	5150.00	58.9 PK	74.0	-15.1	1.61 H	114	55.9	3.0
2	5150.00	46.9 AV	54.0	-7.1	1.61 H	114	43.9	3.0
3	*5210.00	99.4 PK			1.21 H	161	96.7	2.7
4	*5210.00	89.1 AV			1.21 H	161	86.4	2.7
5	5350.00	56.7 PK	74.0	-17.3	1.62 H	120	54.1	2.6
6	5350.00	43.8 AV	54.0	-10.2	1.62 H	120	41.2	2.6
7	5430.00	66.8 PK	74.0	-7.2	1.20 H	175	63.9	2.9
8	5430.00	51.1 AV	54.0	-2.9	1.20 H	175	48.2	2.9
9	*5775.00	103.1 PK			1.44 H	85	99.7	3.4
10	*5775.00	91.5 AV			1.44 H	85	88.1	3.4
11	#10420.00	45.3 PK	74.0	-28.7	3.50 H	137	32.7	12.6
12	#10420.00	35.0 AV	54.0	-19.0	3.50 H	137	22.4	12.6
13	11550.00	46.0 PK	74.0	-28.0	1.79 H	172	32.7	13.3
14	11550.00	36.1 AV	54.0	-17.9	1.79 H	172	22.8	13.3
15	15630.00	49.1 PK	74.0	-24.9	1.20 H	115	36.4	12.7
16	15630.00	38.1 AV	54.0	-15.9	1.20 H	115	25.4	12.7
17	#17325.00	49.7 PK	74.0	-24.3	1.56 H	137	32.6	17.1
18	#17325.00	38.6 AV	54.0	-15.4	1.56 H	137	21.5	17.1
ANTENNA POLARITY & TEST DISTANCE: VERTICAL AT 3 M								
NO.	FREQ. (MHz)	EMISSION LEVEL (dBuV/m)	LIMIT (dBuV/m)	MARGIN (dB)	ANTENNA HEIGHT (m)	TABLE ANGLE (Degree)	RAW VALUE (dBuV)	CORRECTION FACTOR (dB/m)
1	5150.00	51.4 PK	74.0	-22.6	1.53 V	347	48.4	3.0
2	5150.00	41.2 AV	54.0	-12.8	1.53 V	347	38.2	3.0
3	*5210.00	102.7 PK			1.53 V	347	100.0	2.7
4	*5210.00	92.3 AV			1.53 V	347	89.6	2.7
5	5350.00	63.7 PK	74.0	-10.3	1.53 V	347	61.1	2.6
6	5350.00	51.2 AV	54.0	-2.8	1.53 V	347	48.6	2.6
7	5430.00	69.1 PK	74.0	-4.9	1.86 V	112	66.2	2.9
8	5430.00	53.7 AV	54.0	-0.3	1.86 V	112	50.8	2.9
9	*5775.00	105.6 PK			1.94 V	122	102.2	3.4
10	*5775.00	94.2 AV			1.94 V	122	90.8	3.4
11	#10420.00	46.0 PK	74.0	-28.0	2.35 V	91	33.4	12.6
12	#10420.00	35.9 AV	54.0	-18.1	2.35 V	91	23.3	12.6
13	11550.00	45.7 PK	74.0	-28.3	2.14 V	42	32.4	13.3
14	11550.00	35.2 AV	54.0	-18.8	2.14 V	42	21.9	13.3
15	15630.00	48.9 PK	74.0	-25.1	2.00 V	315	36.2	12.7
16	15630.00	37.9 AV	54.0	-16.1	2.00 V	315	25.2	12.7
17	#17325.00	48.4 PK	74.0	-25.6	1.82 V	163	31.3	17.1
18	#17325.00	37.1 AV	54.0	-16.9	1.82 V	163	20.0	17.1

REMARKS:

1. Emission Level(dBuV/m) = Raw Value(dBuV) + Correction Factor(dB/m)
2. Correction Factor(dB/m) = Antenna Factor(dB/m) + Cable Factor(dB) – Pre-Amplifier Factor(dB)
3. The other emission levels were very low against the limit.
4. Margin value = Emission Level – Limit value
5. " * ": Fundamental frequency.
6. " # ": The radiated frequency is out of the restricted band.

Below 1GHz Data:

802.11ax (HE20)

CHANNEL	TX Channel 48	DETECTOR FUNCTION	Quasi-Peak (QP)
FREQUENCY RANGE	9kHz ~ 1GHz		

ANTENNA POLARITY & TEST DISTANCE: HORIZONTAL AT 3 M								
NO.	FREQ. (MHz)	EMISSION LEVEL (dBuV/m)	LIMIT (dBuV/m)	MARGIN (dB)	ANTENNA HEIGHT (m)	TABLE ANGLE (Degree)	RAW VALUE (dBuV)	CORRECTION FACTOR (dB/m)
1	72.21	34.0 QP	40.0	-6.0	1.65 H	247	49.5	-15.5
2	187.52	33.6 QP	43.5	-9.9	1.54 H	211	48.9	-15.3
3	237.76	39.8 QP	46.0	-6.2	1.24 H	222	54.3	-14.5
4	296.65	39.1 QP	46.0	-6.9	1.34 H	165	51.3	-12.2
5	315.65	37.6 QP	46.0	-8.4	1.65 H	211	49.1	-11.5
6	692.59	36.1 QP	46.0	-9.9	1.42 H	242	39.3	-3.2

ANTENNA POLARITY & TEST DISTANCE: VERTICAL AT 3 M								
NO.	FREQ. (MHz)	EMISSION LEVEL (dBuV/m)	LIMIT (dBuV/m)	MARGIN (dB)	ANTENNA HEIGHT (m)	TABLE ANGLE (Degree)	RAW VALUE (dBuV)	CORRECTION FACTOR (dB/m)
1	37.31	35.6 QP	40.0	-4.4	1.23 V	100	49.1	-13.5
2	76.44	35.2 QP	40.0	-4.8	1.42 V	245	51.7	-16.5
3	315.21	41.1 QP	46.0	-4.9	1.65 V	200	52.6	-11.5
4	419.52	38.1 QP	46.0	-7.9	1.65 V	100	46.9	-8.8
5	443.82	37.3 QP	46.0	-8.7	1.62 V	333	45.1	-7.8
6	750.06	36.7 QP	46.0	-9.3	1.24 V	211	38.4	-1.7

REMARKS:

1. Emission Level(dBuV/m) = Raw Value(dBuV) + Correction Factor(dB/m)
2. Correction Factor(dB/m) = Antenna Factor(dB/m) + Cable Factor(dB) – Pre-Amplifier Factor(dB)
3. The other emission levels were very low against the limit.
4. Margin value = Emission Level – Limit value

4.2 Conducted Emission Measurement

4.2.1 Limits of Conducted Emission Measurement

Frequency (MHz)	Conducted Limit (dBuV)	
	Quasi-peak	Average
0.15 - 0.5	66 - 56	56 - 46
0.50 - 5.0	56	46
5.0 - 30.0	60	50

Note: 1. The lower limit shall apply at the transition frequencies.

2. The limit decreases in line with the logarithm of the frequency in the range of 0.15 to 0.50MHz.

4.2.2 Test Instruments

DESCRIPTION & MANUFACTURER	MODEL NO.	SERIAL NO.	CALIBRATED DATE	CALIBRATED UNTIL
Test Receiver R&S	ESCS 30	847124/029	Nov. 01, 2017	Oct. 31, 2018
Line-Impedance Stabilization Network (for EUT) R&S	ESH3-Z5	848773/004	Nov. 15, 2017	Nov. 14, 2018
Line-Impedance Stabilization Network (for Peripheral) R&S	ENV216	100072	June 04, 2018	June 03, 2019
50 ohms Terminator	N/A	EMC-02	Sep. 22, 2017	Sep. 21, 2018
RF Cable	5D-FB	COCCAB-001	Sep. 29, 2017	Sep. 28, 2018
Fixed attenuator EMCI	STI02-2200-10	003	Mar. 16, 2018	Mar. 15, 2019
Software BVADT	BVADT_Cond_ V7.3.7.4	NA	NA	NA

Note:

1. The calibration interval of the above test instruments are 12 months and the calibrations are traceable to NML/ROC and NIST/USA.
2. The test was performed in Conduction 1.
3. Tested Date: June 16, 2018

4.2.3 Test Procedure

- The EUT was placed 0.4 meters from the conducting wall of the shielded room with EUT being connected to the power mains through a line impedance stabilization network (LISN). Other support units were connected to the power mains through another LISN. The two LISNs provide 50 ohm/ 50uH of coupling impedance for the measuring instrument.
- Both lines of the power mains connected to the EUT were checked for maximum conducted interference.
- The frequency range from 150kHz to 30MHz was searched. Emission levels under (Limit - 20dB) was not recorded.

NOTE: All modes of operation were investigated and the worst-case emissions are reported.

4.2.4 Deviation from Test Standard

No deviation.

4.2.5 Test Setup

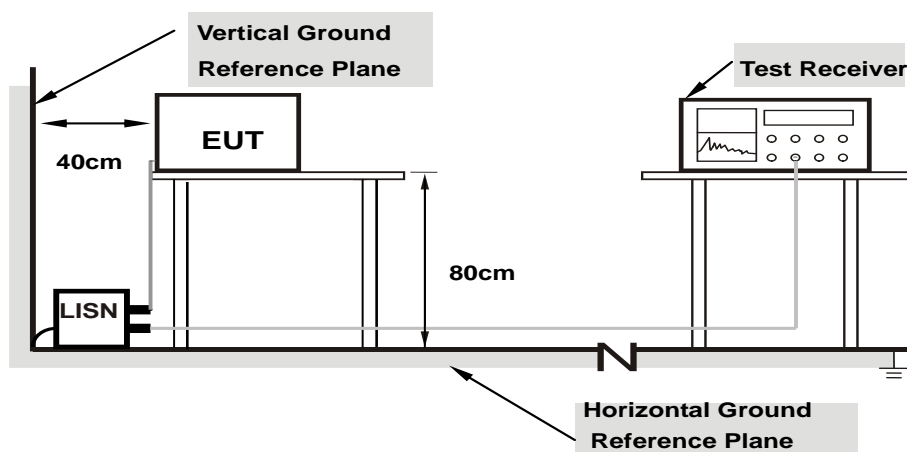

Note: 1.Support units were connected to second LISN.

For the actual test configuration, please refer to the attached file (Test Setup Photo).

4.2.6 EUT Operating Condition

Same as 4.1.6.

4.2.7 Test Results

Phase	Line (L)	Detector Function	Quasi-Peak (QP) / Average (AV)
-------	----------	-------------------	--------------------------------

No	Freq. [MHz]	Corr.	Reading Value		Emission Level		Limit		Margin	
		Factor	[dB (uV)]		[dB (uV)]		[dB (uV)]		(dB)	
	(dB)	Q.P.	AV.	Q.P.	AV.	Q.P.	AV.	Q.P.	AV.	
1	0.15000	10.03	37.15	20.93	47.18	30.96	66.00	56.00	-18.82	-25.04
2	0.20078	10.06	28.22	13.22	38.28	23.28	63.58	53.58	-25.30	-30.30
3	0.42344	10.11	30.59	24.44	40.70	34.55	57.38	47.38	-16.68	-12.83
4	0.84922	10.14	10.50	3.10	20.64	13.24	56.00	46.00	-35.36	-32.76
5	2.70313	10.22	10.94	-0.08	21.16	10.14	56.00	46.00	-34.84	-35.86
6	13.18359	10.72	12.61	5.58	23.33	16.30	60.00	50.00	-36.67	-33.70

REMARKS:

1. Q.P. and AV. are abbreviations of quasi-peak and average individually.
2. The emission levels of other frequencies were very low against the limit.
3. Margin value = Emission level - Limit value
4. Correction factor = Insertion loss + Cable loss
5. Emission Level = Correction Factor + Reading Value.

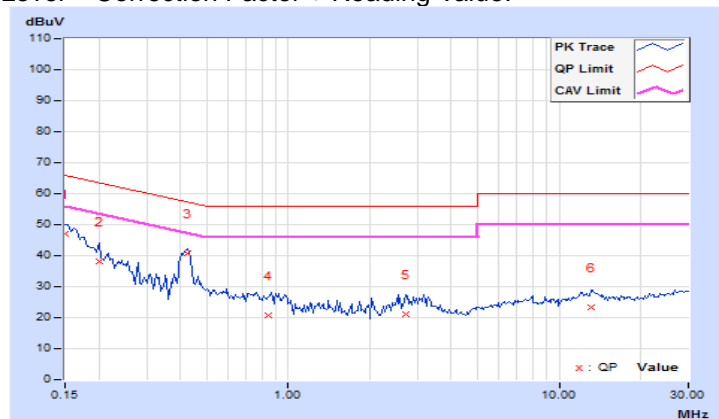

Phase	Neutral (N)	Detector Function	Quasi-Peak (QP) / Average (AV)
-------	-------------	-------------------	--------------------------------

No	Freq. [MHz]	Corr.	Reading Value		Emission Level		Limit		Margin	
		Factor	[dB (uV)]		[dB (uV)]		[dB (uV)]		(dB)	
	(dB)	Q.P.	AV.	Q.P.	AV.	Q.P.	AV.	Q.P.	AV.	
1	0.15000	9.94	36.69	20.72	46.63	30.66	66.00	56.00	-19.37	-25.34
2	0.41953	10.00	31.15	25.27	41.15	35.27	57.46	47.46	-16.31	-12.19
3	0.75156	10.02	18.61	12.68	28.63	22.70	56.00	46.00	-27.37	-23.30
4	2.13281	10.07	9.76	0.99	19.83	11.06	56.00	46.00	-36.17	-34.94
5	13.57422	10.58	12.12	3.37	22.70	13.95	60.00	50.00	-37.30	-36.05
6	29.98438	10.99	12.55	7.26	23.54	18.25	60.00	50.00	-36.46	-31.75

REMARKS:

1. Q.P. and AV. are abbreviations of quasi-peak and average individually.
2. The emission levels of other frequencies were very low against the limit.
3. Margin value = Emission level - Limit value
4. Correction factor = Insertion loss + Cable loss
5. Emission Level = Correction Factor + Reading Value.

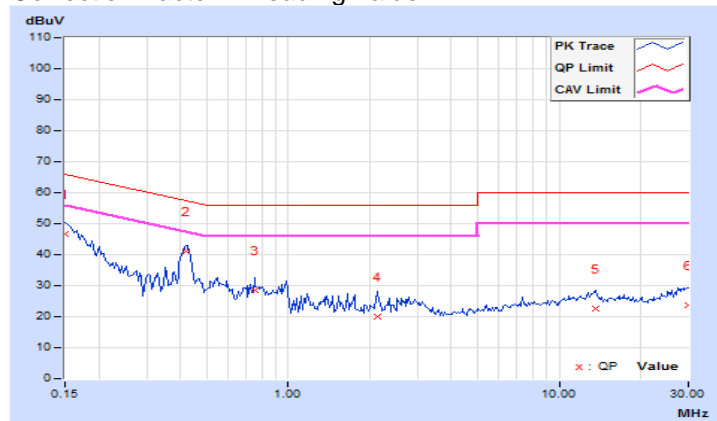

4.3 Transmit Power Measurement

4.3.1 Limits of Transmit Power Measurement

Operation Band	EUT Category		Limit
U-NII-1		Outdoor Access Point	1 Watt (30 dBm) (Max. e.i.r.p \leq 125mW(21 dBm) at any elevation angle above 30 degrees as measured from the horizon)
		Fixed point-to-point Access Point	1 Watt (30 dBm)
	√	Indoor Access Point	1 Watt (30 dBm)
		Client device	250mW (24 dBm)
U-NII-2A	---		250mW (24 dBm) or 11 dBm+10 log B*
U-NII-2C	---		250mW (24 dBm) or 11 dBm+10 log B*
U-NII-3	√		1 Watt (30 dBm)

*B is the 26 dB emission bandwidth in megahertz

Per KDB 662911 Method of conducted output power measurement on IEEE 802.11 devices,

Array Gain = 0 dB (i.e., no array gain) for $N_{ANT} \leq 4$;

Array Gain = 0 dB (i.e., no array gain) for channel widths ≥ 40 MHz for any N_{ANT} ;

Array Gain = $5 \log(N_{ANT}/N_{SS})$ dB or 3 dB, whichever is less for 20-MHz channel widths with $N_{ANT} \geq 5$.

For power measurements on all other devices: Array Gain = $10 \log(N_{ANT}/N_{SS})$ dB.

4.3.2 Test Setup

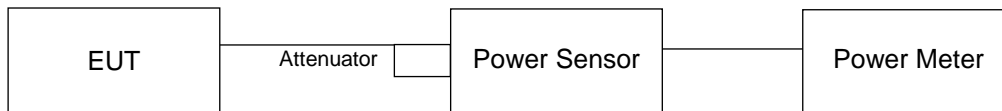

4.3.3 Test Instruments

Refer to section 4.1.2 to get information of above instrument.

4.3.4 Test Procedure

Method PM is used to perform output power measurement, trigger and gating function of wide band power meter is enabled to measure max output power of TX on burst. Duty factor is not added to measured value.

4.3.5 Deviation from Test Standard

No deviation.

4.3.6 EUT Operating Condition

The software provided by client to enable the EUT under transmission condition continuously at lowest, middle and highest channel frequencies individually.

4.3.7 Test Result

802.11a

Chan.	Freq. (MHz)	Maximum Conducted Power (dBm)								Total Power (mW)	Total Power (dBm)	Limit (dBm)	Pass / Fail
		Chain 0	Chain 1	Chain 2	Chain 3	Chain 4	Chain 5	Chain 6	Chain 7				
36	5180	16.47	15.75	17.46	16.22	15.94	17.32	16.7	17.43	374.867	25.74	26.30	Pass
40	5200	16.63	15.66	17.45	15.95	16.01	17.33	16.72	17.48	374.727	25.74	26.30	Pass
48	5240	16.44	15.92	17.95	16.26	15.91	17.16	16.67	17.44	380.688	25.81	26.30	Pass
149	5745	14.92	16.37	15.75	15.89	15.4	17.08	17.26	16.88	338.483	25.30	25.73	Pass
157	5785	14.96	16.58	16.03	15.66	15.73	16.99	17.06	16.85	340.379	25.32	25.73	Pass
165	5825	15.17	15.12	15.75	15.98	15.37	16.78	16.92	16.8	321.75	25.08	25.73	Pass

Note: 1. For UNII-1: Directional gain is 9.7dBi > 6dBi, so the power limit shall be reduced to $30 - (9.7 - 6) = 26.30$ dBm.

2. For UNII-3: Directional gain is 10.27dB > 6dBi, so the power limit shall be reduced to $30 - (10.27 - 6) = 25.73$ dBm.

802.11ac (VHT20)

Chan.	Freq. (MHz)	Maximum Conducted Power (dBm)								Total Power (mW)	Total Power (dBm)	Limit (dBm)	Pass / Fail
		Chain 0	Chain 1	Chain 2	Chain 3	Chain 4	Chain 5	Chain 6	Chain 7				
36	5180	16.93	15.93	17.63	16.21	15.88	17.45	16.36	17.95	388.159	25.89	26.30	Pass
40	5200	16.33	15.73	17.73	15.95	15.78	17.02	17.29	17.46	376.505	25.76	26.30	Pass
48	5240	16.05	15.52	17.71	16.49	15.61	17.32	16.06	17.72	369.366	25.67	26.30	Pass
149	5745	14.59	15.31	16.19	15.96	16.43	15.71	16.98	15.68	311.838	24.94	25.73	Pass
157	5785	15.32	16.76	15.76	15.88	15.57	17.78	16.42	15.63	334.311	25.24	25.73	Pass
165	5825	15.29	16.34	15.77	16.02	15.78	16.85	17.23	15.56	329.692	25.18	25.73	Pass

Note: 1. For UNII-1: Directional gain is 9.7dBi > 6dBi, so the power limit shall be reduced to $30 - (9.7 - 6) = 26.30$ dBm.

2. For UNII-3: Directional gain is 10.27dB > 6dBi, so the power limit shall be reduced to $30 - (10.27 - 6) = 25.73$ dBm.

802.11ac (VHT40)

Chan.	Freq. (MHz)	Maximum Conducted Power (dBm)								Total Power (mW)	Total Power (dBm)	Limit (dBm)	Pass / Fail
		Chain 0	Chain 1	Chain 2	Chain 3	Chain 4	Chain 5	Chain 6	Chain 7				
38	5190	11.80	11.73	13.49	12.27	12.41	13.21	12.88	13.85	151.265	21.80	26.30	Pass
46	5230	15.56	16.17	17.55	16.62	15.38	17.08	16.99	17.38	370.45	25.69	26.30	Pass
151	5755	13.10	14.46	13.54	14.17	15.44	15.76	14.18	12.87	215.27	23.33	25.73	Pass
159	5795	11.92	12.29	12.93	12.02	11.32	13.37	12.64	13.35	143.33	21.56	25.73	Pass

- Note:** 1. For UNII-1: Directional gain is 9.7dBi > 6dBi, so the power limit shall be reduced to $30-(9.7-6) = 26.30$ dBm.
 2. For UNII-3: Directional gain is 10.27dB > 6dBi, so the power limit shall be reduced to $30-(10.27-6) = 25.73$ dBm.

802.11ac (VHT80)

Chan.	Freq. (MHz)	Maximum Conducted Power (dBm)								Total Power (mW)	Total Power (dBm)	Limit (dBm)	Pass / Fail
		Chain 0	Chain 1	Chain 2	Chain 3	Chain 4	Chain 5	Chain 6	Chain 7				
42	5210	12.90	11.52	13.48	12.15	11.6	12.74	12.15	13.07	142.31	21.53	26.30	Pass
155	5775	12.84	13.46	14.43	13.46	14.16	14.91	13.92	15.26	206.598	23.15	25.73	Pass

- Note:** 1. For UNII-1: Directional gain is 9.7dBi > 6dBi, so the power limit shall be reduced to $30-(9.7-6) = 26.30$ dBm.
 2. For UNII-3: Directional gain is 10.27dB > 6dBi, so the power limit shall be reduced to $30-(10.27-6) = 25.73$ dBm.

802.11ac (VHT80+80)

Chan.	Freq. (MHz)	Maximum Conducted Power (dBm)								Total Power (mW)	Total Power (dBm)	Limit (dBm)	Pass / Fail
		Chain 0	Chain 1	Chain 2	Chain 3	Chain 4	Chain 5	Chain 6	Chain 7				
42 +155	5210	-	-	-	-	11.57	13.33	12.5	13.48	75.95	18.81	26.30	Pass
	5775	12.92	13.48	12.47	13.41	-	-	-	-	81.461	19.11	25.73	Pass

- Note:** 1. For UNII-1: Directional gain is 9.7dBi > 6dBi, so the power limit shall be reduced to $30-(9.7-6) = 26.30$ dBm.
 2. For UNII-3: Directional gain is 10.27dB > 6dBi, so the power limit shall be reduced to $30-(10.27-6) = 25.73$ dBm.

802.11ax (HE20)

Chan.	Freq. (MHz)	Maximum Conducted Power (dBm)								Total Power (mW)	Total Power (dBm)	Limit (dBm)	Pass / Fail
		Chain 0	Chain 1	Chain 2	Chain 3	Chain 4	Chain 5	Chain 6	Chain 7				
36	5180	16.77	16.73	17.44	17.37	17.08	17.36	17.21	17.33	416.848	26.20	26.30	Pass
40	5200	16.94	16.82	17.41	17.33	17.05	17.32	17.28	17.38	419.479	26.23	26.30	Pass
48	5240	16.89	16.68	17.48	17.32	17.12	17.46	17.31	17.39	421.247	26.25	26.30	Pass
149	5745	16.42	16.93	16.17	16.25	16.19	16.78	16.84	16.85	362.697	25.60	25.73	Pass
157	5785	16.57	16.85	16.28	16.32	16.22	16.89	16.91	16.88	367.716	25.66	25.73	Pass
165	5825	16.39	16.94	16.31	16.28	16.35	16.92	16.77	16.92	367.294	25.65	25.73	Pass

- Note:** 1. For UNII-1: Directional gain is 9.7dBi > 6dBi, so the power limit shall be reduced to $30-(9.7-6) = 26.30\text{dBm}$.
 2. For UNII-3: Directional gain is 10.27dB > 6dBi, so the power limit shall be reduced to $30-(10.27-6) = 25.73\text{dBm}$.

802.11ax (HE40)

Chan.	Freq. (MHz)	Maximum Conducted Power (dBm)								Total Power (mW)	Total Power (dBm)	Limit (dBm)	Pass / Fail
		Chain 0	Chain 1	Chain 2	Chain 3	Chain 4	Chain 5	Chain 6	Chain 7				
38	5190	11.98	12.05	12.84	12.26	12.28	12.48	12.75	12.9	140.807	21.49	26.30	Pass
46	5230	16.98	16.85	16.97	16.94	16.89	16.87	16.85	16.91	392.524	25.94	26.30	Pass
151	5755	13.33	13.42	13.17	12.91	13.25	13.36	13.24	12.97	167.512	22.24	25.73	Pass
159	5795	13.46	13.44	13.24	12.85	13.47	13.35	13.42	13.01	170.461	22.32	25.73	Pass

- Note:** 1. For UNII-1: Directional gain is 9.7dBi > 6dBi, so the power limit shall be reduced to $30-(9.7-6) = 26.30\text{dBm}$.
 2. For UNII-3: Directional gain is 10.27dB > 6dBi, so the power limit shall be reduced to $30-(10.27-6) = 25.73\text{dBm}$.

802.11ax (HE80)

Chan.	Freq. (MHz)	Maximum Conducted Power (dBm)								Total Power (mW)	Total Power (dBm)	Limit (dBm)	Pass / Fail
		Chain 0	Chain 1	Chain 2	Chain 3	Chain 4	Chain 5	Chain 6	Chain 7				
42	5210	13.44	13.42	13.25	13.28	13.41	13.19	13.32	13.39	172.553	22.37	26.30	Pass
155	5775	13.47	13.38	13.28	13.22	13.46	13.27	13.38	13.45	173.603	22.40	25.73	Pass

- Note:** 1. For UNII-1: Directional gain is 9.7dBi > 6dBi, so the power limit shall be reduced to $30-(9.7-6) = 26.30\text{dBm}$.
 2. For UNII-3: Directional gain is 10.27dB > 6dBi, so the power limit shall be reduced to $30-(10.27-6) = 25.73\text{dBm}$.

802.11ax (HE80+80)

Chan.	Freq. (MHz)	Maximum Conducted Power (dBm)								Total Power (mW)	Total Power (dBm)	Limit (dBm)	Pass / Fail
		Chain 0	Chain 1	Chain 2	Chain 3	Chain 4	Chain 5	Chain 6	Chain 7				
42	5210	-	-	-	-	13.11	13.36	13.28	12.85	82.698	19.17	26.30	Pass
+155	5775	13.28	13.31	13.39	13.42	-	-	-	-	86.516	19.37	25.73	Pass

Note: 1. For UNII-1: Directional gain is 9.7dBi > 6dBi, so the power limit shall be reduced to $30-(9.7-6) = 26.30\text{dBm}$.

2. For UNII-3: Directional gain is 10.27dB > 6dBi, so the power limit shall be reduced to $30-(10.27-6) = 25.73\text{dBm}$.

4.4 Occupied Bandwidth Measurement

4.4.1 Test Setup

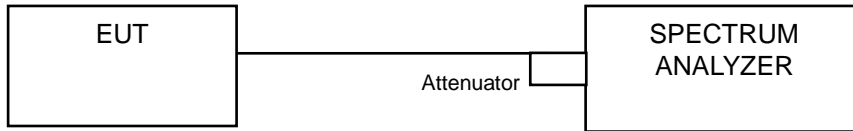

4.4.2 Test Instruments

Refer to section 4.1.2 to get information of above instrument.

4.4.3 Test Procedure

The transmitter output was connected to the spectrum analyzer through an attenuator. The bandwidth of the fundamental frequency was measured by spectrum analyzer with resolution bandwidth in the range of 1% to 5% of the anticipated emission bandwidth, and a video bandwidth at least 3x the resolution bandwidth and set the detector to SAMPLE. The width of a frequency band such that, below the lower and above the upper frequency limits, the mean powers emitted are each equal to a specified percentage 0.5 %of the total mean power of a given emission.

4.4.4 Test Results

802.11a

Channel	Channel Frequency (MHz)	Occupied Bandwidth (MHz)							
		Chain 0	Chain 1	Chain 2	Chain 3	Chain 4	Chain 5	Chain 6	Chain 7
36	5180	17.76	17.76	17.76	17.52	17.52	17.40	17.76	17.76
40	5200	17.40	17.40	17.52	17.64	17.40	17.52	17.52	17.52
48	5240	16.80	16.80	16.80	16.68	16.68	16.68	16.80	16.80
149	5745	17.76	17.76	17.40	17.64	17.64	17.40	18.00	17.52
157	5785	17.88	17.52	17.52	17.64	17.52	17.28	17.76	17.76
165	5825	17.64	17.76	17.40	17.52	17.52	17.52	17.88	17.88

802.11ac (VHT20)

Channel	Channel Frequency (MHz)	Occupied Bandwidth (MHz)							
		Chain 0	Chain 1	Chain 2	Chain 3	Chain 4	Chain 5	Chain 6	Chain 7
36	5180	18.60	18.72	18.60	18.72	18.72	18.72	18.72	18.72
40	5200	18.84	18.72	18.60	18.60	18.48	18.60	18.60	18.96
48	5240	18.12	18.12	17.88	17.88	17.88	17.88	17.88	18.00
149	5745	18.72	18.72	18.60	18.84	18.60	18.60	18.72	18.72
157	5785	18.60	18.84	18.72	18.60	18.60	18.60	18.60	18.60
165	5825	18.84	18.84	18.72	18.48	18.60	18.72	18.72	18.48

802.11ac (VHT40)

Channel	Channel Frequency (MHz)	Occupied Bandwidth (MHz)							
		Chain 0	Chain 1	Chain 2	Chain 3	Chain 4	Chain 5	Chain 6	Chain 7
38	5190	36.96	36.96	37.20	36.96	36.72	36.96	36.96	37.20
46	5230	36.96	36.96	36.72	36.72	36.96	36.72	36.96	36.96
151	5755	36.96	36.96	36.96	36.72	37.20	36.72	36.96	36.72
159	5795	36.96	36.96	37.20	36.96	37.20	36.96	36.96	36.96

802.11ac (VHT80)

Channel	Channel Frequency (MHz)	Occupied Bandwidth (MHz)							
		Chain 0	Chain 1	Chain 2	Chain 3	Chain 4	Chain 5	Chain 6	Chain 7
42	5210	76.32	76.32	76.32	76.32	76.32	75.84	76.32	76.32
155	5775	76.32	76.32	76.32	75.84	76.32	76.32	76.32	76.32

802.11ac (VHT80+80)

Channel	Channel Frequency (MHz)	Occupied Bandwidth (MHz)							
		Chain 0	Chain 1	Chain 2	Chain 3	Chain 4	Chain 5	Chain 6	Chain 7
42+155	5210	-	-	-	-	76.32	76.32	76.32	76.32
	5775	76.32	76.32	76.32	75.84	-	-	-	-

802.11ax (HE20)

Channel	Channel Frequency (MHz)	Occupied Bandwidth (MHz)							
		Chain 0	Chain 1	Chain 2	Chain 3	Chain 4	Chain 5	Chain 6	Chain 7
36	5180	19.80	19.68	19.56	19.68	19.68	19.68	19.68	19.80
40	5200	19.80	19.56	19.68	19.68	19.68	19.56	19.56	19.80
48	5240	19.20	19.08	19.08	19.08	19.08	19.08	19.08	19.08
149	5745	19.56	19.68	19.80	19.56	19.68	19.80	19.56	19.56
157	5785	19.68	19.56	19.80	19.56	19.68	19.68	19.68	19.68
165	5825	19.68	19.68	19.68	19.68	19.80	19.56	19.68	19.56

802.11ax (HE40)

Channel	Channel Frequency (MHz)	Occupied Bandwidth (MHz)							
		Chain 0	Chain 1	Chain 2	Chain 3	Chain 4	Chain 5	Chain 6	Chain 7
38	5190	38.40	38.40	38.40	38.40	38.40	38.16	38.40	38.40
46	5230	38.40	38.64	38.40	38.40	38.40	38.64	38.16	38.40
151	5755	38.16	38.16	38.16	38.40	38.16	38.40	38.40	38.16
159	5795	38.64	38.40	38.64	38.40	38.40	38.40	38.64	38.40

802.11ax (HE80)

Channel	Channel Frequency (MHz)	Occupied Bandwidth (MHz)							
		Chain 0	Chain 1	Chain 2	Chain 3	Chain 4	Chain 5	Chain 6	Chain 7
42	5210	77.76	77.28	78.24	78.24	77.28	77.28	77.76	77.76
155	5775	78.24	78.24	77.28	77.76	78.24	77.76	77.28	78.24

802.11ax (HE80+80)

Channel	Channel Frequency (MHz)	Occupied Bandwidth (MHz)							
		Chain 0	Chain 1	Chain 2	Chain 3	Chain 4	Chain 5	Chain 6	Chain 7
42+155	5210	-	-	-	-	77.76	77.28	77.76	78.24
	5775	77.76	77.28	77.76	77.76	-	-	-	-

Spectrum Plot of Worst Value

802.11a_Chain 6 / CH149

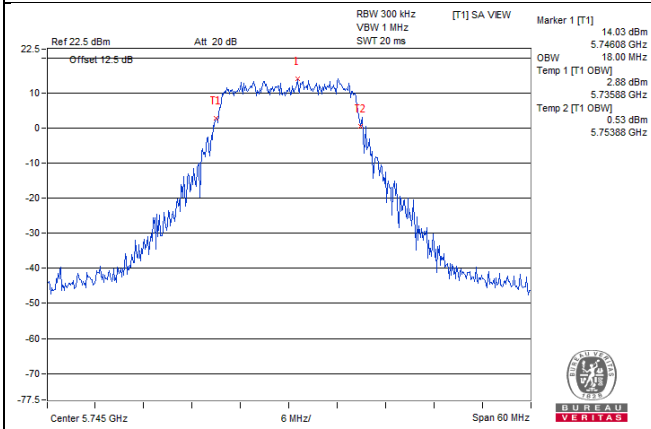

802.11ac (VHT20)_Chain 7 / CH40

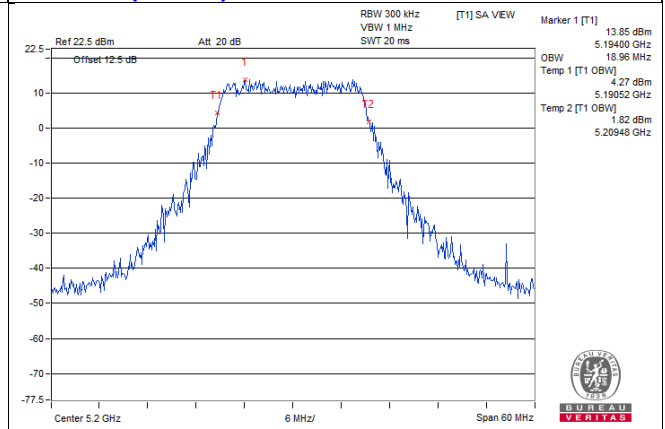

802.11ac (VHT40)_Chain 7 / CH38

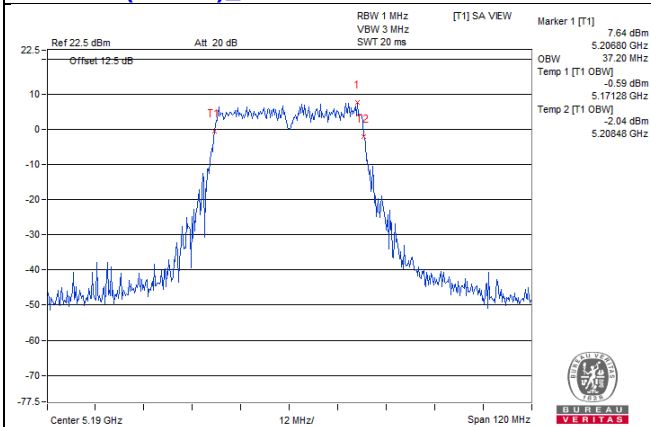

802.11ac (VHT80)_Chain 0 / CH42

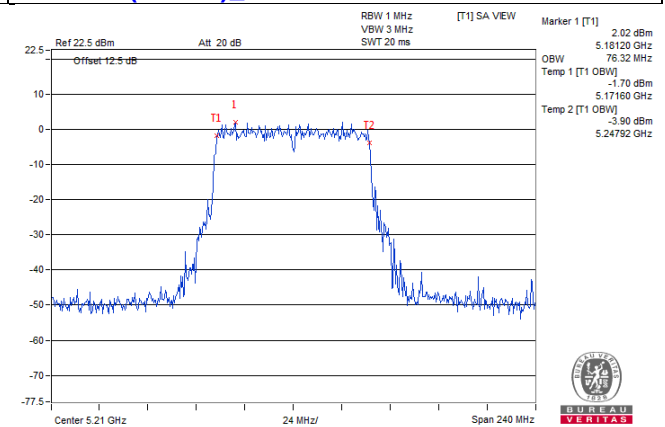

802.11ac (VHT80+80)_Chain 4 / CH42

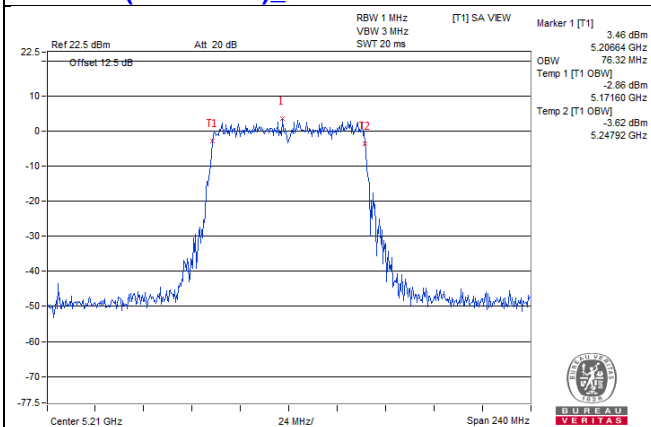

Spectrum Plot of Worst Value

802.11ax (HE20)_Chain 0 / CH36

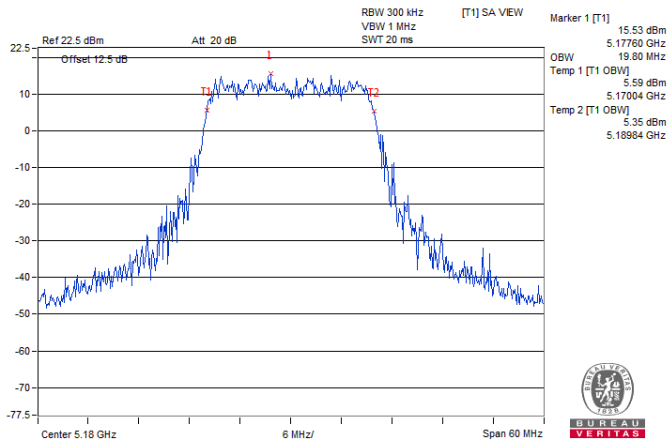

802.11ax (HE40)_Chain 0 / CH159

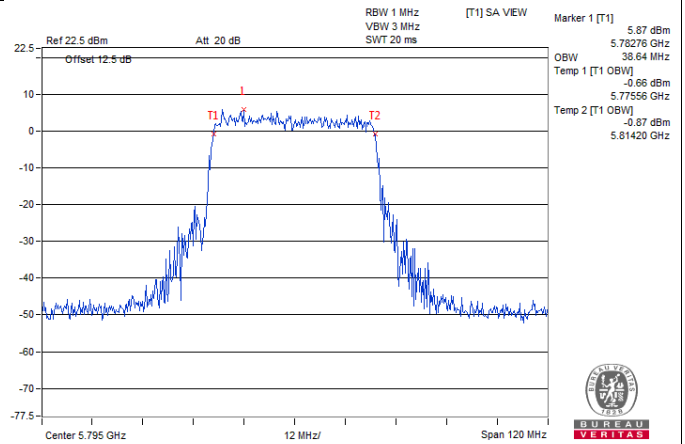

802.11ax (HE80)_Chain 0 / CH155

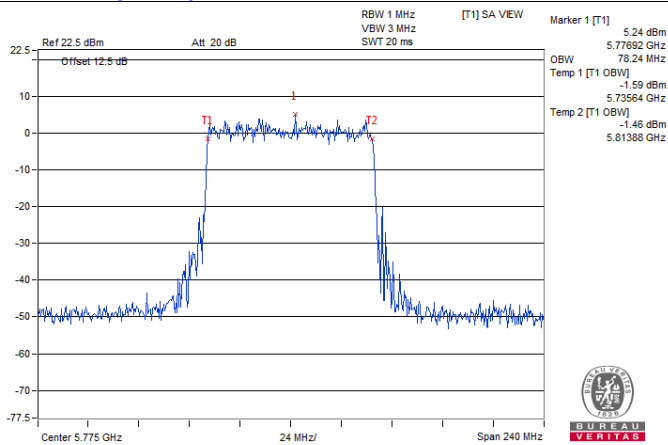

802.11ax (HE80+80)_Chain 7 / CH42

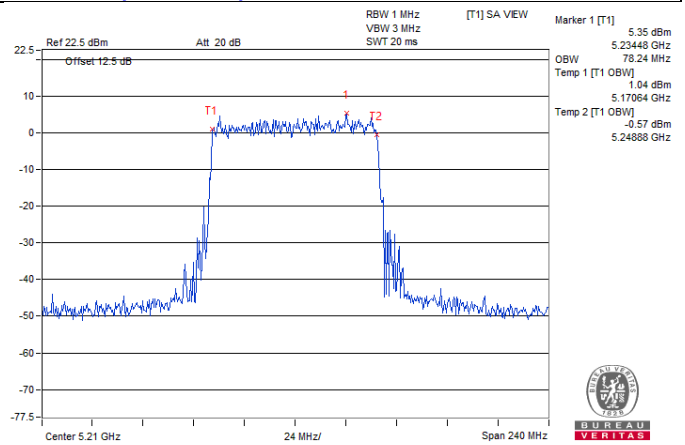

Spectrum Plot for near by DFS band
(DFS is required, if 99% OCP straddle into U-NII-2A band)

802.11a_Chain 0 / CH48

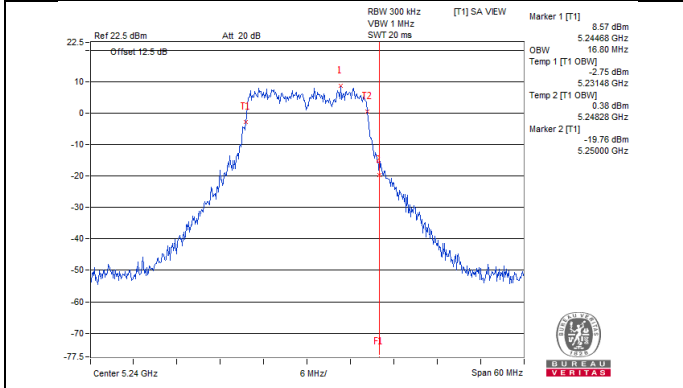

802.11a_Chain 1 / CH48

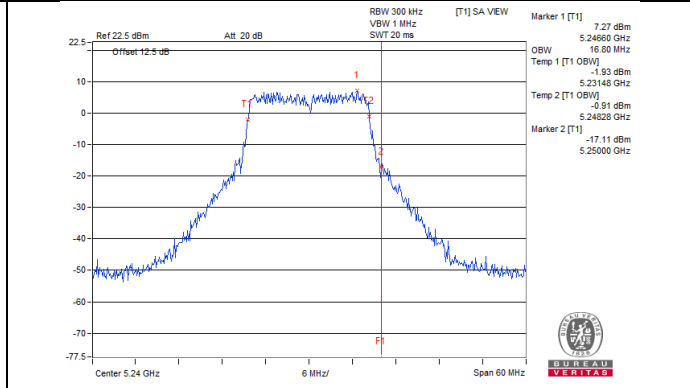

802.11a_Chain 2 / CH48

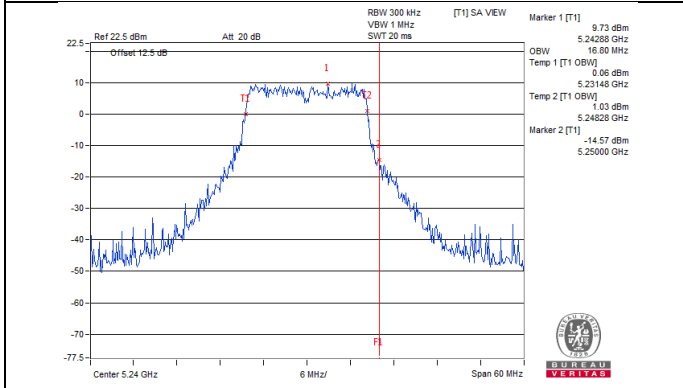

802.11a_Chain 3 / CH48

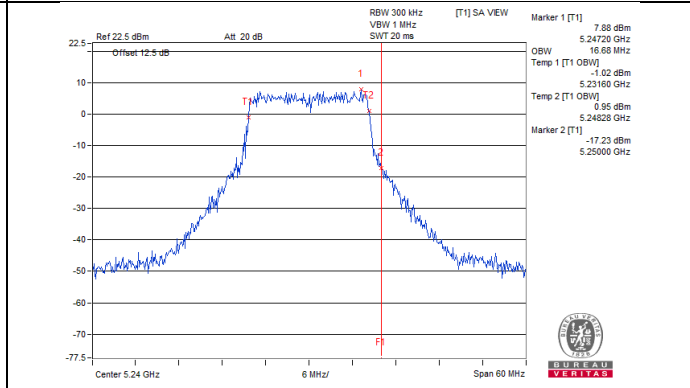

802.11a_Chain 4 / CH48

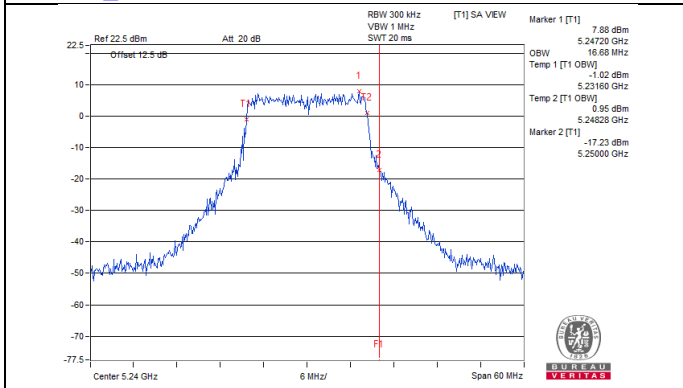

802.11a_Chain 5 / CH48

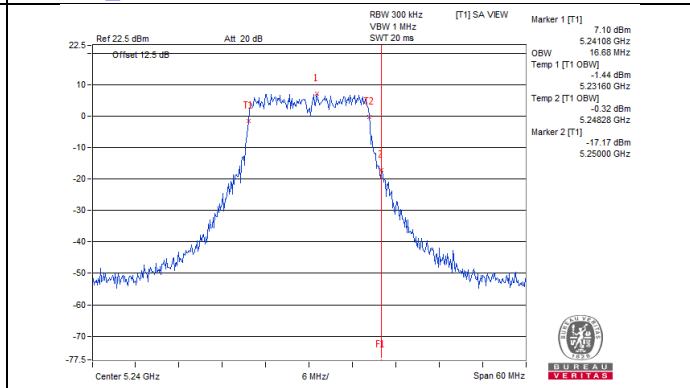

802.11a_Chain 6 / CH48

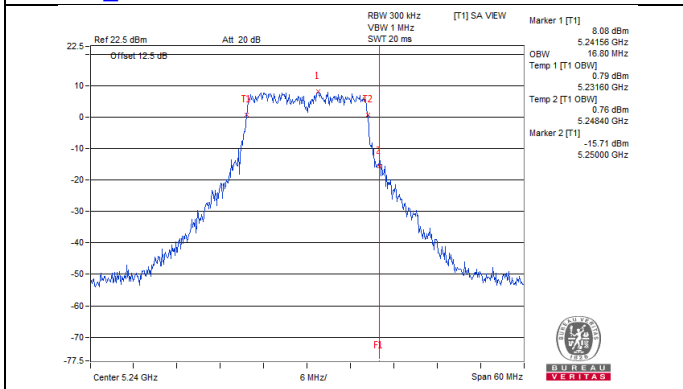

802.11a_Chain 7 / CH48

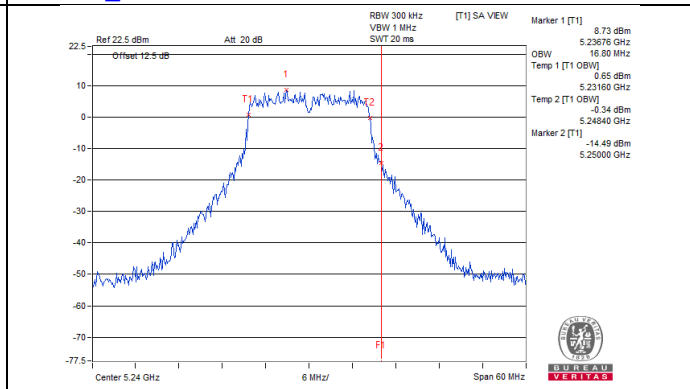

**Spectrum Plot for near by DFS band
(DFS is required, if 99% OCP straddle into U-NII-2A band)**

802.11ac (VHT20)_Chain 0 / CH48

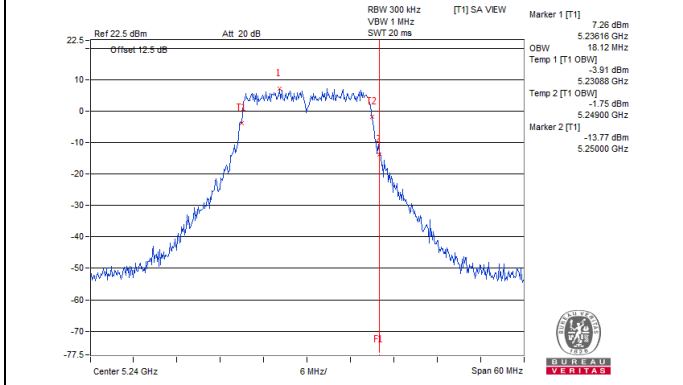

802.11ac (VHT20)_Chain 1 / CH48

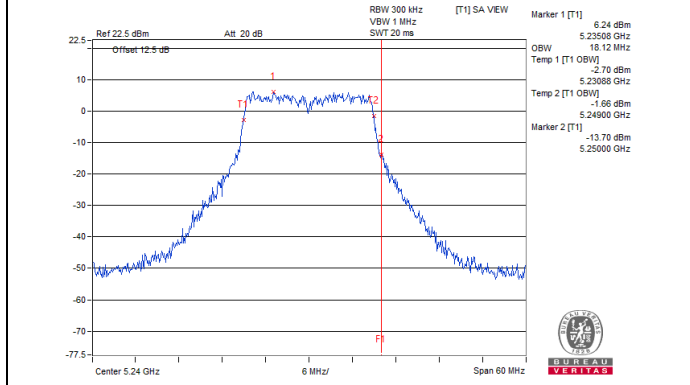

802.11ac (VHT20)_Chain 2 / CH48

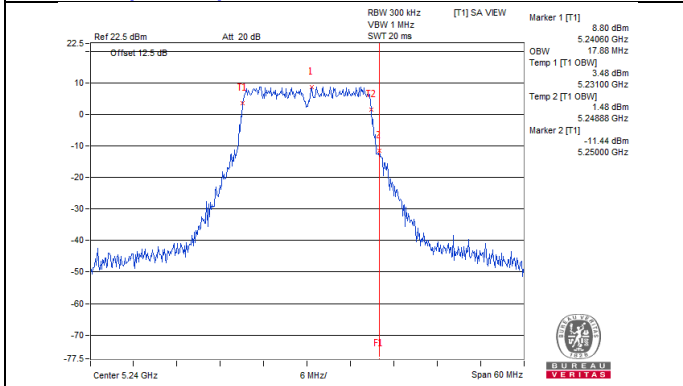

802.11ac (VHT20)_Chain 3 / CH48

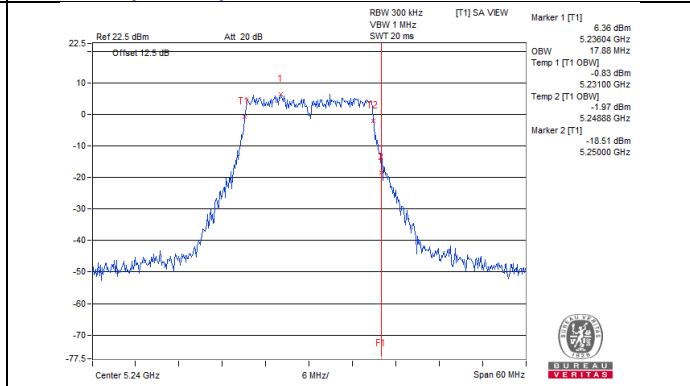

802.11ac (VHT20)_Chain 4 / CH48

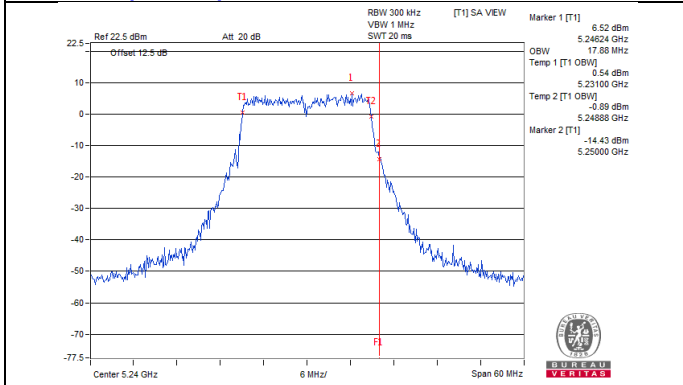

802.11ac (VHT20)_Chain 5 / CH48

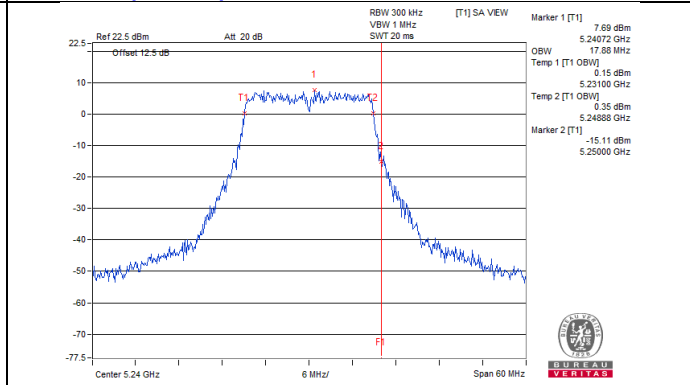

802.11ac (VHT20)_Chain 6 / CH48

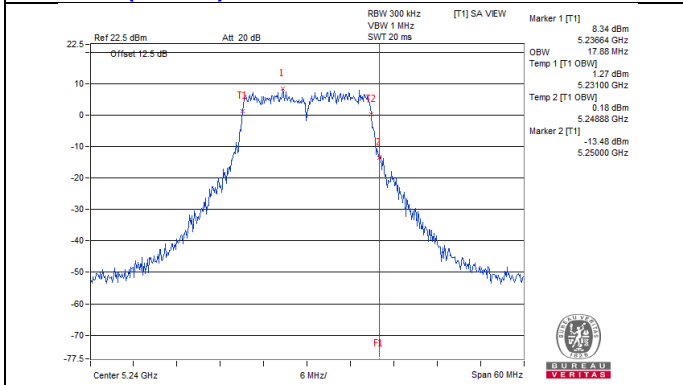

802.11ac (VHT20)_Chain 7 / CH48

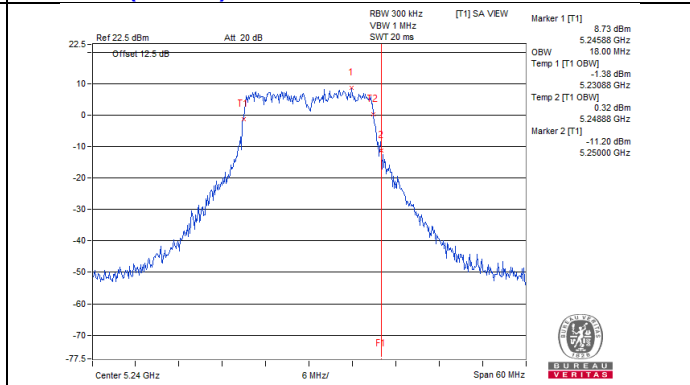

Spectrum Plot for near by DFS band
(DFS is required, if 99% OCP straddle into U-NII-2A band)

802.11ac (VHT40)_Chain 0 / CH46

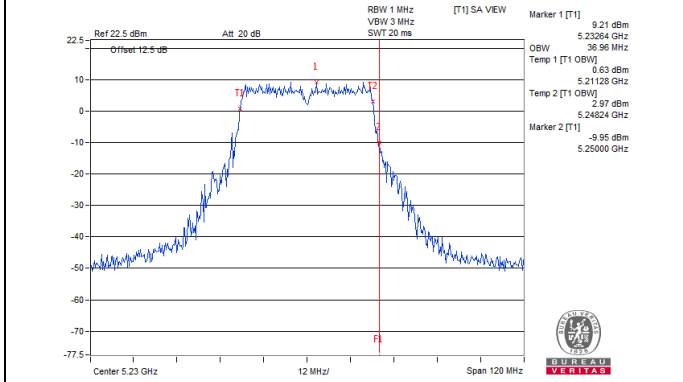

802.11ac (VHT40)_Chain 1 / CH46

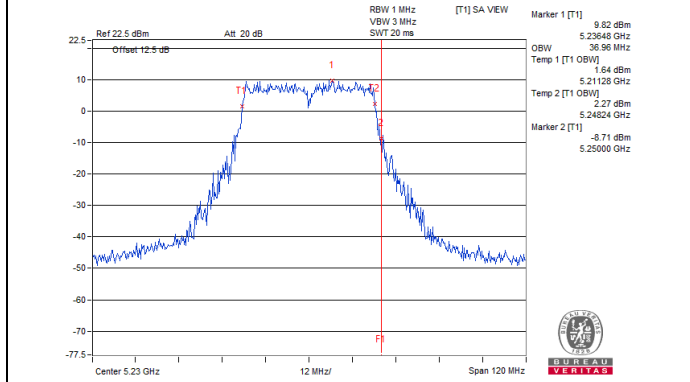

802.11ac (VHT40)_Chain 2 / CH46

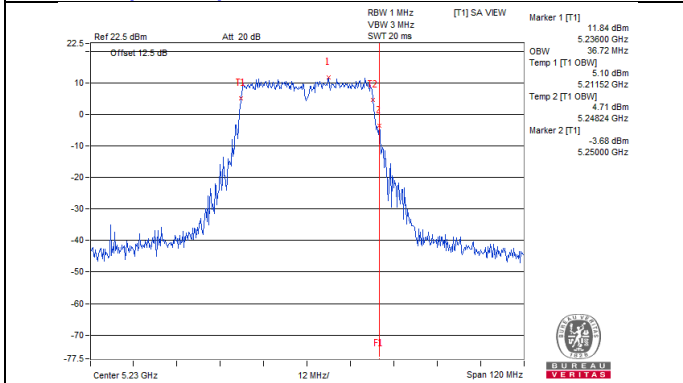

802.11ac (VHT40)_Chain 3 / CH46

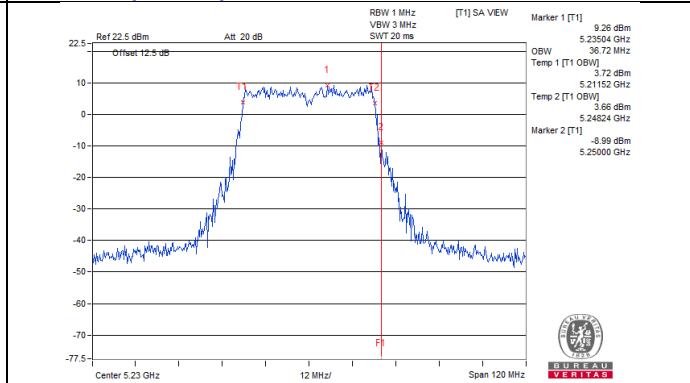

802.11ac (VHT40)_Chain 4 / CH46

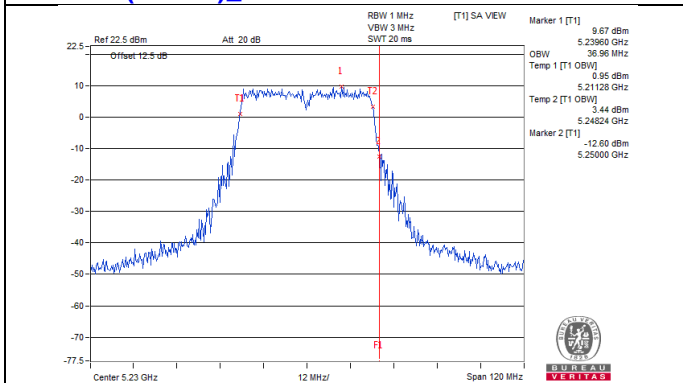

802.11ac (VHT40)_Chain 5 / CH46

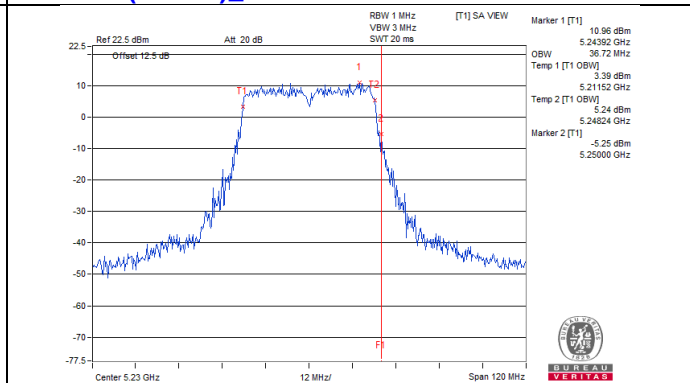

802.11ac (VHT40)_Chain 6 / CH46

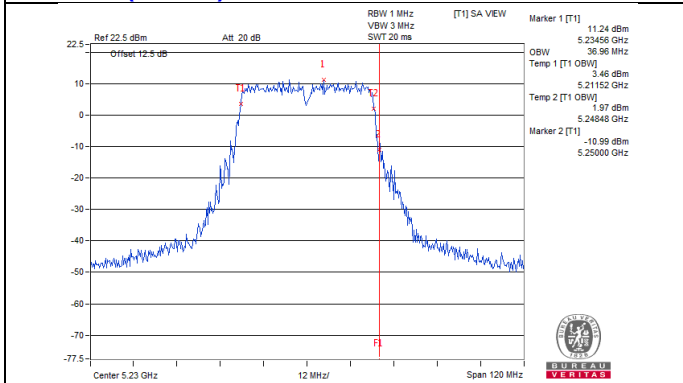

802.11ac (VHT40)_Chain 7 / CH46

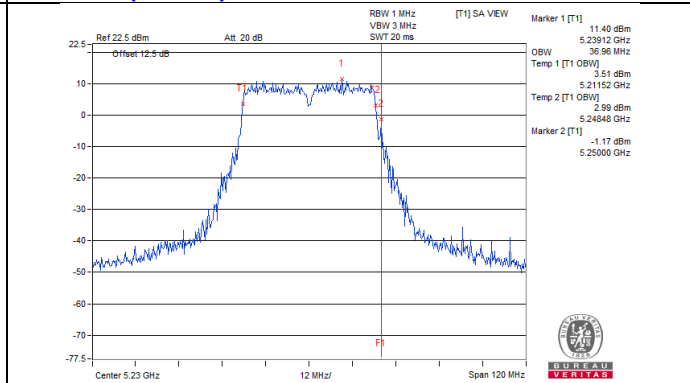

Spectrum Plot for near by DFS band
(DFS is required, if 99% OCP straddle into U-NII-2A band)

802.11ac (VHT80)_Chain 0 / CH42

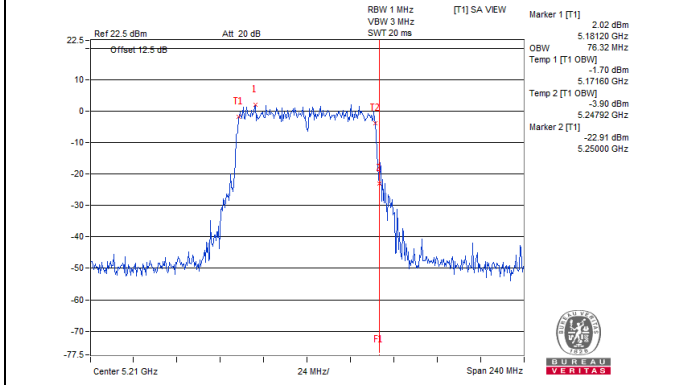

802.11ac (VHT80)_Chain 1 / CH42

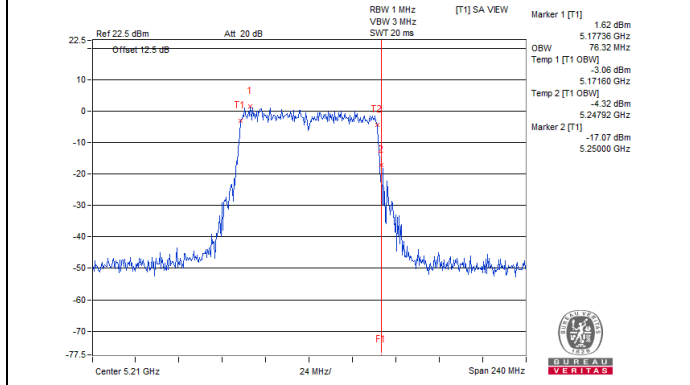

802.11ac (VHT80)_Chain 2 / CH42

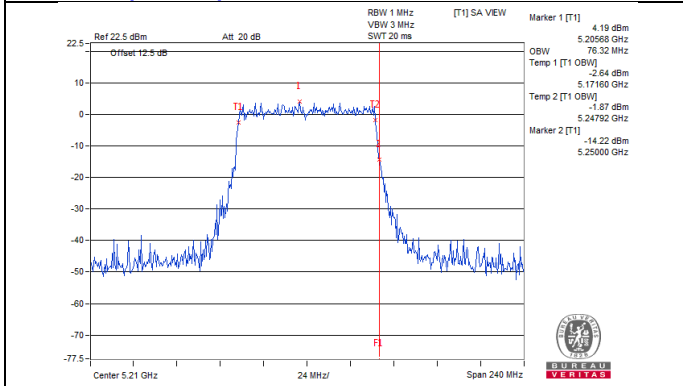

802.11ac (VHT80)_Chain 3 / CH42

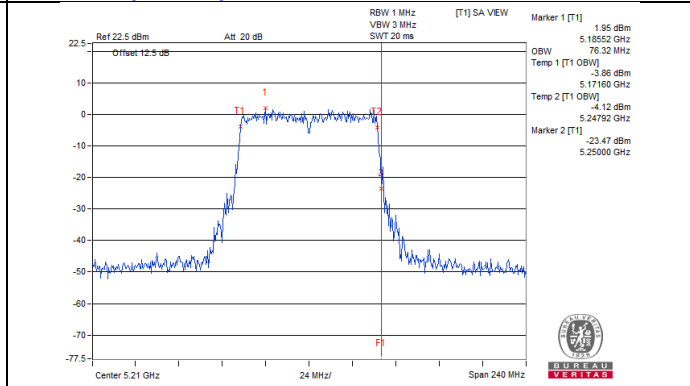

802.11ac (VHT80)_Chain 4 / CH42

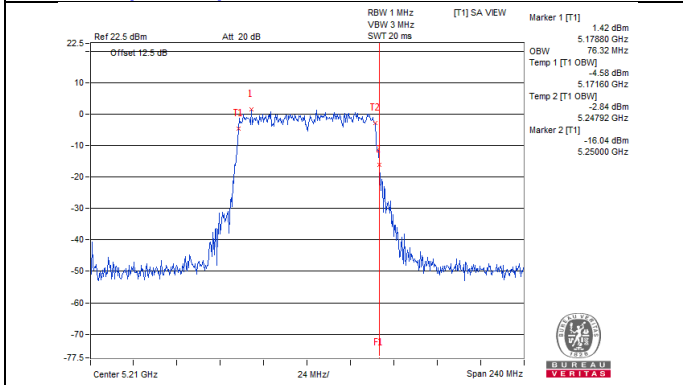

802.11ac (VHT80)_Chain 5 / CH42

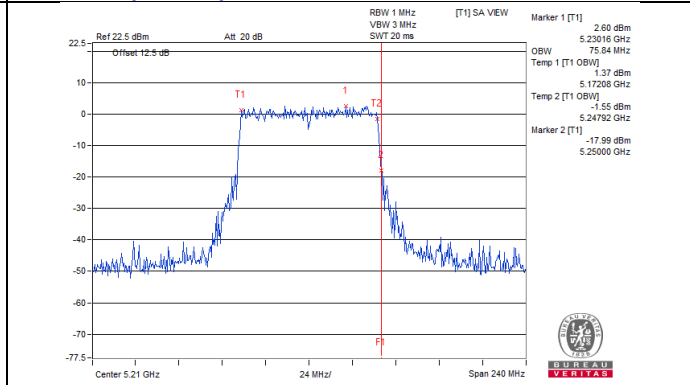

802.11ac (VHT80)_Chain 6 / CH42

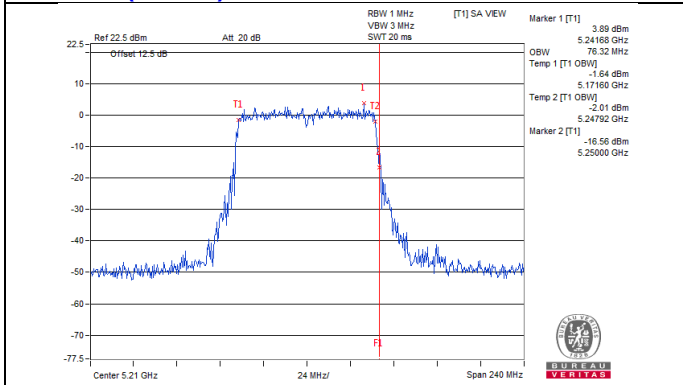

802.11ac (VHT80)_Chain 7 / CH42

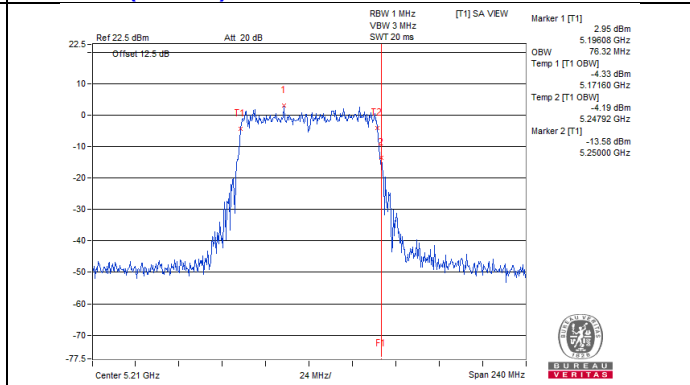

**Spectrum Plot for near by DFS band
(DFS is required, if 99% OCP straddle into U-NII-2A band)**

802.11ac (VHT80+80) / Chain 4 : CH42

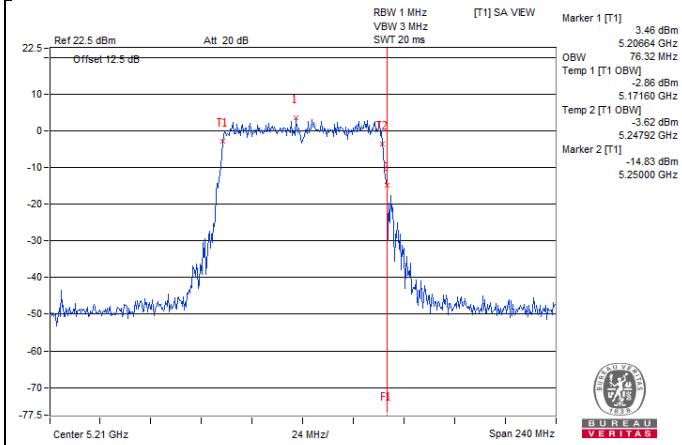

802.11ac (VHT80+80) / Chain 5 : CH42

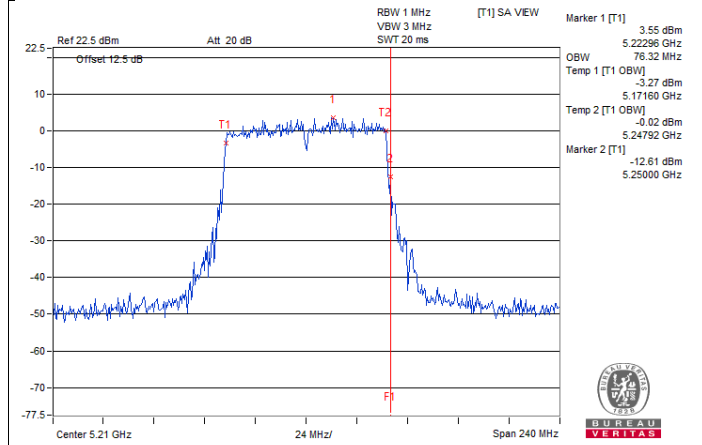

802.11ac (VHT80+80) / Chain 6 : CH42

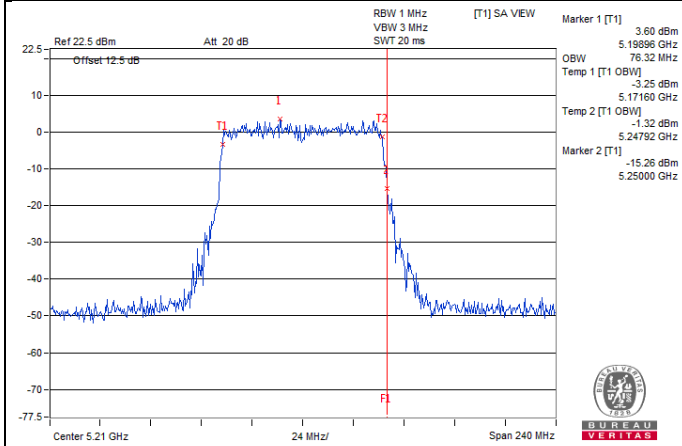

802.11ac (VHT80+80) / Chain 7 : CH42

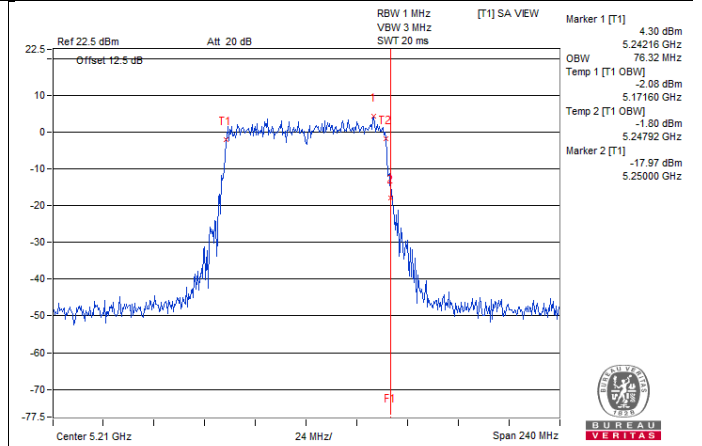

**Spectrum Plot for near by DFS band
(DFS is required, if 99% OCP straddle into U-NII-2A band)**

802.11ax (HE20)_Chain 0 / CH48

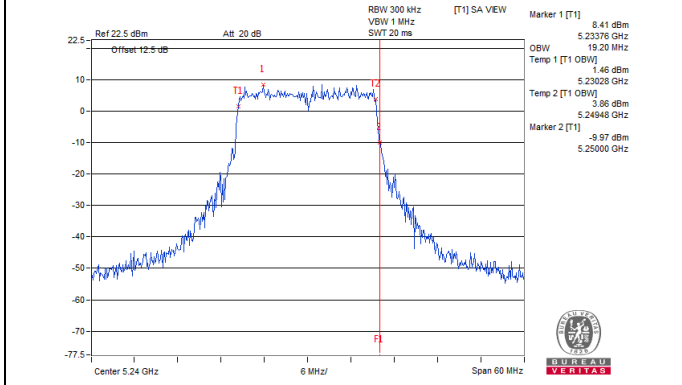

802.11ax (HE20)_Chain 1 / CH48

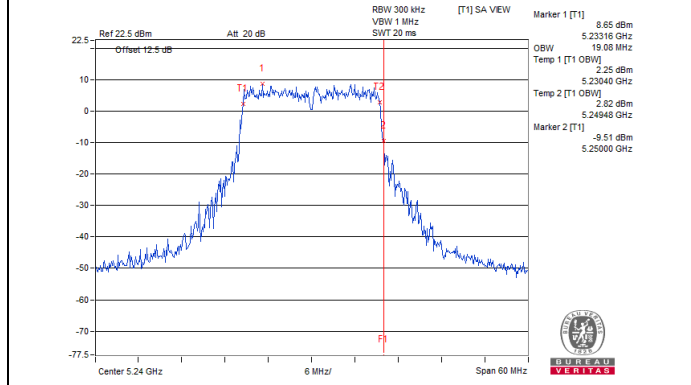

802.11ax (HE20)_Chain 2 / CH48

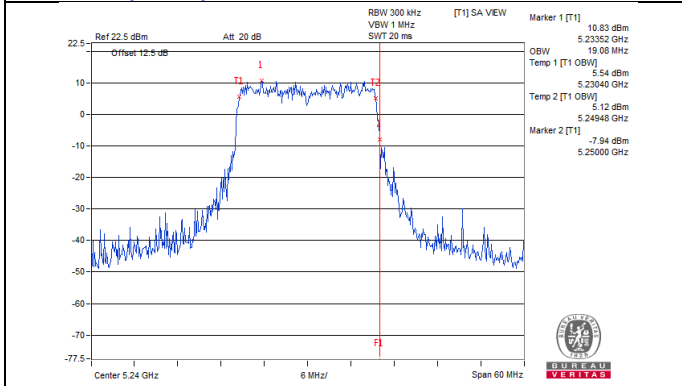

802.11ax (HE20)_Chain 3 / CH48

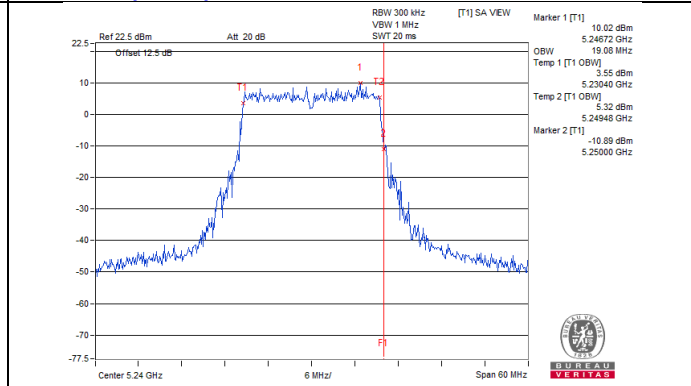

802.11ax (HE20)_Chain 4 / CH48

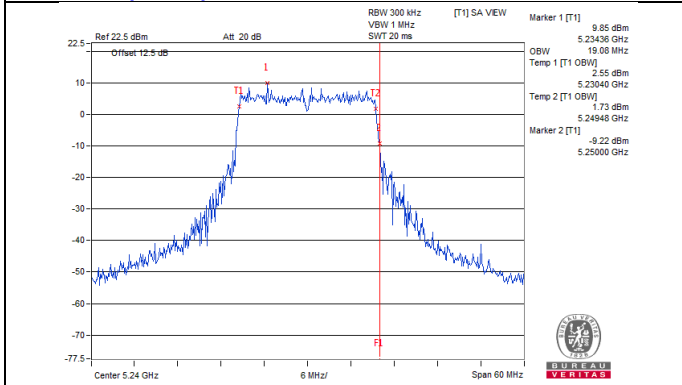

802.11ax (HE20)_Chain 5 / CH48

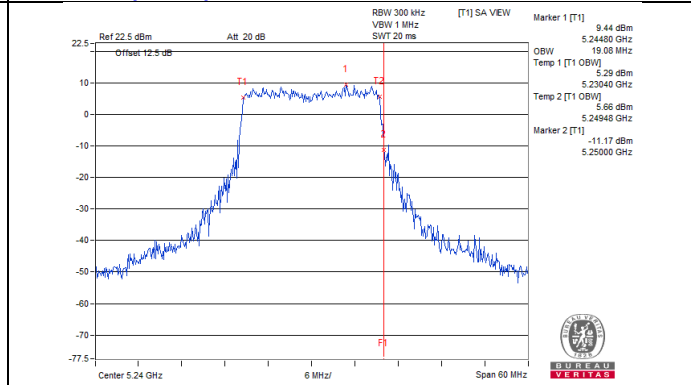

802.11ax (HE20)_Chain 6 / CH48

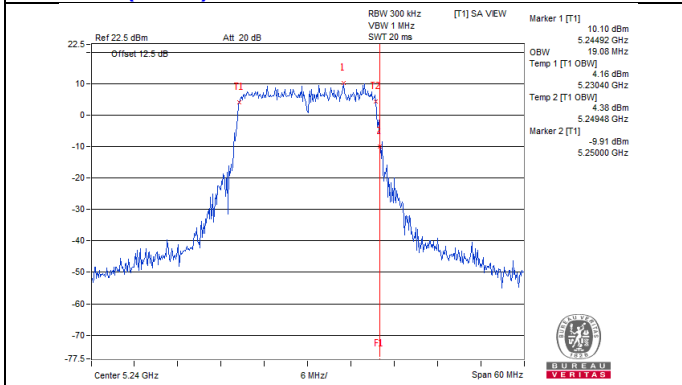

802.11ax (HE20)_Chain 7 / CH48

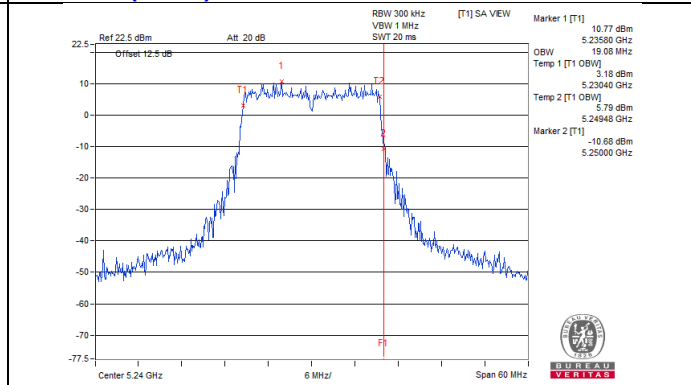

**Spectrum Plot for near by DFS band
(DFS is required, if 99% OCP straddle into U-NII-2A band)**

802.11ax (HE40)_Chain 0 / CH46

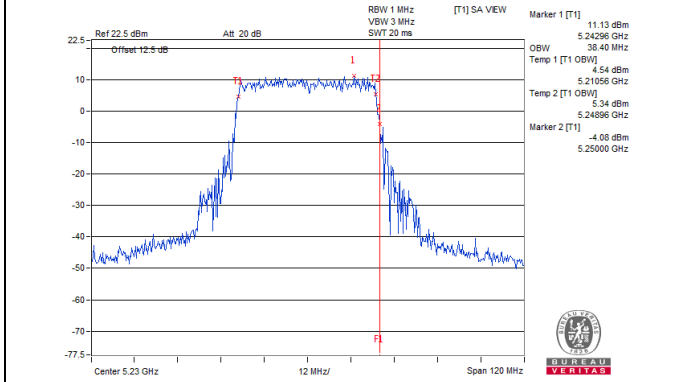

802.11ax (HE40)_Chain 1 / CH46

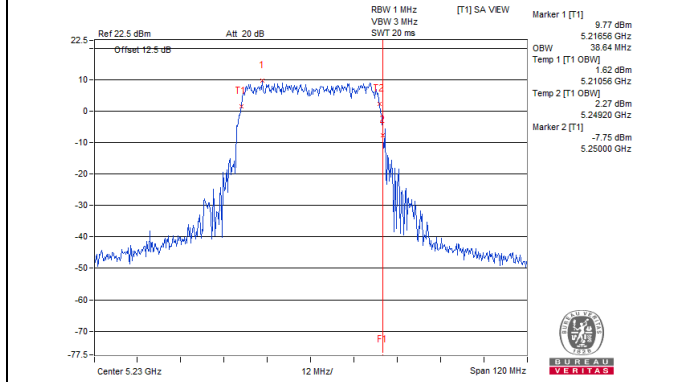

802.11ax (HE40)_Chain 2 / CH46

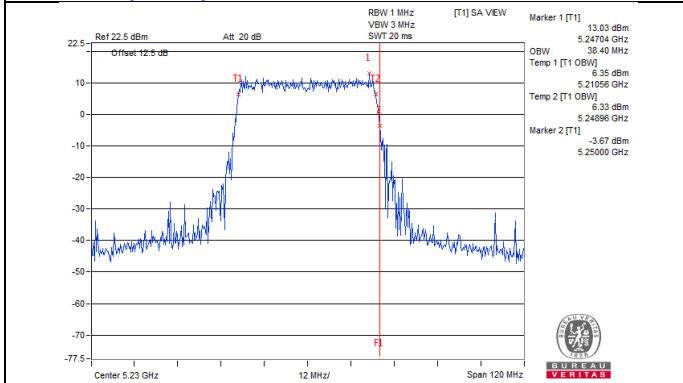

802.11ax (HE40)_Chain 3 / CH46

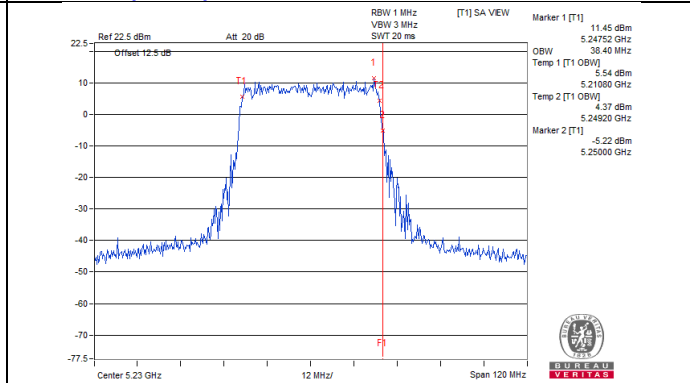

802.11ax (HE40)_Chain 4 / CH46

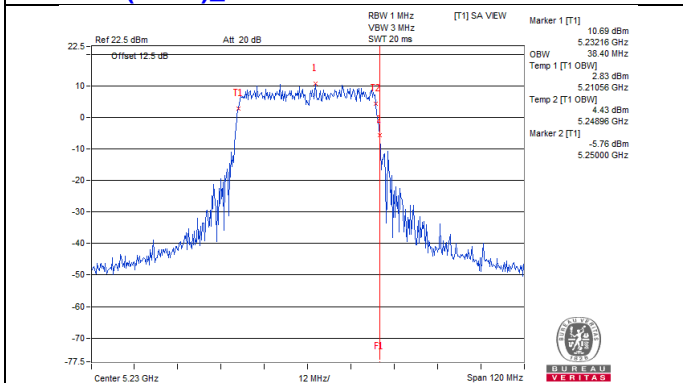

802.11ax (HE40)_Chain 5 / CH46

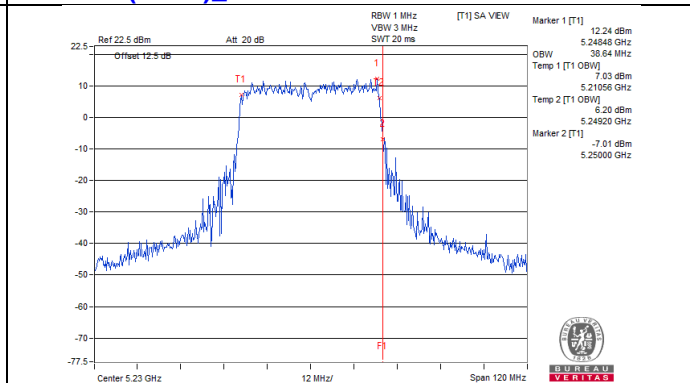

802.11ax (HE40)_Chain 6 / CH46

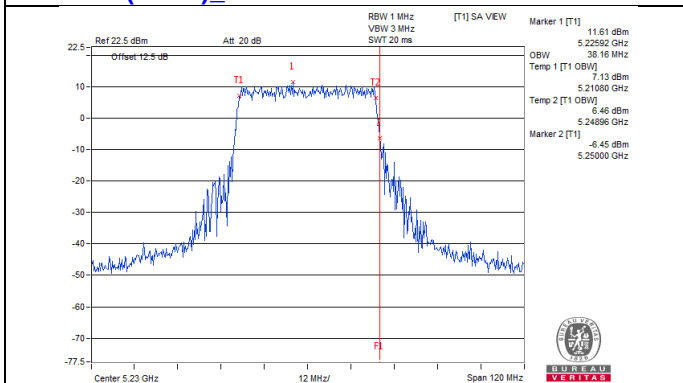

802.11ax (HE40)_Chain 7 / CH46

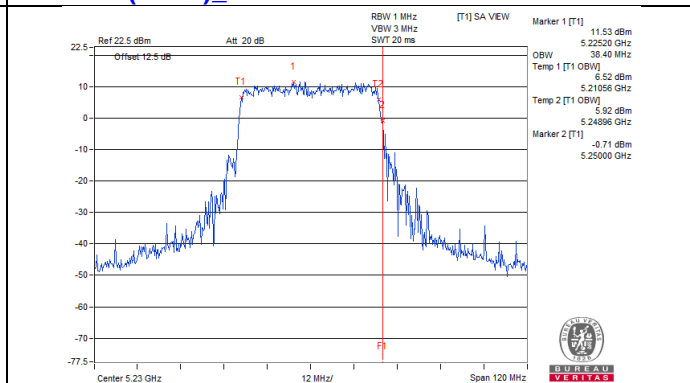

**Spectrum Plot for near by DFS band
(DFS is required, if 99% OCP straddle into U-NII-2A band)**

802.11ax (HE80)_Chain 0 / CH42

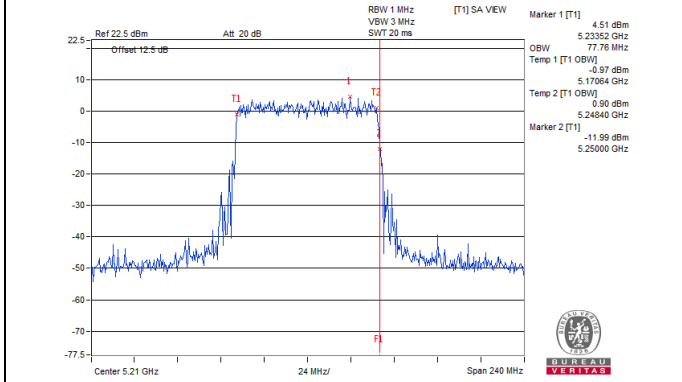

802.11ax (HE80)_Chain 1 / CH42

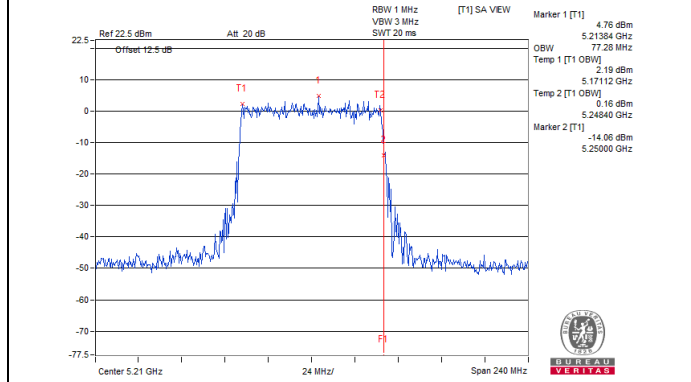

802.11ax (HE80)_Chain 2 / CH42

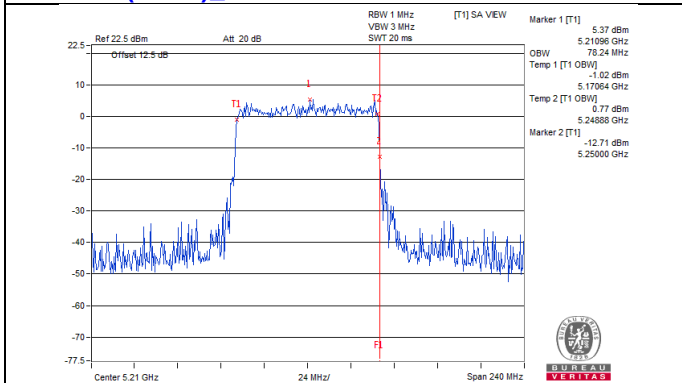

802.11ax (HE80)_Chain 3 / CH42

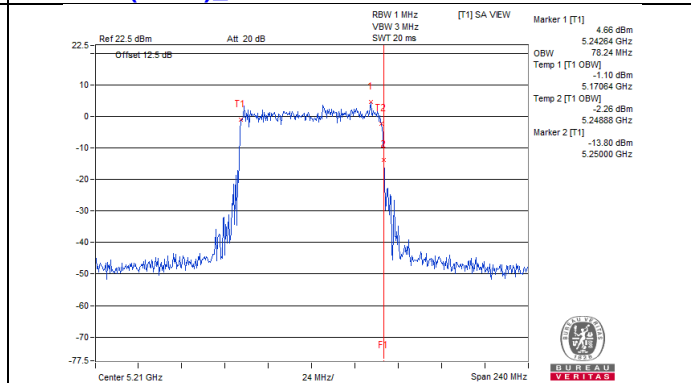

802.11ax (HE80)_Chain 4 / CH42

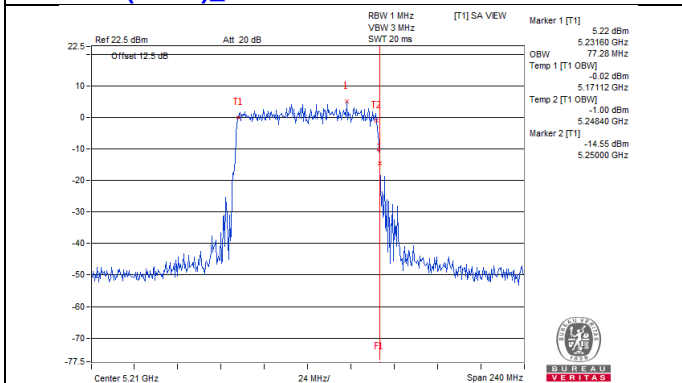

802.11ax (HE80)_Chain 5 / CH42

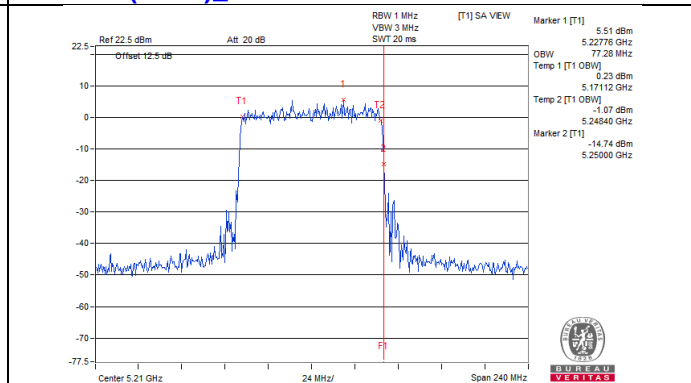

802.11ax (HE80)_Chain 6 / CH42

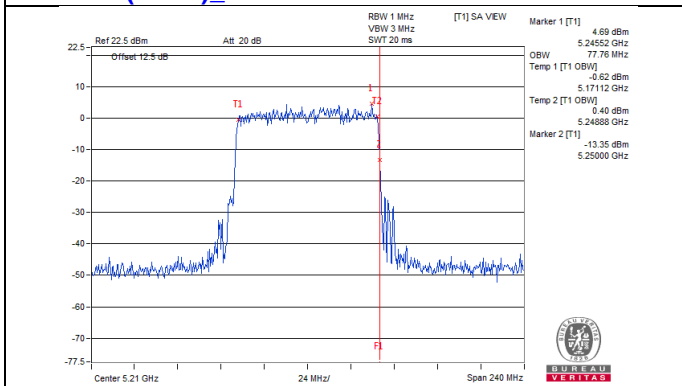

802.11ax (HE80)_Chain 7 / CH42

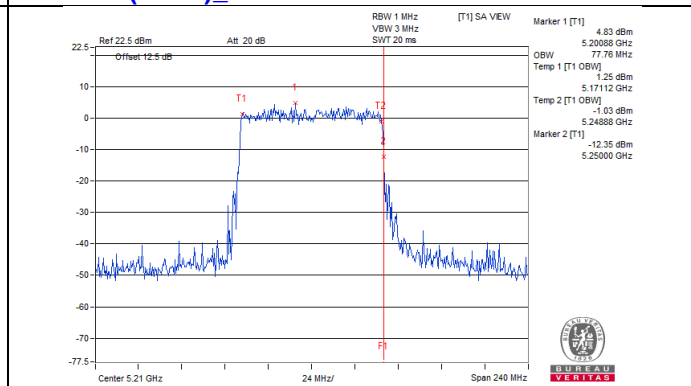

**Spectrum Plot for near by DFS band
(DFS is required, if 99% OCP straddle into U-NII-2A band)**

802.11ax (HE80+80) / Chain 4 : CH42

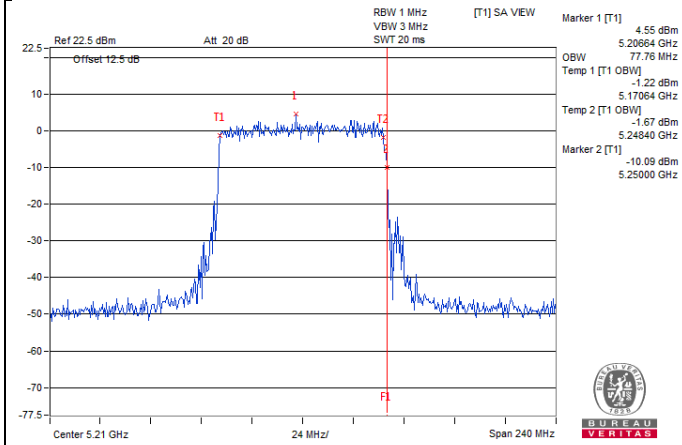

802.11ax (HE80+80) / Chain 5 : CH42

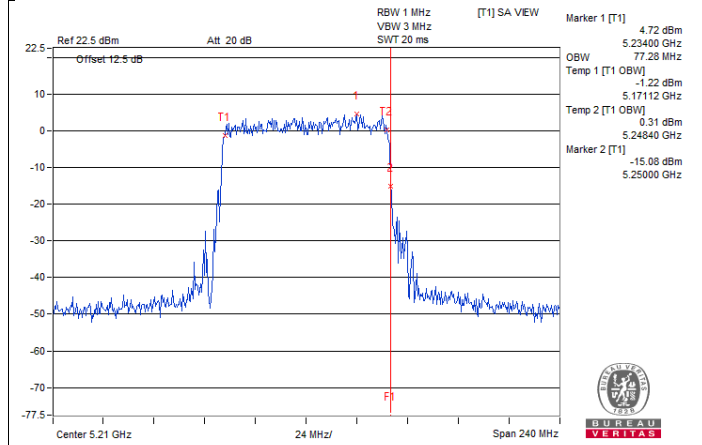

802.11ax (HE80+80) / Chain 6 : CH42

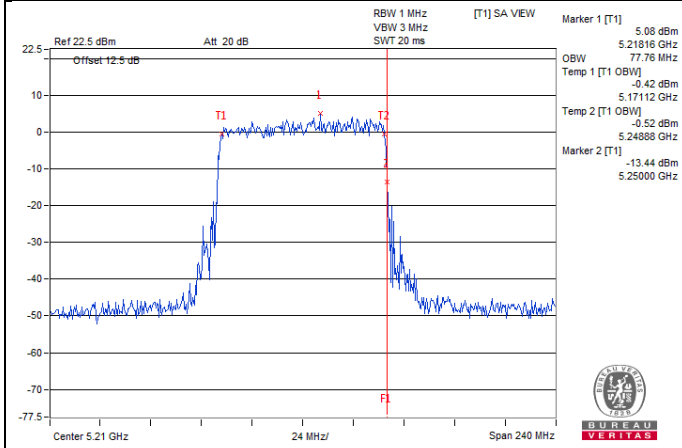

802.11ax (HE80+80) / Chain 7 : CH42

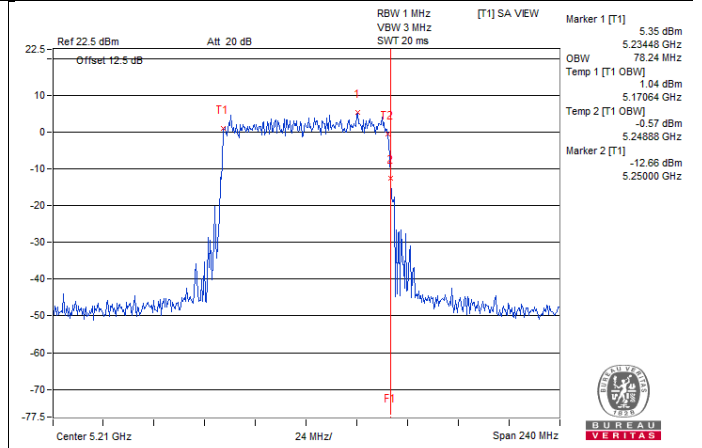

Spectrum Plot for near by DFS band
(DFS is required, if 99% OCP straddle into U-NII-2C band)

802.11a_Chain 0 / CH149

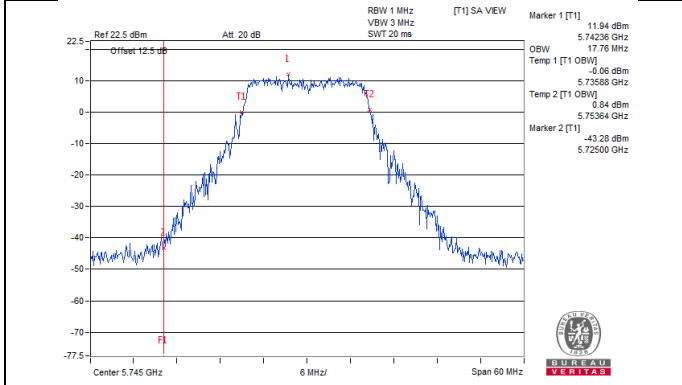

802.11a_Chain 1 / CH149

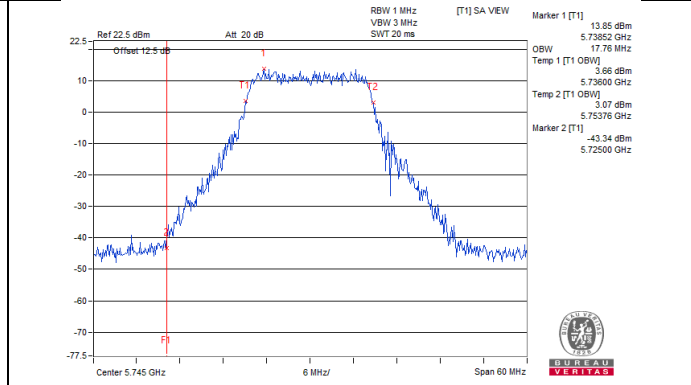

802.11a_Chain 2 / CH149

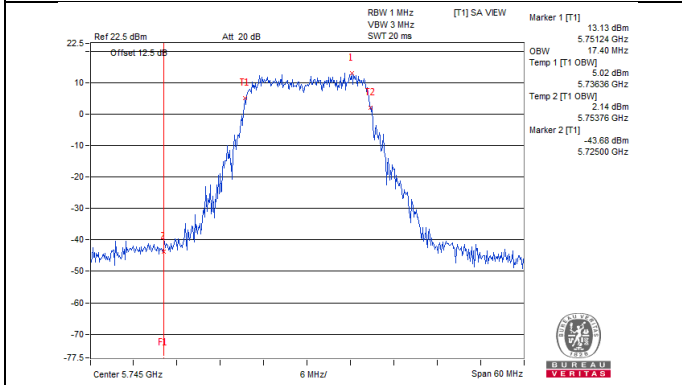

802.11a_Chain 3 / CH149

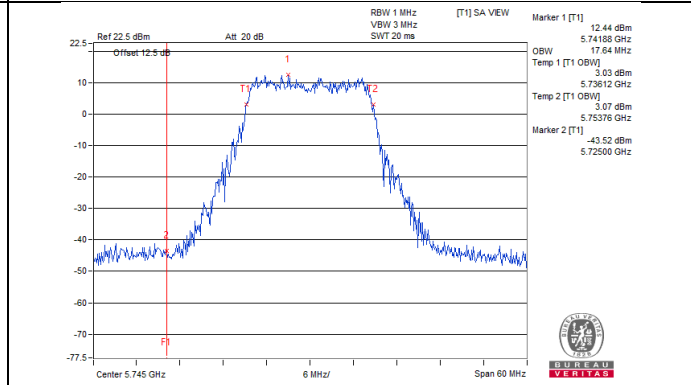

802.11a_Chain 4 / CH149

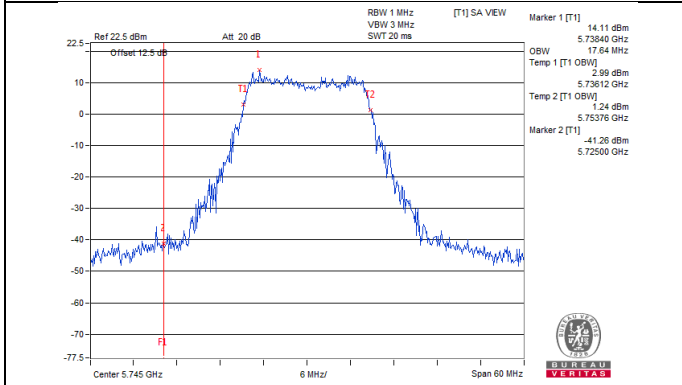

802.11a_Chain 5 / CH149

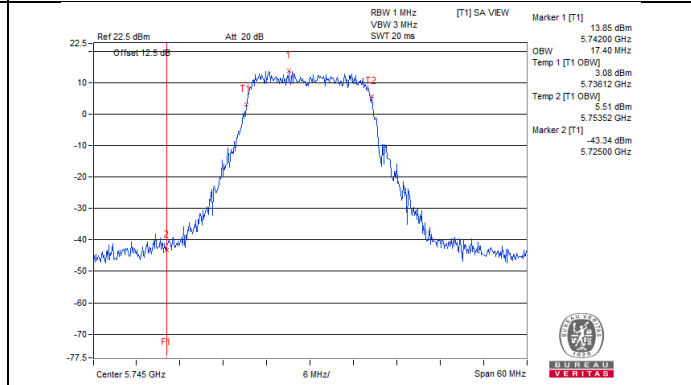

802.11a_Chain 6 / CH149

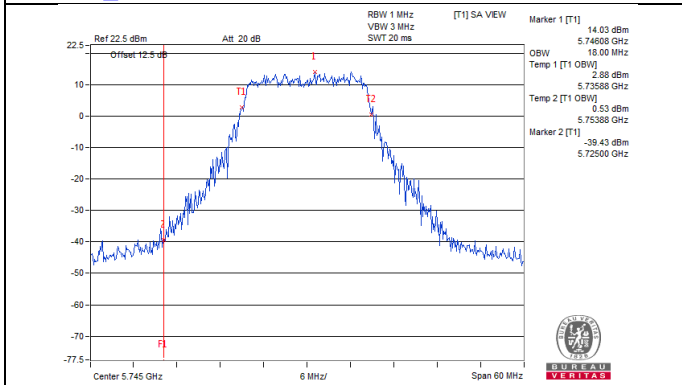

802.11a_Chain 7 / CH149

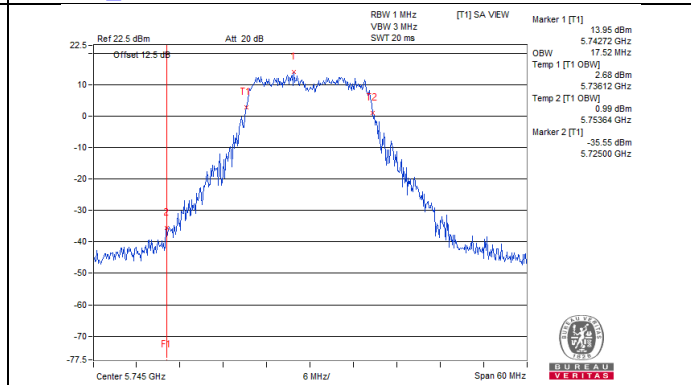

Spectrum Plot for near by DFS band
(DFS is required, if 99% OCP straddle into U-NII-2C band)

802.11ac (VHT20)_Chain 0 / CH149

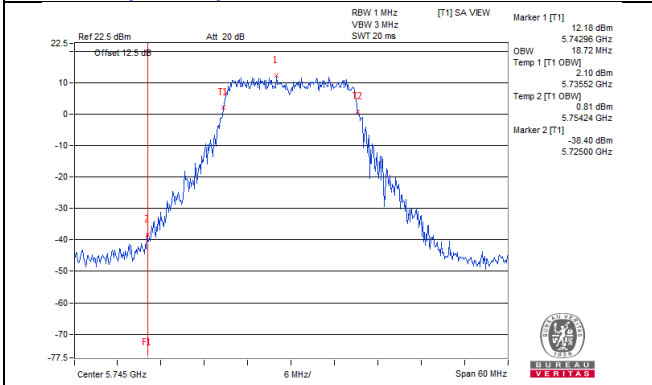

802.11ac (VHT20)_Chain 1 / CH149

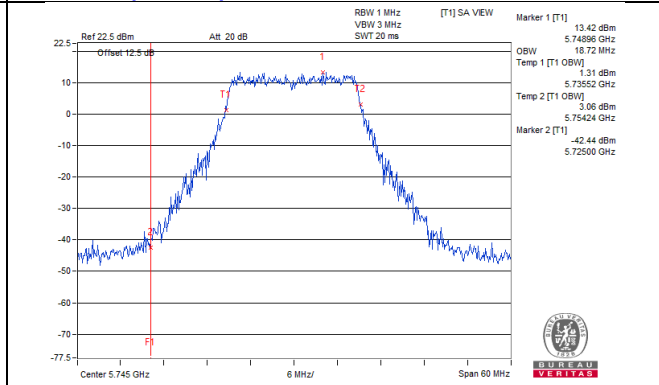

802.11ac (VHT20)_Chain 2 / CH149

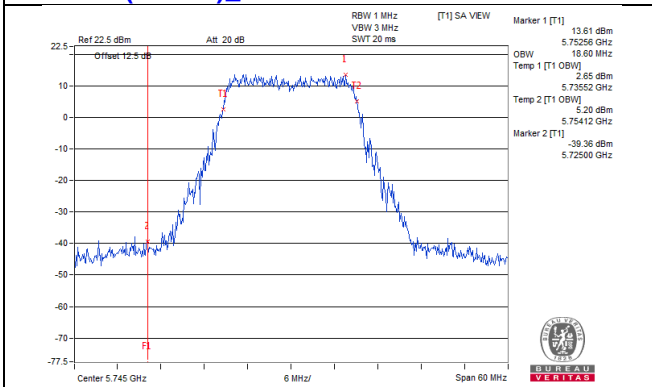

802.11ac (VHT20)_Chain 3 / CH149

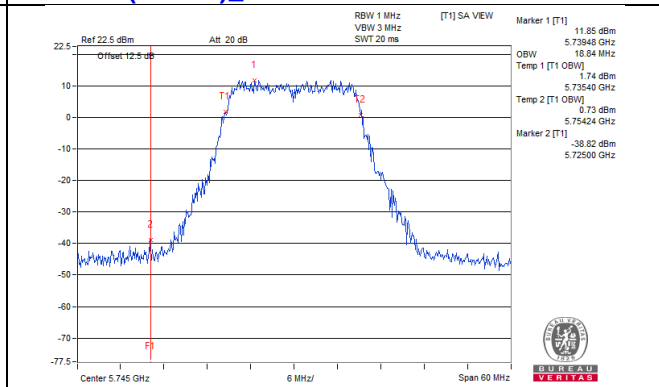

802.11ac (VHT20)_Chain 4 / CH149

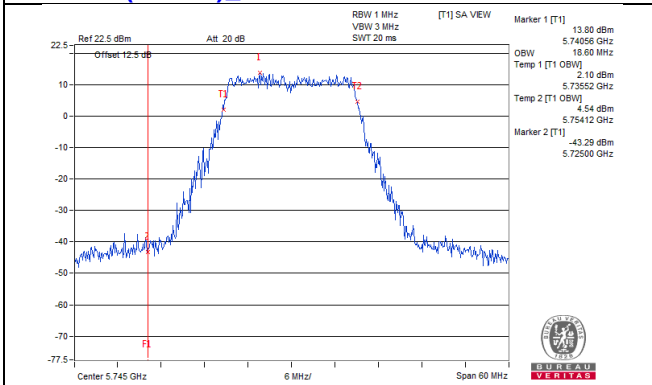

802.11ac (VHT20)_Chain 5 / CH149

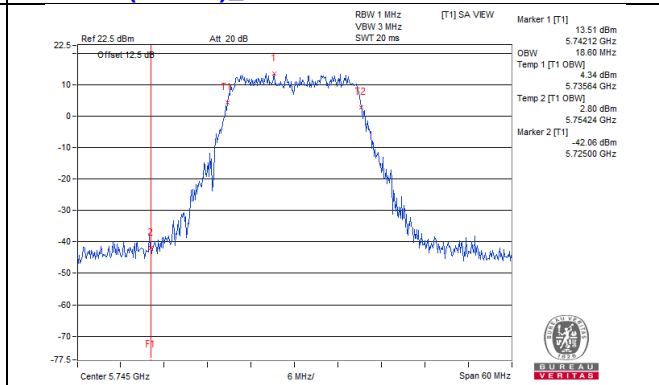

802.11ac (VHT20)_Chain 6 / CH149

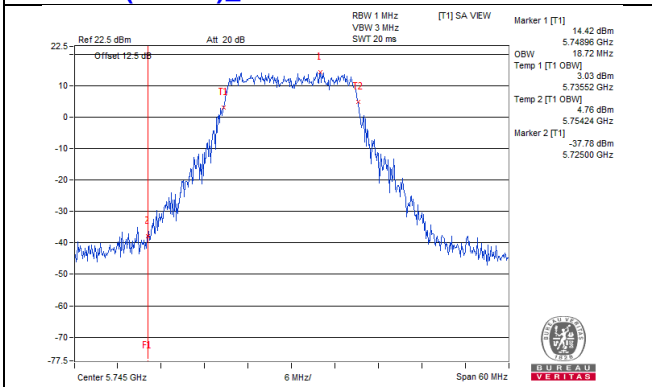

802.11ac (VHT20)_Chain 7 / CH149

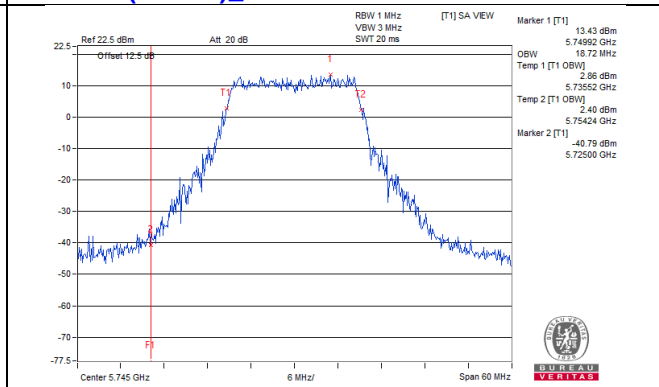

Spectrum Plot for near by DFS band
(DFS is required, if 99% OCP straddle into U-NII-2C band)

802.11ac (VHT40)_Chain 0 / CH151

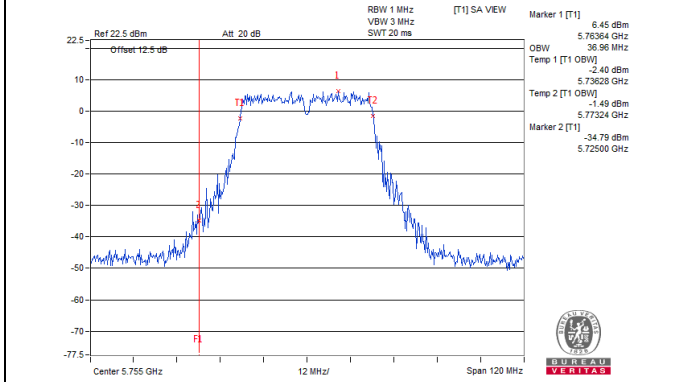

802.11ac (VHT40)_Chain 1 / CH151

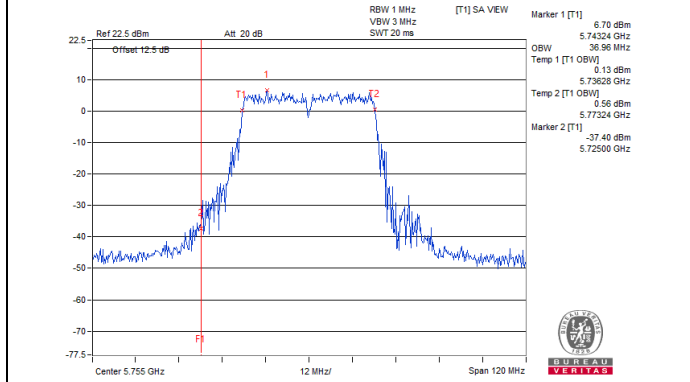

802.11ac (VHT40)_Chain 2 / CH151

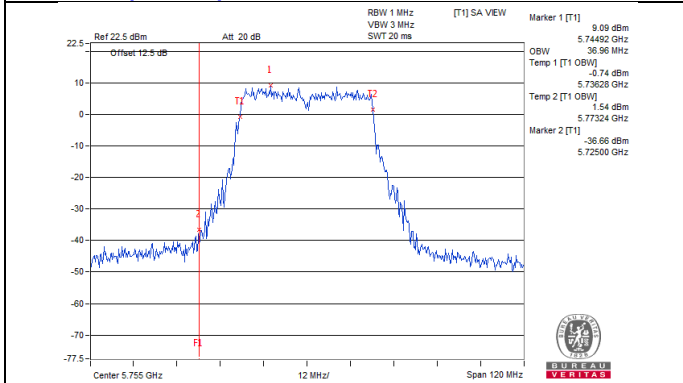

802.11ac (VHT40)_Chain 3 / CH151

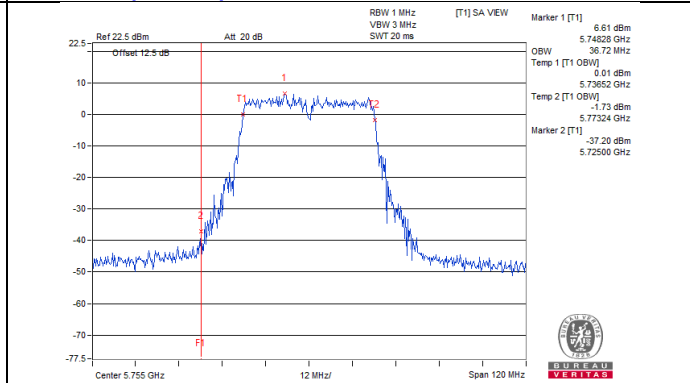

802.11ac (VHT40)_Chain 4 / CH151

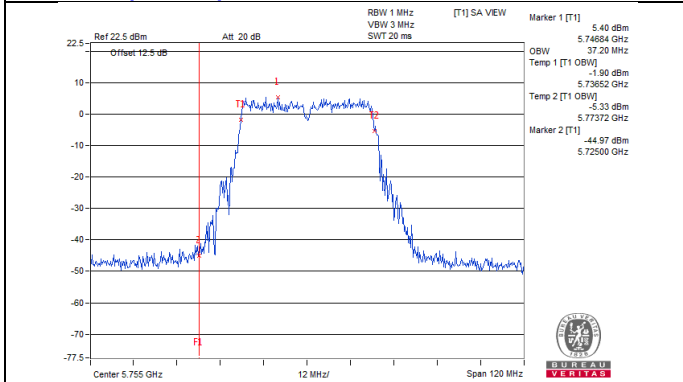

802.11ac (VHT40)_Chain 5 / CH151

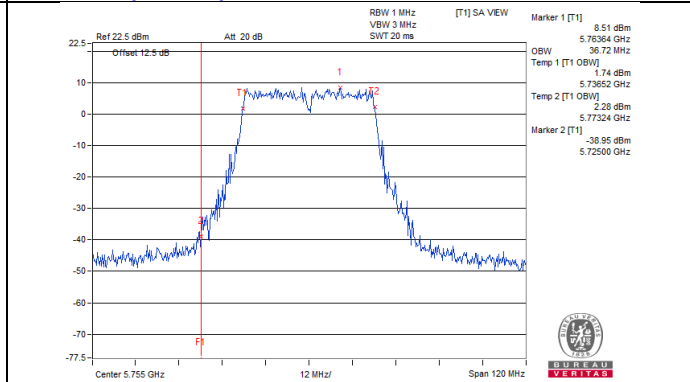

802.11ac (VHT40)_Chain 6 / CH151

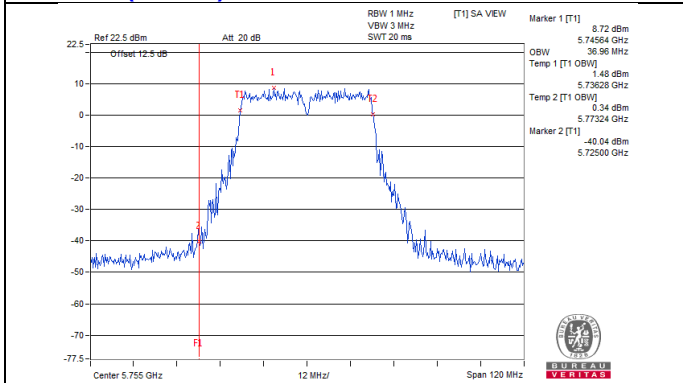

802.11ac (VHT40)_Chain 7 / CH151

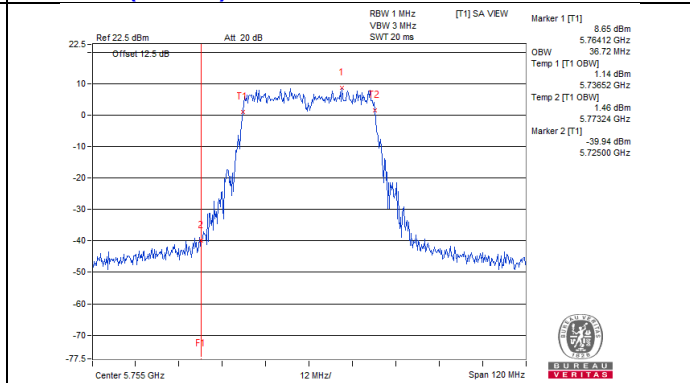

Spectrum Plot for near by DFS band
(DFS is required, if 99% OCP straddle into U-NII-2C band)

802.11ac (VHT80)_Chain 0 / CH155

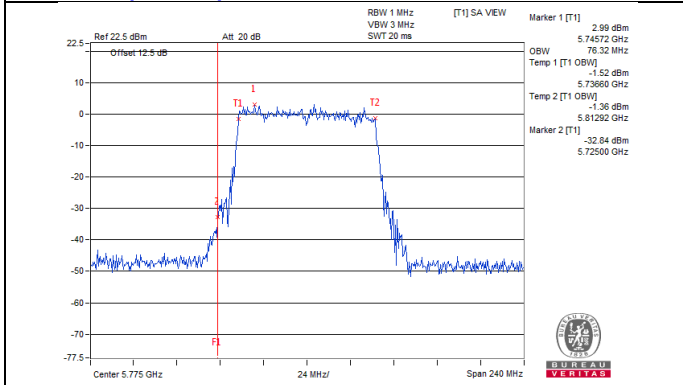

802.11ac (VHT80)_Chain 1 / CH155

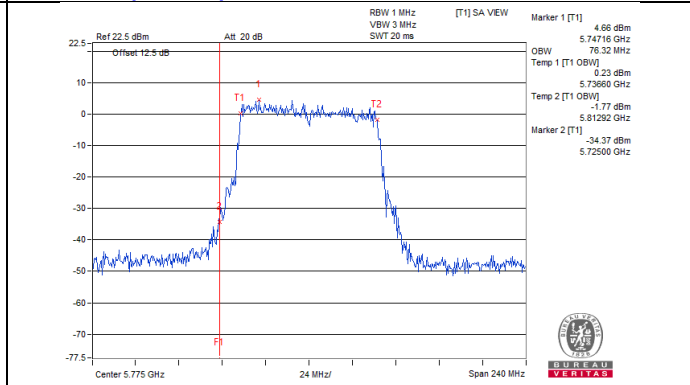

802.11ac (VHT80)_Chain 2 / CH155

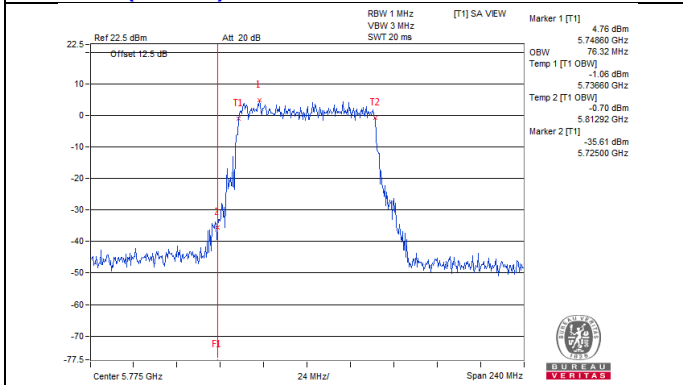

802.11ac (VHT80)_Chain 3 / CH155

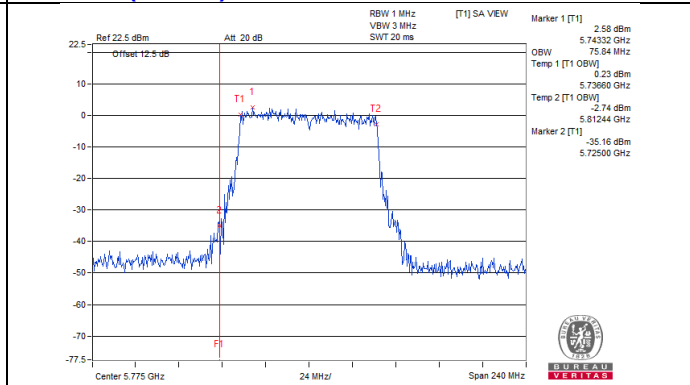

802.11ac (VHT80)_Chain 4 / CH155

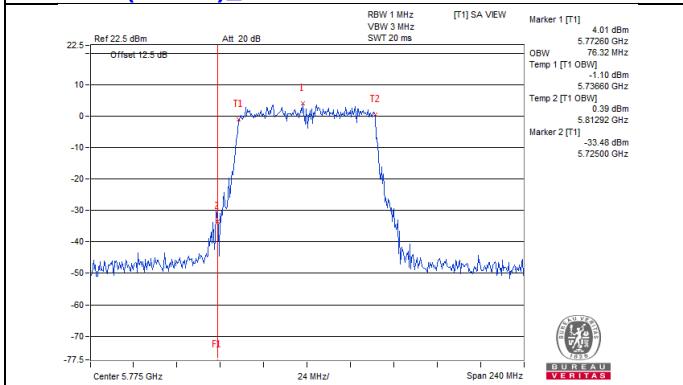

802.11ac (VHT80)_Chain 5 / CH155

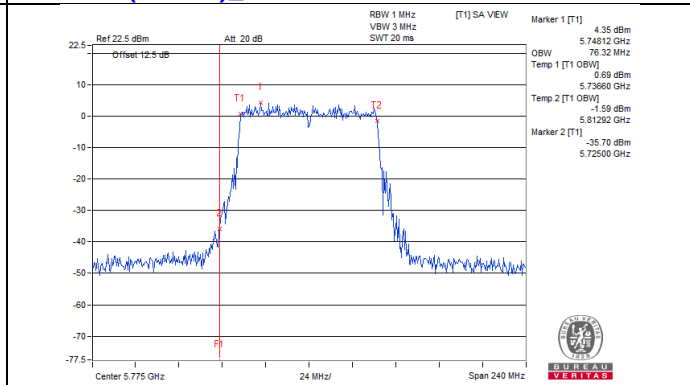

802.11ac (VHT80)_Chain 6 / CH155

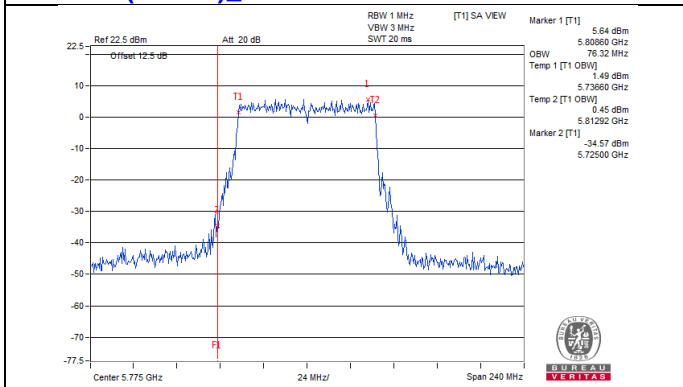

802.11ac (VHT80)_Chain 7 / CH155

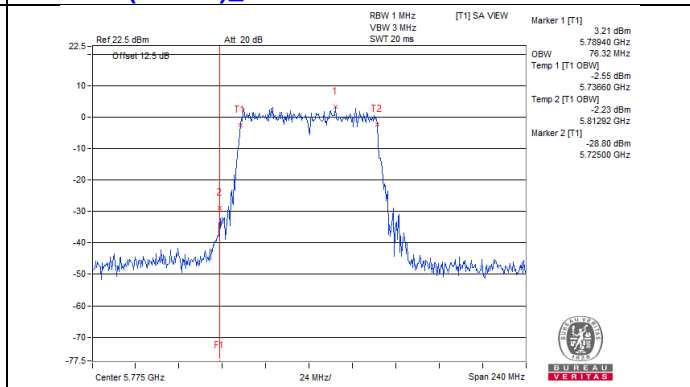

Spectrum Plot for near by DFS band
(DFS is required, if 99% OCP straddle into U-NII-2C band)

802.11ac (VHT80+80) / Chain 0 : CH155

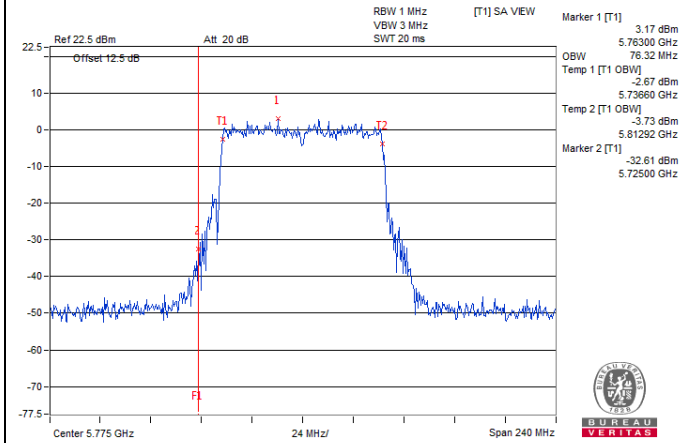

802.11ac (VHT80+80) / Chain 1 : CH155

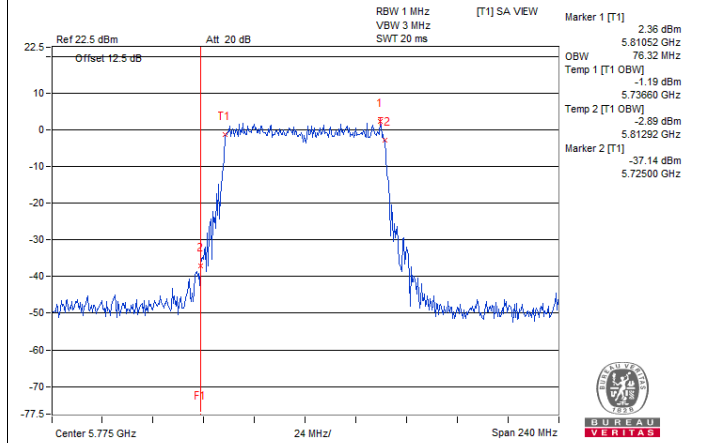

802.11ac (VHT80+80) / Chain 2 : CH155

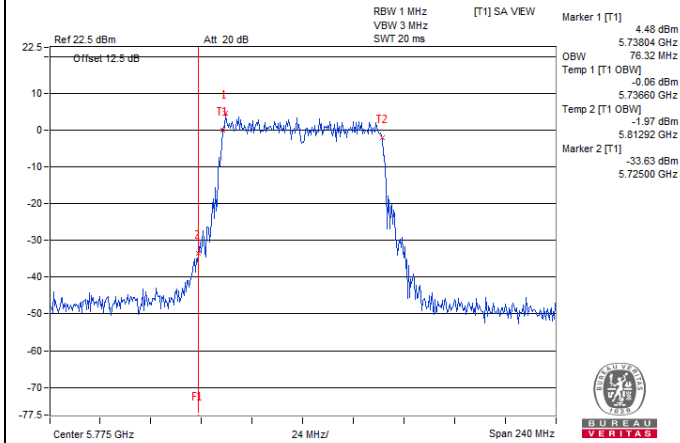

802.11ac (VHT80+80) / Chain 3 : CH155

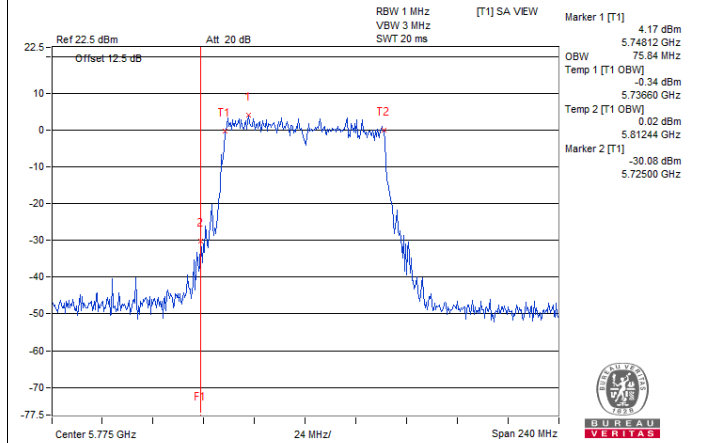

Spectrum Plot for near by DFS band
(DFS is required, if 99% OCP straddle into U-NII-2C band)

802.11ax (HE20)_Chain 0 / CH149

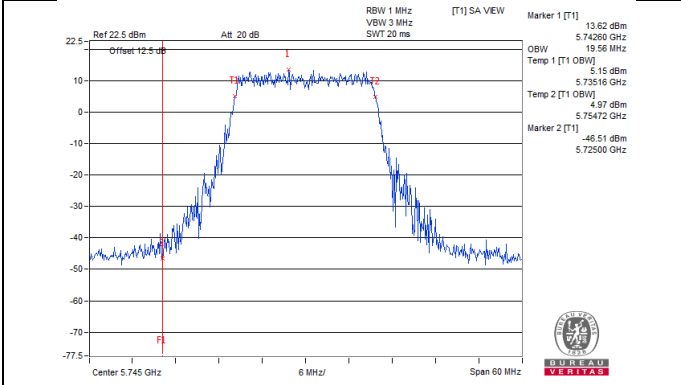

802.11ax (HE20)_Chain 1 / CH149

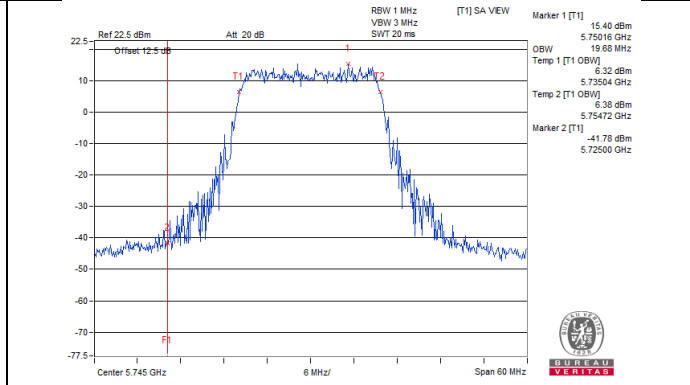

802.11ax (HE20)_Chain 2 / CH149

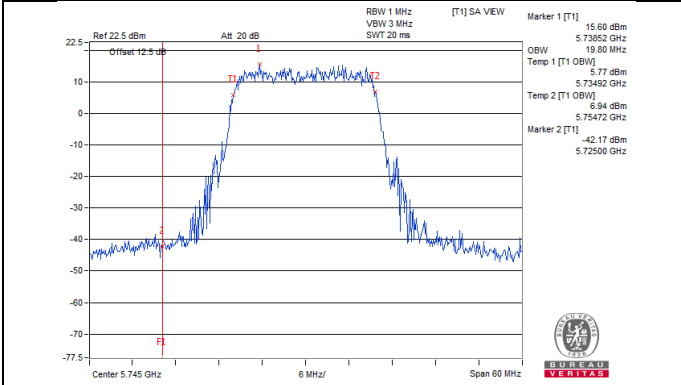

802.11ax (HE20)_Chain 3 / CH149

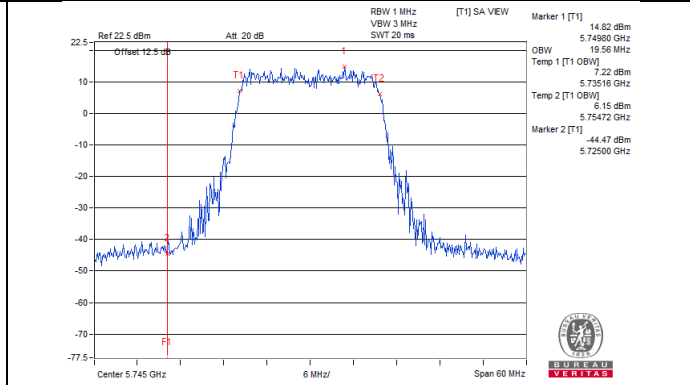

802.11ax (HE20)_Chain 4 / CH149

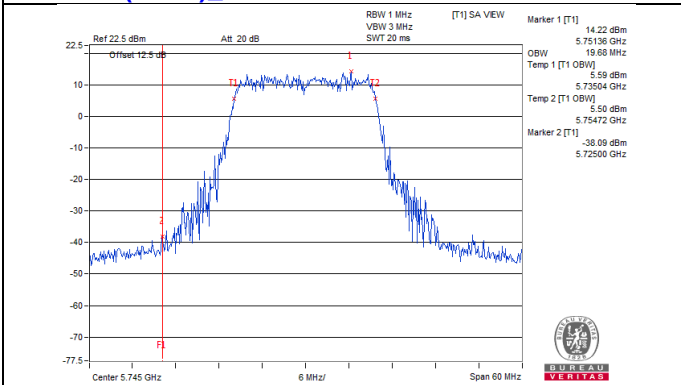

802.11ax (HE20)_Chain 5 / CH149

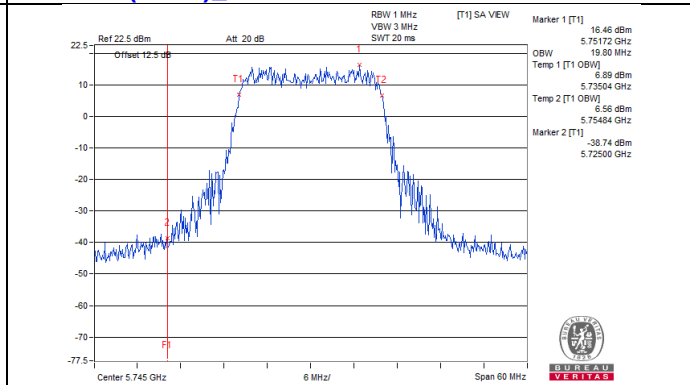

802.11ax (HE20)_Chain 6 / CH149

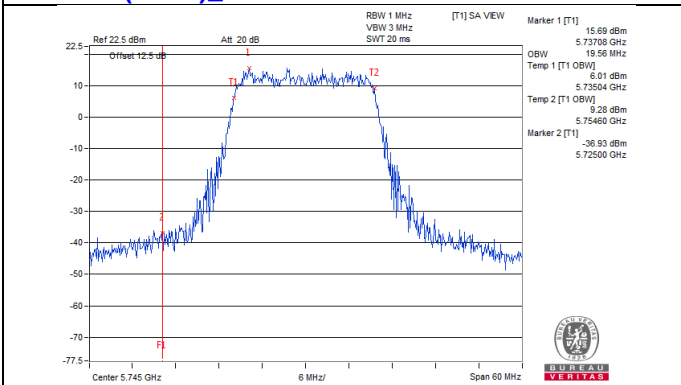

802.11ax (HE20)_Chain 7 / CH149

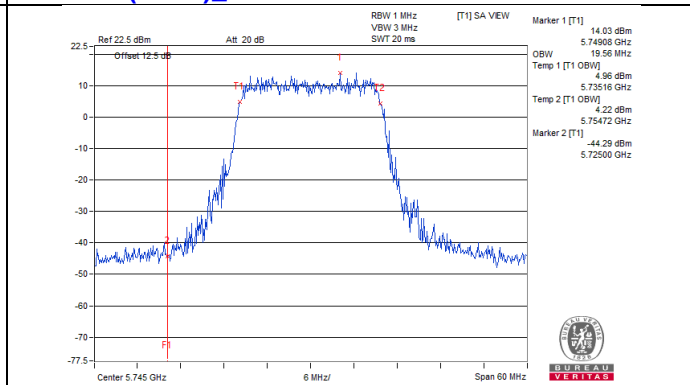

Spectrum Plot for near by DFS band
(DFS is required, if 99% OCP straddle into U-NII-2C band)

802.11ax (HE40)_Chain 0 / CH151

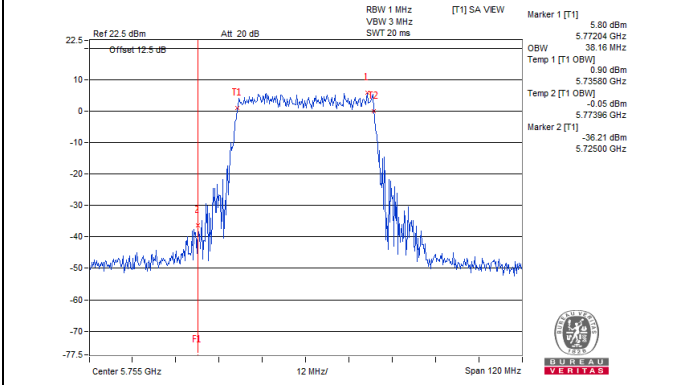

802.11ax (HE40)_Chain 1 / CH151

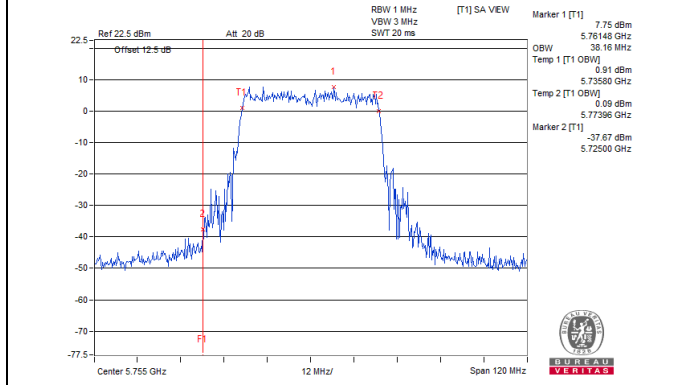

802.11ax (HE40)_Chain 2 / CH151

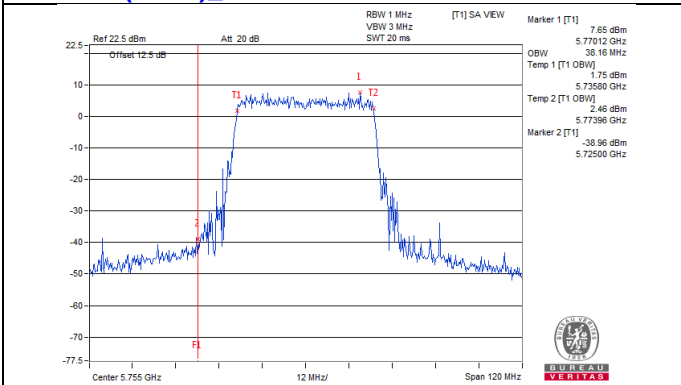

802.11ax (HE40)_Chain 3 / CH151

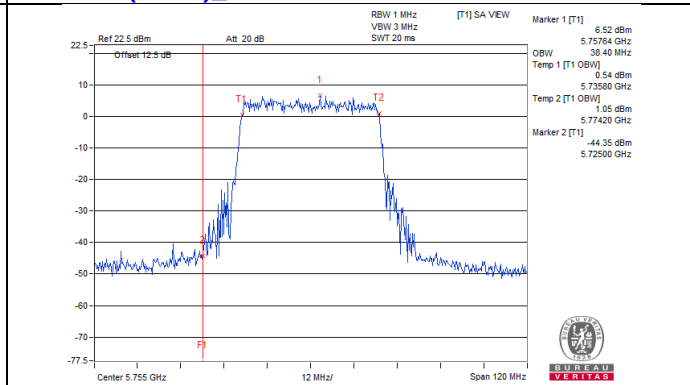

802.11ax (HE40)_Chain 4 / CH151

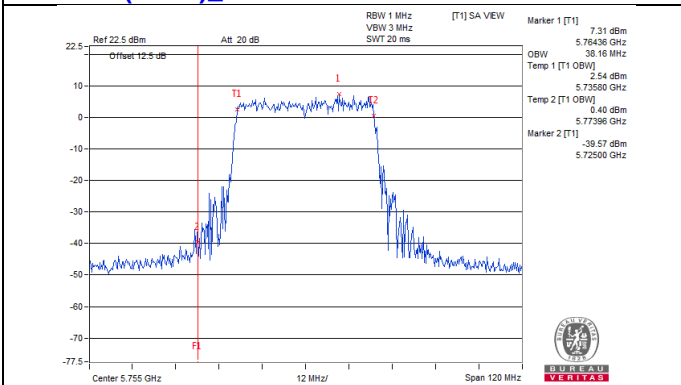

802.11ax (HE40)_Chain 5 / CH151

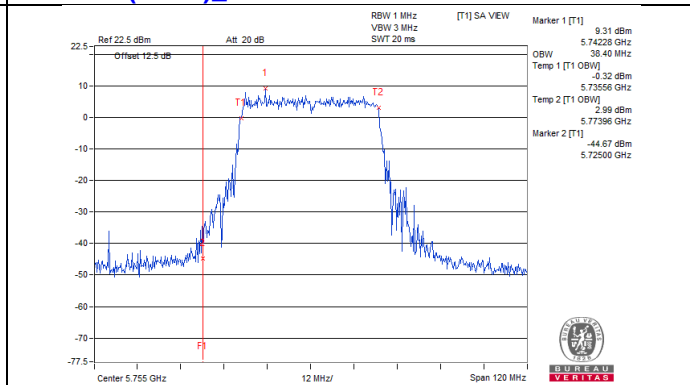

802.11ax (HE40)_Chain 6 / CH151

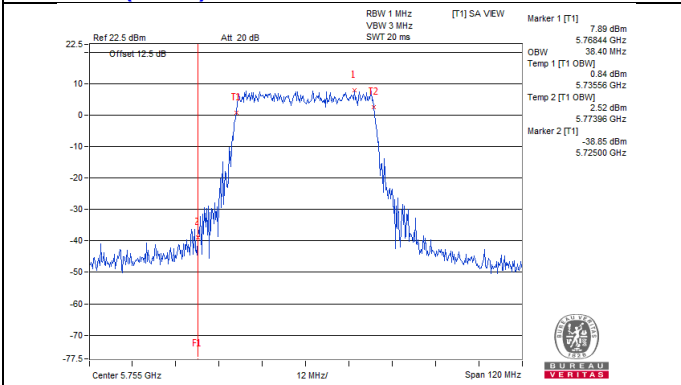

802.11ax (HE40)_Chain 7 / CH151

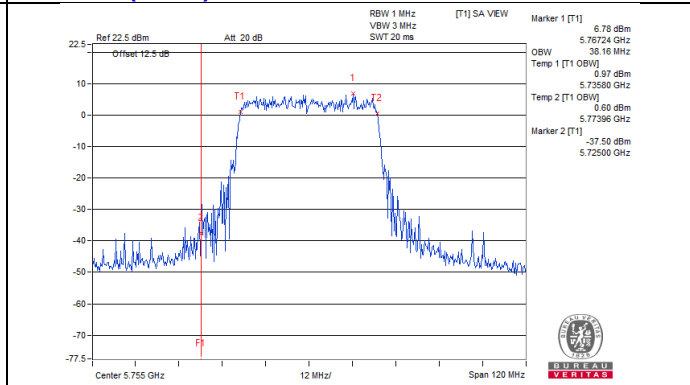

Spectrum Plot for near by DFS band
(DFS is required, if 99% OCP straddle into U-NII-2C band)

802.11ax (HE80)_Chain 0 / CH155

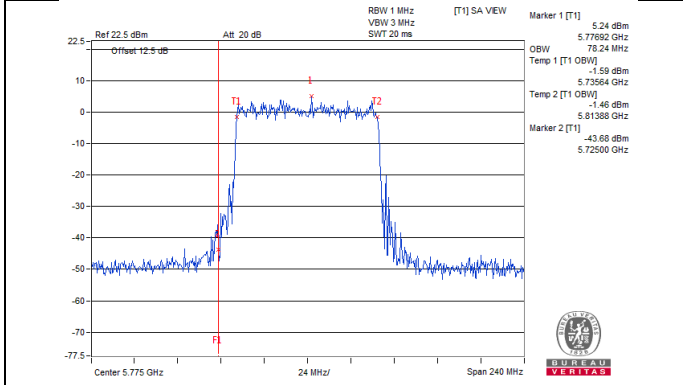

802.11ax (HE80)_Chain 1 / CH155

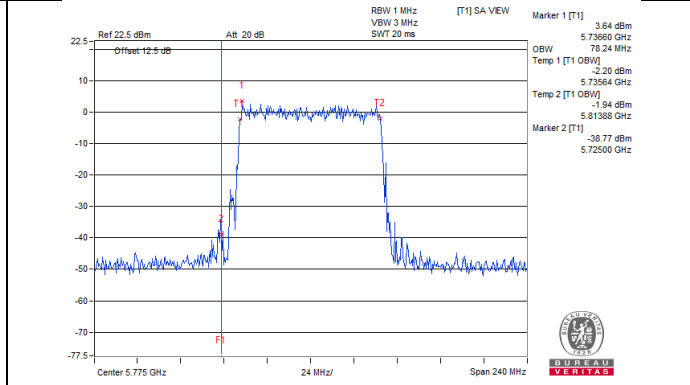

802.11ax (HE80)_Chain 2 / CH155

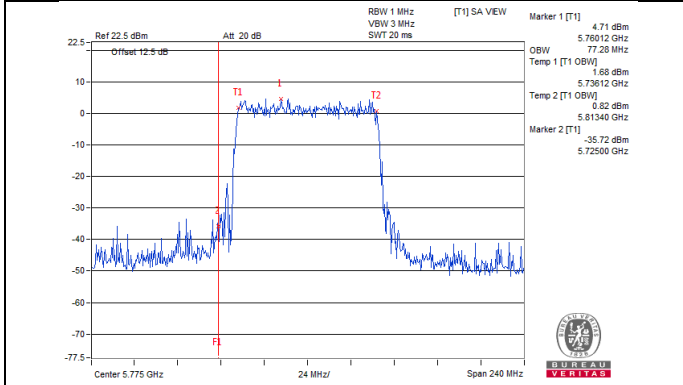

802.11ax (HE80)_Chain 3 / CH155

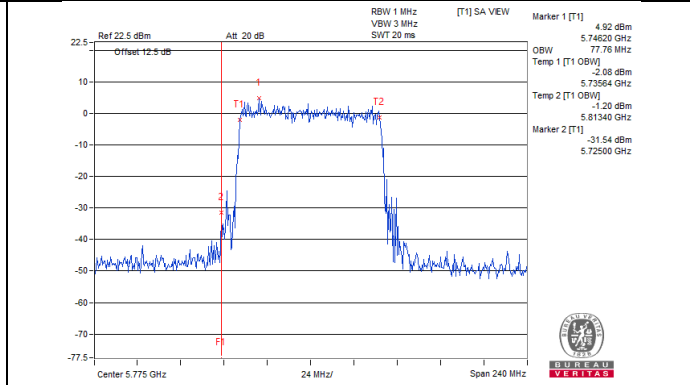

802.11ax (HE80)_Chain 4 / CH155

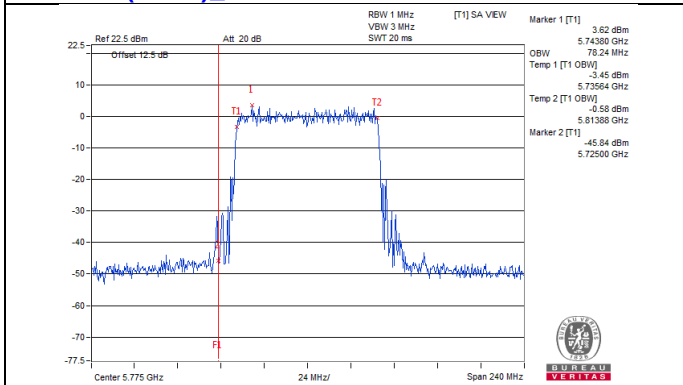

802.11ax (HE80)_Chain 5 / CH155

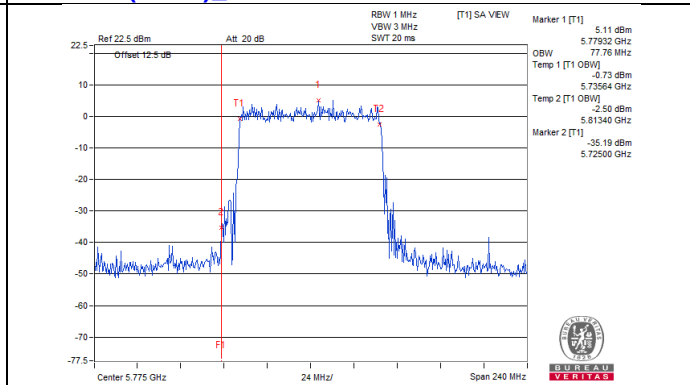

802.11ax (HE80)_Chain 6 / CH155

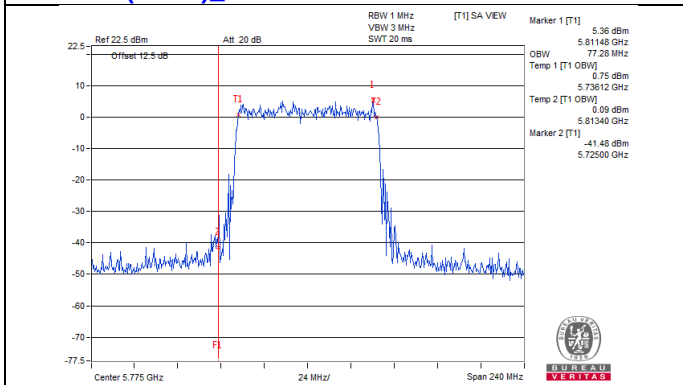

802.11ax (HE80)_Chain 7 / CH155

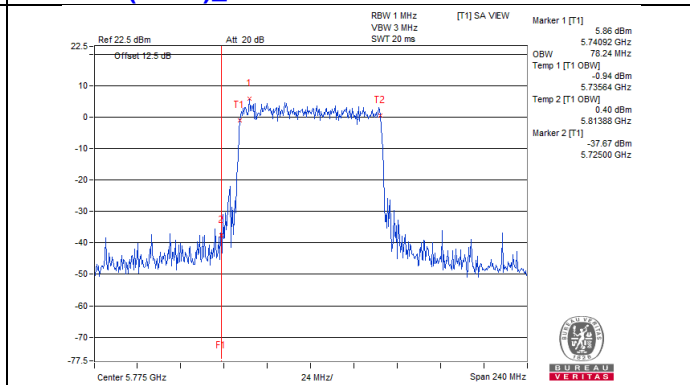

**Spectrum Plot for near by DFS band
(DFS is required, if 99% OCP straddle into U-NII-2C band)**

802.11ax (HE80+80) / Chain 0 : CH155

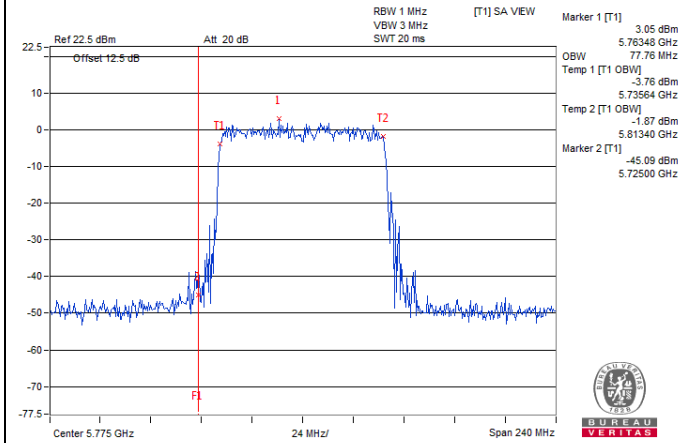

802.11ax (HE80+80) / Chain 1 : CH155

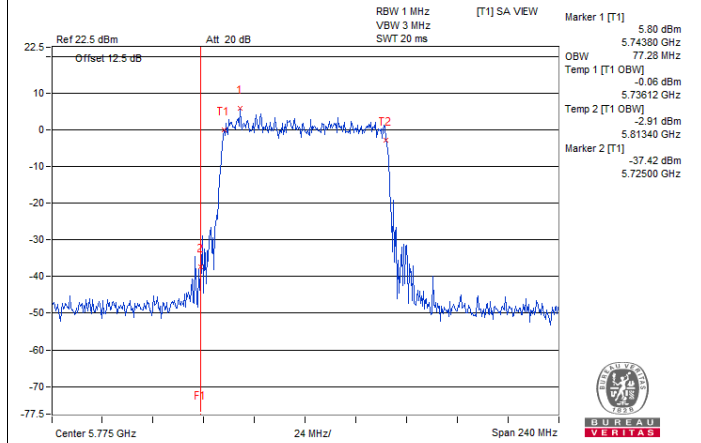

802.11ax (HE80+80) / Chain 2 : CH155

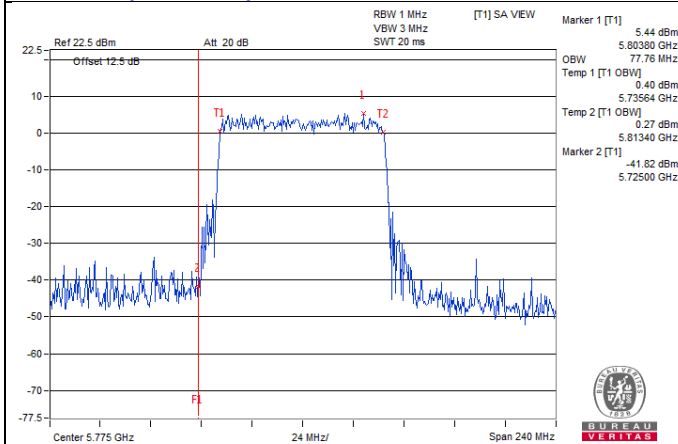

802.11ax (HE80+80) / Chain 3 : CH155

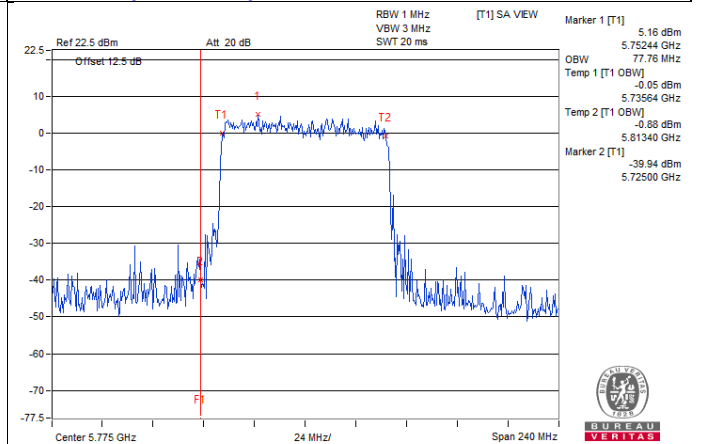

4.5 Peak Power Spectral Density Measurement

4.5.1 Limits of Peak Power Spectral Density Measurement

Operation Band	EUT Category		Limit
U-NII-1		Outdoor Access Point	17dBm/ MHz
		Fixed point-to-point Access Point	
	√	Indoor Access Point	11dBm/ MHz
		Client device	
U-NII-2A	---		11dBm/ MHz
U-NII-2C	---		11dBm/ MHz
U-NII-3	√		30dBm/ 500kHz

4.5.2 Test Setup

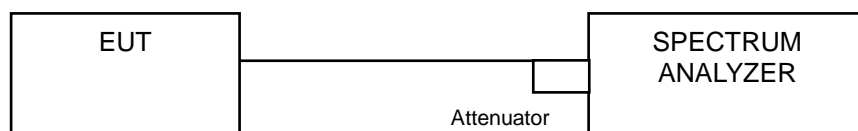

4.5.3 Test Instruments

Refer to section 4.1.2 to get information of above instrument.

4.5.4 Test Procedure

For U-NII-1:

Using method SA-2

1. Set span to encompass the entire emission bandwidth (EBW) of the signal.
2. Set RBW = 1 MHz, Set VBW ≥ 3 MHz, Detector = RMS
3. Sweep time = auto, trigger set to "free run".
4. Trace average at least 100 traces in power averaging mode.
5. Record the max value and add 10 log (1/duty cycle)

For U-NII-3:

1. Set span to encompass the entire emission bandwidth (EBW) of the signal.
2. Set RBW = 300 kHz, Set VBW ≥ 1 MHz, Detector = RMS
3. Use the peak marker function to determine the maximum power level in any 300 kHz band segment within the fundamental EBW.
4. Scale the observed power level to an equivalent value in 500 kHz by adjusting (reducing) the measured power by a bandwidth correction factor (BWCF) where $BWCF = 10\log(500\text{ kHz}/300\text{ kHz})$
5. Sweep time = auto, trigger set to "free run".
6. Trace average at least 100 traces in power averaging mode.
7. Record the max value and add 10 log (1/duty cycle)

4.5.5 Deviation from Test Standard

No deviation.

4.5.6 EUT Operating Condition

Same as Item 4.3.6.

4.5.7 Test Results

For U-NII-1:

802.11a

Chan.	Freq. (MHz)	PSD W/O Duty Factor (dBm)								Duty Factor (dB)	Total PSD With Duty Factor (dBm)	Max. Limit (dBm/MHz)	Pass / Fail
		Chain 0	Chain 1	Chain 2	Chain 3	Chain 4	Chain 5	Chain 6	Chain 7				
36	5180	1.89	1.05	3.46	1.97	1.55	2.44	3.22	2.66	0.52	11.38	13.30	Pass
40	5200	1.87	2.75	3.70	2.83	-0.29	3.82	1.73	1.27	0.52	11.42	13.30	Pass
48	5240	2.28	1.78	3.91	1.73	0.45	2.40	2.72	2.93	0.52	11.41	13.30	Pass

- Note:**
- Method a) of power density measurement of KDB 662911 is using for calculating total power density. Total power density is summing entire spectra across corresponding frequency bins on the various outputs by computer.
 - Directional gain = 9.7dBi > 6dBi, so the power density limit shall be reduced to $17-(9.7-6) = 13.30\text{dBm}$.
 - Refer to section 3.3 for duty cycle spectrum plot.

802.11ac (VHT20)

Chan.	Freq. (MHz)	PSD W/O Duty Factor (dBm)								Duty Factor (dB)	Total PSD With Duty Factor (dBm)	Max. Limit (dBm/MHz)	Pass / Fail
		Chain 0	Chain 1	Chain 2	Chain 3	Chain 4	Chain 5	Chain 6	Chain 7				
36	5180	3.08	1.80	4.35	1.93	2.05	2.95	3.63	3.26	0.17	11.99	13.30	Pass
40	5200	3.68	1.92	3.22	0.88	1.51	2.00	3.15	2.12	0.17	11.43	13.30	Pass
48	5240	2.80	2.02	4.53	1.65	2.10	3.13	3.39	3.53	0.17	12.02	13.30	Pass

- Note:**
- Method a) of power density measurement of KDB 662911 is using for calculating total power density. Total power density is summing entire spectra across corresponding frequency bins on the various outputs by computer.
 - Directional gain = 9.7dBi > 6dBi, so the power density limit shall be reduced to $17-(9.7-6) = 13.30\text{dBm}$.
 - Refer to section 3.3 for duty cycle spectrum plot.

802.11ac (VHT40)

Chan.	Freq. (MHz)	PSD W/O Duty Factor (dBm)								Duty Factor (dB)	Total PSD With Duty Factor (dBm)	Max. Limit (dBm/MHz)	Pass / Fail
		Chain 0	Chain 1	Chain 2	Chain 3	Chain 4	Chain 5	Chain 6	Chain 7				
38	5190	-4.78	-6.07	-2.40	-7.16	-5.03	-4.19	-4.04	-3.49	0.16	4.60	13.30	Pass
46	5230	-1.31	-1.00	1.29	-0.85	-0.57	0.21	-0.12	0.46	0.16	8.87	13.30	Pass

- Note:**
- Method a) of power density measurement of KDB 662911 is using for calculating total power density. Total power density is summing entire spectra across corresponding frequency bins on the various outputs by computer.
 - Directional gain = 9.7dBi > 6dBi, so the power density limit shall be reduced to $17-(9.7-6) = 13.30\text{dBm}$.
 - Refer to section 3.3 for duty cycle spectrum plot.

802.11ac (VHT80)

Chan.	Freq. (MHz)	PSD W/O Duty Factor (dBm)								Duty Factor (dB)	Total PSD With Duty Factor (dBm)	Max. Limit (dBm/MHz)	Pass / Fail
		Chain 0	Chain 1	Chain 2	Chain 3	Chain 4	Chain 5	Chain 6	Chain 7				
42	5210	-8.56	-9.75	-6.39	-8.49	-8.59	-6.86	-7.03	-7.90	0.16	1.21	13.30	Pass

- Note:**
- Method a) of power density measurement of KDB 662911 is using for calculating total power density. Total power density is summing entire spectra across corresponding frequency bins on the various outputs by computer.
 - Directional gain = 9.7dBi > 6dBi, so the power density limit shall be reduced to $17-(9.7-6) = 13.30\text{dBm}$.
 - Refer to section 3.3 for duty cycle spectrum plot.

802.11ac (VHT80+80)

Chan.	Freq. (MHz)	PSD W/O Duty Factor (dBm)								Duty Factor (dB)	Total PSD With Duty Factor (dBm)	Max. Limit (dBm/MHz)	Pass / Fail
		Chain 0	Chain 1	Chain 2	Chain 3	Chain 4	Chain 5	Chain 6	Chain 7				
42+155	5210	-	-	-	-	-7.23	-6.46	-6.77	-6.21	0.16	-0.63	13.30	Pass
	5775	Test results refer to U_NII-3 data											

- Note:**
- Method a) of power density measurement of KDB 662911 is using for calculating total power density. Total power density is summing entire spectra across corresponding frequency bins on the various outputs by computer.
 - Directional gain = 9.7dBi > 6dBi, so the power density limit shall be reduced to $17-(9.7-6) = 13.30\text{dBm}$.
 - Refer to section 3.3 for duty cycle spectrum plot.

802.11ax (HE20)

Chan.	Freq. (MHz)	PSD W/O Duty Factor (dBm)								Duty Factor (dB)	Total PSD With Duty Factor (dBm)	Max. Limit (dBm/MHz)	Pass / Fail
		Chain 0	Chain 1	Chain 2	Chain 3	Chain 4	Chain 5	Chain 6	Chain 7				
36	5180	2.57	2.24	3.68	2.40	2.51	3.71	2.75	4.13	0.16	12.08	13.30	Pass
40	5200	1.03	1.00	3.09	2.60	1.79	2.56	2.64	1.29	0.16	11.10	13.30	Pass
48	5240	2.62	2.42	4.29	2.69	2.22	3.73	3.66	3.58	0.16	12.24	13.30	Pass

- Note:**
- Method a) of power density measurement of KDB 662911 is using for calculating total power density. Total power density is summing entire spectra across corresponding frequency bins on the various outputs by computer.
 - Directional gain = 9.7dBi > 6dBi, so the power density limit shall be reduced to $17-(9.7-6) = 13.30\text{dBm}$.
 - Refer to section 3.3 for duty cycle spectrum plot.

802.11ax (HE40)

Chan.	Freq. (MHz)	PSD W/O Duty Factor (dBm)								Duty Factor (dB)	Total PSD With Duty Factor (dBm)	Max. Limit (dBm/MHz)	Pass / Fail
		Chain 0	Chain 1	Chain 2	Chain 3	Chain 4	Chain 5	Chain 6	Chain 7				
38	5190	-5.32	-5.36	-4.31	-4.91	-5.56	-4.40	-4.80	-4.44	0.18	4.17	13.30	Pass
46	5230	0.08	-1.18	0.84	-0.54	-1.41	0.67	0.14	0.67	0.18	9.01	13.30	Pass

- Note:**
- Method a) of power density measurement of KDB 662911 is using for calculating total power density. Total power density is summing entire spectra across corresponding frequency bins on the various outputs by computer.
 - Directional gain = 9.7dBi > 6dBi, so the power density limit shall be reduced to $17-(9.7-6) = 13.30\text{dBm}$.
 - Refer to section 3.3 for duty cycle spectrum plot.

802.11ax (HE80)

Chan.	Freq. (MHz)	PSD W/O Duty Factor (dBm)								Duty Factor (dB)	Total PSD With Duty Factor (dBm)	Max. Limit (dBm/MHz)	Pass / Fail
		Chain 0	Chain 1	Chain 2	Chain 3	Chain 4	Chain 5	Chain 6	Chain 7				
42	5210	-7.12	-8.05	-5.72	-7.42	-7.02	-6.37	-6.61	-6.65	0.16	2.21	13.30	Pass

- Note:**
- Method a) of power density measurement of KDB 662911 is using for calculating total power density. Total power density is summing entire spectra across corresponding frequency bins on the various outputs by computer.
 - Directional gain = 9.7dBi > 6dBi, so the power density limit shall be reduced to $17-(9.7-6) = 13.30\text{dBm}$.
 - Refer to section 3.3 for duty cycle spectrum plot.

802.11ax (HE80+80)

Chan.	Freq. (MHz)	PSD W/O Duty Factor (dBm)								Duty Factor (dB)	Total PSD With Duty Factor (dBm)	Max. Limit (dBm/MHz)	Pass / Fail
		Chain 0	Chain 1	Chain 2	Chain 3	Chain 4	Chain 5	Chain 6	Chain 7				
42+155	5210	-	-	-	-	-7.38	-6.09	-6.66	-5.80	0.16	-0.42	13.30	Pass
	5775	Test results refer to U_NII-3 data											

- Note:**
1. Method a) of power density measurement of KDB 662911 is using for calculating total power density. Total power density is summing entire spectra across corresponding frequency bins on the various outputs by computer.
 2. Directional gain = 9.7dBi > 6dBi, so the power density limit shall be reduced to $17-(9.7-6) = 13.30\text{dBm}$.
 3. Refer to section 3.3 for duty cycle spectrum plot.

Spectrum Plot of Worst Value

802.11a / Chain 2 : CH48

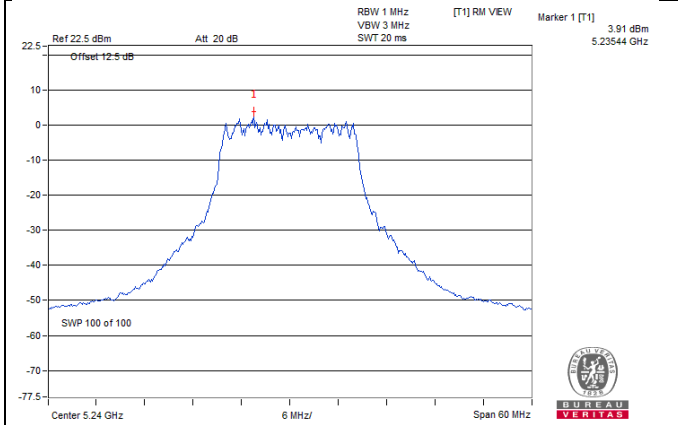

802.11ac (VHT20) / Chain 2 : CH48

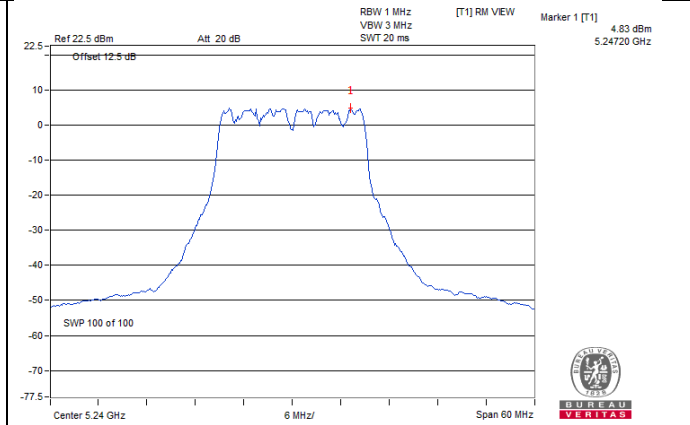

802.11ac (VHT40) / Chain 2: CH46

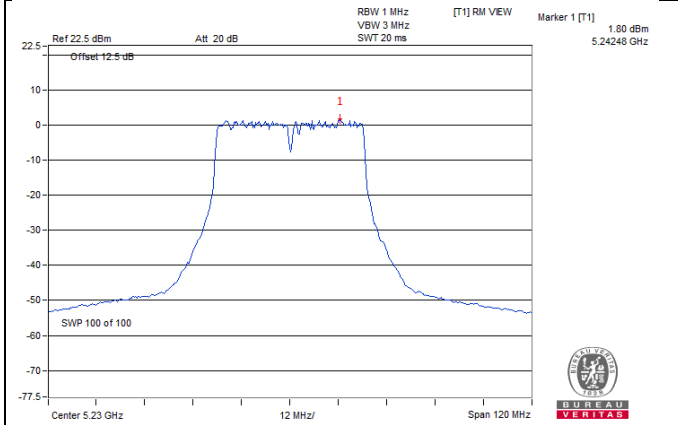

802.11ac (VHT80) / Chain 2 : CH42

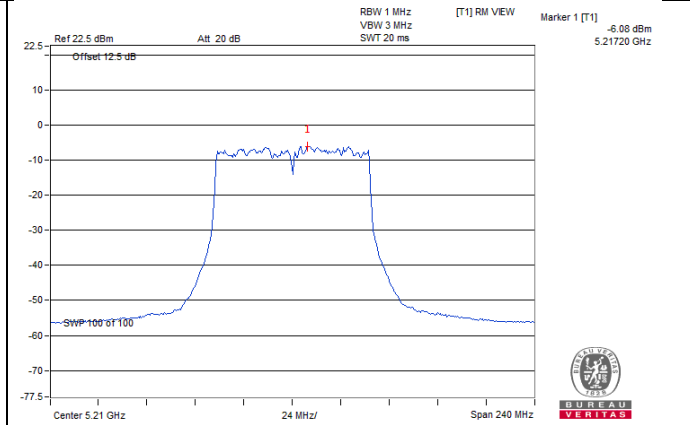

802.11ac (VHT80+80) / Chain 7: CH42

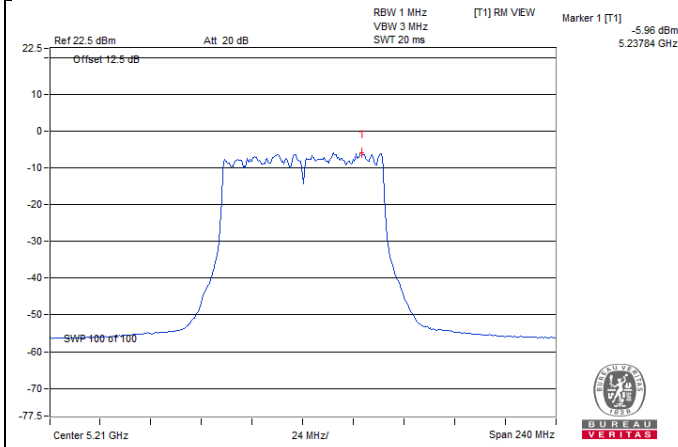

Spectrum Plot of Worst Value

802.11ax (HE20) / Chain 7 : CH36

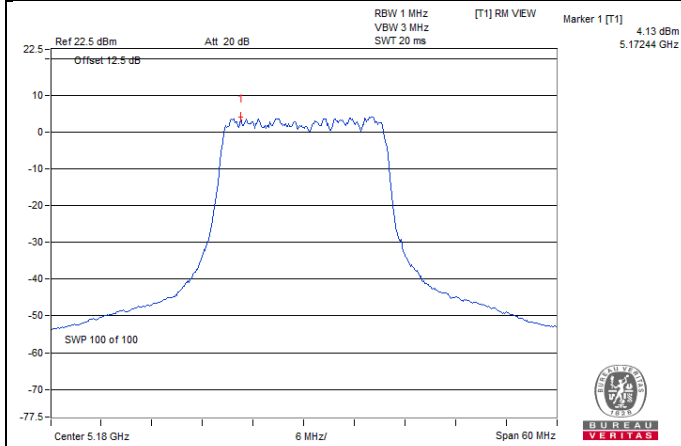

802.11ax (HE40) / Chain 2: CH46

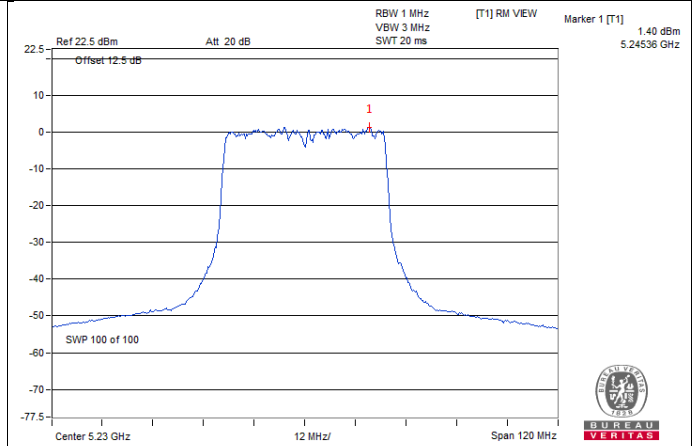

802.11ax (HE80) / Chain 2 : CH42

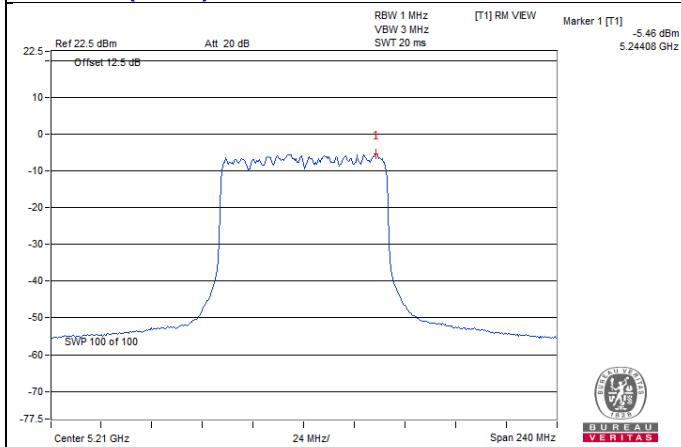

802.11ax (HE80+80) / Chain 7: CH42

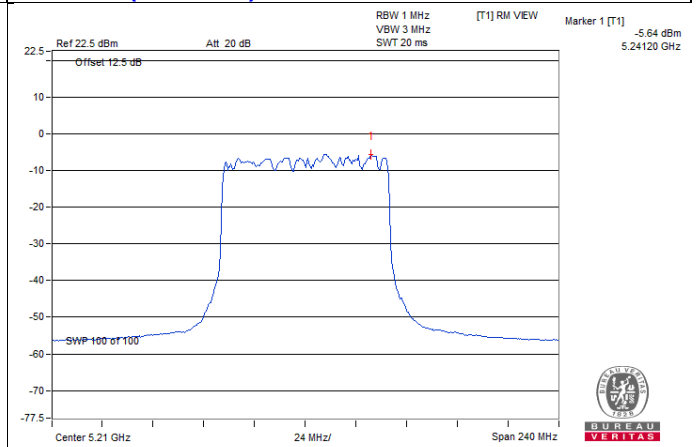

For U-NII-3:

802.11a

Chan.	Freq. (MHz)	PSD W/O Duty Factor (dBm/300kHz)								Duty Factor (dB)	Total PSD With Duty Factor		Total PSD With Duty Factor (dBm/500kHz)	Limit (dBm/500kHz)	Pass /Fail
		Chain 0	Chain 1	Chain 2	Chain 3	Chain 4	Chain 5	Chain 6	Chain 7		mW/300 kHz	dBm/300 kHz			
149	5745	-8.21	-7.81	-9.73	-13.26	-7.26	-6.94	-6.21	-7.06	0.52	1.29656	1.13	3.35	25.73	Pass
157	5785	-8.93	-8.56	-7.81	-9.36	-8.16	-8.57	-7.03	-8.60	0.52	1.1767	0.71	2.93	25.73	Pass
165	5825	-8.65	-9.95	-7.27	-9.12	-9.18	-7.65	-6.89	-7.50	0.52	1.2226	0.87	3.09	25.73	Pass

- Note: 1. Method b) Measure and sum spectral maxima across the outputs of KDB 662911 is using for calculating total power density.
 2. Directional gain = 10.27dBi > 6dBi, so the power density limit shall be reduced to 30-(10.27-6) = 25.73dBm.
 3. Refer to section 3.3 for duty cycle spectrum plot.

802.11ac (VHT20)

Chan.	Freq. (MHz)	PSD W/O Duty Factor (dBm/300kHz)								Duty Factor (dB)	Total PSD With Duty Factor		Total PSD With Duty Factor (dBm/500kHz)	Limit (dBm/500kHz)	Pass /Fail
		Chain 0	Chain 1	Chain 2	Chain 3	Chain 4	Chain 5	Chain 6	Chain 7		mW/300 kHz	dBm/300 kHz			
149	5745	-6.83	-5.07	-5.10	-6.30	-5.34	-4.59	-4.41	-4.72	0.17	2.4016	3.81	6.03	25.73	Pass
157	5785	-7.09	-6.02	-6.06	-7.34	-5.81	-5.97	-4.33	-5.67	0.17	2.0331	3.08	5.30	25.73	Pass
165	5825	-6.01	-5.91	-4.20	-7.40	-6.84	-6.00	-3.83	-6.12	0.17	2.1858	3.40	5.62	25.73	Pass

- Note: 1. Method b) Measure and sum spectral maxima across the outputs of KDB 662911 is using for calculating total power density.
 2. Directional gain = 10.27dBi > 6dBi, so the power density limit shall be reduced to 30-(10.27-6) = 25.73dBm.
 3. Refer to section 3.3 for duty cycle spectrum plot.

802.11ac (VHT40)

Chan.	Freq. (MHz)	PSD W/O Duty Factor (dBm/300kHz)								Duty Factor (dB)	Total PSD With Duty Factor		Total PSD With Duty Factor (dBm/500kHz)	Limit (dBm/500kHz)	Pass /Fail
		Chain 0	Chain 1	Chain 2	Chain 3	Chain 4	Chain 5	Chain 6	Chain 7		mW/300 kHz	dBm/300 kHz			
151	5755	-12.37	-11.64	-9.86	-12.09	-13.73	-9.74	-10.38	-10.23	0.16	0.62657	-2.03	0.19	25.73	Pass
159	5795	-13.86	-12.92	-11.16	-13.91	-12.93	-11.96	-11.53	-12.81	0.16	0.44665	-3.50	-1.28	25.73	Pass

- Note: 1. Method b) Measure and sum spectral maxima across the outputs of KDB 662911 is using for calculating total power density.
 2. Directional gain = 10.27dBi > 6dBi, so the power density limit shall be reduced to 30-(10.27-6) = 25.73dBm.
 3. Refer to section 3.3 for duty cycle spectrum plot.

802.11ac (VHT80)

Chan.	Freq. (MHz)	PSD W/O Duty Factor (dBm/300kHz)								Duty Factor (dB)	Total PSD With Duty Factor		Total PSD With Duty Factor (dBm/500kHz)	Limit (dBm/500kHz)	Pass /Fail
		Chain 0	Chain 1	Chain 2	Chain 3	Chain 4	Chain 5	Chain 6	Chain 7		mW/300 kHz	dBm/300 kHz			
155	5775	-15.39	-14.28	-14.61	-15.03	-15.28	-13.93	-13.25	-15.07	0.16	0.28077	-5.52	-3.30	25.73	Pass

- Note: 1. Method b) Measure and sum spectral maxima across the outputs of KDB 662911 is using for calculating total power density.
 2. Directional gain = 10.27dBi > 6dBi, so the power density limit shall be reduced to 30-(10.27-6) = 25.73dBm.
 3. Refer to section 3.3 for duty cycle spectrum plot.

802.11ac (VHT80+80)

Chan.	Freq. (MHz)	PSD W/O Duty Factor (dBm/300kHz)								Duty Factor (dB)	Total PSD With Duty Factor		Total PSD With Duty Factor (dBm/500kHz)	Limit (dBm/500kHz)	Pass /Fail	
		Chain 0	Chain 1	Chain 2	Chain 3	Chain 4	Chain 5	Chain 6	Chain 7		mW/300 kHz	dBm/300 kHz				
42	5210	Test results refer to U_NII-1 data														
155	5775	-16.15	-15.81	-14.68	-13.98	-	-	-	-	0.16	0.12454	-9.05	-6.83	25.73	Pass	

- Note: 1. Method b) Measure and sum spectral maxima across the outputs of KDB 662911 is using for calculating total power density.
 2. Directional gain = 10.27dBi > 6dBi, so the power density limit shall be reduced to 30-(10.27-6) = 25.73dBm.
 3. Refer to section 3.3 for duty cycle spectrum plot.

802.11ax (HE20)

Chan.	Freq. (MHz)	PSD W/O Duty Factor (dBm/300kHz)								Duty Factor (dB)	Total PSD With Duty Factor		Total PSD With Duty Factor (dBm/500kHz)	Limit (dBm/500kHz)	Pass /Fail
		Chain 0	Chain 1	Chain 2	Chain 3	Chain 4	Chain 5	Chain 6	Chain 7		mW/300 kHz	dBm/300 kHz			
149	5745	-7.31	-5.90	-5.92	-6.27	-6.65	-5.09	-5.51	-7.20	0.16	1.9325	2.86	5.08	25.73	Pass
157	5785	-7.38	-7.25	-6.69	-6.27	-7.12	-4.53	-5.78	-6.97	0.16	1.8331	2.63	4.85	25.73	Pass
165	5825	-7.32	-5.91	-5.24	-7.02	-7.74	-5.42	-4.66	-4.75	0.16	2.0719	3.16	5.38	25.73	Pass

- Note: 1. Method b) Measure and sum spectral maxima across the outputs of KDB 662911 is using for calculating total power density.
 2. Directional gain = 10.27dBi > 6dBi, so the power density limit shall be reduced to 30-(10.27-6) = 25.73dBm.
 3. Refer to section 3.3 for duty cycle spectrum plot.

802.11ax (HE40)

Chan.	Freq. (MHz)	PSD W/O Duty Factor (dBm/300kHz)								Duty Factor (dB)	Total PSD With Duty Factor		Total PSD With Duty Factor (dBm/500kHz)	Limit (dBm/500kHz)	Pass /Fail
		Chain 0	Chain 1	Chain 2	Chain 3	Chain 4	Chain 5	Chain 6	Chain 7		mW/300 kHz	dBm/300 kHz			
151	5755	-13.56	-12.22	-12.29	-12.89	-13.07	-11.90	-11.40	-13.10	0.18	0.44976	-3.47	-1.25	25.73	Pass
159	5795	-14.20	-12.25	-11.23	-12.64	-11.39	-11.72	-12.58	-13.02	0.18	0.47238	-3.26	-1.04	25.73	Pass

- Note: 1. Method b) Measure and sum spectral maxima across the outputs of KDB 662911 is using for calculating total power density.
 2. Directional gain = 10.27dBi > 6dBi, so the power density limit shall be reduced to 30-(10.27-6) = 25.73dBm.
 3. Refer to section 3.3 for duty cycle spectrum plot.

802.11ax (HE80)

Chan.	Freq. (MHz)	PSD W/O Duty Factor (dBm/300kHz)								Duty Factor (dB)	Total PSD With Duty Factor		Total PSD With Duty Factor (dBm/500kHz)	Limit (dBm/500kHz)	Pass /Fail
		Chain 0	Chain 1	Chain 2	Chain 3	Chain 4	Chain 5	Chain 6	Chain 7		mW/300 kHz	dBm/300 kHz			
155	5775	-15.76	-16.20	-14.78	-15.46	-16.55	-15.37	-14.57	-14.34	0.16	0.23514	-6.29	-4.07	25.73	Pass

- Note: 1. Method b) Measure and sum spectral maxima across the outputs of KDB 662911 is using for calculating total power density.
 2. Directional gain = 10.27dBi > 6dBi, so the power density limit shall be reduced to 30-(10.27-6) = 25.73dBm.
 3. Refer to section 3.3 for duty cycle spectrum plot.

802.11ax (HE80+80)

Chan.	Freq. (MHz)	PSD W/O Duty Factor (dBm/300kHz)								Duty Factor (dB)	Total PSD With Duty Factor		Total PSD With Duty Factor (dBm/500kHz)	Limit (dBm/500kHz)	Pass /Fail	
		Chain 0	Chain 1	Chain 2	Chain 3	Chain 4	Chain 5	Chain 6	Chain 7		mW/300 kHz	dBm/300 kHz				
42	5210	Test results refer to U_NII-1 data														
155	5775	-17.00	-15.12	-13.44	-13.98	-	-	-	-	0.16	0.136	-8.66	-6.44	25.73	Pass	

- Note:
- Method b) Measure and sum spectral maxima across the outputs of KDB 662911 is using for calculating total power density.
 - Directional gain = 10.27dBi > 6dBi, so the power density limit shall be reduced to $30 - (10.27 - 6) = 25.73\text{dBm}$.
 - Refer to section 3.3 for duty cycle spectrum plot.

Spectrum Plot of Worst Value

802.11a / Chain 6 : CH149

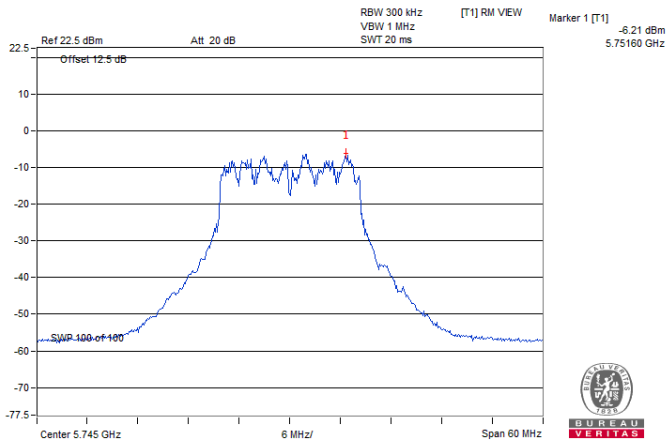

802.11ac (VHT20) / Chain 6 : CH165

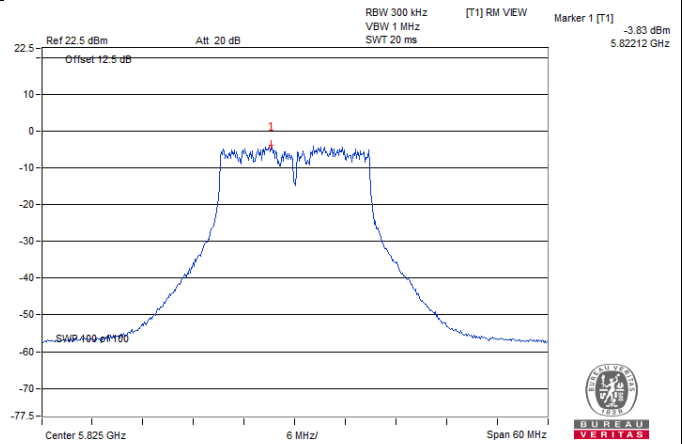

802.11ac (VHT40) / Chain 5: CH151

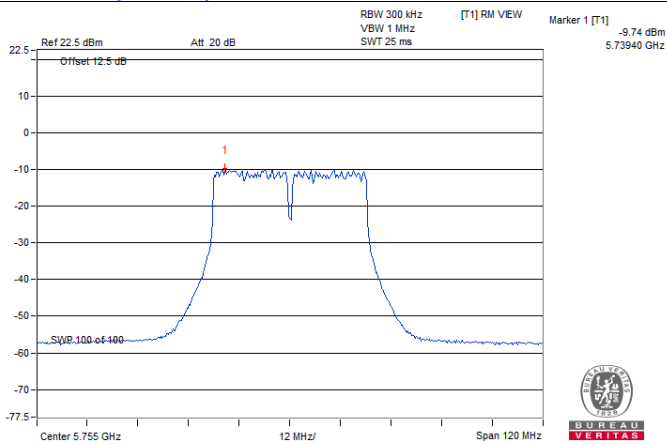

802.11ac (VHT80) / Chain 6 : CH155

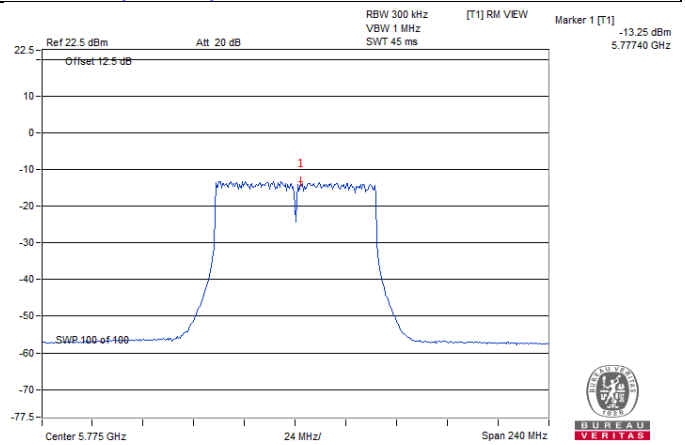

802.11ac (VHT80+80) / Chain 3: CH155

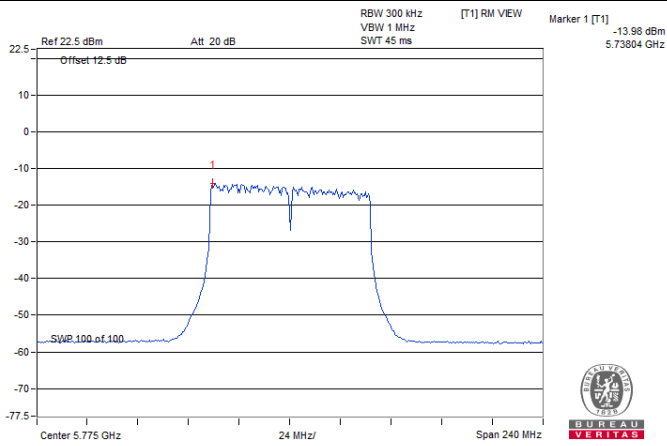

Spectrum Plot of Worst Value

802.11ax (HE20) / Chain 5 : CH157

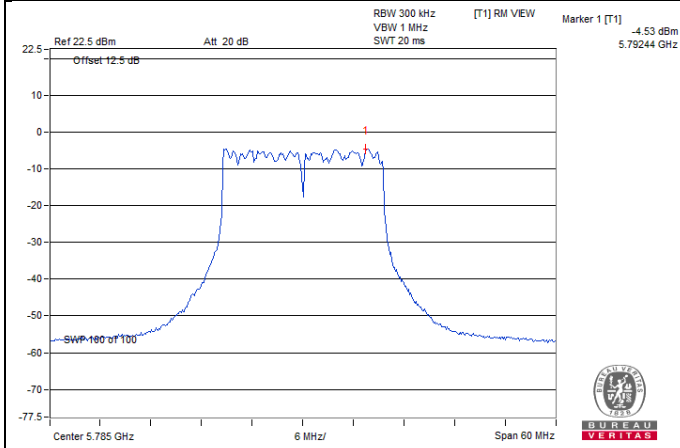

802.11ax (HE40) / Chain 2: CH159

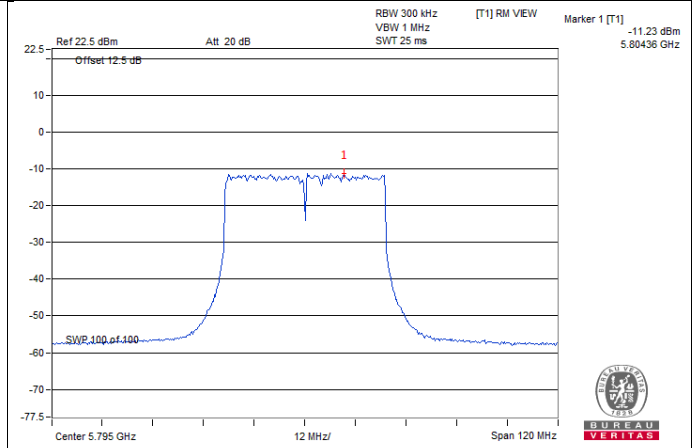

802.11ax (HE80) / Chain 7 : CH155

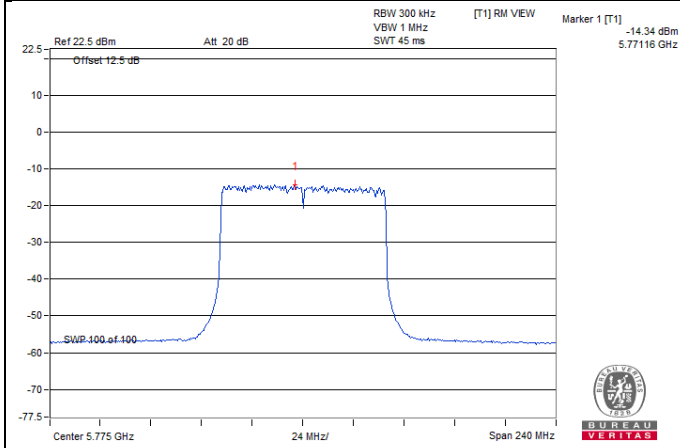

802.11ax (HE80+80) / Chain 2: CH155

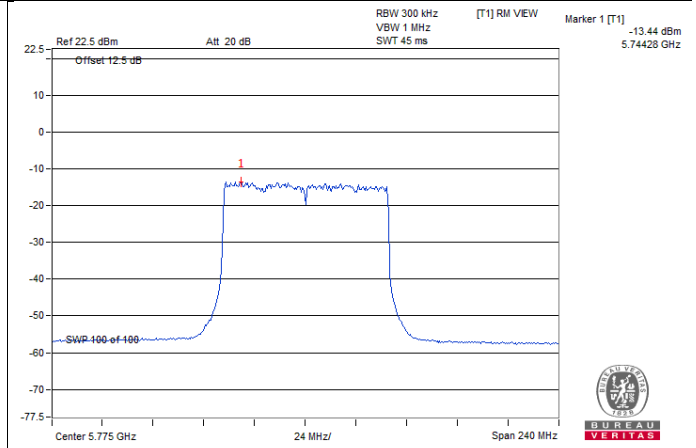

4.6 Frequency Stability Measurement

4.6.1 Limits of Frequency Stability Measurement

The frequency of the carrier signal shall be maintained within band of operation

4.6.2 Test Setup

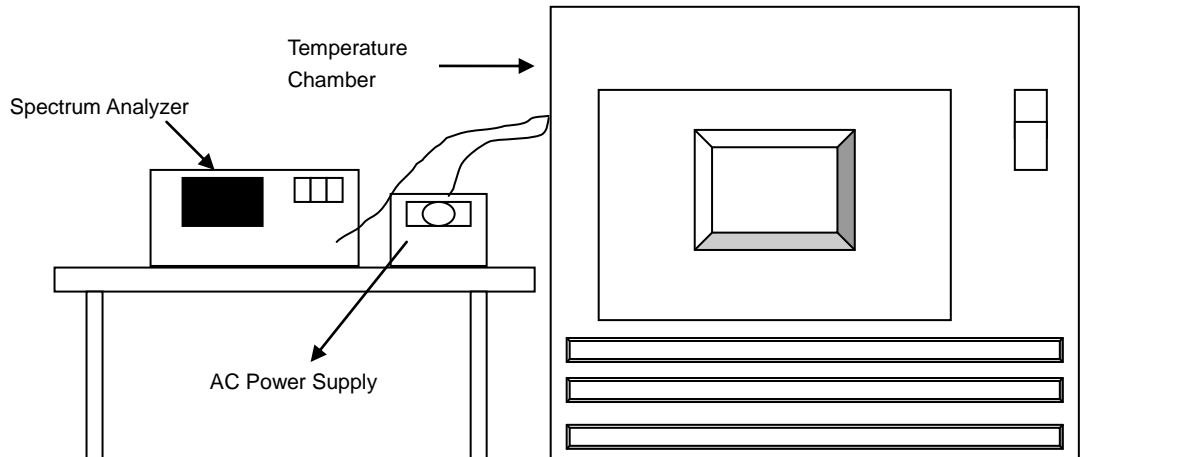

4.6.3 Test Instruments

Refer to section 4.1.2 to get information of above instrument.

4.6.4 Test Procedure

- The EUT was placed inside the environmental test chamber and powered by nominal AC voltage.
- Turn the EUT on and couple its output to a spectrum analyzer.
- Turn the EUT off and set the chamber to the highest temperature specified.
- Allow sufficient time (approximately 30 min) for the temperature of the chamber to stabilize, turn the EUT on and measure the operating frequency after 2, 5, and 10 Minutes.
- Repeat step 2 and 3 with the temperature chamber set to the lowest temperature.
- The test chamber was allowed to stabilize at +20 degree C for a minimum of 30 Minutes. The supply voltage was then adjusted on the EUT from 85% to 115% and the frequency record.

4.6.5 Deviation from Test Standard

No deviation.

4.6.6 EUT Operating Condition

Set the EUT transmit at un-modulation mode to test frequency stability.

4.6.7 Test Results

Frequency Stability Versus Temp.									
Operating Frequency: 5180 MHz									
TEMP. (°C)	Power Supply (Vac)	0 Minute		2 Minutes		5 Minutes		10 Minutes	
		Measured Frequency (MHz)	Pass/Fail	Measured Frequency (MHz)	Pass/Fail	Measured Frequency (MHz)	Pass/Fail	Measured Frequency (MHz)	Pass/Fail
50	120	5180.015	PASS	5180.0161	PASS	5180.017	PASS	5180.0151	PASS
40	120	5179.9876	PASS	5179.9841	PASS	5179.9859	PASS	5179.9861	PASS
30	120	5179.999	PASS	5179.9997	PASS	5179.9988	PASS	5179.9983	PASS
20	120	5180.0163	PASS	5180.014	PASS	5180.0179	PASS	5180.017	PASS
10	120	5180.0097	PASS	5180.012	PASS	5180.0071	PASS	5180.0089	PASS
0	120	5180.0152	PASS	5180.0172	PASS	5180.0147	PASS	5180.0165	PASS
-10	120	5179.9797	PASS	5179.984	PASS	5179.9799	PASS	5179.9824	PASS
-20	120	5179.9906	PASS	5179.9871	PASS	5179.9877	PASS	5179.9915	PASS
-30	120	5179.9803	PASS	5179.9832	PASS	5179.9814	PASS	5179.9847	PASS

Frequency Stability Versus Voltage									
Operating Frequency: 5180 MHz									
TEMP. (°C)	Power Supply (Vac)	0 Minute		2 Minutes		5 Minutes		10 Minutes	
		Measured Frequency (MHz)	Pass/Fail	Measured Frequency (MHz)	Pass/Fail	Measured Frequency (MHz)	Pass/Fail	Measured Frequency (MHz)	Pass/Fail
20	138	5180.0158	PASS	5180.0141	PASS	5180.0175	PASS	5180.0163	PASS
	120	5180.0163	PASS	5180.014	PASS	5180.0179	PASS	5180.017	PASS
	102	5180.0172	PASS	5180.0136	PASS	5180.0185	PASS	5180.0165	PASS

4.7 6dB Bandwidth Measurement

4.7.1 Limits of 6dB Bandwidth Measurement

The minimum of 6dB Bandwidth Measurement is 0.5MHz.

4.7.2 Test Setup

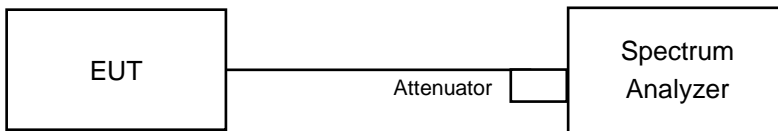

4.7.3 Test Instruments

Refer to section 4.1.2 to get information of above instrument.

4.7.4 Test Procedure

MEASUREMENT PROCEDURE REF

- a. Set resolution bandwidth (RBW) = 100kHz
- b. Set the video bandwidth (VBW) $\geq 3 \times$ RBW, Detector = Peak.
- c. Trace mode = max hold.
- d. Sweep = auto couple.
- e. Measure the maximum width of the emission that is constrained by the frequencies associated with the two amplitude points (upper and lower) that are attenuated by 6 dB relative to the maximum level measured in the fundamental emission

4.7.5 Deviation from Test Standard

No deviation.

4.7.6 EUT Operating Condition

The software provided by client to enable the EUT under transmission condition continuously at lowest, middle and highest channel frequencies individually.

4.7.7 Test Results

802.11a

Channel	Frequency (MHz)	6dB Bandwidth (MHz)								Minimum Limit (MHz)	Pass / Fail
		Chain 0	Chain 1	Chain 2	Chain 3	Chain 4	Chain 5	Chain 6	Chain 7		
149	5745	16.41	16.42	16.03	16.43	16.44	16.42	16.42	16.42	0.5	PASS
157	5785	16.45	16.43	16.42	16.44	16.44	16.43	16.46	16.41	0.5	PASS
165	5825	16.39	16.42	16.43	16.44	16.33	16.41	16.42	16.45	0.5	PASS

802.11ac (VHT20)

Channel	Frequency (MHz)	6dB Bandwidth (MHz)								Minimum Limit (MHz)	Pass / Fail
		Chain 0	Chain 1	Chain 2	Chain 3	Chain 4	Chain 5	Chain 6	Chain 7		
149	5745	17.63	17.69	17.69	17.65	17.72	17.68	17.67	17.70	0.5	PASS
157	5785	17.65	17.64	17.65	17.67	17.72	17.34	17.66	17.62	0.5	PASS
165	5825	17.63	17.65	17.63	17.65	17.61	17.59	17.63	17.59	0.5	PASS

802.11ac (VHT40)

Channel	Frequency (MHz)	6dB Bandwidth (MHz)								Minimum Limit (MHz)	Pass / Fail
		Chain 0	Chain 1	Chain 2	Chain 3	Chain 4	Chain 5	Chain 6	Chain 7		
151	5755	36.47	36.48	36.55	36.48	34.16	36.57	36.45	36.45	0.5	PASS
159	5795	36.42	36.52	36.58	36.17	36.43	36.44	36.44	36.19	0.5	PASS

802.11ac (VHT80)

Channel	Frequency (MHz)	6dB Bandwidth (MHz)								Minimum Limit (MHz)	Pass / Fail
		Chain 0	Chain 1	Chain 2	Chain 3	Chain 4	Chain 5	Chain 6	Chain 7		
155	5775	76.18	76.57	76.49	76.01	76.41	76.57	76.56	75.95	0.5	PASS

802.11ac (VHT80+80)

Channel	Frequency (MHz)	6dB Bandwidth (MHz)								Minimum Limit (MHz)	Pass / Fail
		Chain 0	Chain 1	Chain 2	Chain 3	Chain 4	Chain 5	Chain 6	Chain 7		
42+155	5210	-									
	5775	76.56	76.44	76.01	75.13	-	-	-	-	0.5	PASS

802.11ax (HE20)

Channel	Frequency (MHz)	6dB Bandwidth (MHz)								Minimum Limit (MHz)	Pass / Fail
		Chain 0	Chain 1	Chain 2	Chain 3	Chain 4	Chain 5	Chain 6	Chain 7		
149	5745	19.09	19.09	19.07	19.08	19.04	19.06	19.05	18.85	0.5	PASS
157	5785	19.13	19.02	18.96	19.09	19.07	19.15	19.04	18.96	0.5	PASS
165	5825	19.06	19.04	19.11	19.06	18.90	19.08	19.06	19.14	0.5	PASS

802.11ax (HE40)

Channel	Frequency (MHz)	6dB Bandwidth (MHz)								Minimum Limit (MHz)	Pass / Fail
		Chain 0	Chain 1	Chain 2	Chain 3	Chain 4	Chain 5	Chain 6	Chain 7		
151	5755	38.34	38.21	38.09	38.33	38.18	38.19	38.34	38.17	0.5	PASS
159	5795	38.11	38.28	38.33	38.22	38.35	38.33	38.07	38.02	0.5	PASS

802.11ax (HE80)

Channel	Frequency (MHz)	6dB Bandwidth (MHz)								Minimum Limit (MHz)	Pass / Fail
		Chain 0	Chain 1	Chain 2	Chain 3	Chain 4	Chain 5	Chain 6	Chain 7		
155	5775	78.45	78.16	78.38	78.31	78.11	78.40	78.30	78.36	0.5	PASS

802.11ax (HE80+80)

Channel	Frequency (MHz)	6dB Bandwidth (MHz)								Minimum Limit (MHz)	Pass / Fail
		Chain 0	Chain 1	Chain 2	Chain 3	Chain 4	Chain 5	Chain 6	Chain 7		
42+155	5210	-									
	5775	78.13	78.36	78.30	78.39	-	-	-	-	0.5	PASS

Spectrum Plot of Worst Value

802.11a / Chain 2: CH149

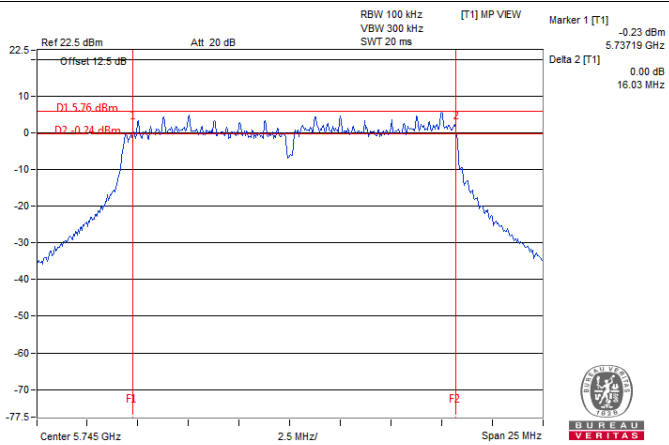

802.11ac (VHT20) / Chain 5: CH157

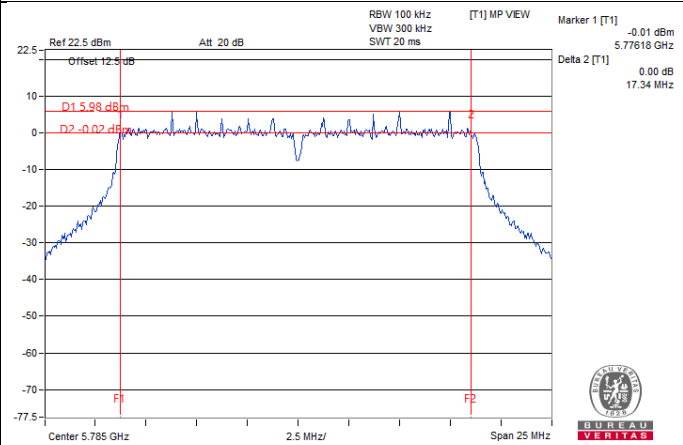

802.11ac (VHT40) / Chain 4: CH151

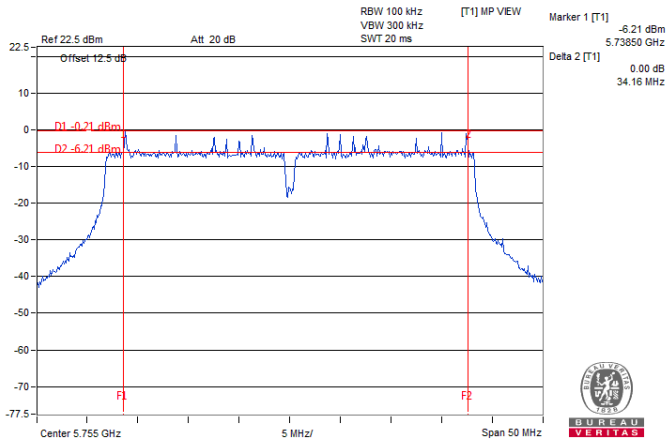

802.11ac (VHT80) / Chain 7: CH155

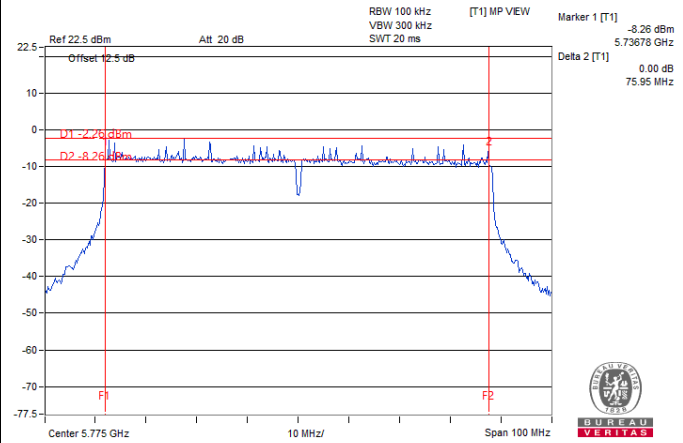

802.11ac (VHT80+80) / Chain 3: CH155

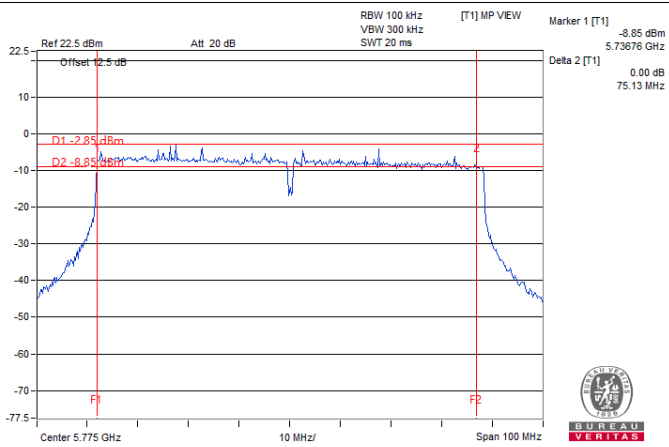

Spectrum Plot of Worst Value

802.11ax (HE20) / Chain 7: CH149

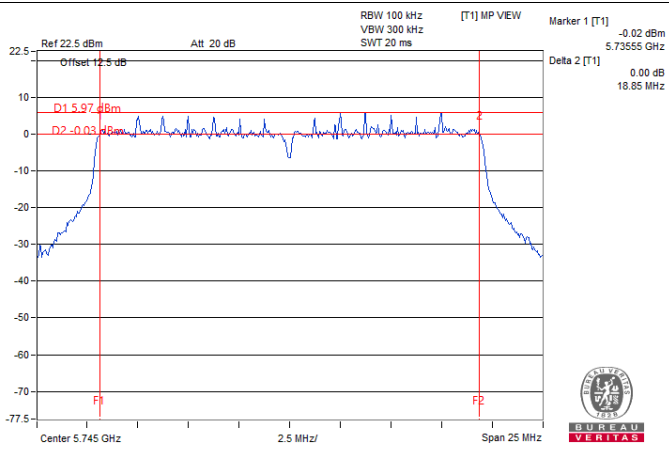

802.11ax (HE40) / Chain 7: CH159

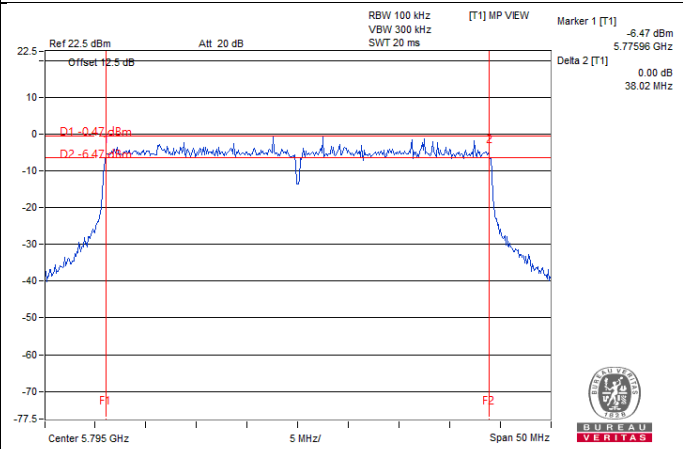

802.11ax (HE80) / Chain 4: CH155

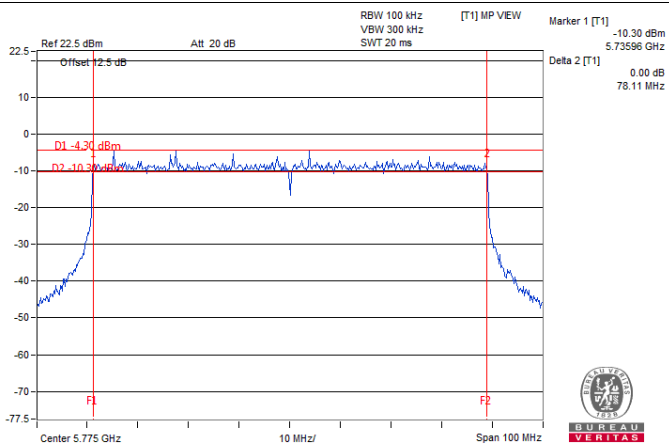

802.11ax (HE80+80) / Chain 0: CH155

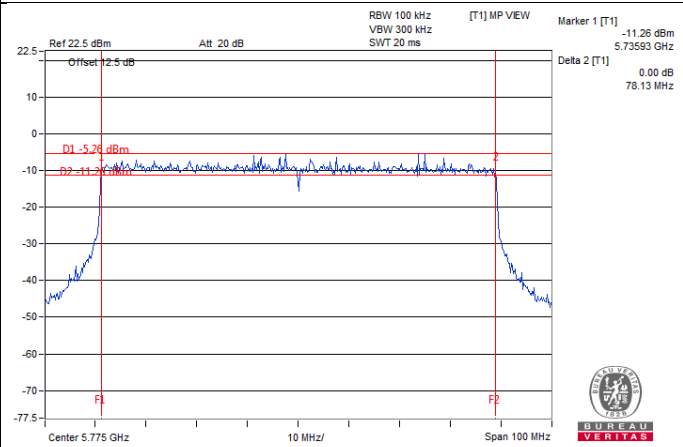

5 Pictures of Test Arrangements

Please refer to the attached file (Test Setup Photo).

Annex A- Radiated Out of Band Emission (OOBE) Measurement (For U-NII-3 band)

802.11a

CH 149 5745 MHz

Horizontal

Vertical

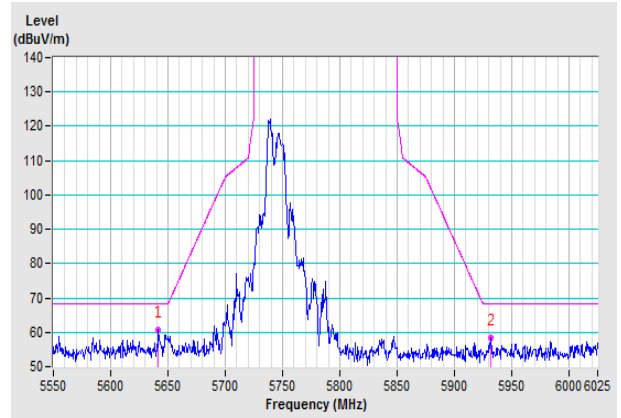
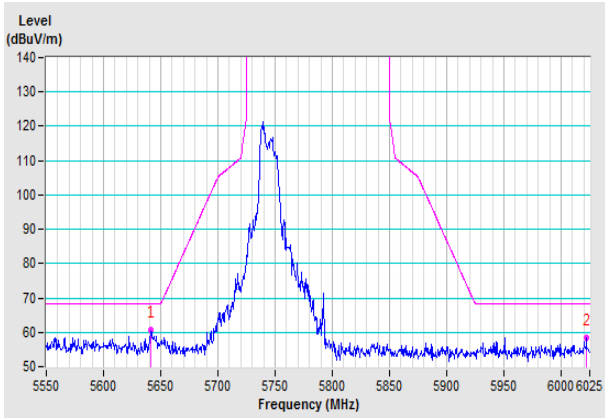

CH 157 5785 MHz

Horizontal

Vertical

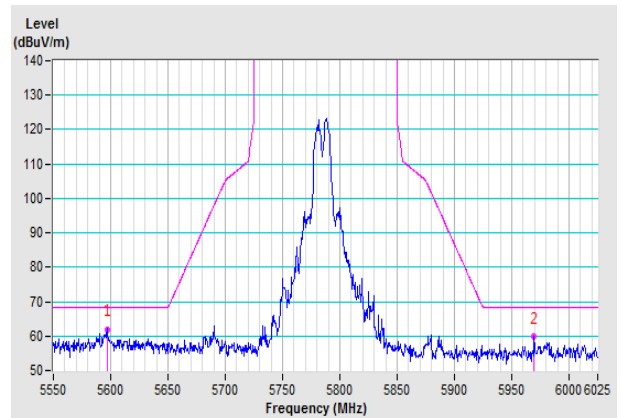
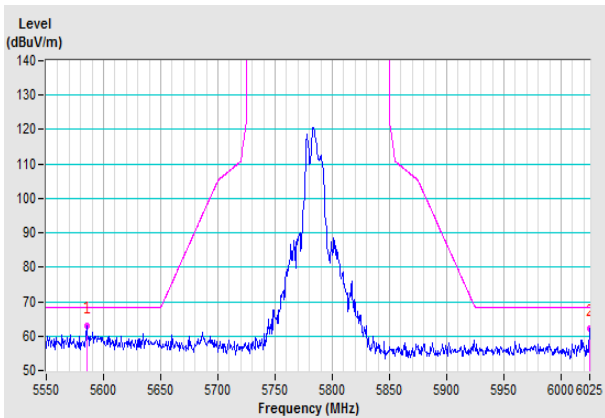

CH 165 5825 MHz

Horizontal

Vertical

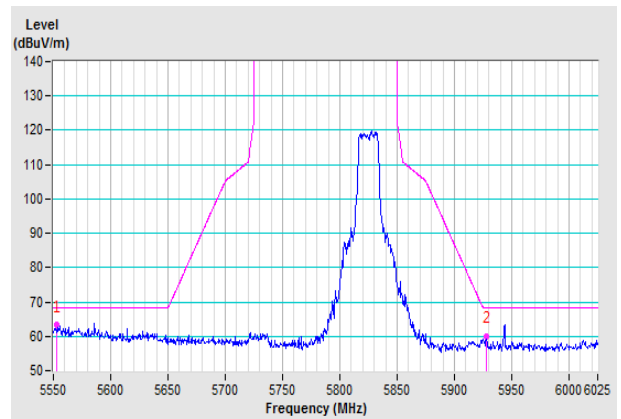
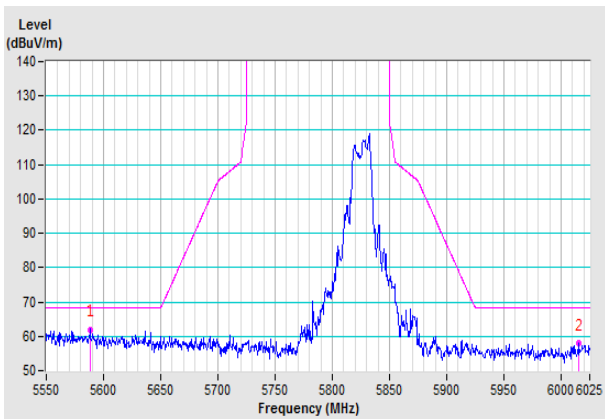

802.11ac (VHT20)

CH 149 5745 MHz

Horizontal

Vertical

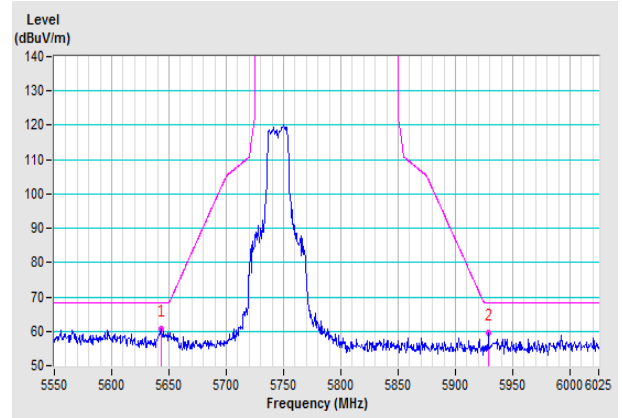
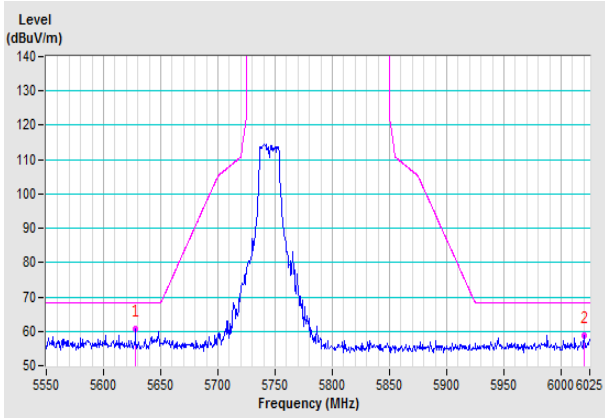

CH 157 5785 MHz

Horizontal

Vertical

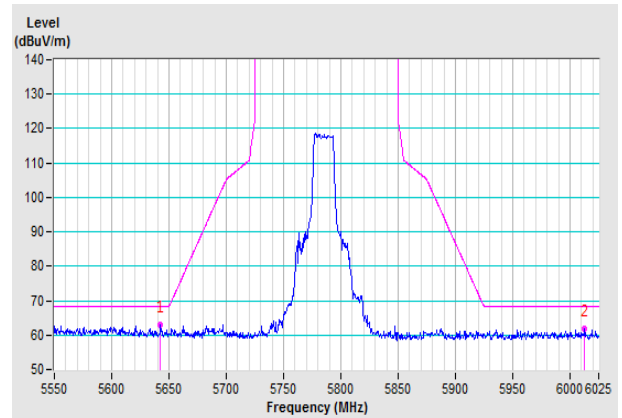
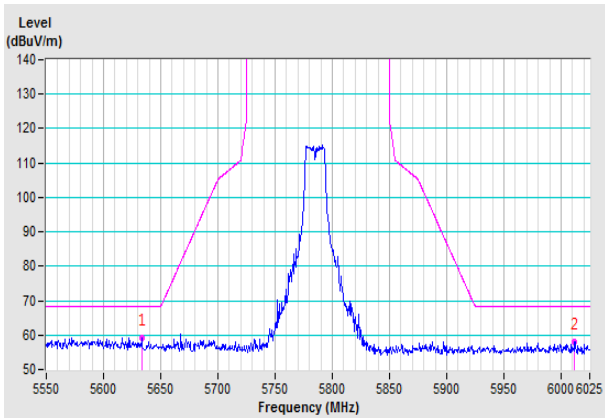

CH 165 5825 MHz

Horizontal

Vertical

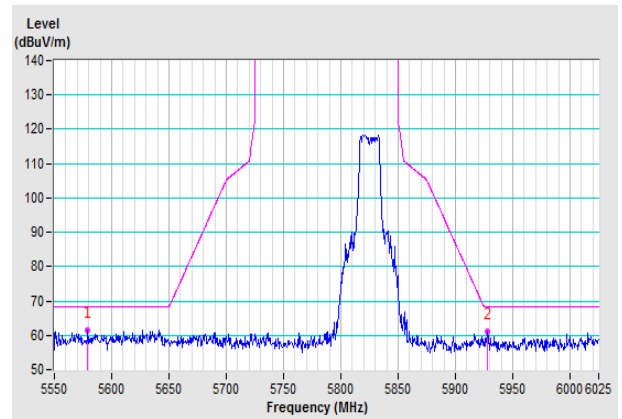
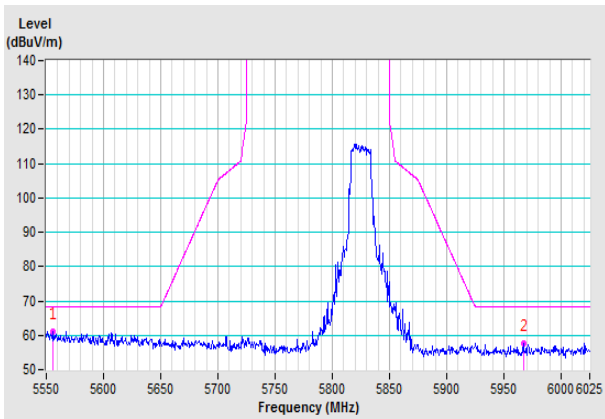

802.11ac (VHT40)

CH 151 5755 MHz

Horizontal

Vertical

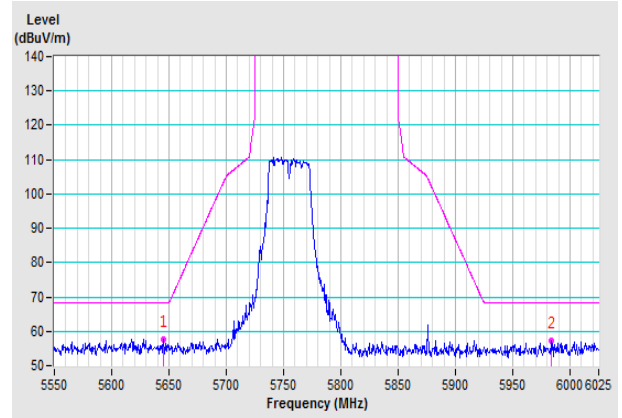
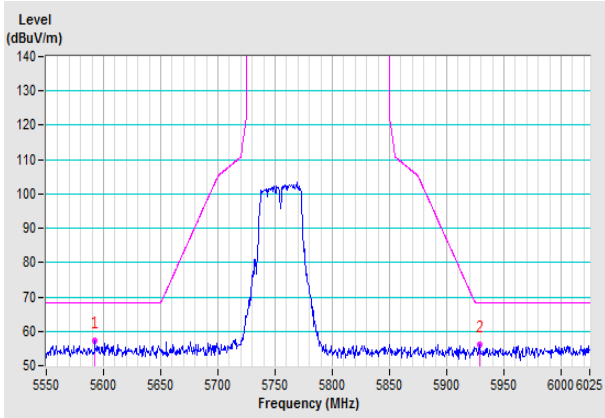

CH 159 5795 MHz

Horizontal

Vertical

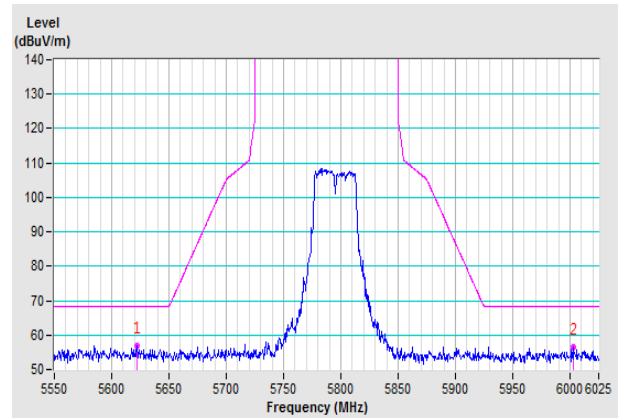
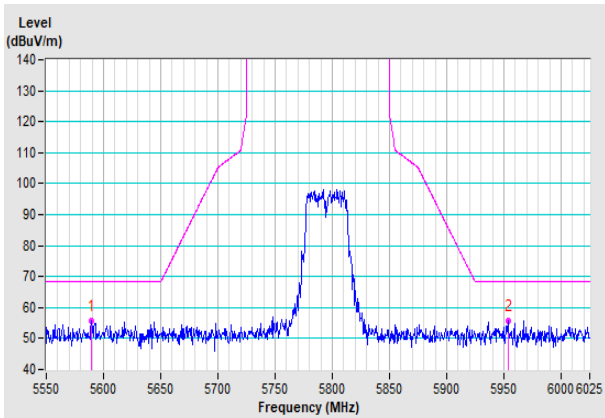

802.11ac (VHT80)

CH 155 5775 MHz

Horizontal

Vertical

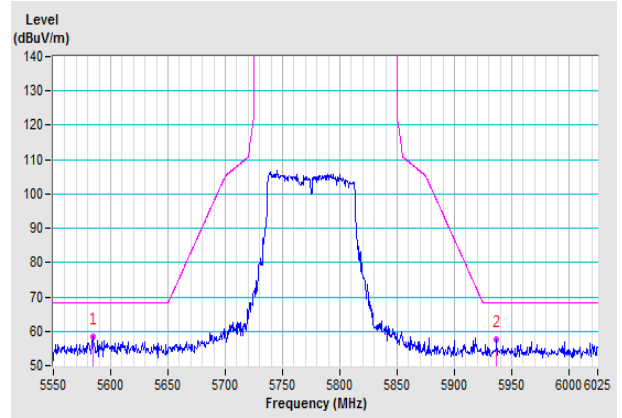
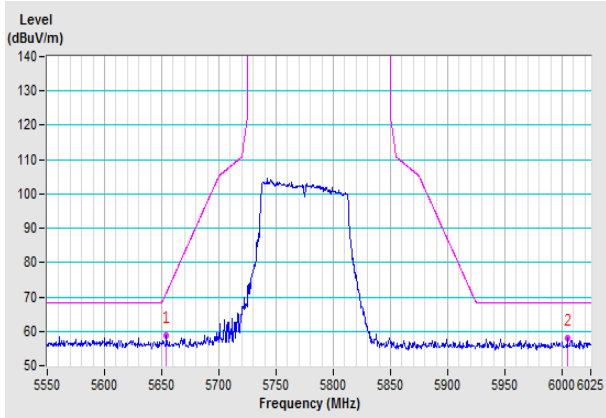

802.11ac (VHT80+80)

CH 42 +155 5210+5775 MHz

Horizontal

Vertical

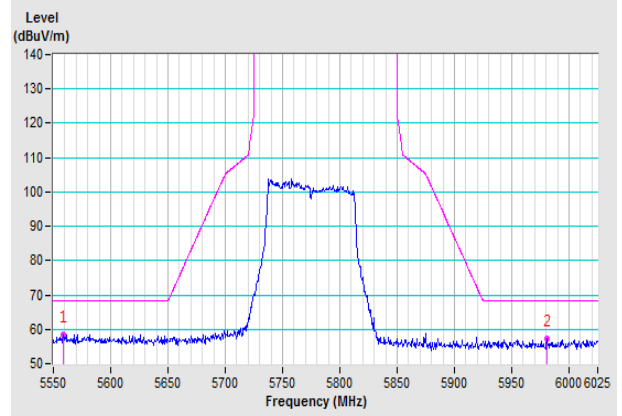
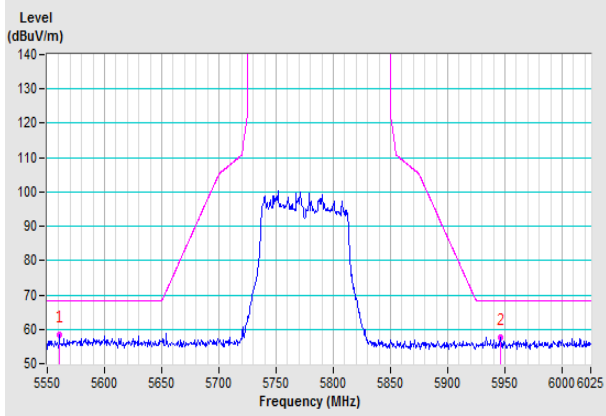

802.11ax (HE20)

CH 149 5745 MHz

Horizontal

Vertical

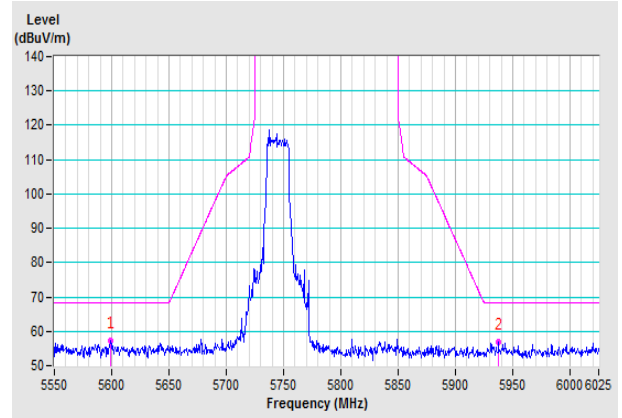
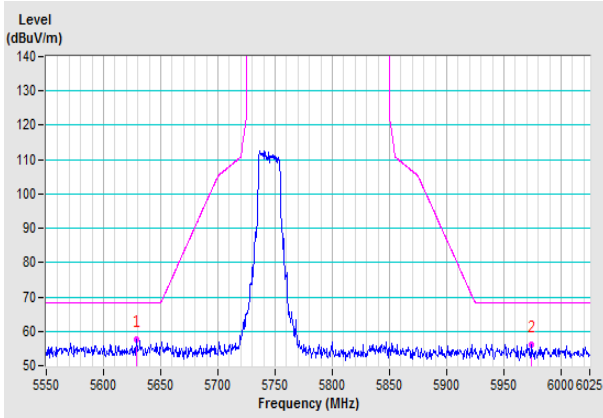

CH 157 5785 MHz

Horizontal

Vertical

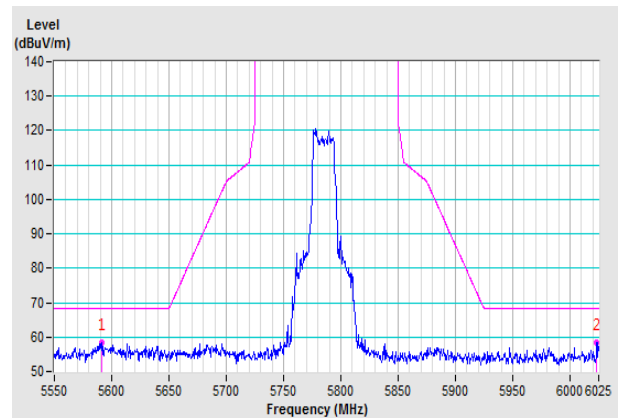
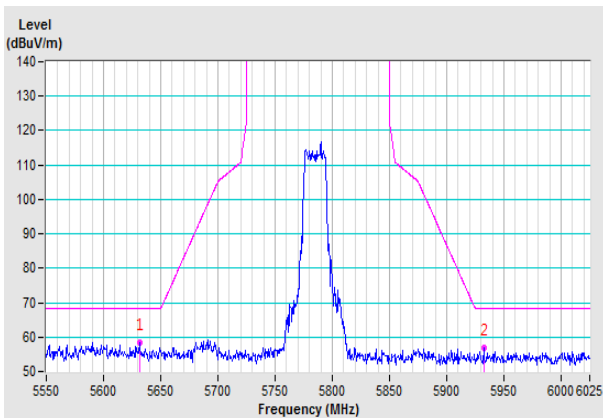

CH 165 5825 MHz

Horizontal

Vertical

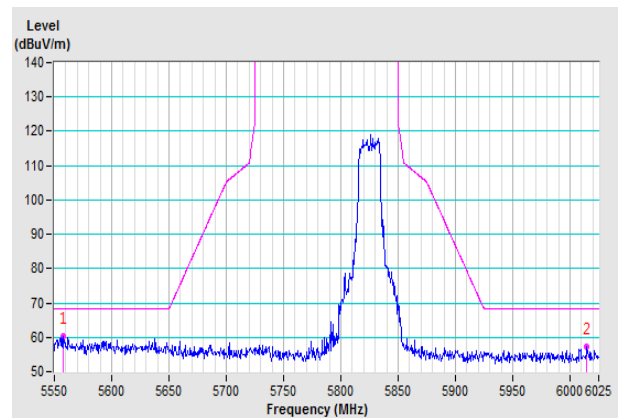
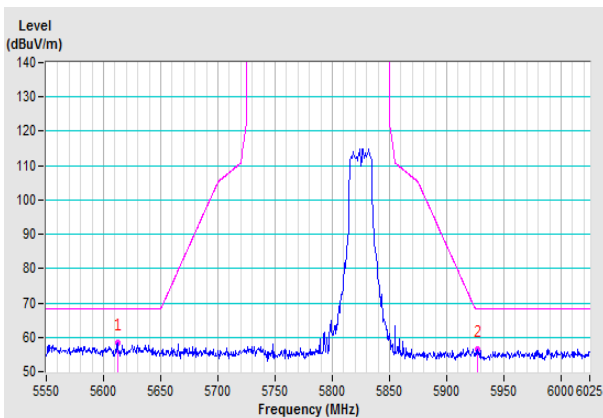

802.11ax (HE40)

CH 151 5755 MHz

Horizontal

Vertical

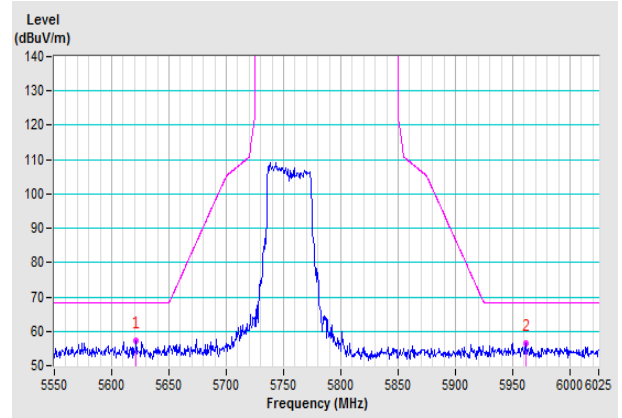
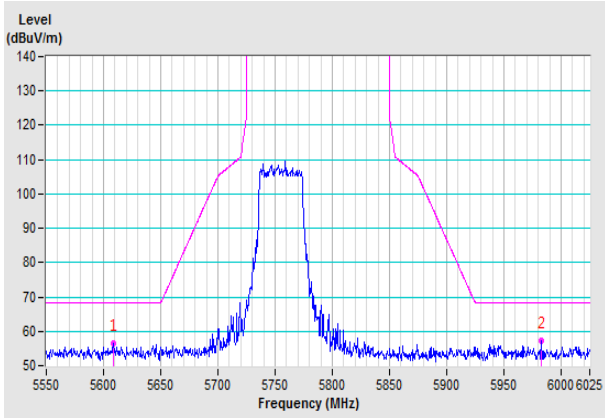

CH 159 5795 MHz

Horizontal

Vertical

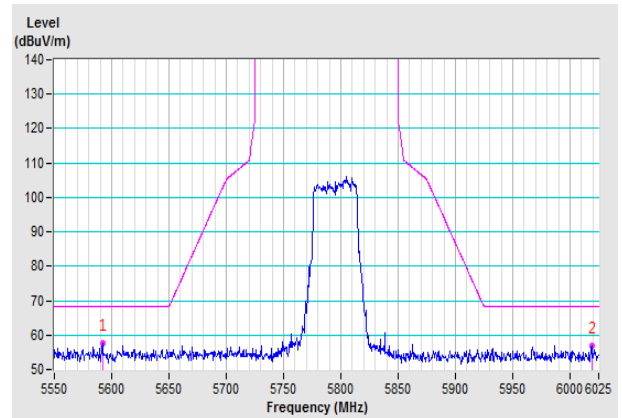
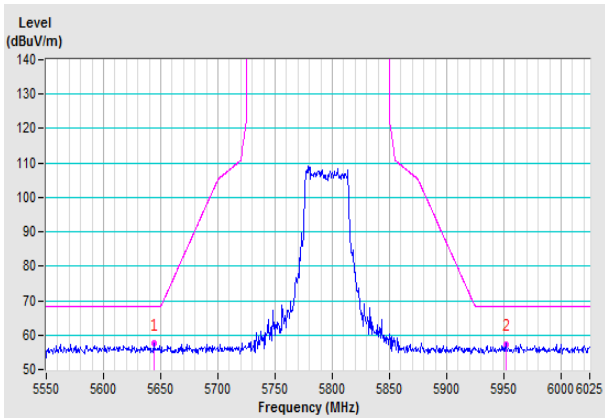

802.11ax (HE80)

CH 155 5775 MHz

Horizontal

Vertical

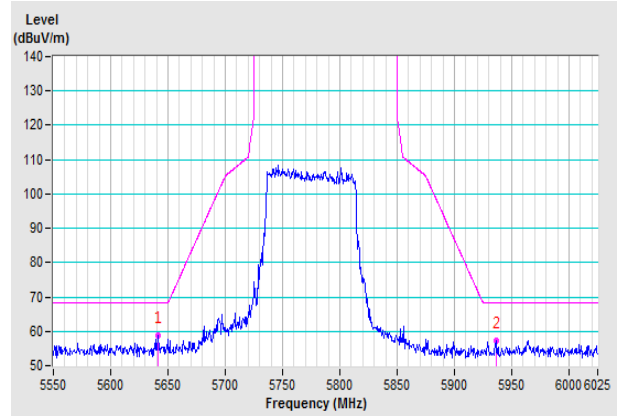
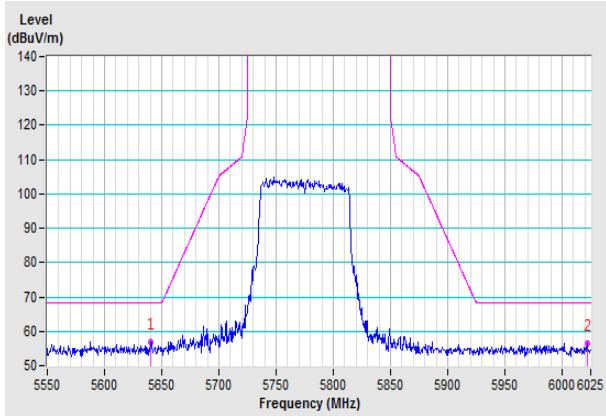

802.11ax (HE80+80)

CH 42+155 5210+5775 MHz

Horizontal

Vertical

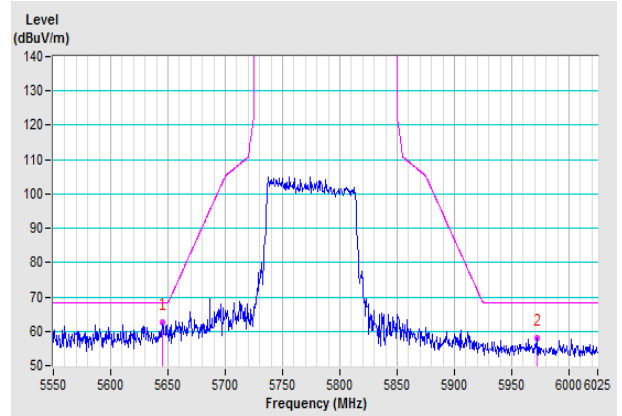
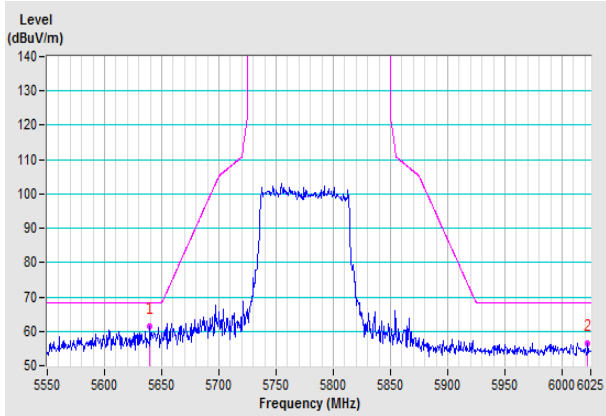

Appendix – Information on the Testing Laboratories

We, Bureau Veritas Consumer Products Services (H.K.) Ltd., Taoyuan Branch, were founded in 1988 to provide our best service in EMC, Radio, Telecom and Safety consultation. Our laboratories are FCC recognized accredited test firms and accredited according to ISO/IEC 17025.

If you have any comments, please feel free to contact us at the following:

Linkou EMC/RF Lab

Tel: 886-2-26052180

Fax: 886-2-26051924

Hsin Chu EMC/RF/Telecom Lab

Tel: 886-3-6668565

Fax: 886-3-6668323

Hwa Ya EMC/RF/Safety Lab

Tel: 886-3-3183232

Fax: 886-3-3270892

Email: service.adt@tw.bureauveritas.com

Web Site: www.bureauveritas-adt.com

The address and road map of all our labs can be found in our web site also.

--- END ---