

FCC Test Report

Report No.: RF180717E02-1

FCC ID: 2ABLK-GM1020

Test Model: GM1020

Received Date: July 18, 2018

Test Date: July 25 to Aug. 20, 2018

Issued Date: Sep. 06, 2018

Applicant: Calix Inc.

Address: 1035 N. McDowell Blvd. Petaluma, CA 94954 U.S.A.

Issued By: Bureau Veritas Consumer Products Services (H.K.) Ltd., Taoyuan Branch
Hsin Chu Laboratory

Lab Address: E-2, No.1, Li Hsin 1st Road, Hsinchu Science Park, Hsinchu City 300,
Taiwan R.O.C.

Test Location: E-2, No.1, Li Hsin 1st Road, Hsinchu Science Park, Hsinchu City 300,
Taiwan R.O.C.

**FCC Registration /
Designation Number:** 723255 / TW2022



This report is for your exclusive use. Any copying or replication of this report to or for any other person or entity, or use of our name or trademark, is permitted only with our prior written permission. This report sets forth our findings solely with respect to the test samples identified herein. The results set forth in this report are not indicative or representative of the quality or characteristics of the lot from which a test sample was taken or any similar or identical product unless specifically and expressly noted. Our report includes all of the tests requested by you and the results thereof based upon the information that you provided to us. You have 60 days from date of issuance of this report to notify us of any material error or omission caused by our negligence, provided, however, that such notice shall be in writing and shall specifically address the issue you wish to raise. A failure to raise such issue within the prescribed time shall constitute your unqualified acceptance of the completeness of this report, the tests conducted and the correctness of the report contents. Unless specific mention, the uncertainty of measurement has been explicitly taken into account to declare the compliance or non-compliance to the specification. The report must not be used by the client to claim product certification, approval, or endorsement by TAF or any government agencies.

Table of Contents

Release Control Record	4
1 Certificate of Conformity	5
2 Summary of Test Results	6
2.1 Measurement Uncertainty	6
2.2 Modification Record	6
3 General Information	7
3.1 General Description of EUT	7
3.2 Description of Test Modes	9
3.2.1 Test Mode Applicability and Tested Channel Detail	10
3.3 Duty Cycle of Test Signal	12
3.4 Description of Support Units	13
3.4.1 Configuration of System under Test	13
3.5 General Description of Applied Standard	14
4 Test Types and Results	15
4.1 Radiated Emission and Bandedge Measurement	15
4.1.1 Limits of Radiated Emission and Bandedge Measurement	15
4.1.2 Test Instruments	16
4.1.3 Test Procedure	17
4.1.4 Deviation from Test Standard	18
4.1.5 Test Setup	18
4.1.6 EUT Operating Condition	19
4.1.7 Test Results	20
4.2 Conducted Emission Measurement	39
4.2.1 Limits of Conducted Emission Measurement	39
4.2.2 Test Instruments	39
4.2.3 Test Procedure	40
4.2.4 Deviation from Test Standard	40
4.2.5 Test Setup	40
4.2.6 EUT Operating Condition	40
4.2.7 Test Results	41
4.3 Transmit Power Measurement	43
4.3.1 Limits of Transmit Power Measurement	43
4.3.2 Test Setup	44
4.3.3 Test Instruments	44
4.3.4 Test Procedure	44
4.3.5 Deviation from Test Standard	44
4.3.6 EUT Operating Condition	44
4.3.7 Test Results	45
4.4 Occupied Bandwidth Measurement	49
4.4.1 Test Setup	49
4.4.2 Test Instruments	49
4.4.3 Test Procedure	49
4.4.4 Test Results	50
4.5 Peak Power Spectral Density Measurement	62
4.5.1 Limits of Peak Power Spectral Density Measurement	62
4.5.2 Test Setup	62
4.5.3 Test Instruments	62
4.5.4 Test Procedure	63
4.5.5 Deviation from Test Standard	63
4.5.6 EUT Operating Condition	63
4.5.7 Test Results	64
4.6 Frequency Stability Measurement	76
4.6.1 Limits of Frequency Stability Measurement	76

4.6.2 Test Setup.....	76
4.6.3 Test Instruments	76
4.6.4 Test Procedure	76
4.6.5 Deviation from Test Standard	76
4.6.6 EUT Operating Condition	76
4.6.7 Test Results	77
4.7 6dB Bandwidth Measurement	78
4.7.1 Limits of 6dB Bandwidth Measurement.....	78
4.7.2 Test Setup.....	78
4.7.3 Test Instruments	78
4.7.4 Test Procedure	78
4.7.5 Deviation from Test Standard	78
4.7.6 EUT Operating Condition	78
4.7.7 Test Results	79
5 Pictures of Test Arrangements.....	83
Annex A- Radiated Out of Band Emission (OOBE) Measurement (For U-NII-3 band).....	84
Appendix – Information on the Testing Laboratories	87

Release Control Record

Issue No.	Description	Date Issued
RF180717E02-1	Original release.	Sep. 06, 2018

1 Certificate of Conformity

Product: LCK1

Brand: Calix

Test Model: GM1020

Sample Status: ENGINEERING SAMPLE

Applicant: Calix Inc.

Test Date: July 25 to Aug. 20, 2018

Standard: 47 CFR FCC Part 15, Subpart E (Section 15.407)
ANSI C63.10: 2013

The above equipment has been tested by **Bureau Veritas Consumer Products Services (H.K.) Ltd., Taoyuan Branch**, and found compliance with the requirement of the above standards. The test record, data evaluation & Equipment Under Test (EUT) configurations represented herein are true and accurate accounts of the measurements of the sample's EMC characteristics under the conditions specified in this report.

Prepared by : Phoenix Huang , **Date:** Sep. 06, 2018
Phoenix Huang / Specialist

Approved by : May Chen , **Date:** Sep. 06, 2018
May Chen / Manager

2 Summary of Test Results

47 CFR FCC Part 15, Subpart E (Section 15.407)			
FCC Clause	Test Item	Result	Remarks
15.407(b)(6)	AC Power Conducted Emissions	Pass	Meet the requirement of limit. Minimum passing margin is -24.36dB at 0.15000MHz.
15.407(b) (1/2/3/4(i/ii)/6)	Radiated Emissions & Band Edge Measurement*	Pass	Meet the requirement of limit. Minimum passing margin is -0.1dB at 5150.00MHz.
15.407(a)(1/2/3)	Max Average Transmit Power	Pass	Meet the requirement of limit.
---	Occupied Bandwidth Measurement	-	Reference only.
15.407(a)(1/2/3)	Peak Power Spectral Density	Pass	Meet the requirement of limit.
15.407(e)	6dB bandwidth	Pass	Meet the requirement of limit. (U-NII-3 Band only)
15.407(g)	Frequency Stability	Pass	Meet the requirement of limit.
15.203	Antenna Requirement	Pass	Antenna connector is none and i-pex(MHF) not a standard connector.

*For U-NII-3 band compliance with rule part 15.407(b)(4)(i), the OOB test plots were recorded in Annex A.

2.1 Measurement Uncertainty

Where relevant, the following measurement uncertainty levels have been estimated for tests performed on the EUT as specified in CISPR 16-4-2:

Measurement	Frequency	Expanded Uncertainty (k=2) (±)
Conducted Emissions at mains ports	150kHz ~ 30MHz	1.84 dB
Radiated Emissions up to 1 GHz	30MHz ~ 1GHz	5.53 dB
Radiated Emissions above 1 GHz	1GHz ~ 6GHz	5.08 dB
	6GHz ~ 18GHz	4.98 dB
	18GHz ~ 40GHz	5.19 dB

2.2 Modification Record

There were no modifications required for compliance.

3 General Information

3.1 General Description of EUT

Product	LCK1
Brand	Calix
Test Model	GM1020
Status of EUT	ENGINEERING SAMPLE
Power Supply Rating	120VAC, 1A
Modulation Type	CCK, DQPSK, DBPSK for DSSS 64QAM, 16QAM, QPSK, BPSK for OFDM 256QAM for OFDM in 11ac mode and VHT (20/40) mode in 2.4GHz
Modulation Technology	DSSS, OFDM
Transfer Rate	802.11b: up to 11Mbps 802.11a/g: up to 54Mbps 802.11n: up to 300Mbps 802.11ac: up to 866.7Mbps
Operating Frequency	2.4GHz: 2.412 ~ 2.462GHz 5GHz: 5.18~ 5.24GHz, 5.745 ~ 5.825GHz
Number of Channel	2.4GHz: 802.11b, 802.11g, 802.11n (HT20), VHT20: 11 802.11n (HT40), VHT40: 7 5GHz: 802.11a, 802.11n (HT20), 802.11ac (VHT20): 9 802.11n (HT40), 802.11ac (VHT40): 4 802.11ac (VHT80): 2
Output Power	2.412 ~ 2.462GHz CDD Mode: 487.203mW Beamforming Mode 483.764mW 5.18 ~ 5.24GHz (Client) CDD Mode: 201.853mW Beamforming Mode 201.853mW 5.18 ~ 5.24GHz (Master) CDD Mode: 336.538mW Beamforming Mode 334.608mW 5.745 ~ 5.825GHz CDD Mode: 450.343mW Beamforming Mode 450.343mW
Antenna Type	Refer to Note
Antenna Connector	Refer to Note
Accessory Device	NA
Data Cable Supplied	NA

Note:

1. This device can support different category application which switched to access point mode and client mode by software.
2. Simultaneously transmission condition.

Condition	Technology	
1	WLAN 2.4GHz	WLAN 5GHz

Note: The emission of the simultaneous operation has been evaluated and no non-compliance was found.

3. The antennas provided to the EUT, please refer to the following table:

Antenna No.	Antenna Net Gain (dBi)	Frequency range (GHz)	Antenna Type	Antenna Connector	Cable Length (mm)
1	2.02	2.4 ~ 2.4835	PIFA	None	-
	2.48	5.15 ~ 5.85			
2	3.94	2.4 ~ 2.4835	PIFA	i-pex(MHF)	53
	5.01	5.15 ~ 5.85			

4. The EUT incorporates a MIMO function

2.4GHz Band			
MODULATION MODE	DATA RATE (MCS)	TX & RX CONFIGURATION	
802.11b	1 ~ 11Mbps	2TX	2RX
802.11g	6 ~ 54Mbps	2TX	2RX
802.11n (HT20)	MCS 0~7	2TX	2RX
	MCS 8~15	2TX	2RX
802.11n (HT40)	MCS 0~7	2TX	2RX
	MCS 8~15	2TX	2RX
VHT20	MCS 0~8, Nss=1	2TX	2RX
	MCS 0~8, Nss=2	2TX	2RX
VHT40	MCS 0~9, Nss=1	2TX	2RX
	MCS 0~9, Nss=2	2TX	2RX
5GHz Band			
MODULATION MODE	DATA RATE (MCS)	TX & RX CONFIGURATION	
802.11a	6 ~ 54Mbps	2TX	2RX
802.11n (HT20)	MCS 0~7	2TX	2RX
	MCS 8~15	2TX	2RX
802.11n (HT40)	MCS 0~7	2TX	2RX
	MCS 8~15	2TX	2RX
802.11ac (VHT20)	MCS 0~8, Nss=1	2TX	2RX
	MCS 0~8, Nss=2	2TX	2RX
802.11ac (VHT40)	MCS 0~9, Nss=1	2TX	2RX
	MCS 0~9, Nss=2	2TX	2RX
802.11ac (VHT80)	MCS 0~9, Nss=1	2TX	2RX
	MCS 0~9, Nss=2	2TX	2RX

Note:

1. All of modulation mode support beamforming function except 802.11a/b/g modulation mode.
2. The EUT support Beamforming and CDD mode, therefore both mode were investigated and the worst case scenario was identified. The worst case data were presented in test report.
3. The modulation and bandwidth are similar for 802.11n mode for 20MHz (40MHz) and 802.11ac mode for 20MHz (40MHz), therefore investigated worst case to representative mode in test report. (Final test mode refer section 3.2.1)

5. The above EUT information is declared by manufacturer and for more detailed features description, please refers to the manufacturer's specifications or user's manual.

3.2 Description of Test Modes

FOR 5180 ~ 5240MHz

4 channels are provided for 802.11a, 802.11n (HT20), 802.11ac (VHT20):

Channel	Frequency	Channel	Frequency
36	5180 MHz	44	5220 MHz
40	5200 MHz	48	5240 MHz

2 channels are provided for 802.11n (HT40), 802.11ac (VHT40):

Channel	Frequency	Channel	Frequency
38	5190 MHz	46	5230 MHz

1 channel is provided for 802.11ac (VHT80):

Channel	Frequency
42	5210 MHz

FOR 5745 ~ 5825MHz:

5 channels are provided for 802.11a, 802.11n (HT20), 802.11ac (VHT20):

Channel	Frequency	Channel	Frequency
149	5745 MHz	161	5805 MHz
153	5765 MHz	165	5825 MHz
157	5785 MHz		

2 channels are provided for 802.11n (HT40), 802.11ac (VHT40):

Channel	Frequency	Channel	Frequency
151	5755 MHz	159	5795 MHz

1 channel is provided for 802.11ac (VHT80):

Channel	Frequency
155	5775 MHz

3.2.1 Test Mode Applicability and Tested Channel Detail

EUT Configure Mode	Applicable To				Description
	RE \geq 1G	RE $<$ 1G	PLC	APCM	
-	√	√	√	√	-

Where **RE \geq 1G**: Radiated Emission above 1GHz

RE $<$ 1G: Radiated Emission below 1GHz

PLC: Power Line Conducted Emission

APCM: Antenna Port Conducted Measurement

Note: The EUT had been pre-tested on the positioned of each 3 axis. The worst case was found when positioned on **Z-plane**.

Radiated Emission Test (Above 1GHz):

- Pre-Scan has been conducted to determine the worst-case mode from all possible combinations between available modulations, data rates and antenna ports (if EUT with antenna diversity architecture).
- Following channel(s) was (were) selected for the final test as listed below.

CDD Mode						
Mode	FREQ. Band (MHz)	Available Channel	Tested Channel	Modulation Technology	Modulation Type	Data Rate (Mbps)
802.11a	5180-5240	36 to 48	36, 40, 48	OFDM	BPSK	6
802.11ac (VHT20)		36 to 48	36, 40, 48	OFDM	BPSK	6.5
802.11ac (VHT40)		38 to 46	38, 46	OFDM	BPSK	13.5
802.11ac (VHT80)		42	42	OFDM	BPSK	29.3
802.11a	5745-5825	149 to 165	149, 157, 165	OFDM	BPSK	6
802.11ac (VHT20)		149 to 165	149, 157, 165	OFDM	BPSK	6.5
802.11ac (VHT40)		151 to 159	151, 159	OFDM	BPSK	13.5
802.11ac (VHT80)		155	155	OFDM	BPSK	29.3

Radiated Emission Test (Below 1GHz):

- Pre-Scan has been conducted to determine the worst-case mode from all possible combinations between available modulations, data rates and antenna ports (if EUT with antenna diversity architecture).
- Following channel(s) was (were) selected for the final test as listed below.

CDD Mode						
Mode	FREQ. Band (MHz)	Available Channel	Tested Channel	Modulation Technology	Modulation Type	Data Rate (Mbps)
802.11ac (VHT20)	5180-5240, 5745-5825	36 to 48, 149 to 165	149	OFDM	BPSK	6.5

Power Line Conducted Emission Test:

- Pre-Scan has been conducted to determine the worst-case mode from all possible combinations between available modulations, data rates and antenna ports (if EUT with antenna diversity architecture).
- Following channel(s) was (were) selected for the final test as listed below.

CDD Mode						
Mode	FREQ. Band (MHz)	Available Channel	Tested Channel	Modulation Technology	Modulation Type	Data Rate (Mbps)
802.11ac (VHT20)	5180-5240, 5745-5825	36 to 48, 149 to 165	149	OFDM	BPSK	6.5

Antenna Port Conducted Measurement:

- This item includes all test value of each mode, but only includes spectrum plot of worst value of each mode.
- Pre-Scan has been conducted to determine the worst-case mode from all possible combinations between available modulations, data rates and antenna ports (if EUT with antenna diversity architecture).
- Following channel(s) was (were) selected for the final test as listed below.

CDD Mode						
(with Client Mode and Master Mode)						
Mode	FREQ. Band (MHz)	Available Channel	Tested Channel	Modulation Technology	Modulation Type	Data Rate (Mbps)
802.11a	5180-5240	36 to 48	36, 40, 48	OFDM	BPSK	6
802.11ac (VHT20)		36 to 48	36, 40, 48	OFDM	BPSK	6.5
802.11ac (VHT40)		38 to 46	38, 46	OFDM	BPSK	13.5
802.11ac (VHT80)		42	42	OFDM	BPSK	29.3
802.11a	5745-5825	149 to 165	149, 157, 165	OFDM	BPSK	6
802.11ac (VHT20)		149 to 165	149, 157, 165	OFDM	BPSK	6.5
802.11ac (VHT40)		151 to 159	151, 159	OFDM	BPSK	13.5
802.11ac (VHT80)		155	155	OFDM	BPSK	29.3
Beamforming Mode (output power only)						
(with Client Mode and Master Mode)						
Mode	FREQ. Band (MHz)	Available Channel	Tested Channel	Modulation Technology	Modulation Type	Data Rate (Mbps)
802.11ac (VHT20)	5180-5240	36 to 48	36, 40, 48	OFDM	BPSK	6.5
802.11ac (VHT40)		38 to 46	38, 46	OFDM	BPSK	13.5
802.11ac (VHT80)		42	42	OFDM	BPSK	29.3
802.11ac (VHT20)	5745-5825	149 to 165	149, 157, 165	OFDM	BPSK	6.5
802.11ac (VHT40)		151 to 159	151, 159	OFDM	BPSK	13.5
802.11ac (VHT80)		155	155	OFDM	BPSK	29.3

Test Condition:

Applicable To	Environmental Conditions	Input Power	Tested By
RE\geq1G	23deg. C, 65%RH	120Vac, 60Hz	Eason Tseng
	22deg. C, 67%RH	120Vac, 60Hz	Eason Tseng
RE$<$1G	22deg. C, 67%RH	120Vac, 60Hz	Andy Ho
PLC	24deg. C, 76%RH	120Vac, 60Hz	Andy Ho
APCM	25deg. C, 60%RH	120Vac, 60Hz	Jyunchun Lin

3.3 Duty Cycle of Test Signal

If duty cycle of test signal is $\geq 98\%$, duty factor is not required.

If duty cycle of test signal is $< 98\%$, duty factor shall be considered.

802.11a: Duty cycle = Duty cycle = $2.026 \text{ ms} / 2.125 \text{ ms} = 0.953$, Duty factor = $10 * \log (1/\text{Duty cycle}) = 0.21$

802.11ac (VHT20): Duty cycle = $4.97 \text{ ms} / 5.06 \text{ ms} = 0.982$

802.11ac (VHT40): Duty cycle = $2.413 \text{ ms} / 2.499 \text{ ms} = 0.966$, Duty factor = $10 * \log (1/\text{Duty cycle}) = 0.15$

802.11ac (VHT80): Duty cycle = $1.136 \text{ ms} / 1.216 \text{ ms} = 0.934$, Duty factor = $10 * \log (1/\text{Duty cycle}) = 0.3$

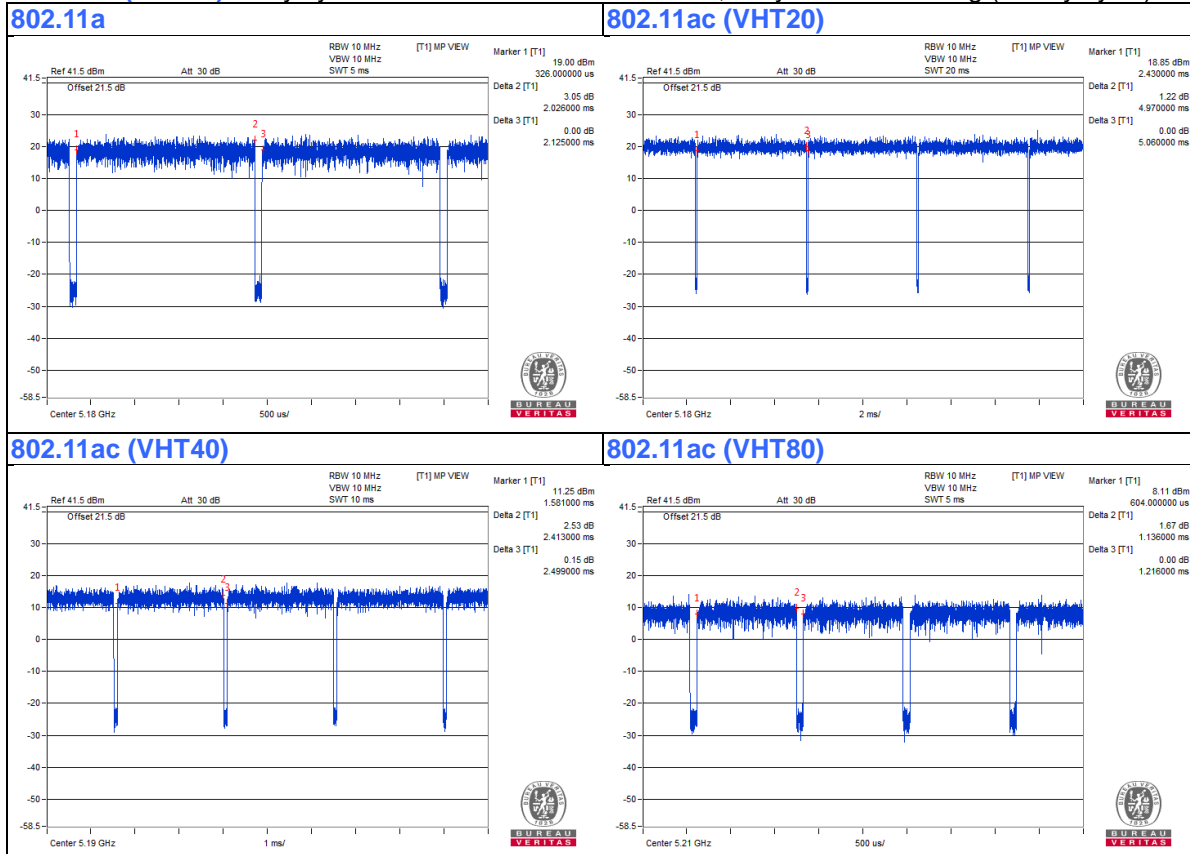

3.4 Description of Support Units

The EUT has been tested as an independent unit together with other necessary accessories or support units. The following support units or accessories were used to form a representative test configuration during the tests.

ID	Product	Brand	Model No.	Serial No.	FCC ID	Remarks
A.	Laptop	DELL	E6420	B92T3R1	FCC DoC	Provided by Lab

Note:

1. All power cords of the above support units are non-shielded (1.8m).

ID	Descriptions	Qty.	Length (m)	Shielding (Yes/No)	Cores (Qty.)	Remarks
1.	RJ-45 Cable	1	10	No	0	Provided by Lab

3.4.1 Configuration of System under Test

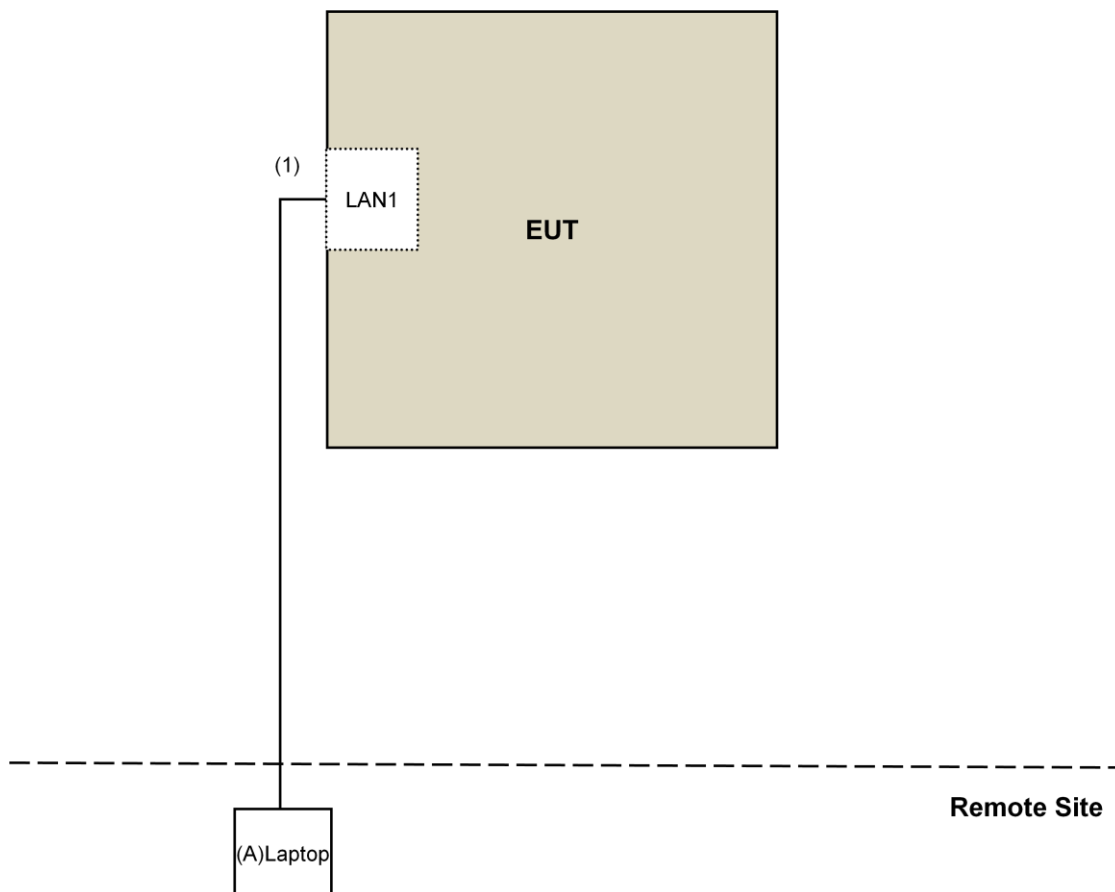

3.5 General Description of Applied Standard

The EUT is a RF Product. According to the specifications of the manufacturer, it must comply with the requirements of the following standards:

FCC Part 15, Subpart E (15.407)

KDB 789033 D02 General UNII Test Procedure New Rules v02r01

KDB 662911 D01 Multiple Transmitter Output v02r01

ANSI C63.10-2013

All test items have been performed and recorded as per the above standards.

4 Test Types and Results

4.1 Radiated Emission and Bandedge Measurement

4.1.1 Limits of Radiated Emission and Bandedge Measurement

Radiated emissions which fall in the restricted bands must comply with the radiated emission limits specified as below table.

Frequencies (MHz)	Field Strength (microvolts/meter)	Measurement Distance (meters)
0.009 ~ 0.490	2400/F(kHz)	300
0.490 ~ 1.705	24000/F(kHz)	30
1.705 ~ 30.0	30	30
30 ~ 88	100	3
88 ~ 216	150	3
216 ~ 960	200	3
Above 960	500	3

NOTE:

1. The lower limit shall apply at the transition frequencies.
2. Emission level (dBuV/m) = 20 log Emission level (uV/m).
3. For frequencies above 1000MHz, the field strength limits are based on average detector, however, the peak field strength of any emission shall not exceed the maximum permitted average limits, specified above by more than 20dB under any condition of modulation.

Limits of unwanted emission out of the restricted bands

Applicable To		Limit	
789033 D02 General UNII Test Procedure New Rules v02r01		Field Strength at 3m	
		PK:74 (dBuV/m)	AV:54 (dBuV/m)
Frequency Band	Applicable To	EIRP Limit	Equivalent Field Strength at 3m
5150~5250 MHz	15.407(b)(1)	PK:-27 (dBm/MHz)	PK:68.2(dBuV/m)
5250~5350 MHz	15.407(b)(2)		
5470~5725 MHz	15.407(b)(3)		
5725~5850 MHz	<input checked="" type="checkbox"/> 15.407(b)(4)(i)	PK:-27 (dBm/MHz) ^{*1} PK:10 (dBm/MHz) ^{*2} PK:15.6 (dBm/MHz) ^{*3} PK:27 (dBm/MHz) ^{*4}	PK: 68.2(dBuV/m) ^{*1} PK:105.2 (dBuV/m) ^{*2} PK: 110.8(dBuV/m) ^{*3} PK:122.2 (dBuV/m) ^{*4}
	<input type="checkbox"/> 15.407(b)(4)(ii)	Emission limits in section 15.247(d)	
^{*1} beyond 75 MHz or more above of the band edge.		^{*2} below the band edge increasing linearly to 10 dBm/MHz at 25 MHz above.	
^{*3} below the band edge increasing linearly to a level of 15.6 dBm/MHz at 5 MHz above.		^{*4} from 5 MHz above or below the band edge increasing linearly to a level of 27 dBm/MHz at the band edge.	

Note:

The following formula is used to convert the equipment isotropic radiated power (eirp) to field strength:

$$E = \frac{1000000\sqrt{30P}}{3} \mu\text{V/m, where } P \text{ is the eirp (Watts).}$$

4.1.2 Test Instruments

DESCRIPTION & MANUFACTURER	MODEL NO.	SERIAL NO.	CALIBRATED DATE	CALIBRATED UNTIL
Test Receiver Agilent	N9038A	MY50010156	July 12, 2018	July 11, 2019
Pre-Amplifier EMCI	EMC001340	980142	Feb. 09, 2018	Feb. 08, 2019
Loop Antenna ⁽¹⁾ Electro-Metrics	EM-6879	264	Dec. 16, 2016	Dec. 15, 2018
RF Cable	NA	LOOPCAB-001	Jan. 15, 2018	Jan. 14, 2019
RF Cable	NA	LOOPCAB-002	Jan. 15, 2018	Jan. 14, 2019
Pre-Amplifier Mini-Circuits	ZFL-1000VH2B	AMP-ZFL-05	May 05, 2018	May 04, 2019
Trilog Broadband Antenna SCHWARZBECK	VULB 9168	9168-361	Nov. 29, 2017	Nov. 28, 2018
RF Cable	8D	966-3-1	Mar. 20, 2018	Mar. 19, 2019
RF Cable	8D	966-3-2	Mar. 20, 2018	Mar. 19, 2019
RF Cable	8D	966-3-3	Mar. 20, 2018	Mar. 19, 2019
Fixed attenuator Mini-Circuits	UNAT-5+	PAD-3m-3-01	Oct. 03, 2017	Oct. 02, 2018
Horn Antenna SCHWARZBECK	BBHA9120-D	9120D-406	Dec. 12, 2017	Dec. 11, 2018
Pre-Amplifier EMCI	EMC12630SE	980384	Jan. 29, 2018	Jan. 28, 2019
RF Cable	EMC104-SM-SM-1200	160922	Jan. 29, 2018	Jan. 28, 2019
RF Cable	EMC104-SM-SM-2000	150317	Jan. 29, 2018	Jan. 28, 2019
RF Cable	EMC104-SM-SM-5000	150322	Jan. 29, 2018	Jan. 28, 2019
Spectrum Analyzer Keysight	N9030A	MY54490679	July 23, 2018	July 22, 2019
Pre-Amplifier EMCI	EMC184045SE	980386	Jan. 29, 2018	Jan. 28, 2019
Horn Antenna SCHWARZBECK	BBHA 9170	BBHA9170608	Dec. 14, 2017	Dec. 13, 2018
RF Cable	EMC102-KM-KM-1200	160924	Jan. 29, 2018	Jan. 28, 2019
Software	ADT_Radiated_V8.7.08	NA	NA	NA
Antenna Tower & Turn Table Max-Full	MF-7802	MF780208406	NA	NA
Boresight Antenna Fixture	FBA-01	FBA-SIP01	NA	NA
Spectrum Analyzer R&S	FSV40	100964	June 20, 2018	June 19, 2019
Power meter Anritsu	ML2495A	1014008	May 09, 2018	May 08, 2019
Power sensor Anritsu	MA2411B	0917122	May 09, 2018	May 08, 2019
AC Power Source Extech Electronics	6205	1440452	NA	NA
Temperature & Humidity Chamber Giant Force	GTH-150-40-SP-AR	MAA0812-008	Jan. 10, 2018	Jan. 09, 2019
True RMS Clamp Meter FLUKE	325	31130711WS	May 22, 2018	May 21, 2019

Note:

1. The calibration interval of the above test instruments is 12 months and the calibrations are traceable to NML/ROC and NIST/USA.
2. *The calibration interval of the above test instruments is 24 months and the calibrations are traceable to NML/ROC and NIST/USA.
3. The test was performed in 966 Chamber No. 3.
4. The CANADA Site Registration No. is 20331-1
5. Loop antenna was used for all emissions below 30 MHz.
6. Tested Date: July 25 to Aug. 20, 2018

4.1.3 Test Procedure

For Radiated emission below 30MHz

- a. The EUT was placed on the top of a rotating table 0.8 meters above the ground at a 3 meter chamber room. The table was rotated 360 degrees to determine the position of the highest radiation.
- b. The EUT was set 3 meters away from the interference-receiving antenna, which was mounted on the top of a variable-height antenna tower.
- c. Parallel, perpendicular, and ground-parallel orientations of the antenna are set to make the measurement.
- d. For each suspected emission, the EUT was arranged to its worst case and the rotatable table was turned from 0 degrees to 360 degrees to find the maximum reading.
- e. The test-receiver system was set to Quasi-Peak Detect Function and Specified Bandwidth with Maximum Hold Mode.

Note:

1. The resolution bandwidth and video bandwidth of test receiver/spectrum analyzer is 9kHz at frequency below 30MHz.

For Radiated emission above 30MHz

- a. The EUT was placed on the top of a rotating table 0.8 meters (for 30MHz ~ 1GHz) / 1.5 meters (for above 1GHz) above the ground at 3 meter chamber room for test. The table was rotated 360 degrees to determine the position of the highest radiation.
- b. The EUT was set 3 meters away from the interference-receiving antenna, which was mounted on the top of a variable-height antenna tower.
- c. The height of antenna is varied from one meter to four meters above the ground to determine the maximum value of the field strength. Both horizontal and vertical polarizations of the antenna are set to make the measurement.
- d. For each suspected emission, the EUT was arranged to its worst case and then the antenna was tuned to heights from 1 meter to 4 meters and the rotatable table was turned from 0 degrees to 360 degrees to find the maximum reading.
- e. The test-receiver system was set to quasi-peak detect function and specified bandwidth with maximum hold mode when the test frequency is below 1 GHz.
- f. The test-receiver system was set to peak and average detects function and specified bandwidth with maximum hold mode when the test frequency is above 1 GHz. If the peak reading value also meets average limit, measurement with the average detector is unnecessary.

Note:

1. The resolution bandwidth and video bandwidth of test receiver/spectrum analyzer is 120kHz for Quasi-peak detection (QP) at frequency below 1GHz.
2. The resolution bandwidth of test receiver/spectrum analyzer is 1 MHz and the video bandwidth is 3 MHz for Peak detection (PK) at frequency above 1GHz.
3. The resolution bandwidth of test receiver/spectrum analyzer is 1MHz and the video bandwidth is $\geq 1/T$ (Duty cycle < 98%) or 10Hz (Duty cycle $\geq 98\%$) for Average detection (AV) at frequency above 1GHz.
4. All modes of operation were investigated and the worst-case emissions are reported.

4.1.4 Deviation from Test Standard

No deviation.

4.1.5 Test Setup

For Radiated emission below 30MHz

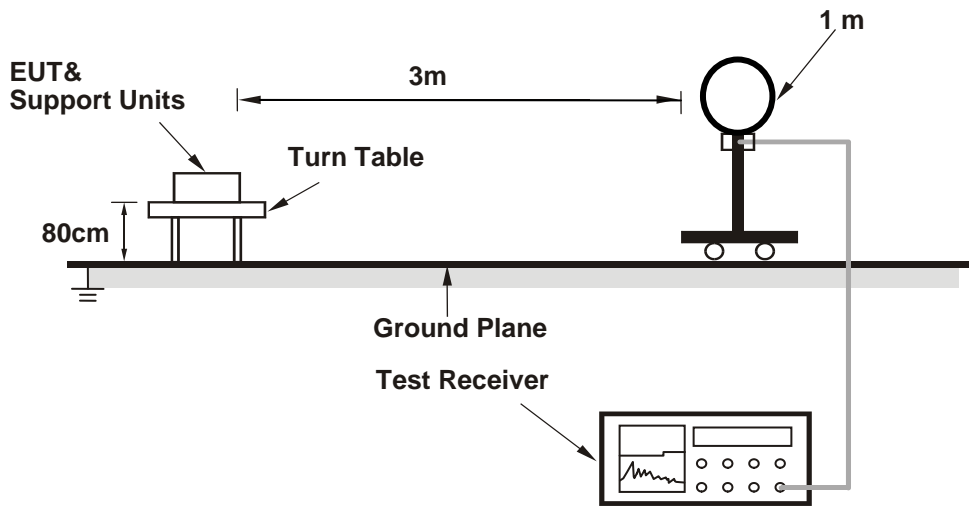

For Radiated emission 30MHz to 1GHz

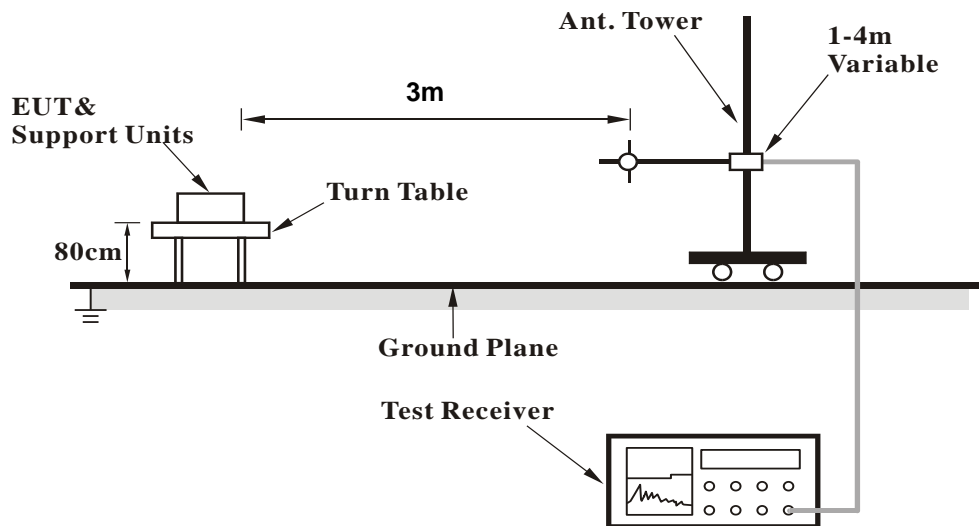

For Radiated emission above 1GHz

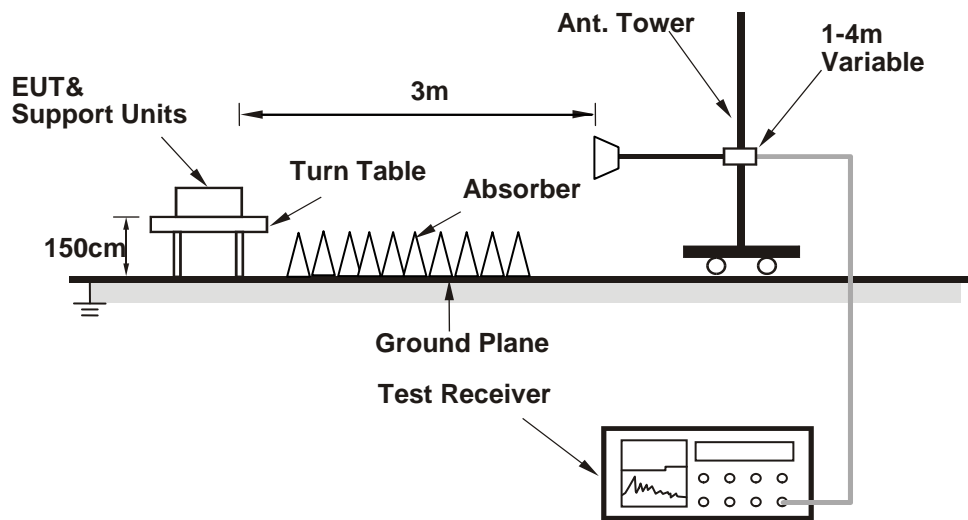

For the actual test configuration, please refer to the attached file (Test Setup Photo).

4.1.6 EUT Operating Condition

- a. Connected the EUT with the Laptop which is placed on remote site.
- b. Controlling software (QDART_1.0.40) has been activated to set the EUT on specific status.

4.1.7 Test Results

CDD Mode

Above 1GHz Data:

802.11a

CHANNEL	TX Channel 36	DETECTOR FUNCTION	Peak (PK)
FREQUENCY RANGE	1GHz ~ 40GHz		Average (AV)

ANTENNA POLARITY & TEST DISTANCE: HORIZONTAL AT 3 M

NO.	FREQ. (MHz)	EMISSION LEVEL (dBuV/m)	LIMIT (dBuV/m)	MARGIN (dB)	ANTENNA HEIGHT (m)	TABLE ANGLE (Degree)	RAW VALUE (dBuV)	CORRECTION FACTOR (dB/m)
1	5150.00	53.4 PK	74.0	-20.6	2.24 H	162	50.8	2.6
2	5150.00	39.8 AV	54.0	-14.2	2.24 H	162	37.2	2.6
3	*5180.00	108.7 PK			2.24 H	162	106.2	2.5
4	*5180.00	99.3 AV			2.24 H	162	96.8	2.5
5	#10360.00	43.1 PK	68.2	-25.1	1.99 H	278	31.2	11.9
6	15540.00	44.4 PK	74.0	-29.6	1.56 H	98	32.0	12.4
7	15540.00	35.3 AV	54.0	-18.7	1.56 H	98	22.9	12.4

ANTENNA POLARITY & TEST DISTANCE: VERTICAL AT 3 M

NO.	FREQ. (MHz)	EMISSION LEVEL (dBuV/m)	LIMIT (dBuV/m)	MARGIN (dB)	ANTENNA HEIGHT (m)	TABLE ANGLE (Degree)	RAW VALUE (dBuV)	CORRECTION FACTOR (dB/m)
1	5150.00	44.7 PK	74.0	-29.3	3.03 V	280	42.1	2.6
2	5150.00	33.0 AV	54.0	-21.0	3.03 V	280	30.4	2.6
3	*5180.00	107.2 PK			3.03 V	280	104.7	2.5
4	*5180.00	97.3 AV			3.03 V	280	94.8	2.5
5	#10360.00	41.9 PK	68.2	-26.3	1.58 V	322	30.0	11.9
6	15540.00	43.2 PK	74.0	-30.8	1.50 V	188	30.8	12.4
7	15540.00	31.9 AV	54.0	-22.1	1.50 V	188	19.5	12.4

REMARKS:

1. Emission Level(dBuV/m) = Raw Value(dBuV) + Correction Factor(dB/m)
2. Correction Factor(dB/m) = Antenna Factor(dB/m) + Cable Factor(dB) – Pre-Amplifier Factor(dB)
3. The other emission levels were very low against the limit.
4. Margin value = Emission Level – Limit value
5. " * ": Fundamental frequency.
6. " # ": The radiated frequency is out of the restricted band.

CHANNEL	TX Channel 40	DETECTOR FUNCTION	Peak (PK)
FREQUENCY RANGE	1GHz ~ 40GHz		Average (AV)

ANTENNA POLARITY & TEST DISTANCE: HORIZONTAL AT 3 M

NO.	FREQ. (MHz)	EMISSION LEVEL (dBuV/m)	LIMIT (dBuV/m)	MARGIN (dB)	ANTENNA HEIGHT (m)	TABLE ANGLE (Degree)	RAW VALUE (dBuV)	CORRECTION FACTOR (dB/m)
1	5150.00	47.6 PK	74.0	-26.4	2.30 H	169	45.0	2.6
2	5150.00	35.5 AV	54.0	-18.5	2.30 H	169	32.9	2.6
3	*5200.00	109.4 PK			2.30 H	169	107.0	2.4
4	*5200.00	99.8 AV			2.30 H	169	97.4	2.4
5	5350.00	49.9 PK	74.0	-24.1	2.30 H	169	47.6	2.3
6	5350.00	37.8 AV	54.0	-16.2	2.30 H	169	35.5	2.3
7	#10400.00	43.4 PK	68.2	-24.8	2.01 H	276	31.2	12.2
8	15600.00	43.8 PK	74.0	-30.2	1.56 H	83	30.9	12.9
9	15600.00	34.9 AV	54.0	-19.1	1.56 H	83	22.0	12.9

ANTENNA POLARITY & TEST DISTANCE: VERTICAL AT 3 M

NO.	FREQ. (MHz)	EMISSION LEVEL (dBuV/m)	LIMIT (dBuV/m)	MARGIN (dB)	ANTENNA HEIGHT (m)	TABLE ANGLE (Degree)	RAW VALUE (dBuV)	CORRECTION FACTOR (dB/m)
1	5150.00	44.5 PK	74.0	-29.5	3.06 V	271	41.9	2.6
2	5150.00	32.7 AV	54.0	-21.3	3.06 V	271	30.1	2.6
3	*5200.00	107.6 PK			3.06 V	271	105.2	2.4
4	*5200.00	97.7 AV			3.06 V	271	95.3	2.4
5	5350.00	46.7 PK	74.0	-27.3	3.06 V	271	44.4	2.3
6	5350.00	34.4 AV	54.0	-19.6	3.06 V	271	32.1	2.3
7	#10400.00	37.8 PK	68.2	-30.4	1.55 V	325	25.6	12.2
8	15600.00	40.5 PK	74.0	-33.5	1.45 V	194	27.6	12.9
9	15600.00	31.9 AV	54.0	-22.1	1.45 V	194	19.0	12.9

REMARKS:

1. Emission Level(dBuV/m) = Raw Value(dBuV) + Correction Factor(dB/m)
2. Correction Factor(dB/m) = Antenna Factor(dB/m) + Cable Factor(dB) – Pre-Amplifier Factor(dB)
3. The other emission levels were very low against the limit.
4. Margin value = Emission Level – Limit value
5. " * ": Fundamental frequency.
6. " # ": The radiated frequency is out of the restricted band.

CHANNEL	TX Channel 48	DETECTOR FUNCTION	Peak (PK)
FREQUENCY RANGE	1GHz ~ 40GHz		Average (AV)

ANTENNA POLARITY & TEST DISTANCE: HORIZONTAL AT 3 M

NO.	FREQ. (MHz)	EMISSION LEVEL (dBuV/m)	LIMIT (dBuV/m)	MARGIN (dB)	ANTENNA HEIGHT (m)	TABLE ANGLE (Degree)	RAW VALUE (dBuV)	CORRECTION FACTOR (dB/m)
1	*5240.00	108.8 PK			2.14 H	161	106.6	2.2
2	*5240.00	99.5 AV			2.14 H	161	97.3	2.2
3	5350.00	54.9 PK	74.0	-19.1	2.14 H	161	52.6	2.3
4	5350.00	40.1 AV	54.0	-13.9	2.14 H	161	37.8	2.3
5	#10480.00	44.2 PK	68.2	-24.0	1.98 H	272	31.8	12.4
6	15720.00	49.8 PK	74.0	-24.2	1.51 H	83	37.8	12.0
7	15720.00	37.6 AV	54.0	-16.4	1.51 H	83	25.6	12.0

ANTENNA POLARITY & TEST DISTANCE: VERTICAL AT 3 M

NO.	FREQ. (MHz)	EMISSION LEVEL (dBuV/m)	LIMIT (dBuV/m)	MARGIN (dB)	ANTENNA HEIGHT (m)	TABLE ANGLE (Degree)	RAW VALUE (dBuV)	CORRECTION FACTOR (dB/m)
1	*5240.00	107.4 PK			3.12 V	269	105.2	2.2
2	*5240.00	97.5 AV			3.12 V	269	95.3	2.2
3	5350.00	46.8 PK	74.0	-27.2	3.12 V	269	44.5	2.3
4	5350.00	34.2 AV	54.0	-19.8	3.12 V	269	31.9	2.3
5	#10480.00	37.6 PK	68.2	-30.6	1.42 V	318	25.2	12.4
6	15720.00	40.1 PK	74.0	-33.9	1.31 V	175	28.1	12.0
7	15720.00	31.8 AV	54.0	-22.2	1.31 V	175	19.8	12.0

REMARKS:

- Emission Level(dBuV/m) = Raw Value(dBuV) + Correction Factor(dB/m)
- Correction Factor(dB/m) = Antenna Factor(dB/m) + Cable Factor(dB) – Pre-Amplifier Factor(dB)
- The other emission levels were very low against the limit.
- Margin value = Emission Level – Limit value
- " * ": Fundamental frequency.
- " # ": The radiated frequency is out of the restricted band.

CHANNEL	TX Channel 149	DETECTOR FUNCTION	Peak (PK)
FREQUENCY RANGE	1GHz ~ 40GHz		Average (AV)

ANTENNA POLARITY & TEST DISTANCE: HORIZONTAL AT 3 M

NO.	FREQ. (MHz)	EMISSION LEVEL (dBuV/m)	LIMIT (dBuV/m)	MARGIN (dB)	ANTENNA HEIGHT (m)	TABLE ANGLE (Degree)	RAW VALUE (dBuV)	CORRECTION FACTOR (dB/m)
1	#5592.04	56.7 PK	68.2	-11.5	1.33 H	178	53.9	2.8
2	*5745.00	120.1 PK			1.33 H	178	117.2	2.9
3	*5745.00	109.5 AV			1.33 H	178	106.6	2.9
4	#5923.18	55.9 PK	69.5	-13.6	1.33 H	178	52.5	3.4
5	11490.00	49.9 PK	74.0	-24.1	1.10 H	82	37.6	12.3
6	11490.00	38.6 AV	54.0	-15.4	1.10 H	82	26.3	12.3
7	#17235.00	52.5 PK	68.2	-15.7	2.21 H	217	37.2	15.3

ANTENNA POLARITY & TEST DISTANCE: VERTICAL AT 3 M

NO.	FREQ. (MHz)	EMISSION LEVEL (dBuV/m)	LIMIT (dBuV/m)	MARGIN (dB)	ANTENNA HEIGHT (m)	TABLE ANGLE (Degree)	RAW VALUE (dBuV)	CORRECTION FACTOR (dB/m)
1	#5639.25	55.5 PK	68.2	-12.7	3.33 V	269	52.8	2.7
2	*5745.00	116.2 PK			3.33 V	269	113.3	2.9
3	*5745.00	107.2 AV			3.33 V	269	104.3	2.9
4	#6001.70	54.2 PK	68.2	-14.0	3.33 V	269	51.0	3.2
5	11490.00	48.2 PK	74.0	-25.8	1.49 V	214	35.9	12.3
6	11490.00	37.2 AV	54.0	-16.8	1.49 V	214	24.9	12.3
7	#17235.00	57.2 PK	68.2	-11.0	1.84 V	173	41.9	15.3

REMARKS:

1. Emission Level(dBuV/m) = Raw Value(dBuV) + Correction Factor(dB/m)
2. Correction Factor(dB/m) = Antenna Factor(dB/m) + Cable Factor(dB) – Pre-Amplifier Factor(dB)
3. The other emission levels were very low against the limit.
4. Margin value = Emission Level – Limit value
5. " * ": Fundamental frequency.
6. " # ": The radiated frequency is out of the restricted band.

CHANNEL	TX Channel 157	DETECTOR FUNCTION	Peak (PK)
FREQUENCY RANGE	1GHz ~ 40GHz		Average (AV)

ANTENNA POLARITY & TEST DISTANCE: HORIZONTAL AT 3 M

NO.	FREQ. (MHz)	EMISSION LEVEL (dBuV/m)	LIMIT (dBuV/m)	MARGIN (dB)	ANTENNA HEIGHT (m)	TABLE ANGLE (Degree)	RAW VALUE (dBuV)	CORRECTION FACTOR (dB/m)
1	#5621.19	58.1 PK	68.2	-10.1	1.60 H	202	55.3	2.8
2	*5785.00	120.4 PK			1.08 H	174	117.3	3.1
3	*5785.00	109.9 AV			1.08 H	174	106.8	3.1
4	#5985.80	56.6 PK	68.2	-11.6	1.60 H	202	53.4	3.2
5	11570.00	49.9 PK	74.0	-24.1	1.10 H	85	37.5	12.4
6	11570.00	38.6 AV	54.0	-15.4	1.10 H	85	26.2	12.4
7	#17355.00	52.6 PK	68.2	-15.6	2.26 H	205	36.6	16.0

ANTENNA POLARITY & TEST DISTANCE: VERTICAL AT 3 M

NO.	FREQ. (MHz)	EMISSION LEVEL (dBuV/m)	LIMIT (dBuV/m)	MARGIN (dB)	ANTENNA HEIGHT (m)	TABLE ANGLE (Degree)	RAW VALUE (dBuV)	CORRECTION FACTOR (dB/m)
1	#5607.69	58.0 PK	68.2	-10.2	3.29 V	268	55.2	2.8
2	*5785.00	116.0 PK			3.29 V	268	112.9	3.1
3	*5785.00	107.1 AV			3.29 V	268	104.0	3.1
4	#5958.58	57.4 PK	68.2	-10.8	3.29 V	268	54.2	3.2
5	11570.00	48.1 PK	74.0	-25.9	1.45 V	226	35.7	12.4
6	11570.00	37.2 AV	54.0	-16.8	1.45 V	226	24.8	12.4
7	#17355.00	57.5 PK	68.2	-10.7	1.89 V	182	41.5	16.0

REMARKS:

1. Emission Level(dBuV/m) = Raw Value(dBuV) + Correction Factor(dB/m)
2. Correction Factor(dB/m) = Antenna Factor(dB/m) + Cable Factor(dB) – Pre-Amplifier Factor(dB)
3. The other emission levels were very low against the limit.
4. Margin value = Emission Level – Limit value
5. " * ": Fundamental frequency.
6. " # ": The radiated frequency is out of the restricted band.

CHANNEL	TX Channel 165	DETECTOR FUNCTION	Peak (PK)
FREQUENCY RANGE	1GHz ~ 40GHz		Average (AV)

ANTENNA POLARITY & TEST DISTANCE: HORIZONTAL AT 3 M

NO.	FREQ. (MHz)	EMISSION LEVEL (dBuV/m)	LIMIT (dBuV/m)	MARGIN (dB)	ANTENNA HEIGHT (m)	TABLE ANGLE (Degree)	RAW VALUE (dBuV)	CORRECTION FACTOR (dB/m)
1	#5603.18	55.3 PK	68.2	-12.9	1.11 H	171	52.5	2.8
2	*5825.00	120.3 PK			1.11 H	171	117.1	3.2
3	*5825.00	109.6 AV			1.11 H	171	106.4	3.2
4	#5935.53	55.5 PK	68.2	-12.7	1.11 H	171	52.1	3.4
5	11650.00	49.9 PK	74.0	-24.1	1.08 H	81	37.5	12.4
6	11650.00	38.9 AV	54.0	-15.1	1.08 H	81	26.5	12.4
7	#17475.00	52.4 PK	68.2	-15.8	2.15 H	224	35.0	17.4

ANTENNA POLARITY & TEST DISTANCE: VERTICAL AT 3 M

NO.	FREQ. (MHz)	EMISSION LEVEL (dBuV/m)	LIMIT (dBuV/m)	MARGIN (dB)	ANTENNA HEIGHT (m)	TABLE ANGLE (Degree)	RAW VALUE (dBuV)	CORRECTION FACTOR (dB/m)
1	#5616.04	57.2 PK	68.2	-11.0	3.34 V	280	54.4	2.8
2	*5825.00	116.4 PK			3.34 V	280	113.2	3.2
3	*5825.00	107.7 AV			3.34 V	280	104.5	3.2
4	#5938.80	57.5 PK	68.2	-10.7	3.34 V	280	54.1	3.4
5	11650.00	48.6 PK	74.0	-25.4	1.54 V	203	36.2	12.4
6	11650.00	37.6 AV	54.0	-16.4	1.54 V	203	25.2	12.4
7	#17475.00	57.6 PK	68.2	-10.6	1.78 V	164	40.2	17.4

REMARKS:

1. Emission Level(dBuV/m) = Raw Value(dBuV) + Correction Factor(dB/m)
2. Correction Factor(dB/m) = Antenna Factor(dB/m) + Cable Factor(dB) – Pre-Amplifier Factor(dB)
3. The other emission levels were very low against the limit.
4. Margin value = Emission Level – Limit value
5. " * ": Fundamental frequency.
6. " # ": The radiated frequency is out of the restricted band.

802.11ac (VHT20)

CHANNEL	TX Channel 36	DETECTOR FUNCTION	Peak (PK)
FREQUENCY RANGE	1GHz ~ 40GHz		Average (AV)

ANTENNA POLARITY & TEST DISTANCE: HORIZONTAL AT 3 M

NO.	FREQ. (MHz)	EMISSION LEVEL (dBuV/m)	LIMIT (dBuV/m)	MARGIN (dB)	ANTENNA HEIGHT (m)	TABLE ANGLE (Degree)	RAW VALUE (dBuV)	CORRECTION FACTOR (dB/m)
1	5150.00	47.1 PK	74.0	-26.9	2.21 H	160	44.5	2.6
2	5150.00	35.2 AV	54.0	-18.8	2.21 H	160	32.6	2.6
3	*5180.00	109.4 PK			2.21 H	160	106.9	2.5
4	*5180.00	99.7 AV			2.21 H	160	97.2	2.5
5	#10360.00	39.4 PK	68.2	-28.8	2.04 H	268	27.5	11.9
6	15540.00	44.1 PK	74.0	-29.9	1.56 H	67	31.7	12.4
7	15540.00	35.3 AV	54.0	-18.7	1.56 H	67	22.9	12.4

ANTENNA POLARITY & TEST DISTANCE: VERTICAL AT 3 M

NO.	FREQ. (MHz)	EMISSION LEVEL (dBuV/m)	LIMIT (dBuV/m)	MARGIN (dB)	ANTENNA HEIGHT (m)	TABLE ANGLE (Degree)	RAW VALUE (dBuV)	CORRECTION FACTOR (dB/m)
1	5150.00	44.8 PK	74.0	-29.2	3.10 V	265	42.2	2.6
2	5150.00	33.2 AV	54.0	-20.8	3.10 V	265	30.6	2.6
3	*5180.00	107.5 PK			3.10 V	265	105.0	2.5
4	*5180.00	97.3 AV			3.10 V	265	94.8	2.5
5	#10360.00	37.5 PK	68.2	-30.7	1.56 V	323	25.6	11.9
6	15540.00	40.5 PK	74.0	-33.5	1.49 V	188	28.1	12.4
7	15540.00	31.5 AV	54.0	-22.5	1.49 V	188	19.1	12.4

REMARKS:

1. Emission Level(dBuV/m) = Raw Value(dBuV) + Correction Factor(dB/m)
2. Correction Factor(dB/m) = Antenna Factor(dB/m) + Cable Factor(dB) – Pre-Amplifier Factor(dB)
3. The other emission levels were very low against the limit.
4. Margin value = Emission Level – Limit value
5. " * ": Fundamental frequency.
6. " # ": The radiated frequency is out of the restricted band.

CHANNEL	TX Channel 40	DETECTOR FUNCTION	Peak (PK)
FREQUENCY RANGE	1GHz ~ 40GHz		Average (AV)

ANTENNA POLARITY & TEST DISTANCE: HORIZONTAL AT 3 M

NO.	FREQ. (MHz)	EMISSION LEVEL (dBuV/m)	LIMIT (dBuV/m)	MARGIN (dB)	ANTENNA HEIGHT (m)	TABLE ANGLE (Degree)	RAW VALUE (dBuV)	CORRECTION FACTOR (dB/m)
1	*5200.00	109.1 PK			2.08 H	160	106.7	2.4
2	*5200.00	99.6 AV			2.08 H	160	97.2	2.4
3	#10400.00	39.2 PK	68.2	-29.0	1.99 H	275	27.0	12.2
4	15600.00	43.8 PK	74.0	-30.2	1.58 H	77	30.9	12.9
5	15600.00	34.8 AV	54.0	-19.2	1.58 H	77	21.9	12.9

ANTENNA POLARITY & TEST DISTANCE: VERTICAL AT 3 M

NO.	FREQ. (MHz)	EMISSION LEVEL (dBuV/m)	LIMIT (dBuV/m)	MARGIN (dB)	ANTENNA HEIGHT (m)	TABLE ANGLE (Degree)	RAW VALUE (dBuV)	CORRECTION FACTOR (dB/m)
1	*5200.00	107.2 PK			3.09 V	280	104.8	2.4
2	*5200.00	97.1 AV			3.09 V	280	94.7	2.4
3	#10400.00	37.4 PK	68.2	-30.8	1.57 V	322	25.2	12.2
4	15600.00	40.3 PK	74.0	-33.7	1.49 V	185	27.4	12.9
5	15600.00	32.0 AV	54.0	-22.0	1.49 V	185	19.1	12.9

REMARKS:

1. Emission Level(dBuV/m) = Raw Value(dBuV) + Correction Factor(dB/m)
2. Correction Factor(dB/m) = Antenna Factor(dB/m) + Cable Factor(dB) – Pre-Amplifier Factor(dB)
3. The other emission levels were very low against the limit.
4. Margin value = Emission Level – Limit value
5. " * ": Fundamental frequency.
6. " # ": The radiated frequency is out of the restricted band.

CHANNEL	TX Channel 48	DETECTOR FUNCTION	Peak (PK)
FREQUENCY RANGE	1GHz ~ 40GHz		Average (AV)

ANTENNA POLARITY & TEST DISTANCE: HORIZONTAL AT 3 M

NO.	FREQ. (MHz)	EMISSION LEVEL (dBuV/m)	LIMIT (dBuV/m)	MARGIN (dB)	ANTENNA HEIGHT (m)	TABLE ANGLE (Degree)	RAW VALUE (dBuV)	CORRECTION FACTOR (dB/m)
1	*5240.00	109.0 PK			2.31 H	158	106.8	2.2
2	*5240.00	99.3 AV			2.31 H	158	97.1	2.2
3	5350.00	49.5 PK	74.0	-24.5	2.31 H	158	47.2	2.3
4	5350.00	40.4 AV	54.0	-13.6	2.31 H	158	38.1	2.3
5	#10480.00	39.1 PK	68.2	-29.1	1.97 H	274	26.7	12.4
6	15720.00	44.0 PK	74.0	-30.0	1.57 H	79	32.0	12.0
7	15720.00	34.8 AV	54.0	-19.2	1.57 H	79	22.8	12.0

ANTENNA POLARITY & TEST DISTANCE: VERTICAL AT 3 M

NO.	FREQ. (MHz)	EMISSION LEVEL (dBuV/m)	LIMIT (dBuV/m)	MARGIN (dB)	ANTENNA HEIGHT (m)	TABLE ANGLE (Degree)	RAW VALUE (dBuV)	CORRECTION FACTOR (dB/m)
1	*5240.00	107.1 PK			3.10 V	284	104.9	2.2
2	*5240.00	97.0 AV			3.10 V	284	94.8	2.2
3	5350.00	45.6 PK	74.0	-28.4	3.10 V	284	43.3	2.3
4	5350.00	34.3 AV	54.0	-19.7	3.10 V	284	32.0	2.3
5	#10480.00	36.9 PK	68.2	-31.3	1.52 V	333	24.5	12.4
6	15720.00	41.2 PK	74.0	-32.8	1.53 V	187	29.2	12.0
7	15720.00	32.7 AV	54.0	-21.3	1.53 V	187	20.7	12.0

REMARKS:

1. Emission Level(dBuV/m) = Raw Value(dBuV) + Correction Factor(dB/m)
2. Correction Factor(dB/m) = Antenna Factor(dB/m) + Cable Factor(dB) – Pre-Amplifier Factor(dB)
3. The other emission levels were very low against the limit.
4. Margin value = Emission Level – Limit value
5. " * ": Fundamental frequency.
6. " # ": The radiated frequency is out of the restricted band.

CHANNEL	TX Channel 149	DETECTOR FUNCTION	Peak (PK)
FREQUENCY RANGE	1GHz ~ 40GHz		Average (AV)

ANTENNA POLARITY & TEST DISTANCE: HORIZONTAL AT 3 M

NO.	FREQ. (MHz)	EMISSION LEVEL (dBuV/m)	LIMIT (dBuV/m)	MARGIN (dB)	ANTENNA HEIGHT (m)	TABLE ANGLE (Degree)	RAW VALUE (dBuV)	CORRECTION FACTOR (dB/m)
1	#5560.05	56.3 PK	68.2	-11.9	1.08 H	177	53.5	2.8
2	*5745.00	118.6 PK			1.08 H	177	115.7	2.9
3	*5745.00	109.2 AV			1.08 H	177	106.3	2.9
4	#5938.10	55.1 PK	68.2	-13.1	1.08 H	177	51.7	3.4
5	11490.00	43.5 PK	74.0	-30.5	2.03 H	280	31.2	12.3
6	11490.00	34.7 AV	54.0	-19.3	2.03 H	280	22.4	12.3
7	#17235.00	46.8 PK	68.2	-21.4	1.59 H	69	31.5	15.3

ANTENNA POLARITY & TEST DISTANCE: VERTICAL AT 3 M

NO.	FREQ. (MHz)	EMISSION LEVEL (dBuV/m)	LIMIT (dBuV/m)	MARGIN (dB)	ANTENNA HEIGHT (m)	TABLE ANGLE (Degree)	RAW VALUE (dBuV)	CORRECTION FACTOR (dB/m)
1	#5617.15	57.8 PK	68.2	-10.4	1.59 V	149	55.0	2.8
2	*5745.00	115.9 PK			3.33 V	252	113.0	2.9
3	*5745.00	107.0 AV			3.33 V	252	104.1	2.9
4	#5977.36	57.0 PK	68.2	-11.2	1.59 V	149	53.8	3.2
5	11490.00	47.9 PK	74.0	-26.1	1.48 V	215	35.6	12.3
6	11490.00	37.3 AV	54.0	-16.7	1.48 V	215	25.0	12.3
7	#17235.00	56.1 PK	68.2	-12.1	1.90 V	174	40.8	15.3

REMARKS:

1. Emission Level(dBuV/m) = Raw Value(dBuV) + Correction Factor(dB/m)
2. Correction Factor(dB/m) = Antenna Factor(dB/m) + Cable Factor(dB) – Pre-Amplifier Factor(dB)
3. The other emission levels were very low against the limit.
4. Margin value = Emission Level – Limit value
5. " * ": Fundamental frequency.
6. " # ": The radiated frequency is out of the restricted band.

CHANNEL	TX Channel 157	DETECTOR FUNCTION	Peak (PK)
FREQUENCY RANGE	1GHz ~ 40GHz		Average (AV)

ANTENNA POLARITY & TEST DISTANCE: HORIZONTAL AT 3 M

NO.	FREQ. (MHz)	EMISSION LEVEL (dBuV/m)	LIMIT (dBuV/m)	MARGIN (dB)	ANTENNA HEIGHT (m)	TABLE ANGLE (Degree)	RAW VALUE (dBuV)	CORRECTION FACTOR (dB/m)
1	#5583.13	55.0 PK	68.2	-13.2	1.10 H	168	52.2	2.8
2	*5785.00	118.9 PK			1.10 H	168	115.8	3.1
3	*5785.00	109.5 AV			1.10 H	168	106.4	3.1
4	#5926.60	53.9 PK	68.2	-14.3	1.10 H	168	50.5	3.4
5	11570.00	43.7 PK	74.0	-30.3	1.96 H	262	31.3	12.4
6	11570.00	34.8 AV	54.0	-19.2	1.96 H	262	22.4	12.4
7	#17355.00	47.1 PK	68.2	-21.1	1.57 H	90	31.1	16.0

ANTENNA POLARITY & TEST DISTANCE: VERTICAL AT 3 M

NO.	FREQ. (MHz)	EMISSION LEVEL (dBuV/m)	LIMIT (dBuV/m)	MARGIN (dB)	ANTENNA HEIGHT (m)	TABLE ANGLE (Degree)	RAW VALUE (dBuV)	CORRECTION FACTOR (dB/m)
1	#5589.38	55.9 PK	68.2	-12.3	3.35 V	248	53.1	2.8
2	*5785.00	116.1 PK			3.35 V	248	113.0	3.1
3	*5785.00	107.4 AV			3.35 V	248	104.3	3.1
4	#5982.55	55.3 PK	68.2	-12.9	3.35 V	248	52.1	3.2
5	11570.00	48.2 PK	74.0	-25.8	1.50 V	216	35.8	12.4
6	11570.00	37.8 AV	54.0	-16.2	1.50 V	216	25.4	12.4
7	#17355.00	56.5 PK	68.2	-11.7	1.85 V	181	40.5	16.0

REMARKS:

1. Emission Level(dBuV/m) = Raw Value(dBuV) + Correction Factor(dB/m)
2. Correction Factor(dB/m) = Antenna Factor(dB/m) + Cable Factor(dB) – Pre-Amplifier Factor(dB)
3. The other emission levels were very low against the limit.
4. Margin value = Emission Level – Limit value
5. " * ": Fundamental frequency.
6. " # ": The radiated frequency is out of the restricted band.

CHANNEL	TX Channel 165	DETECTOR FUNCTION	Peak (PK)
FREQUENCY RANGE	1GHz ~ 40GHz		Average (AV)

ANTENNA POLARITY & TEST DISTANCE: HORIZONTAL AT 3 M

NO.	FREQ. (MHz)	EMISSION LEVEL (dBuV/m)	LIMIT (dBuV/m)	MARGIN (dB)	ANTENNA HEIGHT (m)	TABLE ANGLE (Degree)	RAW VALUE (dBuV)	CORRECTION FACTOR (dB/m)
1	#5625.72	56.7 PK	68.2	-11.5	1.03 H	166	53.9	2.8
2	*5825.00	118.7 PK			1.03 H	166	115.5	3.2
3	*5825.00	109.4 AV			1.03 H	166	106.2	3.2
4	#5963.37	55.3 PK	68.2	-12.9	1.03 H	166	52.0	3.3
5	11650.00	43.6 PK	74.0	-30.4	1.96 H	268	31.2	12.4
6	11650.00	34.8 AV	54.0	-19.2	1.96 H	268	22.4	12.4
7	#17475.00	46.9 PK	68.2	-21.3	1.53 H	97	29.5	17.4

ANTENNA POLARITY & TEST DISTANCE: VERTICAL AT 3 M

NO.	FREQ. (MHz)	EMISSION LEVEL (dBuV/m)	LIMIT (dBuV/m)	MARGIN (dB)	ANTENNA HEIGHT (m)	TABLE ANGLE (Degree)	RAW VALUE (dBuV)	CORRECTION FACTOR (dB/m)
1	#5588.81	59.6 PK	68.2	-8.6	3.40 V	243	56.8	2.8
2	*5825.00	116.4 PK			3.40 V	243	113.2	3.2
3	*5825.00	107.5 AV			3.40 V	243	104.3	3.2
4	#5962.88	58.0 PK	68.2	-10.2	3.40 V	243	54.7	3.3
5	11650.00	47.9 PK	74.0	-26.1	1.51 V	204	35.5	12.4
6	11650.00	37.3 AV	54.0	-16.7	1.51 V	204	24.9	12.4
7	#17475.00	56.6 PK	68.2	-11.6	1.81 V	195	39.2	17.4

REMARKS:

1. Emission Level(dBuV/m) = Raw Value(dBuV) + Correction Factor(dB/m)
2. Correction Factor(dB/m) = Antenna Factor(dB/m) + Cable Factor(dB) – Pre-Amplifier Factor(dB)
3. The other emission levels were very low against the limit.
4. Margin value = Emission Level – Limit value
5. " * ": Fundamental frequency.
6. " # ": The radiated frequency is out of the restricted band.

802.11ac (VHT40)

CHANNEL	TX Channel 38	DETECTOR FUNCTION	Peak (PK)
FREQUENCY RANGE	1GHz ~ 40GHz		Average (AV)

ANTENNA POLARITY & TEST DISTANCE: HORIZONTAL AT 3 M

NO.	FREQ. (MHz)	EMISSION LEVEL (dBuV/m)	LIMIT (dBuV/m)	MARGIN (dB)	ANTENNA HEIGHT (m)	TABLE ANGLE (Degree)	RAW VALUE (dBuV)	CORRECTION FACTOR (dB/m)
1	5150.00	64.2 PK	74.0	-9.8	2.45 H	159	61.6	2.6
2	5150.00	53.9 AV	54.0	-0.1	2.45 H	159	51.3	2.6
3	*5190.00	107.2 PK			2.45 H	159	104.7	2.5
4	*5190.00	98.6 AV			2.45 H	159	96.1	2.5
5	5350.00	51.5 PK	74.0	-22.5	2.45 H	159	49.2	2.3
6	5350.00	42.8 AV	54.0	-11.2	2.45 H	159	40.5	2.3
7	#10380.00	43.5 PK	68.2	-24.7	1.96 H	281	31.5	12.0
8	15570.00	44.2 PK	74.0	-29.8	1.54 H	90	31.6	12.6
9	15570.00	35.2 AV	54.0	-18.8	1.54 H	90	22.6	12.6

ANTENNA POLARITY & TEST DISTANCE: VERTICAL AT 3 M

NO.	FREQ. (MHz)	EMISSION LEVEL (dBuV/m)	LIMIT (dBuV/m)	MARGIN (dB)	ANTENNA HEIGHT (m)	TABLE ANGLE (Degree)	RAW VALUE (dBuV)	CORRECTION FACTOR (dB/m)
1	5150.00	40.3 PK	74.0	-33.7	3.05 V	266	37.7	2.6
2	5150.00	32.7 AV	54.0	-21.3	3.05 V	266	30.1	2.6
3	*5190.00	104.3 PK			3.05 V	266	101.8	2.5
4	*5190.00	95.6 AV			3.05 V	266	93.1	2.5
5	5350.00	45.8 PK	74.0	-28.2	3.05 V	266	43.5	2.3
6	5350.00	34.6 AV	54.0	-19.4	3.05 V	266	32.3	2.3
7	#10380.00	37.4 PK	68.2	-30.8	1.42 V	312	25.4	12.0
8	15570.00	41.1 PK	74.0	-32.9	1.53 V	207	28.5	12.6
9	15570.00	32.3 AV	54.0	-21.7	1.53 V	207	19.7	12.6

REMARKS:

1. Emission Level(dBuV/m) = Raw Value(dBuV) + Correction Factor(dB/m)
2. Correction Factor(dB/m) = Antenna Factor(dB/m) + Cable Factor(dB) – Pre-Amplifier Factor(dB)
3. The other emission levels were very low against the limit.
4. Margin value = Emission Level – Limit value
5. " * ": Fundamental frequency.
6. " # ": The radiated frequency is out of the restricted band.

CHANNEL	TX Channel 46	DETECTOR FUNCTION	Peak (PK)
FREQUENCY RANGE	1GHz ~ 40GHz		Average (AV)

ANTENNA POLARITY & TEST DISTANCE: HORIZONTAL AT 3 M

NO.	FREQ. (MHz)	EMISSION LEVEL (dBuV/m)	LIMIT (dBuV/m)	MARGIN (dB)	ANTENNA HEIGHT (m)	TABLE ANGLE (Degree)	RAW VALUE (dBuV)	CORRECTION FACTOR (dB/m)
1	*5230.00	107.8 PK			2.29 H	160	105.6	2.2
2	*5230.00	99.2 AV			2.29 H	160	97.0	2.2
3	5350.00	51.5 PK	74.0	-22.5	2.29 H	160	49.2	2.3
4	5350.00	41.5 AV	54.0	-12.5	2.29 H	160	39.2	2.3
5	#10460.00	43.8 PK	68.2	-24.4	2.01 H	273	31.4	12.4
6	15690.00	44.6 PK	74.0	-29.4	1.56 H	102	32.4	12.2
7	15690.00	35.7 AV	54.0	-18.3	1.56 H	102	23.5	12.2

ANTENNA POLARITY & TEST DISTANCE: VERTICAL AT 3 M

NO.	FREQ. (MHz)	EMISSION LEVEL (dBuV/m)	LIMIT (dBuV/m)	MARGIN (dB)	ANTENNA HEIGHT (m)	TABLE ANGLE (Degree)	RAW VALUE (dBuV)	CORRECTION FACTOR (dB/m)
1	*5230.00	104.8 PK			3.02 V	279	102.6	2.2
2	*5230.00	95.9 AV			3.02 V	279	93.7	2.2
3	5350.00	45.9 PK	74.0	-28.1	3.02 V	279	43.6	2.3
4	5350.00	34.8 AV	54.0	-19.2	3.02 V	279	32.5	2.3
5	#10460.00	37.9 PK	68.2	-30.3	1.43 V	317	25.5	12.4
6	15690.00	40.8 PK	74.0	-33.2	1.53 V	198	28.6	12.2
7	15690.00	32.5 AV	54.0	-21.5	1.53 V	198	20.3	12.2

REMARKS:

1. Emission Level(dBuV/m) = Raw Value(dBuV) + Correction Factor(dB/m)
2. Correction Factor(dB/m) = Antenna Factor(dB/m) + Cable Factor(dB) – Pre-Amplifier Factor(dB)
3. The other emission levels were very low against the limit.
4. Margin value = Emission Level – Limit value
5. " * ": Fundamental frequency.
6. " # ": The radiated frequency is out of the restricted band.

CHANNEL	TX Channel 151	DETECTOR FUNCTION	Peak (PK)
FREQUENCY RANGE	1GHz ~ 40GHz		Average (AV)

ANTENNA POLARITY & TEST DISTANCE: HORIZONTAL AT 3 M

NO.	FREQ. (MHz)	EMISSION LEVEL (dBuV/m)	LIMIT (dBuV/m)	MARGIN (dB)	ANTENNA HEIGHT (m)	TABLE ANGLE (Degree)	RAW VALUE (dBuV)	CORRECTION FACTOR (dB/m)
1	#5627.12	61.6 PK	68.2	-6.6	1.41 H	179	58.8	2.8
2	*5755.00	116.2 PK			1.41 H	179	113.2	3.0
3	*5755.00	106.1 AV			1.41 H	179	103.1	3.0
4	#5974.63	55.1 PK	68.2	-13.1	1.41 H	179	51.9	3.2
5	11510.00	43.6 PK	74.0	-30.4	1.97 H	275	31.3	12.3
6	11510.00	35.0 AV	54.0	-19.0	1.97 H	275	22.7	12.3
7	#17265.00	46.9 PK	68.2	-21.3	1.55 H	98	31.5	15.4

ANTENNA POLARITY & TEST DISTANCE: VERTICAL AT 3 M

NO.	FREQ. (MHz)	EMISSION LEVEL (dBuV/m)	LIMIT (dBuV/m)	MARGIN (dB)	ANTENNA HEIGHT (m)	TABLE ANGLE (Degree)	RAW VALUE (dBuV)	CORRECTION FACTOR (dB/m)
1	#5552.78	55.9 PK	68.2	-12.3	3.38 V	230	53.2	2.7
2	*5755.00	113.8 PK			3.38 V	230	110.8	3.0
3	*5755.00	104.8 AV			3.38 V	230	101.8	3.0
4	#5953.88	55.6 PK	68.2	-12.6	3.38 V	230	52.4	3.2
5	11510.00	47.8 PK	74.0	-26.2	1.55 V	197	35.5	12.3
6	11510.00	37.4 AV	54.0	-16.6	1.55 V	197	25.1	12.3
7	#17265.00	56.5 PK	68.2	-11.7	1.77 V	198	41.1	15.4

REMARKS:

1. Emission Level(dBuV/m) = Raw Value(dBuV) + Correction Factor(dB/m)
2. Correction Factor(dB/m) = Antenna Factor(dB/m) + Cable Factor(dB) – Pre-Amplifier Factor(dB)
3. The other emission levels were very low against the limit.
4. Margin value = Emission Level – Limit value
5. " * ": Fundamental frequency.
6. " # ": The radiated frequency is out of the restricted band.

CHANNEL	TX Channel 159	DETECTOR FUNCTION	Peak (PK)
FREQUENCY RANGE	1GHz ~ 40GHz		Average (AV)

ANTENNA POLARITY & TEST DISTANCE: HORIZONTAL AT 3 M

NO.	FREQ. (MHz)	EMISSION LEVEL (dBuV/m)	LIMIT (dBuV/m)	MARGIN (dB)	ANTENNA HEIGHT (m)	TABLE ANGLE (Degree)	RAW VALUE (dBuV)	CORRECTION FACTOR (dB/m)
1	#5624.01	56.2 PK	68.2	-12.0	1.23 H	175	53.4	2.8
2	*5795.00	115.9 PK			1.23 H	175	112.9	3.0
3	*5795.00	106.0 AV			1.23 H	175	103.0	3.0
4	#5932.26	57.7 PK	68.2	-10.5	1.23 H	175	54.3	3.4
5	11590.00	43.4 PK	74.0	-30.6	1.93 H	287	31.0	12.4
6	11590.00	34.9 AV	54.0	-19.1	1.93 H	287	22.5	12.4
7	#17385.00	47.2 PK	68.2	-21.0	1.49 H	92	31.0	16.2

ANTENNA POLARITY & TEST DISTANCE: VERTICAL AT 3 M

NO.	FREQ. (MHz)	EMISSION LEVEL (dBuV/m)	LIMIT (dBuV/m)	MARGIN (dB)	ANTENNA HEIGHT (m)	TABLE ANGLE (Degree)	RAW VALUE (dBuV)	CORRECTION FACTOR (dB/m)
1	#5601.51	56.0 PK	68.2	-12.2	3.43 V	220	53.2	2.8
2	*5795.00	113.6 PK			3.43 V	220	110.6	3.0
3	*5795.00	104.4 AV			3.43 V	220	101.4	3.0
4	#5977.74	55.5 PK	68.2	-12.7	3.43 V	220	52.3	3.2
5	11590.00	48.0 PK	74.0	-26.0	1.58 V	211	35.6	12.4
6	11590.00	37.6 AV	54.0	-16.4	1.58 V	211	25.2	12.4
7	#17385.00	56.8 PK	68.2	-11.4	1.75 V	183	40.6	16.2

REMARKS:

1. Emission Level(dBuV/m) = Raw Value(dBuV) + Correction Factor(dB/m)
2. Correction Factor(dB/m) = Antenna Factor(dB/m) + Cable Factor(dB) – Pre-Amplifier Factor(dB)
3. The other emission levels were very low against the limit.
4. Margin value = Emission Level – Limit value
5. " * ": Fundamental frequency.
6. " # ": The radiated frequency is out of the restricted band.

802.11ac (VHT80)

CHANNEL	TX Channel 42	DETECTOR FUNCTION	Peak (PK)
FREQUENCY RANGE	1GHz ~ 40GHz		Average (AV)

ANTENNA POLARITY & TEST DISTANCE: HORIZONTAL AT 3 M

NO.	FREQ. (MHz)	EMISSION LEVEL (dBuV/m)	LIMIT (dBuV/m)	MARGIN (dB)	ANTENNA HEIGHT (m)	TABLE ANGLE (Degree)	RAW VALUE (dBuV)	CORRECTION FACTOR (dB/m)
1	5150.00	65.5 PK	74.0	-8.5	2.32 H	159	62.9	2.6
2	5150.00	53.7 AV	54.0	-0.3	2.32 H	159	51.1	2.6
3	*5210.00	105.2 PK			2.32 H	159	102.8	2.4
4	*5210.00	95.1 AV			2.32 H	159	92.7	2.4
5	5350.00	52.9 PK	74.0	-21.1	2.32 H	159	50.6	2.3
6	5350.00	42.1 AV	54.0	-11.9	2.32 H	159	39.8	2.3
7	#10420.00	39.5 PK	68.2	-28.7	1.96 H	285	27.3	12.2
8	15630.00	43.7 PK	74.0	-30.3	1.56 H	94	31.0	12.7
9	15630.00	34.6 AV	54.0	-19.4	1.56 H	94	21.9	12.7

ANTENNA POLARITY & TEST DISTANCE: VERTICAL AT 3 M

NO.	FREQ. (MHz)	EMISSION LEVEL (dBuV/m)	LIMIT (dBuV/m)	MARGIN (dB)	ANTENNA HEIGHT (m)	TABLE ANGLE (Degree)	RAW VALUE (dBuV)	CORRECTION FACTOR (dB/m)
1	5150.00	39.9 PK	74.0	-34.1	3.06 V	276	37.3	2.6
2	5150.00	32.5 AV	54.0	-21.5	3.06 V	276	29.9	2.6
3	*5210.00	103.4 PK			3.08 V	250	101.0	2.4
4	*5210.00	93.2 AV			3.08 V	250	90.8	2.4
5	5350.00	45.7 PK	74.0	-28.3	3.00 V	275	43.4	2.3
6	5350.00	34.5 AV	54.0	-19.5	3.00 V	275	32.2	2.3
7	#10420.00	37.3 PK	68.2	-30.9	1.37 V	305	25.1	12.2
8	15630.00	41.4 PK	74.0	-32.6	1.55 V	220	28.7	12.7
9	15630.00	32.4 AV	54.0	-21.6	1.55 V	220	19.7	12.7

REMARKS:

1. Emission Level(dBuV/m) = Raw Value(dBuV) + Correction Factor(dB/m)
2. Correction Factor(dB/m) = Antenna Factor(dB/m) + Cable Factor(dB) – Pre-Amplifier Factor(dB)
3. The other emission levels were very low against the limit.
4. Margin value = Emission Level – Limit value
5. " * ": Fundamental frequency.
6. " # ": The radiated frequency is out of the restricted band.

CHANNEL	TX Channel 155	DETECTOR FUNCTION	Peak (PK)
FREQUENCY RANGE	1GHz ~ 40GHz		Average (AV)

ANTENNA POLARITY & TEST DISTANCE: HORIZONTAL AT 3 M

NO.	FREQ. (MHz)	EMISSION LEVEL (dBuV/m)	LIMIT (dBuV/m)	MARGIN (dB)	ANTENNA HEIGHT (m)	TABLE ANGLE (Degree)	RAW VALUE (dBuV)	CORRECTION FACTOR (dB/m)
1	#5647.66	66.5 PK	68.2	-1.7	1.39 H	176	63.8	2.7
2	*5775.00	109.6 PK			1.39 H	176	106.6	3.0
3	*5775.00	101.1 AV			1.39 H	176	98.1	3.0
4	#5926.13	60.8 PK	68.2	-7.4	1.39 H	176	57.4	3.4
5	11550.00	40.2 PK	74.0	-33.8	1.98 H	278	27.8	12.4
6	11550.00	38.3 AV	54.0	-15.7	1.98 H	278	25.9	12.4
7	#17325.00	44.3 PK	68.2	-23.9	1.47 H	93	28.6	15.7

ANTENNA POLARITY & TEST DISTANCE: VERTICAL AT 3 M

NO.	FREQ. (MHz)	EMISSION LEVEL (dBuV/m)	LIMIT (dBuV/m)	MARGIN (dB)	ANTENNA HEIGHT (m)	TABLE ANGLE (Degree)	RAW VALUE (dBuV)	CORRECTION FACTOR (dB/m)
1	#5638.62	64.9 PK	68.2	-3.3	3.47 V	231	62.2	2.7
2	*5775.00	108.2 PK			3.47 V	231	105.2	3.0
3	*5775.00	98.7 AV			3.47 V	231	95.7	3.0
4	#5944.58	56.8 PK	68.2	-11.4	3.47 V	231	53.5	3.3
5	11550.00	46.5 PK	74.0	-27.5	1.60 V	208	34.1	12.4
6	11550.00	36.7 AV	54.0	-17.3	1.60 V	208	24.3	12.4
7	#17325.00	56.8 PK	68.2	-11.4	1.77 V	176	41.1	15.7

REMARKS:

1. Emission Level(dBuV/m) = Raw Value(dBuV) + Correction Factor(dB/m)
2. Correction Factor(dB/m) = Antenna Factor(dB/m) + Cable Factor(dB) – Pre-Amplifier Factor(dB)
3. The other emission levels were very low against the limit.
4. Margin value = Emission Level – Limit value
5. " * ": Fundamental frequency.
6. " # ": The radiated frequency is out of the restricted band.

Below 1GHz Data:

802.11ac (VHT20)

CHANNEL	TX Channel 149	DETECTOR FUNCTION	Quasi-Peak (QP)
FREQUENCY RANGE	9kHz ~ 1GHz		

ANTENNA POLARITY & TEST DISTANCE: HORIZONTAL AT 3 M

NO.	FREQ. (MHz)	EMISSION LEVEL (dBuV/m)	LIMIT (dBuV/m)	MARGIN (dB)	ANTENNA HEIGHT (m)	TABLE ANGLE (Degree)	RAW VALUE (dBuV)	CORRECTION FACTOR (dB/m)
1	91.21	32.0 QP	43.5	-11.5	3.00 H	254	45.6	-13.6
2	141.31	32.2 QP	43.5	-11.3	2.50 H	241	40.1	-7.9
3	375.00	35.6 QP	46.0	-10.4	2.50 H	187	40.6	-5.0
4	500.01	35.3 QP	46.0	-10.7	1.50 H	279	37.3	-2.0
5	625.00	35.3 QP	46.0	-10.7	1.00 H	246	34.4	0.9
6	874.99	38.3 QP	46.0	-7.7	1.00 H	226	33.8	4.5

ANTENNA POLARITY & TEST DISTANCE: VERTICAL AT 3 M

NO.	FREQ. (MHz)	EMISSION LEVEL (dBuV/m)	LIMIT (dBuV/m)	MARGIN (dB)	ANTENNA HEIGHT (m)	TABLE ANGLE (Degree)	RAW VALUE (dBuV)	CORRECTION FACTOR (dB/m)
1	90.50	33.2 QP	43.5	-10.3	1.00 V	265	46.8	-13.6
2	124.99	33.6 QP	43.5	-9.9	1.00 V	311	42.9	-9.3
3	250.00	31.3 QP	46.0	-14.7	1.00 V	206	40.2	-8.9
4	375.00	34.5 QP	46.0	-11.5	1.00 V	341	39.5	-5.0
5	500.01	36.2 QP	46.0	-9.8	1.50 V	187	38.2	-2.0
6	874.99	36.3 QP	46.0	-9.7	1.00 V	279	31.8	4.5

REMARKS:

1. Emission Level(dBuV/m) = Raw Value(dBuV) + Correction Factor(dB/m)
2. Correction Factor(dB/m) = Antenna Factor(dB/m) + Cable Factor(dB) – Pre-Amplifier Factor(dB)
3. The other emission levels were very low against the limit.
4. Margin value = Emission Level – Limit value

4.2 Conducted Emission Measurement

4.2.1 Limits of Conducted Emission Measurement

Frequency (MHz)	Conducted Limit (dBuV)	
	Quasi-peak	Average
0.15 - 0.5	66 - 56	56 - 46
0.50 - 5.0	56	46
5.0 - 30.0	60	50

Note: 1. The lower limit shall apply at the transition frequencies.

2. The limit decreases in line with the logarithm of the frequency in the range of 0.15 to 0.50MHz.

4.2.2 Test Instruments

DESCRIPTION & MANUFACTURER	MODEL NO.	SERIAL NO.	CALIBRATED DATE	CALIBRATED UNTIL
Test Receiver R&S	ESCS 30	847124/029	Nov. 01, 2017	Oct. 31, 2018
Line-Impedance Stabilization Network (for EUT) R&S	ESH3-Z5	848773/004	Nov. 15, 2017	Nov. 14, 2018
Line-Impedance Stabilization Network (for Peripheral) R&S	ENV216	100072	June 04, 2018	June 03, 2019
50 ohms Terminator	N/A	EMC-02	Sep. 22, 2017	Sep. 21, 2018
RF Cable	5D-FB	COCCAB-001	Sep. 29, 2017	Sep. 28, 2018
Fixed attenuator EMCI	STI02-2200-10	003	Mar. 16, 2018	Mar. 15, 2019
Software BVADT	BVADT_Cond_ V7.3.7.4	NA	NA	NA

Note:

1. The calibration interval of the above test instruments are 12 months and the calibrations are traceable to NML/ROC and NIST/USA.
2. The test was performed in Conduction 1.
- 3 Tested Date: Aug. 18, 2018

4.2.3 Test Procedure

- The EUT was placed 0.4 meters from the conducting wall of the shielded room with EUT being connected to the power mains through a line impedance stabilization network (LISN). Other support units were connected to the power mains through another LISN. The two LISNs provide 50 ohm/ 50uH of coupling impedance for the measuring instrument.
- Both lines of the power mains connected to the EUT were checked for maximum conducted interference.
- The frequency range from 150kHz to 30MHz was searched. Emission levels under (Limit - 20dB) was not recorded.

Note: All modes of operation were investigated and the worst-case emissions are reported.

4.2.4 Deviation from Test Standard

No deviation.

4.2.5 Test Setup

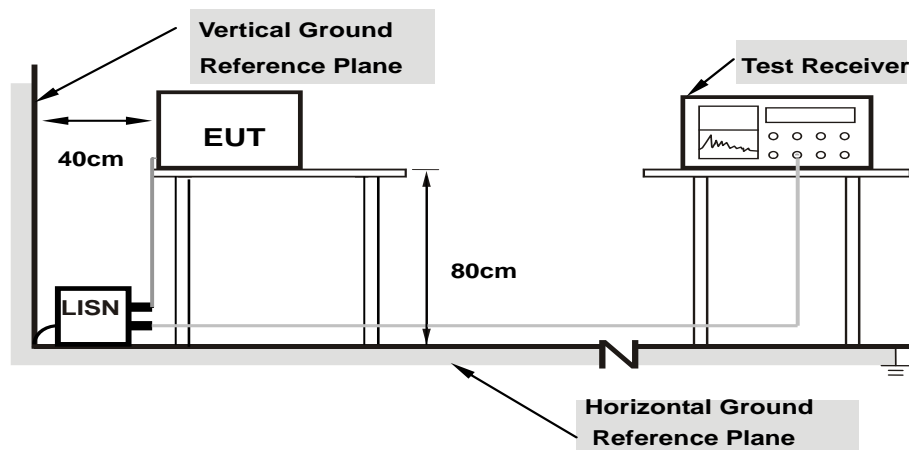

Note: 1.Support units were connected to second LISN.

For the actual test configuration, please refer to the attached file (Test Setup Photo).

4.2.6 EUT Operating Condition

Same as 4.1.6.

4.2.7 Test Results

Phase	Line (L)	Detector Function	Quasi-Peak (QP) / Average (AV)
-------	----------	-------------------	--------------------------------

No	Freq. [MHz]	Corr.	Reading Value		Emission Level		Limit		Margin	
		Factor (dB)	[dB (uV)]		[dB (uV)]		[dB (uV)]		(dB)	
		Q.P.	AV.	Q.P.	AV.	Q.P.	AV.	Q.P.	AV.	
1	0.15000	10.05	30.46	16.87	40.51	26.92	66.00	56.00	-25.49	-29.08
2	0.16953	10.05	28.66	15.92	38.71	25.97	64.98	54.98	-26.27	-29.01
3	0.23594	10.08	20.82	5.45	30.90	15.53	62.24	52.24	-31.34	-36.71
4	0.56406	10.13	13.25	7.10	23.38	17.23	56.00	46.00	-32.62	-28.77
5	8.74219	10.63	12.61	6.87	23.24	17.50	60.00	50.00	-36.76	-32.50
6	20.82422	11.40	10.83	5.12	22.23	16.52	60.00	50.00	-37.77	-33.48

Remarks:

1. Q.P. and AV. are abbreviations of quasi-peak and average individually.
2. The emission levels of other frequencies were very low against the limit.
3. Margin value = Emission level – Limit value
4. Correction factor = Insertion loss + Cable loss
5. Emission Level = Correction Factor + Reading Value

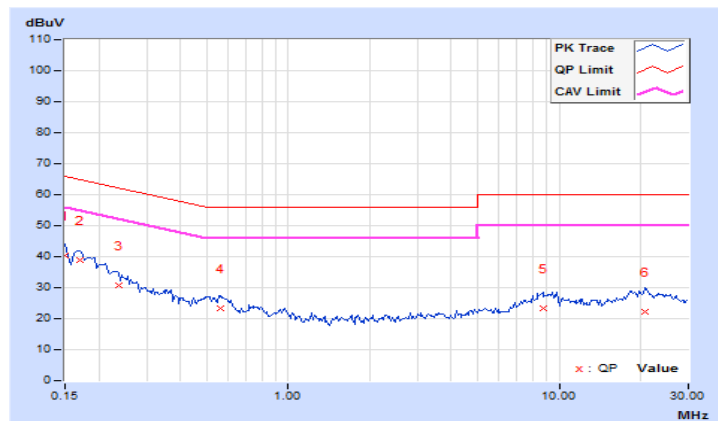

Phase	Neutral (N)	Detector Function	Quasi-Peak (QP) / Average (AV)
-------	-------------	-------------------	--------------------------------

No	Freq.	Corr.	Reading Value		Emission Level		Limit		Margin	
	[MHz]	Factor	[dB (uV)]		[dB (uV)]		[dB (uV)]		(dB)	
		(dB)	Q.P.	AV.	Q.P.	AV.	Q.P.	AV.	Q.P.	AV.
1	0.15000	9.95	31.69	17.19	41.64	27.14	66.00	56.00	-24.36	-28.86
2	0.16953	9.96	29.53	15.94	39.49	25.90	64.98	54.98	-25.49	-29.08
3	0.56406	10.03	11.88	3.74	21.91	13.77	56.00	46.00	-34.09	-32.23
4	3.22656	10.16	-1.28	-8.49	8.88	1.67	56.00	46.00	-47.12	-44.33
5	9.12109	10.49	9.52	2.01	20.01	12.50	60.00	50.00	-39.99	-37.50
6	22.09766	11.19	9.66	3.89	20.85	15.08	60.00	50.00	-39.15	-34.92

Remarks:

1. Q.P. and AV. are abbreviations of quasi-peak and average individually.
2. The emission levels of other frequencies were very low against the limit.
3. Margin value = Emission level – Limit value
4. Correction factor = Insertion loss + Cable loss
5. Emission Level = Correction Factor + Reading Value

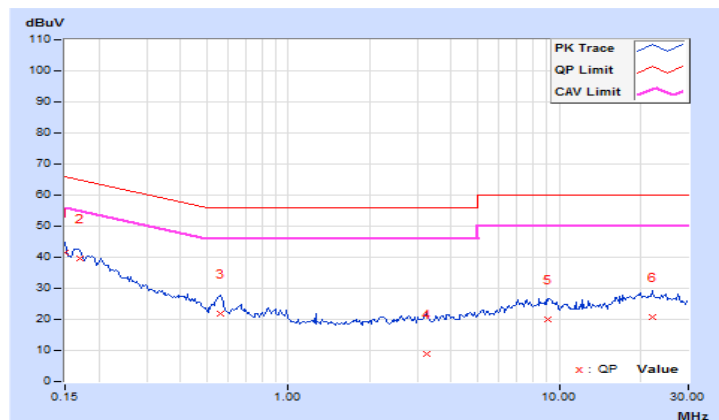

4.3 Transmit Power Measurement

4.3.1 Limits of Transmit Power Measurement

Operation Band	EUT Category		Limit
U-NII-1		Outdoor Access Point	1 Watt (30 dBm) (Max. e.i.r.p \leq 125mW(21 dBm) at any elevation angle above 30 degrees as measured from the horizon)
		Fixed point-to-point Access Point	1 Watt (30 dBm)
	√	Indoor Access Point	1 Watt (30 dBm)
	√	Client device	250mW (24 dBm)
U-NII-2A			250mW (24 dBm) or 11 dBm+10 log B*
U-NII-2C			250mW (24 dBm) or 11 dBm+10 log B*
U-NII-3		√	1 Watt (30 dBm)

*B is the 26 dB emission bandwidth in megahertz

Note: This device can support different category application which switched to access point mode and client mode by software.

Per KDB 662911 Method of conducted output power measurement on IEEE 802.11 devices,

Array Gain = 0 dB (i.e., no array gain) for $N_{ANT} \leq 4$;

Array Gain = 0 dB (i.e., no array gain) for channel widths ≥ 40 MHz for any N_{ANT} ;

Array Gain = $5 \log(N_{ANT}/N_{SS})$ dB or 3 dB, whichever is less for 20-MHz channel widths with $N_{ANT} \geq 5$.

For power measurements on all other devices: Array Gain = $10 \log(N_{ANT}/N_{SS})$ dB.

4.3.2 Test Setup

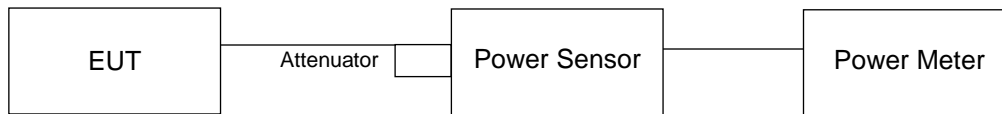

4.3.3 Test Instruments

Refer to section 4.1.2 to get information of above instrument.

4.3.4 Test Procedure

Method PM is used to perform output power measurement, trigger and gating function of wide band power meter is enabled to measure max output power of TX on burst. Duty factor is not added to measured value.

4.3.5 Deviation from Test Standard

No deviation.

4.3.6 EUT Operating Condition

The software provided by client to enable the EUT under transmission condition continuously at lowest, middle and highest channel frequencies individually.

4.3.7 Test Results

Master Mode
CDD Mode
802.11a

Chan.	Chan. Freq. (MHz)	Maximum Conducted (dBm)		Total Power (mW)	Total Power (dBm)	Limit (dBm)	Pass / Fail
		Chain 0	Chain 1				
36	5180	17.74	17.66	117.774	20.71	30.00	Pass
40	5200	22.28	22.24	336.538	25.27	30.00	Pass
48	5240	21.25	21.12	262.772	24.20	30.00	Pass
149	5745	23.55	23.48	449.308	26.53	30.00	Pass
157	5785	23.38	23.36	434.541	26.38	30.00	Pass
165	5825	23.26	23.25	423.185	26.27	30.00	Pass

802.11ac (VHT20)

Chan.	Chan. Freq. (MHz)	Maximum Conducted (dBm)		Total Power (mW)	Total Power (dBm)	Limit (dBm)	Pass / Fail
		Chain 0	Chain 1				
36	5180	17.69	17.72	117.905	20.72	30.00	Pass
40	5200	22.26	22.21	334.608	25.25	30.00	Pass
48	5240	21.22	21.13	262.152	24.19	30.00	Pass
149	5745	23.56	23.49	450.343	26.54	30.00	Pass
157	5785	23.38	23.34	433.545	26.37	30.00	Pass
165	5825	23.45	23.33	436.587	26.40	30.00	Pass

802.11ac (VHT40)

Chan.	Chan. Freq. (MHz)	Maximum Conducted (dBm)		Total Power (mW)	Total Power (dBm)	Limit (dBm)	Pass / Fail
		Chain 0	Chain 1				
38	5190	14.52	14.41	55.92	17.48	30.00	Pass
46	5230	20.06	20.02	201.853	23.05	30.00	Pass
151	5755	23.13	23.11	410.233	26.13	30.00	Pass
159	5795	23.51	23.44	445.188	26.49	30.00	Pass

802.11ac (VHT80)

Chan.	Chan. Freq. (MHz)	Maximum Conducted (dBm)		Total Power (mW)	Total Power (dBm)	Limit (dBm)	Pass / Fail
		Chain 0	Chain 1				
42	5210	13.98	13.96	49.892	16.98	30.00	Pass
155	5775	19.32	19.12	167.165	22.23	30.00	Pass

Beamforming Mode

802.11ac (VHT20)

Chan.	Chan. Freq. (MHz)	Maximum Conducted (dBm)		Total Power (mW)	Total Power (dBm)	Limit (dBm)	Pass / Fail
		Chain 0	Chain 1				
36	5180	17.69	17.72	117.905	20.72	29.15	Pass
40	5200	22.26	22.21	334.608	25.25	29.15	Pass
48	5240	21.22	21.13	262.152	24.19	29.15	Pass
149	5745	23.56	23.49	450.343	26.54	29.15	Pass
157	5785	23.38	23.34	433.545	26.37	29.15	Pass
165	5825	23.45	23.33	436.587	26.40	29.15	Pass

Note: The directional gain = $10 \log[(10^{\text{Chain0}/20} + 10^{\text{Chain1}/20})^2 / 2] = 6.85\text{dBi} > 6\text{dBi}$, so the power limit shall be reduced to $30 - (6.85 - 6) = 29.15\text{dBm}$.

802.11ac (VHT40)

Chan.	Chan. Freq. (MHz)	Maximum Conducted (dBm)		Total Power (mW)	Total Power (dBm)	Limit (dBm)	Pass / Fail
		Chain 0	Chain 1				
38	5190	14.52	14.41	55.92	17.48	29.15	Pass
46	5230	20.06	20.02	201.853	23.05	29.15	Pass
151	5755	23.13	23.11	410.233	26.13	29.15	Pass
159	5795	23.51	23.44	445.188	26.49	29.15	Pass

Note: The directional gain = $10 \log[(10^{\text{Chain0}/20} + 10^{\text{Chain1}/20})^2 / 2] = 6.85\text{dBi} > 6\text{dBi}$, so the power limit shall be reduced to $30 - (6.85 - 6) = 29.15\text{dBm}$.

802.11ac (VHT80)

Chan.	Chan. Freq. (MHz)	Maximum Conducted (dBm)		Total Power (mW)	Total Power (dBm)	Limit (dBm)	Pass / Fail
		Chain 0	Chain 1				
42	5210	13.98	13.96	49.892	16.98	29.15	Pass
155	5775	19.32	19.12	167.165	22.23	29.15	Pass

Note: The directional gain = $10 \log[(10^{\text{Chain0}/20} + 10^{\text{Chain1}/20})^2 / 2] = 6.85\text{dBi} > 6\text{dBi}$, so the power limit shall be reduced to $30 - (6.85 - 6) = 29.15\text{dBm}$.

Client Mode
CDD Mode
802.11a

Chan.	Chan. Freq. (MHz)	Maximum Conducted (dBm)		Total Power (mW)	Total Power (dBm)	Limit (dBm)	Pass / Fail
		Chain 0	Chain 1				
36	5180	17.74	17.66	117.774	20.71	24.00	Pass
40	5200	19.87	19.78	192.111	22.84	24.00	Pass
48	5240	19.76	19.75	189.03	22.77	24.00	Pass
149	5745	23.55	23.48	449.308	26.53	30.00	Pass
157	5785	23.38	23.36	434.541	26.38	30.00	Pass
165	5825	23.26	23.25	423.185	26.27	30.00	Pass

802.11ac (VHT20)

Chan.	Chan. Freq. (MHz)	Maximum Conducted (dBm)		Total Power (mW)	Total Power (dBm)	Limit (dBm)	Pass / Fail
		Chain 0	Chain 1				
36	5180	17.69	17.72	117.905	20.72	24.00	Pass
40	5200	19.76	19.73	188.596	22.76	24.00	Pass
48	5240	19.74	19.69	187.3	22.73	24.00	Pass
149	5745	23.56	23.49	450.343	26.54	30.00	Pass
157	5785	23.38	23.34	433.545	26.37	30.00	Pass
165	5825	23.45	23.33	436.587	26.40	30.00	Pass

802.11ac (VHT40)

Chan.	Chan. Freq. (MHz)	Maximum Conducted (dBm)		Total Power (mW)	Total Power (dBm)	Limit (dBm)	Pass / Fail
		Chain 0	Chain 1				
38	5190	14.52	14.41	55.92	17.48	24.00	Pass
46	5230	20.06	20.02	201.853	23.05	24.00	Pass
151	5755	23.13	23.11	410.233	26.13	30.00	Pass
159	5795	23.51	23.44	445.188	26.49	30.00	Pass

802.11ac (VHT80)

Chan.	Chan. Freq. (MHz)	Maximum Conducted (dBm)		Total Power (mW)	Total Power (dBm)	Limit (dBm)	Pass / Fail
		Chain 0	Chain 1				
42	5210	13.98	13.96	49.892	16.98	24.00	Pass
155	5775	19.32	19.12	167.165	22.23	30.00	Pass

Beamforming Mode

802.11ac (VHT20)

Chan.	Chan. Freq. (MHz)	Maximum Conducted (dBm)		Total Power (mW)	Total Power (dBm)	Limit (dBm)	Pass / Fail
		Chain 0	Chain 1				
36	5180	17.69	17.72	117.905	20.72	23.15	Pass
40	5200	19.76	19.73	188.596	22.76	23.15	Pass
48	5240	19.74	19.69	187.3	22.73	23.15	Pass
149	5745	23.56	23.49	450.343	26.54	29.15	Pass
157	5785	23.38	23.34	433.545	26.37	29.15	Pass
165	5825	23.45	23.33	436.587	26.40	29.15	Pass

- Note: 1. Fot U-NII-1 band: the directional gain = $10 \log[(10^{\text{Chain0}/20} + 10^{\text{Chain1}/20})^2 / 2] = 6.85\text{dBi} > 6\text{dBi}$, so the power limit shall be reduced to $24 - (6.85 - 6) = 23.15\text{dBm}$.
2. Fot U-NII-3 band: the directional gain = $10 \log[(10^{\text{Chain0}/20} + 10^{\text{Chain1}/20})^2 / 2] = 6.85\text{dBi} > 6\text{dBi}$, so the power limit shall be reduced to $30 - (6.85 - 6) = 29.15\text{dBm}$.

802.11ac (VHT40)

Chan.	Chan. Freq. (MHz)	Maximum Conducted (dBm)		Total Power (mW)	Total Power (dBm)	Limit (dBm)	Pass / Fail
		Chain 0	Chain 1				
38	5190	14.52	14.41	55.92	17.48	23.15	Pass
46	5230	20.06	20.02	201.853	23.05	23.15	Pass
151	5755	23.13	23.11	410.233	26.13	29.15	Pass
159	5795	23.51	23.44	445.188	26.49	29.15	Pass

- Note: 1. Fot U-NII-1 band: the directional gain = $10 \log[(10^{\text{Chain0}/20} + 10^{\text{Chain1}/20})^2 / 2] = 6.85\text{dBi} > 6\text{dBi}$, so the power limit shall be reduced to $24 - (6.85 - 6) = 23.15\text{dBm}$.
2. Fot U-NII-3 band: the directional gain = $10 \log[(10^{\text{Chain0}/20} + 10^{\text{Chain1}/20})^2 / 2] = 6.85\text{dBi} > 6\text{dBi}$, so the power limit shall be reduced to $30 - (6.85 - 6) = 29.15\text{dBm}$.

802.11ac (VHT80)

Chan.	Chan. Freq. (MHz)	Maximum Conducted (dBm)		Total Power (mW)	Total Power (dBm)	Limit (dBm)	Pass / Fail
		Chain 0	Chain 1				
42	5210	13.98	13.96	49.892	16.98	23.15	Pass
155	5775	19.32	19.12	167.165	22.23	29.15	Pass

- Note: 1. Fot U-NII-1 band: the directional gain = $10 \log[(10^{\text{Chain0}/20} + 10^{\text{Chain1}/20})^2 / 2] = 6.85\text{dBi} > 6\text{dBi}$, so the power limit shall be reduced to $24 - (6.85 - 6) = 23.15\text{dBm}$.
2. Fot U-NII-3 band: the directional gain = $10 \log[(10^{\text{Chain0}/20} + 10^{\text{Chain1}/20})^2 / 2] = 6.85\text{dBi} > 6\text{dBi}$, so the power limit shall be reduced to $30 - (6.85 - 6) = 29.15\text{dBm}$.

4.4 Occupied Bandwidth Measurement

4.4.1 Test Setup

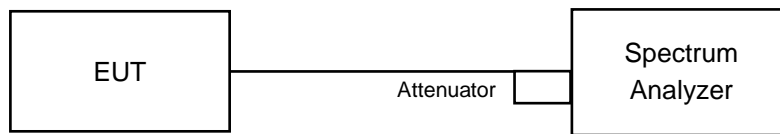

4.4.2 Test Instruments

Refer to section 4.1.2 to get information of above instrument.

4.4.3 Test Procedure

The transmitter output was connected to the spectrum analyzer through an attenuator. The bandwidth of the fundamental frequency was measured by spectrum analyzer with resolution bandwidth in the range of 1% to 5% of the anticipated emission bandwidth, and a video bandwidth at least 3x the resolution bandwidth and set the detector to SAMPLE. The width of a frequency band such that, below the lower and above the upper frequency limits, the mean powers emitted are each equal to a specified percentage 0.5 %of the total mean power of a given emission.

4.4.4 Test Results

CDD Mode

Master Mode

802.11a

Channel	Channel Frequency (MHz)	Occupied Bandwidth (MHz)	
		Chain 0	Chain 1
36	5180	16.56	16.44
40	5200	16.92	18.00
48	5240	16.68	16.80
149	5745	24.60	27.24
157	5785	23.52	27.48
165	5825	22.92	28.92

802.11ac (VHT20)

Channel	Channel Frequency (MHz)	Occupied Bandwidth (MHz)	
		Chain 0	Chain 1
36	5180	17.76	17.76
40	5200	18.00	18.72
48	5240	17.76	17.88
149	5745	25.20	26.88
157	5785	24.48	28.20
165	5825	23.04	30.12

802.11ac (VHT40)

Channel	Channel Frequency (MHz)	Occupied Bandwidth (MHz)	
		Chain 0	Chain 1
38	5190	36.24	36.24
46	5230	36.48	36.48
151	5755	51.84	46.32
159	5795	48.96	55.68

802.11ac (VHT80)

Channel	Channel Frequency (MHz)	Occupied Bandwidth (MHz)	
		Chain 0	Chain 1
42	5210	75.84	76.32
155	5775	75.84	76.32

Spectrum Plot of Max Value

802.11a_Chain 1 / CH165

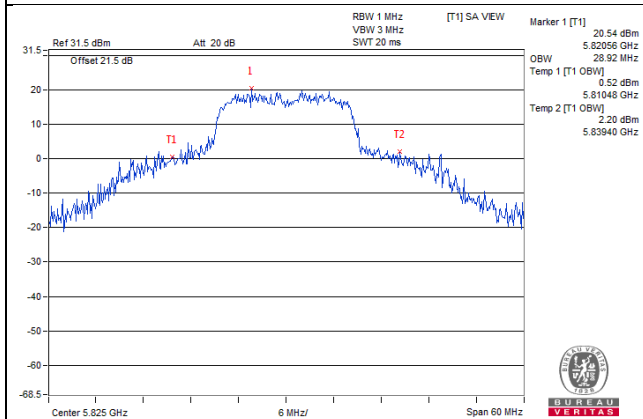

802.11ac (VHT20)_Chain 1 / CH165

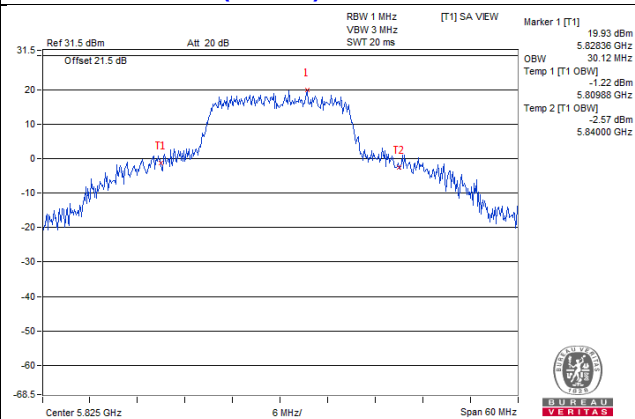

802.11ac (VHT40)_Chain 1 / CH159

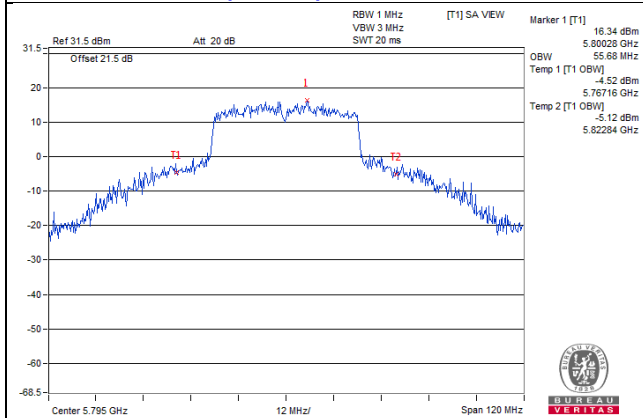

802.11ac (VHT80)_Chain 1 / CH42

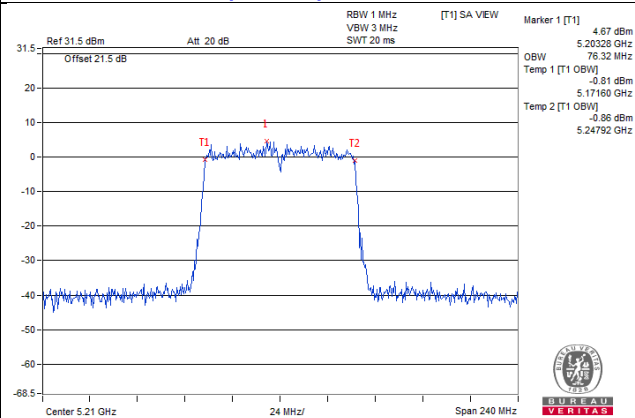

**Spectrum Plot for near by DFS band
(DFS is required, if 99% OCP straddle into U-NII-2A band)**

802.11a_Chain0 / CH48

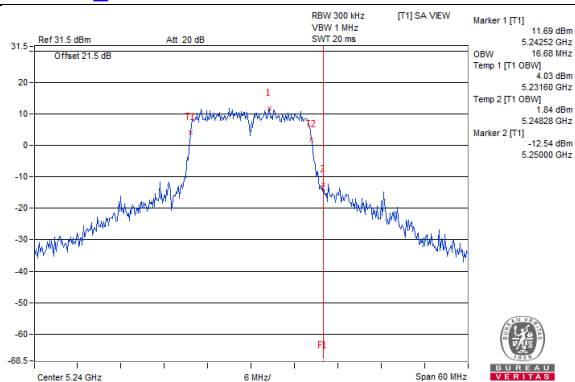

802.11a_Chain1 / CH48

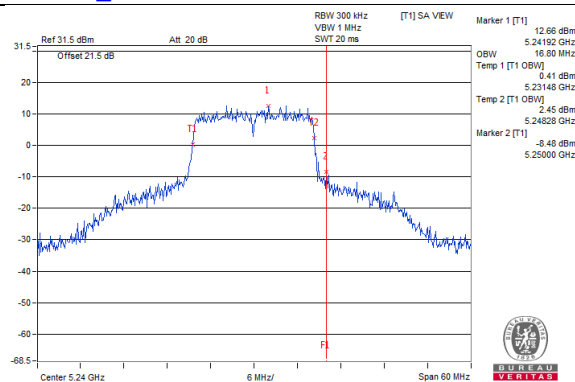

802.11ac (VHT20)_Chain0 / CH48

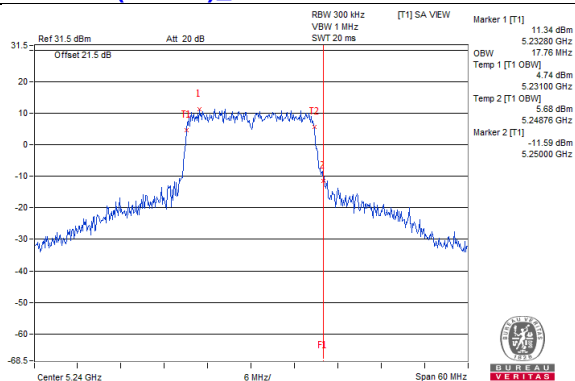

802.11ac (VHT20)_Chain1 / CH48

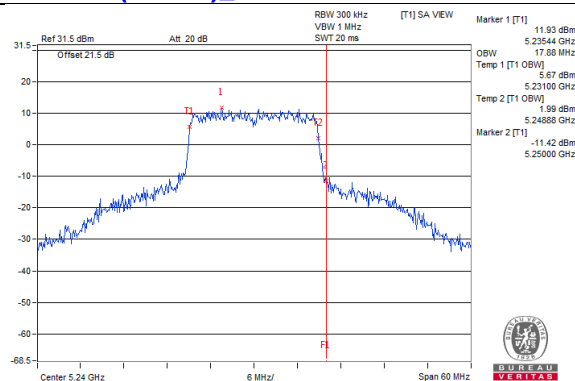

**Spectrum Plot for near by DFS band
(DFS is required, if 99% OCP straddle into U-NII-2A band)**

802.11ac (VHT40)_Chain0 / CH46

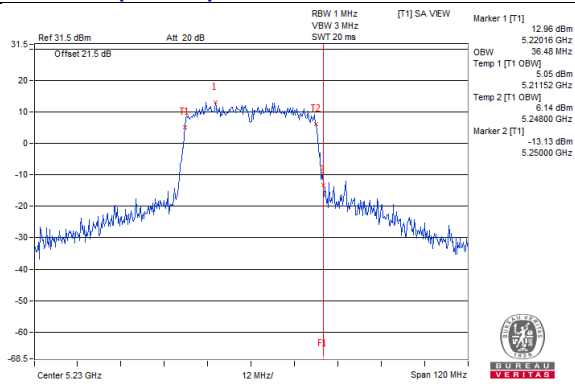

802.11ac (VHT40)_Chain1 / CH46

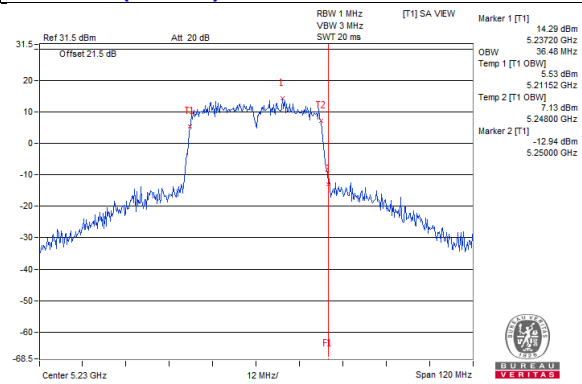

802.11ac (VHT80)_Chain0 / CH42

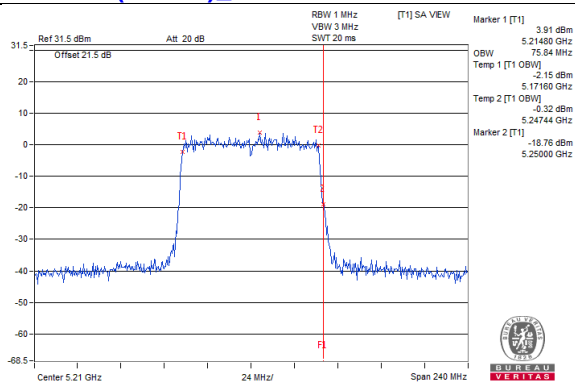

802.11ac (VHT80)_Chain1 / CH42

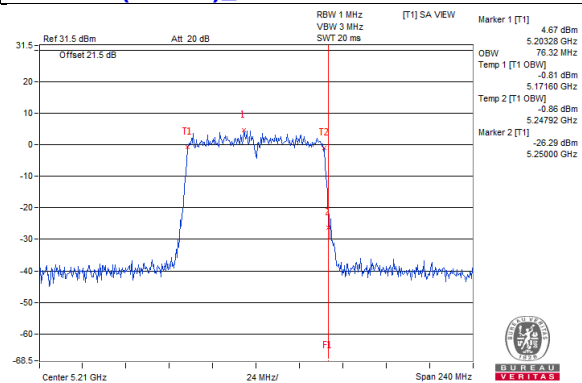

**Spectrum Plot for near by DFS band
(DFS is required, if 99% OCP straddle into U-NII-2C band)**

802.11a_Chain0 / CH149

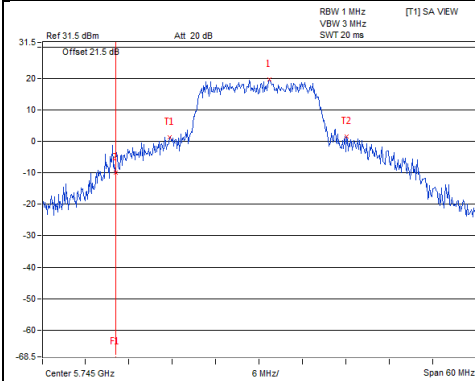

802.11a_Chain1 / CH149

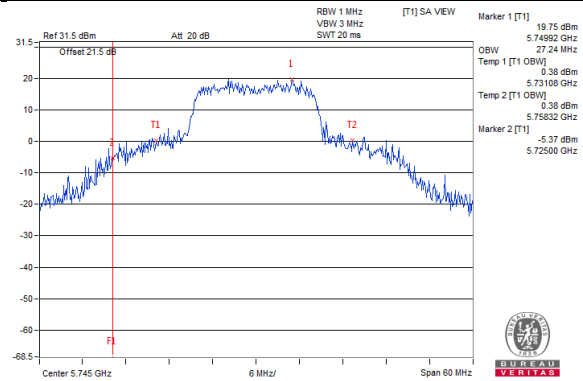

802.11ac (VHT20)_Chain0 / CH149

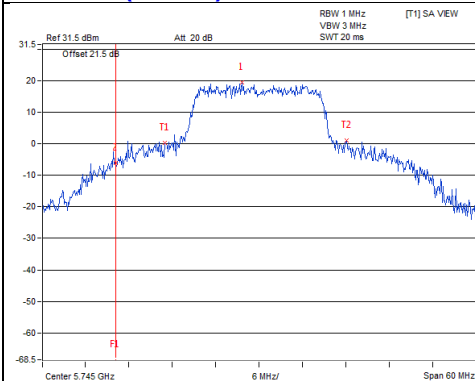

802.11ac (VHT20)_Chain1 / CH149

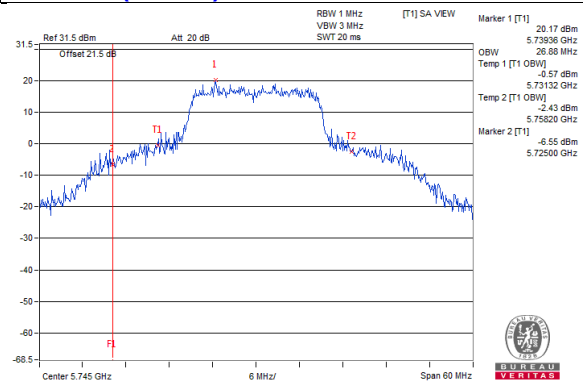

**Spectrum Plot for near by DFS band
(DFS is required, if 99% OCP straddle into U-NII-2C band)**

802.11ac (VHT40)_Chain0 / CH151

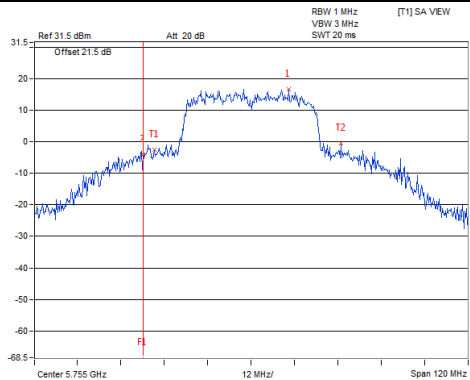

802.11ac (VHT40)_Chain1 / CH151

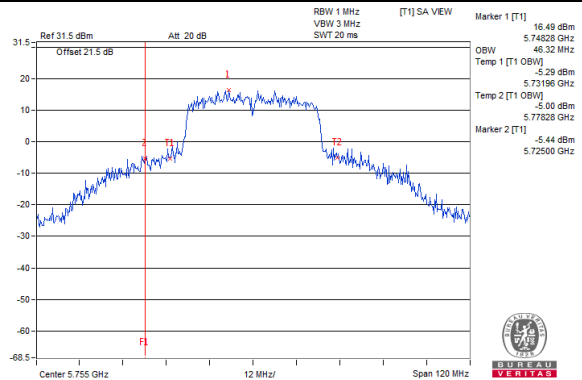

802.11ac (VHT80)_Chain0 / CH155

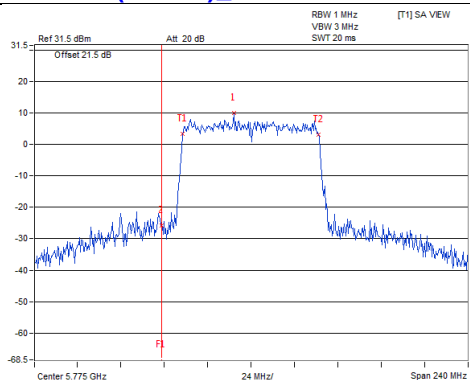

802.11ac (VHT80)_Chain1 / CH155

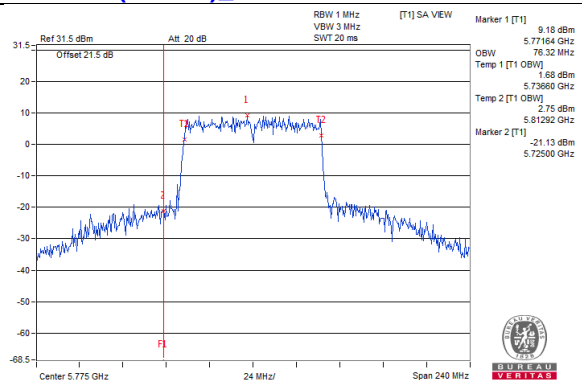

Client Mode
802.11a

Channel	Channel Frequency (MHz)	Occupied Bandwidth (MHz)	
		Chain 0	Chain 1
36	5180	16.56	16.44
40	5200	16.92	16.68
48	5240	16.68	16.56
149	5745	24.60	27.24
157	5785	23.52	27.48
165	5825	22.92	28.92

802.11ac (VHT20)

Channel	Channel Frequency (MHz)	Occupied Bandwidth (MHz)	
		Chain 0	Chain 1
36	5180	17.76	17.76
40	5200	18.00	17.76
48	5240	17.76	17.88
149	5745	25.20	26.88
157	5785	24.48	28.20
165	5825	23.04	30.12

802.11ac (VHT40)

Channel	Channel Frequency (MHz)	Occupied Bandwidth (MHz)	
		Chain 0	Chain 1
38	5190	36.24	36.24
46	5230	36.48	36.48
151	5755	51.84	46.32
159	5795	48.96	55.68

802.11ac (VHT80)

Channel	Channel Frequency (MHz)	Occupied Bandwidth (MHz)	
		Chain 0	Chain 1
42	5210	75.84	76.32
155	5775	75.84	76.32

Spectrum Plot of Max Value

802.11a_Chain 1 / CH165

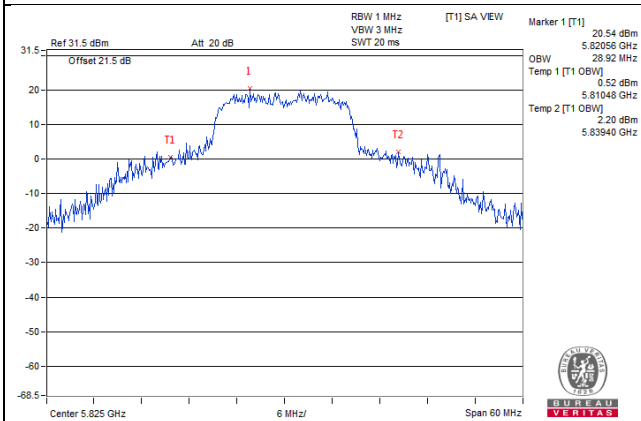

802.11ac (VHT20)_Chain 1 / CH165

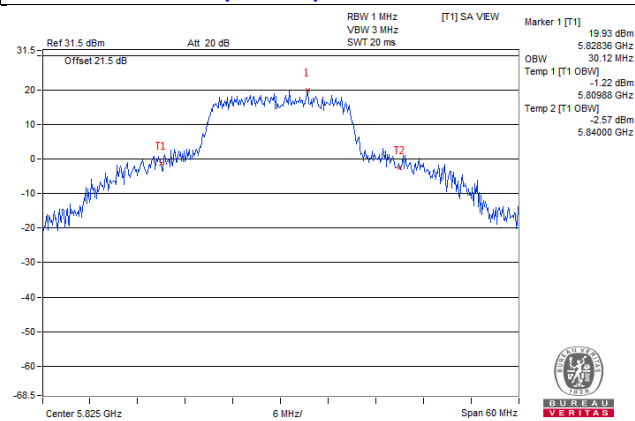

802.11ac (VHT40)_Chain 1 / CH159

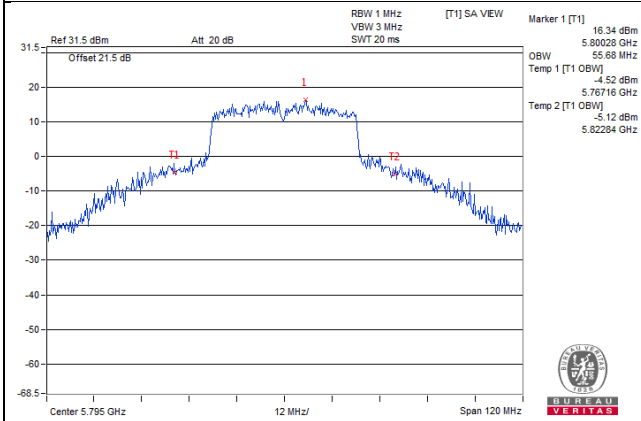

802.11ac (VHT80)_Chain 1 / CH42

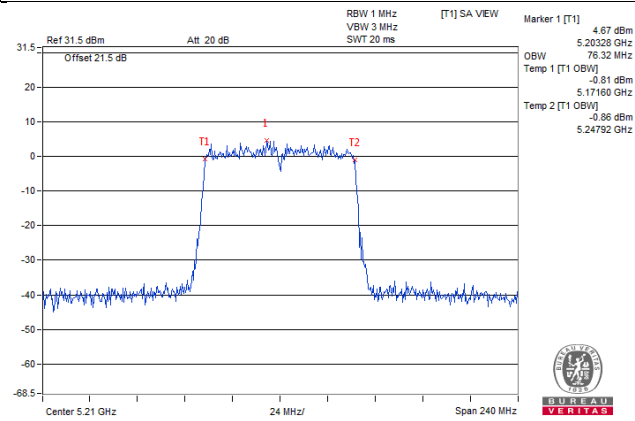

**Spectrum Plot for near by DFS band
(DFS is required, if 99% OCP straddle into U-NII-2A band)**

802.11a_Chain0 / CH48

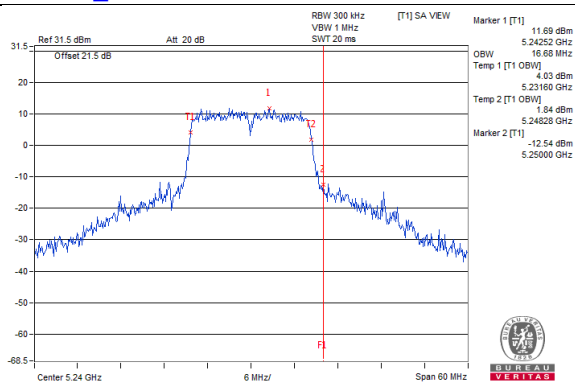

802.11a_Chain1 / CH48

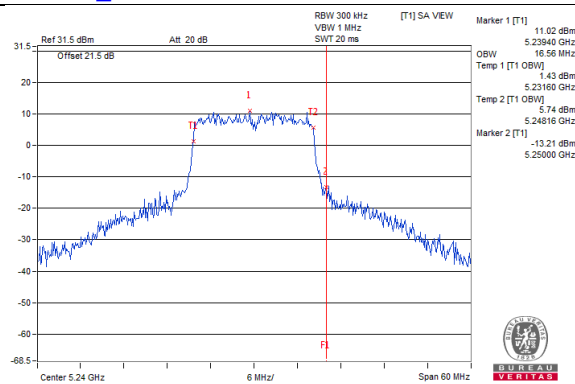

802.11ac (VHT20)_Chain0 / CH48

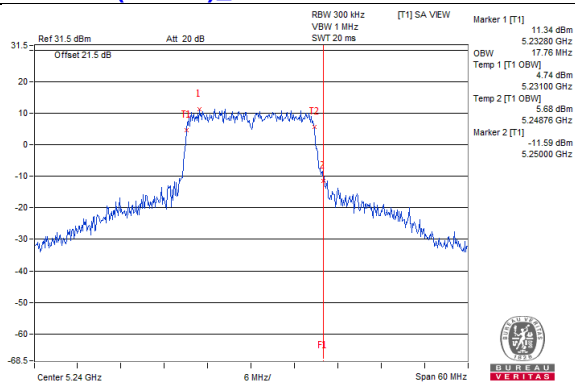

802.11ac (VHT20)_Chain1 / CH48

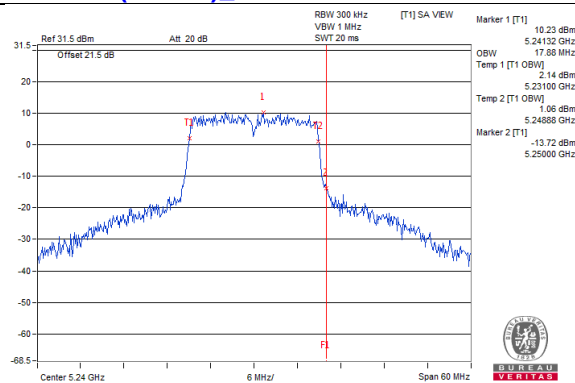

**Spectrum Plot for near by DFS band
(DFS is required, if 99% OCP straddle into U-NII-2A band)**

802.11ac (VHT40)_Chain0 / CH46

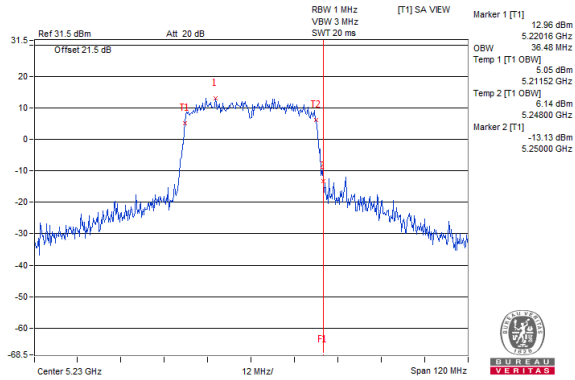

802.11ac (VHT40)_Chain1 / CH46

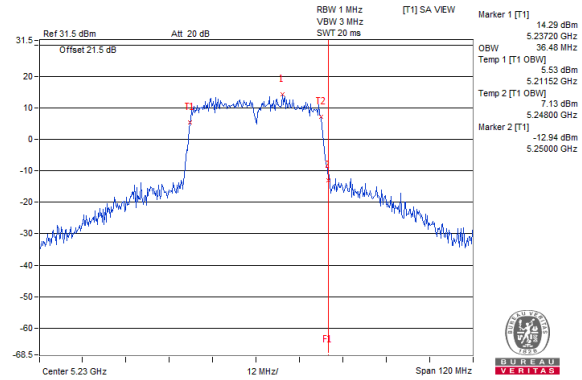

802.11ac (VHT80)_Chain0 / CH42

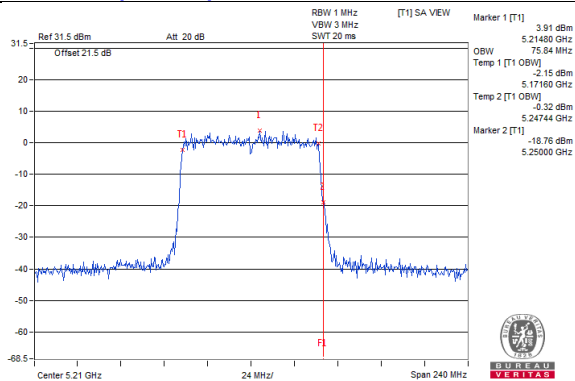

802.11ac (VHT80)_Chain1 / CH42

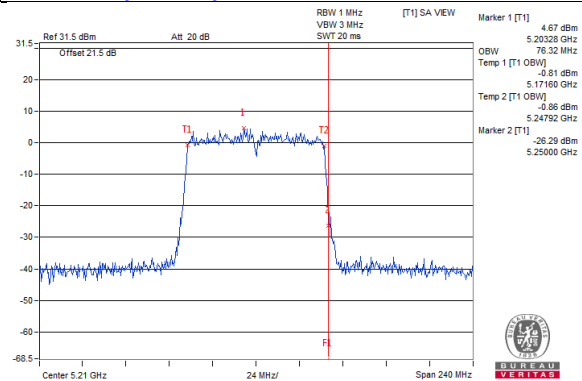

**Spectrum Plot for near by DFS band
(DFS is required, if 99% OCP straddle into U-NII-2C band)**

802.11a_Chain0 / CH149

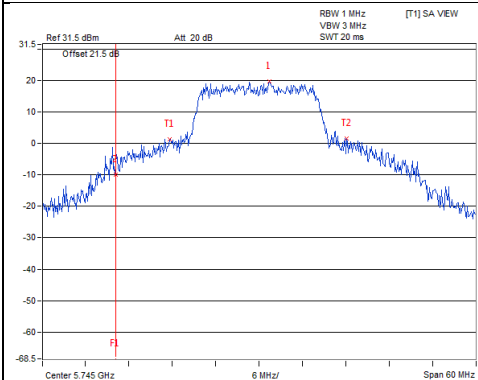

802.11a_Chain1 / CH149

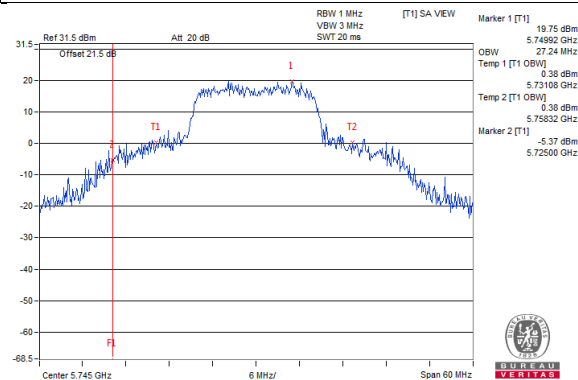

802.11ac (VHT20)_Chain0 / CH149

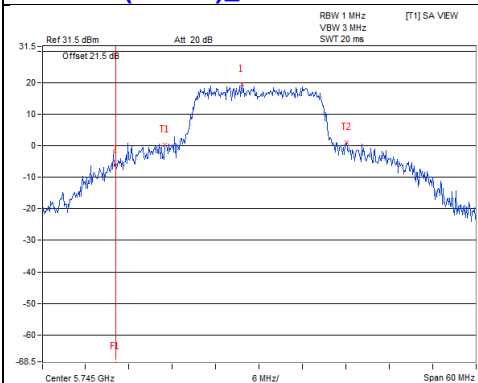

802.11ac (VHT20)_Chain1 / CH149

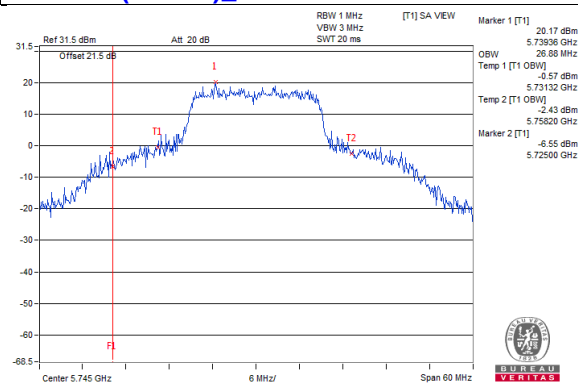

**Spectrum Plot for near by DFS band
(DFS is required, if 99% OCP straddle into U-NII-2C band)**

802.11ac (VHT40)_Chain0 / CH151

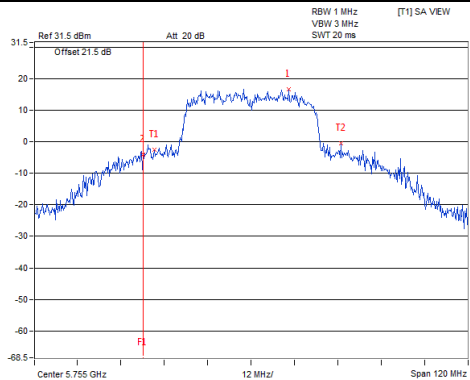

802.11ac (VHT40)_Chain1 / CH151

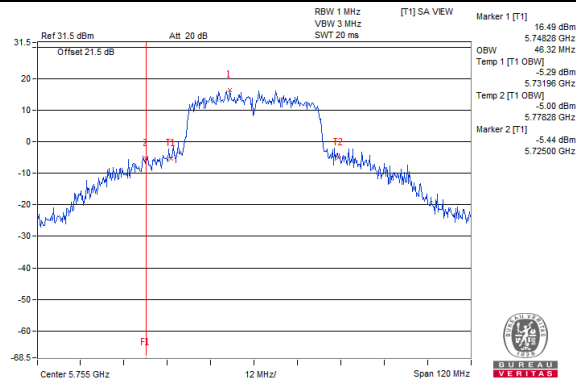

802.11ac (VHT80)_Chain0 / CH155

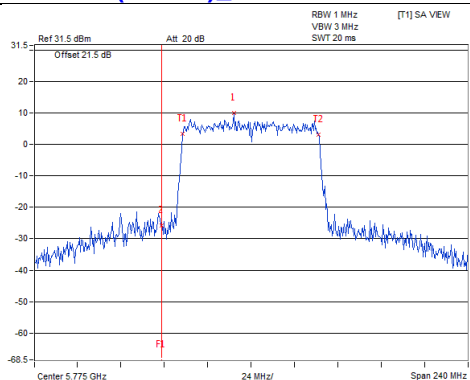

802.11ac (VHT80)_Chain1 / CH155

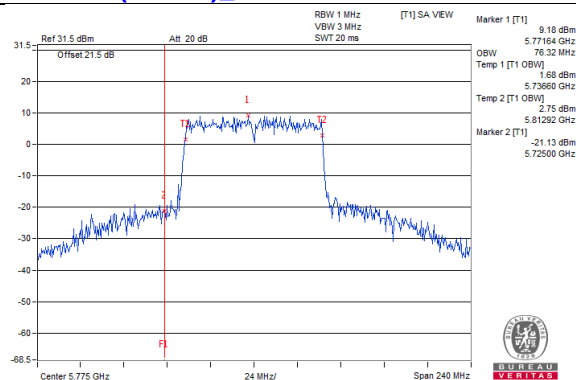

4.5 Peak Power Spectral Density Measurement

4.5.1 Limits of Peak Power Spectral Density Measurement

Operation Band	EUT Category		Limit
U-NII-1		Outdoor Access Point	17dBm/ MHz
		Fixed point-to-point Access Point	
	√	Indoor Access Point	
	√	Client device	
U-NII-2A			11dBm/ MHz
U-NII-2C			11dBm/ MHz
U-NII-3	√		30dBm/ 500kHz

Note: This device can support different category application which switched to access point mode and client mode by software.

4.5.2 Test Setup

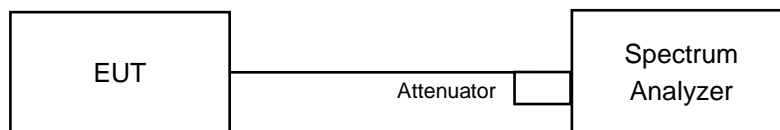

4.5.3 Test Instruments

Refer to section 4.1.2 to get information of above instrument.

4.5.4 Test Procedure

For U-NII-1 band:

For 802.11ac (VHT20)

Using method SA-1

1. Set span to encompass the entire emission bandwidth (EBW) of the signal.
2. Set RBW = 1 MHz, Set VBW \geq 3 MHz, Detector = RMS
3. Sweep time = auto, trigger set to "free run".
4. Trace average at least 100 traces in power averaging mode.
5. Record the max value

For 802.11a, 802.11ac (VHT40) & 802.11ac (VHT80)

Using method SA-2

1. Set span to encompass the entire emission bandwidth (EBW) of the signal.
2. Set RBW = 1 MHz, Set VBW \geq 3 MHz, Detector = RMS
3. Sweep time = auto, trigger set to "free run".
4. Trace average at least 100 traces in power averaging mode.
5. Record the max value and add $10 \log (1/\text{duty cycle})$

For U-NII-3:

For 802.11ac (VHT20)

1. Set span to encompass the entire emission bandwidth (EBW) of the signal.
2. Set RBW = 300 kHz, Set VBW \geq 1 MHz, Detector = RMS
3. Use the peak marker function to determine the maximum power level in any 300 kHz band segment within the fundamental EBW.
4. Scale the observed power level to an equivalent value in 500 kHz by adjusting (reducing) the measured power by a bandwidth correction factor (BWCF) where $\text{BWCF} = 10 \log(500\text{kHz}/300\text{kHz})$
5. Sweep time = auto, trigger set to "free run".
6. Trace average at least 100 traces in power averaging mode.
7. Record the max value

For 802.11a, 802.11ac (VHT40) & 802.11ac (VHT80)

1. Set span to encompass the entire emission bandwidth (EBW) of the signal.
2. Set RBW = 300 kHz, Set VBW \geq 1 MHz, Detector = RMS
3. Use the peak marker function to determine the maximum power level in any 300 kHz band segment within the fundamental EBW.
4. Scale the observed power level to an equivalent value in 500 kHz by adjusting (reducing) the measured power by a bandwidth correction factor (BWCF) where $\text{BWCF} = 10 \log(500\text{kHz}/300\text{kHz})$
5. Sweep time = auto, trigger set to "free run".
6. Trace average at least 100 traces in power averaging mode.
7. Record the max value and add $10 \log (1/\text{duty cycle})$

4.5.5 Deviation from Test Standard

No deviation.

4.5.6 EUT Operating Condition

Same as Item 4.3.6.

4.5.7 Test Results

For U-NII-1:

CDD Mode

Master Mode

802.11a

Chan.	Chan. Freq. (MHz)	PSD W/O Duty Factor (dBm/MHz)		Duty Factor (dB)	Total PSD With Duty Factor (dBm/MHz)	MAX. Limit (dBm/MHz)	Pass / Fail
		Chain 0	Chain 1				
36	5180	3.54	3.62	0.21	6.80	16.15	Pass
40	5200	8.16	8.07	0.21	11.33	16.15	Pass
48	5240	7.54	7.43	0.21	10.70	16.15	Pass

- Note: 1. Method a) of power density measurement of KDB 662911 is using for calculating total power density. Total power density is summing entire spectra across corresponding frequency bins on the various outputs by computer.
2. The Directional gain = $10 \log[(10^{\text{Chain0}/20} + 10^{\text{Chain1}/20})^2 / 2] = 6.85\text{dBi} > 6\text{dBi}$, so the power density limit shall be reduced to $17-(6.85-6) = 16.15\text{dBm}$.
3. Refer to section 3.3 for duty cycle spectrum plot.

802.11ac (VHT20)

Chan.	Chan. Freq. (MHz)	PSD (dBm/MHz)		Total Power Density (dBm/MHz)	MAX. Limit (dBm/MHz)	Pass / Fail
		Chain 0	Chain 1			
36	5180	3.36	3.74	6.56	16.15	Pass
40	5200	8.29	8.23	11.27	16.15	Pass
48	5240	7.17	7.32	10.26	16.15	Pass

- Note: 1. Method a) of power density measurement of KDB 662911 is using for calculating total power density. Total power density is summing entire spectra across corresponding frequency bins on the various outputs by computer.
2. The Directional gain = $10 \log[(10^{\text{Chain0}/20} + 10^{\text{Chain1}/20})^2 / 2] = 6.85\text{dBi} > 6\text{dBi}$, so the power density limit shall be reduced to $17-(6.85-6) = 16.15\text{dBm}$.

802.11ac (VHT40)

Chan.	Chan. Freq. (MHz)	PSD W/O Duty Factor (dBm/MHz)		Duty Factor (dB)	Total PSD With Duty Factor (dBm/MHz)	MAX. Limit (dBm/MHz)	Pass / Fail
		Chain 0	Chain 1				
38	5190	-2.68	-2.74	0.15	0.45	16.15	Pass
46	5230	3.33	3.43	0.15	6.54	16.15	Pass

- Note: 1. Method a) of power density measurement of KDB 662911 is using for calculating total power density. Total power density is summing entire spectra across corresponding frequency bins on the various outputs by computer.
2. The Directional gain = $10 \log[(10^{\text{Chain0}/20} + 10^{\text{Chain1}/20})^2 / 2] = 6.85\text{dBi} > 6\text{dBi}$, so the power density limit shall be reduced to $17 - (6.85 - 6) = 16.15\text{dBm}$.
3. Refer to section 3.3 for duty cycle spectrum plot.

802.11ac (VHT80)

Chan.	Chan. Freq. (MHz)	PSD W/O Duty Factor (dBm/MHz)		Duty Factor (dB)	Total PSD With Duty Factor (dBm/MHz)	MAX. Limit (dBm/MHz)	Pass / Fail
		Chain 0	Chain 1				
42	5210	-6.44	-6.68	0.30	-3.25	16.15	Pass

- Note: 1. Method a) of power density measurement of KDB 662911 is using for calculating total power density. Total power density is summing entire spectra across corresponding frequency bins on the various outputs by computer.
2. The Directional gain = $10 \log[(10^{\text{Chain0}/20} + 10^{\text{Chain1}/20})^2 / 2] = 6.85\text{dBi} > 6\text{dBi}$, so the power density limit shall be reduced to $17 - (6.85 - 6) = 16.15\text{dBm}$.
3. Refer to section 3.3 for duty cycle spectrum plot.

Spectrum Plot of Worst Value

802.11a_Chain 0 / CH40

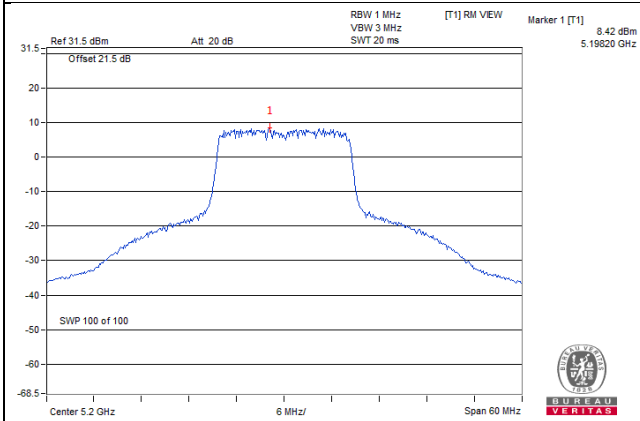

802.11ac (VHT20)_Chain 0 / CH40

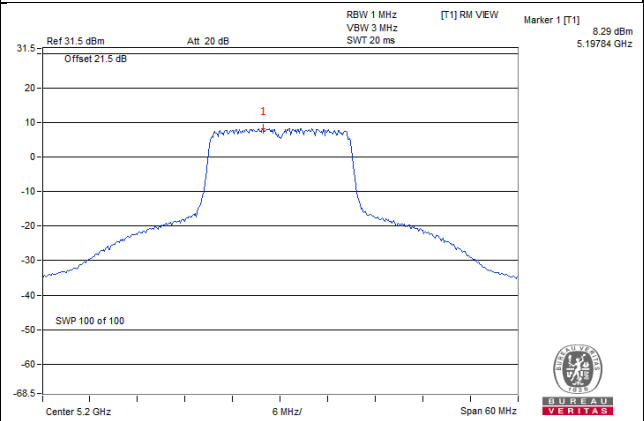

802.11ac (VHT40)_Chain 1 / CH46

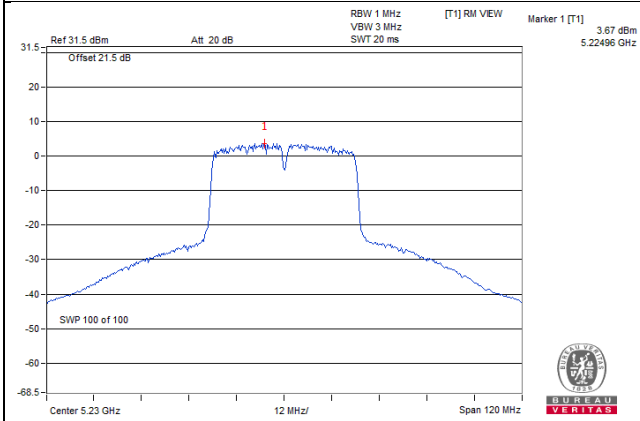

802.11ac (VHT80)_Chain 0 / CH42

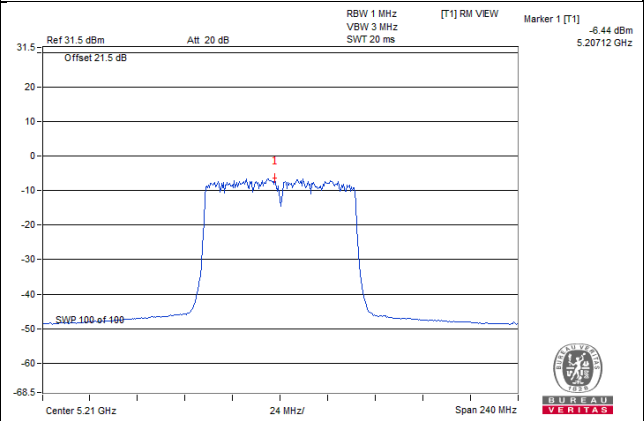

Client Mode

802.11a

Chan.	Chan. Freq. (MHz)	PSD W/O Duty Factor (dBm/MHz)		Duty Factor (dB)	Total PSD With Duty Factor (dBm/MHz)	MAX. Limit (dBm/MHz)	Pass / Fail
		Chain 0	Chain 1				
36	5180	3.54	3.62	0.21	6.80	10.15	Pass
40	5200	7.10	6.37	0.21	9.97	10.15	Pass
48	5240	7.34	6.28	0.21	10.06	10.15	Pass

- Note: 1. Method a) of power density measurement of KDB 662911 is using for calculating total power density. Total power density is summing entire spectra across corresponding frequency bins on the various outputs by computer.
2. The Directional gain = $10 \log[(10^{\text{Chain0}/20} + 10^{\text{Chain1}/20})^2 / 2] = 6.85\text{dBi} > 6\text{dBi}$, so the power density limit shall be reduced to $11-(6.85-6) = 10.15\text{dBm}$.
3. Refer to section 3.3 for duty cycle spectrum plot.

802.11ac (VHT20)

Chan.	Chan. Freq. (MHz)	PSD (dBm/MHz)		Total Power Density (dBm/MHz)	MAX. Limit (dBm/MHz)	Pass / Fail
		Chain 0	Chain 1			
36	5180	3.36	3.74	6.56	10.15	Pass
40	5200	7.11	5.96	9.58	10.15	Pass
48	5240	7.12	6.13	9.66	10.15	Pass

- Note: 1. Method a) of power density measurement of KDB 662911 is using for calculating total power density. Total power density is summing entire spectra across corresponding frequency bins on the various outputs by computer.
2. The Directional gain = $10 \log[(10^{\text{Chain0}/20} + 10^{\text{Chain1}/20})^2 / 2] = 6.85\text{dBi} > 6\text{dBi}$, so the power density limit shall be reduced to $11-(6.85-6) = 10.15\text{dBm}$.

802.11ac (VHT40)

Chan.	Chan. Freq. (MHz)	PSD W/O Duty Factor (dBm/MHz)		Duty Factor (dB)	Total PSD With Duty Factor (dBm/MHz)	MAX. Limit (dBm/MHz)	Pass / Fail
		Chain 0	Chain 1				
38	5190	-2.68	-2.74	0.15	0.45	10.15	Pass
46	5230	3.33	3.43	0.15	6.54	10.15	Pass

- Note: 1. Method a) of power density measurement of KDB 662911 is using for calculating total power density. Total power density is summing entire spectra across corresponding frequency bins on the various outputs by computer.
2. The Directional gain = $10 \log[(10^{\text{Chain0}/20} + 10^{\text{Chain1}/20})^2 / 2] = 6.85\text{dBi} > 6\text{dBi}$, so the power density limit shall be reduced to $11 - (6.85 - 6) = 10.15\text{dBm}$.
3. Refer to section 3.3 for duty cycle spectrum plot.

802.11ac (VHT80)

Chan.	Chan. Freq. (MHz)	PSD W/O Duty Factor (dBm/MHz)		Duty Factor (dB)	Total PSD With Duty Factor (dBm/MHz)	MAX. Limit (dBm/MHz)	Pass / Fail
		Chain 0	Chain 1				
42	5210	-6.44	-6.68	0.30	-3.25	10.15	Pass

- Note: 1. Method a) of power density measurement of KDB 662911 is using for calculating total power density. Total power density is summing entire spectra across corresponding frequency bins on the various outputs by computer.
2. The Directional gain = $10 \log[(10^{\text{Chain0}/20} + 10^{\text{Chain1}/20})^2 / 2] = 6.85\text{dBi} > 6\text{dBi}$, so the power density limit shall be reduced to $11 - (6.85 - 6) = 10.15\text{dBm}$.
3. Refer to section 3.3 for duty cycle spectrum plot.

Spectrum Plot of Worst Value

802.11a_Chain 0 / CH48

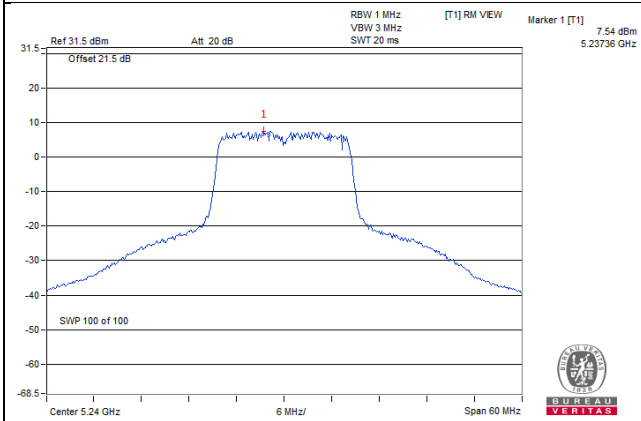

802.11ac (VHT20)_Chain 0 / CH48

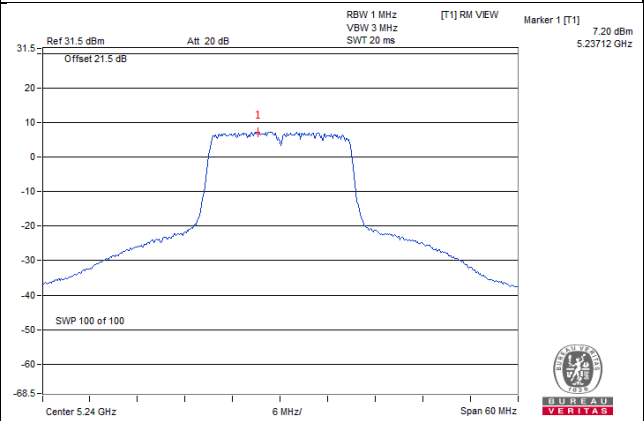

802.11ac (VHT40)_Chain 1 / CH46

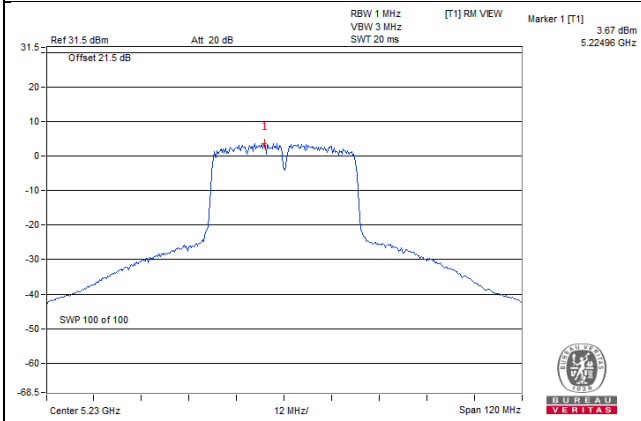

802.11ac (VHT80)_Chain 0 / CH42

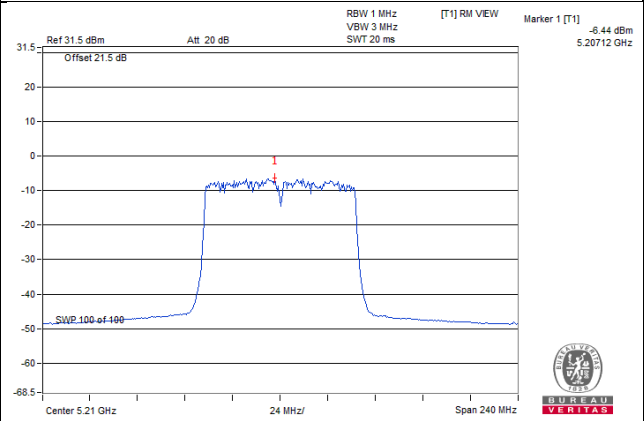

For U-NII-3:

CDD Mode

Master Mode

802.11a

TX chain	Chan.	Chan. Freq. (MHz)	PSD W/O Duty Factor		10 log (N=2) dB	Duty Factor (dB)	Total PSD With Duty Factor (dBm/500kHz)	Limit (dBm/500kHz)	Pass /Fail
			(dBm/300kHz)	(dBm/500kHz)					
0	149	5745	1.37	3.59	3.01	0.21	6.81	29.15	Pass
	157	5785	1.42	3.64	3.01	0.21	6.86	29.15	Pass
	165	5825	1.21	3.43	3.01	0.21	6.65	29.15	Pass
1	149	5745	1.18	3.40	3.01	0.21	6.62	29.15	Pass
	157	5785	1.25	3.47	3.01	0.21	6.69	29.15	Pass
	165	5825	1.52	3.74	3.01	0.21	6.96	29.15	Pass

Note: 1. The Directional gain = $10 \log[(10^{\text{Chain0}/20} + 10^{\text{Chain1}/20})^2 / 2] = 6.85\text{dBi} > 6\text{dBi}$, so the power density limit shall be reduced to $30-(6.85-6) = 29.15\text{dBm}$.

2. Refer to section 3.3 for duty cycle spectrum plot.

802.11ac (VHT20)

TX chain	Chan.	Chan. Freq. (MHz)	PSD		10 log (N=2) dB	Total PSD (dBm/500kHz)	Limit (dBm/500kHz)	Pass /Fail
			(dBm/300kHz)	(dBm/500kHz)				
0	149	5745	1.33	3.55	3.01	6.56	29.15	Pass
	157	5785	1.41	3.63	3.01	6.64	29.15	Pass
	165	5825	1.41	3.63	3.01	6.64	29.15	Pass
1	149	5745	0.95	3.17	3.01	6.18	29.15	Pass
	157	5785	0.93	3.15	3.01	6.16	29.15	Pass
	165	5825	1.24	3.46	3.01	6.47	29.15	Pass

Note: 1. The Directional gain = $10 \log[(10^{\text{Chain0}/20} + 10^{\text{Chain1}/20})^2 / 2] = 6.85\text{dBi} > 6\text{dBi}$, so the power density limit shall be reduced to $30-(6.85-6) = 29.15\text{dBm}$.

802.11ac (VHT40)

TX chain	Chan.	Chan. Freq. (MHz)	PSD W/O Duty Factor		10 log (N=2) dB	Duty Factor (dB)	Total PSD With Duty Factor (dBm/500kHz)	Limit (dBm/500kHz)	Pass /Fail
			(dBm/300kHz)	(dBm/500kHz)					
0	151	5755	-1.77	0.45	3.01	0.15	3.61	29.15	Pass
	159	5795	-2.09	0.13	3.01	0.15	3.29	29.15	Pass
1	151	5755	-2.55	-0.33	3.01	0.15	2.83	29.15	Pass
	159	5795	-2.23	-0.01	3.01	0.15	3.15	29.15	Pass

- Note: 1. The Directional gain = $10 \log[(10^{\text{Chain0}/20} + 10^{\text{Chain1}/20})^2 / 2] = 6.85\text{dBi} > 6\text{dBi}$, so the power density limit shall be reduced to $30 - (6.85 - 6) = 29.15\text{dBm}$.
2. Refer to section 3.3 for duty cycle spectrum plot.

802.11ac (VHT80)

TX chain	Chan.	Chan. Freq. (MHz)	PSD W/O Duty Factor		10 log (N=2) dB	Duty Factor (dB)	Total PSD With Duty Factor (dBm/500kHz)	Limit (dBm/500kHz)	Pass /Fail
			(dBm/300kHz)	(dBm/500kHz)					
0	155	5775	-9.95	-7.73	3.01	0.30	-4.42	29.15	Pass
1	155	5775	-9.42	-7.20	3.01	0.30	-3.89	29.15	Pass

- Note: 1. The Directional gain = $10 \log[(10^{\text{Chain0}/20} + 10^{\text{Chain1}/20})^2 / 2] = 6.85\text{dBi} > 6\text{dBi}$, so the power density limit shall be reduced to $30 - (6.85 - 6) = 29.15\text{dBm}$.
2. Refer to section 3.3 for duty cycle spectrum plot.

Spectrum Plot of Worst Value

802.11a_Chain 1 / CH165

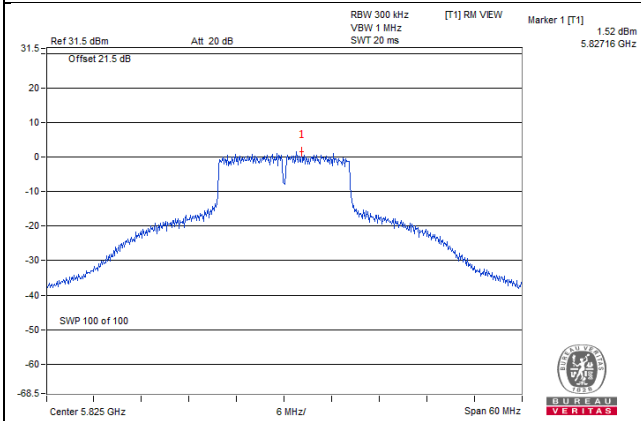

802.11ac (VHT20)_Chain 0 / CH157

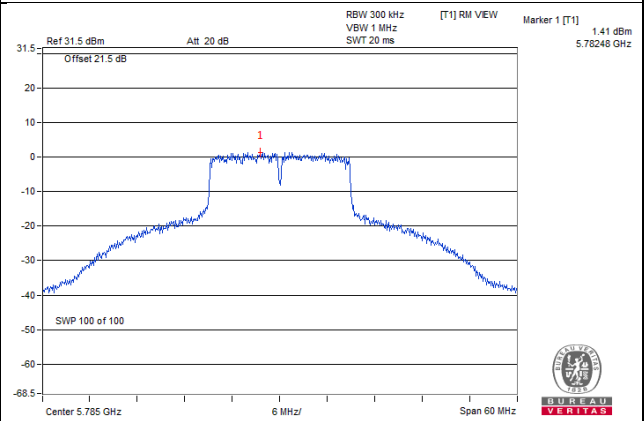

802.11ac (VHT40)_Chain 0 / CH151

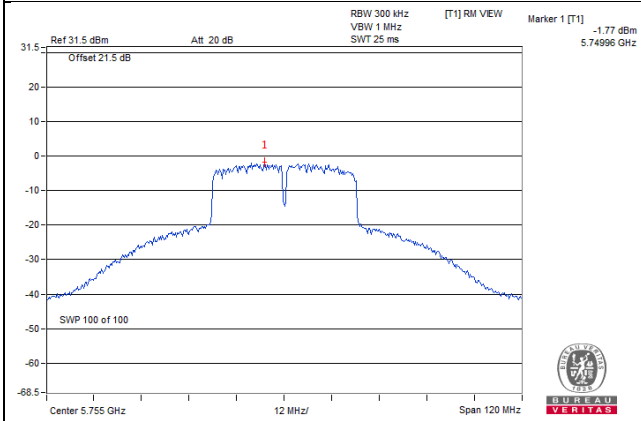

802.11ac (VHT80)_Chain 1 / CH155

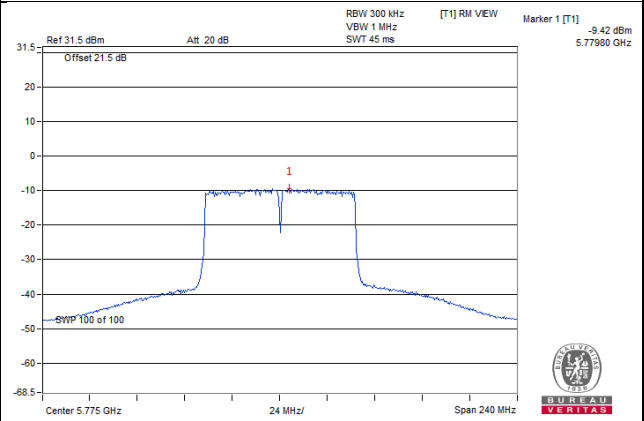

Client Mode

802.11a

TX chain	Chan.	Chan. Freq. (MHz)	PSD W/O Duty Factor		10 log (N=2) dB	Duty Factor (dB)	Total PSD With Duty Factor (dBm/500kHz)	Limit (dBm/500kHz)	Pass /Fail
			(dBm/300kHz)	(dBm/500kHz)					
0	149	5745	1.37	3.59	3.01	0.21	6.81	29.15	Pass
	157	5785	1.42	3.64	3.01	0.21	6.86	29.15	Pass
	165	5825	1.21	3.43	3.01	0.21	6.65	29.15	Pass
1	149	5745	1.18	3.40	3.01	0.21	6.62	29.15	Pass
	157	5785	1.25	3.47	3.01	0.21	6.69	29.15	Pass
	165	5825	1.52	3.74	3.01	0.21	6.96	29.15	Pass

Note: 1. The Directional gain = $10 \log[(10^{\text{Chain0}/20} + 10^{\text{Chain1}/20})^2 / 2] = 6.85\text{dBi} > 6\text{dBi}$, so the power density limit shall be reduced to $30 - (6.85 - 6) = 29.15\text{dBm}$.

2. Refer to section 3.3 for duty cycle spectrum plot.

802.11ac (VHT20)

TX chain	Chan.	Chan. Freq. (MHz)	PSD		10 log (N=2) dB	Total PSD (dBm/500kHz)	Limit (dBm/500kHz)	Pass /Fail
			(dBm/300kHz)	(dBm/500kHz)				
0	149	5745	1.33	3.55	3.01	6.56	29.15	Pass
	157	5785	1.41	3.63	3.01	6.64	29.15	Pass
	165	5825	1.41	3.63	3.01	6.64	29.15	Pass
1	149	5745	0.95	3.17	3.01	6.18	29.15	Pass
	157	5785	0.93	3.15	3.01	6.16	29.15	Pass
	165	5825	1.24	3.46	3.01	6.47	29.15	Pass

Note: 1. The Directional gain = $10 \log[(10^{\text{Chain0}/20} + 10^{\text{Chain1}/20})^2 / 2] = 6.85\text{dBi} > 6\text{dBi}$, so the power density limit shall be reduced to $30 - (6.85 - 6) = 29.15\text{dBm}$.

802.11ac (VHT40)

TX chain	Chan.	Chan. Freq. (MHz)	PSD W/O Duty Factor		10 log (N=2) dB	Duty Factor (dB)	Total PSD With Duty Factor (dBm/500kHz)	Limit (dBm/500kHz)	Pass /Fail
			(dBm/300kHz)	(dBm/500kHz)					
0	151	5755	-1.77	0.45	3.01	0.15	3.61	29.15	Pass
	159	5795	-2.09	0.13	3.01	0.15	3.29	29.15	Pass
1	151	5755	-2.55	-0.33	3.01	0.15	2.83	29.15	Pass
	159	5795	-2.23	-0.01	3.01	0.15	3.15	29.15	Pass

- Note: 1. The Directional gain = $10 \log[(10^{\text{Chain0}/20} + 10^{\text{Chain1}/20})^2 / 2] = 6.85\text{dBi} > 6\text{dBi}$, so the power density limit shall be reduced to $30 - (6.85 - 6) = 29.15\text{dBm}$.
2. Refer to section 3.3 for duty cycle spectrum plot.

802.11ac (VHT80)

TX chain	Chan.	Chan. Freq. (MHz)	PSD W/O Duty Factor		10 log (N=2) dB	Duty Factor (dB)	Total PSD With Duty Factor (dBm/500kHz)	Limit (dBm/500kHz)	Pass /Fail
			(dBm/300kHz)	(dBm/500kHz)					
0	155	5775	-9.95	-7.73	3.01	0.30	-4.42	29.15	Pass
1	155	5775	-9.42	-7.20	3.01	0.30	-3.89	29.15	Pass

- Note: 1. The Directional gain = $10 \log[(10^{\text{Chain0}/20} + 10^{\text{Chain1}/20})^2 / 2] = 6.85\text{dBi} > 6\text{dBi}$, so the power density limit shall be reduced to $30 - (6.85 - 6) = 29.15\text{dBm}$.
2. Refer to section 3.3 for duty cycle spectrum plot.

Spectrum Plot of Worst Value

802.11a_Chain 1 / CH165

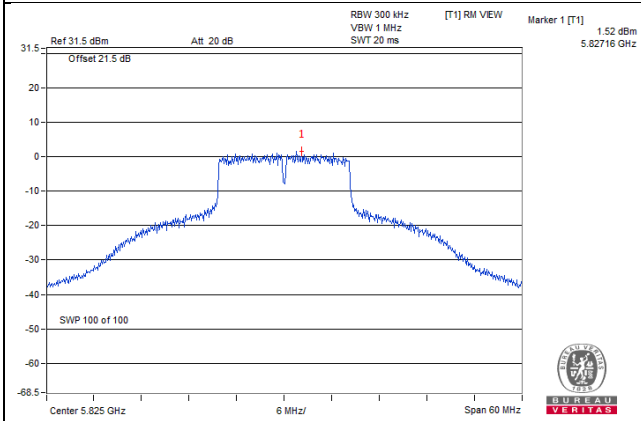

802.11ac (VHT20)_Chain 0 / CH157

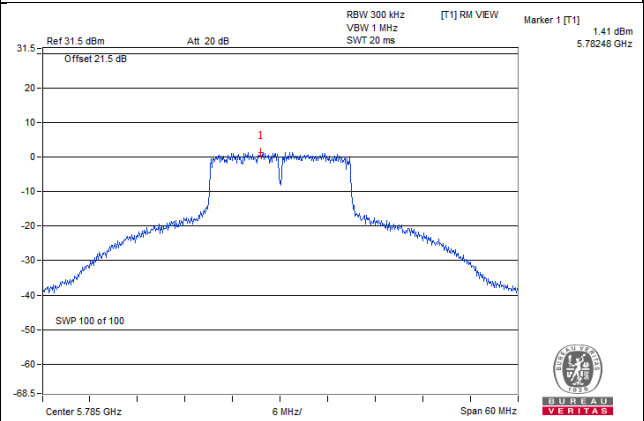

802.11ac (VHT40)_Chain 0 / CH151

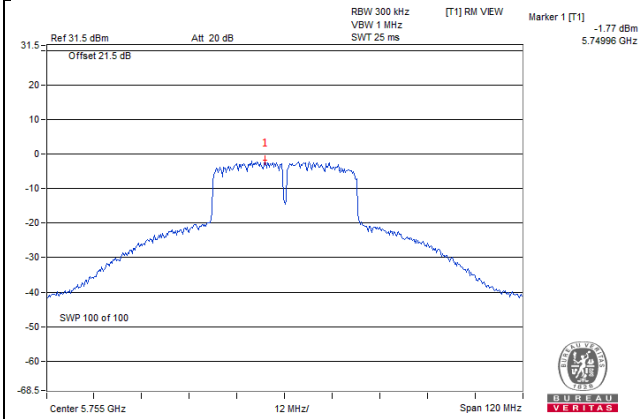

802.11ac (VHT80)_Chain 1 / CH155

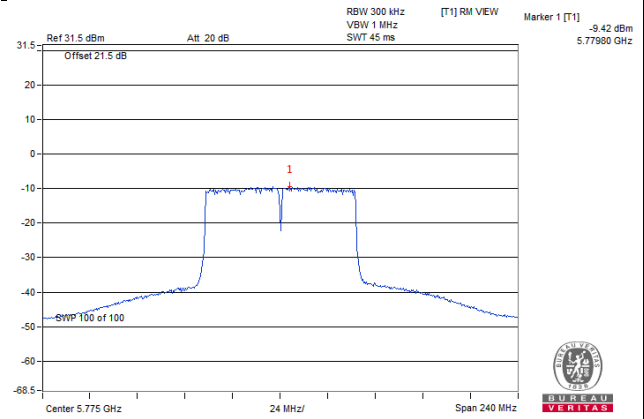

4.6 Frequency Stability Measurement

4.6.1 Limits of Frequency Stability Measurement

The frequency of the carrier signal shall be maintained within band of operation

4.6.2 Test Setup

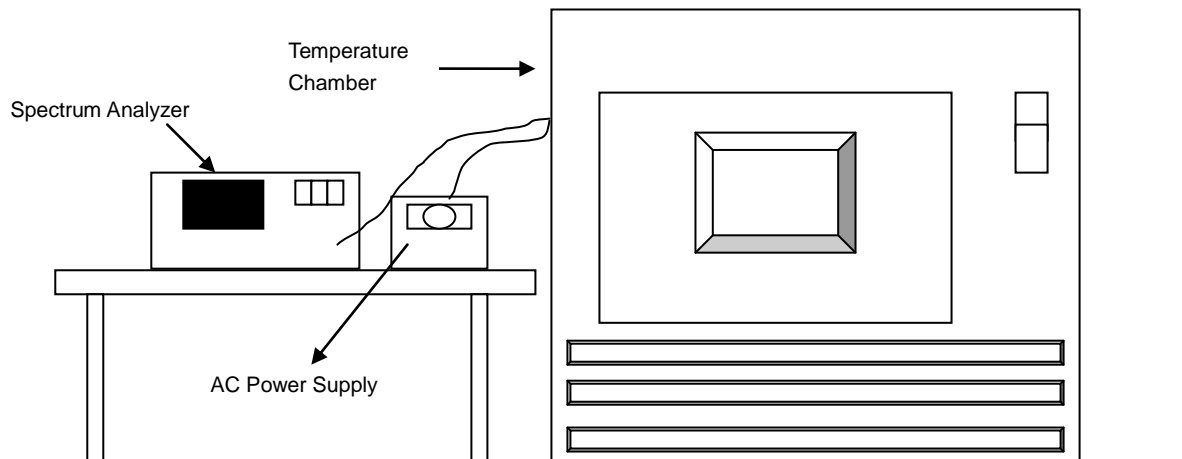

4.6.3 Test Instruments

Refer to section 4.1.2 to get information of above instrument.

4.6.4 Test Procedure

- The EUT was placed inside the environmental test chamber and powered by nominal AC voltage.
- Turn the EUT on and couple its output to a spectrum analyzer.
- Turn the EUT off and set the chamber to the highest temperature specified.
- Allow sufficient time (approximately 30 min) for the temperature of the chamber to stabilize, turn the EUT on and measure the operating frequency after 2, 5, and 10 Minutes.
- Repeat step 2 and 3 with the temperature chamber set to the lowest temperature.
- The test chamber was allowed to stabilize at +20 degree C for a minimum of 30 Minutes. The supply voltage was then adjusted on the EUT from 85% to 115% and the frequency record.

4.6.5 Deviation from Test Standard

No deviation.

4.6.6 EUT Operating Condition

Set the EUT transmit at un-modulation mode to test frequency stability.

4.6.7 Test Results

Frequency Stability Versus Temp.									
Operating Frequency: 5180 MHz									
TEMP. (°C)	Power Supply (Vac)	0 Minute		2 Minutes		5 Minutes		10 Minutes	
		Measured Frequency (MHz)	Pass/Fail	Measured Frequency (MHz)	Pass/Fail	Measured Frequency (MHz)	Pass/Fail	Measured Frequency (MHz)	Pass/Fail
50	120	5180.0195	Pass	5180.0184	Pass	5180.0225	Pass	5180.0216	Pass
40	120	5180.0042	Pass	5180.0048	Pass	5180.0048	Pass	5180.0042	Pass
30	120	5179.9763	Pass	5179.9807	Pass	5179.9782	Pass	5179.9802	Pass
20	120	5179.9867	Pass	5179.9848	Pass	5179.9855	Pass	5179.9854	Pass
10	120	5180.0202	Pass	5180.0172	Pass	5180.0196	Pass	5180.0204	Pass
0	120	5180.013	Pass	5180.014	Pass	5180.0097	Pass	5180.0103	Pass
-10	120	5179.978	Pass	5179.979	Pass	5179.9786	Pass	5179.9782	Pass
-20	120	5179.9901	Pass	5179.9887	Pass	5179.9859	Pass	5179.986	Pass
-30	120	5180.0021	Pass	5180.0009	Pass	5180.0028	Pass	5180.0005	Pass

Frequency Stability Versus Voltage									
Operating Frequency: 5180 MHz									
TEMP. (°C)	Power Supply (Vac)	0 Minute		2 Minutes		5 Minutes		10 Minutes	
		Measured Frequency (MHz)	Pass/Fail	Measured Frequency (MHz)	Pass/Fail	Measured Frequency (MHz)	Pass/Fail	Measured Frequency (MHz)	Pass/Fail
20	138	5179.987	Pass	5179.9854	Pass	5179.9856	Pass	5179.9847	Pass
	120	5179.9867	Pass	5179.9848	Pass	5179.9855	Pass	5179.9854	Pass
	102	5179.9869	Pass	5179.9857	Pass	5179.9861	Pass	5179.9849	Pass

4.7 6dB Bandwidth Measurement

4.7.1 Limits of 6dB Bandwidth Measurement

The minimum of 6dB Bandwidth Measurement is 0.5MHz.

4.7.2 Test Setup

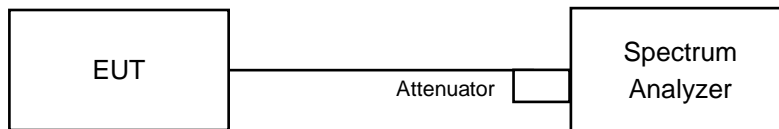

4.7.3 Test Instruments

Refer to section 4.1.2 to get information of above instrument.

4.7.4 Test Procedure

MEASUREMENT PROCEDURE REF

- Set resolution bandwidth (RBW) = 100kHz
- Set the video bandwidth (VBW) $\geq 3 \times$ RBW, Detector = Peak.
- Trace mode = max hold.
- Sweep = auto couple.
- Measure the maximum width of the emission that is constrained by the frequencies associated with the two amplitude points (upper and lower) that are attenuated by 6 dB relative to the maximum level measured in the fundamental emission

4.7.5 Deviation from Test Standard

No deviation.

4.7.6 EUT Operating Condition

The software provided by client to enable the EUT under transmission condition continuously at lowest, middle and highest channel frequencies individually.

4.7.7 Test Results

CDD Mode

Master Mode

802.11a

Channel	Frequency (MHz)	6dB Bandwidth (MHz)		Minimum Limit (MHz)	Pass / Fail
		Chain 0	Chain 1		
149	5745	16.39	16.39	0.5	Pass
157	5785	16.37	16.39	0.5	Pass
165	5825	16.37	16.38	0.5	Pass

802.11ac (VHT20)

Channel	Frequency (MHz)	6dB Bandwidth (MHz)		Minimum Limit (MHz)	Pass / Fail
		Chain 0	Chain 1		
149	5745	17.62	17.58	0.5	Pass
157	5785	17.63	17.57	0.5	Pass
165	5825	17.62	17.59	0.5	Pass

802.11ac (VHT40)

Channel	Frequency (MHz)	6dB Bandwidth (MHz)		Minimum Limit (MHz)	Pass / Fail
		Chain 0	Chain 1		
151	5755	35.57	35.21	0.5	Pass
159	5795	35.19	35.14	0.5	Pass

802.11ac (VHT80)

Channel	Frequency (MHz)	6dB Bandwidth (MHz)		Minimum Limit (MHz)	Pass / Fail
		Chain 0	Chain 1		
155	5775	76.37	75.45	0.5	Pass

Spectrum Plot of Worst Value

802.11a_Chain 0 / CH157

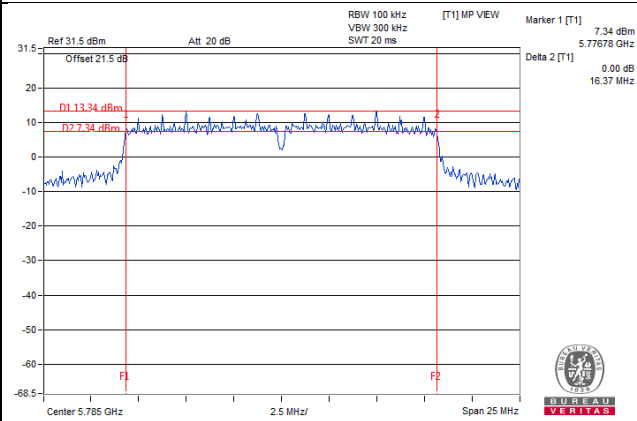

802.11ac (VHT20)_Chain 1 / CH157

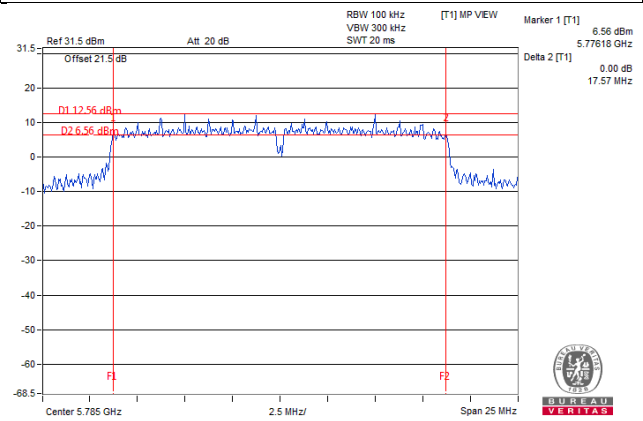

802.11ac (VHT40)_Chain 1 / CH159

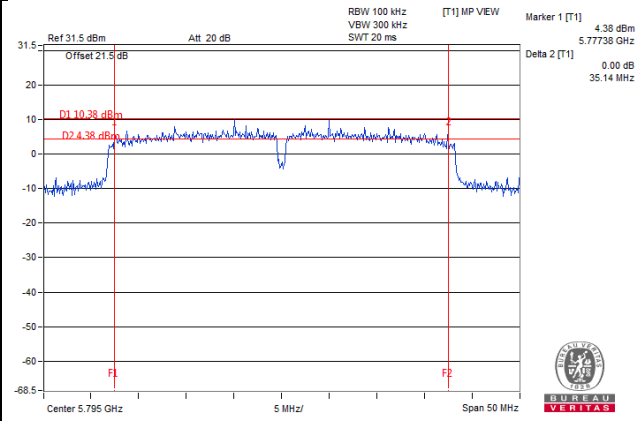

802.11ac (VHT80)_Chain 1 / CH155

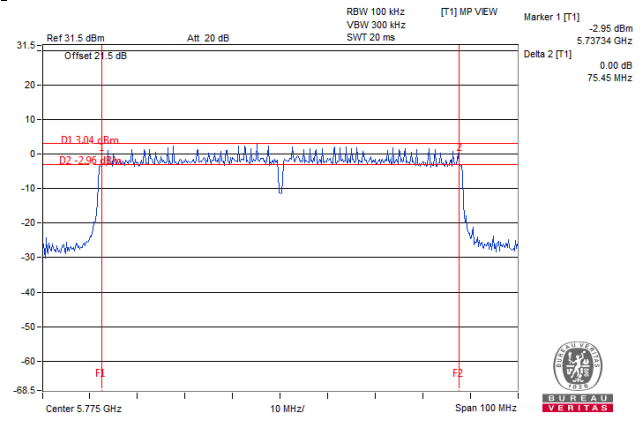

Client Mode

802.11a

Channel	Frequency (MHz)	6dB Bandwidth (MHz)		Minimum Limit (MHz)	Pass / Fail
		Chain 0	Chain 1		
149	5745	16.39	16.39	0.5	Pass
157	5785	16.37	16.39	0.5	Pass
165	5825	16.37	16.38	0.5	Pass

802.11ac (VHT20)

Channel	Frequency (MHz)	6dB Bandwidth (MHz)		Minimum Limit (MHz)	Pass / Fail
		Chain 0	Chain 1		
149	5745	17.62	17.58	0.5	Pass
157	5785	17.63	17.57	0.5	Pass
165	5825	17.62	17.59	0.5	Pass

802.11ac (VHT40)

Channel	Frequency (MHz)	6dB Bandwidth (MHz)		Minimum Limit (MHz)	Pass / Fail
		Chain 0	Chain 1		
151	5755	35.57	35.21	0.5	Pass
159	5795	35.19	35.14	0.5	Pass

802.11ac (VHT80)

Channel	Frequency (MHz)	6dB Bandwidth (MHz)		Minimum Limit (MHz)	Pass / Fail
		Chain 0	Chain 1		
155	5775	76.37	75.45	0.5	Pass

Spectrum Plot of Worst Value

802.11a_Chain 0 / CH157

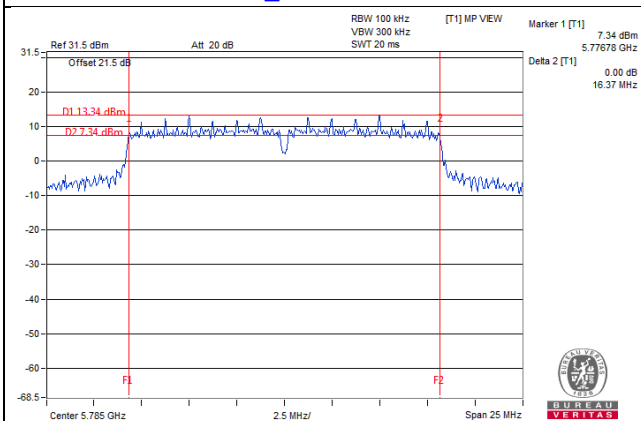

802.11ac (VHT20)_Chain 1 / CH157

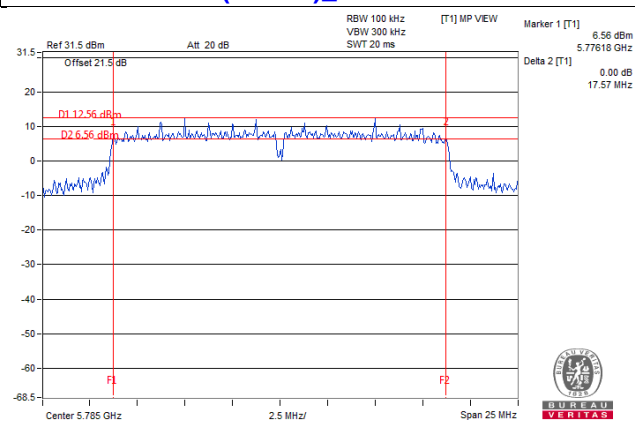

802.11ac (VHT40)_Chain 1 / CH159

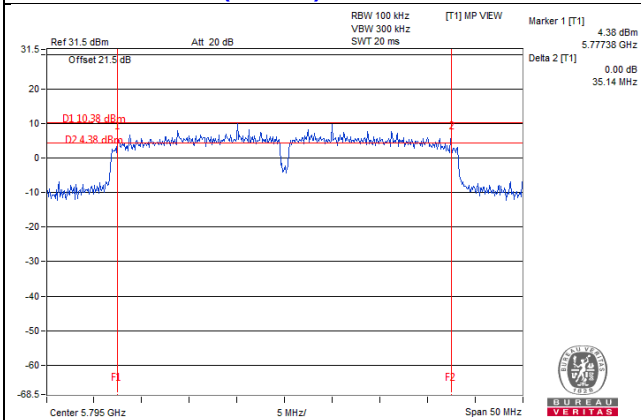

802.11ac (VHT80)_Chain 1 / CH155

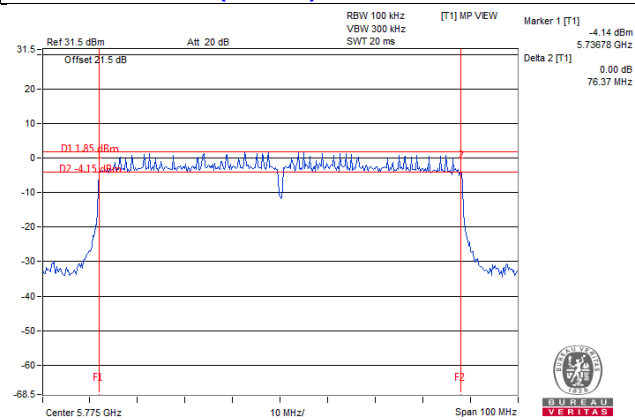

5 Pictures of Test Arrangements

Please refer to the attached file (Test Setup Photo).

Annex A- Radiated Out of Band Emission (OOBE) Measurement (For U-NII-3 band)

802.11a

CH 149 5745 MHz

Horizontal

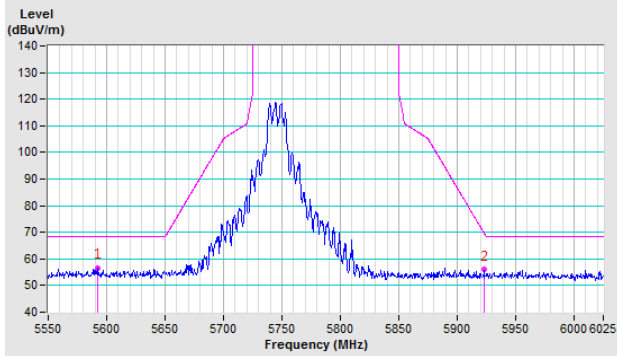

Vertical

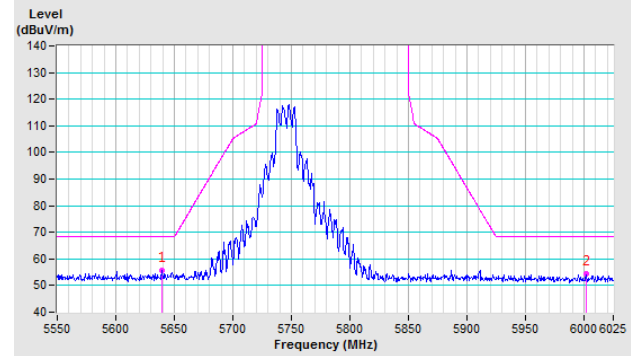

CH 157 5785 MHz

Horizontal

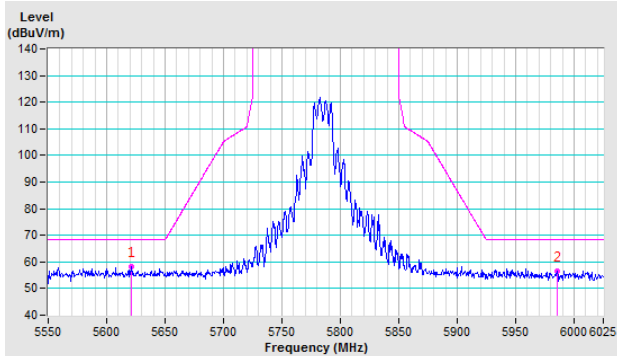

Vertical

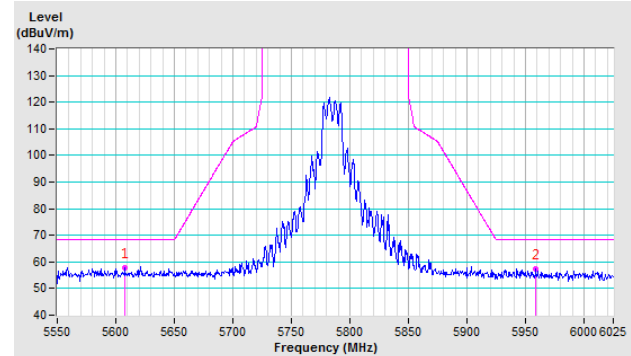

CH 165 5825 MHz

Horizontal

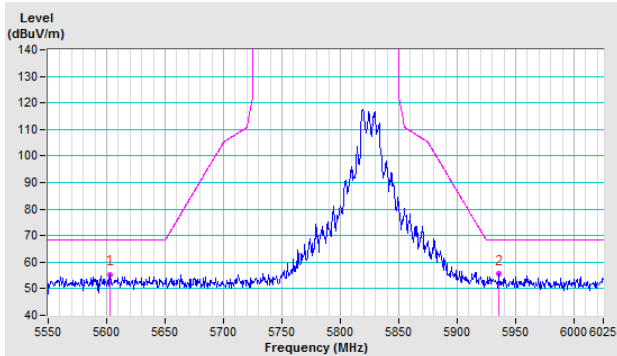

Vertical

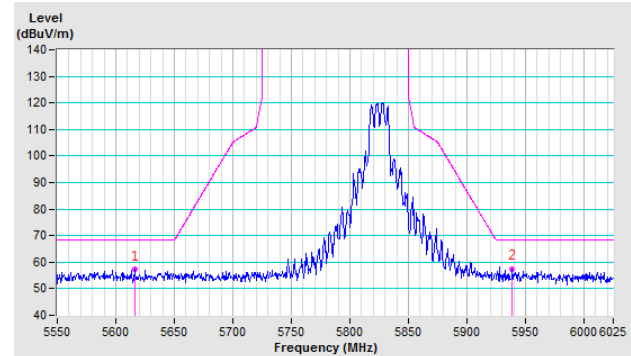

802.11ac (VHT20)

CH 149 5745 MHz

Horizontal

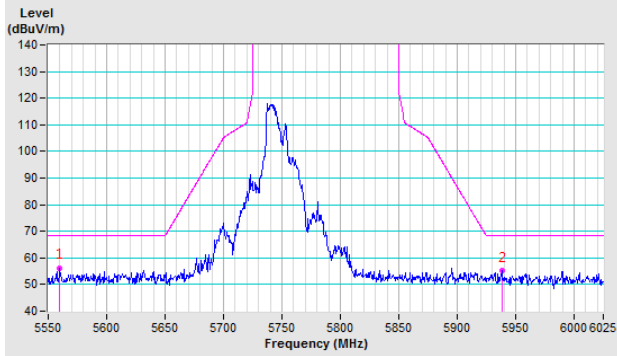

Vertical

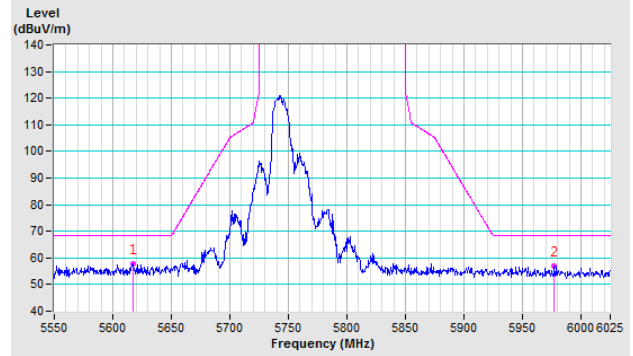

CH 157 5785 MHz

Horizontal

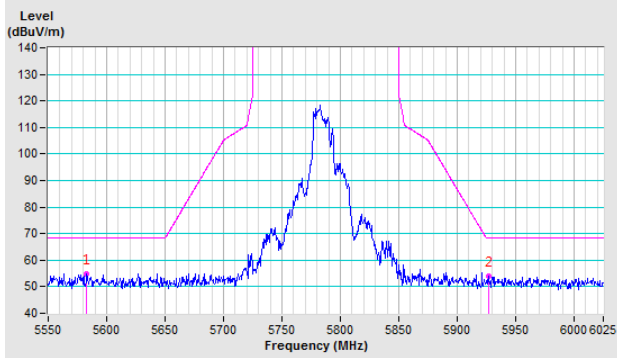

Vertical

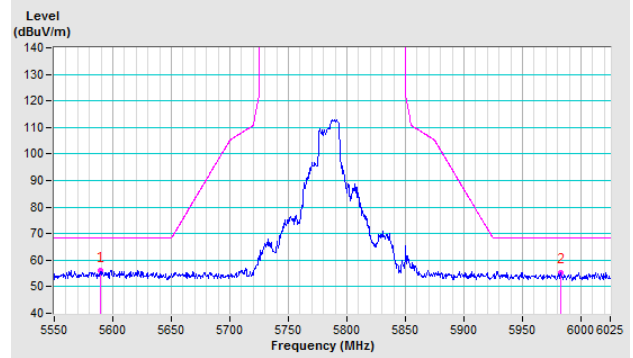

CH 165 5825 MHz

Horizontal

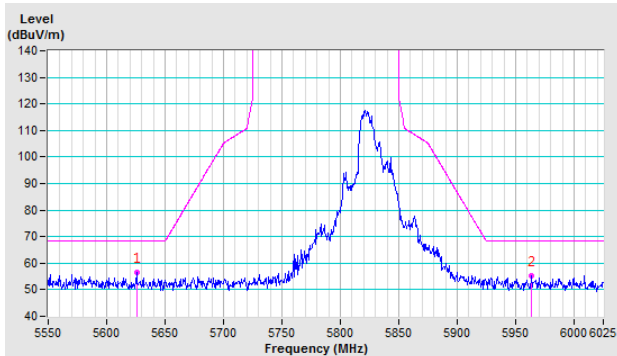

Vertical

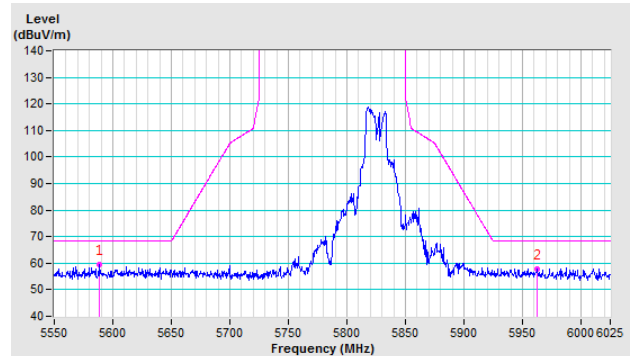

802.11ac (VHT40)

CH 151 5755 MHz

Horizontal

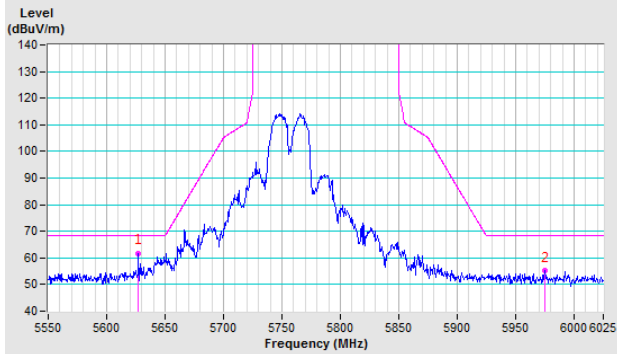

Vertical

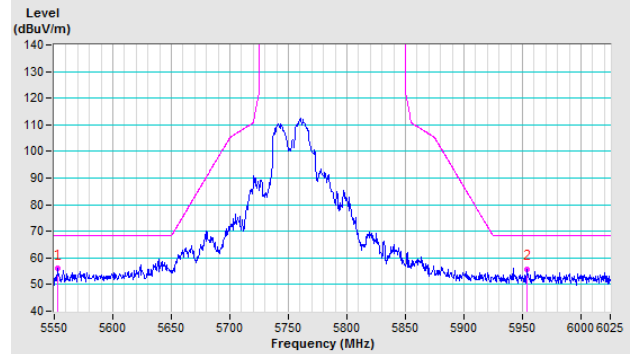

CH 159 5795 MHz

Horizontal

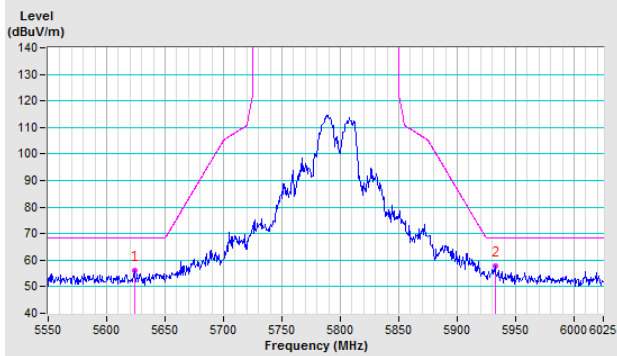

Vertical

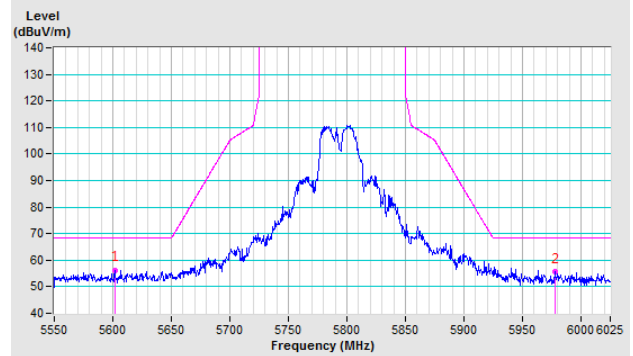

802.11ac (VHT80)

CH 155 5775 MHz

Horizontal

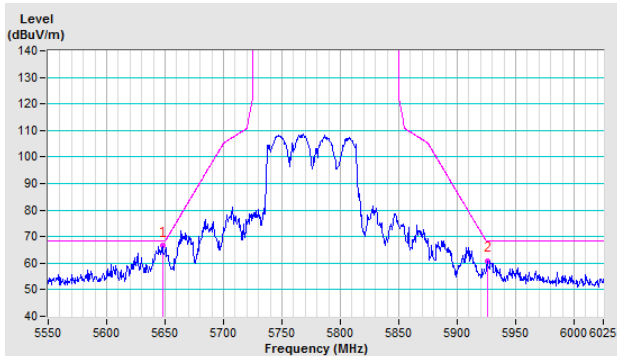

Vertical

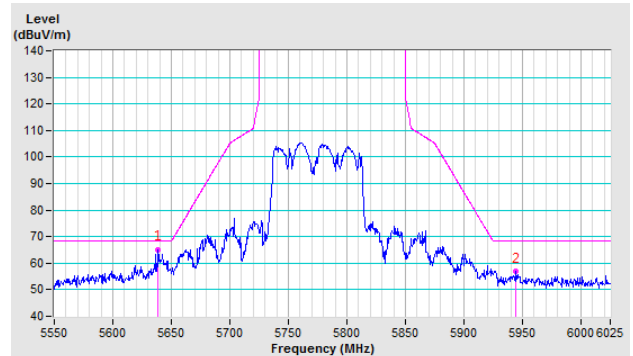

Appendix – Information on the Testing Laboratories

We, Bureau Veritas Consumer Products Services (H.K.) Ltd., Taoyuan Branch, were founded in 1988 to provide our best service in EMC, Radio, Telecom and Safety consultation. Our laboratories are FCC recognized accredited test firms and accredited according to ISO/IEC 17025.

If you have any comments, please feel free to contact us at the following:

Linkou EMC/RF Lab

Tel: 886-2-26052180

Fax: 886-2-26051924

Hsin Chu EMC/RF/Telecom Lab

Tel: 886-3-6668565

Fax: 886-3-6668323

Hwa Ya EMC/RF/Safety Lab

Tel: 886-3-3183232

Fax: 886-3-3270892

Email: service.adt@tw.bureauveritas.com

Web Site: www.bureauveritas-adt.com

The address and road map of all our labs can be found in our web site also.

--- END ---