



GigaSpire BLAST Installation Guide



Contents

About this Guide.....	5
Chapter 1: GigaSpire BLAST u4 Overview	7
GigaSpire Mesh BLAST® u4m Overview.....	12
Agency Listing.....	16
Site Preparation	18
Before you Begin.....	18
Introduction.....	19
Chapter 2: Installation	23
Installation Tips	23
Installation Variables.....	24
Unpacking the GigaSpire u4/u4m	25
Tabletop Mounting Dimensions	26
Wall Mounting Dimensions.....	27
Tabletop Mounting the u4/u4m.....	27
Wall Mounting the u4/u4m	28
Additional Mounting Considerations	29

Chapter 3: Final Set-up and Testing	31
BLAST u4/u4m Reset Behavior	31
Powering the BLAST u4/u4m.....	33
Connecting to the Internet	34
LED States - Power Off & Boot-up	35
LED States - BLAST LED Status.....	35
LED States - Samsung Smart Things.....	36
LED States - Mesh Mode	37
Wall Mount Template.....	39

About this Guide

This document provides general installation practices for the Calix GigaSpire BLAST U4 and the GigaSpire Mesh BLAST u4m.

This document also provides a general description of the products, and guidance for planning, site preparation, power installation, splicing to the outside plant, and basic troubleshooting.

Intended Audiences

This document is intended for use by network planning engineers, outside plant engineers, field support personnel, and craft personnel responsible for installation and maintenance of Calix premises equipment.

Federal Communications Commission (FCC) Statement

This equipment has been tested and found to comply with the limits for a Class B digital device, pursuant to Part 15 of the FCC rules. These limits are designed to provide reasonable protection against harmful interference when the equipment is operated in a commercial environment. This equipment generates, uses, and can radiate radio frequency energy, and, if not installed and used in accordance with the instruction manual, may cause interference to radio communications. Operation of this equipment in a residential area may cause harmful interference; the user will be required to correct the interference at his expense.

Safety Notices

This document uses the following safety notice conventions.



DANGER! Danger indicates the presence of a hazard that will cause severe personal injury or death if not avoided.



WARNING! Warning indicates the presence of a hazard that can cause severe personal injury if not avoided.



CAUTION! Caution indicates the presence of a hazard that can cause minor to moderate personal injury if not avoided.



ALERT! Alert indicates the presence of a hazard that can cause damage to equipment or software, loss of data, or service interruption if not avoided.



DANGER! CLASS 1 LASER PRODUCT. INVISIBLE LASER RADIATION MAY BE PRESENT. Fiber optic radiation can cause severe eye damage or blindness. Do not look into the open end of an optical fiber.

IMPORTANT SAFETY INSTRUCTIONS

When using your equipment, basic safety precautions must always be followed to reduce the risk of fire, electric shock, and injury to persons, including the following:

- Do not use this product near water. For example, near a bathtub, washbowl, kitchen sink, or laundry tub, in a wet basement, or near a swimming pool.
- Use only the power cord indicated in this manual.
- For external power supplies, the external power supply used in this device is to be Class II or a Limited Power Source (LPS) power supply.



Chapter 1

GigaSpire BLAST u4 Overview

The Calix GigaSpire BLAST u4 is a new generation smart home system that extends the access network into the home and acts as a strategic location for control of the ultimate Wi-Fi experience. In addition to supporting broadband connectivity of data and video services, this intelligent, high-performance system offers the latest 802.11ax 'Wi-Fi 6' technology. The BLAST u4 provides switching and routing functions that support multi-Gigabit throughput for IPTV video and data services.

Note: The GigaSpire BLAST u4 and the GigaSpire Mesh BLAST u4m share the same physical footprint. Mounting is identical although features vary depending on the roll the unit plays in the network.

The GigaSpire BLAST u4 is a premium smart home system that delivers the latest 'Wi-Fi 6' certified technology (802.11ax). The BLAST u4 uses a Gigabit Ethernet link at the subscriber's premises to provide carrier-class Wi-Fi and Gigabit Ethernet interfaces for customer multi-media devices. The BLAST u4 enables residential subscribers to receive Gigabit broadband data and Internet Protocol (IP) video services. Using the latest 802.11ax technology in both the 2.4 and 5 GHz radios, the BLAST u4 incorporates dual band 2x2 streams of Wi-Fi delivery (2x2 @ 2.4 GHz and 2x2 @ 5 GHz). In addition, with multi-user multiple-input and multiple-output (MU-MIMO) plus beamforming, the BLAST u4 allows service providers to extend the access network inside the home and establish a strategic location for the delivery and control of broadband services. A USB port is available for other connectivity applications.

With Wi-Fi being the de facto wireless data communication technology of choice for consumers, Calix engineered the GigaSpire BLAST u4 for optimal whole-home coverage with simultaneous dual-band 2.4 GHz and 5 GHz operation and dynamic beamforming. Leveraging the latest Wi-Fi 6 features, the BLAST u4 provides longer range, higher efficiency and less interference compared to earlier generations of Wi-Fi technology. The BLAST u4 also supports the 5 GHz band, The BLAST u4 easily delivers HD and UHD (ultra-HD) video and data throughout a subscriber's home in an increasingly video-rich and mobile broadband environment.

Ensuring consumers can achieve ultra-fast Wi-Fi throughout their premises, the BLAST u4 provides the latest generation of redundant mesh via the Calix Wi-Fi 6 BLAST u4m GigaMesh. With the BLAST u4 as the hub, and the u4m as the satellite, consumers can truly gain the whole home/smart home experience. For even higher mesh performance, multiple u4m systems can be connected to the BLAST u4.

Ensuring consumers can have ultra-fast Wi-Fi throughout their premises, the GigaSpire BLAST u4 provides the latest generation of redundant mesh via the Calix Wi-Fi 6 Mesh BLAST u4m. With the BLAST u4 as the hub, and the Mesh BLAST u4m as the satellite, consumers can gain the entire home/smart home experience. For even higher mesh performance, multiple GigaMesh systems can be connected to the GigaSpire BLAST u4.

With the GigaSpire BLAST u4, Calix has redefined how to install and activate residential services at a subscriber's premises. Using the Calix Smart CommandIQ App feature and a phone or laptop, a field technician can install and apply the subscriber's service profile without special equipment or assistance from the central office. Calix also provides the innovative CSC (Calix Support Cloud (CSC)), which allows the service provider to configure, activate and upgrade the GigaSpire BLAST u4 quickly from a remote location using in-band management or TR-069. Extensive troubleshooting capabilities, remote software downloads, and easy-to-use service activation features ensure that services are delivered and maintained without needless truck rolls and hardware upgrades. Employing GigaSpire BLAST u4 systems allows service providers to reduce their operational expenses while effectively delivering the Gigabit experience to their subscribers.

EXOS is the world's only hardware independent, modular, standards-based, always-on smart home operating system. With EXOS, service providers can use the containerized architecture to quickly deploy new services that leverage a range of pre-integrated smart home solutions and thousands of smart devices (for example, enhanced parental controls or network security).



Key Attributes - BLAST u4

Home Gateway

- Layer 2 bridge and Layer 3 routing for High Speed Internet (HSI) data and IPTV video services
- DHCP server options
- DHCP (IPoE) and PPPoE network connections
- Network Access Translation (NAT), public to private IP addressing
- Configurable IP address schemes, subnets, static-IP addresses
- DNS server
- Bridge port assignment and data traffic mappings
- Port forwarding
- Firewall and security
- Application and website filtering
- Selectable forwarding and blocking policies
- DMZ hosting
- Parental controls, time of day usage
- Denial of service (DoS) protection
- MAC filtering
- Time/Zone support
- Universal Plug-and-Play (UPnP)

WI-FI

- 2.4 GHz and 5 GHz, simultaneous dual-band
- 2.4 GHz and 5 GHz 802.11ax (Wi-Fi 6) certified, 802.11a/n/ac compatible
- 4x4 streams (2x2 @ 2.4 GHz and 2x2 @ 5 GHz)
- WPA/WPA2/WPA3; WEP 64/128 bit encryption
- PuF (Physical Unclonable Functions)
- WPS push-button
- 2x2 DL/UL MU-MIMO with beamforming
- 1024 QAM; OFDMA; BSS Coloring
- DCM (Dual Carrier Modulation)
- TWT (Target Wake Time) for IoT clients
- Wi-Fi Redundant Mesh:
 - Self Managed: self configuration, Air time fairness
 - Dynamic Mesh: load balancing, band/node steering; interference management
 - Self Healing; diagnostics; events
- 1 Gigabit Ethernet (GE) WAN interface:
 - 10/100/1000 BASE-T Ethernet, auto-negotiating
- Gigabit Ethernet (GE) LAN interfaces:
 - Two (2) ports of Multi-rate 10/100/1000 BASE-T Ethernet, auto-negotiating for residential IPTV and data services
- USB port:
 - USB 2.0 - Type A host interface
- Supports multiple data service profiles
- Traffic management and Quality of Service (QoS):
 - 802.1Q VLANs
 - 802.1p service prioritization
 - Q-in-Q tagging
 - Multiple VLANs
 - DiffServ
 - Pre-defined QoS on service type
 - LAG of GE ports
 - MAP-T
- IPTV, IGMPv2, future support of IGMPv3:
 - IGMP Snooping and Proxy

- IGMP Fast Leaves
- Gateway Management:
 - CSC (Calix Support Cloud)
 - TR-069
 - Local Home Gateway GUI, access provisionable
 - Remote WAN side GUI access
 - Default username/password
- AC to 12 VDC power adapter

GigaSpire Mesh BLAST u4m Overview

The Calix GigaSpire Mesh BLAST u4m is the new generation Wi-Fi 6 mesh satellite that complements the Calix GigaSpire family of products. With the broad portfolio of GigaSpire smart home systems, BLAST[®] u4m extends Wi-Fi coverage and capacity within the subscriber's home. The BLAST[®] u4m Wi-Fi 6 backhaul allows communications service providers (CSPs) to deploy satellites with either a wired or wireless connection to the GigaSpire. When connected wirelessly, the 5.0 GHz 802.11ax 2x2 radio acts as an access point (AP) to the end subscribers' Stations (STA). The BLAST[®] u4m enables subscriber self-installs and results in fewer costly truck rolls. The combined solution – GigaSpire, BLAST[®] u4m satellite and Calix Support Cloud is known as Mesh-Enhanced Carrier Class Wi-Fi and it reduces the time to additional revenue by automating and simplifying the deployment of complex multi-device networks. Besides supporting wired or wireless connectivity of data and video services, this convenient service platform supports the latest Wi-Fi 6 technology, extending the ultimate Wi-Fi to enhance the subscriber experience.



MULTI-GIGABIT SUBSCRIBER EXPERIENCE

The GigaSpire Mesh BLAST[®] u4m is a high performance wireless satellite that delivers the latest 802.11ax Wi-Fi technology in a consumer friendly form factor. Subscribers want their Wi-Fi to work with any device in any location throughout their home. Over time, the numbers, types and locations of these devices has exploded. In response to the rapid adoption of Wi-Fi IoT devices – like door locks, IP cameras and thermostats – CSPs must now provide ubiquitous Wi-Fi coverage. In addition, the demand for video content continues to grow and subscribers expect to watch anywhere on any device. The Calix GigaSpire Mesh BLAST u4m enhances coverage and capacity with the latest 802.11ax Wi-Fi radios, transmitting at the maximum allowable regulatory limits. For homes that need additional coverage and capacity, the Calix Mesh-Enhanced Carrier Class Wi-Fi solution has three components: A GigaSpire, GigaSpire Mesh satellites, and the Calix Cloud. The GigaMesh satellites are optimized for interoperability with GigaSpire's 5.0 GHz 802.11ax radio, thus allowing for the delivery of throughput rates of over 1.2 Gbps. Along with the 2x2 2.4 GHz radio, the GigaMesh provides over 1.8 Gbps of total service bandwidth.

In addition to support for high-speed Internet (HSI) services, CSPs need solutions that allow them to support a full complement of additional services, including IPTV and guest Wi-Fi. In response, the Calix solution supports differentiated quality of service (QoS) as well as isolation between the services. To ensure a seamless mobile streaming experience, the software used by the GigaSpire and GigaMesh has been enhanced to support both band steering and network-assisted node steering. Steering directs subscriber Wi-Fi devices to connect to the radio signal that results in the best user experience.

Calix leverages the latest standards for roaming and steering, including 802.11k, 802.11r and 802.11v. The combination of GigaSpire and GigaMesh satellites enables subscribers to receive Gigabit broadband data, IP video, and voice over (VoIP). Using the latest 802.11ax 5 GHz technology – incorporating 2x2 multi-user multiple-input and multiple-output (MU-MIMO) with beamforming – the BLAST u4m satellite allows CSPs to extend the access network inside the home and establish a strategic location for the delivery and control of broadband services.

Calix engineered the BLAST u4m for optimal whole-home coverage with simultaneous dual-band 2.4 GHz and 5 GHz operation and dynamic beamforming at 5 GHz. For maximum performance, the BLAST u4m supports high-power 2x2 MIMO spatial diversity at 2.4 GHz and 2x2 MU-MIMO at 5 GHz. The BLAST u4 and BLAST u4m solution easily delivers high definition (HD) and Ultra HD (UHD) video and data throughout a subscriber's home.

The Calix solution is scalable, allowing CSPs to initially deploy a GigaSpire and then add GigaMesh satellites to the end subscriber's home network as the need arises for additional coverage. One of the strengths of the Calix solution is that CSPs can leverage the instrumentation provided by the GigaSpire and GigaMesh satellites to identify when the end subscriber can benefit from an additional GigaMesh. This allows them to be proactive and upsell additional services and assets.

Market research projects that tens of billions of residential IoT devices will be deployed in the coming years. The GigaSpire and GigaMesh provides powerful Wi-Fi to support the growing IoT deployment. Service providers can now deploy the BLAST u4m with plug-and-play Wi-Fi IoT devices such as security cameras, sensors, and smart plugs.

EASY TO INSTALL, ACTIVATE AND MAINTAIN

With the GigaMesh satellites, Calix has redefined how to install and activate residential services. When deployed with a wired connection it's as simple as plugging a Cat 5e/6 cable in between the GigaMesh RJ-45 port and the parent GigaSpire. The GigaMesh leverages its TR-069 interface to communicate its presence to the Calix Support Cloud, which adds the GigaMesh to the subscriber account. The system harmonizes the services on the GigaMesh. This removes all human error-prone touch points. When deployed with a wireless connection, the subscriber uses the Wi-Fi Protected Setup (WPS) button on both the GigaMesh and the GigaSpire to pair the mesh network. In addition, built-in signal strength indicator on the GigaMesh provides identification for the best placement location. Once this step is done, discovery, configuration and harmonization steps occur. The Calix Support Cloud's extensive troubleshooting capabilities, remote software downloads, and easy-to-use service activation features ensure that services are delivered and maintained without needless truck rolls and hardware upgrades. Employing the GigaSpire and GigaMesh satellites allows CSPs to reduce their operational expenses while effectively delivering an elevated Gigabit experience to their subscribers.

Key Attributes

- Whole Home Coverage Wi-Fi Mesh Satellite
 - Layer 2 bridge and Layer 3 routing for High Speed Internet (HSI) data and IPTV video services
 - Self-Organizing Network (SON)
 - Auto configuration
 - Band and node steering
 - Increased network capacity
 - Bridge port assignment and data traffic pings
 - MAC filtering Wi-Fi
- Wireless:
 - 2.4 GHz and 5 GHz, simultaneous dual-band
 - 2.4GHz and 5 GHz 802.11ax (Wi-Fi 6) certified, 802.11a/n/ac compatible
 - DFS for CE since FCC/IC doesn't support DFS band.
 - 4x4 streams (2x2 @ 2.4 GHz and 2x2 @ 5 GHz)
 - WPA/WPA2/WPA3; WEP 64/128 bit encryption
 - PuF (Physical Unclonable Functions)

Proprietary Information: Not for use or disclosure except by written agreement with Calix.

-
- WPS push-button
 - 2x2 DL/UL MU-MIMO with beamforming
 - 1024 QAM; OFDMA; BSS Coloring
 - Support for 802.11k/r/v/s o
 - 11k Radio Resource Management
 - 11r Fast Roaming
 - 11v Wireless Network Management
 - Support 4-address WDS mode
 - Support 16 SSID Replication per band
 - 1.2 Gbps Radio Backhaul with GigaSpire
 - Channel Optimization DFS
 - Wireless Backhaul Signal Strength
 - Wi-Fi Redundant Mesh:
 - Self Managed: self configuration, Air time fairness
 - Dynamic Mesh: load balancing, band/node steering; interference management
 - Self Healing; diagnostics; events
 - One Gigabit Ethernet (GE) interface – LAN or WAN:
 - Symmetrical 1 Gbps for residential IPTV and data services
 - Multi-rate 10/100/1000 BASE-T Ethernet, auto-negotiation
 - Wi-Fi Redundant Mesh:
 - Self Managed: self configuration, Air time Fairness
 - Dynamic Mesh: load balancing, band/node steering; interference management
 - USB port:
 - USB 2.0 - Type A host interface
 - Supports multiple data service profiles
 - IPTV, IGMPv2, future support of IGMPv3:
 - IGMP Snooping and Proxy
 - IGMP Fast Leaves
 - Gateway Management:
 - CSC (Calix Support Cloud)
 - TR-069
 - Local Home Gateway GUI, access provisionable
 - Remote WAN side GUI access
 - Default username/password
 - AC to 12 VDC power adapter

Agency Listing

FCC WARNING: These devices comply with Part 15 of the FCC Rules and Regulations. Operation is subject to the following conditions.

This device may not cause harmful interference, and, this device must withstand any interference received, including interference that may cause undesired operation.

The ONT has been tested and found to comply with the limits for a Class B digital device pursuant to Part 15 of the FCC Rules and Regulations. These limits are designed to provide reasonable protection against harmful interference when this equipment is operated in a commercial environment. This equipment generates, uses, and can radiate radio frequency energy and, if not installed and used in accordance with the instructions in this guide, may cause harmful interference to radio and television communications.

Radiated Emissions

- This Class-B digital device complies with radiated emissions requirements as defined in Canadian ICES-003.

Power Supply

Note: When using the standard power adapter, units will be inoperable after loss of main power.

- The unit must be powered by a listed power adapter or DC power source marked "LPS" (Limited Power Source) and rated output between 12 VDC, 375 mA minimum, 2 A minimum, T_{ma} = 40° C minimum. If additional help is needed on implementing a power supply, please contact your local Calix service professional.

An external power supply is included with the following rating:

BLAST u4

- Input voltage: 12 VDC (nominal)
- 10 VDC (min.), 15 VDC (max)
- External Power Adapter: 12 VDC, 2 A

BLAST u4m

- Input voltage: 12 VDC (nominal)
- 10 VDC (min.), 15 VDC (max)
- External Power Adapter: 12 VDC, 1.5 A



DANGER! Using non-approved or incorrect power adapters can result in injury.

Proprietary Information: Not for use or disclosure except by written agreement with Calix.

Site Preparation

Before you install any GigaSpire BLAST device, you need to consider the routing of the power adapter cord and Ethernet cable(s) if used.

Note: It is critical that you maintain the proper airflow in and around the unit. GigaSpire BLAST devices are designed for surface mounting only. Do not install cabinetry or other building material around the outside of the unit.

Power Cords

In order to complete the installation, a power cord is required:

- GigaSpire Connectorized Power and Signal Cable - A 2-pin barrel connector to the local AC power receptacle (Type A).

Coaxial Cables

Note that Coaxial cable connections are to be internal connections only. Outdoor connections are not allowed.

Before you Begin

Before starting the installation process, check that the following conditions are met:

- Ensure the site preparation steps are complete based on the model being installed.
- Ensure that all components are on-site or readily available to complete the installation.
- The customer is aware of your planned visit and will provide access to the inside of the home.

Introduction

This document describes the installation of the following:

- GigaSpire BLAST u4
- GigaSpire Mesh BLAST u4m

The BLAST u4 and u4m are designed to be placed in a horizontal table-top configuration or can be wall mounted using the mounting holes molded into the back of the unit.

Powering Options

- By attaching to any 110/220 VAC power outlet using the supplied 12 VDC wall transformer.

Note: For all models, the power cord configuration must be appropriate for use in the country where the device is being deployed.

Note: Only Calix provided and approved power cords or voltage adapters should be used to connect to this product(s).

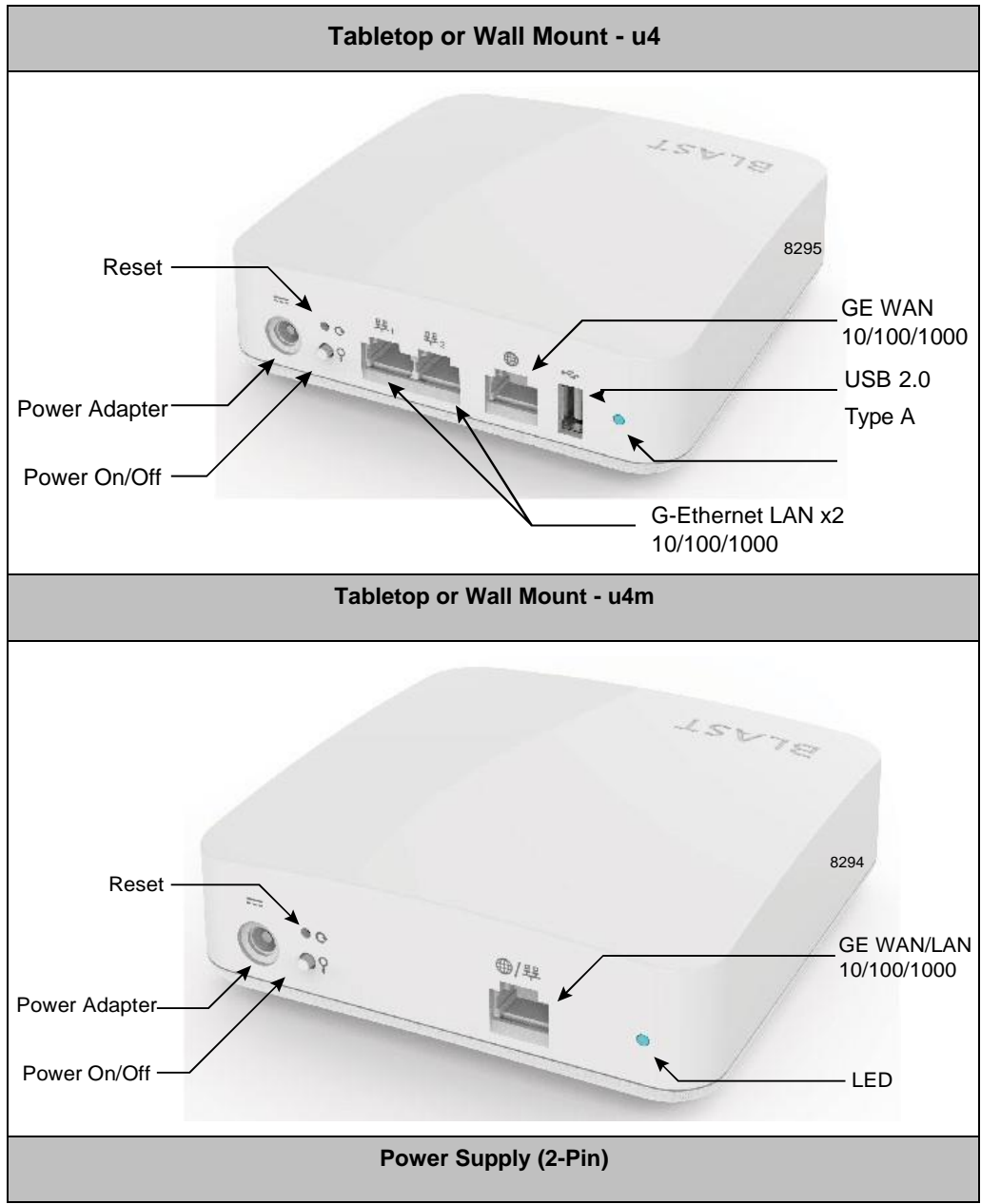



Chapter 2

Installation

Installation Tips



CAUTION! Use of controls or adjustments or performance of procedures other than those specified here may result in hazardous radiation exposure.

Follow these tips when installing a GigaSpire device:

- For subscribers using data services, all data wiring inside the home must be CAT5e cable or better.
- Make sure subscriber connections are tightened properly.
- Check the contents of each box carefully as you receive them. Components may not be located where you might expect them due to certain items being tested immediately before shipment.

About Wi-Fi Placement

Certain building materials are particularly effective at blocking Wi-Fi signals (see table below) and should be taken into consideration when locating the GigaSpire BLAST u4 or Mesh BLAST u4m. Line of sight is not necessary since MIMO technology takes advantage of reflections in the over-the-air path to carry additional data. However, Calix recommends that when possible, Calix GigaSpires should be placed in a centralized location within the home to yield the best possible results for Wi-Fi coverage.

Building Materials and Their Effect on Wi-Fi Signals	
Material	Wi-Fi Attenuation
Wood, Drywall, Particle Board, Tile	Low
Glass	Low
Water	Medium
Bricks, Cinder Block	Medium
Plaster, Stucco	High
Concrete	High
Tinted or Low-E Glass (metalized)	Very High
Metal	Very High

lower the attenuation, the better the performance.

Installation Variables

Before installing the GigaSpire BLAST u4 or Mesh BLAST u4m, consider what additional services may be implemented. Various access points are available on the back of the unit which may or may not be used. Prior to determining the unit's final location, you need to account for the following variables:

- Optional: Where will the Ethernet cable be routed?
- What type of building material is used in this facility? Make sure you have the appropriate drills, drill bits and fasteners for routing Ethernet or power cables as they pass through walls and the like.

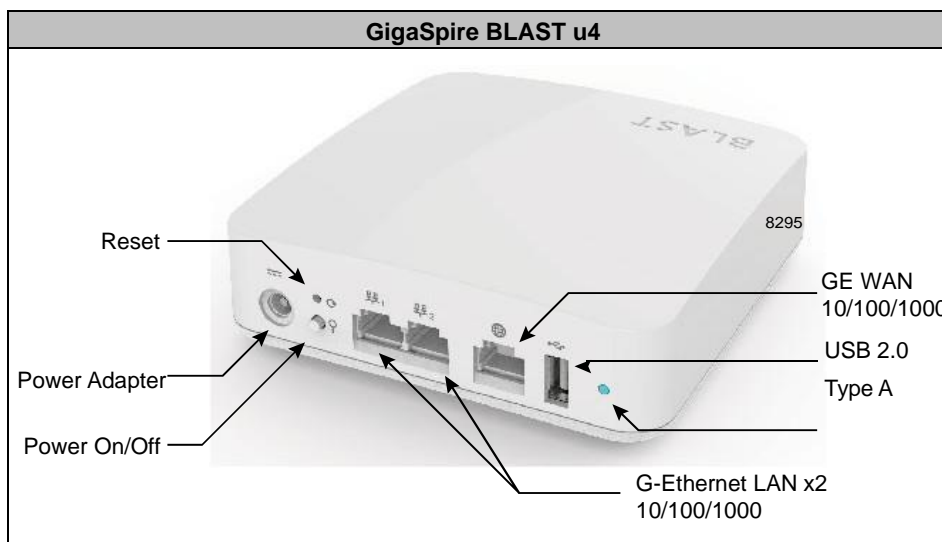

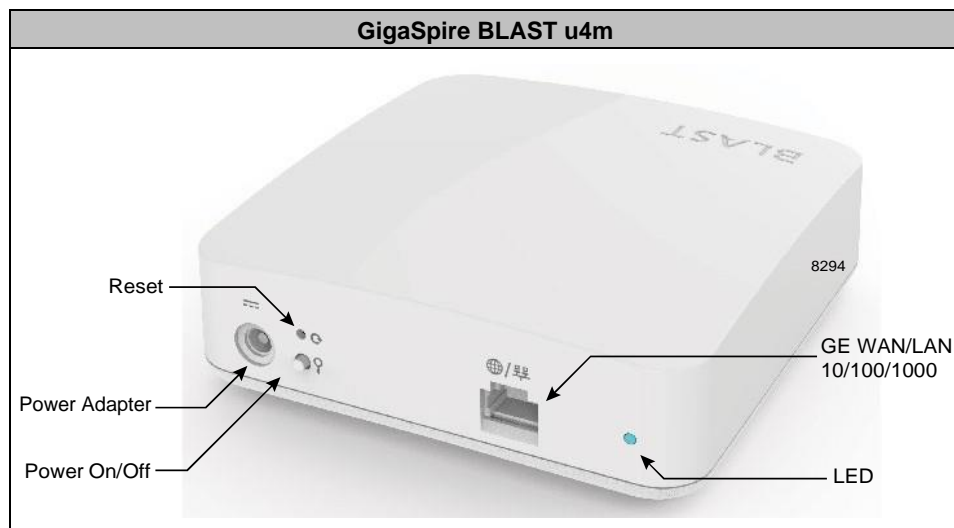

Unpacking the GigaSpire u4/u4m

Each GigaSpire BLAST u4 or u4m is shipped individually in its own carton and contains the following:

- (1) GigaSpire BLAST u4 or (1) GigaSpire Mesh BLAST u4m
- (1) Power Adapter interface cord (wall wart)
- (1) Safety and Regulatory Statements Guide
- (2) Product Identification Labels with Login Credentials

After opening the carton, remove the protective packaging, ensure all components above are present, and prepare for mounting the unit.

Tabletop Mounting Dimensions

Dimensions are shown here for your reference.

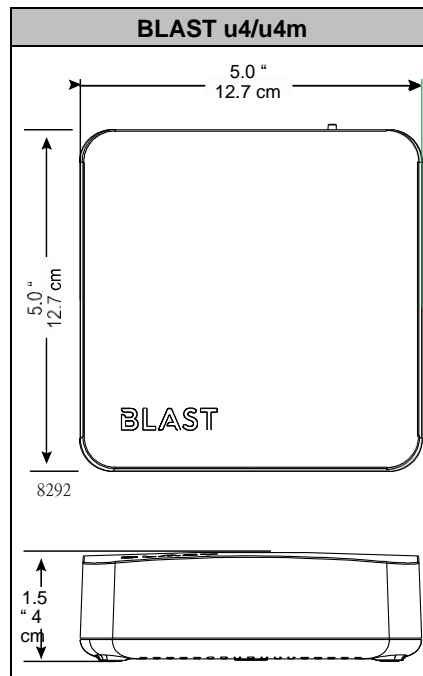

Wall Mounting Dimensions

Dimensions for wall mounting of a GigaSpire BLAST u4 or Mesh BLAST u4m are included here for reference.

Note: There is no wall mount bracket necessary to mount these devices. The bottom chassis itself includes appropriate cut-outs and hanger posts to facilitate wall mounting.

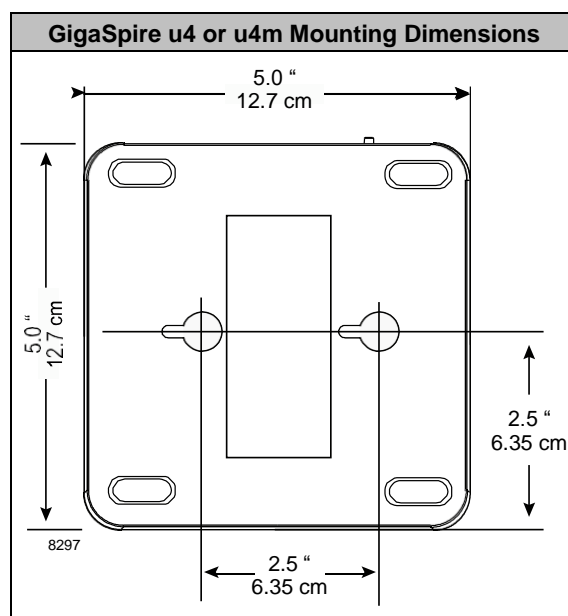

Tabletop Mounting the u4/u4m

Any Calix GigaSpire BLAST u4 or u4m can be mounted flat on a tabletop. Four (4) rubberized feet are pre-installed on the bottom of the unit to provide a non-skid surface when placing the GigaSpire on a table or shelf.

Keep the following information in mind when considering tabletop mounting:

- Due to component placement inside the chassis, do not remove the rubber feet that are installed on the bottom of the unit. Locate the GigaSpire BLAST on the desktop in a location that is unlikely to be bumped or jostled.
- Make sure that the Ethernet cable(s) if used and power supply wiring attached to the GigaSpire are secured properly and out of harms way.

Note: Once the GigaSpire is connected and turned up, Wi-Fi network parameters are persisted in memory. For this reason, if power is lost to the GigaSpire, it will be re-discovered on the network automatically, without operator intervention.

Wall Mounting the u4/u4m

The Calix GigaSpire BLAST u4 and the GigaSpire Mesh BLAST u4m can be wall mounted using. Keep the following information in mind when considering wall mounting:

- Locate the BLAST on the wall in a location that is unlikely to be bumped or jostled.
- Make sure that the Ethernet cable(s) (if used) and power supply wiring attached to the GigaSpire are secured properly and out of harms way.

Note: Once the GigaSpire is connected and turned up, Wi-Fi network parameters are persisted in memory. For this reason, if power is lost to the GigaSpire, it will be re-discovered on the network automatically, without operator intervention.

To wall mount the GigaSpire BLAST u4 or u4m

1. Find a suitable location for attaching unit to the wall. Be mindful of the power source and Ethernet cable requirements when determining a mounting location.
2. Using the template included in the back of this guide, mark the two screw locations on the wall, making sure the device will remain level after mounting.

Note: If attaching to sheet rock or gypsum board, Calix recommends using a wall anchoring system to ensure the bracket is securely attached to the wall.

3. Drill holes in the wall and install appropriate wall anchors if required.
4. Thread the screws into the wall anchors and tighten leaving a gap of about 1/8" between the screw head and the and the back of the unit.

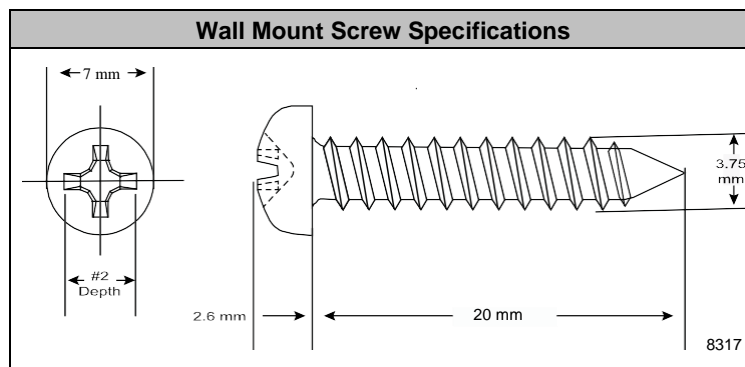

Mounting Screws

The two mounting holes on the back of the unit are designed to accommodate the following screw type:

- larger than 7mm wide and less than 14mm wide
- Screw shaft < 3mm in diameter
- Screw length > 6mm

Depending on the material you are attaching to, use a screw of sufficient length and strength to support the GigaSpire BLAST once attached to the bracket. See below for specifications on what type of screw is recommended.

Additional Mounting Considerations

The options for mounting a GigaSpire BLAST system are many. From a best practices standpoint, keep the following in mind:

- Calix recommends mounting the BLAST as high as possible for Wi-Fi performance reasons. However, this deployment scenario still mandates that an AC power outlet is located within the power cord distance of the Wi-Fi source. If installing in a greenfield environment (initial installation), plan on placing the GigaSpire BLAST within 4 feet of the power supply. As an alternative, longer power cords are available to extend the distance between the BLAST and the power supply.
- Calix also recommends keeping cabling neat and well secured where ever possible. A tidy installation allows for increased safety and an overall neater appearance. Common tools used for this purpose include cable ties and velcro straps for routing cable out of the way. Also, custom made wall plates are often used where the majority of cabling is hidden behind a wall.

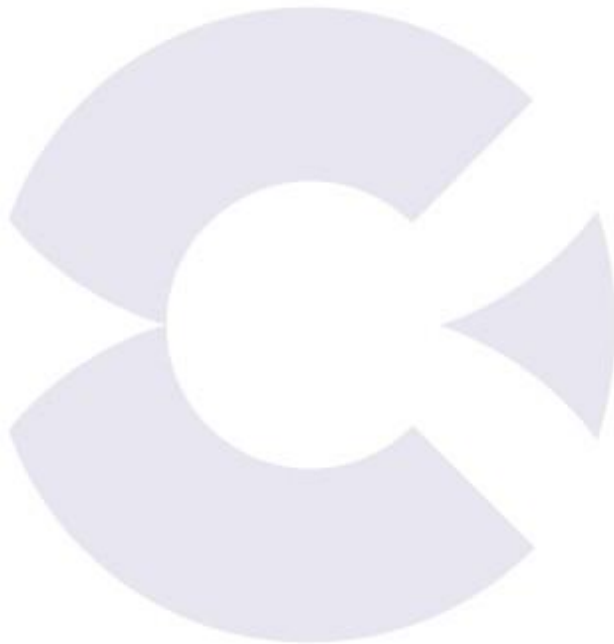

Chapter 3

Final Set-up and Testing

BLAST u4/u4m Reset Behavior

Calix EDGE systems support a variety of system reset functions and provide multiple methods for invoking each of these functions, as described in this topic. Calix defines these functions and behaviors as follows:

1. Basic reset (reboot): Restarts the router.
2. Configuration reset: Resets the RG configuration settings (those visible to the subscriber/Admin user in the EWI, such as SSIDs, LAN IP scope, etc.) to defaults, but retains operator-configured management settings (those visible only to the Support user in the EWI, such as ACS URL and SPID).
3. Factory reset: Resets the router (and any attached mesh satellites) to factory default settings. A factory reset also removes devices from network management systems, including Calix Support Cloud and the Smart Home Admin Dashboard, where applicable.

These reset functions can be used as troubleshooting and/or operations tools for reset/removal scenarios, whether the device is deployed as a Residential Gateway or as a subtended WAP or Satellite (GigaSpire BLAST or GigaMesh). Hardware-invoked resets behave differently depending on how long the reset button is pressed, as described below.

Function	Where Performed
Basic Reset ¹	Hardware: Press Reset button once for 1 second
	Software: EWI > Utilities > Reboot
Configuration Reset ²	Hardware: Press and hold Reset button for 15+ seconds
	Software: EWI > Utilities > Restore Defaults
Factory Reset	Hardware: no option
	Software (for support user only): EWI > Support > Tools > Smart Activate > Factory Reset
<p>Note: For operators with Calix Support Cloud (CSC), remote resets can be invoked as follows:</p> <p>¹ System Tools > Reboot (https://www.calix.com/content/calix/en/site-prod/library-html/software-products/cloud/nm/support/help/index.htm#88688.htm)</p> <p>² System Tools > Factory Reset (https://www.calix.com/content/calix/en/site-prod/library-html/software-products/cloud/nm/support/help/index.htm#88687.htm) (option actually performs just a configuration reset)</p>	

The table below provides additional notes for each Reset event:

BLAST Reset Behavior			
Reset Type	How Invoked	Expected Behavior	Notes
Basic Reset - Hardware	Press Reset button	<ul style="list-style-type: none"> Router or satellite reboots RG configuration and subscriber's custom settings persist 	Pressing the Reset button performs a standard power cycle. All configuration information persists. Device goes offline for 2-3 minutes while it completes the reboot process.
Basic Reset - Software	EWI > Utilities > Reboot	<ul style="list-style-type: none"> Router reboots RG configuration and subscriber's custom settings persist 	Subscriber (Admin user) has access to the EWI to invoke a soft reset. All configuration information persists. Device goes offline for 2-3 minutes while reboot process completes.
Configuration Reset - Hardware	Press and hold Reset button (10+ seconds)	<ul style="list-style-type: none"> Router or satellite reboots RG configuration and subscriber's custom settings reset to defaults Service provider applied management settings persist 	Reset button must be pressed and held until LEDs flash (after about 10 seconds). Device goes offline while it completes the reboot process. Residential Gateway (RG) configuration settings include all subscriber- configurable information such as login credentials for Admin user, SSIDs, LAN IP scope, etc., all of which reset to defaults.
Configuration Reset - Software	EWI > Utilities > Restore Defaults	<ul style="list-style-type: none"> Router reboots RG configuration and subscriber's custom settings reset to defaults Service provider applied management settings persist 	Subscriber (Admin user) has access to the EWI to invoke a configuration reset. Device goes offline while it completes the reboot process. Residential Gateway (RG) configuration settings include all subscriber- configurable information such as login credentials for Admin user, SSIDs, LAN IP scope, etc., all of which reset to defaults.
Factory Reset - Software	EWI > Support Menu > Tools > Smart Activate > Factory Reset	<ul style="list-style-type: none"> Router reboots RG configuration settings reset to factory defaults Service provider applied management settings reset to factory defaults 	Function available only to operators via EWI Support user (not available to subscriber/Admin user). Service provider management settings include all information visible on the EWI Support tab, such as login credentials for Support user, TR-69 ACS URL and login credentials, SPID, etc., all of which reset to defaults.

Powering the BLAST u4/u4m

The information below describes the powering of any GigaSpire BLAST.

To power up the BLAST u4 or u4m

1. Locate the 12 VDC Power Adapter.
2. Attach one end (2-pin barrel connector) to the rear of the BLAST u4/u4m.
3. Plug the other end into any available 110/220 VAC wall outlet.
4. The GigaSpire BLAST begins its start-up sequence (Flashing blue LED).

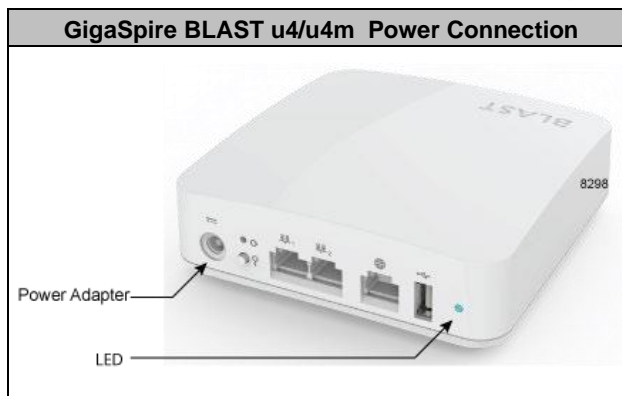

Connecting to the Internet

The method by which the GigaSpire BLAST u4 or GigaSpire Mesh BLAST u4m is deployed will impact the internet connection. With power applied to the BLAST, perform the following steps based on the role the device plays in the network.

Connecting to a residential gateway

If the unit is configured as a Residential Gateway, connect an Ethernet Cable to its WAN port from the WAN modem (ONU, cable modem, or DSL modem).

Connecting as a Mesh point

If the unit is configured as a MESH point, connect an Ethernet cable from its WAN port to another GigaSpire or wirelessly connect the two devices.

Additional Comments

- Once your GigaSpires LED turns BLUE, you are connected to the upstream WAN modem.
- At start-up, Wi-Fi radios are defaulted to on.
- To configure your GigaSpire BLAST device, connect an Ethernet cable between your PC and the LAN port of your unit and enter the default IP Address of the device (192.168.1.1) into your browser.
- Wi-Fi radios can be configured using the default settings:
 - SSID: Printed on the product label in the gift box. (CXNKxxxxxxx)
 - Number of radios: 2 (2.4 GHz and 5 GHz)
 - Wi-Fi Protocol supported: 802.11a/b/n/g/ac/ax
 - Credentials: Login and password printed on the product label in the gift box.

LED States - Power Off & Boot-up

Note: For all LED sequences, the BLAST u4 and the Mesh BLAST u4m incorporate a single LED located on the interface side of the unit.

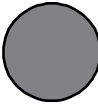
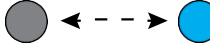
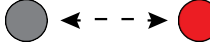
Power Off and Boot-up		
Description	Colors	Indication
OFF <ul style="list-style-type: none"> Power is Off The unit has not been turned on <i>or</i> <ul style="list-style-type: none"> There is no power to the unit <i>or</i> <ul style="list-style-type: none"> Any auxillary battery has been discharged and can no longer power the unit. 	Off	
Booting Up, SW Upgrade in Process <ul style="list-style-type: none"> Unit is in the process of booting up or services/software is being upgraded Flashing ever 1 second assuming software can control the LED 	Off & Cyan Cycles @ 1000 msec	
<ul style="list-style-type: none"> Boot-up Failure Unit boot-up has failed (assuming software can control the LED). 	Off & Red Cycles @ 800 msec	

LED States - BLAST LED Status

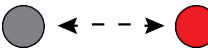
BLAST LED Status		
Description	Colors	Indication
Connect to Internet <ul style="list-style-type: none"> Unit has successfully booted up, local services are up, and connected to the Internet 	CYAN Continuous	
Service Failure - No Internet Connection <ul style="list-style-type: none"> Unit is in the process of booting up or services/software is being upgraded Flashing ever 1 second assuming software can control the LED 	Off & Red Cycles @ 1600 msec	

LED States - Samsung Smart Things

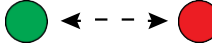
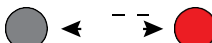
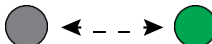
Samsung Smart Things		
Description	Colors	Indication
ST Hub Ready for Setup <ul style="list-style-type: none"> Red & Green Flashing 	LED green and Red cycles at 500 msec. Once set-up, reverts to gateway previous status If set-up is not successful, consult Error states under Smart Things	
Set-up Error <ul style="list-style-type: none"> Flashing Red 	If Set-up is not successful, cycle red @ 500 msec, continue flash for 30 secs, then revert to the gateway previous status	
Searching for Sensor Flashing Green	During search for sensor, LED cycles green @ 500 msec. If sensor is found, the LED reverts to gateway previous status. If the sensor is not found, the blinking continues for 60 secs, then reverts to gateway previous status	

LED States - Mesh Mode

Mesh BLAST u4m with BLAST u4		
Description	Colors	Indication
GS202xE Mesh Satellite (Backhaul pairing cycle can be started by WPS button press [3+ second press] or equivalent EWI or smartphone app activation)	For backhaul pairing press WPS for at least 3 seconds	N/A
Booting Up or SW Upgrade in Process <ul style="list-style-type: none"> Unit is in the process of being boot up or service/software is being upgraded Flashing every 1 second on cyan color - assuming SW can control the LEDs. 	Off and Cyan (1000 msec)	
Boot-up Failure <ul style="list-style-type: none"> Unit boot-up failed (if SW can control the LEDs) 	Off and Red (800 msec)	
WPS Pressed, Pairing Attempt has Begun <ul style="list-style-type: none"> For Satellite/Mesh mode, upon pressing the WPS a single time 3+ seconds, WPS is enabled. The LED bar begins to flash 0.5 second green/off and continues to do so for up to 120 seconds. If the Gateway has also initialized WPS during this time, the Satellite can be paired to the Gateway Wi-Fi radios (5.0 GHz band) thereby creating an association with the Gateway SSID. 	Green and Off (500 msec)	
Display Signal Strength (Positioning Strength) Display strength after any of the following conditions (IP address obtained): <ol style="list-style-type: none"> Successful pairing completed Re-start completed (and previous pairing with Gateway restored) Re-association of link with the Gateway after lost link (e.g., Gateway was powered down then restored) <ul style="list-style-type: none"> If the pairing is successful, following will be the behavior of the WPS/Strength LED: If the Satellite is too close from Gateway but still connected, LED will light up fast blinking green (250 msec). * If the Satellite is too far from Gateway but still connected, LED will light up slow blinking green (1000 msec). * When the Satellite is at an ideal location from Gateway the LED will light up steady green. * After 60 seconds, the light bar begins to reflect Gateway status (not shown in the illustration below). For example, cyan for connected to the Internet 	Gray and Green	Too Close: Fast Blink (250 msec) Too Far: Slow Blink (1000 msec) Ideal: Steady State
Gateway Not Found <ul style="list-style-type: none"> If no device is found after the initial 120 second time-out, the WPS/Strength LED bar shifts from the blinking Green to solid Red. LED bar remains red for another 60 seconds, then revert to the No Internet failure status. If pairing is accomplished, LED bar will change to reflect Gateway status. 	Solid Red	

Proprietary Information: Not for use or disclosure except by written agreement with Calix.

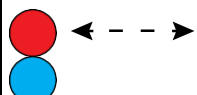
<p>After pairing, follow the Gateway Status</p> <ul style="list-style-type: none"> • After the pairing is complete (60 seconds after the signal strength has been displayed), the light bar indication shall follow the Gateway status as described on the Light Bar tab in this spreadsheet. • • If the mesh is connected via Ethernet connection, if boot up successfully, the light bar indication shall follow the Gateway status as described on the Light Bar tab in this spreadsheet. 	<p>After 60 seconds, Cyan or Red, or Off</p>	
<p>Lost Control plane but data plane is still connected</p> <p>Regardless of what stage the mesh unit is in. If the control plane is loss but the data plane is still in connection. Then flash the LED to red for 15 seconds, after that return the LED to cyan</p>	<p>Flash LED to red for 15 seconds, then revert to Cyan</p>	

Wall Mount Template

Inside the giftbox of the BLAST u4 or u4m, a printed wall mount template is included. This template is scaled to size and should be used when marking the hole locations for the wall mount option. The figure below is a representative example of the template but should not be used as it is not scaled appropriately.

For additional information, refer to *Wall Mounting the u4 / u4m* (on page [28](#)) located in the Installation chapter of this guide.

