

# MEASUREMENT REPORT

## FCC PART 15 Subpart C WLAN 802.11b/g/n/VHT/ax

---

**FCC ID:** 2ABLK-BLASTU4X

**Applicant:** Calix Inc.

**Application Type:** Certification

**Product:** GigaSpire BLAST u4, GigaSpire Mesh BLAST u4m

**Model No.:** GigaSpire BLAST u4, GigaSpire Mesh BLAST u4m

**Brand Name:** 

**FCC Classification:** Digital Transmission System (DTS)

**FCC Rule Part(s):** Part15 Subpart C (Section 15.247)

**Test Procedure(s):** ANSI C63.10-2013, KDB 558074 D01v05r02,  
KDB 662911 D01v02r01

**Test Date:** July 01 ~ August 18, 2020

**Reviewed By:**   
( Kevin Guo )

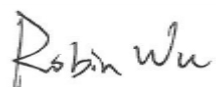
**Approved By:**   
( Robin Wu )



The test results relate only to the samples tested.

This equipment has been shown to be capable of compliance with the applicable technical standards as indicated in the measurement report and was tested in accordance with the measurement procedures specified in ANSI C63.10-2013. Test results reported herein relate only to the item(s) tested.

The test report shall not be reproduced except in full without the written approval of MRT Technology (Suzhou) Co., Ltd.

---

## Revision History

Report No.	Version	Description	Issue Date	Note
2006RSU066-U1	Rev. 01	Initial report	08-21-2020	Valid

---

## CONTENTS

Description	Page
<b>1. INTRODUCTION.....</b>	<b>6</b>
1.1. Scope.....	6
1.2. MRT Test Location.....	6
<b>2. PRODUCT INFORMATION.....</b>	<b>7</b>
2.1. Equipment Description.....	7
2.2. Models Difference.....	7
2.3. Product Specification Subjective to this Report.....	7
2.4. Working Frequencies for this report.....	8
2.5. Description of Available Antennas.....	8
2.6. Description of Antenna RF Port.....	9
2.7. Test Mode.....	9
2.8. Configuration of Test System.....	10
2.9. Test System Details.....	11
2.10. Description of Test Software.....	11
2.11. Test Environment Condition.....	11
2.12. Duty Cycle.....	12
2.13. EMI Suppression Device(s)/Modifications.....	13
2.14. Labeling Requirements.....	13
<b>3. ANTENNA REQUIREMENTS.....</b>	<b>14</b>
<b>4. TEST EQUIPMENT CALIBRATION DATE.....</b>	<b>15</b>
<b>5. MEASUREMENT UNCERTAINTY.....</b>	<b>17</b>
<b>6. TEST RESULT.....</b>	<b>18</b>
6.1. Summary.....	18
6.2. 6dB Bandwidth Measurement.....	19
6.2.1. Test Limit.....	19
6.2.2. Test Procedure used.....	19
6.2.3. Test Setting.....	19
6.2.4. Test Setup.....	19
6.2.5. Test Result.....	20
6.3. Output Power Measurement.....	27
6.3.1. Test Limit.....	27
6.3.2. Test Procedure Used.....	27
6.3.3. Test Setting.....	27
6.3.4. Test Setup.....	27

---

6.3.5.	Test Result.....	28
6.4.	Power Spectral Density Measurement.....	29
6.4.1.	Test Limit .....	29
6.4.2.	Test Procedure Used .....	29
6.4.3.	Test Setting.....	29
6.4.4.	Test Setup .....	30
6.4.5.	Test Result.....	31
6.5.	Conducted Band Edge and Out-of-Band Emissions .....	44
6.5.1.	Test Limit .....	44
6.5.2.	Test Procedure Used .....	44
6.5.3.	Test Setting.....	44
6.5.4.	Test Setup .....	45
6.5.5.	Test Result.....	46
6.6.	Radiated Spurious Emission Measurement .....	71
6.6.1.	Test Limit .....	71
6.6.2.	Test Procedure Used .....	71
6.6.3.	Test Setting.....	71
6.6.4.	Test Setup .....	73
6.6.5.	Test Result.....	74
6.7.	Radiated Restricted Band Edge Measurement.....	101
6.7.1.	Test Limit .....	101
6.7.2.	Test Procedure Used .....	102
6.7.3.	Test Setting.....	102
6.7.4.	Test Setup .....	103
6.7.5.	Test Result.....	104
6.8.	AC Conducted Emissions Measurement .....	168
6.8.1.	Test Limit .....	168
6.8.2.	Test Setup .....	168
6.8.3.	Test Result.....	169
<b>7.</b>	<b>CONCLUSION .....</b>	<b>171</b>
	<b>Appendix A - Test Setup Photograph .....</b>	<b>172</b>
	<b>Appendix B - EUT Photograph.....</b>	<b>173</b>

## General Information

<b>Applicant:</b>	Calix Inc.
<b>Applicant Address:</b>	1035 N. McDowell Blvd Petaluma, CA94954 U.S.A
<b>Manufacturer:</b>	Calix Inc.
<b>Manufacturer Address:</b>	1035 N. McDowell Blvd Petaluma, CA94954 U.S.A
<b>Test Site:</b>	MRT Technology (Suzhou) Co., Ltd
<b>Test Site Address:</b>	D8 Building, No.2 Tian'edang Rd., Wuzhong Economic Development Zone, Suzhou, China

## Test Facility / Accreditations

Measurements were performed at MRT Laboratory located in Tian'edang Rd., Suzhou, China.

- MRT facility is an FCC accredited testing laboratory (MRT Designation No. CN1166) on the FCC website.
- MRT facility is an ISED recognized testing laboratory (MRT Reg. No. CN0001) on the ISED website.
- MRT facility is a VCCI registered (R-20025, G-20034, C-20020, T-20020) test laboratory with the site description on file at VCCI Council.
- MRT Lab is accredited to ISO 17025 by the A2LA under the A2LA Program (Cert. No. 3628.01) and CNAS under the CNAS Program (Cert. No. L10551) in EMC, Safety, Radio, Telecommunications and SAR testing.

## 1. INTRODUCTION

### 1.1. Scope

Measurement and determination of electromagnetic emissions (EMC) of radio frequency devices including intentional and/or unintentional radiators for compliance with the technical rules and regulations of the Federal Communications Commission and the Innovation, Science and Economic Development Canada and Certification and Engineering Bureau.

### 1.2. MRT Test Location

The map below shows the location of the MRT LABORATORY, its proximity to the Taihu Lake. These measurement tests were conducted at the MRT Technology (Suzhou) Co., Ltd. Facility located at D8 Building, No.2 Tian'edang Rd., Wuzhong Economic Development Zone, Suzhou, China. The measurement facility compliant with the test site requirements specified in ANSI C63.4-2014.



## 2. PRODUCT INFORMATION

### 2.1. Equipment Description

Product Name:	GigaSpire BLAST u4, GigaSpire Mesh BLAST u4m
Model No.:	GigaSpire BLAST u4, GigaSpire Mesh BLAST u4m
Brand Name:	
Wi-Fi Specification:	802.11a/b/g/n/ac/ax/VHT
Serial No.:	262007039756 (Radiated Emission & AC Line Conducted Emission) 262007039695 (Conducted)
Accessory	
Switching Mode Power Adapter:	MODEL: F24L9-120200SPAU INPUT: 100-240V~50/60Hz 0.6A OUTPUT: 12V=2A

Note: Between the models, there are the same schematics design, same PCB layout and the same RF parameters except the difference as below (Section 2.2), and GigaSpire BLAST u4 was selected for all RF test.

### 2.2. Models Difference

Model name	Difference
GigaSpire BLAST u4	2 LAN ports, 1 WAN port, 1 USB, 2.4G/5G Wi-Fi, external PSU
GigaSpire Mesh BLAST u4m	1 WAN port, 2.4G/5G Wi-Fi, external PSU

### 2.3. Product Specification Subjective to this Report

Frequency Range:	802.11b/g/n-HT20/VHT20/ax-HE20: 2412 ~ 2462MHz 802.11n-HT40/VHT40/ax-HE40: 2422 ~ 2452MHz
Channel Number:	802.11b/g/n-HT20/VHT20/ax-HE20: 11 802.11n-HT40/VHT40/ax-HE40: 7
Type of Modulation:	802.11b: DSSS 802.11g/n/VHT: OFDM 802.11ax: OFDMA
Data Rate:	802.11b: 1/2/5.5/11Mbps 802.11g: 6/9/12/18/24/36/48/54Mbps 802.11n: up to 300Mbps VHT: up to 400Mbps 802.11ax: up to 591Mbps

Note: For other features of this EUT, test report will be issued separately.

## 2.4. Working Frequencies for this report

802.11b/g/n-HT20/VHT20/ax-HE20

Channel	Frequency	Channel	Frequency	Channel	Frequency
01	2412 MHz	02	2417 MHz	03	2422 MHz
04	2427 MHz	05	2432 MHz	06	2437 MHz
07	2442 MHz	08	2447 MHz	09	2452 MHz
10	2457 MHz	11	2462 MHz	--	--

802.11n-HT40/VHT40/ax-HE40

Channel	Frequency	Channel	Frequency	Channel	Frequency
03	2422 MHz	04	2427 MHz	05	2432 MHz
06	2437 MHz	07	2442 MHz	08	2447 MHz
09	2452 MHz	--	--	--	--

## 2.5. Description of Available Antennas

Model name	Manufacturer	Tx Port	Frequency Band (MHz)	Cable length (mm)
2.4G-2_PCB-LY70FC1	CHANGSHU HONGBO TELECOMMUNICATION TECHNOLOGY CO., LTD.	2.4G Ant 0	2412~2462	70
2.4G-1_PCB-LE160FC3		2.4G Ant 1	2412~2462	160
RFPCA252302IM5B301	WALSIN TECHNOLOGY CORPORATION	5G Ant 0	5150~5850	30
RFPCA252312IM5B301		5G Ant 1	5150~5850	125

Antenna Type	Frequency Band (MHz)	Tx Paths	Directional Gain (dBi)
			CDD & Beamforming
PCB Antenna	2412 ~ 2462	2	5.84
	5150 ~ 5350	2	5.81
	5470 ~ 5725	2	5.93
	5725 ~ 5850	2	5.95

Note 1: The EUT supports Cyclic Delay Diversity (CDD) and Beamforming technology, and the Beamforming mode support 802.11ac/ax, not include 802.11a/b/g. It transmits signals that are correlated, then Directional gain =  $10 \log [(10^{G1/20} + 10^{G2/20} + \dots + 10^{GN/20})^2 / N_{ANT}]$  dBi [Note the "20"s in the denominator of each exponent and the square of the sum of terms; the object is to combine the signal levels coherently.

Note 2: All the messages as above are provided by manufacturer.

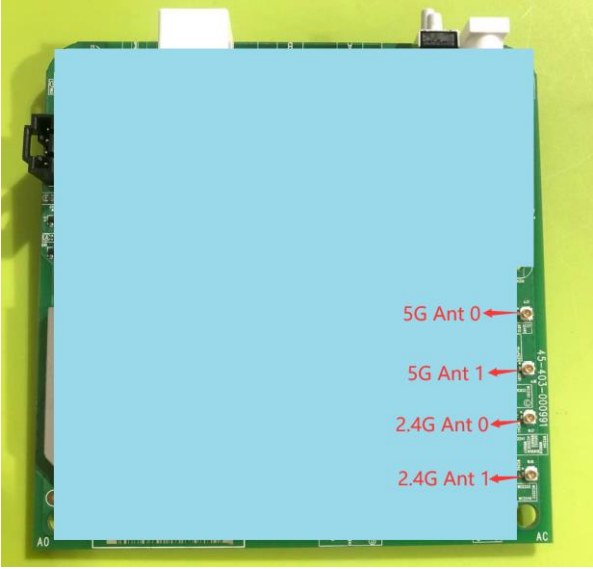

## 2.6. Description of Antenna RF Port

Antenna RF Port				
Software Control Port	2.4GHz RF Port		5GHz RF Port	
	Ant 0	Ant 1	Ant 0	Ant 1
				

## 2.7. Test Mode

Test Mode	Mode 1: Transmit by 802.11b (1Mbps) (CDD Mode)
	Mode 2: Transmit by 802.11g (6Mbps) (CDD Mode)
	Mode 3: Transmit by 802.11n-HT20 (MCS0) (CDD Mode)
	Mode 4: Transmit by 802.11n-HT40 (MCS0) (CDD Mode)
	Mode 5: Transmit by 802.11ax-HE20 (MCS0) (CDD Mode)
	Mode 6: Transmit by 802.11ax-HE40 (MCS0) (CDD Mode)
	Mode 7: Transmit by 802.11ax-HE20 (MCS0) (Beamforming Mode)
	Mode 8: Transmit by 802.11ax-HE40 (MCS0) (Beamforming Mode)

Note: Due to the same modulation between 802.11n and VHT, so VHT mode is covered by 802.11n in this report, meanwhile, power setting for VHT mode will not be greater than 802.11n.

## 2.8. Configuration of Test System

The measurement procedures and appropriate EUT setup described in the American National Standard of Procedures for Compliance Testing of Unlicensed Wireless Devices (ANSI C63.10-2013) was used in the measurement.

Connection Diagram – Radiated Emission testing (CDD mode) & AC Conducted Emissions

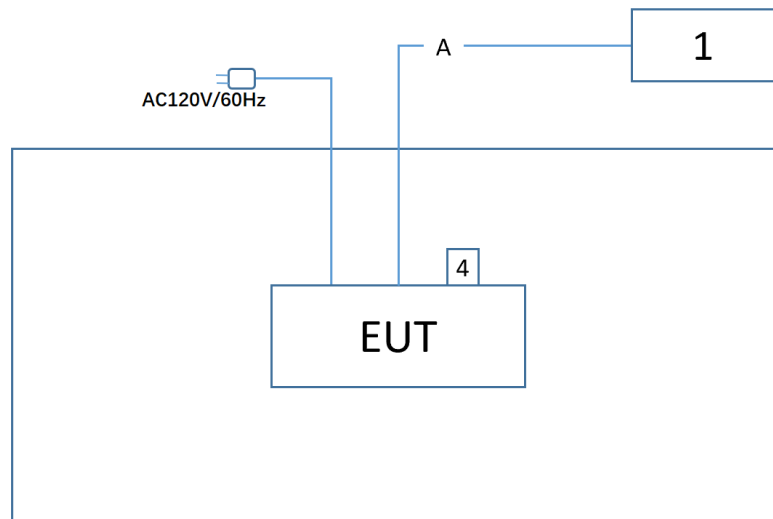

Connection Diagram – Radiated Emission testing (Beamforming mode)

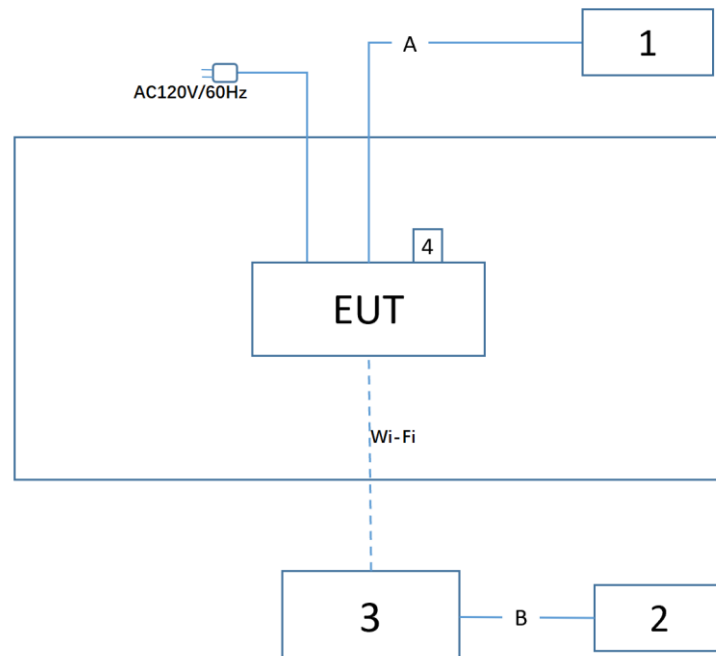

Signal Cable Type		Signal Cable Description
A	LAN Cable	Non shielded, > 10m
B	LAN Cable	Non shielded, 3.0m

## 2.9. Test System Details

The types for all equipments, plus descriptions of all cables used in the tested system (including inserted cards) are:

Product	Manufacturer	Model No.	Serial No.	Power Cord
1 Notebook	Lenovo	E431	PF-10ZRN 13/12	Non-Shielded, 1.8m
2 Notebook	Lenovo	X230i	N/A	Non-Shielded, 1.8m
3 Station Device	Calix	GigaSpire BLAST u4	N/A	N/A
4 USB flash disk	SanDisk	CZ48	N/A	N/A

## 2.10. Description of Test Software

### For CDD mode:

The test utility software used during testing was “Qualcomm Radio Control Tool”, and the version was “4.0.00132.0”.

### For Beamforming mode:

Conducted measurement

The test utility software used during testing was “Qualcomm Radio Control Tool”, and the version was “4.0.00132.0”.

Radiated measurement

- 1) Configure EUT and station device to under the normal operation.
- 2) Set and fix EUT’s mode, channel, and power by telnet.
- 3) Connect EUT with station device, run “*lperf.exe*” to transmit and receive packet continuously by station device.

Note: Final power setting please refer to operational description.

## 2.11. Test Environment Condition

Ambient Temperature	15°C~35°C
Relative Humidity	20%RH ~75%RH

## 2.12. Duty Cycle

2.4GHz WLAN (DTS) operation is possible in 20MHz and 40MHz channel bandwidths. The maximum achievable duty cycles for all modes were determined based on measurements performed on a spectrum analyzer in zero-span mode with RBW = 8MHz, VBW = 50MHz. The RBW and VBW were both greater than 50/T, where T is the minimum transmission duration, and the number of sweep points across T was greater than 100. The duty cycles are as follows:

Test Mode	Duty Cycle
802.11b	62.58%
802.11g	93.25%
802.11n-HT20	91.78%
802.11n-HT40	85.94%
802.11ax-HE20	94.53%
802.11ax-HE40	92.05%

### Duty Cycle (T = Transmission Duration)

802.11b (T = 1.322ms)

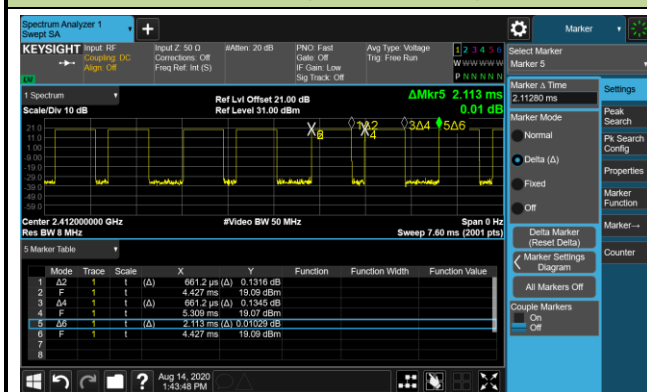

802.11g (T = 1.974ms)

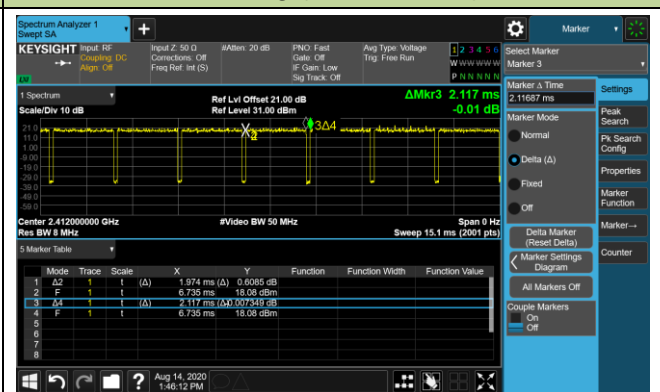

802.11n-HT20 (T = 16.200ms)

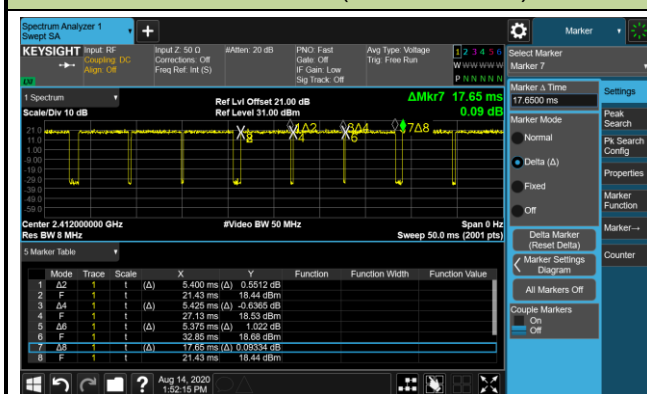

802.11n-HT40 (T = 10.700ms)

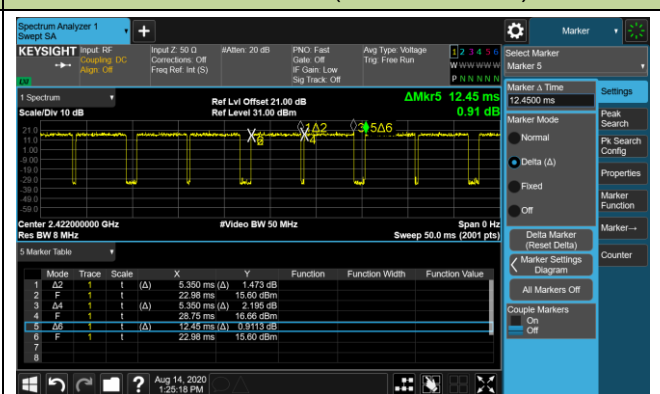

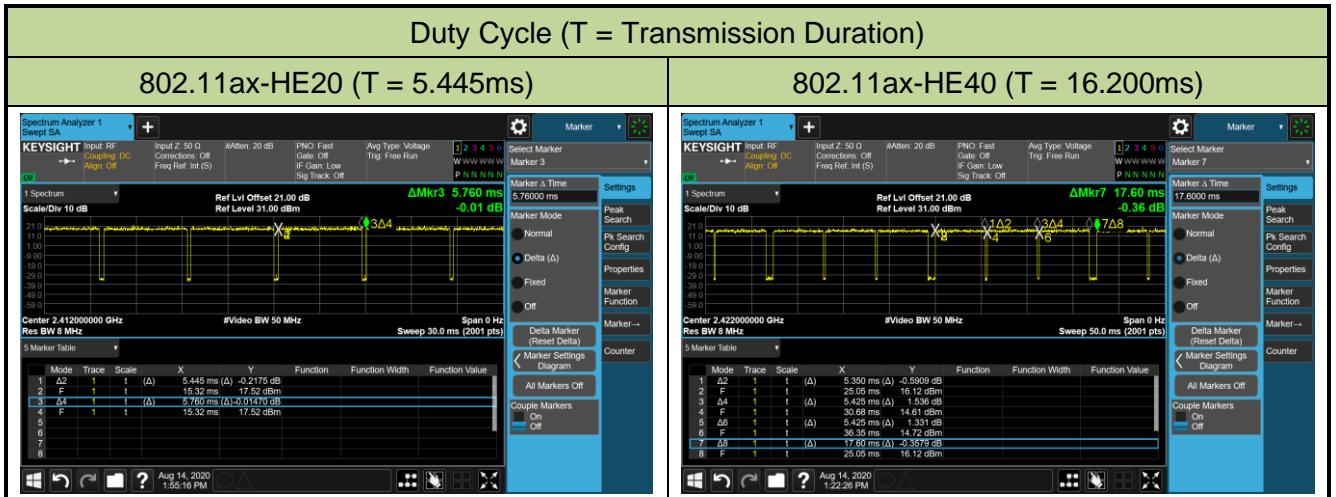

### 2.13. EMI Suppression Device(s)/Modifications

No EMI suppression device(s) were added and/or no modifications were made during testing.

### 2.14. Labeling Requirements

Per 2.1074 & 15.19; Docket 95-19

The label shall be permanently affixed at a conspicuous location on the device; instruction manual or pamphlet supplied to the user and be readily visible to the purchaser at the time of purchase.

However, when the device is so small wherein placement of the label with specified statement is not practical, only the FCC ID must be displayed on the device per Section 15.19(a)(5). Please see attachment for FCC ID label and label location.

### 3. ANTENNA REQUIREMENTS

**Excerpt from §15.203 of the FCC Rules/Regulations:**

“An intentional radiator antenna shall be designed to ensure that no antenna other than that furnished by the responsible party can be used with the device. The use of a permanently attached antenna or of an antenna that uses a unique coupling to the intentional radiator shall be considered sufficient to comply with the provisions of this section.”

- The antenna of the device is **permanently attached**.
- There are no provisions for connection to an external antenna.

**Conclusion:**

The unit complies with the requirement of §15.203.

#### 4. TEST EQUIPMENT CALIBRATION DATE

##### Conducted Emissions - SR2

Instrument	Manufacturer	Type No.	Asset No.	Cali. Interval	Cali. Due Date
EMI Test Receiver	R&S	ESR3	MRTSUE06185	1 year	2021/01/18
Two-Line V-Network	R&S	ENV 216	MRTSUE06002	1 year	2021/06/11
Two-Line V-Network	R&S	ENV 216	MRTSUE06003	1 year	2021/06/11
Thermohygrometer	Testo	608-H1	MRTSUE06404	1 year	2021/07/26

##### Radiated Emissions - AC2

Instrument	Manufacturer	Type No.	Asset No.	Cali. Interval	Cali. Due Date
EMI Test Receiver	R&S	ESR7	MRTSUE06001	1 year	2021/01/18
PXA Signal Analyzer	Keysight	9030B	MRTSUE06395	1 year	2020/09/03
Loop Antenna	Schwarzbeck	FMZB 1519	MRTSUE06025	1 year	2020/11/13
Bilog Period Antenna	Schwarzbeck	VULB 9168	MRTSUE06172	1 year	2021/04/03
Broad Band Horn Antenna	Schwarzbeck	BBHA 9120D	MRTSUE06023	1 year	2020/10/13
Broad Band Horn Antenna	Schwarzbeck	BBHA 9170	MRTSUE06597	1 year	2020/12/17
Microwave System Amplifier	Agilent	83017A	MRTSUE06076	1 year	2020/11/15
Preamplifier	Schwarzbeck	BBV 9721	MRTSUE06121	1 year	2021/06/11
Thermohygrometer	Testo	608-H1	MRTSUE06403	1 year	2021/07/26
Anechoic Chamber	TDK	Chamber-AC2	MRTSUE06212	1 year	2021/04/30

##### Radiated Emission - AC2

Instrument	Manufacturer	Type No.	Asset No.	Cali. Interval	Cali. Due Date
Spectrum Analyzer	Keysight	N9038A	MRTSUE06125	1 year	2021/07/02
Loop Antenna	Schwarzbeck	FMZB 1519	MRTSUE06025	1 year	2020/11/13
Bilog Period Antenna	Schwarzbeck	VULB 9162	MRTSUE06022	1 year	2020/10/13
Horn Antenna	Schwarzbeck	BBHA9120D	MRTSUE06171	1 year	2020/10/27
Broad Band Horn Antenna	Schwarzbeck	BBHA 9170	MRTSUE06597	1 year	2020/12/17
Broadband Coaxial Preamplifier	Schwarzbeck	BBV 9718	MRTSUE06176	1 year	2020/11/15
Preamplifier	Schwarzbeck	BBV 9721	MRTSUE06121	1 year	2021/06/11
Temperature/Humidity Meter	Minggao	ETH529	MRTSUE06170	1 year	2020/12/15
Anechoic Chamber	RIKEN	Chamber-AC2	MRTSUE06213	1 year	2021/04/30

## Conducted Test Equipment - TR3

Instrument	Manufacturer	Type No.	Asset No.	Cali. Interval	Cali. Due Date
EXA Signal Analyzer	Agilent	N9020A	MRTSUE06106	1 year	2021/04/14
EXA Signal Analyzer	Keysight	N9010B	MRTSUE06452	1 year	2021/01/08
Signal Analyzer	R&S	FSV40	MRTSUE06218	1 year	2021/04/14
Power Meter	Agilent	U2021XA	MRTSUE06030	1 year	2020/11/18
USB wideband power sensor	Keysight	U2021XA	MRTSUE06446	1 year	2021/06/11
USB wideband power sensor	Keysight	U2021XA	MRTSUE06447	1 year	2021/06/11
Bluetooth Test Set	Anritsu	MT8852B-042	MRTSUE06389	1 year	2021/06/11
Audio Analyzer	Agilent	U8903B	MRTSUE06143	1 year	2021/06/11
Modulation Analyzer	HP	8901A	MRTSUE06098	1 year	2020/10/10
Wideband Radio Communication Tester	R&S	CMW 500	MRTSUE06243	1 year	2020/11/07
DC Power Supply	GWINSTEK	DPS-3303C	MRTSUE06064	N/A	N/A
Attenuator	MVE	6dB	MRTSUE06534	1 year	2020/12/12
Attenuator	MVE	10dB	MRTSUE06543	1 year	2020/12/12
Temperature & Humidity Chamber	BAOYT	BYH-150CL	MRTSUE06051	1 year	2020/11/07
Thermohygrometer	testo	608-H1	MRTSUE06401	1 year	2021/07/26

Software	Version	Function
EMI Software	V3	EMI Test Software



## 5. MEASUREMENT UNCERTAINTY

Where relevant, the following test uncertainty levels have been estimated for tests performed on the EUT as specified in CISPR 16-4-2. This uncertainty represents an expanded uncertainty expressed at approximately the 95% confidence level using a coverage factor of  $k = 2$ .

<b>Conducted Emission Measurement</b>
Measurement Uncertainty for a Level of Confidence of 95% ( $U=2Uc(y)$ ): 9kHz~150kHz: 3.74dB 150kHz~30MHz: 3.44dB
<b>Radiated Disturbance</b>
Measurement Uncertainty for a Level of Confidence of 95% ( $U=2Uc(y)$ ): Horizontal: 9KHz~300MHz: 5.04dB 300MHz~1GHz: 4.95dB 1GHz~6GHz: 6.40dB Vertical: 9KHz~300MHz: 5.24dB 300MHz~1GHz: 6.03dB 1GHz~40GHz: 6.40dB
<b>Spurious Emissions, Conducted</b>
Measuring Uncertainty for a Level of Confidence of 95% ( $U=2Uc(y)$ ): 0.78dB
<b>Output Power</b>
Measuring Uncertainty for a Level of Confidence of 95% ( $U=2Uc(y)$ ): 1.13dB
<b>Power Spectrum Density</b>
Measuring Uncertainty for a Level of Confidence of 95% ( $U=2Uc(y)$ ): 1.15dB
<b>Occupied Bandwidth</b>
Measuring Uncertainty for a Level of Confidence of 95% ( $U=2Uc(y)$ ): 0.28%

## 6. TEST RESULT

### 6.1. Summary

FCC Section(s)	Test Description	Test Limit	Test Condition	Test Result	Reference
15.247(a)(2)	6dB Bandwidth	$\geq 500\text{kHz}$	Conducted	Pass	Section 6.2
15.247(b)(3)	Output Power	$\leq 30\text{dBm}$		Pass	Section 6.3
15.247(e)	Power Spectral Density	$\leq 8\text{dBm}/3\text{kHz}$		Pass	Section 6.4
15.247(d)	Band Edge / Out-of-Band Emissions	$\geq 30\text{dBc(Average)}$		Pass	Section 6.5
15.205 15.209	General Field Strength Limits (Restricted Bands and Radiated Emission Limits)	Emissions in restricted bands must meet the radiated limits detailed in 15.209	Radiated	Pass	Section 7.6 & 7.7
15.207	AC Conducted Emissions 150kHz - 30MHz	< FCC 15.207 limits	Line Conducted	Pass	Section 6.8

#### Notes:

- 1) The analyzer plots shown in this section were all taken with a correction table loaded into the analyzer. The correction table was used to account for the losses of the cables and attenuators used as part of the system to connect the EUT to the analyzer at all frequencies of interest.
- 2) Output power test was verified over all data rates of each mode (data refers to operational description), and then choose the maximum power output (low data rate) for the final test of each channel.
- 3) For radiated emission tests, every axis (X, Y, Z) was also verified. The test results shown in the following sections represent the worst-case emissions.
- 4) Test Items "6dB Bandwidth" showed the worst test data in this report.
- 5) EUT supports one configuration only in 802.11ax full RU mode, i.e. 242 tone in 11ax-HE20 and 484 tone in 11ax-HE40.

## 6.2. 6dB Bandwidth Measurement

### 6.2.1. Test Limit

The minimum 6dB bandwidth shall be at least 500 kHz.

### 6.2.2. Test Procedure used

ANSI C63.10 Section 11.8

### 6.2.3. Test Setting

1. The Spectrum's automatic bandwidth measurement capability was used to perform the 6dB bandwidth measurement. The "X" dB bandwidth parameter was set to  $X = 6$ . The bandwidth measurement was not influenced by any intermediate power nulls in the fundamental emission.
2. Set RBW = 100 kHz
3. VBW  $\geq 3 \times$  RBW
4. Detector = Peak
5. Trace mode = max hold
6. Sweep = auto couple
7. Allow the trace was allowed to stabilize

### 6.2.4. Test Setup

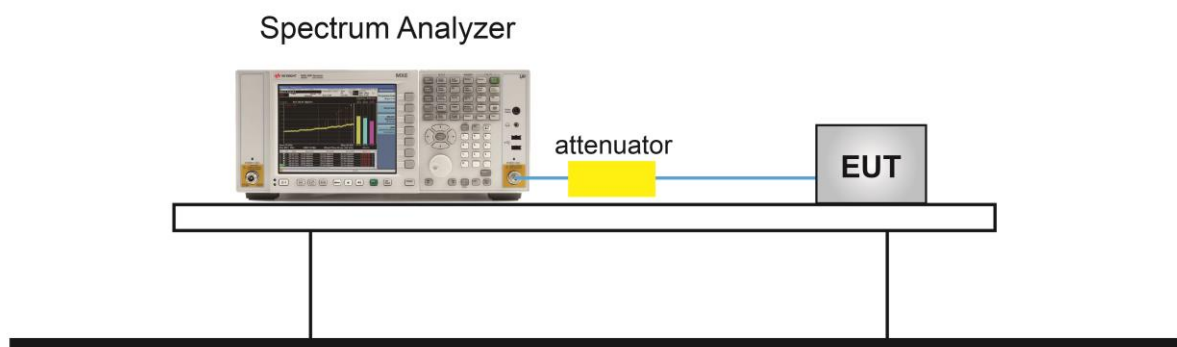

### 6.2.5. Test Result

Product	GigaSpire BLAST u4	Test Engineer	Amy Zhang
Test Date	2020/07/09	Test Site	TR3

Test Mode	Data Rate / MCS	Channel No.	Frequency (MHz)	6dB Bandwidth (MHz)	Limit (MHz)	Result
Ant 0 / Ant 0 + 1						
802.11b	1Mbps	01	2412	8.07	≥ 0.5	Pass
802.11b	1Mbps	06	2437	8.06	≥ 0.5	Pass
802.11b	1Mbps	11	2462	7.59	≥ 0.5	Pass
802.11g	6Mbps	01	2412	16.34	≥ 0.5	Pass
802.11g	6Mbps	06	2437	15.64	≥ 0.5	Pass
802.11g	6Mbps	11	2462	16.03	≥ 0.5	Pass
802.11n-HT20	MCS0	01	2412	16.30	≥ 0.5	Pass
802.11n-HT20	MCS0	06	2437	17.54	≥ 0.5	Pass
802.11n-HT20	MCS0	11	2462	17.32	≥ 0.5	Pass
802.11n-HT40	MCS0	03	2422	36.34	≥ 0.5	Pass
802.11n-HT40	MCS0	06	2437	36.32	≥ 0.5	Pass
802.11n-HT40	MCS0	09	2452	36.30	≥ 0.5	Pass
802.11ax-HE20	MCS0	01	2412	17.95	≥ 0.5	Pass
802.11ax-HE20	MCS0	06	2437	18.02	≥ 0.5	Pass
802.11ax-HE20	MCS0	11	2462	18.57	≥ 0.5	Pass
802.11ax-HE40	MCS0	03	2422	37.88	≥ 0.5	Pass
802.11ax-HE40	MCS0	06	2437	37.92	≥ 0.5	Pass
802.11ax-HE40	MCS0	09	2452	37.72	≥ 0.5	Pass

802.11b 6dB Bandwidth - Ant 0 / Ant 0 + 1

Channel 01 (2412MHz)

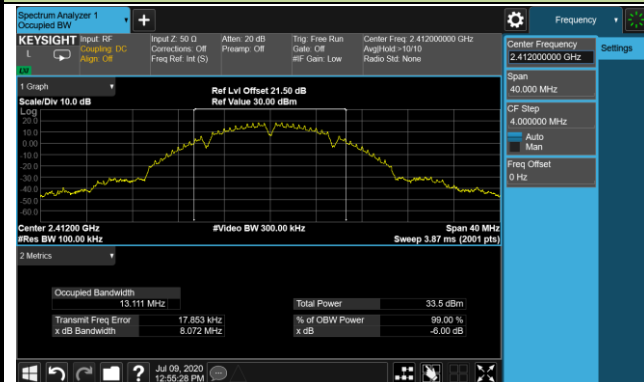

Channel 06 (2437MHz)



Channel 11 (2462MHz)

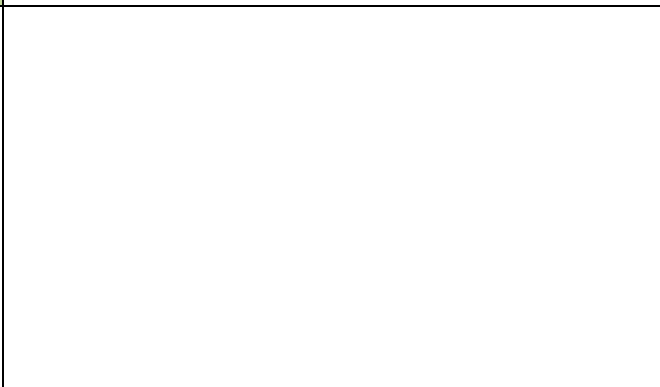

802.11g 6dB Bandwidth - Ant 0 / Ant 0 + 1

Channel 01 (2412MHz)

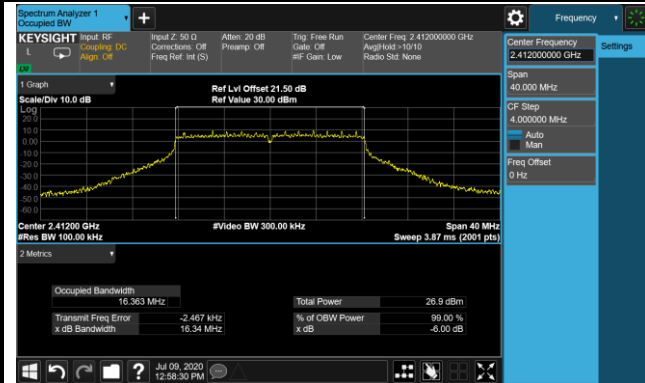

Channel 06 (2437MHz)

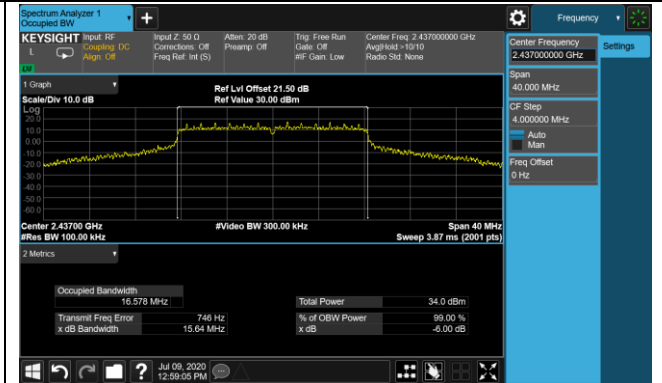

Channel 11 (2462MHz)

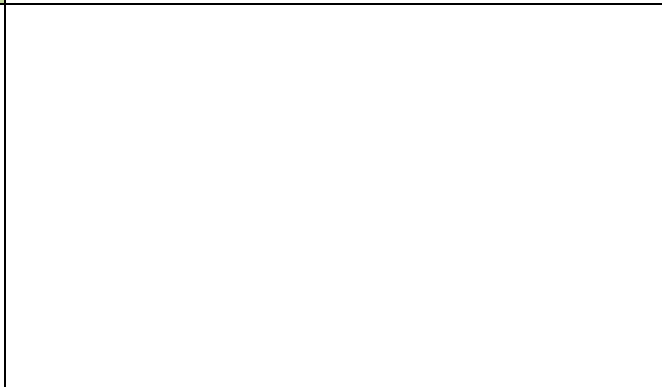
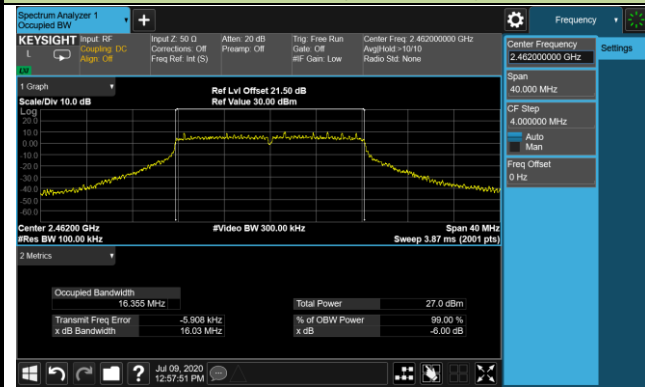

## 802.11n-HT20 6dB Bandwidth - Ant 0 / Ant 0 + 1

## Channel 01 (2412MHz)

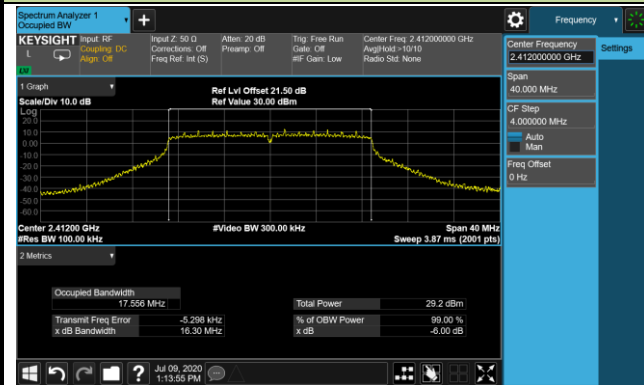

## Channel 06 (2437MHz)

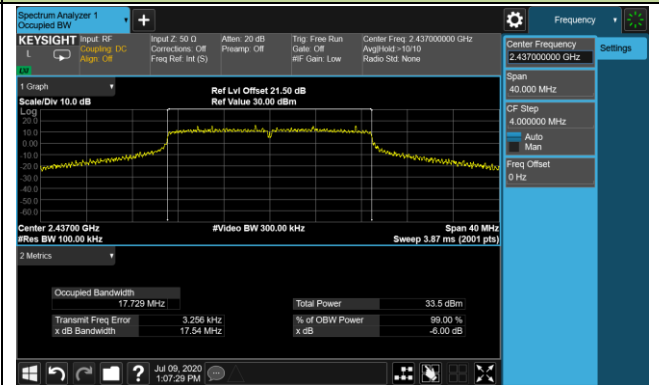

## Channel 11 (2462MHz)

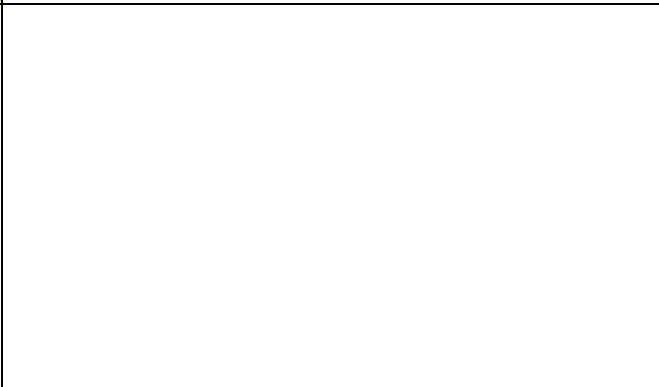
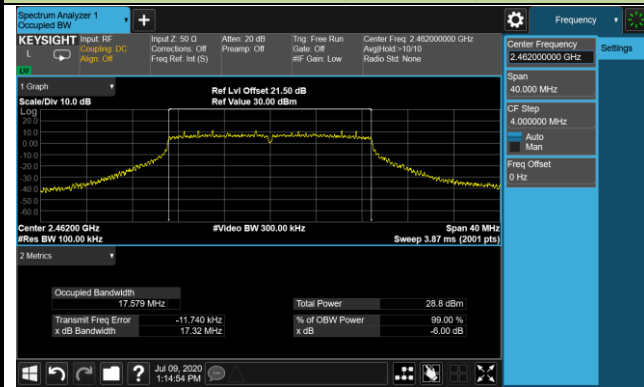

802.11n-HT40 6dB Bandwidth - Ant 0 / Ant 0 + 1

Channel 03 (2422MHz)

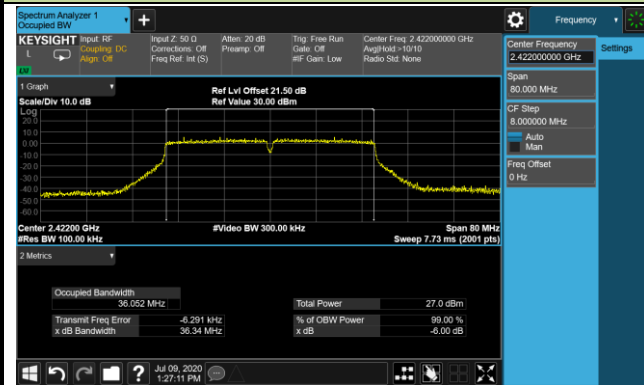

Channel 06 (2437MHz)

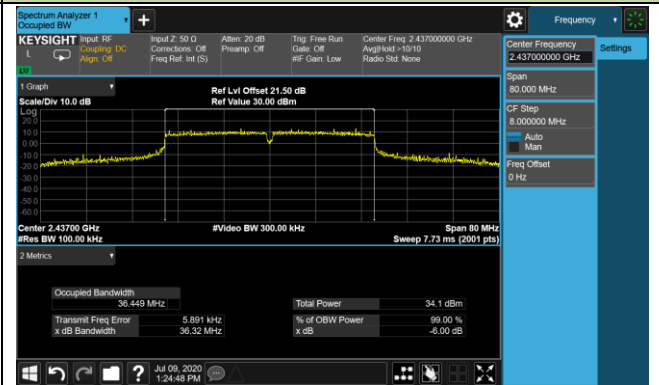

Channel 09 (2452MHz)

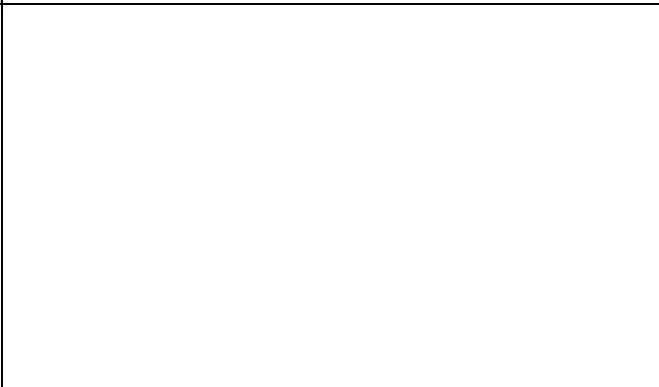
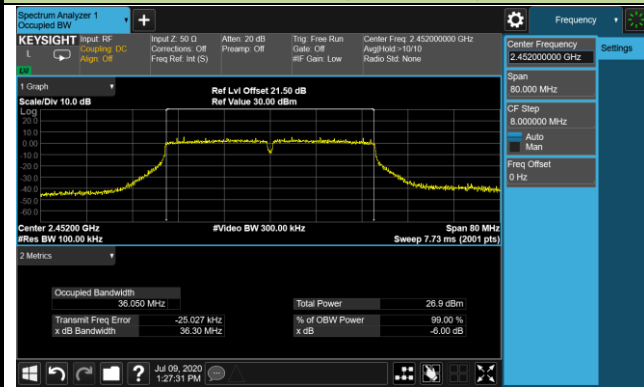



802.11ax-HE20 6dB Bandwidth - Ant 0 / Ant 0 + 1

Channel 01 (2412MHz)

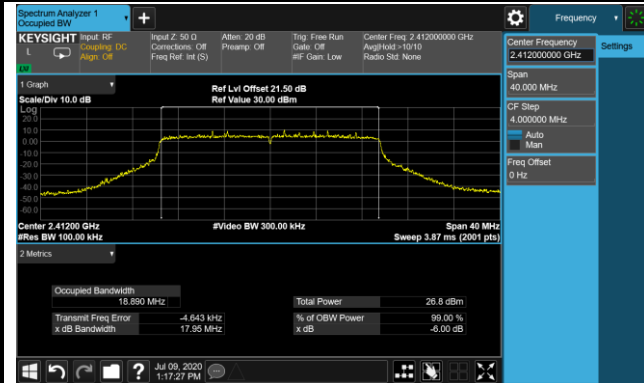

Channel 06 (2437MHz)

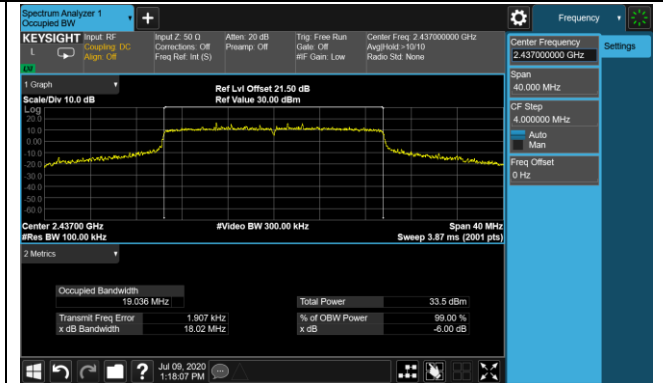

Channel 11 (2462MHz)

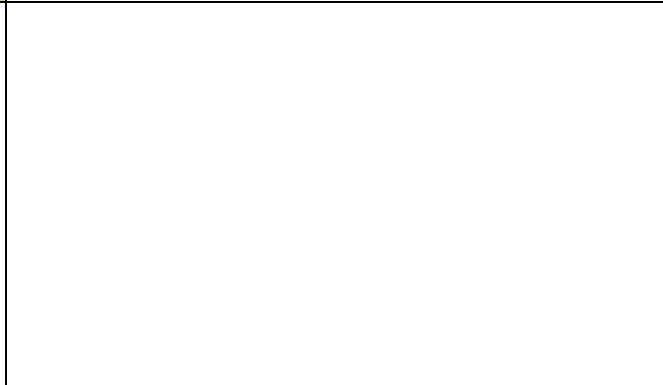
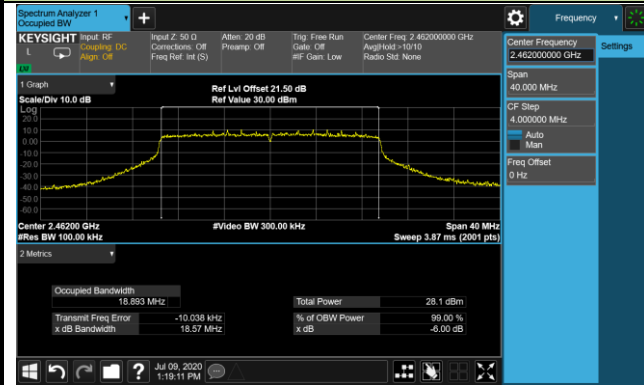

802.11ax-HE40 6dB Bandwidth - Ant 0 / Ant 0 + 1

Channel 03 (2422MHz)

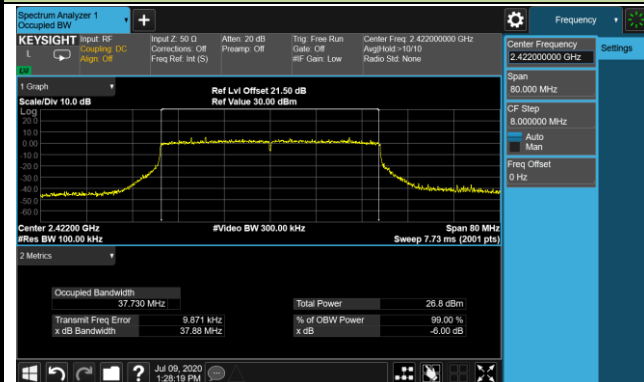

Channel 06 (2437MHz)

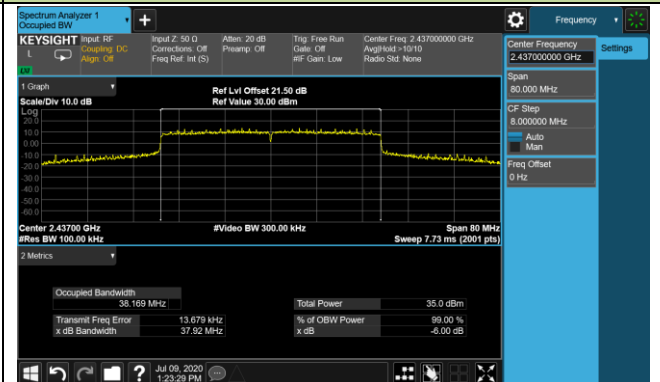

Channel 09 (2452MHz)

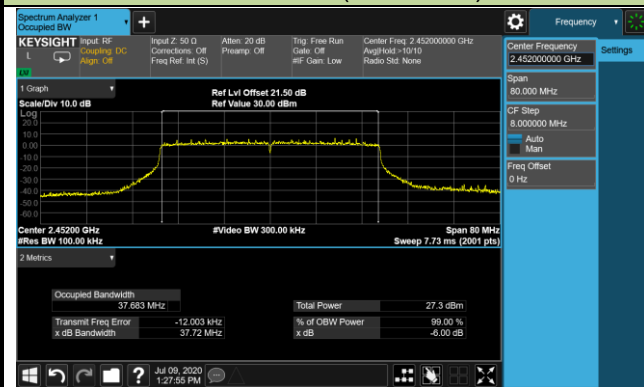

## 6.3. Output Power Measurement

### 6.3.1. Test Limit

The maximum output power shall be less 1 Watt (30dBm).

The conducted output power limit specified in paragraph FCC Part 15.247(b) of this section is based on the use of antennas with directional gains that do not exceed 6 dBi. If transmitting antennas of directional gain greater than 6 dBi are used, the conducted output power from the intentional radiator shall be reduced below the stated values in paragraphs FCC Part 15.247(b)(3) of this section, as appropriate, by the amount in dB that the directional gain of the antenna exceeds 6 dBi.

### 6.3.2. Test Procedure Used

ANSI C63.10 Section 11.9.2.3.2

### 6.3.3. Test Setting

#### Average Power Measurement

Average power measurements were performed only when the EUT was transmitting at its maximum power control level using a broadband power meter with a pulse sensor. The power meter implemented triggering and gating capabilities which were set up such that power measurements were recorded only during the ON time of the transmitter.

### 6.3.4. Test Setup

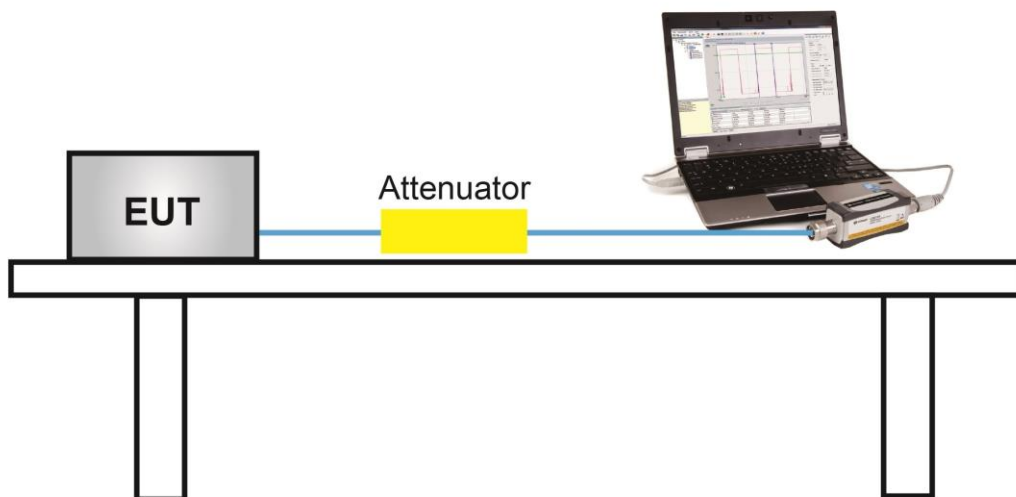

### 6.3.5. Test Result

Product	GigaSpire BLAST u4	Test Engineer	Amy Zhang
Test Date	2020/08/01	Test Site	TR3

Test Mode	Data Rate/ MCS	Channel No.	Freq. (MHz)	Ant 0 Average Power (dBm)	Ant 1 Average Power (dBm)	Total Average Power (dBm)	Limit (dBm)	Result
<b>CDD Mode</b>								
802.11b	1Mbps	01	2412	26.87	26.82	29.86	≤ 30.00	Pass
802.11b	1Mbps	06	2437	26.04	26.16	29.11	≤ 30.00	Pass
802.11b	1Mbps	11	2462	25.37	25.68	28.54	≤ 30.00	Pass
802.11g	6Mbps	01	2412	23.34	23.26	26.31	≤ 30.00	Pass
802.11g	6Mbps	06	2437	26.47	26.63	29.56	≤ 30.00	Pass
802.11g	6Mbps	11	2462	22.48	22.13	25.32	≤ 30.00	Pass
802.11n-HT20	MCS0	01	2412	22.34	22.10	25.23	≤ 30.00	Pass
802.11n-HT20	MCS0	06	2437	26.68	26.79	29.75	≤ 30.00	Pass
802.11n-HT20	MCS0	11	2462	22.21	22.26	25.25	≤ 30.00	Pass
802.11n-HT40	MCS0	03	2422	21.42	21.21	24.33	≤ 30.00	Pass
802.11n-HT40	MCS0	06	2437	26.16	26.08	29.13	≤ 30.00	Pass
802.11n-HT40	MCS0	09	2452	20.38	20.27	23.34	≤ 30.00	Pass
802.11ax-HE20	MCS0	01	2412	22.35	22.13	25.25	≤ 30.00	Pass
802.11ax-HE20	MCS0	06	2437	26.71	26.62	29.68	≤ 30.00	Pass
802.11ax-HE20	MCS0	11	2462	22.38	22.11	25.26	≤ 30.00	Pass
802.11ax-HE40	MCS0	03	2422	21.14	20.88	24.02	≤ 30.00	Pass
802.11ax-HE40	MCS0	06	2437	26.99	26.77	29.89	≤ 30.00	Pass
802.11ax-HE40	MCS0	09	2452	19.03	18.92	21.99	≤ 30.00	Pass
<b>Beamforming Mode</b>								
802.11ax-HE20	MCS0	01	2412	21.22	21.05	24.15	≤ 30.00	Pass
802.11ax-HE20	MCS0	06	2437	26.71	26.62	29.68	≤ 30.00	Pass
802.11ax-HE20	MCS0	11	2462	20.42	20.01	23.23	≤ 30.00	Pass
802.11ax-HE40	MCS0	03	2422	20.04	20.01	23.04	≤ 30.00	Pass
802.11ax-HE40	MCS0	06	2437	26.99	26.77	29.89	≤ 30.00	Pass
802.11ax-HE40	MCS0	09	2452	17.96	18.03	21.01	≤ 30.00	Pass

Note: Total Average Power (dBm) =  $10 \cdot \log \{10^{(\text{Ant 0 Average Power} / 10)} + 10^{(\text{Ant 1 Average Power} / 10)}\}$

## **6.4. Power Spectral Density Measurement**

### **6.4.1. Test Limit**

The maximum permissible power spectral density is 8dBm in any 3 kHz band.

The same method of determining the conducted output power shall be used to determine the power spectral density.

### **6.4.2. Test Procedure Used**

ANSI C63.10 Section 11.10.5

### **6.4.3. Test Setting**

1. Measure the duty cycle (x) of the transmitter output signal.
2. Set instrument center frequency to DTS channel center frequency.
3. Set span to at least 1.5 times the OBW.
4. RBW = 10 kHz.
5. VBW = 30 kHz.
6. Detector = RMS.
7. Ensure that the number of measurement points in the sweep  $\geq 2 \times \text{span}/\text{RBW}$ .
8. Sweep time = auto couple.
9. Don't use sweep triggering. Allow sweep to "free run".
10. Employ trace averaging (RMS) mode over a minimum of 100 traces.
11. Use the peak marker function to determine the maximum amplitude level.
12. Add  $10 \log (1/x)$ , where x is the duty cycle measured in step (a), to the measured PSD to compute the average PSD during the actual transmission time.

### 6.4.4. Test Setup

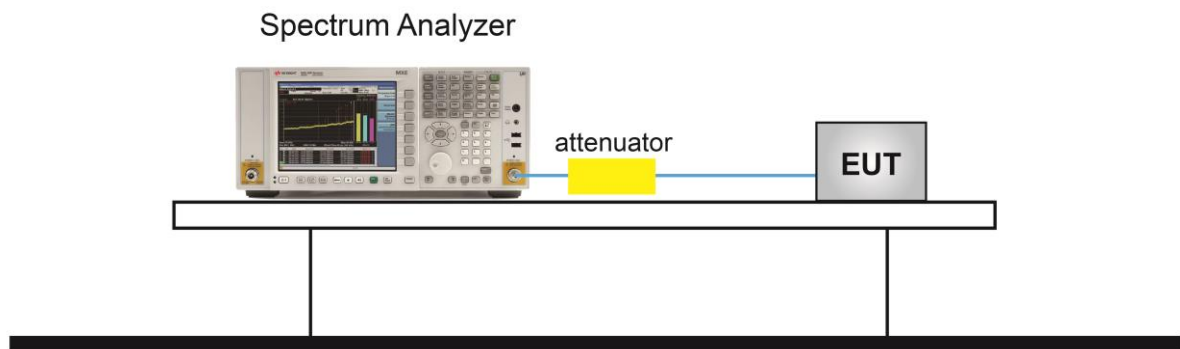

### 6.4.5. Test Result

Product	GigaSpire BLAST u4	Test Engineer	Amy Zhang
Test Date	2020/07/01	Test Site	TR3

Test Mode	Data Rate/ MCS	Channel No.	Freq. (MHz)	Ant 0 PSD (dBm/ 10kHz)	Ant 1 PSD (dBm/ 10kHz)	Duty Cycle (%)	Total PSD (dBm/ 10kHz)	Limit (dBm/ 3kHz)	Result
CDD Mode									
802.11b	1Mbps	01	2412	-1.49	-1.81	62.58	3.40	≤ 8.00	Pass
802.11b	1Mbps	06	2437	-0.81	-2.28	62.58	3.56	≤ 8.00	Pass
802.11b	1Mbps	11	2462	-0.99	-1.77	62.58	3.68	≤ 8.00	Pass
802.11g	6Mbps	01	2412	-10.54	-11.24	93.25	-7.56	≤ 8.00	Pass
802.11g	6Mbps	06	2437	-3.18	-3.45	93.25	0.00	≤ 8.00	Pass
802.11g	6Mbps	11	2462	-10.17	-10.11	93.25	-6.83	≤ 8.00	Pass
802.11n-HT20	MCS0	01	2412	-8.93	-8.78	91.78	-5.47	≤ 8.00	Pass
802.11n-HT20	MCS0	06	2437	-3.90	-4.20	91.78	-0.66	≤ 8.00	Pass
802.11n-HT20	MCS0	11	2462	-9.83	-9.54	91.78	-6.30	≤ 8.00	Pass
802.11n-HT40	MCS0	03	2422	-13.32	-13.62	85.94	-9.80	≤ 8.00	Pass
802.11n-HT40	MCS0	06	2437	-7.72	-7.73	85.94	-4.06	≤ 8.00	Pass
802.11n-HT40	MCS0	09	2452	-16.14	-15.74	85.94	-12.27	≤ 8.00	Pass
802.11ax-HE20	MCS0	01	2412	-10.72	-10.99	94.53	-7.60	≤ 8.00	Pass
802.11ax-HE20	MCS0	06	2437	-5.45	-5.66	94.53	-2.30	≤ 8.00	Pass
802.11ax-HE20	MCS0	11	2462	-12.55	-12.66	94.53	-9.35	≤ 8.00	Pass
802.11ax-HE40	MCS0	03	2422	-14.74	-15.15	92.05	-11.57	≤ 8.00	Pass
802.11ax-HE40	MCS0	06	2437	-8.19	-8.33	92.05	-4.89	≤ 8.00	Pass
802.11ax-HE40	MCS0	09	2452	-17.72	-17.03	92.05	-13.99	≤ 8.00	Pass

Note 1: When EUT duty cycle ≥ 98%, Total AVGPDS =  $10 \cdot \log \{10^{(\text{Ant 0 AVGPDS}/10)} + 10^{(\text{Ant 1 AVGPDS}/10)}\}$ .

Note 2: When EUT duty cycle ≤ 98%, Total AVGPDS =  $10 \cdot \log \{10^{(\text{Ant 0 AVGPDS}/10)} + 10^{(\text{Ant 1 AVGPDS}/10)}\} + 10 \cdot \log(1/\text{duty cycle})$ .

Note 3: Due to the power setting of beamforming mode is less than CDD mode, so beamforming mode result is not reported.

802.11b AVGPDS - Ant 0 / Ant 0 + 1 (CDD Mode)

Channel 01 (2412MHz)

Channel 06 (2437MHz)

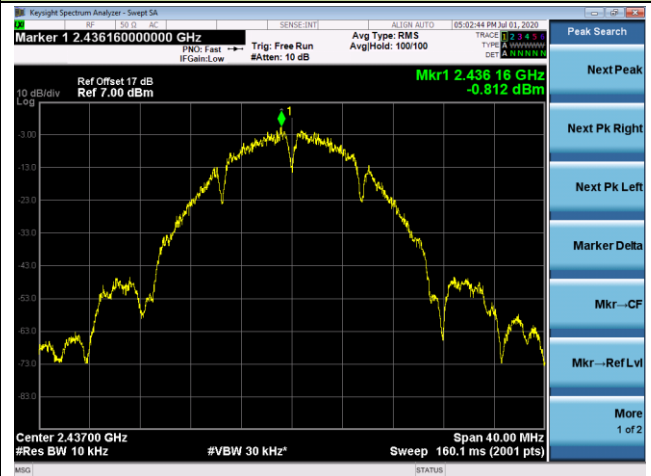
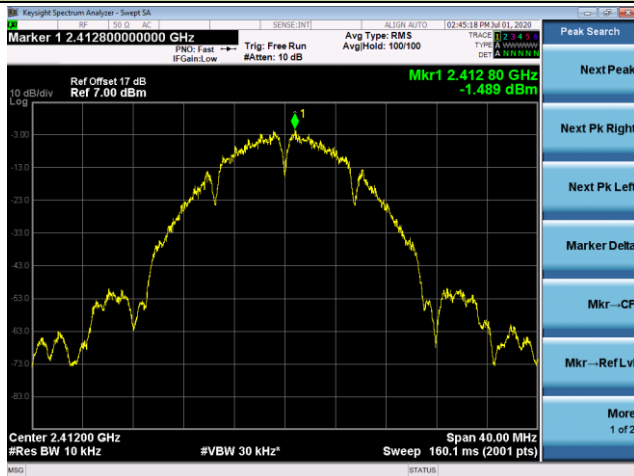

Channel 11 (2462MHz)

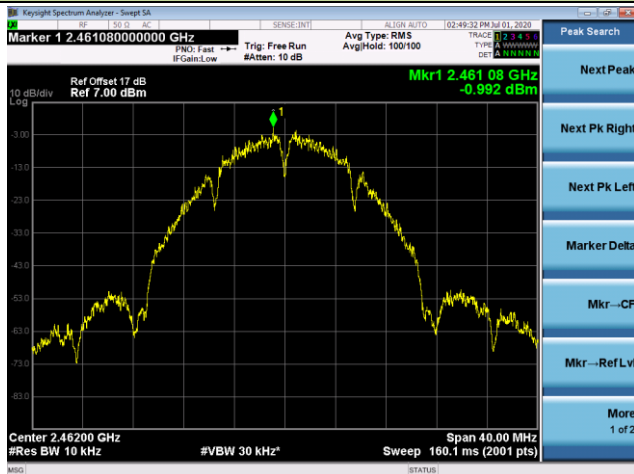



802.11g AVGPDS - Ant 0 / Ant 0 + 1 (CDD Mode)

Channel 01 (2412MHz)

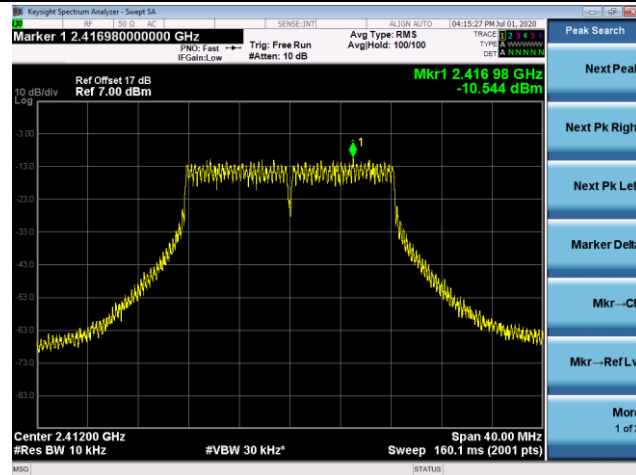

Channel 06 (2437MHz)

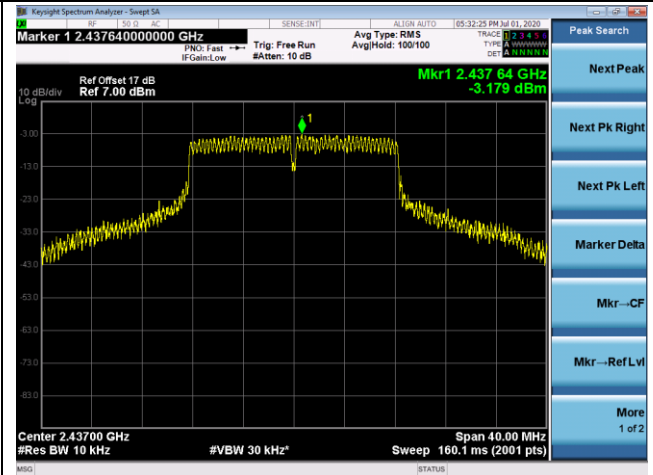

Channel 11 (2462MHz)

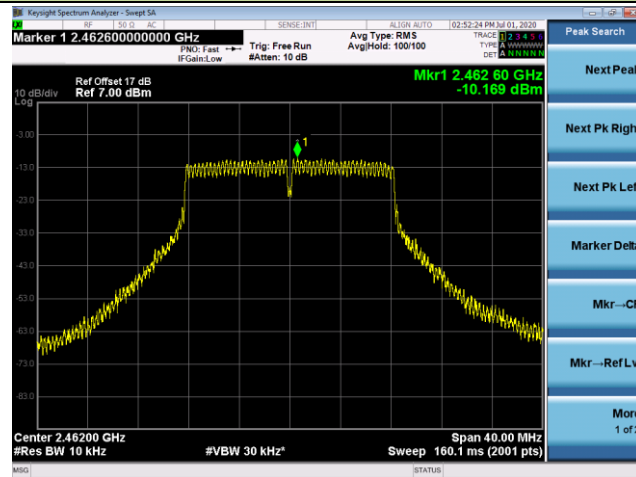

## 802.11n-HT20 AVGPSSD - Ant 0 / Ant 0 + 1 (CDD Mode)

## Channel 01 (2412MHz)

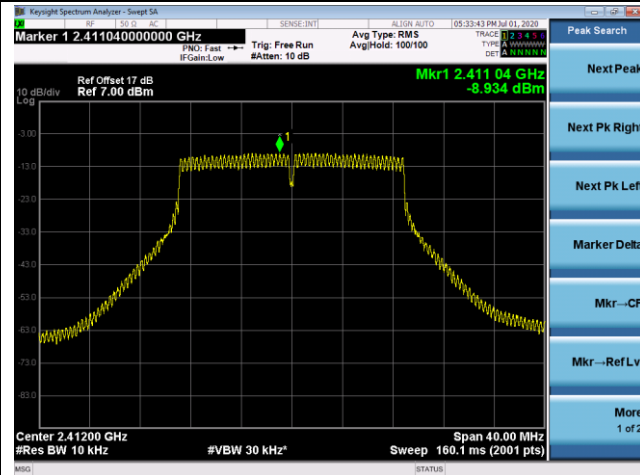

## Channel 06 (2437MHz)

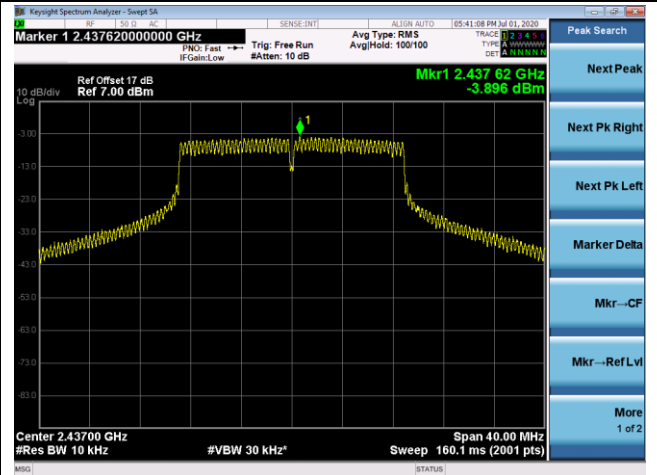

## Channel 11 (2462MHz)

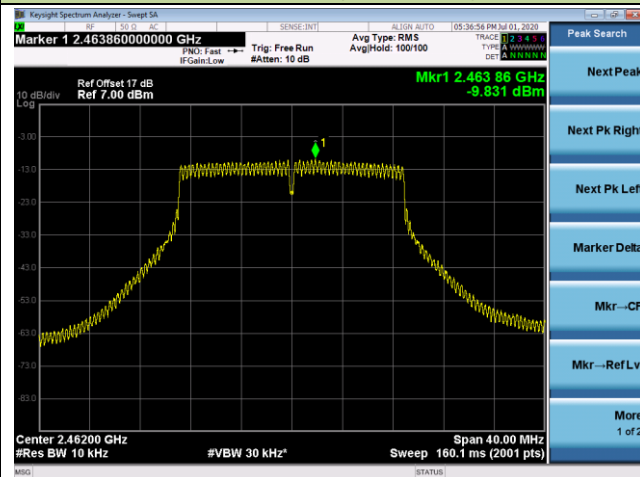

## 802.11n-HT40 AVGPSSD - Ant 0 / Ant 0 + 1 (CDD Mode)

## Channel 03 (2422MHz)

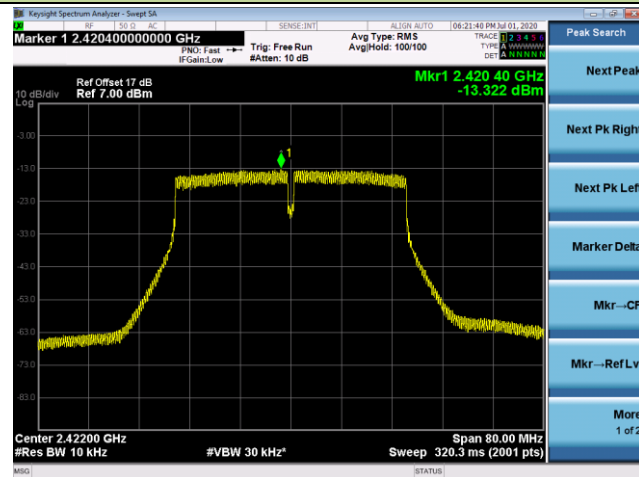

## Channel 06 (2437MHz)

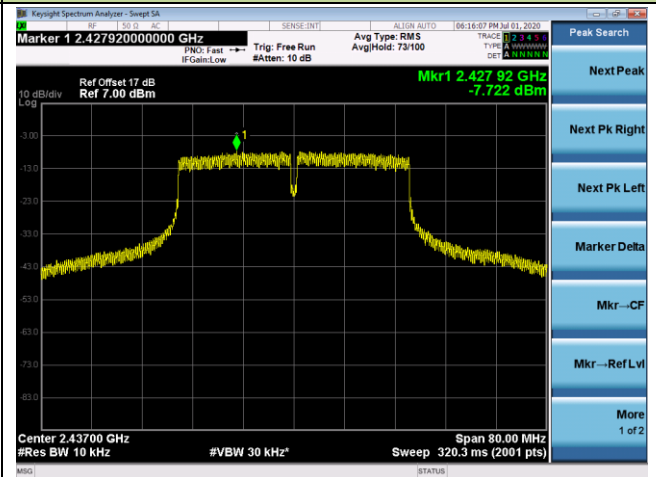

## Channel 09 (2452MHz)

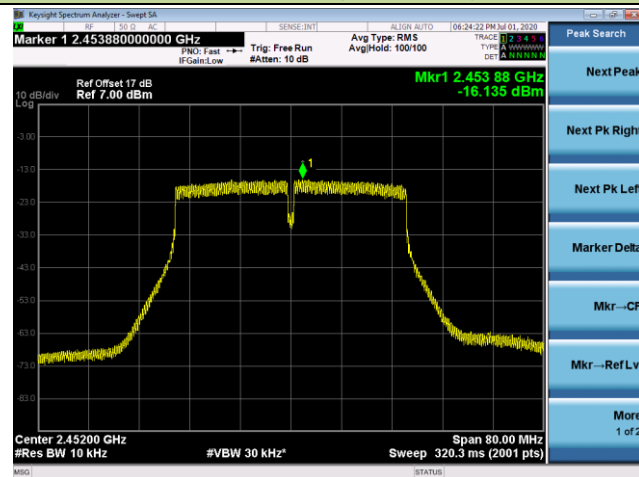

802.11ax-HE20 AVGPSD - Ant 0 / Ant 0 + 1 (CDD Mode)

Channel 01 (2412MHz)

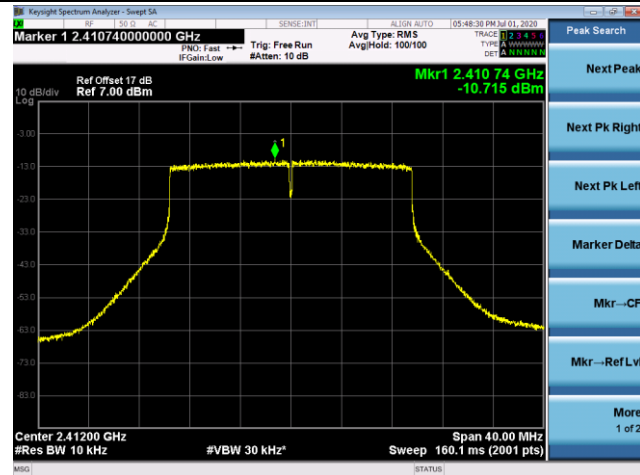

Channel 06 (2437MHz)

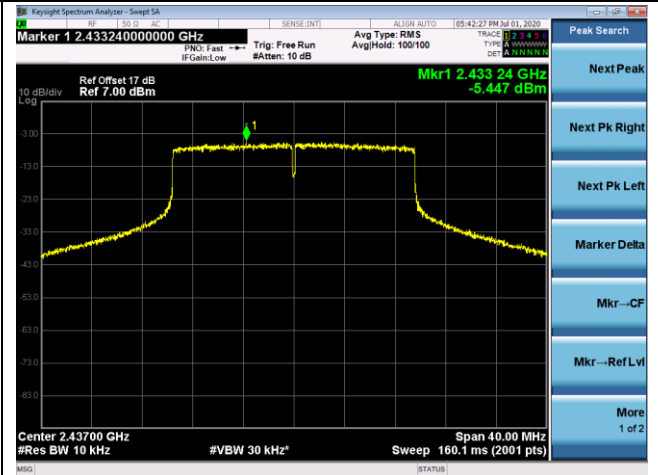

Channel 11 (2462MHz)

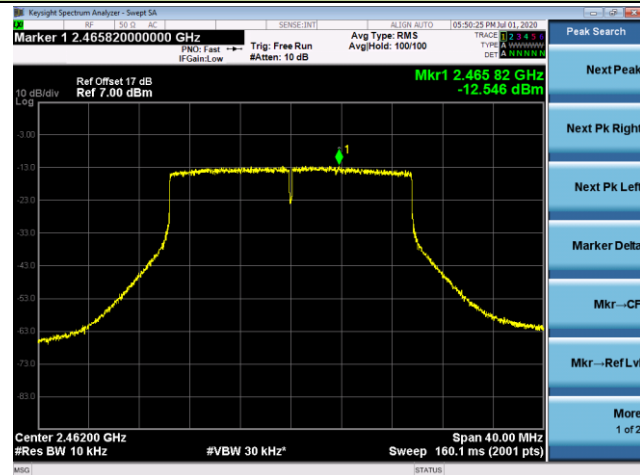

## 802.11ax-HE40 AVGPSD - Ant 0 / Ant 0 + 1 (CDD Mode)

## Channel 03 (2422MHz)

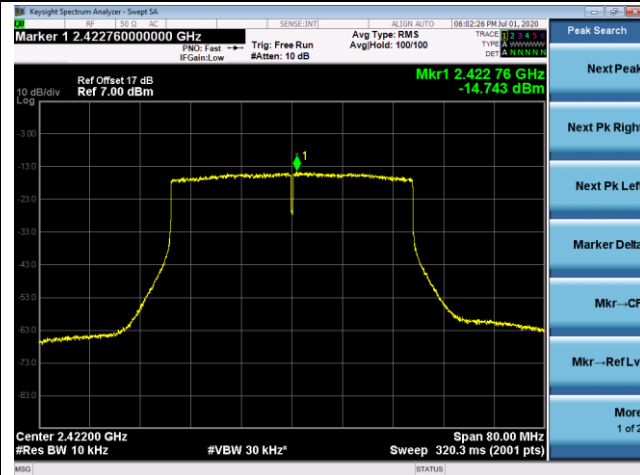

## Channel 06 (2437MHz)

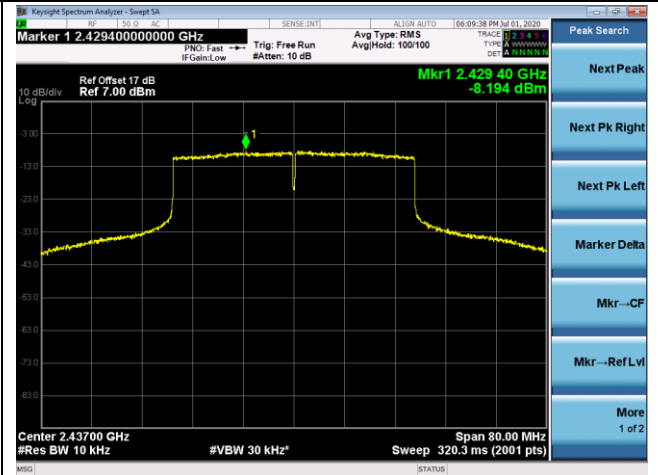

## Channel 09 (2452MHz)

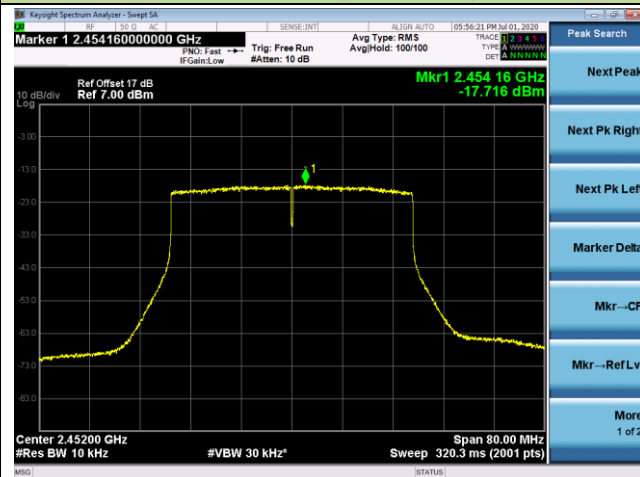

802.11b AVGPDS - Ant 1 / Ant 0 + 1 (CDD Mode)

Channel 01 (2412MHz)

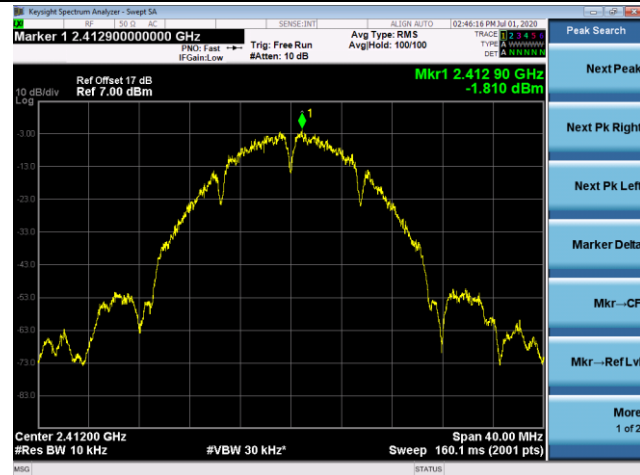

Channel 06 (2437MHz)

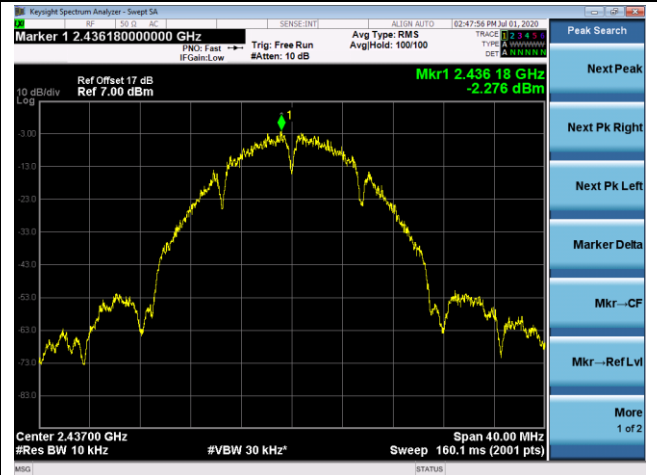

Channel 11 (2462MHz)

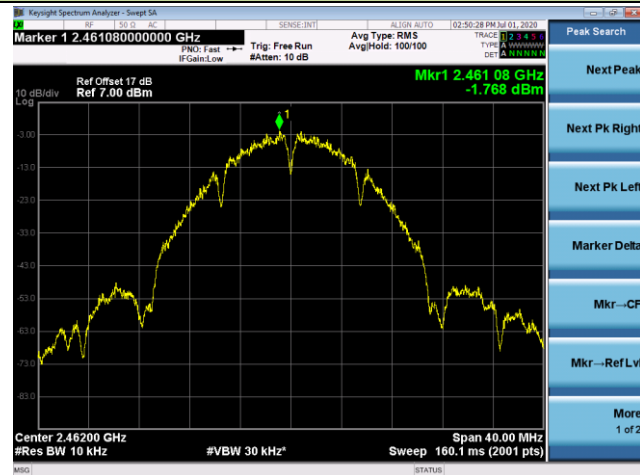

## 802.11g AVGPDS - Ant 1 / Ant 0 + 1 (CDD Mode)

## Channel 01 (2412MHz)

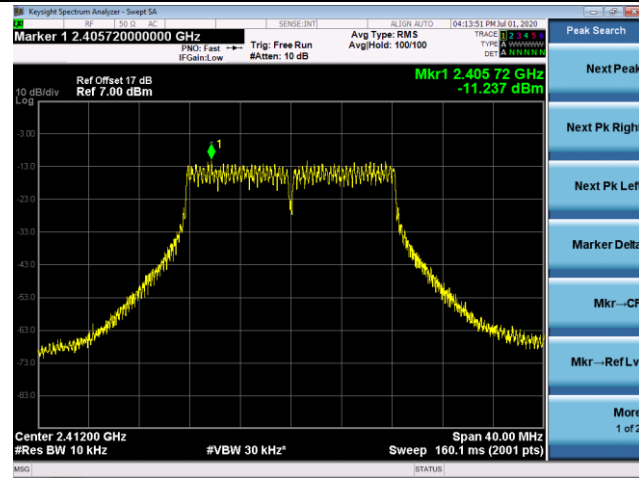

## Channel 06 (2437MHz)

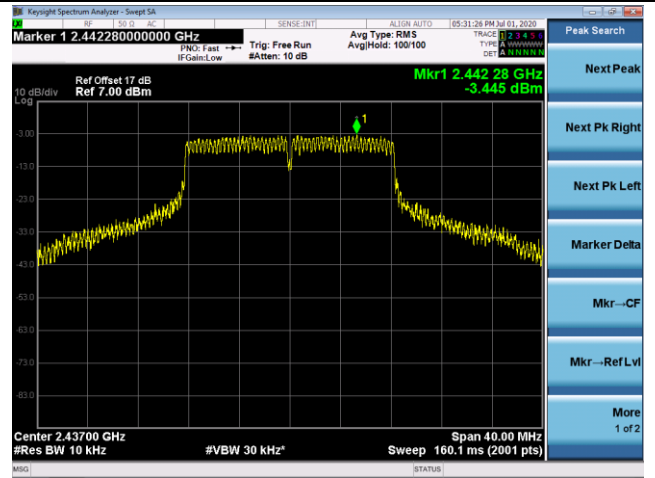

## Channel 11 (2462MHz)

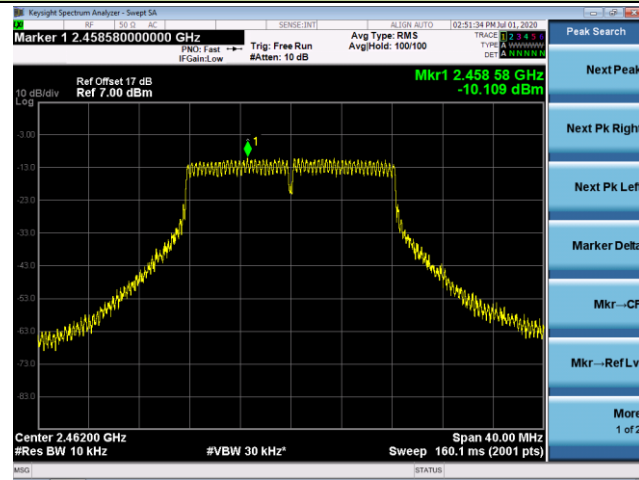

802.11n-HT20 AVGPDS - Ant 1 / Ant 0 + 1 (CDD Mode)

Channel 01 (2412MHz)

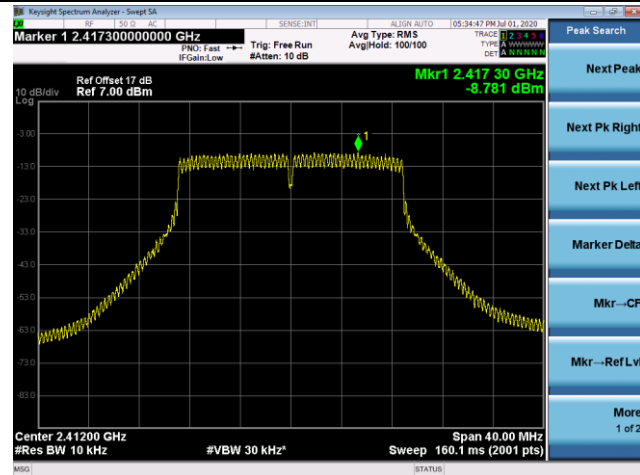

Channel 06 (2437MHz)

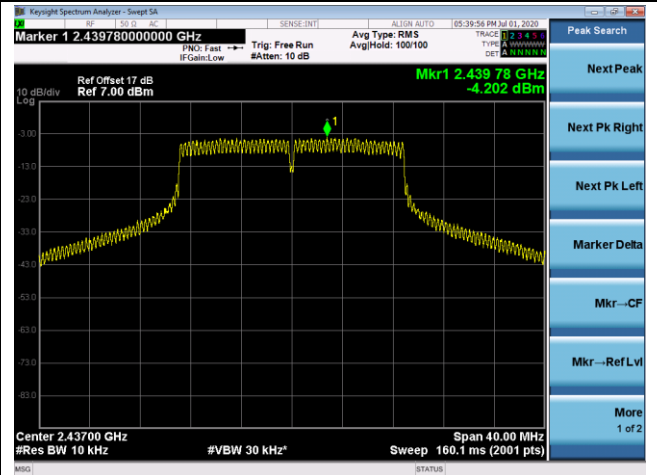

Channel 11 (2462MHz)

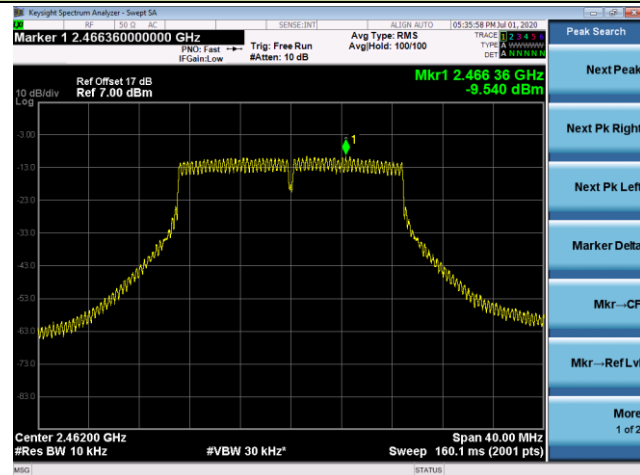



## 802.11n-HT40 AVGPSSD - Ant 1 / Ant 0 + 1 (CDD Mode)

## Channel 03 (2422MHz)

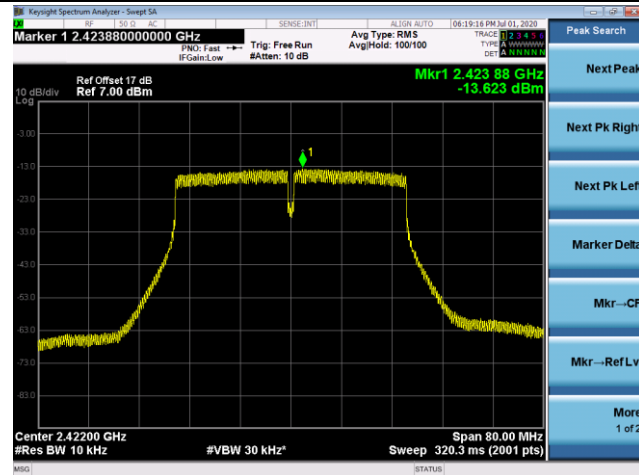

## Channel 06 (2437MHz)

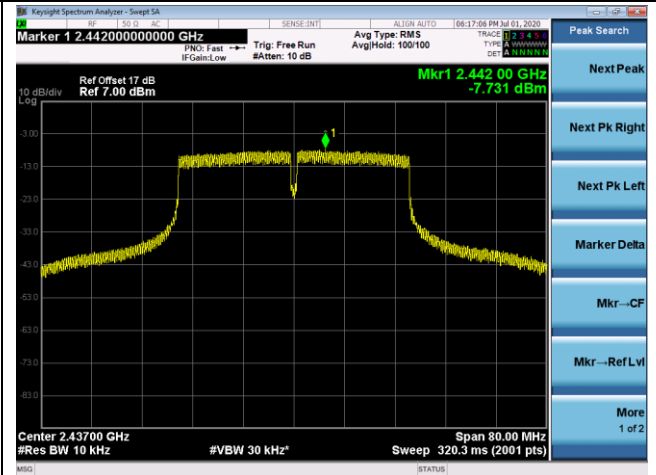

## Channel 09 (2452MHz)

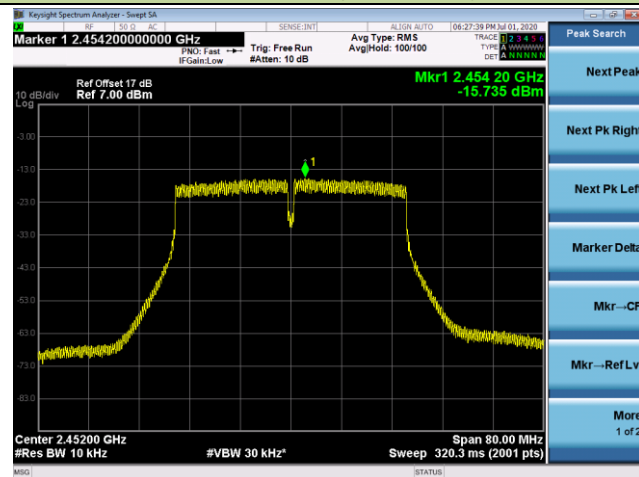

802.11ax-HE20 AVGPSD - Ant 1 / Ant 0 + 1 (CDD Mode)

Channel 01 (2412MHz)

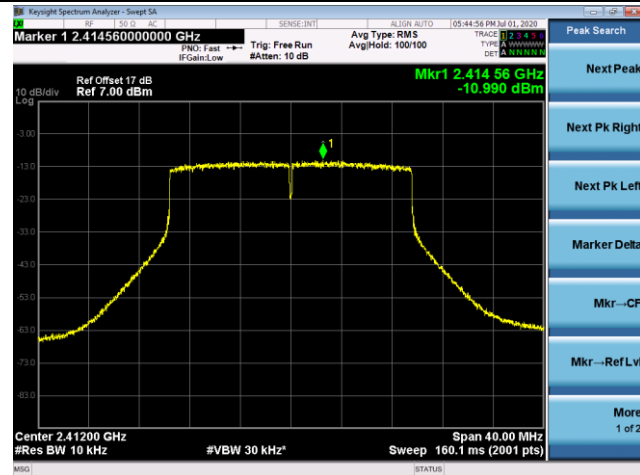

Channel 06 (2437MHz)

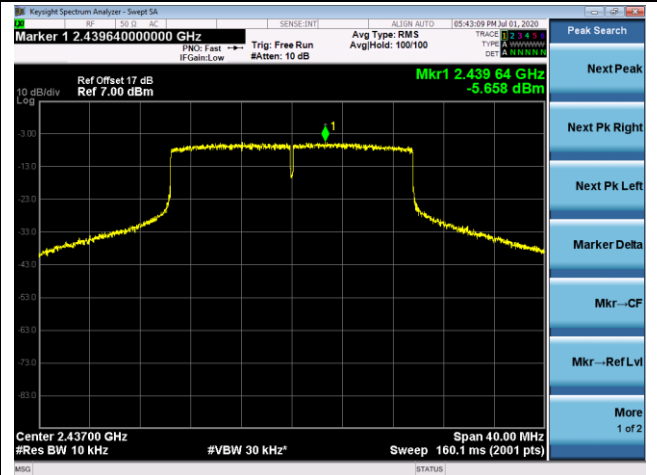

Channel 11 (2462MHz)

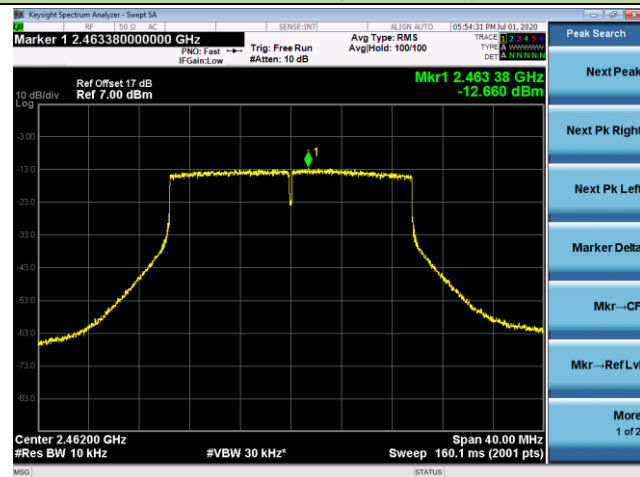

802.11ax-HE40 AVGPSD - Ant 1 / Ant 0 + 1 (CDD Mode)

Channel 03 (2422MHz)

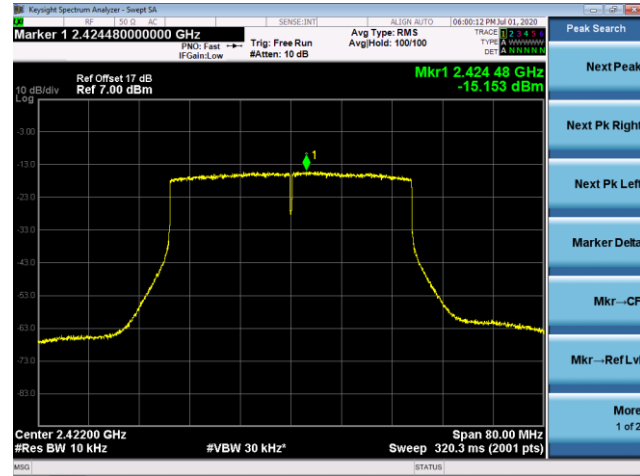

Channel 06 (2437MHz)

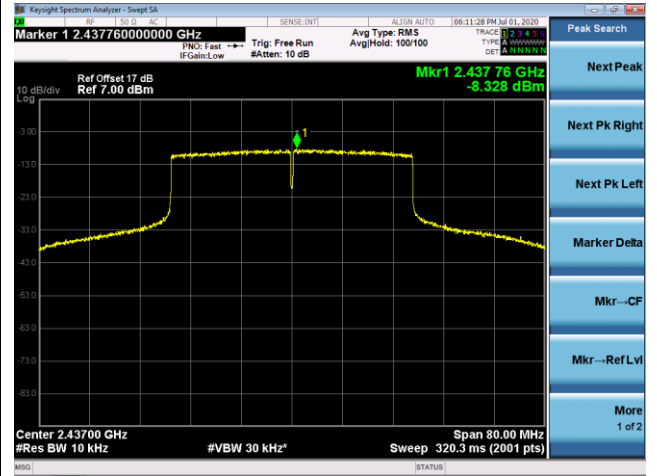

Channel 09 (2452MHz)

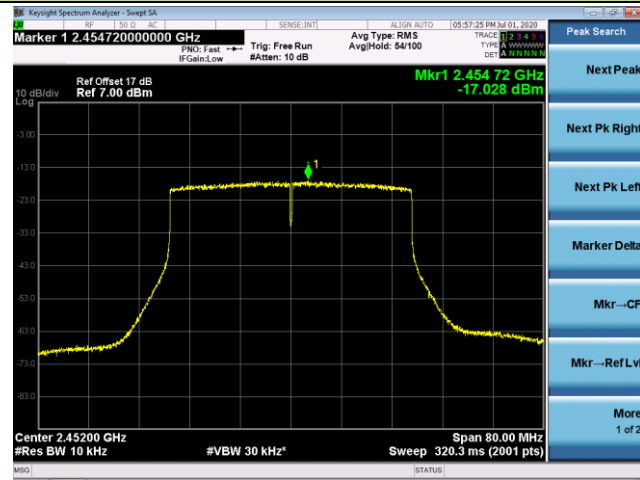

## **6.5. Conducted Band Edge and Out-of-Band Emissions**

### **6.5.1. Test Limit**

The limit for out-of-band spurious emissions at the band edge is 30dB below the fundamental emission level, as determined from the in-band power measurement of the DTS channel performed in a 100 kHz bandwidth per the PSD procedure.

### **6.5.2. Test Procedure Used**

ANSI C63.10 Section 11.11

### **6.5.3. Test Setting**

#### **Reference level measurement**

1. Set instrument center frequency to DTS channel center frequency
2. Set the span to  $\geq 1.5$  times the DTS bandwidth
3. Set the RBW = 100 kHz
4. Set the VBW  $\geq 3 \times$  RBW
5. Detector = peak
6. Sweep time = auto couple
7. Trace mode = max hold
8. Allow trace to fully stabilize

#### **Emission level measurement**

1. Set the center frequency and span to encompass frequency range to be measured
2. RBW = 100KHz
3. VBW = 300KHz
4. Detector = Peak
5. Trace mode = max hold
6. Sweep time = auto couple
7. The trace was allowed to stabilize

### 6.5.4. Test Setup

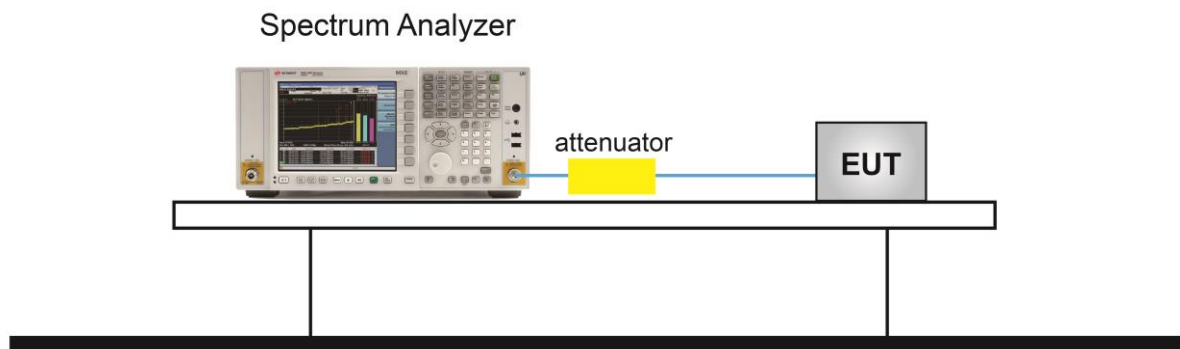

### 6.5.5. Test Result

Product	GigaSpire BLAST u4	Test Engineer	Amy Zhang
Test Date	2020/07/09 ~ 2020/08/14	Test Site	TR3

Test Mode	Data Rate / MCS	Channel No.	Frequency (MHz)	Limit (dBc)	Result
CDD mode					
802.11b	1Mbps	01	2412	30	Pass
802.11b	1Mbps	06	2437	30	Pass
802.11b	1Mbps	11	2462	30	Pass
802.11g	6Mbps	01	2412	30	Pass
802.11g	6Mbps	06	2437	30	Pass
802.11g	6Mbps	11	2462	30	Pass
802.11n-HT20	MCS0	01	2412	30	Pass
802.11n-HT20	MCS0	06	2437	30	Pass
802.11n-HT20	MCS0	11	2462	30	Pass
802.11n-HT40	MCS0	03	2422	30	Pass
802.11n-HT40	MCS0	06	2437	30	Pass
802.11n-HT40	MCS0	09	2452	30	Pass
802.11ax-HE20	MCS0	01	2412	30	Pass
802.11ax-HE20	MCS0	06	2437	30	Pass
802.11ax-HE20	MCS0	11	2462	30	Pass
802.11ax-HE40	MCS0	03	2422	30	Pass
802.11ax-HE40	MCS0	06	2437	30	Pass
802.11ax-HE40	MCS0	09	2452	30	Pass

Note: Due to the power setting of beamforming mode is less than CDD mode, so beamforming mode result is not reported.