



DFS MEASUREMENT REPORT

FCC PART 15.407

FCC ID: 2ABLK-8X4G-1V2

APPLICANT: Calix Inc.

Application Type: Certification

Product: WIFI dual band 4 GE LAN GPON HGU

Model No.: 844G-1, 854G-1, 844GE-1

Brand Name: Calix

FCC Classification: Unlicensed National Information Infrastructure (UNII)

FCC Rule Part(s): Part 15.407

KDB 905462 D02v01r01, KDB 905462 D04v01

Type of Device: Master Device
 Client Device (No radar detection)
 Client Device with radar detection

Test Date: March 12 ~ 23, 2015

Reviewed By : Robin Wu
(Robin Wu)

Approved By : Marlin Chen
(Marlin Chen)



The test results relate only to the samples tested.

This equipment has been shown to be capable of compliance with the applicable technical standards as indicated in the measurement report and was tested in accordance with the measurement procedures specified in KDB 905462 D02v01r01. Test results reported herein relate only to the item(s) tested.

The test report shall not be reproduced except in full without the written approval of MRT Technology (Suzhou) Co., Ltd.

Revision History

Report No.	Version	Description	Issue Date
1502RSU00403	Rev. 01	Initial report	04-01-2015
1502RSU00403	Rev. 02	Added the model number "844GE-1"	11-24-2015

CONTENTS

Description	Page
Revision History	2
§2.1033 General Information	5
1. INTRODUCTION	6
1.1. Scope	6
1.2. MRT Test Location	6
2. PRODUCT INFORMATION	7
2.1. Equipment Description.....	7
2.2. Description of Available Antennas	8
2.3. Description of Antenna RF Port	9
2.4. DFS Band Carrier Frequencies Operation	10
2.5. Test Mode	11
3. DFS DETECTION THRESHOLDS AND RADAR TEST WAVEFORMS	12
3.1. Applicability	12
3.2. DFS Devices Requirements.....	13
3.3. DFS Detection Threshold Values	14
3.4. Parameters of DFS Test Signals	15
3.5. Conducted Test Setup	18
4. TEST EQUIPMENT CALIBRATION DATE	19
5. TEST RESULT	20
5.1. Summary	20
5.2. Radar Waveform Calibration.....	21
5.2.1. Calibration Setup	21
5.2.2. Calibration Procedure	21
5.2.3. Calibration Result	22
5.3. Channel Loading Test Result	26
5.4. UNII Detection Bandwidth Measurement	28
5.4.1. Test Limit	28
5.4.2. Test Procedure	28
5.4.3. Test Result.....	29
5.5. Initial Channel Availability Check Time Measurement	35
5.5.1. Test Limit	35
5.5.2. Test Procedure	35
5.5.3. Test Result.....	36

5.6.	Radar Burst at the Beginning of the Channel Availability Check Time Measurement ..	37
5.6.1.	Test Limit	37
5.6.2.	Test Procedure	37
5.6.3.	Test Result.....	38
5.7.	Radar Burst at the End of the Channel Availability Check Time Measurement	39
5.7.1.	Test Limit	39
5.7.2.	Test Procedure	39
5.7.3.	Test Result.....	40
5.8.	In-Service Monitoring for Channel Move Time, Channel Closing Transmission Time and Non-Occupancy Period Measurement	41
5.8.1.	Test Limit	41
5.8.2.	Test Procedure Used	41
5.8.3.	Test Result.....	42
5.9.	Statistical Performance Check Measurement.....	44
5.9.1.	Test Limit	44
5.9.2.	Test Procedure	44
5.9.3.	Test Result.....	45
6.	CONCLUSION.....	122

§2.1033 General Information

Applicant:	Calix Inc.
Applicant Address:	1035 N. McDowell Blvd Petaluma, CA94954 U.S.A
Manufacturer:	Calix Inc.
Manufacturer Address:	1035 N. McDowell Blvd Petaluma, CA94954 U.S.A
Test Site:	MRT Technology (Suzhou) Co., Ltd
Test Site Address:	D8 Building, Youxin Industrial Park, No.2 Tian'edang Rd., Wuzhong Economic Development Zone, Suzhou, China
MRT FCC Registration No.:	809388
Model No.:	844G-1, 854G-1, 844GE-1
FCC ID:	2ABLK-8X4G-1V2
Test Device Serial No.:	N/A <input type="checkbox"/> Production <input checked="" type="checkbox"/> Pre-Production <input type="checkbox"/> Engineering
FCC Classification:	Unlicensed National Information Infrastructure (UNII)

Test Facility / Accreditations

Measurements were performed at MRT Laboratory located in Tian'edang Rd., Suzhou, China.

- MRT facility is a FCC registered (MRT Reg. No. 809388) test facility with the site description report on file and has met all the requirements specified in Section 2.948 of the FCC Rules.
- MRT facility is an IC registered (MRT Reg. No. 11384A-1) test laboratory with the site description on file at Industry Canada.
- MRT facility is a VCCI registered (R-4179, G-814, C-4664, T-2206) test laboratory with the site description on file at VCCI Council.
- MRT Lab is accredited to ISO 17025 by the American Association for Laboratory Accreditation (A2LA) under the American Association for Laboratory Accreditation Program (A2LA Cert. No. 3628.01) in EMC, Telecommunications and Radio testing for FCC, Industry Canada, EU and TELEC Rules.



1. INTRODUCTION

1.1. Scope

Measurement and determination of electromagnetic emissions (EMC) of radio frequency devices including intentional and/or unintentional radiators for compliance with the technical rules and regulations of the Federal Communications Commission and the Industry Canada Certification and Engineering Bureau.

1.2. MRT Test Location

The map below shows the location of the MRT LABORATORY, its proximity to the Taihu Lake. These measurement tests were conducted at the MRT Technology (Suzhou) Co., Ltd. Facility located at D8 Building, Youxin Industrial Park, No.2 Tian'edang Rd., Wuzhong Economic Development Zone, Suzhou, China. The detailed description of the measurement facility was found to be in compliance with the requirements of § 2.948 according to ANSI C63.4-2009 on September 30, 2013.



2. PRODUCT INFORMATION

2.1. Equipment Description

Product Name	WIFI dual band 4 GE LAN GPON HGU
Model No.	844G-1, 854G-1, 844GE-1
Radio Type	Intentional Transceiver
Operation Mode	Master Device
Frequency Range	For 802.11a/n-HT20: 5260~5320MHz, 5500~5700MHz For 802.11ac-VHT20: 5260~5320MHz, 5500~5720MHz For 802.11n-HT40: 5270~5310MHz, 5510~5670MHz For 802.11ac-VHT40: 5270~5310MHz, 5510~5710MHz For 802.11ac-VHT80: 5290MHz, 5530MHz, 5610MHz, 5690MHz
Maximum Output Power	802.11a: 20.65dBm 802.11n-HT20: 20.50dBm 802.11ac-VHT20: 21.16dBm 802.11n-HT40: 20.79dBm 802.11ac-VHT40: 21.26dBm 802.11ac-VHT80: 20.92dBm
Type of Modulation	802.11a/n/ac: OFDM;
Power-on cycle	Requires 181.7 seconds to complete its power-on cycle.
Uniform Spreading	For the 5250-5350MHz, 5470-5725 MHz bands, the Master device provides, on aggregate, uniform loading of the spectrum across all devices by selecting an operating channel among the available channels using a random algorithm.

Note 1: There is different laser module between models “844G-1” & “844GE-1”.

Note 2: For this model “844GE-1” has been assessed the worst case mode in this report, and showed in the Annex 1.

2.2. Description of Available Antennas

Antenna Type	Frequency Band (GHz)	T _x Paths	Directional Gain (dBi)
PCB Antenna	2.4	2	1.90

Antenna Type	Frequency Band (GHz)	T _x Paths	Directional Gain (dBi)	
			Beam Forming	CDD
PCB Antenna	5.2	4	8.04	8.04
	5.3	4	7.78	7.78
	5.6	4	8.38	8.38
	5.8	4	8.70	8.70

Note:

- Transmit at 2.4GHz support two antennas, and support four antennas at 5GHz transmit. There are different antenna gains between each antenna.
- The EUT working on Beam Forming mode, and the Beam Forming support 802.11n/ac, not include 802.11a, and 802.11a working on CDD mode.
- Correlated signals include, but are not limited to, signals transmitted in any of the following modes:
 - Any transmit Beam Forming mode, whether fixed or adaptive (e.g., phased array modes, closed loop MIMO modes, Transmitter Adaptive Antenna modes, Maximum Ratio Transmission (MRT) modes, and Statistical Eigen Beam Forming (EBF) modes).
- Unequal antenna gains, with equal transmit powers. For antenna gains given by G_1, G_2, \dots, G_N dBi
 - transmit signals are correlated, then
 - Directional gain = $10 \log[(10^{G_1/20} + 10^{G_2/20} + \dots + 10^{G_N/20})^2 / N_{ANT}]$ dBi [Note the "20"s in the denominator of each exponent and the square of the sum of terms; the object is to combine the signal levels coherently.]

2.3. Description of Antenna RF Port

RF Port				
Test Mode	Software Control Port			
2.4GHz T _x	Ant 0	Ant 1	--	--
Test Mode	Software Control Port			
5GHz T _x	Ant 0	Ant 1	Ant 2	Ant 3

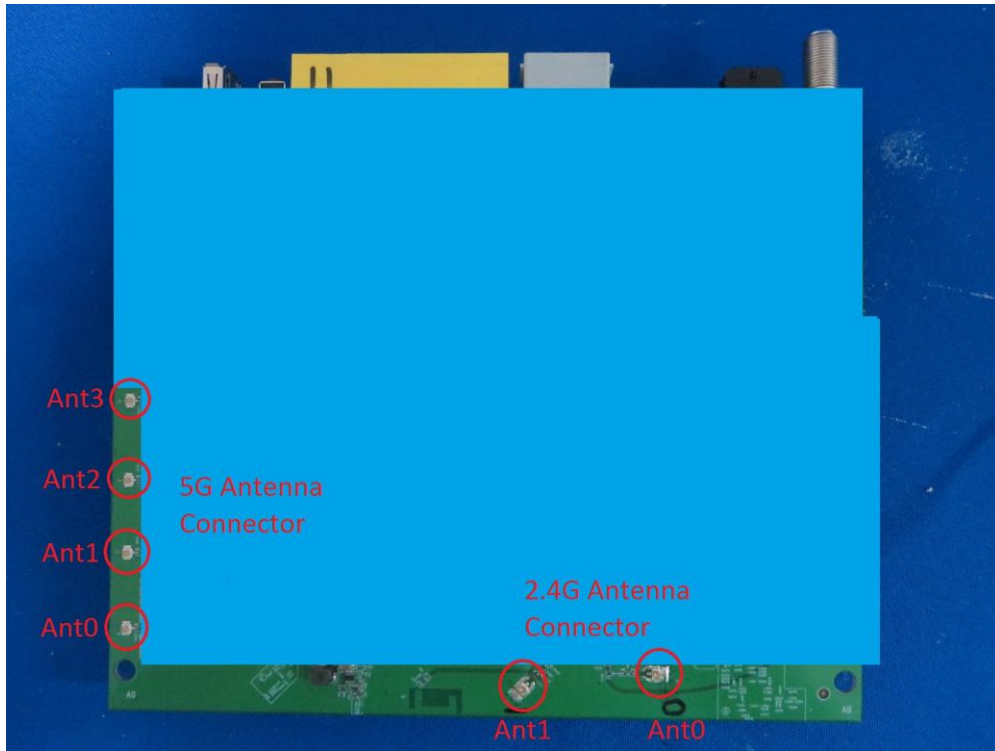

2.4. DFS Band Carrier Frequencies Operation

802.11a/n-HT20 Center Working Frequency of Each Channel

Channel	Frequency	Channel	Frequency	Channel	Frequency
52	5260 MHz	56	5280 MHz	60	5300 MHz
64	5320 MHz	100	5500 MHz	104	5520 MHz
108	5540 MHz	112	5560 MHz	116	5580 MHz
120	5600 MHz	124	5620 MHz	128	5640 MHz
132	5660 MHz	136	5680 MHz	140	5700 MHz

802.11ac-VHT20 Center Working Frequency of Each Channel

Channel	Frequency	Channel	Frequency	Channel	Frequency
52	5260 MHz	56	5280 MHz	60	5300 MHz
64	5320 MHz	100	5500 MHz	104	5520 MHz
108	5540 MHz	112	5560 MHz	116	5580 MHz
120	5600 MHz	124	5620 MHz	128	5640 MHz
132	5660 MHz	136	5680 MHz	140	5700 MHz
144	5720 MHz	N/A	N/A	N/A	N/A

802.11n-HT40 Center Working Frequency of Each Channel

Channel	Frequency	Channel	Frequency	Channel	Frequency
54	5270 MHz	62	5310 MHz	102	5510 MHz
110	5550 MHz	118	5590 MHz	126	5630 MHz
134	5670 MHz	N/A	N/A	N/A	N/A

802.11ac-VHT40 Center Working Frequency of Each Channel

Channel	Frequency	Channel	Frequency	Channel	Frequency
54	5270 MHz	62	5310 MHz	102	5510 MHz
110	5550 MHz	118	5590 MHz	126	5630 MHz
134	5670 MHz	142	5710MHz	N/A	N/A

802.11ac-VHT80 Center Working Frequency of Each Channel

Channel	Frequency	Channel	Frequency	Channel	Frequency
58	5290 MHz	106	5530 MHz	122	5610 MHz
138	5690 MHz	N/A	N/A	N/A	N/A

2.5. Test Mode

Test Mode	Mode 1: Communication with Notebook
-----------	-------------------------------------

3. DFS DETECTION THRESHOLDS AND RADAR TEST WAVEFORMS

3.1. Applicability

The following table from FCC KDB 905462 D02 UNII DFS Compliance Procedures New Rules v01r01 lists the applicable requirements for the DFS testing.

Requirement	Operational Mode		
	Master	Client Without Radar Detection	Client With Radar Detection
Non-Occupancy Period	Yes	Not required	Yes
DFS Detection Threshold	Yes	Not required	Yes
Channel Availability Check Time	Yes	Not required	Not required
U-NII Detection Bandwidth	Yes	Not required	Yes

Table 3-1: Applicability of DFS Requirements Prior to Use of a Channel

Requirement	Operational Mode	
	Master Device or Client With Radar Detection	Client Without Radar Detection
DFS Detection Threshold	Yes	Not required
Channel Closing Transmission Time	Yes	Yes
Channel Move Time	Yes	Yes
U-NII Detection Bandwidth	Yes	Not required

Additional requirements for devices with multiple bandwidth modes	Master Device or Client with Radar Detection	Client Without Radar Detection
U-NII Detection Bandwidth and Statistical Performance Check	All BW modes must be tested	Not required
Channel Move Time and Channel Closing Transmission Time	Test using widest BW mode available	Test using the widest BW mode available for the link
All other tests	Any single BW mode	Not required

Note: Frequencies selected for statistical performance check should include several frequencies within the radar detection bandwidth and frequencies near the edge of the radar detection bandwidth. For 802.11 devices it is suggested to select frequencies in each of the bonded 20 MHz channels and the channel center frequency.

Table 3-2: Applicability of DFS Requirements during normal operation

3.2. DFS Devices Requirements

Per FCC KDB 905462 D02 UNII DFS Compliance Procedures New Rules v01r01 the following are the requirements for Master Devices:

- (a) The Master Device will use DFS in order to detect Radar Waveforms with received signal strength above the DFS Detection Threshold in the 5250 ~ 5350 MHz and 5470 ~ 5725 MHz bands. DFS is not required in the 5150 ~ 5250 MHz or 5725 ~ 5825 MHz bands.
- (b) Before initiating a network on a Channel, the Master Device will perform a Channel Availability Check for a specified time duration (Channel Availability Check Time) to ensure that there is no radar system operating on the Channel, using DFS described under subsection a) above.
- (c) The Master Device initiates a U-NII network by transmitting control signals that will enable other U-NII devices to Associate with the Master Device.
- (d) During normal operation, the Master Device will monitor the Channel (In-Service Monitoring) to ensure that there is no radar system operating on the Channel, using DFS described under a).
- (e) If the Master Device has detected a Radar Waveform during In-Service Monitoring as described under d), the Operating Channel of the U-NII network is no longer an Available Channel. The Master Device will instruct all associated Client Device(s) to stop transmitting on this Channel within the Channel Move Time. The transmissions during the Channel Move Time will be limited to the Channel Closing Transmission Time.
- (f) Once the Master Device has detected a Radar Waveform it will not utilize the Channel for the duration of the Non-Occupancy Period.
- (g) If the Master Device delegates the In-Service Monitoring to a Client Device, then the combination will be tested to the requirements described under d) through f) above.

Channel Move Time and Channel Closing Transmission Time requirements are listed in the following table.

Parameter	Value
Non-occupancy period	Minimum 30 minutes
Channel Availability Check Time	60 seconds
Channel Move Time	10 seconds See Note 1.
Channel Closing Transmission Time	200 milliseconds + an aggregate of 60 milliseconds over remaining 10 second period. See Notes 1 and 2.
U-NII Detection Bandwidth	Minimum 100% of the U-NII 99% transmission power bandwidth. See Note 3.
Note 1: Channel Move Time and the Channel Closing Transmission Time should be performed with Radar Type 0. The measurement timing begins at the end of the Radar Type 0 burst.	

Note 2: The Channel Closing Transmission Time is comprised of 200 milliseconds starting at the beginning of the Channel Move Time plus any additional intermittent control signals required to facilitate a Channel move (an aggregate of 60 milliseconds) during the remainder of the 10 second period. The aggregate duration of control signals will not count quiet periods in between transmissions.

Note 3: During the U-NII Detection Bandwidth detection test, radar type 0 should be used. For each frequency step the minimum percentage of detection is 90 percent. Measurements are performed with no data traffic.

Table 3-3: DFS Response Requirements

3.3. DFS Detection Threshold Values

The DFS detection thresholds are defined for Master devices and Client Devices with In-service monitoring. These detection thresholds are listed in the following table.

Maximum Transmit Power	Value (See Notes 1, 2, and 3)
EIRP \geq 200 milliwatt	-64 dBm
EIRP < 200 milliwatt and power spectral density < 10 dBm/MHz	-62 dBm
EIRP < 200 milliwatt that do not meet the power spectral density requirement	-64 dBm
<p>Note 1: This is the level at the input of the receiver assuming a 0 dBi receive antenna.</p> <p>Note 2: Throughout these test procedures an additional 1 dB has been added to the amplitude of the test transmission waveforms to account for variations in measurement equipment. This will ensure that the test signal is at or above the detection threshold level to trigger a DFS response.</p> <p>Note3: EIRP is based on the highest antenna gain. For MIMO devices refer to KDB Publication 662911 D01.</p>	

Table 3-4: Detection Thresholds for Master Devices and Client Devices with Radar Detection

3.4. Parameters of DFS Test Signals

This section provides the parameters for required test waveforms, minimum percentage of successful detections, and the minimum number of trials that must be used for determining DFS conformance. Step intervals of 0.1 microsecond for Pulse Width, 1 microsecond for PRI, 1 MHz for chirp width and 1 for the number of pulses will be utilized for the random determination of specific test waveforms.

Short Pulse Radar Test Waveforms

Radar Type	Pulse Width (μsec)	PRI (μsec)	Number of Pulses	Minimum Percentage of Successful Detection	Minimum Number of Trials
0	1	1428	18	See Note 1	See Note 1
1	1	Test A: 15 unique PRI values randomly selected from the list of 23 PRI values in Table 3-6	$\text{Roundup} \left\{ \left(\frac{1}{360} \right) \cdot \left(\frac{19 \cdot 10^6}{\text{PRI}_{\mu\text{sec}}} \right) \right\}$	60%	30
		Test B: 15 unique PRI values randomly selected within the range of 518-3066 μsec, with a minimum increment of 1 μsec, excluding PRI values selected in Test A			
2	1-5	150-230	23-29	60%	30
3	6-10	200-500	16-18	60%	30
4	11-20	200-500	12-16	60%	30
Aggregate (Radar Types 1-4)				80%	120
Note 1: Short Pulse Radar Type 0 should be used for the detection bandwidth test, channel move time, and channel closing time tests.					

Table 3-5: Parameters for Short Pulse Radar Waveforms

A minimum of 30 unique waveforms are required for each of the Short Pulse Radar Types 2 through 4. If more than 30 waveforms are used for Short Pulse Radar Types 2 through 4, then each additional waveform must also be unique and not repeated from the previous waveforms.

Pulse Repetition Frequency Number	Pulse Repetition Frequency (Pulses Per Second)	Pulse Repetition Interval (Microseconds)
1	1930.5	518
2	1858.7	538
3	1792.1	558
4	1730.1	578
5	1672.2	598
6	1618.1	618
7	1567.4	638
8	1519.8	658
9	1474.9	678
10	1432.7	698
11	1392.8	718
12	1355	738
13	1319.3	758
14	1285.3	778
15	1253.1	798
16	1222.5	818
17	1193.3	838
18	1165.6	858
19	1139	878
20	1113.6	898
21	1089.3	918
22	1066.1	938
23	326.2	3066

Table 3-6: Pulse Repetition Intervals Values for Test A

Long Pulse Radar Test Waveform

Radar Type	Pulse Width (μsec)	Chirp Width (MHz)	PRI (μsec)	Number of Pulses per Burst	Number of Bursts	Minimum Percentage of Successful Detection	Minimum Number of Trials
5	50 - 100	5 - 20	1000 - 2000	1 - 3	8 - 20	80%	30

Table 3-7: Parameters for Long Pulse Radar Waveforms

The parameters for this waveform are randomly chosen. Thirty unique waveforms are required for the Long Pulse Radar Type waveforms. If more than 30 waveforms are used for the Long Pulse Radar Type waveforms, then each additional waveform must also be unique and not repeated from the previous waveforms.

Frequency Hopping Radar Test Waveform

Radar Type	Pulse Width (μsec)	PRI (μsec)	Pulses Per Hop	Hopping Rate (kHz)	Hopping Sequence Length (msec)	Minimum Percentage of Successful Detection	Minimum Number of Trials
6	1	333	9	0.333	300	70%	30

Table 3-8: Parameters for Frequency Hopping Radar Waveforms

For the Frequency Hopping Radar Type, the same Burst parameters are used for each waveform. The hopping sequence is different for each waveform and a 100-length segment is selected from the hopping sequence defined by the following algorithm:

The first frequency in a hopping sequence is selected randomly from the group of 475 integer frequencies from 5250 – 5724MHz. Next, the frequency that was just chosen is removed from the group and a frequency is randomly selected from the remaining 474 frequencies in the group. This process continues until all 475 frequencies are chosen for the set. For selection of a random frequency, the frequencies remaining within the group are always treated as equally likely.

3.5. Conducted Test Setup

The FCC KDB 905462 D02 UNII DFS Compliance Procedures New Rules v01r01 describes a radiated test setup and a conducted test setup. The conducted test setup was used for this testing.

Figure 3-1 shows the typical test setup.

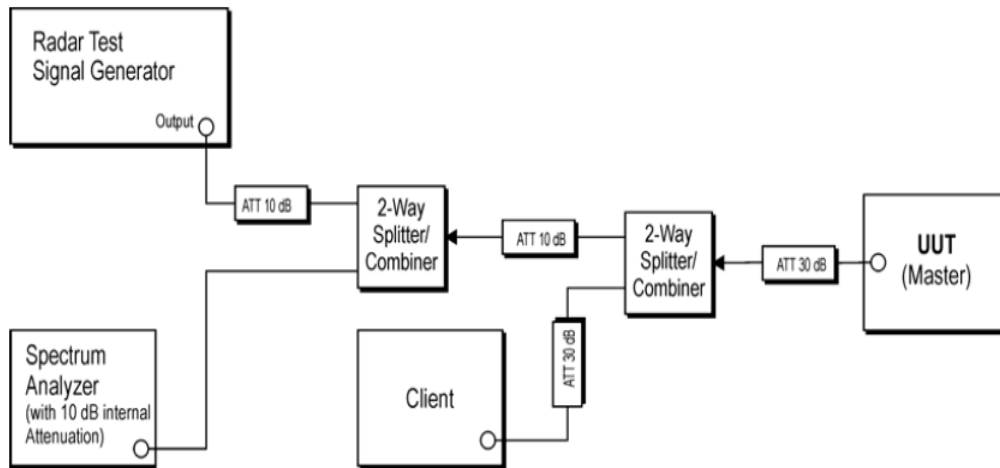

Figure 3-1: Conducted Test Setup where UUT is a Master and Radar Test Waveforms are injected into the Masters

4. TEST EQUIPMENT CALIBRATION DATE

Dynamic Frequency Selection (DFS)

Instrument	Manufacturer	Type No.	Asset No.	Cali. Interval	Cali. Due Date
Spectrum Analyzer	Agilent	N9020A	MRTSUE06106	1 year	2016/05/08
ESG Vector Signal Generator	Agilent	E4438C	MRTSUE06026	1 year	2015/12/09
Temperature/Humidity Meter	Ouleinuo	N/A	MRTSUE06112	1 year	2015/11/20

Software	Version	Manufacturer	Function
Pulse Building	N/A	Agilent	Radar Signal Generation Software
DFS Tool	V 6.9.2	Agilent	DFS Test Software

5. TEST RESULT

5.1. Summary

Company Name: Calix Inc.
FCC ID: 2ABLK-8X4G-1V2
FCC Classification: Unlicensed National Information Infrastructure (UNII)

Parameter	Limit	Test Result	Reference
UNII Detection Bandwidth Measurement	Refer Table 3-3	Pass	Section 5.4
Initial Channel Availability Check Time	Refer Table 3-3	Pass	Section 5.5
Radar Burst at the Beginning of the Channel Availability Check Time	Refer Table 3-3	Pass	Section 5.6
Radar Burst at the End of the Channel Availability Check Time	Refer Table 3-3	Pass	Section 5.7
In-Service Monitoring for Channel Move Time, Channel Closing Transmission Time	Refer Table 3-3	Pass	Section 5.8
Non-Occupancy Period	Refer Table 3-3	Pass	Section 5.8
Statistical Performance Check	Refer Table 3-3	Pass	Section 5.9

5.2. Radar Waveform Calibration

5.2.1. Calibration Setup

The conducted test setup was used for this calibration testing. Figure 3-2 shows the typical test setup.

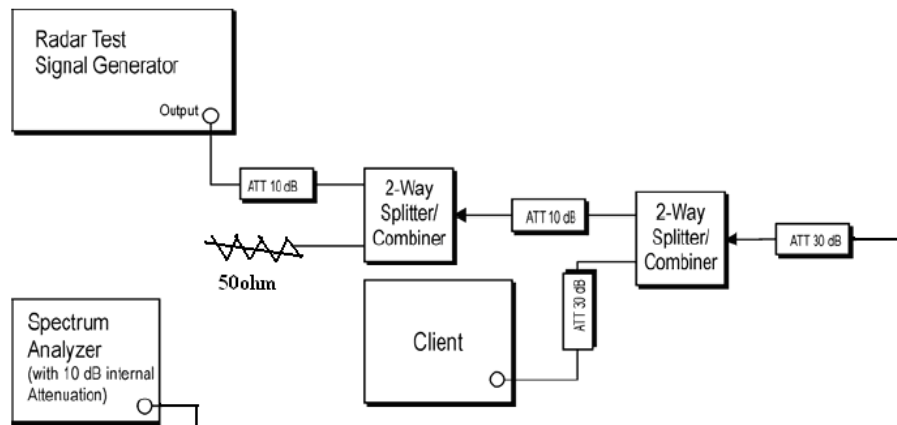

Figure 3-2: Conducted Test Setup

5.2.2. Calibration Procedure

The Interference Radar Detection Threshold Level is $(-64\text{dBm}) + (0) [\text{dBi}] + 1 \text{ dB} = -63 \text{ dBm}$ that had been taken into account the output power range and antenna gain. The above equipment setup was used to calibrate the conducted Radar Waveform. A vector signal generator was utilized to establish the test signal level for each radar type. During this process there were replace 50ohm terminal form Master and Client device and no transmissions by either the Master or Client Device. The spectrum analyzer was switched to the zero span (Time Domain) at the frequency of the Radar Waveform generator. Peak detection was used. The spectrum analyzer resolution bandwidth (RBW) and video bandwidth (VBW) were set to at least 3MHz. The vector signal generator amplitude was set so that the power level measured at the spectrum analyzer was $(-64\text{dBm}) + (0) [\text{dBi}] + 1 \text{ dB} = -63\text{dBm}$. Capture the spectrum analyzer plots on short pulse radar types, long pulse radar type and hopping radar waveform.

5.2.3. Cablibration Result

Radar #0 DFS detection threshold level and the burst of pulses on the Channel frequency

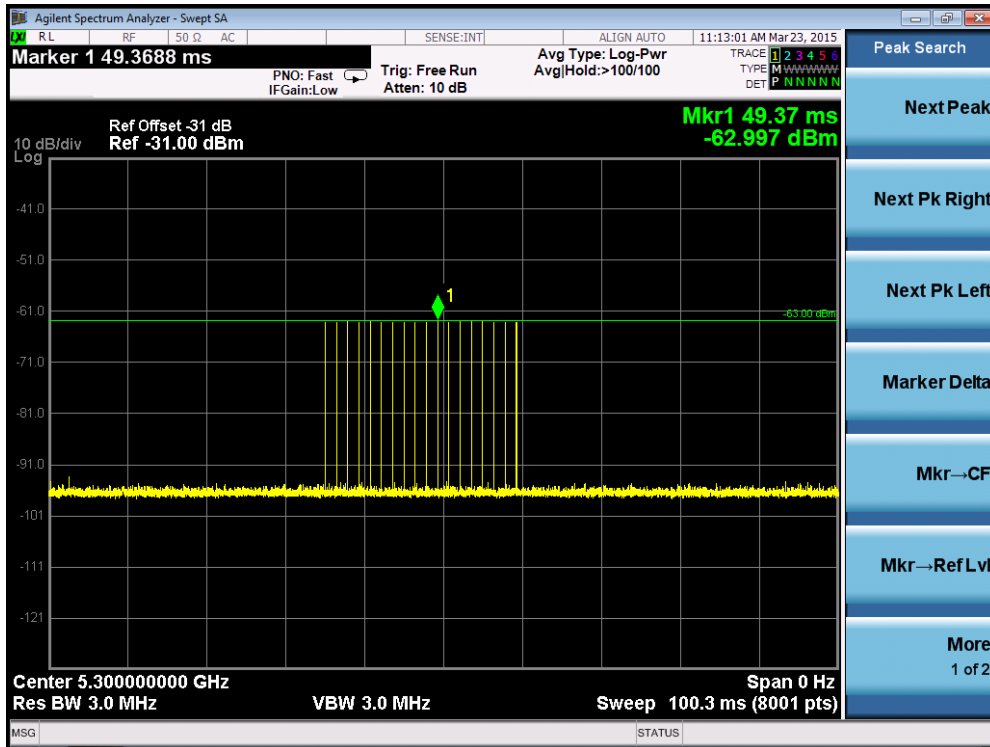

Radar #1(Test A) DFS detection threshold level and the burst of pulses on the Channel frequency

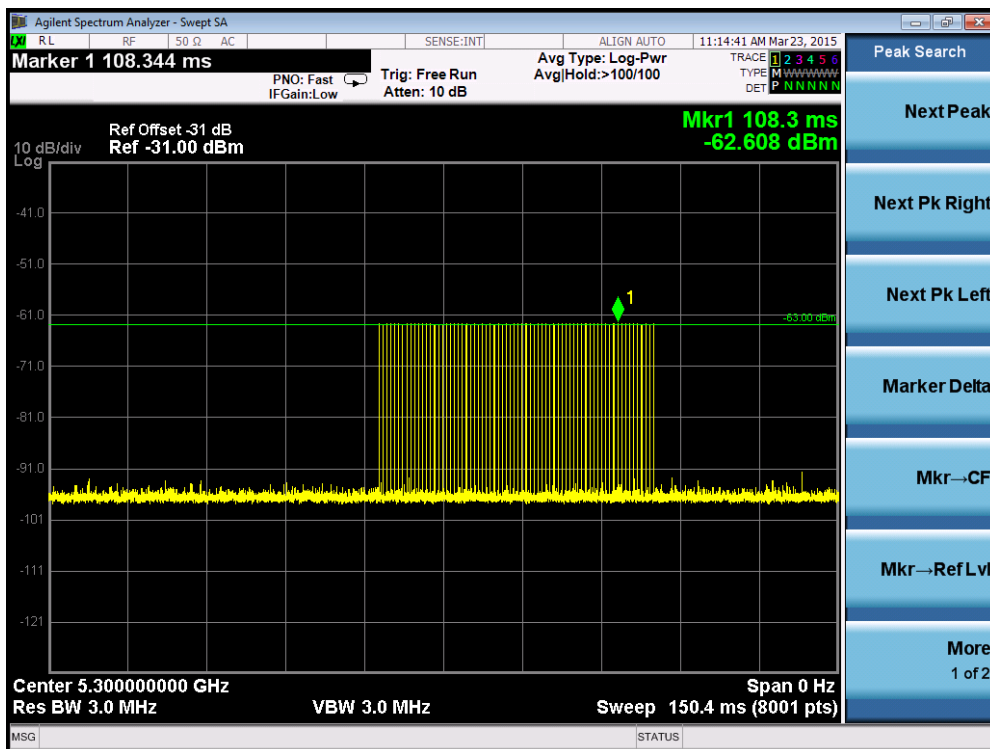

PRI = 758us and the number of pulses = 70

Radar #1(Test B) DFS detection threshold level and the burst of pulses on the Channel frequency

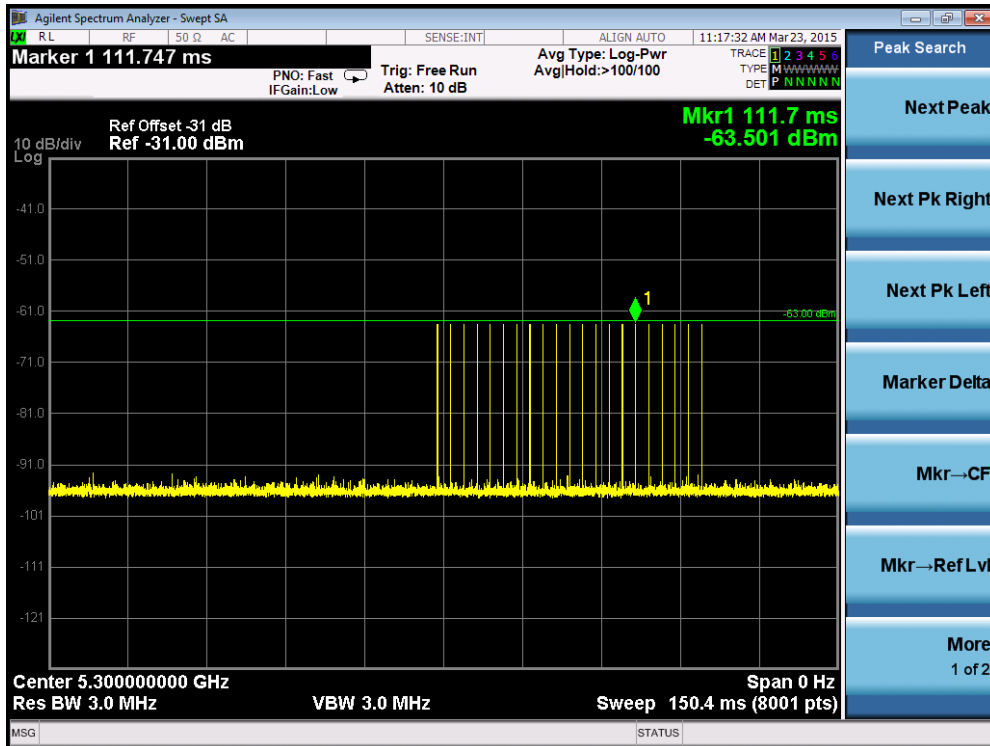

PRI = 2.575ms and the number of pulses = 21

Radar #2 DFS detection threshold level and the burst of pulses on the Channel frequency

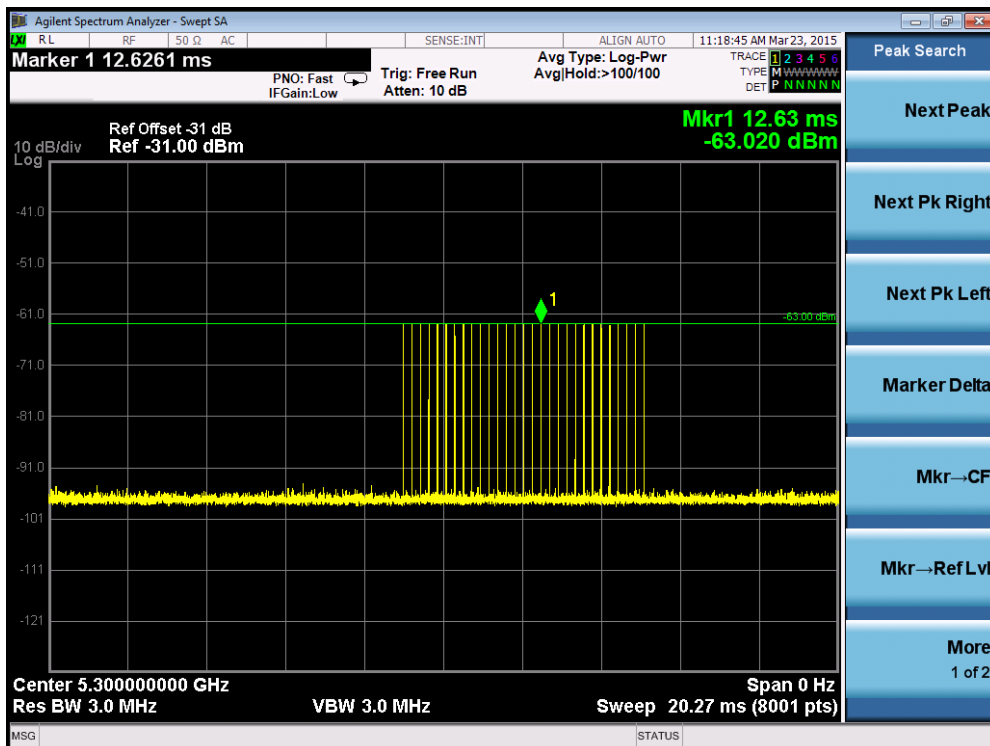

Radar #3 DFS detection threshold level and the burst of pulses on the Channel frequency

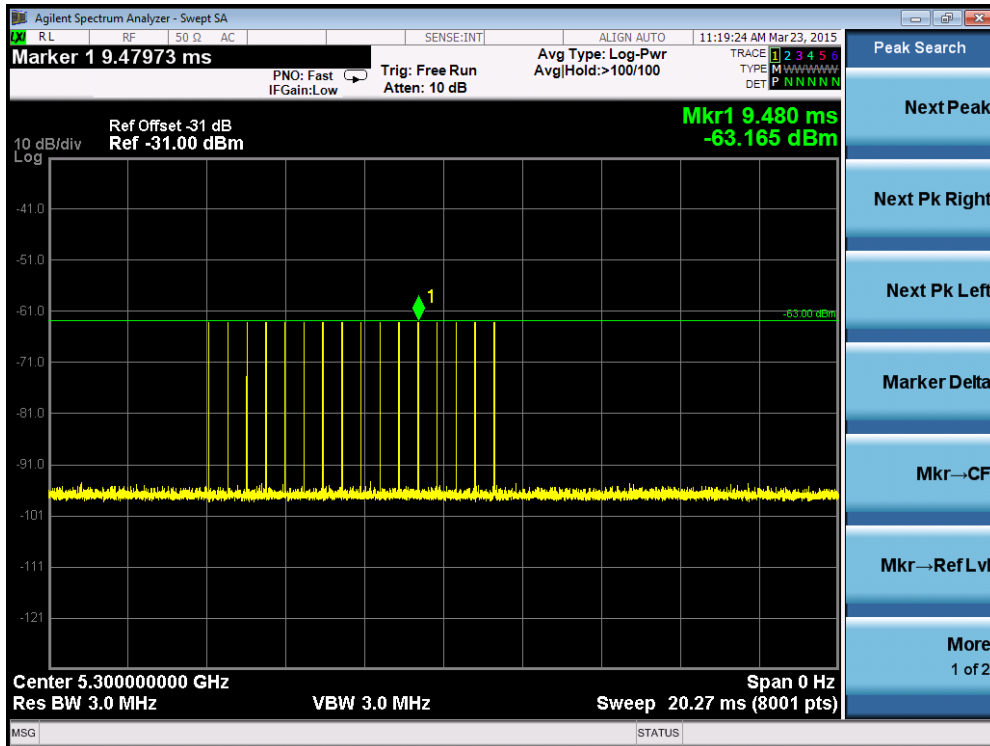

Radar #4 DFS detection threshold level and the burst of pulses on the Channel frequency

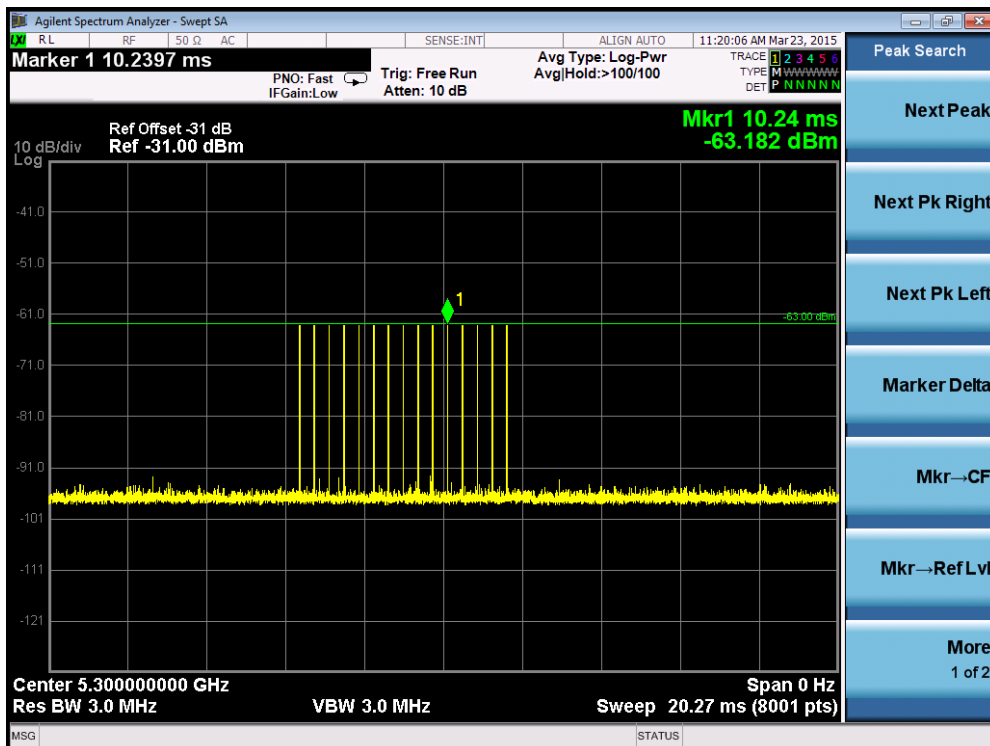

Radar #5 DFS detection threshold level and 12sec long burst on the Channel frequency

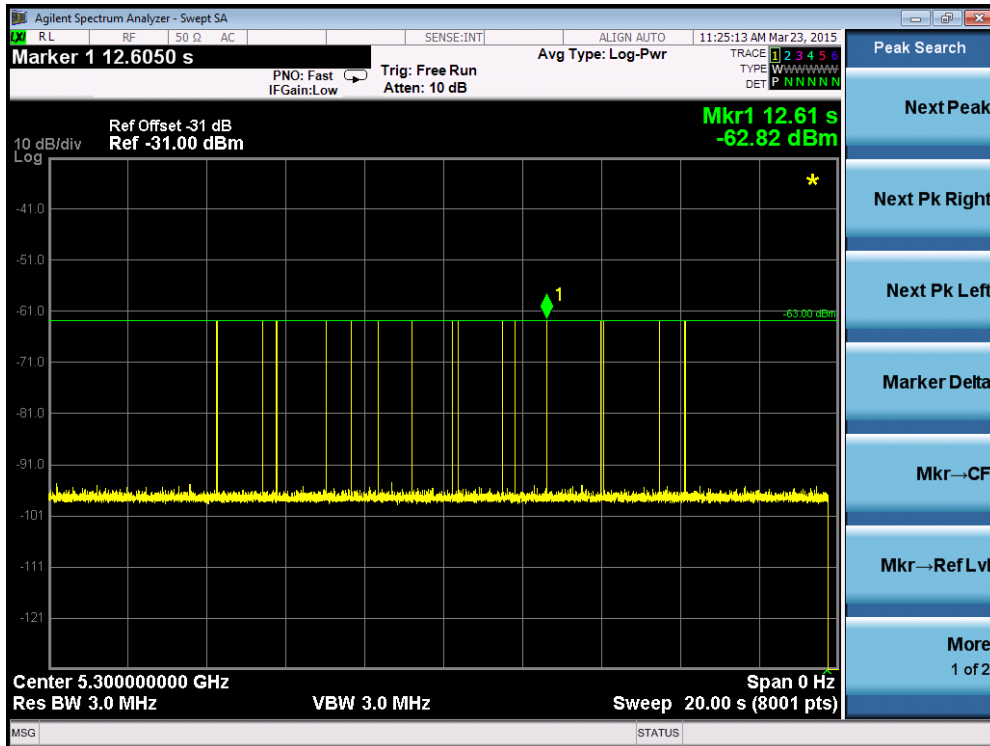

Radar #6 DFS detection threshold level and a single hop (9 pulses) on the Channel frequency within UNII detection bandwidth

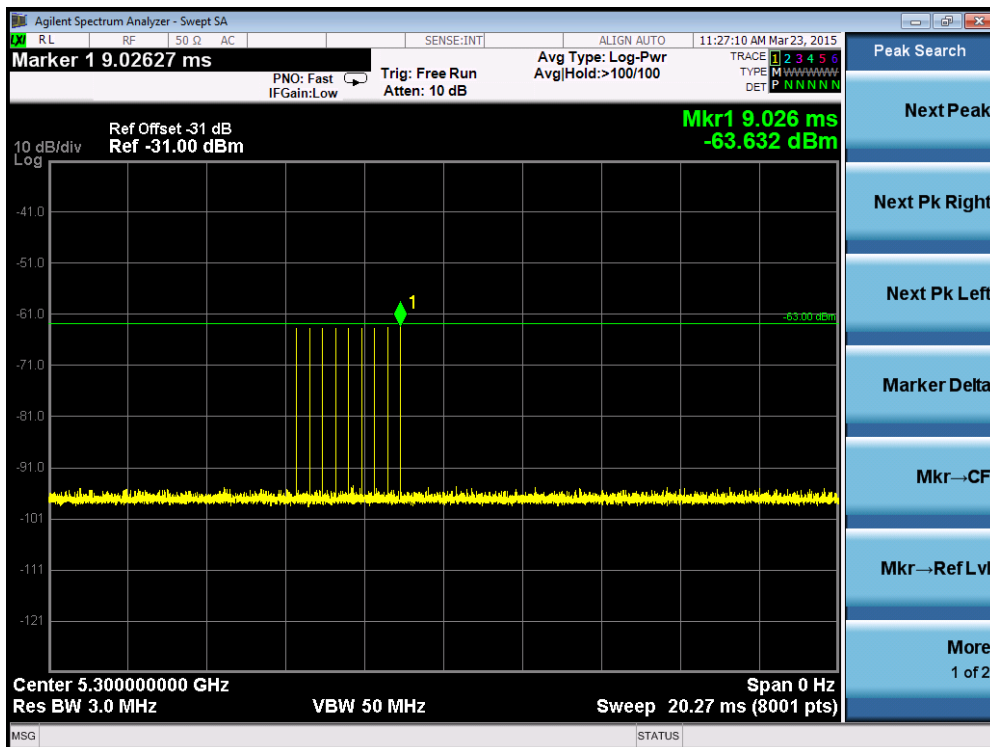

5.3. Channel Loading Test Result

System testing was performed with the designated MPEG test file that streams full motion video from the Indoor GPON HGU to the Client in full motion video mode using the media player with the V2.61 Codec package. This file is used by IP and Frame based systems for loading the test channel during the In-service compliance testing of the U-NII device. Packet ratio = Time On/ (Time On + Off Time).

Channel Loading Plot - 802.11a-5300MHz

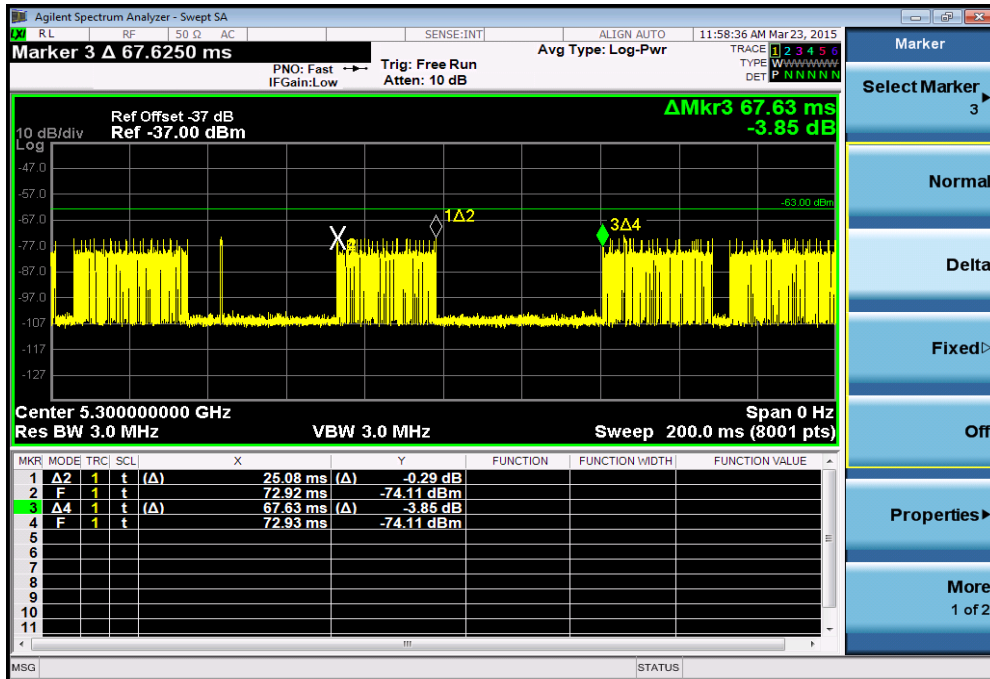

Channel Loading Plot - 802.11n-HT40-5310MHz

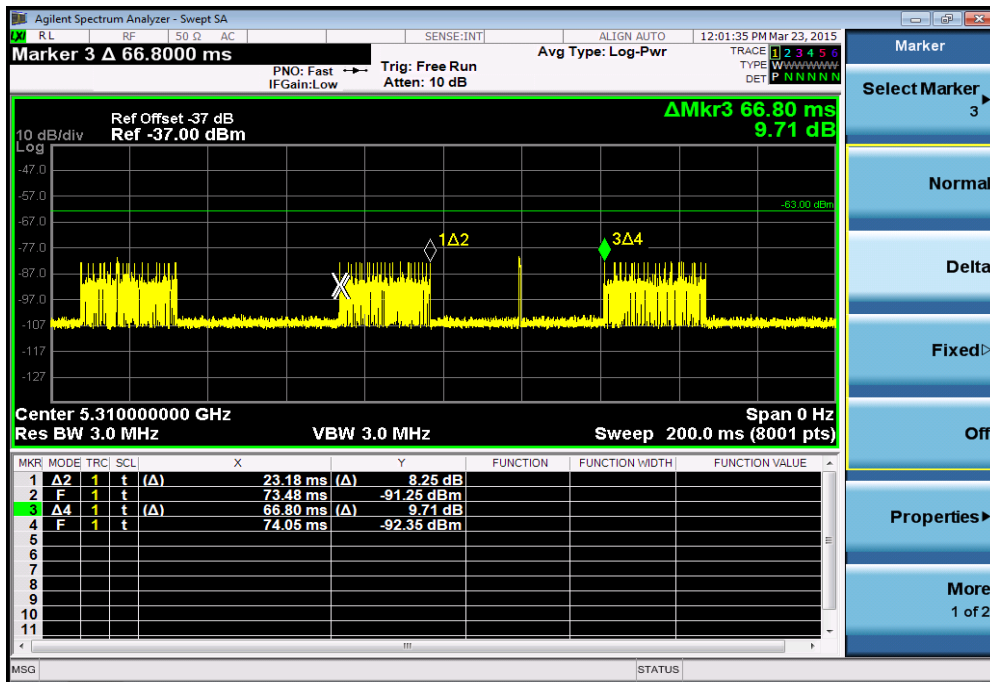

Channel Loading Plot - 802.11ac-VHT80-5290MHz

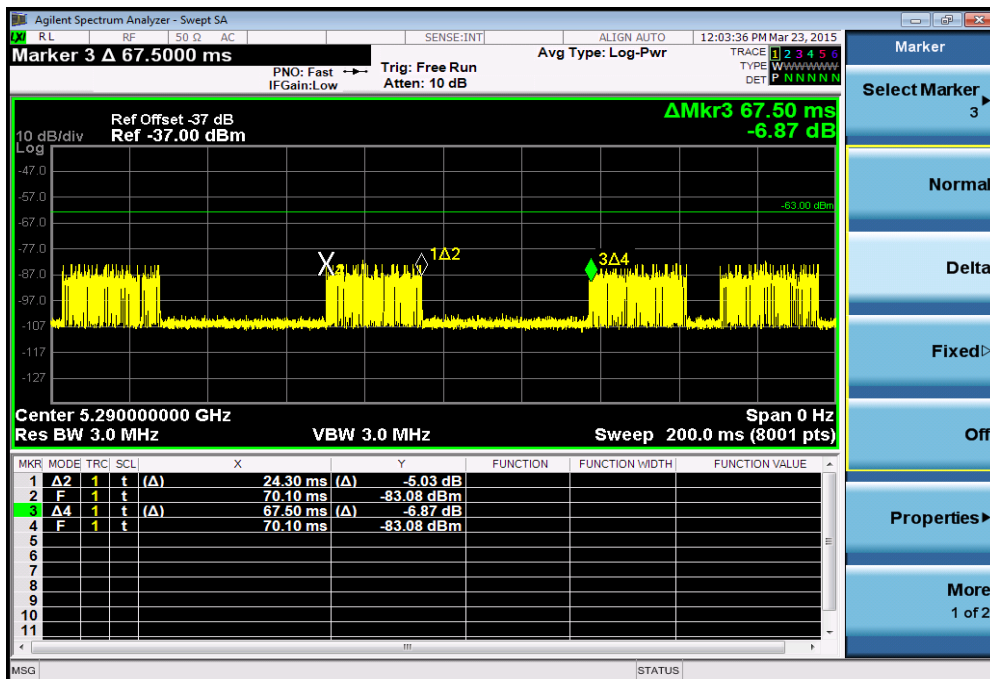

Test Mode	Packet ratio	Requirement ratio	Test Result
802.11a	37.08%	>17%	Pass
802.11n-HT40	34.70%	>17%	Pass
802.11ac-VHT80	36.00%	>17%	Pass

5.4. UNII Detection Bandwidth Measurement

5.4.1. Test Limit

Minimum 100% of the UNII 99% transmission power bandwidth. During the U-NII Detection Bandwidth detection test, each frequency step the minimum percentage of detection is 90 percent. Measurements are performed with no data traffic.

5.4.2. Test Procedure

1. Adjust the equipment to produce a single Burst of any one of the Short Pulse Radar Types 0-4 in Table 3-5 at the center frequency of the EUT Operating Channel at the specified DFS Detection Threshold level.
2. The generating equipment is configured as shown in the Conducted Test Setup above section 3.5.
3. The EUT is set up as a stand-alone device (no associated Client or Master, as appropriate) and no traffic. Frame based systems will be set to a talk/listen ratio reflecting the worst case (maximum) that is user configurable during this test.
4. Generate a single radar Burst, and note the response of the EUT. Repeat for a minimum of 10 trials. The EUT must detect the Radar Waveform using the specified U-NII Detection Bandwidth criterion shown in Table 3-5. In cases where the channel bandwidth may exceed past the DFS band edge on specific channels (i.e., 802.11ac or wideband frame based systems) select a channel that has the entire emission bandwidth within the DFS band. If this is not possible, test the detection BW to the DFS band edge.
5. Starting at the center frequency of the UUT operating Channel, increase the radar frequency in 5 MHz steps, repeating the above test sequence, until the detection rate falls below the U-NII Detection Bandwidth criterion specified in Table 3-3. Repeat this measurement in 1MHz steps at frequencies 5 MHz below where the detection rate begins to fall. Record the highest frequency (denote as FH) at which detection is greater than or equal to the U-NII Detection Bandwidth criterion. Recording the detection rate at frequencies above FH is not required to demonstrate compliance.
6. Starting at the center frequency of the EUT operating Channel, decrease the radar frequency in 1 MHz steps, repeating the above item 4 test sequence, until the detection rate falls below the U-NII Detection Bandwidth criterion. Record the lowest frequency (denote as FL) at which detection is greater than or equal to the U-NII Detection Bandwidth criterion. Recording the detection rate at frequencies below FL is not required to demonstrate compliance.
7. The U-NII Detection Bandwidth is calculated as follows: U-NII Detection Bandwidth = FH – FL
8. The U-NII Detection Bandwidth must be at least 100% of the EUT transmitter 99% power, otherwise, the EUT does not comply with DFS requirements.

5.4.3. Test Result

EUT Frequency=5300MHz for 802.11a											
Radar Frequency (MHz)	DFS Detection Trials (1=Detection, 0= No Detection)										Detection Rate (%)
	1	2	3	4	5	6	7	8	9	10	
5290	0	0	0	0	0	0	0	0	0	0	0%
5291 FL	1	1	1	1	1	1	1	1	1	1	100%
5292	1	1	1	1	1	1	1	1	1	1	100%
5293	1	1	1	1	1	1	1	1	1	1	100%
5294	1	1	1	1	1	1	1	1	1	1	100%
5295	1	1	1	1	1	1	1	1	1	1	100%
5296	1	1	1	1	1	1	1	1	1	1	100%
5297	1	1	1	1	1	1	1	1	1	1	100%
5298	1	1	1	1	1	1	1	1	1	1	100%
5299	1	1	1	1	1	1	1	1	1	1	100%
5300	1	1	1	1	1	1	1	1	1	1	100%
5301	1	1	1	1	1	1	1	1	1	1	100%
5302	1	1	1	1	1	1	1	1	1	1	100%
5303	1	1	1	1	1	1	1	1	1	1	100%
5304	1	1	1	1	1	1	1	1	1	1	100%
5305	1	1	1	1	1	1	1	1	1	1	100%
5306	1	1	1	1	1	1	1	1	1	1	100%
5307	1	1	1	1	1	1	1	1	1	1	100%
5308	1	1	1	1	1	1	1	1	1	1	100%
5309 FH	1	1	1	1	1	1	1	1	1	1	100%
5310	0	0	0	0	0	0	0	0	0	0	0%
Detection Bandwidth = FH - FL = 5309MHz - 5291MHz = 18MHz											
EUT 99% Bandwidth = 16.69MHz (see note)											
UNII Detection Bandwidth Min. Limit (MHz): 16.69MHz x 100% = 16.69MHz											

Note: All UNII channels for this device have identical Channel bandwidths. Therefore, all DFS testing was done at 5300MHz. The 99% channel bandwidth is 16.75MHz. (See the 99% BW section of the RF report for further measurement details).



EUT Frequency=5310MHz for 802.11n-HT40											
Radar Frequency (MHz)	DFS Detection Trials (1=Detection, 0= No Detection)										Detection Rate (%)
	1	2	3	4	5	6	7	8	9	10	
5291	0	0	0	0	0	0	0	0	0	0	0%
5292 FL	1	1	1	1	1	1	1	1	1	1	100%
5293	1	1	1	1	1	1	1	1	1	1	100%
5294	1	1	1	1	1	1	1	1	1	1	100%
5295	1	1	1	1	1	1	1	1	1	1	100%
5296	1	1	1	1	1	1	1	1	1	1	100%
5297	1	1	1	1	1	1	1	1	1	1	100%
5298	1	1	1	1	1	1	1	1	1	1	100%
5299	1	1	1	1	1	1	1	1	1	1	100%
5300	1	1	1	1	1	1	1	1	1	1	100%
5301	1	1	1	1	1	1	1	1	1	1	100%
5302	1	1	1	1	1	1	1	1	1	1	100%
5303	1	1	1	1	1	1	1	1	1	1	100%
5304	1	1	1	1	1	1	1	1	1	1	100%
5305	1	1	1	1	1	1	1	1	1	1	100%
5306	1	1	1	1	1	1	1	1	1	1	100%
5307	1	1	1	1	1	1	1	1	1	1	100%
5308	1	1	1	1	1	1	1	1	1	1	100%
5309	1	1	1	1	1	1	1	1	1	1	100%
5310	1	1	1	1	1	1	1	1	1	1	100%
5311	1	1	1	1	1	1	1	1	1	1	100%
5312	1	1	1	1	1	1	1	1	1	1	100%
5313	1	1	1	1	1	1	1	1	1	1	100%
5314	1	1	1	1	1	1	1	1	1	1	100%
5315	1	1	1	1	1	1	1	1	1	1	100%
5316	1	1	1	1	1	1	1	1	1	1	100%
5317	1	1	1	1	1	1	1	1	1	1	100%
5318	1	1	1	1	1	1	1	1	1	1	100%
5319	1	1	1	1	1	1	1	1	1	1	100%
5320	1	1	1	1	1	1	1	1	1	1	100%
5321	1	1	1	1	1	1	1	1	1	1	100%

5322	1	1	1	1	1	1	1	1	1	1	100%
5323	1	1	1	1	1	1	1	1	1	1	100%
5324	1	1	1	1	1	1	1	1	1	1	100%
5325	1	1	1	1	1	1	1	1	1	1	100%
5326	1	1	1	1	1	1	1	1	1	1	100%
5327	1	1	1	1	1	1	1	1	1	1	100%
5328	1	1	1	1	1	1	1	1	1	1	100%
5329 FH	1	1	1	1	1	1	1	1	1	1	100%
5330	0	0	0	0	0	0	0	0	0	0	0%
Detection Bandwidth = FH - FL = 5329MHz - 5292MHz = 37MHz											
EUT 99% Bandwidth = 36.26MHz (see note)											
UNII Detection Bandwidth Min. Limit (MHz): 36.26MHz x 100% = 36.26MHz											

Note: All UNII channels for this device have identical Channel bandwidths. Therefore, all DFS testing was done at 5310MHz. The 99% channel bandwidth is 36.30MHz. (See the 99% BW section of the RF report for further measurement details).

EUT Frequency=5290MHz for 802.11ac-VHT80											
Radar Frequency (MHz)	DFS Detection Trials (1=Detection, 0= No Detection)										Detection Rate (%)
	1	2	3	4	5	6	7	8	9	10	
5249	0	0	0	0	0	0	0	0	0	0	0%
5250 FL	1	1	1	1	1	1	1	1	1	1	100%
5251	1	1	1	1	1	1	1	1	1	1	100%
5252	1	1	1	1	1	1	1	1	1	1	100%
5253	1	1	1	1	1	1	1	1	1	1	100%
5254	1	1	1	1	1	1	1	1	1	1	100%
5255	1	1	1	1	1	1	1	1	1	1	100%
5256	1	1	1	1	1	1	1	1	1	1	100%
5257	1	1	1	1	1	1	1	1	1	1	100%
5258	1	1	1	1	1	1	1	1	1	1	100%
5259	1	1	1	1	1	1	1	1	1	1	100%
5260	1	1	1	1	1	1	1	1	1	1	100%
5261	1	1	1	1	1	1	1	1	1	1	100%
5262	1	1	1	1	1	1	1	1	1	1	100%
5263	1	1	1	1	1	1	1	1	1	1	100%
5264	1	1	1	1	1	1	1	1	1	1	100%
5265	1	1	1	1	1	1	1	1	1	1	100%
5266	1	1	1	1	1	1	1	1	1	1	100%
5267	1	1	1	1	1	1	1	1	1	1	100%
5268	1	1	1	1	1	1	1	1	1	1	100%
5269	1	1	1	1	1	1	1	1	1	1	100%
5270	1	1	1	1	1	1	1	1	1	1	100%
5271	1	1	1	1	1	1	1	1	1	1	100%
5272	1	1	1	1	1	1	1	1	1	1	100%
5273	1	1	1	1	1	1	1	1	1	1	100%
5274	1	1	1	1	1	1	1	1	1	1	100%
5275	1	1	1	1	1	1	1	1	1	1	100%
5276	1	1	1	1	1	1	1	1	1	1	100%
5277	1	1	1	1	1	1	1	1	1	1	100%



5278	1	1	1	1	1	1	1	1	1	1	100%
5279	1	1	1	1	1	1	1	1	1	1	100%
5280	1	1	1	1	1	1	1	1	1	1	100%
5281	1	1	1	1	1	1	1	1	1	1	100%
5282	1	1	1	1	1	1	1	1	1	1	100%
5283	1	1	1	1	1	1	1	1	1	1	100%
5284	1	1	1	1	1	1	1	1	1	1	100%
5285	1	1	1	1	1	1	1	1	1	1	100%
5286	1	1	1	1	1	1	1	1	1	1	100%
5287	1	1	1	1	1	1	1	1	1	1	100%
5288	1	1	1	1	1	1	1	1	1	1	100%
5289	1	1	1	1	1	1	1	1	1	1	100%
5290	1	1	1	1	1	1	1	1	1	1	100%
5291	1	1	1	1	1	1	1	1	1	1	100%
5292	1	1	1	1	1	1	1	1	1	1	100%
5293	1	1	1	1	1	1	1	1	1	1	100%
5294	1	1	1	1	1	1	1	1	1	1	100%
5295	1	1	1	1	1	1	1	1	1	1	100%
5296	1	1	1	1	1	1	1	1	1	1	100%
5297	1	1	1	1	1	1	1	1	1	1	100%
5298	1	1	1	1	1	1	1	1	1	1	100%
5299	1	1	1	1	1	1	1	1	1	1	100%
5300	1	1	1	1	1	1	1	1	1	1	100%
5301	1	1	1	1	1	1	1	1	1	1	100%
5302	1	1	1	1	1	1	1	1	1	1	100%
5303	1	1	1	1	1	1	1	1	1	1	100%
5304	1	1	1	1	1	1	1	1	1	1	100%
5305	1	1	1	1	1	1	1	1	1	1	100%
5306	1	1	1	1	1	1	1	1	1	1	100%
5307	1	1	1	1	1	1	1	1	1	1	100%
5308	1	1	1	1	1	1	1	1	1	1	100%
5309	1	1	1	1	1	1	1	1	1	1	100%
5310	1	1	1	1	1	1	1	1	1	1	100%
5311	1	1	1	1	1	1	1	1	1	1	100%

5312	1	1	1	1	1	1	1	1	1	1	100%
5313	1	1	1	1	1	1	1	1	1	1	100%
5314	1	1	1	1	1	1	1	1	1	1	100%
5315	1	1	1	1	1	1	1	1	1	1	100%
5316	1	1	1	1	1	1	1	1	1	1	100%
5317	1	1	1	1	1	1	1	1	1	1	100%
5318	1	1	1	1	1	1	1	1	1	1	100%
5319	1	1	1	1	1	1	1	1	1	1	100%
5320	1	1	1	1	1	1	1	1	1	1	100%
5321	1	1	1	1	1	1	1	1	1	1	100%
5322	1	1	1	1	1	1	1	1	1	1	100%
5323	1	1	1	1	1	1	1	1	1	1	100%
5324	1	1	1	1	1	1	1	1	1	1	100%
5325	1	1	1	1	1	1	1	1	1	1	100%
5326	1	1	1	1	1	1	1	1	1	1	100%
5327	1	1	1	1	1	1	1	1	1	1	100%
5328	1	1	1	1	1	1	1	1	1	1	100%
5329	1	1	1	1	1	1	1	1	1	1	100%
5330 FH	1	1	1	1	1	1	1	1	1	1	100%
5331	0	0	0	0	0	0	0	0	0	0	0%
Detection Bandwidth = FH - FL = 5330MHz - 5250MHz = 80MHz											
EUT 99% Bandwidth = 72.24MHz (see note)											
UNII Detection Bandwidth Min. Limit (MHz): 72.24MHz x 100% = 72.24MHz											

Note: All UNII channels for this device have identical Channel bandwidths. Therefore, all DFS testing was done at 5290MHz. The 99% channel bandwidth is 75.00MHz. (See the 99% BW section of the RF report for further measurement details).

5.5. Initial Channel Availability Check Time Measurement

5.5.1. Test Limit

The EUT shall perform a Channel Availability Check to ensure that there is no radar operating on the channel. After power-up sequence, receive at least 1 minute on the intended operating frequency.

5.5.2. Test Procedure

1. The U-NII devices will be powered on and be instructed to operate on the appropriate U-NII Channel that must incorporate DFS functions. At the same time the EUT is powered on, the spectrum analyzer will be set to zero span mode with a 3 MHz RBW and 3 MHz VBW on the Channel occupied by the radar (Chr) with a 2.5 minute sweep time. The spectrum analyzer's sweep will be started at the same time power is applied to the U-NII device.
2. The EUT should not transmit any beacon or data transmissions until at least 1 minute after the completion of the power-on cycle.
3. Confirm that the EUT initiates transmission on the channel. Measurement system showing its nominal noise floor is marker1.

5.5.3. Test Result

The EUT does not transmit any beacon or data transmissions until at least 1 minute after the completion of the power-on cycle (121.7 sec). Initial beacons/data transmissions are indicated by marker 1 (181.7sec).

Initial Channel Availability Check Time for 802.11a

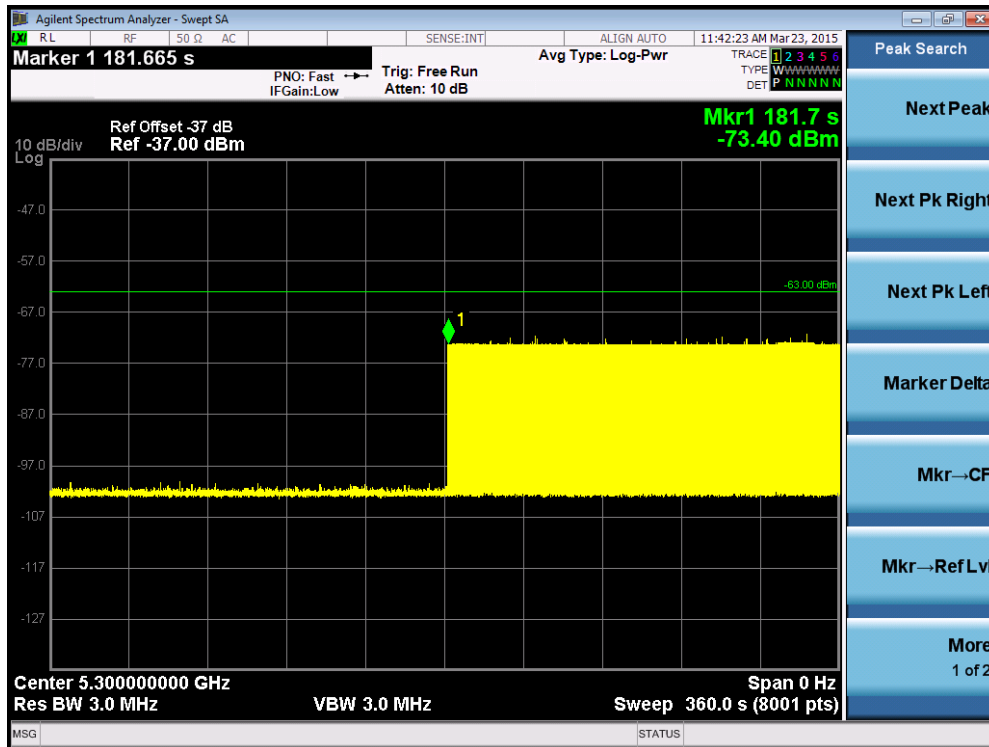

5.6. Radar Burst at the Beginning of the Channel Availability Check Time Measurement

5.6.1. Test Limit

In beginning of the Channel Availability Check (CAC) Time, radar is detected on this channel, select another intended channel and perform a CAC on that channel.

5.6.2. Test Procedure

1. The steps below define the procedure to verify successful radar detection on the selected Channel during a period equal to the Channel Availability Check Time and avoidance of operation on that Channel when a radar Burst with a level equal to the DFS Detection Threshold + 1 dB occurs at the beginning of the Channel Availability Check Time.
2. The EUT is in completion power-up cycle (from T0 to T1). T1 denotes the instant when the EUT has completed its power-up sequence. The Channel Availability Check Time commences at instant T1 and will end no sooner than T1 + 60 seconds. A single Burst of one of Short Pulse Radar Types 0-4 at DFS Detection Threshold + 1 dB will commence within a 6 second window starting at T1.
3. Visual indication on the EUT of successful detection of the radar Burst will be recorded and reported. Observation of emissions at 5300MHz (for 802.11a) will continue for 2.5 minutes after the radar Burst has been generated. Verify that during the 2.5 minutes measurement window no EUT transmissions occurred at 5300MHz (for 802.11a).

5.6.3. Test Result

Radar Burst at the Beginning of the Channel Availability Check Time for 802.11a

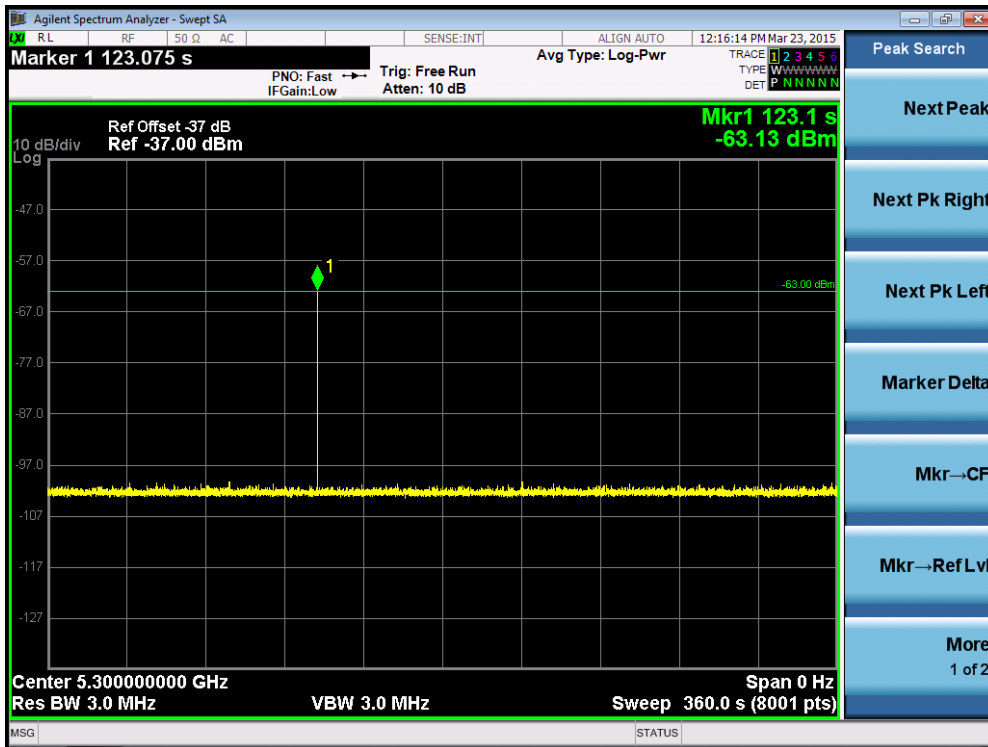

5.7. Radar Burst at the End of the Channel Availability Check Time Measurement

5.7.1. Test Limit

In the end of Channel Availability Check (CAC) Time, radar is detected on this channel, select another intended channel and perform a CAC on that channel.

5.7.2. Test Procedure

1. The steps below define the procedure to verify successful radar detection on the selected Channel during a period equal to the Channel Availability Check Time and avoidance of operation on that Channel when a radar Burst with a level equal to the DFS Detection Threshold + 1 dB occurs at the beginning of the Channel Availability Check Time.
2. The EUT is powered on at T0. T1 denotes the instant when the EUT has completed its power-up sequence. The Channel Availability Check Time commences at instant T1 and will end no sooner than $T1 + 60$ seconds. A single Burst of one of Short Pulse Radar Types 0-4 at DFS Detection Threshold + 1 dB will commence within a 6 second window starting at $T1 + 54$ seconds.
3. Visual indication on the EUT of successful detection of the radar Burst will be recorded and reported. Observation of emissions at 5300MHz (for 802.11a) will continue for 2.5 minutes after the radar Burst has been generated. Verify that during the 2.5 minutes measurement window no EUT transmissions occurred at 5300MHz (for 802.11a).

5.7.3. Test Result

Radar Burst at the End of the Channel Availability Check Time for 802.11a

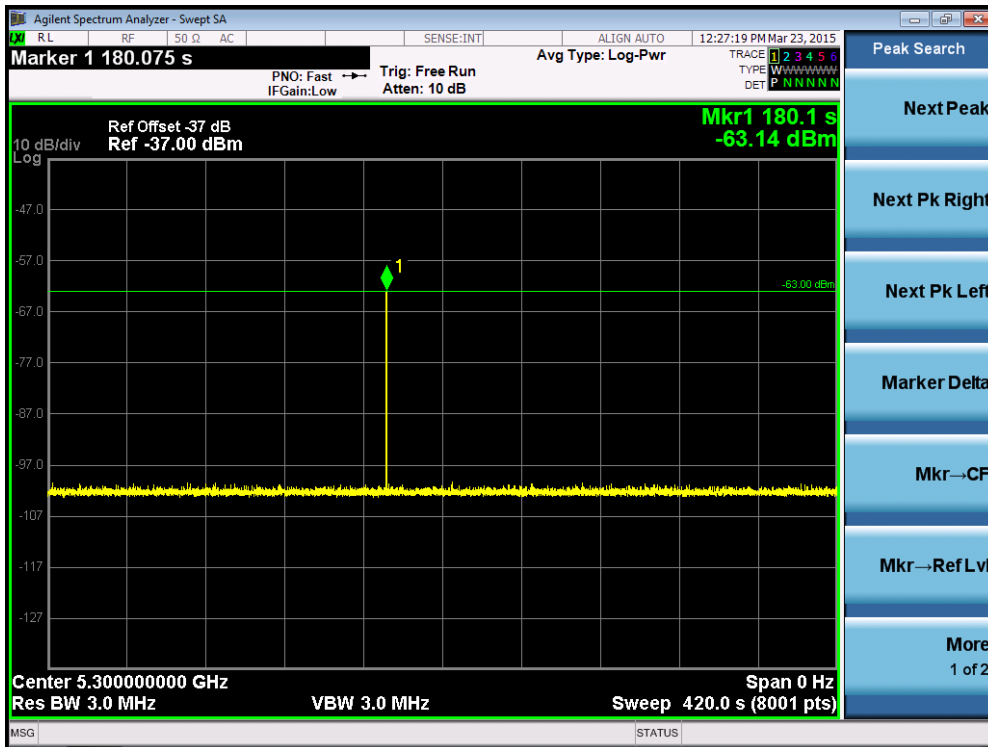

5.8. In-Service Monitoring for Channel Move Time, Channel Closing Transmission Time and Non-Occupancy Period Measurement

5.8.1. Test Limit

The EUT has In-Service Monitoring function to continuously monitor the radar signals. If the radar is detected, must leave the channel (Shutdown). The Channel Move Time to cease all transmissions on the current channel upon detection of a Radar Waveform above the DFS Detection Threshold within 10 sec. The total duration of Channel Closing Transmission Time is 260ms, consisting of data signals and the aggregate of control signals, by a U-NII device during the Channel Move Time. The Non-Occupancy Period time is 30 minute during which a Channel will not be utilized after a Radar Waveform is detected on that Channel.

5.8.2. Test Procedure Used

1. The test should be performed with Radar Type 0. The measurement timing begins at the end of the Radar Type 0.
2. When the radar burst with a level equal to the DFS Detection Threshold + 1dB is generated on the Operating Channel of the U-NII device. A U-NII device operating as a Master Device will associate with the Client Device at Channel. Stream the MPEG test file from the Master Device to the Client Device on the selected Channel for the entire period of the test. At time T0 the Radar Waveform generator sends a Burst of pulses for each of the radar types at Detection Threshold + 1dB.
3. Observe the transmissions of the EUT at the end of the radar Burst on the Operating Channel. Measure and record the transmissions from the EUT during the observation time (Channel Move Time).
4. Measurement of the aggregate duration of the Channel Closing Transmission Time method. With the spectrum analyzer set to zero span tuned to the center frequency of the EUT operating channel at the radar simulated frequency, peak detection, and max hold, the dwell time per bin is given by: $Dwell (1.5ms) = S (12 \text{ sec}) / B (8000)$; where Dwell is the dwell time per spectrum analyzer sampling bin, S is the sweep time and B is the number of spectrum analyzer sampling bins. An upper bound of the aggregate duration of the intermittent control signals of Channel Closing Transmission Time is calculated by: $80MHz: C (0 \text{ ms}) = N (0) \times Dwell (1.5 \text{ ms})$; where C is the Closing Time, N is the number of spectrum analyzer sampling bins showing a U-NII transmission and Dwell is the dwell time per bin.
5. Measure the EUT for more than 30 minutes following the channel close/move time to verify that the EUT does not resume any transmissions on this Channel.

5.8.3. Test Result

Channel Move Time and Channel Closing Transmission Time for 802.11ac-VHT80

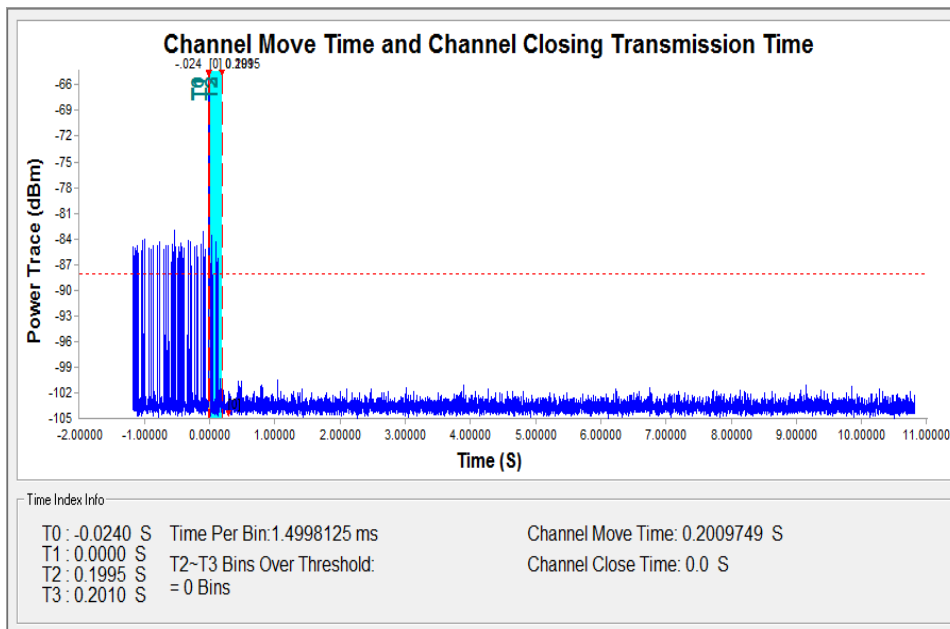
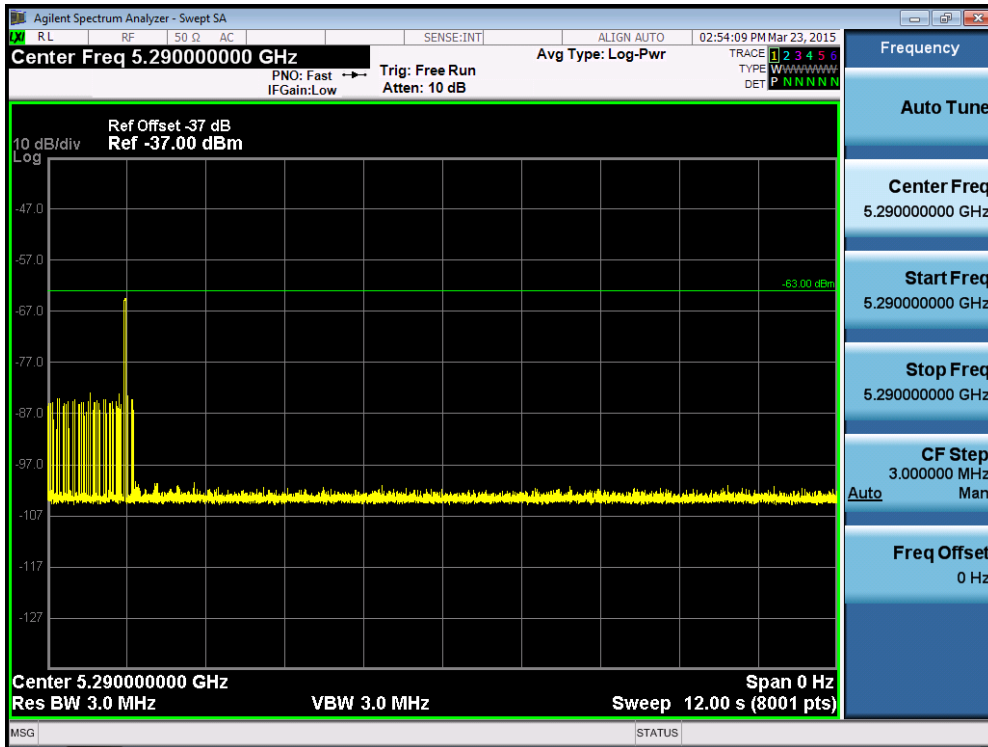

Non-Occupancy Period for 802.11a

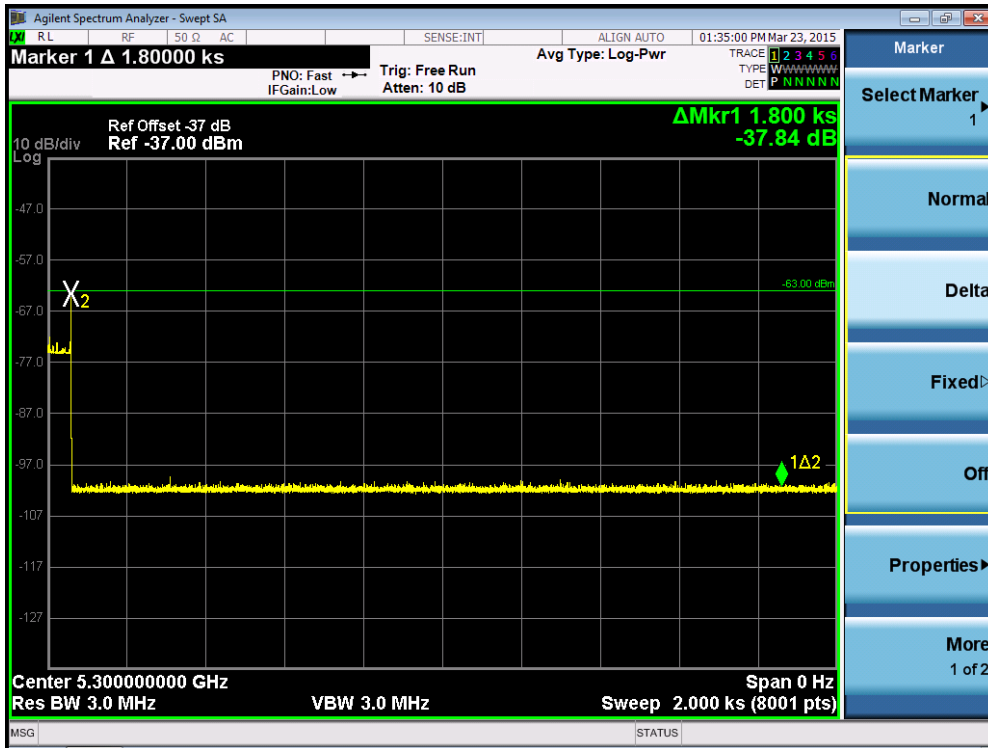

Parameter	Test Result	Limit
	Type 0	
Channel Move Time (s)	0.200s	<10s
Channel Closing Transmission Time (ms) (Note)	0ms	< 60ms
Non-Occupancy Period (min)	≥ 30min	≥ 30 min

Note: The Channel Closing Transmission Time is comprised of 200 milliseconds starting at the beginning of the Channel Move Time plus any additional intermittent control signals required to facilitate a Channel move (an aggregate of 60 milliseconds) during the remainder of the 10 seconds period. The aggregate duration of control signals will not count quiet periods in between transmissions.

5.9. Statistical Performance Check Measurement

5.9.1. Test Limit

The minimum percentage of successful detection requirements found in below table when a radar burst with a level equal to the DFS Detection Threshold + 1dB is generated on the Operating Channel of the U-NII device (In- Service Monitoring).

Radar Type	Minimum Number of Trails	Detection Probability
0	30	Pd > 60%
1	30(15 of test A and 15 of test B)	Pd > 60%
2	30	Pd > 60%
3	30	Pd > 60%
4	30	Pd > 60%
Aggregate (Radar Types 1-4)	120	Pd > 80%
5	30	Pd > 80%
6	30	Pd > 70%

The percentage of successful detection is calculated by:

$(\text{Total Waveform Detections} / \text{Total Waveform Trails}) * 100 = \text{Probability of Detection Radar}$

Waveform In addition an aggregate minimum percentage of successful detection across all Short Pulse Radar Types 1-4 is required and is calculated as follows: $(Pd1 + Pd2 + Pd3 + Pd4) / 4$.

5.9.2. Test Procedure

1. Stream the MPEG test file from the Master Device to the Client Device on the test Channel for the entire period of the test.
2. At time T0 the Radar Waveform generator sends the individual waveform for each of the Radar Types 1-6, at levels equal to the DFS Detection Threshold + 1dB, on the Operating Channel.
3. Observe the transmissions of the EUT at the end of the Burst on the Operating Channel for duration greater than 10 seconds for Short Pulse Radar Types 0 to ensure detection occurs.
4. Observe the transmissions of the EUT at the end of the Burst on the Operating Channel for duration greater than 22 seconds for Long Pulse Radar Type 5 to ensure detection occurs.
5. The device can utilize a test mode to demonstrate when detection occurs to prevent the need to reset the device between trial runs.
6. The Minimum number of trails, minimum percentage of successful detection and the average minimum percentage of successful detection are found in below table.

5.9.3. Test Result

Statistical Performance Check for 802.11a

Radar Type 1 - Radar Statistical Performance

Trail #	Test Freq. (MHz)	Pulse Width (us)	PRI (us)	Pulses / Burst	1=Detection 0=No Detection
1	5291	1	918	58	1
2	5291	1	518	102	1
3	5291	1	698	76	1
4	5291	1	838	63	1
5	5291	1	3066	18	1
6	5291	1	638	83	1
7	5291	1	578	92	1
8	5291	1	818	65	1
9	5291	1	798	67	1
10	5291	1	758	70	1
11	5291	1	558	95	1
12	5291	1	718	74	1
13	5291	1	778	68	1
14	5291	1	738	72	1
15	5291	1	938	57	1
16	5291	1	718	74	1
17	5291	1	2761	20	1
18	5291	1	2136	25	1
19	5291	1	3054	18	1
20	5291	1	936	57	1
21	5291	1	571	93	1
22	5291	1	1219	44	1
23	5291	1	2131	25	1
24	5291	1	1832	29	1
25	5291	1	1648	33	1
26	5291	1	834	64	1
27	5291	1	2684	20	1
28	5291	1	3024	18	1
29	5291	1	2799	19	1
30	5291	1	527	101	1
Detection Percentage (%)					100%

Radar Type 2 - Radar Statistical Performance

Trail #	Test Freq. (MHz)	Pulse Width (us)	PRI (us)	Pulses / Burst	1=Detection 0=No Detection
1	5300	3.0	151	27	1
2	5300	3.0	230	27	1
3	5300	4.3	184	27	1
4	5300	2.2	218	23	1
5	5300	4.7	178	26	1
6	5300	1.9	184	25	1
7	5300	3.4	185	24	1
8	5300	3.0	212	26	1
9	5300	5.0	170	25	1
10	5300	2.3	168	27	1
11	5300	3.8	226	26	1
12	5300	2.9	189	25	1
13	5300	5.0	176	29	1
14	5300	1.9	187	26	1
15	5300	4.7	218	28	1
16	5300	4.2	184	26	1
17	5300	3.1	215	29	1
18	5300	3.0	196	23	1
19	5300	2.5	176	26	1
20	5300	3.9	154	24	1
21	5300	1.6	213	27	1
22	5300	2.9	172	27	1
23	5300	4.3	156	29	1
24	5300	3.3	219	27	1
25	5300	2.8	230	27	1
26	5300	2.3	167	24	1
27	5300	3.7	230	26	1
28	5300	4.2	186	29	1
29	5300	1.0	158	27	1
30	5300	2.3	193	29	1
Detection Percentage (%)					100%

Radar Type 3 - Radar Statistical Performance

Trail #	Test Freq. (MHz)	Pulse Width (us)	PRI (us)	Pulses / Burst	1=Detection 0=No Detection
1	5309	8.9	328	18	1
2	5309	8.1	462	17	1
3	5309	6.6	396	16	1
4	5309	8.7	344	17	1
5	5309	10.0	325	16	1
6	5309	6.1	471	16	1
7	5309	6.2	290	16	1
8	5309	9.7	408	17	1
9	5309	6.3	395	18	1
10	5309	7.3	453	18	1
11	5309	8.4	399	17	1
12	5309	7.2	368	18	1
13	5309	6.9	499	18	1
14	5309	7.2	491	18	1
15	5309	9.3	260	17	1
16	5309	7.6	292	17	1
17	5309	9.0	306	17	1
18	5309	8.0	261	16	1
19	5309	7.0	334	17	1
20	5309	6.3	347	18	1
21	5309	6.8	460	17	1
22	5309	6.7	294	16	1
23	5309	8.8	431	16	1
24	5309	8.3	257	16	0
25	5309	9.9	442	18	1
26	5309	9.1	494	18	1
27	5309	9.9	286	18	1
28	5309	8.8	348	18	1
29	5309	9.5	408	16	1
30	5309	6.5	500	16	1
Detection Percentage (%)					96.7%

Radar Type 4 - Radar Statistical Performance

Trail #	Test Freq. (MHz)	Pulse Width (us)	PRI (us)	Pulses / Burst	1=Detection 0=No Detection
1	5291	14.0	363	14	1
2	5291	14.7	268	13	1
3	5291	17.8	450	14	1
4	5291	13.1	264	14	1
5	5291	17.7	251	13	1
6	5291	11.2	348	15	1
7	5291	13.6	343	16	1
8	5291	19.3	500	13	1
9	5291	15.1	497	15	1
10	5291	13.0	376	16	1
11	5291	14.2	302	12	1
12	5291	13.5	281	12	1
13	5291	20.0	440	12	1
14	5291	12.7	258	16	1
15	5291	15.8	282	14	1
16	5291	11.8	251	15	1
17	5291	14.9	405	15	1
18	5291	12.1	388	12	1
19	5291	17.6	395	15	1
20	5291	16.9	403	15	1
21	5291	18.0	416	12	1
22	5291	14.8	472	12	1
23	5291	13.0	301	13	1
24	5291	14.0	379	16	1
25	5291	14.0	283	12	1
26	5291	15.1	338	15	1
27	5291	12.4	393	13	1
28	5291	18.1	337	15	1
29	5291	19.4	387	12	1
30	5291	16.1	283	15	0
Detection Percentage (%)					96.7%

Note: In addition an average minimum percentage of successful detection across all four Short pulse radar test

waveforms is as follows: $\frac{P_d1 + P_d2 + P_d3 + P_d4}{4} = (100\% + 100\% + 96.7\% + 96.7\%) / 4 = 98.35\% (>80\%)$



Radar Type 5 - Radar Statistical Performance

Trail #	Test Freq. (MHz)	1=Detection 0=No Detection	Trail #	Test Freq. (MHz)	1=Detection 0=No Detection
1	5492	1	16	5507	1
2	5493	1	17	5508	1
3	5494	1	18	5492	1
4	5495	1	19	5493	1
5	5496	1	20	5494	1
6	5497	1	21	5495	1
7	5498	1	22	5496	1
8	5499	1	23	5497	1
9	5500	1	24	5498	1
10	5501	1	25	5499	1
11	5502	1	26	5500	1
12	5503	1	27	5501	1
13	5504	1	28	5502	1
14	5505	1	29	5503	1
15	5506	1	30	5504	1
Detection Percentage (%)					100%

Type 5 Radar Waveform_1												
Waveform Num = 1	Num of Bursts = 20	Burst Interval (us) = 600000	Off Time (us)	# Pulses	Chirp (MHz)	PW (us)	Pulse 1 Pri (us)	Pulse 2 Pri (us)	Pulse 3 Pri (us)	Start Loc (us)	Start Burst Interval (us)	End Burst Interval (us)
1	265817	1	5	90	1423	0	265817	0	699999			
2	699820	3	10	60	1050	1426	961060	600000	1199999			
3	725012	2	18	90	1656	1235	1689599	1200000	1799999			
4	658160	2	15	65	1180	1493	0	2350650	1800000	2399999		
5	415482	2	13	90	1594	1319	0	2768805	2400000	2999999		
6	300869	3	20	65	1353	1680	1992	3072587	3000000	3599999		
7	891087	3	10	90	1626	1202	1220	3968699	3600000	4199999		
8	307715	1	9	75	1432	0	0	4280462	4200000	4799999		
9	999311	2	16	95	1264	1939	0	5281205	4800000	5399999		
10	290004	1	18	70	1572	0	0	5574412	5400000	5999999		
11	708697	3	12	70	1650	1689	1148	6284681	6000000	6599999		
12	405512	1	14	75	1856	0	0	6694680	6600000	7199999		
13	590693	3	12	60	1476	1126	1840	7287229	7200000	7799999		
14	557156	2	8	95	1888	1520	0	7848827	7800000	8399999		
15	963122	1	18	80	1244	0	0	8815357	8400000	8999999		
16	255199	3	9	85	1472	1731	1374	9071800	9000000	9599999		
17	703288	1	8	75	1077	0	0	9779665	9600000	10199999		
18	1013435	1	18	65	1857	0	0	10794177	10200000	10799999		
19	292189	1	9	80	1318	0	0	11088223	10800000	11399999		
20	366637	1	15	100	1519	0	0	11456178	11400000	11999999		
Total number of pulses in waveform = 37												



Type 5 Radar Waveform_2

Waveform Num = 2
Num of Bursts = 10
Burst Interval (us)= 1200000

Burst #	Off Time (us)	# Pulses	Chirp (MHz)	PW (us)	Pulse 1 Pri (us)	Pulse 2 Pri (us)	Pulse 3 Pri (us)	Start Loc (us)	Start Burst Interval (us)	End Burst Interval (us)
1	1128156	1	16	70	1957	0	0	1128156	0	1199999
2	293495	2	8	50	1180	1855	0	1423608	1200000	2399999
3	1982475	1	20	70	1606	0	0	3409118	2400000	3599999
4	213673	1	5	70	1898	0	0	3624397	3600000	4799999
5	1989033	2	8	85	1231	1197	0	5615328	4800000	5999999
6	840202	1	18	100	1264	0	0	6457958	6000000	7199999
7	903240	1	8	100	1014	0	0	7362462	7200000	8399999
8	1305912	3	14	95	1483	1247	1113	8669388	8400000	9599999
9	1366601	1	5	55	1980	0	0	10039832	9600000	10799999
10	1243848	2	8	50	1166	1632	0	11285660	10800000	11999999

Total number of pulses in waveform = 15

Type 5 Radar Waveform_3

Waveform Num = 3
Num of Bursts = 16
Burst Interval (us)= 750000

Burst #	Off Time (us)	# Pulses	Chirp (MHz)	PW (us)	Pulse 1 Pri (us)	Pulse 2 Pri (us)	Pulse 3 Pri (us)	Start Loc (us)	Start Burst Interval (us)	End Burst Interval (us)
1	413697	1	17	100	1627	0	0	413697	0	749999
2	665435	1	12	50	1391	0	0	1080759	750000	1499999
3	644293	1	5	75	1689	0	0	1726443	1500000	2249999
4	564481	3	11	90	1691	1181	1260	2292613	2250000	2999999
5	904885	2	18	60	1406	1617	0	3201630	3000000	3749999
6	784751	3	20	95	1111	1089	1469	3989404	3750000	4499999
7	1187422	3	17	80	1179	1579	1730	5180495	4500000	5249999
8	356398	2	5	70	1407	1972	0	5541371	5250000	5999999
9	772471	1	6	65	1605	0	0	6317221	6000000	6749999
10	627416	1	16	75	1350	0	0	6946242	6750000	7499999
11	578674	3	20	90	1363	1606	1971	7526266	7500000	8249999
12	1057715	1	9	95	1638	0	0	8588921	8250000	8999999
13	580973	3	18	100	1005	1914	1102	9171532	9000000	9749999
14	817144	2	19	70	1938	1030	0	9992697	9750000	10499999
15	1206469	3	8	100	1946	1455	1578	11202134	10500000	11249999
16	314975	2	14	55	1539	1278	0	11522088	11250000	11999999

Total number of pulses in waveform = 32

Type 5 Radar Waveform_4

Waveform Num = 4
Num of Bursts = 11
Burst Interval (us)= 1090909

Burst #	Off Time (us)	# Pulses	Chirp (MHz)	PW (us)	Pulse 1 Pri (us)	Pulse 2 Pri (us)	Pulse 3 Pri (us)	Start Loc (us)	Start Burst Interval (us)	End Burst Interval (us)
1	684360	1	8	75	1856	0	0	684360	0	1090908
2	1176067	3	11	100	1167	1719	1816	1862283	1090909	2181817
3	405340	1	10	60	1436	0	0	2272325	2181818	3272726
4	1569769	2	9	65	1014	1287	0	3843530	3272727	4363635
5	603905	1	9	100	1202	0	0	4449736	4363636	5454544
6	1320672	2	8	75	1489	1541	0	5771610	5454545	6545453
7	1789051	2	19	70	1922	1265	0	7563691	6545454	7636362
8	977663	2	5	50	1523	1858	0	8544541	7636363	8727271
9	537211	1	19	60	1478	0	0	9085133	8727272	9818180
10	1378784	1	13	70	1258	0	0	10465395	9818181	10909089
11	1186551	2	11	85	1422	1201	0	11653204	10909090	11999998

Total number of pulses in waveform = 13



Type 5 Radar Waveform_5

Waveform Num = 5
 Num of Bursts = 20
 Burst Interval (us) = 800000

Burst #	Off Time (us)	# Pulses	Chirp (MHz)	PW (us)	Pulse 1 Pri (us)	Pulse 2 Pri (us)	Pulse 3 Pri (us)	Start Loc (us)	Start Burst Interval (us)	End Burst Interval (us)
1	19741	1	19	95	1744	0	0	19741	0	599999
2	639175	2	16	95	1233	1207	0	660660	600000	1199999
3	1066796	1	8	100	1679	0	0	1728896	1200000	1799999
4	554364	3	15	100	1699	1162	1986	2285939	1800000	2399999
5	331260	2	17	60	1834	1366	0	2622046	2400000	2999999
6	593366	1	20	100	1617	0	0	3218632	3000000	3599999
7	426033	1	15	95	1243	0	0	3646282	3600000	4199999
8	965182	3	17	65	1666	1089	1543	4612707	4200000	4799999
9	599109	2	17	95	1675	1726	0	5216114	4800000	5399999
10	297062	3	19	60	1850	1292	1102	5516577	5400000	5999999
11	752307	2	6	60	1114	1972	0	6273128	6000000	6599999
12	579542	2	16	55	1165	1880	0	6855756	6600000	7199999
13	343512	3	14	90	1271	1147	1737	7202313	7200000	7799999
14	984143	1	15	60	1067	0	0	8190511	7800000	8399999
15	413224	2	5	75	1839	1987	0	8604902	8400000	8999999
16	582278	2	20	85	1267	1327	0	9191006	9000000	9599999
17	940345	1	10	90	1245	0	0	10133945	9600000	10199999
18	227731	1	7	50	1536	0	0	10362921	10200000	10799999
19	932508	1	16	100	1843	0	0	11296965	10800000	11399999
20	383971	1	15	65	1245	0	0	11682779	11400000	11999999

Total number of pulses in waveform = 35

Type 5 Radar Waveform_6

Waveform Num = 6
 Num of Bursts = 11
 Burst Interval (us) = 1090909

Burst #	Off Time (us)	# Pulses	Chirp (MHz)	PW (us)	Pulse 1 Pri (us)	Pulse 2 Pri (us)	Pulse 3 Pri (us)	Start Loc (us)	Start Burst Interval (us)	End Burst Interval (us)
1	217208	3	17	50	1941	1556	1707	217208	0	1090908
2	1927659	1	18	100	1986	0	0	2150071	1090909	2181817
3	390235	2	14	50	1964	1709	0	2542292	2181818	3272726
4	1014578	3	11	90	1920	1865	1171	3560543	3272727	4363635
5	1551961	2	13	100	1616	1618	0	5117460	4363636	5454544
6	722929	2	18	70	1166	1995	0	5843623	5454545	6545453
7	1021057	2	16	70	1792	1211	0	6867841	6545454	7636362
8	1260205	1	12	70	1116	0	0	8131049	7636363	8727271
9	817349	3	11	80	1024	1091	1737	8949514	8727272	9818180
10	1642958	3	14	70	1399	1188	1599	10596324	9818181	10909089
11	1369693	1	7	60	1152	0	0	11970203	10909090	11999998

Total number of pulses in waveform = 23

Type 5 Radar Waveform_7

Waveform Num = 7
 Num of Bursts = 17
 Burst Interval (us) = 705882

Burst #	Off Time (us)	# Pulses	Chirp (MHz)	PW (us)	Pulse 1 Pri (us)	Pulse 2 Pri (us)	Pulse 3 Pri (us)	Start Loc (us)	Start Burst Interval (us)	End Burst Interval (us)
1	606568	1	18	80	1084	0	0	606568	0	705881
2	753598	3	19	90	1386	1912	1999	1361250	705882	1411763
3	445568	3	5	65	1161	1831	1065	1812115	1411764	2117645
4	786346	2	8	95	1584	1729	0	2602518	2117646	2823527
5	873752	1	19	100	1586	0	0	3479583	2823528	3529409
6	665657	2	20	95	1504	1870	0	4146826	3529410	4235291
7	213456	3	5	90	1772	1356	1927	4363656	4235292	4941173
8	1082449	3	16	75	1337	1627	1022	5451180	4941174	5647055
9	769695	3	18	60	1973	1788	1401	6224841	5647056	6352937
10	215479	2	18	55	1200	1544	0	6445482	6352938	7058819
11	1001823	3	12	75	1194	1657	1381	7450049	7058820	7764701
12	980352	3	11	90	1805	1027	1728	8434633	7764702	8470583
13	618335	3	17	55	1434	1978	1666	9057528	8470584	9176465
14	245363	1	19	95	1747	0	0	9307969	9176466	9882347
15	611040	1	9	100	1264	0	0	9920756	9882348	10588229
16	717463	2	20	75	1358	1389	0	10639483	10688230	11294111
17	801891	1	10	75	1753	0	0	11444121	11294112	11999993

Total number of pulses in waveform = 37



Type 5 Radar Waveform_8

Waveform Num = 8
Num of Bursts = 8
Burst Interval (us)= 1500000

Burst #	Off Time (us)	# Pulses	Chirp (MHz)	PW (us)	Pulse 1 Pri(us)	Pulse 2 Pri(us)	Pulse 3 Pri(us)	Start Loc (us)	Start Burst Interval (us)	End Burst Interval (us)
1	1209854	1	13	50	1797	0	0	1209854	0	1499999
2	851180	3	20	65	1613	1585	1915	2062831	1500000	2999999
3	1358538	1	11	50	1586	0	0	3426482	3000000	4499999
4	2502574	2	16	80	1053	1043	0	5930642	4500000	5999999
5	917863	3	7	55	1468	1905	1924	6850601	6000000	7499999
6	1765791	2	12	95	1190	1528	0	8621689	7500000	8999999
7	479122	3	6	90	1588	1162	1735	9103529	9000000	10499999
8	2609102	1	10	70	1041	0	0	11717116	10500000	11999999

Total number of pulses in waveform = 16

Type 5 Radar Waveform_9

Waveform Num = 9
Num of Bursts = 20
Burst Interval (us)= 600000

Burst #	Off Time (us)	# Pulses	Chirp (MHz)	PW (us)	Pulse 1 Pri(us)	Pulse 2 Pri(us)	Pulse 3 Pri(us)	Start Loc (us)	Start Burst Interval (us)	End Burst Interval (us)
1	408762	2	17	55	1216	1666	0	408762	0	599999
2	285294	3	17	55	1630	1083	1839	696938	600000	1199999
3	604093	2	12	55	1614	1853	0	1305583	1200000	1799999
4	849071	3	9	60	1616	1392	1792	2158121	1800000	2399999
5	782327	2	6	60	1101	1906	0	2945248	2400000	2999999
6	89804	3	17	55	1731	1666	0	3038059	3000000	3699999
7	1152724	2	5	70	1481	1931	1094	4194180	3600000	4199999
8	407054	1	18	85	1787	0	0	4605740	4200000	4799999
9	202335	2	11	100	1028	1080	0	4809862	4800000	5399999
10	1010185	3	13	65	1327	1194	1019	5822155	5400000	5999999
11	195192	3	17	50	1522	1366	1551	6020887	6000000	6699999
12	1045050	3	5	70	1287	1162	1448	7070376	6600000	7199999
13	599820	2	9	55	1421	1373	0	7674093	7200000	7799999
14	329630	2	20	65	1535	1923	0	8006517	7800000	8399999
15	767991	2	7	70	1006	1647	0	8777966	8400000	8999999
16	280923	2	15	85	1797	1529	0	9061542	9000000	9699999
17	657640	1	14	90	1420	0	0	9722508	9600000	10199999
18	1033977	1	9	65	1462	0	0	10757905	10200000	10799999
19	58554	2	17	55	1096	1091	0	10817921	10800000	11399999
20	1019049	2	5	50	1513	1661	0	11839157	11400000	11999999

Total number of pulses in waveform = 43

Type 5 Radar Waveform_10

Waveform Num = 10
Num of Bursts = 8
Burst Interval (us)= 1500000

Burst #	Off Time (us)	# Pulses	Chirp (MHz)	PW (us)	Pulse 1 Pri(us)	Pulse 2 Pri(us)	Pulse 3 Pri(us)	Start Loc (us)	Start Burst Interval (us)	End Burst Interval (us)
1	1037520	2	14	95	1415	1826	0	1037520	0	1499999
2	1428404	1	19	50	1319	0	0	2469165	1500000	2999999
3	648942	1	18	90	1208	0	0	3119426	3000000	4499999
4	2081144	2	19	100	1623	1051	0	5201778	4500000	5999999
5	1679616	2	5	65	1264	1464	0	6884068	6000000	7499999
6	1238077	3	16	55	1592	1322	1876	8124873	7500000	8999999
7	1141963	3	8	60	1536	1454	1895	9271626	9000000	10499999
8	1566446	3	13	50	1748	1590	1734	10842957	10500000	11999999

Total number of pulses in waveform = 17



Type 5 Radar Waveform_11

```

|
Waveform Num = 11
Num of Bursts = 16
Burst Interval (us)= 750000

```

Burst #	Off Time (us)	# Pulses	Chirp (MHz)	PW (us)	Pulse 1 Pri (us)	Pulse 2 Pri (us)	Pulse 3 Pri (us)	Start Loc (us)	Start Burst Interval (us)	End Burst Interval (us)
1	463937	1	13	80	1029	0	0	463937	0	749999
2	422488	2	16	80	1962	1476	0	887454	750000	1499999
3	1309996	2	16	70	1245	1904	0	2200888	1500000	2249999
4	154712	2	17	60	1239	1691	0	2358749	2250000	2999999
5	923513	2	13	90	1348	1800	0	3285192	3000000	3749999
6	1201210	2	11	50	1607	1123	0	4489550	3750000	4499999
7	754598	1	19	100	1337	0	0	5246878	4500000	5249999
8	674081	1	12	70	1350	0	0	5922296	5250000	5999999
9	249419	2	6	70	1153	1430	0	6173065	6000000	6749999
10	906557	1	5	70	1136	0	0	7082205	6750000	7499999
11	550056	1	16	95	1167	0	0	7633397	7500000	8249999
12	1203469	2	17	80	1833	1653	0	8838033	8250000	8999999
13	752176	3	5	60	1642	1585	1783	9593695	9000000	9749999
14	260922	3	13	70	1839	1188	1455	9859627	9750000	10499999
15	722936	1	8	85	1839	0	0	10587045	10500000	11249999
16	968902	1	11	100	1387	0	0	11557786	11250000	11999999

Total number of pulses in waveform = 27

Type 5 Radar Waveform_12

```

|
Waveform Num = 12
Num of Bursts = 17
Burst Interval (us)= 705882

```

Burst #	Off Time (us)	# Pulses	Chirp (MHz)	PW (us)	Pulse 1 Pri (us)	Pulse 2 Pri (us)	Pulse 3 Pri (us)	Start Loc (us)	Start Burst Interval (us)	End Burst Interval (us)
1	221369	3	14	80	1363	1371	1756	221369	0	705881
2	1173947	3	18	55	1880	1265	1563	1399806	705882	1411763
3	576412	3	18	50	1208	1510	1195	1980926	1411764	2117645
4	165313	2	6	55	1266	1833	0	2150152	2117646	2823527
5	916125	3	12	50	1984	1634	1658	3069376	2823528	3529409
6	1117119	3	12	75	1193	1888	1314	4191771	3529410	4235291
7	201864	1	18	65	1488	0	0	4398030	4235292	4941173
8	1120295	3	10	50	1455	1498	1042	5519813	4941174	5647055
9	480788	3	8	85	1720	1210	1705	6004596	5647056	6352937
10	482251	2	7	80	1495	1726	0	6491482	6352938	7058819
11	1211913	1	20	85	1561	0	0	7706616	7058820	7764701
12	585466	3	15	60	1142	1731	1403	8293643	7764702	8470583
13	594316	2	18	65	1503	1334	0	8892235	8470584	9176465
14	303027	3	6	100	1657	1080	1115	9198099	9176466	9882347
15	1178373	2	10	50	1311	1468	0	10380324	9882348	10688229
16	691968	2	9	75	1991	1765	0	11075061	10688230	11294111
17	453704	2	13	55	1469	1250	0	11532521	11294112	11999993

Total number of pulses in waveform = 41

Type 5 Radar Waveform_13

```

|
Waveform Num = 13
Num of Bursts = 11
Burst Interval (us)= 1090909

```

Burst #	Off Time (us)	# Pulses	Chirp (MHz)	PW (us)	Pulse 1 Pri (us)	Pulse 2 Pri (us)	Pulse 3 Pri (us)	Start Loc (us)	Start Burst Interval (us)	End Burst Interval (us)
1	590704	3	11	60	1128	1327	1012	590704	0	1090908
2	1115214	3	5	65	1708	1421	1546	1709385	1090909	2181817
3	1292319	3	8	95	1894	1095	1387	3006379	2181818	3272726
4	1073575	1	7	70	1366	0	0	4084330	3272727	4363635
5	891262	1	12	55	1513	0	0	4976959	4363636	5454544
6	762428	3	5	90	1481	1475	1766	5740899	5454545	6545453
7	1849498	1	9	75	1509	0	0	7595119	6545454	7636362
8	129884	1	19	90	1908	0	0	7726512	7636363	8727271
9	1891536	1	20	65	1568	0	0	9619956	8727272	9818180
10	1016364	1	14	95	1812	0	0	10637888	9818181	10909089
11	1069236	3	17	100	1147	1652	1516	11708936	10909090	11999998

Total number of pulses in waveform = 21



Type 5 Radar Waveform_14

Waveform Num = 14
Num of Bursts = 12
Burst Interval (us)= 1000000

Burst #	Off Time (us)	# Pulses	Chirp (MHz)	PW (us)	Pulse 1 Pri (us)	Pulse 2 Pri (us)	Pulse 3 Pri (us)	Start Loc (us)	Start Burst Interval (us)	End Burst Interval (us)
1	547941	2	12	95	1580	1081	0	547941	0	999999
2	838076	1	12	75	1041	0	0	1388673	1000000	1999999
3	700154	3	5	55	1261	1923	1435	2089873	2000000	2999999
4	1317652	2	11	85	1497	1415	0	3412144	3000000	3999999
5	606059	2	7	100	1172	1197	0	4021115	4000000	4999999
6	1495553	3	20	80	1245	1537	1702	5519037	5000000	5999999
7	1075955	3	15	60	1495	1145	1120	6599476	6000000	6999999
8	504106	2	6	90	1413	1863	0	7107342	7000000	7999999
9	1064372	2	20	100	1728	1109	0	8174990	8000000	8999999
10	943035	3	9	95	1914	1468	1727	9120862	9000000	9999999
11	1362489	2	14	55	1187	1064	0	10488460	10000000	10999999
12	573745	3	10	75	1269	1057	1675	11064456	11000000	11999999

Total number of pulses in waveform = 28

Type 5 Radar Waveform_15

Waveform Num = 15
Num of Bursts = 10
Burst Interval (us)= 1200000

Burst #	Off Time (us)	# Pulses	Chirp (MHz)	PW (us)	Pulse 1 Pri (us)	Pulse 2 Pri (us)	Pulse 3 Pri (us)	Start Loc (us)	Start Burst Interval (us)	End Burst Interval (us)
1	193439	1	19	85	1152	0	0	193439	0	1199999
2	1145980	2	6	85	1394	1619	0	1340571	1200000	2399999
3	1372081	2	8	65	1719	1670	0	2715665	2400000	3599999
4	1464955	1	5	75	1789	0	0	4184009	3600000	4799999
5	871107	1	13	50	1175	0	0	5056905	4800000	5999999
6	1356410	3	19	80	1944	1712	1990	6414490	6000000	7199999
7	1003678	3	18	95	1204	1456	1994	7423814	7200000	8399999
8	2117619	1	20	50	1891	0	0	9546087	8400000	9599999
9	892930	3	7	90	1615	1571	1361	10440908	9600000	10799999
10	1203032	2	20	75	1407	1001	0	11648487	10800000	11999999

Total number of pulses in waveform = 19

Type 5 Radar Waveform_16

Waveform Num = 16
Num of Bursts = 10
Burst Interval (us)= 1200000

Burst #	Off Time (us)	# Pulses	Chirp (MHz)	PW (us)	Pulse 1 Pri (us)	Pulse 2 Pri (us)	Pulse 3 Pri (us)	Start Loc (us)	Start Burst Interval (us)	End Burst Interval (us)
1	319345	2	7	95	1708	1676	0	319345	0	1199999
2	925656	1	17	90	1750	0	0	1248385	1200000	2399999
3	1375445	2	11	75	1782	1881	0	2625580	2400000	3599999
4	1241632	2	15	95	1099	1626	0	3870875	3600000	4799999
5	1544387	1	5	100	1456	0	0	5417987	4800000	5999999
6	943361	1	8	75	1559	0	0	6362304	6000000	7199999
7	2025392	2	10	85	1758	1344	0	8389755	7200000	8399999
8	819943	1	13	70	1651	0	0	9212800	8400000	9599999
9	490825	1	7	80	1785	0	0	9705276	9600000	10799999
10	1967131	3	16	50	1013	1332	1767	11674192	10800000	11999999

Total number of pulses in waveform = 16



Type 5 Radar Waveform_17

Waveform Num = 17
Num of Bursts = 14
Burst Interval (us)= 857143

Burst #	Off Time (us)	# Pulses	Chirp (MHz)	PW (us)	Pulse 1 Pri (us)	Pulse 2 Pri (us)	Pulse 3 Pri (us)	Start Loc (us)	Start Burst Interval (us)	End Burst Interval (us)
1	423662	2	17	95	1949	1725	0	423662	0	857142
2	1254398	1	6	95	1350	0	0	1681734	857143	1714285
3	545877	2	16	85	1877	1574	0	2228991	1714286	2571428
4	585002	2	6	85	1357	1053	0	2817444	2571429	3428571
5	1182577	1	5	5	1938	0	0	4002431	3428572	4285714
6	490334	1	12	70	1117	0	0	4494703	4285715	5142857
7	1448720	2	16	75	1941	1570	0	5944540	5142858	6000000
8	268608	3	13	90	1557	1164	1691	6216659	6000001	6857143
9	1076044	2	9	50	1167	1038	0	7297115	6857144	7714286
10	1013146	3	8	95	1752	1363	1683	8312466	7714287	8571429
11	909523	2	5	65	1451	1519	0	9226787	8571430	9428572
12	941948	3	13	65	1350	1309	1809	10171705	9428573	10285715
13	556843	3	8	75	1979	1319	1153	10733016	10285716	11142858
14	830429	2	10	90	1980	1647	0	11567896	11142859	12000001

Total number of pulses in waveform = 29

Type 5 Radar Waveform_18

Waveform Num = 18
Num of Bursts = 20
Burst Interval (us)= 600000

Burst #	Off Time (us)	# Pulses	Chirp (MHz)	PW (us)	Pulse 1 Pri (us)	Pulse 2 Pri (us)	Pulse 3 Pri (us)	Start Loc (us)	Start Burst Interval (us)	End Burst Interval (us)
1	32401	1	12	60	1929	0	0	32401	0	599999
2	628774	1	17	85	1470	0	0	663104	600000	1199999
3	635008	1	16	85	1008	0	0	1299642	1200000	1799999
4	1073440	1	13	85	1543	0	0	2374090	1800000	2399999
5	326940	2	13	75	1875	1605	0	2702573	2400000	2999999
6	405738	2	18	80	1590	1647	0	3111791	3000000	3599999
7	544965	3	14	100	1372	1215	1108	3659993	3600000	4199999
8	692987	1	15	75	1998	0	0	4356675	4200000	4799999
9	997830	1	17	70	1025	0	0	5356503	4800000	5399999
10	317271	3	18	55	1548	1339	1728	5674799	5400000	5999999
11	472609	3	19	85	1121	1816	1265	6152023	6000000	6599999
12	923334	2	17	90	1858	1425	0	7079559	6600000	7199999
13	397823	1	17	55	1381	0	0	7480665	7200000	7799999
14	729077	3	16	100	1086	1202	1384	8211123	7800000	8399999
15	392023	3	17	90	1612	1941	1944	8606818	8400000	8999999
16	710679	3	12	80	1654	1651	1465	9322594	9000000	9599999
17	861221	3	9	70	1753	1741	1851	10188585	9600000	10199999
18	583152	1	10	60	1289	0	0	10777082	10200000	10799999
19	459162	3	12	95	1809	1535	1326	11237533	10800000	11399999
20	412077	1	11	85	1071	0	0	11654280	11400000	11999999

Total number of pulses in waveform = 39

Type 5 Radar Waveform_19

Waveform Num = 19
Num of Bursts = 13
Burst Interval (us)= 923077

Burst #	Off Time (us)	# Pulses	Chirp (MHz)	PW (us)	Pulse 1 Pri (us)	Pulse 2 Pri (us)	Pulse 3 Pri (us)	Start Loc (us)	Start Burst Interval (us)	End Burst Interval (us)
1	716105	2	15	65	1108	1751	0	716105	0	923076
2	847604	3	17	65	1828	1842	1132	1566568	923077	1846153
3	377938	2	8	65	1374	1744	0	1949308	1846154	2769230
4	1272965	3	20	80	1982	1143	1119	3225391	2769231	3692307
5	895050	2	18	75	1950	1144	0	4124685	3692308	4615384
6	1313982	1	14	85	1703	0	0	5441761	4615385	5538461
7	537927	2	18	65	1994	1336	0	5981391	5538462	6461538
8	992194	3	12	80	1843	1109	1076	6976915	6461539	7384615
9	1075194	3	17	50	1118	1920	1802	8056137	7384616	8307692
10	956964	3	12	85	1559	1031	1471	9017941	8307693	9230769
11	257567	2	11	80	1992	1212	0	9279569	9230770	10153846
12	1099750	3	7	70	1982	1961	1028	10382523	10153847	11076923
13	1602805	1	12	60	1991	0	0	11990299	11076924	12000000

Total number of pulses in waveform = 30



Type 5 Radar Waveform_20

Waveform Num = 20
Num of Bursts = 15
Burst Interval (us)= 750000

Burst #	Off Time (us)	# Pulses	Chirp (MHz)	PW (us)	Pulse 1 Pri (us)	Pulse 2 Pri (us)	Pulse 3 Pri (us)	Start Loc (us)	Start Burst Interval (us)	End Burst Interval (us)
1	399940	1	16	70	1530	0	0	399940	0	749999
2	1041733	3	15	100	1899	1824	1725	1443203	750000	1499999
3	229558	3	10	55	1163	1835	1083	1678209	1500000	2249999
4	732404	1	7	85	1857	0	0	2414694	2250000	2999999
5	661062	2	13	65	1119	1190	0	3077613	3000000	3749999
6	674610	3	20	60	1596	1021	1697	3754532	3750000	4499999
7	1095960	2	10	80	1617	1788	0	4854806	4500000	5249999
8	1125679	3	6	50	1114	1112	1429	5983890	5250000	5999999
9	594655	2	11	85	1423	1976	0	6582200	6000000	6749999
10	338789	1	5	50	1241	0	0	6924388	6750000	7499999
11	640310	3	11	90	1902	1248	1644	7565939	7500000	8249999
12	1209732	1	16	90	1548	0	0	8780465	8250000	8999999
13	533520	3	6	60	1644	1250	1712	9315533	9000000	9749999
14	658058	1	15	85	1113	0	0	9978197	9750000	10499999
15	1023822	3	20	50	1944	1206	1026	11003132	10500000	11249999
16	750534	2	16	75	1803	1110	0	11757842	11250000	11999999

Total number of pulses in waveform = 34

Type 5 Radar Waveform_21

Waveform Num = 21
Num of Bursts = 12
Burst Interval (us)= 1000000

Burst #	Off Time (us)	# Pulses	Chirp (MHz)	PW (us)	Pulse 1 Pri (us)	Pulse 2 Pri (us)	Pulse 3 Pri (us)	Start Loc (us)	Start Burst Interval (us)	End Burst Interval (us)
1	504053	3	9	60	1659	1838	1671	504053	0	999999
2	1192417	3	5	75	1024	1515	1631	1701638	1000000	1999999
3	470160	2	20	75	1566	1540	0	2175968	2000000	2999999
4	1492364	2	19	50	1734	1267	0	3671438	3000000	3999999
5	414644	3	16	90	1916	1964	1239	4089083	4000000	4999999
6	1719337	3	18	55	1024	1487	1926	5813539	5000000	5999999
7	1005794	2	17	80	1709	1654	0	6823770	6000000	6999999
8	602952	3	12	95	1828	1715	1763	7430085	7000000	7999999
9	609575	1	7	65	1530	0	0	8044966	8000000	8999999
10	1406300	1	19	100	1270	0	0	9452796	9000000	9999999
11	1228144	1	13	70	1916	0	0	10682210	10000000	10999999
12	953619	1	19	95	1782	0	0	11637745	11000000	11999999

Total number of pulses in waveform = 25

Type 5 Radar Waveform_22

Waveform Num = 22
Num of Bursts = 16
Burst Interval (us)= 750000

Burst #	Off Time (us)	# Pulses	Chirp (MHz)	PW (us)	Pulse 1 Pri (us)	Pulse 2 Pri (us)	Pulse 3 Pri (us)	Start Loc (us)	Start Burst Interval (us)	End Burst Interval (us)
1	721697	3	18	90	1805	1662	1044	721697	0	749999
2	386735	1	6	70	1057	0	0	1112943	750000	1499999
3	941633	2	13	85	1891	1708	0	2055633	1500000	2249999
4	747999	1	17	100	1673	0	0	2807231	2250000	2999999
5	888300	3	20	95	1165	1506	1544	3697204	3000000	3749999
6	255469	1	10	80	1383	0	0	3956888	3750000	4499999
7	826802	1	19	70	1179	0	0	4785073	4500000	5249999
8	798532	3	13	95	1692	1516	1433	5884784	5250000	5999999
9	698884	1	13	60	1010	0	0	6288309	6000000	6749999
10	1000290	1	18	90	1139	0	0	7289609	6750000	7499999
11	407429	3	11	100	1689	1642	1640	7698177	7500000	8249999
12	854611	3	18	65	1939	1373	1570	8557759	8250000	8999999
13	754107	3	12	95	1426	1631	1441	9316748	9000000	9749999
14	669605	1	5	80	1242	0	0	9990851	9750000	10499999
15	644827	1	14	85	1032	0	0	10636920	10500000	11249999
16	1281578	2	9	95	1049	1402	0	11919530	11250000	11999999

Total number of pulses in waveform = 30



Type 5 Radar Waveform_23

Waveform Num = 23
Num of Bursts = 18
Burst Interval (us) = 666667

Burst #	Off Time (us)	# Pulses	Chirp (MHz)	PW (us)	Pulse 1 Pri (us)	Pulse 2 Pri (us)	Pulse 3 Pri (us)	Start Loc (us)	Start Burst Interval (us)	End Burst Interval (us)
1	273996	3	7	75	1025	1858	1186	273996	0	666666
2	571519	1	12	85	1938	0	0	849584	666667	1333333
3	985022	2	10	90	1765	1112	0	1836544	1333334	2000000
4	648793	2	12	65	1280	1453	0	2629995	2000001	2666667
5	70798	2	15	60	1263	1795	0	3281521	2666668	3333334
6	1172774	1	6	100	1955	0	0	3355377	3333335	4000001
7	384630	1	19	85	1870	0	0	4530105	4000002	4666668
8	612349	3	5	65	1951	1768	1912	4916605	4666669	5333335
9	657008	1	7	70	1156	0	0	5534586	5333336	6000002
10	999557	3	11	85	1613	1838	1279	6192750	6000003	6666669
11	159196	1	19	100	1917	0	0	7197037	6666670	7333336
12	1212797	3	6	100	1391	1892	1699	7368150	7333337	8000003
13	720902	3	20	95	1371	1057	1947	8575929	8000004	8666670
14	385694	1	16	60	1120	0	0	9301206	8666671	9333337
15	874338	1	16	50	1515	0	0	9688020	9333338	10000004
16	583907	2	16	55	1925	1816	0	10563873	10000005	10666671
17	328331	1	8	100	1005	0	0	11151521	10666672	11333338
18	159196	2	11	60	1823	1960	0	11480657	11333339	12000005

Total number of pulses in waveform = 33

Type 5 Radar Waveform_24

Waveform Num = 24
Num of Bursts = 14
Burst Interval (us) = 857143

Burst #	Off Time (us)	# Pulses	Chirp (MHz)	PW (us)	Pulse 1 Pri (us)	Pulse 2 Pri (us)	Pulse 3 Pri (us)	Start Loc (us)	Start Burst Interval (us)	End Burst Interval (us)
1	561948	1	18	100	1982	0	0	561948	0	857142
2	361459	3	12	65	1961	1237	1058	925389	857143	1714285
3	1018883	1	20	60	1510	0	0	1948528	1714286	2571428
4	1440370	1	19	85	1458	0	0	3390408	2571429	3428571
5	230674	1	15	50	1682	0	0	3622540	3428572	4285714
6	1476753	1	17	95	1181	0	0	5100975	4285715	5142857
7	760955	1	19	85	1592	0	0	5863111	5142858	6000000
8	982224	1	11	100	1620	0	0	6846927	6000001	6857143
9	589329	2	20	100	1984	1213	0	7437876	6857144	7714286
10	395118	2	10	60	1892	1421	0	7836191	7714287	8571429
11	993855	1	14	60	1135	0	0	8833359	8571430	9428572
12	678830	2	11	55	1984	1760	0	9513324	9428573	10285715
13	1505168	1	15	100	1058	0	0	11022236	10285716	11142858
14	659668	1	11	95	1339	0	0	11682962	11142859	12000001

Total number of pulses in waveform = 19

Type 5 Radar Waveform_25

Waveform Num = 25
Num of Bursts = 18
Burst Interval (us) = 666667

Burst #	Off Time (us)	# Pulses	Chirp (MHz)	PW (us)	Pulse 1 Pri (us)	Pulse 2 Pri (us)	Pulse 3 Pri (us)	Start Loc (us)	Start Burst Interval (us)	End Burst Interval (us)
1	320664	1	17	90	1124	0	0	320664	0	666666
2	869652	2	16	100	1763	1704	0	1191440	666667	1333333
3	686106	1	12	50	1728	0	0	1881013	1333334	2000000
4	710808	3	8	65	1061	1134	1088	2593549	2000001	2666667
5	584154	3	9	100	1743	1175	1265	3180686	2666668	3333334
6	209451	1	5	55	1823	0	0	3394620	3333335	4000001
7	706594	3	13	85	1200	1079	1470	4103037	4000002	4666668
8	1154850	3	14	100	1050	1642	1264	5261636	4666669	5333335
9	621420	2	16	80	1405	1692	0	5887012	5333336	6000002
10	167737	3	9	85	1489	1214	1321	6057846	6000003	6666669
11	1184618	3	12	100	1048	1136	1568	7246488	6666670	7333336
12	226627	1	9	90	1724	0	0	7476867	7333337	8000003
13	1123488	1	20	85	1359	0	0	8602079	8000004	8666670
14	670588	3	15	100	1460	1357	1218	9274026	8666671	9333337
15	544801	1	18	60	1656	0	0	9822862	9333338	10000004
16	651900	3	11	80	1029	1091	1441	10476418	10000005	10666671
17	533841	1	17	100	1537	0	0	11013820	10666672	11333338
18	851963	1	11	55	1003	0	0	11867320	11333339	12000005

Total number of pulses in waveform = 36



Type 5 Radar Waveform_26

```

|
Waveform Num = 26
Num of Bursts = 17
Burst Interval (us) = 705882

```

Burst #	Off Time (us)	# Pulses	Chirp (MHz)	PW (us)	Pulse 1 Pri (us)	Pulse 2 Pri (us)	Pulse 3 Pri (us)	Start Loc (us)	Start Burst Interval (us)	End Burst Interval (us)
1	678934	3	19	60	1951	1633	1025	678934	0	705881
2	252950	2	19	95	1684	1201	0	936493	705882	1411763
3	738207	1	17	70	1317	0	0	1677585	1411764	2117645
4	1087433	2	7	55	1043	1366	0	2766335	2117646	2823527
5	329250	2	15	90	1585	1371	0	3097994	2823528	3529409
6	996688	2	15	55	1168	1322	0	4097638	3529410	4235291
7	569518	2	11	60	1331	1506	0	4669646	4235292	4941173
8	395272	3	10	65	1720	1941	1883	5067755	4941174	5647055
9	983759	1	10	65	1110	0	0	6057058	5647056	6352937
10	355804	2	8	100	1762	1966	0	6423972	6352938	7058819
11	812965	2	14	55	1705	1420	0	7240655	7058820	7764701
12	1081152	1	13	95	1142	0	0	8324943	7764702	8470583
13	808068	2	13	60	1609	1711	0	9134153	8470584	9176465
14	282364	3	19	50	1078	1973	1026	9419837	9176466	9882347
15	716158	3	5	95	1027	1132	1585	10140072	9882348	10588229
16	564663	1	15	70	1254	0	0	10708479	10588230	11294111
17	807171	2	18	100	1030	1298	0	11516904	11294112	11999993

Total number of pulses in waveform = 34

Type 5 Radar Waveform_27

```

|
Waveform Num = 27
Num of Bursts = 18
Burst Interval (us) = 666667

```

Burst #	Off Time (us)	# Pulses	Chirp (MHz)	PW (us)	Pulse 1 Pri (us)	Pulse 2 Pri (us)	Pulse 3 Pri (us)	Start Loc (us)	Start Burst Interval (us)	End Burst Interval (us)
1	508083	2	16	80	1963	1645	0	508083	0	666666
2	556166	2	7	90	1046	1757	0	1067757	666667	1333333
3	374470	3	18	100	1569	1648	1438	1445030	1333334	2000000
4	871040	1	14	60	1300	0	0	2320725	2000001	2666667
5	507308	2	7	80	1627	1885	0	2829333	2666668	3333334
6	1112542	3	19	70	1699	1921	1258	3945387	3333335	4000001
7	419695	3	14	60	1286	1529	1374	4369960	4000002	4666668
8	523711	2	20	95	1216	1692	0	4897860	4666669	5333335
9	675085	1	5	85	1215	0	0	5575853	5333336	6000002
10	857705	1	14	85	1592	0	0	6434773	6000003	6666669
11	795767	1	9	90	1984	0	0	7232132	6666670	7333336
12	630355	2	6	60	1243	1316	0	7864471	7333337	8000003
13	592988	3	16	70	1107	1416	1792	8460016	8000004	8666670
14	280747	1	5	70	1457	0	0	8745078	8666671	9333337
15	648926	1	8	65	1447	0	0	9395461	9333338	10000004
16	633422	2	13	50	1600	1625	0	10030330	10000005	10666671
17	761036	2	12	60	1861	1688	0	10794591	10666672	11333338
18	807207	2	13	50	1128	1662	0	11805347	11333339	12000005

Total number of pulses in waveform = 34

Type 5 Radar Waveform_28

```

|
Waveform Num = 28
Num of Bursts = 15
Burst Interval (us) = 800000

```

Burst #	Off Time (us)	# Pulses	Chirp (MHz)	PW (us)	Pulse 1 Pri (us)	Pulse 2 Pri (us)	Pulse 3 Pri (us)	Start Loc (us)	Start Burst Interval (us)	End Burst Interval (us)
1	26247	2	18	80	1400	1479	0	26247	0	799999
2	940710	3	16	70	1106	1645	1050	969836	800000	1599999
3	1057964	1	11	65	1165	0	0	2031601	1600000	2399999
4	630761	2	16	60	1456	1533	0	2663527	2400000	3199999
5	746664	1	5	95	1380	0	0	3413180	3200000	3999999
6	1134355	3	15	65	1748	1115	1776	4548915	4000000	4799999
7	814368	3	6	75	1714	1481	1441	5367922	4800000	5599999
8	937768	2	7	75	1439	1621	0	6310326	5600000	6399999
9	737072	1	9	100	1909	0	0	7050458	6400000	7199999
10	589427	2	6	65	1186	1608	0	7641794	7200000	7999999
11	462308	2	19	100	1613	1601	0	8106896	8000000	8799999
12	1059138	3	9	60	1603	1060	1843	9169248	8800000	9599999
13	898092	2	8	60	1355	1192	0	10071846	9600000	10399999
14	946044	3	7	90	1189	1998	1124	11020437	10400000	11199999
15	806985	2	17	90	1400	1414	0	11831733	11200000	11999999

Total number of pulses in waveform = 32



Type 5 Radar Waveform_29

Waveform Num = 29
Num of Bursts = 10
Burst Interval (us)= 1200000

Burst #	Off Time (us)	# Pulses	Chirp (MHz)	PW (us)	Pulse 1 Pri(us)	Pulse 2 Pri(us)	Pulse 3 Pri(us)	Start Loc (us)	Start Burst Interval(us)	End Burst Interval(us)
1	1154235	2	5	55	1253	1491	0	1154235	0	1199999
2	622494	1	6	70	1259	0	0	1779473	1200000	2399999
3	1308356	3	11	90	1649	1543	1914	3089088	2400000	3599999
4	1702123	2	16	50	1702	1918	0	4796317	3600000	4799999
5	516126	1	20	85	1338	0	0	5316063	4800000	5999999
6	854165	1	14	55	1982	0	0	6171566	6000000	7199999
7	1253814	2	15	65	1233	1087	0	7427362	7200000	8399999
8	1150511	2	9	95	1582	1550	0	8580193	8400000	9599999
9	1840132	1	18	95	1226	0	0	10423457	9600000	10799999
10	1200003	2	14	95	1831	1224	0	11624686	10800000	11999999

Total number of pulses in waveform = 17

Type 5 Radar Waveform_30

Waveform Num = 30
Num of Bursts = 14
Burst Interval (us)= 857143

Burst #	Off Time (us)	# Pulses	Chirp (MHz)	PW (us)	Pulse 1 Pri(us)	Pulse 2 Pri(us)	Pulse 3 Pri(us)	Start Loc (us)	Start Burst Interval(us)	End Burst Interval(us)
1	13795	1	8	95	1357	0	0	13795	0	857142
2	1640031	1	17	50	1741	0	0	1655183	857143	1714285
3	485399	3	18	65	1323	1039	1296	2142323	1714286	2571428
4	1241865	2	19	95	1882	1519	0	3387846	2571429	3428571
5	291757	2	10	90	1611	1597	0	3683004	3428572	4285714
6	900125	2	18	65	1044	1167	0	4586337	4285715	5142857
7	1389363	1	9	50	1482	0	0	5977911	5142858	6000000
8	347738	3	7	100	1261	1322	1538	6327131	6000001	6857143
9	1154186	1	10	60	1362	0	0	7485438	6857144	7714286
10	344071	1	11	80	1828	0	0	7830871	7714287	8571429
11	1188644	1	8	55	1497	0	0	9021343	8571430	9428572
12	1235390	3	11	55	1363	1283	1727	10258230	9428573	10285715
13	692731	3	14	90	1756	1753	1939	10955334	10285716	11142858
14	494331	1	12	100	1009	0	0	11455113	11142859	12000001

Total number of pulses in waveform = 25

Radar Type 6 - Radar Statistical Performance

Trail #	Test Freq. (MHz)	1=Detection 0=No Detection	Trail #	Test Freq. (MHz)	1=Detection 0=No Detection
1	5309	1	16	5309	1
2	5309	1	17	5309	1
3	5309	1	18	5309	1
4	5309	1	19	5309	1
5	5309	1	20	5309	1
6	5309	1	21	5309	1
7	5309	1	22	5309	1
8	5309	1	23	5309	1
9	5309	1	24	5309	1
10	5309	1	25	5309	1
11	5309	1	26	5309	1
12	5309	1	27	5309	1
13	5309	1	28	5309	1
14	5309	1	29	5309	1
15	5309	1	30	5309	1
Detection Percentage (%)					100%

Radar waveform #1			Radar waveform #2		
Hopping Number	Frequency (MHz)	Pulse Start (ms)	Hopping Number	Frequency (MHz)	Pulse Start (ms)
1	5327	3	7	5317	21
8	5317	24	10	5332	30
9	5336	27	22	5293	66
19	5285	57	24	5292	72
33	5316	99	29	5297	87
35	5294	105	30	5339	90
39	5305	117	35	5298	105
69	5326	207	43	5318	129
84	5335	252	47	5327	141
87	5339	261	50	5338	150
99	5325	297	54	5288	162
--	--	--	76	5289	228
--	--	--	99	5313	297

Radar waveform #3			Radar waveform #4		
Hopping Number	Frequency (MHz)	Pulse Start (ms)	Hopping Number	Frequency (MHz)	Pulse Start (ms)
9	5329	27	0	5306	0
20	5324	60	10	5313	30
23	5315	69	15	5329	45
36	5328	108	16	5308	48
38	5280	114	25	5335	75
41	5334	123	28	5296	84
53	5306	159	33	5315	99
71	5326	213	39	5318	117
77	5327	231	47	5312	141
82	5331	246	52	5283	156
84	5320	252	59	5334	177
85	5317	255	60	5300	180
96	5309	288	65	5317	195
--	--	--	72	5319	216
--	--	--	85	5281	255

Radar waveform #5			Radar waveform #6		
Hopping Number	Frequency (MHz)	Pulse Start (ms)	Hopping Number	Frequency (MHz)	Pulse Start (ms)
37	5316	111	2	5292	6
40	5301	120	9	5328	27
42	5280	126	12	5281	36
47	5299	141	21	5282	63
54	5302	162	33	5327	99
59	5294	177	39	5301	117
60	5285	180	42	5308	126
61	5339	183	58	5311	174
62	5310	186	66	5303	198
72	5284	216	72	5285	216
--	--	--	74	5287	222
--	--	--	85	5321	255
--	--	--	95	5330	285
--	--	--	96	5314	288

Radar waveform #7			Radar waveform #8		
Hopping Number	Frequency (MHz)	Pulse Start (ms)	Hopping Number	Frequency (MHz)	Pulse Start (ms)
1	5289	3	9	5324	27
8	5334	24	15	5338	45
13	5311	39	57	5305	171
18	5310	54	58	5316	174
23	5325	69	61	5280	183
24	5320	72	65	5294	195
38	5293	114	70	5309	210
39	5314	117	72	5310	216
68	5313	204	82	5314	246
72	5333	216	87	5291	261
74	5321	222	92	5281	276
91	5318	273	97	5303	291

Radar waveform #9			Radar waveform #10		
Hopping Number	Frequency (MHz)	Pulse Start (ms)	Hopping Number	Frequency (MHz)	Pulse Start (ms)
11	5333	33	0	5303	0
22	5316	66	10	5311	30
37	5303	111	13	5334	39
44	5313	132	29	5322	87
47	5285	141	32	5302	96
55	5337	165	35	5305	105
65	5306	195	41	5299	123
72	5290	216	42	5281	126
98	5312	294	51	5318	153
--	--	--	66	5283	198
--	--	--	74	5319	222
--	--	--	89	5284	267
--	--	--	98	5336	294

Radar waveform #11			Radar waveform #12		
Hopping Number	Frequency (MHz)	Pulse Start (ms)	Frequency (MHz)	Hopping Number	Pulse Start (ms)
0	5286	0	0	5286	0
2	5290	6	6	5287	18
15	5283	45	9	5303	27
16	5319	48	24	5311	72
20	5311	60	35	5313	105
34	5315	102	37	5317	111
41	5316	123	52	5307	156
47	5329	141	65	5320	195
66	5293	198	82	5334	246
67	5292	201	83	5338	249
76	5281	228	90	5283	270
92	5321	276	--	--	--
98	5295	294	--	--	--

Radar waveform #13			Radar waveform #14		
Hopping Number	Frequency (MHz)	Pulse Start (ms)	Hopping Number	Frequency (MHz)	Pulse Start (ms)
0	5283	0	0	5300	0
11	5293	33	10	5335	30
12	5315	36	12	5313	36
20	5316	60	13	5319	39
23	5306	69	20	5280	60
41	5303	123	23	5318	69
44	5281	132	25	5336	75
67	5295	201	33	5326	99
77	5286	231	40	5308	120
85	5321	255	41	5324	123
86	5309	258	43	5328	129
87	5285	261	48	5320	144
89	5288	267	64	5333	192
90	5305	270	65	5294	195
99	5308	297	86	5304	258
--	--	--	96	5285	288
--	--	--	97	5288	291

Radar waveform #15			Radar waveform #16		
Hopping Number	Frequency (MHz)	Pulse Start (ms)	Hopping Number	Frequency (MHz)	Pulse Start (ms)
5	5297	15	18	5328	54
12	5322	36	19	5301	57
19	5301	57	21	5293	63
20	5294	60	34	5282	102
33	5313	99	35	5333	105
34	5280	102	49	5325	147
35	5333	105	50	5332	150
37	5331	111	51	5318	153
48	5305	144	55	5339	165
49	5289	147	59	5283	177
66	5317	198	66	5281	198
70	5320	210	71	5331	213
76	5328	228	84	5336	252
90	5282	270	95	5323	285
96	5291	288	--	--	--

Radar waveform #17			Radar waveform #18		
Hopping Number	Frequency (MHz)	Pulse Start (ms)	Hopping Number	Frequency (MHz)	Pulse Start (ms)
5	5314	15	22	5319	66
15	5327	45	33	5315	99
43	5335	129	57	5290	171
52	5302	156	68	5288	204
56	5296	168	77	5291	231
66	5331	198	82	5304	246
77	5336	231	85	5329	255
81	5301	243	92	5298	276
82	5334	246	97	5328	291
84	5309	252	99	5336	297
98	5322	294	--	--	--

Radar waveform #19			Radar waveform #20		
Hopping Number	Frequency (MHz)	Pulse Start (ms)	Hopping Number	Frequency (MHz)	Pulse Start (ms)
8	5285	24	10	5290	30
14	5284	42	36	5289	108
48	5317	144	43	5321	129
59	5307	177	59	5280	177
65	5326	195	73	5324	219
85	5305	255	77	5336	231
91	5322	273	82	5294	246
95	5297	285	87	5302	261
--	--	--	88	5320	264
--	--	--	90	5311	270

Radar waveform #21			Radar waveform #22		
Hopping Number	Frequency (MHz)	Pulse Start (ms)	Hopping Number	Frequency (MHz)	Pulse Start (ms)
7	5291	21	2	5283	6
16	5281	48	3	5281	9
33	5327	99	6	5321	18
38	5300	114	11	5290	33
44	5293	132	28	5338	84
50	5326	150	29	5322	87
66	5296	198	57	5339	171
75	5328	225	60	5295	180
80	5306	240	62	5303	186
86	5313	258	69	5314	207
88	5330	264	72	5312	216
95	5302	285	78	5319	234
96	5336	288	80	5306	240
--	--	--	82	5291	246
--	--	--	83	5280	249
--	--	--	90	5317	270
--	--	--	91	5296	273

Radar waveform #23			Radar waveform #24		
Hopping Number	Frequency (MHz)	Pulse Start (ms)	Hopping Number	Frequency (MHz)	Pulse Start (ms)
4	5280	12	17	5283	51
6	5282	18	22	5329	66
36	5330	108	25	5334	75
41	5284	123	51	5325	153
42	5317	126	53	5316	159
55	5303	165	73	5287	219
66	5295	198	75	5327	225
68	5326	204	83	5301	249
77	5291	231	86	5333	258
78	5334	234	93	5317	279
90	5279	270	97	5311	291

Radar waveform #25			Radar waveform #26		
Hopping Number	Frequency (MHz)	Pulse Start (ms)	Hopping Number	Frequency (MHz)	Pulse Start (ms)
7	5299	21	1	5301	3
27	5286	81	11	5300	33
61	5280	183	27	5280	81
79	5307	237	29	5333	87
81	5308	243	40	5324	120
84	5282	252	53	5290	159
87	5339	261	99	5306	297
88	5332	264	--	--	--
90	5310	270	--	--	--

Radar waveform #27			Radar waveform #28		
Hopping Number	Frequency (MHz)	Pulse Start (ms)	Hopping Number	Frequency (MHz)	Pulse Start (ms)
5	5324	15	1	5322	3
14	5280	42	3	5323	9
20	5322	60	31	5291	93
31	5338	93	34	5325	102
36	5332	108	44	5283	132
37	5299	111	48	5300	144
48	5333	144	50	5320	150
50	5308	150	52	5332	156
66	5336	198	56	5316	168
70	5294	210	60	5336	180
86	5337	258	62	5302	186
97	5317	291	65	5292	195
98	5329	294	68	5311	204
--	--	--	91	5305	273
--	--	--	98	5331	294

Radar waveform #29			Radar waveform #30		
Hopping Number	Frequency (MHz)	Pulse Start (ms)	Hopping Number	Frequency (MHz)	Pulse Start (ms)
18	5339	54	12	5330	36
22	5324	66	13	5332	39
43	5287	129	17	5288	51
46	5333	138	41	5334	123
60	5312	180	60	5309	180
65	5305	195	63	5337	189
76	5338	228	67	5293	201
77	5286	231	69	5317	207
80	5283	240	78	5301	234
85	5282	255	80	5319	240
91	5318	273	83	5308	249
--	--	--	84	5311	252
--	--	--	89	5305	267
--	--	--	90	5290	270
--	--	--	91	5318	273

Radar Statistical Performance for 802.11n-HT40

Radar Type 1 - Radar Statistical Performance

Trail #	Test Freq. (MHz)	Pulse Width (us)	PRI (us)	Pulses / Burst	1=Detection 0=No Detection
1	5291	1	758	70	1
2	5291	1	618	86	1
3	5291	1	938	57	1
4	5291	1	658	81	1
5	5291	1	878	61	1
6	5291	1	3066	18	1
7	5291	1	918	58	1
8	5291	1	838	63	1
9	5291	1	818	65	1
10	5291	1	778	68	1
11	5291	1	538	99	1
12	5291	1	718	74	1
13	5291	1	638	83	1
14	5291	1	738	72	1
15	5291	1	598	89	1
16	5291	1	592	90	1
17	5291	1	900	59	1
18	5291	1	3019	18	1
19	5291	1	599	89	1
20	5291	1	637	83	1
21	5291	1	1065	50	1
22	5291	1	1270	42	1
23	5291	1	957	56	1
24	5291	1	1699	32	1
25	5291	1	1652	32	1
26	5291	1	1122	48	1
27	5291	1	3059	18	1
28	5291	1	1045	51	1
29	5291	1	2402	22	1
30	5291	1	2203	24	1
Detection Percentage (%)					100%

Radar Type 2 - Radar Statistical Performance

Trail #	Test Freq. (MHz)	Pulse Width (us)	PRI (us)	Pulses / Burst	1=Detection 0=No Detection
1	5300	4.8	226	28	1
2	5300	3.5	201	28	1
3	5300	3.1	171	28	1
4	5300	2.4	191	29	1
5	5300	3.2	207	25	1
6	5300	3.3	200	23	1
7	5300	2.8	225	24	1
8	5300	1.8	196	28	1
9	5300	1.0	164	23	1
10	5300	3.0	181	23	1
11	5300	3.5	223	27	1
12	5300	4.2	181	24	1
13	5300	2.6	168	23	1
14	5300	3.9	170	27	1
15	5300	2.7	228	28	1
16	5300	1.4	218	25	1
17	5300	3.3	194	25	1
18	5300	2.2	176	27	1
19	5300	4.3	194	27	1
20	5300	4.3	200	25	1
21	5300	2.5	154	26	1
22	5300	3.7	169	26	1
23	5300	1.2	213	28	1
24	5300	3.0	207	25	1
25	5300	3.9	150	25	1
26	5300	1.7	156	26	1
27	5300	2.1	171	27	1
28	5300	2.9	175	28	1
29	5300	2.7	162	29	1
30	5300	2.1	217	29	1
Detection Percentage (%)					100%

Radar Type 3 - Radar Statistical Performance

Trail #	Test Freq. (MHz)	Pulse Width (us)	PRI (us)	Pulses / Burst	1=Detection 0=No Detection
1	5310	8.2	305	16	1
2	5310	8.1	442	17	1
3	5310	6.4	284	17	1
4	5310	9.3	269	16	1
5	5310	8.8	366	16	0
6	5310	8.6	488	18	1
7	5310	7.5	250	17	1
8	5310	9.0	353	17	1
9	5310	9.2	313	16	1
10	5310	9.8	447	16	1
11	5310	7.7	466	18	1
12	5310	7.1	378	16	1
13	5310	8.7	314	16	1
14	5310	7.5	355	18	1
15	5310	6.5	369	17	1
16	5310	7.7	280	18	1
17	5310	9.9	267	17	1
18	5310	9.7	399	18	1
19	5310	9.9	275	16	1
20	5310	8.1	275	18	1
21	5310	6.3	302	16	1
22	5310	6.8	327	18	1
23	5310	9.7	478	17	1
24	5310	9.2	362	16	1
25	5310	9.3	319	18	1
26	5310	8.5	312	16	1
27	5310	8.8	304	16	0
28	5310	8.0	330	16	1
29	5310	8.6	297	16	1
30	5310	7.5	469	18	1
Detection Percentage (%)					93.3%

Radar Type 4 - Radar Statistical Performance

Trail #	Test Freq. (MHz)	Pulse Width (us)	PRI (us)	Pulses / Burst	1=Detection 0=No Detection
1	5315	17.1	377	13	1
2	5315	15.0	463	15	1
3	5315	18.7	481	12	1
4	5315	19.5	323	16	1
5	5315	13.2	447	13	1
6	5315	13.3	301	16	1
7	5315	18.6	271	16	1
8	5315	14.8	495	13	1
9	5315	12.0	444	13	1
10	5315	15.6	352	12	1
11	5315	16.1	402	12	1
12	5315	14.0	352	12	1
13	5315	14.8	493	12	1
14	5315	12.9	380	16	1
15	5315	13.9	475	13	1
16	5315	13.0	321	15	1
17	5315	19.3	290	13	1
18	5315	19.5	348	16	1
19	5315	15.4	250	16	1
20	5315	16.1	340	16	1
21	5315	17.9	462	13	1
22	5315	18.9	301	14	1
23	5315	19.9	417	13	1
24	5315	13.0	250	16	1
25	5315	17.3	403	12	1
26	5315	19.4	426	15	1
27	5315	17.0	451	16	1
28	5315	11.7	277	13	1
29	5315	12.1	359	16	1
30	5315	12.4	426	13	1
Detection Percentage (%)					100%

Note: In addition an average minimum percentage of successful detection across all four Short pulse radar test

waveforms is as follows: $\frac{P_d1 + P_d2 + P_d3 + P_d4}{4} = (100\% + 100\% + 93.3\% + 100\%) / 4 = 98.3\% (>80\%)$



Radar Type 5 - Radar Statistical Performance

Trail #	Test Freq. (MHz)	1=Detection 0=No Detection	Trail #	Test Freq. (MHz)	1=Detection 0=No Detection
1	5320	1	16	5320	1
2	5320	1	17	5320	1
3	5320	1	18	5320	1
4	5320	1	19	5320	1
5	5320	1	20	5320	1
6	5320	1	21	5320	1
7	5320	1	22	5320	1
8	5320	1	23	5320	1
9	5320	1	24	5320	1
10	5320	1	25	5320	1
11	5320	1	26	5320	1
12	5320	1	27	5320	1
13	5320	1	28	5320	1
14	5320	1	29	5320	1
15	5320	1	30	5320	1
Detection Percentage (%)					100%

Type 5 Radar Waveform_1										
Waveform Num = 1 Num of Bursts = 20 Burst Interval (us) = 600000 Burst # Off Time (us) # Pulses Chirp (MHz) PW (us) Pulse 1 Pri (us) Pulse 2 Pri (us) Pulse 3 Pri (us) Start Loc (us) Start Burst Interval (us) End Burst Interval (us)										
1	63069	3	20	60	1774	1376	1533	63069	0	599999
2	701595	2	16	95	1605	1807	0	769347	600000	1199999
3	502739	1	19	70	1252	0	0	1275498	1200000	1799999
4	1004731	2	20	70	1493	1106	0	2281481	1800000	2399999
5	173711	2	14	85	1742	1915	0	2457791	2400000	2999999
6	859774	2	8	55	1945	1765	0	3321222	3000000	3599999
7	764240	3	8	100	1542	1802	1317	4089172	3600000	4199999
8	164515	2	6	80	1990	1469	0	4258348	4200000	4799999
9	1087746	3	10	55	1898	1026	1453	5349553	4800000	5399999
10	190736	3	12	85	1451	1341	1147	5544666	5400000	5999999
11	674352	2	5	100	1563	1771	0	6222957	6000000	6599999
12	594320	2	18	75	1673	1753	0	6820611	6600000	7199999
13	526732	1	11	80	1928	0	0	7350769	7200000	7799999
14	792849	3	12	100	1611	1757	1717	8145546	7800000	8399999
15	817615	3	11	50	1981	1746	1265	8968246	8400000	8999999
16	268515	1	10	60	1342	0	0	9241753	9000000	9599999
17	585096	1	15	80	1244	0	0	9828191	9600000	10199999
18	954832	3	14	50	1848	1204	1395	10784267	10200000	10799999
19	290774	3	10	95	1991	1023	1012	11079488	10800000	11399999
20	743930	3	5	55	1712	1241	1280	11827444	11400000	11999999
Total number of pulses in waveform = 45										



Type 5 Radar Waveform_2

Waveform Num = 2
Num of Bursts = 12
Burst Interval (us)= 1000000

Burst #	Off Time (us)	# Pulses	Chirp (MHz)	PW (us)	Pulse 1 Pri (us)	Pulse 2 Pri (us)	Pulse 3 Pri (us)	Start Loc (us)	Start Burst Interval (us)	End Burst Interval (us)
1	735493	2	10	85	1778	1982	0	735493	0	999999
2	954237	3	9	85	1981	1031	1994	1693490	1000000	1999999
3	348875	1	9	85	1882	0	0	2047371	2000000	2999999
4	1013744	2	13	50	1927	1393	0	3062997	3000000	3999999
5	1581435	3	15	75	1416	1200	1186	4647752	4000000	4999999
6	838473	3	9	85	1509	1667	1856	5490027	5000000	5999999
7	1127743	2	18	90	1206	1754	0	6622802	6000000	6999999
8	620949	2	6	75	1617	1931	0	7246711	7000000	7999999
9	1475141	3	13	80	1144	1732	1062	8725400	8000000	8999999
10	1241981	3	6	50	1040	1479	1328	9971319	9000000	9999999
11	860854	2	9	90	1677	1616	0	10836020	10000000	10999999
12	513264	2	9	85	1387	1861	0	11352577	11000000	11999999

Total number of pulses in waveform = 28

Type 5 Radar Waveform_3

Waveform Num = 4
Num of Bursts = 14
Burst Interval (us)= 857143

Burst #	Off Time (us)	# Pulses	Chirp (MHz)	PW (us)	Pulse 1 Pri (us)	Pulse 2 Pri (us)	Pulse 3 Pri (us)	Start Loc (us)	Start Burst Interval (us)	End Burst Interval (us)
1	731821	2	10	100	1915	1727	0	731821	0	857142
2	464066	3	15	60	1158	1509	1837	1199529	857143	1714285
3	1079656	1	12	80	1140	0	0	2283689	1714286	2571428
4	667967	1	5	50	1828	0	0	2952796	2571429	3428571
5	1031785	3	6	90	1715	1265	1984	3986409	3428572	4285714
6	1047211	2	14	80	1352	1962	0	5038584	4285715	5142857
7	936199	2	7	85	1511	1353	0	5978097	5142858	6000000
8	587451	3	13	70	1797	1549	1108	6568412	6000001	6857143
9	640757	1	5	75	1133	0	0	7213623	6857144	7714286
10	1048601	3	16	100	1246	1638	1269	8263357	7714287	8571429
11	580971	2	11	60	1359	1304	0	8848481	8571430	9428572
12	785733	1	17	75	1583	0	0	9636877	9428573	10285715
13	1351335	1	8	55	1478	0	0	10989795	10285716	11142858
14	522023	3	13	55	1905	1891	1894	11513296	11142859	12000001

Total number of pulses in waveform = 28

Type 5 Radar Waveform_4

Waveform Num = 4
Num of Bursts = 11
Burst Interval (us)= 1090909

Burst #	Off Time (us)	# Pulses	Chirp (MHz)	PW (us)	Pulse 1 Pri (us)	Pulse 2 Pri (us)	Pulse 3 Pri (us)	Start Loc (us)	Start Burst Interval (us)	End Burst Interval (us)
1	559767	2	10	95	1607	1328	0	559767	0	1090908
2	1097795	1	11	50	1199	0	0	1660497	1090909	2181817
3	739856	3	12	80	1690	1400	1149	2401552	2181818	3272726
4	1120275	1	13	95	1050	0	0	3526066	3272727	4363635
5	1057253	3	18	75	1347	1928	1815	4584369	4363636	5454544
6	1834374	1	17	75	1927	0	0	6423833	5454545	6545453
7	1114591	2	7	65	1110	1391	0	7540351	6545454	7636362
8	980843	1	5	100	1503	0	0	8523695	7636363	8727271
9	313535	1	12	55	1705	0	0	8838733	8727272	9818180
10	2005622	2	19	55	1807	1175	0	10846060	9818181	10909089
11	958632	3	8	50	1339	1045	1305	11807674	10909090	11999998

Total number of pulses in waveform = 20



Type 5 Radar Waveform_5

Waveform Num = 5
 Num of Bursts = 18
 Burst Interval (us) = 666667

Burst #	Off Time (us)	# Pulses	Chirp (MHz)	PW (us)	Pulse 1 Pri (us)	Pulse 2 Pri (us)	Pulse 3 Pri (us)	Start Loc (us)	Start Burst Interval (us)	End Burst Interval (us)
1	57708	3	17	80	1969	1286	1442	57708	0	666666
2	1146562	2	6	95	1452	1050	0	1208967	666667	1333333
3	423295	1	10	65	1432	0	0	1912026	1333334	2000000
4	419914	3	8	100	1580	1528	1614	2336753	2000001	2666667
5	771982	2	15	65	1321	1463	0	2761389	2666668	3333334
6	518421	2	9	80	1024	1528	0	3536155	3333335	4000001
7	877077	1	17	75	1562	0	0	4057128	4000002	4666668
8	793187	3	12	60	1456	1866	1207	4935767	4666669	5333335
9	845404	1	12	50	1093	0	0	5733483	5333336	6000002
10	653246	3	11	90	1004	1741	1776	6579980	6000003	6666669
11	689178	1	5	95	1865	0	0	7237747	6666670	7333336
12	684057	1	8	60	1773	0	0	7928790	7333337	8000003
13	407165	3	18	55	1385	1664	1746	8614620	8000004	8666670
14	757739	2	19	50	1122	1184	0	9026580	8666671	9333337
15	423448	3	10	65	1032	1709	1583	9786625	9333338	10000004
16	887768	3	15	70	1365	1283	1460	10214397	10000005	10666671
17	795171	3	19	60	1035	1884	1388	11106273	10666672	11333338
18		2	15	75	1596	1599	0	11905751	11333339	12000005

Total number of pulses in waveform = 39

Type 5 Radar Waveform_6

Waveform Num = 6
 Num of Bursts = 13
 Burst Interval (us) = 923077

Burst #	Off Time (us)	# Pulses	Chirp (MHz)	PW (us)	Pulse 1 Pri (us)	Pulse 2 Pri (us)	Pulse 3 Pri (us)	Start Loc (us)	Start Burst Interval (us)	End Burst Interval (us)
1	172968	2	10	65	1700	1566	0	172968	0	923076
2	1107866	1	17	80	1804	0	0	1284100	923077	1846153
3	1325703	3	15	70	1274	1853	1853	2611607	1846154	2769230
4	1035822	2	19	80	1741	1230	0	3652409	2769231	3692307
5	772855	1	17	85	1882	0	0	4428235	3692308	4615384
6	724711	2	16	60	1411	1131	0	5154828	4615385	5538461
7	562801	1	5	50	1795	0	0	5720171	5538462	6461538
8	1121718	2	16	95	1644	1361	0	6843684	6461539	7384615
9	816407	1	9	95	1443	0	0	7663096	7384616	8307692
10	1378988	3	9	90	1478	1389	1305	9043527	8307693	9230769
11	731123	1	20	70	1643	0	0	9778822	9230770	10153846
12	1036052	1	7	60	1164	0	0	10816517	10153847	11076923
13	561023	3	20	60	1710	1674	1696	11378704	11076924	12000000

Total number of pulses in waveform = 23

Type 5 Radar Waveform_7

Waveform Num = 7
 Num of Bursts = 12
 Burst Interval (us) = 1000000

Burst #	Off Time (us)	# Pulses	Chirp (MHz)	PW (us)	Pulse 1 Pri (us)	Pulse 2 Pri (us)	Pulse 3 Pri (us)	Start Loc (us)	Start Burst Interval (us)	End Burst Interval (us)
1	518183	3	8	100	1735	1242	1561	518183	0	999999
2	1073791	2	13	75	1582	1018	0	1596512	1000000	1999999
3	1098150	2	19	65	1960	1746	0	2697262	2000000	2999999
4	452385	2	14	85	1464	1727	0	3153353	3000000	3999999
5	883102	2	12	80	1250	1045	0	4039646	4000000	4999999
6	1808266	2	8	90	1619	1170	0	5850207	5000000	5999999
7	835932	3	13	95	1762	1202	1248	6688928	6000000	6999999
8	382271	2	14	55	1195	1591	0	7075411	7000000	7999999
9	1186731	1	13	95	1883	0	0	8264928	8000000	8999999
10	1141464	1	5	95	1945	0	0	9408275	9000000	9999999
11	1146005	3	13	75	1326	1422	1911	10556225	10000000	10999999
12	1156005	3	15	55	1631	1034	1809	11716889	11000000	11999999

Total number of pulses in waveform = 26



Type 5 Radar Waveform_8

Waveform Num = 8
Num of Bursts = 17
Burst Interval (us) = 705882

Burst #	Off Time (us)	# Pulses	Chirp (MHz)	PW (us)	Pulse 1 Pri (us)	Pulse 2 Pri (us)	Pulse 3 Pri (us)	Start Loc (us)	Start Burst Interval (us)	End Burst Interval (us)
1	537406	3	8	85	1528	1668	1434	537406	0	705881
2	349810	1	16	65	1340	0	0	891846	705882	1411763
3	703436	1	15	50	1426	0	0	1596622	1411764	2117645
4	569252	2	14	65	1267	1984	0	2167300	2117646	2823527
5	794445	2	15	90	1118	1081	0	2964996	2823528	3529409
6	961766	3	13	65	1393	1910	1135	3928961	3529410	4235291
7	958806	2	10	90	1042	1021	0	4892205	4235292	4941173
8	307893	3	15	70	1652	1522	1323	5202161	4941174	5647055
9	712979	3	20	80	1973	1753	1108	5919637	5647056	6352937
10	444302	1	17	60	1814	0	0	6368773	6352938	7058819
11	1350058	1	8	85	1626	0	0	7720645	7058820	7764701
12	531647	3	20	90	1793	1381	1396	8253918	7764702	8470583
13	810363	3	7	90	1732	1677	1228	9068851	8470584	9176465
14	289637	3	9	100	1312	1858	1232	9363125	9176466	9882347
15	1067228	1	10	65	1964	0	0	10434755	9882348	10588229
16	198305	2	11	60	1491	1910	0	10635024	10588230	11294111
17	1293096	2	16	55	1107	1657	0	11931521	11294112	11999993

Total number of pulses in waveform = 36

Type 5 Radar Waveform_9

Waveform Num = 9
Num of Bursts = 13
Burst Interval (us) = 923077

Burst #	Off Time (us)	# Pulses	Chirp (MHz)	PW (us)	Pulse 1 Pri (us)	Pulse 2 Pri (us)	Pulse 3 Pri (us)	Start Loc (us)	Start Burst Interval (us)	End Burst Interval (us)
1	894082	3	19	55	1723	1998	1394	894082	0	923076
2	431600	2	13	75	1702	1238	0	1330797	923077	1846153
3	1139092	2	11	50	1886	1235	0	2472829	1846154	2769230
4	988254	2	9	65	1079	1913	0	3464204	2769231	3692307
5	984394	2	12	50	1808	1119	0	4451590	3692308	4615384
6	1011115	2	7	70	1349	1271	0	5465632	4615385	5538461
7	439230	3	14	60	1970	1117	1132	5907482	5538462	6461538
8	1039929	2	8	55	1653	1371	0	6951630	6461539	7384615
9	916462	2	17	65	1988	1265	0	7871116	7384616	8307692
10	1171356	2	5	90	1294	1821	0	9045725	8307693	9230769
11	289344	2	14	65	1161	1865	0	9338184	9230770	10153846
12	1247381	1	14	100	1945	0	0	10588591	10153847	11076923
13	1027128	3	13	100	1789	1978	1854	11617664	11076924	12000000

Total number of pulses in waveform = 28

Type 5 Radar Waveform_10

Waveform Num = 10
Num of Bursts = 12
Burst Interval (us) = 1000000

Burst #	Off Time (us)	# Pulses	Chirp (MHz)	PW (us)	Pulse 1 Pri (us)	Pulse 2 Pri (us)	Pulse 3 Pri (us)	Start Loc (us)	Start Burst Interval (us)	End Burst Interval (us)
1	147965	1	13	75	1221	0	0	147965	0	999999
2	1070015	2	6	80	1842	1077	0	1219201	1000000	1999999
3	905876	1	10	65	1973	0	0	2127996	2000000	2999999
4	1705203	1	9	55	1258	0	0	3835172	3000000	3999999
5	209699	3	15	70	1079	1485	1631	4046129	4000000	4999999
6	1019782	2	18	80	1238	1809	0	5070106	5000000	5999999
7	1764410	1	16	50	1402	0	0	6837563	6000000	6999999
8	664290	1	18	95	1532	0	0	7503255	7000000	7999999
9	1024604	2	18	60	1520	1810	0	8529391	8000000	8999999
10	1348933	1	8	100	1656	0	0	9881654	9000000	9999999
11	1013257	3	17	70	1161	1839	1895	10896567	10000000	10999999
12	287575	1	6	95	1532	0	0	11189037	11000000	11999999

Total number of pulses in waveform = 19



Type 5 Radar Waveform_11

Waveform Num = 11
Num of Bursts = 13
Burst Interval (us)= 923077

Burst #	Off Time (us)	# Pulses	Chirp (MHz)	PW (us)	Pulse 1 Pri (us)	Pulse 2 Pri (us)	Pulse 3 Pri (us)	Start Loc (us)	Start Burst Interval (us)	End Burst Interval (us)
1	455768	3	17	50	1778	1357	1424	455768	0	923076
2	951394	2	13	60	1873	1540	0	1411721	923077	1846153
3	1156367	1	18	65	1093	0	0	2571501	1846154	2769230
4	573733	2	7	50	1792	1276	0	3146327	2769231	3692307
5	1208323	2	13	70	1140	1014	0	4357718	3692308	4615384
6	1054905	1	11	85	1561	0	0	5414777	4615385	5538461
7	782625	3	7	60	1125	1275	1604	6198963	5538462	6461538
8	691685	3	11	60	1730	1124	1382	6894652	6461539	7384615
9	508997	1	12	90	1425	0	0	7407885	7384616	8307692
10	1072997	1	9	55	1312	0	0	8482307	8307693	9230769
11	1531905	2	20	100	1726	1083	0	10015524	9230770	10153846
12	347795	2	14	55	1570	1649	0	10366128	10153847	11076923
13	1089265	3	12	55	1264	1698	1061	11458612	11076924	12000000

Total number of pulses in waveform = 26

Type 5 Radar Waveform_12

Waveform Num = 12
Num of Bursts = 13
Burst Interval (us)= 923077

Burst #	Off Time (us)	# Pulses	Chirp (MHz)	PW (us)	Pulse 1 Pri (us)	Pulse 2 Pri (us)	Pulse 3 Pri (us)	Start Loc (us)	Start Burst Interval (us)	End Burst Interval (us)
1	912244	2	17	60	1249	1910	0	912244	0	923076
2	909468	3	19	90	1093	1780	1042	1824871	923077	1846153
3	809030	3	20	80	1260	1798	1504	2637816	1846154	2769230
4	865825	1	15	80	1970	0	0	3508203	2769231	3692307
5	474855	2	12	55	1417	1718	0	3985028	3692308	4615384
6	1114060	2	20	90	1715	1132	0	5102223	4615385	5538461
7	835596	1	7	75	1633	0	0	5940666	5538462	6461538
8	1175323	3	16	75	1724	1816	1409	7117622	6461539	7384615
9	610547	2	10	85	1462	1724	0	7733118	7384616	8307692
10	915633	2	11	85	1415	1190	0	8651937	8307693	9230769
11	672066	1	14	50	1877	0	0	9326608	9230770	10153846
12	1372611	1	11	60	1731	0	0	10701096	10153847	11076923
13	1264230	1	14	90	1093	0	0	11967057	11076924	12000000

Total number of pulses in waveform = 24

Type 5 Radar Waveform_13

Waveform Num = 13
Num of Bursts = 10
Burst Interval (us)= 1200000

Burst #	Off Time (us)	# Pulses	Chirp (MHz)	PW (us)	Pulse 1 Pri (us)	Pulse 2 Pri (us)	Pulse 3 Pri (us)	Start Loc (us)	Start Burst Interval (us)	End Burst Interval (us)
1	1109971	3	19	100	1885	1662	1696	1109971	0	1199999
2	678023	3	18	80	1235	1381	1534	1793237	1200000	2399999
3	610096	3	6	85	1678	1705	1183	2407483	2400000	3599999
4	1625876	3	10	60	1225	1301	1488	4037925	3600000	4799999
5	1158751	2	16	100	1644	1375	0	5200690	4800000	5999999
6	1529705	2	19	55	1576	1160	0	6733414	6000000	7199999
7	1278468	2	19	80	1137	1869	0	8014618	7200000	8399999
8	779495	2	7	65	1002	1692	0	8797119	8400000	9599999
9	1758559	1	9	65	1372	0	0	10558372	9600000	10799999
10	319042	3	16	55	1815	1156	1297	10878786	10800000	11999999

Total number of pulses in waveform = 24



Type 5 Radar Waveform_14

Waveform Num = 14
Num of Bursts = 9
Burst Interval (us)= 1333333

Burst #	Off Time (us)	# Pulses	Chirp (MHz)	PW (us)	Pulse 1 Pri (us)	Pulse 2 Pri (us)	Pulse 3 Pri (us)	Start Loc (us)	Start Burst Interval (us)	End Burst Interval (us)
1	200935	2	14	65	1346	1634	0	200935	0	1333332
2	2087423	1	12	90	1609	0	0	2291338	1333333	2666665
3	635609	1	17	80	1547	0	0	2928556	2666666	3999998
4	1973622	1	10	90	1508	0	0	4903725	3999999	5333331
5	652239	2	6	55	1789	1123	0	5557472	5333332	6666664
6	2218050	3	15	50	1709	1371	1774	7778434	6666665	7999997
7	743226	2	17	55	1070	1277	0	8526514	7999998	9333330
8	1897682	1	15	90	1026	0	0	10426543	9333331	10666663
9	1403605	2	12	95	1044	1538	0	11831174	10666664	11999996

Total number of pulses in waveform = 15

Type 5 Radar Waveform_15

Waveform Num = 15
Num of Bursts = 9
Burst Interval (us)= 1333333

Burst #	Off Time (us)	# Pulses	Chirp (MHz)	PW (us)	Pulse 1 Pri (us)	Pulse 2 Pri (us)	Pulse 3 Pri (us)	Start Loc (us)	Start Burst Interval (us)	End Burst Interval (us)
1	193788	1	17	100	1200	0	0	193788	0	1333332
2	2215619	2	18	50	1109	1410	0	2410607	1333333	2666665
3	1493814	2	8	80	1843	1185	0	3906940	2666666	3999998
4	543029	3	13	65	1417	1181	1161	4452997	3999999	5333331
5	1061446	2	16	60	1118	1269	0	5518202	5333332	6666664
6	1625379	1	16	55	1875	0	0	7145968	6666665	7999997
7	2001191	2	15	65	1924	1326	0	9149034	7999998	9333330
8	1392756	2	17	75	1254	1384	0	10545040	9333331	10666663
9	1347062	2	9	80	1572	1969	0	11894740	10666664	11999996

Total number of pulses in waveform = 17

Type 5 Radar Waveform_16

Waveform Num = 16
Num of Bursts = 17
Burst Interval (us)= 705882

Burst #	Off Time (us)	# Pulses	Chirp (MHz)	PW (us)	Pulse 1 Pri (us)	Pulse 2 Pri (us)	Pulse 3 Pri (us)	Start Loc (us)	Start Burst Interval (us)	End Burst Interval (us)
1	144343	1	14	65	1006	0	0	144343	0	705881
2	991402	3	6	55	1029	1249	1869	1136751	705882	1411763
3	498568	1	15	85	1214	0	0	1639466	1411764	2117645
4	540842	1	17	60	1823	0	0	2181522	2117646	2823527
5	1224740	2	11	55	1753	1576	0	3408085	2823528	3529409
6	662704	2	16	60	1301	1242	0	4074118	3529410	4235291
7	718119	1	17	90	1205	0	0	4794780	4235292	4941173
8	467756	1	6	100	1002	0	0	5263741	4941174	5647055
9	552252	3	15	55	1649	1694	1941	5816995	5647056	6352937
10	1140564	2	7	65	1068	1837	0	6962843	6352938	7058819
11	231408	3	14	55	1606	1979	1552	7197156	7058820	7764701
12	843123	3	5	55	1080	1141	1618	8045416	7764702	8470583
13	901526	3	17	55	1087	1697	1789	8950781	8470584	9176465
14	358992	3	7	55	1810	1950	1586	9314346	9176466	9882347
15	786187	3	7	50	1373	1476	1410	10105879	9882348	10588229
16	654153	1	19	50	1915	0	0	10764291	10588230	11294111
17	830342	1	15	100	1082	0	0	11596548	11294112	11999993

Total number of pulses in waveform = 34



Type 5 Radar Waveform_17

Waveform Num = 17
Num of Bursts = 13
Burst Interval (us) = 923077

Burst #	Off Time (us)	# Pulses	Chirp (MHz)	PW (us)	Pulse 1 Pri (us)	Pulse 2 Pri (us)	Pulse 3 Pri (us)	Start Loc (us)	Start Burst Interval (us)	End Burst Interval (us)
1	164108	1	10	90	1941	0	0	164108	0	923076
2	1114720	1	17	65	1403	0	0	1280769	923077	1846153
3	1046351	3	16	70	1482	1813	1163	2328523	1846154	2769230
4	881490	3	11	60	1989	1643	1935	3214471	2769231	3692307
5	607683	3	15	100	1238	1319	1195	3827721	3692308	4615384
6	1491318	3	6	75	1973	1442	1668	5322791	4615385	5538461
7	636395	1	14	60	1472	0	0	5964269	5538462	6461538
8	984720	1	17	85	1347	0	0	6950461	6461539	7384615
9	633903	2	15	95	1497	1344	0	7585711	7384616	8307692
10	1093238	1	8	70	1477	0	0	8681790	8307693	9230769
11	1409683	2	13	80	1197	1184	0	10092950	9230770	10153846
12	842043	1	15	80	1397	0	0	10937374	10153847	11076923
13	169670	1	7	65	1608	0	0	11108441	11076924	12000000

Total number of pulses in waveform = 23

Type 5 Radar Waveform_18

Waveform Num = 18
Num of Bursts = 16
Burst Interval (us) = 750000

Burst #	Off Time (us)	# Pulses	Chirp (MHz)	PW (us)	Pulse 1 Pri (us)	Pulse 2 Pri (us)	Pulse 3 Pri (us)	Start Loc (us)	Start Burst Interval (us)	End Burst Interval (us)
1	239462	1	19	90	1566	0	0	239462	0	749999
2	856668	2	15	75	1637	1749	0	1097696	750000	1499999
3	528793	2	5	85	1644	1267	0	1629875	1500000	2249999
4	943350	3	17	70	1301	1006	1689	2576136	2250000	2999999
5	946843	1	10	75	1056	0	0	3526975	3000000	3749999
6	382792	1	20	95	1729	0	0	3910823	3750000	4499999
7	890531	2	10	75	1121	1022	0	4803083	4500000	5249999
8	889834	2	12	90	1664	1239	0	5695060	5250000	5999999
9	499513	1	13	85	1859	0	0	6197476	6000000	6749999
10	982002	1	5	80	1226	0	0	7181337	6750000	7499999
11	735390	2	6	90	1939	1333	0	7917953	7500000	8249999
12	640266	2	13	100	1728	1569	0	8561491	8250000	8999999
13	659859	1	14	55	1406	0	0	9224647	9000000	9749999
14	779153	1	8	95	1925	0	0	10005206	9750000	10499999
15	911391	2	14	90	1059	1548	0	10918522	10500000	11249999
16	628262	2	9	95	1604	1487	0	11549391	11250000	11999999

Total number of pulses in waveform = 26

Type 5 Radar Waveform_19

Waveform Num = 19
Num of Bursts = 11
Burst Interval (us) = 1090909

Burst #	Off Time (us)	# Pulses	Chirp (MHz)	PW (us)	Pulse 1 Pri (us)	Pulse 2 Pri (us)	Pulse 3 Pri (us)	Start Loc (us)	Start Burst Interval (us)	End Burst Interval (us)
1	971397	1	7	75	1562	0	0	971397	0	1090908
2	1185757	1	9	55	1080	0	0	2158716	1090909	2181817
3	603362	3	7	65	1264	1984	1416	2763158	2181818	3272726
4	1541833	2	5	80	1383	1810	0	4309655	3272727	4363635
5	202814	1	15	50	1919	0	0	4515662	4363636	5454544
6	1123928	2	15	55	1135	1989	0	5641509	5454545	6545453
7	975275	1	19	95	1086	0	0	6619908	6545454	7636362
8	1506432	1	16	65	1832	0	0	8127426	7636363	8727271
9	1136710	2	11	75	1119	1458	0	9265968	8727272	9818180
10	1015944	3	5	95	1245	1850	1885	10284439	9818181	10909089
11	993118	1	20	60	1794	0	0	11282587	10909090	11999998

Total number of pulses in waveform = 18



Type 5 Radar Waveform_20

Waveform Num = 20
Num of Bursts = 16
Burst Interval (us) = 750000

Burst #	Off Time (us)	# Pulses	Chirp (MHz)	PW (us)	Pulse 1 Pri (us)	Pulse 2 Pri (us)	Pulse 3 Pri (us)	Start Loc (us)	Start Burst Interval (us)	End Burst Interval (us)
1	132607	1	18	85	1405	0	0	132607	0	749999
2	681516	2	11	95	1068	1019	0	815528	750000	1499999
3	1384193	3	18	75	1951	1959	1386	2201808	1500000	2249999
4	359016	1	10	100	1883	0	0	2566120	2250000	2999999
5	718112	3	16	100	1455	1290	1605	3286115	3000000	3749999
6	847079	1	11	70	1640	0	0	4137544	3750000	4499999
7	769141	1	12	55	1564	0	0	4908325	4500000	5249999
8	375554	3	11	85	1380	1639	1379	5285443	5250000	5999999
9	1365949	1	19	100	1624	0	0	6655790	6000000	6749999
10	574091	1	17	55	1436	0	0	7231505	6750000	7499999
11	283227	2	12	70	1018	1147	0	7516168	7500000	8249999
12	742679	1	15	50	1700	0	0	8261012	8250000	8999999
13	1379903	2	15	75	1935	1685	0	9642615	9000000	9749999
14	657797	2	18	55	1645	1368	0	10304032	9750000	10499999
15	670650	3	15	60	1228	1871	1848	10977695	10500000	11249999
16	327098	3	17	95	1865	1534	1458	11309740	11250000	11999999

Total number of pulses in waveform = 30

Type 5 Radar Waveform_21

Waveform Num = 21
Num of Bursts = 14
Burst Interval (us) = 357143

Burst #	Off Time (us)	# Pulses	Chirp (MHz)	PW (us)	Pulse 1 Pri (us)	Pulse 2 Pri (us)	Pulse 3 Pri (us)	Start Loc (us)	Start Burst Interval (us)	End Burst Interval (us)
1	363808	3	13	65	1224	1476	1069	363808	0	857142
2	806560	2	6	55	1734	1255	0	1174137	857143	1714285
3	1094265	3	17	55	1923	1882	1288	2271391	1714286	2571428
4	1118644	2	6	50	1207	1393	0	3395128	2571429	3428571
5	601134	1	17	60	1007	0	0	3998862	3428572	4285714
6	997440	3	17	55	1351	1258	1298	4997309	4285715	5142857
7	418486	2	11	100	1117	1240	0	5419702	5142858	6000000
8	906278	2	6	65	1181	1946	0	6328337	6000001	6857143
9	1075406	1	12	80	1227	0	0	7406870	6857144	7714286
10	1030327	3	12	70	1925	1908	1738	8438424	7714287	8571429
11	325950	3	6	65	1127	1194	1004	8769945	8571430	9428572
12	660807	2	20	50	1974	1769	0	9434077	9428573	10285715
13	1697152	3	9	50	1890	1289	1015	11134972	10285716	11142858
14	594017	3	17	75	1149	1066	1829	11733183	11142859	12000001

Total number of pulses in waveform = 33

Type 5 Radar Waveform_22

Waveform Num = 22
Num of Bursts = 16
Burst Interval (us) = 750000

Burst #	Off Time (us)	# Pulses	Chirp (MHz)	PW (us)	Pulse 1 Pri (us)	Pulse 2 Pri (us)	Pulse 3 Pri (us)	Start Loc (us)	Start Burst Interval (us)	End Burst Interval (us)
1	688064	3	7	95	1698	1662	1813	688064	0	749999
2	528372	3	13	80	1725	1322	1672	1221609	750000	1499999
3	509930	2	5	75	1480	1968	0	1736258	1500000	2249999
4	713467	1	5	55	1191	0	0	2453173	2250000	2999999
5	863051	3	17	85	1260	1989	1979	3317415	3000000	3749999
6	1117608	1	18	55	1696	0	0	4440251	3750000	4499999
7	185692	1	17	70	1260	0	0	4627639	4500000	5249999
8	1260690	2	13	50	1223	1222	0	5889589	5250000	5999999
9	711047	1	14	75	1683	0	0	6603081	6000000	6749999
10	248603	1	20	55	1514	0	0	6853367	6750000	7499999
11	1092760	2	11	85	1589	1382	0	7947641	7500000	8249999
12	585973	2	10	65	1375	1384	0	8536585	8250000	8999999
13	1186822	3	9	65	1061	1897	1015	9726166	9000000	9749999
14	126390	2	20	60	1710	1830	0	9856529	9750000	10499999
15	642861	1	14	65	1523	0	0	10502930	10500000	11249999
16	1469266	1	11	70	1309	0	0	11973719	11250000	11999999

Total number of pulses in waveform = 29



Type 5 Radar Waveform_23

Waveform Num = 23
Num of Bursts = 16
Burst Interval (us) = 750000

Burst #	Off Time (us)	# Pulses	Chirp (MHz)	PW (us)	Pulse 1 Pri (us)	Pulse 2 Pri (us)	Pulse 3 Pri (us)	Start Loc (us)	Start Burst Interval (us)	End Burst Interval (us)
1	38059	1	10	60	1243	0	0	38059	0	749999
2	1418904	3	12	85	1490	1794	1704	1458206	750000	1499999
3	704274	3	14	95	1116	1014	1058	2167468	1500000	2249999
4	157906	3	19	85	1292	1932	1534	2328562	2250000	2999999
5	998794	2	16	85	1195	1561	0	3322114	3000000	3749999
6	650743	2	20	90	1580	1150	0	3985613	3750000	4499999
7	1229641	2	20	85	1233	1543	0	5217984	4500000	5249999
8	481459	2	7	50	1174	1169	0	5702219	5250000	5999999
9	819135	1	5	65	1115	0	0	6523697	6000000	6749999
10	557390	3	12	65	1527	1114	1579	7082202	6750000	7499999
11	1105641	1	5	85	1773	0	0	8192063	7500000	8249999
12	779947	1	10	85	1455	0	0	8973783	8250000	8999999
13	494087	3	18	55	1871	1301	1298	9469325	9000000	9749999
14	850725	1	20	75	1756	0	0	10324580	9750000	10499999
15	855685	1	20	55	1984	0	0	11182021	10500000	11249999
16	608171	2	12	55	1701	1183	0	11792176	11250000	11999999

Total number of pulses in waveform = 31

Type 5 Radar Waveform_24

Waveform Num = 24
Num of Bursts = 18
Burst Interval (us) = 666667

Burst #	Off Time (us)	# Pulses	Chirp (MHz)	PW (us)	Pulse 1 Pri (us)	Pulse 2 Pri (us)	Pulse 3 Pri (us)	Start Loc (us)	Start Burst Interval (us)	End Burst Interval (us)
1	302928	1	16	65	1741	0	0	302928	0	666666
2	501719	1	9	55	1737	0	0	806388	666667	1333333
3	1084379	3	12	60	1337	1140	1691	1892504	1333334	2000000
4	686294	3	9	90	1141	1666	1366	2582966	2000001	2666667
5	590546	1	16	50	1604	0	0	3177785	2666668	3333334
6	595116	3	18	75	1919	1538	1885	3774505	3333335	4000001
7	863154	2	8	75	1158	1383	0	4643001	4000002	4666668
8	123997	2	18	60	1654	1755	0	4769539	4666669	5333335
9	925507	2	14	100	1748	1693	0	5698455	5333336	6000002
10	752725	1	14	75	1673	0	0	6454621	6000003	6666669
11	229622	1	19	50	1463	0	0	6685916	6666670	7333336
12	1217865	3	11	80	1579	1912	1761	7905244	7333337	8000003
13	566492	1	17	85	1512	0	0	8476988	8000004	8666670
14	566497	1	19	90	1586	0	0	9044997	8666671	9333337
15	802700	2	8	100	1742	1196	0	9849283	9333338	10000004
16	490884	2	20	65	1630	1971	0	10343105	10000005	10666671
17	751018	1	18	80	1222	0	0	11097724	10666672	11333338
18	746073	2	5	100	1455	1033	0	11845019	11333339	12000005

Total number of pulses in waveform = 32

Type 5 Radar Waveform_25

Waveform Num = 25
Num of Bursts = 9
Burst Interval (us) = 1333333

Burst #	Off Time (us)	# Pulses	Chirp (MHz)	PW (us)	Pulse 1 Pri (us)	Pulse 2 Pri (us)	Pulse 3 Pri (us)	Start Loc (us)	Start Burst Interval (us)	End Burst Interval (us)
1	255850	3	20	90	1922	1615	1139	255850	0	1333332
2	2290477	3	11	70	1799	1030	1072	2551003	1333333	2666665
3	318964	3	5	70	1551	1686	1937	2873868	2666666	3999998
4	1468933	3	13	50	1086	1666	1042	4347975	3999999	5333331
5	1396209	2	9	90	1378	1528	0	5747978	5333332	6666664
6	1915215	3	5	75	1665	1675	1228	7666099	6666665	7999997
7	1473151	3	7	55	1094	1979	1348	9143818	7999998	9333330
8	1394700	2	17	60	1855	1756	0	10542939	9333331	10666663
9	493323	1	8	55	1491	0	0	11039873	10666664	11999996

Total number of pulses in waveform = 23



Type 5 Radar Waveform_26

Waveform Num = 26
Num of Bursts = 13
Burst Interval (us) = 923077

Burst #	Off Time (us)	# Pulses	Chirp (MHz)	PW (us)	Pulse 1 Pri (us)	Pulse 2 Pri (us)	Pulse 3 Pri (us)	Start Loc (us)	Start Burst Interval (us)	End Burst Interval (us)
1	400491	2	15	90	1450	1399	0	400491	0	923076
2	533002	1	11	80	1242	0	0	936342	923077	1846153
3	1050722	3	6	90	1132	1706	1020	1988306	1846154	2769230
4	1030462	3	15	65	1464	1010	1762	3022626	2769231	3692307
5	1128130	2	11	70	1429	1409	0	4154992	3692308	4615384
6	1188190	3	6	95	1107	1344	1665	5346020	4615385	5538461
7	472033	2	12	50	1648	1352	0	5822169	5538462	6461538
8	668374	1	14	95	1298	0	0	6493543	6461539	7384615
9	1071798	3	10	60	1714	1947	1214	7566639	7384616	8307692
10	947249	3	11	85	1522	1129	1905	8518763	8307693	9230769
11	1339547	3	12	100	1972	1019	1837	9862866	9230770	10153846
12	293551	2	18	95	1263	1312	0	10161245	10153847	11076923
13	1112156	1	9	100	1918	0	0	11275976	11076924	12000000

Total number of pulses in waveform = 29

Type 5 Radar Waveform_27

Waveform Num = 27
Num of Bursts = 20
Burst Interval (us) = 600000

Burst #	Off Time (us)	# Pulses	Chirp (MHz)	PW (us)	Pulse 1 Pri (us)	Pulse 2 Pri (us)	Pulse 3 Pri (us)	Start Loc (us)	Start Burst Interval (us)	End Burst Interval (us)
1	350637	1	7	90	1566	0	0	350637	0	599999
2	424534	2	9	95	1769	1663	0	776737	600000	1199999
3	645149	2	10	95	1491	1045	0	1425318	1200000	1799999
4	927286	1	17	70	1949	0	0	2355140	1800000	2399999
5	198460	3	17	70	1822	1607	1349	2555549	2400000	2999999
6	676649	3	10	75	1178	1410	1632	3236976	3000000	3599999
7	637488	1	20	95	1048	0	0	3878684	3600000	4199999
8	886130	1	18	55	1573	0	0	4765862	4200000	4799999
9	271419	2	11	100	1997	1752	0	5038854	4800000	5399999
10	925919	1	12	80	1031	0	0	5968522	5400000	5999999
11	245764	1	5	95	1568	0	0	6215317	6000000	6599999
12	866334	1	10	75	1959	0	0	7083219	6600000	7199999
13	181743	2	14	85	1511	1310	0	7266921	7200000	7799999
14	1087048	3	11	85	1813	1335	1112	8356790	7800000	8399999
15	538250	2	15	85	1678	1845	0	8899300	8400000	8999999
16	461303	1	16	75	1077	0	0	9364126	9000000	9599999
17	335060	1	7	70	1775	0	0	9700263	9600000	10199999
18	654925	1	16	80	1741	0	0	10358963	10200000	10799999
19	749308	3	20	65	1741	1863	1349	11108012	10800000	11399999
20	870738	2	11	90	1244	1764	0	11983703	11400000	11999999

Total number of pulses in waveform = 34

Type 5 Radar Waveform_28

Waveform Num = 28
Num of Bursts = 10
Burst Interval (us) = 1200000

Burst #	Off Time (us)	# Pulses	Chirp (MHz)	PW (us)	Pulse 1 Pri (us)	Pulse 2 Pri (us)	Pulse 3 Pri (us)	Start Loc (us)	Start Burst Interval (us)	End Burst Interval (us)
1	836885	2	11	55	1953	1549	0	836885	0	1199999
2	1070047	1	7	60	1794	0	0	1910434	1200000	2399999
3	754260	3	18	70	1732	1322	1366	2666488	2400000	3599999
4	1536425	2	16	75	1019	1418	0	4207333	3600000	4799999
5	1303195	2	17	80	1979	1777	0	5512965	4800000	5999999
6	1267531	1	8	100	1835	0	0	6784252	6000000	7199999
7	701868	2	8	90	1683	2000	0	7487955	7200000	8399999
8	1740607	2	6	80	1450	1168	0	9232245	8400000	9599999
9	735190	1	14	85	1623	0	0	9970053	9600000	10799999
10	1989268	3	17	85	1439	1876	1608	11960944	10800000	11999999

Total number of pulses in waveform = 19



Type 5 Radar Waveform_29

Waveform Num = 29
Num of Bursts = 18
Burst Interval (us) = 666667

Burst #	Off Time (us)	# Pulses	Chirp (MHz)	PW (us)	Pulse 1 Pri (us)	Pulse 2 Pri (us)	Pulse 3 Pri (us)	Start Loc (us)	Start Burst Interval (us)	End Burst Interval (us)
1	453063	1	7	95	1705	0	0	458063	0	666666
2	307918	3	17	90	1475	1550	1682	767686	666667	1333333
3	928715	1	12	90	1695	0	0	1701108	1333334	2000000
4	624497	2	18	65	1424	1616	0	2327300	2000001	2666667
5	592483	2	5	65	1781	1327	0	2922823	2666668	3333334
6	544157	2	16	65	1671	1419	0	3470088	3333335	4000001
7	813412	3	19	90	1497	1326	1700	4286590	4000002	4666668
8	1010606	2	6	70	1314	1944	0	5301719	4666669	5333335
9	456838	2	6	85	1877	1631	0	5761815	5333336	6000002
10	438250	2	11	75	1543	1166	0	6203573	6000003	6666669
11	1078049	1	17	65	1290	0	0	7284331	6666670	7333336
12	679739	3	5	65	1391	1033	1281	7965360	7333337	8000003
13	625310	3	16	55	1932	1184	1324	8594375	8000004	8666670
14	532091	1	16	70	1499	0	0	9130906	8666671	9333337
15	414648	1	18	55	1391	0	0	9547053	9333338	10000004
16	758143	1	15	65	1977	0	0	10306587	10000005	10666671
17	572424	3	14	75	1633	1350	1902	10880988	10666672	11333338
18	677875	1	13	75	1683	0	0	11563748	11333339	12000005

Total number of pulses in waveform = 34

Type 5 Radar Waveform_30

Waveform Num = 30
Num of Bursts = 20
Burst Interval (us) = 600000

Burst #	Off Time (us)	# Pulses	Chirp (MHz)	PW (us)	Pulse 1 Pri (us)	Pulse 2 Pri (us)	Pulse 3 Pri (us)	Start Loc (us)	Start Burst Interval (us)	End Burst Interval (us)
1	192494	2	13	55	1136	1680	0	192494	0	599999
2	573895	1	17	95	1508	0	0	769205	600000	1199999
3	753253	3	5	75	1436	1992	1318	1523966	1200000	1799999
4	474634	3	12	70	1885	1978	1925	2003346	1800000	2399999
5	878654	2	8	55	1950	1868	0	2887788	2400000	2999999
6	669655	2	14	50	1458	1563	0	3561261	3000000	3599999
7	479646	3	6	100	1234	2000	1211	4043928	3600000	4199999
8	212938	2	5	70	1866	1581	0	4261311	4200000	4799999
9	818277	3	16	65	1133	1226	1196	5083035	4800000	5399999
10	782687	1	12	95	1582	0	0	5869277	5400000	5999999
11	420035	2	12	95	1182	1062	0	6290894	6000000	6599999
12	544507	3	12	75	1303	1222	1820	6837645	6600000	7199999
13	385022	1	20	60	1305	0	0	7227012	7200000	7799999
14	815431	1	19	90	1668	0	0	8043748	7800000	8399999
15	614401	1	10	55	1888	0	0	8659817	8400000	8999999
16	693415	3	16	100	1786	1427	1626	9355120	9000000	9599999
17	641462	1	12	65	1524	0	0	10001421	9600000	10199999
18	422762	1	17	55	1127	0	0	10425707	10200000	10799999
19	607370	2	20	100	1243	1435	0	11034204	10800000	11399999
20	765354	1	15	85	1410	0	0	11802236	11400000	11999999

Total number of pulses in waveform = 38

Radar Type 6 - Radar Statistical Performance

Trail #	Test Freq. (MHz)	1=Detection 0=No Detection	Trail #	Test Freq. (MHz)	1=Detection 0=No Detection
1	5329	1	16	5329	1
2	5329	1	17	5329	1
3	5329	1	18	5329	1
4	5329	1	19	5329	1
5	5329	1	20	5329	1
6	5329	1	21	5329	1
7	5329	1	22	5329	1
8	5329	1	23	5329	1
9	5329	1	24	5329	1
10	5329	1	25	5329	1
11	5329	1	26	5329	1
12	5329	1	27	5329	1
13	5329	1	28	5329	1
14	5329	1	29	5329	1
15	5329	1	30	5329	1
Detection Percentage (%)					100%

Radar waveform #1			Radar waveform #2		
Hopping Number	Frequency (MHz)	Pulse Start (ms)	Hopping Number	Frequency (MHz)	Pulse Start (ms)
3	5334	9	9	5330	27
13	5353	39	11	5311	33
15	5342	45	24	5340	72
23	5335	69	55	5312	165
33	5352	99	56	5348	168
35	5351	105	72	5357	216
41	5303	123	73	5351	219
46	5355	138	83	5306	249
47	5322	141	88	5303	264
54	5324	162	89	5353	267
58	5306	174	90	5344	270
70	5350	210	95	5326	285
75	5300	225	--	--	--
76	5345	228	--	--	--
79	5320	237	--	--	--
94	5349	282	--	--	--
97	5316	291	--	--	--
99	5304	297	--	--	--

Radar waveform #3			Radar waveform #4		
Hopping Number	Frequency (MHz)	Pulse Start (ms)	Hopping Number	Frequency (MHz)	Pulse Start (ms)
9	5319	27	6	5351	18
10	5322	30	13	5324	39
11	5321	33	25	5334	75
16	5311	48	35	5313	105
32	5334	96	37	5325	111
39	5312	117	56	5309	168
42	5299	126	70	5339	210
45	5338	135	73	5356	219
51	5330	153	85	5322	255
57	5354	171	87	5320	261
60	5345	180	88	5305	264
75	5340	225	98	5327	294
79	5303	237	--	--	--
81	5335	243	--	--	--
90	5336	270	--	--	--
91	5349	273	--	--	--
92	5350	276	--	--	--
93	5305	279	--	--	--

Radar waveform #5			Radar waveform #6		
Hopping Number	Frequency (MHz)	Pulse Start (ms)	Hopping Number	Frequency (MHz)	Pulse Start (ms)
4	5317	12	1	5303	3
24	5303	72	24	5302	72
26	5357	78	31	5310	93
35	5312	105	40	5337	120
37	5326	111	42	5309	126
40	5328	120	44	5318	132
48	5324	144	46	5344	138
53	5306	159	68	5322	204
59	5300	177	84	5348	252
61	5341	183	86	5324	258
63	5351	189	96	5304	288
77	5299	231	--	--	--
80	5304	240	--	--	--

Radar waveform #7			Radar waveform #8		
Hopping Number	Frequency (MHz)	Pulse Start (ms)	Hopping Number	Frequency (MHz)	Pulse Start (ms)
2	5322	6	34	5338	102
16	5321	48	36	5347	108
22	5305	66	37	5316	111
37	5356	111	43	5314	129
57	5319	171	59	5309	177
60	5355	180	60	5303	180
74	5344	222	68	5351	204
77	5349	231	70	5354	210
82	5304	246	72	5305	216
86	5335	258	85	5340	255
87	5345	261	91	5336	273
96	5342	288	98	5355	294
99	5312	297	--	--	--

Radar waveform #9			Radar waveform #10		
Hopping Number	Frequency (MHz)	Pulse Start (ms)	Hopping Number	Frequency (MHz)	Pulse Start (ms)
1	5324	3	20	5331	60
11	5318	33	21	5343	63
52	5351	156	29	5328	87
54	5321	162	31	5341	93
59	5346	177	36	5346	108
62	5326	186	41	5305	123
71	5337	213	48	5327	144
73	5302	219	50	5354	150
74	5352	222	54	5322	162
87	5308	261	55	5307	165
92	5349	276	58	5303	174
--	--	--	61	5339	183
--	--	--	66	5355	198
--	--	--	76	5359	228
--	--	--	91	5335	273
--	--	--	98	5301	294

Radar waveform #11			Radar waveform #12		
Hopping Number	Frequency (MHz)	Pulse Start (ms)	Hopping Number	Frequency (MHz)	Pulse Start (ms)
11	5330	33	0	5315	0
26	5337	78	5	5332	15
28	5347	84	14	5326	42
50	5354	150	21	5302	63
53	5345	159	31	5358	93
54	5336	162	34	5299	102
56	5300	168	40	5348	120
60	5343	180	44	5359	132
61	5342	183	46	5319	138
64	5316	192	52	5330	156
65	5321	195	77	5350	231
80	5325	240	80	5314	240
82	5312	246	81	5346	243
84	5341	252	84	5303	252
--	--	--	90	5333	270
--	--	--	95	5329	285

Radar waveform #13			Radar waveform #14		
Hopping Number	Frequency (MHz)	Pulse Start (ms)	Hopping Number	Frequency (MHz)	Pulse Start (ms)
2	5356	6	11	5321	33
24	5343	72	25	5356	75
31	5329	93	28	5358	84
39	5304	117	47	5345	141
66	5334	198	63	5326	189
73	5357	219	70	5310	210
83	5302	249	73	5336	219
95	5305	285	79	5315	237
--	--	--	80	5353	240
--	--	--	85	5323	255
--	--	--	90	5331	270
--	--	--	99	5346	297

Radar waveform #15			Radar waveform #16		
Hopping Number	Frequency (MHz)	Pulse Start (ms)	Hopping Number	Frequency (MHz)	Pulse Start (ms)
17	5348	51	5	5324	15
20	5322	60	6	5306	18
23	5339	69	10	5347	30
28	5345	84	28	5315	84
30	5305	90	37	5305	111
36	5300	108	38	5319	114
38	5335	114	39	5340	117
49	5359	147	43	5332	129
52	5333	156	47	5341	141
56	5338	168	49	5326	147
66	5321	198	56	5349	168
75	5337	225	61	5344	183
78	5320	234	78	5301	234
91	5326	273	84	5317	252
99	5314	297	89	5359	267
--	--	--	95	5350	285
--	--	--	99	5355	297

Radar waveform #17			Radar waveform #18		
Hopping Number	Frequency (MHz)	Pulse Start (ms)	Hopping Number	Frequency (MHz)	Pulse Start (ms)
14	5358	42	12	5334	36
15	5304	45	14	5342	42
33	5312	99	18	5337	54
41	5342	123	31	5306	93
51	5325	153	47	5347	141
68	5356	204	48	5330	144
75	5330	225	50	5352	150
83	5353	249	69	5335	207
--	--	--	73	5350	219
--	--	--	75	5307	225
--	--	--	78	5309	234
--	--	--	92	5331	276
--	--	--	97	5339	291

Radar waveform #19			Radar waveform #20		
Hopping Number	Frequency (MHz)	Pulse Start (ms)	Hopping Number	Frequency (MHz)	Pulse Start (ms)
9	5328	27	2	5321	6
16	5337	48	4	5330	12
30	5341	90	5	5302	15
36	5302	108	6	5319	18
51	5324	153	12	5318	36
56	5313	168	25	5316	75
59	5326	177	29	5350	87
61	5335	183	31	5346	93
63	5353	189	46	5352	138
66	5346	198	52	5332	156
72	5306	216	53	5334	159
74	5312	222	66	5337	198
94	5340	282	70	5312	210
--	--	--	82	5314	246

Radar waveform #21			Radar waveform #22		
Hopping Number	Frequency (MHz)	Pulse Start (ms)	Hopping Number	Frequency (MHz)	Pulse Start (ms)
0	5327	0	7	5349	21
3	5319	9	9	5327	27
15	5337	45	13	5343	39
19	5338	57	17	5304	51
23	5320	69	31	5324	93
32	5328	96	40	5345	120
39	5323	117	55	5351	165
43	5322	129	57	5305	171
49	5347	147	71	5322	213
53	5333	159	72	5341	216
56	5307	168	76	5330	228
61	5325	183	80	5300	240
62	5354	186	--	--	--
68	5308	204	--	--	--
92	5341	276	--	--	--

Radar waveform #23			Radar waveform #24		
Hopping Number	Frequency (MHz)	Pulse Start (ms)	Hopping Number	Frequency (MHz)	Pulse Start (ms)
2	5324	6	11	5309	33
6	5316	18	14	5343	42
7	5337	21	15	5345	45
31	5352	93	17	5324	51
46	5310	138	20	5339	60
52	5340	156	21	5351	63
56	5311	168	27	5318	81
66	5319	198	29	5333	87
72	5341	216	43	5301	129
80	5358	240	48	5325	144
87	5350	261	51	5350	153
91	5333	273	57	5331	171
95	5348	285	58	5340	174
96	5345	288	60	5344	180
--	--	--	72	5317	216
--	--	--	77	5338	231
--	--	--	83	5357	249
--	--	--	84	5315	252
--	--	--	87	5314	261
--	--	--	88	5358	264
--	--	--	99	5305	297

Radar waveform #25			Radar waveform #26		
Hopping Number	Frequency (MHz)	Pulse Start (ms)	Hopping Number	Frequency (MHz)	Pulse Start (ms)
3	5305	9	2	5348	6
9	5341	27	4	5345	12
18	5324	54	12	5312	36
20	5307	60	23	5322	69
21	5342	63	36	5324	108
45	5354	135	38	5305	114
67	5323	201	41	5341	123
68	5340	204	48	5306	144
69	5327	207	56	5340	168
78	5304	234	57	5331	171
81	5358	243	82	5311	246
85	5329	255	83	5346	249
88	5338	264	99	5317	297
89	5349	267	--	--	--
90	5331	270	--	--	--

Radar waveform #27			Radar waveform #28		
Hopping Number	Frequency (MHz)	Pulse Start (ms)	Hopping Number	Frequency (MHz)	Pulse Start (ms)
8	5348	24	13	5305	39
12	5318	36	24	5340	72
33	5351	99	26	5348	78
34	5353	102	47	5335	141
35	5333	105	64	5337	192
36	5312	108	68	5330	204
37	5346	111	81	5318	243
45	5355	135	85	5301	255
47	5358	141	87	5336	261
56	5308	168	88	5332	264
65	5317	195	--	--	--
70	5322	210	--	--	--
74	5316	222	--	--	--
96	5323	288	--	--	--
97	5338	291	--	--	--
98	5356	294	--	--	--
99	5306	297	--	--	--

Radar waveform #29			Radar waveform #30		
Hopping Number	Frequency (MHz)	Pulse Start (ms)	Hopping Number	Frequency (MHz)	Pulse Start (ms)
3	5318	9	5	5317	15
8	5309	24	18	5354	54
9	5354	27	23	5314	69
14	5356	42	25	5337	75
29	5311	87	26	5299	78
54	5337	162	37	5342	111
71	5355	213	39	5359	117
84	5310	252	60	5350	180
85	5346	255	62	5328	186
90	5350	270	66	5318	198
94	5324	282	71	5305	213
96	5312	288	73	5336	219
97	5314	291	92	5348	276
--	--	--	95	5343	285
--	--	--	98	5332	294

Radar Statistical Performance for 802.11ac-VHT80

Radar Type 1 - Radar Statistical Performance

Trail #	Test Freq. (MHz)	Pulse Width (us)	PRI (us)	Pulses / Burst	1=Detection 0=No Detection
1	5251	1	918	58	1
2	5251	1	878	61	1
3	5251	1	538	99	1
4	5251	1	738	72	1
5	5251	1	798	67	1
6	5251	1	598	89	1
7	5251	1	698	76	1
8	5251	1	838	63	1
9	5251	1	818	65	1
10	5251	1	518	102	1
11	5251	1	718	74	1
12	5251	1	558	95	1
13	5251	1	638	83	1
14	5251	1	578	92	1
15	5251	1	858	62	1
16	5251	1	2183	25	1
17	5251	1	1358	39	1
18	5251	1	1322	40	1
19	5251	1	2686	20	1
20	5251	1	1529	35	1
21	5251	1	1523	35	1
22	5251	1	527	101	1
23	5251	1	1782	30	1
24	5251	1	2941	18	1
25	5251	1	1684	32	1
26	5251	1	2051	26	1
27	5251	1	2569	21	1
28	5251	1	3041	18	1
29	5251	1	2817	19	1
30	5251	1	1258	42	1
Detection Percentage (%)					100%

Radar Type 2 - Radar Statistical Performance

Trail #	Test Freq. (MHz)	Pulse Width (us)	PRI (us)	Pulses / Burst	1=Detection 0=No Detection
1	5270	5.0	227	26	1
2	5270	2.2	218	23	1
3	5270	4.0	181	29	1
4	5270	3.2	185	27	1
5	5270	2.9	217	25	1
6	5270	4.0	187	23	1
7	5270	5.0	191	27	1
8	5270	2.8	163	25	1
9	5270	1.1	215	25	1
10	5270	4.0	200	25	1
11	5270	3.4	171	25	1
12	5270	1.8	189	25	1
13	5270	4.1	176	25	1
14	5270	3.5	159	24	1
15	5270	2.5	157	24	1
16	5270	4.2	216	28	1
17	5270	3.4	225	23	1
18	5270	4.5	175	26	1
19	5270	2.1	175	25	1
20	5270	3.3	165	25	1
21	5270	2.8	185	29	1
22	5270	3.9	230	27	1
23	5270	4.7	208	23	1
24	5270	1.7	223	25	1
25	5270	1.2	171	24	1
26	5270	2.8	179	27	1
27	5270	1.8	181	23	1
28	5270	3.7	193	29	1
29	5270	4.3	195	26	1
30	5270	3.0	215	24	1
Detection Percentage (%)					100%

Radar Type 3 - Radar Statistical Performance

Trail #	Test Freq. (MHz)	Pulse Width (us)	PRI (us)	Pulses / Burst	1=Detection 0=No Detection
1	5290	6.9	495	16	1
2	5290	6.0	399	16	1
3	5290	8.6	291	16	1
4	5290	7.8	284	17	1
5	5290	7.5	253	16	1
6	5290	6.4	376	17	1
7	5290	8.8	449	17	1
8	5290	8.5	455	17	1
9	5290	8.2	318	18	1
10	5290	8.8	325	17	1
11	5290	8.8	293	17	1
12	5290	6.3	311	16	1
13	5290	6.7	403	18	1
14	5290	6.2	482	16	1
15	5290	8.8	307	18	1
16	5290	9.0	366	17	1
17	5290	9.3	466	17	1
18	5290	6.1	387	16	1
19	5290	8.1	355	18	1
20	5290	9.5	258	18	1
21	5290	6.2	406	17	1
22	5290	9.9	353	17	1
23	5290	9.0	491	17	1
24	5290	8.0	486	17	1
25	5290	6.3	319	16	1
26	5290	7.1	403	16	1
27	5290	8.0	325	17	1
28	5290	9.9	282	18	1
29	5290	9.0	331	17	1
30	5290	9.3	259	17	1
Detection Percentage (%)					100%

Radar Type 4 - Radar Statistical Performance

Trail #	Test Freq. (MHz)	Pulse Width (us)	PRI (us)	Pulses / Burst	1=Detection 0=No Detection
1	5305	18.3	308	13	1
2	5305	12.3	444	16	1
3	5305	17.5	273	16	1
4	5305	13.8	396	16	1
5	5305	18.2	319	12	1
6	5305	16.8	496	16	1
7	5305	17.1	462	14	1
8	5305	11.2	495	16	1
9	5305	11.6	419	16	1
10	5305	17.3	438	15	1
11	5305	15.4	334	13	1
12	5305	13.5	416	16	1
13	5305	15.7	491	15	1
14	5305	17.0	266	15	1
15	5305	15.4	366	13	1
16	5305	17.5	369	15	1
17	5305	17.2	275	12	1
18	5305	12.7	262	16	1
19	5305	18.4	406	12	1
20	5305	13.3	344	13	1
21	5305	14.0	457	15	1
22	5305	15.5	443	15	1
23	5305	16.8	415	13	1
24	5305	14.5	429	15	1
25	5305	13.3	273	14	1
26	5305	19.6	394	14	1
27	5305	15.3	480	16	1
28	5305	15.4	303	14	1
29	5305	18.6	486	12	1
30	5305	18.9	262	13	1
Detection Percentage (%)					100%

Note: In addition an average minimum percentage of successful detection across all four Short pulse radar test

waveforms is as follows:
$$\frac{P_d1 + P_d2 + P_d3 + P_d4}{4} = (100\% + 100\% + 100\% + 100\%) / 4 = 100\% (>80\%)$$



Radar Type 5 - Radar Statistical Performance

Trail #	Test Freq. (MHz)	1=Detection 0=No Detection	Trail #	Test Freq. (MHz)	1=Detection 0=No Detection
1	5310	1	16	5310	1
2	5310	1	17	5310	1
3	5310	1	18	5310	1
4	5310	1	19	5310	1
5	5310	1	20	5310	1
6	5310	1	21	5310	1
7	5310	1	22	5310	1
8	5310	1	23	5310	1
9	5310	1	24	5310	1
10	5310	1	25	5310	1
11	5310	1	26	5310	1
12	5310	1	27	5310	1
13	5310	1	28	5310	1
14	5310	1	29	5310	1
15	5310	1	30	5310	1
Detection Percentage (%)					100%

Type 5 Radar Waveform_1										
Waveform Num = 1 Num of Bursts = 19 Burst Interval (us) = 631579 Burst Off Time (us) = 496124										
#	Off Time (us)	# Pulses	Chirp (MHz)	PW (us)	Pulse 1 Pri (us)	Pulse 2 Pri (us)	Pulse 3 Pri (us)	Start Loc (us)	Start Burst Interval (us)	End Burst Interval (us)
1	496124	3	13	85	1977	1073	1092	496124	0	631578
2	635941	2	18	65	1920	1884	0	1136207	631579	1263157
3	189563	1	5	95	1990	0	0	1329574	1263158	1894736
4	1111404	1	11	65	1564	0	0	2442968	1894737	2526315
5	609520	2	11	60	1141	1378	0	3054052	2526316	3157894
6	362442	2	15	55	1210	1908	0	3419013	3157895	3789473
7	716527	1	19	70	1095	0	0	4138658	3789474	4421052
8	806856	3	19	70	1811	1869	1308	4946609	4421053	5052631
9	235414	2	9	90	1617	1686	0	5187011	5052632	5684210
10	944531	3	19	90	1244	1810	1198	6134845	5684211	6315789
11	220895	1	15	55	1856	0	0	6359992	6315790	6947368
12	828410	3	11	80	1679	1327	1936	7190258	6947369	7578947
13	638437	2	17	60	1886	1741	0	7833637	7578948	8210526
14	391173	2	10	95	1695	1735	0	8228437	8210527	8842105
15	1059438	1	13	55	1509	0	0	9291305	8842106	9473684
16	786384	3	14	65	1121	1963	1636	10079198	9473685	10105263
17	321619	1	15	80	1792	0	0	10405537	10105264	10736842
18	923599	1	16	85	1801	0	0	11330928	10736843	11368421
19	541471	2	11	80	1864	1144	0	11874200	11368422	12000000
Total number of pulses in waveform = 36										



Type 5 Radar Waveform_2

Waveform Num = 2
Num of Bursts = 11
Burst Interval (us)= 1090909

Burst #	Off Time (us)	# Pulses	Chirp (MHz)	PW (us)	Pulse 1 Pri (us)	Pulse 2 Pri (us)	Pulse 3 Pri (us)	Start Loc (us)	Start Burst Interval (us)	End Burst Interval (us)
1	751990	1	13	80	1685	0	0	751990	0	1090908
2	1128391	3	13	85	1891	1051	1865	1882066	1090909	2181817
3	847508	3	20	90	1534	1982	1059	2734381	2181818	3272726
4	1273816	1	20	80	1896	0	0	4012772	3272727	4363635
5	1290862	2	14	95	1867	1639	0	5305530	4363636	5454544
6	347169	2	19	65	1800	1916	0	5656205	5454545	6545453
7	1530413	3	13	100	1468	1247	1562	7190334	6545454	7636362
8	1351334	3	19	60	1983	1756	1686	8545945	7636363	8727271
9	825317	2	10	80	1846	1153	0	9376687	8727272	9818180
10	772070	2	8	60	1558	1029	0	10151756	9818181	10909089
11	891765	2	18	100	1536	1155	0	11046108	10909090	11999998

Total number of pulses in waveform = 24

Type 5 Radar Waveform_3

Waveform Num = 3
Num of Bursts = 11
Burst Interval (us)= 1090909

Burst #	Off Time (us)	# Pulses	Chirp (MHz)	PW (us)	Pulse 1 Pri (us)	Pulse 2 Pri (us)	Pulse 3 Pri (us)	Start Loc (us)	Start Burst Interval (us)	End Burst Interval (us)
1	598860	3	18	55	1040	1858	1685	598860	0	1090908
2	681671	2	12	70	1575	1568	0	1285114	1090909	2181817
3	984091	2	8	80	1003	1002	0	2272348	2181818	3272726
4	1587838	1	8	70	1698	0	0	3862191	3272727	4363635
5	1522219	3	16	80	1209	1293	1050	5386108	4363636	5454544
6	316900	1	8	80	1500	0	0	5706560	5454545	6545453
7	1924899	2	19	80	1173	1481	0	7632959	6545454	7636362
8	479978	1	8	75	1275	0	0	8115591	7636363	8727271
9	1528875	1	18	55	1962	0	0	9645741	8727272	9818180
10	623685	2	11	60	1805	1297	0	10271388	9818181	10909089
11	1381833	2	13	60	1097	1960	0	11656323	10909090	11999998

Total number of pulses in waveform = 20

Type 5 Radar Waveform_4

Waveform Num = 4
Num of Bursts = 17
Burst Interval (us)= 705882

Burst #	Off Time (us)	# Pulses	Chirp (MHz)	PW (us)	Pulse 1 Pri (us)	Pulse 2 Pri (us)	Pulse 3 Pri (us)	Start Loc (us)	Start Burst Interval (us)	End Burst Interval (us)
1	204080	1	13	50	1131	0	0	204080	0	705881
2	884268	2	12	85	1360	1380	0	1089479	705882	1411763
3	1014432	1	11	95	1595	0	0	2106651	1411764	2117645
4	277561	3	9	50	1603	1975	1111	2385807	2117646	2823527
5	574337	1	17	60	1929	0	0	2964833	2823528	3529409
6	758428	1	9	65	1290	0	0	3725190	3529410	4235291
7	562657	3	19	100	1125	1175	1643	4289137	4235292	4941173
8	1205541	1	16	95	1043	0	0	5498621	4941174	5647055
9	413429	3	17	90	1327	1958	1877	5913093	5647056	6352937
10	989107	1	17	90	1586	0	0	6907362	6352938	7058819
11	206826	2	7	100	1317	1397	0	7115774	7058820	7764701
12	904364	3	13	70	1389	1412	1217	8022852	7764702	8470583
13	825147	2	9	95	1871	1063	0	8852017	8470584	9176465
14	482724	3	17	90	1401	1882	1233	9337675	9176466	9882347
15	998885	3	12	75	1283	1977	1030	10341076	9882348	10588229
16	651319	3	15	95	1708	1424	1090	10996685	10588230	11294111
17	791356	3	11	75	1849	1195	1005	11792263	11294112	11999993

Total number of pulses in waveform = 36



Type 5 Radar Waveform_5

Waveform Num = 5
Num of Bursts = 10
Burst Interval (us)= 1200000

Burst #	Off Time (us)	# Pulses	Chirp (MHz)	PW (us)	Pulse 1 Pri (us)	Pulse 2 Pri (us)	Pulse 3 Pri (us)	Start Loc (us)	Start Burst Interval (us)	End Burst Interval (us)
1	844572	2	20	75	1562	1759	0	844572	0	1199999
2	605417	3	20	50	1022	1992	1041	1453310	1200000	2399999
3	1810487	1	13	75	1433	0	0	3267852	2400000	3599999
4	352061	2	6	80	1849	1881	0	3621346	3600000	4799999
5	1472445	1	18	65	1493	0	0	5097521	4800000	5999999
6	1393480	3	19	95	1263	1074	1936	6492494	6000000	7199999
7	1073522	3	15	55	1182	1726	1568	7570289	7200000	8399999
8	1618150	1	9	60	1820	0	0	9192915	8400000	9599999
9	1398921	1	11	85	1837	0	0	10593656	9600000	10799999
10	512326	3	15	85	1242	1203	1851	11107819	10800000	11999999

Total number of pulses in waveform = 20

Type 5 Radar Waveform_6

Waveform Num = 6
Num of Bursts = 20
Burst Interval (us)= 600000

Burst #	Off Time (us)	# Pulses	Chirp (MHz)	PW (us)	Pulse 1 Pri (us)	Pulse 2 Pri (us)	Pulse 3 Pri (us)	Start Loc (us)	Start Burst Interval (us)	End Burst Interval (us)
1	240579	2	18	85	1499	1643	0	240579	0	599999
2	474382	2	10	100	1371	1265	0	718103	600000	1199999
3	637968	3	13	55	1971	1981	1893	1358707	1200000	1799999
4	851679	3	15	85	1284	1677	1703	2216231	1800000	2399999
5	194836	2	9	50	1389	1308	0	2415731	2400000	2999999
6	625109	3	20	90	1430	1470	1065	3043537	3000000	3599999
7	1104795	3	13	55	1190	1363	1676	4152297	3600000	4199999
8	44779	2	17	65	1837	1850	0	4201305	4200000	4799999
9	1037793	2	9	60	1643	1079	0	5242785	4800000	5399999
10	448791	3	17	95	1126	1856	1103	5694298	5400000	5999999
11	611192	2	10	55	1114	1524	0	6309575	6000000	6599999
12	364918	1	10	80	1665	0	0	6677131	6600000	7199999
13	701671	3	8	75	1163	1077	1574	7380467	7200000	7799999
14	684419	2	12	55	1745	1361	0	8068700	7800000	8399999
15	756923	1	14	60	1088	0	0	8828729	8400000	8999999
16	248595	1	10	95	1274	0	0	9078412	9000000	9599999
17	1054025	2	14	85	1103	1082	0	10133711	9600000	10199999
18	241711	3	12	55	1428	1332	1349	10377607	10200000	10799999
19	421240	3	13	70	1583	1902	1095	10802956	10800000	11399999
20	629965	3	10	50	1586	1243	1833	11437501	11400000	11999999

Total number of pulses in waveform = 46

Type 5 Radar Waveform_7

Waveform Num = 7
Num of Bursts = 15
Burst Interval (us)= 800000

Burst #	Off Time (us)	# Pulses	Chirp (MHz)	PW (us)	Pulse 1 Pri (us)	Pulse 2 Pri (us)	Pulse 3 Pri (us)	Start Loc (us)	Start Burst Interval (us)	End Burst Interval (us)
1	580544	2	17	65	1114	1885	0	580544	0	799999
2	865316	2	14	70	1321	1373	0	1448859	800000	1599999
3	184533	3	19	90	1244	1788	1896	1636086	1600000	2399999
4	1112087	1	13	90	1229	0	0	2753101	2400000	3199999
5	1239223	1	10	70	1467	0	0	3993553	3200000	3999999
6	207325	2	19	60	1861	1250	0	4202345	4000000	4799999
7	968973	2	10	95	1030	1356	0	5174429	4800000	5599999
8	1053885	1	20	65	1323	0	0	6230700	5600000	6399999
9	459068	2	11	65	1943	1766	0	6691091	6400000	7199999
10	1161609	2	13	85	1766	1100	0	7856409	7200000	7999999
11	916916	1	14	60	1068	0	0	8776191	8000000	8799999
12	242366	3	7	65	1633	1066	1532	9019625	8800000	9599999
13	615506	1	10	50	1879	0	0	9639362	9600000	10399999
14	1434963	3	8	75	1202	1533	1361	11076204	10400000	11199999
15	335832	1	18	50	1011	0	0	11416132	11200000	11999999

Total number of pulses in waveform = 27



Type 5 Radar Waveform_8

Waveform Num = 8
Num of Bursts = 10
Burst Interval (us)= 1200000

Burst #	Off Time (us)	# Pulses	Chirp (MHz)	PW (us)	Pulse 1 Pri (us)	Pulse 2 Pri (us)	Pulse 3 Pri (us)	Start Loc (us)	Start Burst Interval (us)	End Burst Interval (us)
1	781431	2	11	80	1545	1167	0	781431	0	1199999
2	965107	3	10	95	1622	1145	1977	1749250	1200000	2399999
3	1057674	2	13	100	1480	1724	0	2811668	2400000	3599999
4	1896304	2	18	65	1014	1387	0	4711176	3600000	4799999
5	708171	3	13	65	1064	1106	1536	5421748	4800000	5999999
6	1662083	3	5	70	1125	1492	1486	7087537	6000000	7199999
7	633575	2	5	75	1615	1610	0	7725215	7200000	8399999
8	1017799	3	6	75	1939	1247	1071	8746239	8400000	9599999
9	1656139	3	12	90	1561	1251	1261	10406635	9600000	10799999
10	1345681	1	9	100	1593	0	0	11756389	10800000	11999999

Total number of pulses in waveform = 24

Type 5 Radar Waveform_9

Waveform Num = 9
Num of Bursts = 11
Burst Interval (us)= 1090909

Burst #	Off Time (us)	# Pulses	Chirp (MHz)	PW (us)	Pulse 1 Pri (us)	Pulse 2 Pri (us)	Pulse 3 Pri (us)	Start Loc (us)	Start Burst Interval (us)	End Burst Interval (us)
1	993353	1	12	50	1098	0	0	993353	0	1090908
2	99287	3	14	90	1039	1552	1777	1093738	1090909	2181817
3	2114859	1	10	50	1485	0	0	3212965	2181818	3272726
4	190307	3	15	75	1578	1285	1282	3404757	3272727	4363635
5	1003981	2	6	95	1516	1177	0	4412883	4363636	5454544
6	1086745	3	13	90	1806	1398	1490	5502321	5454545	6545453
7	1702714	2	9	65	1122	1788	0	7209729	6545454	7636362
8	593566	3	9	100	1911	1441	1481	7806205	7636363	8727271
9	1263205	3	15	80	1030	1931	1520	9074243	8727272	9818180
10	1284092	3	6	90	1344	1563	1218	10362816	9818181	10909089
11	669413	2	12	60	1809	1643	0	11036354	10909090	11999998

Total number of pulses in waveform = 26

Type 5 Radar Waveform_10

Waveform Num = 10
Num of Bursts = 17
Burst Interval (us)= 705882

Burst #	Off Time (us)	# Pulses	Chirp (MHz)	PW (us)	Pulse 1 Pri (us)	Pulse 2 Pri (us)	Pulse 3 Pri (us)	Start Loc (us)	Start Burst Interval (us)	End Burst Interval (us)
1	100672	1	15	70	1752	0	0	100672	0	705881
2	1130990	2	17	95	1371	1153	0	1233414	705882	1411763
3	819510	1	20	50	1185	0	0	2055448	1411764	2111764
4	508442	1	8	55	1598	0	0	2565075	2117646	2823527
5	957709	3	18	100	1690	1363	1612	3524382	2823528	3529409
6	582057	2	17	90	1326	1509	0	4111104	3529410	4235291
7	621566	3	8	80	1584	1277	1779	4735505	4235292	4941173
8	492516	1	11	55	1508	0	0	5232661	4941174	5647055
9	520060	1	8	55	1083	0	0	5754229	5647056	6352937
10	829409	3	14	75	1558	1192	1710	6584721	6352938	7058819
11	604691	2	7	75	1345	1983	0	7193872	7058820	7764701
12	1013000	2	17	65	1553	1743	0	8210200	7764702	8470583
13	889675	1	11	60	1720	0	0	9103171	8470584	9176465
14	751532	1	14	65	1841	0	0	9856423	9176466	9882347
15	149830	1	5	55	1168	0	0	10008094	9882348	10588229
16	682179	2	9	90	1951	1885	0	10691441	10588230	11294111
17	1018903	1	8	70	1768	0	0	11714180	11294112	11999993

Total number of pulses in waveform = 28



Type 5 Radar Waveform_11

Waveform Num = 11
Num of Bursts = 10
Burst Interval (us)= 1200000

Burst #	Off Time (us)	# Pulses	Chirp (MHz)	PW (us)	Pulse 1 Pri (us)	Pulse 2 Pri (us)	Pulse 3 Pri (us)	Start Loc (us)	Start Burst Interval (us)	End Burst Interval (us)
1	210647	3	19	50	1805	1613	1834	210647	0	1199999
2	1347157	1	17	65	1813	0	0	1563056	1200000	2399999
3	916251	2	19	95	1233	1890	0	2481120	2400000	3599999
4	1422102	1	18	95	1308	0	0	3906345	3600000	4799999
5	1576616	2	14	65	1814	1612	0	5484269	4800000	5999999
6	551163	1	6	90	1075	0	0	6032858	6000000	7199999
7	1849544	2	20	65	1354	1686	0	7889477	7200000	8399999
8	866351	3	16	75	1597	1237	1460	8758868	8400000	9599999
9	1344277	2	12	80	1265	1375	0	10107439	9600000	10799999
10	1397862	3	19	55	1753	1498	1175	11507941	10800000	11999999

Total number of pulses in waveform = 20

Type 5 Radar Waveform_12

Waveform Num = 12
Num of Bursts = 15
Burst Interval (us)= 800000

Burst #	Off Time (us)	# Pulses	Chirp (MHz)	PW (us)	Pulse 1 Pri (us)	Pulse 2 Pri (us)	Pulse 3 Pri (us)	Start Loc (us)	Start Burst Interval (us)	End Burst Interval (us)
1	621395	3	13	70	1270	1045	1741	621395	0	799999
2	280142	3	11	90	1566	1914	1431	905593	800000	1599999
3	904008	2	15	65	1551	1264	0	1814512	1600000	2399999
4	1062565	2	20	65	1756	1715	0	2879892	2400000	3199999
5	722833	3	19	50	1430	1128	1932	3606196	3200000	3999999
6	1177432	3	10	55	1697	1077	1897	4788118	4000000	4799999
7	798197	3	10	55	1406	1504	1266	5590986	4800000	5599999
8	743106	1	6	100	1283	0	0	6338268	5600000	6399999
9	417784	2	16	95	1806	1332	0	6757335	6400000	7199999
10	746577	1	6	90	1866	0	0	7507050	7200000	7999999
11	1039542	2	20	55	1004	1964	0	8548458	8000000	8799999
12	324641	2	14	95	1615	1541	0	8876067	8800000	9599999
13	1176031	3	19	85	1883	1973	1478	10055254	9600000	10399999
14	1088049	2	18	95	1038	1797	0	11148637	10400000	11199999
15	302405	3	13	50	1987	1429	1492	11453877	11200000	11999999

Total number of pulses in waveform = 35

Type 5 Radar Waveform_13

Waveform Num = 13
Num of Bursts = 20
Burst Interval (us)= 600000

Burst #	Off Time (us)	# Pulses	Chirp (MHz)	PW (us)	Pulse 1 Pri (us)	Pulse 2 Pri (us)	Pulse 3 Pri (us)	Start Loc (us)	Start Burst Interval (us)	End Burst Interval (us)
1	289392	3	16	70	1418	1998	1695	289392	0	599999
2	671455	3	20	85	1881	1857	1936	965958	600000	1199999
3	397010	1	20	70	1037	0	0	1368642	1200000	1799999
4	709977	3	8	50	1435	1957	1102	2079656	1800000	2399999
5	806462	1	8	60	1159	0	0	2890612	2400000	2999999
6	665784	1	14	90	1719	0	0	3557555	3000000	3599999
7	126328	2	11	60	1989	1609	0	3685602	3600000	4199999
8	1100271	2	17	75	1079	1311	0	4789471	4200000	4799999
9	501539	2	6	1398	95	1005	0	5293400	4800000	5399999
10	481960	2	18	95	1618	1354	0	5777763	5400000	5999999
11	674054	1	6	65	1768	0	0	6454789	6000000	6599999
12	584190	3	8	50	1446	1680	1535	7040747	6600000	7199999
13	265889	2	5	55	1263	1565	0	7311297	7200000	7799999
14	823002	3	10	50	1335	1327	1832	8137127	7800000	8399999
15	579181	2	7	100	1354	1860	0	8720802	8400000	8999999
16	427800	2	5	80	1469	1630	0	9151816	9000000	9599999
17	555186	3	6	60	1415	1313	1010	9710101	9600000	10199999
18	914866	2	16	85	1855	1589	0	10628705	10200000	10799999
19	541097	2	20	90	1988	1717	0	11173246	10800000	11399999
20	501127	1	5	90	1270	0	0	11678078	11400000	11999999

Total number of pulses in waveform = 41



Type 5 Radar Waveform_14

```
Waveform Num = 14
Num of Bursts = 19
Burst Interval (us) = 631579
```

Burst #	Off Time (us)	# Pulses	Chirp (MHz)	PW (us)	Pulse 1 Pri (us)	Pulse 2 Pri (us)	Pulse 3 Pri (us)	Start Loc (us)	Start Burst Interval (us)	End Burst Interval (us)
1	601751	3	6	50	1781	1961	1776	601751	0	631578
2	604870	2	5	80	1864	1322	0	1212139	631579	1263157
3	588302	2	16	100	1092	1385	0	1803627	1263158	1894736
4	534923	1	12	95	1741	0	0	2341027	1894737	2526315
5	612337	2	15	65	1350	1373	0	2955105	2526316	3157894
6	225664	1	16	95	1656	0	0	3183492	3157895	3789473
7	808033	3	20	80	1229	1904	1893	3993181	3789474	4421052
8	983664	2	11	80	1994	1476	0	4981871	4421053	5052631
9	114088	1	18	90	1682	0	0	5099429	5052632	5684210
10	925961	3	15	65	1474	1094	1674	6027072	5684211	6315789
11	538476	1	12	80	1417	0	0	6569790	6315790	6947368
12	829839	1	12	85	1600	0	0	7401046	6947369	7578947
13	277281	2	12	80	1791	1361	0	7679927	7578948	8210526
14	530077	2	7	55	1432	1904	0	8213156	8210527	8842105
15	1200664	3	17	80	1500	1582	1204	9417156	8842106	9473684
16	140776	2	11	95	1179	1500	0	9562218	9473685	10105263
17	853958	2	13	55	1793	1249	0	10418855	10105264	10736842
18	614589	1	17	75	1318	0	0	11036486	10736843	11368421
19	482135	3	11	50	1121	1628	1831	11519939	11368422	12000000

Total number of pulses in waveform = 37

Type 5 Radar Waveform_15

```
Waveform Num = 15
Num of Bursts = 9
Burst Interval (us) = 1333333
```

Burst #	Off Time (us)	# Pulses	Chirp (MHz)	PW (us)	Pulse 1 Pri (us)	Pulse 2 Pri (us)	Pulse 3 Pri (us)	Start Loc (us)	Start Burst Interval (us)	End Burst Interval (us)
1	1087457	1	8	100	1636	0	0	1087457	0	1333332
2	1418994	2	14	55	1587	1077	0	2508087	1333333	2666665
3	520029	1	11	90	1858	0	0	3030780	2666666	3999998
4	1182246	2	14	85	1026	1966	0	4214884	3999999	5333331
5	1427717	3	5	90	1488	1872	1446	5645593	5333332	6666664
6	1299190	1	7	50	1596	0	0	6949589	6666665	7999997
7	1718238	2	16	75	1682	1863	0	8669423	7999998	9333330
8	1813058	3	14	80	1227	1179	1566	10486026	9333331	10666663
9	1171662	1	6	65	1710	0	0	11661660	10666664	11999996

Total number of pulses in waveform = 16

Type 5 Radar Waveform_16

```
Waveform Num = 16
Num of Bursts = 10
Burst Interval (us) = 1200000
```

Burst #	Off Time (us)	# Pulses	Chirp (MHz)	PW (us)	Pulse 1 Pri (us)	Pulse 2 Pri (us)	Pulse 3 Pri (us)	Start Loc (us)	Start Burst Interval (us)	End Burst Interval (us)
1	130679	2	19	55	1559	1081	0	130679	0	1199999
2	1985940	3	16	70	1075	1955	1597	2119259	1200000	2399999
3	634407	1	17	70	1115	0	0	2758293	2400000	3599999
4	1425080	3	19	55	1469	1630	1756	4184488	3600000	4799999
5	848475	1	5	75	1774	0	0	5037818	4800000	5999999
6	1246239	2	20	80	1943	1631	0	6285831	6000000	7199999
7	1065709	1	12	60	1314	0	0	7355114	7200000	8399999
8	2209730	1	13	75	1474	0	0	9566158	8400000	9599999
9	492192	2	16	90	1495	1111	0	10059824	9600000	10799999
10	1655428	1	10	90	1229	0	0	11717858	10800000	11999999

Total number of pulses in waveform = 17



Type 5 Radar Waveform_17

Waveform Num = 17
Num of Bursts = 13
Burst Interval (us) = 923077

Burst #	Off Time (us)	# Pulses	Chirp (MHz)	PW (us)	Pulse 1 Pri (us)	Pulse 2 Pri (us)	Pulse 3 Pri (us)	Start Loc (us)	Start Burst Interval (us)	End Burst Interval (us)
1	370991	3	20	75	1092	1213	1144	370991	0	923076
2	941341	2	8	55	1573	1247	0	1315781	923077	1846153
3	1171576	3	5	100	1276	1716	1164	2490177	1846154	2769230
4	331139	3	15	70	1271	1667	1063	2825472	2769231	3692307
5	1585604	3	11	65	1589	1775	1375	4415077	3692308	4615384
6	248180	3	20	55	1680	1807	1416	4667996	4615385	5538461
7	1609993	2	11	65	1386	1735	0	6282892	5538462	6461538
8	863698	2	14	95	1553	1974	0	7149711	6461539	7384615
9	1118592	1	11	90	1487	0	0	8271830	7384616	8307692
10	130171	1	9	95	1180	0	0	8403488	8307693	9230769
11	1469372	2	14	95	1507	1051	0	9874040	9230770	10153846
12	696864	2	9	55	1273	1755	0	10573462	10153847	11076923
13	936069	1	10	90	1132	0	0	11512559	11076924	12000000

Total number of pulses in waveform = 28

Type 5 Radar Waveform_18

Waveform Num = 18
Num of Bursts = 17
Burst Interval (us) = 705882

Burst #	Off Time (us)	# Pulses	Chirp (MHz)	PW (us)	Pulse 1 Pri (us)	Pulse 2 Pri (us)	Pulse 3 Pri (us)	Start Loc (us)	Start Burst Interval (us)	End Burst Interval (us)
1	477898	3	18	60	1129	1129	1256	477898	0	705881
2	654457	2	18	85	1093	1217	0	1135869	705882	1411763
3	940239	1	20	100	1760	0	0	2078418	1411764	2117645
4	424246	2	11	70	1253	1331	0	2504424	2117646	2823527
5	675416	1	7	85	1494	0	0	3182424	2823528	3529409
6	827386	1	7	90	1250	0	0	4011304	3529410	4235291
7	768337	3	17	85	1353	1485	1728	4780891	4235292	4941173
8	704709	1	9	75	1607	0	0	5490166	4941174	5647055
9	763211	3	18	55	1308	1087	1267	6254984	5647056	6352937
10	250911	2	5	65	1531	1772	0	6509557	6352938	7058819
11	751648	3	5	75	1776	1240	1582	7264508	7058820	7764701
12	585293	1	6	65	1254	0	0	7854399	7764702	8470583
13	782052	3	17	95	1307	1315	1103	8637705	8470584	9176465
14	1133952	2	5	50	1361	1745	0	9775382	9176466	9882347
15	737034	2	19	55	1003	1085	0	10515522	9882348	10588229
16	589588	2	7	75	1180	1493	0	11107198	10588230	11294111
17	197616	1	12	50	1204	0	0	11307487	11294112	11999993

Total number of pulses in waveform = 33

Type 5 Radar Waveform_19

Waveform Num = 19
Num of Bursts = 18
Burst Interval (us) = 666667

Burst #	Off Time (us)	# Pulses	Chirp (MHz)	PW (us)	Pulse 1 Pri (us)	Pulse 2 Pri (us)	Pulse 3 Pri (us)	Start Loc (us)	Start Burst Interval (us)	End Burst Interval (us)
1	433227	3	7	80	1528	1955	1585	433227	0	666666
2	337961	2	20	95	1759	1357	0	776256	666667	1333333
3	698933	2	14	70	1486	1819	0	1478305	1333334	2000000
4	1073457	3	6	80	1219	1998	1917	2555067	2000001	2666667
5	483506	3	5	70	1992	1956	1535	3043707	2666668	3333334
6	475528	2	19	95	1577	1213	0	3524718	3333335	4000001
7	850065	1	5	95	1764	0	0	4377573	4000002	4666668
8	429490	3	11	70	1591	1544	1232	4808827	4666669	5333335
9	1056415	1	10	80	1474	0	0	5869609	5333336	6000002
10	488328	3	11	80	1919	1670	1281	6359411	6000003	6666669
11	671561	2	5	95	1956	1079	0	7035842	6666670	7333336
12	411056	1	15	85	1994	0	0	7449933	7333337	8000003
13	865061	1	10	55	1702	0	0	8316988	8000004	8666670
14	826956	1	20	90	1176	0	0	9145646	8666671	9333337
15	395686	3	8	95	1348	1682	1091	9542508	9333338	10000004
16	923913	1	20	95	1404	0	0	10470542	10000005	10666671
17	215466	2	12	55	1081	1550	0	10687412	10666672	11333338
18	891787	2	16	55	1354	1898	0	11581830	11333339	12000005

Total number of pulses in waveform = 36



Type 5 Radar Waveform_20

```
Waveform Num = 20
Num of Bursts = 20
Burst Interval (us)= 600000
```

Burst #	Off Time (us)	# Pulses	Chirp (MHz)	PW (us)	Pulse 1 Pri (us)	Pulse 2 Pri (us)	Pulse 3 Pri (us)	Start Loc (us)	Start Burst Interval (us)	End Burst Interval (us)
1	278757	1	18	100	1348	0	0	278757	0	599999
2	891920	2	17	95	1274	1712	0	1172025	600000	1199999
3	176127	3	10	75	1930	1859	1045	1351138	1200000	1799999
4	798638	1	13	65	1801	0	0	2154610	1800000	2399999
5	316630	3	13	85	1750	1464	1785	2473041	2400000	2999999
6	771418	1	7	65	1756	0	0	3249458	3000000	3599999
7	377279	1	15	50	1313	0	0	3628493	3600000	4199999
8	954296	3	13	95	1121	1043	1651	4584102	4200000	4799999
9	752058	2	10	80	1667	1151	0	5339975	4800000	5399999
10	635605	3	5	50	1387	1679	1133	5978398	5400000	5999999
11	306677	1	13	55	1460	0	0	6289274	6000000	6599999
12	464203	1	13	55	1981	0	0	6754937	6600000	7199999
13	919327	1	19	100	1730	0	0	7676245	7200000	7799999
14	450291	2	20	70	1628	1395	0	8128266	7800000	8399999
15	290246	2	18	85	1925	1514	0	8421535	8400000	8999999
16	756359	3	5	75	1235	1574	1757	9181333	9000000	9599999
17	768440	1	13	75	1121	0	0	9954339	9600000	10199999
18	382911	3	5	75	1791	1118	1243	10338371	10200000	10799999
19	853032	1	6	80	1298	0	0	11195555	10800000	11399999
20	759310	2	16	80	1075	1368	0	11956163	11400000	11999999

Total number of pulses in waveform = 37

Type 5 Radar Waveform_21

```
Waveform Num = 21
Num of Bursts = 13
Burst Interval (us)= 923077
```

Burst #	Off Time (us)	# Pulses	Chirp (MHz)	PW (us)	Pulse 1 Pri (us)	Pulse 2 Pri (us)	Pulse 3 Pri (us)	Start Loc (us)	Start Burst Interval (us)	End Burst Interval (us)
1	615573	3	7	55	1797	1689	1574	615573	0	923076
2	484131	3	5	85	1377	1022	1664	1104764	923077	1846153
3	947713	2	17	95	1513	1318	0	2056540	1846154	2769230
4	903972	2	5	95	1514	1383	0	2963343	2769231	3692307
5	1583366	3	8	55	1379	1002	1081	4549606	3692308	4615384
6	670467	1	18	100	1463	0	0	5223535	4615385	5538461
7	855485	1	19	85	1862	0	0	6080483	5538462	6461538
8	1261405	3	6	55	1109	1411	1996	7343750	6461539	7384615
9	264281	2	5	65	1405	1686	0	7612547	7384616	8307692
10	1322665	1	8	95	1510	0	0	8938303	8307693	9230769
11	1110398	3	13	50	1139	1185	1699	10050211	9230770	10153846
12	118549	1	13	75	1884	0	0	10172783	10153847	11076923
13	1225621	1	6	65	1510	0	0	11400288	11076924	12000000

Total number of pulses in waveform = 26

Type 5 Radar Waveform_22

```
Waveform Num = 22
Num of Bursts = 11
Burst Interval (us)= 1090909
```

Burst #	Off Time (us)	# Pulses	Chirp (MHz)	PW (us)	Pulse 1 Pri (us)	Pulse 2 Pri (us)	Pulse 3 Pri (us)	Start Loc (us)	Start Burst Interval (us)	End Burst Interval (us)
1	429467	1	20	95	1097	0	0	429467	0	1090908
2	1654030	2	14	80	1181	1932	0	2084594	1090909	2181817
3	334438	3	17	50	1925	1885	1877	2422145	2181818	3272726
4	1820227	2	14	70	1843	1305	0	4248059	3272727	4363635
5	268292	3	14	75	1746	1876	1225	4519499	4363636	5454544
6	1081577	3	15	60	1523	1991	1106	5605923	5454545	6545453
7	1005425	1	13	50	1944	0	0	6615968	6545454	7636362
8	1079531	3	14	80	1560	1941	1821	7697443	7636363	8727271
9	1147030	3	6	95	1252	1237	1626	8849795	8727272	9818180
10	1583605	2	9	50	1374	1741	0	10437515	9818181	10909089
11	838706	3	20	55	1523	1108	1396	11279336	10909090	11999998

Total number of pulses in waveform = 26



Type 5 Radar Waveform_23

Waveform Num = 23
 Num of Bursts = 19
 Burst Interval (us) = 631579
 Burst # Off Time (us) # Pulses Chirp (MHz) PW (us) Pulse 1 Pri (us) Pulse 2 Pri (us) Pulse 3 Pri (us) Start Loc (us) Start Burst Interval (us) End Burst Interval (us)

1	85157	2	8	70	1339	1512	0	85157	0	631578
2	579979	3	13	90	1328	1670	1664	667987	631579	1263157
3	944753	2	14	75	1129	1869	0	1617402	1263158	1894736
4	556890	3	19	65	1861	1273	1432	2177290	1894737	2526315
5	868485	3	12	80	1801	1169	1660	3050341	2526316	3157894
6	396781	1	6	55	1136	0	0	3451752	3157895	3789473
7	429428	1	7	60	1557	0	0	3882316	3789474	4421052
8	674872	3	10	50	1084	1652	1654	458745	4421053	5052631
9	1072121	3	16	80	1040	1229	1638	5635256	5052632	5684210
10	602318	1	19	70	1322	0	0	6241481	5684211	6315789
11	588988	2	20	50	1037	1496	0	6831791	6315790	6947368
12	511376	1	17	95	1282	0	0	7345700	6947369	7578947
13	278945	1	16	90	1939	0	0	7625927	7578948	8210526
14	1068893	3	11	85	1434	1577	1767	8696759	8210527	8842105
15	282351	3	5	50	1645	1535	1432	8983888	8842106	9473684
16	770373	3	17	85	1975	1442	1585	9758873	9473685	10105263
17	952767	1	15	50	1051	0	0	10716642	10105264	10736842
18	219507	2	14	55	1473	1863	0	10937200	10736843	11368421
19	965503	1	19	80	1918	0	0	11906039	11368422	12000000

Total number of pulses in waveform = 39

Type 5 Radar Waveform_24

Waveform Num = 24
 Num of Bursts = 9
 Burst Interval (us) = 1333333

Burst #	Off Time (us)	# Pulses	Chirp (MHz)	PW (us)	Pulse 1 Pri (us)	Pulse 2 Pri (us)	Pulse 3 Pri (us)	Start Loc (us)	Start Burst Interval (us)	End Burst Interval (us)
1	593147	2	20	70	1039	1618	0	593147	0	1333332
2	1781960	1	10	100	1491	0	0	2377764	1333333	2666665
3	331919	3	16	100	1997	1791	1851	2711174	2666666	3999998
4	1912279	2	5	75	1228	1851	0	4629092	3999999	5333331
5	1095185	2	5	60	1912	1417	0	5727356	5333332	6666664
6	1070379	2	20	100	1591	1827	0	6801064	6666665	7999997
7	2302032	3	20	85	1881	1819	1915	9106514	7999998	9333330
8	626115	2	20	75	1396	1283	0	9738244	9333331	10666663
9	1319137	3	8	65	1087	1987	1744	11060060	10666664	11999996

Total number of pulses in waveform = 20

Type 5 Radar Waveform_25

Waveform Num = 25
 Num of Bursts = 14
 Burst Interval (us) = 857143

Burst #	Off Time (us)	# Pulses	Chirp (MHz)	PW (us)	Pulse 1 Pri (us)	Pulse 2 Pri (us)	Pulse 3 Pri (us)	Start Loc (us)	Start Burst Interval (us)	End Burst Interval (us)
1	131264	3	14	55	1750	1234	1916	131264	0	857142
2	1037637	2	9	85	1029	1415	0	1173801	857143	1714285
3	1210587	2	9	50	1516	1178	0	2386832	1714286	2571428
4	487003	1	18	95	1735	0	0	2876529	2571429	3428571
5	965579	1	10	90	1085	0	0	3843843	3428572	4285714
6	1205084	3	14	90	1616	1267	1356	5050012	4285715	5142857
7	711188	1	16	100	1193	0	0	5765439	5142858	6000000
8	1044233	1	7	100	1859	0	0	6810865	6000001	6857143
9	259926	3	15	100	1150	1859	1943	7072650	6857144	7714286
10	851906	1	5	85	1125	0	0	7929508	7714287	8571429
11	645877	2	12	50	1049	1290	0	8576510	8571430	9428572
12	1090243	3	11	80	1350	1185	1801	9669092	9428573	10285715
13	1202431	3	14	85	1789	1344	1964	10875859	10285716	11142858
14	662197	2	10	65	1811	1113	0	11543153	11142859	12000001

Total number of pulses in waveform = 28



Type 5 Radar Waveform_26

Waveform Num = 26
Num of Bursts = 10
Burst Interval (us) = 1200000

Burst #	Off Time (us)	# Pulses	Chirp (MHz)	PW (us)	Pulse 1 Pri (us)	Pulse 2 Pri (us)	Pulse 3 Pri (us)	Start Loc (us)	Start Burst Interval (us)	End Burst Interval (us)
1	542952	1	19	100	1811	0	0	542952	0	1199999
2	1621500	3	20	80	1553	1657	1277	2166263	1200000	2399999
3	790204	2	11	95	1831	1969	0	2960954	2400000	3599999
4	920885	1	15	90	1312	0	0	3885639	3600000	4799999
5	925614	3	6	90	1780	1568	1397	4812565	4800000	5999999
6	2005372	3	16	75	1228	1826	1866	6822682	6000000	7199999
7	392944	1	9	90	1334	0	0	7220546	7200000	8399999
8	1947625	1	16	80	1018	0	0	9169505	8400000	9599999
9	946838	2	14	75	1899	1633	0	10117411	9600000	10799999
10	1552137	3	17	55	1842	1818	1715	11673080	10800000	11999999

Total number of pulses in waveform = 20

Type 5 Radar Waveform_27

Waveform Num = 27
Num of Bursts = 13
Burst Interval (us) = 923077

Burst #	Off Time (us)	# Pulses	Chirp (MHz)	PW (us)	Pulse 1 Pri (us)	Pulse 2 Pri (us)	Pulse 3 Pri (us)	Start Loc (us)	Start Burst Interval (us)	End Burst Interval (us)
1	253741	2	13	55	1429	1279	0	253741	0	923076
2	1410988	2	20	95	1060	1223	0	1667437	923077	1846153
3	532082	1	19	60	1096	0	0	2201802	1846154	2769230
4	995900	2	12	95	1052	1094	0	3198798	2769231	3692307
5	857531	3	15	100	1030	1767	1002	4058475	3692308	4615384
6	563681	2	18	95	1757	1562	0	4625955	4615385	5538461
7	1225917	1	8	50	1265	0	0	5855191	5538462	6461538
8	1330178	2	19	75	1457	1017	0	7186634	6461539	7384615
9	453332	1	16	95	1630	0	0	7642440	7384616	8307692
10	1290356	1	7	75	1455	0	0	8934426	8307693	9230769
11	787878	3	9	100	1650	1983	1260	9723759	9230770	10153846
12	1097981	2	10	55	1163	1770	0	10826633	10153847	11076923
13	908736	1	16	80	1908	0	0	11738302	11076924	12000000

Total number of pulses in waveform = 23

Type 5 Radar Waveform_28

Waveform Num = 28
Num of Bursts = 10
Burst Interval (us) = 1200000

Burst #	Off Time (us)	# Pulses	Chirp (MHz)	PW (us)	Pulse 1 Pri (us)	Pulse 2 Pri (us)	Pulse 3 Pri (us)	Start Loc (us)	Start Burst Interval (us)	End Burst Interval (us)
1	914856	3	12	80	1486	1989	1265	914856	0	1199999
2	855543	1	8	80	1917	0	0	1775139	1200000	2399999
3	1518537	2	17	85	1555	1095	0	3295593	2400000	3599999
4	1197852	2	9	75	1845	1474	0	4496095	3600000	4799999
5	934152	2	10	95	1128	1897	0	5433566	4800000	5999999
6	632163	2	18	50	1037	1091	0	6068754	6000000	7199999
7	1904490	3	9	100	1068	1495	1233	7975372	7200000	8399999
8	644500	2	6	75	1025	1077	0	8623668	8400000	9599999
9	1762362	2	10	75	1137	1059	0	10388132	9600000	10799999
10	1351475	3	8	55	1759	1798	1016	11741803	10800000	11999999

Total number of pulses in waveform = 22



Type 5 Radar Waveform_29

Waveform Num = 29
Num of Bursts = 10
Burst Interval (us)= 1200000

Burst #	Off Time (us)	# Pulses	Chirp (MHz)	PW (us)	Pulse 1 Pri (us)	Pulse 2 Pri (us)	Pulse 3 Pri (us)	Start Loc (us)	Start Burst Interval (us)	End Burst Interval (us)
1	462811	2	9	55	1673	1448	0	462811	0	1199999
2	1238296	1	12	70	1848	0	0	1704228	1200000	2399999
3	1336650	2	13	60	1774	1865	0	3042726	2400000	3599999
4	1538332	3	9	85	1809	1492	1333	4584697	3600000	4799999
5	359495	1	12	90	1757	0	0	4948326	4800000	5999999
6	1102027	1	13	100	1204	0	0	6052610	6000000	7199999
7	1676642	1	9	55	1455	0	0	7730456	7200000	8399999
8	1751910	2	7	90	1648	1785	0	9483821	8400000	9599999
9	171227	1	6	95	1531	0	0	9658481	9600000	10799999
10	1196564	1	6	60	1106	0	0	10856576	10800000	11999999

Total number of pulses in waveform = 15

Type 5 Radar Waveform_30

Waveform Num = 30
Num of Bursts = 9
Burst Interval (us)= 1333333

Burst #	Off Time (us)	# Pulses	Chirp (MHz)	PW (us)	Pulse 1 Pri (us)	Pulse 2 Pri (us)	Pulse 3 Pri (us)	Start Loc (us)	Start Burst Interval (us)	End Burst Interval (us)
1	1261524	1	13	70	1236	0	0	1261524	0	1333332
2	140489	3	14	85	1016	1484	1266	1403249	1333333	2666665
3	1300117	1	8	100	1256	0	0	2707132	2666666	3999998
4	2299842	3	7	70	1384	1543	1352	5008230	3999999	5333331
5	447084	3	8	60	1791	1542	1766	5459593	5333332	6666664
6	1202227	3	14	90	1025	1505	1180	6666919	6666665	7999997
7	1726595	2	6	60	1000	1617	0	8397224	7999998	9333330
8	1260135	2	18	55	1996	1195	0	9659976	9333331	10666663
9	1052165	2	17	70	1903	1766	0	10715332	10666664	11999996

Total number of pulses in waveform = 20

Radar Type 6 - Radar Statistical Performance

Trail #	Test Freq. (MHz)	1=Detection 0=No Detection	Trail #	Test Freq. (MHz)	1=Detection 0=No Detection
1	5329	1	16	5329	1
2	5329	1	17	5329	1
3	5329	1	18	5329	1
4	5329	1	19	5329	1
5	5329	1	20	5329	1
6	5329	1	21	5329	1
7	5329	1	22	5329	1
8	5329	1	23	5329	1
9	5329	1	24	5329	1
10	5329	1	25	5329	1
11	5329	1	26	5329	1
12	5329	1	27	5329	1
13	5329	1	28	5329	1
14	5329	1	29	5329	1
15	5329	1	30	5329	1
Detection Percentage (%)					100%

Radar waveform #1			Radar waveform #2		
Hopping Number	Frequency (MHz)	Pulse Start (ms)	Hopping Number	Frequency (MHz)	Pulse Start (ms)
0	5308	0	11	5321	33
13	5320	39	20	5319	60
33	5301	99	24	5318	72
38	5311	114	51	5308	153
41	5324	123	52	5358	156
52	5329	156	62	5333	186
66	5335	198	66	5349	198
74	5356	222	68	5329	204
75	5351	225	71	5312	213
77	5355	231	90	5341	270
80	5353	240	99	5328	297
85	5348	255	--	--	--
96	5310	288	--	--	--
98	5345	294	--	--	--

Radar waveform #3			Radar waveform #4		
Hopping Number	Frequency (MHz)	Pulse Start (ms)	Hopping Number	Frequency (MHz)	Pulse Start (ms)
3	5335	9	13	5304	39
12	5316	36	28	5327	84
18	5356	54	30	5323	90
32	5303	96	40	5336	120
34	5312	102	55	5311	165
44	5304	132	57	5329	171
45	5324	135	59	5314	177
55	5317	165	65	5348	195
56	5326	168	77	5333	231
59	5352	177	78	5312	234
60	5323	180	92	5353	276
82	5299	246	96	5308	288
--	--	--	98	5352	294

Radar waveform #5			Radar waveform #6		
Hopping Number	Frequency (MHz)	Pulse Start (ms)	Hopping Number	Frequency (MHz)	Pulse Start (ms)
27	5352	81	7	5300	21
30	5316	90	17	5356	51
39	5299	117	29	5355	87
55	5343	165	47	5315	141
59	5331	177	50	5346	150
63	5357	189	55	5312	165
66	5314	198	59	5302	177
76	5320	228	84	5340	252
78	5330	234	93	5348	279
81	5359	243	95	5321	285
85	5332	255	99	5299	297
91	5307	273	--	--	--

Radar waveform #7			Radar waveform #8		
Hopping Number	Frequency (MHz)	Pulse Start (ms)	Hopping Number	Frequency (MHz)	Pulse Start (ms)
2	5305	6	6	5335	18
5	5350	15	10	5316	30
8	5346	24	32	5336	96
11	5333	33	36	5340	108
18	5328	54	42	5357	126
20	5331	60	54	5341	162
37	5344	111	61	5312	183
41	5359	123	66	5299	198
53	5322	159	71	5353	213
55	5316	165	77	5319	231
65	5335	195	94	5333	282
71	5330	213	98	5338	294
74	5355	222	--	--	--

Radar waveform #9			Radar waveform #10		
Hopping Number	Frequency (MHz)	Pulse Start (ms)	Hopping Number	Frequency (MHz)	Pulse Start (ms)
12	5356	36	6	5337	18
21	5347	63	8	5349	24
32	5311	96	14	5314	42
43	5320	129	24	5306	72
49	5344	147	46	5299	138
54	5300	162	48	5358	144
55	5332	165	64	5307	192
63	5303	189	68	5346	204
72	5309	216	73	5347	219
80	5341	240	95	5338	285
98	5342	294	99	5352	297

Radar waveform #11			Radar waveform #12		
Hopping Number	Frequency (MHz)	Pulse Start (ms)	Hopping Number	Frequency (MHz)	Pulse Start (ms)
11	5333	33	18	5307	54
13	5342	39	22	5302	66
14	5308	42	30	5305	90
28	5349	84	31	5314	93
56	5318	168	34	5357	102
58	5327	174	49	5330	147
60	5309	180	54	5353	162
79	5301	237	55	5333	165
80	5306	240	57	5328	171
86	5343	258	58	5346	174
93	5299	279	73	5351	219
--	--	--	74	5354	222
--	--	--	82	5329	246
--	--	--	83	5315	249

Radar waveform #13			Radar waveform #14		
Hopping Number	Frequency (MHz)	Pulse Start (ms)	Hopping Number	Frequency (MHz)	Pulse Start (ms)
3	5316	9	1	5303	3
14	5328	42	14	5326	42
16	5348	48	20	5339	60
18	5305	54	34	5311	102
25	5315	75	35	5357	105
31	5345	93	42	5346	126
35	5308	105	50	5327	150
36	5319	108	54	5302	162
45	5318	135	55	5332	165
53	5317	159	64	5301	192
60	5303	180	84	5309	252
75	5321	225	85	5299	255
87	5330	261	89	5330	267
89	5322	267	98	5313	294

Radar waveform #15			Radar waveform #16		
Hopping Number	Frequency (MHz)	Pulse Start (ms)	Hopping Number	Frequency (MHz)	Pulse Start (ms)
5	5306	15	4	5358	12
12	5302	36	6	5337	18
15	5336	45	7	5300	21
31	5353	93	13	5311	39
34	5344	102	22	5338	66
36	5321	108	23	5349	69
42	5338	126	26	5314	78
83	5313	249	42	5336	126
90	5311	270	45	5301	135
97	5319	291	50	5335	150
99	5323	297	62	5330	186
--	--	--	65	5350	195
--	--	--	68	5310	204
--	--	--	83	5341	249
--	--	--	84	5333	252
--	--	--	86	5299	258
--	--	--	94	5320	282

Radar waveform #17			Radar waveform #18		
Hopping Number	Frequency (MHz)	Pulse Start (ms)	Hopping Number	Frequency (MHz)	Pulse Start (ms)
21	5309	63	1	5355	3
29	5303	87	13	5309	39
37	5345	111	17	5356	51
44	5357	132	19	5346	57
58	5317	174	20	5359	60
64	5347	192	30	5350	90
81	5308	243	39	5349	117
90	5331	270	55	5342	165
--	--	--	69	5344	207
--	--	--	91	5352	273
--	--	--	93	5321	279

Radar waveform #19			Radar waveform #20		
Hopping Number	Frequency (MHz)	Pulse Start (ms)	Hopping Number	Frequency (MHz)	Pulse Start (ms)
0	5309	0	4	5315	12
3	5350	9	16	5350	48
4	5339	12	23	5307	69
13	5354	39	30	5310	90
27	5349	81	42	5347	126
40	5322	120	43	5339	129
44	5347	132	53	5326	159
54	5323	162	54	5352	162
75	5301	225	56	5314	168
--	--	--	58	5353	174
--	--	--	61	5301	183
--	--	--	72	5340	216

Radar waveform #21			Radar waveform #22		
Hopping Number	Frequency (MHz)	Pulse Start (ms)	Hopping Number	Frequency (MHz)	Pulse Start (ms)
8	5299	24	19	5307	57
17	5326	51	22	5339	66
24	5321	72	32	5315	96
25	5304	75	37	5337	111
36	5308	108	47	5358	141
43	5340	129	60	5345	180
57	5345	171	64	5342	192
59	5301	177	74	5320	222
61	5359	183	96	5303	288
62	5302	186	--	--	--
64	5309	192	--	--	--
80	5356	240	--	--	--
82	5320	246	--	--	--
83	5348	249	--	--	--
88	5322	264	--	--	--
90	5343	270	--	--	--

Radar waveform #23			Radar waveform #24		
Hopping Number	Frequency (MHz)	Pulse Start (ms)	Hopping Number	Frequency (MHz)	Pulse Start (ms)
2	5356	6	13	5356	39
34	5314	102	22	5311	66
39	5315	117	24	5302	72
40	5303	120	28	5336	84
57	5347	171	40	5357	120
68	5311	204	46	5333	138
70	5306	210	62	5338	186
72	5358	216	68	5348	204
80	5353	240	77	5322	231
88	5355	264	88	5350	264
96	5329	288	--	--	--
99	5336	297	--	--	--

Radar waveform #25			Radar waveform #26		
Hopping Number	Frequency (MHz)	Pulse Start (ms)	Hopping Number	Frequency (MHz)	Pulse Start (ms)
1	5331	3	2	5310	6
2	5327	6	6	5335	18
17	5342	51	33	5349	99
28	5340	84	38	5332	114
34	5301	102	41	5320	123
37	5303	111	42	5346	126
48	5337	144	43	5330	129
49	5329	147	51	5302	153
55	5349	165	52	5326	156
59	5322	177	60	5317	180
68	5325	204	75	5312	225
72	5309	216	83	5347	249
91	5343	273	90	5356	270
93	5344	279	91	5355	273
96	5320	288	--	--	--

Radar waveform #27			Radar waveform #28		
Hopping Number	Frequency (MHz)	Pulse Start (ms)	Hopping Number	Frequency (MHz)	Pulse Start (ms)
12	5345	36	10	5313	30
14	5310	42	11	5341	33
21	5329	63	22	5319	66
36	5356	108	29	5343	87
53	5321	159	32	5310	96
57	5307	171	35	5324	105
60	5357	180	38	5321	114
63	5339	189	45	5312	135
82	5351	246	47	5356	141
83	5332	249	53	5306	159
87	5358	261	61	5318	183
90	5304	270	66	5339	198
92	5335	276	77	5316	231
--	--	--	80	5337	240
--	--	--	84	5350	252
--	--	--	87	5309	261
--	--	--	94	5300	282
--	--	--	96	5330	288

Radar waveform #29			Radar waveform #30		
Hopping Number	Frequency (MHz)	Pulse Start (ms)	Hopping Number	Frequency (MHz)	Pulse Start (ms)
1	5330	3	42	5303	126
3	5314	9	47	5329	141
15	5301	45	63	5352	189
21	5302	63	66	5323	198
38	5322	114	73	5350	219
52	5346	156	77	5351	231
70	5299	210	87	5322	261
81	5338	243	--	--	--
91	5332	273	--	--	--
96	5327	288	--	--	--
97	5308	291	--	--	--

6. CONCLUSION

The data collected relate only the item(s) tested and show that the **WIFI dual band 4 GE LAN GPON HGU FCC ID: 2ABLK-8X4G-1V2** is in compliance with Part 15E of the FCC Rules.

The End