



DFS MEASUREMENT REPORT

FCC PART 15.407 / IC RSS-210 WLAN 802.11a/n/ac

FCC ID: 2ABLK-8X4G-1
IC: 4009A-8X4G1
APPLICANT: Calix Inc.
Application Type: Certification
Product: WIFI dual band 4 GE LAN GPON HGU
Model No.: 844G-1, 854G-1
Brand Name: Calix
FCC Classification: Unlicensed National Information Infrastructure (UNII)
FCC Rule Part(s): Part 15.407
IC Specification(s): RSS-210 Issue 8
Type of Device: Master Device
 Client Device (No radar detection)
 Client Device with radar detection
Test Date: July 23 ~ 29, 2014

Reviewed By : Robin Wu
(Robin Wu)

Approved By : Marlin Chen
(Marlin Chen)



The test results relate only to the samples tested.

This equipment has been shown to be capable of compliance with the applicable technical standards as indicated in the measurement report and was tested in accordance with the measurement procedures specified in KDB 905462 D01. Test results reported herein relate only to the item(s) tested.

The test report shall not be reproduced except in full without the written approval of MRT Technology (Suzhou) Co., Ltd.

Revision History

Report No.	Version	Description	Issue Date
1407RSU01405	Rev. 01	Initial report	08-06-2014

CONTENTS

Description	Page
Revision History.....	2
§2.1033 General Information	5
1. INTRODUCTION	6
1.1. Scope	6
1.2. MRT Test Location	6
2. PRODUCT INFORMATION	7
2.1. Equipment Description.....	7
2.2. Description of Available Antennas	8
2.3. DFS Band Carrier Frequencies Operation	9
2.4. Test Mode	9
3. DFS DETECTION THRESHOLDS AND RADAR TEST WAVEFORMS.....	10
3.1. Applicability	10
3.2. DFS Devices Requirements.....	11
3.3. DFS Detection Threshold Values	12
3.4. Parameters of DFS Test Signals	13
3.5. Conducted Test Setup	14
4. TEST EQUIPMENT CALIBRATION DATE	15
5. TEST RESULT	16
5.1. Summary	16
5.2. Radar Waveform Calibration.....	17
5.2.1. Calibration Setup	17
5.2.2. Calibration Procedure	17
5.2.3. Cablibration Result	18
5.2.4. Test Setup Photo	21
5.3. UNII Detection Bandwidth Measurement	22
5.3.1. Test Limit	22
5.3.2. Test Procedure	22
5.3.3. Test Result.....	23
5.4. Initial Channel Availability Check Time Measurement	29
5.4.1. Test Limit	29
5.4.2. Test Procedure	29
5.4.3. Test Result.....	30
5.5. Radar Burst at the Beginning of the Channel Availability Check Time Measurement ..	31

5.5.1. Test Limit	31
5.5.2. Test Procedure	31
5.5.3. Test Result.....	32
5.6. Radar Burst at the End of the Channel Availability Check Time Measurement	33
5.6.1. Test Limit	33
5.6.2. Test Procedure	33
5.6.3. Test Result.....	34
5.7. In-Service Monitoring for Channel Move Time, Channel Closing Transmission Time and Non-Occupancy Period Measurement.....	35
5.7.1. Test Limit	35
5.7.2. Test Procedure Used	35
5.7.3. Test Result.....	36
5.8. Statistical Performance Check Measurement.....	38
5.8.1. Test Limit	38
5.8.2. Test Procedure	38
5.8.3. Test Result.....	40
6. CONCLUSION.....	114

§2.1033 General Information

Applicant:	Calix Inc.
Applicant Address:	1035 N. McDowell Blvd Petaluma, CA94954 U.S.A
Manufacturer:	Calix Inc.
Manufacturer Address:	1035 N. McDowell Blvd Petaluma, CA94954 U.S.A
Test Site:	MRT Technology (Suzhou) Co., Ltd
Test Site Address:	D8 Building, Youxin Industrial Park, No.2 Tian'edang Rd., Wuzhong Economic Development Zone, Suzhou, China
MRT Registration No.:	809388
MRT IC Registration No.:	11384A
Model No.:	844G-1, 854G-1
FCC ID:	2ABLK-8X4G-1
IC:	4009A-8X4G1
Test Device Serial No.:	N/A <input type="checkbox"/> Production <input checked="" type="checkbox"/> Pre-Production <input type="checkbox"/> Engineering
Date(s) of Test:	July 23 ~ 29, 2014
Test Report S/N:	1407RSU01405

Test Facility / Accreditations

Measurements were performed at MRT Laboratory located in Tian'edang Rd., Suzhou, China.

- MRT Lab is accredited to ISO 17025 by the American Association for Laboratory Accreditation (A2LA) under the American Association for Laboratory Accreditation Program (A2LA Cert. No. 3628.01) in EMC, Telecommunications and Radio testing for FCC, Industry Canada, EU and TELEC Rules.
- MRT facility is a FCC registered (MRT Reg. No. 809388) test facility with the site description report on file and has met all the requirements specified in Section 2.948 of the FCC Rules and Industry Canada (11384A-1).
- MRT facility is an IC registered (11384A-1) test laboratory with the site description on file at Industry Canada.



1. INTRODUCTION

1.1. Scope

Measurement and determination of electromagnetic emissions (EMC) of radio frequency devices including intentional and/or unintentional radiators for compliance with the technical rules and regulations of the Federal Communications Commission and the Industry Canada Certification and Engineering Bureau.

1.2. MRT Test Location

The map below shows the location of the MRT LABORATORY, its proximity to the Taihu Lake. These measurement tests were conducted at the MRT Technology (Suzhou) Co., Ltd. Facility located at D8 Building, Youxin Industrial Park, No.2 Tian'edang Rd., Wuzhong Economic Development Zone, Suzhou, China. The detailed description of the measurement facility was found to be in compliance with the requirements of § 2.948 according to ANSI C63.4-2009 on September 30, 2013.



2. PRODUCT INFORMATION

2.1. Equipment Description

Product Name	WIFI dual band 4 GE LAN GPON HGU
Model No.	844G-1, 854G-1
Radio Type	Intentional Transceiver
Operation Mode	Master Device
Frequency Range	<p>For 802.11a/n-HT20: 5260~5320MHz, 5500~5580, 5660~5700MHz</p> <p>For 802.11ac-VHT20: 5260~5320MHz, 5500~5580MHz, 5660~5720MHz</p> <p>For 802.11n-HT40: 5270~5310MHz, 5510~5550MHz, 5670MHz</p> <p>For 802.11ac-VHT40: 5270~5310MHz, 5510~5550MHz, 5670~5710MHz</p> <p>For 802.11ac-VHT80: 5290MHz, 5530MHz, 5690MHz</p>
Maximum Output Power	<p>802.11a: 20.73dBm</p> <p>802.11n-HT20: 20.55dBm</p> <p>802.11n-HT40: 20.35dBm</p> <p>802.11ac-VHT20: 20.28dBm</p> <p>802.11ac-VHT40: 20.42dBm</p> <p>802.11ac-VHT80: 19.98dBm</p>
Type of Modulation	802.11a/n/ac: OFDM;
Power-on cycle	Requires 168.0 seconds to complete its power-on cycle.
Uniform Spreading	For the 5250-5350MHz, 5470-5725 MHz bands, the Master device provides, on aggregate, uniform loading of the spectrum across all devices by selecting an operating channel among the available channels using a random algorithm.

Note: There are different Fiber modules of model number, and evaluated the different Fiber module in "FCC DOC report".

2.2. Description of Available Antennas

Antenna Type	Frequency Band (GHz)	T _x Paths	Directional Gain (dBi)	
			Non Beam Forming	Beam Forming
PCB Antenna	2.4	2	1.90	--
	5.2	4	2.17	8.04
	5.3	4	2.03	7.78
	5.6	4	2.55	8.38
	5.8	4	2.70	8.70

Note:

1. Transmit at 2.4GHz support two antennas, and support four antennas at 5GHz transmit.
2. The EUT supports Beam Forming mode, and the Beam Forming support 802.11n/ac, not include 802.11a.
3. Correlated signals include, but are not limited to, signals transmitted in any of the following modes:
 - Any transmit Beam Forming mode, whether fixed or adaptive (e.g., phased array modes, closed loop MIMO modes, Transmitter Adaptive Antenna modes, Maximum Ratio Transmission (MRT) modes, and Statistical Eigen Beam Forming (EBF) modes).
4. Unequal antenna gains, with equal transmit powers. For antenna gains given by G_1, G_2, \dots, G_N dBi
 - transmit signals are correlated, then
 - Directional gain = $10 \log[(10^{G_1/20} + 10^{G_2/20} + \dots + 10^{G_N/20})^2 / N_{ANT}]$ dBi [Note the "20"s in the denominator of each exponent and the square of the sum of terms; the object is to combine the signal levels coherently.]

2.3. DFS Band Carrier Frequencies Operation

802.11a/n-HT20 Center Working Frequency of Each Channel

Channel	Frequency	Channel	Frequency	Channel	Frequency
52	5260 MHz	56	5280 MHz	60	5300 MHz
64	5320 MHz	100	5500 MHz	104	5520 MHz
108	5540 MHz	112	5560 MHz	116	5580 MHz
132	5660 MHz	136	5680 MHz	140	5700 MHz

802.11ac-VHT20 Center Working Frequency of Each Channel

Channel	Frequency	Channel	Frequency	Channel	Frequency
52	5260 MHz	56	5280 MHz	60	5300 MHz
64	5320 MHz	100	5500 MHz	104	5520 MHz
108	5540 MHz	112	5560 MHz	116	5580 MHz
132	5660 MHz	136	5680 MHz	140	5700 MHz
144	5720 MHz	--	--	--	--

802.11n-HT40 Center Working Frequency of Each Channel

Channel	Frequency	Channel	Frequency	Channel	Frequency
54	5270 MHz	62	5310 MHz	102	5510 MHz
110	5550 MHz	134	5670 MHz	--	--

802.11ac-VHT40 Center Working Frequency of Each Channel

Channel	Frequency	Channel	Frequency	Channel	Frequency
54	5270 MHz	62	5310 MHz	102	5510 MHz
110	5550 MHz	134	5670 MHz	142	5710MHz

802.11ac-VHT80 Center Working Frequency of Each Channel

Channel	Frequency	Channel	Frequency	Channel	Frequency
58	5290 MHz	106	5530 MHz	138	5690 MHz

2.4. Test Mode

Test Mode	Normal Operation
-----------	------------------

3. DFS DETECTION THRESHOLDS AND RADAR TEST WAVEFORMS

3.1. Applicability

The following table from KDB 905462 D01 lists the applicable requirements for the DFS testing.

Requirement	Operational Mode		
	Master	Client Without Radar Detection	Client With Radar Detection
Non-Occupancy Period	Yes	Not required	Yes
DFS Detection Threshold	Yes	Not required	Yes
Channel Availability Check Time	Yes	Not required	Not required
Uniform Spreading	Yes	Not required	Not required
U-NII Detection Bandwidth	Yes	Not required	Yes

Table 3-1: Applicability of DFS Requirements Prior to Use of a Channel

Requirement	Operational Mode	
	Master Device or Client With Radar Detection	Client Without Radar Detection
DFS Detection Threshold	Yes	Not required
Channel Closing Transmission Time	Yes	Yes
Channel Move Time	Yes	Yes
U-NII Detection Bandwidth	Yes	Not required

Table 3-2: Applicability of DFS Requirements during normal operation

3.2. DFS Devices Requirements

Per KDB 905462 D01 the following are the requirements for Master Devices:

- (a) The Master Device will use DFS in order to detect Radar Waveforms with received signal strength above the DFS Detection Threshold in the 5250 ~ 5350 MHz and 5470 ~ 5725 MHz bands. DFS is not required in the 5150 ~ 5250 MHz or 5725 ~ 5825 MHz bands.
- (b) Before initiating a network on a Channel, the Master Device will perform a Channel Availability Check for a specified time duration (Channel Availability Check Time) to ensure that there is no radar system operating on the Channel, using DFS described under subsection a) above.
- (c) The Master Device initiates a U-NII network by transmitting control signals that will enable other U-NII devices to Associate with the Master Device.
- (d) During normal operation, the Master Device will monitor the Channel (In-Service Monitoring) to ensure that there is no radar system operating on the Channel, using DFS described under a).
- (e) If the Master Device has detected a Radar Waveform during In-Service Monitoring as described under d), the Operating Channel of the U-NII network is no longer an Available Channel. The Master Device will instruct all associated Client Device(s) to stop transmitting on this Channel within the Channel Move Time. The transmissions during the Channel Move Time will be limited to the Channel Closing Transmission Time.
- (f) Once the Master Device has detected a Radar Waveform it will not utilize the Channel for the duration of the Non-Occupancy Period.
- (g) If the Master Device delegates the In-Service Monitoring to a Client Device, then the combination will be tested to the requirements described under d) through f) above.

Channel Move Time and Channel Closing Transmission Time requirements are listed in the following table.

Parameter	Value
Non-occupancy period	Minimum 30 minutes
Channel Availability Check Time	60 seconds
Channel Move Time	10 seconds See Note 1.
Channel Closing Transmission Time	200 milliseconds + an aggregate of 60 milliseconds over remaining 10 second period. See Notes 1 and 2.
U-NII Detection Bandwidth	Minimum 80% of the U-NII 99% transmission power bandwidth. See Note 3.
Note 1: The instant that the Channel Move Time and the Channel Closing Transmission Time begins	

is as follows:

- For the Short Pulse Radar Test Signals this instant is the end of the Burst.
- For the Frequency Hopping radar Test Signal, this instant is the end of the last radar Burst generated.
- For the Long Pulse Radar Test Signal this instant is the end of the 12 second period defining the Radar Waveform.

Note 2: The Channel Closing Transmission Time is comprised of 200 milliseconds starting at the beginning of the Channel Move Time plus any additional intermittent control signals required to facilitate a Channel move (an aggregate of 60 milliseconds) during the remainder of the 10 second period. The aggregate duration of control signals will not count quiet periods in between transmissions.

Note 3: During the U-NII Detection Bandwidth detection test, radar type 1 is used and for each frequency step the minimum percentage of detection is 90 percent. Measurements are performed with no data traffic.

Table 3-3: DFS Response Requirements

3.3. DFS Detection Threshold Values

The DFS detection thresholds are defined for Master devices and Client Devices with In-service monitoring. These detection thresholds are listed in the following table.

Maximum Transmit Power	Value (See Notes 1 and 2)
≥ 200 milliwatt	-64 dBm
< 200 milliwatt	-62 dBm

Note 1: This is the level at the input of the receiver assuming a 0 dBi receive antenna.

Note 2: Throughout these test procedures an additional 1 dB has been added to the amplitude of the test transmission waveforms to account for variations in measurement equipment. This will ensure that the test signal is at or above the detection threshold level to trigger a DFS response.

Tablet 3-4: Detection Thresholds for Master Devices

3.4. Parameters of DFS Test Signals

This section provides the parameters for required test waveforms, minimum percentage of successful detections, and the minimum number of trials that must be used for determining DFS conformance. Step intervals of 0.1 microsecond for Pulse Width, 1 microsecond for PRI, 1 MHz for chirp width and 1 for the number of pulses will be utilized for the random determination of specific test waveforms.

Radar Type	Pulse Width (μsec)	PRI (μsec)	Number of Pulses	Minimum Percentage of Successful Detection	Minimum Number of Trials
1	1	1428	18	60%	30
2	1 ~ 5	150 ~ 230	23 ~ 29	60%	30
3	6 ~ 10	200 ~ 500	16 ~ 18	60%	30
4	11 ~ 20	200 ~ 500	12 ~ 16	60%	30
Aggregate (Radar Types 1-4)				80%	120

Tablet 3-5: Parameters for Short Pulse Radar Waveforms

Radar Type	Pulse Width (μsec)	Chirp Width (MHz)	PRI (μsec)	Number of Pulses per Burst	Number of Bursts	Minimum Percentage of Successful Detection	Minimum Number of Trials
5	50 ~ 100	5 ~ 20	1000 ~ 2000	1 ~ 3	8 ~ 20	60%	30

Tablet 3-6: Parameters for Long Pulse Radar Waveforms

Radar Type	Pulse Width (μsec)	PRI (μsec)	Pulses Per Hop	Hopping Rate (kHz)	Hopping Sequence Length (msec)	Minimum Percentage of Successful Detection	Minimum Number of Trials
6	1	333	9	0.333	300	70%	30

Tablet 3-7: Parameters for Frequency Hopping Radar Waveforms

3.5. Conducted Test Setup

The RSS-210 describes a radiated test setup and a conducted test setup. The conducted test setup was used for this testing. Figure 3-1 shows the typical test setup.

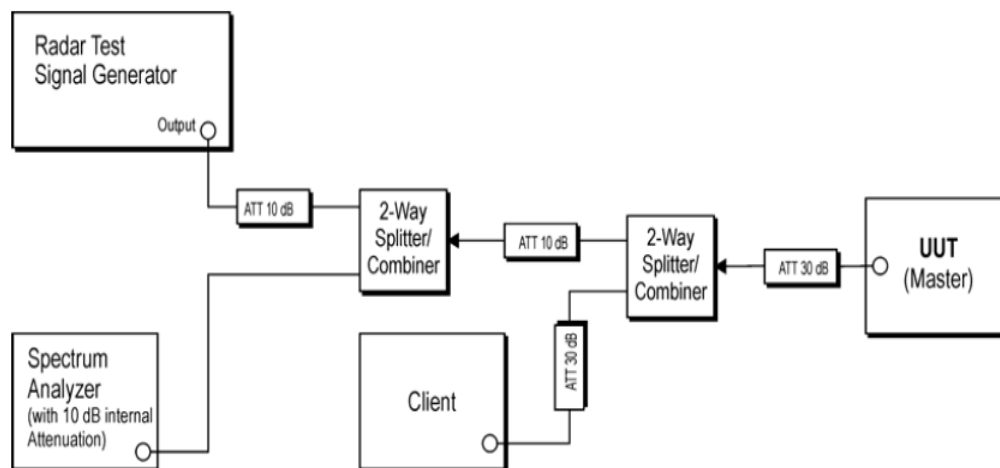

Figure 3-1: Conducted Test Setup where UUT is a Master and Radar Test Waveforms are injected into the Masters

4. TEST EQUIPMENT CALIBRATION DATE

Dynamic Frequency Selection (DFS)

Instrument	Manufacturer	Type No.	Serial No.	Cali. Due Date
Spectrum Analyzer	Agilent	N9010A	MY51440164	2014/08/15
ESG Vector Signal Generator	Agilent	E4438C	MY49872484	2014/12/14

Software	Manufacturer	Function
Pulse Building	Agilent	Radar Signal Generation Software
DFS Tool	Agilent	DFS Test Software

5. TEST RESULT

5.1. Summary

Company Name: WIFI dual band 4 GE LAN GPON HGU

FCC ID: 2ABLK-8X4G-1

IC: 4009A-8X4G1

Parameter	Limit	Test Result	Reference
UNII Detection Bandwidth Measurement	Refer Tablet 3-3	Pass	Section 5.4
Initial Channel Availability Check Time	Refer Tablet 3-3	Pass	Section 5.5
Radar Burst at the Beginning of the Channel Availability Check Time	Refer Tablet 3-3	Pass	Section 5.6
Radar Burst at the End of the Channel Availability Check Time	Refer Tablet 3-3	Pass	Section 5.7
In-Service Monitoring for Channel Move Time, Channel Closing Transmission Time and Non-Occupancy Period	Refer Tablet 3-3	Pass	Section 5.8
Statistical Performance Check	Refer Tablet 3-3	Pass	Section 5.9

5.2. Radar Waveform Calibration

5.2.1. Calibration Setup

The conducted test setup was used for this calibration testing. Figure 3-2 shows the typical test setup.

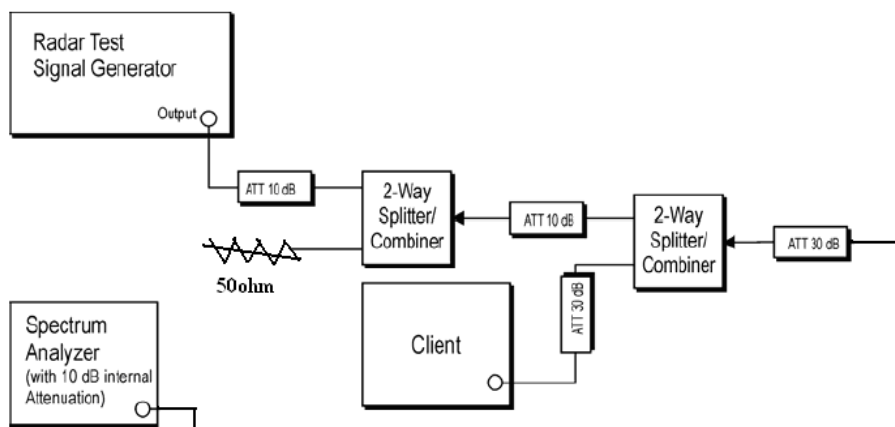

Figure 3-2: Conducted Test Setup

5.2.2. Calibration Procedure

The Interference Radar Detection Threshold Level is $(-64\text{dBm}) + (0) [\text{dBi}] + 1 \text{ dB} = -63 \text{ dBm}$ that had been taken into account the output power range and antenna gain. The above equipment setup was used to calibrate the conducted Radar Waveform. A vector signal generator was utilized to establish the test signal level for each radar type. During this process there were replace 50ohm terminal form Master and Client device and no transmissions by either the Master or Client Device. The spectrum analyzer was switched to the zero span (Time Domain) at the frequency of the Radar Waveform generator. Peak detection was used. The spectrum analyzer resolution bandwidth (RBW) and video bandwidth (VBW) were set to at least 3MHz. The vector signal generator amplitude was set so that the power level measured at the spectrum analyzer was $(-64\text{dBm}) + (0) [\text{dBi}] + 1 \text{ dB} = -63\text{dBm}$. Capture the spectrum analyzer plots on short pulse radar types, long pulse radar type and hopping radar waveform.

5.2.3. Cablibration Result

Radar #1 DFS detection threshold level and the burst of pulses on the Channel frequency

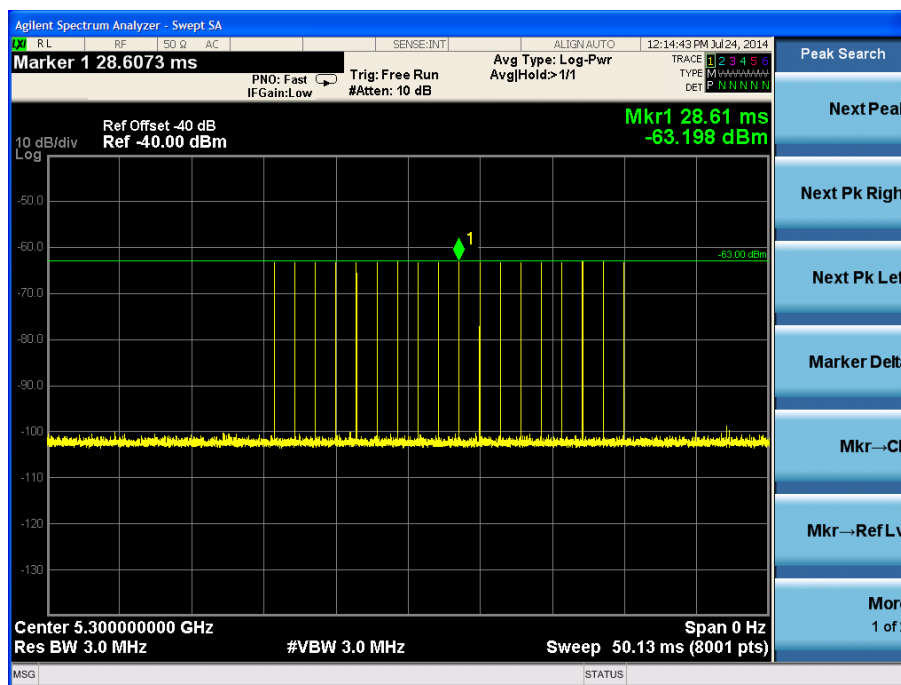

Radar #2 DFS detection threshold level and the burst of pulses on the Channel frequency

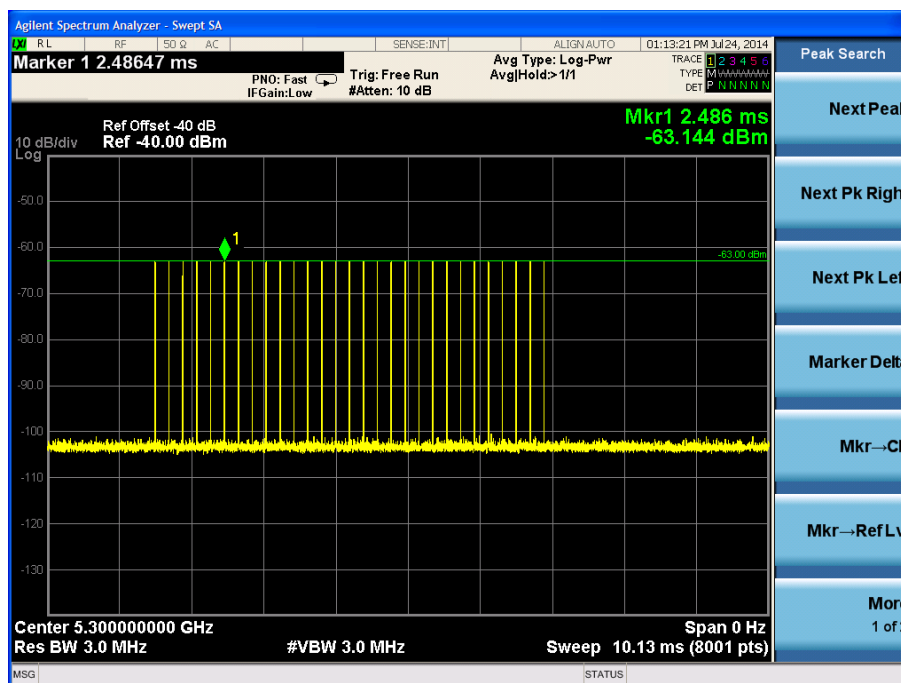

Radar #3 DFS detection threshold level and the burst of pulses on the Channel frequency

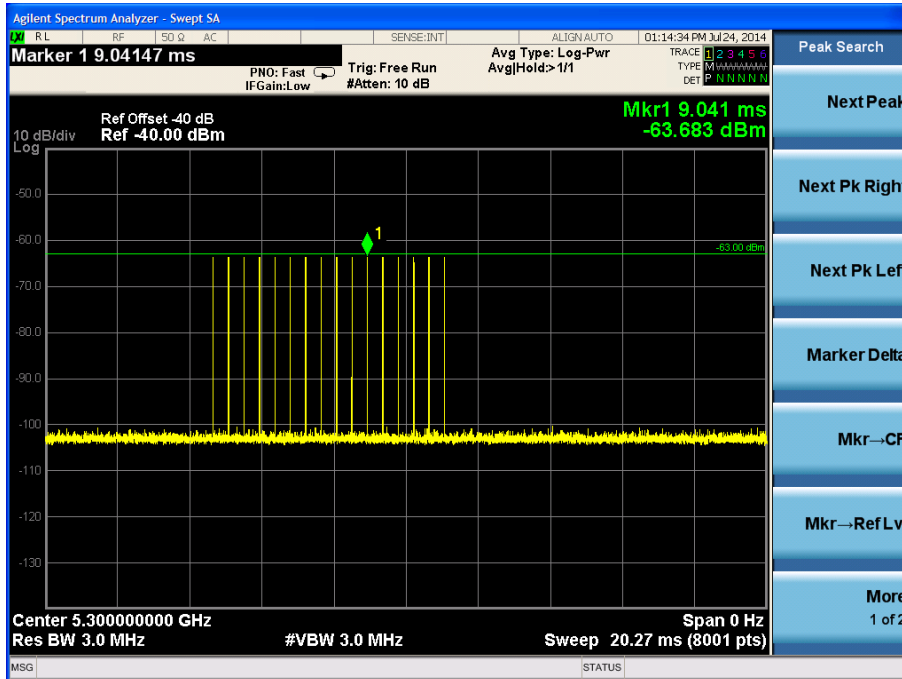

Radar #4 DFS detection threshold level and the burst of pulses on the Channel frequency

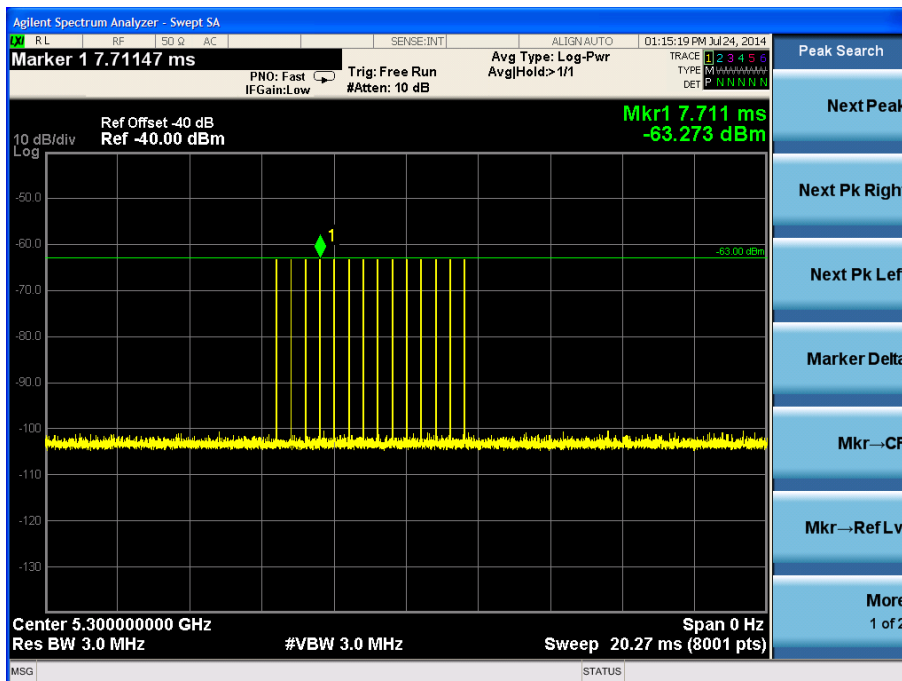

Radar #5 DFS detection threshold level and 12sec long burst on the Channel frequency

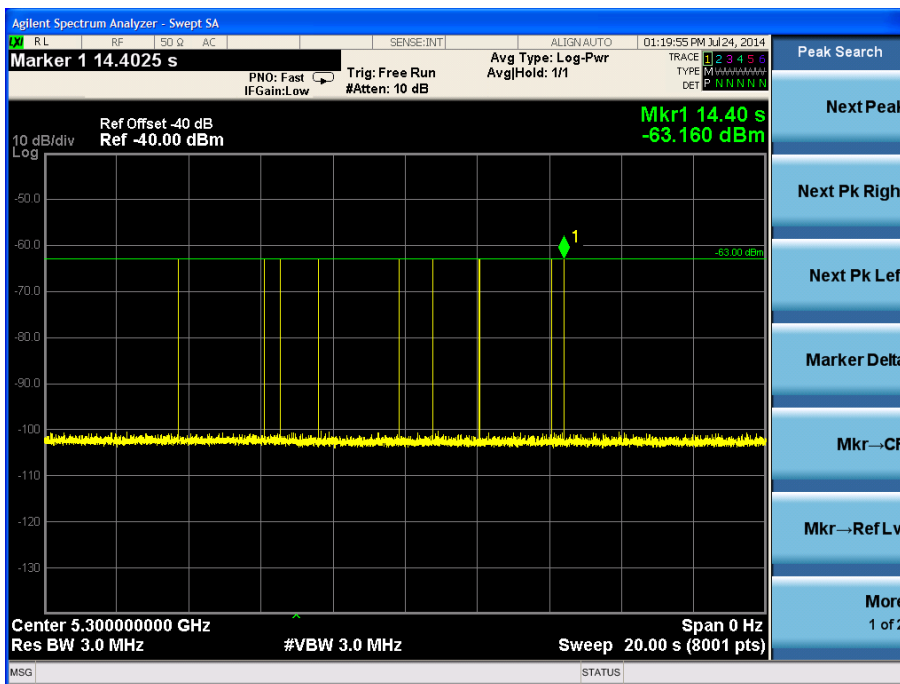

Radar #6 DFS detection threshold level and a single hop (9 pulses) on the Channel frequency within UNII detection bandwidth

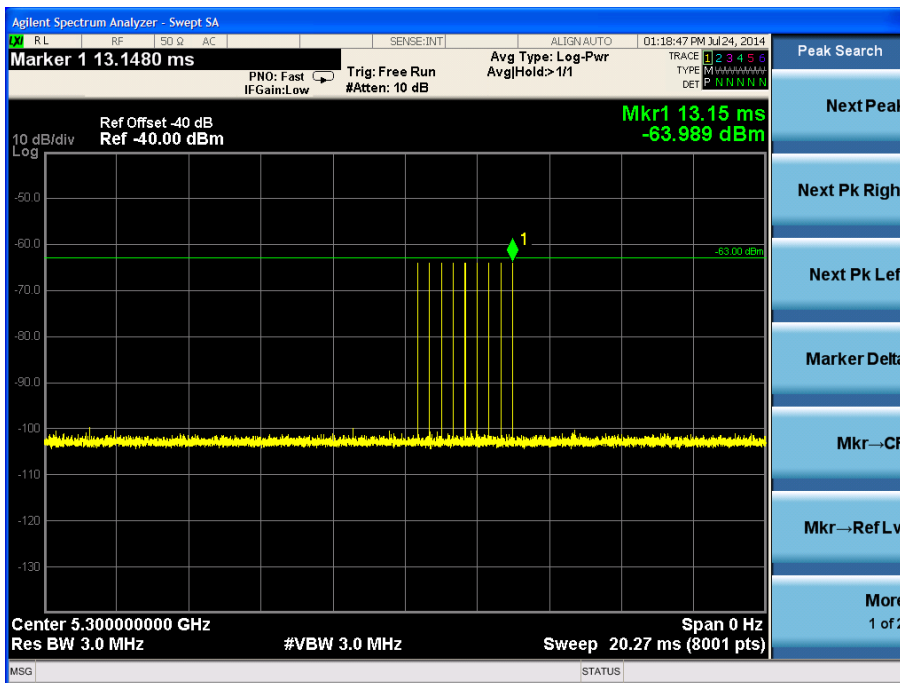

5.2.4. Test Setup Photo

Description: Test Setup Photo



5.3. UNII Detection Bandwidth Measurement

5.3.1. Test Limit

Minimum 80% of the UNII 99% transmission power bandwidth. During the U-NII Detection Bandwidth detection test, radar type 1 is used and for each frequency step the minimum percentage of detection is 90 percent. Measurements are performed with no data traffic.

5.3.2. Test Procedure

1. Adjust the equipment to produce a single Burst of the Short Pulse Radar Type 1 at the center frequency of the EUT Operating Channel at the specified DFS Detection Threshold level.
2. The generating equipment is configured as shown in the Conducted Test Setup above section 4.1.1.
3. The EUT is set up as a stand-alone device (no associated Client and no traffic). Frame based systems will be set to a talk/listen ratio of 0%/100% during this test.
4. Generate single radar Burst, and note the response of the EUT. Repeat for a minimum of 10 trials. The EUT must detect the Radar Waveform using the specified U-NII Detection Bandwidth criterion.
5. Starting at the center frequency of the EUT operating Channel, increase the radar frequency in 1 MHz steps, repeating the above item 4 test sequence, until the detection rate falls below the U-NII Detection Bandwidth criterion. Record the highest frequency (denote as FH) at which detection is greater than or equal to the U-NII Detection Bandwidth criterion. Recording the detection rate at frequencies above FH is not required to demonstrate compliance.
6. Starting at the center frequency of the EUT operating Channel, decrease the radar frequency in 1 MHz steps, repeating the above item 4 test sequence, until the detection rate falls below the U-NII Detection Bandwidth criterion. Record the lowest frequency (denote as FL) at which detection is greater than or equal to the U-NII Detection Bandwidth criterion. Recording the detection rate at frequencies below FL is not required to demonstrate compliance.
7. The U-NII Detection Bandwidth is calculated as follows: $U\text{-NII Detection Bandwidth} = FH - FL$
8. The U-NII Detection Bandwidth must be at least 80% of the EUT transmitter 99% power, otherwise, the EUT does not comply with DFS requirements.

5.3.3. Test Result

EUT Frequency=5300MHz for 802.11n-HT20											
Radar Frequency (MHz)	DFS Detection Trials (1=Detection, 0= No Detection)										Detection Rate (%)
	1	2	3	4	5	6	7	8	9	10	
5290	0	0	0	0	0	0	0	0	0	0	0%
5291 FL	1	1	1	1	1	1	1	1	1	1	100%
5292	1	1	1	1	1	1	1	1	1	1	100%
5293	1	1	1	1	1	1	1	1	1	1	100%
5294	1	1	1	1	1	1	1	1	1	1	100%
5295	1	1	1	1	1	1	1	1	1	1	100%
5296	1	1	1	1	1	1	1	1	1	1	100%
5297	1	1	1	1	1	1	1	1	1	1	100%
5298	1	1	1	1	1	1	1	1	1	1	100%
5299	1	1	1	1	1	1	1	1	1	1	100%
5300	1	1	1	1	1	1	1	1	1	1	100%
5301	1	1	1	1	1	1	1	1	1	1	100%
5302	1	1	1	1	1	1	1	1	1	1	100%
5303	1	1	1	1	1	1	1	1	1	1	100%
5304	1	1	1	1	1	1	1	1	1	1	100%
5305	1	1	1	1	1	1	1	1	1	1	100%
5306	1	1	1	1	1	1	1	1	1	1	100%
5307	1	1	1	1	1	1	1	1	1	1	100%
5308	1	1	1	1	1	1	1	1	1	1	100%
5309 FH	1	1	1	1	1	1	1	1	1	1	100%
5310	0	0	0	0	0	0	0	0	0	0	0%
Detection Bandwidth = FH - FL = 5309MHz - 5291MHz = 18MHz											
EUT 99% Bandwidth = 16.72MHz (see note)											
UNII Detection Bandwidth Min. Limit (MHz): 16.72MHz x 80% = 13.38MHz											

Note: All UNII channels for this device have identical Channel bandwidths. Therefore, all DFS testing was done at 5300MHz. The 99% channel bandwidth is 16.72MHz. (See the 99% BW section of the RF report for further measurement details).



EUT Frequency=5510MHz for 802.11n-HT40											
Radar Frequency (MHz)	DFS Detection Trials (1=Detection, 0= No Detection)										Detection Rate (%)
	1	2	3	4	5	6	7	8	9	10	
5491	0	0	0	0	0	0	0	0	0	0	0%
5492	0	0	0	0	0	0	0	0	0	0	0%
5493 FL	1	1	1	1	1	1	1	1	1	1	100%
5494	1	1	1	1	1	1	1	1	1	1	100%
5495	1	1	1	1	1	1	1	1	1	1	100%
5496	1	1	1	1	1	1	1	1	1	1	100%
5497	1	1	1	1	1	1	1	1	1	1	100%
5498	1	1	1	1	1	1	1	1	1	1	100%
5499	1	1	1	1	1	1	1	1	1	1	100%
5500	1	1	1	1	1	1	1	1	1	1	100%
5501	1	1	1	1	1	1	1	1	1	1	100%
5502	1	1	1	1	1	1	1	1	1	1	100%
5503	1	1	1	1	1	1	1	1	1	1	100%
5504	1	1	1	1	1	1	1	1	1	1	100%
5505	1	1	1	1	1	1	1	1	1	1	100%
5506	1	1	1	1	1	1	1	1	1	1	100%
5507	1	1	1	1	1	1	1	1	1	1	100%
5508	1	1	1	1	1	1	1	1	1	1	100%
5509	1	1	1	1	1	1	1	1	1	1	100%
5510	1	1	1	1	1	1	1	1	1	1	100%
5511	1	1	1	1	1	1	1	1	1	1	100%
5512	1	1	1	1	1	1	1	1	1	1	100%
5513	1	1	1	1	1	1	1	1	1	1	100%
5514	1	1	1	1	1	1	1	1	1	1	100%
5515	1	1	1	1	1	1	1	1	1	1	100%
5516	1	1	1	1	1	1	1	1	1	1	100%
5517	1	1	1	1	1	1	1	1	1	1	100%
5518	1	1	1	1	1	1	1	1	1	1	100%
5519	1	1	1	1	1	1	1	1	1	1	100%
5520	1	1	1	1	1	1	1	1	1	1	100%
5521	1	1	1	1	1	1	1	1	1	1	100%

5522	1	1	1	1	1	1	1	1	1	1	100%
5523	1	1	1	1	1	1	1	1	1	1	100%
5524	1	1	1	1	1	1	1	1	1	1	100%
5525	1	1	1	1	1	1	1	1	1	1	100%
5526	1	1	1	1	1	1	1	1	1	1	100%
5527 FH	1	1	1	1	1	1	1	1	1	1	100%
5528	0	0	0	0	0	0	0	0	0	0	0%
5529	0	0	0	0	0	0	0	0	0	0	0%
Detection Bandwidth = FH - FL = 5527MHz - 5293MHz = 34MHz											
EUT 99% Bandwidth = 36.27MHz (see note)											
UNII Detection Bandwidth Min. Limit (MHz): 36.27MHz x 80% = 29.02MHz											

Note: All UNII channels for this device have identical Channel bandwidths. Therefore, all DFS testing was done at 5510MHz. The 99% channel bandwidth is 36.27MHz. (See the 99% BW section of the RF report for further measurement details).



EUT Frequency=5530MHz for 802.11ac-VHT80											
Radar Frequency (MHz)	DFS Detection Trials (1=Detection, 0= No Detection)										Detection Rate (%)
	1	2	3	4	5	6	7	8	9	10	
5494	0	0	0	0	0	0	0	0	0	0	0%
5495	0	0	0	0	0	0	0	0	0	0	0%
5496 FL	1	1	1	1	1	1	1	1	1	1	100%
5497	1	1	1	1	1	1	1	1	1	1	100%
5498	1	1	1	1	1	1	1	1	1	1	100%
5499	1	1	1	1	1	1	1	1	1	1	100%
5500	1	1	1	1	1	1	1	1	1	1	100%
5501	1	1	1	1	1	1	1	1	1	1	100%
5502	1	1	1	1	1	1	1	1	1	1	100%
5503	1	1	1	1	1	1	1	1	1	1	100%
5504	1	1	1	1	1	1	1	1	1	1	100%
5505	1	1	1	1	1	1	1	1	1	1	100%
5506	1	1	1	1	1	1	1	1	1	1	100%
5507	1	1	1	1	1	1	1	1	1	1	100%
5508	1	1	1	1	1	1	1	1	1	1	100%
5509	1	1	1	1	1	1	1	1	1	1	100%
5510	1	1	1	1	1	1	1	1	1	1	100%
5511	1	1	1	1	1	1	1	1	1	1	100%
5512	1	1	1	1	1	1	1	1	1	1	100%
5513	1	1	1	1	1	1	1	1	1	1	100%
5514	1	1	1	1	1	1	1	1	1	1	100%
5515	1	1	1	1	1	1	1	1	1	1	100%
5516	1	1	1	1	1	1	1	1	1	1	100%
5517	1	1	1	1	1	1	1	1	1	1	100%
5518	1	1	1	1	1	1	1	1	1	1	100%
5519	1	1	1	1	1	1	1	1	1	1	100%
5520	1	1	1	1	1	1	1	1	1	1	100%
5521	1	1	1	1	1	1	1	1	1	1	100%
5522	1	1	1	1	1	1	1	1	1	1	100%
5523	1	1	1	1	1	1	1	1	1	1	100%
5524	1	1	1	1	1	1	1	1	1	1	100%



5525	1	1	1	1	1	1	1	1	1	1	100%
5526	1	1	1	1	1	1	1	1	1	1	100%
5527	1	1	1	1	1	1	1	1	1	1	100%
5528	1	1	1	1	1	1	1	1	1	1	100%
5529	1	1	1	1	1	1	1	1	1	1	100%
5530	1	1	1	1	1	1	1	1	1	1	100%
5531	1	1	1	1	1	1	1	1	1	1	100%
5532	1	1	1	1	1	1	1	1	1	1	100%
5533	1	1	1	1	1	1	1	1	1	1	100%
5534	1	1	1	1	1	1	1	1	1	1	100%
5535	1	1	1	1	1	1	1	1	1	1	100%
5536	1	1	1	1	1	1	1	1	1	1	100%
5537	1	1	1	1	1	1	1	1	1	1	100%
5538	1	1	1	1	1	1	1	1	1	1	100%
5539	1	1	1	1	1	1	1	1	1	1	100%
5540	1	1	1	1	1	1	1	1	1	1	100%
5541	1	1	1	1	1	1	1	1	1	1	100%
5542	1	1	1	1	1	1	1	1	1	1	100%
5543	1	1	1	1	1	1	1	1	1	1	100%
5544	1	1	1	1	1	1	1	1	1	1	100%
5545	1	1	1	1	1	1	1	1	1	1	100%
5546	1	1	1	1	1	1	1	1	1	1	100%
5547	1	1	1	1	1	1	1	1	1	1	100%
5548	1	1	1	1	1	1	1	1	1	1	100%
5549	1	1	1	1	1	1	1	1	1	1	100%
5550	1	1	1	1	1	1	1	1	1	1	100%
5551	1	1	1	1	1	1	1	1	1	1	100%
5552	1	1	1	1	1	1	1	1	1	1	100%
5553	1	1	1	1	1	1	1	1	1	1	100%
5554	1	1	1	1	1	1	1	1	1	1	100%
5555	1	1	1	1	1	1	1	1	1	1	100%
5556	1	1	1	1	1	1	1	1	1	1	100%
5557	1	1	1	1	1	1	1	1	1	1	100%
5558	1	1	1	1	1	1	1	1	1	1	100%

5559	1	1	1	1	1	1	1	1	1	1	100%
5560	1	1	1	1	1	1	1	1	1	1	100%
5561	1	1	1	1	1	1	1	1	1	1	100%
5562	1	1	1	1	1	1	1	1	1	1	100%
5563	1	1	1	1	1	1	1	1	1	1	100%
5564 FH	1	1	1	1	1	1	1	1	1	1	100%
5565	0	0	0	0	0	0	0	0	0	0	0%
5566	0	0	0	0	0	0	0	0	0	0	0%
Detection Bandwidth = FH - FL = 5564MHz - 5496MHz = 68MHz											
EUT 99% Bandwidth = 74.87MHz (see note)											
UNII Detection Bandwidth Min. Limit (MHz): 74.87MHz x 80% = 59.90MHz											

Note: All UNII channels for this device have identical Channel bandwidths. Therefore, all DFS testing was done at 5530MHz. The 99% channel bandwidth is 74.87MHz. (See the 99% BW section of the RF report for further measurement details).

5.4. Initial Channel Availability Check Time Measurement

5.4.1. Test Limit

The EUT shall perform a Channel Availability Check to ensure that there is no radar operating on the channel. After power-up sequence, receive at least 1 minute on the intended operating frequency.

5.4.2. Test Procedure

1. The U-NII devices will be powered on and be instructed to operate on the appropriate U-NII Channel that must incorporate DFS functions. At the same time the EUT is powered on, the spectrum analyzer will be set to zero span mode with a 3 MHz RBW and 3 MHz VBW on the Channel occupied by the radar (Chr) with a 2.5 minute sweep time. The spectrum analyzer's sweep will be started at the same time power is applied to the U-NII device.
2. The EUT should not transmit any beacon or data transmissions until at least 1 minute after the completion of the power-on cycle.
3. Confirm that the EUT initiates transmission on the channel. Measurement system showing its nominal noise floor is marker1.

5.4.3. Test Result

The EUT does not transmit any beacon or data transmissions until at least 1 minute after the completion of the power-on cycle (108.0 sec). Initial beacons/data transmissions are indicated by marker 1 (168.0 sec).

Initial Channel Availability Check Time for 802.11n-HT20

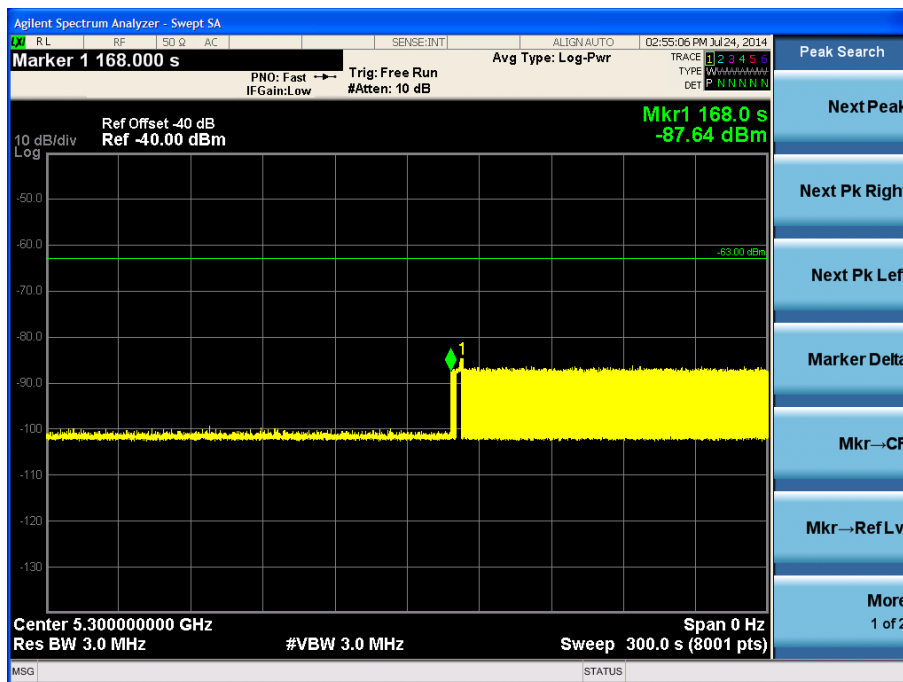

5.5. Radar Burst at the Beginning of the Channel Availability Check Time Measurement

5.5.1. Test Limit

In beginning of the Channel Availability Check (CAC) Time, radar is detected on this channel, select another intended channel and perform a CAC on that channel.

5.5.2. Test Procedure

1. The steps below define the procedure to verify successful radar detection on the selected Channel during a period equal to the Channel Availability Check Time and avoidance of operation on that Channel when a radar Burst with a level equal to the DFS Detection Threshold + 1 dB occurs at the beginning of the Channel Availability Check Time.
2. The EUT is in completion power-up cycle (from T0 to T1). T1 denotes the instant when the EUT has completed its power-up sequence. The Channel Availability Check Time commences at instant T1 and will end no sooner than T1 + 60 seconds. A single Burst of one of Short Pulse Radar Types 1-4 at DFS Detection Threshold + 1 dB will commence within a 6 second window starting at T1.
3. Visual indication on the EUT of successful detection of the radar Burst will be recorded and reported. Observation of emissions at 5300MHz (for 802.11n-HT20) will continue for 112.1 seconds after the radar Burst has been generated. Verify that during the 2.5 minutes measurement window no EUT transmissions occurred at 5300MHz (for 802.11n-HT20).

5.5.3. Test Result

Radar Burst at the Beginning of the Channel Availability Check Time for 802.11n-HT20 (Radar Type 1#)

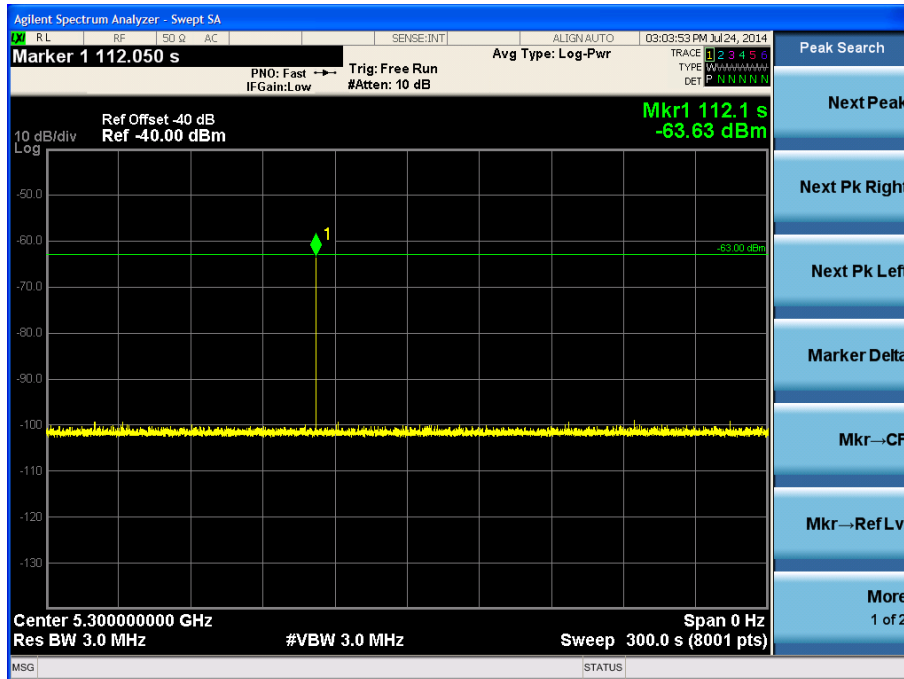

5.6. Radar Burst at the End of the Channel Availability Check Time Measurement

5.6.1. Test Limit

In the end of Channel Availability Check (CAC) Time, radar is detected on this channel, select another intended channel and perform a CAC on that channel.

5.6.2. Test Procedure

1. The steps below define the procedure to verify successful radar detection on the selected Channel during a period equal to the Channel Availability Check Time and avoidance of operation on that Channel when a radar Burst with a level equal to the DFS Detection Threshold + 1 dB occurs at the beginning of the Channel Availability Check Time.
2. The EUT is powered on at T0. T1 denotes the instant when the EUT has completed its power-up sequence. The Channel Availability Check Time commences at instant T1 and will end no sooner than T1 + 60 seconds. A single Burst of one of Short Pulse Radar Types 1-4 at DFS Detection Threshold + 1 dB will commence within a 6 second window starting at T1+ 54 seconds.
3. Visual indication on the EUT of successful detection of the radar Burst will be recorded and reported. Observation of emissions at 5300MHz (for 802.11n-HT20) will continue for 162.9 seconds after the radar Burst has been generated. Verify that during the 2.5 minutes measurement window no EUT transmissions occurred at 5300MHz (for 802.11n-HT20).

5.6.3. Test Result

Radar Burst at the End of the Channel Availability Check Time for 802.11n-HT20 (Radar Type 1#)

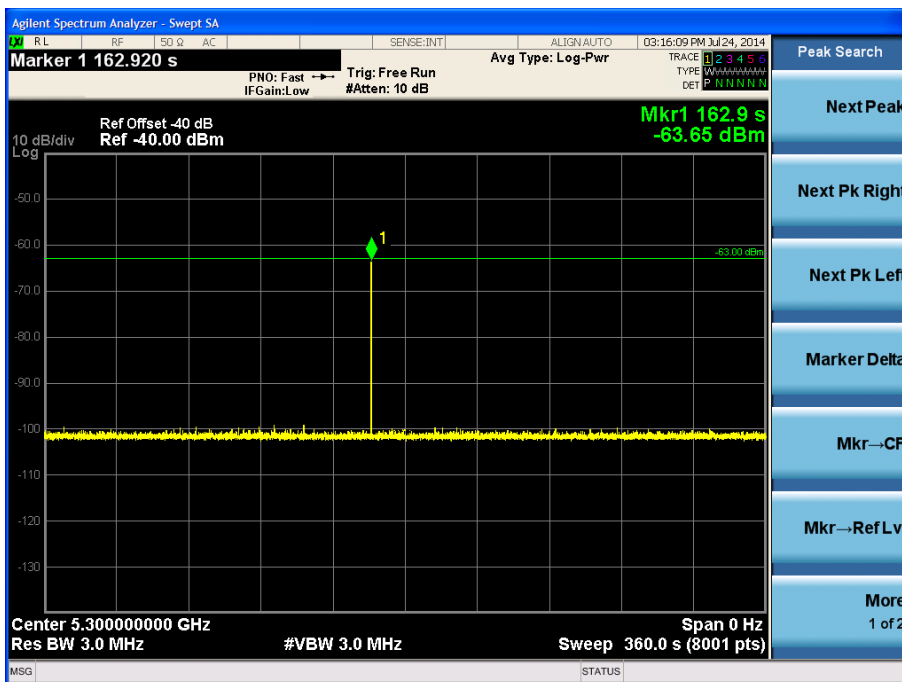

5.7. In-Service Monitoring for Channel Move Time, Channel Closing Transmission Time and Non-Occupancy Period Measurement

5.7.1. Test Limit

The EUT has In-Service Monitoring function to continuously monitor the radar signals. If the radar is detected, must leave the channel (Shutdown). The Channel Move Time to cease all transmissions on the current channel upon detection of a Radar Waveform above the DFS Detection Threshold within 10 sec. The total duration of Channel Closing Transmission Time is 260ms, consisting of data signals and the aggregate of control signals, by a U-NII device during the Channel Move Time. The Non-Occupancy Period time is 30 minute during which a Channel will not be utilized after a Radar Waveform is detected on that Channel.

5.7.2. Test Procedure Used

1. The test should be performed with Radar Type 1. The measurement timing begins at the end of the Radar Type 1.
2. When the radar burst with a level equal to the DFS Detection Threshold + 1dB is generated on the Operating Channel of the U-NII device. A U-NII device operating as a Master Device will associate with the Client Device at Channel. Stream the MPEG test file from the Master Device to the Client Device on the selected Channel for the entire period of the test. At time T0 the Radar Waveform generator sends a Burst of pulses for each of the radar types at Detection Threshold + 1dB.
2. Observe the transmissions of the EUT at the end of the radar Burst on the Operating Channel. Measure and record the transmissions from the EUT during the observation time (Channel Move Time).
3. Measurement of the aggregate duration of the Channel Closing Transmission Time method. With the spectrum analyzer set to zero span tuned to the center frequency of the EUT operating channel at the radar simulated frequency, peak detection, and max hold, the dwell time per bin is given by: $Dwell (1.5ms) = S (12 \text{ sec}) / B (8000)$; where Dwell is the dwell time per spectrum analyzer sampling bin, S is the sweep time and B is the number of spectrum analyzer sampling bins. An upper bound of the aggregate duration of the intermittent control signals of Channel Closing Transmission Time is calculated by: $80MHz: C (4.5 \text{ ms}) = N (3) \times Dwell (1.5 \text{ ms})$; where C is the Closing Time, N is the number of spectrum analyzer sampling bins showing a U-NII transmission and Dwell is the dwell time per bin.
4. Measure the EUT for more than 30 minutes following the channel close/move time to verify that the EUT does not resume any transmissions on this Channel.

5.7.3. Test Result

Channel Move Time and Channel Closing Transmission Time for 802.11ac-VHT80 (Radar Type 1#)

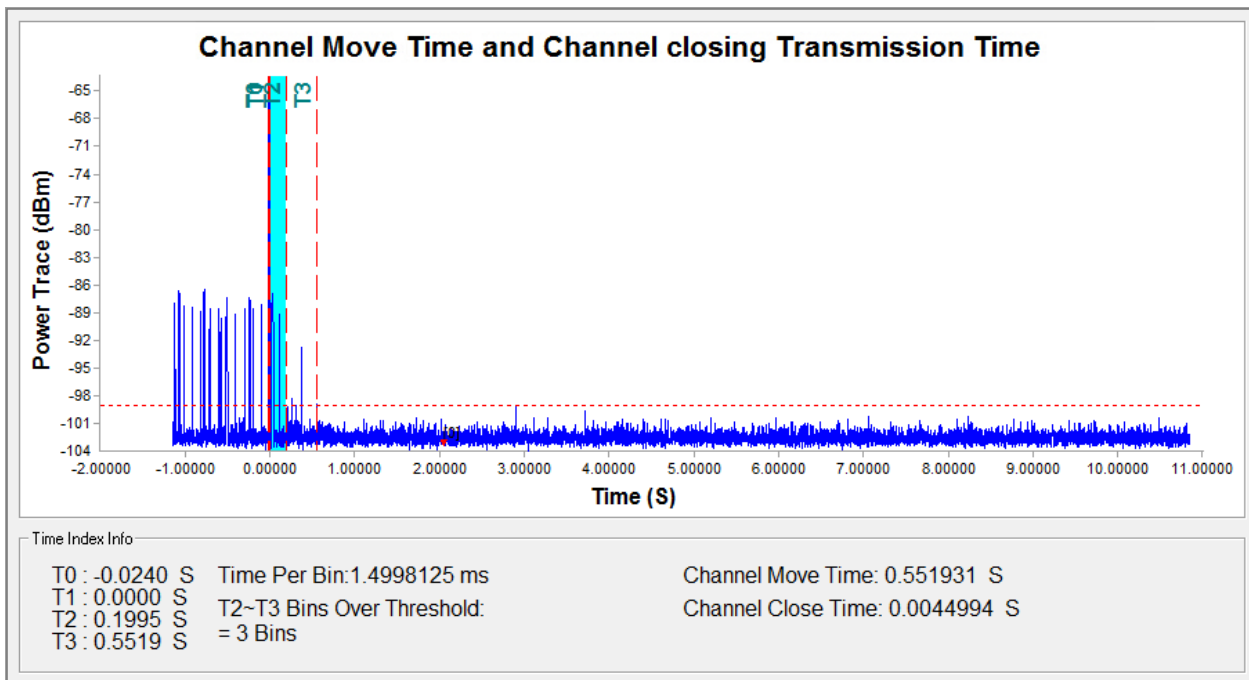
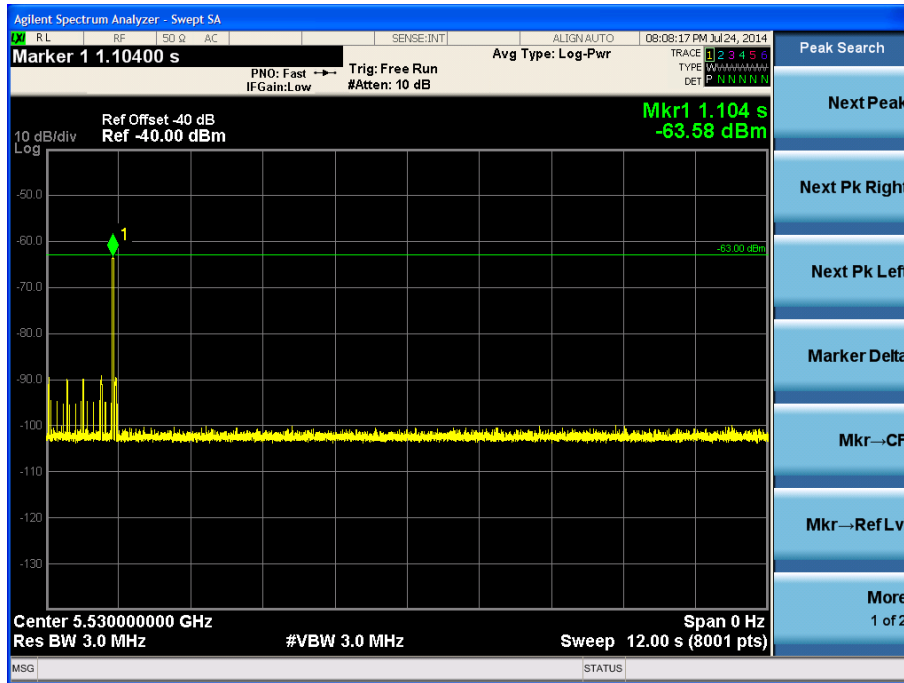

Non-Occupancy Period for 802.11ac-VHT80 (Radar Type 1#)

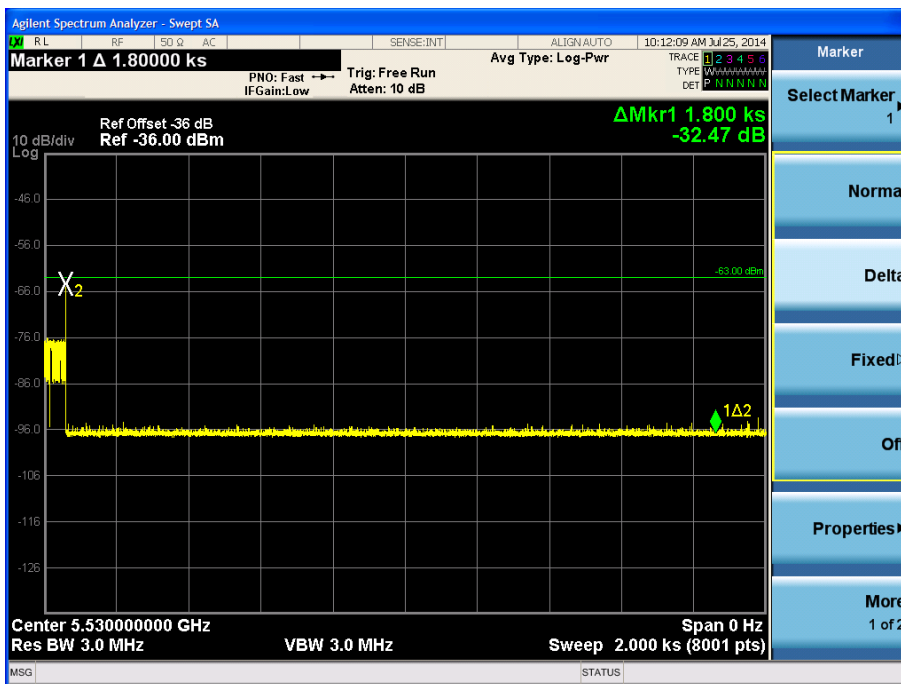

Parameter	Test Result	Limit
	Radar Type 1	
Test Channel (MHz)	5530	N/A
Channel Move Time (s)	0.5519	<10
Channel Closing Transmission Time (ms) (Note)	4.50	< 60
Non-Occupancy Period (min)	≥ 30	≥ 30

Note: The Channel Closing Transmission Time is comprised of 200 milliseconds starting at the beginning of the Channel Move Time plus any additional intermittent control signals required to facilitate a Channel move (an aggregate of 60 milliseconds) during the remainder of the 10 seconds period. The aggregate duration of control signals will not count quiet periods in between transmissions.

5.8. Statistical Performance Check Measurement

5.8.1. Test Limit

The minimum percentage of successful detection requirements found in below table when a radar burst with a level equal to the DFS Detection Threshold + 1dB is generated on the Operating Channel of the U-NII device (In- Service Monitoring).

Radar Type	Minimum Number of Trails	Detection Probability
1	30	Pd > 60%
2	30	Pd > 60%
3	30	Pd > 60%
4	30	Pd > 60%
Aggregate (Radar Types 1-4)	120	Pd > 80%
5	30	Pd > 80%
6	30	Pd > 70%

The percentage of successful detection is calculated by:

$(\text{Total Waveform Detections} / \text{Total Waveform Trails}) * 100 = \text{Probability of Detection Radar}$

Waveform In addition an aggregate minimum percentage of successful detection across all Short Pulse Radar Types 1-4 is required and is calculated as follows: $(Pd1 + Pd2 + Pd3 + Pd4) / 4$.

5.8.2. Test Procedure

1. Stream the MPEG test file from the Master Device to the Client Device on the test Channel for the entire period of the test.
2. At time T0 the Radar Waveform generator sends the individual waveform for each of the Radar Types 1-6, at levels equal to the DFS Detection Threshold + 1dB, on the Operating Channel.
3. Observe the transmissions of the EUT at the end of the Burst on the Operating Channel for duration greater than 10 seconds for Short Pulse Radar Types 1-4 and 6 to ensure detection occurs.
4. Observe the transmissions of the EUT at the end of the Burst on the Operating Channel for duration greater than 22 seconds for Long Pulse Radar Type 5 to ensure detection occurs.
5. The device can utilize a test mode to demonstrate when detection occurs to prevent the need to

reset the device between trial runs.

6. The Minimum number of trails, minimum percentage of successful detection and the average minimum percentage of successful detection are found in below table.

5.8.3. Test Result

For 802.11n-HT20

Type 1 Radar Statistical Performance

Trail #	Test Freq. (MHz)	Pulse Width (us)	PRI (us)	Pulses / Burst	1=Detection 0=No Detection
1	5300	1	1428	18	1
2	5300	1	1428	18	1
3	5300	1	1428	18	1
4	5300	1	1428	18	1
5	5300	1	1428	18	1
6	5300	1	1428	18	1
7	5300	1	1428	18	1
8	5300	1	1428	18	1
9	5300	1	1428	18	1
10	5300	1	1428	18	1
11	5300	1	1428	18	1
12	5300	1	1428	18	1
13	5300	1	1428	18	1
14	5300	1	1428	18	1
15	5300	1	1428	18	1
16	5300	1	1428	18	1
17	5300	1	1428	18	1
18	5300	1	1428	18	1
19	5300	1	1428	18	1
20	5300	1	1428	18	1
21	5300	1	1428	18	1
22	5300	1	1428	18	1
23	5300	1	1428	18	1
24	5300	1	1428	18	1
25	5300	1	1428	18	1
26	5300	1	1428	18	1
27	5300	1	1428	18	1
28	5300	1	1428	18	1
29	5300	1	1428	18	1
30	5300	1	1428	18	1
Detection Percentage (%)					100%

Type 2 Radar Statistical Performance

Trail #	Test Freq. (MHz)	Pulse Width (us)	PRI (us)	Pulses / Burst	1=Detection 0=No Detection
1	5300	2.0	158	29	1
2	5300	2.5	167	24	1
3	5300	3.0	210	24	1
4	5300	1.2	161	25	1
5	5300	2.3	217	27	1
6	5300	2.7	207	27	1
7	5300	1.3	151	23	1
8	5300	4.4	155	27	1
9	5300	1.2	165	27	1
10	5300	3.7	198	28	1
11	5300	3.6	159	24	1
12	5300	3.9	195	27	1
13	5300	1.3	157	28	1
14	5300	1.3	221	23	1
15	5300	2.4	200	27	1
16	5300	2.2	181	29	1
17	5300	2.4	171	24	1
18	5300	4.7	186	29	1
19	5300	4.0	221	24	1
20	5300	2.0	196	23	1
21	5300	3.9	203	25	1
22	5300	2.7	154	26	1
23	5300	2.0	161	26	1
24	5300	2.1	173	28	1
25	5300	3.8	184	26	1
26	5300	4.2	202	26	1
27	5300	1.9	191	27	1
28	5300	1.5	193	28	1
29	5300	2.0	218	28	1
30	5300	2.9	199	24	1
Detection Percentage (%)					100%

Type 3 Radar Statistical Performance

Trail #	Test Freq. (MHz)	Pulse Width (us)	PRI (us)	Pulses / Burst	1=Detection 0=No Detection
1	5300	7.1	292	16	1
2	5300	9.0	354	18	1
3	5300	6.8	285	16	1
4	5300	7.9	304	17	1
5	5300	9.9	387	16	1
6	5300	9.8	378	16	1
7	5300	7.5	440	17	1
8	5300	8.0	428	18	1
9	5300	9.3	305	17	0
10	5300	9.8	268	18	1
11	5300	6.2	314	16	1
12	5300	7.3	354	18	1
13	5300	6.8	407	16	1
14	5300	7.2	379	17	1
15	5300	8.5	419	17	1
16	5300	6.0	278	17	1
17	5300	7.6	273	16	1
18	5300	8.3	471	17	1
19	5300	7.4	408	18	1
20	5300	8.8	403	16	1
21	5300	9.1	303	16	1
22	5300	9.8	365	17	1
23	5300	10.0	469	17	1
24	5300	9.1	255	17	1
25	5300	7.5	386	16	1
26	5300	7.4	328	17	1
27	5300	8.0	354	17	1
28	5300	6.6	380	18	1
29	5300	6.9	265	16	1
30	5300	8.9	439	16	1
Detection Percentage (%)					96.7%

Type 4 Radar Statistical Performance

Trail #	Test Freq. (MHz)	Pulse Width (us)	PRI (us)	Pulses / Burst	1=Detection 0=No Detection
1	5300	18.3	266	14	1
2	5300	11.4	463	14	1
3	5300	20.0	273	12	1
4	5300	11.2	252	15	1
5	5300	19.4	278	15	1
6	5300	16.3	335	14	1
7	5300	20.0	404	13	1
8	5300	12.5	252	15	1
9	5300	15.0	363	12	1
10	5300	15.0	416	15	1
11	5300	12.8	462	12	1
12	5300	15.5	331	12	1
13	5300	11.3	479	14	1
14	5300	17.0	468	12	1
15	5300	19.1	450	16	1
16	5300	17.7	302	13	1
17	5300	15.0	443	14	1
18	5300	15.3	469	15	1
19	5300	11.3	372	13	1
20	5300	13.9	280	14	0
21	5300	13.4	360	16	1
22	5300	16.6	381	13	1
23	5300	18.7	432	15	1
24	5300	19.1	347	16	1
25	5300	12.7	413	16	1
26	5300	12.5	495	13	1
27	5300	11.7	386	12	1
28	5300	19.3	267	16	1
29	5300	12.2	389	16	1
30	5300	11.1	403	14	1
Detection Percentage (%)					96.7%

Note: In addition an average minimum percentage of successful detection across all four Short pulse radar test

waveforms is as follows: $\frac{P_d1+P_d2+P_d3+P_d4}{4} = (100\%+100\%+96.7\%+96.7\%)/4 = 98.33\% (>80\%)$



Type 5 Radar Statistical Performance

Trail #	Test Freq. (MHz)	1=Detection 0=No Detection	Trail #	Test Freq. (MHz)	1=Detection 0=No Detection
1	5300	1	16	5300	1
2	5300	1	17	5300	1
3	5300	1	18	5300	1
4	5300	1	19	5300	1
5	5300	1	20	5300	1
6	5300	1	21	5300	1
7	5300	1	22	5300	1
8	5300	1	23	5300	1
9	5300	1	24	5300	1
10	5300	1	25	5300	1
11	5300	1	26	5300	1
12	5300	1	27	5300	1
13	5300	1	28	5300	1
14	5300	1	29	5300	1
15	5300	1	30	5300	1
Detection Percentage (%)					100%

Type 5 Radar Waveform_1										
Waveform Num = 1										
Num of Bursts = 14										
Burst Interval (us) = 857143										
Burst #	Off Time (us)	# Pulses	Chirp (MHz)	PW (us)	Pulse 1 Pri (us)	Pulse 2 Pri (us)	Pulse 3 Pri (us)	Start Loc (us)	Start Burst Interval (us)	End Burst Interval (us)
1	205637	1	14	70	1991	0	0	205637	0	857142
2	995611	1	13	60	1558	0	0	1203239	857143	1714285
3	1054285	2	11	85	1090	1592	0	2259082	1714286	2571428
4	740533	3	15	75	1207	1250	1009	3002297	2571429	3428571
5	854830	2	14	85	1666	1365	0	3860593	3428572	4285714
6	432074	2	11	70	1455	1410	0	4295698	4285715	5142857
7	1118591	2	6	60	1229	1676	0	5417154	5142858	6000000
8	1429848	2	12	65	1281	1965	0	6849907	6000001	6857143
9	296217	2	19	85	1419	1347	0	7149370	6857144	7714286
10	632795	1	13	80	1156	0	0	7784931	7714287	8571429
11	1421138	1	20	55	1834	0	0	9207225	8571430	9428572
12	643730	1	5	85	1497	0	0	9852789	9428573	10285715
13	543151	3	12	70	1030	1673	1313	10397437	10285716	11142858
14	1108319	1	14	100	1361	0	0	11509772	11142859	12000001
Total number of pulses in waveform = 24										



Type 5 Radar Waveform_2

Waveform Num = 2
Num of Bursts = 15
Burst Interval (us)= 800000

Burst #	Off Time (us)	# Pulses	Chirp (MHz)	PW (us)	Pulse 1 Pri (us)	Pulse 2 Pri (us)	Pulse 3 Pri (us)	Start Loc (us)	Start Burst Interval (us)	End Burst Interval (us)
1	153752	2	19	90	1569	1417	0	153752	0	799999
2	818767	2	7	70	1300	1295	0	975505	800000	1599999
3	668984	3	19	65	1578	1593	1810	1647084	1600000	2399999
4	1229093	2	13	75	1302	1885	0	2881158	2400000	3199999
5	607198	2	11	95	1823	1205	0	3491543	3200000	3999999
6	1193607	3	12	95	1342	1736	1889	4688178	4000000	4799999
7	1432233	1	17	55	1264	0	0	4836378	4800000	5599999
8	1182714	1	8	80	1309	0	0	6020356	5600000	6399999
9	416989	1	16	65	1917	0	0	6438654	6400000	7199999
10	768882	1	11	70	1176	0	0	7209453	7200000	7999999
11	867541	1	5	95	1853	0	0	8078170	8000000	8799999
12	776223	3	7	75	1965	1127	1934	8856246	8800000	9599999
13	1356454	3	16	60	1358	1656	1534	10217726	9600000	10399999
14	696523	3	19	95	1944	1373	1531	10918797	10400000	11199999
15	353654	3	18	70	1687	1952	1183	11277299	11200000	11999999

Total number of pulses in waveform = 31

Type 5 Radar Waveform_3

Waveform Num = 3
Num of Bursts = 16
Burst Interval (us)= 750000

Burst #	Off Time (us)	# Pulses	Chirp (MHz)	PW (us)	Pulse 1 Pri (us)	Pulse 2 Pri (us)	Pulse 3 Pri (us)	Start Loc (us)	Start Burst Interval (us)	End Burst Interval (us)
1	208320	2	13	85	1397	1953	0	208320	0	749999
2	1044300	1	15	75	1026	0	0	1255970	750000	1499999
3	729395	1	15	90	1182	0	0	1986391	1500000	2249999
4	559686	2	12	65	1105	1704	0	2547259	2250000	2999999
5	606846	2	11	55	1202	1735	0	3156914	3000000	3749999
6	981370	3	15	55	1168	1642	1952	4141221	3750000	4499999
7	604021	1	5	70	1694	0	0	4750004	4500000	5249999
8	1000119	1	5	55	1270	0	0	5751817	5250000	5999999
9	592747	2	5	95	1289	1991	0	6345834	6000000	6749999
10	943726	1	12	80	1722	0	0	7292840	6750000	7499999
11	639630	2	6	60	1428	1106	0	7934192	7500000	8249999
12	725401	1	14	80	1751	0	0	8662127	8250000	8999999
13	456922	3	18	70	1106	1106	1783	9120800	9000000	9749999
14	1038095	2	5	50	1674	1513	0	10162890	9750000	10499999
15	771764	3	15	75	1102	1340	1601	10937841	10500000	11249999
16	810847	1	13	65	1775	0	0	11752731	11250000	11999999

Total number of pulses in waveform = 28

Type 5 Radar Waveform_4

Waveform Num = 4
Num of Bursts = 14
Burst Interval (us)= 857143

Burst #	Off Time (us)	# Pulses	Chirp (MHz)	PW (us)	Pulse 1 Pri (us)	Pulse 2 Pri (us)	Pulse 3 Pri (us)	Start Loc (us)	Start Burst Interval (us)	End Burst Interval (us)
1	344439	3	13	55	1477	1323	1771	344439	0	857142
2	765406	3	10	65	1123	1594	1143	1114416	857143	1714285
3	1112001	2	18	100	1659	1391	0	2230277	1714286	2571428
4	485486	1	13	60	1069	0	0	2718813	2571429	3428571
5	1052111	2	6	80	1791	1821	0	3771993	3428572	4285714
6	1317597	3	12	70	1926	1736	1573	5093202	4285715	5142857
7	670931	1	20	90	1972	0	0	5769368	5142858	6000000
8	602766	1	17	80	1856	0	0	6374106	6000001	6857143
9	502527	3	10	95	1391	1963	1710	6878489	6857144	7714286
10	1037870	2	17	60	1862	1302	0	7921423	7714287	8571429
11	968243	1	9	95	1083	0	0	8892830	8571430	9428572
12	807741	3	10	50	1738	1210	1226	9701654	9428573	10285715
13	719455	1	13	85	1430	0	0	10425283	10285716	11142858
14	1230554	2	14	55	1588	1997	0	11657267	11142859	12000001

Total number of pulses in waveform = 28



Type 5 Radar Waveform_5

Waveform Num = 5
Num of Bursts = 10
Burst Interval (us)= 1200000

Burst #	Off Time (us)	# Pulses	Chirp (MHz)	PW (us)	Pulse 1 Pri (us)	Pulse 2 Pri (us)	Pulse 3 Pri (us)	Start Loc (us)	Start Burst Interval (us)	End Burst Interval (us)
1	1178607	2	12	70	1277	1410	0	1178607	0	1199999
2	525223	2	13	70	1184	1622	0	1706517	1200000	2399999
3	1711251	2	11	90	1636	1019	0	3420574	2400000	3599999
4	1024164	2	6	50	1827	1070	0	4447393	3600000	4799999
5	1519443	2	13	85	1890	1243	0	5969733	4800000	5999999
6	598396	2	17	90	1925	1420	0	6571262	6000000	7199999
7	1441139	2	12	100	1422	1118	0	8015746	7200000	8399999
8	1428980	1	10	80	1306	0	0	9447266	8400000	9599999
9	213016	1	12	55	1702	0	0	9661588	9600000	10799999
10	1859561	2	8	75	1656	1615	0	11522851	10800000	11999999

Total number of pulses in waveform = 18

Type 5 Radar Waveform_6

Waveform Num = 6
Num of Bursts = 20
Burst Interval (us)= 600000

Burst #	Off Time (us)	# Pulses	Chirp (MHz)	PW (us)	Pulse 1 Pri (us)	Pulse 2 Pri (us)	Pulse 3 Pri (us)	Start Loc (us)	Start Burst Interval (us)	End Burst Interval (us)
1	440764	2	7	70	1906	1311	0	440764	0	599999
2	303561	2	12	65	1655	1831	0	747542	600000	1199999
3	740642	2	11	65	1725	1415	0	1491670	1200000	1799999
4	359987	3	14	75	1401	1978	1405	1854797	1800000	2399999
5	1111920	3	9	60	1677	1007	1058	2971501	2400000	2999999
6	403271	2	15	90	1418	1894	0	3378514	3000000	3599999
7	384142	3	6	55	1410	1421	1917	3765968	3600000	4199999
8	953163	2	15	65	1891	1425	0	4723879	4200000	4799999
9	146312	2	19	65	1475	1320	0	4873507	4800000	5399999
10	662808	2	13	80	1416	1369	0	5539110	5400000	5999999
11	596035	2	17	95	1029	1428	0	6137930	6000000	6599999
12	1056923	2	13	50	1048	1919	0	7196310	6600000	7199999
13	204404	3	10	65	1008	1159	1789	7403681	7200000	7799999
14	936646	1	17	85	1639	0	0	8344283	7800000	8399999
15	512836	3	6	70	1621	1570	1559	8858768	8400000	8999999
16	491194	2	8	85	1326	1016	0	9354702	9000000	9599999
17	593403	2	9	90	1597	1675	0	9950447	9600000	10199999
18	512417	2	17	95	1363	1611	0	10466136	10200000	10799999
19	522150	2	15	90	1032	1690	0	10991260	10800000	11399999
20	891684	2	14	75	1327	1395	0	11885666	11400000	11999999

Total number of pulses in waveform = 44

Type 5 Radar Waveform_7

Waveform Num = 7
Num of Bursts = 19
Burst Interval (us)= 631579

Burst #	Off Time (us)	# Pulses	Chirp (MHz)	PW (us)	Pulse 1 Pri (us)	Pulse 2 Pri (us)	Pulse 3 Pri (us)	Start Loc (us)	Start Burst Interval (us)	End Burst Interval (us)
1	295362	2	6	85	1173	1402	0	295362	0	631578
2	586288	1	16	95	1304	0	0	884225	631579	1263157
3	602110	1	10	65	1995	0	0	1487639	1263158	1894736
4	544300	1	20	50	1805	0	0	2033934	1894737	2526315
5	651104	3	10	100	1816	1414	1056	2686843	2526316	3157894
6	351751	3	18	65	1917	1812	1077	3542880	3157895	3789473
7	442551	2	10	70	1878	1756	0	3990237	3789474	4421052
8	646739	3	8	75	1517	1653	1557	4640610	4421053	5052631
9	759432	1	7	50	1145	0	0	5404769	5052632	5684210
10	590048	3	19	80	1226	1379	1568	5995962	5684211	6315789
11	395483	3	20	50	1663	1153	1313	6395618	6315790	6947368
12	1142072	1	19	85	1938	0	0	7541819	6947369	7578947
13	228803	2	9	60	1292	1333	0	7772560	7578948	8210526
14	508397	1	6	50	1760	0	0	8283582	8210527	8842105
15	1070409	1	17	70	1657	0	0	9355751	8842106	9473684
16	236469	3	15	70	1043	1198	1359	9593877	9473685	10105263
17	571504	1	11	50	1369	0	0	10168981	10105264	10736842
18	939850	2	6	50	1293	1743	0	11110200	10736843	11368421
19	668662	2	8	60	1106	1826	0	11781898	11368422	12000000

Total number of pulses in waveform = 36



Type 5 Radar Waveform_8

Waveform Num = 8
Num of Bursts = 13
Burst Interval (us)= 923077

Burst #	Off Time (us)	# Pulses	Chirp (MHz)	PW (us)	Pulse 1 Pri (us)	Pulse 2 Pri (us)	Pulse 3 Pri (us)	Start Loc (us)	Start Burst Interval (us)	End Burst Interval (us)
1	715729	3	9	65	1052	1914	1678	715729	0	923076
2	636014	3	17	65	1345	1124	1089	1356387	923077	1846153
3	543308	3	11	70	1544	1195	1437	1903253	1846154	2769230
4	1416794	1	13	75	1583	0	0	3324223	2769231	3692307
5	1162996	2	18	90	1966	1950	0	4488802	3692308	4615384
6	237041	2	19	70	1101	1432	0	4729759	4615385	5538461
7	1120952	2	5	80	1131	1414	0	5853244	5538462	6461538
8	1190364	1	5	90	1316	0	0	7046153	6461539	7384615
9	442237	3	16	80	1371	1026	1567	7489706	7384616	8307692
10	870554	3	11	85	1288	1286	1823	8364224	8307693	9230769
11	1301115	2	16	85	1290	1725	0	9669736	9230770	10153846
12	696307	1	10	80	1003	0	0	10369058	10153847	11076923
13	1391943	3	14	65	1599	1918	1365	11762004	11076924	12000000

Total number of pulses in waveform = 29

Type 5 Radar Waveform_9

Waveform Num = 9
Num of Bursts = 20
Burst Interval (us)= 600000

Burst #	Off Time (us)	# Pulses	Chirp (MHz)	PW (us)	Pulse 1 Pri (us)	Pulse 2 Pri (us)	Pulse 3 Pri (us)	Start Loc (us)	Start Burst Interval (us)	End Burst Interval (us)
1	298721	1	18	60	1381	0	0	298721	0	699999
2	453998	2	8	85	1271	1874	0	754100	600000	1199999
3	687067	3	19	60	1520	1250	1641	1444312	1200000	1799999
4	886950	1	15	60	1686	0	0	2334673	1800000	2399999
5	452128	2	8	90	1826	1581	0	2788487	2400000	2999999
6	804114	1	14	80	1704	0	0	3596008	3000000	3599999
7	355159	1	18	85	1059	0	0	3952871	3600000	4199999
8	654751	3	7	90	1996	1448	1923	4608681	4200000	4799999
9	323874	3	14	60	1417	1608	1227	4937922	4800000	5399999
10	958769	1	15	95	1881	0	0	5900943	5400000	5999999
11	467933	3	15	90	1919	1982	1227	6370757	6000000	6599999
12	562467	3	12	55	1596	1581	1847	6938352	6600000	7199999
13	478202	1	7	65	1776	0	0	7421578	7200000	7799999
14	506760	1	13	80	1363	0	0	7930114	7800000	8399999
15	804435	3	11	80	1205	1980	1156	8735912	8400000	8999999
16	600914	1	14	85	1304	0	0	9341167	9000000	9599999
17	322182	1	5	65	1448	0	0	9664653	9600000	10199999
18	889427	3	11	90	1244	1159	1162	10555528	10200000	10799999
19	529127	3	10	65	1217	1193	1265	11088220	10800000	11399999
20	455786	1	17	100	1951	0	0	11547681	11400000	11999999

Total number of pulses in waveform = 38

Type 5 Radar Waveform_10

Waveform Num = 10
Num of Bursts = 12
Burst Interval (us)= 1000000

Burst #	Off Time (us)	# Pulses	Chirp (MHz)	PW (us)	Pulse 1 Pri (us)	Pulse 2 Pri (us)	Pulse 3 Pri (us)	Start Loc (us)	Start Burst Interval (us)	End Burst Interval (us)
1	161118	1	17	90	1566	0	0	161118	0	999999
2	1046550	2	17	100	1679	1363	0	1209234	1000000	1999999
3	1453758	3	9	60	1017	1729	1348	2666034	2000000	2999999
4	693592	3	17	95	1699	1460	1145	3363720	3000000	3999999
5	1273251	1	9	90	1475	0	0	4641275	4000000	4999999
6	649535	2	7	65	1140	1564	0	5292285	5000000	5999999
7	1144749	1	7	85	1834	0	0	6439738	6000000	6999999
8	1357622	3	13	60	1450	1310	1851	7799194	7000000	7999999
9	822560	2	15	75	1151	1596	0	8626365	8000000	8999999
10	1058853	1	17	80	1478	0	0	9687965	9000000	9999999
11	376565	1	11	80	1556	0	0	10066008	10000000	10999999
12	1051416	2	18	85	1554	1076	0	11118980	11000000	11999999

Total number of pulses in waveform = 22



Type 5 Radar Waveform_11

Waveform Num = 11
Num of Bursts = 18
Burst Interval (us)= 666667

Burst #	Off Time (us)	# Pulses	Chirp (MHz)	PW (us)	Pulse 1 Pri (us)	Pulse 2 Pri (us)	Pulse 3 Pri (us)	Start Loc (us)	Start Burst Interval (us)	End Burst Interval (us)
1	218767	1	13	60	1349	0	0	216767	0	666666
2	895015	2	19	70	1941	1530	0	1113131	666667	1333333
3	339722	1	16	55	1510	0	0	1456324	1333334	2000000
4	680371	2	17	90	1889	1070	0	2138205	2000001	2666667
5	529251	1	17	65	1934	0	0	2670415	2666668	3333334
6	696918	2	12	50	1676	1509	0	3369267	3333335	4000001
7	1085110	2	13	60	1385	1986	0	4457562	4000002	4666668
8	681261	3	5	55	1626	1388	1988	5142194	4666669	5333335
9	360253	2	13	75	1286	1445	0	5507449	5333336	6000002
10	638276	3	6	95	1130	1486	1786	6148456	6000003	6666669
11	1121838	2	11	1603	70	1308	0	7274696	6666670	7333336
12	676948	1	19	100	1361	0	0	7954555	7333337	8000003
13	538701	1	6	70	1023	0	0	8494617	8000004	8666670
14	526409	2	9	80	1622	1010	0	9022049	8666671	9333337
15	487102	1	13	80	1969	0	0	9511783	9333338	10000004
16	630829	3	19	80	1078	1373	1060	10144581	10000005	10666671
17	914477	1	19	55	1910	0	0	11062569	10666672	11333338
18	618970	1	18	50	1036	0	0	11683449	11333339	12000005

Total number of pulses in waveform = 31

Type 5 Radar Waveform_12

Waveform Num = 12
Num of Bursts = 10
Burst Interval (us)= 1200000

Burst #	Off Time (us)	# Pulses	Chirp (MHz)	PW (us)	Pulse 1 Pri (us)	Pulse 2 Pri (us)	Pulse 3 Pri (us)	Start Loc (us)	Start Burst Interval (us)	End Burst Interval (us)
1	157740	2	7	75	1645	1533	0	157740	0	1199999
2	2189045	3	7	60	1202	1357	1544	2349963	1200000	2399999
3	107931	3	15	65	1263	1695	1784	2461997	2400000	3599999
4	2044890	2	7	65	1968	1819	0	4511629	3600000	4799999
5	1022020	3	11	60	1722	1573	1819	5537436	4800000	5999999
6	560341	3	19	55	1615	1075	1582	6102891	6000000	7199999
7	1956359	2	20	100	1850	1710	0	8063522	7200000	8399999
8	775473	2	7	80	1747	1152	0	8842555	8400000	9599999
9	1085967	2	15	70	1031	1637	0	9931421	9600000	10799999
10	1935605	2	12	85	1921	1096	0	11869694	10800000	11999999

Total number of pulses in waveform = 24

Type 5 Radar Waveform_13

Waveform Num = 13
Num of Bursts = 15
Burst Interval (us)= 800000

Burst #	Off Time (us)	# Pulses	Chirp (MHz)	PW (us)	Pulse 1 Pri (us)	Pulse 2 Pri (us)	Pulse 3 Pri (us)	Start Loc (us)	Start Burst Interval (us)	End Burst Interval (us)
1	738740	3	10	90	1076	1442	1224	738740	0	799999
2	630029	2	11	50	1725	1565	0	1372511	800000	1599999
3	248440	3	9	100	1375	1106	1993	1624241	1600000	2399999
4	891221	1	7	50	1524	0	0	2519936	2400000	3199999
5	691543	1	20	100	1424	0	0	3213003	3200000	3999999
6	1207934	3	13	60	1264	1326	1610	4422361	4000000	4799999
7	894205	3	7	70	1915	1921	1750	5320766	4800000	5599999
8	458512	3	12	70	1089	1752	1001	5784864	5600000	6399999
9	665251	2	17	95	1785	1709	0	6453957	6400000	7199999
10	862993	1	15	50	1252	0	0	7320444	7200000	7999999
11	1306029	2	18	70	1761	1385	0	8627725	8000000	8799999
12	596400	3	18	85	1297	1255	1612	9227271	8800000	9599999
13	554056	3	13	70	1236	1276	1099	9785491	9600000	10399999
14	905306	3	14	60	1859	1881	1181	10694408	10400000	11199999
15	1265101	3	10	75	1266	1978	1488	11964430	11200000	11999999

Total number of pulses in waveform = 36



Type 5 Radar Waveform_14

Waveform Num = 14
 Num of Bursts = 18
 Burst Interval (us) = 666667

Burst #	Off Time (us)	# Pulses	Chirp (MHz)	PW (us)	Pulse 1 Pri (us)	Pulse 2 Pri (us)	Pulse 3 Pri (us)	Start Loc (us)	Start Burst Interval (us)	End Burst Interval (us)
1	215767	1	20	55	1565	0	0	215767	0	666666
2	589953	1	19	95	1419	0	0	807285	666667	1333333
3	797450	2	10	75	1878	1095	0	1606154	1333334	2000000
4	526806	3	10	100	1169	1571	1308	2135933	2000001	2666667
5	1050252	2	16	95	1803	1843	0	3190233	2666668	3333334
6	504613	2	5	100	1400	1799	0	3698492	3333335	4000001
7	730240	2	17	90	1335	1191	0	4431931	4000002	4666668
8	405464	3	9	95	1161	1103	1614	4839921	4666669	5333335
9	1136700	1	10	100	1304	0	0	5980499	5333336	6000002
10	561350	3	10	60	1579	1244	1769	6543153	6000003	6666669
11	383960	1	5	80	1279	0	0	6931705	6666670	7333336
12	536200	1	16	90	1385	0	0	7469184	7333337	8000003
13	828950	2	13	50	1279	1277	0	8299519	8000004	8666670
14	748435	3	13	95	1301	1125	1539	9050510	8666671	9333337
15	633677	3	13	95	1354	1623	1894	9688152	9333338	10000004
16	631494	1	16	60	1234	0	0	10324457	10000005	10666671
17	575154	3	18	65	1455	1553	1154	10900845	10666672	11333338
18	836369	3	6	55	1816	1084	1782	11741376	11333339	12000005

Total number of pulses in waveform = 37

Type 5 Radar Waveform_15

Waveform Num = 15
 Num of Bursts = 10
 Burst Interval (us) = 1200000

Burst #	Off Time (us)	# Pulses	Chirp (MHz)	PW (us)	Pulse 1 Pri (us)	Pulse 2 Pri (us)	Pulse 3 Pri (us)	Start Loc (us)	Start Burst Interval (us)	End Burst Interval (us)
1	318113	3	10	50	1436	1962	1442	318113	0	1199999
2	2008621	3	16	50	1432	1876	1301	2331574	1200000	2399999
3	676407	3	7	85	1645	1695	1029	3012590	2400000	3599999
4	1057704	3	8	95	1248	1459	1829	4074663	3600000	4799999
5	1772591	2	12	100	1073	1890	0	5851790	4800000	5999999
6	500309	1	18	70	1951	0	0	6355062	6000000	7199999
7	1189923	3	20	55	1230	1218	1062	7546936	7200000	8399999
8	1549837	3	13	80	1589	1513	1623	9100283	8400000	9599999
9	1181412	1	8	85	1742	0	0	10286420	9600000	10799999
10	675020	3	7	65	1655	1579	1390	10963182	10800000	11999999

Total number of pulses in waveform = 25

Type 5 Radar Waveform_16

Waveform Num = 16
 Num of Bursts = 10
 Burst Interval (us) = 1200000

Burst #	Off Time (us)	# Pulses	Chirp (MHz)	PW (us)	Pulse 1 Pri (us)	Pulse 2 Pri (us)	Pulse 3 Pri (us)	Start Loc (us)	Start Burst Interval (us)	End Burst Interval (us)
1	788128	1	17	55	1073	0	0	788128	0	1199999
2	1313789	2	10	65	1509	1350	0	2102990	1200000	2399999
3	565670	3	14	85	1131	1593	1573	2671519	2400000	3599999
4	1770621	2	13	75	1398	1349	0	4446437	3600000	4799999
5	1171742	2	13	65	1965	1565	0	5620926	4800000	5999999
6	1383531	2	16	70	1802	1345	0	7007987	6000000	7199999
7	690231	2	8	55	1522	1566	0	7701365	7200000	8399999
8	818490	3	18	80	1830	1379	1133	8522943	8400000	9599999
9	2153328	1	19	50	1145	0	0	10680613	9600000	10799999
10	979100	2	11	100	1790	1968	0	11660858	10800000	11999999

Total number of pulses in waveform = 20



Type 5 Radar Waveform_17

Waveform Num = 17
 Num of Bursts = 17
 Burst Interval (us)= 705882

Burst #	Off Time (us)	# Pulses	Chirp (MHz)	PW (us)	Pulse 1 Pri (us)	Pulse 2 Pri (us)	Pulse 3 Pri (us)	Start Loc (us)	Start Burst Interval (us)	End Burst Interval (us)
1	25986	3	16	85	1634	1086	1719	25986	0	705881
2	1196447	3	15	70	1187	1156	1882	1226872	705882	1411763
3	382738	1	20	95	1756	0	0	1613835	1411764	2117645
4	747504	3	15	90	1239	1769	1487	2363095	2117646	2823527
5	845500	3	9	85	1700	1275	1120	3213090	2823528	3529409
6	994780	1	8	80	1580	0	0	4211965	3529410	4235291
7	116382	1	8	95	1735	0	0	4329927	4235292	4941173
8	854001	2	19	75	1480	1348	0	5185663	4941174	5647055
9	950496	2	19	75	1507	1144	0	6138987	5647056	6352937
10	599619	1	13	65	1547	0	0	6741257	6352938	7058819
11	412273	1	18	50	1015	0	0	7155077	7058820	7764701
12	776523	3	8	60	1373	1567	1371	7932615	7764702	8470583
13	885478	2	7	50	1055	1907	0	8822404	8470584	9176465
14	828540	2	17	50	1732	1175	0	9653906	9176466	9882347
15	615092	2	16	85	1009	1926	0	10271905	9882348	10588229
16	598019	3	12	50	1570	1418	1431	10872859	10588230	11294111
17	774205	2	20	50	1874	1292	0	11651483	11294112	11999993

Total number of pulses in waveform = 35

Type 5 Radar Waveform_18

Waveform Num = 18
 Num of Bursts = 8
 Burst Interval (us)= 1500000

Burst #	Off Time (us)	# Pulses	Chirp (MHz)	PW (us)	Pulse 1 Pri (us)	Pulse 2 Pri (us)	Pulse 3 Pri (us)	Start Loc (us)	Start Burst Interval (us)	End Burst Interval (us)
1	1298536	2	7	85	1028	1053	0	1298536	0	1499999
2	525067	3	14	90	1761	1076	1016	1825684	1500000	2999999
3	1838578	2	9	85	1050	1080	0	3668115	3000000	4499999
4	1515432	2	20	95	1680	1029	0	5185677	4500000	5999999
5	2156561	3	15	55	1108	1083	1653	7344947	6000000	7499999
6	1097322	3	7	70	1749	1379	1431	8446113	7500000	8999999
7	1865746	2	16	90	1528	1062	0	10316418	9000000	10499999
8	1337919	1	14	50	1448	0	0	11656927	10500000	11999999

Total number of pulses in waveform = 18

Type 5 Radar Waveform_19

Waveform Num = 19
 Num of Bursts = 16
 Burst Interval (us)= 750000

Burst #	Off Time (us)	# Pulses	Chirp (MHz)	PW (us)	Pulse 1 Pri (us)	Pulse 2 Pri (us)	Pulse 3 Pri (us)	Start Loc (us)	Start Burst Interval (us)	End Burst Interval (us)
1	212917	2	13	65	1025	1207	0	212917	0	749999
2	654280	1	14	75	1149	0	0	869429	750000	1499999
3	913532	3	7	100	1247	1275	1942	1784110	1500000	2249999
4	724540	3	6	65	1878	1404	1554	2513114	2250000	2999999
5	622032	3	10	95	1214	1347	1178	3139982	3000000	3749999
6	697265	1	9	50	1135	0	0	3840986	3750000	4499999
7	1049941	3	16	55	1673	1434	1283	4892062	4500000	5249999
8	459357	3	10	65	1262	1316	1242	5355809	5250000	5999999
9	972147	2	8	60	1770	1490	0	6331776	6000000	6749999
10	895827	3	11	70	1328	1210	1974	7230863	6750000	7499999
11	587493	1	14	55	1196	0	0	7822868	7500000	8249999
12	732327	2	11	90	1859	1801	0	8556391	8250000	8999999
13	817139	2	6	70	1660	1729	0	9377190	9000000	9749999
14	793899	3	11	95	1963	1031	1838	10174478	9750000	10499999
15	836065	2	16	65	1627	1987	0	11015375	10500000	11249999
16	622110	1	7	65	1959	0	0	11641099	11250000	11999999

Total number of pulses in waveform = 35



Type 5 Radar Waveform_20

Waveform Num = 20
Num of Bursts = 10
Burst Interval (us)= 1200000

Burst #	Off Time (us)	# Pulses	Chirp (MHz)	PW (us)	Pulse 1 Pri (us)	Pulse 2 Pri (us)	Pulse 3 Pri (us)	Start Loc (us)	Start Burst Interval (us)	End Burst Interval (us)
1	578983	2	8	90	1512	1653	0	578983	0	1199999
2	1106659	1	17	75	1607	0	0	1688807	1200000	2399999
3	1044390	2	10	65	1498	1551	0	2734804	2400000	3599999
4	1110364	1	12	100	1430	0	0	3848217	3600000	4799999
5	1227053	3	9	70	1232	1006	1255	5076700	4800000	5999999
6	1133093	3	11	85	1175	1591	1563	6213286	6000000	7199999
7	1323538	1	10	65	1009	0	0	7541153	7200000	8399999
8	911755	2	18	55	1428	1758	0	8453917	8400000	9599999
9	1548870	2	12	60	1113	1827	0	10005973	9600000	10799999
10	1639109	2	16	50	1803	1042	0	11648022	10800000	11999999

Total number of pulses in waveform = 19

Type 5 Radar Waveform_21

Waveform Num = 21
Num of Bursts = 12
Burst Interval (us)= 1000000

Burst #	Off Time (us)	# Pulses	Chirp (MHz)	PW (us)	Pulse 1 Pri (us)	Pulse 2 Pri (us)	Pulse 3 Pri (us)	Start Loc (us)	Start Burst Interval (us)	End Burst Interval (us)
1	156214	3	9	100	1613	1774	1595	156214	0	999999
2	1764869	2	11	70	1995	1449	0	1926065	1000000	1999999
3	806346	2	20	90	1628	1176	0	2735855	2000000	2999999
4	1042645	2	16	95	1149	1531	0	3781304	3000000	3999999
5	536211	2	16	100	1139	1769	0	4320195	4000000	4999999
6	747852	2	16	65	1881	1345	0	5070955	5000000	5999999
7	1789592	1	16	75	1543	0	0	6863773	6000000	6999999
8	141314	3	7	95	1582	1669	1132	7006630	7000000	7999999
9	1376401	1	16	90	1925	0	0	8327414	8000000	8999999
10	954864	1	7	55	1108	0	0	9344203	9000000	9999999
11	825795	1	20	95	1807	0	0	10171106	10000000	10999999
12	1018425	2	17	95	1060	1670	0	11191338	11000000	11999999

Total number of pulses in waveform = 22

Type 5 Radar Waveform_22

Waveform Num = 22
Num of Bursts = 10
Burst Interval (us)= 1200000

Burst #	Off Time (us)	# Pulses	Chirp (MHz)	PW (us)	Pulse 1 Pri (us)	Pulse 2 Pri (us)	Pulse 3 Pri (us)	Start Loc (us)	Start Burst Interval (us)	End Burst Interval (us)
1	134490	1	12	90	1378	0	0	134490	0	1199999
2	2110500	2	9	100	1994	1448	0	2246368	1200000	2399999
3	1225768	1	17	95	1272	0	0	3475578	2400000	3599999
4	901970	1	20	85	1866	0	0	4378820	3600000	4799999
5	1605420	3	7	65	1874	1570	1219	5986106	4800000	5999999
6	998390	3	19	95	1100	1419	1901	6989159	6000000	7199999
7	666051	3	12	50	1914	1129	1377	7659630	7200000	8399999
8	1585525	3	7	70	1228	1951	1936	9249575	8400000	9599999
9	689290	2	18	70	1562	1818	0	9943980	9600000	10799999
10	1212199	1	7	100	1422	0	0	11159559	10800000	11999999

Total number of pulses in waveform = 20



Type 5 Radar Waveform_23

Waveform Num = 23
Num of Bursts = 9
Burst Interval (us)= 1333333

Burst #	Off Time (us)	# Pulses	Chirp (MHz)	PW (us)	Pulse 1 Pri (us)	Pulse 2 Pri (us)	Pulse 3 Pri (us)	Start Loc (us)	Start Burst Interval (us)	End Burst Interval (us)
1	210251	3	16	50	1912	1515	1588	210251	0	1333332
2	1795399	3	20	80	1376	1406	1369	2010665	1333333	2666665
3	1323489	2	9	90	1362	1832	0	3338305	2666666	3999998
4	1898280	1	9	50	1043	0	0	5239779	3999999	5333331
5	1153274	1	9	60	1466	0	0	6394096	5333332	6666664
6	727162	3	9	55	1227	1516	1618	7122724	6666665	7999997
7	1325642	1	15	85	1973	0	0	8452727	7999998	9333330
8	1358839	3	13	100	1613	1216	1689	9813539	9333331	10666663
9	939332	1	9	95	1173	0	0	10757389	10666664	11999996

Total number of pulses in waveform = 18

Type 5 Radar Waveform_24

Waveform Num = 24
Num of Bursts = 10
Burst Interval (us)= 1200000

Burst #	Off Time (us)	# Pulses	Chirp (MHz)	PW (us)	Pulse 1 Pri (us)	Pulse 2 Pri (us)	Pulse 3 Pri (us)	Start Loc (us)	Start Burst Interval (us)	End Burst Interval (us)
1	556966	1	13	95	1036	0	0	556966	0	1199999
2	1835519	3	12	75	1542	1388	1981	2393521	1200000	2399999
3	58257	3	13	65	1026	1054	1192	2456689	2400000	3599999
4	1506288	3	16	100	1916	1335	1322	3966249	3600000	4799999
5	888936	2	19	60	1712	1862	0	4859758	4800000	5999999
6	1655890	1	8	55	1722	0	0	6519222	6000000	7199999
7	1396655	3	14	65	1239	1128	1270	7917599	7200000	8399999
8	936929	3	11	100	1225	1075	1271	8858165	8400000	9599999
9	1322843	1	5	75	1511	0	0	10184579	9600000	10799999
10	1389230	1	14	60	1691	0	0	11575320	10800000	11999999

Total number of pulses in waveform = 21

Type 5 Radar Waveform_25

Waveform Num = 25
Num of Bursts = 16
Burst Interval (us)= 750000

Burst #	Off Time (us)	# Pulses	Chirp (MHz)	PW (us)	Pulse 1 Pri (us)	Pulse 2 Pri (us)	Pulse 3 Pri (us)	Start Loc (us)	Start Burst Interval (us)	End Burst Interval (us)
1	269171	3	10	80	1888	1720	1131	269171	0	749999
2	573955	3	8	100	1166	1676	1455	847865	750000	1499999
3	669564	1	19	80	1522	0	0	1521726	1500000	2249999
4	773356	3	14	75	1476	1711	1205	2296604	2250000	2999999
5	710978	2	17	60	1227	1585	0	3011974	3000000	3749999
6	825929	3	15	65	1073	1526	1629	3840715	3750000	4499999
7	1288933	3	14	50	1396	1761	1875	5133876	4500000	5249999
8	306188	1	5	95	1852	0	0	5445096	5250000	5999999
9	928508	2	15	70	1755	1242	0	6375456	6000000	6749999
10	766342	2	11	75	1528	1476	0	7144795	6750000	7499999
11	394223	1	17	65	1109	0	0	7542022	7500000	8249999
12	922594	1	17	50	1286	0	0	8465725	8250000	8999999
13	941797	2	20	55	1627	1824	0	9408808	9000000	9749999
14	565506	3	6	85	1221	1294	1748	9977765	9750000	10499999
15	919671	1	19	80	1875	0	0	10901699	10500000	11249999
16	354657	1	18	95	1291	0	0	11258231	11250000	11999999

Total number of pulses in waveform = 32



Type 5 Radar Waveform_26

Waveform Num = 26
Num of Bursts = 11
Burst Interval (us)= 1090909

Burst #	Off Time (us)	# Pulses	Chirp (MHz)	PW (us)	Pulse 1 Pri (us)	Pulse 2 Pri (us)	Pulse 3 Pri (us)	Start Loc (us)	Start Burst Interval (us)	End Burst Interval (us)
1	37120	3	17	75	1608	1292	1400	37120	0	1090908
2	1692146	3	15	60	1677	1614	1169	1733566	1090909	2181817
3	477231	2	20	50	1725	1326	0	2215257	2181818	3272726
4	1289412	1	11	90	1586	0	0	3507720	3272727	4363635
5	878751	1	12	60	1192	0	0	4388057	4363636	5454544
6	1629908	3	18	90	1943	1933	1421	6019157	5454545	6545453
7	827353	3	6	95	1884	1795	1595	6851807	6545454	7636362
8	929175	3	8	55	1412	1643	1817	7786256	7636363	8727271
9	1373716	1	8	65	1049	0	0	9164844	8727272	9818180
10	1202618	3	8	70	1485	1241	1314	10368511	9818181	10909089
11	562753	2	10	100	1007	1558	0	10935304	10909090	11999998

Total number of pulses in waveform = 25

Type 5 Radar Waveform_27

Waveform Num = 27
Num of Bursts = 15
Burst Interval (us)= 800000

Burst #	Off Time (us)	# Pulses	Chirp (MHz)	PW (us)	Pulse 1 Pri (us)	Pulse 2 Pri (us)	Pulse 3 Pri (us)	Start Loc (us)	Start Burst Interval (us)	End Burst Interval (us)
1	390523	2	11	80	1538	1537	0	390523	0	799999
2	1034167	1	16	90	1008	0	0	1427815	800000	1599999
3	612126	2	8	100	1684	1560	0	2040949	1600000	2399999
4	1143657	2	10	55	1053	1245	0	3187850	2400000	3199999
5	675780	1	15	60	1982	0	0	3865928	3200000	3999999
6	814906	3	6	100	1886	1106	1145	4682816	4000000	4799999
7	277699	2	5	95	1311	1594	0	4964652	4800000	5599999
8	1045292	3	9	75	1065	1630	1073	6012849	5600000	6399999
9	1172818	1	9	60	1898	0	0	7189435	6400000	7199999
10	189175	3	6	80	1156	1206	1549	7380508	7200000	7999999
11	1184310	2	10	80	1667	1507	0	8568729	8000000	8799999
12	650111	3	10	75	1578	1612	1255	9222014	8800000	9599999
13	999949	3	16	100	1653	1354	1442	10226408	9600000	10399999
14	804791	2	13	70	1811	1652	0	11035648	10400000	11199999
15	297131	1	8	80	1628	0	0	11336242	11200000	11999999

Total number of pulses in waveform = 31

Type 5 Radar Waveform_28

Waveform Num = 28
Num of Bursts = 18
Burst Interval (us)= 666667

Burst #	Off Time (us)	# Pulses	Chirp (MHz)	PW (us)	Pulse 1 Pri (us)	Pulse 2 Pri (us)	Pulse 3 Pri (us)	Start Loc (us)	Start Burst Interval (us)	End Burst Interval (us)
1	1008	1	20	50	1761	0	0	1008	0	666666
2	978034	3	9	60	1853	1220	1946	980803	666667	1333333
3	368902	1	16	100	1245	0	0	1354724	1333334	2000000
4	1181563	1	13	85	1692	0	0	2537532	2000001	2666667
5	327233	2	19	60	1284	1212	0	2866457	2666668	3333334
6	1056527	3	11	100	1970	1745	1307	3925480	3333335	4000001
7	140932	2	5	50	1006	1359	0	4071434	4000002	4666668
8	1092971	1	8	90	1062	0	0	5166770	4666669	5333335
9	221492	1	18	75	1595	0	0	5389324	5333336	6000002
10	1228097	3	15	90	1103	1491	1441	6619016	6000003	6666669
11	78261	2	13	55	1923	1839	0	6701312	6666670	7333336
12	1167041	3	9	55	1182	1475	1267	7872115	7333337	8000003
13	418865	2	11	55	1447	1350	0	8294904	8000004	8666670
14	694075	2	14	100	1846	1890	0	8991776	8666671	9333337
15	582884	3	14	60	1296	1195	1479	9578396	9333338	10000004
16	544951	2	10	95	1027	1157	0	10127317	10000005	10666671
17	761210	1	8	85	1476	0	0	10890711	10666672	11333338
18	761868	2	20	50	1316	1603	0	11654055	11333339	12000005

Total number of pulses in waveform = 35



Type 5 Radar Waveform_29

Waveform Num = 29
Num of Bursts = 16
Burst Interval (us) = 750000

Burst #	Off Time (us)	# Pulses	Chirp (MHz)	PW (us)	Pulse 1 Pri (us)	Pulse 2 Pri (us)	Pulse 3 Pri (us)	Start Loc (us)	Start Burst Interval (us)	End Burst Interval (us)
1	138059	2	14	100	1377	1822	0	138059	0	749999
2	672769	3	9	85	1633	1403	1768	814027	750000	1499999
3	766230	2	15	95	1440	1019	0	1585061	1500000	2249999
4	1309822	2	15	100	1007	1021	0	2897342	2250000	2999999
5	120902	2	16	65	1927	1430	0	3020272	3000000	3749999
6	1207179	1	16	100	1873	0	0	4230808	3750000	4499999
7	833939	1	5	55	1338	0	0	5066620	4500000	5249999
8	352420	1	18	55	1554	0	0	5420378	5250000	5999999
9	855586	2	13	50	1091	1030	0	6277518	6000000	6749999
10	1050105	1	9	100	1467	0	0	7329744	6750000	7499999
11	517914	3	9	50	1660	1902	1592	7849125	7500000	8249999
12	911047	2	12	80	1606	1560	0	8765326	8250000	8999999
13	699327	1	18	80	1690	0	0	9467819	9000000	9749999
14	467279	3	7	80	1498	1500	1083	9936788	9750000	10499999
15	1271031	3	12	70	1586	1187	1238	11211900	10500000	11249999
16	373853	3	17	55	1325	1830	1034	11589764	11250000	11999999

Total number of pulses in waveform = 32

Type 5 Radar Waveform_30

Waveform Num = 30
Num of Bursts = 10
Burst Interval (us) = 1200000

Burst #	Off Time (us)	# Pulses	Chirp (MHz)	PW (us)	Pulse 1 Pri (us)	Pulse 2 Pri (us)	Pulse 3 Pri (us)	Start Loc (us)	Start Burst Interval (us)	End Burst Interval (us)
1	703122	3	12	90	1894	1457	1654	703122	0	1199999
2	1460310	2	13	75	1809	1820	0	2168437	1200000	2399999
3	421397	3	14	85	1987	1273	1866	2593463	2400000	3599999
4	1938623	3	13	85	1989	1581	1311	4537212	3600000	4799999
5	558322	3	6	60	1354	1796	1297	5100415	4800000	5999999
6	920699	1	10	75	1969	0	0	6025561	6000000	7199999
7	1910228	1	8	65	1010	0	0	7937758	7200000	8399999
8	621281	1	6	85	1853	0	0	8560049	8400000	9599999
9	1312361	3	19	50	1137	1018	1278	9874263	9600000	10799999
10	1349066	3	10	90	1421	1673	1120	11226762	10800000	11999999

Total number of pulses in waveform = 23

Type 6 Radar Statistical Performance

Trail #	Test Freq. (MHz)	1=Detection 0=No Detection	Trail #	Test Freq. (MHz)	1=Detection 0=No Detection
1	5300	1	16	5300	1
2	5300	1	17	5300	1
3	5300	1	18	5300	1
4	5300	1	19	5300	1
5	5300	1	20	5300	1
6	5300	1	21	5300	1
7	5300	1	22	5300	1
8	5300	1	23	5300	1
9	5300	1	24	5300	1
10	5300	1	25	5300	1
11	5300	1	26	5300	1
12	5300	1	27	5300	1
13	5300	1	28	5300	1
14	5300	1	29	5300	1
15	5300	1	30	5300	1
Detection Percentage (%)					100%



Radar waveform #1			Radar waveform #2		
Hopping Number	Frequency (MHz)	Pulse Start (ms)	Hopping Number	Frequency (MHz)	Pulse Start (ms)
2	5290	6	20	5305	60
12	5329	36	24	5328	72
20	5275	60	27	5327	81
24	5306	72	47	5286	141
29	5319	87	57	5329	171
41	5278	123	79	5310	237
47	5323	141	86	5297	258
52	5321	156	88	5306	264
56	5313	168	--	--	--
57	5316	171	--	--	--
70	5271	210	--	--	--
74	5326	222	--	--	--
86	5291	258	--	--	--
89	5298	267	--	--	--
90	5289	270	--	--	--
Radar waveform #3			Radar waveform #4		
Hopping Number	Frequency (MHz)	Pulse Start (ms)	Hopping Number	Frequency (MHz)	Pulse Start (ms)
3	5321	9	18	5319	54
14	5295	42	21	5314	63
26	5309	78	34	5286	102
34	5319	102	40	5320	120
35	5317	105	41	5291	123
46	5288	138	72	5318	216
48	5282	144	81	5326	243
49	5287	147	83	5270	249
51	5305	153	85	5274	255
55	5301	165	--	--	--
56	5283	168	--	--	--
94	5325	282	--	--	--

Radar waveform #5			Radar waveform #6		
Hopping Number	Frequency (MHz)	Pulse Start (ms)	Hopping Number	Frequency (MHz)	Pulse Start (ms)
0	5311	0	6	5282	18
2	5278	6	12	5281	36
13	5308	39	20	5305	60
19	5279	57	47	5302	141
26	5307	78	64	5301	192
37	5273	111	72	5276	216
47	5291	141	74	5327	222
65	5316	195	81	5308	243
68	5271	204	96	5317	288
82	5317	246	--	--	--
87	5330	261	--	--	--
91	5288	273	--	--	--
Radar waveform #7			Radar waveform #8		
Hopping Number	Frequency (MHz)	Pulse Start (ms)	Hopping Number	Frequency (MHz)	Pulse Start (ms)
8	5284	24	3	5280	9
11	5303	33	7	5329	21
18	5290	54	17	5299	51
21	5292	63	26	5305	78
22	5309	66	29	5285	87
23	5313	69	31	5270	93
36	5324	108	37	5286	111
47	5294	141	38	5300	114
57	5321	171	54	5313	162
65	5325	195	88	5304	264
75	5274	225	90	5319	270
96	5305	288	99	5312	297
99	5312	297	--	--	--

Radar waveform #9			Radar waveform #10		
Hopping Number	Frequency (MHz)	Pulse Start (ms)	Hopping Number	Frequency (MHz)	Pulse Start (ms)
0	5325	0	2	5286	6
1	5317	3	4	5308	12
3	5293	9	20	5297	60
5	5327	15	28	5287	84
10	5291	30	35	5314	105
18	5315	54	37	5329	111
23	5295	69	44	5320	132
27	5329	81	45	5272	135
30	5302	90	47	5280	141
39	5328	117	48	5313	144
41	5301	123	55	5270	165
43	5318	129	60	5278	180
45	5272	135	72	5284	216
48	5292	144	86	5283	258
49	5314	147	88	5316	264
57	5286	171	--	--	--
61	5285	183	--	--	--
81	5322	243	--	--	--
94	5278	282	--	--	--
95	5326	285	--	--	--
98	5320	294	--	--	--

Radar waveform #11			Radar waveform #12		
Hopping Number	Frequency (MHz)	Pulse Start (ms)	Frequency (MHz)	Hopping Number	Pulse Start (ms)
9	5292	27	0	5278	0
13	5289	39	6	5303	18
19	5271	57	10	5294	30
22	5318	66	14	5298	42
25	5325	75	16	5328	48
27	5303	81	20	5327	60
29	5284	87	31	5319	93
36	5273	108	41	5315	123
38	5274	114	58	5295	174
55	5305	165	60	5329	180
63	5304	189	65	5322	195
75	5322	225	69	5323	207
77	5301	231	70	5326	210
86	5291	258	73	5277	219
89	5290	267	80	5317	240
90	5293	270	84	5311	252
97	5286	291	--	--	--

Radar waveform #13			Radar waveform #14		
Hopping Number	Frequency (MHz)	Pulse Start (ms)	Hopping Number	Frequency (MHz)	Pulse Start (ms)
0	5285	0	3	5307	9
2	5305	6	4	5321	12
26	5325	78	6	5322	18
32	5278	96	12	5297	36
45	5316	135	20	5292	60
53	5297	159	22	5293	66
60	5319	180	27	5319	81
62	5328	186	28	5291	84
92	5303	276	31	5294	93
94	5290	282	50	5286	150
--	--	--	58	5290	174
--	--	--	68	5300	204
--	--	--	79	5279	237
--	--	--	84	5270	252
--	--	--	86	5327	258
--	--	--	94	5326	282
Radar waveform #15			Radar waveform #16		
Hopping Number	Frequency (MHz)	Pulse Start (ms)	Hopping Number	Frequency (MHz)	Pulse Start (ms)
0	5308	0	5	5313	15
4	5288	12	19	5308	57
10	5322	30	31	5316	93
16	5279	48	47	5307	141
38	5319	114	66	5298	198
45	5305	135	73	5314	219
49	5306	147	83	5297	249
63	5293	189	85	5282	255
64	5298	192	87	5324	261
70	5289	210	--	--	--

Radar waveform #17			Radar waveform #18		
Hopping Number	Frequency (MHz)	Pulse Start (ms)	Hopping Number	Frequency (MHz)	Pulse Start (ms)
37	5303	111	17	5294	51
41	5326	123	27	5290	81
50	5270	150	29	5280	87
52	5312	156	37	5310	111
53	5321	159	51	5274	153
54	5300	162	54	5279	162
57	5319	171	59	5327	177
65	5292	195	61	5272	183
70	5320	210	65	5308	195
75	5316	225	67	5328	201
76	5289	228	68	5284	204
95	5298	285	71	5277	213
96	5330	288	80	5287	240
97	5308	291	94	5322	282
--	--	--	95	5309	285
--	--	--	98	5283	294

Radar waveform #19			Radar waveform #20		
Hopping Number	Frequency (MHz)	Pulse Start (ms)	Hopping Number	Frequency (MHz)	Pulse Start (ms)
6	5322	18	5	5273	15
17	5309	51	7	5304	21
19	5298	57	23	5298	69
28	5321	84	35	5296	105
35	5319	105	39	5328	117
44	5282	132	46	5282	138
56	5297	168	56	5280	168
59	5278	177	58	5286	174
72	5314	216	59	5292	177
80	5312	240	68	5310	204
82	5313	246	70	5288	210
86	5311	258	71	5291	213
96	5307	288	90	5313	270
98	5326	294	--	--	--
Radar waveform #21			Radar waveform #22		
Hopping Number	Frequency (MHz)	Pulse Start (ms)	Hopping Number	Frequency (MHz)	Pulse Start (ms)
9	5279	27	3	5306	9
11	5309	33	17	5274	51
17	5310	51	23	5299	69
32	5303	96	32	5284	96
35	5306	105	33	5322	99
38	5330	114	57	5270	171
52	5283	156	61	5317	183
53	5298	159	66	5272	198
54	5312	162	87	5302	261
64	5285	192	88	5303	264
68	5273	204	89	5290	267
75	5288	225	93	5293	279
76	5305	228	--	--	--
91	5274	273	--	--	--
98	5270	294	--	--	--

Radar waveform #23			Radar waveform #24		
Hopping Number	Frequency (MHz)	Pulse Start (ms)	Hopping Number	Frequency (MHz)	Pulse Start (ms)
5	5308	15	2	5284	6
13	5302	39	7	5297	21
31	5271	93	14	5303	42
47	5278	141	18	5301	54
51	5309	153	29	5292	87
54	5330	162	37	5271	111
61	5312	183	51	5330	153
65	5313	195	64	5314	192
74	5307	222	76	5329	228
85	5292	255	86	5302	258
--	--	--	90	5277	270
--	--	--	95	5291	285
Radar waveform #25			Radar waveform #26		
Hopping Number	Frequency (MHz)	Pulse Start (ms)	Hopping Number	Frequency (MHz)	Pulse Start (ms)
3	5310	9	4	5318	12
22	5293	66	14	5317	42
29	5305	87	17	5305	51
30	5319	90	24	5277	72
40	5307	120	25	5311	75
47	5328	141	33	5298	99
51	5280	153	39	5284	117
52	5315	156	45	5295	135
64	5313	192	51	5306	153
68	5325	204	55	5282	165
89	5321	267	71	5302	213
92	5278	276	73	5276	219
98	5320	294	78	5274	234
--	--	--	83	5319	249
--	--	--	98	5296	294

Radar waveform #27			Radar waveform #28		
Hopping Number	Frequency (MHz)	Pulse Start (ms)	Hopping Number	Frequency (MHz)	Pulse Start (ms)
4	5292	12	3	5323	9
5	5314	15	11	5277	33
20	5297	60	16	5274	48
30	5305	90	18	5324	54
32	5313	96	20	5308	60
33	5293	99	23	5282	69
52	5299	156	25	5299	75
57	5284	171	36	5275	108
60	5301	180	52	5330	156
67	5279	201	57	5298	171
69	5274	207	74	5279	222
77	5316	231	93	5320	279
91	5321	273	--	--	--
Radar waveform #29			Radar waveform #30		
Hopping Number	Frequency (MHz)	Pulse Start (ms)	Hopping Number	Frequency (MHz)	Pulse Start (ms)
5	5320	15	15	5300	45
8	5287	24	17	5303	51
35	5270	105	29	5314	87
42	5282	126	43	5297	129
44	5302	132	52	5324	156
54	5326	162	60	5298	180
55	5280	165	61	5291	183
59	5329	177	64	5315	192
69	5305	207	80	5277	240
77	5295	231	81	5299	243
--	--	--	89	5310	267
--	--	--	91	5270	273
--	--	--	92	5282	276
--	--	--	93	5329	279

For 802.11n-HT40

Type 1 Radar Statistical Performance

Trail #	Test Freq. (MHz)	Pulse Width (us)	PRI (us)	Pulses / Burst	1=Detection 0=No Detection
1	5510	1	1428	18	1
2	5510	1	1428	18	1
3	5510	1	1428	18	1
4	5510	1	1428	18	1
5	5510	1	1428	18	1
6	5510	1	1428	18	1
7	5510	1	1428	18	1
8	5510	1	1428	18	1
9	5510	1	1428	18	1
10	5510	1	1428	18	1
11	5510	1	1428	18	1
12	5510	1	1428	18	1
13	5510	1	1428	18	1
14	5510	1	1428	18	1
15	5510	1	1428	18	1
16	5510	1	1428	18	1
17	5510	1	1428	18	1
18	5510	1	1428	18	1
19	5510	1	1428	18	1
20	5510	1	1428	18	1
21	5510	1	1428	18	1
22	5510	1	1428	18	1
23	5510	1	1428	18	1
24	5510	1	1428	18	1
25	5510	1	1428	18	1
26	5510	1	1428	18	1
27	5510	1	1428	18	1
28	5510	1	1428	18	1
29	5510	1	1428	18	1
30	5510	1	1428	18	1
Detection Percentage (%)					100%



Type 2 Radar Statistical Performance

Trail #	Test Freq. (MHz)	Pulse Width (us)	PRI (us)	Pulses / Burst	1=Detection 0=No Detection
1	5510	3.4	226	27	1
2	5510	4.7	157	27	1
3	5510	4.1	198	24	1
4	5510	4.2	207	26	1
5	5510	3.8	170	29	1
6	5510	3.4	201	24	1
7	5510	4.8	196	27	1
8	5510	2.2	210	26	1
9	5510	1.5	188	24	1
10	5510	4.3	153	26	1
11	5510	3.6	159	27	1
12	5510	4.2	200	27	1
13	5510	4.4	151	25	1
14	5510	1.8	192	29	1
15	5510	2.8	173	23	1
16	5510	4.1	163	26	1
17	5510	3.4	184	28	1
18	5510	2.3	211	23	1
19	5510	2.2	169	28	1
20	5510	1.4	187	28	1
21	5510	1.1	225	26	1
22	5510	1.7	181	26	1
23	5510	1.2	208	26	1
24	5510	3.9	196	29	1
25	5510	3.4	177	27	1
26	5510	3.0	228	29	1
27	5510	4.4	171	24	1
28	5510	1.8	186	27	1
29	5510	4.6	159	24	1
30	5510	4.6	152	27	1
Detection Percentage (%)					100%

Type 3 Radar Statistical Performance

Trail #	Test Freq. (MHz)	Pulse Width (us)	PRI (us)	Pulses / Burst	1=Detection 0=No Detection
1	5510	7.0	300	18	1
2	5510	7.1	478	18	1
3	5510	7.9	338	16	1
4	5510	10.0	353	17	1
5	5510	6.5	440	16	1
6	5510	6.8	423	17	1
7	5510	7.8	279	17	1
8	5510	6.3	401	16	1
9	5510	6.1	281	17	1
10	5510	9.4	385	17	1
11	5510	7.8	429	18	1
12	5510	8.8	362	16	1
13	5510	8.9	427	18	1
14	5510	6.8	475	18	1
15	5510	9.3	318	18	1
16	5510	9.5	255	16	1
17	5510	9.0	329	18	1
18	5510	6.9	386	17	1
19	5510	9.7	278	17	1
20	5510	9.4	434	18	1
21	5510	9.8	346	16	1
22	5510	9.8	290	16	1
23	5510	8.4	397	17	1
24	5510	6.3	412	18	1
25	5510	9.1	494	18	1
26	5510	6.1	297	18	1
27	5510	6.2	464	17	1
28	5510	6.7	394	16	1
29	5510	7.9	370	17	1
30	5510	7.6	387	16	1
Detection Percentage (%)					100%

Type 4 Radar Statistical Performance

Trail #	Test Freq. (MHz)	Pulse Width (us)	PRI (us)	Pulses / Burst	1=Detection 0=No Detection
1	5510	17.2	290	16	1
2	5510	20.0	270	16	1
3	5510	19.7	334	12	1
4	5510	18.7	442	13	1
5	5510	16.8	479	14	1
6	5510	12.5	264	12	1
7	5510	12.0	283	15	1
8	5510	15.1	370	13	1
9	5510	15.4	387	15	1
10	5510	14.0	458	16	1
11	5510	17.9	496	14	1
12	5510	13.5	326	15	1
13	5510	14.7	450	15	1
14	5510	16.6	269	14	1
15	5510	13.5	341	13	1
16	5510	19.0	453	16	1
17	5510	16.6	307	16	1
18	5510	16.1	477	15	1
19	5510	16.2	292	14	1
20	5510	18.4	327	14	0
21	5510	13.1	376	14	1
22	5510	12.9	363	13	1
23	5510	16.1	450	14	1
24	5510	15.9	253	14	1
25	5510	11.1	339	12	1
26	5510	11.6	337	12	1
27	5510	19.4	364	12	0
28	5510	16.5	314	12	1
29	5510	12.1	308	15	1
30	5510	17.3	269	15	1
Detection Percentage (%)					93.3%

Note: In addition an average minimum percentage of successful detection across all four Short pulse radar test

waveforms is as follows: $\frac{P_d1 + P_d2 + P_d3 + P_d4}{4} = (100\% + 100\% + 100\% + 93.3\%) / 4 = 98.33\% (>80\%)$



Type 5 Radar Statistical Performance

Trail #	Test Freq. (MHz)	1=Detection 0=No Detection	Trail #	Test Freq. (MHz)	1=Detection 0=No Detection
1	5510	1	16	5510	1
2	5510	1	17	5510	1
3	5510	1	18	5510	1
4	5510	1	19	5510	1
5	5510	1	20	5510	1
6	5510	1	21	5510	1
7	5510	1	22	5510	1
8	5510	1	23	5510	1
9	5510	1	24	5510	1
10	5510	1	25	5510	1
11	5510	1	26	5510	1
12	5510	1	27	5510	1
13	5510	1	28	5510	1
14	5510	1	29	5510	1
15	5510	1	30	5510	1
Detection Percentage (%)					100%

Type 5 Radar Waveform_1

```

Waveform Num = 1
Num of Bursts = 16
Burst Interval (us) = 750000

```

Burst #	Off Time (us)	# Pulses	Chirp (MHz)	PW (us)	Pulse 1 Pri (us)	Pulse 2 Pri (us)	Pulse 3 Pri (us)	Start Loc (us)	Start Burst Interval (us)	End Burst Interval (us)
1	138405	2	6	75	1291	1335	0	138405	0	749999
2	1156864	2	12	60	1092	1855	0	1297895	750000	1499999
3	316114	3	20	50	1856	1486	1955	1616956	1500000	2249999
4	878576	2	20	100	1034	1830	0	2500829	2250000	2999999
5	625373	2	8	50	1569	1618	0	3129066	3000000	3749999
6	1333487	2	13	65	1581	1866	0	4465740	3750000	4499999
7	361376	1	8	85	1809	0	0	4830563	4500000	5249999
8	731873	3	17	95	1361	1313	1815	5564245	5250000	5999999
9	634050	3	8	70	1650	1029	1485	6202784	6000000	6749999
10	1022326	2	17	60	1111	1111	0	7229274	6750000	7499999
11	915267	1	9	60	1873	0	0	8146763	7500000	8249999
12	340248	1	16	60	1632	0	0	8488884	8250000	8999999
13	633068	1	5	65	1464	0	0	9123584	9000000	9749999
14	1243543	1	14	95	1316	0	0	10368591	9750000	10499999
15	601447	2	5	50	1282	1712	0	10971354	10500000	11249999
16	895188	2	17	60	1488	1015	0	11869536	11250000	11999999

Total number of pulses in waveform = 30



Type 5 Radar Waveform_2

Waveform Num = 2
Num of Bursts = 11
Burst Interval (us)= 1090909

Burst #	Off Time (us)	# Pulses	Chirp (MHz)	PW (us)	Pulse 1 Pri (us)	Pulse 2 Pri (us)	Pulse 3 Pri (us)	Start Loc (us)	Start Burst Interval (us)	End Burst Interval (us)
1	816770	2	12	80	1331	1775	0	816770	0	1090908
2	1041201	2	16	55	1298	1727	0	1861077	1090909	2181817
3	935103	3	6	85	1101	1049	1927	2799205	2181818	3272726
4	1024253	2	5	80	1784	1146	0	3827535	3272727	4363635
5	1335749	1	20	90	1535	0	0	5166214	4363636	5454544
6	440898	1	19	100	1693	0	0	5608647	5454545	6545453
7	1196505	1	19	75	1782	0	0	6806845	6545454	7636362
8	1124510	3	15	70	1532	1129	1313	7933137	7636363	8727271
9	1207872	2	7	55	1327	1310	0	9144983	8727272	9818180
10	1741347	1	15	50	1393	0	0	10888967	9818181	10909089
11	334149	2	6	65	1827	1212	0	11224509	10909090	11999998

Total number of pulses in waveform = 20

Type 5 Radar Waveform_3

Waveform Num = 3
Num of Bursts = 20
Burst Interval (us)= 600000

Burst #	Off Time (us)	# Pulses	Chirp (MHz)	PW (us)	Pulse 1 Pri (us)	Pulse 2 Pri (us)	Pulse 3 Pri (us)	Start Loc (us)	Start Burst Interval (us)	End Burst Interval (us)
1	197918	2	5	100	1234	1663	0	197918	0	599999
2	452337	2	16	50	1882	1778	0	653052	600000	1199999
3	809468	2	12	55	1788	1838	0	1466180	1200000	1799999
4	683247	1	20	60	1627	0	0	2153053	1800000	2399999
5	782455	1	17	55	1865	0	0	2937135	2400000	2999999
6	104215	3	20	95	1153	1368	1978	3043215	3000000	3599999
7	967032	3	20	60	1078	1784	1219	4014746	3600000	4199999
8	368272	2	17	80	1518	1664	0	4377099	4200000	4799999
9	715922	2	15	50	1216	1729	0	5096203	4800000	5399999
10	876239	3	7	100	1062	1107	1492	5976387	5400000	5999999
11	427941	1	16	85	1445	0	0	6406989	6000000	6599999
12	527042	1	5	80	1953	0	0	6935476	6600000	7199999
13	342539	2	14	55	1740	1648	0	7279968	7200000	7799999
14	1091998	3	12	50	1405	1608	1959	8376554	7800000	8399999
15	88391	3	11	70	1144	1111	1106	8468917	8400000	8999999
16	750547	1	14	65	1617	0	0	9222825	9000000	9599999
17	967343	2	7	55	1777	1472	0	10191785	9600000	10199999
18	62715	1	15	90	1293	0	0	10257749	10200000	10799999
19	887804	2	7	50	1046	1855	0	11146846	10800000	11399999
20	434604	2	16	75	1050	1957	0	11584351	11400000	11999999

Total number of pulses in waveform = 39

Type 5 Radar Waveform_4

Waveform Num = 4
Num of Bursts = 13
Burst Interval (us)= 923077

Burst #	Off Time (us)	# Pulses	Chirp (MHz)	PW (us)	Pulse 1 Pri (us)	Pulse 2 Pri (us)	Pulse 3 Pri (us)	Start Loc (us)	Start Burst Interval (us)	End Burst Interval (us)
1	767007	2	5	85	1990	1429	0	767007	0	923076
2	1043239	1	15	55	1974	0	0	1813665	923077	1846153
3	70571	2	19	90	1916	1224	0	1886210	1846154	2769230
4	1620435	3	15	85	1782	1322	1040	3509785	2769231	3692307
5	214451	3	16	80	1387	1020	1214	3728380	3692308	4615384
6	1298651	1	14	100	1594	0	0	5030652	4615385	5538461
7	792054	3	9	95	1385	1320	1177	5824300	5538462	6461538
8	1513465	3	8	55	1232	1189	1401	7341647	6461539	7384615
9	579360	2	15	65	1413	1439	0	7924829	7384616	8307692
10	1030848	2	10	60	1700	1301	0	8958529	8307693	9230769
11	1150931	2	17	100	1393	1199	0	10112461	9230770	10153846
12	515906	2	15	50	1883	1517	0	10630959	10153847	11076923
13	637966	2	14	75	1617	1280	0	11272325	11076924	12000000

Total number of pulses in waveform = 28



Type 5 Radar Waveform_5

Waveform Num = 5
 Num of Bursts = 17
 Burst Interval (us) = 705882

Burst #	Off Time (us)	# Pulses	Chirp (MHz)	PW (us)	Pulse 1 Pri (us)	Pulse 2 Pri (us)	Pulse 3 Pri (us)	Start Loc (us)	Start Burst Interval (us)	End Burst Interval (us)
1	386052	1	12	85	1603	0	0	386052	0	705881
2	655795	1	9	90	1072	0	0	1043450	705882	1411763
3	654892	2	6	65	1695	1161	0	1699414	1411764	2117645
4	919664	1	7	75	1666	0	0	2621934	2117646	2823527
5	874257	3	8	70	1164	1587	1189	3497857	2823528	3529409
6	151859	2	17	85	1739	1821	0	3653656	3529410	4235291
7	908429	1	18	55	1720	0	0	4565645	4235292	4941173
8	549382	3	9	95	1290	1925	1656	5116747	4941174	5647055
9	902134	1	7	90	1727	0	0	6023752	5647056	6352937
10	813517	1	16	75	1519	0	0	6838996	6352938	7058819
11	517746	3	13	60	1116	1841	1408	7358261	7058820	7764701
12	895584	2	18	55	1300	1819	0	8258210	7764702	8470583
13	639478	2	6	90	1006	1086	0	8900807	8470584	9176465
14	294477	3	16	90	1169	1390	1201	9197376	9176466	9882347
15	1258988	3	11	75	1220	1153	1227	10460124	9882348	10588229
16	290543	1	7	50	1352	0	0	10754267	10588230	11294111
17	1100364	3	10	60	1259	1139	1711	11855983	11294112	11999993

Total number of pulses in waveform = 33

Type 5 Radar Waveform_6

Waveform Num = 6
 Num of Bursts = 19
 Burst Interval (us) = 631579

Burst #	Off Time (us)	# Pulses	Chirp (MHz)	PW (us)	Pulse 1 Pri (us)	Pulse 2 Pri (us)	Pulse 3 Pri (us)	Start Loc (us)	Start Burst Interval (us)	End Burst Interval (us)
1	161397	3	11	65	1427	1506	1501	161397	0	631578
2	565825	2	11	50	1035	1202	0	731656	631579	1263157
3	746615	1	9	75	1521	0	0	1480408	1263158	1894736
4	520418	3	9	55	1041	1649	1239	2002347	1894737	2526315
5	997263	2	18	90	1816	1369	0	3003539	2526316	3157894
6	242829	1	10	100	1718	0	0	3249553	3157895	3789473
7	565199	3	19	80	1593	1286	1575	3816470	3789474	4421052
8	888460	1	10	90	1471	0	0	4689384	4421053	5052631
9	717934	1	11	95	1694	0	0	5408789	5052632	5684210
10	793087	3	8	65	1364	1622	1054	6203570	5684211	6315789
11	234066	1	5	50	6441696	0	0	6441696	6315790	6947368
12	787038	3	7	100	1253	1452	1832	7230067	6947369	7578947
13	387018	1	5	75	1364	0	0	7621622	7578948	8210526
14	698608	1	13	50	1954	0	0	8321594	8210527	8842105
15	551634	3	6	60	1166	1951	1306	8876182	8842106	9473684
16	609690	2	8	65	1779	1547	0	9489295	9473685	10105263
17	791581	3	7	100	1670	1701	1966	10284202	10105264	10736842
18	694932	2	11	55	1113	1417	0	10884471	10736843	11368421
19	692306	2	14	100	1724	1714	0	11579307	11368422	12000000

Total number of pulses in waveform = 38

Type 5 Radar Waveform_7

Waveform Num = 7
 Num of Bursts = 16
 Burst Interval (us) = 750000

Burst #	Off Time (us)	# Pulses	Chirp (MHz)	PW (us)	Pulse 1 Pri (us)	Pulse 2 Pri (us)	Pulse 3 Pri (us)	Start Loc (us)	Start Burst Interval (us)	End Burst Interval (us)
1	477079	1	16	80	1752	0	0	477079	0	749999
2	622882	3	17	85	1722	1573	1949	1101713	750000	1499999
3	1088754	2	18	60	1636	1757	0	2195711	1500000	2249999
4	686555	3	13	70	1077	1455	1634	2885659	2250000	2999999
5	184106	3	20	85	1444	1531	1949	3073931	3000000	3749999
6	751430	1	13	100	1132	0	0	3830285	3750000	4499999
7	852271	2	5	70	1831	1693	0	4683688	4500000	5249999
8	1209972	2	7	75	1570	1542	0	5897184	5250000	5999999
9	685168	1	19	65	1274	0	0	6585464	6000000	6749999
10	768851	2	8	60	1192	1296	0	7355589	6750000	7499999
11	441301	2	17	55	1720	1720	0	7799378	7500000	8249999
12	671982	2	8	85	1202	1991	0	8474800	8250000	8999999
13	752021	1	17	95	1949	0	0	9230014	9000000	9749999
14	970345	2	20	80	1672	1454	0	10202308	9750000	10499999
15	557789	1	12	85	1045	0	0	10763223	10500000	11249999
16	1105975	1	6	50	1960	0	0	11870243	11250000	11999999

Total number of pulses in waveform = 29



Type 5 Radar Waveform_8

```

Waveform Num = 8
Num of Bursts = 20
Burst Interval (us) = 600000

```

Burst #	Off Time (us)	# Pulses	Chirp (MHz)	PW (us)	Pulse 1 Pri (us)	Pulse 2 Pri (us)	Pulse 3 Pri (us)	Start Loc (us)	Start Burst Interval (us)	End Burst Interval (us)
1	197918	2	5	100	1234	1663	0	197918	0	599999
2	452337	2	16	50	1882	1778	0	653052	600000	1199999
3	809468	2	12	55	1788	1838	0	1466180	1200000	1799999
4	683247	1	20	60	1627	0	0	2153053	1800000	2399999
5	782455	1	17	55	1865	0	0	2937135	2400000	2999999
6	104215	3	20	95	1153	1368	1978	3043215	3000000	3599999
7	967032	3	20	60	1078	1784	1219	4014746	3600000	4199999
8	358272	2	17	80	1518	1664	0	4377099	4200000	4799999
9	715922	2	15	50	1216	1729	0	5096203	4800000	5399999
10	876239	3	7	100	1062	1107	1492	5975387	5400000	5999999
11	427941	1	16	85	1445	0	0	6406989	6000000	6599999
12	527042	1	5	80	1953	0	0	6935476	6600000	7199999
13	342539	2	14	55	1740	1848	0	7279968	7200000	7799999
14	1091998	3	12	50	1405	1608	1959	8376564	7800000	8399999
15	88391	3	11	70	1144	1111	1106	8468917	8400000	8999999
16	750547	1	14	65	1617	0	0	9222825	9000000	9599999
17	967943	2	7	55	1777	1472	0	10191785	9600000	10199999
18	62715	1	15	90	1293	0	0	10257749	10200000	10799999
19	887804	2	7	50	1046	1855	0	11146846	10800000	11399999
20	434604	2	16	75	1050	1957	0	11584351	11400000	11999999

Total number of pulses in waveform = 39

Type 5 Radar Waveform_9

```

Waveform Num = 9
Num of Bursts = 19
Burst Interval (us) = 631579

```

Burst #	Off Time (us)	# Pulses	Chirp (MHz)	PW (us)	Pulse 1 Pri (us)	Pulse 2 Pri (us)	Pulse 3 Pri (us)	Start Loc (us)	Start Burst Interval (us)	End Burst Interval (us)
1	454532	2	11	50	1422	1633	0	454532	0	631578
2	679713	3	15	85	1996	1401	1828	1137300	631579	1263157
3	539685	2	6	60	1489	1948	0	1682210	1263158	1894736
4	423209	1	19	75	1028	0	0	2108856	1894737	2526315
5	639672	3	13	85	1616	1833	1275	2749556	2526316	3157894
6	864742	3	12	95	1262	1946	1846	3619022	3157895	3789473
7	734808	3	12	80	1762	1057	1993	4358684	3789474	4421052
8	515579	2	16	60	1659	1683	0	4879075	4421053	5052631
9	285624	1	9	55	1741	0	0	5168041	5052632	5684210
10	722126	2	16	80	1992	1928	0	5891908	5684211	6315789
11	533327	1	11	80	1900	0	0	6429155	6315790	6947368
12	915438	2	7	85	1492	1010	0	7346493	6947369	7578947
13	271359	2	13	95	1034	1521	0	7620354	7578948	8210526
14	1107825	2	19	70	1979	1874	0	8730734	8210527	8842105
15	335448	2	15	85	1264	1085	0	9070035	8842106	9473684
16	681593	1	14	95	1929	0	0	9753977	9473685	10105263
17	373725	2	11	90	1412	1762	0	10129631	10105264	10736842
18	818738	3	6	65	1739	1786	1828	10951543	10736843	11368421
19	566714	1	14	65	1884	0	0	11523610	11368422	12000000

Total number of pulses in waveform = 38

Type 5 Radar Waveform_10

```

Waveform Num = 10
Num of Bursts = 18
Burst Interval (us) = 666667

```

Burst #	Off Time (us)	# Pulses	Chirp (MHz)	PW (us)	Pulse 1 Pri (us)	Pulse 2 Pri (us)	Pulse 3 Pri (us)	Start Loc (us)	Start Burst Interval (us)	End Burst Interval (us)
1	66583	2	9	85	1589	1455	0	66583	0	666666
2	783688	3	7	75	1907	1552	1032	863215	666667	1333333
3	941905	2	15	100	1901	1752	0	1799611	1333334	2000000
4	245864	1	12	100	1227	0	0	2049128	2000001	2666667
5	680655	3	12	80	1548	1601	1093	2731210	2666668	3333334
6	1216036	2	17	50	1998	1006	0	3951488	3333335	4000001
7	211394	2	9	60	1149	1036	0	4165886	4000002	4666668
8	857129	3	7	85	1685	1550	1231	5025200	4666669	5333335
9	732811	3	8	90	1701	1746	1472	5762477	5333336	6000002
10	635262	1	13	60	1515	0	0	6402658	6000003	6666669
11	348351	3	12	80	1140	1357	1600	6752524	6666670	7333336
12	722002	3	15	85	1239	1990	1730	7478623	7333337	8000003
13	1059304	2	10	50	1240	1484	0	8542886	8000004	8666670
14	305919	1	9	80	1834	0	0	8851529	8666671	9333337
15	1137585	1	8	70	1461	0	0	9990948	9333338	10000004
16	567218	2	14	70	1190	1888	0	10559627	10000005	10666671
17	163818	1	17	95	1166	0	0	10726523	10666672	11333338
18	654263	1	6	100	1524	0	0	11381952	11333339	12000005

Total number of pulses in waveform = 36



Type 5 Radar Waveform_11

Waveform Num = 11
Num of Bursts = 14
Burst Interval (us)= 857143

Burst #	Off Time (us)	# Pulses	Chirp (MHz)	PW (us)	Pulse 1 Pri (us)	Pulse 2 Pri (us)	Pulse 3 Pri (us)	Start Loc (us)	Start Burst Interval (us)	End Burst Interval (us)
1	236948	1	7	60	1946	0	0	236948	0	857142
2	715091	1	15	85	1053	0	0	953985	857143	1714285
3	1346246	1	14	95	1203	0	0	2301284	1714286	2571428
4	1068971	2	12	90	1986	1012	0	3371458	2571429	3428571
5	139424	2	6	60	1233	1510	0	3513880	3428572	4285714
6	1060118	1	12	55	1839	0	0	4576741	4285715	5142857
7	994907	1	17	90	1048	0	0	5573487	5142858	6000000
8	993112	3	9	70	1113	1366	1038	6567647	6000001	6857143
9	877724	1	14	85	1092	0	0	7448888	6857144	7714286
10	417845	1	20	100	1245	0	0	7867825	7714287	8571429
11	748900	3	5	75	1187	1397	1125	8617970	8571430	9428572
12	968308	2	18	55	1386	1850	0	9589987	9428573	10285715
13	1312356	3	15	100	1025	1057	1554	10905579	10285716	11142858
14	514678	3	7	55	1570	1057	1964	11423893	11142859	12000001

Total number of pulses in waveform = 25

Type 5 Radar Waveform_12

Waveform Num = 12
Num of Bursts = 17
Burst Interval (us)= 705882

Burst #	Off Time (us)	# Pulses	Chirp (MHz)	PW (us)	Pulse 1 Pri (us)	Pulse 2 Pri (us)	Pulse 3 Pri (us)	Start Loc (us)	Start Burst Interval (us)	End Burst Interval (us)
1	205134	1	14	50	1770	0	0	205134	0	705881
2	905354	1	19	85	1911	0	0	1112258	705882	1411763
3	908464	3	10	55	1796	1725	1560	2022633	1411764	2117645
4	524230	2	12	80	1202	1615	0	2551944	2117646	2823527
5	540356	1	16	90	1867	0	0	3096117	2823528	3529409
6	1097421	2	14	75	1895	1282	0	4194405	3529410	4235291
7	483835	2	18	100	1470	1618	0	4691417	4235292	4941173
8	604455	3	7	70	1752	1072	1247	5288960	4941174	5647055
9	917027	3	6	65	1039	1065	1258	6210058	5647056	6352937
10	813326	3	10	50	1434	1071	1484	7026746	6352938	7058819
11	28979	1	5	95	1163	0	0	7059714	7058820	7764701
12	1070198	2	19	50	1834	1091	0	8131075	7764702	8470583
13	413023	1	15	85	1902	0	0	8547023	8470584	9176465
14	831700	3	14	75	1610	1605	1764	9380625	9176466	9882347
15	579948	2	5	75	1356	1812	0	9965552	9882348	10588229
16	1077832	2	14	95	1413	1783	0	11046552	10588230	11294111
17	940647	3	5	70	1437	1813	1137	11990395	11294112	11999993

Total number of pulses in waveform = 35

Type 5 Radar Waveform_13

Waveform Num = 13
Num of Bursts = 15
Burst Interval (us)= 800000

Burst #	Off Time (us)	# Pulses	Chirp (MHz)	PW (us)	Pulse 1 Pri (us)	Pulse 2 Pri (us)	Pulse 3 Pri (us)	Start Loc (us)	Start Burst Interval (us)	End Burst Interval (us)
1	235211	1	18	100	1001	0	0	235211	0	799999
2	892162	2	5	50	1230	1566	0	1128374	800000	1599999
3	887712	3	17	65	1710	1093	1304	2018882	1600000	2399999
4	1155154	2	7	55	1117	1673	0	3178143	2400000	3199999
5	382915	3	18	55	1770	1238	1588	3563848	3200000	3999999
6	1187583	2	19	95	1098	1779	0	4756027	4000000	4799999
7	531760	3	15	75	1780	1240	1422	5290664	4800000	5599999
8	309664	2	11	65	1172	1272	0	5604770	5600000	6399999
9	1118420	3	11	50	1635	1621	1626	6725634	6400000	7199999
10	590935	2	14	75	1023	1461	0	7321451	7200000	7999999
11	1402286	2	18	80	1263	1870	0	8726221	8000000	8799999
12	164257	1	14	70	1344	0	0	8893611	8800000	9599999
13	715995	1	17	75	1799	0	0	9610950	9600000	10399999
14	971241	1	10	70	1856	0	0	10583990	10400000	11199999
15	764091	2	18	85	1202	1447	0	11349937	11200000	11999999

Total number of pulses in waveform = 30



Type 5 Radar Waveform_14

Waveform Num = 14
 Num of Bursts = 9
 Burst Interval (us)= 1333333

Burst #	Off Time (us)	# Pulses	Chirp (MHz)	PW (us)	Pulse 1 Pri (us)	Pulse 2 Pri (us)	Pulse 3 Pri (us)	Start Loc (us)	Start Burst Interval (us)	End Burst Interval (us)
1	239691	3	6	50	1183	1393	1245	239691	0	1333332
2	1816448	1	15	90	1812	0	0	2059960	1333333	2666665
3	1528305	2	20	85	1203	1747	0	3590077	2666666	3999998
4	544016	1	13	95	1429	0	0	4137043	3999999	5333331
5	1658416	3	12	75	1000	1888	1736	5796888	5333332	6666664
6	2098516	3	18	65	1438	1722	1857	7900028	6666665	7999997
7	1038937	3	5	80	1340	1458	1633	8943982	7999998	9333330
8	1705810	1	16	75	1672	0	0	10654223	9333331	10666663
9	819198	1	20	60	1427	0	0	11475093	10666664	11999996

Total number of pulses in waveform = 18

Type 5 Radar Waveform_15

Waveform Num = 15
 Num of Bursts = 13
 Burst Interval (us)= 923077

Burst #	Off Time (us)	# Pulses	Chirp (MHz)	PW (us)	Pulse 1 Pri (us)	Pulse 2 Pri (us)	Pulse 3 Pri (us)	Start Loc (us)	Start Burst Interval (us)	End Burst Interval (us)
1	760449	3	12	85	1073	1093	1848	760449	0	923076
2	966240	1	18	70	1082	0	0	1730703	923077	1846153
3	404791	1	19	85	1977	0	0	2136576	1846154	2769230
4	1480705	1	18	50	1390	0	0	3619258	2769231	3692307
5	272265	3	7	80	1366	1481	1764	3892913	3692308	4615384
6	1022063	2	20	90	1710	1464	0	4919587	4615385	5538461
7	1174035	1	20	85	1808	0	0	6096796	5538462	6461538
8	404751	3	5	55	1844	1542	1723	6503355	6461539	7384615
9	1618753	2	12	65	1652	1993	0	8127217	7384616	8307692
10	884478	1	16	80	1508	0	0	9015340	8307693	9230769
11	413467	3	6	60	1671	1584	1651	9430315	9230770	10153846
12	1070128	2	14	95	1091	1091	0	10505349	10153847	11076923
13	1005555	2	20	65	1370	1721	0	11513086	11076924	12000000

Total number of pulses in waveform = 25

Type 5 Radar Waveform_16

Waveform Num = 16
 Num of Bursts = 10
 Burst Interval (us)= 1200000

Burst #	Off Time (us)	# Pulses	Chirp (MHz)	PW (us)	Pulse 1 Pri (us)	Pulse 2 Pri (us)	Pulse 3 Pri (us)	Start Loc (us)	Start Burst Interval (us)	End Burst Interval (us)
1	1046861	2	17	75	1774	1601	0	1046861	0	1199999
2	1341692	3	10	95	1131	1920	1622	2391928	1200000	2399999
3	348406	2	20	65	1195	1889	0	2745007	2400000	3599999
4	1171413	1	10	75	1594	0	0	3919504	3600000	4799999
5	1797147	3	11	50	1388	1569	1040	5718245	4800000	5999999
6	771898	2	17	60	1289	1415	0	6494140	6000000	7199999
7	908319	1	13	90	1252	0	0	7405163	7200000	8399999
8	1851580	2	9	50	1027	1435	0	9257995	8400000	9599999
9	1021678	1	12	55	1809	0	0	10282135	9600000	10799999
10	520509	3	5	60	1096	1769	1399	10804453	10800000	11999999

Total number of pulses in waveform = 20



Type 5 Radar Waveform_17

Waveform Num = 17
Num of Bursts = 11
Burst Interval (us) = 1090909

Burst #	Off Time (us)	# Pulses	Chirp (MHz)	PW (us)	Pulse 1 Pri (us)	Pulse 2 Pri (us)	Pulse 3 Pri (us)	Start Loc (us)	Start Burst Interval (us)	End Burst Interval (us)
1	49011	2	16	75	1932	1992	0	49011	0	1090908
2	1841397	2	10	90	1097	1857	0	1894332	1090909	2181817
3	486446	2	19	90	1945	1241	0	2383732	2181818	3272726
4	1244491	1	18	70	1148	0	0	3631409	3272727	4363635
5	1094300	1	9	50	1964	0	0	4726857	4363636	5454544
6	1666257	1	17	80	1619	0	0	6395078	5454545	6545453
7	817589	2	13	90	1971	1578	0	7214286	6545454	7636362
8	840613	2	8	90	1489	1984	0	8058448	7636363	8727271
9	1084282	3	14	100	1495	1364	1933	9146203	8727272	9818180
10	1069090	2	20	80	1396	1115	0	10220085	9818181	10909089
11	1074154	3	13	50	1532	1545	1947	11296750	10909090	11999998

Total number of pulses in waveform = 21

Type 5 Radar Waveform_18

Waveform Num = 18
Num of Bursts = 17
Burst Interval (us) = 705882

Burst #	Off Time (us)	# Pulses	Chirp (MHz)	PW (us)	Pulse 1 Pri (us)	Pulse 2 Pri (us)	Pulse 3 Pri (us)	Start Loc (us)	Start Burst Interval (us)	End Burst Interval (us)
1	459775	3	20	55	1934	1105	1473	459775	0	705881
2	602436	2	13	80	1461	1109	0	1066723	705882	1411763
3	680252	3	15	80	1852	1677	1467	1749545	1411764	2117645
4	537119	3	18	100	1501	1630	1462	2291660	2117646	2823527
5	1140687	1	15	90	1024	0	0	3436940	2823528	3529409
6	135215	1	15	100	1310	0	0	3573179	3529410	4235291
7	976692	2	18	75	1527	1251	0	4551181	4235292	4941173
8	892806	3	16	70	1149	1623	1489	5446765	4941174	5647055
9	609488	2	6	60	1788	1992	0	6060514	5647056	6352937
10	781191	2	17	75	1963	1274	0	6845485	6352938	7058819
11	881479	1	8	100	1781	0	0	7730201	7058820	7764701
12	394471	2	11	60	1210	1276	0	8126453	7764702	8470583
13	951088	1	20	65	1321	0	0	9080027	8470584	9176465
14	329335	3	7	90	1100	1718	1170	9410683	9176466	9882347
15	734913	3	14	60	1113	1797	1888	10149584	9882348	10588229
16	737898	1	10	85	1389	0	0	10892280	10588230	11294111
17	794405	1	9	50	1730	0	0	11688074	11294112	11999993

Total number of pulses in waveform = 34

Type 5 Radar Waveform_19

Waveform Num = 19
Num of Bursts = 14
Burst Interval (us) = 857143

Burst #	Off Time (us)	# Pulses	Chirp (MHz)	PW (us)	Pulse 1 Pri (us)	Pulse 2 Pri (us)	Pulse 3 Pri (us)	Start Loc (us)	Start Burst Interval (us)	End Burst Interval (us)
1	551742	3	8	75	1710	1711	1660	551742	0	857142
2	1142871	1	14	100	1306	0	0	1699694	857143	1714285
3	461501	3	15	55	1839	1552	1210	2162501	1714286	2571428
4	815887	2	9	100	1037	1219	0	2982989	2571429	3428571
5	534816	3	15	95	1463	1619	1627	3520061	3428572	4285714
6	1595696	2	6	65	1212	1739	0	5120466	4285715	5142857
7	522193	2	7	80	1356	1733	0	5645610	5142858	6000000
8	987987	1	5	55	1442	0	0	6636686	6000001	6857143
9	598920	2	9	65	1429	1950	0	7237048	6857144	7714286
10	1049106	3	17	70	1004	1812	1473	8289533	7714287	8571429
11	316651	1	8	85	1035	0	0	8610473	8571430	9428572
12	1522040	1	18	65	1564	0	0	10133548	9428573	10285715
13	816038	1	13	60	1278	0	0	10951150	10285716	11142858
14	579851	2	14	100	1481	1662	0	11532279	11142859	12000001

Total number of pulses in waveform = 27



Type 5 Radar Waveform_20

Waveform Num = 20
Num of Bursts = 15
Burst Interval (us) = 800000

Burst #	Off Time (us)	# Pulses	Chirp (MHz)	PW (us)	Pulse 1 Pri (us)	Pulse 2 Pri (us)	Pulse 3 Pri (us)	Start Loc (us)	Start Burst Interval (us)	End Burst Interval (us)
1	149161	3	18	100	1274	1539	1870	149161	0	799999
2	1401848	1	9	55	1365	0	0	1555692	800000	1599999
3	366532	3	13	80	1616	1186	1654	1923589	1600000	2399999
4	1244728	2	17	75	1639	1110	0	3172773	2400000	3199999
5	319380	1	16	100	1399	0	0	3494902	3200000	3999999
6	1089444	3	16	55	1031	1391	1313	4585745	4000000	4799999
7	411041	2	14	75	1075	1262	0	5000521	4800000	5599999
8	844553	2	19	70	1951	1002	0	5847411	5600000	6399999
9	1240771	2	14	65	1567	1214	0	7091135	6400000	7199999
10	511565	1	8	100	1688	0	0	7605481	7200000	7999999
11	826761	2	7	70	1922	1412	0	8433930	8000000	8799999
12	659010	1	19	80	1112	0	0	9096274	8800000	9599999
13	543538	3	9	75	1103	1563	1325	9640924	9600000	10399999
14	1123144	2	6	75	1312	1779	0	10768059	10400000	11199999
15	677585	2	9	70	1439	1426	0	11448735	11200000	11999999

Total number of pulses in waveform = 30

Type 5 Radar Waveform_21

Waveform Num = 21
Num of Bursts = 16
Burst Interval (us) = 750000

Burst #	Off Time (us)	# Pulses	Chirp (MHz)	PW (us)	Pulse 1 Pri (us)	Pulse 2 Pri (us)	Pulse 3 Pri (us)	Start Loc (us)	Start Burst Interval (us)	End Burst Interval (us)
1	148735	2	8	80	1208	1134	0	148735	0	749999
2	857808	3	16	65	1612	1024	1604	1008885	750000	1499999
3	839765	3	13	75	1429	1369	1994	1852890	1500000	2249999
4	502052	3	7	50	1947	1639	1778	2359734	2250000	2999999
5	647174	2	15	55	1055	1822	0	3012272	3000000	3749999
6	739571	1	6	100	1001	0	0	3754720	3750000	4499999
7	1393679	1	10	75	1266	0	0	5149400	4500000	5249999
8	234391	2	12	90	1173	1617	0	5385057	5250000	5999999
9	696549	3	12	95	1081	1690	1447	6084396	6000000	6749999
10	689914	1	15	70	1702	0	0	6778528	6750000	7499999
11	1055228	3	12	60	1019	1631	1104	7835458	7500000	8249999
12	950120	1	13	90	1669	0	0	8789332	8250000	8999999
13	318817	3	10	100	1942	1768	1742	9109818	9000000	9749999
14	1209327	3	5	50	1379	1083	1966	10324597	9750000	10499999
15	321594	3	18	90	1398	1277	1948	10650619	10500000	11249999
16	1099459	1	8	65	1356	0	0	11754701	11250000	11999999

Total number of pulses in waveform = 35

Type 5 Radar Waveform_22

Waveform Num = 22
Num of Bursts = 13
Burst Interval (us) = 923077

Burst #	Off Time (us)	# Pulses	Chirp (MHz)	PW (us)	Pulse 1 Pri (us)	Pulse 2 Pri (us)	Pulse 3 Pri (us)	Start Loc (us)	Start Burst Interval (us)	End Burst Interval (us)
1	12253	1	11	85	1903	0	0	12253	0	923076
2	1786765	3	19	80	1743	1788	1410	1800921	923077	1846153
3	66850	1	20	60	1760	0	0	1872712	1846154	2769230
4	1559187	3	18	50	1898	1274	1844	3433659	2769231	3692307
5	415063	1	10	80	1189	0	0	3853738	3692308	4615384
6	1457055	3	9	65	1284	1085	1246	5311982	4615385	5538461
7	263095	1	8	75	1140	0	0	5578692	5538462	6461538
8	1595952	3	9	50	1564	1925	1442	7175784	6461539	7384615
9	963617	1	14	65	1695	0	0	8144332	7384616	8307692
10	432482	3	13	80	1887	1030	1655	8578509	8307693	9230769
11	1377032	3	10	55	1928	1729	1161	9960113	9230770	10153846
12	872752	3	6	85	1062	1968	1821	10837683	10153847	11076923
13	1141371	3	5	85	1519	1030	1906	11983905	11076924	12000000

Total number of pulses in waveform = 29



Type 5 Radar Waveform_23

Waveform Num = 23
 Num of Bursts = 19
 Burst Interval (us) = 631579

Burst #	Off Time (us)	# Pulses	Chirp (MHz)	PW (us)	Pulse 1 Pri (us)	Pulse 2 Pri (us)	Pulse 3 Pri (us)	Start Loc (us)	Start Burst Interval (us)	End Burst Interval (us)
1	125711	2	8	70	1380	1975	0	186711	0	631578
2	562180	3	10	55	1028	1025	1034	752246	631579	1263157
3	1124513	2	11	95	1118	1826	0	1879846	1263158	1894736
4	540242	2	13	80	1578	1223	0	2423032	1894737	2526315
5	516036	3	10	80	1336	1011	1654	2941869	2526316	3157894
6	411089	1	8	75	1079	0	0	3356959	3157895	3789473
7	902890	3	15	75	1146	1237	1759	4260928	3789474	4421052
8	757777	1	13	95	1722	0	0	5022847	4421053	5052631
9	239167	1	18	100	1584	0	0	5263736	5052632	5684210
10	744340	3	9	100	1749	1374	1458	6009660	5684211	6315789
11	782270	3	6	85	1936	1383	1287	6796511	6315790	6947368
12	442282	3	5	90	1712	1423	1871	7243999	6947369	7578947
13	510855	3	16	90	1729	1515	1232	7759260	7578948	8210526
14	720563	1	8	60	1462	0	0	8484399	8210527	8842105
15	894638	2	19	70	1605	1054	0	9380499	8842106	9473684
16	249766	2	11	65	1365	1244	0	9632924	9473685	10105263
17	579412	1	13	75	1801	0	0	10214945	10105264	10736842
18	602800	1	12	80	1890	0	0	10819546	10736843	11368421
19	1143413	1	20	75	1104	0	0	11964849	11368422	12000000

Total number of pulses in waveform = 38

Type 5 Radar Waveform_24

Waveform Num = 24
 Num of Bursts = 10
 Burst Interval (us) = 1200000

Burst #	Off Time (us)	# Pulses	Chirp (MHz)	PW (us)	Pulse 1 Pri (us)	Pulse 2 Pri (us)	Pulse 3 Pri (us)	Start Loc (us)	Start Burst Interval (us)	End Burst Interval (us)
1	832428	3	20	50	1190	1287	1819	832428	0	1199999
2	1170226	3	13	90	1854	1230	1000	2006950	1200000	2399999
3	492340	2	20	85	1068	1404	0	2503374	2400000	3599999
4	1892747	2	5	65	1984	1665	0	4398593	3600000	4799999
5	906374	2	19	80	1157	1506	0	5308616	4800000	5999999
6	742906	1	19	80	1331	0	0	6054185	6000000	7199999
7	1209094	3	17	85	1765	1956	1830	7264610	7200000	8399999
8	2279803	1	14	75	1316	0	0	9549964	8400000	9599999
9	56047	2	18	60	1200	1731	0	9607327	9600000	10799999
10	1402677	3	7	85	1830	1148	1707	11012935	10800000	11999999

Total number of pulses in waveform = 22

Type 5 Radar Waveform_25

Waveform Num = 25
 Num of Bursts = 14
 Burst Interval (us) = 857143

Burst #	Off Time (us)	# Pulses	Chirp (MHz)	PW (us)	Pulse 1 Pri (us)	Pulse 2 Pri (us)	Pulse 3 Pri (us)	Start Loc (us)	Start Burst Interval (us)	End Burst Interval (us)
1	642231	1	18	65	1943	0	0	642231	0	857142
2	318944	2	16	80	1194	1033	0	963118	857143	1714285
3	1305770	3	9	85	1470	1845	1646	2271115	1714286	2571428
4	393626	3	11	70	1523	1091	1251	2669702	2571429	3428571
5	937183	3	20	95	1930	1775	1303	3610750	3428572	4285714
6	1106870	3	14	75	1591	1818	1157	4722628	4285715	5142857
7	681152	1	17	100	1473	0	0	5408346	5142858	6000000
8	1243964	2	15	65	1315	1088	0	6653783	6000001	6857143
9	258287	1	9	90	1936	0	0	6914473	6857144	7714286
10	843830	3	16	50	1006	1999	1639	7760239	7714287	8571429
11	1458161	1	6	65	1465	0	0	9223044	8571430	9428572
12	949298	2	10	90	1071	1322	0	10173807	9428573	10285715
13	946146	2	8	50	1781	1051	0	11122346	10285716	11142858
14	704509	2	7	65	1539	1423	0	11829687	11142859	12000001

Total number of pulses in waveform = 29



Type 5 Radar Waveform_26

Waveform Num = 26
 Num of Bursts = 17
 Burst Interval (us)= 705882

Burst #	Off Time (us)	# Pulses	Chirp (MHz)	PW (us)	Pulse 1 Pri (us)	Pulse 2 Pri (us)	Pulse 3 Pri (us)	Start Loc (us)	Start Burst Interval (us)	End Burst Interval (us)
1	521893	1	11	55	1218	0	0	521893	0	705881
2	357191	2	20	50	1424	1980	0	880302	705882	1411763
3	1115701	3	11	70	1019	1526	1488	1999407	1411764	2117645
4	745739	1	20	55	1470	0	0	2749179	2117646	2823527
5	631706	1	15	90	1549	0	0	3382355	2823528	3529409
6	335427	3	20	90	1136	1797	1501	3719331	3529410	4235291
7	594795	2	15	70	1524	1247	0	4318560	4235292	4941173
8	640097	1	12	90	1898	0	0	4961428	4941174	5647055
9	1379621	3	12	70	1457	1706	1288	6342947	5647056	6352937
10	18852	1	12	50	1821	0	0	6366250	6352938	7058819
11	1198567	2	9	90	1927	1720	0	7566638	7058820	7764701
12	700103	3	5	70	1039	1016	1305	8270388	7764702	8470583
13	280191	3	19	50	1231	1252	1978	8553939	8470584	9176465
14	1213490	3	8	65	1698	1774	1709	9771890	9176466	9882347
15	706098	1	10	60	1892	0	0	10483169	9882348	10588229
16	343539	3	16	65	1344	1600	1680	10828600	10588230	11294111
17	1038151	2	10	75	1873	1003	0	11871375	11294112	11999933

Total number of pulses in waveform = 35

Type 5 Radar Waveform_27

Waveform Num = 27
 Num of Bursts = 15
 Burst Interval (us)= 800000

Burst #	Off Time (us)	# Pulses	Chirp (MHz)	PW (us)	Pulse 1 Pri (us)	Pulse 2 Pri (us)	Pulse 3 Pri (us)	Start Loc (us)	Start Burst Interval (us)	End Burst Interval (us)
1	514338	2	20	95	1192	1480	0	514338	0	799999
2	727343	1	14	70	1020	0	0	1244353	800000	1599999
3	1142339	2	15	85	1555	1223	0	2387772	1600000	2399999
4	247096	1	15	85	1849	0	0	2637646	2400000	3199999
5	1331544	3	6	65	1795	1028	1306	3971039	3200000	3999999
6	445126	1	18	50	1374	0	0	4420294	4000000	4799999
7	822943	2	19	70	1761	1162	0	5244611	4800000	5599999
8	686124	1	11	95	1854	0	0	5933658	5600000	6399999
9	592074	2	13	75	1189	1013	0	6527586	6400000	7199999
10	1129475	1	18	90	1975	0	0	7659263	7200000	7999999
11	901627	2	17	80	1416	1384	0	8562865	8000000	8799999
12	412994	3	13	55	1455	1105	1398	8978659	8800000	9599999
13	1291866	1	8	50	1364	0	0	10274483	9600000	10399999
14	835329	1	12	75	1723	0	0	11111176	10400000	11199999
15	521102	1	6	50	1725	0	0	11634001	11200000	11999999

Total number of pulses in waveform = 24

Type 5 Radar Waveform_28

Waveform Num = 28
 Num of Bursts = 9
 Burst Interval (us)= 1333333

Burst #	Off Time (us)	# Pulses	Chirp (MHz)	PW (us)	Pulse 1 Pri (us)	Pulse 2 Pri (us)	Pulse 3 Pri (us)	Start Loc (us)	Start Burst Interval (us)	End Burst Interval (us)
1	162324	2	15	90	1331	1390	0	162324	0	1333332
2	1908703	2	15	75	1169	1539	0	2073748	1333333	2666665
3	1373680	3	5	75	1260	1531	1669	3450136	2666666	3999998
4	1208569	1	14	70	1881	0	0	4663165	3999999	5333331
5	902888	3	7	70	1563	1975	1029	5567934	5333332	6666664
6	1448988	1	8	85	1218	0	0	7021489	6666665	7999997
7	1667430	3	10	95	1339	1610	1979	8690137	7999998	9333330
8	1425067	2	20	75	1118	1099	0	10120132	9333331	10666663
9	1579904	3	14	85	1426	1982	1910	11702253	10666664	11999996

Total number of pulses in waveform = 20



Type 5 Radar Waveform_29

```

Waveform Num = 29
Num of Bursts = 18
Burst Interval (us) = 666667

```

Burst #	Off Time (us)	# Pulses	Chirp (MHz)	PW (us)	Pulse 1 Pri (us)	Pulse 2 Pri (us)	Pulse 3 Pri (us)	Start Loc (us)	Start Burst Interval (us)	End Burst Interval (us)
1	175253	3	12	60	1545	1002	1212	178253	0	666666
2	1125310	3	10	75	1219	1338	1436	1307322	666667	1333333
3	263220	2	5	75	1548	1285	0	1574535	1333334	2000000
4	970477	1	16	80	1345	0	0	2547845	2000001	2666667
5	171258	1	11	50	1555	0	0	2720448	2666668	3333334
6	688771	2	13	70	1980	1845	0	3410774	3333335	4000001
7	814969	2	8	65	1913	1470	0	4229568	4000002	4666668
8	533513	2	10	95	1366	1885	0	4766464	4666669	5333335
9	953836	3	13	80	1731	1568	1144	5723551	5333336	6000002
10	458301	2	10	75	1821	1296	0	6186295	6000003	6666669
11	661030	1	18	50	1478	0	0	6850442	6666670	7333336
12	558247	2	11	70	1997	1528	0	7410167	7333337	8000003
13	843215	3	18	100	1233	1834	1530	8256907	8000004	8666670
14	411997	2	9	70	1442	1493	0	8673501	8666671	9333337
15	1056128	2	15	75	1194	1912	0	9732564	9333338	10000004
16	613905	3	19	50	1603	1491	1322	10349575	10000005	10666671
17	846439	1	16	60	1132	0	0	11200430	10666672	11333338
18	440494	1	12	60	1956	0	0	11642056	11333339	12000005

Total number of pulses in waveform = 36

Type 5 Radar Waveform_30

```

Waveform Num = 30
Num of Bursts = 18
Burst Interval (us) = 666667

```

Burst #	Off Time (us)	# Pulses	Chirp (MHz)	PW (us)	Pulse 1 Pri (us)	Pulse 2 Pri (us)	Pulse 3 Pri (us)	Start Loc (us)	Start Burst Interval (us)	End Burst Interval (us)
1	275521	2	9	95	1035	1264	0	275521	0	666666
2	807534	1	11	80	1538	0	0	1085354	666667	1333333
3	668896	2	8	55	1442	1502	0	1755788	1333334	2000000
4	701027	3	15	65	1447	1097	1395	2459759	2000001	2666667
5	305540	2	18	75	1799	1412	0	2769238	2666668	3333334
6	1187397	3	18	90	1795	1864	1360	3959846	3333335	4000001
7	190220	2	7	80	1149	1947	0	4155085	4000002	4666668
8	594850	1	14	80	1330	0	0	4753031	4666669	5333335
9	590292	3	14	55	1431	1283	1740	5344653	5333336	6000002
10	1177944	1	19	80	1678	0	0	6527051	6000003	6666669
11	528743	2	13	80	1982	1108	0	7057472	6666670	7333336
12	926982	1	19	60	1832	0	0	7987544	7333337	8000003
13	19878	2	20	90	1784	1386	0	8009254	8000004	8666670
14	872178	1	17	60	1934	0	0	8884602	8666671	9333337
15	591501	2	12	90	1610	1206	0	9478037	9333338	10000004
16	636013	3	17	90	1340	1230	1376	10116866	10000005	10666671
17	721248	3	6	85	1883	1947	1256	10842060	10666672	11333338
18	609379	1	19	85	1099	0	0	11456525	11333339	12000005

Type 6 Radar Statistical Performance

Trail #	Test Freq. (MHz)	1=Detection 0=No Detection	Trail #	Test Freq. (MHz)	1=Detection 0=No Detection
1	5510	1	16	5510	1
2	5510	1	17	5510	1
3	5510	1	18	5510	0
4	5510	1	19	5510	1
5	5510	1	20	5510	0
6	5510	1	21	5510	1
7	5510	1	22	5510	1
8	5510	1	23	5510	1
9	5510	1	24	5510	1
10	5510	1	25	5510	1
11	5510	1	26	5510	0
12	5510	1	27	5510	1
13	5510	0	28	5510	1
14	5510	1	29	5510	1
15	5510	1	30	5510	1
Detection Percentage (%)					86.7%

Radar waveform #1			Radar waveform #2		
Hopping Number	Frequency (MHz)	Pulse Start (ms)	Hopping Number	Frequency (MHz)	Pulse Start (ms)
10	5483	30	7	5493	21
16	5496	48	10	5510	30
17	5526	51	19	5524	57
38	5516	114	22	5499	66
56	5528	168	35	5525	105
63	5517	189	41	5309	123
68	5494	204	49	5502	147
81	5505	243	52	5537	156
--	--	--	59	5507	177
--	--	--	64	5497	192
--	--	--	70	5528	210
--	--	--	77	5504	231
--	--	--	95	5506	285
--	--	--	97	5532	291
Radar waveform #3			Radar waveform #4		
Hopping Number	Frequency (MHz)	Pulse Start (ms)	Hopping Number	Frequency (MHz)	Pulse Start (ms)
22	5506	66	2	5497	6
45	5518	135	7	5537	21
46	5495	138	8	5533	24
51	5508	153	29	5527	87
52	5497	156	45	5496	135
59	5540	177	46	5490	138
61	5522	183	66	5540	198
82	5504	246	67	5494	201
92	5514	276	70	5484	210
--	--	--	71	5517	213
--	--	--	83	5493	249
--	--	--	91	5518	273
--	--	--	92	5502	276



Radar waveform #5			Radar waveform #6		
Hopping Number	Frequency (MHz)	Pulse Start (ms)	Hopping Number	Frequency (MHz)	Pulse Start (ms)
4	5499	12	15	5533	45
20	5538	60	40	5501	120
22	5532	66	43	5529	129
37	5503	111	47	5539	141
38	5507	114	49	5488	147
58	5501	174	66	5487	198
60	5514	180	72	5522	216
69	5485	207	80	5485	240
70	5533	210	81	5519	243
76	5505	228	82	5537	246
82	5489	246	93	5525	279
90	5528	270	--	--	--
95	5496	285	--	--	--
98	5525	294	--	--	--
Radar waveform #7			Radar waveform #8		
Hopping Number	Frequency (MHz)	Pulse Start (ms)	Hopping Number	Frequency (MHz)	Pulse Start (ms)
6	5532	18	2	5480	6
15	5527	45	5	5485	15
21	5539	63	21	5528	63
60	5525	180	23	5509	69
66	5500	198	35	5521	105
126	5498	378	46	5493	138
141	5486	423	54	5536	162
171	5490	513	65	5535	195
219	5505	657	69	5533	207
282	5511	846	71	5531	213
285	5495	855	72	5514	216
--	--	--	81	5518	243
--	--	--	82	5497	246
--	--	--	85	5532	255
--	--	--	87	5511	261
--	--	--	94	5522	282

Radar waveform #9			Radar waveform #10		
Hopping Number	Frequency (MHz)	Pulse Start (ms)	Hopping Number	Frequency (MHz)	Pulse Start (ms)
4	5513	12	0	5527	0
6	5506	18	8	5514	24
7	5510	21	58	5537	174
22	5522	66	59	5509	177
37	5504	111	64	5510	192
57	5526	171	68	5493	204
65	5537	195	69	5532	207
78	5539	234	76	5487	228
92	5487	276	77	5528	231
95	5484	285	97	5494	291
97	5529	291	--	--	--
Radar waveform #11			Radar waveform #12		
Hopping Number	Frequency (MHz)	Pulse Start (ms)	Frequency (MHz)	Hopping Number	Pulse Start (ms)
1	5503	3	5	5484	15
5	5519	15	11	5483	33
8	5492	24	20	5489	60
12	5505	36	28	5514	84
18	5497	54	35	5519	105
28	5534	84	42	5481	126
34	5517	102	51	5504	153
41	5510	123	61	5538	183
42	5491	126	65	5506	195
47	5521	141	68	5530	204
61	5481	183	70	5503	210
69	5524	207	81	5487	243
90	5518	270	94	5482	282
94	5522	282	97	5536	291
97	5513	291	--	--	--
98	5507	294	--	--	--
99	5502	297	--	--	--

Radar waveform #13			Radar waveform #14		
Hopping Number	Frequency (MHz)	Pulse Start (ms)	Hopping Number	Frequency (MHz)	Pulse Start (ms)
0	5540	0	2	5529	6
3	5480	9	9	5539	27
16	5489	48	21	5507	63
28	5517	84	24	5520	72
43	5491	129	34	5536	102
45	5488	135	35	5509	105
47	5531	141	41	5533	123
51	5516	153	51	5493	153
64	5535	192	64	5531	192
82	5490	246	70	5530	210
--	--	--	84	5489	252
--	--	--	95	5502	285
Radar waveform #15			Radar waveform #16		
Hopping Number	Frequency (MHz)	Pulse Start (ms)	Hopping Number	Frequency (MHz)	Pulse Start (ms)
1	5530	3	13	5490	39
3	5503	9	18	5497	54
4	5531	12	36	5521	108
5	5488	15	42	5507	126
18	5523	54	46	5503	138
35	5484	105	59	5492	177
40	5518	120	76	5502	228
45	5509	135	77	5483	231
58	5524	174	83	5505	249
60	5538	180	89	5520	267
65	5540	195	--	--	--
89	5486	267	--	--	--
93	5519	279	--	--	--
95	5495	285	--	--	--

Radar waveform #17			Radar waveform #18		
Hopping Number	Frequency (MHz)	Pulse Start (ms)	Hopping Number	Frequency (MHz)	Pulse Start (ms)
1	5538	3	6	5527	18
12	5535	36	12	5514	36
17	5503	51	36	5535	108
24	5487	72	40	5534	120
26	5490	78	55	5496	165
28	5514	84	66	5487	198
30	5486	90	75	5537	225
32	5502	96	90	5510	270
41	5539	123	--	--	--
55	5515	165	--	--	--
56	5531	168	--	--	--
64	5508	192	--	--	--
Radar waveform #19			Radar waveform #20		
Hopping Number	Frequency (MHz)	Pulse Start (ms)	Hopping Number	Frequency (MHz)	Pulse Start (ms)
3	5534	9	3	5503	9
13	5524	39	16	5538	48
14	5505	42	18	5493	54
16	5501	48	19	5511	57
17	5494	51	22	5485	66
34	5496	102	28	5501	84
44	5539	132	34	5484	102
46	5537	138	46	5521	138
50	5511	150	51	5499	153
60	5486	180	56	5518	168
85	5512	255	60	5486	180
89	5504	267	81	5525	243
90	5489	270	89	5505	267
98	5518	294	96	5550	288
99	5502	297	--	--	--

Radar waveform #21			Radar waveform #22		
Hopping Number	Frequency (MHz)	Pulse Start (ms)	Hopping Number	Frequency (MHz)	Pulse Start (ms)
10	5493	30	9	5519	27
17	5534	51	30	5511	90
30	5517	90	44	5515	132
33	5523	99	58	5494	174
46	5510	138	61	5522	183
52	5539	156	70	5539	210
73	5501	219	83	5496	249
81	5535	243	89	5526	267
92	5500	276	93	5504	279
97	5522	291	96	5537	288
--	--	--	97	5498	291
--	--	--	98	5487	294
Radar waveform #23			Radar waveform #24		
Hopping Number	Frequency (MHz)	Pulse Start (ms)	Hopping Number	Frequency (MHz)	Pulse Start (ms)
10	5535	30	11	5503	33
16	5485	48	13	5533	39
19	5499	57	18	5509	54
20	5533	60	19	5491	57
26	5524	78	27	5496	81
28	5508	84	28	5527	84
31	5481	93	34	5525	102
33	5534	99	58	5531	174
38	5512	114	65	5492	195
44	5497	132	82	5522	246
45	5483	135	83	5500	249
46	5526	138	87	5497	261
51	5519	153	89	5502	267
65	5529	195	93	5493	279
97	5517	291	94	5499	282
--	--	--	96	5530	288
--	--	--	97	5534	291

Radar waveform #25			Radar waveform #26		
Hopping Number	Frequency (MHz)	Pulse Start (ms)	Hopping Number	Frequency (MHz)	Pulse Start (ms)
10	5539	30	4	5498	12
20	5519	60	16	5532	48
34	5488	102	27	5495	81
40	5480	120	28	5482	84
42	5526	126	30	5497	90
59	5501	177	39	5528	117
64	5517	192	51	5519	153
65	5491	195	67	5520	201
68	5524	204	79	5493	237
74	5527	222	83	5499	249
83	5528	249	90	5489	270
85	5532	255	95	5527	285
Radar waveform #27			Radar waveform #28		
Hopping Number	Frequency (MHz)	Pulse Start (ms)	Hopping Number	Frequency (MHz)	Pulse Start (ms)
0	5496	0	0	5528	0
7	5487	21	3	501	9
31	5519	93	12	5532	36
36	5492	108	19	5497	57
41	5530	123	25	5489	75
51	5531	153	36	5488	108
69	5509	207	46	5486	138
83	5538	249	52	5498	156
84	5480	252	53	5482	159
86	5536	258	82	5539	246
97	5512	291			

Radar waveform #29			Radar waveform #30		
Hopping Number	Frequency (MHz)	Pulse Start (ms)	Hopping Number	Frequency (MHz)	Pulse Start (ms)
6	5507	18	4	5487	12
17	5532	51	9	5499	27
23	5492	69	13	5507	39
25	5501	75	16	5518	48
28	5531	84	19	5533	57
32	5510	96	22	5534	66
43	5483	129	48	5524	144
45	5526	135	53	5496	159
54	5528	162	55	5520	165
67	5506	201	64	5512	192
71	5480	213	68	5486	204
75	5514	225	79	5501	237
80	5486	240	83	5531	249
95	5499	285	91	5491	273
98	5525	294	94	5494	282



For 802.11ac-VHT80

Type 1 Radar Statistical Performance

Trail #	Test Freq. (MHz)	Pulse Width (us)	PRI (us)	Pulses / Burst	1=Detection 0=No Detection
1	5530	1	1428	18	1
2	5530	1	1428	18	1
3	5530	1	1428	18	1
4	5530	1	1428	18	1
5	5530	1	1428	18	1
6	5530	1	1428	18	1
7	5530	1	1428	18	1
8	5530	1	1428	18	1
9	5530	1	1428	18	1
10	5530	1	1428	18	1
11	5530	1	1428	18	1
12	5530	1	1428	18	1
13	5530	1	1428	18	1
14	5530	1	1428	18	1
15	5530	1	1428	18	1
16	5530	1	1428	18	1
17	5530	1	1428	18	1
18	5530	1	1428	18	1
19	5530	1	1428	18	1
20	5530	1	1428	18	1
21	5530	1	1428	18	1
22	5530	1	1428	18	1
23	5530	1	1428	18	1
24	5530	1	1428	18	1
25	5530	1	1428	18	1
26	5530	1	1428	18	1
27	5530	1	1428	18	1
28	5530	1	1428	18	1
29	5530	1	1428	18	1
30	5530	1	1428	18	1
Detection Percentage (%)					100%

Type 2 Radar Statistical Performance

Trail #	Test Freq. (MHz)	Pulse Width (us)	PRI (us)	Pulses / Burst	1=Detection 0=No Detection
1	5530	1.2	193	25	1
2	5530	2.9	215	28	1
3	5530	1.4	155	26	1
4	5530	1.1	192	28	1
5	5530	2.1	216	24	1
6	5530	1.6	181	28	1
7	5530	1.6	195	29	1
8	5530	2.5	168	25	1
9	5530	5.0	228	28	1
10	5530	4.3	228	24	1
11	5530	2.7	180	24	1
12	5530	1.7	216	23	1
13	5530	2.3	195	23	1
14	5530	2.2	199	28	1
15	5530	2.3	207	29	1
16	5530	4.4	187	23	1
17	5530	1.1	158	24	1
18	5530	3.8	156	24	1
19	5530	1.2	158	28	1
20	5530	4.8	219	27	1
21	5530	2.2	169	27	1
22	5530	2.7	192	26	1
23	5530	4.2	192	28	1
24	5530	2.5	150	25	1
25	5530	1.4	157	23	1
26	5530	3.4	155	27	1
27	5530	4.6	180	23	1
28	5530	3.4	159	27	1
29	5530	3.0	193	27	1
30	5530	2.7	221	23	1
Detection Percentage (%)					100%

Type 3 Radar Statistical Performance

Trail #	Test Freq. (MHz)	Pulse Width (us)	PRI (us)	Pulses / Burst	1=Detection 0=No Detection
1	5530	6.8	471	16	1
2	5530	9.6	340	18	1
3	5530	6.9	392	18	1
4	5530	7.9	366	17	1
5	5530	9.3	297	17	1
6	5530	7.0	480	16	1
7	5530	9.6	294	18	1
8	5530	9.9	296	17	1
9	5530	7.9	430	16	1
10	5530	7.7	385	17	1
11	5530	9.8	418	16	1
12	5530	8.2	362	17	1
13	5530	9.3	366	17	1
14	5530	6.4	259	16	1
15	5530	7.1	316	16	1
16	5530	6.6	350	16	1
17	5530	6.4	282	17	1
18	5530	9.6	252	16	1
19	5530	6.3	472	16	1
20	5530	7.1	272	17	1
21	5530	6.9	483	17	1
22	5530	7.8	414	18	1
23	5530	6.9	480	17	1
24	5530	6.0	477	17	1
25	5530	6.7	450	17	1
26	5530	9.0	317	17	1
27	5530	9.7	460	17	1
28	5530	6.8	379	16	1
29	5530	8.9	312	18	1
30	5530	8.6	330	18	1
Detection Percentage (%)					100%

Type 4 Radar Statistical Performance

Trail #	Test Freq. (MHz)	Pulse Width (us)	PRI (us)	Pulses / Burst	1=Detection 0=No Detection
1	5530	13.2	494	13	1
2	5530	15.1	329	15	1
3	5530	16.1	494	13	1
4	5530	18.7	261	12	1
5	5530	18.1	421	12	1
6	5530	17.7	446	12	1
7	5530	12.7	435	16	1
8	5530	17.5	392	16	1
9	5530	15.6	268	16	1
10	5530	11.4	449	12	1
11	5530	18.0	301	15	1
12	5530	16.2	349	12	1
13	5530	16.5	354	15	1
14	5530	15.1	322	12	1
15	5530	17.0	264	12	1
16	5530	11.0	486	15	1
17	5530	13.5	391	14	1
18	5530	18.9	322	12	1
19	5530	11.4	375	16	1
20	5530	16.1	340	16	1
21	5530	19.7	315	12	1
22	5530	12.4	385	15	1
23	5530	12.5	467	12	1
24	5530	18.5	456	15	1
25	5530	13.8	313	14	1
26	5530	15.8	468	12	1
27	5530	19.5	295	13	1
28	5530	14.9	317	12	1
29	5530	18.9	427	15	1
30	5530	19.5	341	13	1
Detection Percentage (%)					100%

Note: In addition an average minimum percentage of successful detection across all four Short pulse radar test

waveforms is as follows: $\frac{P_d1 + P_d2 + P_d3 + P_d4}{4} = (100\% + 100\% + 100\% + 100\%) / 4 = 100\% (>80\%)$



Type 5 Radar Statistical Performance

Trail #	Test Freq. (MHz)	1=Detection 0=No Detection	Trail #	Test Freq. (MHz)	1=Detection 0=No Detection
1	5530	1	16	5530	1
2	5530	1	17	5530	1
3	5530	1	18	5530	1
4	5530	1	19	5530	1
5	5530	1	20	5530	1
6	5530	1	21	5530	1
7	5530	1	22	5530	1
8	5530	1	23	5530	1
9	5530	1	24	5530	1
10	5530	1	25	5530	1
11	5530	1	26	5530	1
12	5530	1	27	5530	1
13	5530	1	28	5530	1
14	5530	1	29	5530	1
15	5530	1	30	5530	1
Detection Percentage (%)					100%

Type 5 Radar Waveform_1										
Waveform Num = 1										
Num of Bursts = 11										
Burst Interval (us)= 1090909										
Burst #	Off Time (us)	# Pulses	Chirp (MHz)	PW (us)	Pulse 1 Pri (us)	Pulse 2 Pri (us)	Pulse 3 Pri (us)	Start Loc (us)	Start Burst Interval (us)	End Burst Interval (us)
1	777079	3	17	60	1890	1967	1014	777079	0	1090908
2	517623	1	6	70	1686	0	0	1299573	1090909	2181817
3	1590422	2	8	80	1463	1292	0	2891681	2181818	3272726
4	505660	3	5	85	1147	1155	1185	3400096	3272727	4363635
5	1589921	3	13	65	1187	1020	1197	4993504	4363636	5454544
6	760503	3	6	95	1126	1477	1823	5757411	5454545	6545453
7	1177706	2	19	65	1879	1936	0	6939543	6545454	7636362
8	1163513	3	11	55	1060	1277	1044	8106871	7636363	8727271
9	1691885	2	14	70	1663	1185	0	9802137	8727272	9818180
10	609801	1	18	65	1545	0	0	10414788	9818181	10909089
11	839020	3	15	90	1619	1495	1841	11255351	10909090	11999998
Total number of pulses in waveform = 26										



Type 5 Radar Waveform_2

Waveform Num = 2
Num of Bursts = 13
Burst Interval (us)= 923077

Burst #	Off Time (us)	# Pulses	Chirp (MHz)	PW (us)	Pulse 1 Pri (us)	Pulse 2 Pri (us)	Pulse 3 Pri (us)	Start Loc (us)	Start Burst Interval (us)	End Burst Interval (us)
1	633971	3	16	95	1901	1519	1659	633971	0	923076
2	589609	3	7	95	1912	1736	1571	1228659	923077	1846153
3	967674	3	11	95	1956	1876	1905	2201552	1846154	2769230
4	960921	2	10	60	1549	1865	0	3168210	2769231	3692307
5	1052436	3	6	50	1763	1571	1152	4224060	3692308	4615384
6	610068	1	8	70	1609	0	0	4838614	4615385	5538461
7	891396	1	10	80	1322	0	0	5731619	5538462	6461538
8	766955	1	9	90	1229	0	0	6499896	6461539	7384615
9	1353494	1	17	60	1408	0	0	7854619	7384616	8307692
10	685506	2	19	55	1835	1081	0	8541533	8307693	9230769
11	1307890	3	12	80	1938	1844	1133	9852339	9230770	10153846
12	359584	2	15	85	1803	1441	0	10216838	10153847	11076923
13	1312947	3	12	90	1583	1237	1145	11533029	11076924	12000000

Total number of pulses in waveform = 28

Type 5 Radar Waveform_3

Waveform Num = 3
Num of Bursts = 12
Burst Interval (us)= 1000000

Burst #	Off Time (us)	# Pulses	Chirp (MHz)	PW (us)	Pulse 1 Pri (us)	Pulse 2 Pri (us)	Pulse 3 Pri (us)	Start Loc (us)	Start Burst Interval (us)	End Burst Interval (us)
1	802195	2	13	80	1452	1741	0	802195	0	999999
2	1165245	2	15	80	1913	1167	0	1970633	1000000	1999999
3	97341	1	18	55	1057	0	0	2071054	2000000	2999999
4	1009725	1	11	65	1559	0	0	3081836	3000000	3999999
5	1309680	2	10	95	1354	1101	0	4393075	4000000	4999999
6	801523	1	15	85	1568	0	0	5197053	5000000	5999999
7	1562438	3	10	85	1726	1877	1214	6761059	6000000	6999999
8	1024049	2	20	90	1727	1248	0	7789925	7000000	7999999
9	886312	2	8	90	1591	1115	0	8679212	8000000	8999999
10	1172458	3	15	70	1971	1875	1587	9854376	9000000	9999999
11	1094647	3	6	65	1486	1534	1050	10954456	10000000	10999999
12	197755	2	16	70	1036	1910	0	11156281	11000000	11999999

Total number of pulses in waveform = 24

Type 5 Radar Waveform_4

Waveform Num = 4
Num of Bursts = 11
Burst Interval (us)= 1090909

Burst #	Off Time (us)	# Pulses	Chirp (MHz)	PW (us)	Pulse 1 Pri (us)	Pulse 2 Pri (us)	Pulse 3 Pri (us)	Start Loc (us)	Start Burst Interval (us)	End Burst Interval (us)
1	247181	1	14	65	1742	0	0	247181	0	1090908
2	1063120	2	14	95	1588	1533	0	1312043	1090909	2181817
3	1168786	3	9	75	1498	1873	1854	2483950	2181818	3272726
4	1137627	3	18	55	1953	1504	1035	3626802	3272727	4363635
5	1488551	2	18	70	1222	1040	0	5119845	4363636	5454544
6	1099112	2	16	70	1939	1945	0	6221219	5454545	6545453
7	535660	3	12	95	1811	1507	1354	6760763	6545454	7636362
8	1349172	3	13	55	1495	1669	1789	8114607	7636363	8727271
9	1067498	2	5	85	1126	1417	0	9187058	8727272	9818180
10	1658193	2	6	50	1144	1950	0	10847794	9818181	10909089
11	979127	3	15	65	1378	1846	1341	11830015	10909090	11999998

Total number of pulses in waveform = 26



Type 5 Radar Waveform_5

Waveform Num = 5
Num of Bursts = 16
Burst Interval (us)= 750000

Burst #	Off Time (us)	# Pulses	Chirp (MHz)	PW (us)	Pulse 1 Pri (us)	Pulse 2 Pri (us)	Pulse 3 Pri (us)	Start Loc (us)	Start Burst Interval (us)	End Burst Interval (us)
1	488770	3	14	75	1194	1928	1000	488770	0	749999
2	634221	1	8	65	1427	0	0	1127113	750000	1499999
3	864013	2	7	90	1300	1118	0	1992553	1500000	2249999
4	341131	3	10	60	1770	1966	1220	2336102	2250000	2999999
5	1257269	3	18	100	1758	1535	1470	3598327	3000000	3749999
6	495633	2	10	65	1324	1822	0	4098723	3750000	4499999
7	446494	3	19	70	1857	1355	1353	4548363	4500000	5249999
8	764341	1	11	90	1556	0	0	5317269	5250000	5999999
9	754406	1	14	65	1784	0	0	6073231	6000000	6749999
10	1188399	1	11	60	1882	0	0	7263414	6750000	7499999
11	612041	1	15	80	1954	0	0	7877337	7500000	8249999
12	386320	2	12	90	1891	1661	0	8265611	8250000	8999999
13	958623	3	16	65	1683	1256	1702	9227786	9000000	9749999
14	1169593	2	13	55	1354	1439	0	10402020	9750000	10499999
15	279935	3	9	100	1326	1178	1568	10684748	10500000	11249999
16	857408	2	14	50	1227	1865	0	11546228	11250000	11999999

Total number of pulses in waveform = 33

Type 5 Radar Waveform_6

Waveform Num = 6
Num of Bursts = 10
Burst Interval (us)= 1200000

Burst #	Off Time (us)	# Pulses	Chirp (MHz)	PW (us)	Pulse 1 Pri (us)	Pulse 2 Pri (us)	Pulse 3 Pri (us)	Start Loc (us)	Start Burst Interval (us)	End Burst Interval (us)
1	1090123	3	6	50	1369	1352	1509	1090123	0	1199999
2	835001	2	19	100	1448	1811	0	1929354	1200000	2399999
3	1301100	2	8	70	1536	1060	0	3233713	2400000	3599999
4	1222944	2	7	80	1122	1573	0	4459253	3600000	4799999
5	1363752	3	13	100	1866	1771	1211	5825700	4800000	5999999
6	862527	3	17	50	1273	1940	1849	6693075	6000000	7199999
7	1113997	2	10	50	1968	1714	0	7812134	7200000	8399999
8	1293808	3	10	75	1687	1054	1372	9109624	8400000	9599999
9	891888	1	5	55	1643	0	0	10005625	9600000	10799999
10	1460009	2	6	100	1098	1365	0	11467277	10800000	11999999

Total number of pulses in waveform = 23

Type 5 Radar Waveform_7

Waveform Num = 7
Num of Bursts = 18
Burst Interval (us)= 666667

Burst #	Off Time (us)	# Pulses	Chirp (MHz)	PW (us)	Pulse 1 Pri (us)	Pulse 2 Pri (us)	Pulse 3 Pri (us)	Start Loc (us)	Start Burst Interval (us)	End Burst Interval (us)
1	474346	2	12	95	1023	1003	0	474346	0	666666
2	430966	3	8	70	1423	1034	1806	907338	666667	1333333
3	990896	1	9	60	1803	0	0	1902497	1333334	2000000
4	545804	2	13	65	1665	1651	0	2450104	2000001	2666667
5	353371	1	6	85	1490	0	0	2806791	2666668	3333334
6	712332	3	6	75	1847	1168	1254	3520613	3333335	4000001
7	1041564	1	9	70	1006	0	0	4566446	4000002	4666668
8	350530	1	14	55	1463	0	0	4917982	4666669	5333335
9	650109	1	13	1296	0	0	0	5569554	5333336	6000002
10	748741	2	15	60	1817	1737	0	6319591	6000003	6666669
11	603556	3	5	80	1672	1178	1512	6926701	6666670	7333336
12	443434	3	11	65	1677	1892	1508	7374497	7333337	8000003
13	1043303	2	20	95	1738	1872	0	8422877	8000004	8666670
14	526865	3	9	75	1172	1892	1977	8953352	8666671	9333337
15	749543	2	10	70	1668	1269	0	9707936	9333338	10000004
16	651811	2	10	70	1002	1917	0	10362684	10000005	10666671
17	309727	1	11	65	1736	0	0	10675330	10666672	11333338
18	748446	1	13	55	1653	0	0	11425512	11333339	12000005

Total number of pulses in waveform = 34



Type 5 Radar Waveform_8

Waveform Num = 8
Num of Bursts = 9
Burst Interval (us)= 1333333

Burst #	Off Time (us)	# Pulses	Chirp (MHz)	PW (us)	Pulse 1 Pri (us)	Pulse 2 Pri (us)	Pulse 3 Pri (us)	Start Loc (us)	Start Burst Interval (us)	End Burst Interval (us)
1	338577	2	6	85	1835	1164	0	338577	0	1333332
2	1099886	3	12	65	1810	1095	1271	1441462	1333333	2666665
3	2504151	1	12	75	1548	0	0	3949789	2666666	3999998
4	329190	3	14	50	1410	1038	1960	4280527	3999999	5333331
5	1951210	1	11	85	1760	0	0	6236145	5333332	6666664
6	911387	1	13	50	1666	0	0	7149292	6666665	7999997
7	1959226	2	5	70	1793	1058	0	9110184	7999998	9333330
8	440424	2	14	70	1988	1690	0	9553459	9333331	10666663
9	2369521	1	9	60	1400	0	0	11926658	10666664	11999996

Total number of pulses in waveform = 16

Type 5 Radar Waveform_9

Waveform Num = 9
Num of Bursts = 11
Burst Interval (us)= 1090909

Burst #	Off Time (us)	# Pulses	Chirp (MHz)	PW (us)	Pulse 1 Pri (us)	Pulse 2 Pri (us)	Pulse 3 Pri (us)	Start Loc (us)	Start Burst Interval (us)	End Burst Interval (us)
1	472232	1	5	65	1899	0	0	472232	0	1090908
2	714773	1	16	50	1613	0	0	1188904	1090909	2181817
3	1067013	1	6	60	1609	0	0	2257530	2181818	3272726
4	1768217	1	6	70	1103	0	0	4027356	3272727	4363635
5	757445	3	8	85	1588	1311	1032	4785904	4363636	5454544
6	942519	1	18	85	1154	0	0	5732354	5454545	6545453
7	1276321	3	10	55	1180	1638	1493	7009829	6545454	7636362
8	1578791	2	5	50	1095	1961	0	8592931	7636363	8727271
9	394435	2	14	95	1270	1201	0	8990422	8727272	9818180
10	1898701	1	13	70	1182	0	0	10891594	9818181	10909089
11	896768	3	6	65	1676	1384	1061	11789544	10909090	11999998

Total number of pulses in waveform = 19

Type 5 Radar Waveform_10

Waveform Num = 10
Num of Bursts = 8
Burst Interval (us)= 1500000

Burst #	Off Time (us)	# Pulses	Chirp (MHz)	PW (us)	Pulse 1 Pri (us)	Pulse 2 Pri (us)	Pulse 3 Pri (us)	Start Loc (us)	Start Burst Interval (us)	End Burst Interval (us)
1	1283521	3	9	100	1599	1446	1876	1283521	0	1499999
2	863791	2	10	70	1963	1401	0	2152233	1500000	2999999
3	1561207	1	11	90	1478	0	0	3716804	3000000	4499999
4	1331061	3	17	55	1531	1958	1044	5049343	4500000	5999999
5	2066349	2	13	55	1373	1588	0	7120225	6000000	7499999
6	1011854	1	9	65	1104	0	0	8135040	7500000	8999999
7	1651613	2	5	70	1071	1170	0	9787757	9000000	10499999
8	829870	3	19	90	1730	1605	1872	10619868	10500000	11999999

Total number of pulses in waveform = 17



Type 5 Radar Waveform_11

```

Waveform Num = 11
Num of Bursts = 19
Burst Interval (us)= 631579

```

Burst #	Off Time (us)	# Pulses	Chirp (MHz)	PW (us)	Pulse 1 Pri (us)	Pulse 2 Pri (us)	Pulse 3 Pri (us)	Start Loc (us)	Start Burst Interval (us)	End Burst Interval (us)
1	231424	3	11	95	1417	1221	1482	231424	0	631578
2	554684	2	8	85	1376	1165	0	790228	631579	1263157
3	995544	1	6	80	1492	0	0	1788313	1263158	1894736
4	327542	2	20	100	1679	1288	0	2117347	1894737	2526315
5	472242	2	15	85	1663	1666	0	2592556	2526316	3157894
6	743555	1	20	100	1051	0	0	3339440	3157895	3789473
7	897859	3	5	80	1377	1623	1249	4238350	3789474	4421052
8	693971	3	7	95	1328	1941	1099	4936570	4421053	5052631
9	346711	2	15	85	1452	1969	0	5287649	5052632	5684210
10	567409	1	15	100	1099	0	0	5858479	5684211	6315789
11	1039156	1	6	70	1435	0	0	6898734	6315790	6947368
12	178681	3	13	100	1563	1820	1268	7078850	6947369	7578947
13	832499	3	15	55	1838	1740	1093	7916000	7578948	8210526
14	889908	2	9	50	1208	1050	0	8810579	8210527	8842105
15	195356	2	9	95	1626	1434	0	9008193	8842106	9473684
16	674112	3	14	55	1801	1594	1105	9685365	9473685	10105263
17	1013221	1	16	70	1202	0	0	10703086	10105264	10736842
18	279887	3	17	50	1154	1956	1512	10984175	10736843	11368421
19	472685	3	12	100	1094	1688	1965	11461482	11368422	12000000

Total number of pulses in waveform = 41

Type 5 Radar Waveform_12

```

Waveform Num = 12
Num of Bursts = 11
Burst Interval (us)= 1090909

```

Burst #	Off Time (us)	# Pulses	Chirp (MHz)	PW (us)	Pulse 1 Pri (us)	Pulse 2 Pri (us)	Pulse 3 Pri (us)	Start Loc (us)	Start Burst Interval (us)	End Burst Interval (us)
1	1033132	2	16	55	1728	1824	0	1033132	0	1090908
2	759444	2	11	75	1647	1307	0	1796128	1090909	2181817
3	1239670	2	5	95	1153	1504	0	3038752	2181818	3272726
4	1201206	1	5	70	1022	0	0	4242615	3272727	4363635
5	217080	2	14	65	1489	1586	0	4460717	4363636	5454544
6	1530720	1	13	55	1592	0	0	5994512	5454545	6545453
7	1443004	1	19	70	1849	0	0	7439108	6545454	7636362
8	1023349	2	10	60	1815	1652	0	8464306	7636363	8727271
9	698829	2	8	85	1319	1350	0	9166602	8727272	9818180
10	1219022	1	11	90	1262	0	0	10388293	9818181	10909089
11	563117	1	12	90	1285	0	0	10952672	10909090	11999998

Total number of pulses in waveform = 17

Type 5 Radar Waveform_13

```

Waveform Num = 13
Num of Bursts = 13
Burst Interval (us)= 923077

```

Burst #	Off Time (us)	# Pulses	Chirp (MHz)	PW (us)	Pulse 1 Pri (us)	Pulse 2 Pri (us)	Pulse 3 Pri (us)	Start Loc (us)	Start Burst Interval (us)	End Burst Interval (us)
1	375467	2	12	75	1018	1541	0	375467	0	923076
2	847854	1	14	60	1240	0	0	1225880	923077	1846153
3	947664	2	14	90	1888	1298	0	2174784	1846154	2769230
4	1004261	3	14	50	1107	1156	1598	3182231	2769231	3692307
5	1296446	2	16	75	1177	1144	0	4482538	3692308	4615384
6	1037813	2	18	95	1358	1998	0	5522672	4615385	5538461
7	791638	2	5	95	1681	1516	0	6317666	5538462	6461538
8	245549	1	19	55	1045	0	0	6566412	6461539	7384615
9	1636954	3	5	90	1252	1508	1058	8204411	7384616	8307692
10	942997	2	15	50	1778	1463	0	9151226	8307693	9230769
11	823029	1	18	60	1210	0	0	9977496	9230770	10153846
12	1059524	3	6	65	1481	1762	1604	11038230	10153847	11076923
13	829648	2	19	85	1607	1999	0	11872725	11076924	12000000

Total number of pulses in waveform = 26



Type 5 Radar Waveform_14

Waveform Num = 14
Num of Bursts = 19
Burst Interval (us) = 631579

Burst #	Off Time (us)	# Pulses	Chirp (MHz)	PW (us)	Pulse 1 Pri (us)	Pulse 2 Pri (us)	Pulse 3 Pri (us)	Start Loc (us)	Start Burst Interval (us)	End Burst Interval (us)
1	296704	1	15	100	1628	0	0	296704	0	631578
2	626484	3	7	75	1109	1340	1037	924816	631579	1263157
3	408396	2	10	65	1272	1760	0	1336698	1263158	1894736
4	1023923	1	5	85	1792	0	0	2363653	1894737	2526315
5	758800	3	9	85	1253	1984	1513	3124245	2526316	3157894
6	451309	3	13	90	1326	1460	1563	3580304	3157895	3789473
7	380342	1	7	60	1673	0	0	3964995	3789474	4421052
8	719405	2	8	70	1454	1583	0	4686073	4421053	5052631
9	470507	1	10	50	1931	0	0	5159617	5052632	5684210
10	1127446	3	11	65	1843	1900	1682	6288994	5684211	6315789
11	521882	3	14	90	1785	1097	1482	6815701	6315790	6947368
12	302113	1	8	95	1792	0	0	7122178	6947369	7578947
13	726958	2	8	95	1407	1130	0	7850928	7578948	8210526
14	612041	2	18	50	1344	1959	0	8465506	8210527	8842105
15	499203	1	20	100	1300	0	0	8968012	8842106	9473684
16	1111774	3	19	95	1453	1199	1040	10081086	9473685	10105263
17	419159	3	17	50	1240	1412	1746	10503937	10105264	10736842
18	497197	3	18	90	1749	1010	1893	11005532	10736843	11368421
19	897733	3	19	60	1795	1788	1373	11907917	11368422	12000000

Total number of pulses in waveform = 41

Type 5 Radar Waveform_15

Waveform Num = 15
Num of Bursts = 11
Burst Interval (us) = 1090909

Burst #	Off Time (us)	# Pulses	Chirp (MHz)	PW (us)	Pulse 1 Pri (us)	Pulse 2 Pri (us)	Pulse 3 Pri (us)	Start Loc (us)	Start Burst Interval (us)	End Burst Interval (us)
1	186768	2	12	60	1975	1302	0	186768	0	1090908
2	1950233	3	15	95	1049	1167	1683	2140278	1090909	2181817
3	463258	1	14	100	1755	0	0	2607435	2181818	3272726
4	1616191	1	9	75	1843	0	0	4225381	3272727	4363635
5	1018997	1	7	80	1792	0	0	5246221	4363636	5454544
6	1002567	2	12	50	1611	1545	0	6250580	5454545	6545453
7	320872	1	8	85	1127	0	0	6574608	6545454	7636362
8	1877644	2	14	55	1687	1940	0	8453379	7636363	8727271
9	335853	1	15	85	1778	0	0	8792859	8727272	9818180
10	1635051	1	14	90	1638	0	0	10429688	9818181	10909089
11	991447	3	15	60	1825	1152	1235	11422773	10909090	11999998

Total number of pulses in waveform = 18

Type 5 Radar Waveform_16

Waveform Num = 16
Num of Bursts = 17
Burst Interval (us) = 705882

Burst #	Off Time (us)	# Pulses	Chirp (MHz)	PW (us)	Pulse 1 Pri (us)	Pulse 2 Pri (us)	Pulse 3 Pri (us)	Start Loc (us)	Start Burst Interval (us)	End Burst Interval (us)
1	32238	1	12	75	1315	0	0	32238	0	705881
2	677837	3	15	65	1187	1184	1213	711390	705882	1411763
3	900869	1	13	90	1253	0	0	1615843	1411764	2117645
4	739953	3	6	80	1029	1465	1694	2357049	2117646	2823527
5	490283	2	16	70	1901	1737	0	2851520	2823528	3529409
6	697332	2	13	95	1042	1337	0	3552490	3529410	4235291
7	770031	2	11	95	1211	1215	0	4324900	4235292	4941173
8	1064749	1	20	85	1146	0	0	5392075	4941174	5647055
9	925635	1	11	100	1756	0	0	6318856	5647056	6352937
10	443131	1	18	80	1104	0	0	6763743	6352938	7058819
11	742130	3	12	55	1950	1581	1221	7506977	7058820	7764701
12	438356	2	16	55	1965	1354	0	7950085	7764702	8470583
13	521498	3	11	75	1658	1889	1687	8474902	8470584	9176465
14	1130532	2	6	65	1185	1536	0	9610668	9176466	9882347
15	551220	3	14	60	1989	1852	1876	10164609	9882348	10588229
16	732661	3	5	70	1698	1576	1457	10902987	10588230	11294111
17	803070	1	11	95	1577	0	0	11710788	11294112	11999993

Total number of pulses in waveform = 34



Type 5 Radar Waveform_17

Waveform Num = 17
Num of Bursts = 16
Burst Interval (us)= 750000

Burst #	Off Time (us)	# Pulses	Chirp (MHz)	PW (us)	Pulse 1 Pri (us)	Pulse 2 Pri (us)	Pulse 3 Pri (us)	Start Loc (us)	Start Burst Interval (us)	End Burst Interval (us)
1	101739	1	14	90	1790	0	0	101739	0	749999
2	935073	1	6	95	1437	0	0	1038602	750000	1499999
3	712674	2	14	85	1260	1680	0	1752713	1500000	2249999
4	828945	2	13	50	1677	1431	0	2584598	2250000	2999999
5	452801	3	8	90	1610	1285	1303	3040507	3000000	3749999
6	1111353	2	7	90	1007	1284	0	4156058	3750000	4499999
7	810282	1	19	100	1685	0	0	4968631	4500000	5249999
8	822388	1	6	90	1931	0	0	5792704	5250000	5999999
9	582742	3	6	100	1141	1807	1206	6377377	6000000	6749999
10	561580	1	9	70	1206	0	0	6943111	6750000	7499999
11	749740	3	15	90	1759	1961	1475	7694057	7500000	8249999
12	1057301	3	11	60	1048	1565	1301	8756553	8250000	8999999
13	614317	2	8	85	1703	1435	0	9374784	9000000	9749999
14	741599	3	10	70	1314	1572	1059	10119521	9750000	10499999
15	950379	2	6	60	1162	1024	0	11073845	10500000	11249999
16	863005	3	15	80	1332	1105	1137	11939036	11250000	11999999

Total number of pulses in waveform = 33

Type 5 Radar Waveform_18

Waveform Num = 18
Num of Bursts = 10
Burst Interval (us)= 1200000

Burst #	Off Time (us)	# Pulses	Chirp (MHz)	PW (us)	Pulse 1 Pri (us)	Pulse 2 Pri (us)	Pulse 3 Pri (us)	Start Loc (us)	Start Burst Interval (us)	End Burst Interval (us)
1	229201	3	20	80	1289	1848	1562	229201	0	1199999
2	1230069	1	5	85	1084	0	0	1463969	1200000	2399999
3	1069549	3	18	80	1303	1845	1204	2534602	2400000	3599999
4	1227518	2	18	75	1366	1731	0	3766472	3600000	4799999
5	2018899	1	15	100	1554	0	0	5788468	4800000	5999999
6	830312	3	19	55	1205	1504	1251	6620334	6000000	7199999
7	1193137	3	8	100	1736	1327	1862	7817431	7200000	8399999
8	642192	1	18	95	1451	0	0	8464548	8400000	9599999
9	1882768	2	16	65	1539	1453	0	10348767	9600000	10799999
10	860768	2	19	55	1342	1107	0	11212527	10800000	11999999

Total number of pulses in waveform = 21

Type 5 Radar Waveform_19

Waveform Num = 19
Num of Bursts = 16
Burst Interval (us)= 750000

Burst #	Off Time (us)	# Pulses	Chirp (MHz)	PW (us)	Pulse 1 Pri (us)	Pulse 2 Pri (us)	Pulse 3 Pri (us)	Start Loc (us)	Start Burst Interval (us)	End Burst Interval (us)
1	18706	3	10	55	1354	1819	1028	18706	0	749999
2	1245792	3	19	70	1232	1228	1980	1268699	750000	1499999
3	748943	1	5	90	1713	0	0	2022082	1500000	2249999
4	962452	2	9	100	1542	1555	0	2986247	2250000	2999999
5	72879	2	7	75	1307	1370	0	3062223	3000000	3749999
6	771665	3	11	60	1365	1516	1561	3836565	3750000	4499999
7	1265299	3	9	50	1396	1927	1381	5106306	4500000	5249999
8	496708	1	18	100	1655	0	0	5607718	5250000	5999999
9	987413	2	11	85	1643	1612	0	6596786	6000000	6749999
10	649076	3	18	85	1700	1096	1756	7249117	6750000	7499999
11	879173	3	5	55	1956	1917	1838	8132842	7500000	8249999
12	113087	3	5	75	1745	1717	1498	8251640	8250000	8999999
13	961928	1	9	50	1228	0	0	9218528	9000000	9749999
14	767152	2	9	75	1321	1007	0	9986908	9750000	10499999
15	982559	1	8	80	1077	0	0	10971795	10500000	11249999
16	406125	1	12	80	1096	0	0	11378997	11250000	11999999

Total number of pulses in waveform = 34



Type 5 Radar Waveform_20

Waveform Num = 20
Num of Bursts = 13
Burst Interval (us)= 923077

Burst #	Off Time (us)	# Pulses	Chirp (MHz)	PW (us)	Pulse 1 Pri (us)	Pulse 2 Pri (us)	Pulse 3 Pri (us)	Start Loc (us)	Start Burst Interval (us)	End Burst Interval (us)
1	806670	2	19	70	1065	1120	0	806670	0	923076
2	982818	1	16	100	1576	0	0	1791673	923077	1846153
3	624499	1	19	55	1733	0	0	2417748	1846154	2769230
4	947077	3	9	70	1584	1699	1740	3366558	2769231	3692307
5	546339	1	6	75	1737	0	0	3917920	3692308	4615384
6	1317983	2	14	75	1885	1884	0	5237640	4615385	5538461
7	1121911	1	17	80	1664	0	0	6363320	5538462	6461538
8	606396	2	14	75	1926	1645	0	6971380	6461539	7384615
9	413469	2	13	60	1259	1632	0	7388420	7384616	8307692
10	1677935	3	6	100	1916	1925	1715	9069246	8307693	9230769
11	1008168	1	9	100	1003	0	0	10082970	9230770	10153846
12	146416	3	8	95	1938	1362	1642	10230389	10153847	11076923
13	1360887	1	11	100	1704	0	0	11596218	11076924	12000000

Total number of pulses in waveform = 23

Type 5 Radar Waveform_21

Waveform Num = 21
Num of Bursts = 11
Burst Interval (us)= 1090909

Burst #	Off Time (us)	# Pulses	Chirp (MHz)	PW (us)	Pulse 1 Pri (us)	Pulse 2 Pri (us)	Pulse 3 Pri (us)	Start Loc (us)	Start Burst Interval (us)	End Burst Interval (us)
1	1050170	2	6	65	1535	1193	0	1050170	0	1090908
2	156837	2	9	60	1566	1269	0	1209735	1090909	2181817
3	1325610	2	19	75	1344	1544	0	2538180	2181818	3272726
4	1034523	1	9	60	1135	0	0	3575591	3272727	4363635
5	859294	3	15	50	1166	1618	1302	4436020	4363636	5454544
6	2041470	2	11	85	1851	1619	0	6481576	5454545	6545453
7	106426	3	18	55	1137	1311	1090	6591472	6545454	7636362
8	1689817	3	14	50	1111	1386	1437	8284827	7636363	8727271
9	605146	2	16	60	1843	1973	0	8893907	8727272	9818180
10	960471	2	9	65	1328	1910	0	9858194	9818181	10909089
11	1897266	1	11	70	1725	0	0	11758698	10909090	11999998

Total number of pulses in waveform = 23

Type 5 Radar Waveform_22

Waveform Num = 22
Num of Bursts = 19
Burst Interval (us)= 631579

Burst #	Off Time (us)	# Pulses	Chirp (MHz)	PW (us)	Pulse 1 Pri (us)	Pulse 2 Pri (us)	Pulse 3 Pri (us)	Start Loc (us)	Start Burst Interval (us)	End Burst Interval (us)
1	9091	2	5	80	1731	1266	0	9091	0	631578
2	846419	3	9	80	1158	1425	1094	888507	631579	1263157
3	406735	3	14	95	1930	1890	1425	1268919	1263158	1894736
4	734413	2	18	100	1633	1260	0	2008577	1894737	2526315
5	540103	1	8	75	1326	0	0	2551573	2526316	3157894
6	1223333	1	17	95	1850	0	0	3776232	3157895	3789473
7	313963	3	5	85	1474	1701	1973	4092045	3789474	4421052
8	605667	2	19	75	1863	1966	0	4702860	4421053	5052631
9	637193	2	16	55	1777	1154	0	5343882	5052632	5684210
10	395206	2	12	95	1230	1766	0	5742019	5684211	6315789
11	600243	1	13	90	1523	0	0	6345258	6315790	6947368
12	1221002	1	9	65	1966	0	0	7567783	6947369	7578947
13	427424	1	10	75	1648	0	0	7997173	7578948	8210526
14	481142	3	6	95	1187	1957	1515	8479963	8210527	8842105
15	590178	2	8	75	1123	1504	0	9074800	8842106	9473684
16	531447	3	8	90	1564	1657	1865	9608874	9473685	10105263
17	504755	3	11	55	1647	1883	1068	10118715	10105264	10736842
18	1161994	1	19	75	1577	0	0	11285307	10736843	11368421
19	417779	2	18	90	1027	1860	0	11704663	11368422	12000000

Total number of pulses in waveform = 38



Type 5 Radar Waveform_23

Waveform Num = 23
Num of Bursts = 8
Burst Interval (us)= 1500000

Burst #	Off Time (us)	# Pulses	Chirp (MHz)	PW (us)	Pulse 1 Pri (us)	Pulse 2 Pri (us)	Pulse 3 Pri (us)	Start Loc (us)	Start Burst Interval (us)	End Burst Interval (us)
1	421505	1	10	90	1881	0	0	421505	0	1499999
2	1091415	3	6	100	1042	1730	1123	1514801	1500000	2999999
3	2077107	3	18	75	1751	1986	1518	3595803	3000000	4499999
4	1033013	3	10	75	1532	1451	1257	4634071	4500000	5999999
5	1530242	1	10	85	1593	0	0	6168553	6000000	7499999
6	2405367	2	19	95	1212	1647	0	8575513	7500000	8999999
7	1762894	1	9	75	1011	0	0	10341266	9000000	10499999
8	524110	2	17	75	1641	1592	0	10866387	10500000	11999999

Total number of pulses in waveform = 16

Type 5 Radar Waveform_24

Waveform Num = 24
Num of Bursts = 17
Burst Interval (us)= 705882

Burst #	Off Time (us)	# Pulses	Chirp (MHz)	PW (us)	Pulse 1 Pri (us)	Pulse 2 Pri (us)	Pulse 3 Pri (us)	Start Loc (us)	Start Burst Interval (us)	End Burst Interval (us)
1	609715	1	9	70	1365	0	0	609715	0	705881
2	104779	1	13	65	1470	0	0	715859	705882	1411763
3	836191	2	12	50	1612	1237	0	1553520	1411764	2117645
4	787356	1	6	75	1343	0	0	2343725	2117646	2823527
5	606554	2	14	80	1975	1289	0	2951622	2823528	3529409
6	860957	1	14	95	1482	0	0	3815843	3529410	4235291
7	504870	3	18	100	1014	1257	1834	4322195	4235292	4941173
8	627574	2	15	65	1846	1114	0	4953874	4941174	5647055
9	1058084	3	14	95	1085	1730	1048	6014918	5647056	6352937
10	645467	1	10	60	1300	0	0	6664248	6352938	7058819
11	553125	2	9	80	1503	1031	0	7218673	7058820	7764701
12	605042	2	14	60	1348	1267	0	7826249	7764702	8470583
13	1092861	2	7	65	1411	1224	0	8921725	8470584	9176465
14	444404	1	12	50	1423	0	0	9368764	9176466	9882347
15	1120767	1	6	80	1887	0	0	10490954	9882348	10588229
16	336765	2	15	85	1961	1617	0	10829606	10588230	11294111
17	873510	1	15	90	1382	0	0	11706694	11294112	11999993

Total number of pulses in waveform = 28

Type 5 Radar Waveform_25

Waveform Num = 25
Num of Bursts = 20
Burst Interval (us)= 600000

Burst #	Off Time (us)	# Pulses	Chirp (MHz)	PW (us)	Pulse 1 Pri (us)	Pulse 2 Pri (us)	Pulse 3 Pri (us)	Start Loc (us)	Start Burst Interval (us)	End Burst Interval (us)
1	12160	3	9	65	1133	1055	1090	12160	0	599999
2	1014427	3	14	95	1545	1772	1411	1029865	600000	1199999
3	2052294	2	13	60	1476	1192	0	1239887	1200000	1799999
4	1063128	1	7	60	1802	0	0	2305683	1800000	2399999
5	568065	2	7	90	1051	1052	0	2875550	2400000	2999999
6	393074	1	20	75	1051	0	0	3270727	3000000	3599999
7	632964	1	20	100	1665	0	0	3904742	3600000	4199999
8	833166	3	16	55	1415	1024	1688	4739573	4200000	4799999
9	290387	2	18	85	1841	1279	0	5034087	4800000	5399999
10	768261	1	5	90	1134	0	0	5805468	5400000	5999999
11	233128	3	12	85	1972	1941	1808	6039730	6000000	6599999
12	839882	1	5	100	1685	0	0	6885333	6600000	7199999
13	594891	3	5	60	1726	1326	1453	7481909	7200000	7799999
14	360615	2	6	85	1094	1763	0	7847029	7800000	8399999
15	1092210	1	9	70	1913	0	0	8942096	8400000	8999999
16	572967	1	17	55	1824	0	0	9516976	9000000	9599999
17	596223	3	15	80	1069	1099	1280	10115023	9600000	10199999
18	449874	3	17	100	1374	1307	1103	10568345	10200000	10799999
19	794989	1	16	70	1034	0	0	11367118	10800000	11399999
20	484608	2	20	60	1566	1536	0	11852760	11400000	11999999

Total number of pulses in waveform = 39



Type 5 Radar Waveform_26

Waveform Num = 26
Num of Bursts = 16
Burst Interval (us)= 750000

Burst #	Off Time (us)	# Pulses	Chirp (MHz)	PW (us)	Pulse 1 Pri (us)	Pulse 2 Pri (us)	Pulse 3 Pri (us)	Start Loc (us)	Start Burst Interval (us)	End Burst Interval (us)
1	566471	2	9	75	1496	1317	0	566471	0	749999
2	844888	1	12	100	1607	0	0	1414172	750000	1499999
3	392151	3	7	60	1305	1972	1121	1807930	1500000	2249999
4	484997	3	17	75	1271	1807	1979	2297325	2250000	2999999
5	884304	1	6	65	1933	0	0	3186686	3000000	3749999
6	582699	1	12	65	1731	0	0	3771318	3750000	4499999
7	769320	1	7	100	1367	0	0	4542369	4500000	5249999
8	992278	2	13	75	1511	1941	0	5536014	5250000	5999999
9	867565	1	13	100	1490	0	0	6407031	6000000	6749999
10	487956	1	5	90	1344	0	0	6896477	6750000	7499999
11	1210698	3	6	100	1873	1534	1575	8108519	7500000	8249999
12	647032	3	9	60	1737	1682	1218	8760533	8250000	8999999
13	379790	2	7	100	1444	1552	0	9144960	9000000	9749999
14	1020847	1	5	55	1873	0	0	10168803	9750000	10499999
15	939376	2	9	60	1825	1055	0	11110052	10500000	11249999
16	294363	3	16	75	1575	1526	1113	11407295	11250000	11999999

Total number of pulses in waveform = 30

Type 5 Radar Waveform_27

Waveform Num = 27
Num of Bursts = 9
Burst Interval (us)= 1333333

Burst #	Off Time (us)	# Pulses	Chirp (MHz)	PW (us)	Pulse 1 Pri (us)	Pulse 2 Pri (us)	Pulse 3 Pri (us)	Start Loc (us)	Start Burst Interval (us)	End Burst Interval (us)
1	959478	2	18	100	1061	1945	0	959478	0	1333332
2	1243240	1	9	100	1980	0	0	2205724	1333333	2666665
3	1419545	1	8	85	1885	0	0	3627249	2666666	3999998
4	1494422	2	11	55	1543	1368	0	5123556	3999999	5333331
5	1211630	3	12	80	1109	1157	1890	6338097	5333332	6666664
6	1278746	3	11	75	1115	1535	1630	7620999	6666665	7999997
7	715508	1	10	95	1151	0	0	8340787	7999998	9333330
8	2268254	1	9	65	1734	0	0	10610192	9333331	10666663
9	276576	1	17	75	1560	0	0	10888502	10666664	11999996

Total number of pulses in waveform = 15

Type 5 Radar Waveform_28

Waveform Num = 28
Num of Bursts = 14
Burst Interval (us)= 857143

Burst #	Off Time (us)	# Pulses	Chirp (MHz)	PW (us)	Pulse 1 Pri (us)	Pulse 2 Pri (us)	Pulse 3 Pri (us)	Start Loc (us)	Start Burst Interval (us)	End Burst Interval (us)
1	356668	2	11	90	1417	1170	0	356668	0	857142
2	991853	2	20	70	1813	1695	0	1351108	857143	1714285
3	396977	1	10	85	1316	0	0	1751593	1714286	2571428
4	912472	3	16	85	1723	1984	1977	2665381	2571429	3428571
5	1413553	1	6	75	1303	0	0	4084618	3428572	4285714
6	205130	2	17	60	1504	1097	0	4291051	4285715	5142857
7	1097505	2	9	75	1497	1123	0	5391157	5142858	6000000
8	1141054	2	13	90	1625	1105	0	6534831	6000001	6857143
9	878471	2	16	60	1627	1160	0	7416032	6857144	7714286
10	574403	3	13	55	1954	1836	1036	7993222	7714287	8571429
11	840061	2	20	95	1231	1592	0	8838109	8571430	9428572
12	669097	3	8	90	1919	1033	1351	9510029	9428573	10285715
13	776780	3	13	80	1395	1616	1627	10291112	10285716	11142858
14	1581975	1	20	75	1994	0	0	11877725	11142859	12000001

Total number of pulses in waveform = 29



Type 5 Radar Waveform_29

Waveform Num = 29
Num of Bursts = 11
Burst Interval (us)= 1090909

Burst #	Off Time (us)	# Pulses	Chirp (MHz)	PW (us)	Pulse 1 Pri (us)	Pulse 2 Pri (us)	Pulse 3 Pri (us)	Start Loc (us)	Start Burst Interval (us)	End Burst Interval (us)
1	261436	2	12	65	1643	1006	0	261436	0	1090908
2	1577048	1	20	85	1595	0	0	1841133	1090909	2181817
3	459048	2	8	60	1966	1263	0	2301776	2181818	3272726
4	1928434	3	17	80	1777	1770	1147	4233439	3272727	4363635
5	1213057	1	19	75	1899	0	0	5451190	4363636	5454544
6	778594	2	10	85	1027	1424	0	6231683	5454545	6545453
7	1068665	2	7	100	1284	1105	0	7302799	6545454	7636362
8	691048	1	13	95	1111	0	0	7996236	7636363	8727271
9	876746	1	14	60	1667	0	0	8874093	8727272	9818180
10	947382	2	15	75	1780	1309	0	9823142	9818181	10909089
11	2104232	2	20	90	1129	1026	0	11930463	10909090	11999998

Total number of pulses in waveform = 19

Type 5 Radar Waveform_30

Waveform Num = 30
Num of Bursts = 11
Burst Interval (us)= 1090909

Burst #	Off Time (us)	# Pulses	Chirp (MHz)	PW (us)	Pulse 1 Pri (us)	Pulse 2 Pri (us)	Pulse 3 Pri (us)	Start Loc (us)	Start Burst Interval (us)	End Burst Interval (us)
1	1073993	1	5	80	1370	0	0	1073993	0	1090908
2	628349	3	20	80	1865	1999	1231	1703712	1090909	2181817
3	969621	2	13	60	1402	1289	0	2678428	2181818	3272726
4	629683	1	10	100	1037	0	0	3310802	3272727	4363635
5	1229171	1	15	95	1434	0	0	4541010	4363636	5454544
6	1065014	1	15	55	1270	0	0	5607458	5454545	6545453
7	1414312	2	20	80	1981	1583	0	7023040	6545454	7636362
8	1171928	3	5	90	1154	1274	1097	8198532	7636363	8727271
9	681935	1	19	75	1624	0	0	8883992	8727272	9818180
10	1436234	3	13	50	1281	1231	1962	10321850	9818181	10909089
11	1215464	2	10	90	1376	1704	0	11541788	10909090	11999998

Total number of pulses in waveform = 20

Type 6 Radar Statistical Performance

Trail #	Test Freq. (MHz)	1=Detection 0=No Detection	Trail #	Test Freq. (MHz)	1=Detection 0=No Detection
1	5530	1	16	5530	1
2	5530	1	17	5530	1
3	5530	1	18	5530	1
4	5530	1	19	5530	1
5	5530	1	20	5530	1
6	5530	1	21	5530	1
7	5530	1	22	5530	1
8	5530	1	23	5530	1
9	5530	1	24	5530	1
10	5530	1	25	5530	1
11	5530	1	26	5530	1
12	5530	1	27	5530	1
13	5530	1	28	5530	1
14	5530	1	29	5530	1
15	5530	1	30	5530	1
Detection Percentage (%)					100%

Radar waveform #1			Radar waveform #2		
Hopping Number	Frequency (MHz)	Pulse Start (ms)	Hopping Number	Frequency (MHz)	Pulse Start (ms)
1	5501	3	7	5546	21
7	5508	21	32	5507	96
16	5538	48	37	5528	111
24	5525	72	38	5555	114
33	5531	99	40	5556	120
46	5547	138	44	5544	132
57	5559	171	50	5506	150
58	5553	174	69	5504	207
63	5502	189	81	5514	243
72	5516	216	85	5505	255
97	5535	291	86	5519	258
Radar waveform #3			Radar waveform #4		
Hopping Number	Frequency (MHz)	Pulse Start (ms)	Hopping Number	Frequency (MHz)	Pulse Start (ms)
2	5520	6	7	5536	21
4	5537	12	11	5556	33
8	5517	24	12	5500	36
15	5535	45	16	5560	48
25	5540	75	19	5553	57
47	5523	141	35	5519	105
52	5508	156	39	5525	117
65	5505	195	61	5558	183
67	5529	201	66	5509	198
72	5553	216	72	5516	216
80	5506	240	79	5546	237
81	5558	243	86	5526	258
83	5551	249	--	--	--

Radar waveform #5			Radar waveform #6		
Hopping Number	Frequency (MHz)	Pulse Start (ms)	Hopping Number	Frequency (MHz)	Pulse Start (ms)
4	5536	12	17	5502	51
43	5526	129	25	5532	75
53	5553	159	27	5509	81
60	5520	180	34	5550	102
62	5555	186	38	5529	114
64	5503	192	40	5508	120
78	5552	234	43	5537	129
96	5548	288	53	5544	159
--	--	--	54	5543	162
--	--	--	56	5514	168
--	--	--	58	5534	174
--	--	--	59	5512	177
--	--	--	64	5531	192
--	--	--	66	5554	198
--	--	--	67	5530	201
--	--	--	68	5539	204
--	--	--	69	5523	207
--	--	--	70	5501	210
--	--	--	83	5518	249
--	--	--	97	5556	291

Radar waveform #7			Radar waveform #8		
Hopping Number	Frequency (MHz)	Pulse Start (ms)	Hopping Number	Frequency (MHz)	Pulse Start (ms)
2	5545	6	6	5543	18
4	5523	12	10	5534	30
19	5549	57	14	5502	42
32	5516	96	26	5523	78
38	5517	114	34	5503	102
49	5547	147	37	5516	111
55	5531	165	49	5539	147
59	5524	177	50	5558	150
60	5535	180	57	5522	171
64	5508	192	63	5530	189
65	5510	195	67	5514	201
72	5500	216	73	5512	219
75	5555	225	77	5517	231
93	5521	279	78	5507	234
94	5553	282	79	5532	237
98	5542	294	96	5535	288
Radar waveform #9			Radar waveform #10		
Hopping Number	Frequency (MHz)	Pulse Start (ms)	Frequency (MHz)	Hopping Number	Pulse Start (ms)
1	5534	3	3	5557	9
4	5556	12	9	5504	27
12	5542	36	23	5508	69
26	5513	78	24	5512	72
32	5530	96	30	5546	90
33	5529	99	34	5529	102
37	5532	111	36	5527	108
46	5512	138	37	5505	111
64	5501	192	41	5523	123
71	5524	213	43	5552	129
77	5549	231	72	5514	216
78	5545	234	76	5543	228
97	5541	291	77	5501	231
--	--	--	84	5547	252
--	--	--	95	5555	285

Radar waveform #11			Radar waveform #12		
Hopping Number	Frequency (MHz)	Pulse Start (ms)	Hopping Number	Frequency (MHz)	Pulse Start (ms)
3	5554	9	4	5500	12
10	5523	30	6	5560	18
11	5507	33	12	5509	36
13	5552	39	41	5502	123
17	5500	51	48	5556	144
28	5556	84	52	5551	156
30	5516	90	60	5520	180
35	5547	105	72	5547	216
39	5528	117	78	5543	234
40	5511	120	88	5514	264
51	5557	153	98	5507	294
67	5520	201	--	--	--
69	5555	207	--	--	--
84	5553	252	--	--	--
Radar waveform #13			Radar waveform #14		
Hopping Number	Frequency (MHz)	Pulse Start (ms)	Hopping Number	Frequency (MHz)	Pulse Start (ms)
3	5551	9	15	5521	45
11	5557	33	22	5532	66
14	5549	42	38	5553	114
17	5548	51	46	5535	138
22	5559	66	50	5557	150
30	5539	90	55	5505	165
43	5511	129	56	5513	168
54	5515	162	61	5551	183
59	5512	177	66	5517	198
61	5540	183	70	5538	210
74	5525	222	74	5516	222
86	5531	258	79	5554	237
90	5508	270	82	5525	246
96	5533	288	--	--	--
97	5523	291	--	--	--
99	5545	297	--	--	--

Radar waveform #15			Radar waveform #16		
Hopping Number	Frequency (MHz)	Pulse Start (ms)	Hopping Number	Frequency (MHz)	Pulse Start (ms)
0	5559	0	4	5548	12
1	5500	3	7	5504	21
13	5540	39	9	5546	27
14	5519	42	22	5516	66
18	5531	54	53	5540	159
27	5509	81	54	5514	162
33	5542	99	58	5553	174
52	5525	156	68	5508	204
55	5507	165	69	5502	207
71	5529	213	71	5523	213
75	5537	225	75	5512	225
83	5543	249	79	5535	237
88	5555	264	87	5543	261
89	5553	267	97	5513	291
95	5546	285	99	5510	297
96	5503	288	--	--	--
99	5508	297	--	--	--

Radar waveform #17			Radar waveform #28		
Hopping Number	Frequency (MHz)	Pulse Start (ms)	Hopping Number	Frequency (MHz)	Pulse Start (ms)
2	5548	6	2	5520	6
4	5510	12	4	5530	12
5	5556	15	11	5560	33
8	5522	24	12	5502	36
11	5550	33	20	5507	60
13	5506	39	34	5523	102
28	5519	84	35	5555	105
35	5500	105	49	5508	147
39	5539	117	61	5536	183
40	5552	120	78	5510	234
52	5503	156	87	5514	261
59	5520	177	98	5534	294
60	5542	180	--	--	--
61	5524	183	--	--	--
70	5551	210	--	--	--
72	5502	216	--	--	--
82	5554	246	--	--	--



Radar waveform #19			Radar waveform #20		
Hopping Number	Frequency (MHz)	Pulse Start (ms)	Hopping Number	Frequency (MHz)	Pulse Start (ms)
7	5557	21	0	5503	0
12	5541	36	1	5540	3
13	5522	39	3	5536	9
14	5544	42	14	5546	42
19	5539	57	29	5515	87
24	5548	72	31	5517	93
31	5552	93	41	5547	123
37	5560	111	43	5507	129
41	5500	123	64	5504	192
59	5542	177	72	5520	216
66	5510	198	75	5513	225
85	5550	255	82	5560	246
87	5521	261	93	5550	279
--	--	--	94	5548	282
--	--	--	97	5539	291
Radar waveform #21			Radar waveform #22		
Hopping Number	Frequency (MHz)	Pulse Start (ms)	Hopping Number	Frequency (MHz)	Pulse Start (ms)
3	5500	9	0	5507	0
11	5560	33	16	5551	48
13	5510	39	39	5532	117
17	5513	51	69	5543	207
26	5558	78	72	5547	216
28	5505	84	78	5506	234
43	5502	129	80	5537	240
60	5526	180	93	5501	279
64	5541	192	--	--	--
70	5540	210	--	--	--
78	5531	234	--	--	--
82	5548	246	--	--	--
97	5539	291	--	--	--

Radar waveform #23			Radar waveform #24		
Hopping Number	Frequency (MHz)	Pulse Start (ms)	Hopping Number	Frequency (MHz)	Pulse Start (ms)
10	5531	30	0	5544	0
14	5533	42	2	5517	6
21	5520	63	15	5553	45
27	5544	81	25	5545	75
36	5542	108	46	5556	138
40	5538	120	48	5510	144
44	5543	132	58	5540	174
52	5549	156	66	5508	198
54	5527	162	68	5520	204
59	5517	177	70	5559	210
84	5554	252	76	5501	228
--	--	--	77	5521	231
--	--	--	87	5500	261
--	--	--	95	5560	285
--	--	--	99	5554	297
Radar waveform #25			Radar waveform #26		
Hopping Number	Frequency (MHz)	Hopping Number	Frequency (MHz)	Hopping Number	Frequency (MHz)
15	5530	45	3	5549	9
25	5526	75	10	5542	30
26	5508	78	12	5558	36
40	5540	120	17	5505	51
41	5542	123	37	5536	111
43	5541	129	38	5550	114
56	5502	168	42	5519	126
60	5522	180	91	5543	273
77	5547	231	97	5531	291



Radar waveform #27			Radar waveform #28		
Hopping Number	Frequency (MHz)	Pulse Start (ms)	Hopping Number	Frequency (MHz)	Pulse Start (ms)
6	5505	18	14	5513	42
9	5533	27	21	5518	63
38	5534	114	22	5554	66
39	5517	117	26	5526	78
40	5536	120	28	5517	84
46	5535	138	40	5550	120
51	5522	153	48	5545	144
53	5512	159	57	5521	171
57	5508	171	70	5516	210
73	5529	219	75	5538	225
74	5549	222	83	5556	249
90	5501	270	85	5535	255
95	5546	285	91	5541	273
98	5526	294	--	--	--
Radar waveform #29			Radar waveform #30		
Hopping Number	Frequency (MHz)	Pulse Start (ms)	Hopping Number	Frequency (MHz)	Pulse Start (ms)
0	5554	0	3	5550	9
10	5545	30	5	5538	15
12	5504	36	18	5532	54
27	5555	81	24	5555	72
37	5529	111	29	5516	87
40	5541	120	31	5540	93
44	5513	132	56	5521	168
48	5538	144	59	5548	177
55	5544	165	93	5507	279
56	5553	168	98	5512	294
64	5559	192	--	--	--
65	5525	195	--	--	--
84	5558	252	--	--	--
87	5521	261	--	--	--
88	5517	264	--	--	--
89	5557	267	--	--	--
98	5556	294	--	--	--

6. CONCLUSION

The data collected relate only the item(s) tested and show that the **WIFI dual band 4 GE LAN GPON HGU FCC ID: 2ABLK-8X4G-1** is in compliance with Part 15E of the FCC Rules.

The End