

Site: AC1	Time: 2015/01/14 - 15:11
Limit: FCC_Part15.209_RE(3m)	Engineer: Roy Cheng
Probe: BBHA9120D_1-18GHz	Polarity: Vertical
EUT: WiFi Concurrent 4 Port GE LAN VoIP Ethernet Gateway with USB	Power: AC 120V/60Hz
Test Mode: Transmit at channel 5320MHz by 802.11n-HT20 Ant 0+1+2+3	

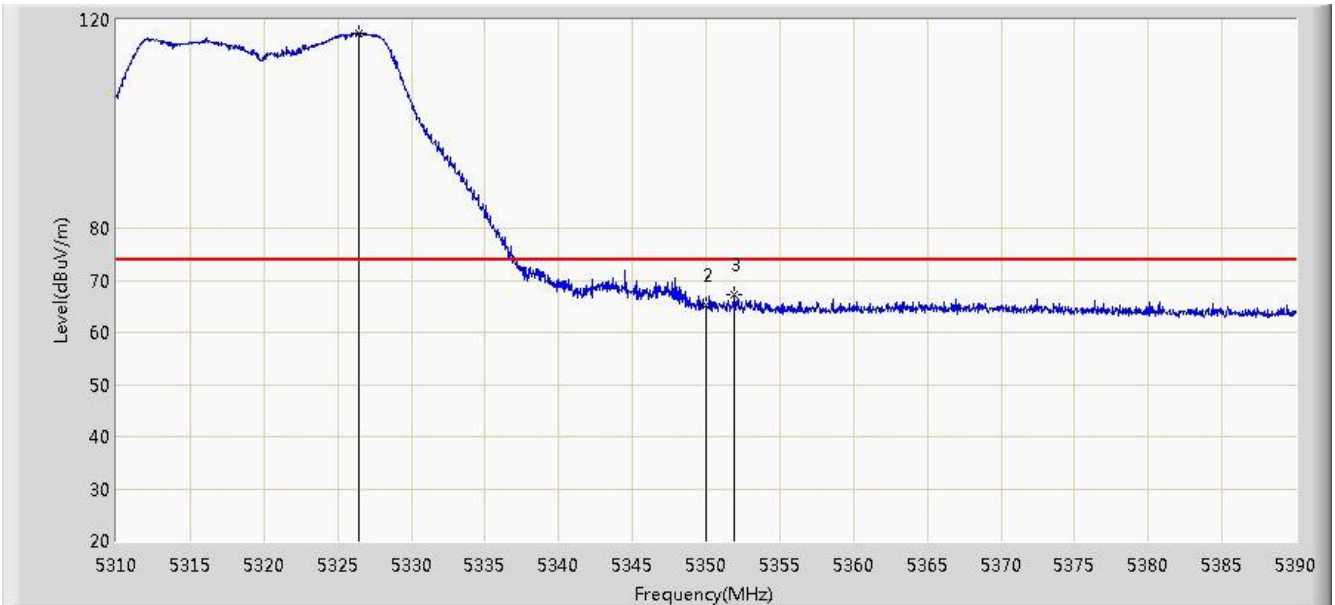

No	Flag	Mark	Frequency (MHz)	Measure Level (dBuV/m)	Reading Level (dBuV)	Over Limit (dB)	Limit (dBuV/m)	Factor (dB)	Type
1		*	5326.440	117.414	80.189	N/A	N/A	37.225	PK
2			5350.000	65.108	27.822	-8.892	74.000	37.286	PK
3			5351.920	67.155	29.863	-6.845	74.000	37.292	PK

Note: Measure Level (dBuV/m) = Reading Level (dBuV) + Factor (dB)

Factor (dB) = Cable Loss (dB) + Antenna Factor (dB/m).

Site: AC1	Time: 2015/01/14 - 15:13
Limit: FCC_Part15.209_RE(3m)	Engineer: Roy Cheng
Probe: BBHA9120D_1-18GHz	Polarity: Vertical
EUT: WiFi Concurrent 4 Port GE LAN VoIP Ethernet Gateway with USB	Power: AC 120V/60Hz
Test Mode: Transmit at channel 5320MHz by 802.11n-HT20 Ant 0+1+2+3	

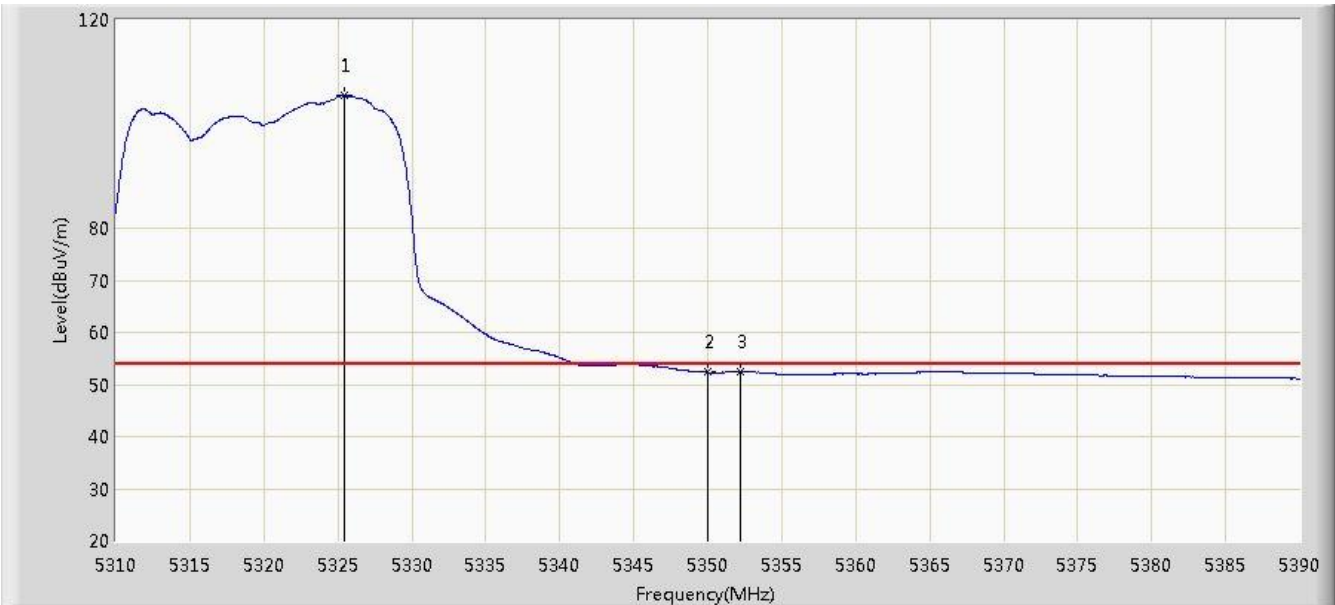

No	Flag	Mark	Frequency (MHz)	Measure Level (dBuV/m)	Reading Level (dBuV)	Over Limit (dB)	Limit (dBuV/m)	Factor (dB)	Type
1		*	5325.400	105.458	68.235	N/A	N/A	37.224	AV
2			5350.000	52.329	15.043	-1.671	54.000	37.286	AV
3			5352.240	52.463	15.170	-1.537	54.000	37.293	AV

Note: Measure Level (dBuV/m) = Reading Level (dBuV) + Factor (dB)

Factor (dB) = Cable Loss (dB) + Antenna Factor (dB/m).

Site: AC1	Time: 2015/01/14 - 15:14
Limit: FCC_Part15.209_RE(3m)	Engineer: Roy Cheng
Probe: BBHA9120D_1-18GHz	Polarity: Horizontal
EUT: WiFi Concurrent 4 Port GE LAN VoIP Ethernet Gateway with USB	Power: AC 120V/60Hz
Test Mode: Transmit at channel 5500MHz by 802.11n-HT20 Ant 0+1+2+3	

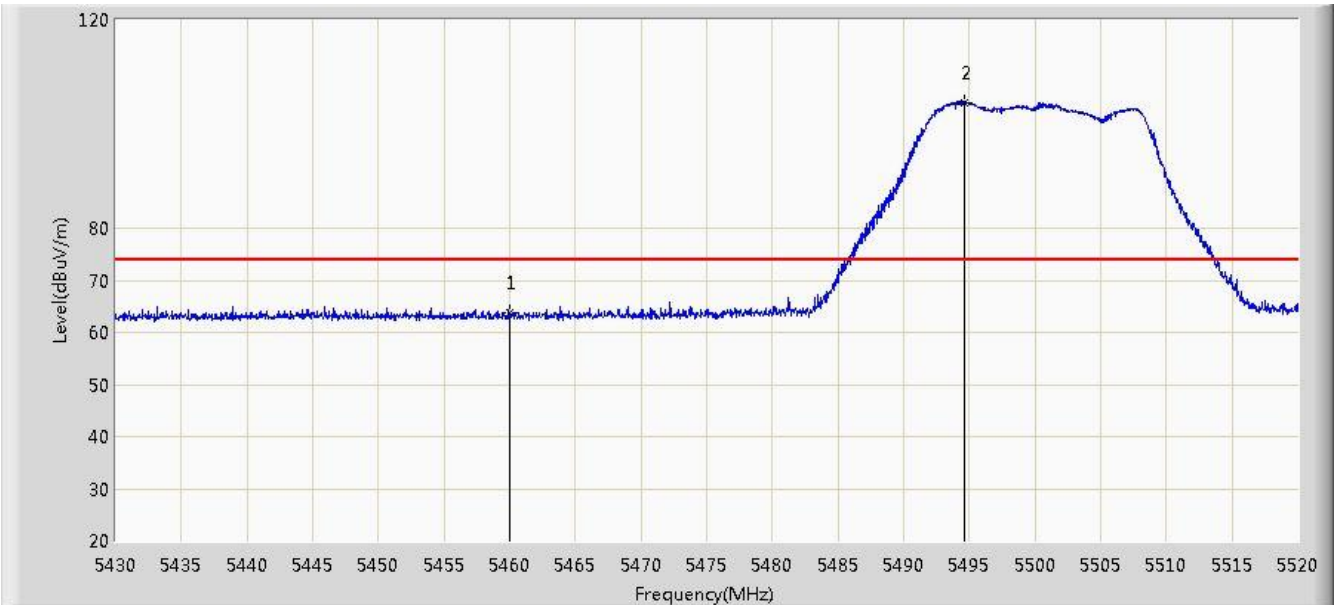

No	Flag	Mark	Frequency (MHz)	Measure Level (dBuV/m)	Reading Level (dBuV)	Over Limit (dB)	Limit (dBuV/m)	Factor (dB)	Type
1			5460.000	63.642	26.079	-10.358	74.000	37.563	PK
2		*	5494.620	104.142	66.523	N/A	N/A	37.618	PK

Note: Measure Level (dBμV/m) = Reading Level (dBμV) + Factor (dB)

Factor (dB) = Cable Loss (dB) + Antenna Factor (dB/m).

Site: AC1	Time: 2015/01/14 - 15:16
Limit: FCC_Part15.209_RE(3m)	Engineer: Roy Cheng
Probe: BBHA9120D_1-18GHz	Polarity: Horizontal
EUT: WiFi Concurrent 4 Port GE LAN VoIP Ethernet Gateway with USB	Power: AC 120V/60Hz
Test Mode: Transmit at channel 5500MHz by 802.11n-HT20 Ant 0+1+2+3	

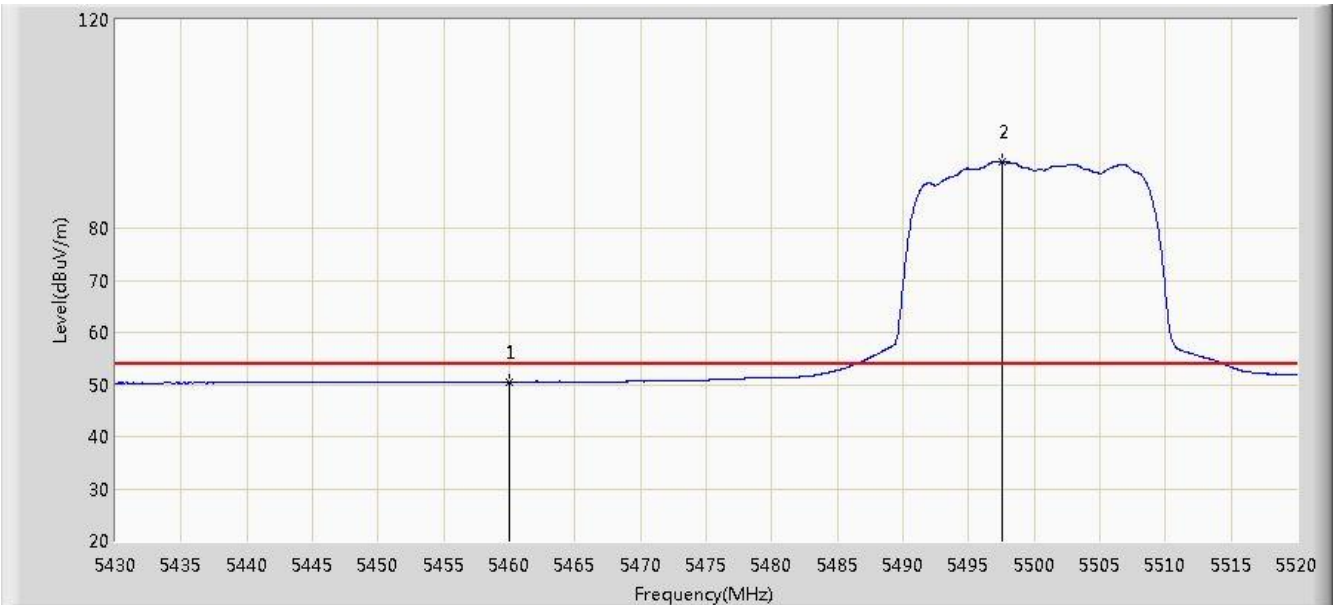

No	Flag	Mark	Frequency (MHz)	Measure Level (dBuV/m)	Reading Level (dBuV)	Over Limit (dB)	Limit (dBuV/m)	Factor (dB)	Type
1			5460.000	50.518	12.955	-3.482	54.000	37.563	AV
2		*	5497.545	92.706	55.084	N/A	N/A	37.622	AV

Note: Measure Level (dBμV/m) = Reading Level (dBμV) + Factor (dB)

Factor (dB) = Cable Loss (dB) + Antenna Factor (dB/m).

Site: AC1	Time: 2015/01/14 - 15:17
Limit: FCC_Part15.209_RE(3m)	Engineer: Roy Cheng
Probe: BBHA9120D_1-18GHz	Polarity: Vertical
EUT: WiFi Concurrent 4 Port GE LAN VoIP Ethernet Gateway with USB	Power: AC 120V/60Hz
Test Mode: Transmit at channel 5500MHz by 802.11n-HT20 Ant 0+1+2+3	

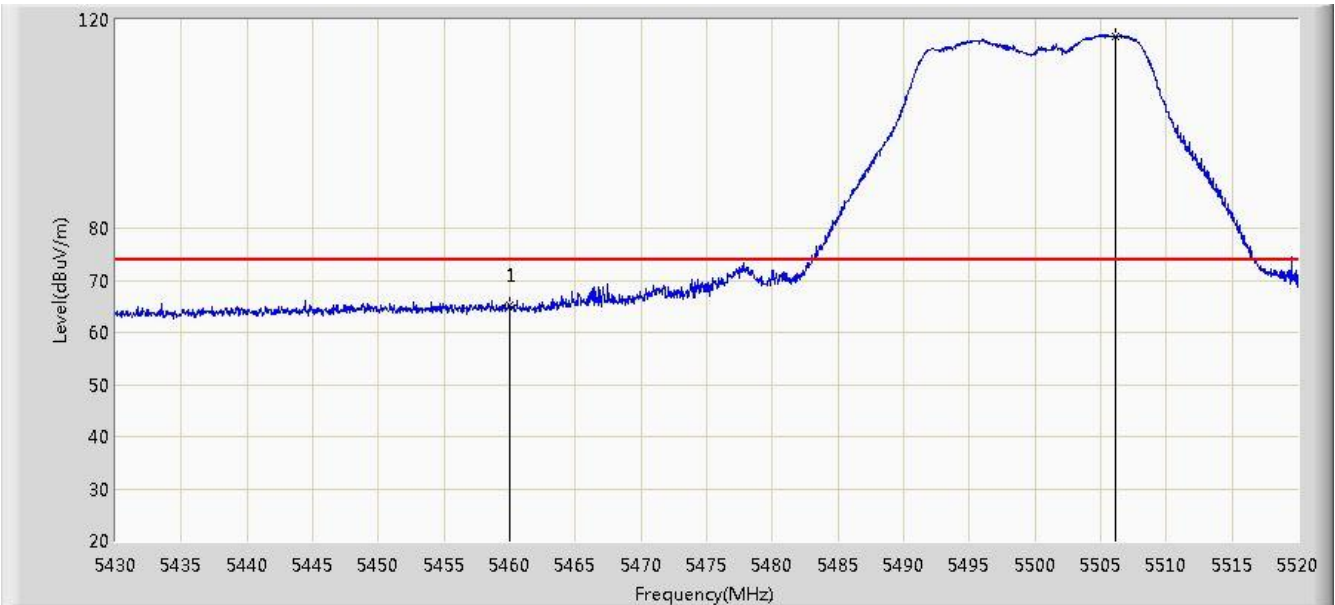

No	Flag	Mark	Frequency (MHz)	Measure Level (dBuV/m)	Reading Level (dBuV)	Over Limit (dB)	Limit (dBuV/m)	Factor (dB)	Type
1			5460.000	65.163	27.600	-8.837	74.000	37.563	PK
2		*	5506.095	116.842	79.211	N/A	N/A	37.631	PK

Note: Measure Level (dB μ V/m) = Reading Level (dB μ V) + Factor (dB)

Factor (dB) = Cable Loss (dB) + Antenna Factor (dB/m).

Site: AC1	Time: 2015/01/14 - 15:19
Limit: FCC_Part15.209_RE(3m)	Engineer: Roy Cheng
Probe: BBHA9120D_1-18GHz	Polarity: Vertical
EUT: WiFi Concurrent 4 Port GE LAN VoIP Ethernet Gateway with USB	Power: AC 120V/60Hz
Test Mode: Transmit at channel 5500MHz by 802.11n-HT20 Ant 0+1+2+3	

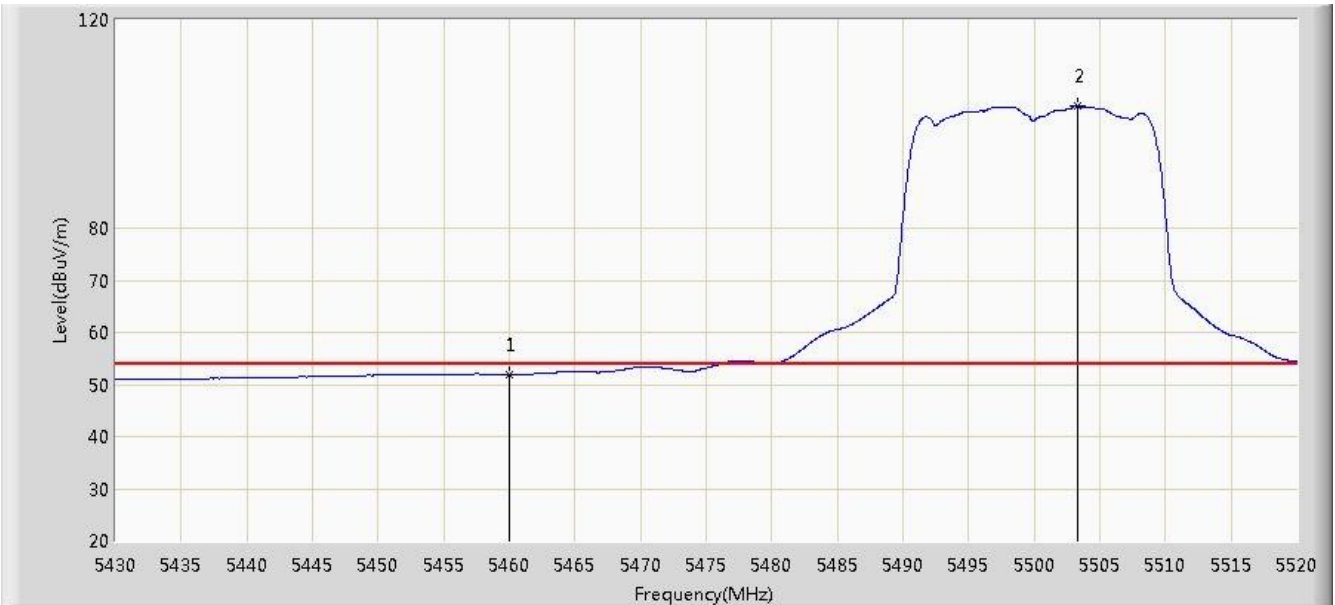

No	Flag	Mark	Frequency (MHz)	Measure Level (dBuV/m)	Reading Level (dBuV)	Over Limit (dB)	Limit (dBuV/m)	Factor (dB)	Type
1			5460.000	51.921	14.358	-2.079	54.000	37.563	AV
2		*	5503.305	103.461	65.833	N/A	N/A	37.628	AV

Note: Measure Level (dB μ V/m) = Reading Level (dB μ V) + Factor (dB)

Factor (dB) = Cable Loss (dB) + Antenna Factor (dB/m).

Site: AC1	Time: 2015/01/14 - 15:20
Limit: FCC_Part15.209_RE(3m)	Engineer: Roy Cheng
Probe: BBHA9120D_1-18GHz	Polarity: Horizontal
EUT: WiFi Concurrent 4 Port GE LAN VoIP Ethernet Gateway with USB	Power: AC 120V/60Hz
Test Mode: Transmit at channel 5700MHz by 802.11n-HT20 Ant 0+1+2+3	

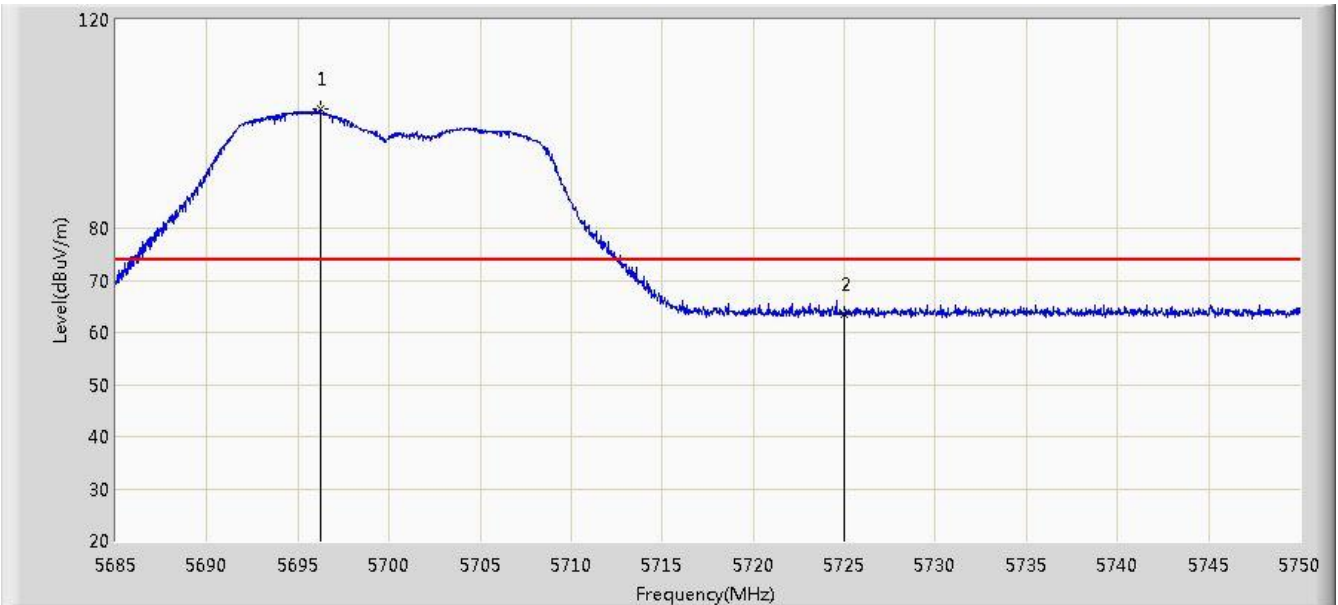

No	Flag	Mark	Frequency (MHz)	Measure Level (dBuV/m)	Reading Level (dBuV)	Over Limit (dB)	Limit (dBuV/m)	Factor (dB)	Type
1		*	5696.212	102.846	64.963	N/A	N/A	37.883	PK
2			5725.000	63.391	25.401	-10.609	74.000	37.990	PK

Note: Measure Level (dB μ V/m) = Reading Level (dB μ V) + Factor (dB)

Factor (dB) = Cable Loss (dB) + Antenna Factor (dB/m).

Site: AC1	Time: 2015/01/14 - 15:22
Limit: FCC_Part15.209_RE(3m)	Engineer: Roy Cheng
Probe: BBHA9120D_1-18GHz	Polarity: Horizontal
EUT: WiFi Concurrent 4 Port GE LAN VoIP Ethernet Gateway with USB	Power: AC 120V/60Hz
Test Mode: Transmit at channel 5700MHz by 802.11n-HT20 Ant 0+1+2+3	

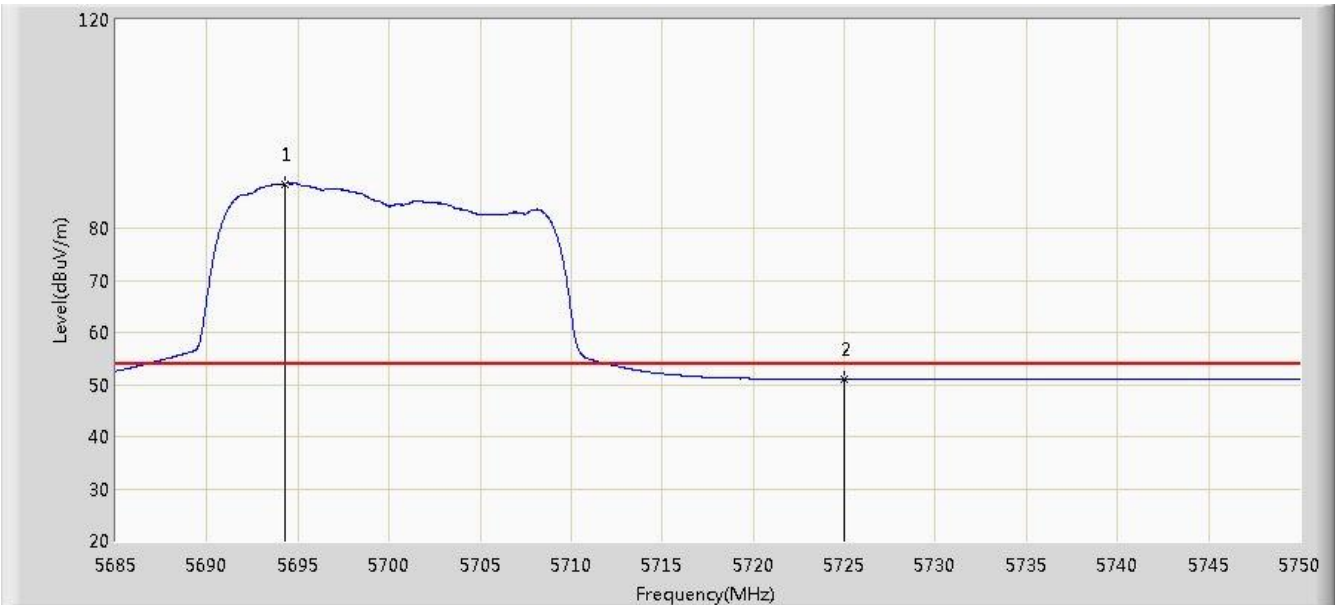

No	Flag	Mark	Frequency (MHz)	Measure Level (dBuV/m)	Reading Level (dBuV)	Over Limit (dB)	Limit (dBuV/m)	Factor (dB)	Type
1		*	5694.263	88.543	50.665	N/A	N/A	37.878	AV
2			5725.000	51.097	13.107	-2.903	54.000	37.990	AV

Note: Measure Level (dBμV/m) = Reading Level (dBμV) + Factor (dB)

Factor (dB) = Cable Loss (dB) + Antenna Factor (dB/m).

Site: AC1	Time: 2015/01/14 - 15:24
Limit: FCC_Part15.209_RE(3m)	Engineer: Roy Cheng
Probe: BBHA9120D_1-18GHz	Polarity: Vertical
EUT: WiFi Concurrent 4 Port GE LAN VoIP Ethernet Gateway with USB	Power: AC 120V/60Hz
Test Mode: Transmit at channel 5700MHz by 802.11n-HT20 Ant 0+1+2+3	

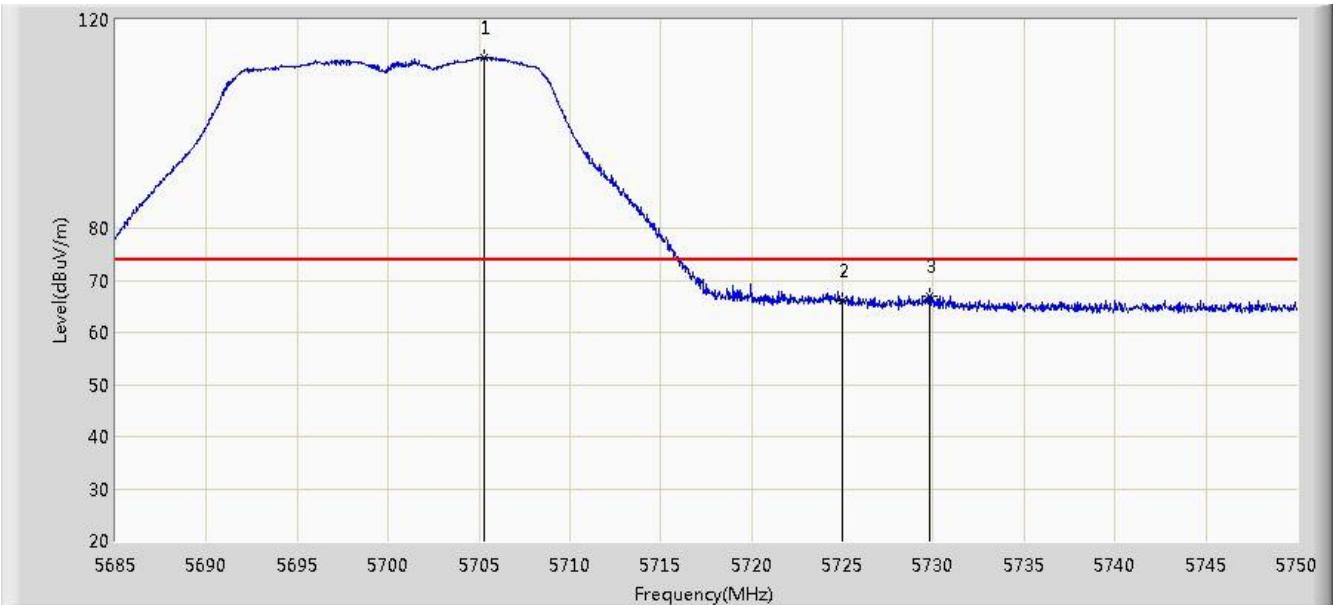

No	Flag	Mark	Frequency (MHz)	Measure Level (dBuV/m)	Reading Level (dBuV)	Over Limit (dB)	Limit (dBuV/m)	Factor (dB)	Type
1		*	5705.280	112.771	74.862	N/A	N/A	37.909	PK
2			5725.000	66.153	28.163	-7.847	74.000	37.990	PK
3			5729.785	67.054	29.045	-6.946	74.000	38.009	PK

Note: Measure Level (dBuV/m) = Reading Level (dBuV) + Factor (dB)

Factor (dB) = Cable Loss (dB) + Antenna Factor (dB/m).

Site: AC1	Time: 2015/01/14 - 15:27
Limit: FCC_Part15.209_RE(3m)	Engineer: Roy Cheng
Probe: BBHA9120D_1-18GHz	Polarity: Vertical
EUT: WiFi Concurrent 4 Port GE LAN VoIP Ethernet Gateway with USB	Power: AC 120V/60Hz
Test Mode: Transmit at channel 5700MHz by 802.11n-HT20 Ant 0+1+2+3	

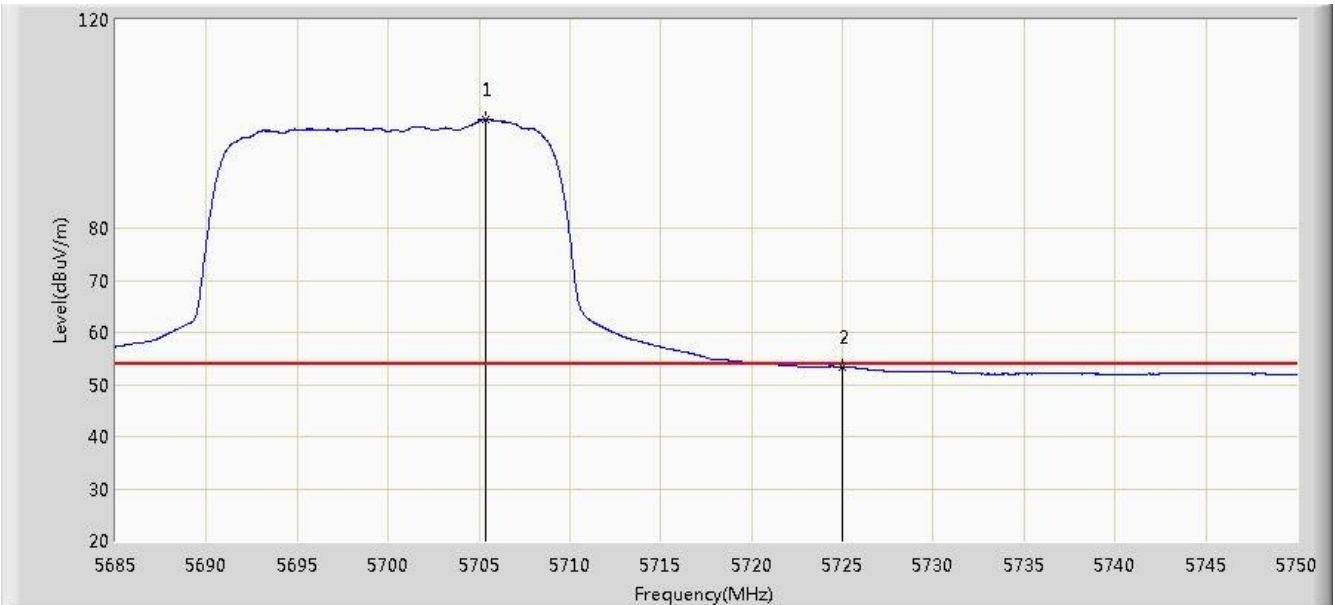

No	Flag	Mark	Frequency (MHz)	Measure Level (dBuV/m)	Reading Level (dBuV)	Over Limit (dB)	Limit (dBuV/m)	Factor (dB)	Type
1		*	5705.377	100.737	62.827	N/A	N/A	37.909	AV
2			5725.000	53.385	15.395	-0.615	54.000	37.990	AV

Note: Measure Level (dBμV/m) = Reading Level (dBμV) + Factor (dB)

Factor (dB) = Cable Loss (dB) + Antenna Factor (dB/m).

Site: AC1	Time: 2015/01/14 - 15:30
Limit: FCC 15.407	Engineer: Roy Cheng
Probe: BBHA9120D_1-18GHz	Polarity: Horizontal
EUT: WiFi Concurrent 4 Port GE LAN VoIP Ethernet Gateway with USB	Power: AC 120V/60Hz
Test Mode: Transmit at channel 5745MHz by 802.11n-HT20 Ant 0+1+2+3	

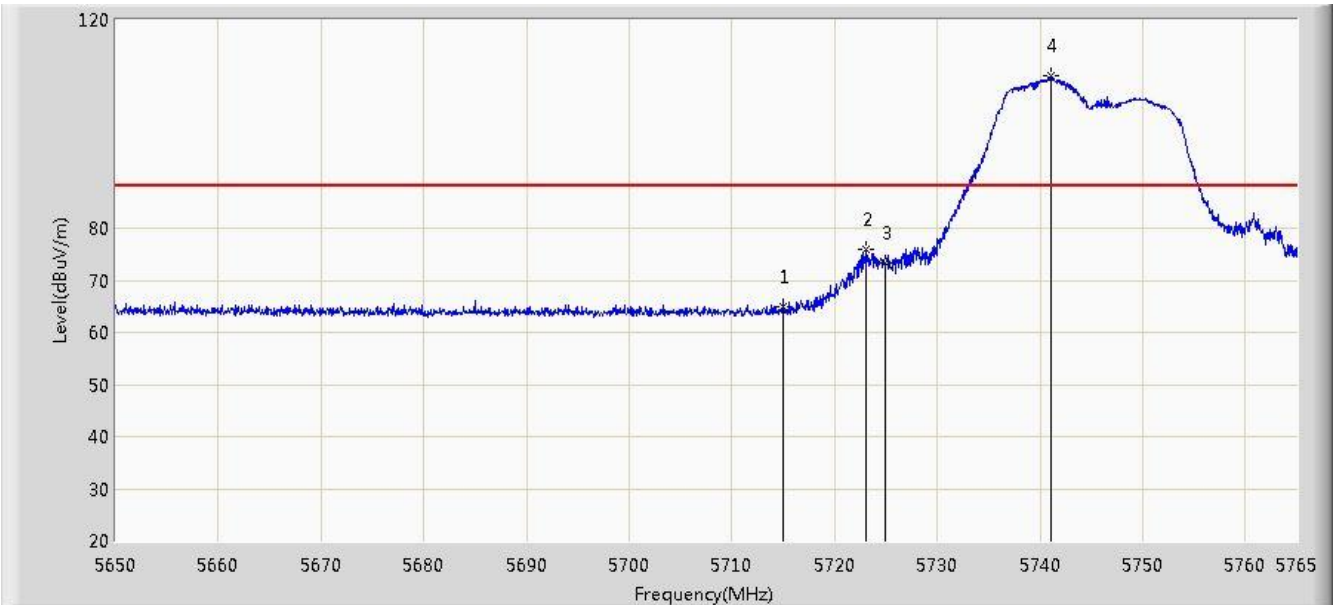

No	Flag	Mark	Frequency (MHz)	Measure Level (dBuV/m)	Reading Level (dBuV)	Over Limit (dB)	Limit (dBuV/m)	Factor (dB)	Type
1			5715.000	64.863	26.914	-23.337	88.200	37.949	PK
2			5723.083	76.012	38.030	-12.188	88.200	37.982	PK
3			5725.000	73.341	35.351	-24.859	98.200	37.990	PK
4		*	5741.080	109.149	71.094	N/A	N/A	38.055	PK

Note: Measure Level (dB μ V/m) = Reading Level (dB μ V) + Factor (dB)

Factor (dB) = Cable Loss (dB) + Antenna Factor (dB/m).

Site: AC1	Time: 2015/01/14 - 15:36
Limit: FCC 15.407	Engineer: Roy Cheng
Probe: BBHA9120D_1-18GHz	Polarity: Horizontal
EUT: WiFi Concurrent 4 Port GE LAN VoIP Ethernet Gateway with USB	Power: AC 120V/60Hz
Test Mode: Transmit at channel 5745MHz by 802.11n-HT20 Ant 0+1+2+3	

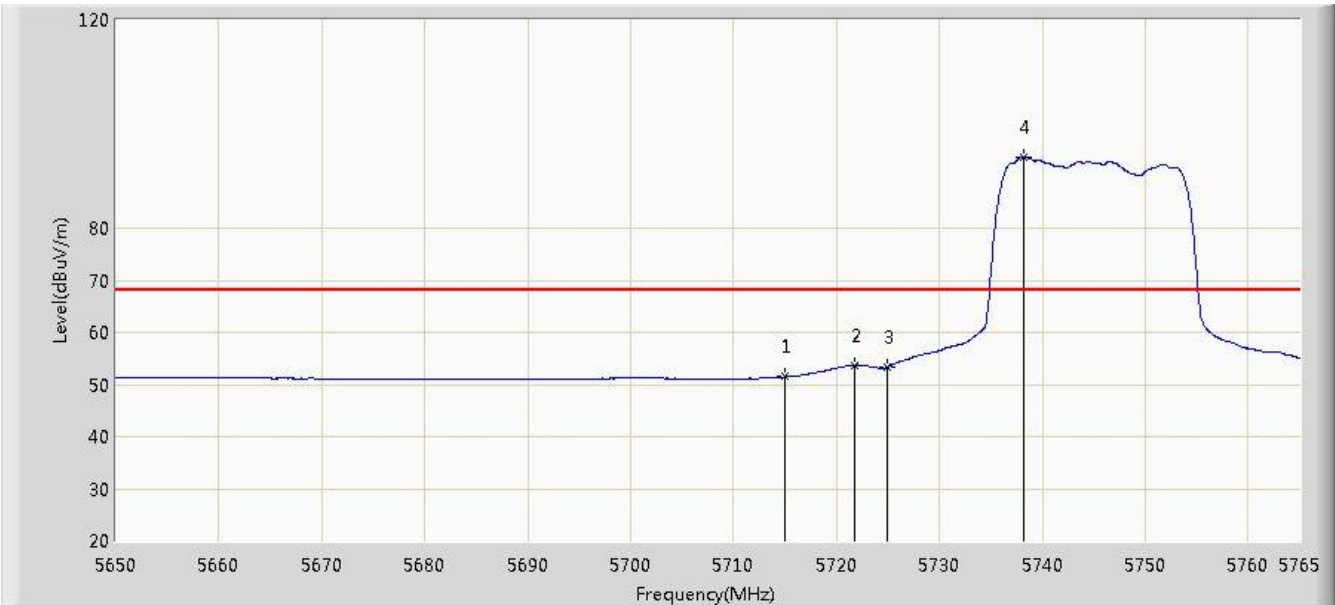

No	Flag	Mark	Frequency (MHz)	Measure Level (dBuV/m)	Reading Level (dBuV)	Over Limit (dB)	Limit (dBuV/m)	Factor (dB)	Type
1			5715.000	51.460	13.511	-16.740	68.200	37.949	AV
2			5721.817	53.739	15.762	-24.461	78.200	37.977	AV
3			5725.000	53.384	15.394	-24.816	78.200	37.990	AV
4		*	5738.263	93.669	55.625	N/A	N/A	38.045	AV

Note: Measure Level (dB μ V/m) = Reading Level (dB μ V) + Factor (dB)

Factor (dB) = Cable Loss (dB) + Antenna Factor (dB/m).

Site: AC1	Time: 2015/01/14 - 15:37
Limit: FCC 15.407	Engineer: Roy Cheng
Probe: BBHA9120D_1-18GHz	Polarity: Vertical
EUT: WiFi Concurrent 4 Port GE LAN VoIP Ethernet Gateway with USB	Power: AC 120V/60Hz
Test Mode: Transmit at channel 5745MHz by 802.11n-HT20 Ant 0+1+2+3	

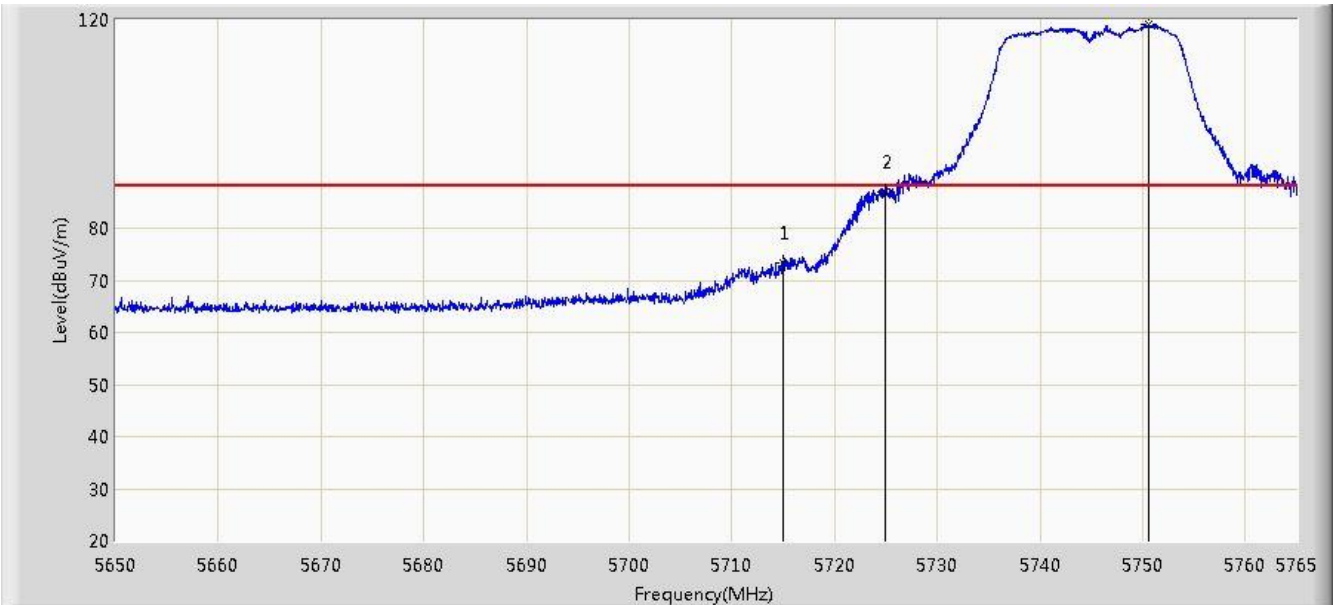

No	Flag	Mark	Frequency (MHz)	Measure Level (dBuV/m)	Reading Level (dBuV)	Over Limit (dB)	Limit (dBuV/m)	Factor (dB)	Type
1			5715.000	73.326	35.377	-14.874	88.200	37.949	PK
2			5725.000	86.982	48.992	-11.218	98.200	37.990	PK
3		*	5750.625	119.048	80.949	N/A	N/A	38.098	PK

Note: Measure Level (dBuV/m) = Reading Level (dBuV) + Factor (dB)

Factor (dB) = Cable Loss (dB) + Antenna Factor (dB/m).

Site: AC1	Time: 2015/01/14 - 15:38
Limit: FCC 15.407	Engineer: Roy Cheng
Probe: BBHA9120D_1-18GHz	Polarity: Vertical
EUT: WiFi Concurrent 4 Port GE LAN VoIP Ethernet Gateway with USB	Power: AC 120V/60Hz
Test Mode: Transmit at channel 5745MHz by 802.11n-HT20 Ant 0+1+2+3	

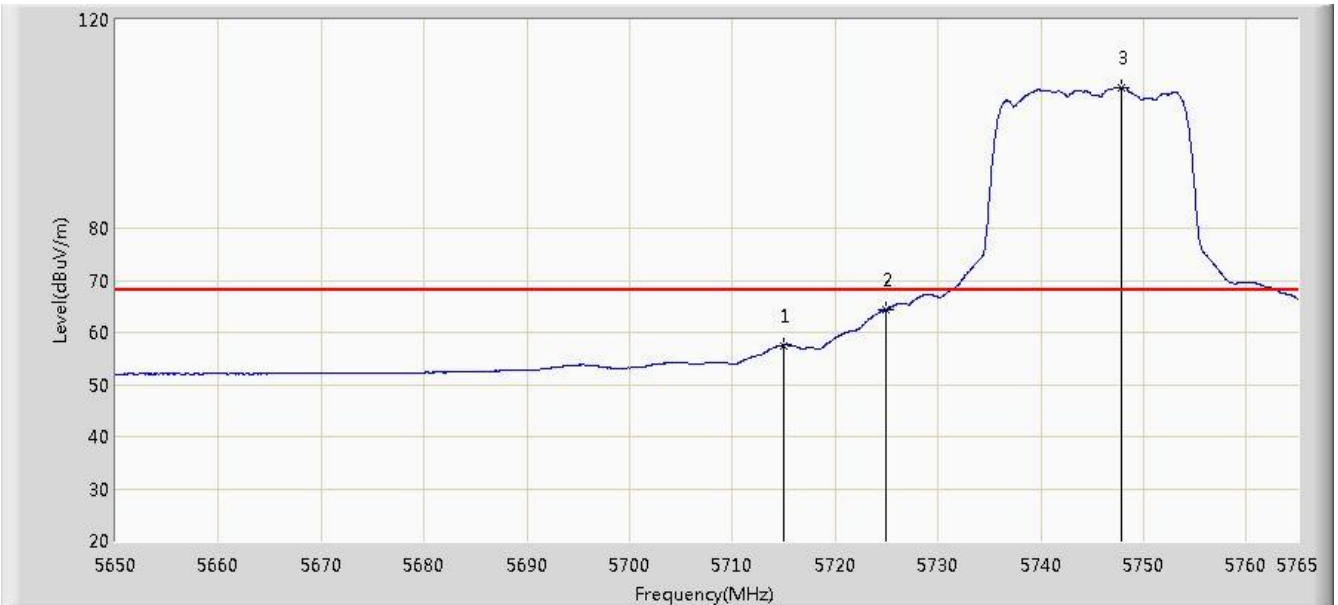

No	Flag	Mark	Frequency (MHz)	Measure Level (dBuV/m)	Reading Level (dBuV)	Over Limit (dB)	Limit (dBuV/m)	Factor (dB)	Type
1			5715.000	57.533	19.584	-10.667	68.200	37.949	AV
2			5725.000	64.387	26.397	-13.813	78.200	37.990	AV
3		*	5747.922	107.096	69.010	N/A	N/A	38.086	AV

Note: Measure Level (dBuV/m) = Reading Level (dBuV) + Factor (dB)

Factor (dB) = Cable Loss (dB) + Antenna Factor (dB/m).

Site: AC1	Time: 2015/01/14 - 15:41
Limit: FCC 15.407	Engineer: Roy Cheng
Probe: BBHA9120D_1-18GHz	Polarity: Horizontal
EUT: WiFi Concurrent 4 Port GE LAN VoIP Ethernet Gateway with USB	Power: AC 120V/60Hz
Test Mode: Transmit at channel 5825MHz by 802.11n-HT20 Ant 0+1+2+3	



No	Flag	Mark	Frequency (MHz)	Measure Level (dBuV/m)	Reading Level (dBuV)	Over Limit (dB)	Limit (dBuV/m)	Factor (dB)	Type
1		*	5821.007	108.978	70.639	N/A	N/A	38.339	PK
2			5850.000	66.059	27.606	-32.141	98.200	38.454	PK
3			5860.000	64.979	26.501	-23.221	88.200	38.478	PK

Note: Measure Level (dBμV/m) = Reading Level (dBμV) + Factor (dB)

Factor (dB) = Cable Loss (dB) + Antenna Factor (dB/m).

Site: AC1	Time: 2015/01/14 - 15:43
Limit: FCC 15.407	Engineer: Roy Cheng
Probe: BBHA9120D_1-18GHz	Polarity: Horizontal
EUT: WiFi Concurrent 4 Port GE LAN VoIP Ethernet Gateway with USB	Power: AC 120V/60Hz
Test Mode: Transmit at channel 5825MHz by 802.11n-HT20 Ant 0+1+2+3	

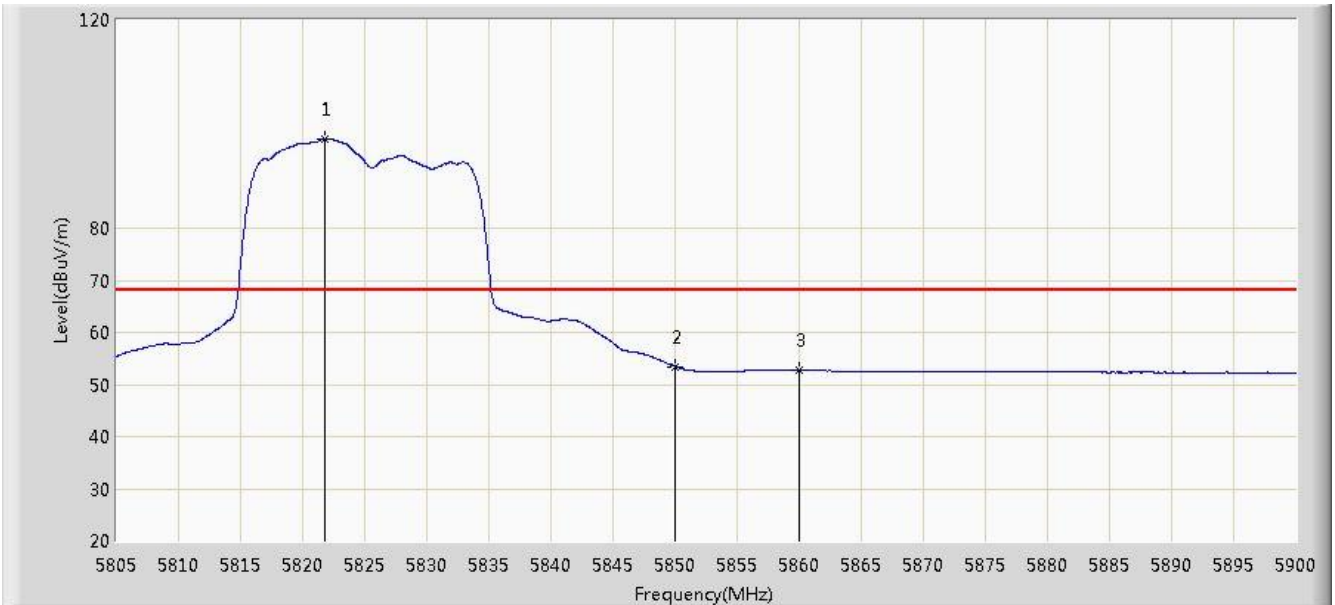

No	Flag	Mark	Frequency (MHz)	Measure Level (dBuV/m)	Reading Level (dBuV)	Over Limit (dB)	Limit (dBuV/m)	Factor (dB)	Type
1		*	5821.815	97.197	58.855	N/A	N/A	38.342	AV
2			5850.000	53.473	15.020	-24.727	78.200	38.454	AV
3			5860.000	52.725	14.247	-15.475	68.200	38.478	AV

Note: Measure Level (dBμV/m) = Reading Level (dBμV) + Factor (dB)

Factor (dB) = Cable Loss (dB) + Antenna Factor (dB/m).

Site: AC1	Time: 2015/01/14 - 15:45
Limit: FCC 15.407	Engineer: Roy Cheng
Probe: BBHA9120D_1-18GHz	Polarity: Vertical
EUT: WiFi Concurrent 4 Port GE LAN VoIP Ethernet Gateway with USB	Power: AC 120V/60Hz
Test Mode: Transmit at channel 5825MHz by 802.11n-HT20 Ant 0+1+2+3	

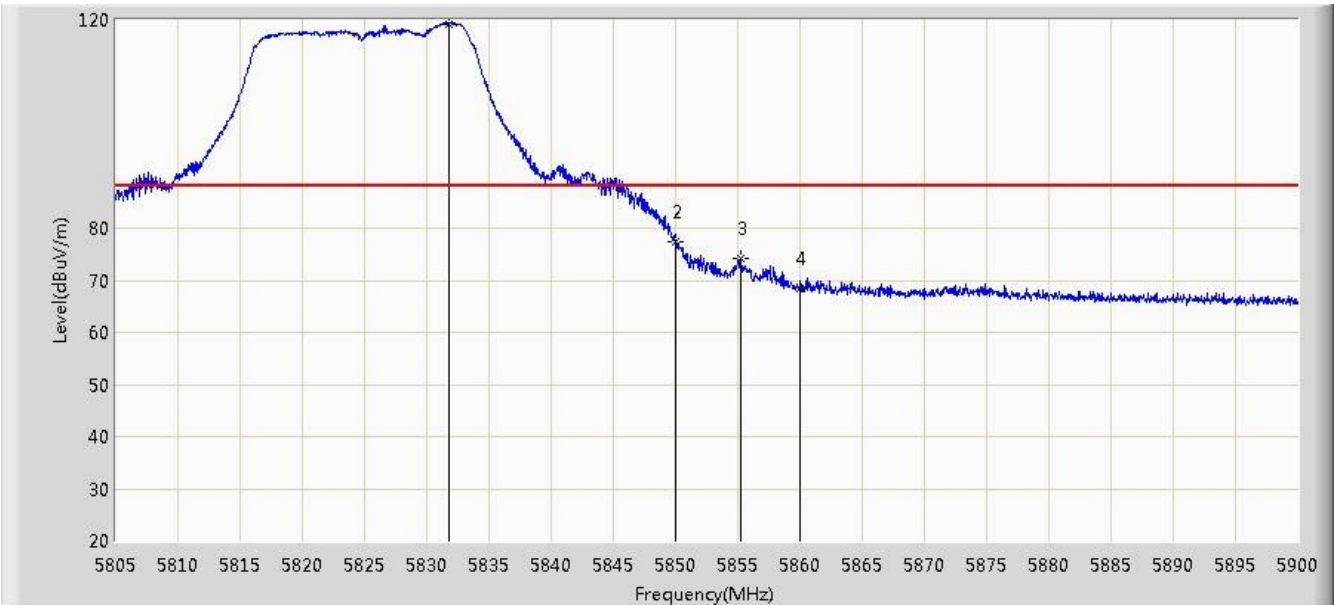

No	Flag	Mark	Frequency (MHz)	Measure Level (dBuV/m)	Reading Level (dBuV)	Over Limit (dB)	Limit (dBuV/m)	Factor (dB)	Type
1		*	5831.837	119.247	80.862	N/A	N/A	38.385	PK
2			5850.000	77.345	38.892	-20.855	98.200	38.454	PK
3			5855.208	74.126	35.660	-24.074	98.200	38.466	PK
4			5860.000	68.277	29.799	-19.923	88.200	38.478	PK

Note: Measure Level (dB μ V/m) = Reading Level (dB μ V) + Factor (dB)

Factor (dB) = Cable Loss (dB) + Antenna Factor (dB/m).

Site: AC1	Time: 2015/01/14 - 15:46
Limit: FCC 15.407	Engineer: Roy Cheng
Probe: BBHA9120D_1-18GHz	Polarity: Vertical
EUT: WiFi Concurrent 4 Port GE LAN VoIP Ethernet Gateway with USB	Power: AC 120V/60Hz
Test Mode: Transmit at channel 5825MHz by 802.11n-HT20 Ant 0+1+2+3	

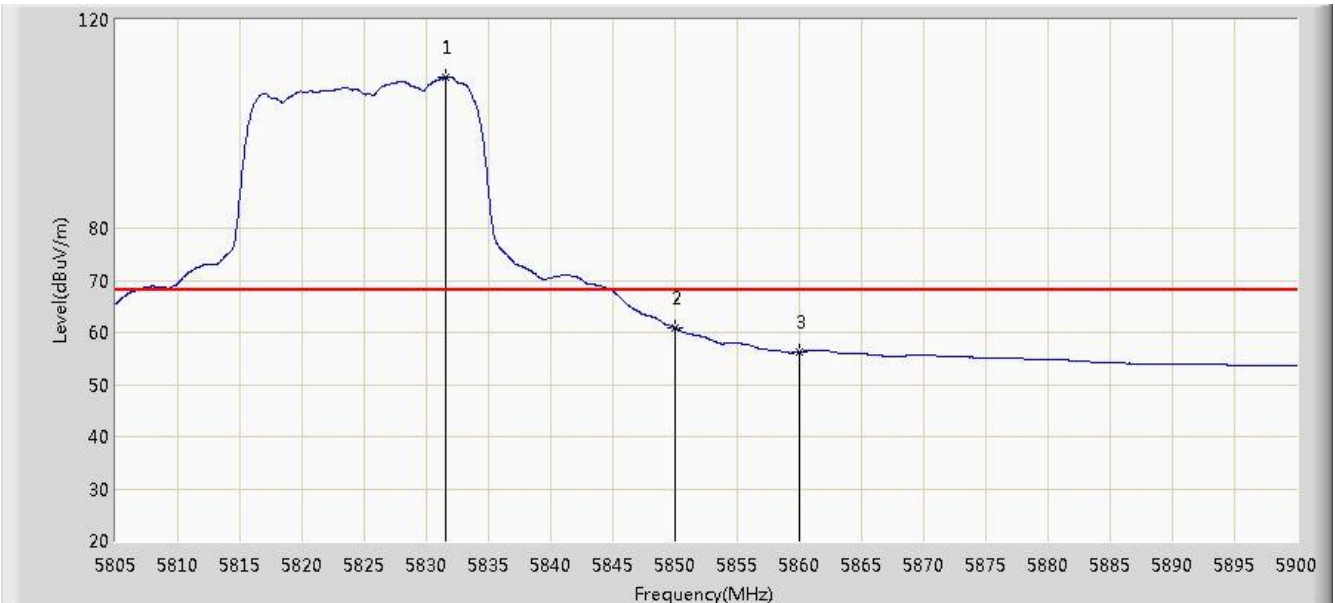

No	Flag	Mark	Frequency (MHz)	Measure Level (dBuV/m)	Reading Level (dBuV)	Over Limit (dB)	Limit (dBuV/m)	Factor (dB)	Type
1		*	5831.553	109.047	70.664	N/A	N/A	38.383	AV
2			5850.000	60.835	22.382	-17.365	78.200	38.454	AV
3			5860.000	56.247	17.769	-11.953	68.200	38.478	AV

Note: Measure Level (dBuV/m) = Reading Level (dBuV) + Factor (dB)

Factor (dB) = Cable Loss (dB) + Antenna Factor (dB/m).

Site: AC1	Time: 2015/01/14 - 15:49
Limit: FCC_Part15.209_RE(3m)	Engineer: Roy Cheng
Probe: BBHA9120D_1-18GHz	Polarity: Horizontal
EUT: WiFi Concurrent 4 Port GE LAN VoIP Ethernet Gateway with USB	Power: AC 120V/60Hz
Test Mode: Transmit at channel 5190MHz by 802.11n-HT40 Ant 0+1+2+3	

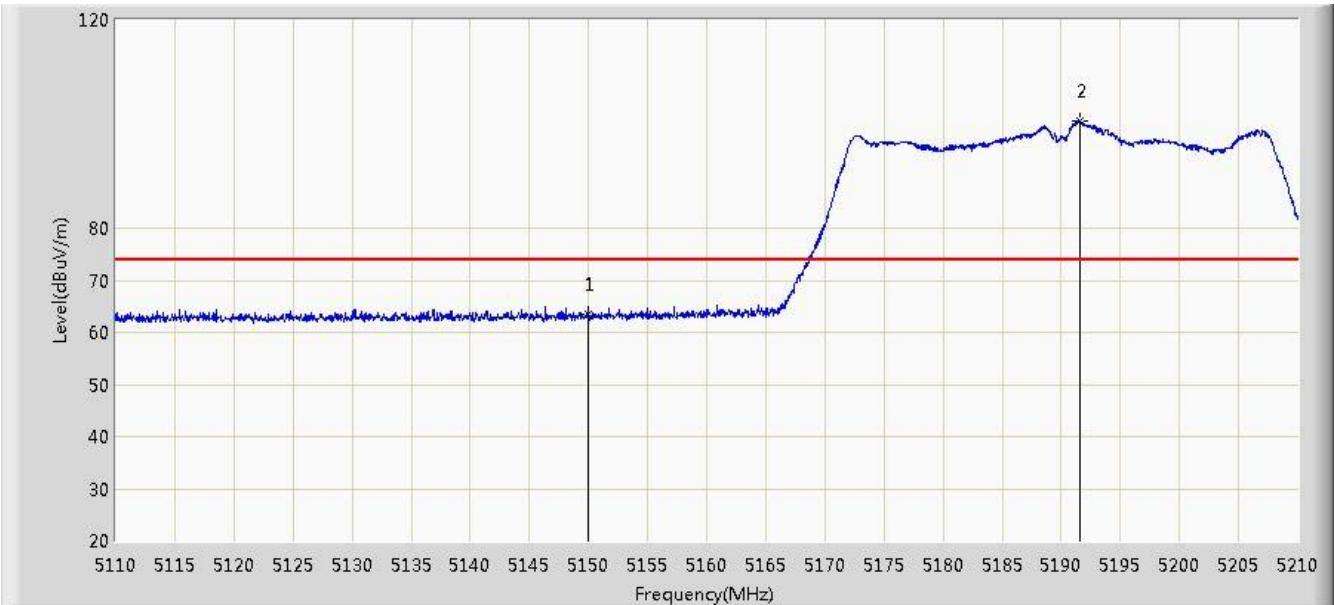

No	Flag	Mark	Frequency (MHz)	Measure Level (dBuV/m)	Reading Level (dBuV)	Over Limit (dB)	Limit (dBuV/m)	Factor (dB)	Type
1			5150.000	63.458	26.006	-10.542	74.000	37.452	PK
2		*	5191.600	100.446	63.101	N/A	N/A	37.345	PK

Note: Measure Level (dB μ V/m) = Reading Level (dB μ V) + Factor (dB)

Factor (dB) = Cable Loss (dB) + Antenna Factor (dB/m).

Site: AC1	Time: 2015/01/14 - 15:51
Limit: FCC_Part15.209_RE(3m)	Engineer: Roy Cheng
Probe: BBHA9120D_1-18GHz	Polarity: Horizontal
EUT: WiFi Concurrent 4 Port GE LAN VoIP Ethernet Gateway with USB	Power: AC 120V/60Hz
Test Mode: Transmit at channel 5190MHz by 802.11n-HT40 Ant 0+1+2+3	



No	Flag	Mark	Frequency (MHz)	Measure Level (dBuV/m)	Reading Level (dBuV)	Over Limit (dB)	Limit (dBuV/m)	Factor (dB)	Type
1			5150.000	50.505	13.053	-3.495	54.000	37.452	AV
2		*	5188.150	87.378	50.025	N/A	N/A	37.353	AV

Note: Measure Level (dB μ V/m) = Reading Level (dB μ V) + Factor (dB)

Factor (dB) = Cable Loss (dB) + Antenna Factor (dB/m).

Site: AC1	Time: 2015/01/14 - 16:03
Limit: FCC_Part15.209_RE(3m)	Engineer: Roy Cheng
Probe: BBHA9120D_1-18GHz	Polarity: Vertical
EUT: WiFi Concurrent 4 Port GE LAN VoIP Ethernet Gateway with USB	Power: AC 120V/60Hz
Test Mode: Transmit at channel 5190MHz by 802.11n-HT40 Ant 0+1+2+3	

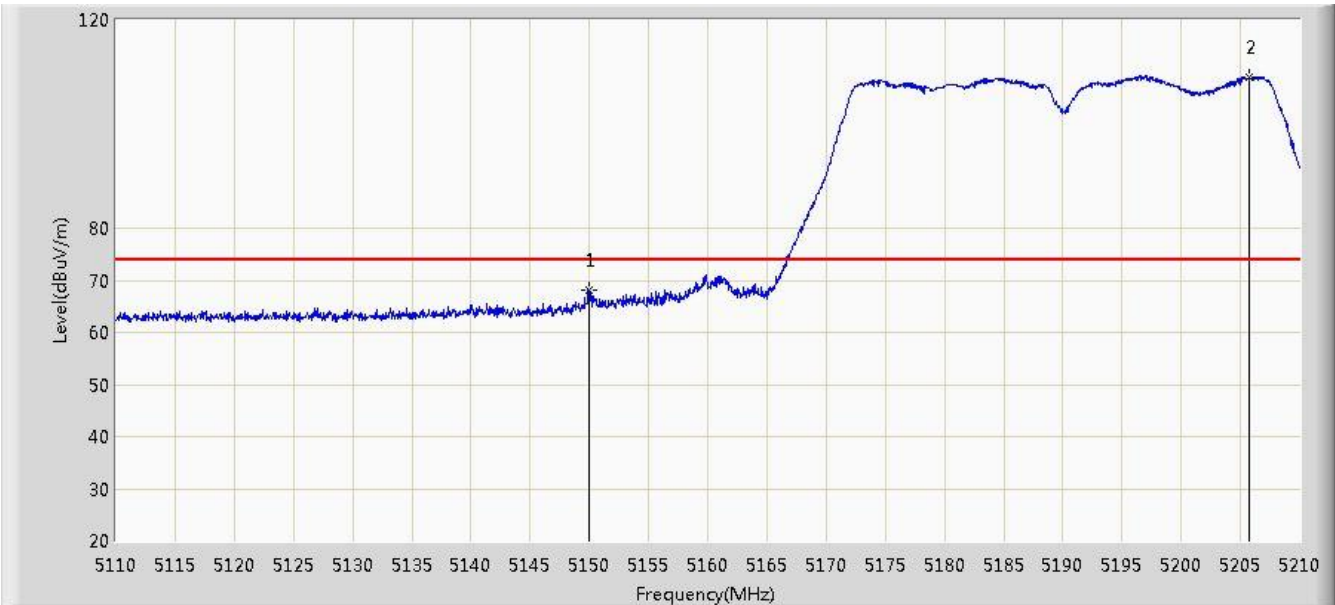

No	Flag	Mark	Frequency (MHz)	Measure Level (dBuV/m)	Reading Level (dBuV)	Over Limit (dB)	Limit (dBuV/m)	Factor (dB)	Type
1			5150.000	67.973	30.521	-6.027	74.000	37.452	PK
2		*	5205.700	108.983	71.678	N/A	N/A	37.304	PK

Note: Measure Level (dB μ V/m) = Reading Level (dB μ V) + Factor (dB)

Factor (dB) = Cable Loss (dB) + Antenna Factor (dB/m).

Site: AC1	Time: 2015/01/14 - 16:00
Limit: FCC_Part15.209_RE(3m)	Engineer: Roy Cheng
Probe: BBHA9120D_1-18GHz	Polarity: Vertical
EUT: WiFi Concurrent 4 Port GE LAN VoIP Ethernet Gateway with USB	Power: AC 120V/60Hz
Test Mode: Transmit at channel 5190MHz by 802.11n-HT40 Ant 0+1+2+3	

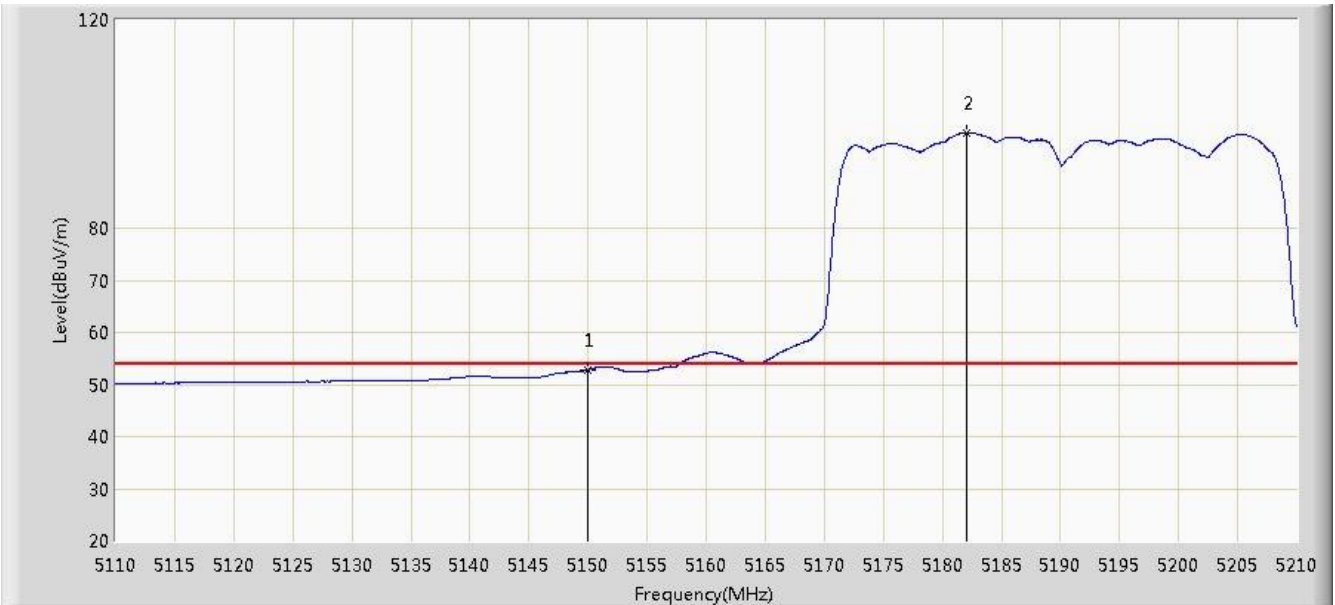

No	Flag	Mark	Frequency (MHz)	Measure Level (dBuV/m)	Reading Level (dBuV)	Over Limit (dB)	Limit (dBuV/m)	Factor (dB)	Type
1			5150.000	52.847	15.395	-1.153	54.000	37.452	AV
2		*	5182.100	98.380	61.011	N/A	N/A	37.369	AV

Note: Measure Level (dB μ V/m) = Reading Level (dB μ V) + Factor (dB)

Factor (dB) = Cable Loss (dB) + Antenna Factor (dB/m).

Site: AC1	Time: 2015/01/14 - 16:04
Limit: FCC_Part15.209_RE(3m)	Engineer: Roy Cheng
Probe: BBHA9120D_1-18GHz	Polarity: Horizontal
EUT: WiFi Concurrent 4 Port GE LAN VoIP Ethernet Gateway with USB	Power: AC 120V/60Hz
Test Mode: Transmit at channel 5190MHz by 802.11n-HT40 Ant 0+1+2+3	

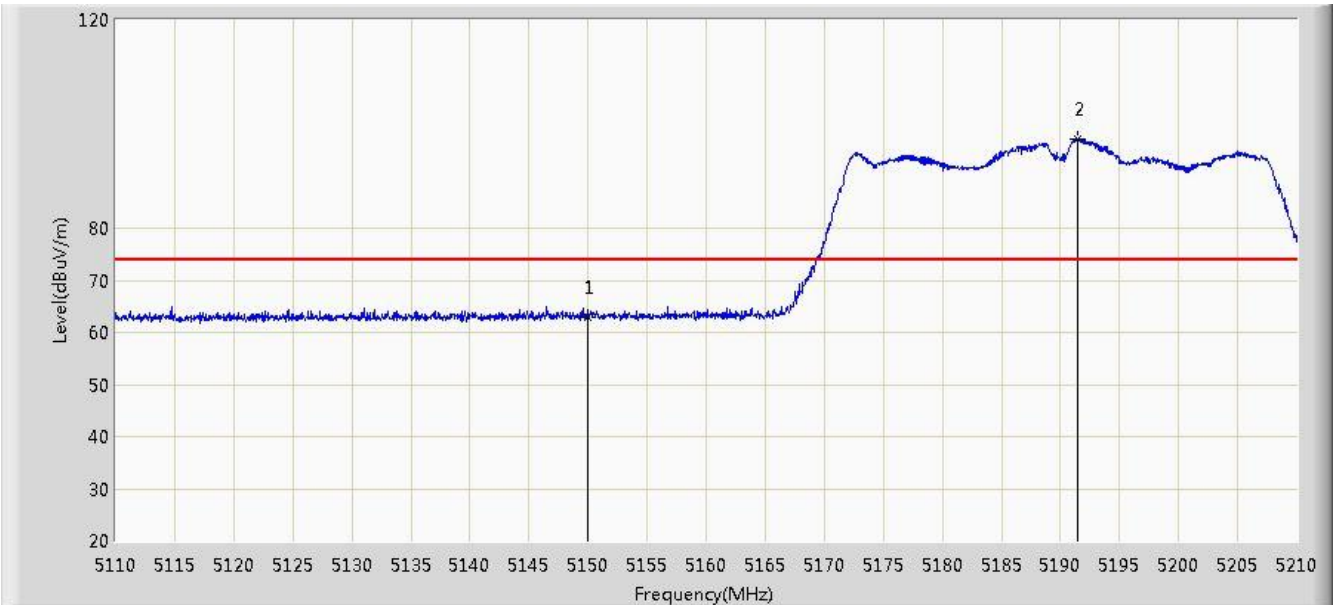

No	Flag	Mark	Frequency (MHz)	Measure Level (dBuV/m)	Reading Level (dBuV)	Over Limit (dB)	Limit (dBuV/m)	Factor (dB)	Type
1			5150.000	62.922	25.470	-11.078	74.000	37.452	PK
2		*	5191.400	97.194	59.849	N/A	N/A	37.345	PK

Note: Measure Level (dB μ V/m) = Reading Level (dB μ V) + Factor (dB)

Factor (dB) = Cable Loss (dB) + Antenna Factor (dB/m).

Site: AC1	Time: 2015/01/14 - 16:06
Limit: FCC_Part15.209_RE(3m)	Engineer: Roy Cheng
Probe: BBHA9120D_1-18GHz	Polarity: Horizontal
EUT: WiFi Concurrent 4 Port GE LAN VoIP Ethernet Gateway with USB	Power: AC 120V/60Hz
Test Mode: Transmit at channel 5190MHz by 802.11n-HT40 Ant 0+1+2+3	

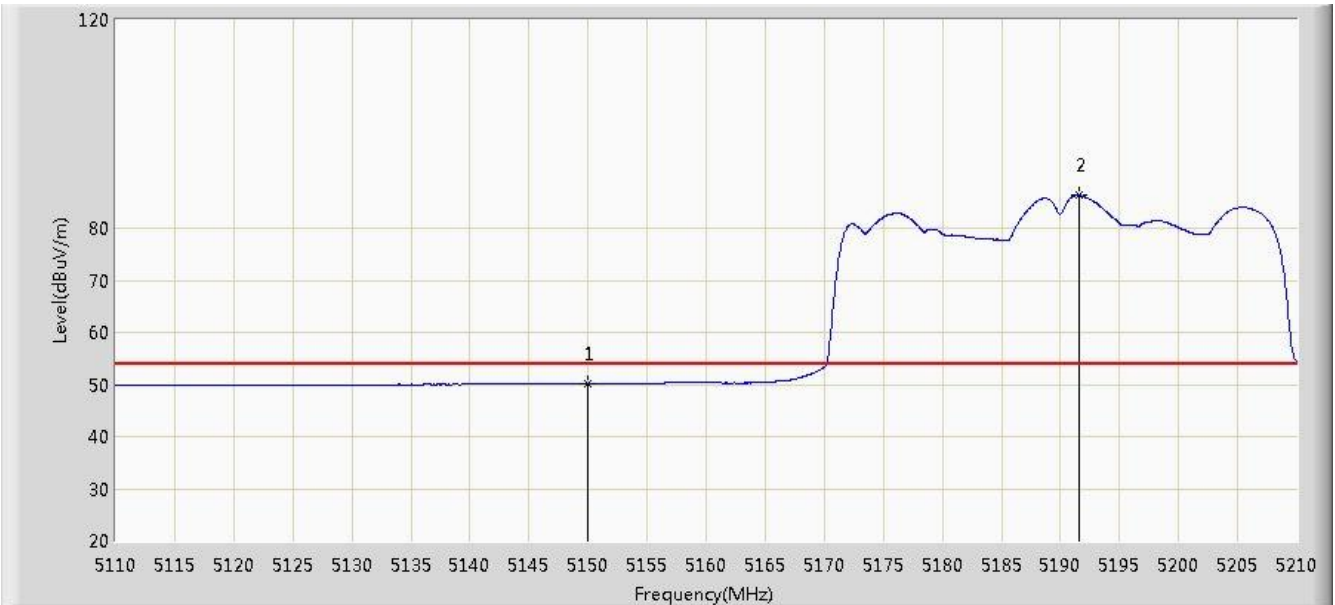

No	Flag	Mark	Frequency (MHz)	Measure Level (dBuV/m)	Reading Level (dBuV)	Over Limit (dB)	Limit (dBuV/m)	Factor (dB)	Type
1			5150.000	50.143	12.691	-3.857	54.000	37.452	AV
2		*	5191.600	86.268	48.923	N/A	N/A	37.345	AV

Note: Measure Level (dB μ V/m) = Reading Level (dB μ V) + Factor (dB)

Factor (dB) = Cable Loss (dB) + Antenna Factor (dB/m).

Site: AC1	Time: 2015/01/14 - 16:26
Limit: FCC_Part15.209_RE(3m)	Engineer: Roy Cheng
Probe: BBHA9120D_1-18GHz	Polarity: Horizontal
EUT: WiFi Concurrent 4 Port GE LAN VoIP Ethernet Gateway with USB	Power: AC 120V/60Hz
Test Mode: Transmit at channel 5310MHz by 802.11n-HT40 Ant 0+1+2+3	

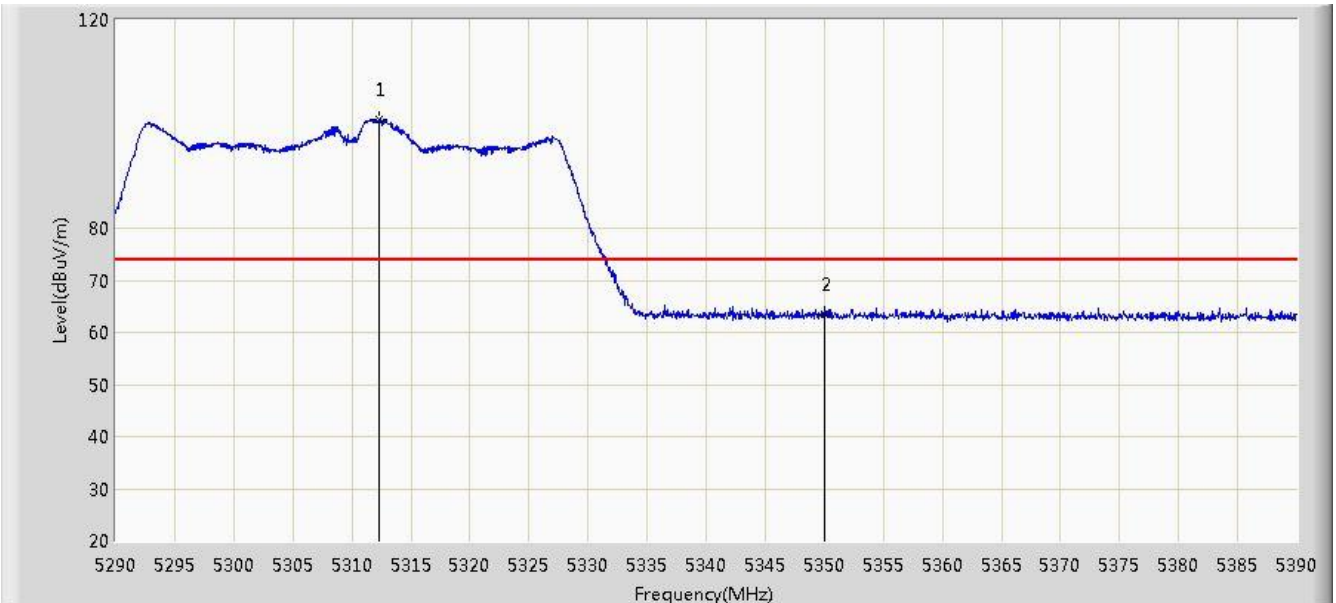

No	Flag	Mark	Frequency (MHz)	Measure Level (dBuV/m)	Reading Level (dBuV)	Over Limit (dB)	Limit (dBuV/m)	Factor (dB)	Type
1		*	5312.250	100.749	63.549	N/A	N/A	37.201	PK
2			5350.000	63.339	26.053	-10.661	74.000	37.286	PK

Note: Measure Level (dB μ V/m) = Reading Level (dB μ V) + Factor (dB)

Factor (dB) = Cable Loss (dB) + Antenna Factor (dB/m).

Site: AC1	Time: 2015/01/14 - 16:28
Limit: FCC_Part15.209_RE(3m)	Engineer: Roy Cheng
Probe: BBHA9120D_1-18GHz	Polarity: Horizontal
EUT: WiFi Concurrent 4 Port GE LAN VoIP Ethernet Gateway with USB	Power: AC 120V/60Hz
Test Mode: Transmit at channel 5310MHz by 802.11n-HT40 Ant 0+1+2+3	

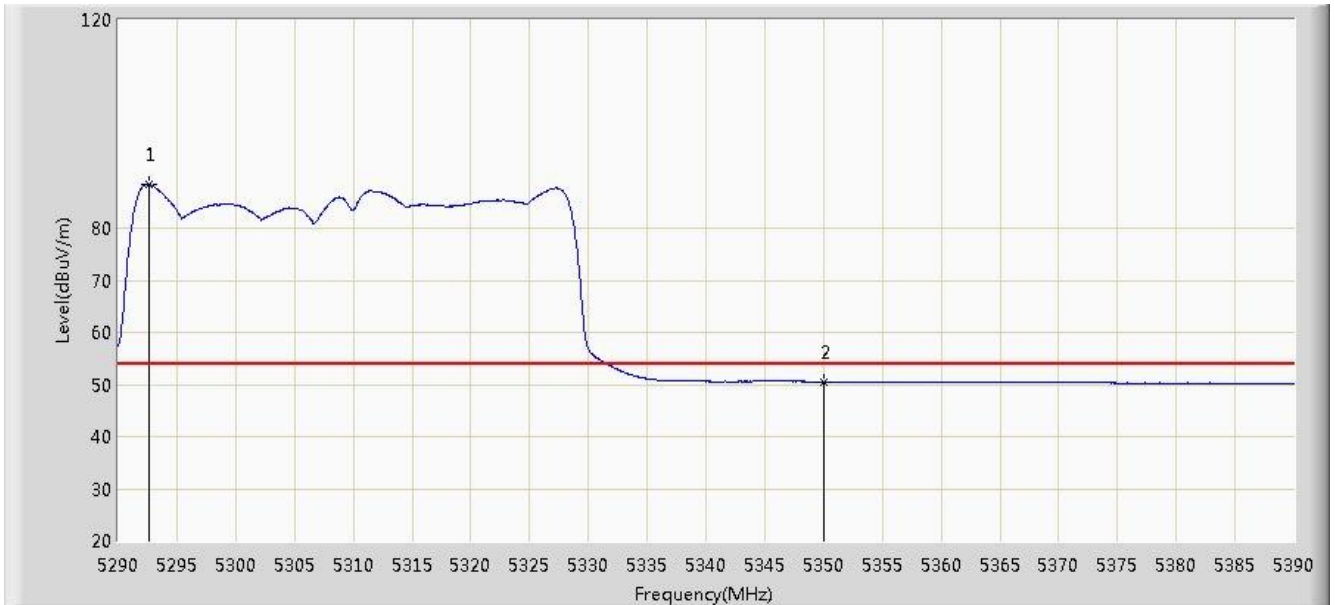

No	Flag	Mark	Frequency (MHz)	Measure Level (dBuV/m)	Reading Level (dBuV)	Over Limit (dB)	Limit (dBuV/m)	Factor (dB)	Type
1		*	5292.600	88.403	51.224	N/A	N/A	37.180	AV
2			5350.000	50.492	13.206	-3.508	54.000	37.286	AV

Note: Measure Level (dB μ V/m) = Reading Level (dB μ V) + Factor (dB)

Factor (dB) = Cable Loss (dB) + Antenna Factor (dB/m).

Site: AC1	Time: 2015/01/14 - 16:25
Limit: FCC_Part15.209_RE(3m)	Engineer: Roy Cheng
Probe: BBHA9120D_1-18GHz	Polarity: Vertical
EUT: WiFi Concurrent 4 Port GE LAN VoIP Ethernet Gateway with USB	Power: AC 120V/60Hz
Test Mode: Transmit at channel 5310MHz by 802.11n-HT40 Ant 0+1+2+3	

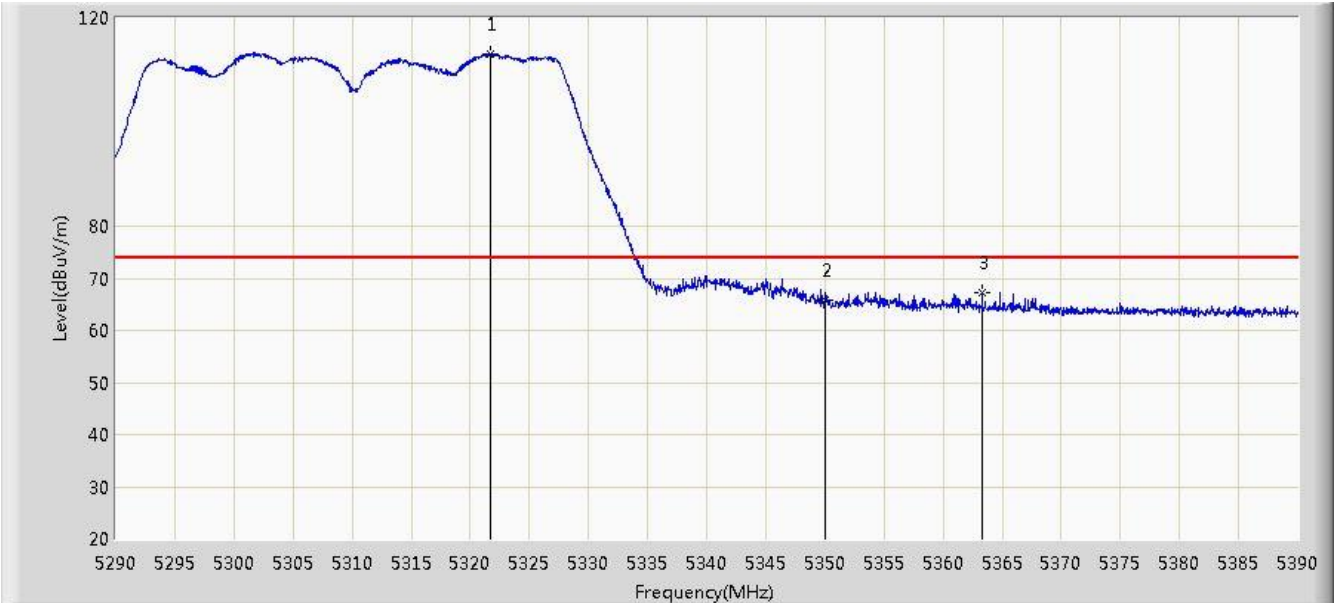

No	Flag	Mark	Frequency (MHz)	Measure Level (dBuV/m)	Reading Level (dBuV)	Over Limit (dB)	Limit (dBuV/m)	Factor (dB)	Type
1		*	5321.650	113.086	75.869	N/A	N/A	37.217	PK
2			5350.000	65.794	28.508	-8.206	74.000	37.286	PK
3			5363.300	67.127	29.804	-6.873	74.000	37.323	PK

Note: Measure Level (dBuV/m) = Reading Level (dBuV) + Factor (dB)

Factor (dB) = Cable Loss (dB) + Antenna Factor (dB/m).

Site: AC1	Time: 2015/01/14 - 16:16
Limit: FCC_Part15.209_RE(3m)	Engineer: Roy Cheng
Probe: BBHA9120D_1-18GHz	Polarity: Vertical
EUT: WiFi Concurrent 4 Port GE LAN VoIP Ethernet Gateway with USB	Power: AC 120V/60Hz
Test Mode: Transmit at channel 5310MHz by 802.11n-HT40 Ant 0+1+2+3	

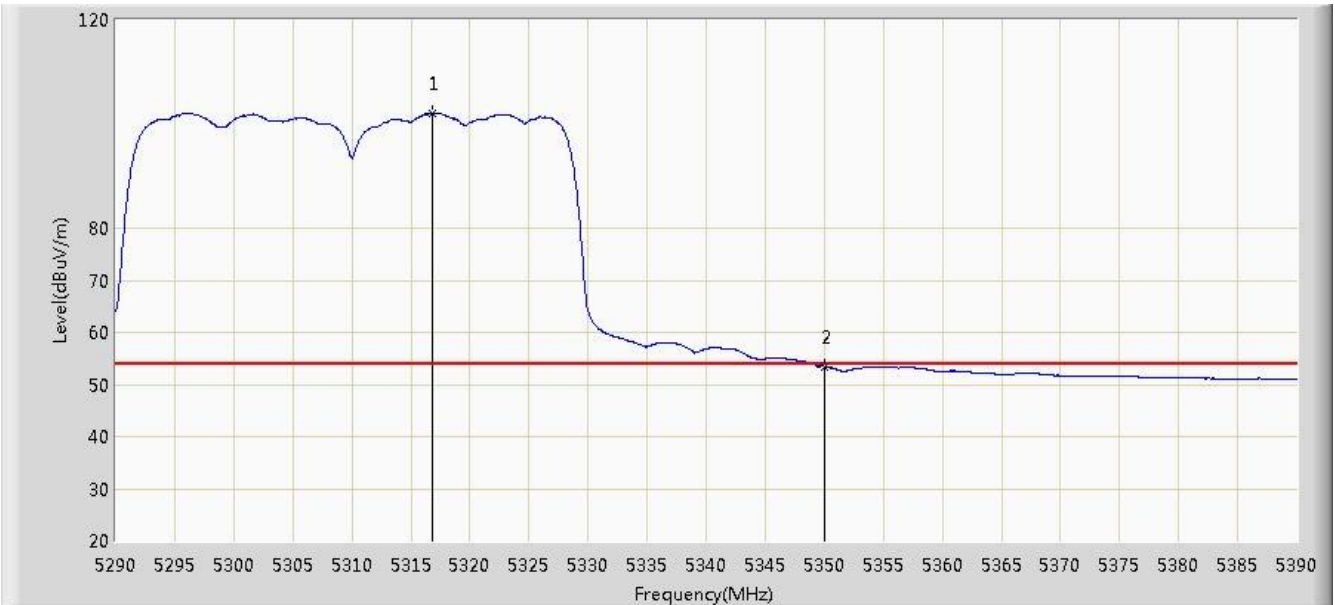

No	Flag	Mark	Frequency (MHz)	Measure Level (dBuV/m)	Reading Level (dBuV)	Over Limit (dB)	Limit (dBuV/m)	Factor (dB)	Type
1		*	5316.850	102.022	64.814	N/A	N/A	37.208	AV
2			5350.000	53.441	16.155	-0.559	54.000	37.286	AV

Note: Measure Level (dB μ V/m) = Reading Level (dB μ V) + Factor (dB)

Factor (dB) = Cable Loss (dB) + Antenna Factor (dB/m).

Site: AC1	Time: 2015/01/14 - 16:30
Limit: FCC_Part15.209_RE(3m)	Engineer: Roy Cheng
Probe: BBHA9120D_1-18GHz	Polarity: Horizontal
EUT: WiFi Concurrent 4 Port GE LAN VoIP Ethernet Gateway with USB	Power: AC 120V/60Hz
Test Mode: Transmit at channel 5510MHz by 802.11n-HT40 Ant 0+1+2+3	

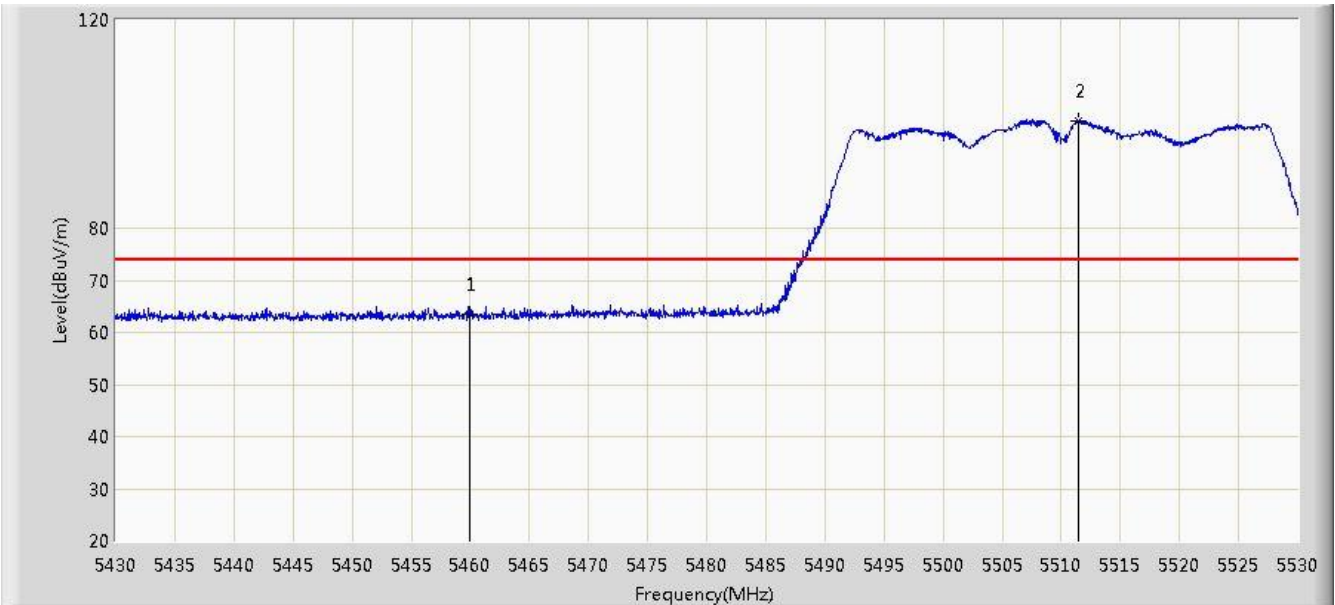

No	Flag	Mark	Frequency (MHz)	Measure Level (dBuV/m)	Reading Level (dBuV)	Over Limit (dB)	Limit (dBuV/m)	Factor (dB)	Type
1			5460.000	63.441	25.878	-10.559	74.000	37.563	PK
2		*	5511.450	100.689	63.052	N/A	N/A	37.637	PK

Note: Measure Level (dB μ V/m) = Reading Level (dB μ V) + Factor (dB)

Factor (dB) = Cable Loss (dB) + Antenna Factor (dB/m).

Site: AC1	Time: 2015/01/14 - 16:32
Limit: FCC_Part15.209_RE(3m)	Engineer: Roy Cheng
Probe: BBHA9120D_1-18GHz	Polarity: Horizontal
EUT: WiFi Concurrent 4 Port GE LAN VoIP Ethernet Gateway with USB	Power: AC 120V/60Hz
Test Mode: Transmit at channel 5510MHz by 802.11n-HT40 Ant 0+1+2+3	

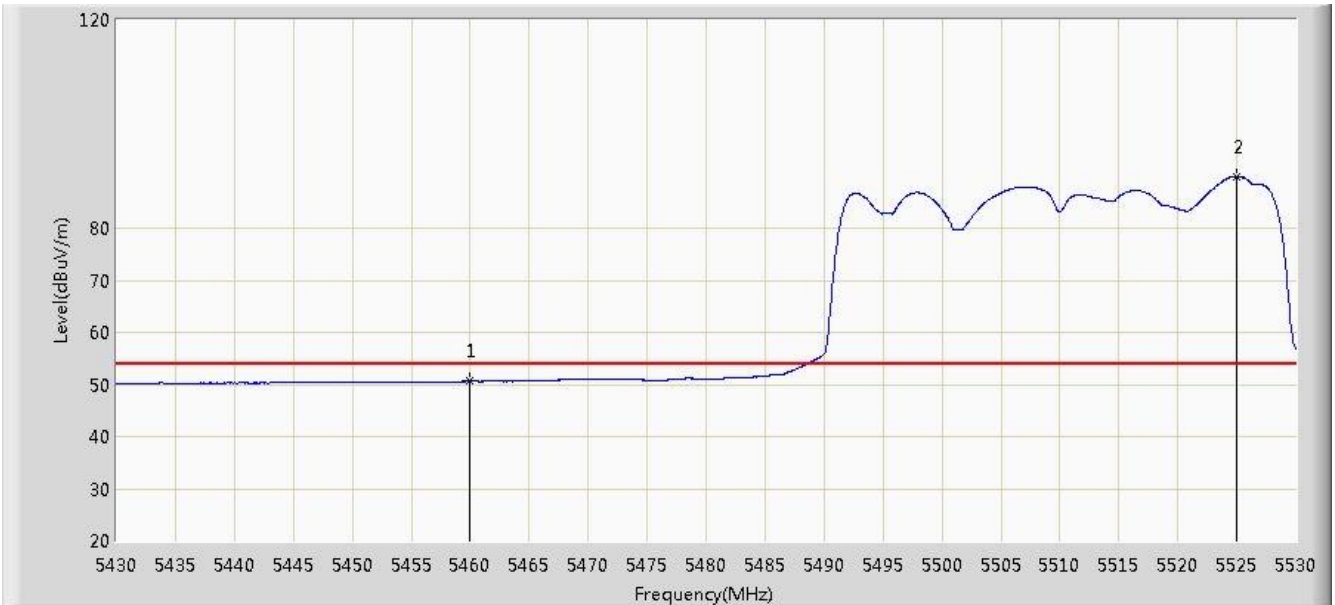

No	Flag	Mark	Frequency (MHz)	Measure Level (dBuV/m)	Reading Level (dBuV)	Over Limit (dB)	Limit (dBuV/m)	Factor (dB)	Type
1			5460.000	50.582	13.019	-3.418	54.000	37.563	AV
2		*	5524.950	89.802	52.147	N/A	N/A	37.655	AV

Note: Measure Level (dB μ V/m) = Reading Level (dB μ V) + Factor (dB)

Factor (dB) = Cable Loss (dB) + Antenna Factor (dB/m).

Site: AC1	Time: 2015/01/14 - 16:33
Limit: FCC_Part15.209_RE(3m)	Engineer: Roy Cheng
Probe: BBHA9120D_1-18GHz	Polarity: Vertical
EUT: WiFi Concurrent 4 Port GE LAN VoIP Ethernet Gateway with USB	Power: AC 120V/60Hz
Test Mode: Transmit at channel 5510MHz by 802.11n-HT40 Ant 0+1+2+3	

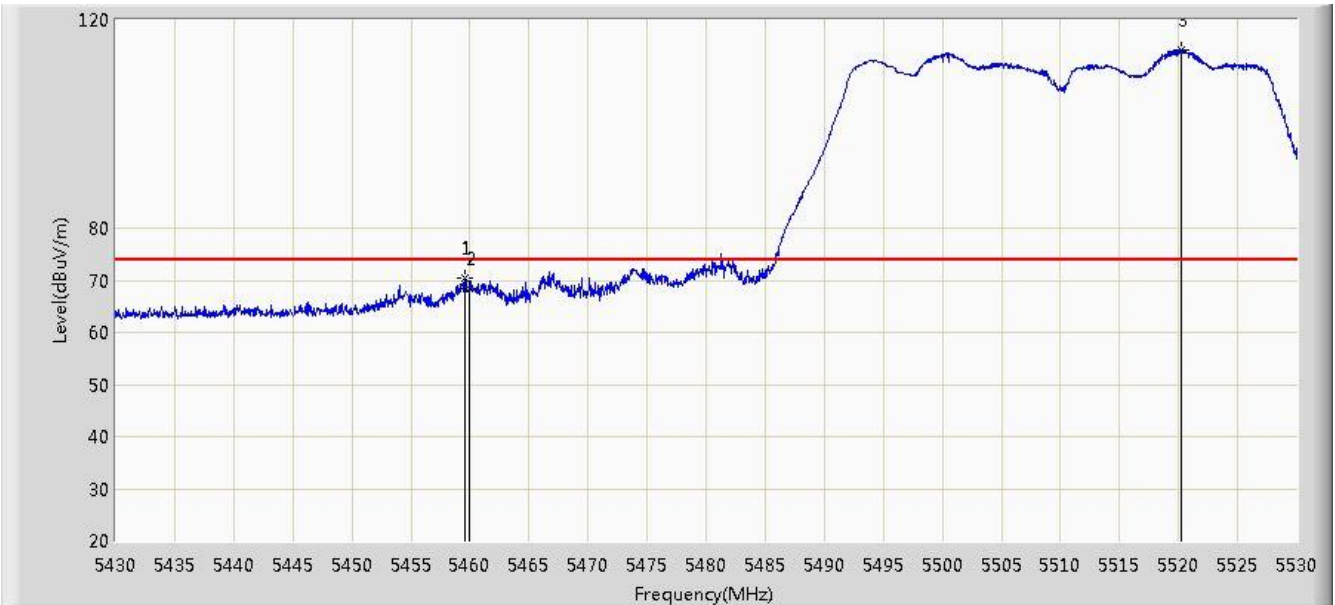

No	Flag	Mark	Frequency (MHz)	Measure Level (dBuV/m)	Reading Level (dBuV)	Over Limit (dB)	Limit (dBuV/m)	Factor (dB)	Type
1			5459.600	70.352	32.791	-3.648	74.000	37.562	PK
2			5460.000	68.282	30.719	-5.718	74.000	37.563	PK
3		*	5520.250	114.255	76.608	N/A	N/A	37.647	PK

Note: Measure Level (dB μ V/m) = Reading Level (dB μ V) + Factor (dB)

Factor (dB) = Cable Loss (dB) + Antenna Factor (dB/m).

Site: AC1	Time: 2015/01/14 - 16:39
Limit: FCC_Part15.209_RE(3m)	Engineer: Roy Cheng
Probe: BBHA9120D_1-18GHz	Polarity: Vertical
EUT: WiFi Concurrent 4 Port GE LAN VoIP Ethernet Gateway with USB	Power: AC 120V/60Hz
Test Mode: Transmit at channel 5510MHz by 802.11n-HT40 Ant 0+1+2+3	

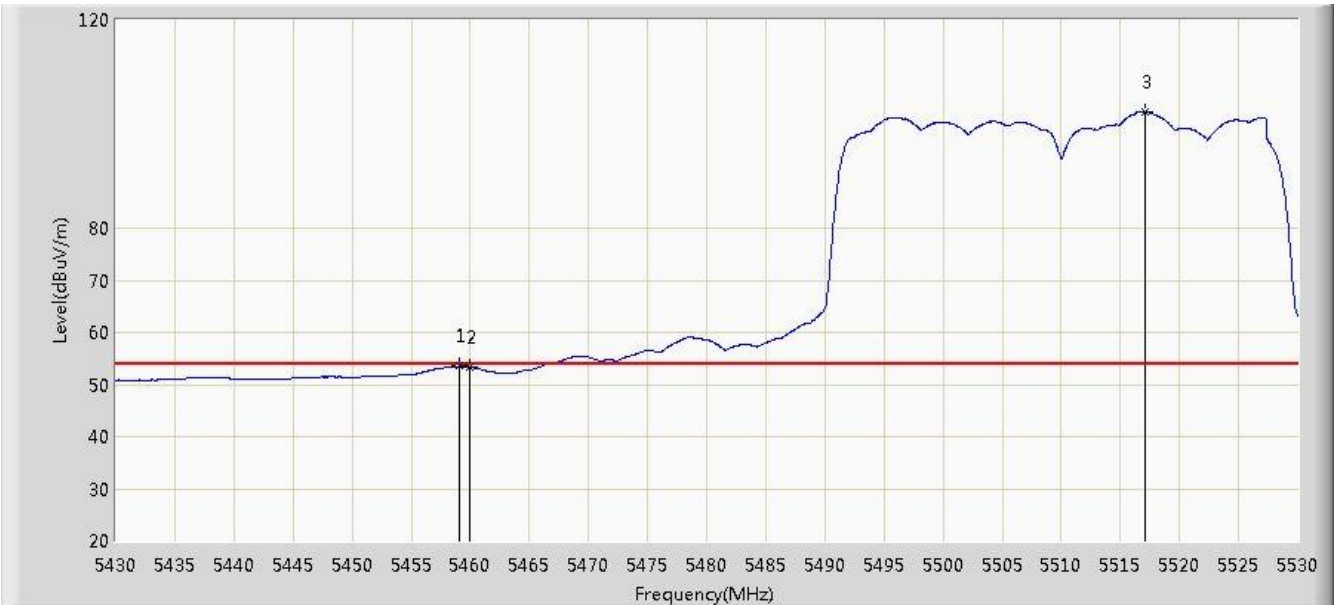

No	Flag	Mark	Frequency (MHz)	Measure Level (dBuV/m)	Reading Level (dBuV)	Over Limit (dB)	Limit (dBuV/m)	Factor (dB)	Type
1			5459.050	53.503	15.943	-0.497	54.000	37.560	AV
2			5460.000	53.343	15.780	-0.657	54.000	37.563	AV
3		*	5517.050	102.376	64.733	N/A	N/A	37.643	AV

Note: Measure Level (dBμV/m) = Reading Level (dBμV) + Factor (dB)

Factor (dB) = Cable Loss (dB) + Antenna Factor (dB/m).

Site: AC1	Time: 2015/01/14 - 16:52
Limit: FCC_Part15.209_RE(3m)	Engineer: Roy Cheng
Probe: BBHA9120D_1-18GHz	Polarity: Horizontal
EUT: WiFi Concurrent 4 Port GE LAN VoIP Ethernet Gateway with USB	Power: AC 120V/60Hz
Test Mode: Transmit at channel 5670MHz by 802.11n-HT40 Ant 0+1+2+3	

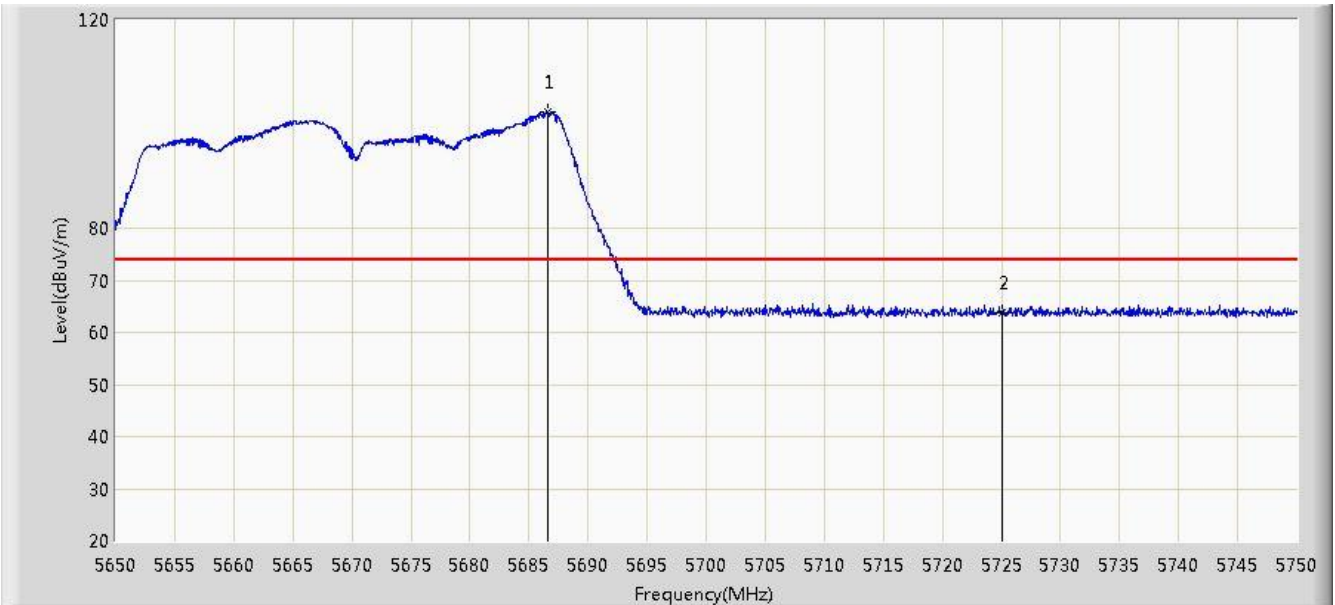

No	Flag	Mark	Frequency (MHz)	Measure Level (dBuV/m)	Reading Level (dBuV)	Over Limit (dB)	Limit (dBuV/m)	Factor (dB)	Type
1		*	5686.550	102.354	64.501	N/A	N/A	37.853	PK
2			5725.000	63.769	25.779	-10.231	74.000	37.990	PK

Note: Measure Level (dB μ V/m) = Reading Level (dB μ V) + Factor (dB)

Factor (dB) = Cable Loss (dB) + Antenna Factor (dB/m).

Site: AC1	Time: 2015/01/14 - 16:53
Limit: FCC_Part15.209_RE(3m)	Engineer: Roy Cheng
Probe: BBHA9120D_1-18GHz	Polarity: Horizontal
EUT: WiFi Concurrent 4 Port GE LAN VoIP Ethernet Gateway with USB	Power: AC 120V/60Hz
Test Mode: Transmit at channel 5670MHz by 802.11n-HT40 Ant 0+1+2+3	

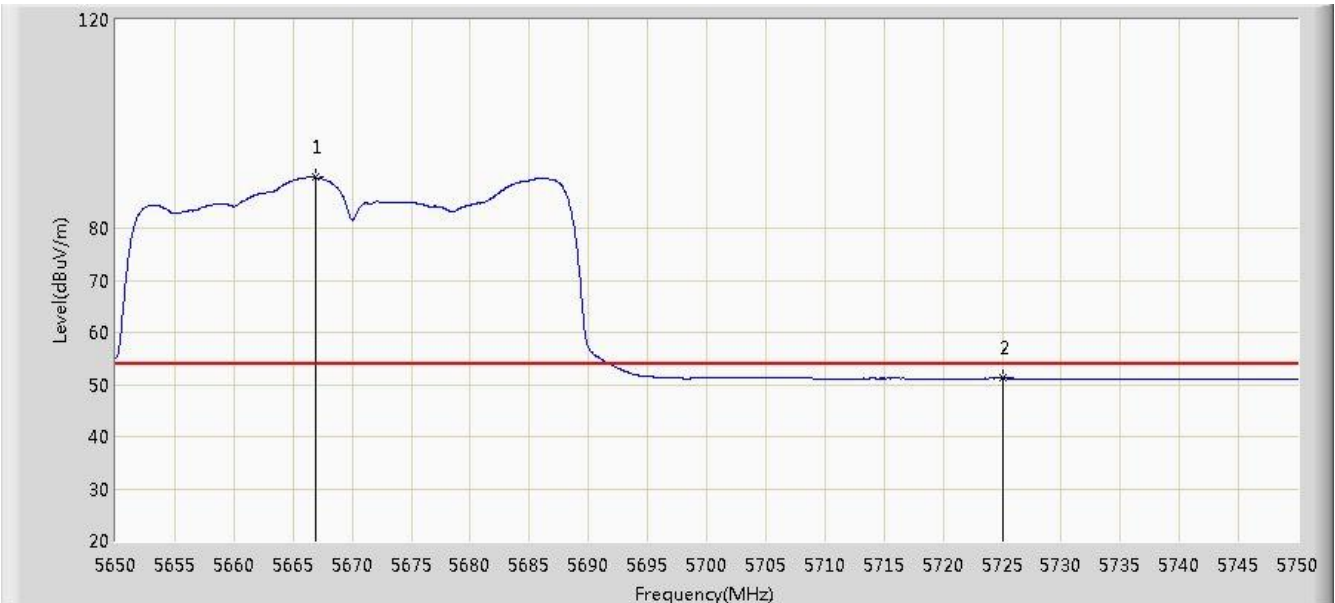

No	Flag	Mark	Frequency (MHz)	Measure Level (dBuV/m)	Reading Level (dBuV)	Over Limit (dB)	Limit (dBuV/m)	Factor (dB)	Type
1		*	5666.900	89.744	51.939	N/A	N/A	37.805	AV
2			5725.000	51.213	13.223	-2.787	54.000	37.990	AV

Note: Measure Level (dB μ V/m) = Reading Level (dB μ V) + Factor (dB)

Factor (dB) = Cable Loss (dB) + Antenna Factor (dB/m).

Site: AC1	Time: 2015/01/14 - 16:51
Limit: FCC_Part15.209_RE(3m)	Engineer: Roy Cheng
Probe: BBHA9120D_1-18GHz	Polarity: Vertical
EUT: WiFi Concurrent 4 Port GE LAN VoIP Ethernet Gateway with USB	Power: AC 120V/60Hz
Test Mode: Transmit at channel 5670MHz by 802.11n-HT40 Ant 0+1+2+3	

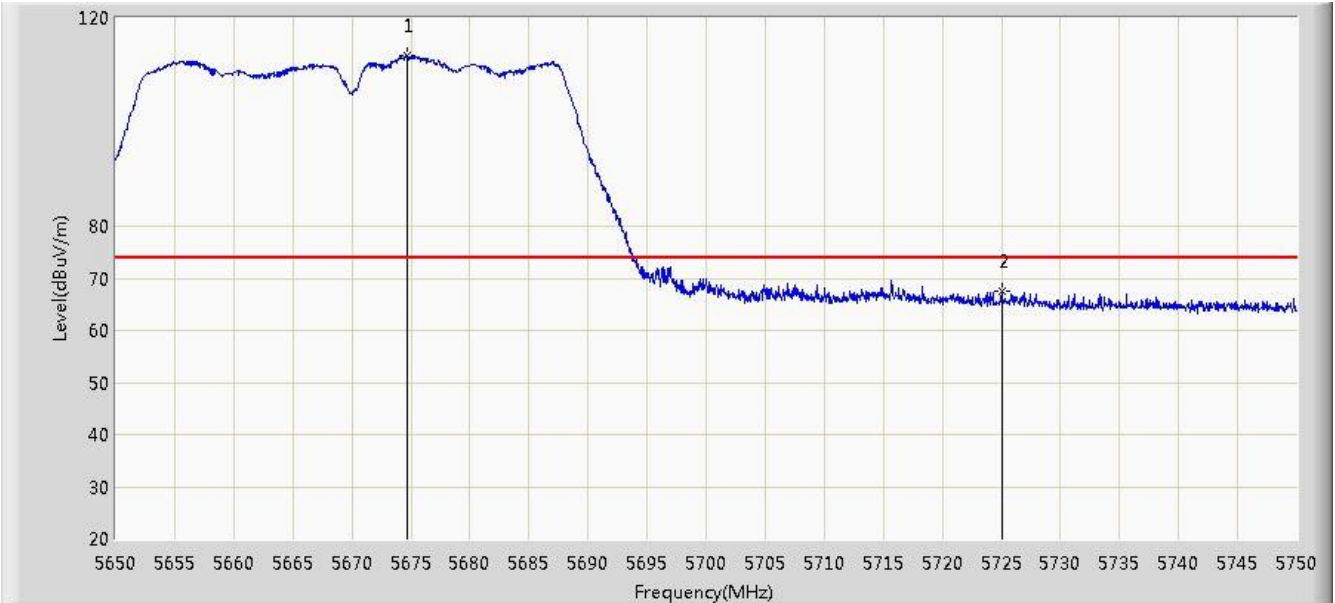

No	Flag	Mark	Frequency (MHz)	Measure Level (dBuV/m)	Reading Level (dBuV)	Over Limit (dB)	Limit (dBuV/m)	Factor (dB)	Type
1		*	5674.700	112.641	74.826	N/A	N/A	37.815	PK
2			5725.000	67.444	29.454	-6.556	74.000	37.990	PK

Note: Measure Level (dB μ V/m) = Reading Level (dB μ V) + Factor (dB)

Factor (dB) = Cable Loss (dB) + Antenna Factor (dB/m).

Site: AC1	Time: 2015/01/14 - 16:48
Limit: FCC_Part15.209_RE(3m)	Engineer: Roy Cheng
Probe: BBHA9120D_1-18GHz	Polarity: Vertical
EUT: WiFi Concurrent 4 Port GE LAN VoIP Ethernet Gateway with USB	Power: AC 120V/60Hz
Test Mode: Transmit at channel 5670MHz by 802.11n-HT40 Ant 0+1+2+3	

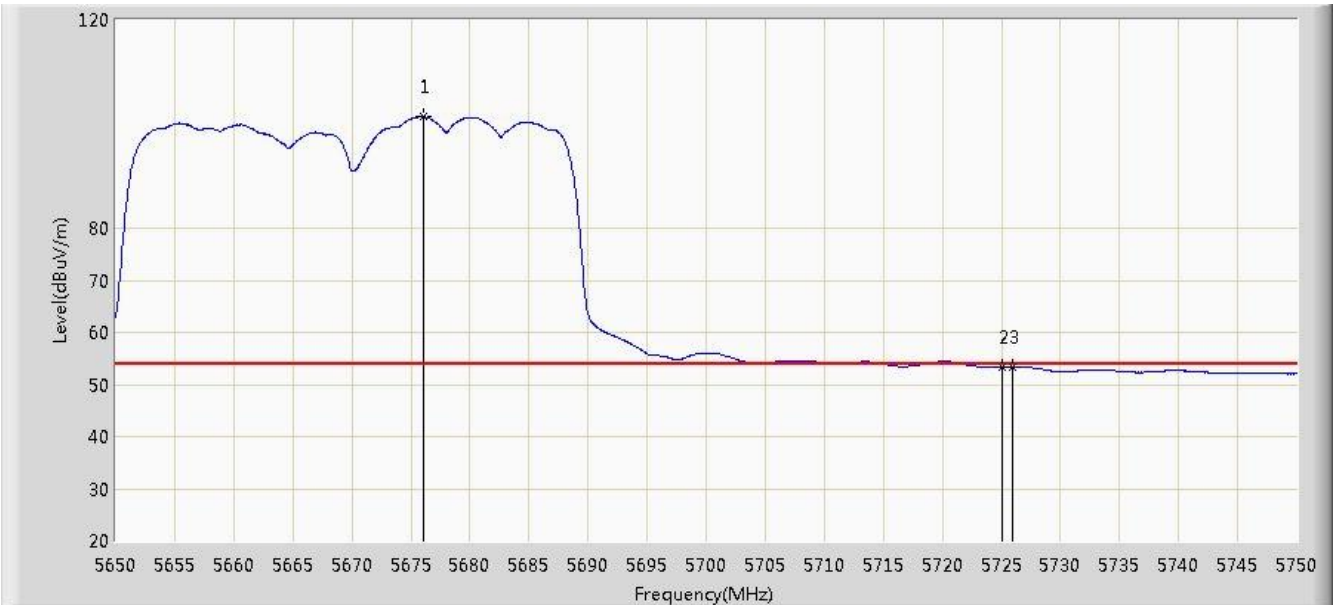

No	Flag	Mark	Frequency (MHz)	Measure Level (dBuV/m)	Reading Level (dBuV)	Over Limit (dB)	Limit (dBuV/m)	Factor (dB)	Type
1		*	5676.050	101.425	63.606	N/A	N/A	37.820	AV
2			5725.000	53.360	15.370	-0.640	54.000	37.990	AV
3			5726.000	53.412	15.418	-0.588	54.000	37.994	AV

Note: Measure Level (dB μ V/m) = Reading Level (dB μ V) + Factor (dB)

Factor (dB) = Cable Loss (dB) + Antenna Factor (dB/m).

Site: AC1	Time: 2015/01/14 - 16:56
Limit: FCC 15.407	Engineer: Roy Cheng
Probe: BBHA9120D_1-18GHz	Polarity: Horizontal
EUT: WiFi Concurrent 4 Port GE LAN VoIP Ethernet Gateway with USB	Power: AC 120V/60Hz
Test Mode: Transmit at channel 5755MHz by 802.11n-HT40 Ant 0+1+2+3	

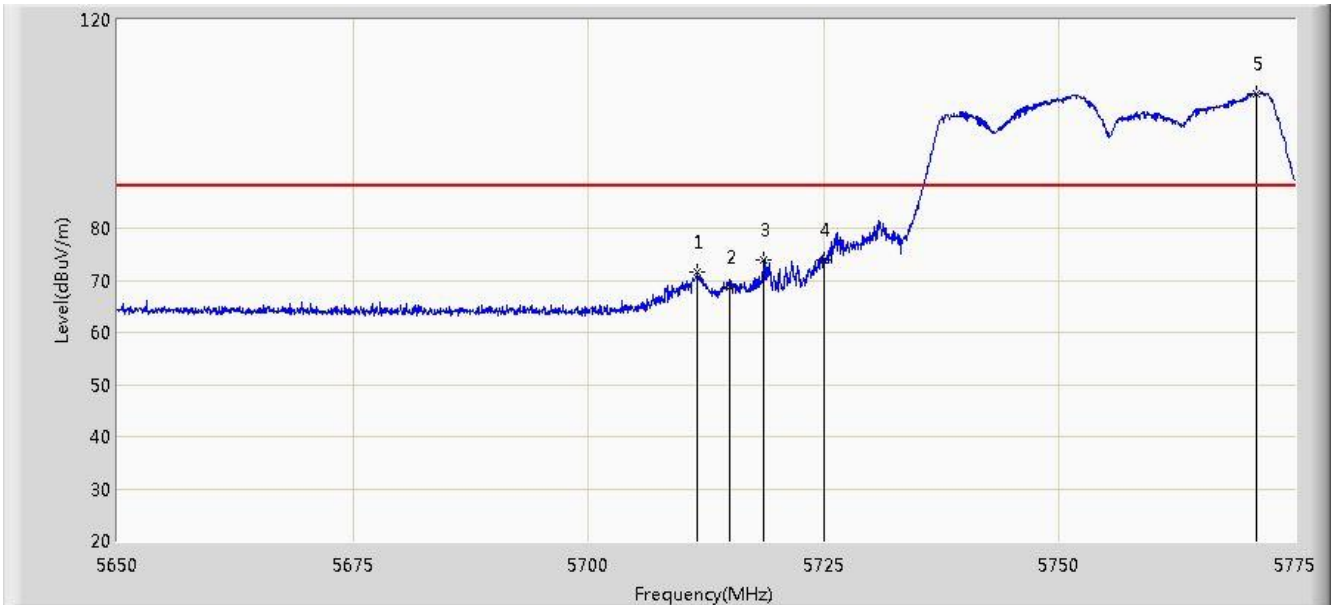

No	Flag	Mark	Frequency (MHz)	Measure Level (dBuV/m)	Reading Level (dBuV)	Over Limit (dB)	Limit (dBuV/m)	Factor (dB)	Type
1			5711.562	71.487	33.552	-16.713	88.200	37.936	PK
2			5715.000	68.822	30.873	-19.378	88.200	37.949	PK
3			5718.687	73.878	35.914	-24.322	98.200	37.964	PK
4			5725.000	74.006	36.016	-24.194	98.200	37.990	PK
5		*	5770.875	105.904	67.736	N/A	N/A	38.168	PK

Note: Measure Level (dBuV/m) = Reading Level (dBuV) + Factor (dB)

Factor (dB) = Cable Loss (dB) + Antenna Factor (dB/m).

Site: AC1	Time: 2015/01/14 - 16:58
Limit: FCC 15.407	Engineer: Roy Cheng
Probe: BBHA9120D_1-18GHz	Polarity: Horizontal
EUT: WiFi Concurrent 4 Port GE LAN VoIP Ethernet Gateway with USB	Power: AC 120V/60Hz
Test Mode: Transmit at channel 5755MHz by 802.11n-HT40 Ant 0+1+2+3	

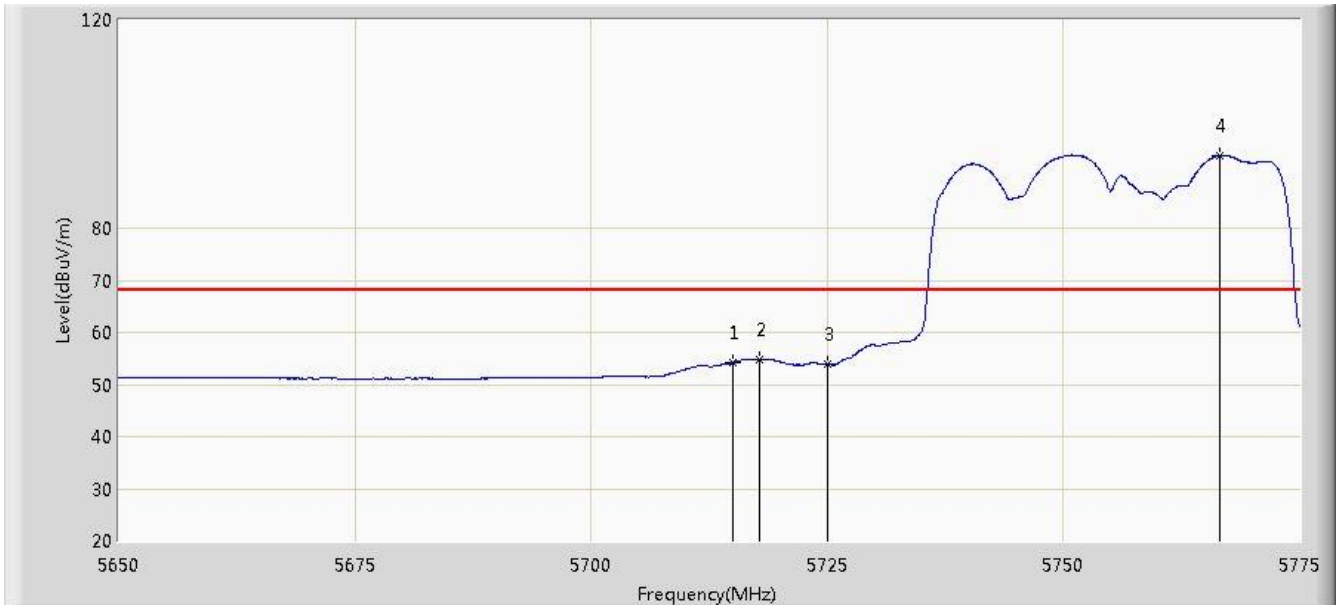

No	Flag	Mark	Frequency (MHz)	Measure Level (dBuV/m)	Reading Level (dBuV)	Over Limit (dB)	Limit (dBuV/m)	Factor (dB)	Type
1			5715.000	54.211	16.262	-13.989	68.200	37.949	AV
2			5717.750	54.769	16.809	-23.431	78.200	37.960	AV
3			5725.000	53.858	15.868	-24.342	78.200	37.990	AV
4		*	5766.562	93.942	55.785	N/A	N/A	38.157	AV

Note: Measure Level (dB μ V/m) = Reading Level (dB μ V) + Factor (dB)

Factor (dB) = Cable Loss (dB) + Antenna Factor (dB/m).

Site: AC1	Time: 2015/01/14 - 16:59
Limit: FCC 15.407	Engineer: Roy Cheng
Probe: BBHA9120D_1-18GHz	Polarity: Vertical
EUT: WiFi Concurrent 4 Port GE LAN VoIP Ethernet Gateway with USB	Power: AC 120V/60Hz
Test Mode: Transmit at channel 5755MHz by 802.11n-HT40 Ant 0+1+2+3	

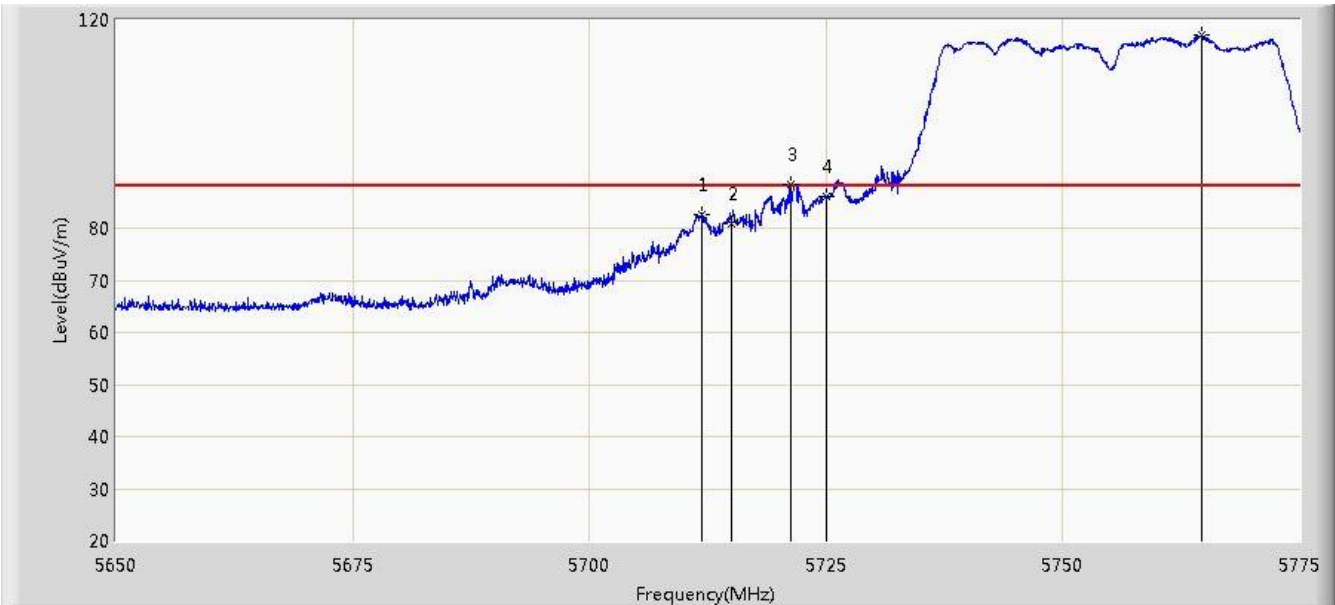

No	Flag	Mark	Frequency (MHz)	Measure Level (dBuV/m)	Reading Level (dBuV)	Over Limit (dB)	Limit (dBuV/m)	Factor (dB)	Type
1			5711.812	82.661	44.725	-5.539	88.200	37.937	PK
2			5715.000	80.870	42.921	-7.330	88.200	37.949	PK
3			5721.250	88.319	50.345	-9.881	98.200	37.974	PK
4			5725.000	86.209	48.219	-11.991	98.200	37.990	PK
5		*	5764.687	116.971	78.818	N/A	N/A	38.153	PK

Note: Measure Level (dB μ V/m) = Reading Level (dB μ V) + Factor (dB)

Factor (dB) = Cable Loss (dB) + Antenna Factor (dB/m).

Site: AC1	Time: 2015/01/14 - 17:03
Limit: FCC 15.407	Engineer: Roy Cheng
Probe: BBHA9120D_1-18GHz	Polarity: Vertical
EUT: WiFi Concurrent 4 Port GE LAN VoIP Ethernet Gateway with USB	Power: AC 120V/60Hz
Test Mode: Transmit at channel 5755MHz by 802.11n-HT40 Ant 0+1+2+3	

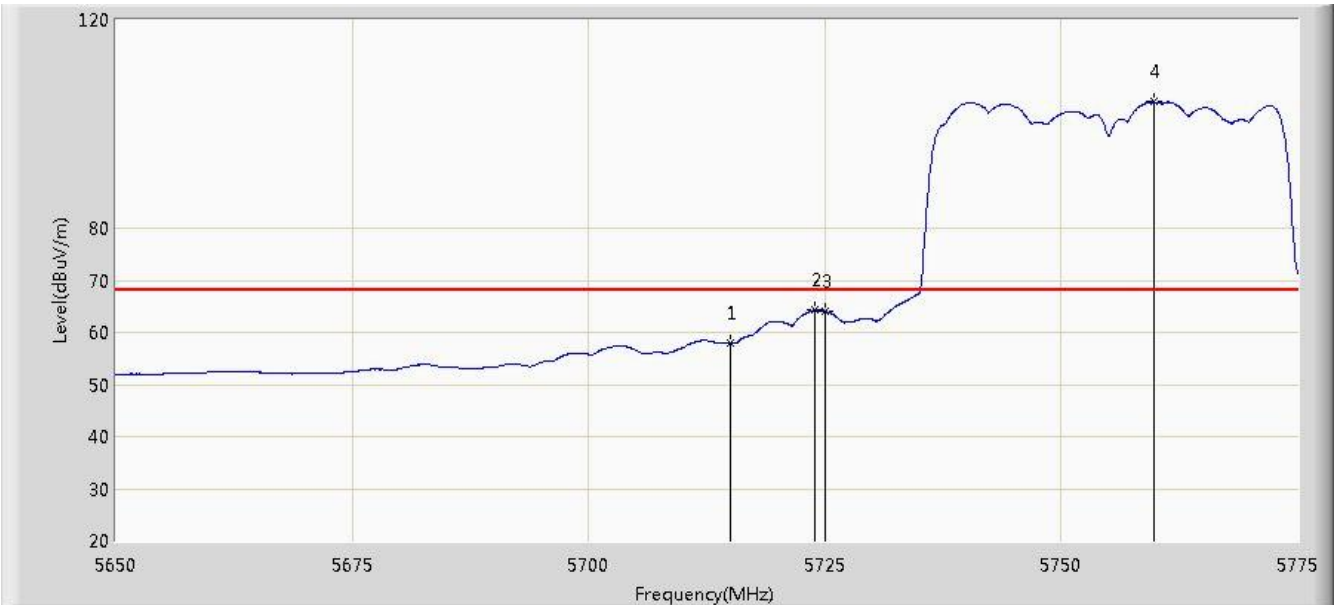

No	Flag	Mark	Frequency (MHz)	Measure Level (dBuV/m)	Reading Level (dBuV)	Over Limit (dB)	Limit (dBuV/m)	Factor (dB)	Type
1			5715.000	57.931	19.982	-10.269	68.200	37.949	AV
2			5723.937	64.255	26.270	-13.945	78.200	37.986	AV
3			5725.000	63.957	25.967	-14.243	78.200	37.990	AV
4		*	5759.750	104.288	66.148	N/A	N/A	38.140	AV

Note: Measure Level (dB μ V/m) = Reading Level (dB μ V) + Factor (dB)

Factor (dB) = Cable Loss (dB) + Antenna Factor (dB/m).

Site: AC1	Time: 2015/01/14 - 17:07
Limit: FCC 15.407	Engineer: Roy Cheng
Probe: BBHA9120D_1-18GHz	Polarity: Horizontal
EUT: WiFi Concurrent 4 Port GE LAN VoIP Ethernet Gateway with USB	Power: AC 120V/60Hz
Test Mode: Transmit at channel 5795MHz by 802.11n-HT40 Ant 0+1+2+3	

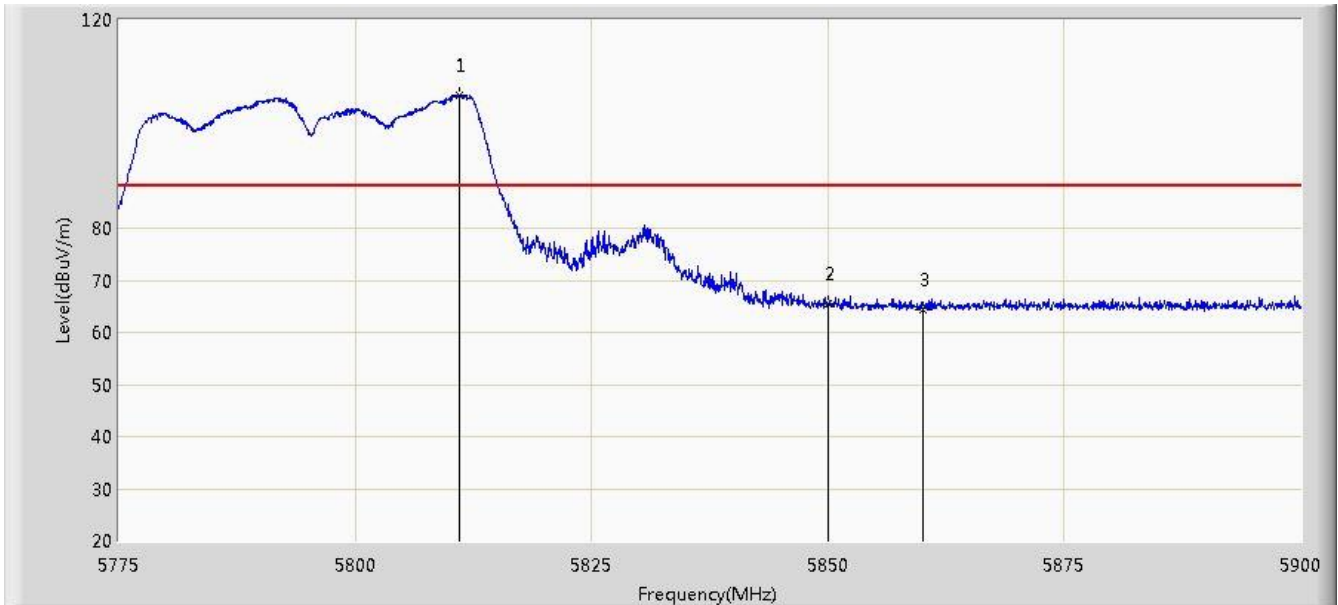

No	Flag	Mark	Frequency (MHz)	Measure Level (dBuV/m)	Reading Level (dBuV)	Over Limit (dB)	Limit (dBuV/m)	Factor (dB)	Type
1		*	5811.000	105.602	67.305	N/A	N/A	38.297	PK
2			5850.000	65.408	26.955	-32.792	98.200	38.454	PK
3			5860.000	64.419	25.941	-23.781	88.200	38.478	PK

Note: Measure Level (dBμV/m) = Reading Level (dBμV) + Factor (dB)

Factor (dB) = Cable Loss (dB) + Antenna Factor (dB/m).

Site: AC1	Time: 2015/01/14 - 17:09
Limit: FCC 15.407	Engineer: Roy Cheng
Probe: BBHA9120D_1-18GHz	Polarity: Horizontal
EUT: WiFi Concurrent 4 Port GE LAN VoIP Ethernet Gateway with USB	Power: AC 120V/60Hz
Test Mode: Transmit at channel 5795MHz by 802.11n-HT40 Ant 0+1+2+3	

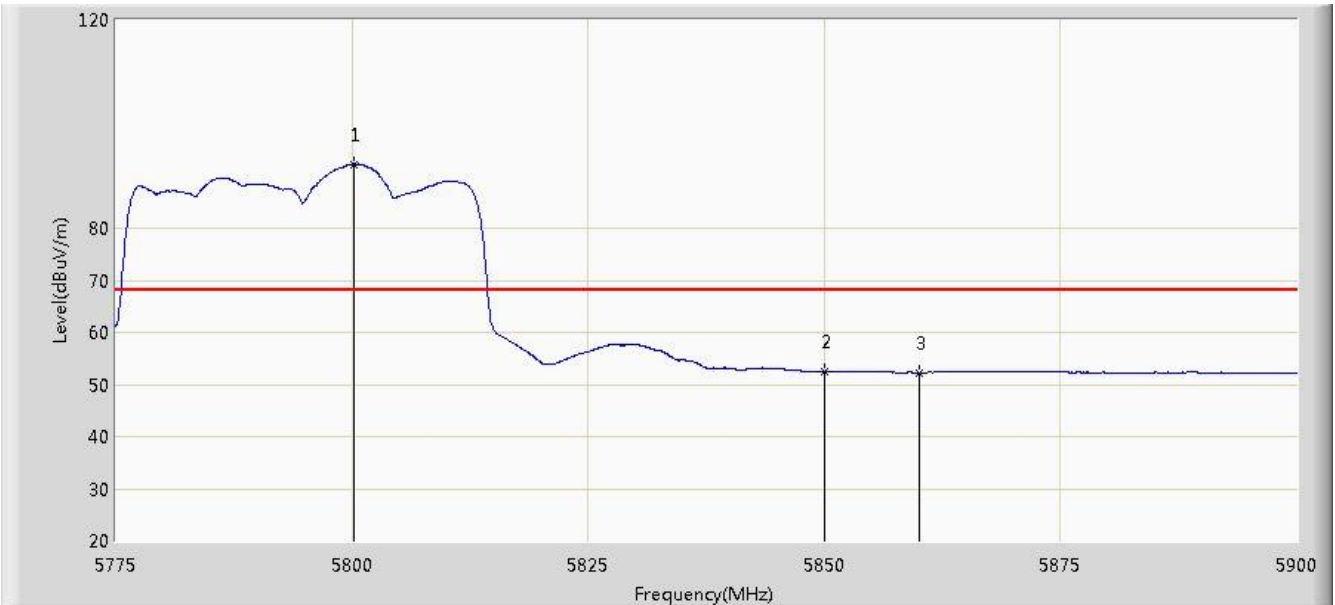

No	Flag	Mark	Frequency (MHz)	Measure Level (dBuV/m)	Reading Level (dBuV)	Over Limit (dB)	Limit (dBuV/m)	Factor (dB)	Type
1		*	5800.187	92.269	54.004	N/A	N/A	38.264	AV
2			5850.000	52.486	14.033	-25.714	78.200	38.454	AV
3			5860.000	52.249	13.771	-15.951	68.200	38.478	AV

Note: Measure Level (dBuV/m) = Reading Level (dBuV) + Factor (dB)

Factor (dB) = Cable Loss (dB) + Antenna Factor (dB/m).

Site: AC1	Time: 2015/01/14 - 17:11
Limit: FCC 15.407	Engineer: Roy Cheng
Probe: BBHA9120D_1-18GHz	Polarity: Vertical
EUT: WiFi Concurrent 4 Port GE LAN VoIP Ethernet Gateway with USB	Power: AC 120V/60Hz
Test Mode: Transmit at channel 5795MHz by 802.11n-HT40 Ant 0+1+2+3	

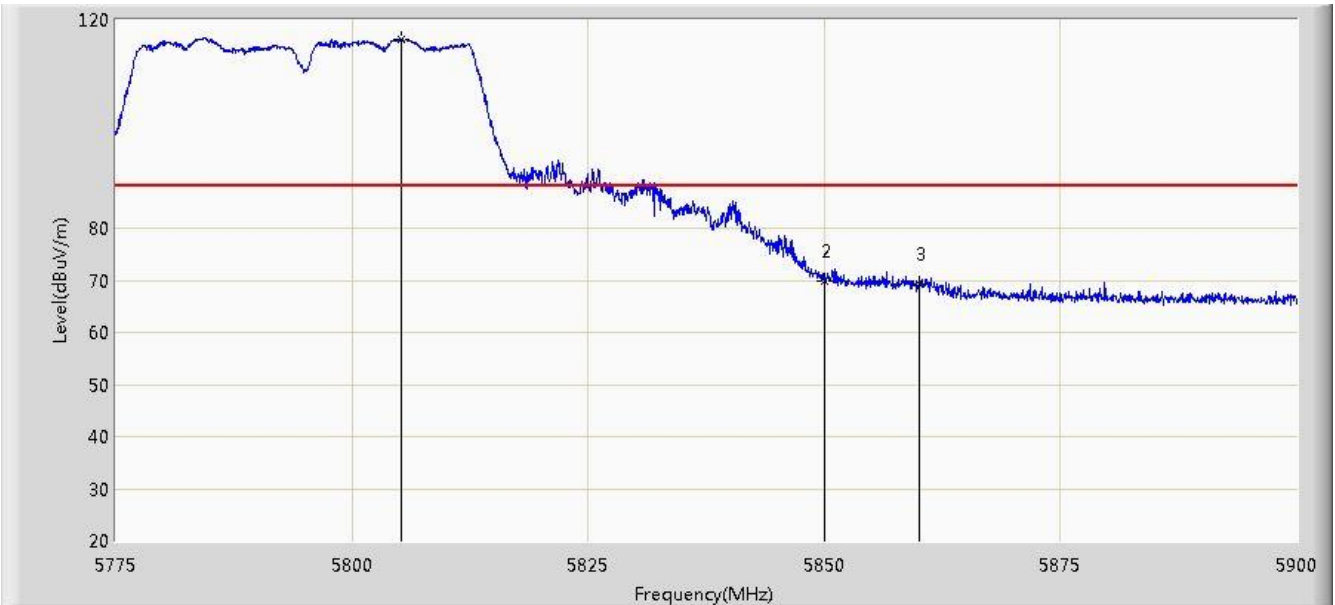

No	Flag	Mark	Frequency (MHz)	Measure Level (dBuV/m)	Reading Level (dBuV)	Over Limit (dB)	Limit (dBuV/m)	Factor (dB)	Type
1		*	5805.250	116.290	78.010	N/A	N/A	38.280	PK
2			5850.000	69.816	31.363	-28.384	98.200	38.454	PK
3			5860.000	69.282	30.804	-18.918	88.200	38.478	PK

Note: Measure Level (dBμV/m) = Reading Level (dBμV) + Factor (dB)

Factor (dB) = Cable Loss (dB) + Antenna Factor (dB/m).

Site: AC1	Time: 2015/01/14 - 17:12
Limit: FCC 15.407	Engineer: Roy Cheng
Probe: BBHA9120D_1-18GHz	Polarity: Vertical
EUT: WiFi Concurrent 4 Port GE LAN VoIP Ethernet Gateway with USB	Power: AC 120V/60Hz
Test Mode: Transmit at channel 5795MHz by 802.11n-HT40 Ant 0+1+2+3	

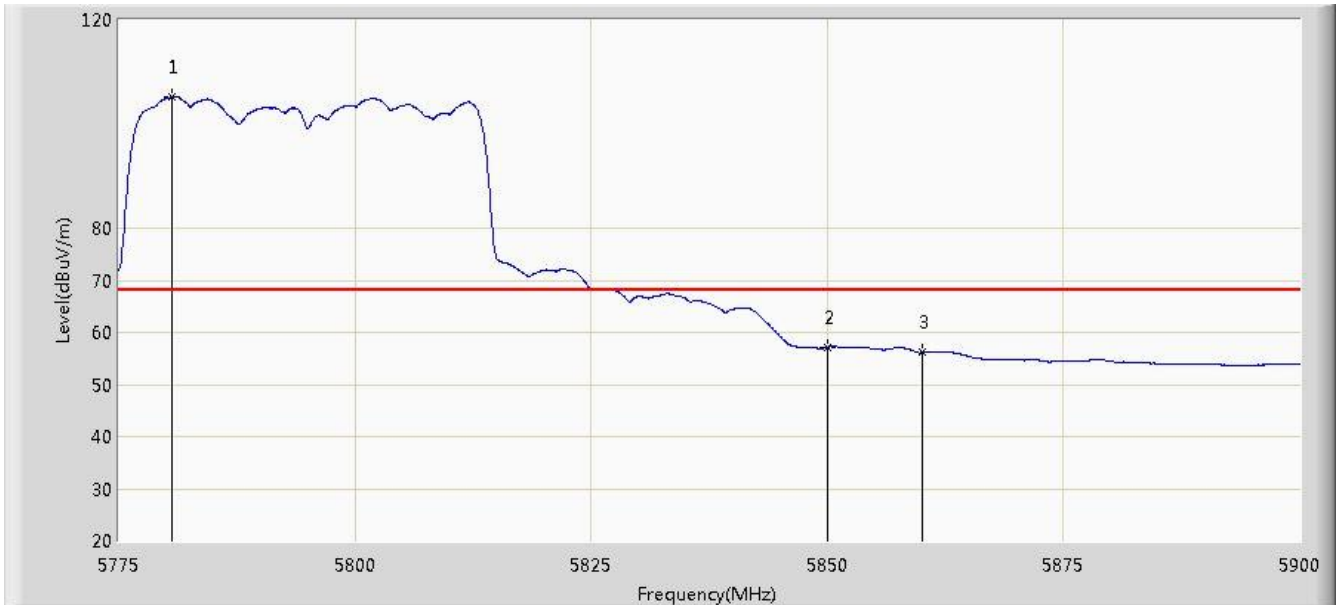

No	Flag	Mark	Frequency (MHz)	Measure Level (dBuV/m)	Reading Level (dBuV)	Over Limit (dB)	Limit (dBuV/m)	Factor (dB)	Type
1		*	5780.562	105.120	66.924	N/A	N/A	38.196	AV
2			5850.000	57.128	18.675	-21.072	78.200	38.454	AV
3			5860.000	56.092	17.614	-12.108	68.200	38.478	AV

Note: Measure Level (dBuV/m) = Reading Level (dBuV) + Factor (dB)

Factor (dB) = Cable Loss (dB) + Antenna Factor (dB/m).

Site: AC1	Time: 2015/01/14 - 17:15
Limit: FCC_Part15.209_RE(3m)	Engineer: Roy Cheng
Probe: BBHA9120D_1-18GHz	Polarity: Horizontal
EUT: WiFi Concurrent 4 Port GE LAN VoIP Ethernet Gateway with USB	Power: AC 120V/60Hz
Test Mode: Transmit at channel 5180MHz by 802.11ac-VHT20 Ant 0+1+2+3	

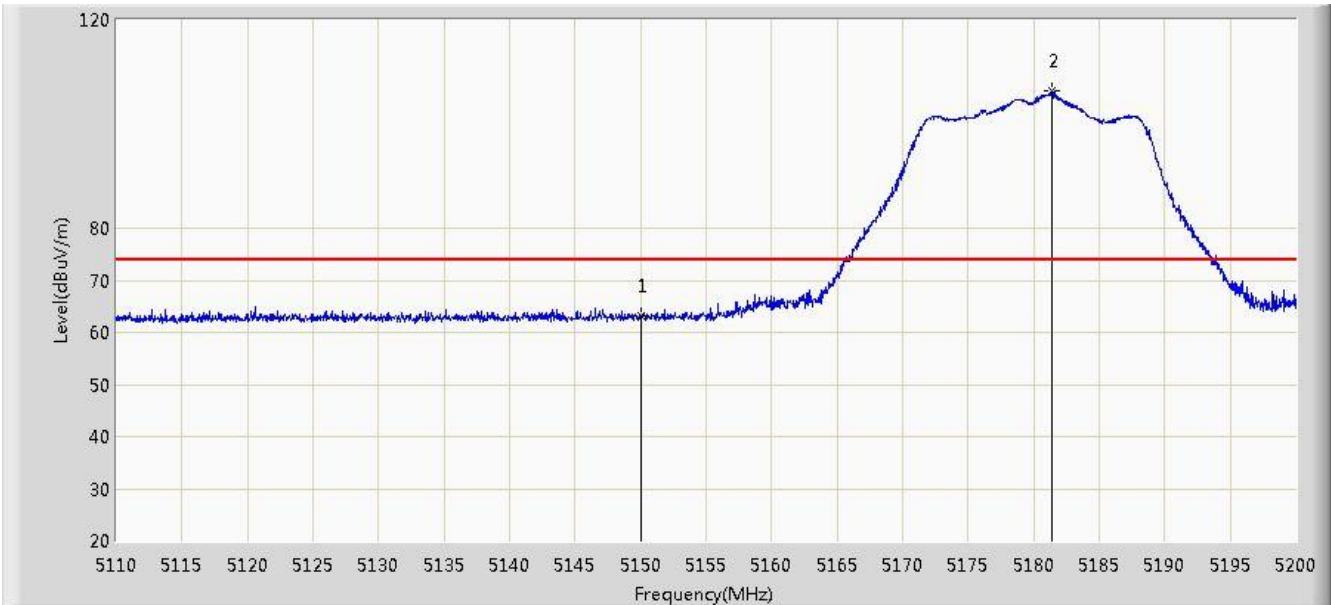

No	Flag	Mark	Frequency (MHz)	Measure Level (dBuV/m)	Reading Level (dBuV)	Over Limit (dB)	Limit (dBuV/m)	Factor (dB)	Type
1			5150.000	63.215	25.763	-10.785	74.000	37.452	PK
2		*	5181.415	106.378	69.007	N/A	N/A	37.370	PK

Note: Measure Level (dB μ V/m) = Reading Level (dB μ V) + Factor (dB)

Factor (dB) = Cable Loss (dB) + Antenna Factor (dB/m).

Site: AC1	Time: 2015/01/14 - 17:17
Limit: FCC_Part15.209_RE(3m)	Engineer: Roy Cheng
Probe: BBHA9120D_1-18GHz	Polarity: Horizontal
EUT: WiFi Concurrent 4 Port GE LAN VoIP Ethernet Gateway with USB	Power: AC 120V/60Hz
Test Mode: Transmit at channel 5180MHz by 802.11ac-VHT20 Ant 0+1+2+3	

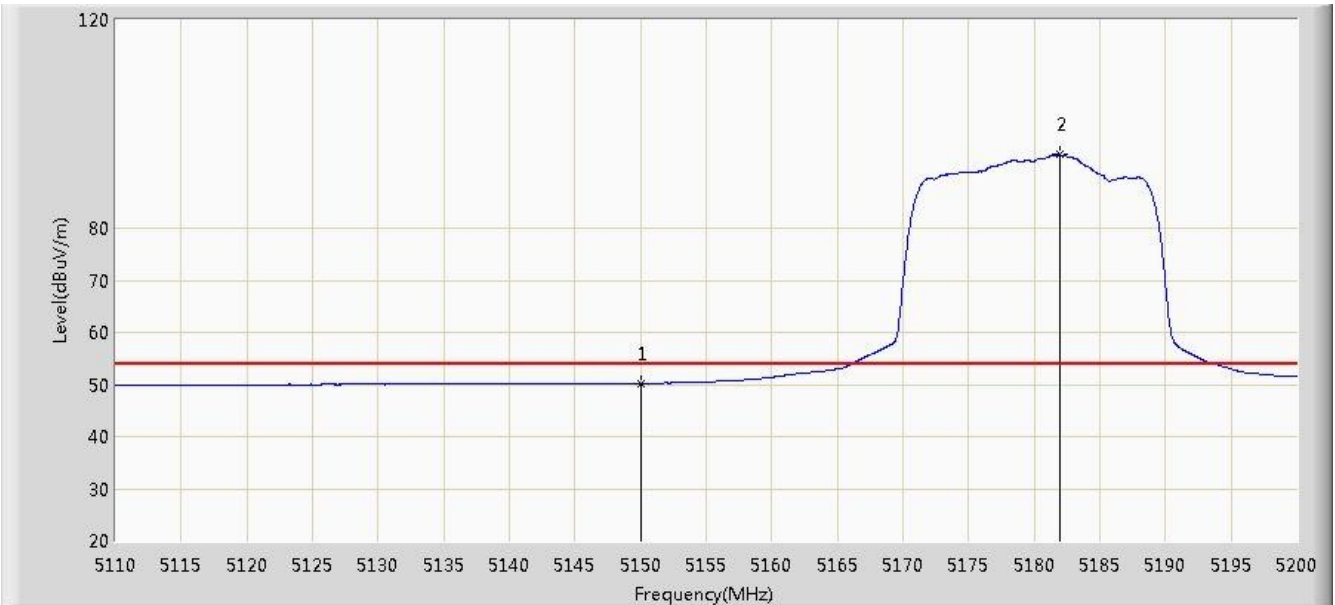

No	Flag	Mark	Frequency (MHz)	Measure Level (dBuV/m)	Reading Level (dBuV)	Over Limit (dB)	Limit (dBuV/m)	Factor (dB)	Type
1			5150.000	50.231	12.779	-3.769	54.000	37.452	AV
2		*	5181.955	94.075	56.706	N/A	N/A	37.369	AV

Note: Measure Level (dB μ V/m) = Reading Level (dB μ V) + Factor (dB)

Factor (dB) = Cable Loss (dB) + Antenna Factor (dB/m).

Site: AC1	Time: 2015/01/14 - 17:19
Limit: FCC_Part15.209_RE(3m)	Engineer: Roy Cheng
Probe: BBHA9120D_1-18GHz	Polarity: Vertical
EUT: WiFi Concurrent 4 Port GE LAN VoIP Ethernet Gateway with USB	Power: AC 120V/60Hz
Test Mode: Transmit at channel 5180MHz by 802.11ac-VHT20 Ant 0+1+2+3	

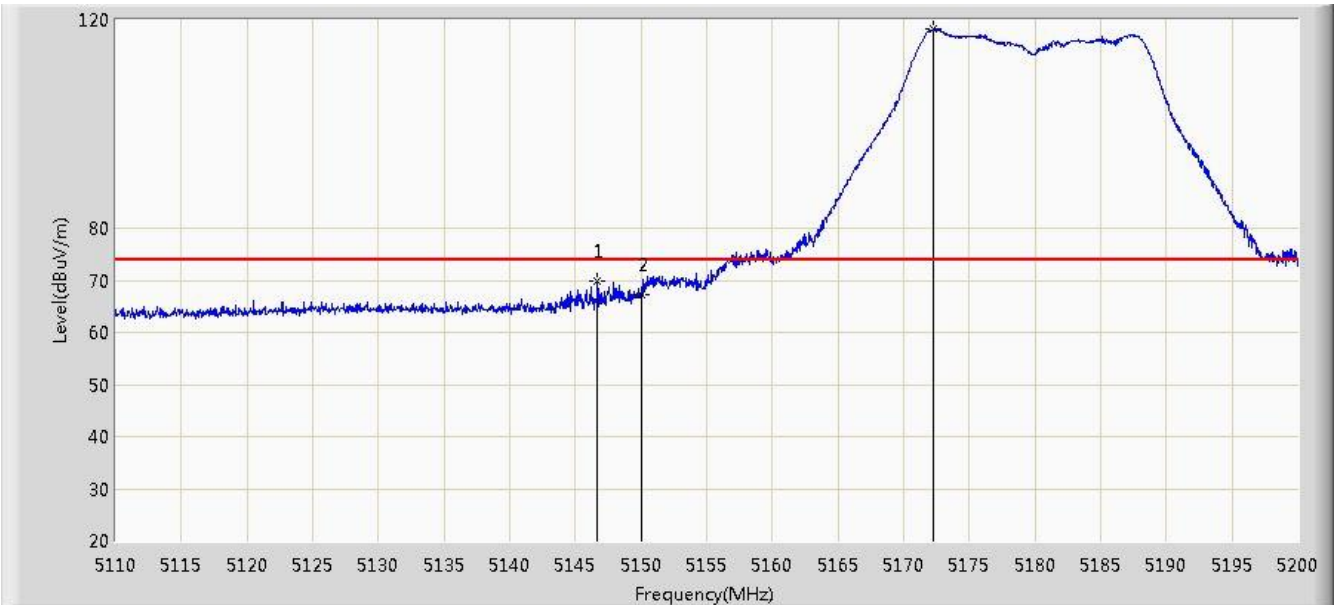

No	Flag	Mark	Frequency (MHz)	Measure Level (dBuV/m)	Reading Level (dBuV)	Over Limit (dB)	Limit (dBuV/m)	Factor (dB)	Type
1			5146.675	69.845	32.388	-4.155	74.000	37.457	PK
2			5150.000	67.340	29.888	-6.660	74.000	37.452	PK
3		*	5172.235	118.129	80.738	N/A	N/A	37.392	PK

Note: Measure Level (dBuV/m) = Reading Level (dBuV) + Factor (dB)

Factor (dB) = Cable Loss (dB) + Antenna Factor (dB/m).

Site: AC1	Time: 2015/01/14 - 17:20
Limit: FCC_Part15.209_RE(3m)	Engineer: Roy Cheng
Probe: BBHA9120D_1-18GHz	Polarity: Vertical
EUT: WiFi Concurrent 4 Port GE LAN VoIP Ethernet Gateway with USB	Power: AC 120V/60Hz
Test Mode: Transmit at channel 5180MHz by 802.11ac-VHT20 Ant 0+1+2+3	

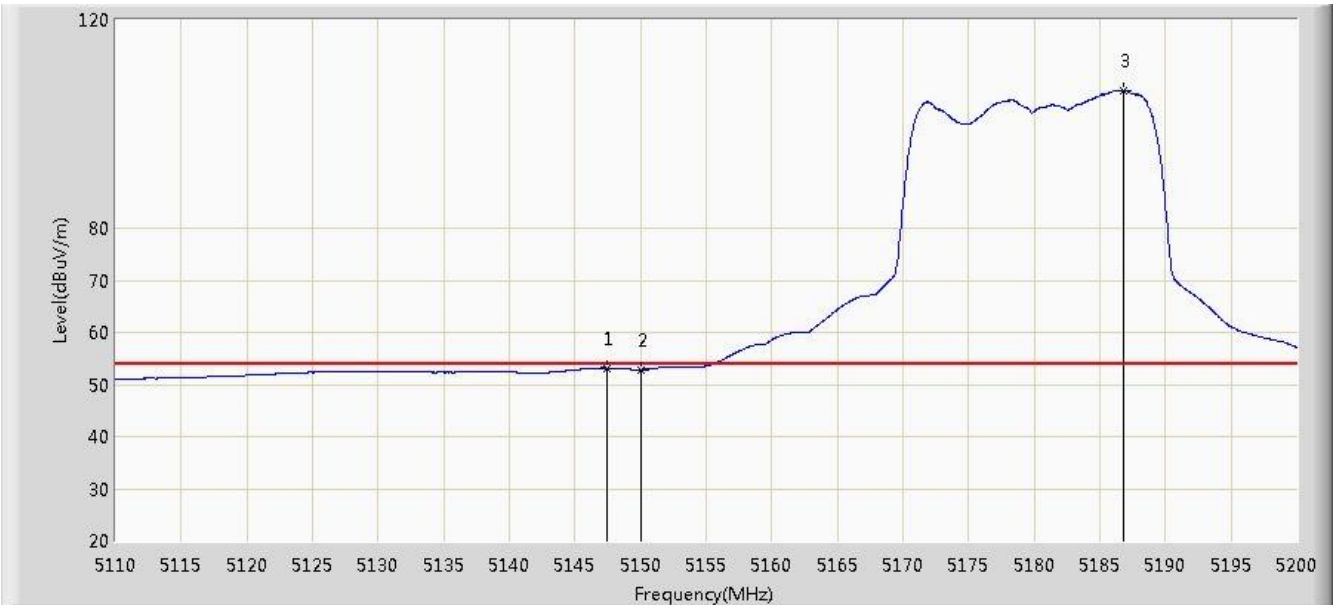

No	Flag	Mark	Frequency (MHz)	Measure Level (dBuV/m)	Reading Level (dBuV)	Over Limit (dB)	Limit (dBuV/m)	Factor (dB)	Type
1			5147.485	53.178	15.722	-0.822	54.000	37.455	AV
2			5150.000	52.851	15.399	-1.149	54.000	37.452	AV
3		*	5186.815	106.499	69.142	N/A	N/A	37.357	AV

Note: Measure Level (dBuV/m) = Reading Level (dBuV) + Factor (dB)

Factor (dB) = Cable Loss (dB) + Antenna Factor (dB/m).

Site: AC1	Time: 2015/01/14 - 17:21
Limit: FCC_Part15.209_RE(3m)	Engineer: Roy Cheng
Probe: BBHA9120D_1-18GHz	Polarity: Horizontal
EUT: WiFi Concurrent 4 Port GE LAN VoIP Ethernet Gateway with USB	Power: AC 120V/60Hz
Test Mode: Transmit at channel 5320MHz by 802.11ac-VHT20 Ant 0+1+2+3	

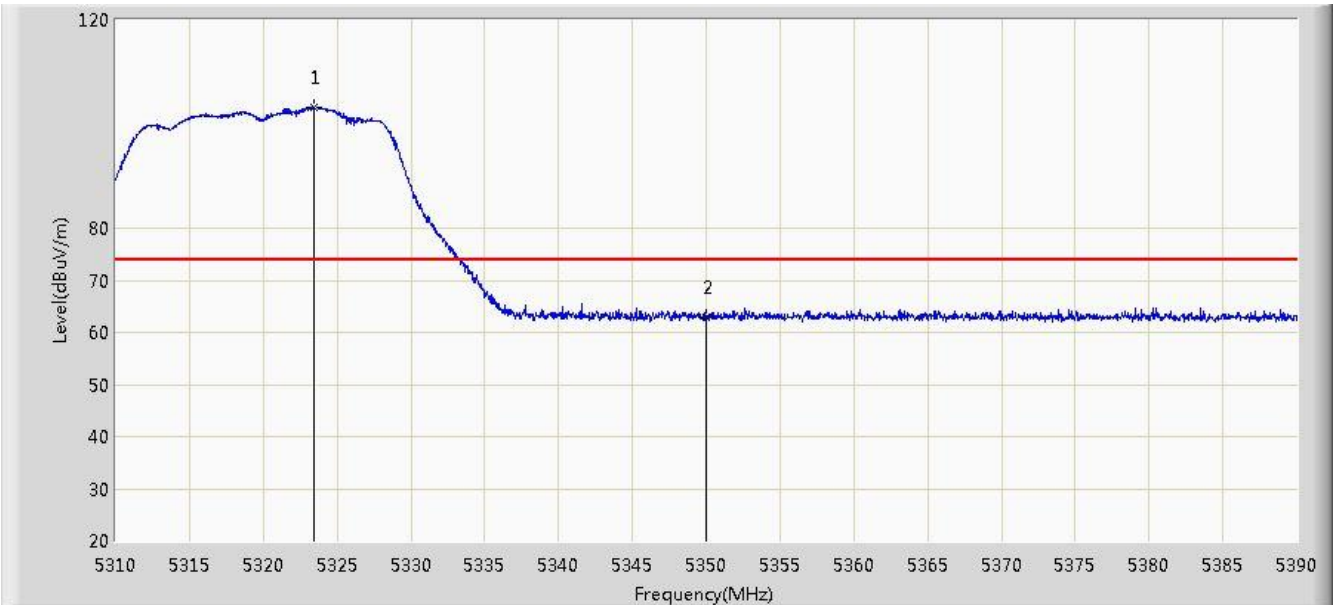

No	Flag	Mark	Frequency (MHz)	Measure Level (dBuV/m)	Reading Level (dBuV)	Over Limit (dB)	Limit (dBuV/m)	Factor (dB)	Type
1		*	5323.400	103.097	65.877	N/A	N/A	37.220	PK
2			5350.000	62.870	25.584	-11.130	74.000	37.286	PK

Note: Measure Level (dB μ V/m) = Reading Level (dB μ V) + Factor (dB)

Factor (dB) = Cable Loss (dB) + Antenna Factor (dB/m).

Site: AC1	Time: 2015/01/14 - 17:23
Limit: FCC_Part15.209_RE(3m)	Engineer: Roy Cheng
Probe: BBHA9120D_1-18GHz	Polarity: Horizontal
EUT: WiFi Concurrent 4 Port GE LAN VoIP Ethernet Gateway with USB	Power: AC 120V/60Hz
Test Mode: Transmit at channel 5320MHz by 802.11ac-VHT20 Ant 0+1+2+3	

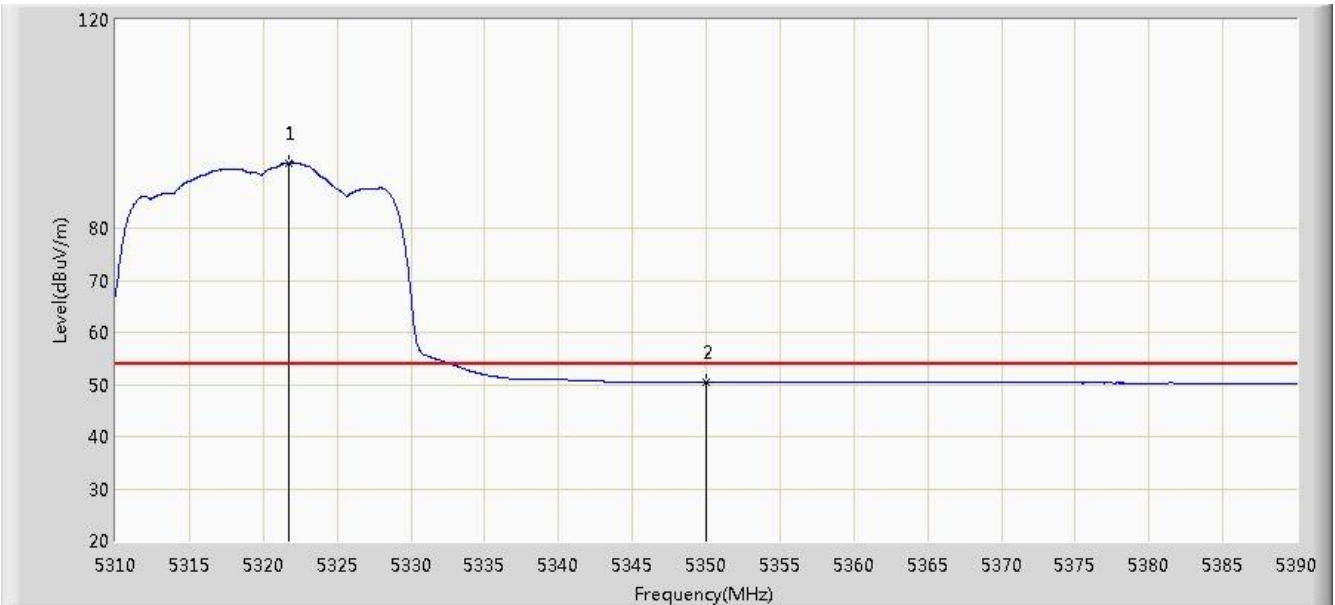

No	Flag	Mark	Frequency (MHz)	Measure Level (dBuV/m)	Reading Level (dBuV)	Over Limit (dB)	Limit (dBuV/m)	Factor (dB)	Type
1		*	5321.760	92.532	55.315	N/A	N/A	37.217	AV
2			5350.000	50.416	13.130	-3.584	54.000	37.286	AV

Note: Measure Level (dBμV/m) = Reading Level (dBμV) + Factor (dB)

Factor (dB) = Cable Loss (dB) + Antenna Factor (dB/m).

Site: AC1	Time: 2015/01/14 - 17:25
Limit: FCC_Part15.209_RE(3m)	Engineer: Roy Cheng
Probe: BBHA9120D_1-18GHz	Polarity: Vertical
EUT: WiFi Concurrent 4 Port GE LAN VoIP Ethernet Gateway with USB	Power: AC 120V/60Hz
Test Mode: Transmit at channel 5320MHz by 802.11ac-VHT20 Ant 0+1+2+3	

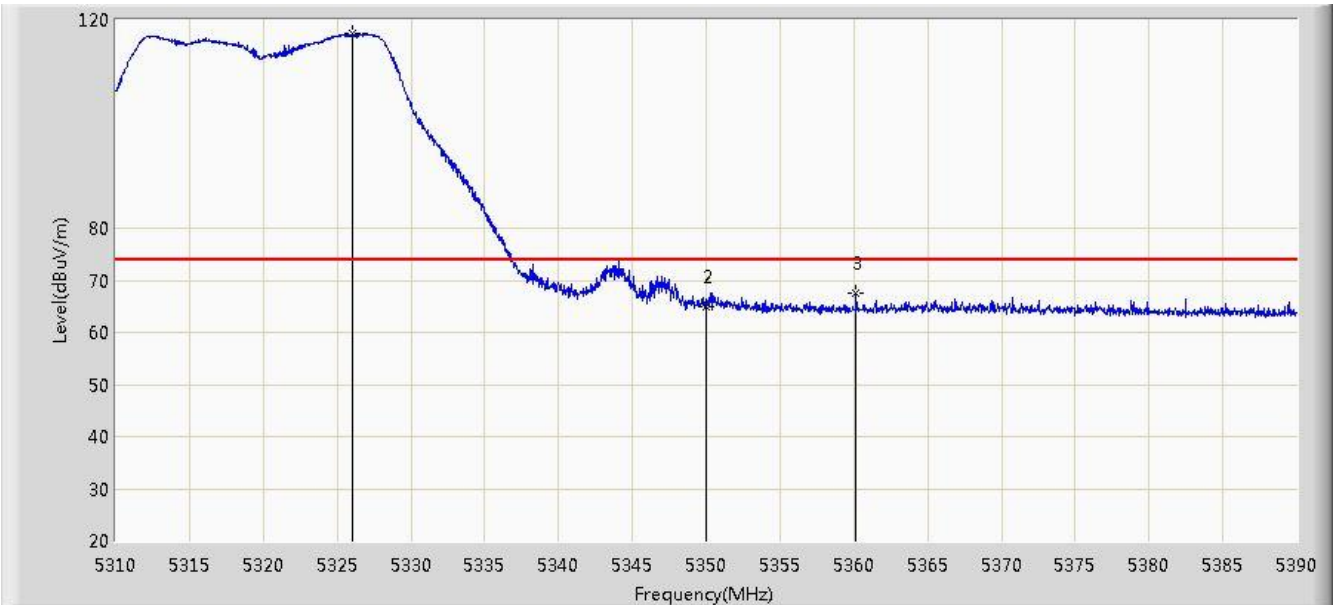

No	Flag	Mark	Frequency (MHz)	Measure Level (dBuV/m)	Reading Level (dBuV)	Over Limit (dB)	Limit (dBuV/m)	Factor (dB)	Type
1		*	5326.040	117.402	80.178	N/A	N/A	37.225	PK
2			5350.000	64.970	27.684	-9.030	74.000	37.286	PK
3			5360.160	67.558	30.243	-6.442	74.000	37.314	PK

Note: Measure Level (dBuV/m) = Reading Level (dBuV) + Factor (dB)

Factor (dB) = Cable Loss (dB) + Antenna Factor (dB/m).

Site: AC1	Time: 2015/01/14 - 17:27
Limit: FCC_Part15.209_RE(3m)	Engineer: Roy Cheng
Probe: BBHA9120D_1-18GHz	Polarity: Vertical
EUT: WiFi Concurrent 4 Port GE LAN VoIP Ethernet Gateway with USB	Power: AC 120V/60Hz
Test Mode: Transmit at channel 5320MHz by 802.11ac-VHT20 Ant 0+1+2+3	

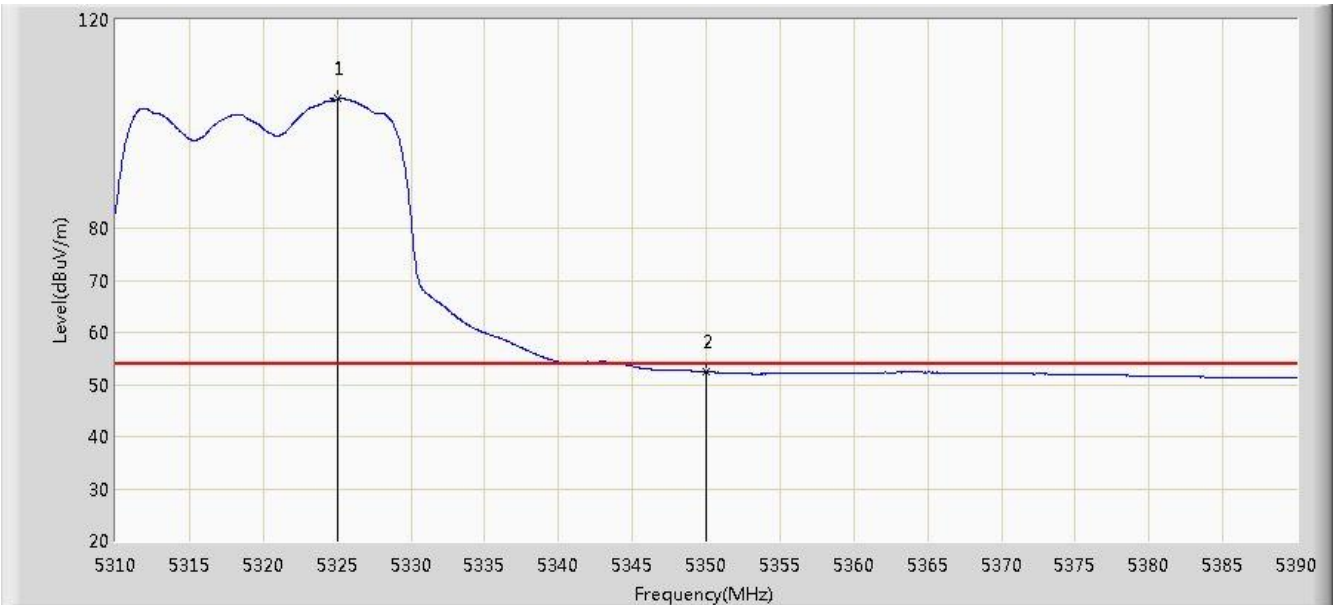

No	Flag	Mark	Frequency (MHz)	Measure Level (dBuV/m)	Reading Level (dBuV)	Over Limit (dB)	Limit (dBuV/m)	Factor (dB)	Type
1		*	5325.080	104.944	67.721	N/A	N/A	37.223	AV
2			5350.000	52.452	15.166	-1.548	54.000	37.286	AV

Note: Measure Level (dBμV/m) = Reading Level (dBμV) + Factor (dB)

Factor (dB) = Cable Loss (dB) + Antenna Factor (dB/m).

Site: AC1	Time: 2015/01/14 - 17:28
Limit: FCC_Part15.209_RE(3m)	Engineer: Roy Cheng
Probe: BBHA9120D_1-18GHz	Polarity: Horizontal
EUT: WiFi Concurrent 4 Port GE LAN VoIP Ethernet Gateway with USB	Power: AC 120V/60Hz
Test Mode: Transmit at channel 5500MHz by 802.11ac-VHT20 Ant 0+1+2+3	

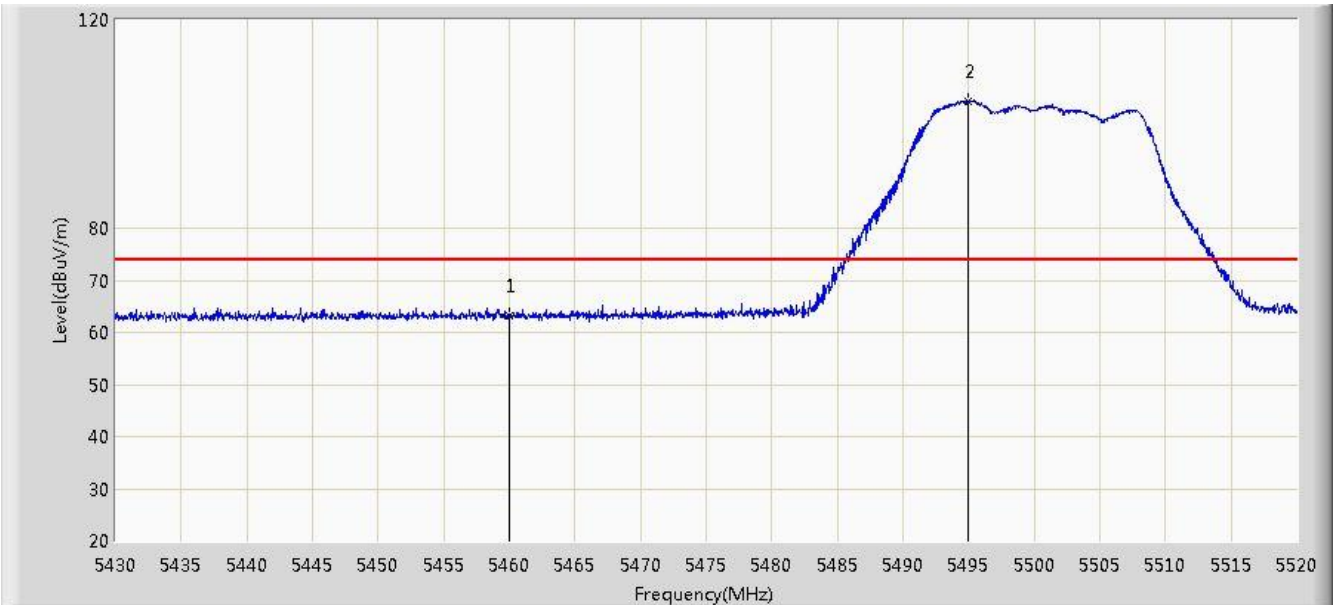

No	Flag	Mark	Frequency (MHz)	Measure Level (dBuV/m)	Reading Level (dBuV)	Over Limit (dB)	Limit (dBuV/m)	Factor (dB)	Type
1			5460.000	63.237	25.674	-10.763	74.000	37.563	PK
2		*	5494.935	104.432	66.813	N/A	N/A	37.619	PK

Note: Measure Level (dB μ V/m) = Reading Level (dB μ V) + Factor (dB)

Factor (dB) = Cable Loss (dB) + Antenna Factor (dB/m).

Site: AC1	Time: 2015/01/14 - 17:29
Limit: FCC_Part15.209_RE(3m)	Engineer: Roy Cheng
Probe: BBHA9120D_1-18GHz	Polarity: Horizontal
EUT: WiFi Concurrent 4 Port GE LAN VoIP Ethernet Gateway with USB	Power: AC 120V/60Hz
Test Mode: Transmit at channel 5500MHz by 802.11ac-VHT20 Ant 0+1+2+3	

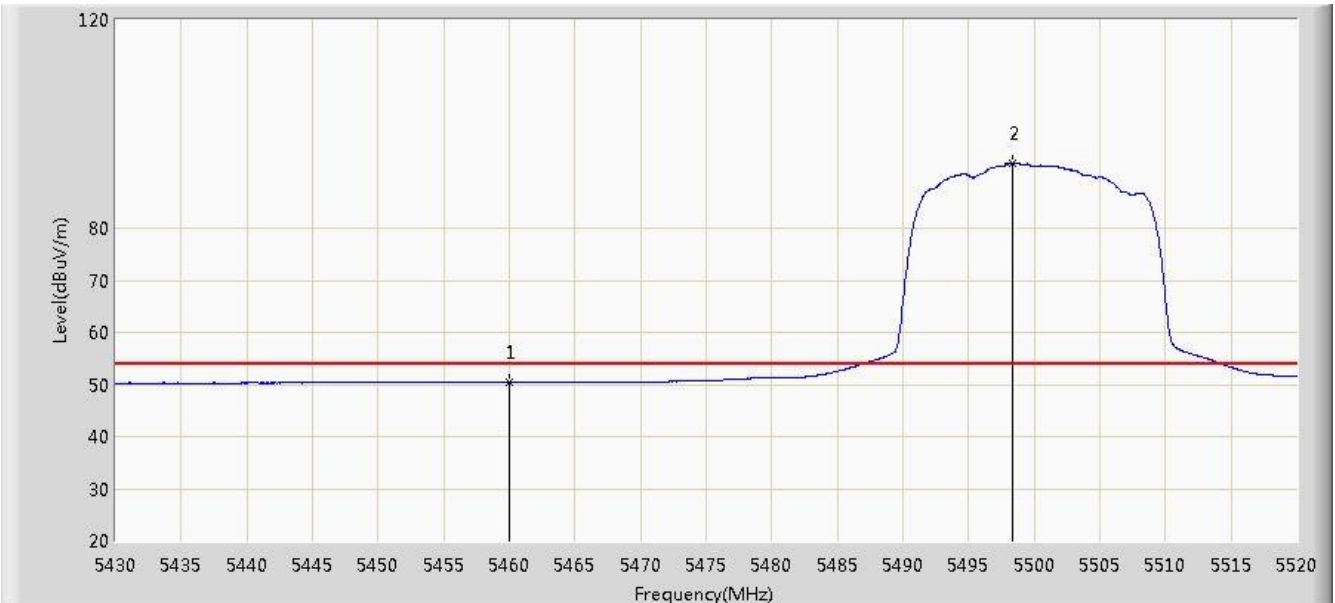

No	Flag	Mark	Frequency (MHz)	Measure Level (dBuV/m)	Reading Level (dBuV)	Over Limit (dB)	Limit (dBuV/m)	Factor (dB)	Type
1			5460.000	50.424	12.861	-3.576	54.000	37.563	AV
2		*	5498.310	92.533	54.910	N/A	N/A	37.623	AV

Note: Measure Level (dB μ V/m) = Reading Level (dB μ V) + Factor (dB)

Factor (dB) = Cable Loss (dB) + Antenna Factor (dB/m).

Site: AC1	Time: 2015/01/14 - 17:31
Limit: FCC_Part15.209_RE(3m)	Engineer: Roy Cheng
Probe: BBHA9120D_1-18GHz	Polarity: Vertical
EUT: WiFi Concurrent 4 Port GE LAN VoIP Ethernet Gateway with USB	Power: AC 120V/60Hz
Test Mode: Transmit at channel 5500MHz by 802.11ac-VHT20 Ant 0+1+2+3	

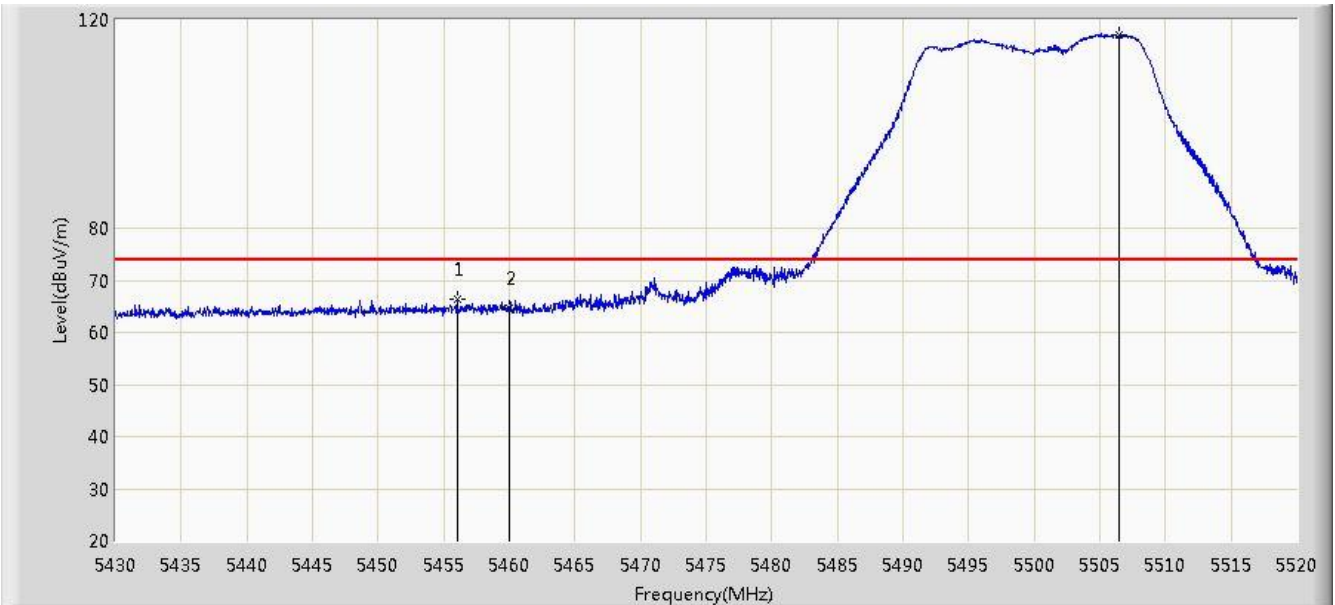

No	Flag	Mark	Frequency (MHz)	Measure Level (dBuV/m)	Reading Level (dBuV)	Over Limit (dB)	Limit (dBuV/m)	Factor (dB)	Type
1			5456.010	66.391	28.839	-7.609	74.000	37.552	PK
2			5460.000	64.495	26.932	-9.505	74.000	37.563	PK
3		*	5506.500	117.109	79.478	N/A	N/A	37.631	PK

Note: Measure Level (dBuV/m) = Reading Level (dBuV) + Factor (dB)

Factor (dB) = Cable Loss (dB) + Antenna Factor (dB/m).

Site: AC1	Time: 2015/01/14 - 17:33
Limit: FCC_Part15.209_RE(3m)	Engineer: Roy Cheng
Probe: BBHA9120D_1-18GHz	Polarity: Vertical
EUT: WiFi Concurrent 4 Port GE LAN VoIP Ethernet Gateway with USB	Power: AC 120V/60Hz
Test Mode: Transmit at channel 5500MHz by 802.11ac-VHT20 Ant 0+1+2+3	

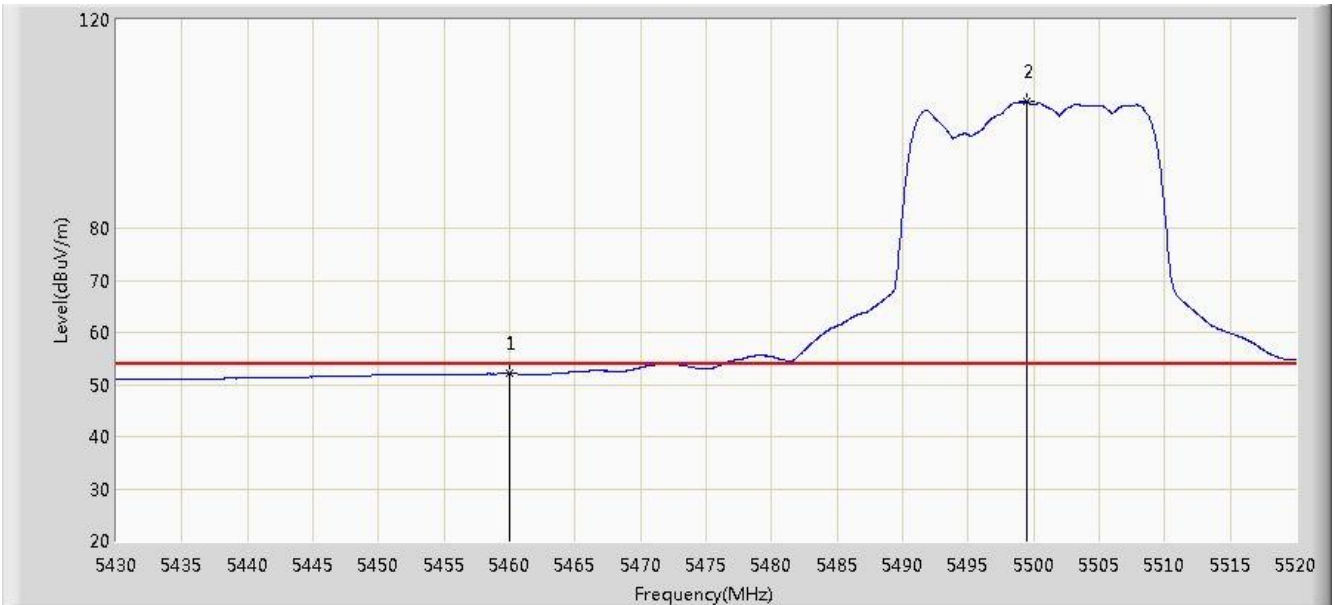

No	Flag	Mark	Frequency (MHz)	Measure Level (dBuV/m)	Reading Level (dBuV)	Over Limit (dB)	Limit (dBuV/m)	Factor (dB)	Type
1			5460.000	52.214	14.651	-1.786	54.000	37.563	AV
2		*	5499.525	104.342	66.718	N/A	N/A	37.624	AV

Note: Measure Level (dB μ V/m) = Reading Level (dB μ V) + Factor (dB)

Factor (dB) = Cable Loss (dB) + Antenna Factor (dB/m).

Site: AC1	Time: 2015/01/14 - 17:34
Limit: FCC_Part15.209_RE(3m)	Engineer: Roy Cheng
Probe: BBHA9120D_1-18GHz	Polarity: Horizontal
EUT: WiFi Concurrent 4 Port GE LAN VoIP Ethernet Gateway with USB	Power: AC 120V/60Hz
Test Mode: Transmit at channel 5700MHz by 802.11ac-VHT20 Ant 0+1+2+3	

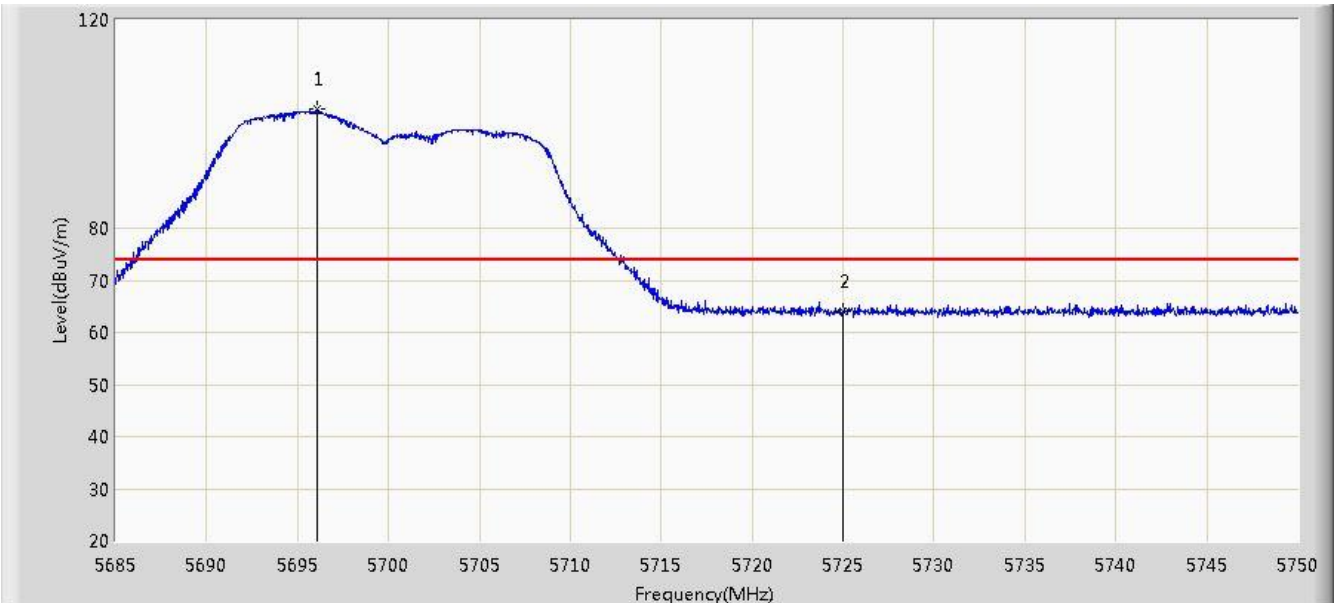

No	Flag	Mark	Frequency (MHz)	Measure Level (dBuV/m)	Reading Level (dBuV)	Over Limit (dB)	Limit (dBuV/m)	Factor (dB)	Type
1		*	5696.050	102.819	64.937	N/A	N/A	37.882	PK
2			5725.000	63.937	25.947	-10.063	74.000	37.990	PK

Note: Measure Level (dB μ V/m) = Reading Level (dB μ V) + Factor (dB)

Factor (dB) = Cable Loss (dB) + Antenna Factor (dB/m).

Site: AC1	Time: 2015/01/14 - 17:36
Limit: FCC_Part15.209_RE(3m)	Engineer: Roy Cheng
Probe: BBHA9120D_1-18GHz	Polarity: Horizontal
EUT: WiFi Concurrent 4 Port GE LAN VoIP Ethernet Gateway with USB	Power: AC 120V/60Hz
Test Mode: Transmit at channel 5700MHz by 802.11ac-VHT20 Ant 0+1+2+3	

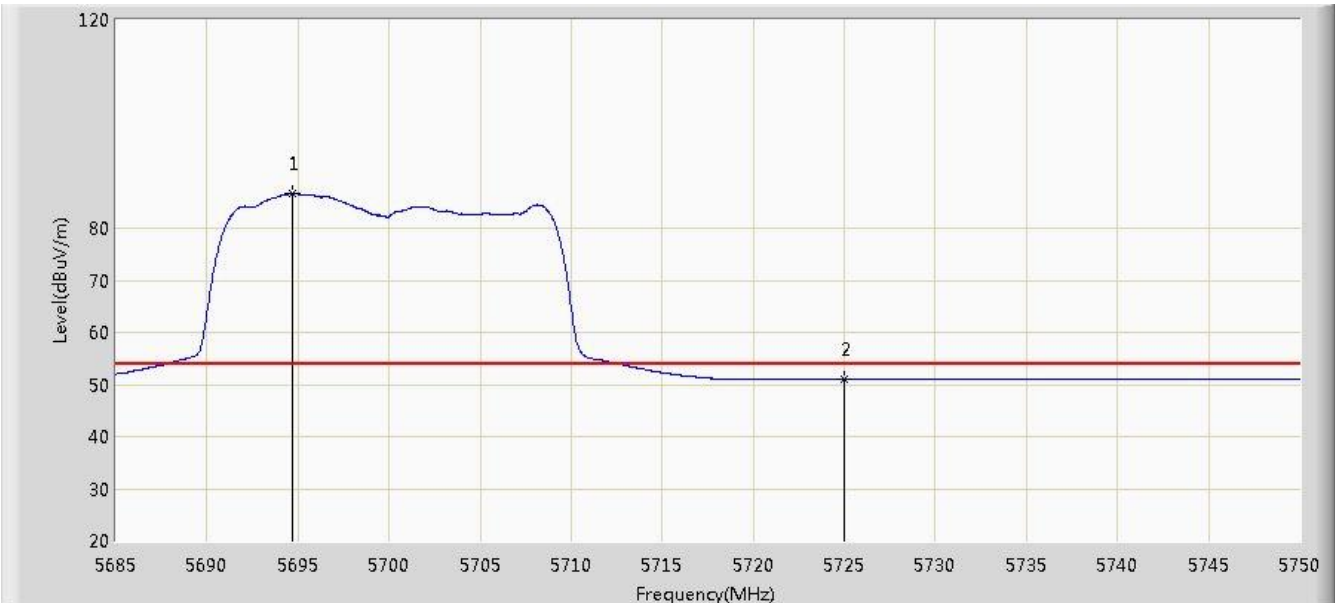

No	Flag	Mark	Frequency (MHz)	Measure Level (dBuV/m)	Reading Level (dBuV)	Over Limit (dB)	Limit (dBuV/m)	Factor (dB)	Type
1		*	5694.685	86.639	48.760	N/A	N/A	37.879	AV
2			5725.000	51.039	13.049	-2.961	54.000	37.990	AV

Note: Measure Level (dB μ V/m) = Reading Level (dB μ V) + Factor (dB)

Factor (dB) = Cable Loss (dB) + Antenna Factor (dB/m).

Site: AC1	Time: 2015/01/14 - 17:44
Limit: FCC_Part15.209_RE(3m)	Engineer: Roy Cheng
Probe: BBHA9120D_1-18GHz	Polarity: Vertical
EUT: WiFi Concurrent 4 Port GE LAN VoIP Ethernet Gateway with USB	Power: AC 120V/60Hz
Test Mode: Transmit at channel 5700MHz by 802.11ac-VHT20 Ant 0+1+2+3	

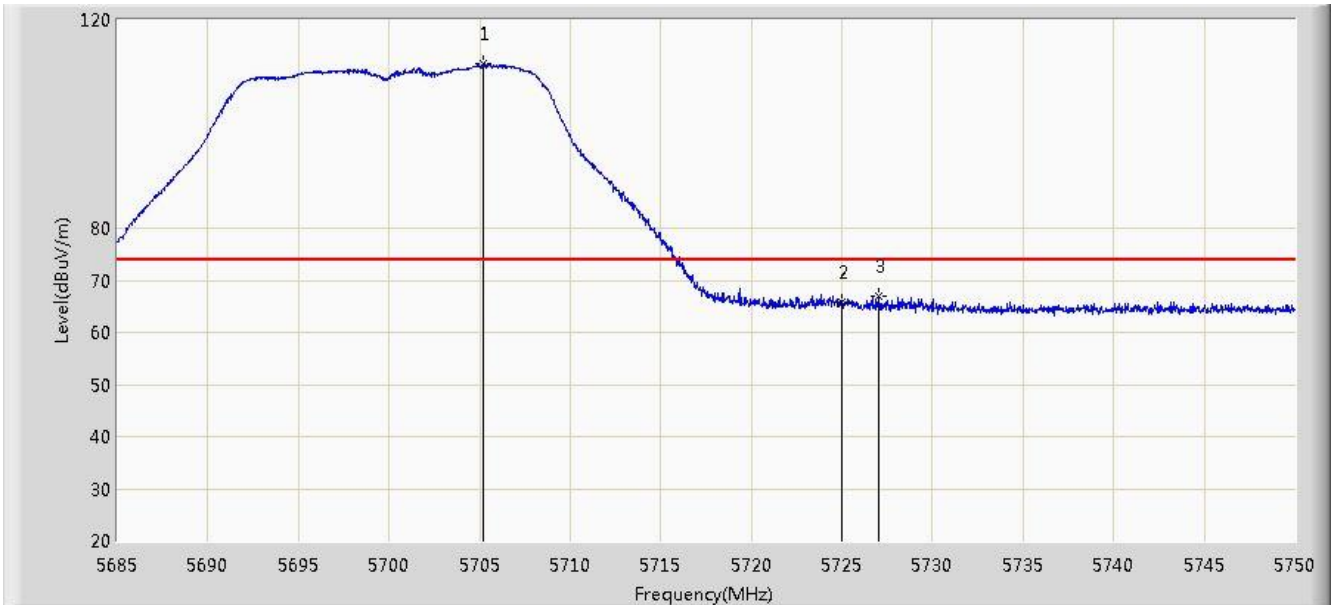

No	Flag	Mark	Frequency (MHz)	Measure Level (dBuV/m)	Reading Level (dBuV)	Over Limit (dB)	Limit (dBuV/m)	Factor (dB)	Type
1		*	5705.183	111.622	73.713	N/A	N/A	37.909	PK
2			5725.000	65.851	27.861	-8.149	74.000	37.990	PK
3			5727.055	66.915	28.917	-7.085	74.000	37.998	PK

Note: Measure Level (dBuV/m) = Reading Level (dBuV) + Factor (dB)

Factor (dB) = Cable Loss (dB) + Antenna Factor (dB/m).

Site: AC1	Time: 2015/01/14 - 17:40
Limit: FCC_Part15.209_RE(3m)	Engineer: Roy Cheng
Probe: BBHA9120D_1-18GHz	Polarity: Vertical
EUT: WiFi Concurrent 4 Port GE LAN VoIP Ethernet Gateway with USB	Power: AC 120V/60Hz
Test Mode: Transmit at channel 5700MHz by 802.11ac-VHT20 Ant 0+1+2+3	

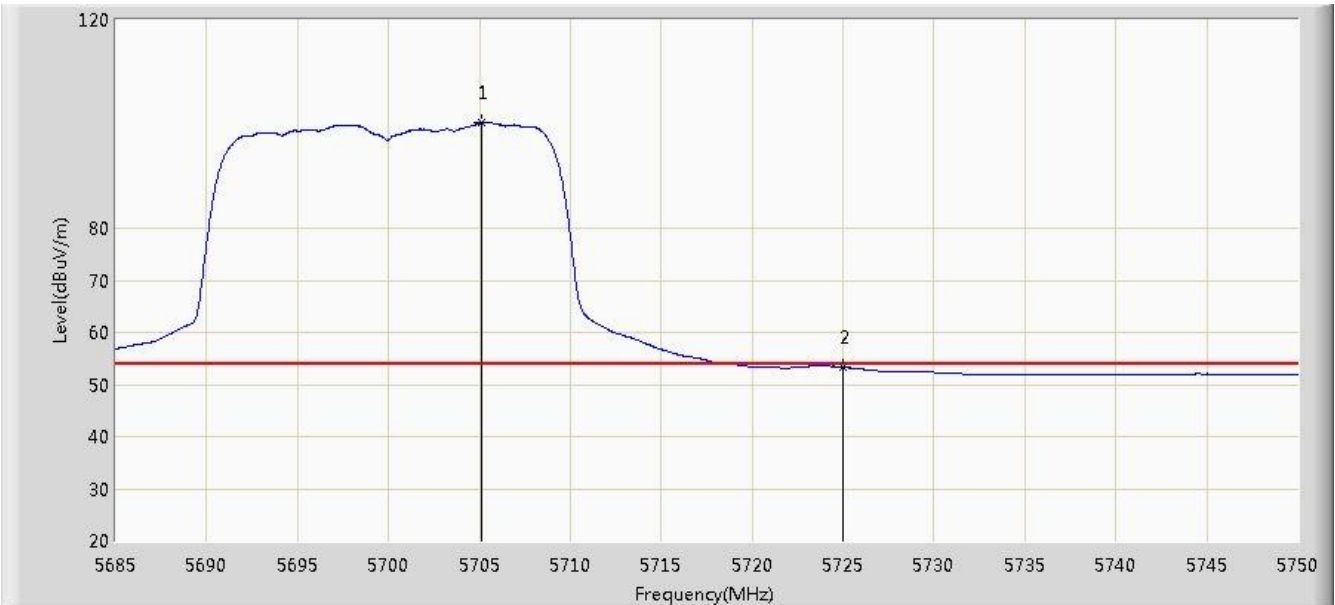

No	Flag	Mark	Frequency (MHz)	Measure Level (dBuV/m)	Reading Level (dBuV)	Over Limit (dB)	Limit (dBuV/m)	Factor (dB)	Type
1		*	5705.085	100.284	62.376	N/A	N/A	37.908	AV
2			5725.000	53.357	15.367	-0.643	54.000	37.990	AV

Note: Measure Level (dBμV/m) = Reading Level (dBμV) + Factor (dB)

Factor (dB) = Cable Loss (dB) + Antenna Factor (dB/m).

Site: AC1	Time: 2015/01/14 - 17:46
Limit: FCC 15.407	Engineer: Roy Cheng
Probe: BBHA9120D_1-18GHz	Polarity: Horizontal
EUT: WiFi Concurrent 4 Port GE LAN VoIP Ethernet Gateway with USB	Power: AC 120V/60Hz
Test Mode: Transmit at channel 5745MHz by 802.11ac-VHT20 Ant 0+1+2+3	

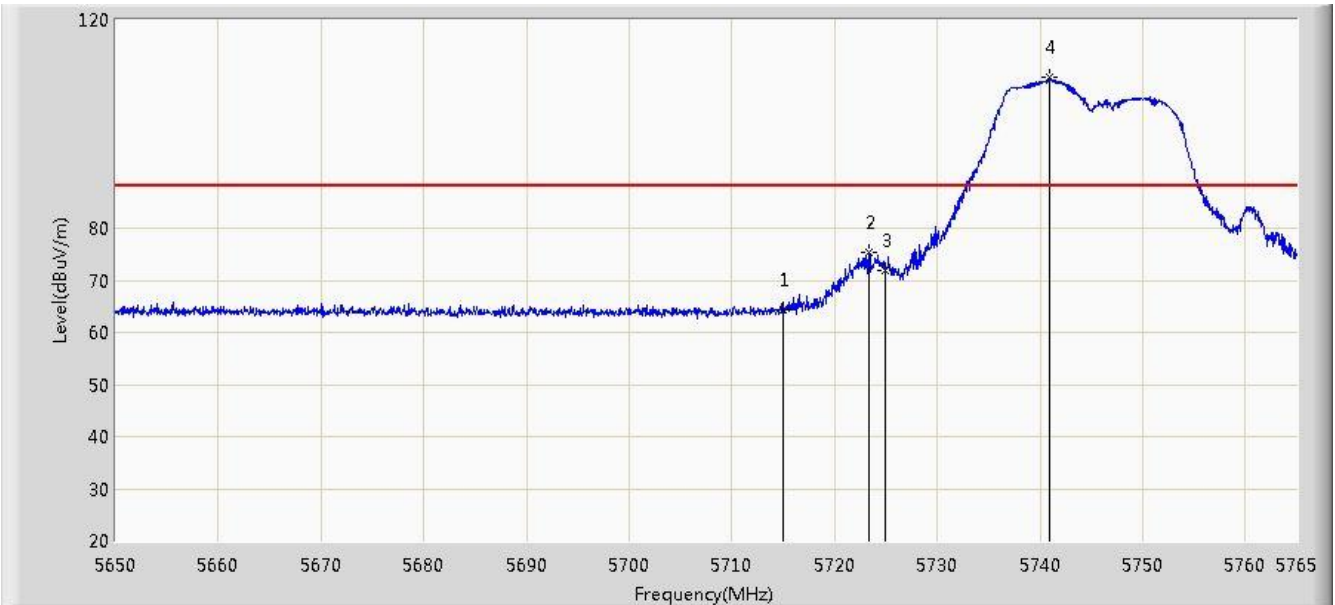

No	Flag	Mark	Frequency (MHz)	Measure Level (dBuV/m)	Reading Level (dBuV)	Over Limit (dB)	Limit (dBuV/m)	Factor (dB)	Type
1			5715.000	64.394	26.445	-23.806	88.200	37.949	PK
2			5723.312	75.291	37.308	-22.909	98.200	37.982	PK
3			5725.000	72.022	34.032	-26.178	98.200	37.990	PK
4		*	5740.908	108.911	70.857	N/A	N/A	38.054	PK

Note: Measure Level (dB μ V/m) = Reading Level (dB μ V) + Factor (dB)

Factor (dB) = Cable Loss (dB) + Antenna Factor (dB/m).

Site: AC1	Time: 2015/01/14 - 17:48
Limit: FCC 15.407	Engineer: Roy Cheng
Probe: BBHA9120D_1-18GHz	Polarity: Horizontal
EUT: WiFi Concurrent 4 Port GE LAN VoIP Ethernet Gateway with USB	Power: AC 120V/60Hz
Test Mode: Transmit at channel 5745MHz by 802.11ac-VHT20 Ant 0+1+2+3	

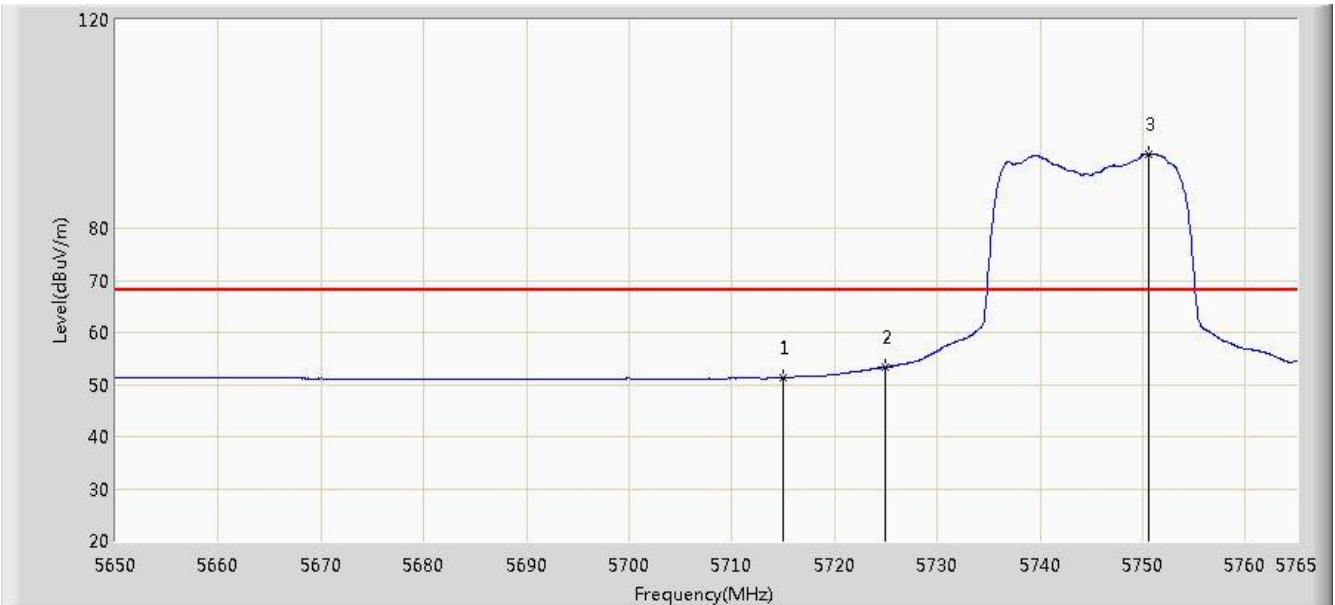

No	Flag	Mark	Frequency (MHz)	Measure Level (dBuV/m)	Reading Level (dBuV)	Over Limit (dB)	Limit (dBuV/m)	Factor (dB)	Type
1			5715.000	51.314	13.365	-16.886	68.200	37.949	AV
2			5725.000	53.331	15.341	-24.869	78.200	37.990	AV
3		*	5750.625	94.293	56.194	N/A	N/A	38.098	AV

Note: Measure Level (dBuV/m) = Reading Level (dBuV) + Factor (dB)

Factor (dB) = Cable Loss (dB) + Antenna Factor (dB/m).

Site: AC1	Time: 2015/01/14 - 17:49
Limit: FCC 15.407	Engineer: Roy Cheng
Probe: BBHA9120D_1-18GHz	Polarity: Vertical
EUT: WiFi Concurrent 4 Port GE LAN VoIP Ethernet Gateway with USB	Power: AC 120V/60Hz
Test Mode: Transmit at channel 5745MHz by 802.11ac-VHT20 Ant 0+1+2+3	

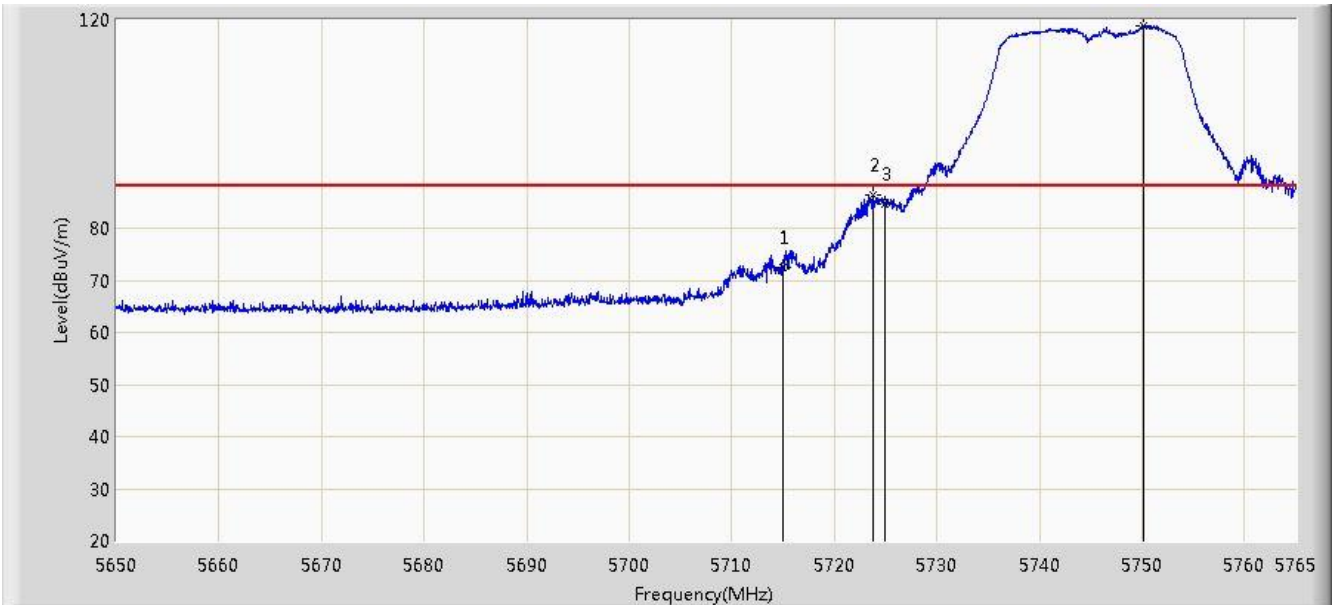

No	Flag	Mark	Frequency (MHz)	Measure Level (dBuV/m)	Reading Level (dBuV)	Over Limit (dB)	Limit (dBuV/m)	Factor (dB)	Type
1			5715.000	72.392	34.443	-15.808	88.200	37.949	PK
2			5723.830	86.271	48.286	-11.929	98.200	37.984	PK
3			5725.000	84.710	46.720	-13.490	98.200	37.990	PK
4		*	5750.165	118.762	80.665	N/A	N/A	38.097	PK

Note: Measure Level (dB μ V/m) = Reading Level (dB μ V) + Factor (dB)

Factor (dB) = Cable Loss (dB) + Antenna Factor (dB/m).

Site: AC1	Time: 2015/01/14 - 17:51
Limit: FCC 15.407	Engineer: Roy Cheng
Probe: BBHA9120D_1-18GHz	Polarity: Vertical
EUT: WiFi Concurrent 4 Port GE LAN VoIP Ethernet Gateway with USB	Power: AC 120V/60Hz
Test Mode: Transmit at channel 5745MHz by 802.11ac-VHT20 Ant 0+1+2+3	

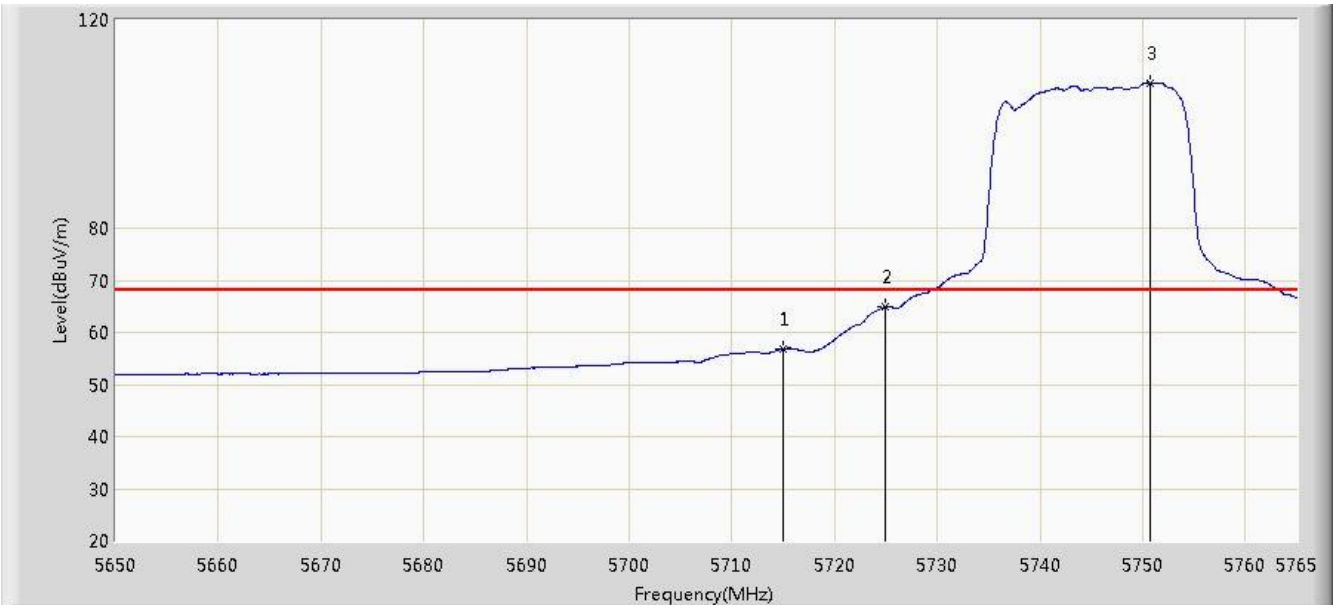

No	Flag	Mark	Frequency (MHz)	Measure Level (dBuV/m)	Reading Level (dBuV)	Over Limit (dB)	Limit (dBuV/m)	Factor (dB)	Type
1			5715.000	56.803	18.854	-11.397	68.200	37.949	AV
2			5725.000	64.819	26.829	-13.381	78.200	37.990	AV
3		*	5750.797	107.822	69.722	N/A	N/A	38.100	AV

Note: Measure Level (dBuV/m) = Reading Level (dBuV) + Factor (dB)

Factor (dB) = Cable Loss (dB) + Antenna Factor (dB/m).

Site: AC1	Time: 2015/01/14 - 17:53
Limit: FCC 15.407	Engineer: Roy Cheng
Probe: BBHA9120D_1-18GHz	Polarity: Horizontal
EUT: WiFi Concurrent 4 Port GE LAN VoIP Ethernet Gateway with USB	Power: AC 120V/60Hz
Test Mode: Transmit at channel 5825MHz by 802.11ac-VHT20 Ant 0+1+2+3	

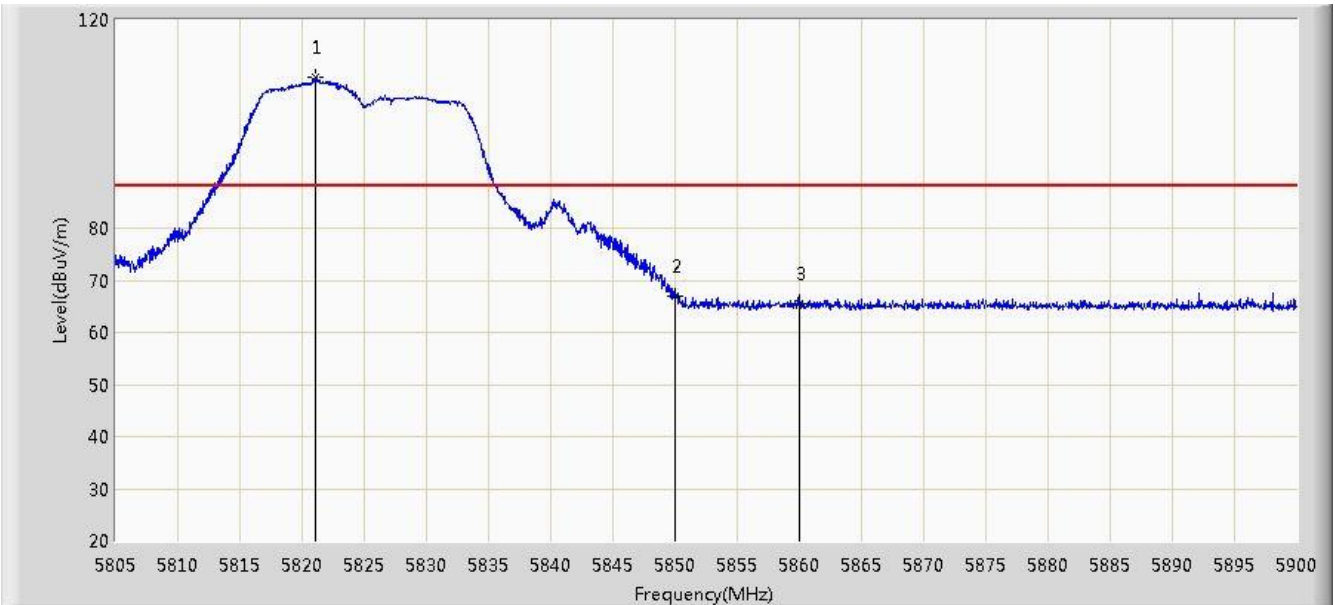

No	Flag	Mark	Frequency (MHz)	Measure Level (dBuV/m)	Reading Level (dBuV)	Over Limit (dB)	Limit (dBuV/m)	Factor (dB)	Type
1		*	5821.055	109.062	70.723	N/A	N/A	38.340	PK
2			5850.000	67.083	28.630	-31.117	98.200	38.454	PK
3			5860.000	65.435	26.957	-22.765	88.200	38.478	PK

Note: Measure Level (dB μ V/m) = Reading Level (dB μ V) + Factor (dB)

Factor (dB) = Cable Loss (dB) + Antenna Factor (dB/m).

Site: AC1	Time: 2015/01/14 - 17:54
Limit: FCC 15.407	Engineer: Roy Cheng
Probe: BBHA9120D_1-18GHz	Polarity: Horizontal
EUT: WiFi Concurrent 4 Port GE LAN VoIP Ethernet Gateway with USB	Power: AC 120V/60Hz
Test Mode: Transmit at channel 5825MHz by 802.11ac-VHT20 Ant 0+1+2+3	

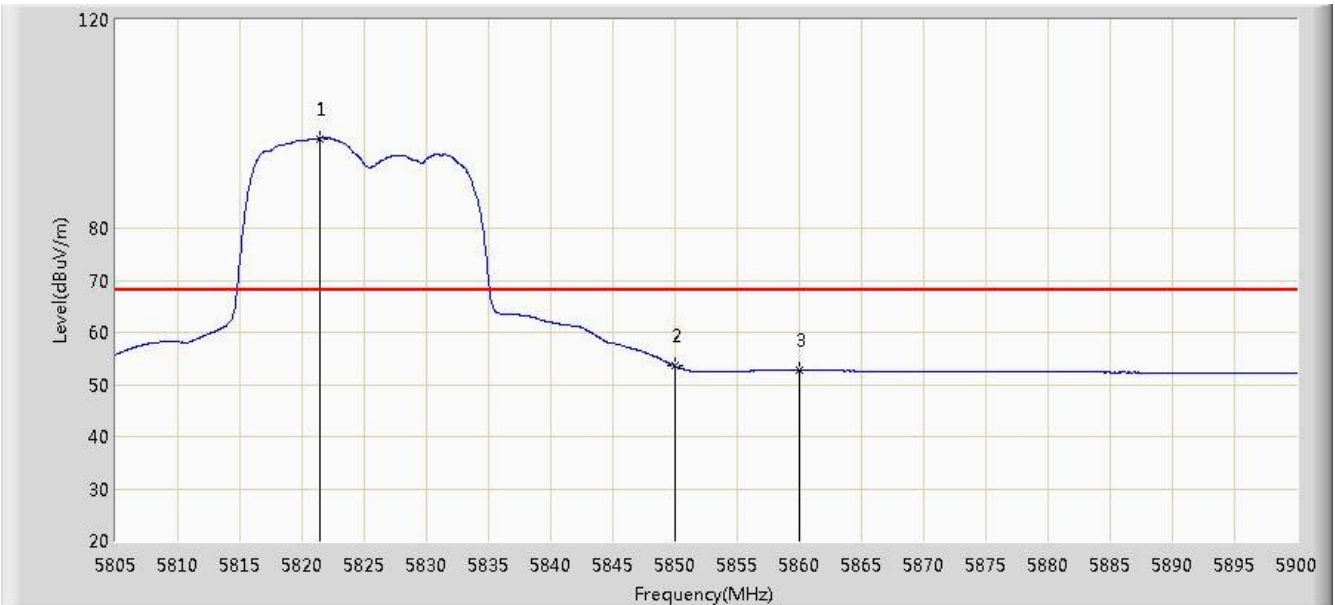

No	Flag	Mark	Frequency (MHz)	Measure Level (dBuV/m)	Reading Level (dBuV)	Over Limit (dB)	Limit (dBuV/m)	Factor (dB)	Type
1		*	5821.388	97.204	58.863	N/A	N/A	38.341	AV
2			5850.000	53.545	15.092	-24.655	78.200	38.454	AV
3			5860.000	52.726	14.248	-15.474	68.200	38.478	AV

Note: Measure Level (dBμV/m) = Reading Level (dBμV) + Factor (dB)

Factor (dB) = Cable Loss (dB) + Antenna Factor (dB/m).

Site: AC1	Time: 2015/01/14 - 17:57
Limit: FCC 15.407	Engineer: Roy Cheng
Probe: BBHA9120D_1-18GHz	Polarity: Vertical
EUT: WiFi Concurrent 4 Port GE LAN VoIP Ethernet Gateway with USB	Power: AC 120V/60Hz
Test Mode: Transmit at channel 5825MHz by 802.11ac-VHT20 Ant 0+1+2+3	

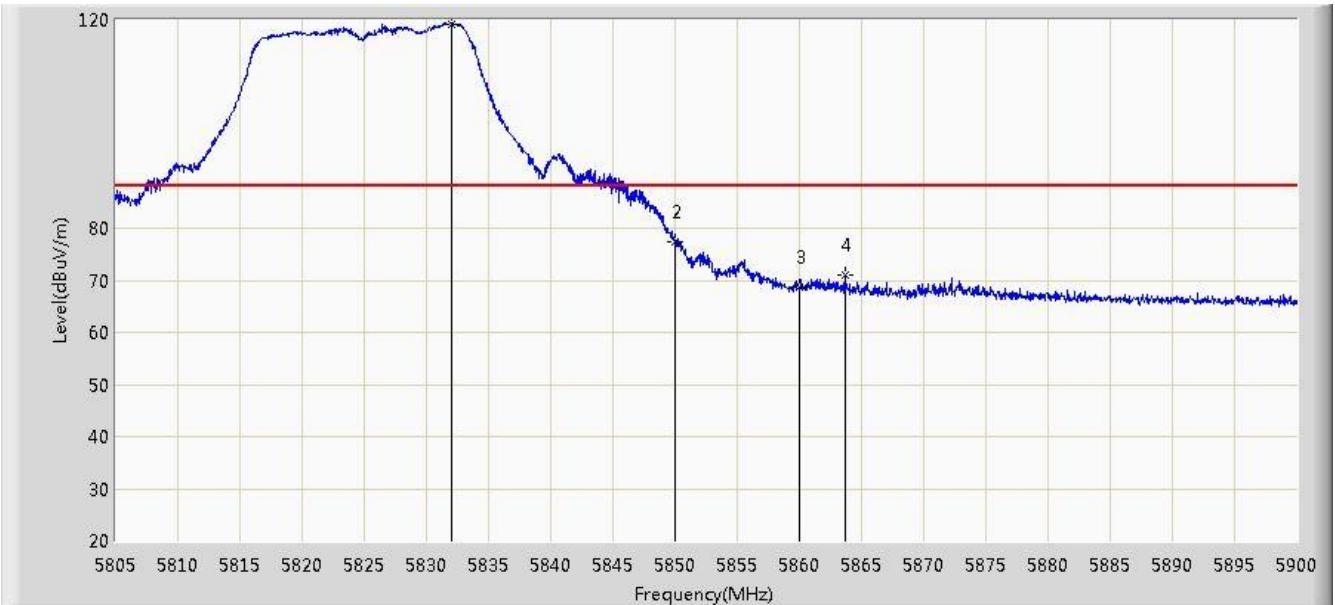

No	Flag	Mark	Frequency (MHz)	Measure Level (dBuV/m)	Reading Level (dBuV)	Over Limit (dB)	Limit (dBuV/m)	Factor (dB)	Type
1		*	5831.980	119.259	80.874	N/A	N/A	38.386	PK
2			5850.000	77.532	39.079	-20.668	98.200	38.454	PK
3			5860.000	68.598	30.120	-19.602	88.200	38.478	PK
4			5863.663	71.118	32.633	-17.082	88.200	38.484	PK

Note: Measure Level (dB μ V/m) = Reading Level (dB μ V) + Factor (dB)

Factor (dB) = Cable Loss (dB) + Antenna Factor (dB/m).

Site: AC1	Time: 2015/01/14 - 17:58
Limit: FCC 15.407	Engineer: Roy Cheng
Probe: BBHA9120D_1-18GHz	Polarity: Vertical
EUT: WiFi Concurrent 4 Port GE LAN VoIP Ethernet Gateway with USB	Power: AC 120V/60Hz
Test Mode: Transmit at channel 5825MHz by 802.11ac-VHT20 Ant 0+1+2+3	

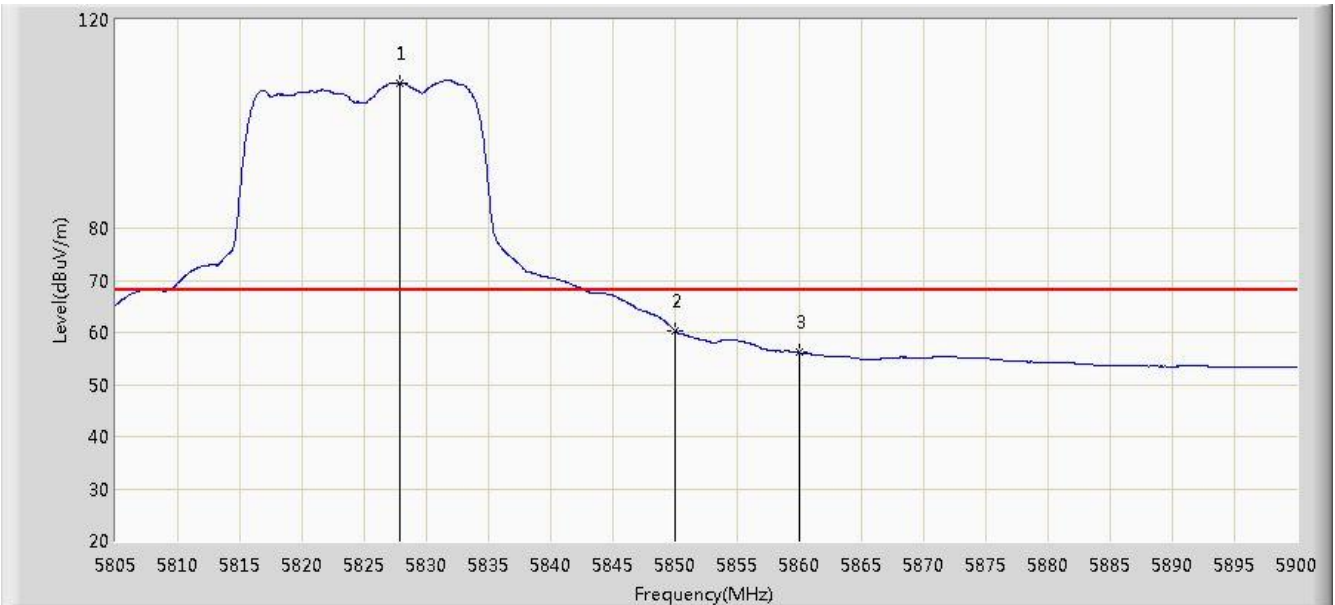

No	Flag	Mark	Frequency (MHz)	Measure Level (dBuV/m)	Reading Level (dBuV)	Over Limit (dB)	Limit (dBuV/m)	Factor (dB)	Type
1		*	5827.848	107.910	69.543	N/A	N/A	38.368	AV
2			5850.000	60.377	21.924	-17.823	78.200	38.454	AV
3			5860.000	56.098	17.620	-12.102	68.200	38.478	AV

Note: Measure Level (dBuV/m) = Reading Level (dBuV) + Factor (dB)

Factor (dB) = Cable Loss (dB) + Antenna Factor (dB/m).

Site: AC1	Time: 2015/01/14 - 20:15
Limit: FCC_Part15.209_RE(3m)	Engineer: Roy Cheng
Probe: BBHA9120D_1-18GHz	Polarity: Horizontal
EUT: WiFi Concurrent 4 Port GE LAN VoIP Ethernet Gateway with USB	Power: AC 120V/60Hz
Test Mode: Transmit at channel 5190MHz by 802.11ac-VHT40 Ant 0+1+2+3	

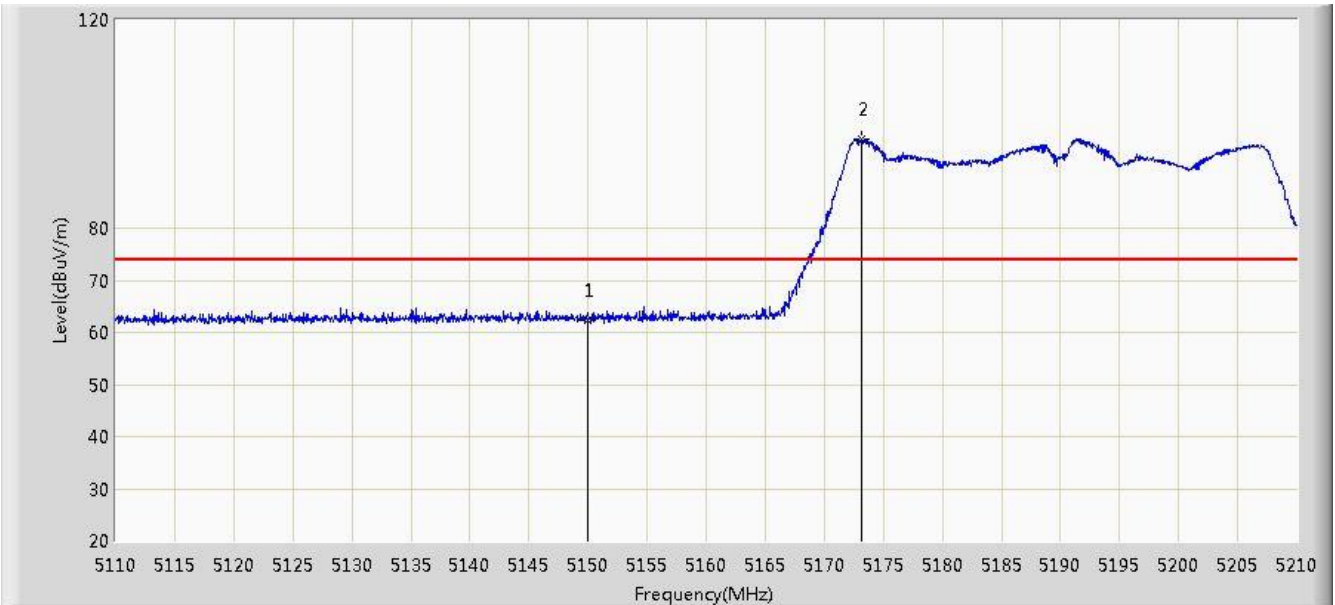

No	Flag	Mark	Frequency (MHz)	Measure Level (dBuV/m)	Reading Level (dBuV)	Over Limit (dB)	Limit (dBuV/m)	Factor (dB)	Type
1			5150.000	62.174	24.722	-11.826	74.000	37.452	PK
2		*	5173.200	97.199	59.810	N/A	N/A	37.390	PK

Note: Measure Level (dB μ V/m) = Reading Level (dB μ V) + Factor (dB)

Factor (dB) = Cable Loss (dB) + Antenna Factor (dB/m).

Site: AC1	Time: 2015/01/14 - 20:17
Limit: FCC_Part15.209_RE(3m)	Engineer: Roy Cheng
Probe: BBHA9120D_1-18GHz	Polarity: Horizontal
EUT: WiFi Concurrent 4 Port GE LAN VoIP Ethernet Gateway with USB	Power: AC 120V/60Hz
Test Mode: Transmit at channel 5190MHz by 802.11ac-VHT40 Ant 0+1+2+3	

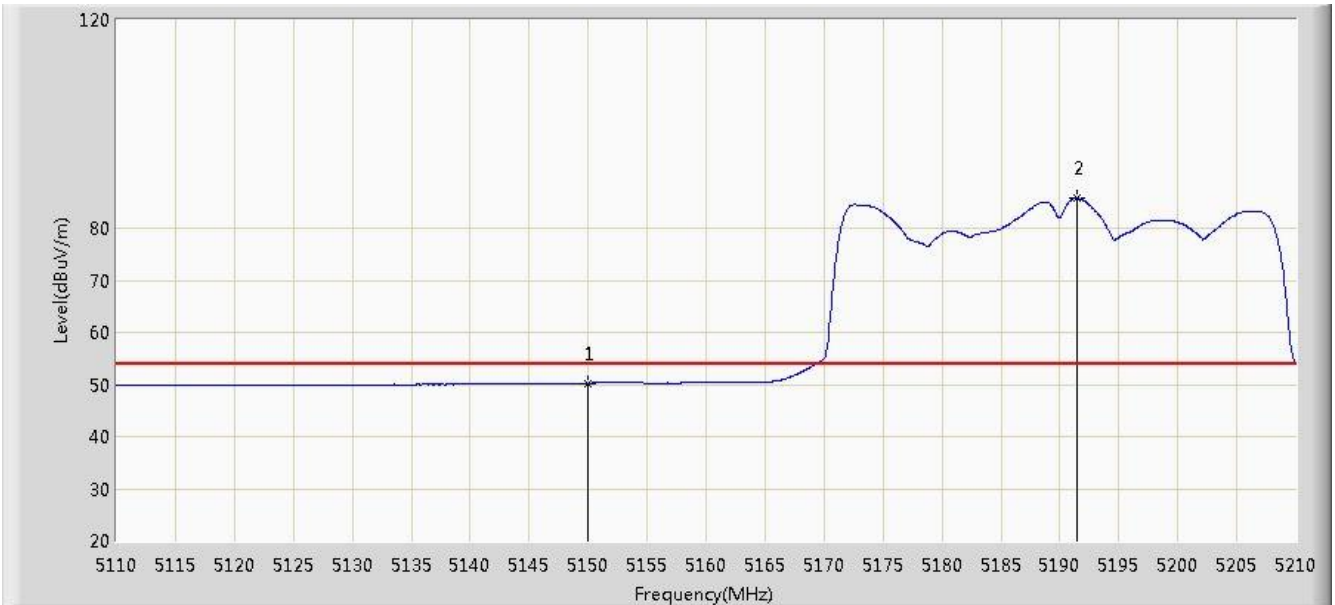

No	Flag	Mark	Frequency (MHz)	Measure Level (dBuV/m)	Reading Level (dBuV)	Over Limit (dB)	Limit (dBuV/m)	Factor (dB)	Type
1			5150.000	50.275	12.823	-3.725	54.000	37.452	AV
2		*	5191.450	85.713	48.368	N/A	N/A	37.345	AV

Note: Measure Level (dB μ V/m) = Reading Level (dB μ V) + Factor (dB)

Factor (dB) = Cable Loss (dB) + Antenna Factor (dB/m).

Site: AC1	Time: 2015/01/14 - 20:14
Limit: FCC_Part15.209_RE(3m)	Engineer: Roy Cheng
Probe: BBHA9120D_1-18GHz	Polarity: Vertical
EUT: WiFi Concurrent 4 Port GE LAN VoIP Ethernet Gateway with USB	Power: AC 120V/60Hz
Test Mode: Transmit at channel 5190MHz by 802.11ac-VHT40 Ant 0+1+2+3	

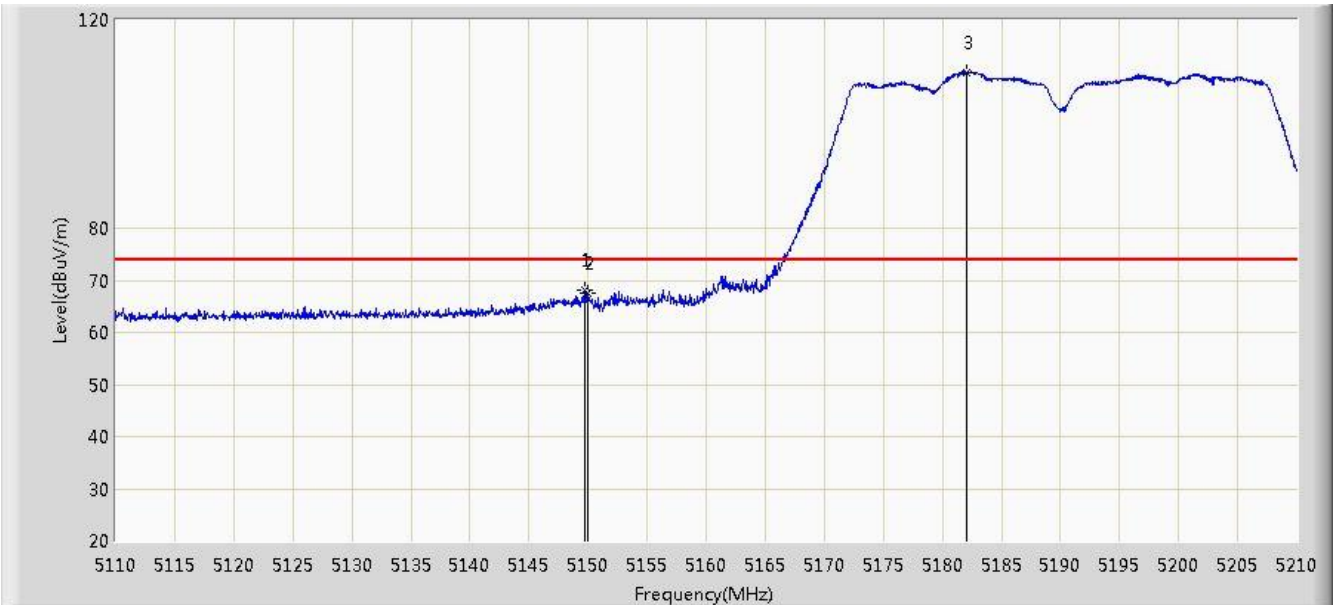

No	Flag	Mark	Frequency (MHz)	Measure Level (dBuV/m)	Reading Level (dBuV)	Over Limit (dB)	Limit (dBuV/m)	Factor (dB)	Type
1			5149.700	68.003	30.551	-5.997	74.000	37.452	PK
2			5150.000	67.579	30.127	-6.421	74.000	37.452	PK
3		*	5182.000	109.981	72.612	N/A	N/A	37.369	PK

Note: Measure Level (dBuV/m) = Reading Level (dBuV) + Factor (dB)

Factor (dB) = Cable Loss (dB) + Antenna Factor (dB/m).

Site: AC1	Time: 2015/01/14 - 18:29
Limit: FCC_Part15.209_RE(3m)	Engineer: Roy Cheng
Probe: BBHA9120D_1-18GHz	Polarity: Vertical
EUT: WiFi Concurrent 4 Port GE LAN VoIP Ethernet Gateway with USB	Power: AC 120V/60Hz
Test Mode: Transmit at channel 5190MHz by 802.11ac-VHT40 Ant 0+1+2+3	

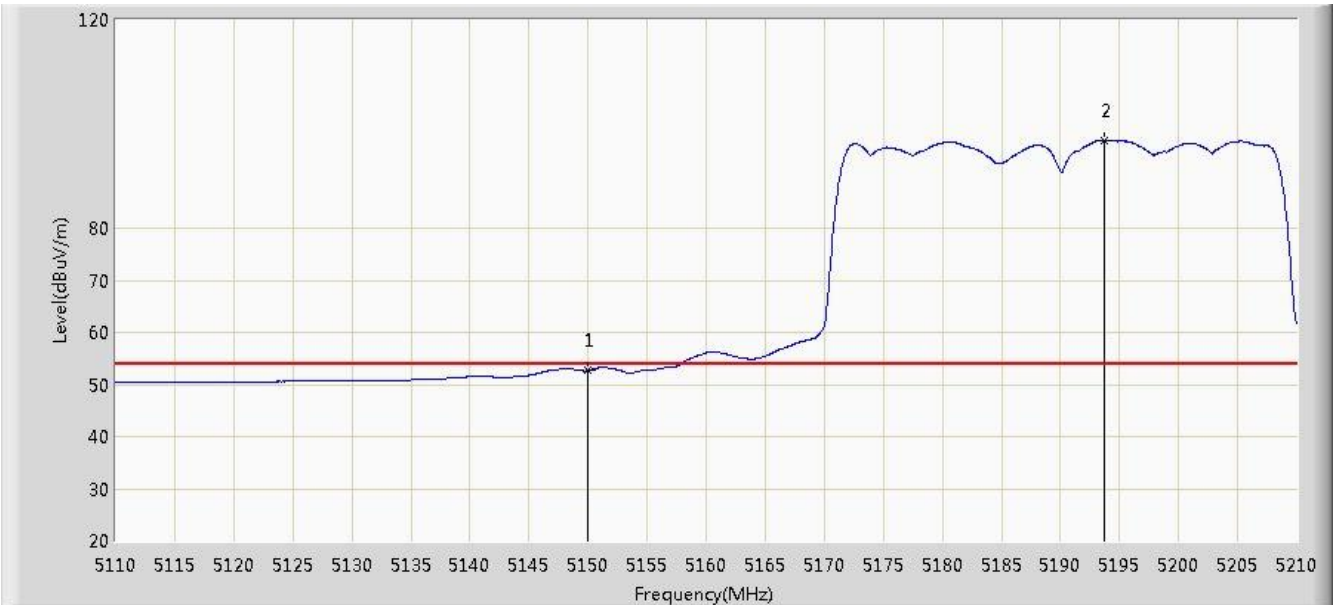

No	Flag	Mark	Frequency (MHz)	Measure Level (dBuV/m)	Reading Level (dBuV)	Over Limit (dB)	Limit (dBuV/m)	Factor (dB)	Type
1			5150.000	52.703	15.251	-1.297	54.000	37.452	AV
2		*	5193.650	96.865	59.525	N/A	N/A	37.340	AV

Note: Measure Level (dB μ V/m) = Reading Level (dB μ V) + Factor (dB)

Factor (dB) = Cable Loss (dB) + Antenna Factor (dB/m).

Site: AC1	Time: 2015/01/14 - 20:31
Limit: FCC_Part15.209_RE(3m)	Engineer: Roy Cheng
Probe: BBHA9120D_1-18GHz	Polarity: Horizontal
EUT: WiFi Concurrent 4 Port GE LAN VoIP Ethernet Gateway with USB	Power: AC 120V/60Hz
Test Mode: Transmit at channel 5310MHz by 802.11ac-VHT40 Ant 0+1+2+3	

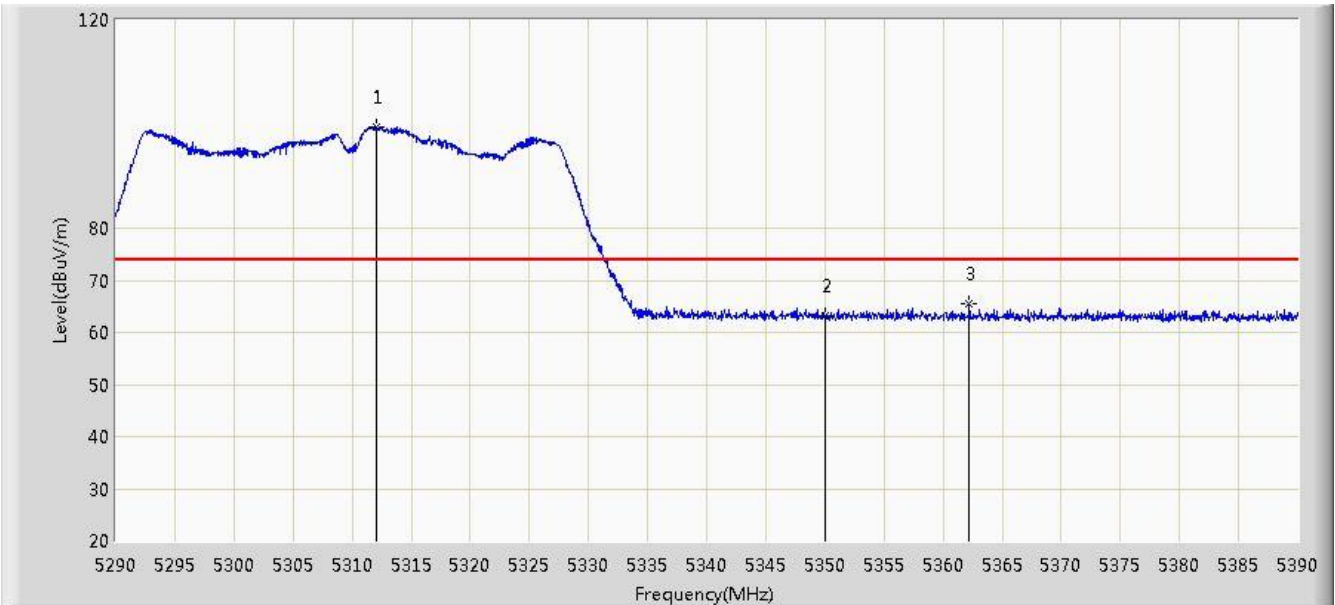

No	Flag	Mark	Frequency (MHz)	Measure Level (dBuV/m)	Reading Level (dBuV)	Over Limit (dB)	Limit (dBuV/m)	Factor (dB)	Type
1		*	5312.050	99.352	62.152	N/A	N/A	37.200	PK
2			5350.000	63.091	25.805	-10.909	74.000	37.286	PK
3			5362.200	65.441	28.121	-8.559	74.000	37.320	PK

Note: Measure Level (dBuV/m) = Reading Level (dBuV) + Factor (dB)

Factor (dB) = Cable Loss (dB) + Antenna Factor (dB/m).

Site: AC1	Time: 2015/01/14 - 20:32
Limit: FCC_Part15.209_RE(3m)	Engineer: Roy Cheng
Probe: BBHA9120D_1-18GHz	Polarity: Horizontal
EUT: WiFi Concurrent 4 Port GE LAN VoIP Ethernet Gateway with USB	Power: AC 120V/60Hz
Test Mode: Transmit at channel 5310MHz by 802.11ac-VHT40 Ant 0+1+2+3	

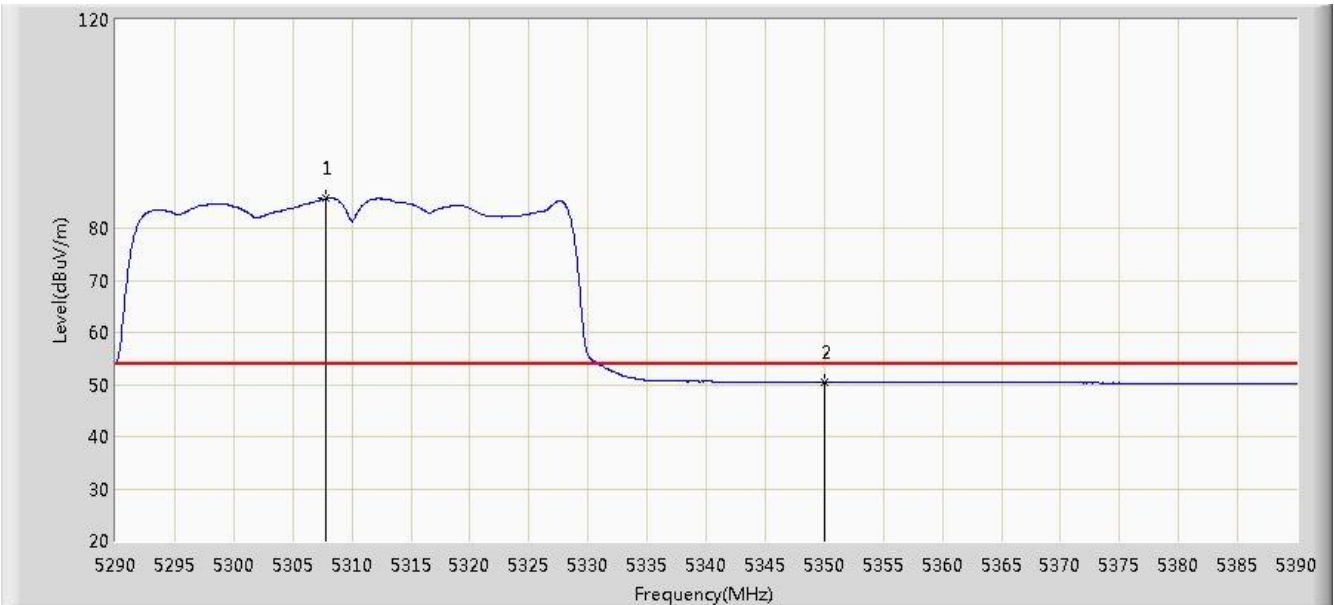

No	Flag	Mark	Frequency (MHz)	Measure Level (dBuV/m)	Reading Level (dBuV)	Over Limit (dB)	Limit (dBuV/m)	Factor (dB)	Type
1		*	5307.850	85.754	48.559	N/A	N/A	37.195	AV
2			5350.000	50.564	13.278	-3.436	54.000	37.286	AV

Note: Measure Level (dB μ V/m) = Reading Level (dB μ V) + Factor (dB)

Factor (dB) = Cable Loss (dB) + Antenna Factor (dB/m).

Site: AC1	Time: 2015/01/14 - 20:30
Limit: FCC_Part15.209_RE(3m)	Engineer: Roy Cheng
Probe: BBHA9120D_1-18GHz	Polarity: Vertical
EUT: WiFi Concurrent 4 Port GE LAN VoIP Ethernet Gateway with USB	Power: AC 120V/60Hz
Test Mode: Transmit at channel 5310MHz by 802.11ac-VHT40 Ant 0+1+2+3	

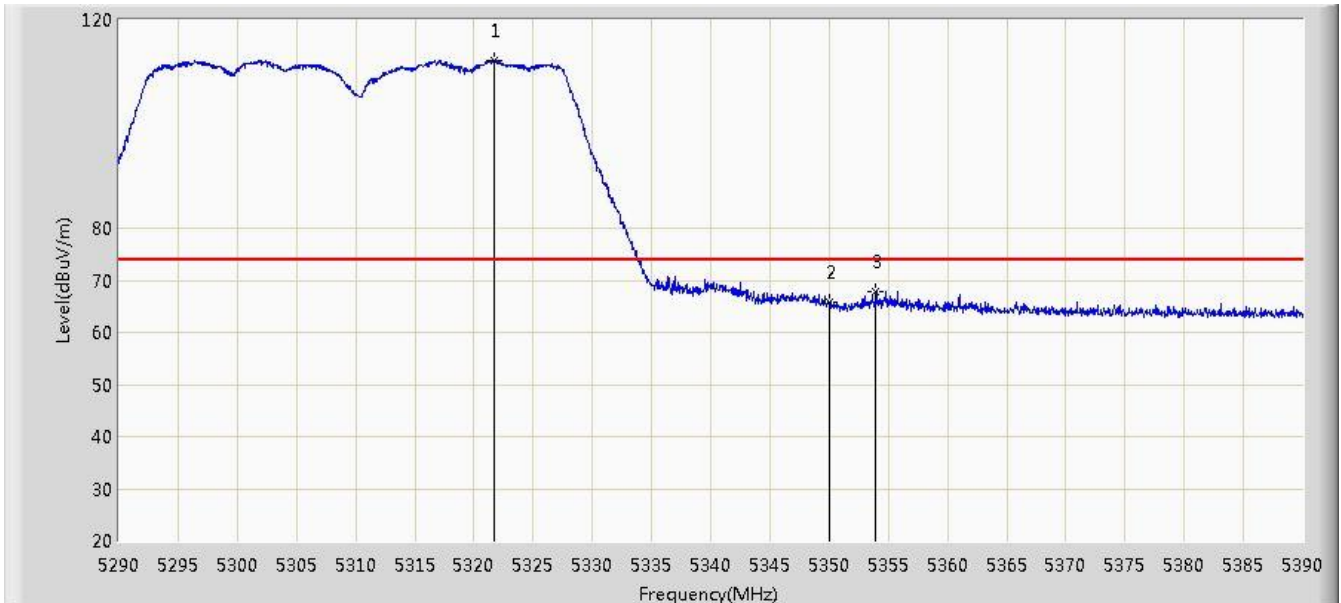

No	Flag	Mark	Frequency (MHz)	Measure Level (dBuV/m)	Reading Level (dBuV)	Over Limit (dB)	Limit (dBuV/m)	Factor (dB)	Type
1		*	5321.650	112.092	74.875	N/A	N/A	37.217	PK
2			5350.000	65.863	28.577	-8.137	74.000	37.286	PK
3			5353.900	67.810	30.512	-6.190	74.000	37.298	PK

Note: Measure Level (dBuV/m) = Reading Level (dBuV) + Factor (dB)

Factor (dB) = Cable Loss (dB) + Antenna Factor (dB/m).

Site: AC1	Time: 2015/01/14 - 20:28
Limit: FCC_Part15.209_RE(3m)	Engineer: Roy Cheng
Probe: BBHA9120D_1-18GHz	Polarity: Vertical
EUT: WiFi Concurrent 4 Port GE LAN VoIP Ethernet Gateway with USB	Power: AC 120V/60Hz
Test Mode: Transmit at channel 5310MHz by 802.11ac-VHT40 Ant 0+1+2+3	

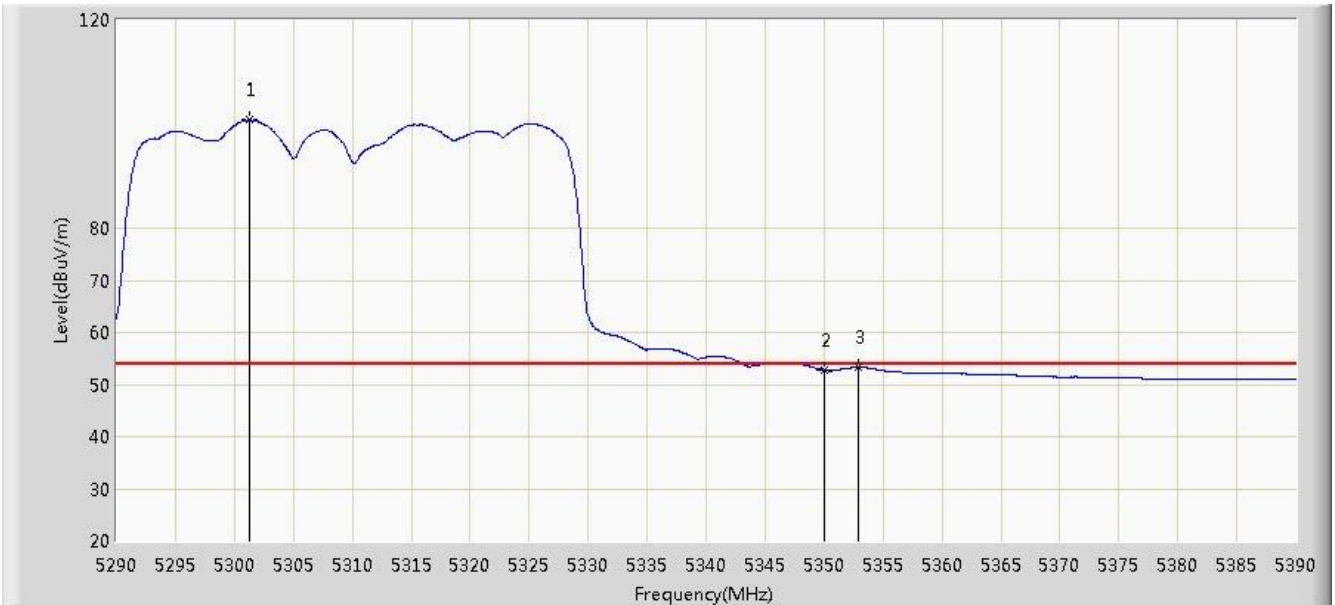

No	Flag	Mark	Frequency (MHz)	Measure Level (dBuV/m)	Reading Level (dBuV)	Over Limit (dB)	Limit (dBuV/m)	Factor (dB)	Type
1		*	5301.300	100.745	63.557	N/A	N/A	37.188	AV
2			5350.000	52.734	15.448	-1.266	54.000	37.286	AV
3			5352.950	53.250	15.955	-0.750	54.000	37.295	AV

Note: Measure Level (dBuV/m) = Reading Level (dBuV) + Factor (dB)

Factor (dB) = Cable Loss (dB) + Antenna Factor (dB/m).

Site: AC1	Time: 2015/01/14 - 20:45
Limit: FCC_Part15.209_RE(3m)	Engineer: Roy Cheng
Probe: BBHA9120D_1-18GHz	Polarity: Horizontal
EUT: WiFi Concurrent 4 Port GE LAN VoIP Ethernet Gateway with USB	Power: AC 120V/60Hz
Test Mode: Transmit at channel 5510MHz by 802.11ac-VHT40 Ant 0+1+2+3	

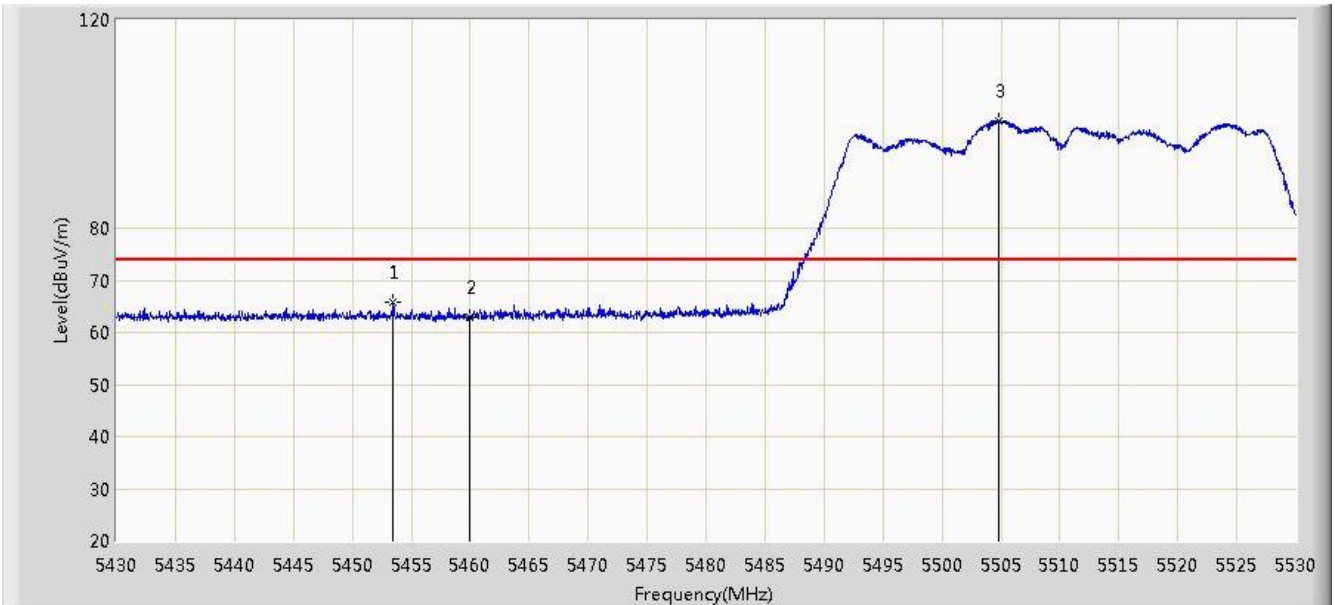

No	Flag	Mark	Frequency (MHz)	Measure Level (dBuV/m)	Reading Level (dBuV)	Over Limit (dB)	Limit (dBuV/m)	Factor (dB)	Type
1			5453.450	65.717	28.172	-8.283	74.000	37.545	PK
2			5460.000	63.025	25.462	-10.975	74.000	37.563	PK
3		*	5504.850	100.657	63.027	N/A	N/A	37.630	PK

Note: Measure Level (dBuV/m) = Reading Level (dBuV) + Factor (dB)

Factor (dB) = Cable Loss (dB) + Antenna Factor (dB/m).

Site: AC1	Time: 2015/01/14 - 20:46
Limit: FCC_Part15.209_RE(3m)	Engineer: Roy Cheng
Probe: BBHA9120D_1-18GHz	Polarity: Horizontal
EUT: WiFi Concurrent 4 Port GE LAN VoIP Ethernet Gateway with USB	Power: AC 120V/60Hz
Test Mode: Transmit at channel 5510MHz by 802.11ac-VHT40 Ant 0+1+2+3	

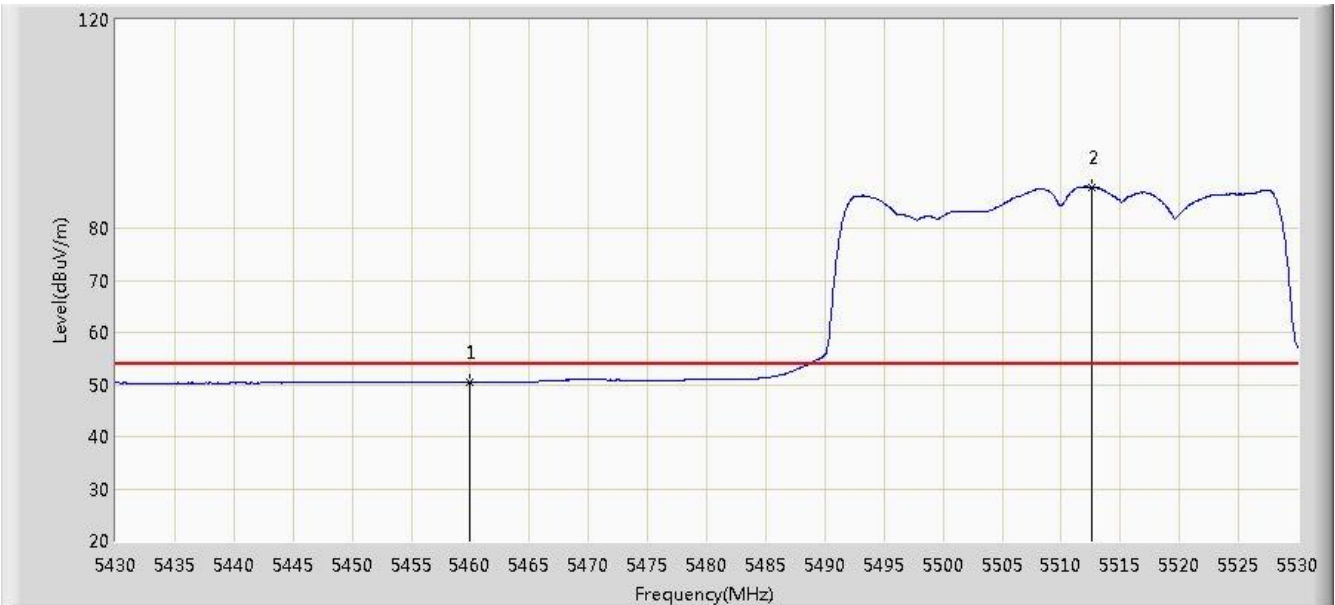

No	Flag	Mark	Frequency (MHz)	Measure Level (dBuV/m)	Reading Level (dBuV)	Over Limit (dB)	Limit (dBuV/m)	Factor (dB)	Type
1			5460.000	50.451	12.888	-3.549	54.000	37.563	AV
2		*	5512.550	87.860	50.222	N/A	N/A	37.638	AV

Note: Measure Level (dB μ V/m) = Reading Level (dB μ V) + Factor (dB)

Factor (dB) = Cable Loss (dB) + Antenna Factor (dB/m).

Site: AC1	Time: 2015/01/14 - 20:43
Limit: FCC_Part15.209_RE(3m)	Engineer: Roy Cheng
Probe: BBHA9120D_1-18GHz	Polarity: Vertical
EUT: WiFi Concurrent 4 Port GE LAN VoIP Ethernet Gateway with USB	Power: AC 120V/60Hz
Test Mode: Transmit at channel 5510MHz by 802.11ac-VHT40 Ant 0+1+2+3	

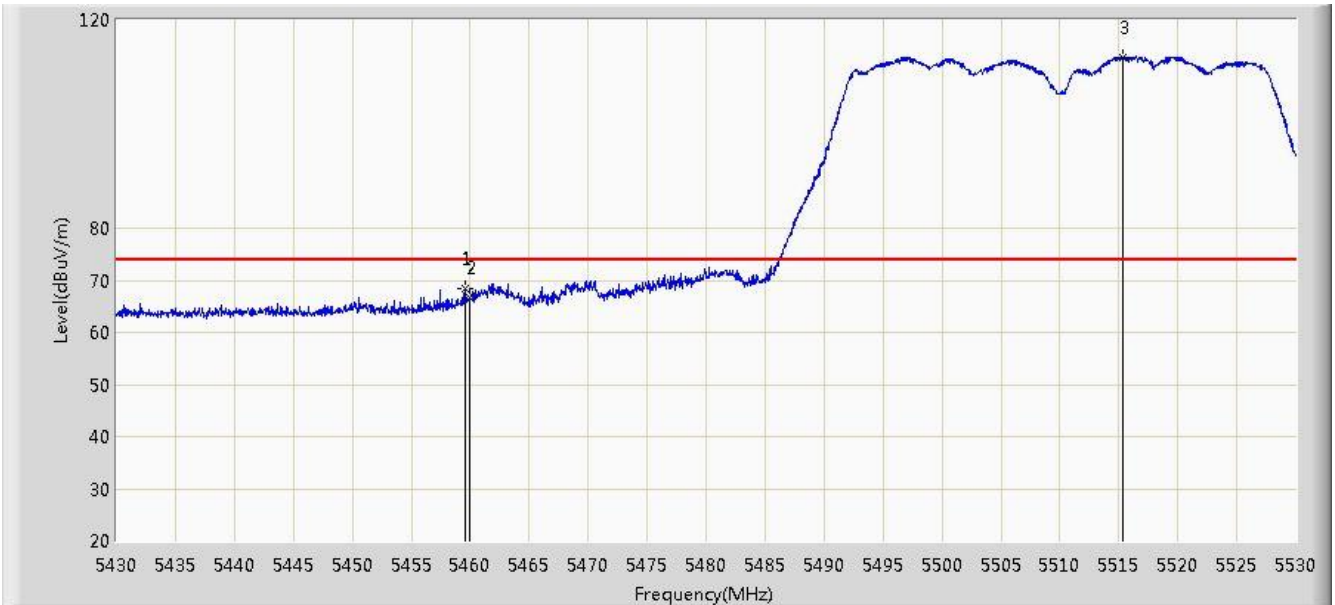

No	Flag	Mark	Frequency (MHz)	Measure Level (dBuV/m)	Reading Level (dBuV)	Over Limit (dB)	Limit (dBuV/m)	Factor (dB)	Type
1			5459.550	68.543	30.982	-5.457	74.000	37.562	PK
2			5460.000	66.613	29.050	-7.387	74.000	37.563	PK
3		*	5515.400	112.752	75.110	N/A	N/A	37.641	PK

Note: Measure Level (dBμV/m) = Reading Level (dBμV) + Factor (dB)

Factor (dB) = Cable Loss (dB) + Antenna Factor (dB/m).

Site: AC1	Time: 2015/01/14 - 20:40
Limit: FCC_Part15.209_RE(3m)	Engineer: Roy Cheng
Probe: BBHA9120D_1-18GHz	Polarity: Vertical
EUT: WiFi Concurrent 4 Port GE LAN VoIP Ethernet Gateway with USB	Power: AC 120V/60Hz
Test Mode: Transmit at channel 5510MHz by 802.11ac-VHT40 Ant 0+1+2+3	

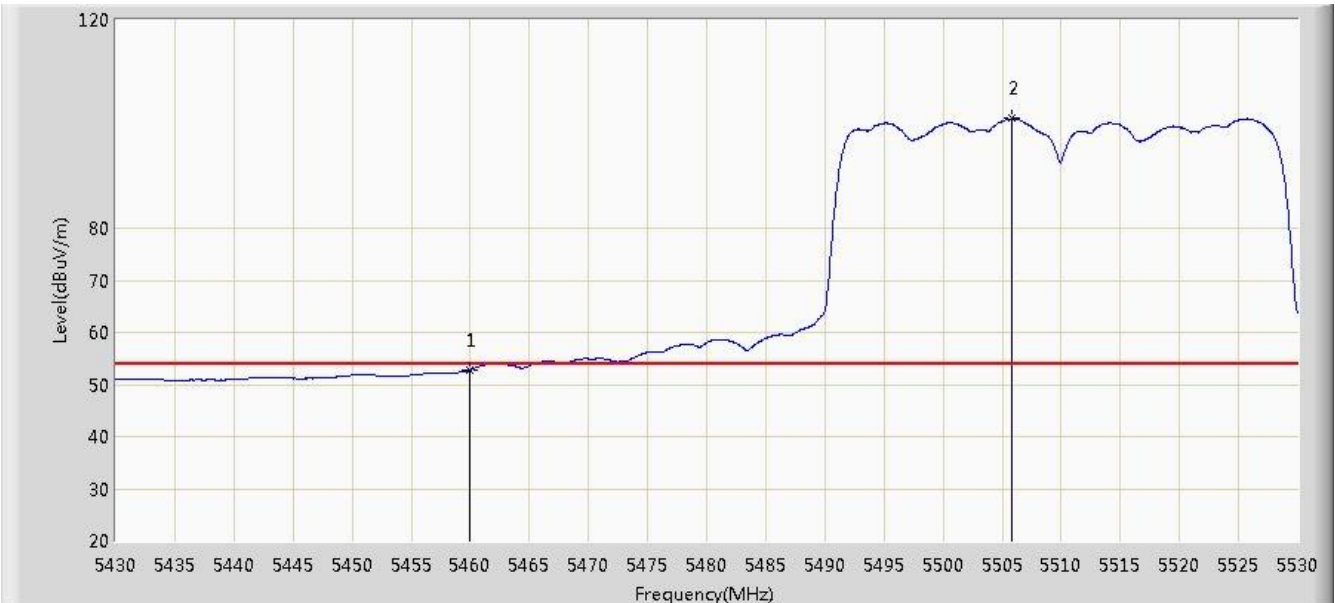

No	Flag	Mark	Frequency (MHz)	Measure Level (dBuV/m)	Reading Level (dBuV)	Over Limit (dB)	Limit (dBuV/m)	Factor (dB)	Type
1			5460.000	52.856	15.293	-1.144	54.000	37.563	AV
2		*	5505.850	101.033	63.402	N/A	N/A	37.631	AV

Note: Measure Level (dB μ V/m) = Reading Level (dB μ V) + Factor (dB)

Factor (dB) = Cable Loss (dB) + Antenna Factor (dB/m).

Site: AC1	Time: 2015/01/14 - 20:47
Limit: FCC_Part15.209_RE(3m)	Engineer: Roy Cheng
Probe: BBHA9120D_1-18GHz	Polarity: Horizontal
EUT: WiFi Concurrent 4 Port GE LAN VoIP Ethernet Gateway with USB	Power: AC 120V/60Hz
Test Mode: Transmit at channel 5670MHz by 802.11ac-VHT40 Ant 0+1+2+3	

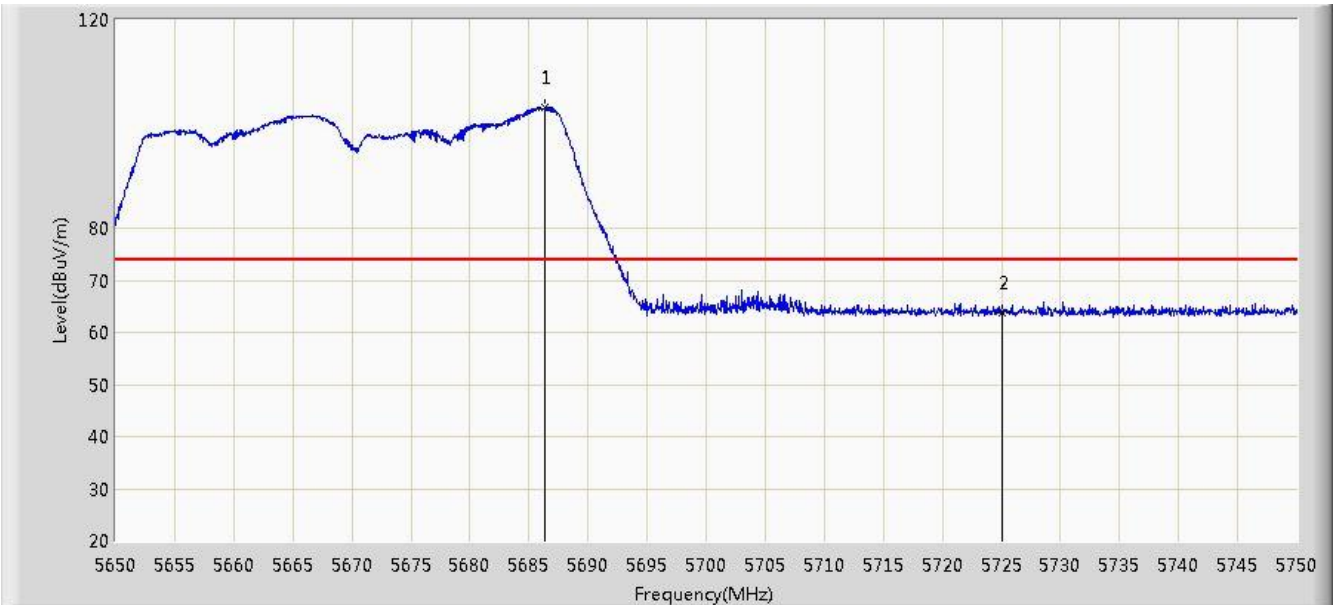

No	Flag	Mark	Frequency (MHz)	Measure Level (dBuV/m)	Reading Level (dBuV)	Over Limit (dB)	Limit (dBuV/m)	Factor (dB)	Type
1		*	5686.350	103.132	65.280	N/A	N/A	37.852	PK
2			5725.000	63.702	25.712	-10.298	74.000	37.990	PK

Note: Measure Level (dB μ V/m) = Reading Level (dB μ V) + Factor (dB)

Factor (dB) = Cable Loss (dB) + Antenna Factor (dB/m).

Site: AC1	Time: 2015/01/14 - 20:49
Limit: FCC_Part15.209_RE(3m)	Engineer: Roy Cheng
Probe: BBHA9120D_1-18GHz	Polarity: Horizontal
EUT: WiFi Concurrent 4 Port GE LAN VoIP Ethernet Gateway with USB	Power: AC 120V/60Hz
Test Mode: Transmit at channel 5670MHz by 802.11ac-VHT40 Ant 0+1+2+3	

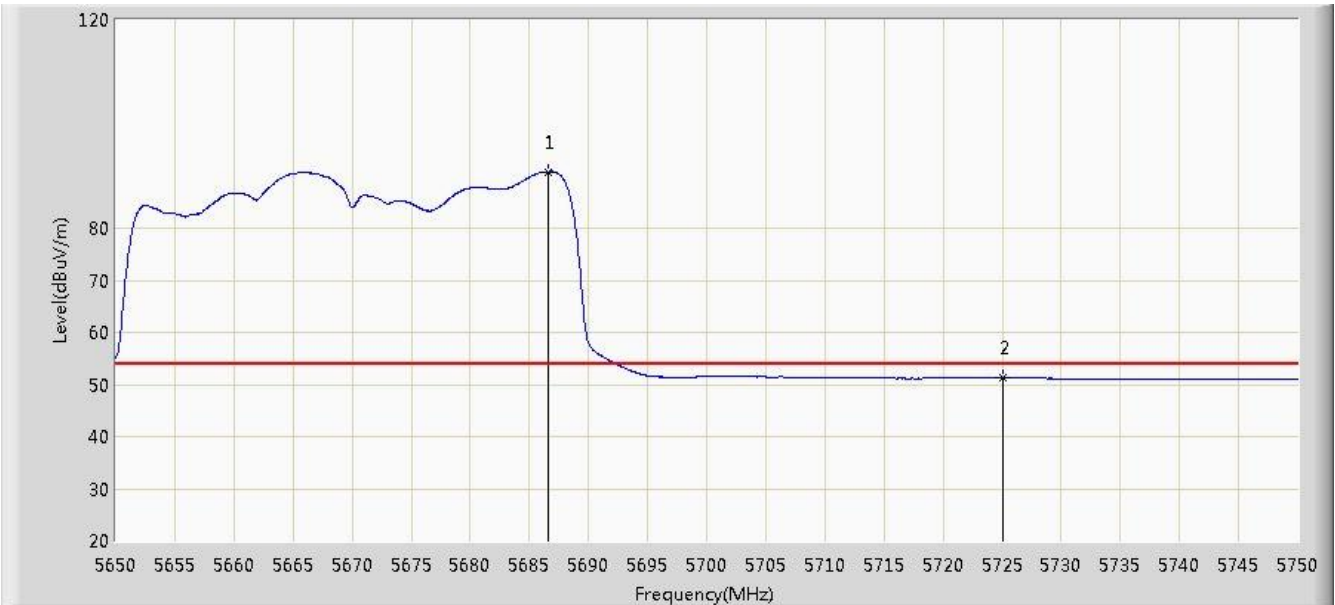

No	Flag	Mark	Frequency (MHz)	Measure Level (dBuV/m)	Reading Level (dBuV)	Over Limit (dB)	Limit (dBuV/m)	Factor (dB)	Type
1		*	5686.650	90.823	52.970	N/A	N/A	37.854	AV
2			5725.000	51.286	13.296	-2.714	54.000	37.990	AV

Note: Measure Level (dB μ V/m) = Reading Level (dB μ V) + Factor (dB)

Factor (dB) = Cable Loss (dB) + Antenna Factor (dB/m).

Site: AC1	Time: 2015/01/14 - 20:56
Limit: FCC_Part15.209_RE(3m)	Engineer: Roy Cheng
Probe: BBHA9120D_1-18GHz	Polarity: Vertical
EUT: WiFi Concurrent 4 Port GE LAN VoIP Ethernet Gateway with USB	Power: AC 120V/60Hz
Test Mode: Transmit at channel 5670MHz by 802.11ac-VHT40 Ant 0+1+2+3	

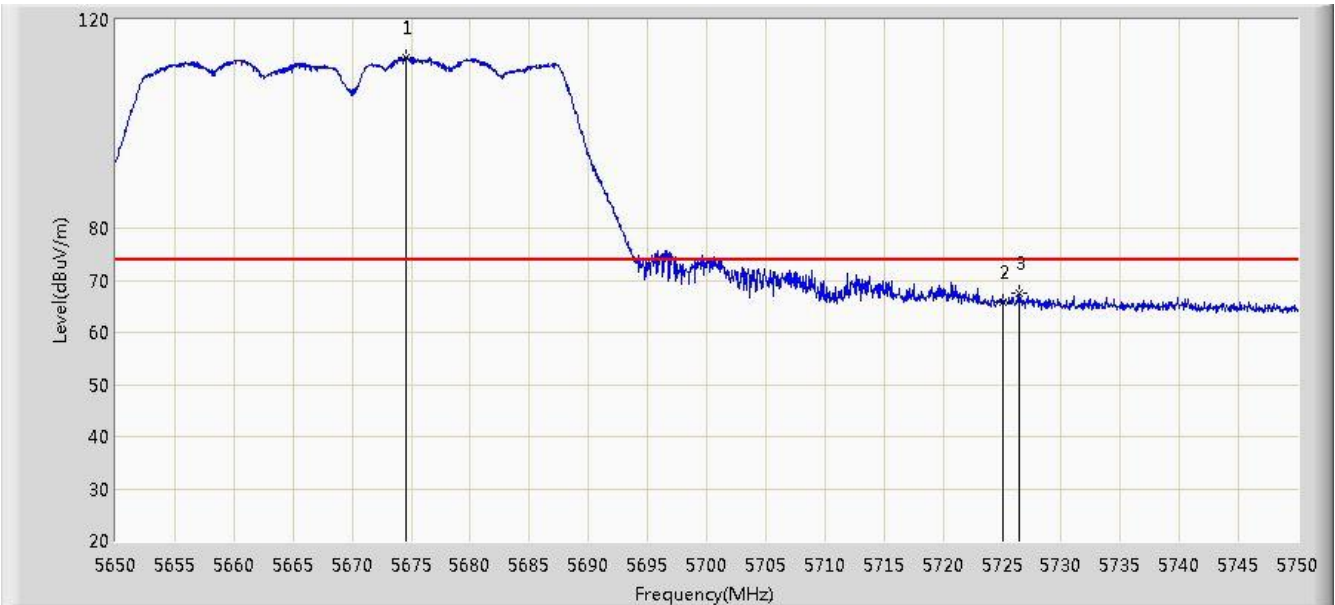

No	Flag	Mark	Frequency (MHz)	Measure Level (dBuV/m)	Reading Level (dBuV)	Over Limit (dB)	Limit (dBuV/m)	Factor (dB)	Type
1		*	5674.550	112.747	74.932	N/A	N/A	37.815	PK
2			5725.000	65.925	27.935	-8.075	74.000	37.990	PK
3			5726.500	67.546	29.550	-6.454	74.000	37.996	PK

Note: Measure Level (dBuV/m) = Reading Level (dBuV) + Factor (dB)

Factor (dB) = Cable Loss (dB) + Antenna Factor (dB/m).

Site: AC1	Time: 2015/01/14 - 20:53
Limit: FCC_Part15.209_RE(3m)	Engineer: Roy Cheng
Probe: BBHA9120D_1-18GHz	Polarity: Vertical
EUT: WiFi Concurrent 4 Port GE LAN VoIP Ethernet Gateway with USB	Power: AC 120V/60Hz
Test Mode: Transmit at channel 5670MHz by 802.11ac-VHT40 Ant 0+1+2+3	

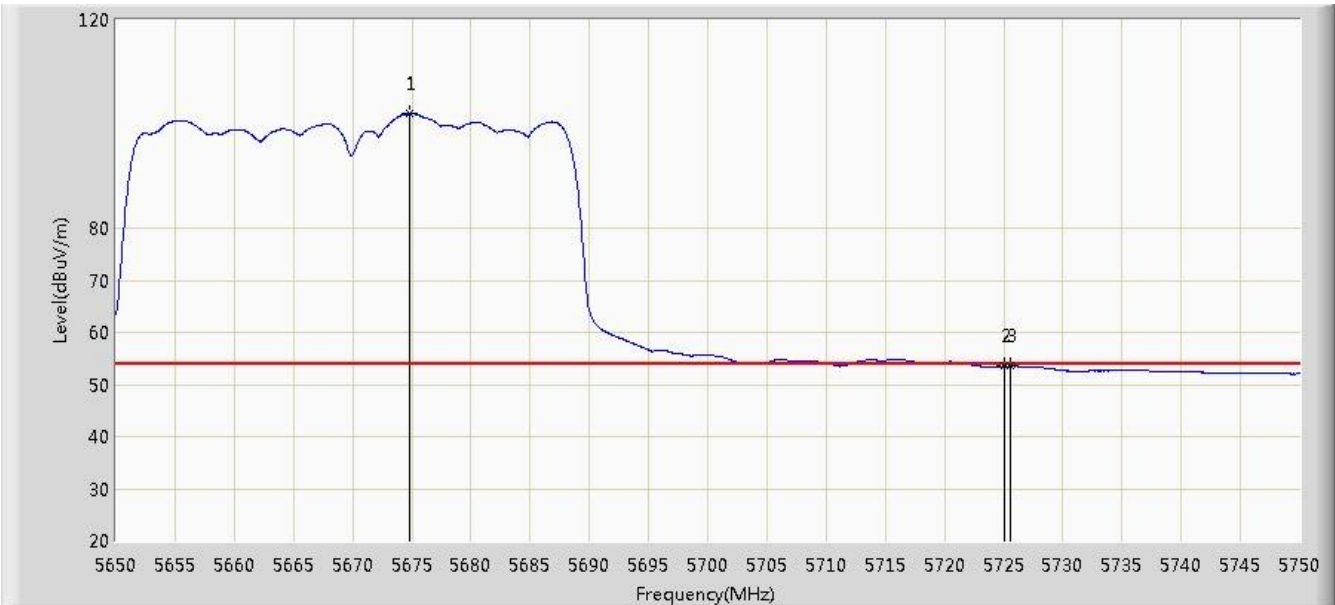

No	Flag	Mark	Frequency (MHz)	Measure Level (dBuV/m)	Reading Level (dBuV)	Over Limit (dB)	Limit (dBuV/m)	Factor (dB)	Type
1		*	5674.850	101.918	64.102	N/A	N/A	37.816	AV
2			5725.000	53.490	15.500	-0.510	54.000	37.990	AV
3			5725.550	53.484	15.492	-0.516	54.000	37.992	AV

Note: Measure Level (dBuV/m) = Reading Level (dBuV) + Factor (dB)

Factor (dB) = Cable Loss (dB) + Antenna Factor (dB/m).

Site: AC1	Time: 2015/01/14 - 20:58
Limit: FCC 15.407	Engineer: Roy Cheng
Probe: BBHA9120D_1-18GHz	Polarity: Horizontal
EUT: WiFi Concurrent 4 Port GE LAN VoIP Ethernet Gateway with USB	Power: AC 120V/60Hz
Test Mode: Transmit at channel 5755MHz by 802.11ac-VHT40 Ant 0+1+2+3	

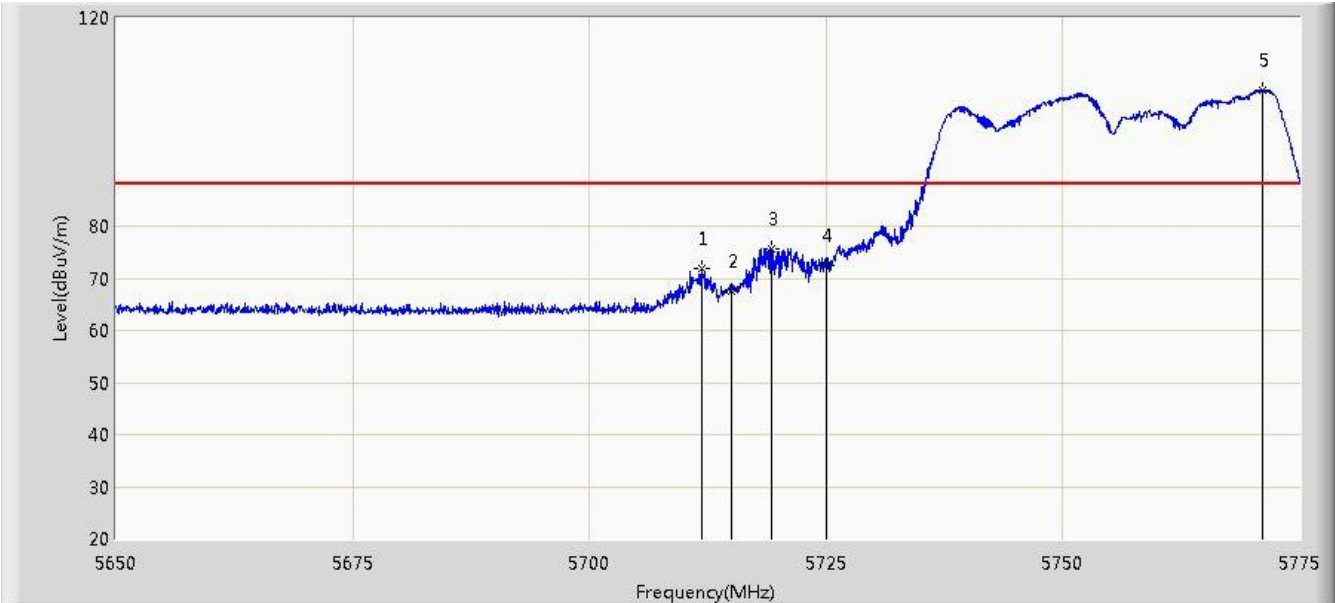

No	Flag	Mark	Frequency (MHz)	Measure Level (dBuV/m)	Reading Level (dBuV)	Over Limit (dB)	Limit (dBuV/m)	Factor (dB)	Type
1			5711.937	71.942	34.005	-16.258	88.200	37.937	PK
2			5715.000	67.628	29.679	-20.572	88.200	37.949	PK
3			5719.312	75.768	37.801	-22.432	98.200	37.966	PK
4			5725.000	72.479	34.489	-25.721	98.200	37.990	PK
5		*	5771.125	106.186	68.017	N/A	N/A	38.169	PK

Note: Measure Level (dBuV/m) = Reading Level (dBuV) + Factor (dB)

Factor (dB) = Cable Loss (dB) + Antenna Factor (dB/m).

Site: AC1	Time: 2015/01/14 - 20:59
Limit: FCC 15.407	Engineer: Roy Cheng
Probe: BBHA9120D_1-18GHz	Polarity: Horizontal
EUT: WiFi Concurrent 4 Port GE LAN VoIP Ethernet Gateway with USB	Power: AC 120V/60Hz
Test Mode: Transmit at channel 5755MHz by 802.11ac-VHT40 Ant 0+1+2+3	

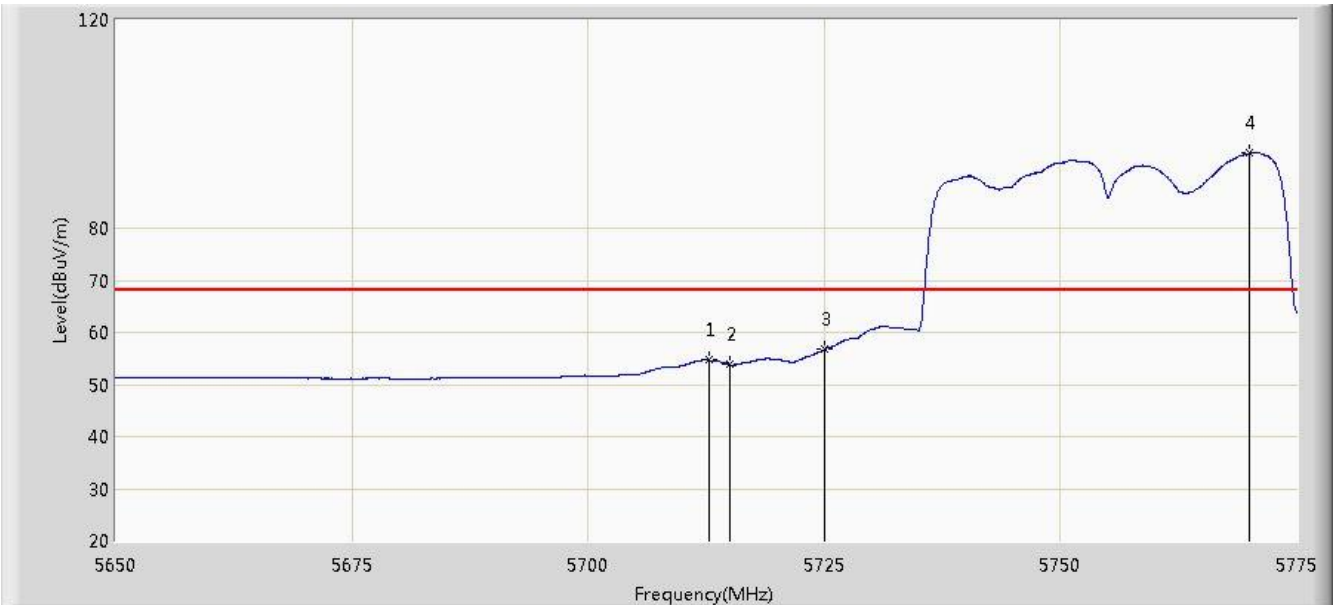

No	Flag	Mark	Frequency (MHz)	Measure Level (dBuV/m)	Reading Level (dBuV)	Over Limit (dB)	Limit (dBuV/m)	Factor (dB)	Type
1			5712.750	54.643	16.703	-13.557	68.200	37.940	AV
2			5715.000	53.862	15.913	-14.338	68.200	37.949	AV
3			5725.000	56.685	18.695	-21.515	78.200	37.990	AV
4		*	5770.062	94.410	56.244	N/A	N/A	38.166	AV

Note: Measure Level (dB μ V/m) = Reading Level (dB μ V) + Factor (dB)

Factor (dB) = Cable Loss (dB) + Antenna Factor (dB/m).

Site: AC1	Time: 2015/01/14 - 21:02
Limit: FCC 15.407	Engineer: Roy Cheng
Probe: BBHA9120D_1-18GHz	Polarity: Vertical
EUT: WiFi Concurrent 4 Port GE LAN VoIP Ethernet Gateway with USB	Power: AC 120V/60Hz
Test Mode: Transmit at channel 5755MHz by 802.11ac-VHT40 Ant 0+1+2+3	

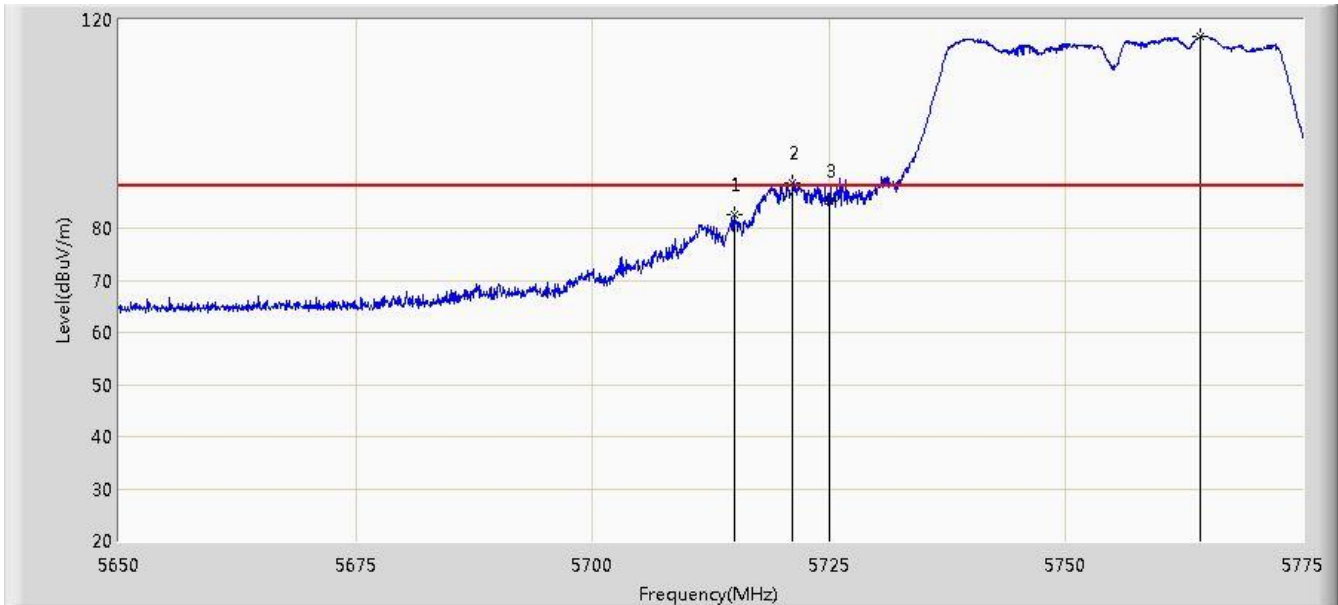

No	Flag	Mark	Frequency (MHz)	Measure Level (dBuV/m)	Reading Level (dBuV)	Over Limit (dB)	Limit (dBuV/m)	Factor (dB)	Type
1			5715.000	82.520	44.571	-5.680	88.200	37.949	PK
2			5721.125	88.717	50.743	-9.483	98.200	37.974	PK
3			5725.000	85.241	47.251	-12.959	98.200	37.990	PK
4		*	5764.250	116.754	78.602	N/A	N/A	38.152	PK

Note: Measure Level (dB μ V/m) = Reading Level (dB μ V) + Factor (dB)

Factor (dB) = Cable Loss (dB) + Antenna Factor (dB/m).

Site: AC1	Time: 2015/01/14 - 21:03
Limit: FCC 15.407	Engineer: Roy Cheng
Probe: BBHA9120D_1-18GHz	Polarity: Vertical
EUT: WiFi Concurrent 4 Port GE LAN VoIP Ethernet Gateway with USB	Power: AC 120V/60Hz
Test Mode: Transmit at channel 5755MHz by 802.11ac-VHT40 Ant 0+1+2+3	



No	Flag	Mark	Frequency (MHz)	Measure Level (dBuV/m)	Reading Level (dBuV)	Over Limit (dB)	Limit (dBuV/m)	Factor (dB)	Type
1			5712.000	77.966	40.029	-10.234	88.200	37.937	PK
2			5715.000	77.547	39.598	-10.653	88.200	37.949	PK
3			5724.187	86.396	48.410	-11.804	98.200	37.987	PK
4			5725.000	85.556	47.566	-12.644	98.200	37.990	PK
5		*	5744.250	115.517	77.449	N/A	N/A	38.069	PK

Note: Measure Level (dB μ V/m) = Reading Level (dB μ V) + Factor (dB)

Factor (dB) = Cable Loss (dB) + Antenna Factor (dB/m).

Site: AC1	Time: 2015/01/14 - 21:06
Limit: FCC 15.407	Engineer: Roy Cheng
Probe: BBHA9120D_1-18GHz	Polarity: Vertical
EUT: WiFi Concurrent 4 Port GE LAN VoIP Ethernet Gateway with USB	Power: AC 120V/60Hz
Test Mode: Transmit at channel 5755MHz by 802.11ac-VHT40 Ant 0+1+2+3	

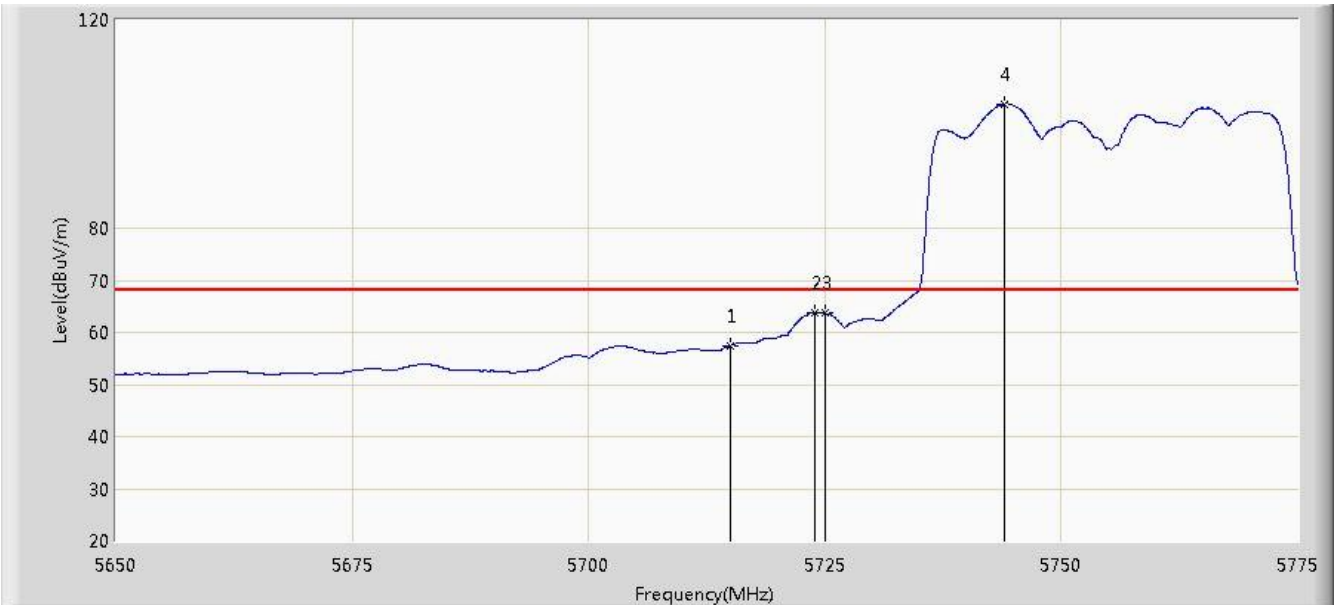

No	Flag	Mark	Frequency (MHz)	Measure Level (dBuV/m)	Reading Level (dBuV)	Over Limit (dB)	Limit (dBuV/m)	Factor (dB)	Type
1			5715.000	57.443	19.494	-10.757	68.200	37.949	AV
2			5724.000	63.844	25.858	-14.356	78.200	37.986	AV
3			5725.000	63.678	25.688	-14.522	78.200	37.990	AV
4		*	5744.000	103.895	65.828	N/A	N/A	38.067	AV

Note: Measure Level (dB μ V/m) = Reading Level (dB μ V) + Factor (dB)

Factor (dB) = Cable Loss (dB) + Antenna Factor (dB/m).

Site: AC1	Time: 2015/01/14 - 21:09
Limit: FCC 15.407	Engineer: Roy Cheng
Probe: BBHA9120D_1-18GHz	Polarity: Horizontal
EUT: WiFi Concurrent 4 Port GE LAN VoIP Ethernet Gateway with USB	Power: AC 120V/60Hz
Test Mode: Transmit at channel 5795MHz by 802.11ac-VHT40 Ant 0+1+2+3	

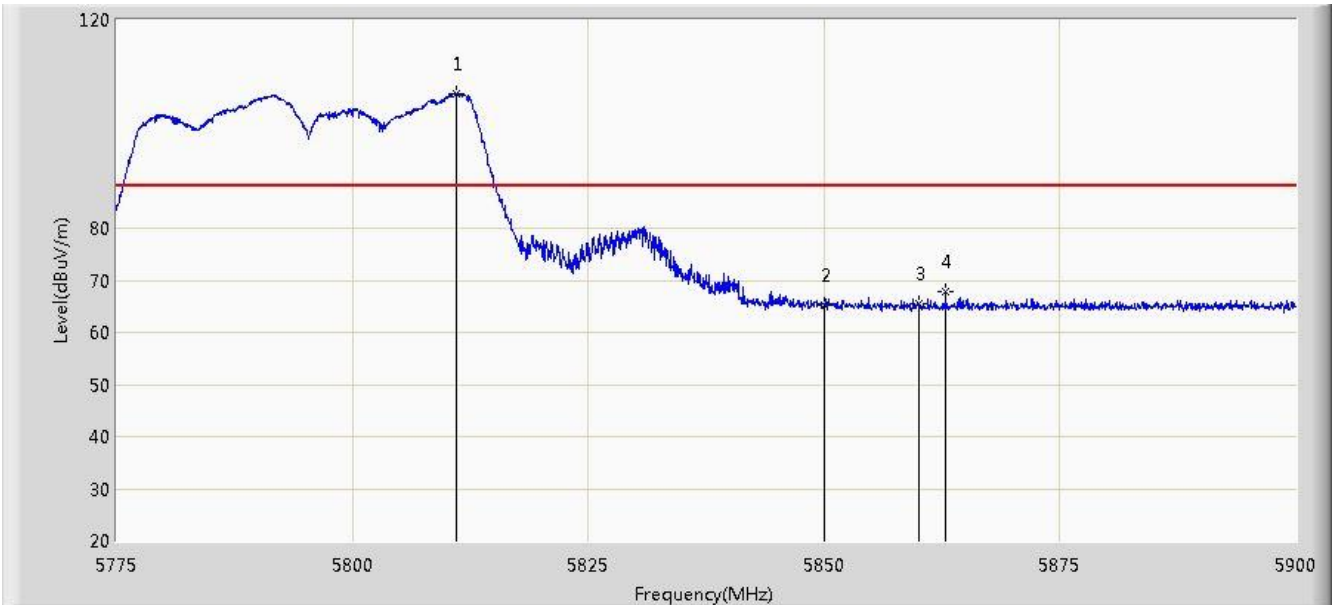

No	Flag	Mark	Frequency (MHz)	Measure Level (dBuV/m)	Reading Level (dBuV)	Over Limit (dB)	Limit (dBuV/m)	Factor (dB)	Type
1		*	5811.062	105.772	67.474	N/A	N/A	38.298	PK
2			5850.000	65.348	26.895	-32.852	98.200	38.454	PK
3			5860.000	65.371	26.893	-22.829	88.200	38.478	PK
4			5862.875	67.705	29.221	-20.495	88.200	38.484	PK

Note: Measure Level (dB μ V/m) = Reading Level (dB μ V) + Factor (dB)

Factor (dB) = Cable Loss (dB) + Antenna Factor (dB/m).

Site: AC1	Time: 2015/01/14 - 21:10
Limit: FCC 15.407	Engineer: Roy Cheng
Probe: BBHA9120D_1-18GHz	Polarity: Horizontal
EUT: WiFi Concurrent 4 Port GE LAN VoIP Ethernet Gateway with USB	Power: AC 120V/60Hz
Test Mode: Transmit at channel 5795MHz by 802.11ac-VHT40 Ant 0+1+2+3	

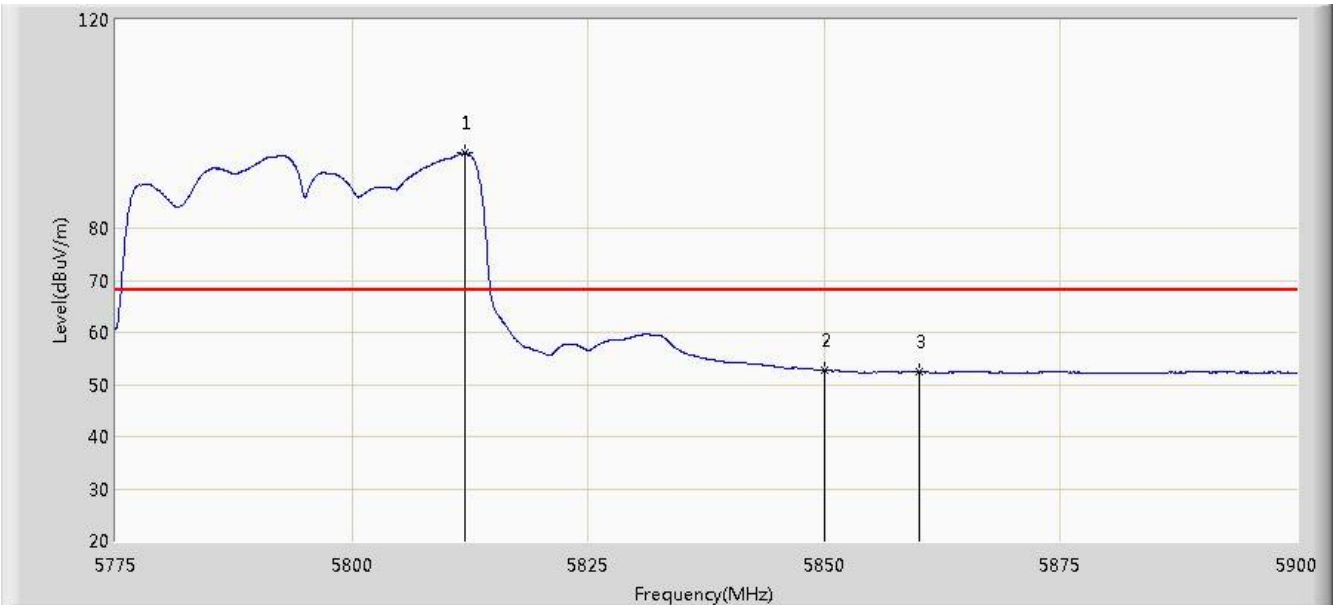

No	Flag	Mark	Frequency (MHz)	Measure Level (dBuV/m)	Reading Level (dBuV)	Over Limit (dB)	Limit (dBuV/m)	Factor (dB)	Type
1		*	5811.937	94.394	56.093	N/A	N/A	38.302	AV
2			5850.000	52.744	14.291	-25.456	78.200	38.454	AV
3			5860.000	52.367	13.889	-15.833	68.200	38.478	AV

Note: Measure Level (dBμV/m) = Reading Level (dBμV) + Factor (dB)

Factor (dB) = Cable Loss (dB) + Antenna Factor (dB/m).

Site: AC1	Time: 2015/01/14 - 21:13
Limit: FCC 15.407	Engineer: Roy Cheng
Probe: BBHA9120D_1-18GHz	Polarity: Vertical
EUT: WiFi Concurrent 4 Port GE LAN VoIP Ethernet Gateway with USB	Power: AC 120V/60Hz
Test Mode: Transmit at channel 5795MHz by 802.11ac-VHT40 Ant 0+1+2+3	

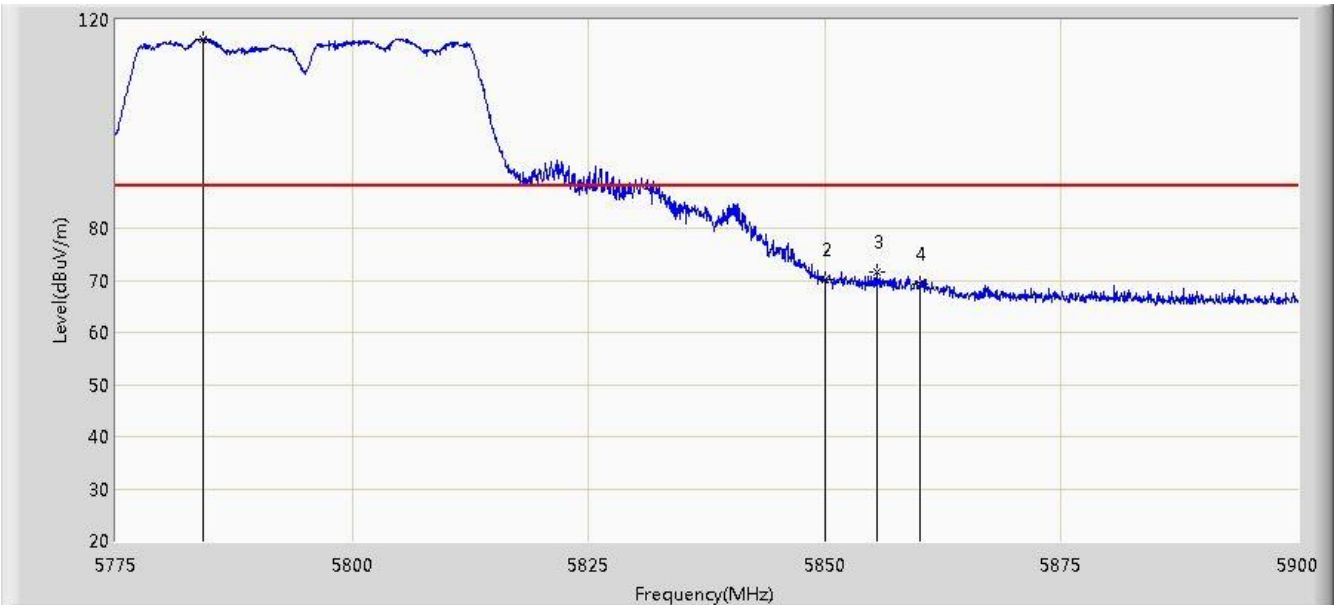

No	Flag	Mark	Frequency (MHz)	Measure Level (dBuV/m)	Reading Level (dBuV)	Over Limit (dB)	Limit (dBuV/m)	Factor (dB)	Type
1		*	5784.250	116.343	78.133	N/A	N/A	38.210	PK
2			5850.000	70.186	31.733	-28.014	98.200	38.454	PK
3			5855.562	71.608	33.141	-26.592	98.200	38.466	PK
4			5860.000	69.373	30.895	-18.827	88.200	38.478	PK

Note: Measure Level (dB μ V/m) = Reading Level (dB μ V) + Factor (dB)

Factor (dB) = Cable Loss (dB) + Antenna Factor (dB/m).

Site: AC1	Time: 2015/01/14 - 21:14
Limit: FCC 15.407	Engineer: Roy Cheng
Probe: BBHA9120D_1-18GHz	Polarity: Vertical
EUT: WiFi Concurrent 4 Port GE LAN VoIP Ethernet Gateway with USB	Power: AC 120V/60Hz
Test Mode: Transmit at channel 5795MHz by 802.11ac-VHT40 Ant 0+1+2+3	

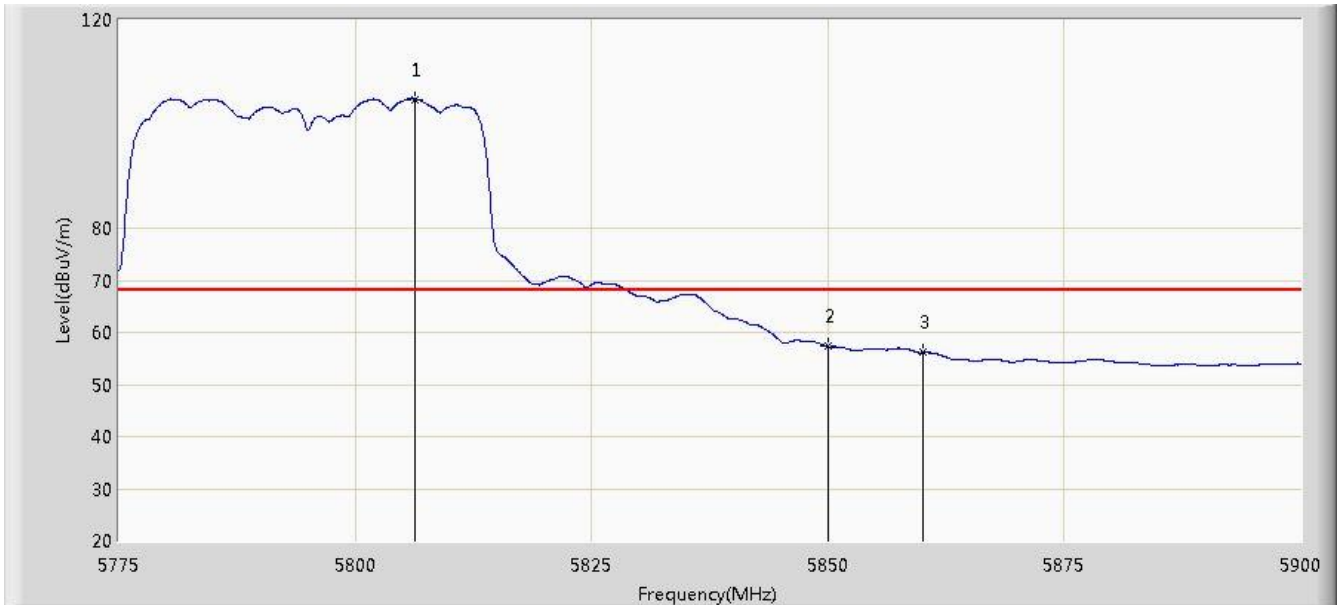

No	Flag	Mark	Frequency (MHz)	Measure Level (dBuV/m)	Reading Level (dBuV)	Over Limit (dB)	Limit (dBuV/m)	Factor (dB)	Type
1		*	5806.250	104.770	66.487	N/A	N/A	38.283	AV
2			5850.000	57.283	18.830	-20.917	78.200	38.454	AV
3			5860.000	56.151	17.673	-12.049	68.200	38.478	AV

Note: Measure Level (dBuV/m) = Reading Level (dBuV) + Factor (dB)

Factor (dB) = Cable Loss (dB) + Antenna Factor (dB/m).

Site: AC1	Time: 2015/01/14 - 21:32
Limit: FCC_Part15.209_RE(3m)	Engineer: Roy Cheng
Probe: BBHA9120D_1-18GHz	Polarity: Horizontal
EUT: WiFi Concurrent 4 Port GE LAN VoIP Ethernet Gateway with USB	Power: AC 120V/60Hz
Test Mode: Transmit at channel 5210MHz by 802.11ac-VHT80 Ant 0+1+2+3	

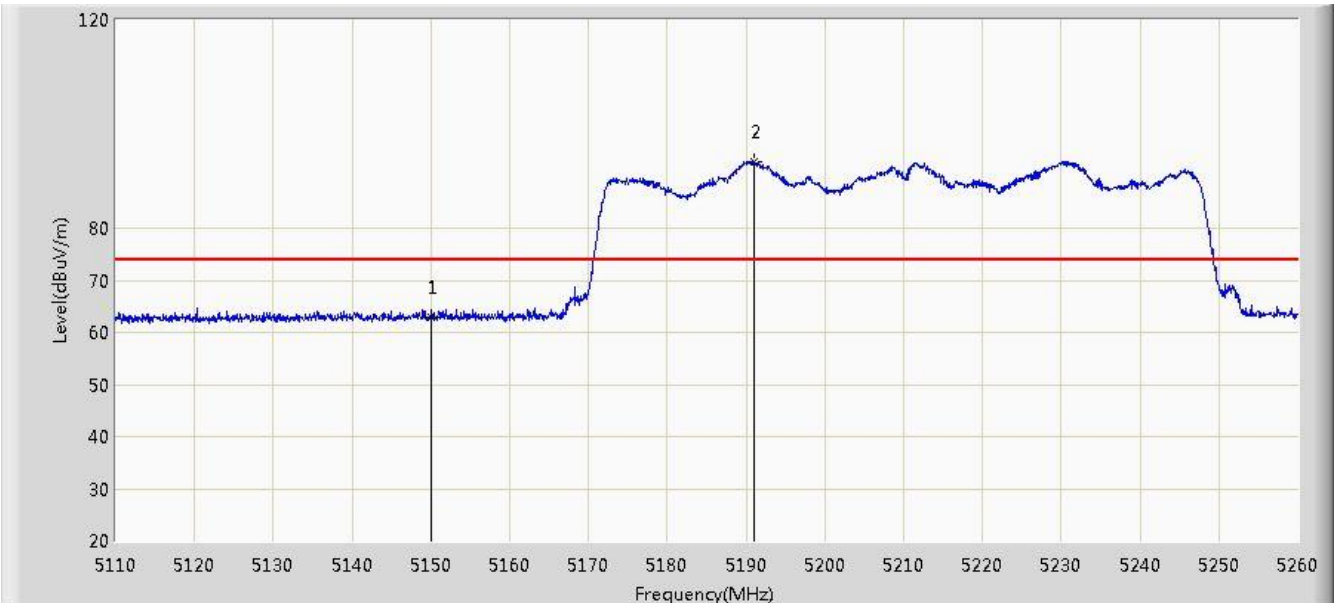

No	Flag	Mark	Frequency (MHz)	Measure Level (dBuV/m)	Reading Level (dBuV)	Over Limit (dB)	Limit (dBuV/m)	Factor (dB)	Type
1			5150.000	62.965	25.513	-11.035	74.000	37.452	PK
2		*	5191.000	92.860	55.514	N/A	N/A	37.346	PK

Note: Measure Level (dB μ V/m) = Reading Level (dB μ V) + Factor (dB)

Factor (dB) = Cable Loss (dB) + Antenna Factor (dB/m).

Site: AC1	Time: 2015/01/14 - 21:33
Limit: FCC_Part15.209_RE(3m)	Engineer: Roy Cheng
Probe: BBHA9120D_1-18GHz	Polarity: Horizontal
EUT: WiFi Concurrent 4 Port GE LAN VoIP Ethernet Gateway with USB	Power: AC 120V/60Hz
Test Mode: Transmit at channel 5210MHz by 802.11ac-VHT80 Ant 0+1+2+3	

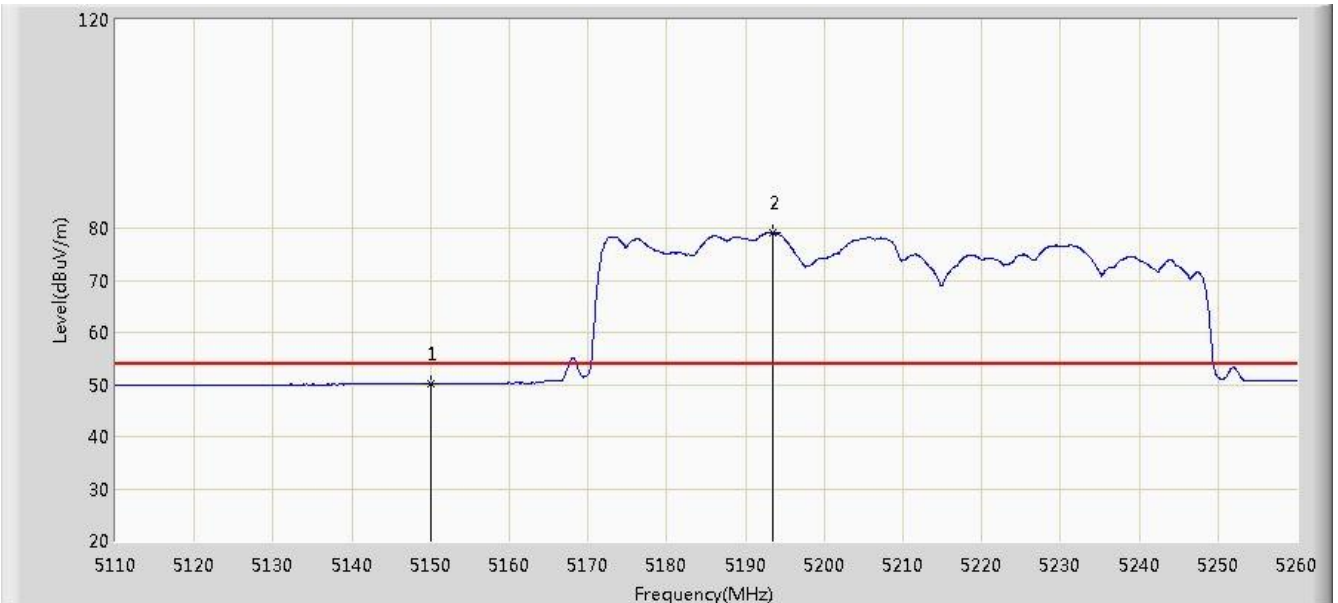

No	Flag	Mark	Frequency (MHz)	Measure Level (dBuV/m)	Reading Level (dBuV)	Over Limit (dB)	Limit (dBuV/m)	Factor (dB)	Type
1			5150.000	50.212	12.760	-3.788	54.000	37.452	AV
2		*	5193.400	79.165	41.824	N/A	N/A	37.341	AV

Note: Measure Level (dB μ V/m) = Reading Level (dB μ V) + Factor (dB)

Factor (dB) = Cable Loss (dB) + Antenna Factor (dB/m).

Site: AC1	Time: 2015/01/14 - 21:30
Limit: FCC_Part15.209_RE(3m)	Engineer: Roy Cheng
Probe: BBHA9120D_1-18GHz	Polarity: Vertical
EUT: WiFi Concurrent 4 Port GE LAN VoIP Ethernet Gateway with USB	Power: AC 120V/60Hz
Test Mode: Transmit at channel 5210MHz by 802.11ac-VHT80 Ant 0+1+2+3	

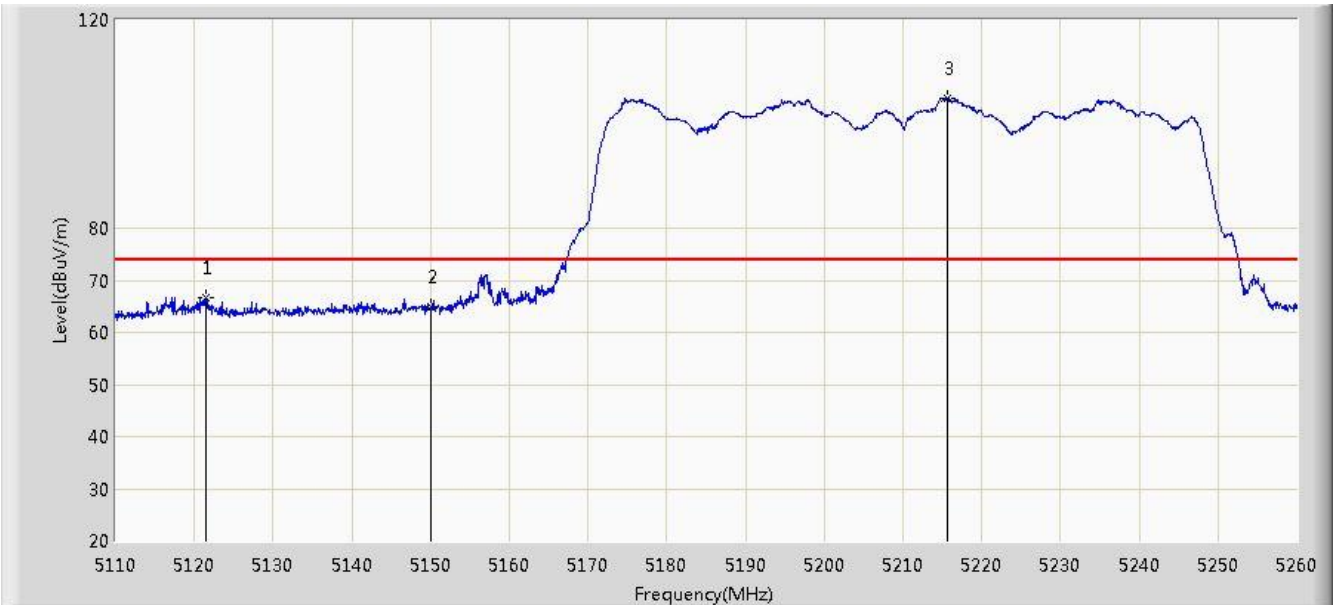

No	Flag	Mark	Frequency (MHz)	Measure Level (dBuV/m)	Reading Level (dBuV)	Over Limit (dB)	Limit (dBuV/m)	Factor (dB)	Type
1			5121.475	66.617	29.139	-7.383	74.000	37.478	PK
2			5150.000	64.923	27.471	-9.077	74.000	37.452	PK
3		*	5215.675	104.943	67.671	N/A	N/A	37.272	PK

Note: Measure Level (dBuV/m) = Reading Level (dBuV) + Factor (dB)

Factor (dB) = Cable Loss (dB) + Antenna Factor (dB/m).

Site: AC1	Time: 2015/01/14 - 21:28
Limit: FCC_Part15.209_RE(3m)	Engineer: Roy Cheng
Probe: BBHA9120D_1-18GHz	Polarity: Vertical
EUT: WiFi Concurrent 4 Port GE LAN VoIP Ethernet Gateway with USB	Power: AC 120V/60Hz
Test Mode: Transmit at channel 5210MHz by 802.11ac-VHT80 Ant 0+1+2+3	

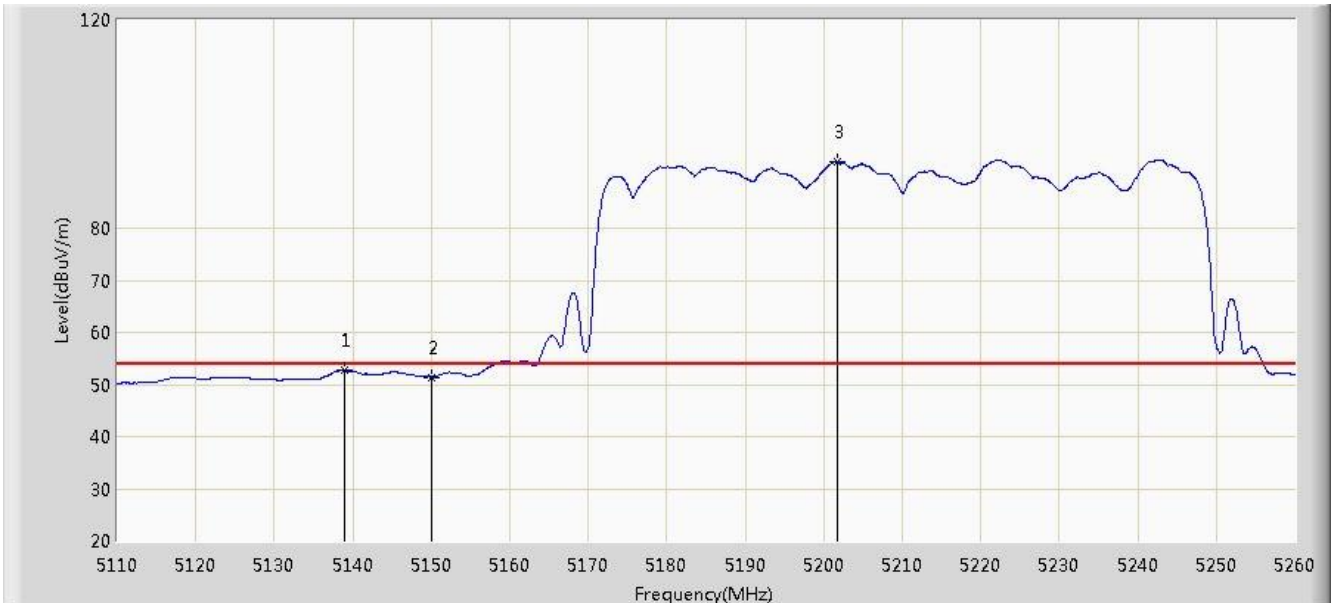

No	Flag	Mark	Frequency (MHz)	Measure Level (dBuV/m)	Reading Level (dBuV)	Over Limit (dB)	Limit (dBuV/m)	Factor (dB)	Type
1			5138.875	52.683	15.214	-1.317	54.000	37.470	AV
2			5150.000	51.439	13.987	-2.561	54.000	37.452	AV
3		*	5201.800	92.840	55.522	N/A	N/A	37.318	AV

Note: Measure Level (dBuV/m) = Reading Level (dBuV) + Factor (dB)

Factor (dB) = Cable Loss (dB) + Antenna Factor (dB/m).

Site: AC1	Time: 2015/01/14 - 21:49
Limit: FCC_Part15.209_RE(3m)	Engineer: Roy Cheng
Probe: BBHA9120D_1-18GHz	Polarity: Horizontal
EUT: WiFi Concurrent 4 Port GE LAN VoIP Ethernet Gateway with USB	Power: AC 120V/60Hz
Test Mode: Transmit at channel 5290MHz by 802.11ac-VHT80 Ant 0+1+2+3	

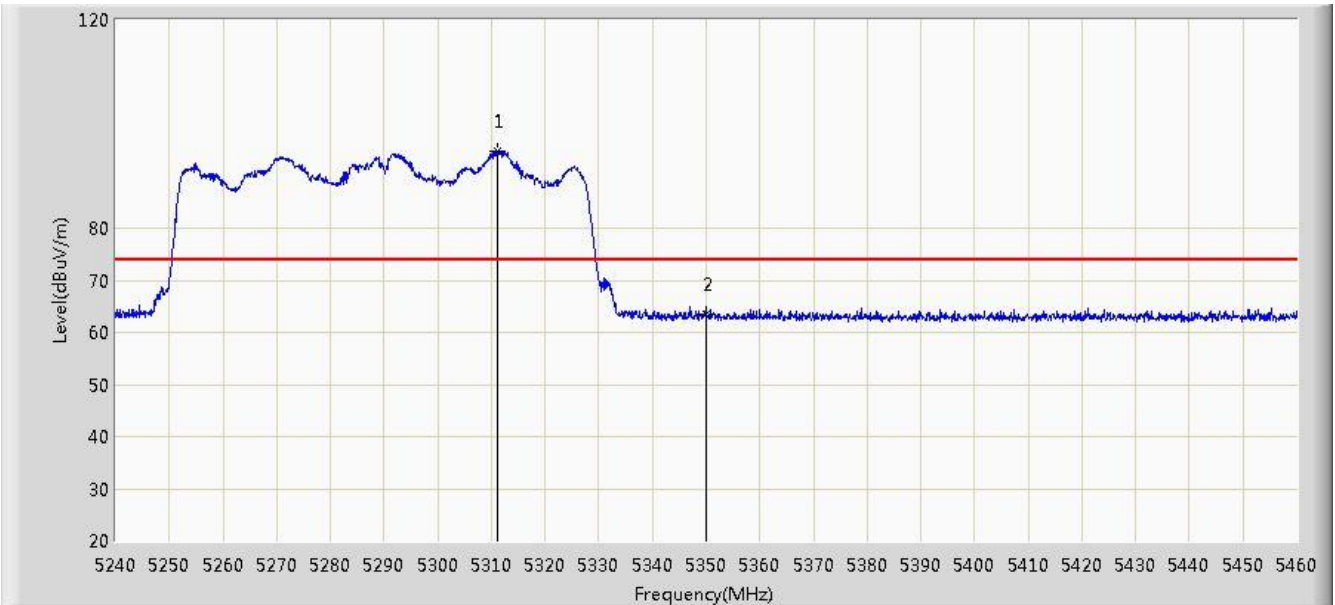

No	Flag	Mark	Frequency (MHz)	Measure Level (dBuV/m)	Reading Level (dBuV)	Over Limit (dB)	Limit (dBuV/m)	Factor (dB)	Type
1		*	5311.060	94.845	57.646	N/A	N/A	37.199	PK
2			5350.000	63.384	26.098	-10.616	74.000	37.286	PK

Note: Measure Level (dB μ V/m) = Reading Level (dB μ V) + Factor (dB)

Factor (dB) = Cable Loss (dB) + Antenna Factor (dB/m).

Site: AC1	Time: 2015/01/14 - 21:50
Limit: FCC_Part15.209_RE(3m)	Engineer: Roy Cheng
Probe: BBHA9120D_1-18GHz	Polarity: Horizontal
EUT: WiFi Concurrent 4 Port GE LAN VoIP Ethernet Gateway with USB	Power: AC 120V/60Hz
Test Mode: Transmit at channel 5290MHz by 802.11ac-VHT80 Ant 0+1+2+3	

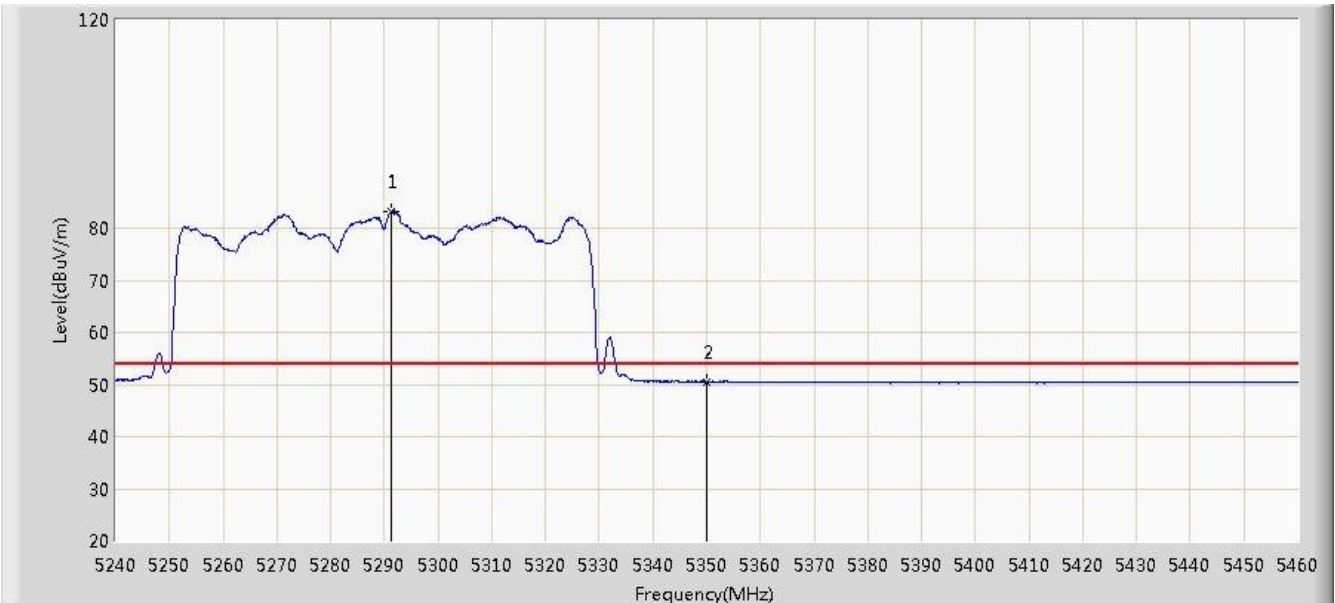

No	Flag	Mark	Frequency (MHz)	Measure Level (dBuV/m)	Reading Level (dBuV)	Over Limit (dB)	Limit (dBuV/m)	Factor (dB)	Type
1		*	5291.260	83.241	46.061	N/A	N/A	37.180	AV
2			5350.000	50.517	13.231	-3.483	54.000	37.286	AV

Note: Measure Level (dBμV/m) = Reading Level (dBμV) + Factor (dB)

Factor (dB) = Cable Loss (dB) + Antenna Factor (dB/m).

Site: AC1	Time: 2015/01/14 - 21:47
Limit: FCC_Part15.209_RE(3m)	Engineer: Roy Cheng
Probe: BBHA9120D_1-18GHz	Polarity: Vertical
EUT: WiFi Concurrent 4 Port GE LAN VoIP Ethernet Gateway with USB	Power: AC 120V/60Hz
Test Mode: Transmit at channel 5290MHz by 802.11ac-VHT80 Ant 0+1+2+3	

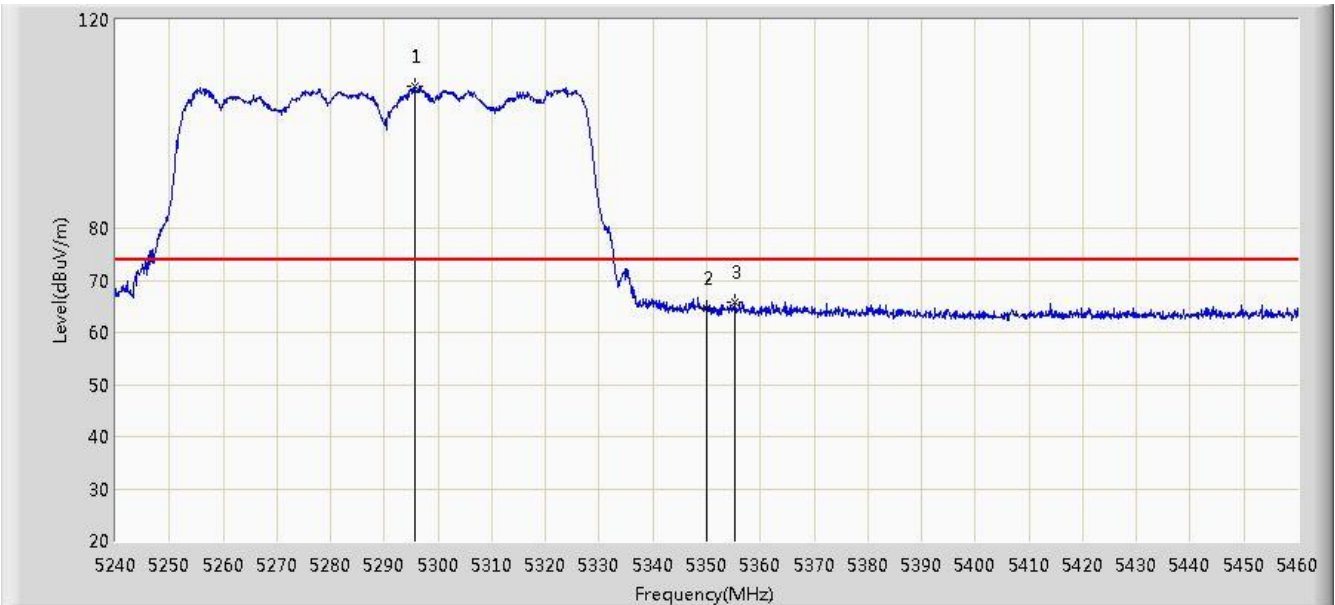

No	Flag	Mark	Frequency (MHz)	Measure Level (dBuV/m)	Reading Level (dBuV)	Over Limit (dB)	Limit (dBuV/m)	Factor (dB)	Type
1		*	5295.660	107.186	70.008	N/A	N/A	37.178	PK
2			5350.000	64.753	27.467	-9.247	74.000	37.286	PK
3			5355.280	65.921	28.620	-8.079	74.000	37.302	PK

Note: Measure Level (dB μ V/m) = Reading Level (dB μ V) + Factor (dB)

Factor (dB) = Cable Loss (dB) + Antenna Factor (dB/m).

Site: AC1	Time: 2015/01/14 - 21:46
Limit: FCC_Part15.209_RE(3m)	Engineer: Roy Cheng
Probe: BBHA9120D_1-18GHz	Polarity: Vertical
EUT: WiFi Concurrent 4 Port GE LAN VoIP Ethernet Gateway with USB	Power: AC 120V/60Hz
Test Mode: Transmit at channel 5290MHz by 802.11ac-VHT80 Ant 0+1+2+3	

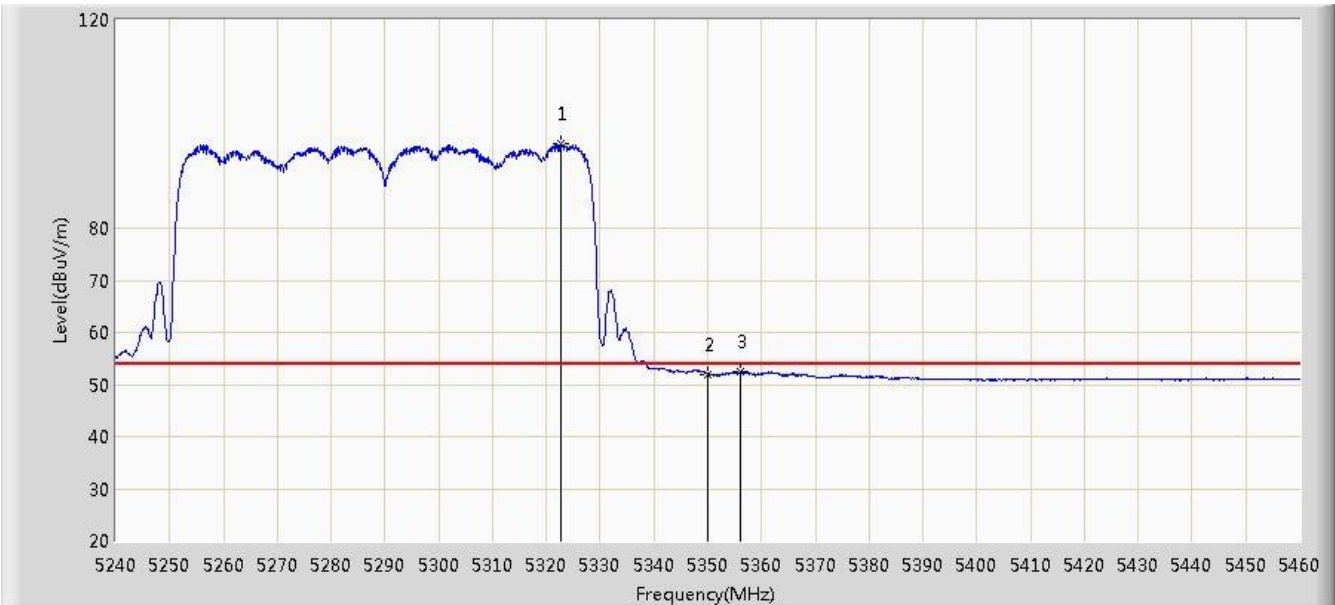

No	Flag	Mark	Frequency (MHz)	Measure Level (dBuV/m)	Reading Level (dBuV)	Over Limit (dB)	Limit (dBuV/m)	Factor (dB)	Type
1		*	5322.720	96.230	59.012	N/A	N/A	37.219	AV
2			5350.000	51.991	14.705	-2.009	54.000	37.286	AV
3			5356.160	52.510	15.206	-1.490	54.000	37.304	AV

Note: Measure Level (dBuV/m) = Reading Level (dBuV) + Factor (dB)

Factor (dB) = Cable Loss (dB) + Antenna Factor (dB/m).

Site: AC1	Time: 2015/01/14 - 21:59
Limit: FCC_Part15.209_RE(3m)	Engineer: Roy Cheng
Probe: BBHA9120D_1-18GHz	Polarity: Horizontal
EUT: WiFi Concurrent 4 Port GE LAN VoIP Ethernet Gateway with USB	Power: AC 120V/60Hz
Test Mode: Transmit at channel 5530MHz by 802.11ac-VHT80 Ant 0+1+2+3	

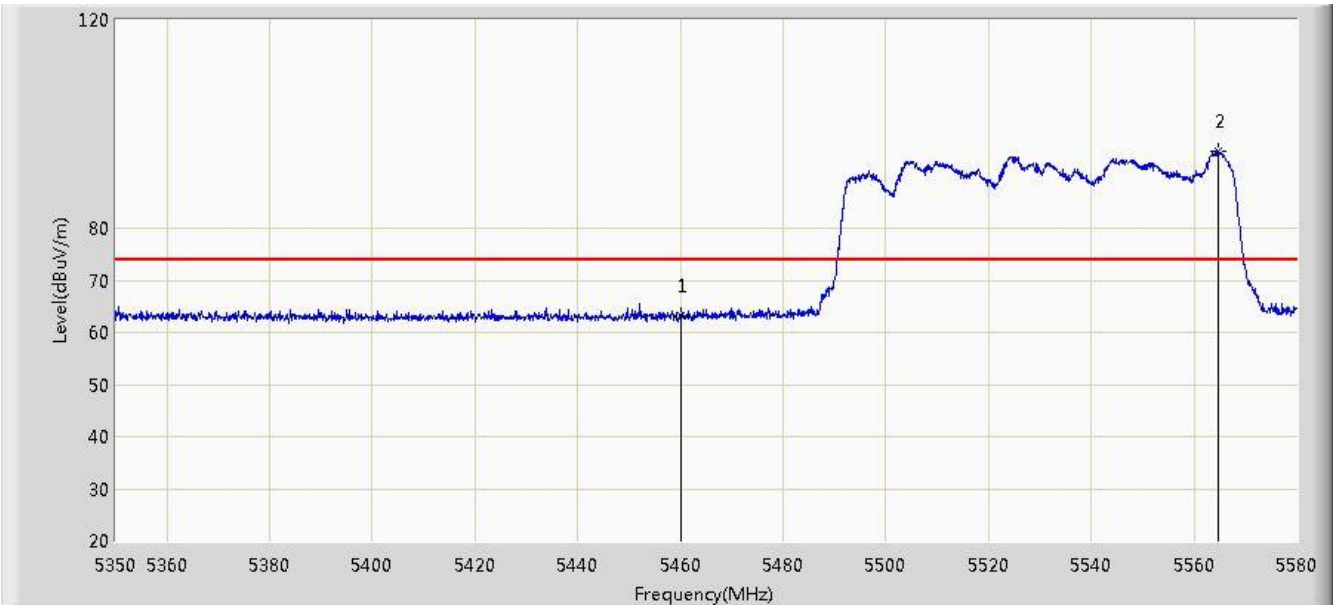

No	Flag	Mark	Frequency (MHz)	Measure Level (dBuV/m)	Reading Level (dBuV)	Over Limit (dB)	Limit (dBuV/m)	Factor (dB)	Type
1			5460.000	63.068	25.505	-10.932	74.000	37.563	PK
2		*	5564.820	94.837	57.130	N/A	N/A	37.707	PK

Note: Measure Level (dB μ V/m) = Reading Level (dB μ V) + Factor (dB)

Factor (dB) = Cable Loss (dB) + Antenna Factor (dB/m).

Site: AC1	Time: 2015/01/14 - 22:00
Limit: FCC_Part15.209_RE(3m)	Engineer: Roy Cheng
Probe: BBHA9120D_1-18GHz	Polarity: Horizontal
EUT: WiFi Concurrent 4 Port GE LAN VoIP Ethernet Gateway with USB	Power: AC 120V/60Hz
Test Mode: Transmit at channel 5530MHz by 802.11ac-VHT80 Ant 0+1+2+3	

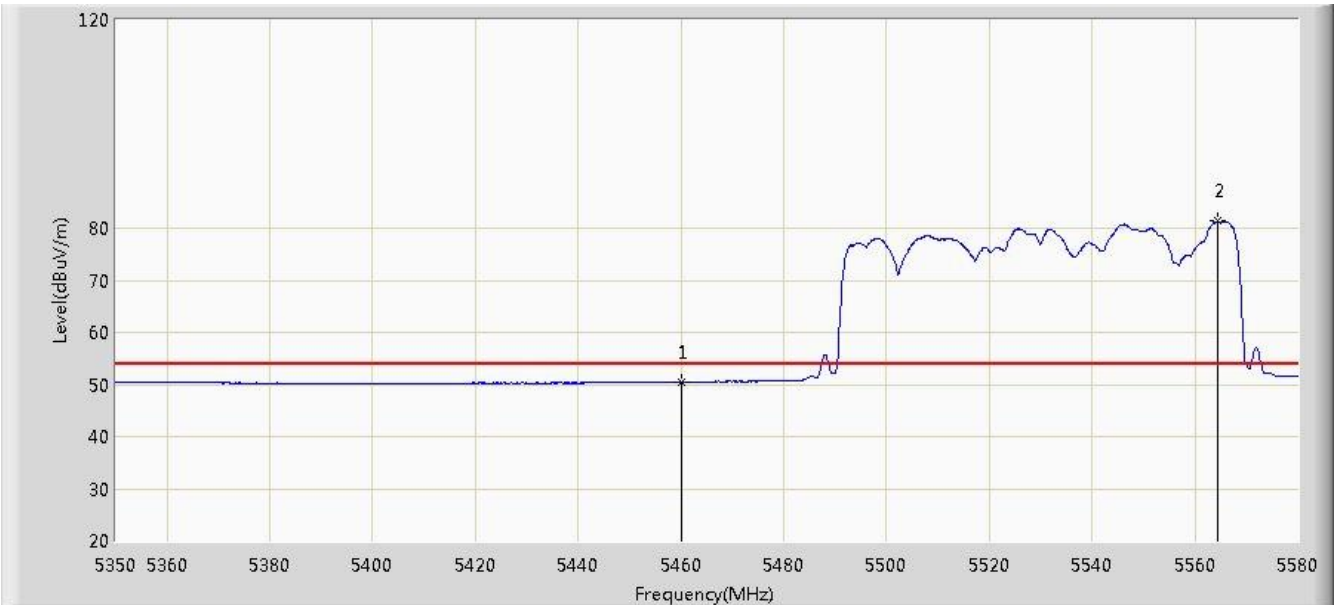

No	Flag	Mark	Frequency (MHz)	Measure Level (dBuV/m)	Reading Level (dBuV)	Over Limit (dB)	Limit (dBuV/m)	Factor (dB)	Type
1			5460.000	50.410	12.847	-3.590	54.000	37.563	AV
2		*	5564.360	81.353	43.646	N/A	N/A	37.706	AV

Note: Measure Level (dB μ V/m) = Reading Level (dB μ V) + Factor (dB)

Factor (dB) = Cable Loss (dB) + Antenna Factor (dB/m).

Site: AC1	Time: 2015/01/14 - 21:54
Limit: FCC_Part15.209_RE(3m)	Engineer: Roy Cheng
Probe: BBHA9120D_1-18GHz	Polarity: Vertical
EUT: WiFi Concurrent 4 Port GE LAN VoIP Ethernet Gateway with USB	Power: AC 120V/60Hz
Test Mode: Transmit at channel 5530MHz by 802.11ac-VHT80 Ant 0+1+2+3	

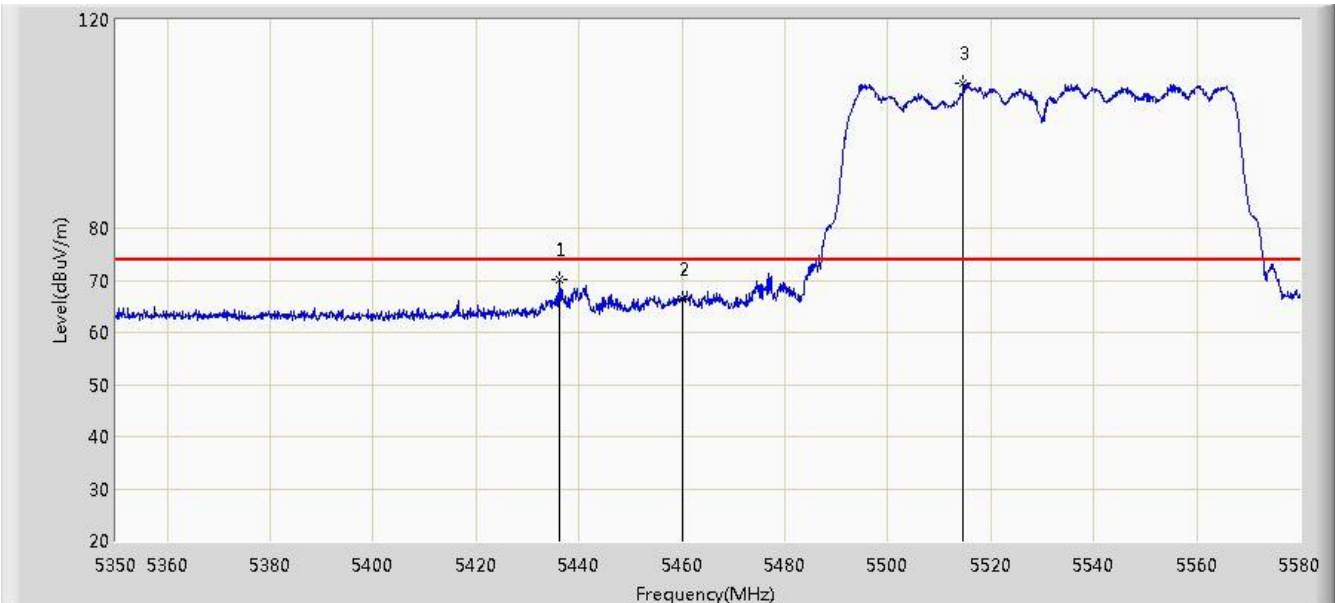

No	Flag	Mark	Frequency (MHz)	Measure Level (dBuV/m)	Reading Level (dBuV)	Over Limit (dB)	Limit (dBuV/m)	Factor (dB)	Type
1			5436.135	70.076	32.554	-3.924	74.000	37.522	PK
2			5460.000	66.380	28.817	-7.620	74.000	37.563	PK
3		*	5514.680	107.749	70.108	N/A	N/A	37.641	PK

Note: Measure Level (dB μ V/m) = Reading Level (dB μ V) + Factor (dB)

Factor (dB) = Cable Loss (dB) + Antenna Factor (dB/m).

Site: AC1	Time: 2015/01/14 - 21:57
Limit: FCC_Part15.209_RE(3m)	Engineer: Roy Cheng
Probe: BBHA9120D_1-18GHz	Polarity: Vertical
EUT: WiFi Concurrent 4 Port GE LAN VoIP Ethernet Gateway with USB	Power: AC 120V/60Hz
Test Mode: Transmit at channel 5530MHz by 802.11ac-VHT80 Ant 0+1+2+3	

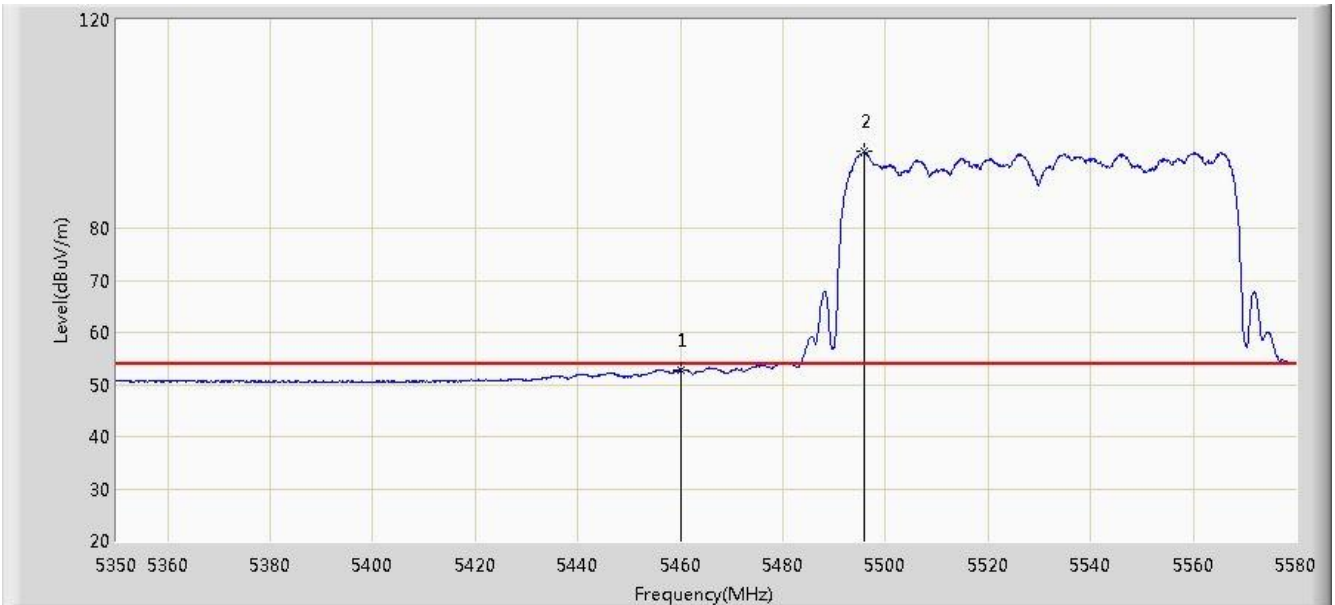

No	Flag	Mark	Frequency (MHz)	Measure Level (dBuV/m)	Reading Level (dBuV)	Over Limit (dB)	Limit (dBuV/m)	Factor (dB)	Type
1			5460.000	52.795	15.232	-1.205	54.000	37.563	AV
2		*	5495.820	94.707	57.087	N/A	N/A	37.619	AV

Note: Measure Level (dB μ V/m) = Reading Level (dB μ V) + Factor (dB)

Factor (dB) = Cable Loss (dB) + Antenna Factor (dB/m).

Site: AC1	Time: 2015/01/14 - 22:03
Limit: FCC 15.407	Engineer: Roy Cheng
Probe: BBHA9120D_1-18GHz	Polarity: Horizontal
EUT: WiFi Concurrent 4 Port GE LAN VoIP Ethernet Gateway with USB	Power: AC 120V/60Hz
Test Mode: Transmit at channel 5775MHz by 802.11ac-VHT80 Ant 0+1+2+3	

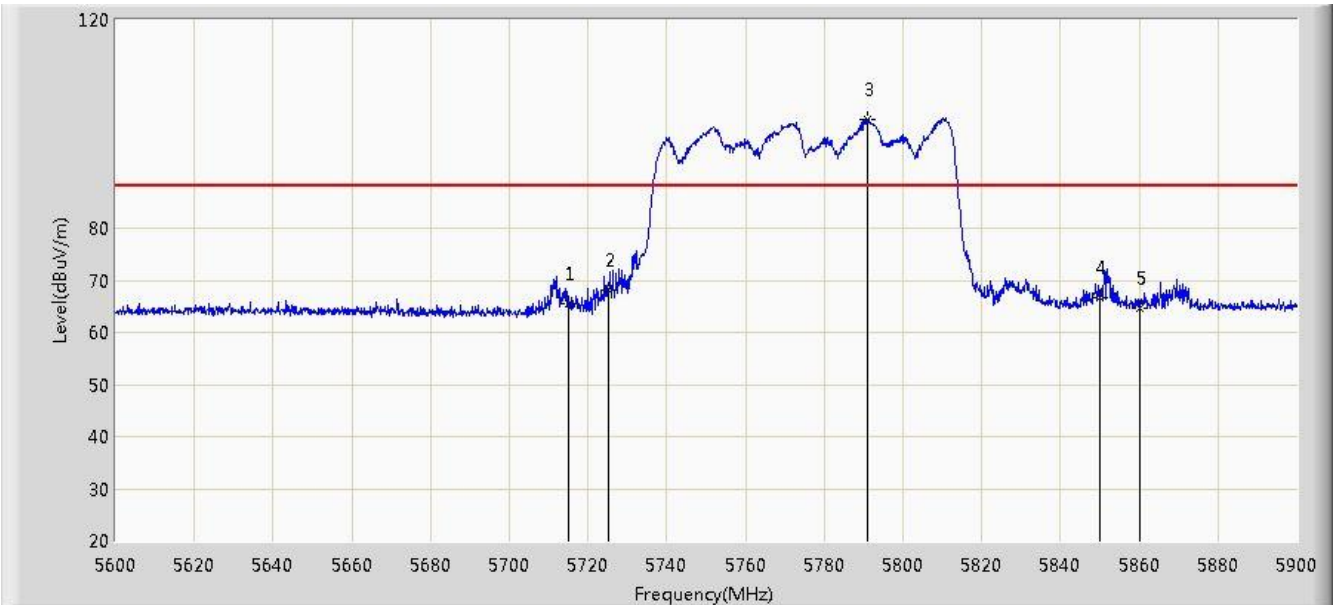

No	Flag	Mark	Frequency (MHz)	Measure Level (dBuV/m)	Reading Level (dBuV)	Over Limit (dB)	Limit (dBuV/m)	Factor (dB)	Type
1			5715.000	65.413	27.464	-22.787	88.200	37.949	PK
2			5725.000	68.158	30.168	-30.042	98.200	37.990	PK
3		*	5791.100	100.971	62.736	N/A	N/A	38.235	PK
4			5850.000	66.622	28.169	-31.578	98.200	38.454	PK
5			5860.000	64.734	26.256	-23.466	88.200	38.478	PK

Note: Measure Level (dBuV/m) = Reading Level (dBuV) + Factor (dB)

Factor (dB) = Cable Loss (dB) + Antenna Factor (dB/m).

Site: AC1	Time: 2015/01/14 - 22:03
Limit: FCC 15.407	Engineer: Roy Cheng
Probe: BBHA9120D_1-18GHz	Polarity: Horizontal
EUT: WiFi Concurrent 4 Port GE LAN VoIP Ethernet Gateway with USB	Power: AC 120V/60Hz
Test Mode: Transmit at channel 5775MHz by 802.11ac-VHT80 Ant 0+1+2+3	

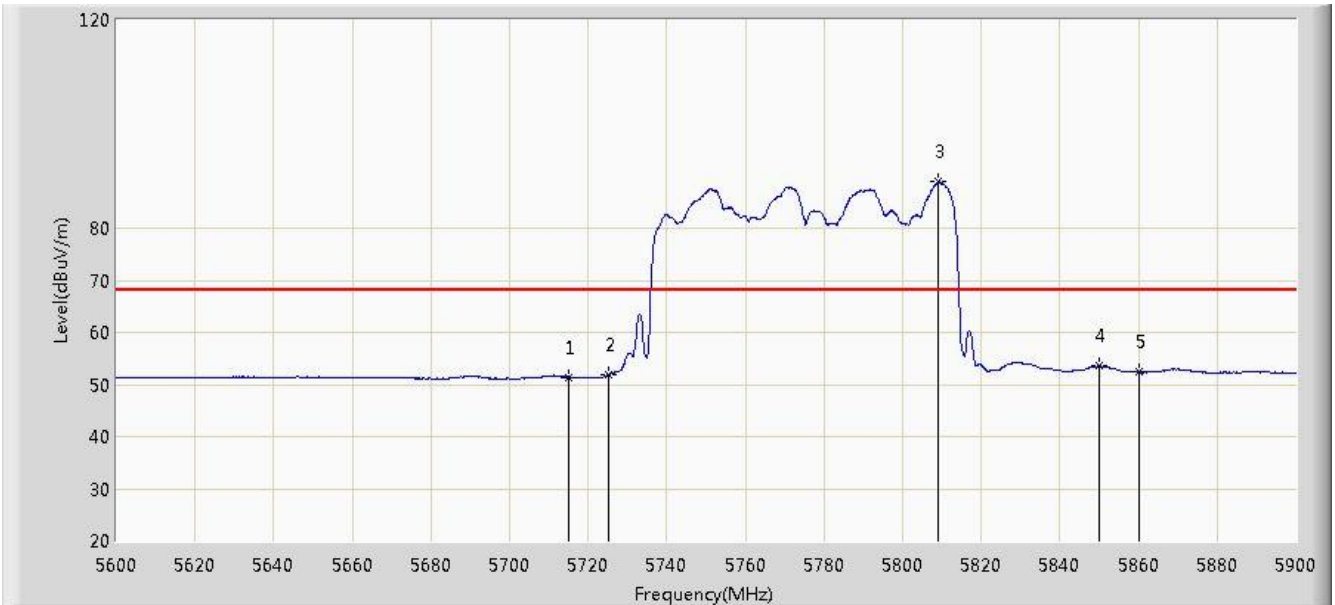

No	Flag	Mark	Frequency (MHz)	Measure Level (dBuV/m)	Reading Level (dBuV)	Over Limit (dB)	Limit (dBuV/m)	Factor (dB)	Type
1			5715.000	51.443	13.494	-16.757	68.200	37.949	AV
2			5725.000	51.779	13.789	-26.421	78.200	37.990	AV
3		*	5809.100	88.876	50.585	N/A	N/A	38.291	AV
4			5850.000	53.520	15.067	-24.680	78.200	38.454	AV
5			5860.000	52.325	13.847	-15.875	68.200	38.478	AV

Note: Measure Level (dB μ V/m) = Reading Level (dB μ V) + Factor (dB)

Factor (dB) = Cable Loss (dB) + Antenna Factor (dB/m).

Site: AC1	Time: 2015/01/14 - 22:06
Limit: FCC 15.407	Engineer: Roy Cheng
Probe: BBHA9120D_1-18GHz	Polarity: Vertical
EUT: WiFi Concurrent 4 Port GE LAN VoIP Ethernet Gateway with USB	Power: AC 120V/60Hz
Test Mode: Transmit at channel 5775MHz by 802.11ac-VHT80 Ant 0+1+2+3	

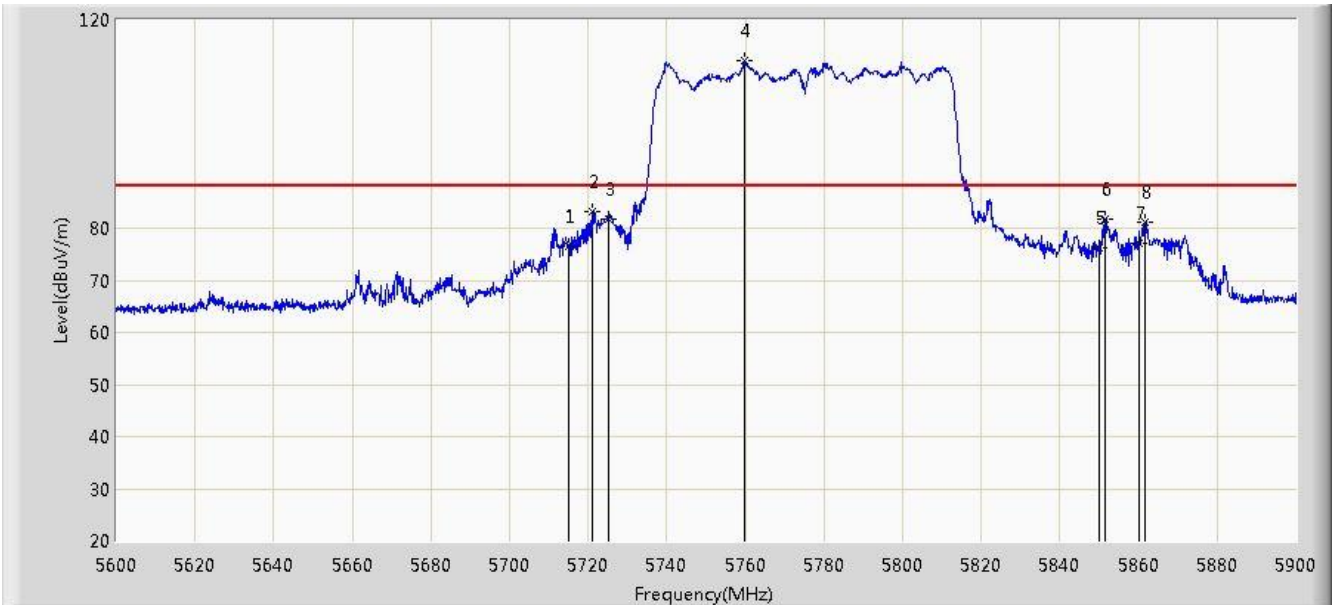

No	Flag	Mark	Frequency (MHz)	Measure Level (dBuV/m)	Reading Level (dBuV)	Over Limit (dB)	Limit (dBuV/m)	Factor (dB)	Type
1			5715.000	76.560	38.611	-11.640	88.200	37.949	PK
2			5721.200	83.206	45.232	-14.994	98.200	37.974	PK
3			5725.000	81.680	43.690	-16.520	98.200	37.990	PK
4		*	5759.600	112.246	74.107	N/A	N/A	38.139	PK
5			5850.000	76.368	37.915	-51.832	98.200	38.454	PK
6			5851.550	81.706	43.249	-16.494	98.200	38.457	PK
7			5860.000	77.202	38.724	-10.998	88.200	38.478	PK
8			5861.750	81.034	42.552	-7.166	88.200	38.482	PK

Note: Measure Level (dBuV/m) = Reading Level (dBuV) + Factor (dB)

Factor (dB) = Cable Loss (dB) + Antenna Factor (dB/m).

Site: AC1	Time: 2015/01/14 - 22:07
Limit: FCC 15.407	Engineer: Roy Cheng
Probe: BBHA9120D_1-18GHz	Polarity: Vertical
EUT: WiFi Concurrent 4 Port GE LAN VoIP Ethernet Gateway with USB	Power: AC 120V/60Hz
Test Mode: Transmit at channel 5775MHz by 802.11ac-VHT80 Ant 0+1+2+3	

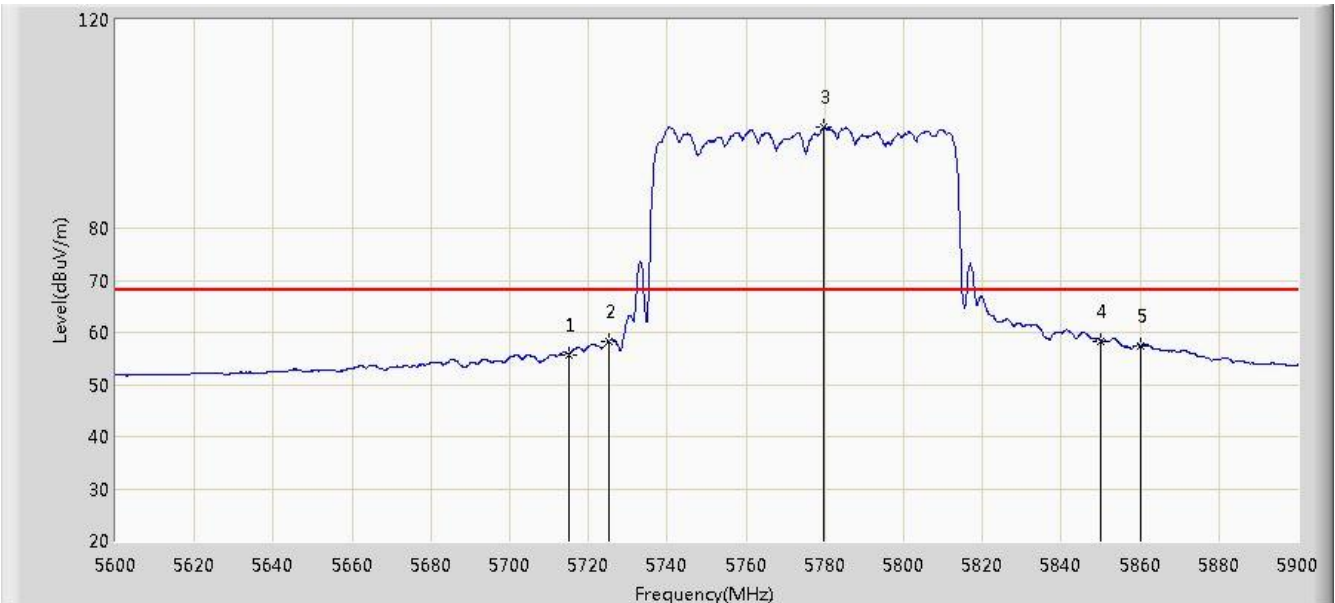

No	Flag	Mark	Frequency (MHz)	Measure Level (dBuV/m)	Reading Level (dBuV)	Over Limit (dB)	Limit (dBuV/m)	Factor (dB)	Type
1			5715.000	55.770	17.821	-12.430	68.200	37.949	AV
2			5725.000	58.187	20.197	-20.013	78.200	37.990	AV
3		*	5779.850	99.349	61.155	N/A	N/A	38.193	AV
4			5850.000	58.401	19.948	-19.799	78.200	38.454	AV
5			5860.000	57.441	18.963	-10.759	68.200	38.478	AV

Note: Measure Level (dBuV/m) = Reading Level (dBuV) + Factor (dB)

Factor (dB) = Cable Loss (dB) + Antenna Factor (dB/m).

7.10. AC Conducted Emissions Measurement

7.10.1. Test Limit

FCC Part 15 Subpart C Paragraph 15.207		
Frequency (MHz)	QP (dB μ V)	AV (dB μ V)
0.15 - 0.50	66 - 56	56 - 46
0.50 - 5.0	56	46
5.0 - 30	60	50

Note 1: The lower limit shall apply at the transition frequencies.

Note 2: The limit decreases linearly with the logarithm of the frequency in the range 0.15MHz to 0.5MHz.

7.10.2. Test Procedure

The EUT was setup according to ANSI C63.4, 2009 and tested according to KDB 789033 for compliance to FCC 47CFR 15.247 requirements. The EUT was placed on a platform of nominal size, 1 m by 1.5 m, raised 80 cm above the conducting ground plane. The vertical conducting plane was located 40 cm to the rear of the EUT. All other surfaces of EUT were at least 80 cm from any other grounded conducting surface. The EUT and simulators are connected to the main power through a line impedance stabilization network (LISN). The LISN provides a 50 ohm /50uH coupling impedance for the measuring equipment. The peripheral devices are also connected to the main power through a LISN. (Please refer to the block diagram of the test setup and photographs) Each current-carrying conductor of the EUT power cord, except the ground (safety) conductor, was individually connected through a LISN to the input power source.

The excess length of the power cord between the EUT and the LISN receptacle were folded back and forth at the center of the lead to form a bundle not exceeding 40 cm in length.

Conducted emissions were investigated over the frequency range from 0.15MHz to 30MHz using a receiver bandwidth of 9 kHz.

7.10.3. Test Setup

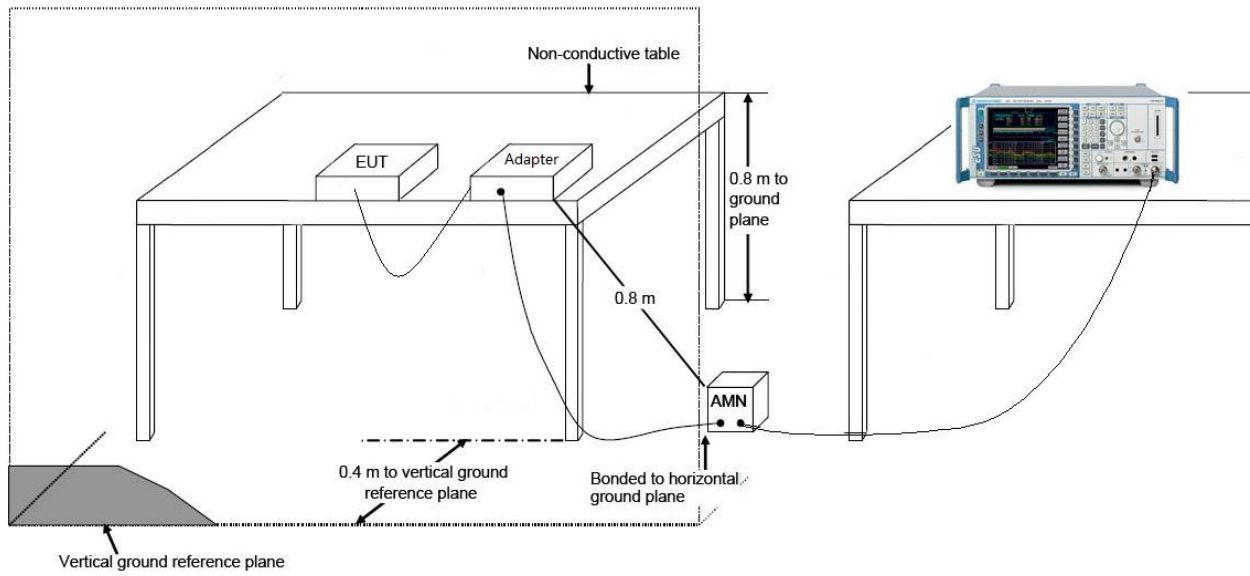

7.10.4. Test Result

Site: SR2	Time: 2015/01/31 - 19:16
Limit: FCC_Part15.107_CE_Class B	Engineer: Roy Cheng
Probe: ENV216_101683_Filter On	Polarity: Line
EUT: WiFi Concurrent 4 Port GE LAN VoIP Ethernet Gateway with USB	Power: AC 120V/60Hz
Note: Mode 1	

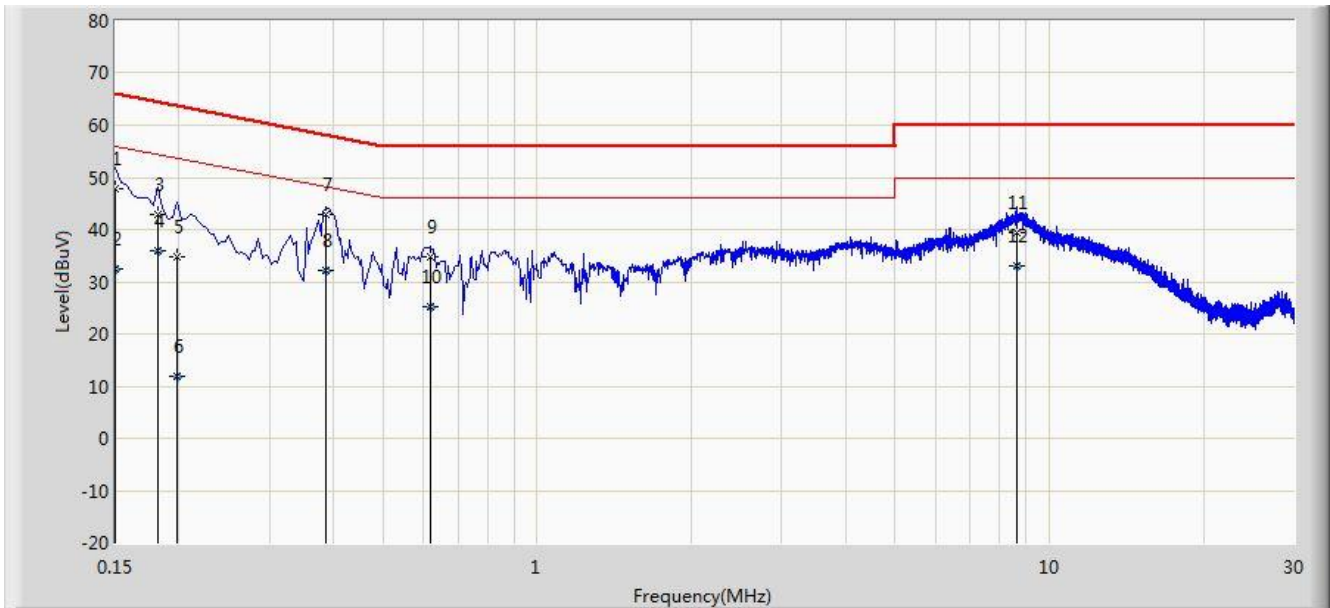

No	Flag	Mark	Frequency (MHz)	Measure Level (dBuV)	Reading Level (dBuV)	Over Limit (dB)	Limit (dBuV)	Factor (dB)	Type
1			0.150	47.724	36.582	-18.276	66.000	11.142	QP
2			0.150	32.331	21.189	-23.669	56.000	11.142	AV
3			0.182	42.838	32.795	-21.556	64.394	10.042	QP
4			0.182	35.867	25.825	-18.527	54.394	10.042	AV
5			0.198	34.756	24.742	-28.938	63.694	10.015	QP
6			0.198	11.826	1.811	-41.868	53.694	10.015	AV
7		*	0.386	42.872	32.770	-15.277	58.149	10.102	QP
8			0.386	32.098	21.996	-16.051	48.149	10.102	AV
9			0.618	34.905	24.783	-21.095	56.000	10.121	QP
10			0.618	25.260	15.139	-20.740	46.000	10.121	AV
11			8.630	39.359	29.161	-20.641	60.000	10.199	QP
12			8.630	32.975	22.777	-17.025	50.000	10.199	AV

Note: Measure Level (dBμV) = Reading Level (dBμV) + Factor (dB)

Factor (dB) = Cable Loss (dB) + LISN Factor (dB)

Site: SR2	Time: 2015/01/31 - 19:20
Limit: FCC_Part15.207_CE_Class B	Engineer: Roy Cheng
Probe: ENV216_101683_Filter On	Polarity: Neutral
EUT: WiFi Concurrent 4 Port GE LAN VoIP Ethernet Gateway with USB	Power: AC 120V/60Hz
Note: Mode 1	

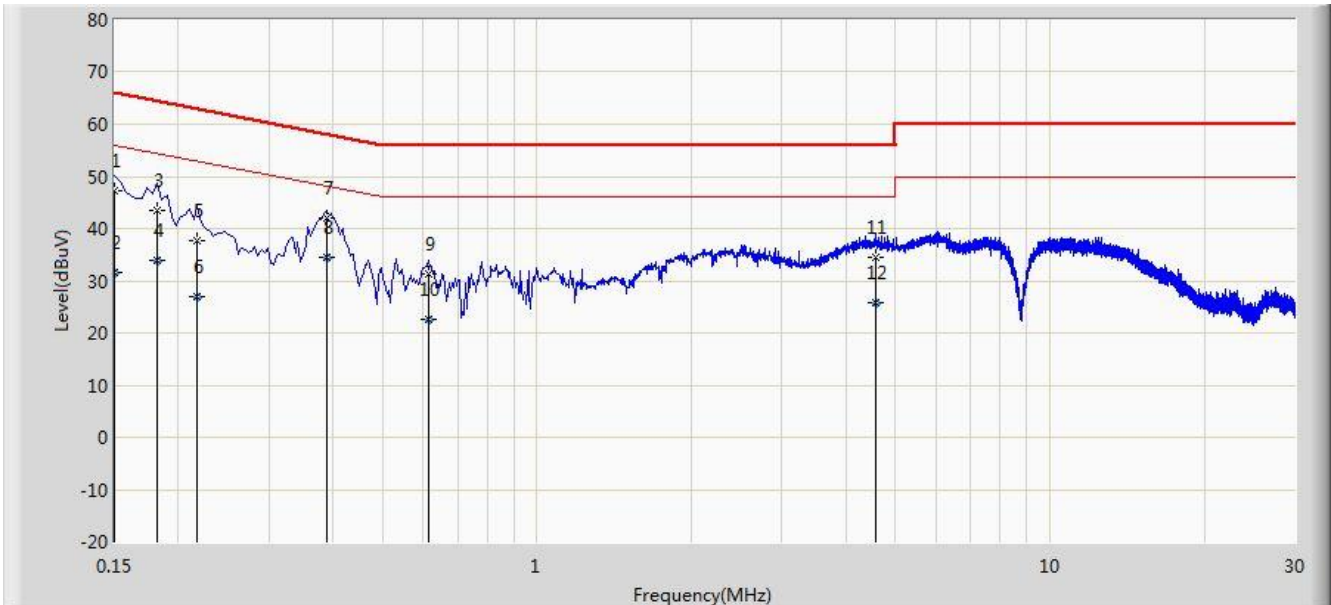

No	Flag	Mark	Frequency (MHz)	Measure Level (dBuV)	Reading Level (dBuV)	Over Limit (dB)	Limit (dBuV)	Factor (dB)	Type
1			0.150	47.154	36.012	-18.846	66.000	11.142	QP
2			0.150	31.458	20.316	-24.542	56.000	11.142	AV
3			0.182	43.519	33.476	-20.875	64.394	10.042	QP
4			0.182	34.031	23.988	-20.363	54.394	10.042	AV
5			0.218	37.691	27.710	-25.204	62.895	9.981	QP
6			0.218	26.953	16.972	-25.942	52.895	9.981	AV
7			0.390	42.100	31.995	-15.964	58.064	10.105	QP
8		*	0.390	34.369	24.265	-13.694	48.064	10.105	AV
9			0.614	31.375	21.251	-24.625	56.000	10.124	QP
10			0.614	22.489	12.366	-23.511	46.000	10.124	AV
11			4.586	34.458	24.453	-21.542	56.000	10.005	QP
12			4.586	25.669	15.664	-20.331	46.000	10.005	AV

Note: Measure Level (dBμV) = Reading Level (dBμV) + Factor (dB)

Factor (dB) = Cable Loss (dB) + LISN Factor (dB)

8. CONCLUSION

The data collected relate only the item(s) tested and show that the **WiFi Concurrent 4 Port GE LAN VoIP Ethernet Gateway with USB FCC ID: 2ABLK-844E-2** is in compliance with Part 15E of the FCC Rules.

The End