

FCC PART 15B CERTIFICATION TEST REPORT FOR

Applicant	:	Digital China Networks (Beijing) Limited
Address	:	Digital Technology Plaza, No.9 shangdi 9th street, Haidian District Beijing China
Equipment under Test	:	Outdoor Access Point
Model No	:	DCWL-7962OT
FCC ID	:	2ABKDCWL-7962OT
Trade Mark	:	DCN
Manufacturer	:	Digital China Networks (Beijing) Limited
Address	:	Digital Technology Plaza, No.9 shangdi 9 th street, Haidian District Beijing China

Issued By: Dongguan Dongdian Testing Service Co., Ltd.

Add: No. 17, Zongbu Road 2, Songshan Lake Sci&Tech, Industry Park, Dongguan City,
Guangdong Province, China, 523808

Tel: +86-0769-22891499 [Http://www.dgddt.com](http://www.dgddt.com)

REPORT

TABLE OF CONTENTS

- Test report declare 3
- 1. Summary of test results 4
- 2. General test information..... 5
 - 2.1. Description of EUT 5
 - 2.2. Assistant equipment used for test..... 5
 - 2.3. Block diagram EUT configuration for test..... 5
 - 2.4. Test environment conditions 6
 - 2.5. Deviations of test standard 6
 - 2.6. Test laboratory..... 6
 - 2.7. Measurement uncertainty 6
- 3. Equipment Used during Test..... 8
- 4. Power Line Conducted Emission Test 9
 - 4.1. Test equipment 9
 - 4.2. Block diagram of test setup 9
 - 4.3. Power Line Conducted Emission Limits(Class B)..... 9
 - 4.4. Test Procedure..... 9
 - 4.5. Test Result..... 10
- 5. Radiated emission test..... 13
 - 5.1. Test equipment 13
 - 5.2. Block diagram of test setup 13
 - 5.3. Radiated emission limit(Class B) 14
 - 5.4. Test Procedure..... 14
 - 5.5. Test result 15
- 6. Test setup photograph 20
 - 6.1. Photos of power line conducted emission test..... 20
 - 6.2. Photos of radiated emission test 20
- 7. Photos of the EUT 21

TEST REPORT DECLARE

Applicant	:	Digital China Networks (Beijing) Limited
Address	:	Digital Technology Plaza, No.9 shangdi 9 th street, Haidian District Beijing China
Equipment under Test	:	Outdoor Access Point
Model No	:	DCWL-7962OT
FCC ID	:	2ABKCDCWL-7962OT
Trade Mark	:	DCN
Manufacturer	:	Digital China Networks (Beijing) Limited
Address	:	Digital Technology Plaza, No.9 shangdi 9th street, Haidian District Beijing China

Test Standard Used:

FCC Rules and Regulations Part 15 Subpart B Class B 2015; ANSI C63.4:2014.

We Declare:

The equipment described above is tested by Dongguan Dongdian Testing Service Co., Ltd and in the configuration tested the equipment complied with the standards specified above (class B). The test results are contained in this test report and Dongguan Dongdian Testing Service Co., Ltd is assumed of full responsibility for the accuracy and completeness of these tests.

After test and evaluation, our opinion is that the equipment provided for test compliance with the requirement of the above FCC standards.

Report No:	DDT-R15Q0831-1E1		
Date of Test:	Sept. 24, 2015	Date of Report:	Oct. 21, 2015

Prepared By:



Leo Liu/Engineer



Kevin Feng/EMC Manager

Note: This report applies to above tested sample only. This report shall not be reproduced in parts without written approval of Dongguan Dongdian Testing Service Co., Ltd

1. Summary of test results

Description of Test Item	Standard	Limits	Results
Power Line Conducted Emission Test	FCC Part 15: 2015 ANSI C63.4: 2014	Class B	PASS
Radiated Emission Test	FCC Part 15: 2015 ANSI C63.4: 2015	Class B	PASS

2. General test information

2.1. Description of EUT

EUT* Name	: Outdoor Access Point
Model Number	: DCWL-7962OT
EUT function description	: Please reference user manual of this device
Power supply	: DC 50V from external POE adapter : Note: This device not sales with power adapter, and a typical power adapter was by provided by Manufacturer for test.
Maximum work frequency	: >108MHz
EUT Class	: Class B, intended primarily for use in the domestic environment
Date of Receipt	: 2015/9/24
Sample Type	: Series production

Note 1: EUT is the ab. of equipment under test.

Note 2: This test report only for EMC performance of non-wireless function of device, and for all other wireless functions EMC performance was tested and reported in another EMC test report.

2.2. Assistant equipment used for test

Description of Assistant equipment	Manufacturer	Model number or Type	EMC Compliance	Other
Notebook1	DELL	Latitude D610	FCC DOC	00045-534-136-300
Notebook2	DELL	Latitude D610	FCC DOC	00045-534-136-320
POE Adapter	Digital China Networks (Beijing) Limited	DCWL-PoEINJ-G+(R3)	FCC VOC	AC Line: 1.5m long, unshielded LAN line: 1.5m long, unshielded
Printer	HP	LaserJet 1020 plus	FCC DOC	AC Line: 1.8m long, unshielded USB line: 1.8m long, unshielded
Keyboard	HP	KB-0316	FCC DOC	Signal line: 1.5m long, unshielded

2.3. Block diagram EUT configuration for test

EUT ON (Communicate with PC) Mode:

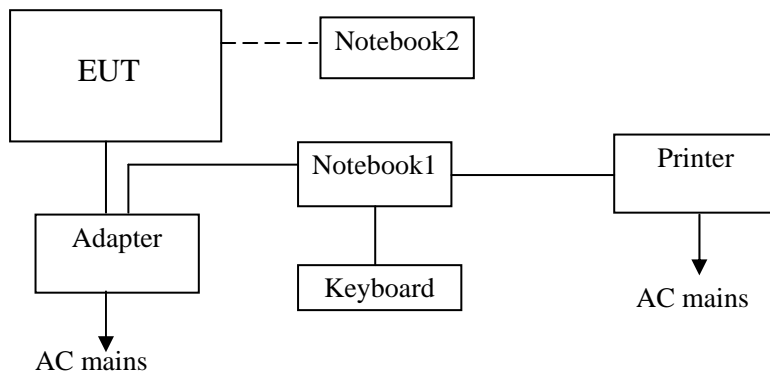

Notebook 2 connected to EUT by wireless connection, Notebook1 connected to EUT though LAN port, Notebook 1 located outside test site. Notebook 2 transmit data with Notebook1 through EUT.

Note: This EUT not contains power adapter, a typical power adapter was used for test.

2.4. Test environment conditions

During the measurement the environmental conditions were within the listed ranges:

Temperature range:	21-25°C
Humidity range:	40-75%
Pressure range:	86-106kPa

2.5. Deviations of test standard

No Deviation.

2.6. Test laboratory

Dongguan Dongdian Testing Service Co., Ltd

Add: No. 17, Zongbu Road 2, Songshan Lake Sci&Tech, Industry Park, Dongguan City, Guangdong Province, China, 523808 Tel: +86-0769-22891499 <http://www.dgddt.com>

FCC Registration Number: 270092

2.7. Measurement uncertainty

Test Item	Uncertainty
Uncertainty for Conduction emission test	±2.44dB (150KHz-30MHz)
	±2.94dB (9KHz-150KHz)
Uncertainty for Radiation Emission test (30MHz-1GHz)	±3.14 dB (Antenna Polarize: V)
	±3.16 dB (Antenna Polarize: H)

Uncertainty for Radiation Emission test (1GHz-18GHz)	$\pm 4.14\text{dB}(1-6\text{GHz})$
	$\pm 4.46\text{dB}(6\text{GHz}-18\text{GHz})$
Note: This uncertainty represents an expanded uncertainty expressed at approximately the 95% confidence level using a coverage factor of $k=2$.	

3. Equipment Used during Test

Equipment	Manufacturer	Model No.	Serial No.	Last Cal.	Cal. Interval
Power Line Conducted Emission Test					
Test Receiver	R&S	ESU8	100316	2014/10/25	1 Year
LISN 1	R&S	ENV216	101109	2014/10/25	1 Year
LISN 2	R&S	ESH2-Z5	100309	2014/10/25	1 Year
Pulse Limiter	R&S	ESH3-Z2	101242	2014/10/25	1 Year
CE Cable 1	HUBSER	ESU8/RF2	W10.01	2014/10/25	1 Year
Test software	Audix	E3	V 6.11111b	/	/
Radiated Emission Test					
EMI Test Receiver	R&S	ESU8	100316	2014/10/25	1Year
Spectrum analyzer	R&S	FSU26	1166.1660.26	2014/10/25	1Year
Trilog Broadband Antenna	Schwarzbeck	VULB9163	9163-462	2015/05/30	1 Year
Active Loop antenna	Schwarzbeck	FMZB-1519	1519-038	2014/11/01	1 Year
Double Ridged Horn Antenna	R&S	HF907	100276	2014/11/01	1 Year
Pre-amplifier	A.H.	PAM-0118	360	2015/08/18	1 Year
RF Cable	HUBSER	CP-X2	W11.03	2014/10/25	1Year
RF Cable	HUBSER	CP-X1	W12.02	2014/10/25	1 Year
MI Cable	HUBSER	C10-01-01-1M	1091629	2014/10/25	1 Year
Test software	Audix	E3	V 6.11111b	/	/

4. Power Line Conducted Emission Test

4.1. Test equipment

Please refer to Section 3 this report.

4.2. Block diagram of test setup

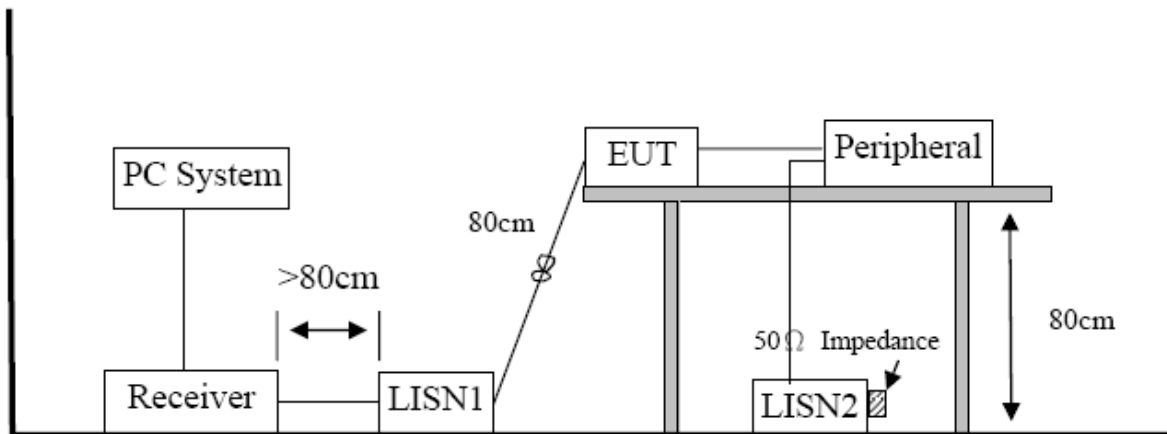

4.3. Power Line Conducted Emission Limits(Class B)

Frequency	Quasi-Peak Level dB(μ V)	Average Level dB(μ V)
150kHz ~ 500kHz	66 ~ 56*	56 ~ 46*
500kHz ~ 5MHz	56	46
5MHz ~ 30MHz	60	50

Note 1: * Decreasing linearly with logarithm of frequency.

Note 2: The lower limit shall apply at the transition frequencies.

4.4. Test Procedure

The EUT and Support equipment, if needed, were put placed on a non-metallic table, 80cm above the ground plane.

Configuration EUT to simulate typical usage as described in clause 2.3 and test equipment as described in clause 3.2 of this report.

All I/O cables were positioned to simulate typical actual usage as per ANSI C63.4.

All support equipment power received from a second LISN.

Emissions were measured on each current carrying line of the EUT using an EMI Test Receiver connected to the LISN powering the EUT.

The Receiver scanned from 150 kHz to 30MHz for emissions in each of the test modes.

During the above scans, the emissions were maximized by cable manipulation.

The test mode(s) described in clause 2.3 were scanned during the preliminary test.

After the preliminary scan, we found the test mode producing the highest emission level.

The EUT configuration and worse cable configuration of the above highest emission levels were recorded for reference of the final test.

EUT and support equipment were set up on the test bench as per the configuration with highest emission level in the preliminary test.

A scan was taken on both power lines, Neutral and Line, recording at least the six highest emissions. Emission frequency and amplitude were recorded into a computer in which correction factors were used to calculate the emission level and compare reading to the applicable limit.

The test data of the worst-case condition(s) was recorded.

The bandwidth of test receiver is set at 9 KHz.

4.5. Test Result

PASS. (See below detailed test result)

Note1: All emissions not reported below are too low against the prescribed limits.

Note2: “----” means Peak detection; “-----” mans Average detection

TR-4-E-010 Conducted Emission Test Result

: DDT 1# Shield Room E:\2015 report data\15Q0831-1\CE.EM6
Test Date : 2015-09-24 **Tested By** : Sincere
EUT : Outdoor Access Point **Model Number** : DCWL-7962OT
Power Supply : DC 50V from external POE adapter **Test Mode** : EUT ON
Condition : Temp:24.5°C,Humi:55%, **LISN** : 2014 ENV216/NEUTRAL
 Press:100.1kPa
Memo :

Data: 6

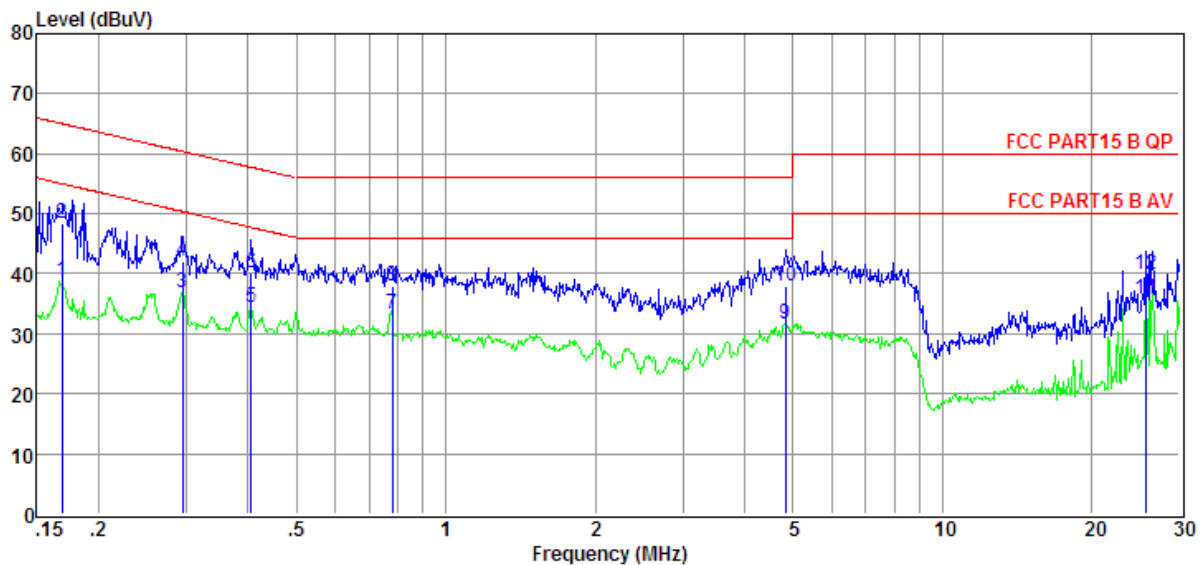

Item (Mark)	Freq (MHz)	Read Level (dBμV)	LISN Factor (dB)	Cable Loss (dB)	Pulse Limiter Factor (dB)	Result Level (dBμV)	Limit Line (dBμV)	Over Limit (dB)	Detector	Phase
1	0.17	19.23	9.60	0.01	9.84	38.68	55.03	-16.35	Average	NEUTRAL
2	0.17	29.02	9.60	0.01	9.84	48.47	65.03	-16.56	QP	NEUTRAL
3	0.30	17.27	9.60	0.02	9.85	36.74	50.37	-13.63	Average	NEUTRAL
4	0.30	22.58	9.60	0.02	9.85	42.05	60.37	-18.32	QP	NEUTRAL
5	0.41	14.79	9.61	0.03	9.86	34.29	47.73	-13.44	Average	NEUTRAL
6	0.41	20.57	9.61	0.03	9.86	40.07	57.73	-17.66	QP	NEUTRAL
7	0.78	13.69	9.61	0.08	9.86	33.24	46.00	-12.76	Average	NEUTRAL
8	0.78	18.35	9.61	0.08	9.86	37.90	56.00	-18.10	QP	NEUTRAL
9	4.82	11.92	9.62	0.11	9.88	31.53	46.00	-14.47	Average	NEUTRAL
10	4.82	18.40	9.62	0.11	9.88	38.01	56.00	-17.99	QP	NEUTRAL
11	25.69	15.61	10.02	0.17	9.97	35.77	50.00	-14.23	Average	NEUTRAL
12	25.69	19.70	10.02	0.17	9.97	39.86	60.00	-20.14	QP	NEUTRAL

Note: 1. Result Level = Read Level + LISN Factor + Pulse Limiter Factor + Cable loss.
 2. If QP Result complies with AV limit, AV Result is deemed to comply with AV limit.
 3. Test setup: RBW: 200 Hz (9 kHz—150 kHz), 9 kHz (150 kHz—30 MHz), Step size: 4 kHz, Scan time: auto.

TR-4-E-010 Conducted Emission Test Result

	: DDT 1# Shield Room	E:\2015 report data\15Q0831-1\CE.EM6
Test Date	: 2015-09-24	Tested By : Sincere
EUT	: Outdoor Access Point	Model Number : DCWL-7962OT
Power Supply	: DC 50V from external POE adapter	Test Mode : EUT ON
Condition	: Temp:24.5°C,Humi:55%, Press:100.1kPa	LISN : 2014 ENV216/LINE
Memo	:	

Data: 8

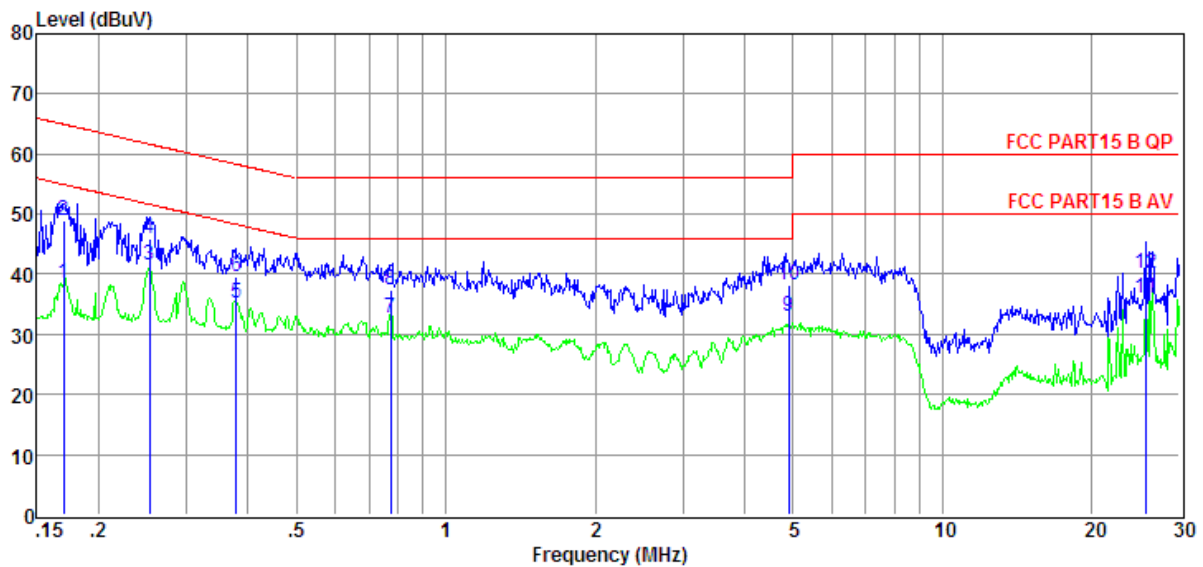

Item (Mark)	Freq (MHz)	Read Level (dBμV)	LISN Factor (dB)	Cable Loss (dB)	Pulse Limiter Factor (dB)	Result Level (dBμV)	Limit Line (dBμV)	Over Limit (dB)	Detector	Phase
1	0.17	19.03	9.61	0.01	9.84	38.49	54.94	-16.45	Average	LINE
2	0.17	29.36	9.61	0.01	9.84	48.82	64.94	-16.12	QP	LINE
3	0.25	22.13	9.62	0.02	9.85	41.62	51.64	-10.02	Average	LINE
4	0.25	26.46	9.62	0.02	9.85	45.95	61.64	-15.69	QP	LINE
5	0.38	15.67	9.63	0.02	9.86	35.18	48.30	-13.12	Average	LINE
6	0.38	20.05	9.63	0.02	9.86	39.56	58.30	-18.74	QP	LINE
7	0.78	13.22	9.62	0.08	9.86	32.78	46.00	-13.22	Average	LINE
8	0.78	17.85	9.62	0.08	9.86	37.41	56.00	-18.59	QP	LINE
9	4.90	13.33	9.68	0.11	9.88	33.00	46.00	-13.00	Average	LINE
10	4.90	18.50	9.68	0.11	9.88	38.17	56.00	-17.83	QP	LINE
11	25.69	15.91	9.98	0.17	9.97	36.03	50.00	-13.97	Average	LINE
12	25.69	20.09	9.98	0.17	9.97	40.21	60.00	-19.79	QP	LINE

Note: 1. Result Level = Read Level + LISN Factor + Pulse Limiter Factor + Cable loss.
 2. If QP Result complies with AV limit, AV Result is deemed to comply with AV limit.
 3. Test setup: RBW: 200 Hz (9 kHz—150 kHz), 9 kHz (150 kHz—30 MHz), Step size: 4 kHz, Scan time: auto.

5. Radiated emission test

5.1. Test equipment

Please refer to Section 3 this report.

5.2. Block diagram of test setup

Below 1GHz

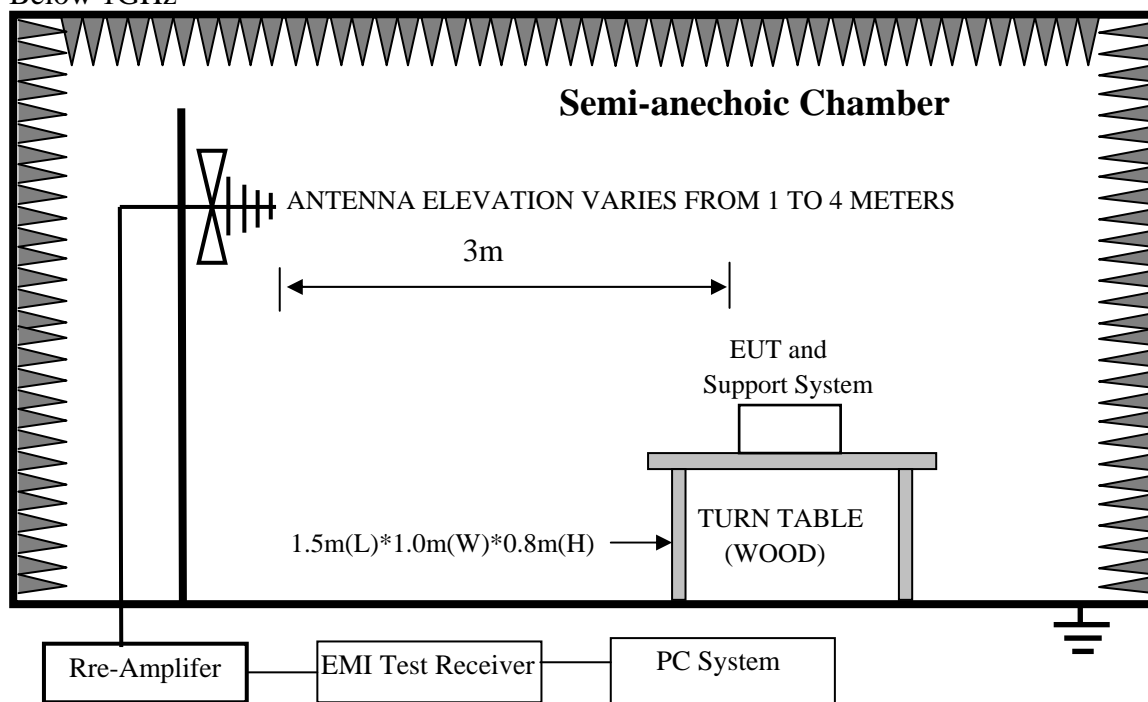

Above 1GHz

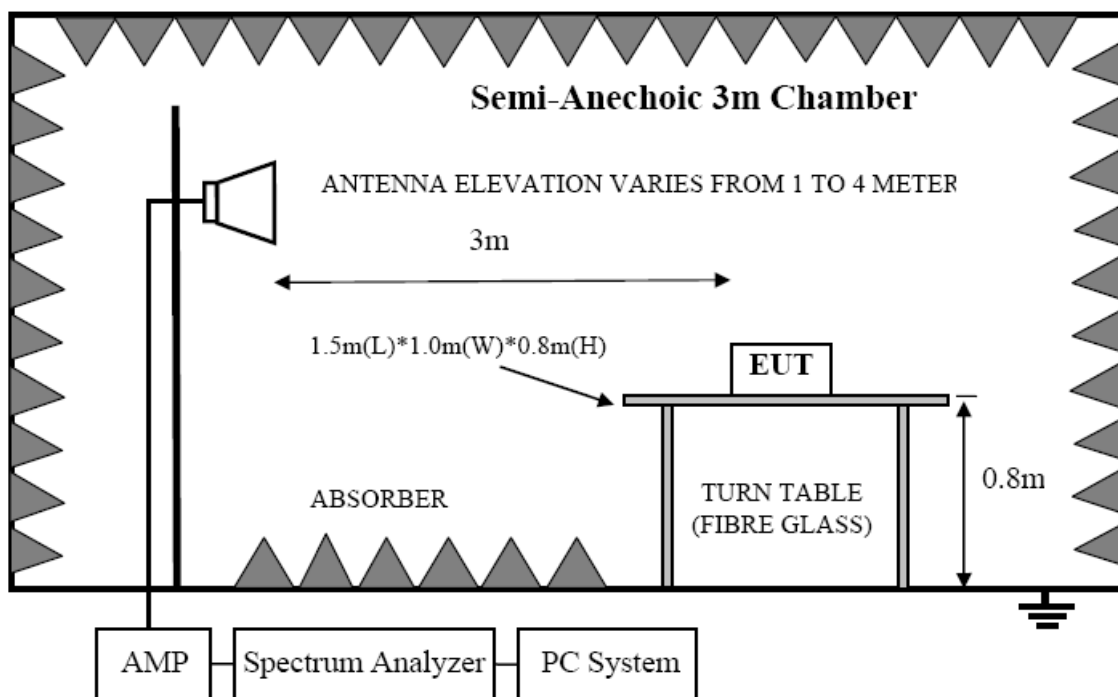

5.3. Radiated emission limit(Class B)

Frequency (MHz)	Distance (Meters)	Field Strengths Limits dB(μ V)/m
30--88	3	40.0
88--216	3	43.5
216--960	3	46.0
960--1000	3	54.0
1000--5000	3	Average:54 ; Peak:74

Note: (1) The smaller limit shall apply at the cross point between two frequency bands.

(2)Distance is the distance in meters between the measuring instrument, antenna and the closest point of any part of the device or system.

5.4. Test Procedure

Procedure of Preliminary Test

The EUT and Support equipment, if needed, were put placed on a non-metallic table, 80cm above the ground plane.

Configuration EUT to simulate typical usage as described in clause 2.3 and test equipment as described in clause 4.2 of this report.

All I/O cables were positioned to simulate typical actual usage as per ANSI C63.4.

Mains cables, telephone lines or other connections to auxiliary equipment located outside the test are shall drape to the floor, be fitted with ferrite clamps or ferrite tubes placed on the floor at the point where the cable reaches the floor and then routed to the place where they leave the turntable. No extension cords shall be used to mains receptacle.

The antenna was placed at 3 meter away from the EUT as stated in ANSI C63.4. The antenna connected to the Spectrum Analyzer via a cable and at times a pre-amplifier would be used.

The Analyzer / Receiver quickly scanned from 30MHz to 1000MHz. The EUT test program was started. Emissions were scanned and measured rotating the EUT to 360 degrees and positioning the antenna 1 to 4 meters above the ground plane, in both the vertical and the horizontal polarization, to maximize the emission reading level.

The test mode(s) described in clause 2.4 were scanned during the preliminary test:

After the preliminary scan, we found the test mode producing the highest emission level. The EUT and cable configuration, antenna position, polarization and turntable position of the above highest emission level were recorded for the final test.

Procedure of Final Test

EUT and support equipment were set up on the turntable as per the configuration with highest emission level in the preliminary test.

The Analyzer / Receiver scanned from 30MHz to 1000MHz. Emissions were scanned and measured rotating the EUT to 360 degrees, varying cable placement and positioning the antenna 1 to 4 meters above the ground plane, in both the vertical and the horizontal polarization, to maximize the emission reading level.

Recorded at least the six highest emissions. Emission frequency, amplitude, antenna position, polarization and turntable position were recorded into a computer in which correction factors were used to calculate the emission level and compare reading to the applicable limit and only Q.P. reading is presented.

The test data of the worst-case condition(s) was recorded.

The bandwidth setting of the test receiver is 120 kHz.

5.5. Test result

PASS. (See below detailed test result)

Note1: All emissions not reported below are too low against the prescribed limits.

TR-4-E-009 Radiated Emission Test Result

Test Site	: DDT 3m Chamber	E:\2015 Report Data\15Q0831-1\RE.EM6
Test Date	: 2015-09-24	Tested By : Toby
EUT	: Outdoor Access Point	Model Number : DCWL-7962OT
Power Supply	: DC 50V from external POE adapter	Test Mode : EUT ON
Condition	: Temp:24.5'C,Humi:55%, Press:100.1kPa	Antenna/Distance : 2014 VULB 9163/3m/VERTICAL
Memo	:	

Data: 1

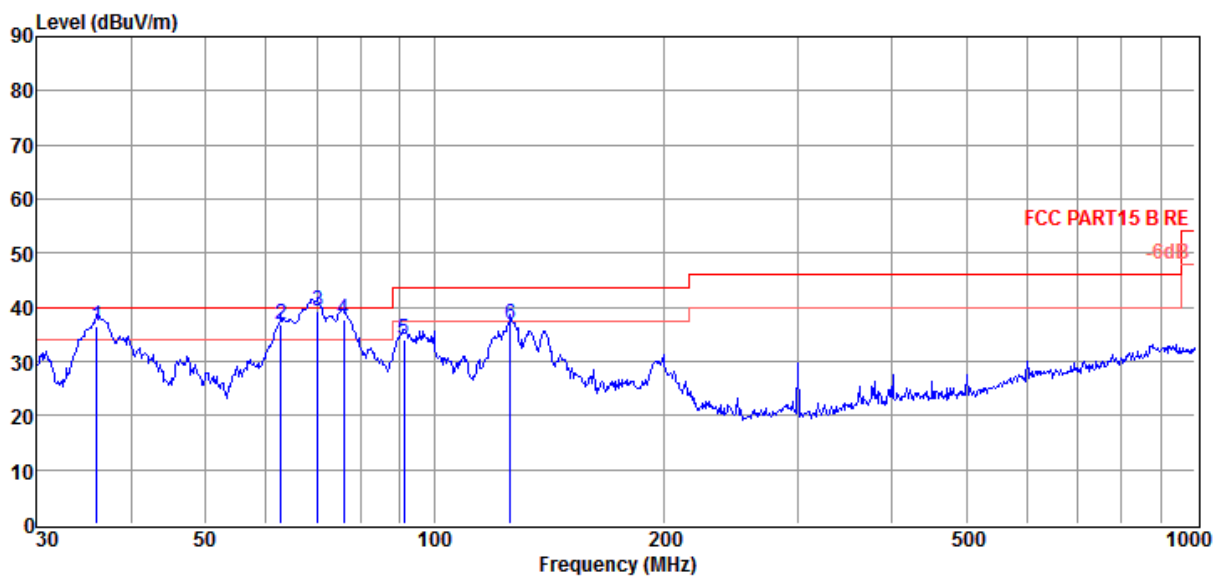

Item (Mark)	Freq (MHz)	Read Level (dBμV)	Antenna Factor (dB/m)	Cable Loss dB	Result Level (dBμV/m)	Limit Line (dBμV/m)	Over Limit (dB)	Detector	Polarization
1	36.00	23.32	12.30	0.95	36.57	40.00	-3.43	QP	VERTICAL
2	62.87	23.65	12.10	1.15	36.90	40.00	-3.10	QP	VERTICAL
3	70.34	29.02	9.10	1.21	39.33	40.00	-0.67	QP	VERTICAL
4	75.98	28.69	7.65	1.30	37.64	40.00	-2.36	QP	VERTICAL
5	91.18	20.67	11.80	1.44	33.91	43.50	-9.59	QP	VERTICAL
6	125.89	26.30	8.83	1.59	36.72	43.50	-6.78	QP	VERTICAL

- Note: 1. Result Level = Read Level + Antenna Factor + Cable loss.
 2. If Peak Result complies with QP limit, QP Result is deemed to comply with QP limit.
 3. Test setup: RBW: 120 kHz, VBW: 300 kHz, Sweep time: auto.

TR-4-E-009 Radiated Emission Test Result

Test Site : DDT 3m Chamber E:\2015 Report Data\15Q0831-1\RE.EM6
Test Date : 2015-09-24 **Tested By** : Toby
EUT : Outdoor Access Point **Model Number** : DCWL-7962OT
Power Supply : DC 50V from external POE adapter **Test Mode** : EUT ON
Condition : Temp:24.5°C,Humi:55%,
 Press:100.1kPa **Antenna/Distance** : 2014 VULB 9163/3m/HORIZONTAL
Memo :

Data: 2

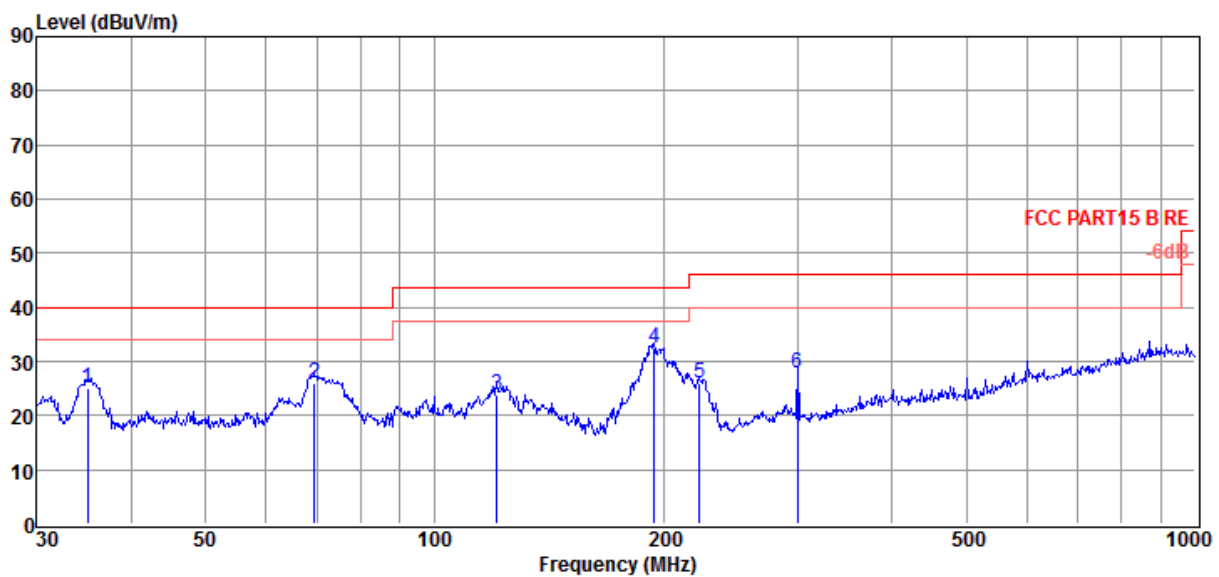

Item (Mark)	Freq (MHz)	Read Level (dBμV)	Antenna Factor (dB/m)	Cable Loss (dB)	Result Level (dBμV/m)	Limit Line (dBμV/m)	Over Limit (dB)	Detector	Polarization
1	35.01	11.72	12.30	0.94	24.96	40.00	-15.04	QP	HORIZONTAL
2	69.60	15.54	9.10	1.21	25.85	40.00	-14.15	QP	HORIZONTAL
3	120.70	12.43	9.90	1.57	23.90	43.50	-19.60	QP	HORIZONTAL
4	194.45	20.22	10.17	2.13	32.52	43.50	-10.98	QP	HORIZONTAL
5	222.95	13.22	10.60	2.22	26.04	46.00	-19.96	QP	HORIZONTAL
6	300.37	11.63	13.40	2.70	27.73	46.00	-18.27	QP	HORIZONTAL

- Note: 1. Result Level = Read Level + Antenna Factor + Cable loss.
 2. If Peak Result complies with QP limit, QP Result is deemed to comply with QP limit.
 3. Test setup: RBW: 120 kHz, VBW: 300 kHz, Sweep time: auto.

TR-4-E-009 Radiated Emission Test Result

Test Site	: DDT 3m Chamber	E:\2015 Report Data\15Q0831-1\RE.EM6
Test Date	: 2015-09-25	Tested By : Toby
EUT	: Outdoor Access Point	Model Number : DCWL-7962OT
Power Supply	: DC 50V from external POE adapter	Test Mode : EUT ON
Condition	: Temp:24.5'C,Humi:55%, Press:100.1kPa	Antenna/Distance : 2014 HF907/3m/HORIZONTAL
Memo	:	

Data: 11

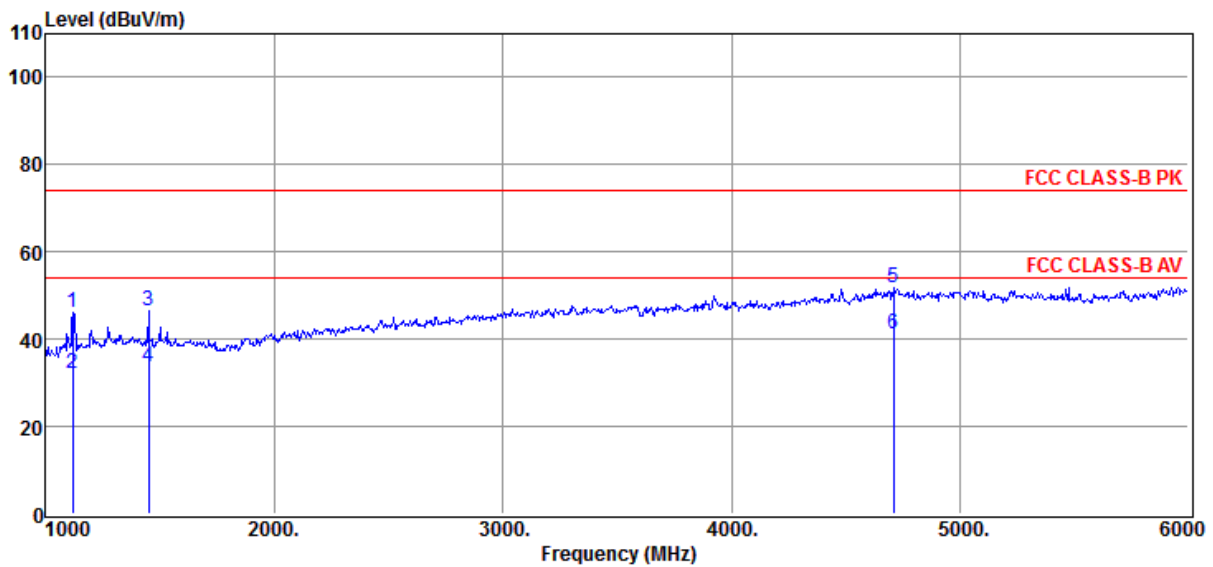

Item (Mark)	Freq (MHz)	Read Level (dBμV)	Antenna Factor (dB/m)	PRM Factor dB	Cable Loss dB	Result Level (dBμV/m)	Limit Line (dBμV/m)	Over Limit (dB)	Detector	Polarization
1	1120.00	45.12	25.01	27.36	3.39	46.16	74.00	-27.84	Peak	HORIZONTAL
2	1120.00	30.90	25.01	27.36	3.39	31.94	54.00	-22.06	Average	HORIZONTAL
3	1450.00	44.95	26.12	28.27	3.84	46.64	74.00	-27.36	Peak	HORIZONTAL
4	1450.00	32.10	26.12	28.27	3.84	33.79	54.00	-20.21	Average	HORIZONTAL
5	4710.00	37.60	35.23	29.18	8.03	51.68	74.00	-22.32	Peak	HORIZONTAL
6	4710.00	27.11	35.23	29.18	8.03	41.19	54.00	-12.81	Average	HORIZONTAL

- Note: 1. Result Level = Read Level + Antenna Factor + Cable loss - PRM Factor.
 2. If Peak Result complies with AV limit, AV Result is deemed to comply with AV limit.
 3. Test setup: RBW: 1 MHz, VBW: 3 MHz, Sweep time: auto.

TR-4-E-009 Radiated Emission Test Result

Test Site	: DDT 3m Chamber	E:\2015 Report Data\15Q0831-1\RE.EM6
Test Date	: 2015-09-25	Tested By : Toby
EUT	: Outdoor Access Point	Model Number : DCWL-7962OT
Power Supply	: DC 50V from external POE adapter	Test Mode : EUT ON
Condition	: Temp:24.5°C,Humi:55%, Press:100.1kPa	Antenna/Distance : 2014 HF907/3m/VERTICAL
Memo	:	

Data: 12

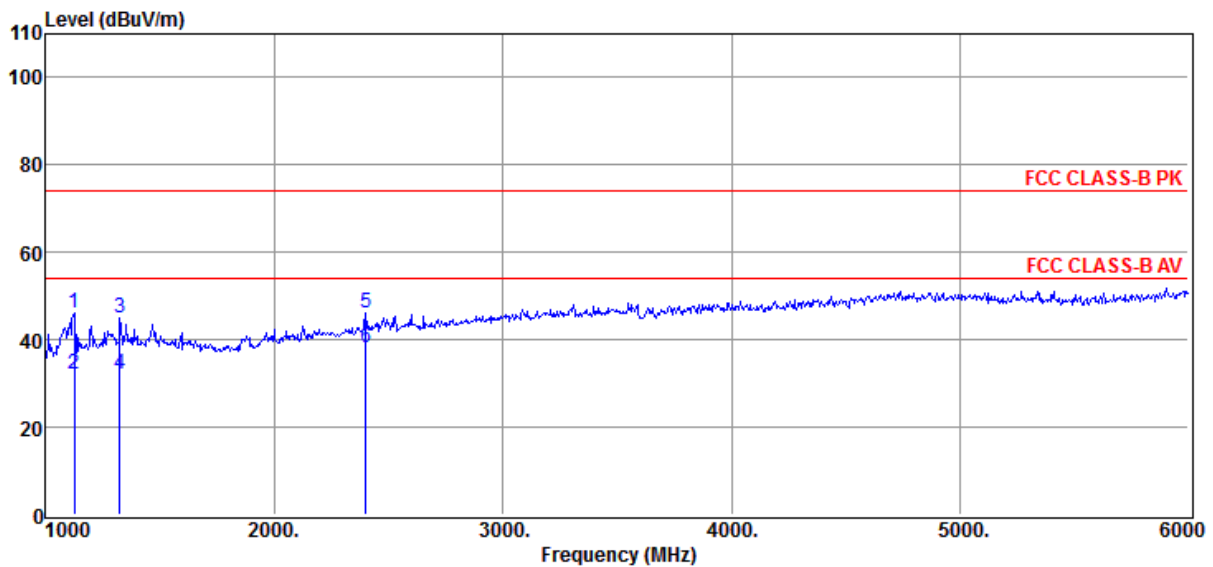

Item (Mark)	Freq (MHz)	Read Level (dBμV)	Antenna Factor (dB/m)	PRM Factor dB	Cable Loss dB	Result Level (dBμV/m)	Limit Line (dBμV/m)	Over Limit (dB)	Detector	Polarization
1	1125.00	45.18	25.01	27.36	3.39	46.22	74.00	-27.78	Peak	VERTICAL
2	1125.00	31.18	25.01	27.36	3.39	32.22	54.00	-21.78	Average	VERTICAL
3	1325.00	43.47	25.71	27.87	3.64	44.95	74.00	-29.05	Peak	VERTICAL
4	1325.00	30.47	25.71	27.87	3.64	31.95	54.00	-22.05	Average	VERTICAL
5	2400.00	41.31	29.99	30.21	5.17	46.26	74.00	-27.74	Peak	VERTICAL
6	2400.00	33.31	29.99	30.21	5.17	38.26	54.00	-15.74	Average	VERTICAL

Note: 1. Result Level = Read Level + Antenna Factor + Cable loss - PRM Factor.
 2. If Peak Result complies with AV limit, AV Result is deemed to comply with AV limit.
 3. Test setup: RBW: 1 MHz, VBW: 3 MHz, Sweep time: auto.

6. Test setup photograph

6.1. Photos of power line conducted emission test



6.2. Photos of radiated emission test

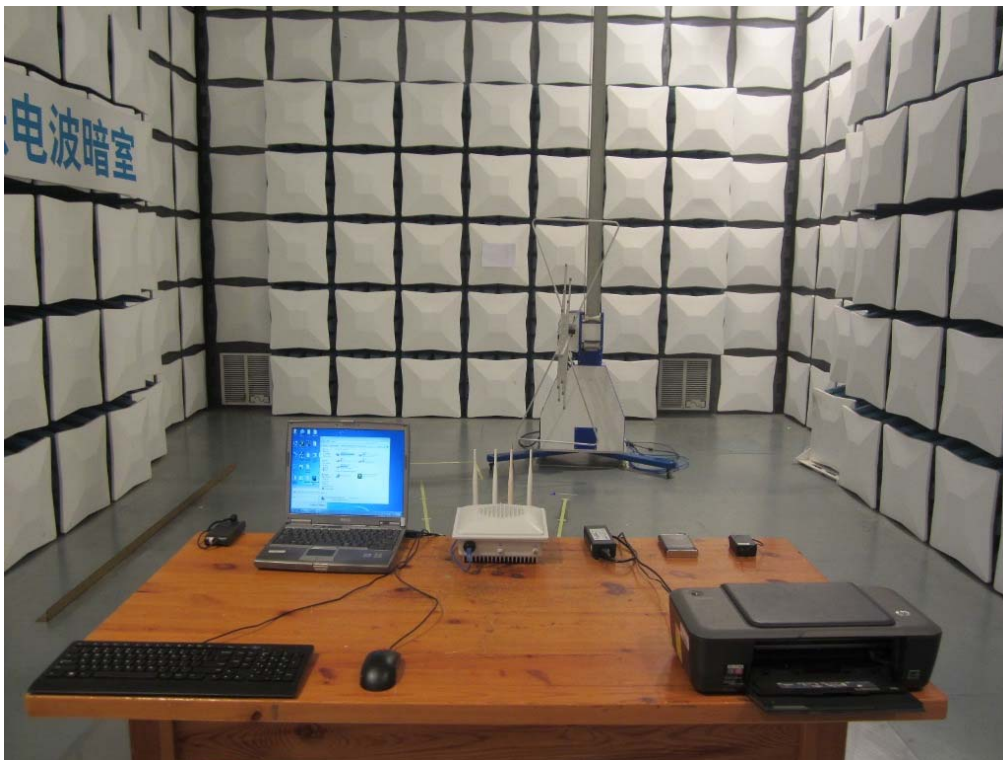

7. Photos of the EUT

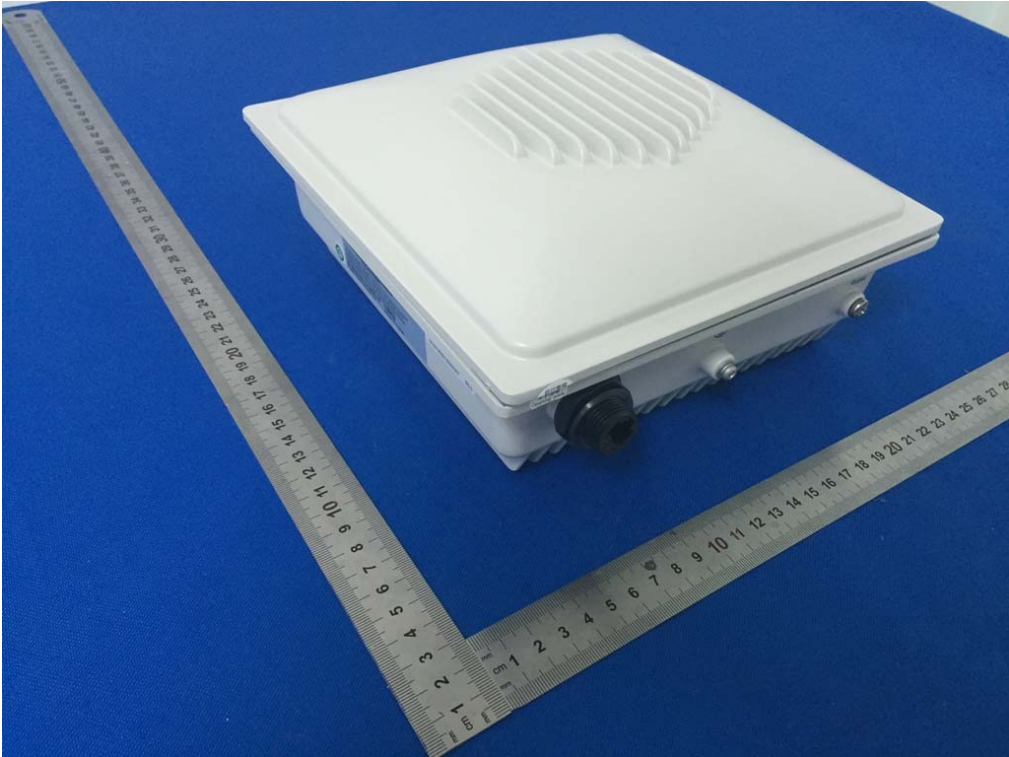
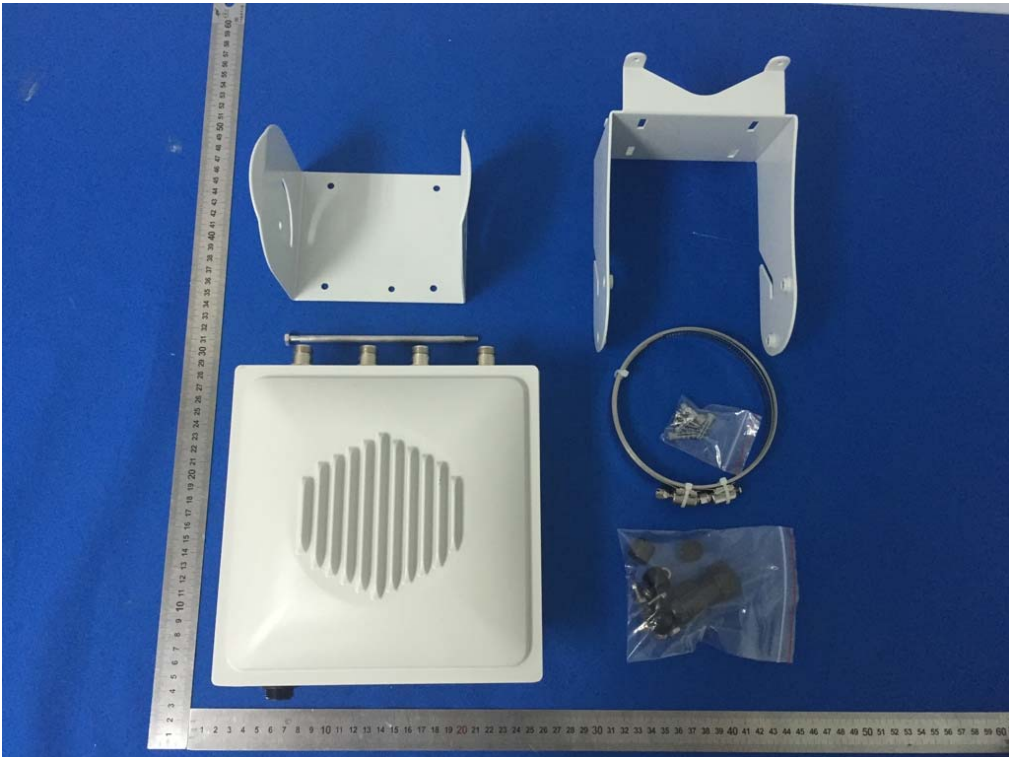

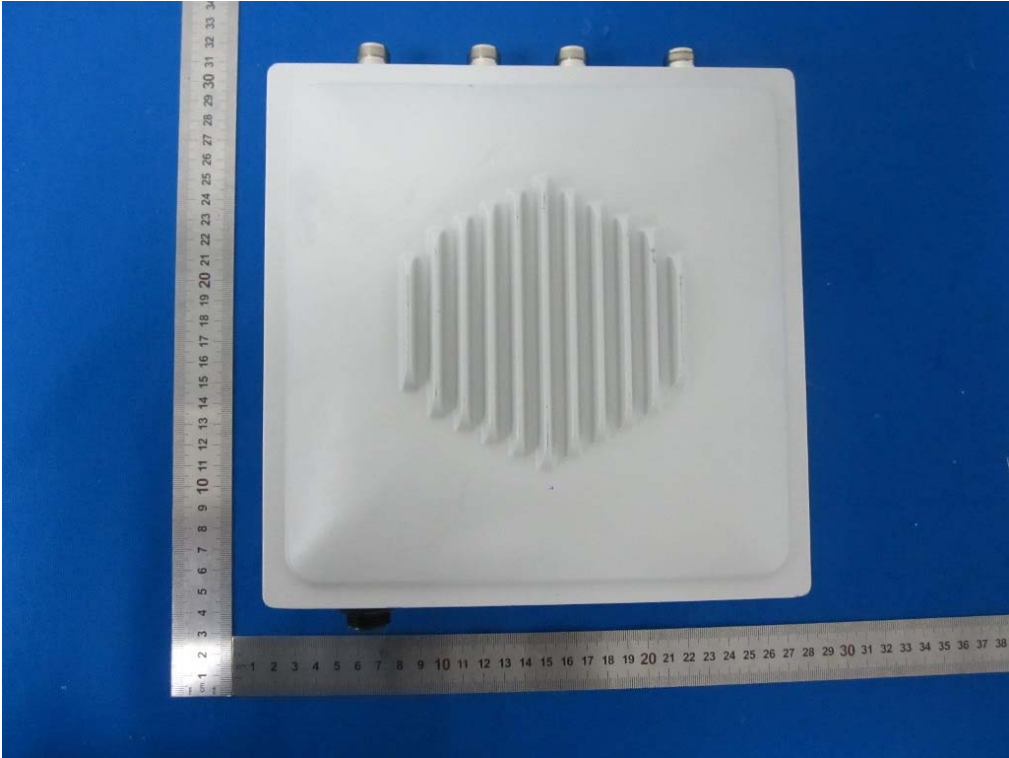
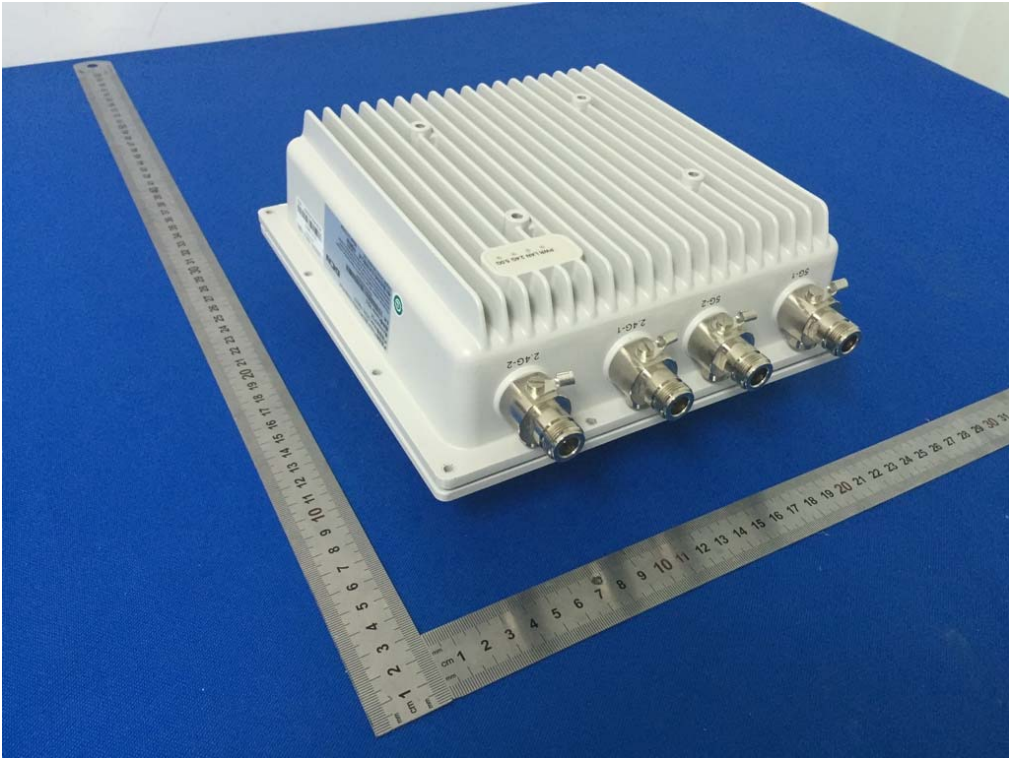



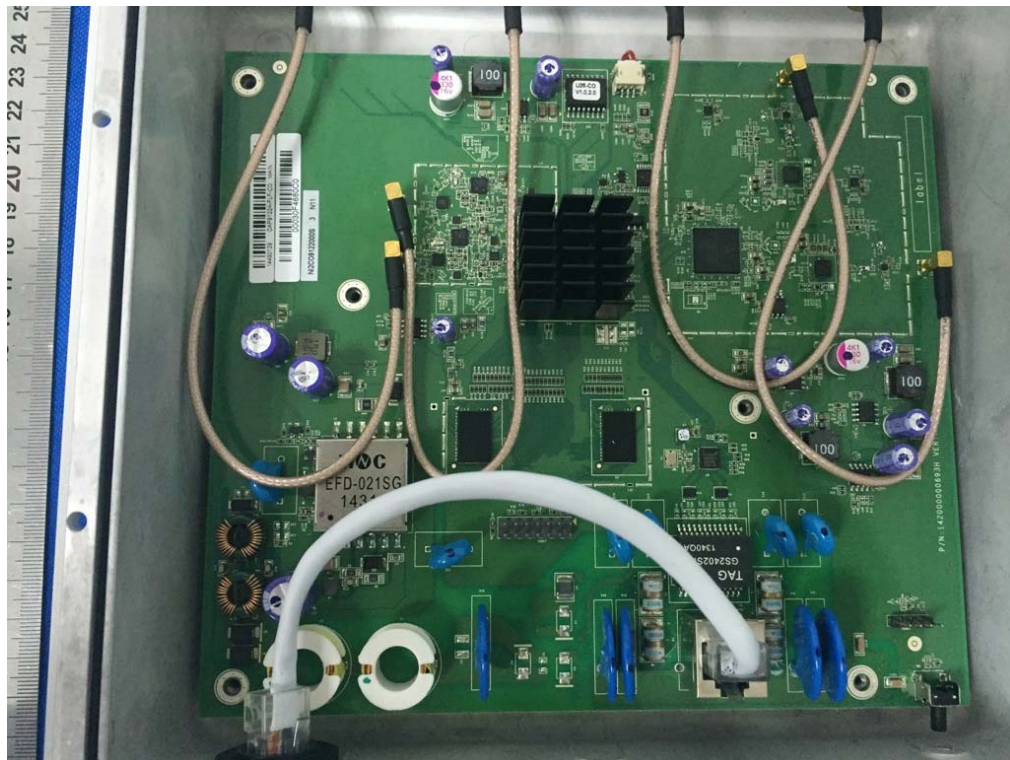
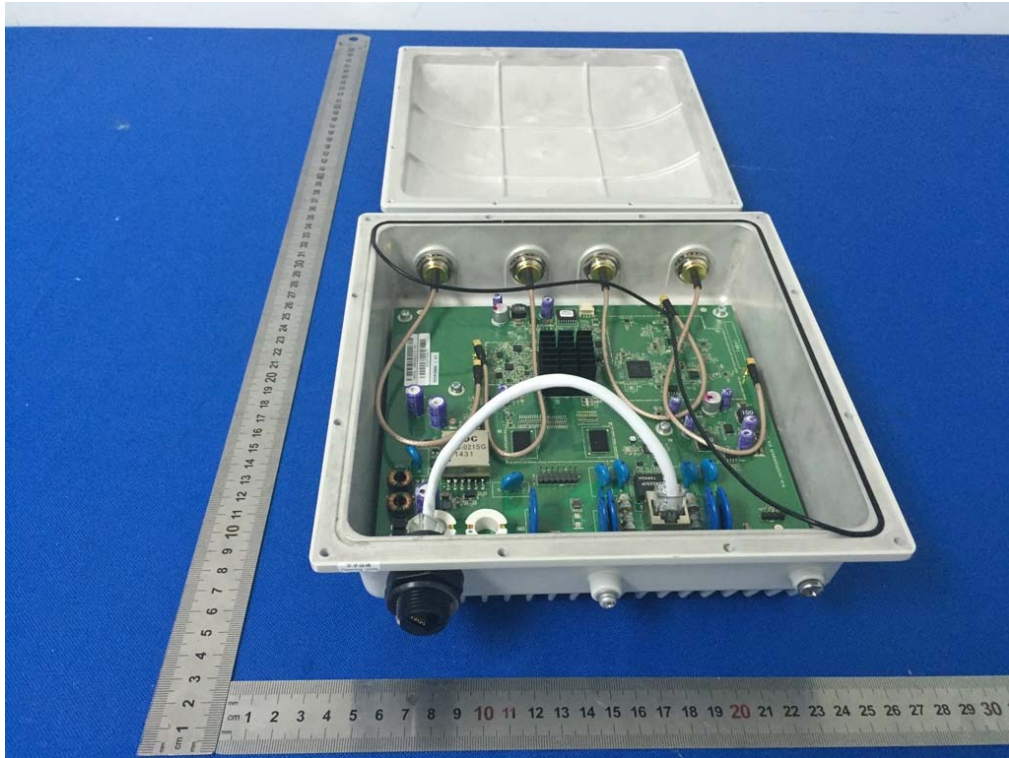

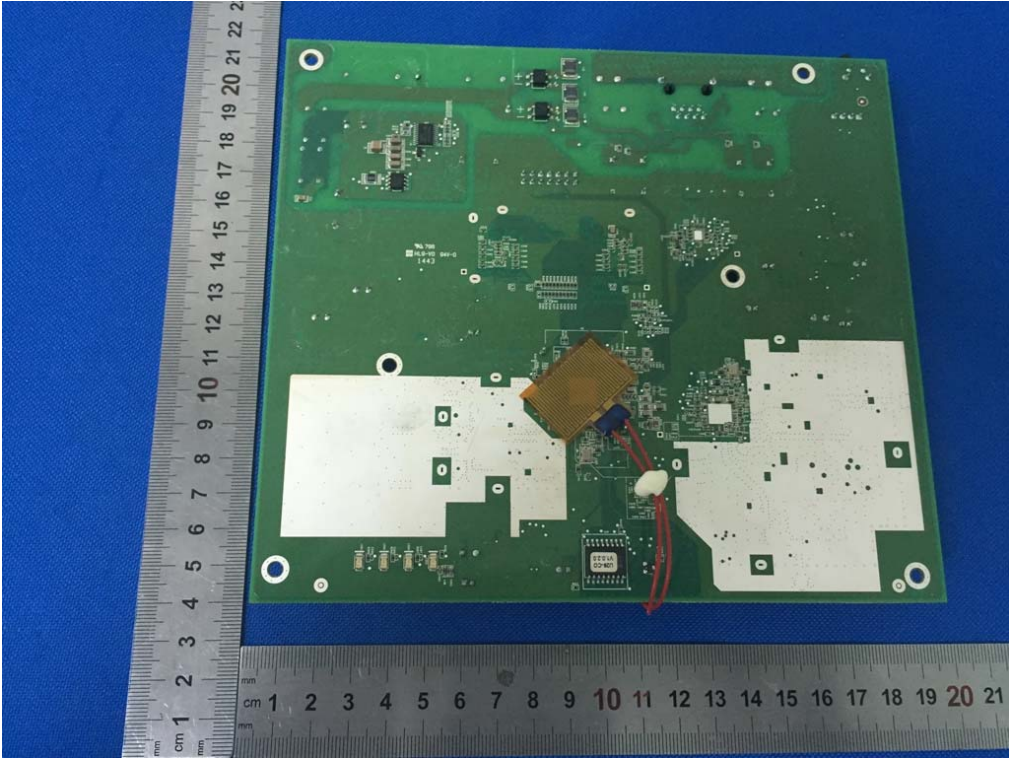
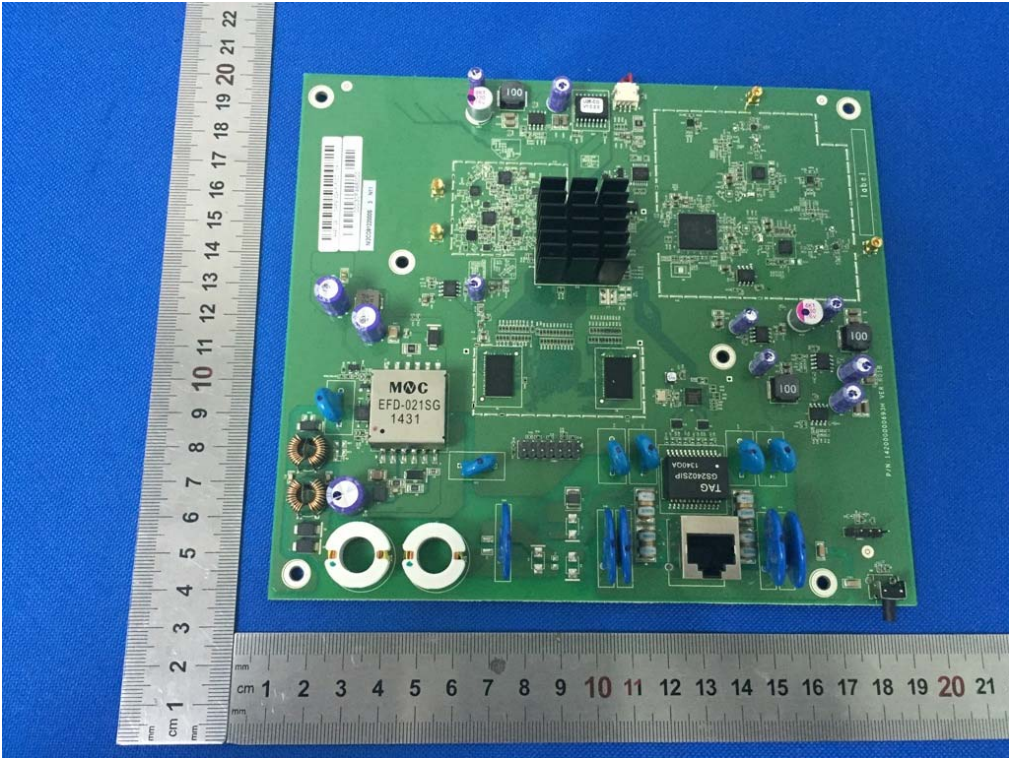

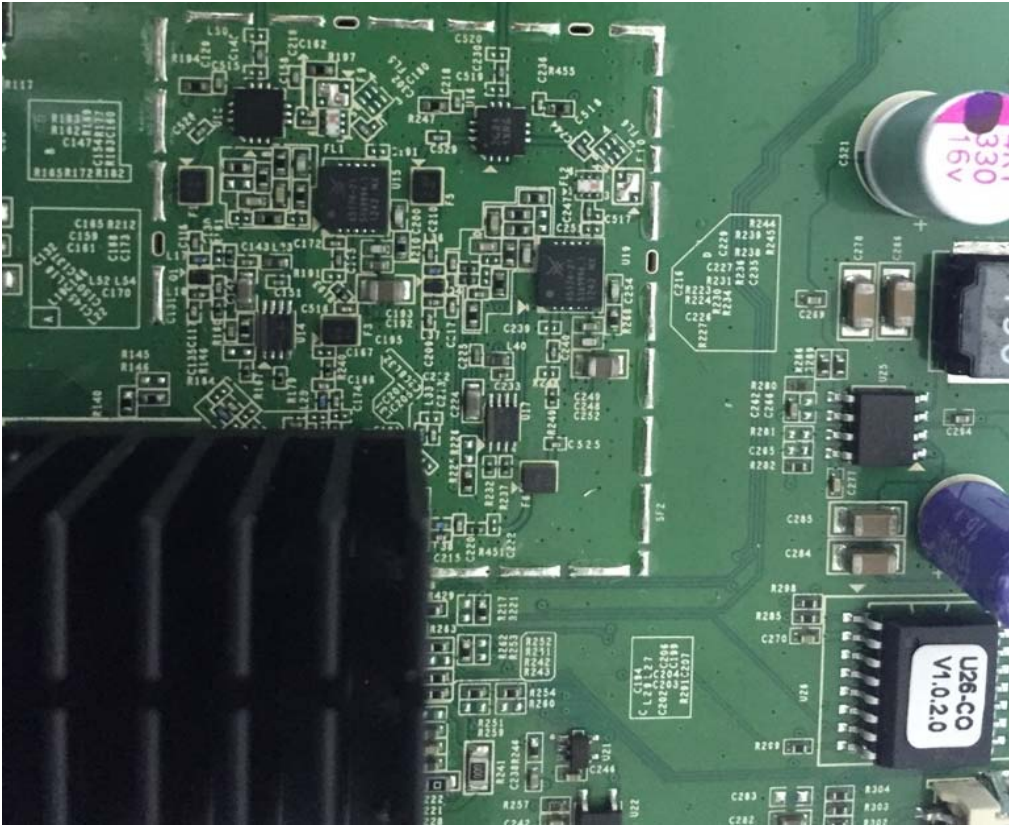
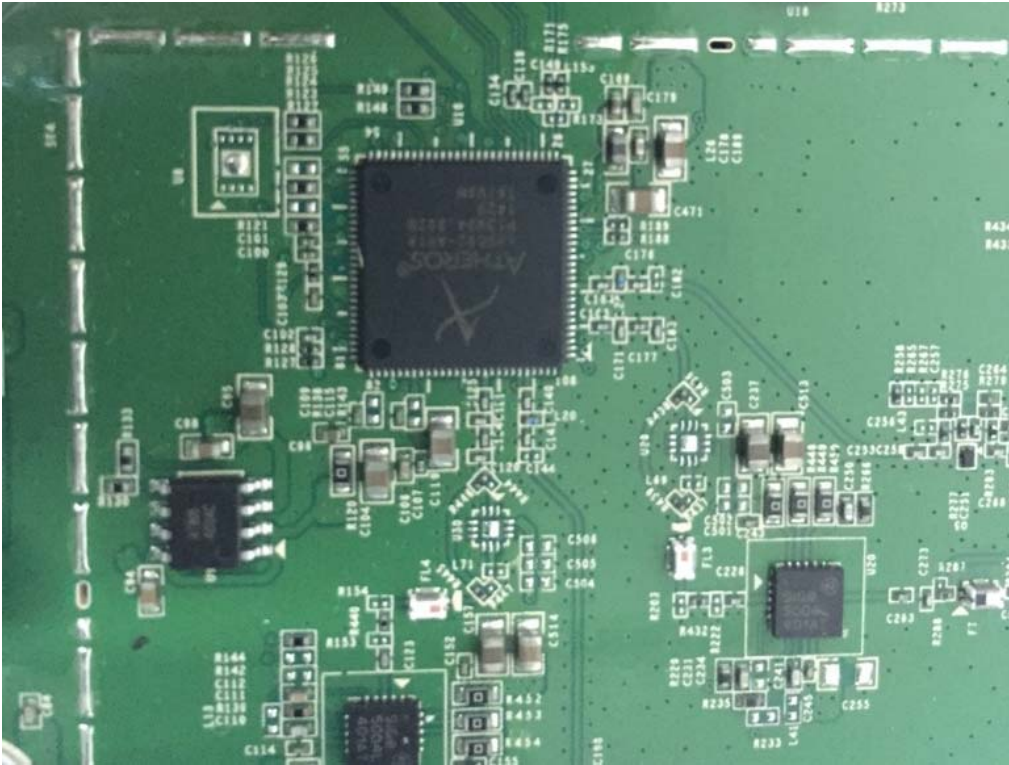

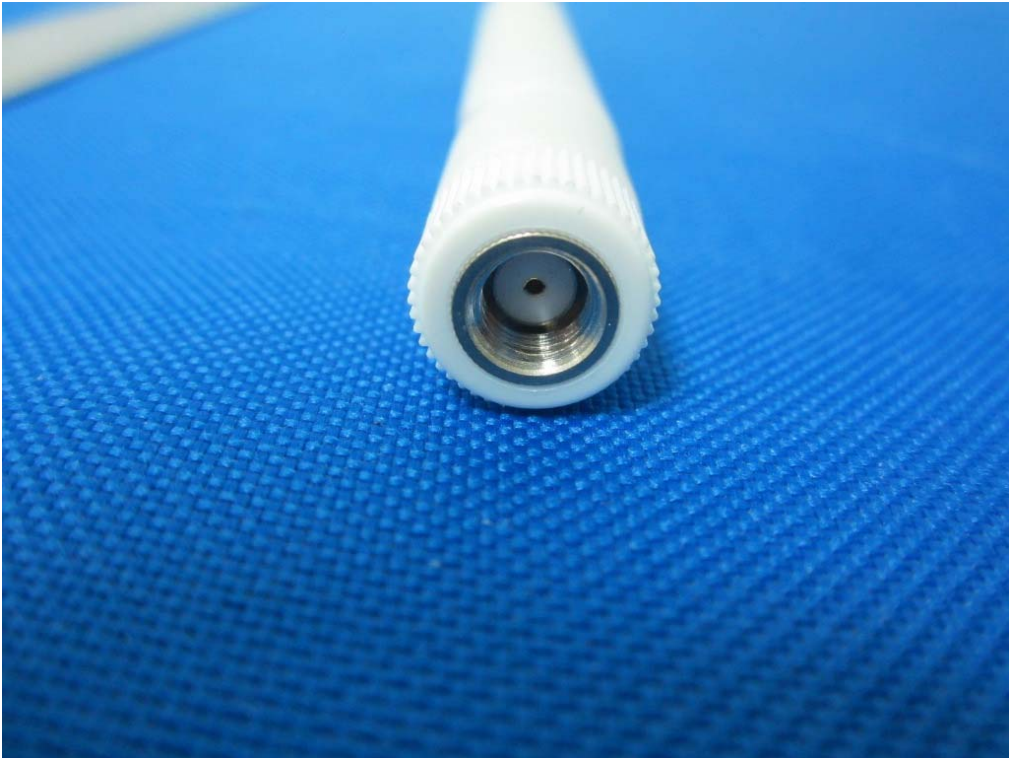

END OF REPORT