

FCC CERTIFICATION TEST REPORT

FOR

Applicant	:	Digital China Networks (Beijing) Limited
Address	:	Digital Technology Plaza, No.9 shangdi 9th street, Haidian District Beijing China
Equipment under Test	:	Outdoor Access Point
Model No	:	DCWL-7962OT
FCC ID	:	2ABKDCWL-7962OT
Trade Mark	:	
Manufacturer	:	Digital China Networks (Beijing) Limited
Address	:	Digital Technology Plaza, No.9 shangdi 9th street, Haidian District Beijing China

Issued By: Dongguan Dongdian Testing Service Co., Ltd.

Add: No. 17, Zongbu Road 2, Songshan Lake Sci&Tech, Industry Park, Dongguan City,
Guangdong Province, China, 523808

Tel: +86-0769-22891499 [Http://www.dgddt.com](http://www.dgddt.com)

REPORT

TABLE OF CONTENTS

- Test report declares.....4
- 1. Summary of test results 5
- 2. General test information..... 6
 - 2.1. Description of EUT 6
 - 2.2. Accessories of EUT..... 6
 - 2.3. Assistant equipment used for test..... 6
 - 2.4. Block diagram of EUT configuration for test 7
 - 2.5. Deviations of test standard 7
 - 2.6. Test environment conditions 7
 - 2.7. Test laboratory..... 7
 - 2.8. Measurement uncertainty 8
- 3. Equipment used during test 9
- 4. 6dB Bandwidth..... 10
 - 4.1. Test equipment 10
 - 4.2. Block diagram of test setup 10
 - 4.3. Limits 10
 - 4.4. Test Procedure..... 10
 - 4.5. Test Result..... 11
 - 4.6. Original test data 11
- 5. Maximum Peak Output Power 14
 - 5.1. Test equipment 14
 - 5.2. Block diagram of test setup 14
 - 5.3. Limits 14
 - 5.4. Test Procedure..... 15
 - 5.5. Test Result..... 15
 - 5.6. Original test data 16
- 6. Power Spectral Density 17
 - 6.1. Test equipment 17
 - 6.2. Block diagram of test setup 17
 - 6.3. Limits 17
 - 6.4. Test Procedure..... 18
 - 6.5. Test Result..... 18
 - 6.6. Original test data 19
- 7. Emissions in non-restricted frequency bands 22
 - 7.1. Test equipment 22
 - 7.2. Block diagram of test setup 22

7.3.	Limits	22
7.4.	Test Procedure.....	22
7.5.	Test Result.....	23
7.6.	Original test data	23
8.	Emissions in restricted frequency bands	36
8.1.	Test equipment	36
8.2.	Block diagram of test setup	36
8.3.	Limit	37
8.4.	Test Procedure.....	38
8.5.	Test result	39
9.	Band Edge Compliance	43
9.1.	Test equipment	43
9.2.	Block diagram of test setup	43
9.3.	Limit	43
9.4.	Test Procedure.....	43
9.5.	Test result	43
10.	Power Line Conducted Emission	60
10.1.	Test equipment	60
10.2.	Block diagram of test setup	60
10.3.	Power Line Conducted Emission Limits(Class B).....	60
10.4.	Test Procedure.....	60
10.5.	Test Result.....	61
11.	Antenna Requirements	64
11.1.	Limit	64
11.2.	Result.....	64
12.	Test setup photograph	65
13.	Photos of the EUT	67

TEST REPORT DECLARE

Applicant	:	Digital China Networks (Beijing) Limited
Address	:	Digital Technology Plaza, No.9 shangdi 9th street, Haidian District Beijing China
Equipment under Test	:	Outdoor Access Point
Model No	:	DCWL-7962OT
FCC ID	:	2ABKCDCWL-7962OT
Trade Mark	:	DCN
Manufacturer	:	Digital China Networks (Beijing) Limited
Address	:	Digital Technology Plaza, No.9 shangdi 9th street, Haidian District Beijing China

Test Standard Used: FCC Rules and Regulations Part 15 Subpart C: 2015

Test procedure used: ANSI C63.10:2013, ANSI C63.4:2014, KDB558074 D01 DTS Meas Guidance V03r02. KDB 913591.

We Declare:

The equipment described above is tested by Dongguan Dongdian Testing Service Co., Ltd and in the configuration tested the equipment complied with the standards specified above. The test results are contained in this test report and Dongguan Dongdian Testing Service Co., Ltd is assumed of full responsibility for the accuracy and completeness of these tests.

After test and evaluation, our opinion is that the equipment provided for test compliance with the requirement of the above FCC standards.

Report No:	DDT-R15Q0831-1E2		
Date of Test:	Sept. 24, 2015~Oct. 20, 2015	Date of Report:	Oct. 21, 2015

Prepared By:



Leo Liu/Engineer



Kevin Peng/EMC Manager

Note: This report applies to above tested sample only. This report shall not be reproduced in parts without written approval of Dongguan Dongdian Testing Service Co., Ltd.

1. Summary of test results

The EUT have been tested according to the applicable standards as referenced below.		
Description of Test Item	Standard	Results
6dB Bandwidth	FCC Part 15: 15.247 KDB558074	PASS
Peak Output Power	FCC Part 15: 15.247 KDB558074	PASS
Power Spectral Density	FCC Part 15: 15.247 KDB558074	PASS
Emissions in non-restricted frequency bands	FCC Part 15: 15.247 KDB558074	PASS
Emissions in restricted frequency bands	FCC Part 15: 15.209 FCC Part 15: 15.247 ANSI C63.10: 2013 ANSI C63.4:2014 KDB558074	PASS
Band Edge Compliance	FCC Part 15: 15.209 FCC Part 15: 15.247 ANSI C63.10: 2013 ANSI C63.4:2014 KDB558074 KDB 913591	PASS
Power Line Conducted Emission	FCC Part 15: 15.207 ANSI C63.10: 2013 ANSI C63.4:2014	PASS
Antenna requirement	FCC Part 15: 15.203	PASS

2. General test information

2.1. Description of EUT

EUT* Name	: Outdoor Access Point
Model Number	: DCWL-7962OT
EUT function description	: Please reference user manual of this device
Power supply	: DC 50V from external POE adapter : Note: This device not sales with power adapter, and a typical power adapter was by provided by Manufacturer for test.
Radio Technology	: IEEE802.11b/g/n
FCC Operation frequency	: IEEE 802.11b: 2412MHz—2462MHz : IEEE 802.11g: 2412MHz—2462MHz : IEEE 802.11n HT20: 2412MHz—2462MHz : IEEE 802.11n HT40:2422MHz—2452MHz
Modulation	: IEEE 802.11b: DSSS(CCK,DQPSK,DBPSK) : IEEE 802.11g: OFDM(64QAM, 16QAM, QPSK, BPSK) : IEEE 802.11n HT20, HT40: OFDM (64QAM, 16QAM, QPSK,BPSK)
Antenna Type	: 2.4G: External Antenna, 3.4dBi Single root Antenna gain, : MIMO 2X2.Total ANT=3.4+10*LOG(2)=6.4dBi
Date of Receipt	: 2015/9/24
Sample Type	: Series production

Note: EUT is the ab.of equipment under test.

Channle information							
CH	Frequency	CH	Frequency	CH	Frequency	CH	Frequency
1	2412	5	2432	9	2452	/	/
2	2417	6	2437	10	2457	/	/
3	2422	7	2442	11	2462	/	/
4	2427	8	2447	/	/	/	/

2.2. Accessories of EUT

Description of Accessories	Manufacturer	Model number or Type	Output.
/	/	/	/

2.3. Assistant equipment used for test

Description of Assistant equipment	Manufacturer	Model number or Type	EMC Compliance	SN
Notebook	DELL	Latitude D610	FCC DOC	00045-534-136-300
Mouse	HP	M-SBF96	FCC DOC	417441-001
Earphone	Apple inc	A1429	FCC DOC	/
POE Adapter	Digital China Networks (Beijing)	DCWL-PoEINJ-G+(R3)	FCC VOC	WL005630DC3000022 3

	Limited			
Printer	HP	LaserJet 1020 plus	FCC DOC	CNCFV90866
Keyboard	HP	KB-0316	FCC DOC	BAUEK00VB 2B0VB

2.4. Block diagram of EUT configuration for test

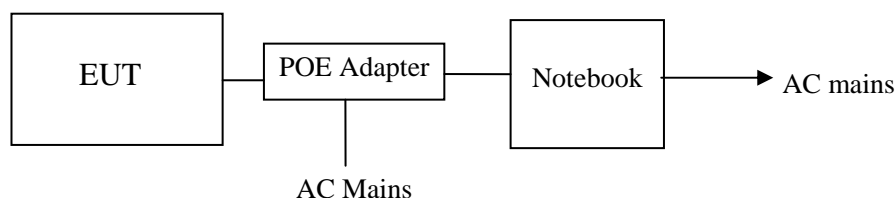

EUT was connected to control provided by manufacturer which has a standard RSS-232 connector to connect to Notebook, and the Notebook will run a special test software “artgui” provided by manufacturer to control EUT work in Continuous TX mode (>98% duty cycle), and select test channel, wireless mode and data rate.

Tested mode, channel, and data rate information			
Mode	data rate (Mbps) (see Note)	Channel	Frequency (MHz)
IEEE 802.11b	11	Low :CH1	2412
	11	Middle: CH6	2437
	11	High: CH11	2462
IEEE 802.11g	6	Low :CH1	2412
	6	Middle: CH6	2437
	6	High: CH11	2462
IEEE 802.11n HT20	MCS 0	Low :CH1	2412
	MCS 0	Middle: CH6	2437
	MCS 0	High: CH11	2462

Note: According exploratory test, EUT will have maximum output power in those data rate, so those data rate were used for all test.
After verification, all tests were carried out with the worst case test modes as shown in this report

2.5. Deviations of test standard

No Deviation

2.6. Test environment conditions

During the measurement the environmental conditions were within the listed ranges:

Temperature range:	21-25°C
Humidity range:	40-75%
Pressure range:	86-106kPa

2.7. Test laboratory

Dongguan Dongdian Testing Service Co., Ltd

Add: No. 17, Zongbu Road 2, Songshan Lake Sci&Tech, Industry Park, Dongguan City, Guangdong Province, China, 523808 Tel: +86-0769-22891499 <http://www.dgddt.com>

FCC Registration Number: 270092 Industry Canada site registration number: 10288A-1

2.8. Measurement uncertainty

Test Item	Uncertainty
Bandwidth	±1.1%
Peak Output Power(Conducted)(Spectrum analyzer)	0.86dB(10 MHz ≤ f < 3.6GHz);
	1.38dB(3.6GHz ≤ f < 8GHz)
Peak Output Power(Conducted)(Power Sensor)	0.74dB
Dwell Time	±0.6%
Conducted spurious emissions	0.86dB(10 MHz ≤ f < 3.6GHz);
	1.40dB(3.6GHz ≤ f < 8GHz)
	1.66dB(8GHz ≤ f < 22GHz)
Uncertainty for radio frequency (RBW<20KHz)	3×10 ⁻⁸
Temperature	±0.4°C
Humidity	±2%
Uncertainty for Radiation Emission test (30MHz-1GHz)	±3.14 dB (Antenna Polarize: V)
	±3.16 dB (Antenna Polarize: H)
Uncertainty for Radiation Emission test (1GHz-18GHz)	±4.14dB(1-6GHz)
	±4.46dB (6GHz-18Gz)
Uncertainty for Power line conduction emission test	2.44dB (150KHz-30MHz)
Note: This uncertainty represents an expanded uncertainty expressed at approximately the 95% confidence level using a coverage factor of k=2.	

3. Equipment used during test

Equipment	Manufacturer	Model No.	Serial No.	Last Cal.	Cal. Interval
RF Connected Test					
Spectrum analyzer	R&S	FSU26	1166.1660.26	2014/10/25	1 Year
Attenuator	Mini-Circuits	BW-S10W2	101109	2014/10/25	1 Year
RF Cable	Micable	C10-01-01-1	100309	2015-08-18	1 Year
Radiated Emission Test					
EMI Test Receiver	R&S	ESU8	100316	2014/10/25	1 Year
Spectrum analyzer	R&S	FSU26	1166.1660.26	2014/10/25	1 Year
Trilog Broadband Antenna	Schwarzbeck	VULB9163	9163-462	2015/05/30	1 Year
Active Loop antenna	Schwarzbeck	FMZB-1519	1519-038	2014/11/01	1 Year
Double Ridged Horn Antenna	R&S	HF907	100276	2014/11/01	1 Year
Pre-amplifier	A.H.	PAM-0118	360	2015/08/18	1 Year
RF Cable	HUBSER	CP-X2	W11.03	2014/10/25	1 Year
RF Cable	HUBSER	CP-X1	W12.02	2014/10/25	1 Year
MI Cable	HUBSER	C10-01-01-1M	1091629	2014/10/25	1 Year
Test software	Audix	E3	V 6.11111b	/	/
Power Line Conducted Emissions Test					
Test Receiver	R&S	ESU8	100316	2014/10/25	1 Year
LISN 1	R&S	ENV216	101109	2014/10/25	1 Year
Pulse Limiter	R&S	ESH3-Z2	101242	2014/10/25	1 Year
CE Cable 1	HUBSER	ESU8/RF2	W10.01	2014/10/25	1 Year
Test software	Audix	E3	V 6.11111b	/	/

4. 6dB Bandwidth

4.1. Test equipment

Please refer to Section 3 this report.

4.2. Block diagram of test setup

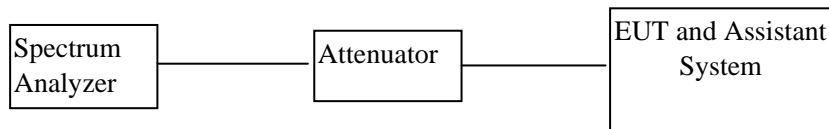

4.3. Limits

For direct sequence systems, the minimum 6dB bandwidth shall be at least 500 KHz

4.4. Test Procedure

- (1) Configure EUT and assistant system according clause 2.4 and 4.2
- (2) Connect EUT's antenna output to spectrum analyzer by RF cable.
- (3) Configure EUT work in test mode as stated in clause 2.4.
- (4) Set the spectrum analyzer as follows:

RBW:	100KHz
VBW:	300KHz
Detector Mode:	Peak
Sweep time:	auto
Trace mode	Max hold
- (5) Allow the trace to stabilize, measure the maximum width of the emission that is constrained by the frequencies associated with the two outermost amplitude points (upper and lower frequencies) that are attenuated by 6 dB relative to the maximum level measured in the fundamental emission.

4.5. Test Result

Mode	CH or Frequency	Result (MHz)	Mode	CH or Frequency	Result (MHz)
11b	CH1 2412MHz	10.176	11g	CH1 2412MHz	16.587
	CH6 2437MHz	10.096		CH6 2437MHz	16.667
	CH11 2462MHz	10.978		CH11 2462MHz	16.587
11n HT 20/Chain 0	CH1 2412MHz	17.869	11n HT 40/Chain 0	CH3 2422MHz	36.699
	CH6 2437MHz	17.869		CH6 2437MHz	36.699
	CH11 2462MHz	17.708		CH9 2452MHz	36.699
11n HT 20/Chain 1	CH1 2412MHz	17.788	11n HT 40/Chain 1	CH3 2422MHz	36.699
	CH6 2437MHz	17.869		CH6 2437MHz	36.699
	CH11 2462MHz	17.788		CH9 2452MHz	36.699
Conclusion: Pass					
Test Date : 2015/10/13			Test Engineer : Toby		

4.6. Original test data

6dB bandwidth

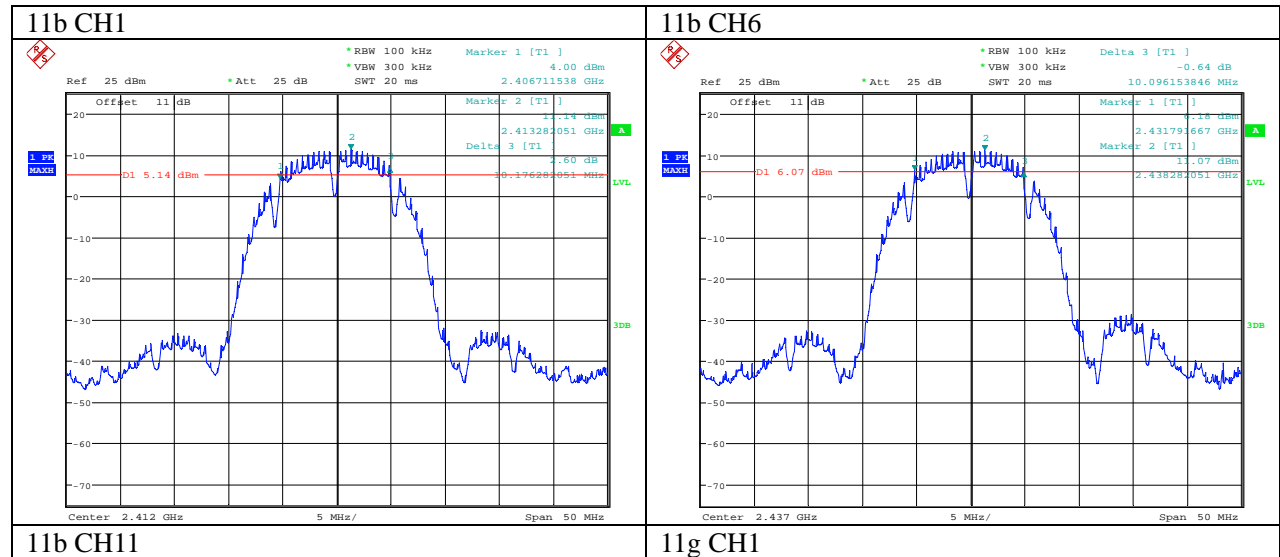

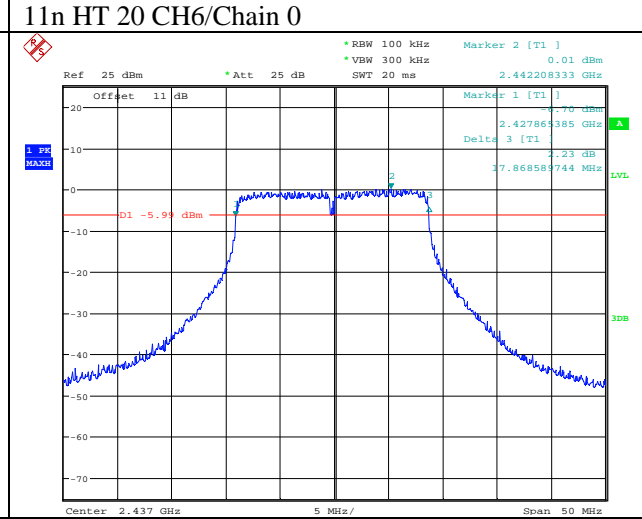
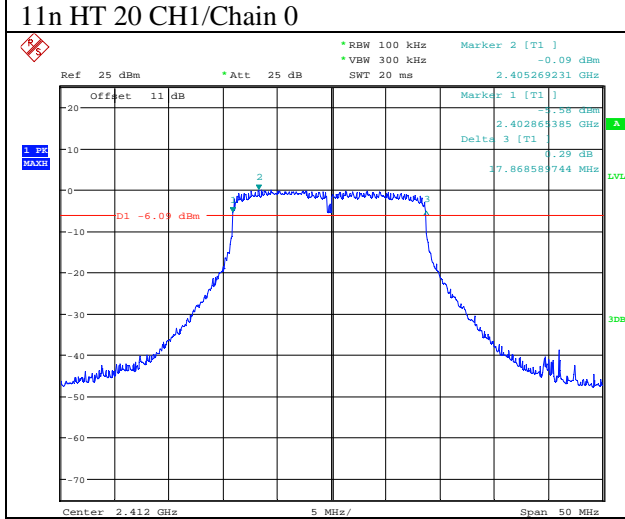
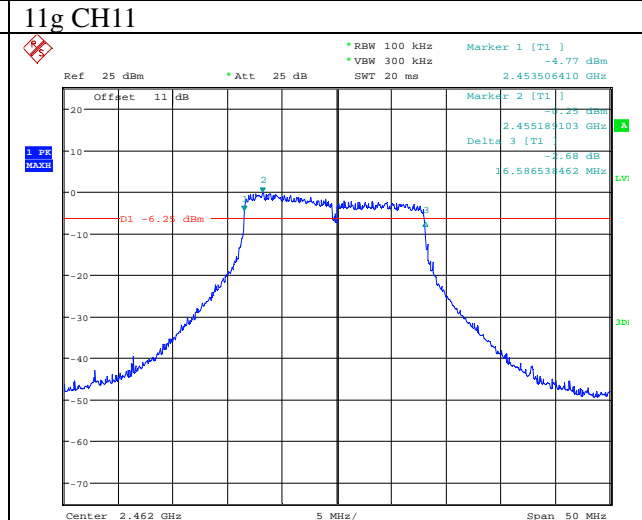
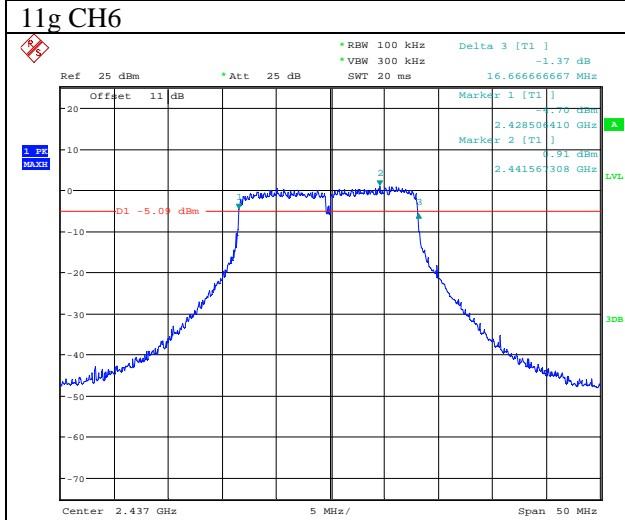
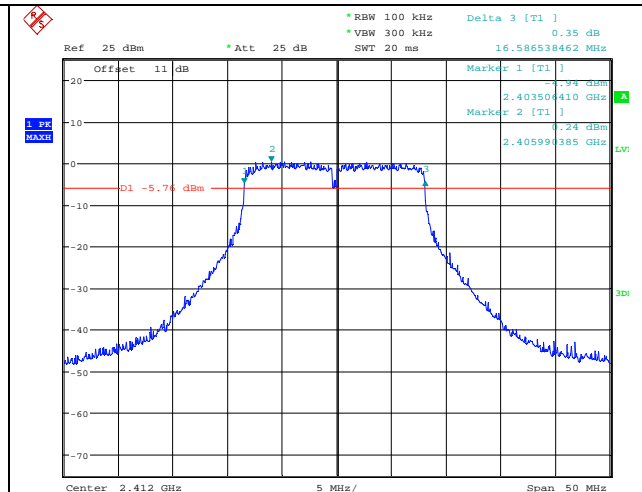
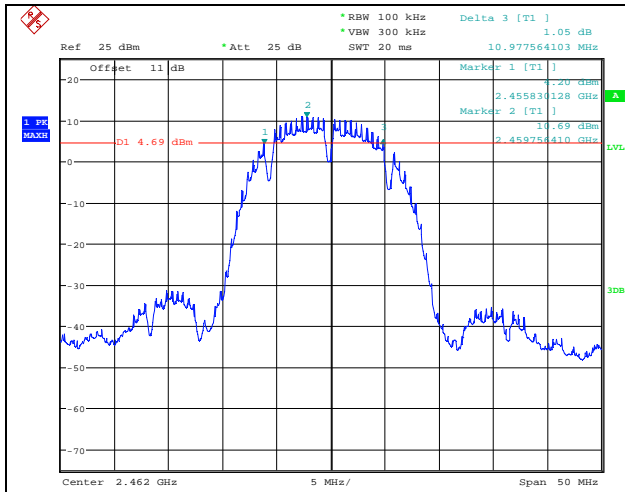

11n HT 20 CH11/Chain 0

11n HT 40 CH3/Chain 0

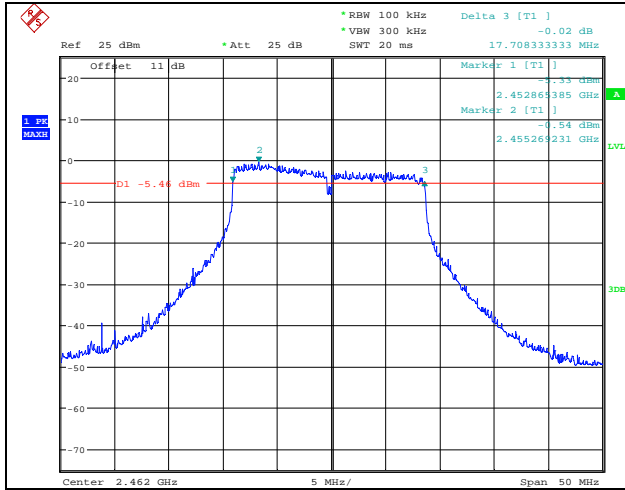

11n HT 40 CH6/Chain 0

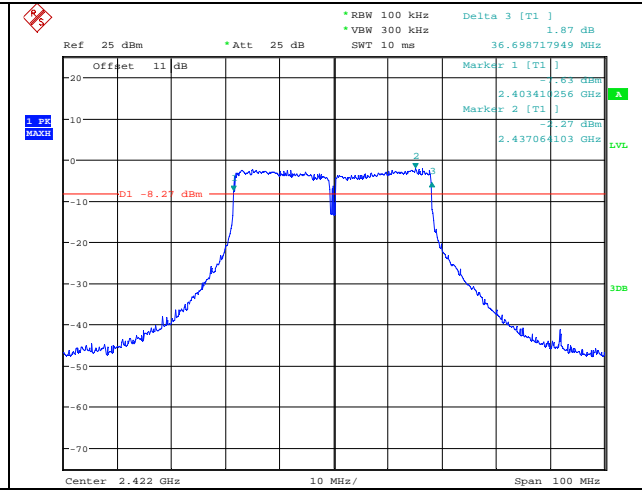

11n HT 40 CH9/Chain 0

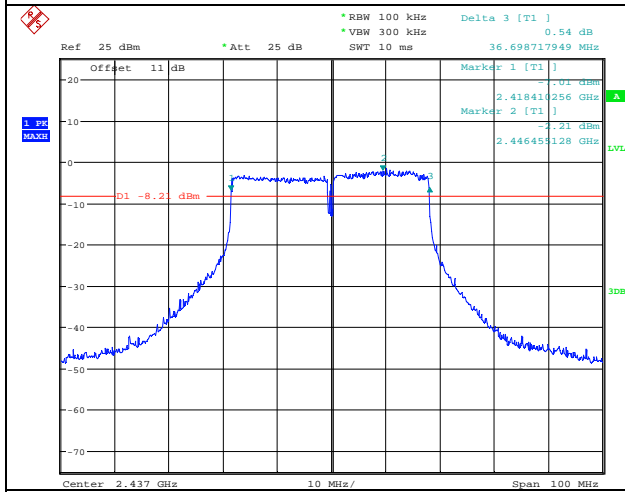

11n HT 20 CH1/Chain 1

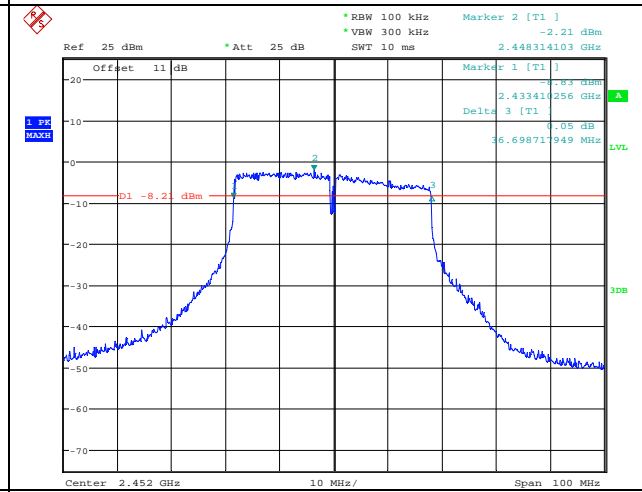

11n HT 20 CH6/Chain 1

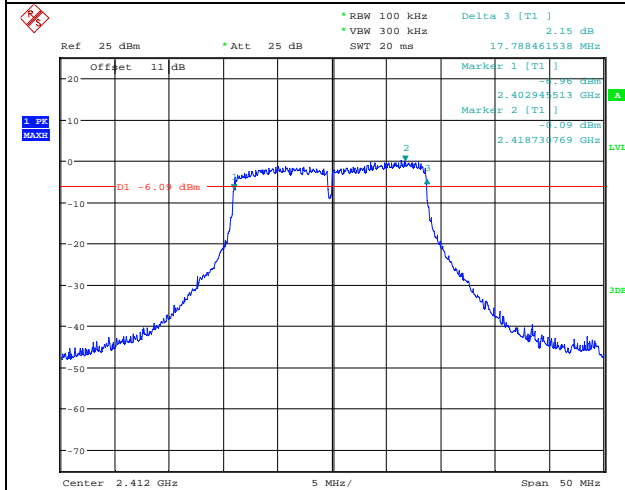

11n HT 20 CH11/Chain 1

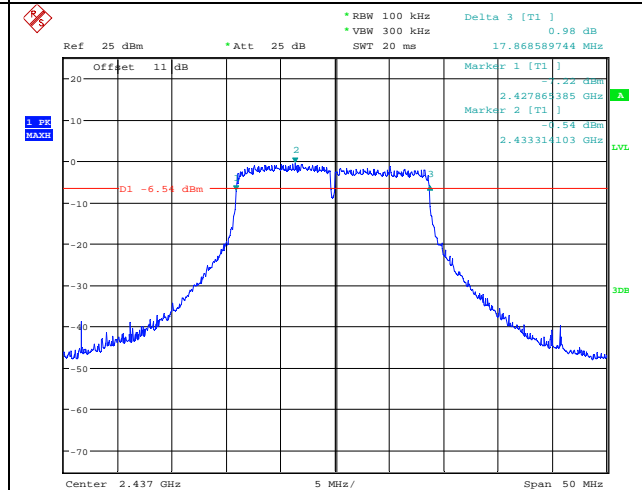

11n HT 40 CH3/Chain 1

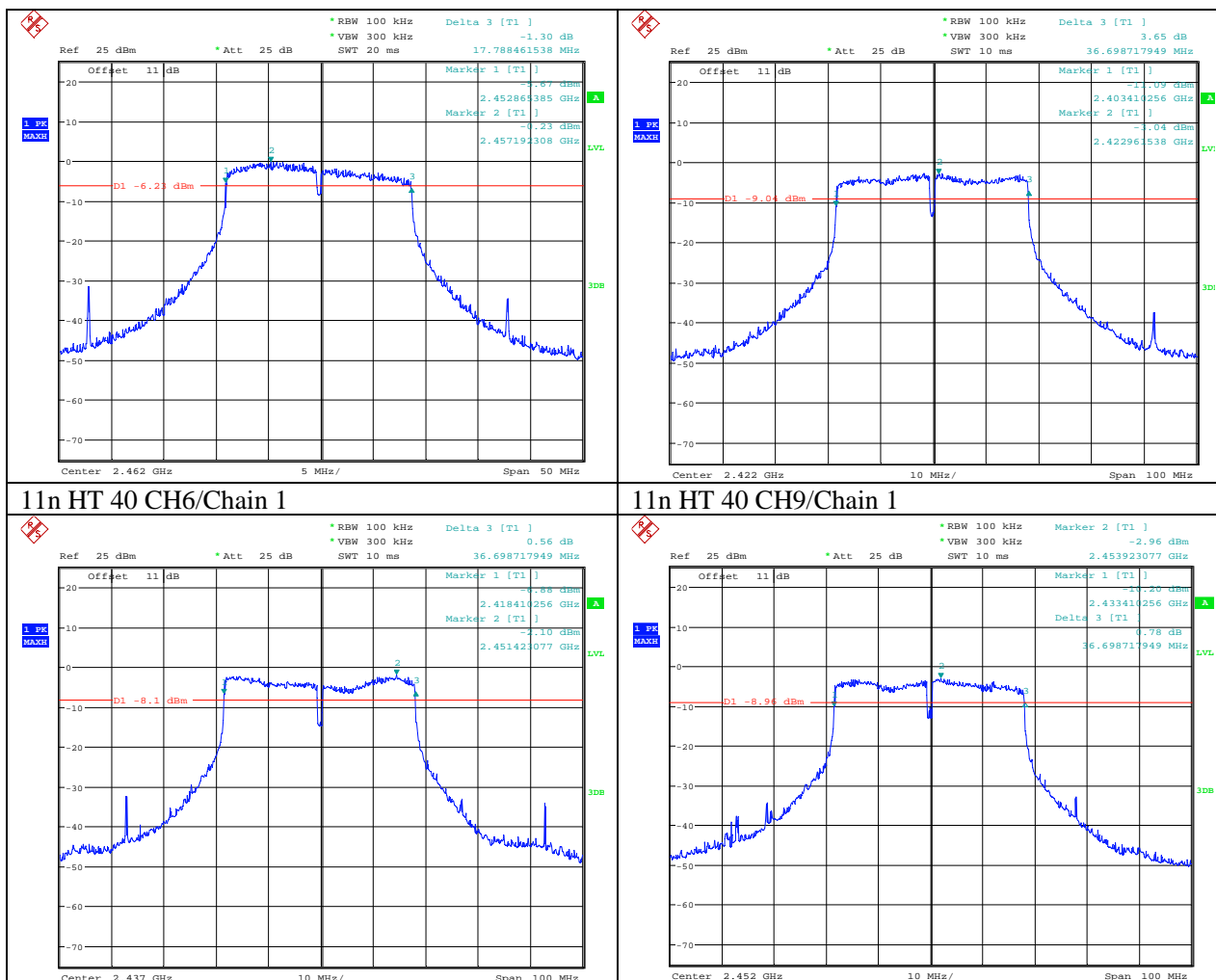

5. Maximum Peak Output Power

5.1. Test equipment

Please refer to Section 3 this report.

5.2. Block diagram of test setup

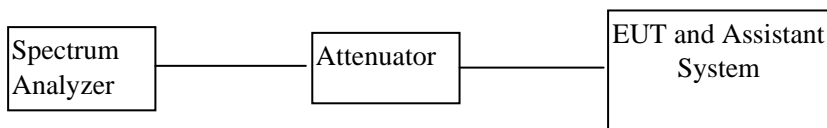

5.3. Limits

For systems using digital modulation in the 902-928 MHz, 2400-2483.5 MHz, and 5725-5850 MHz bands: 1 Watt. If transmitting antennas of directional gain greater than 6 dBi are used, the conducted output power from the intentional radiator shall be reduced below the stated values as appropriate, by the amount in dB that the directional gain of the antenna exceeds 6 dBi.

5.4. Test Procedure

- (1) Configure EUT and assistant system according clause 2.4 and 5.2
- (2) Connect each EUT's antenna output to power sensor by RF cable and attenuator
- (3) Configure EUT work in test mode as stated in clause 2.4.
- (4) Measure the PK output power of each antenna port by Spectrum Analyzer.

5.5. Test Result

Mode	CH or Frequency	Peak Result (dBm)	Mode	CH or Frequency	Peak Result (dBm)
11b	CH1 2412MHz	22.46	11g	CH1 2412MHz	22.60
	CH6 2437MHz	22.04		CH6 2437MHz	22.56
	CH11 2462MHz	22.16		CH11 2462MHz	22.67
Limit: 30dBm			Conclusion: Pass		
Test Date : 2015/10/13			Test Engineer : Toby		

Mode	CH or Frequency	China 0 Peak Result (dBm)	China 1 Peak Result (dBm)	Total Output Power (dBm)
11n HT 20	CH1 2412MHz	20.79	20.10	23.47
	CH6 2437MHz	20.50	20.16	23.34
	CH11 2462MHz	19.60	19.98	22.80
11n HT 40	CH3 2422MHz	20.66	20.33	23.51
	CH6 2437MHz	20.57	20.53	23.56
	CH9 2452MHz	20.29	20.17	23.24
Limit: 29.6dBm		Conclusion: Pass		
Test Date : 2015/10/13		Test Engineer : Toby		
Remark: 1.Total Output Power (w) = Chain 0 (10^(Output Power /10)/1000)+ Chain 1 (10^(Output Power /10)/1000)				
2. The maximum antenna gain is 6.4dBi; therefore the reduction due to antenna gain is 0.4dBi, so the limit is 29.6dBm.				

5.6. Original test data

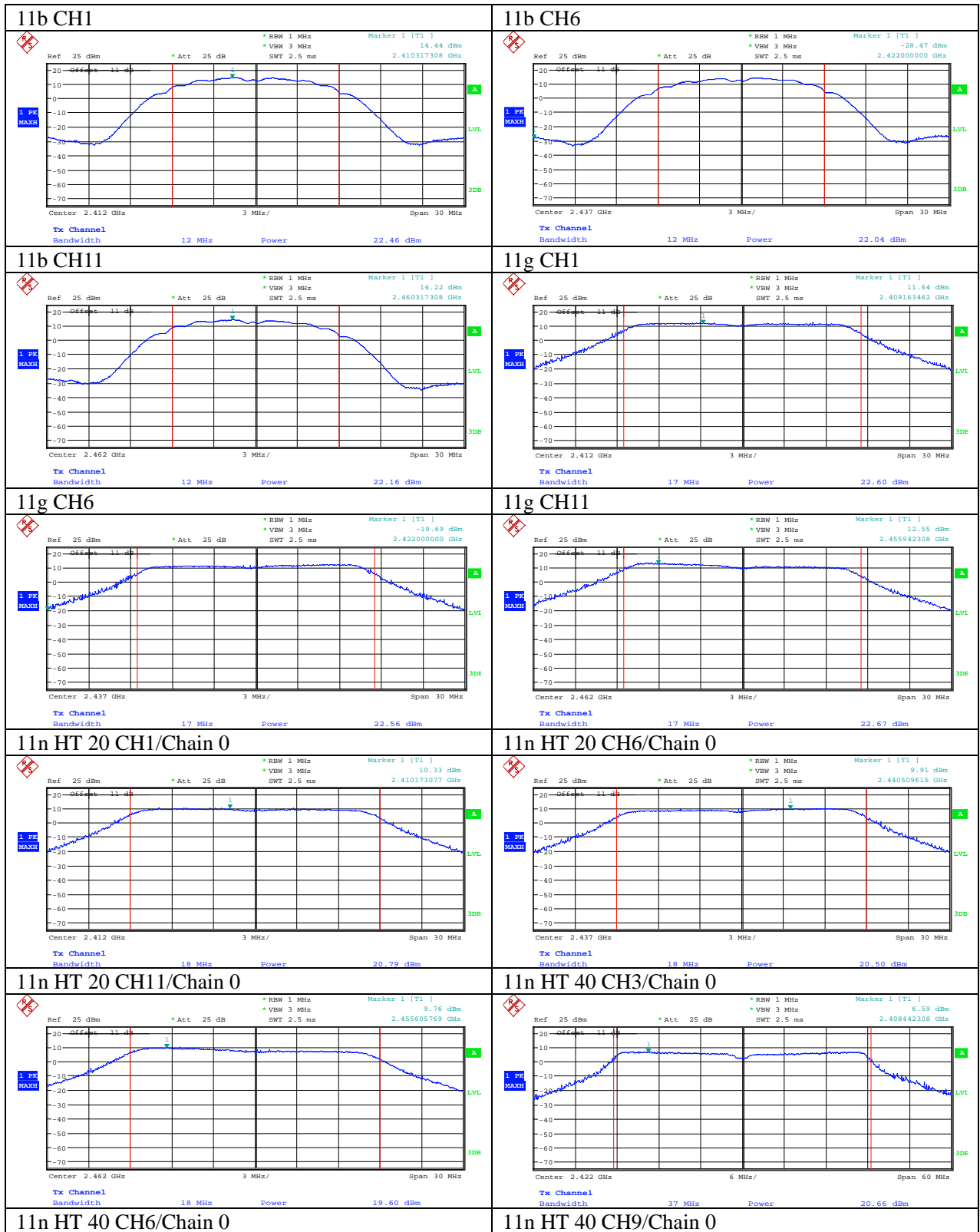

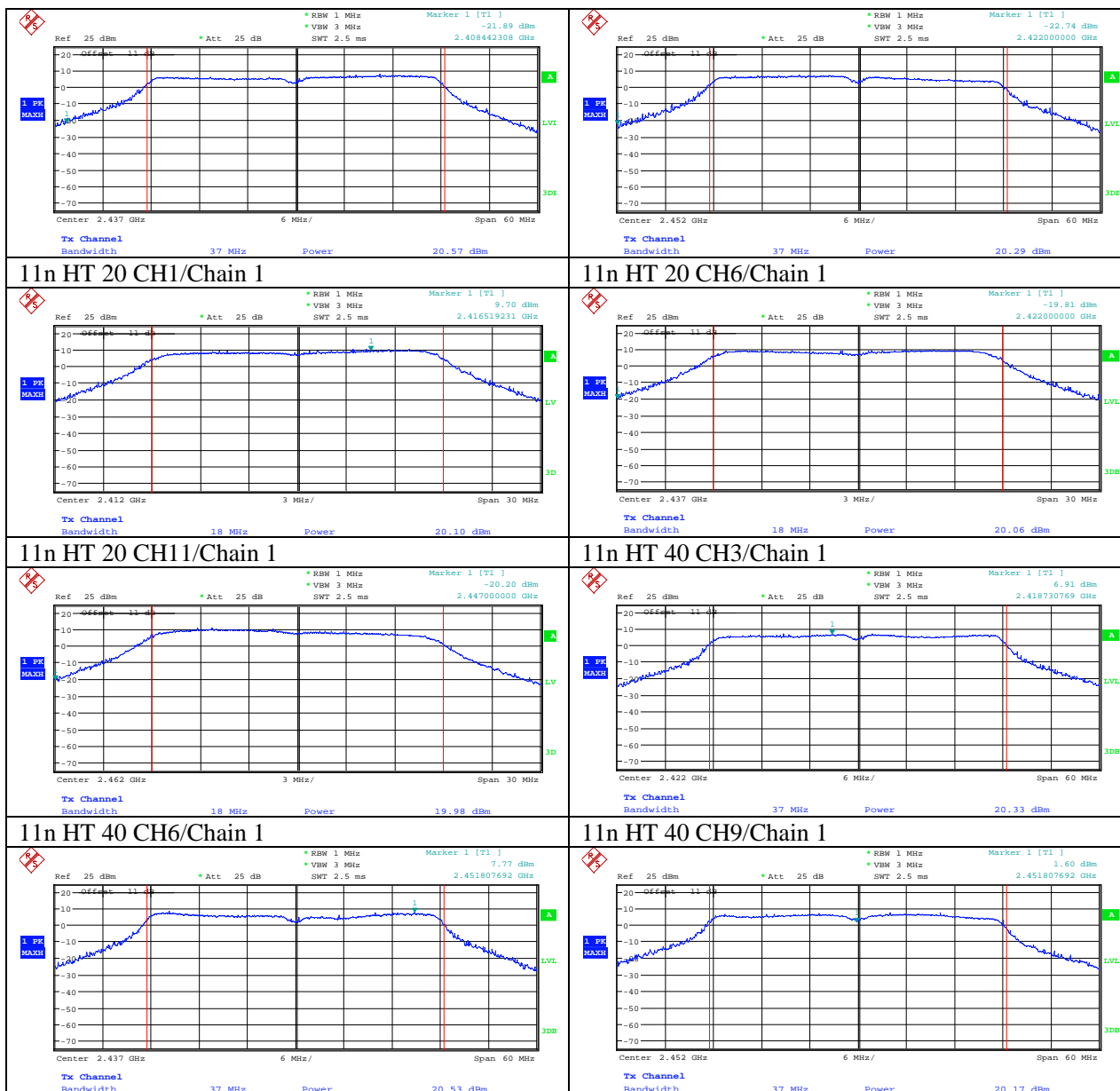

6. Power Spectral Density

6.1. Test equipment

Please refer to Section 3 this report.

6.2. Block diagram of test setup

Same with 4.2

6.3. Limits

For digitally modulated systems, the power spectral density conducted from the intentional radiator to the antenna shall not be greater than 8dBm in any 3 kHz band during any time interval of continuous transmission.

6.4. Test Procedure

- (1) Configure EUT and assistant system according clause 2.4 and 6.2
- (2) Connect EUT's antenna output to spectrum analyzer by RF cable.
- (3) Configure EUT work in test mode as stated in clause 2.4.
- (4) Set the spectrum analyzer as follows:

Center frequency	DTS Channel center frequency
RBW:	$3 \text{ kHz} \leq \text{RBW} \leq 100 \text{ kHz}$
VBW:	$\geq 3\text{RBW}$
Span	1.5times the DTS bandwidth
Detector Mode:	Peak
Sweep time:	auto
Trace mode	Max hold
- (5) Allow the trace to stabilize, use the peak marker function to determine the maximum amplitude level within the RBW.
- (6) If measured value exceeds limit, reduce RBW (no less than 3 kHz) and repeat.

6.5. Test Result

Mode	CH or Frequency	Peak Result (dBm/30KHz)	Peak Result (dBm/3KHz)	Mode	CH or Frequency	Peak Result (dBm/30KHz)	Peak Result (dBm/3KHz)
11b	CH1 2412MHz	1.79	-8.21	11g	CH1 2412MHz	-2.14	-12.14
	CH6 2437MHz	2.43	-7.57		CH6 2437MHz	-1.36	-11.36
	CH11 2462MHz	1.99	-8.01		CH11 2462MHz	-2.68	-12.68
Limit: <8dBm/3KHz				Conclusion: Pass			
Test Date : 2015/10/13				Test Engineer : Toby			

Mode	CH or Frequency	China 0 Peak Result (dBm/30KHz)	China 1 Peak Result (dBm/30KHz)	Total Output Power (dBm/30KHz)	Total Output Power (dBm/3KHz)
11n HT 20	CH1 2412MHz	-2.17	-1.79	1.03	-8.97
	CH6 2437MHz	-2.07	-3.00	0.50	-9.50
	CH11 2462MHz	-2.88	-2.07	0.55	-9.45
11n HT 40	CH3 2422MHz	-5.02	-5.11	-2.05	-12.05
	CH6 2437MHz	-4.17	-3.95	-1.05	-11.05
	CH9 2452MHz	-4.60	-5.47	-2.00	-12.00
Limit: <7.6dBm/3KHz		Conclusion: Pass			
Test Date : 2015/10/13		Test Engineer: Toby			
Remark: 1.Total Output Power (w) = Chain 0 (10^(Output Power /10)/1000)+ Chain 1 (10^(Output Power /10)/1000)					
2. The maximum antenna gain is 6.4dBi; therefore the reduction due to antenna gain is 0.4dBi, so the limit is 7.6dBm.					

6.6. Original test data

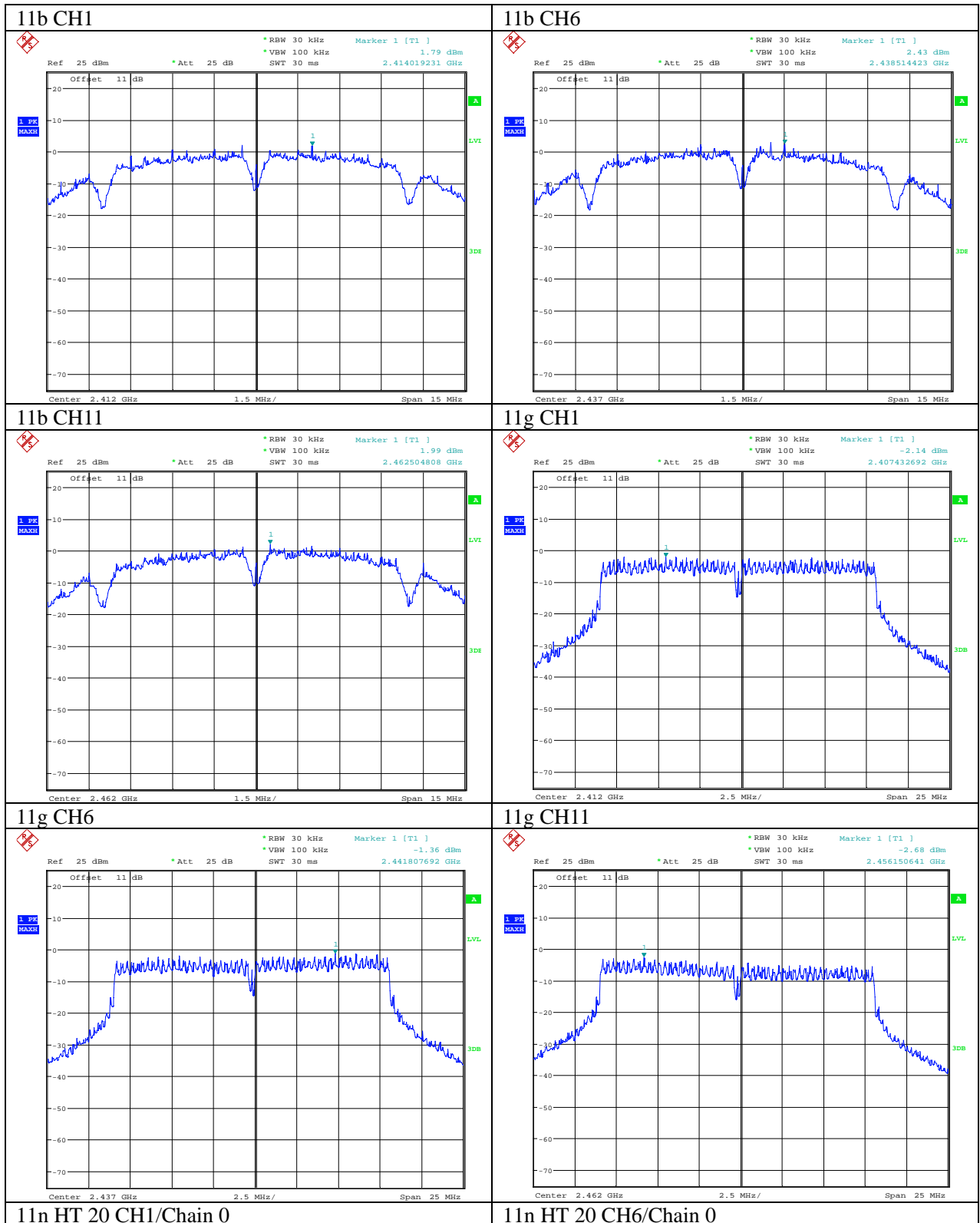

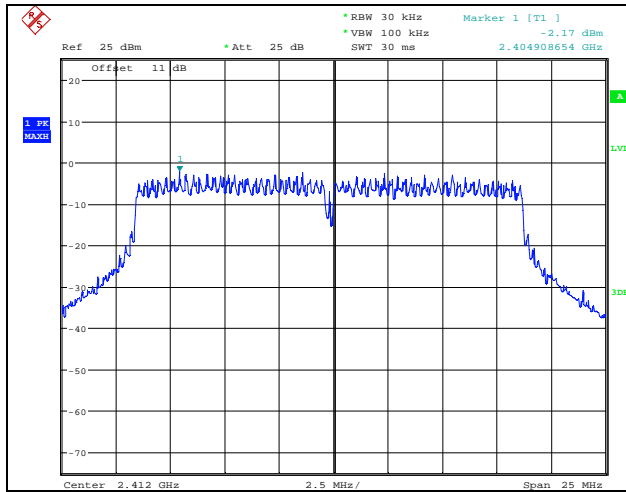

11n HT 20 CH11/Chain 0

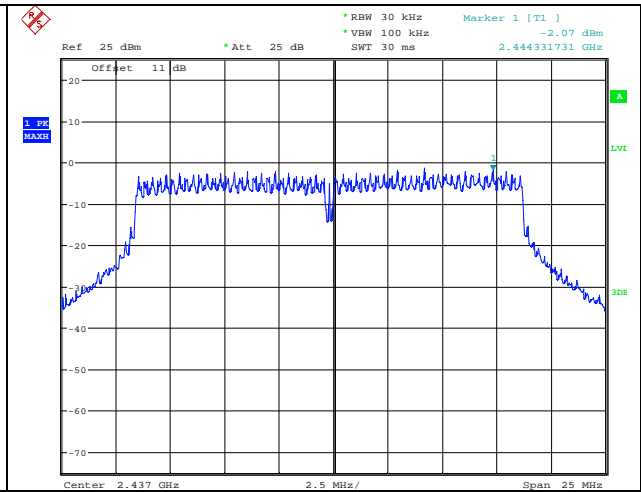

11n HT 40 CH3/Chain 0

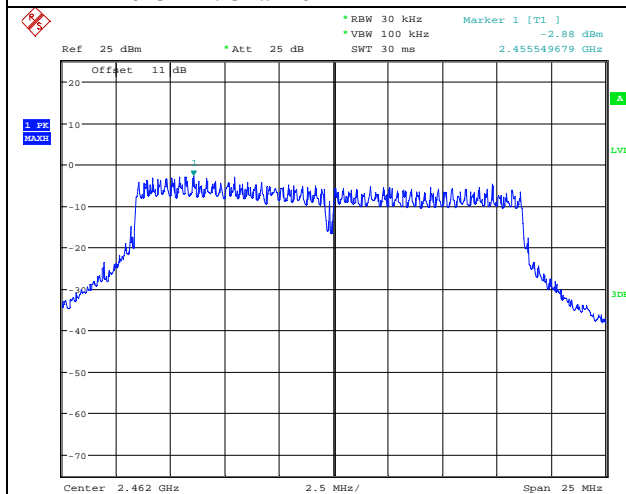

11n HT 40 CH6/Chain 0

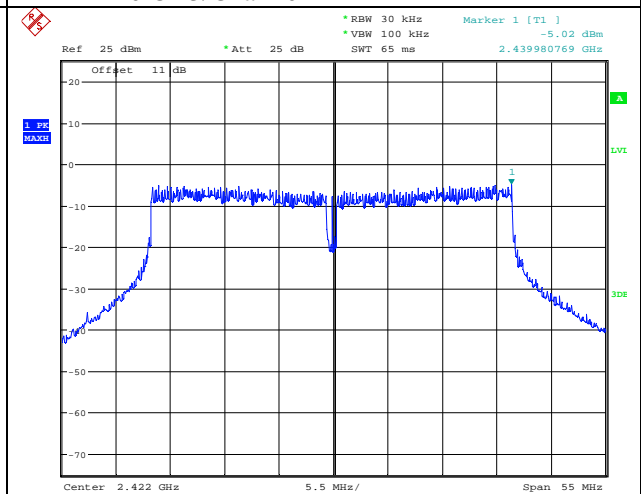

11n HT 40 CH9/Chain 0

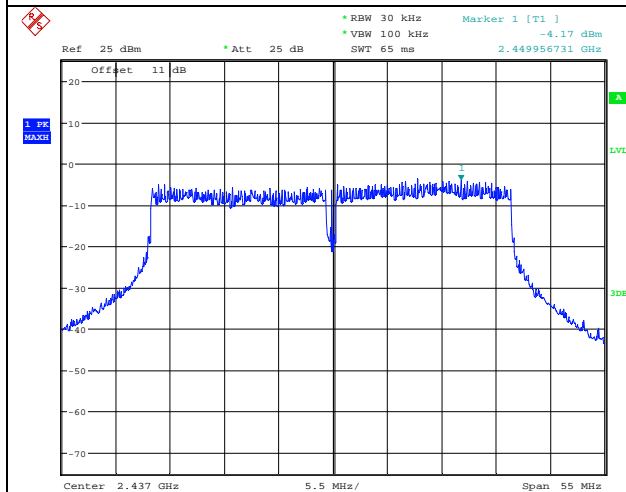

11n HT 20 CH1/Chain 1

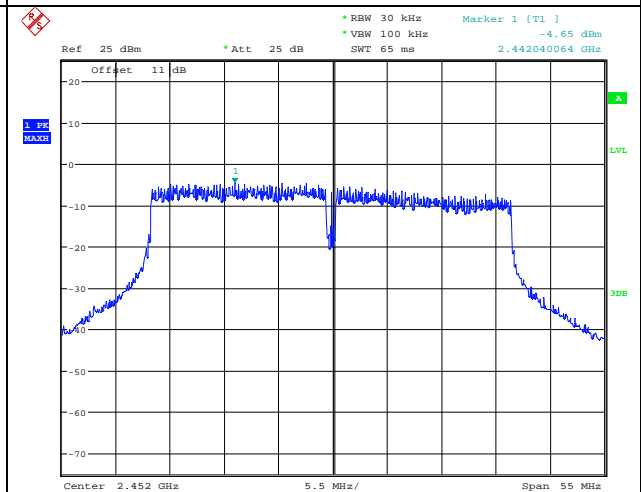

11n HT 20 CH6/Chain 1

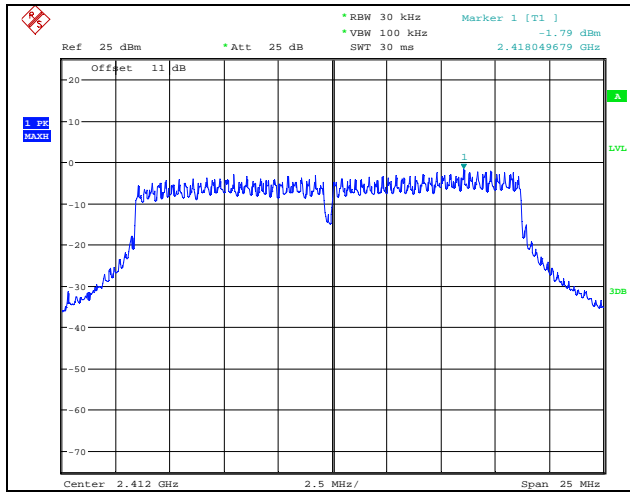

11n HT 20 CH11/Chain 1

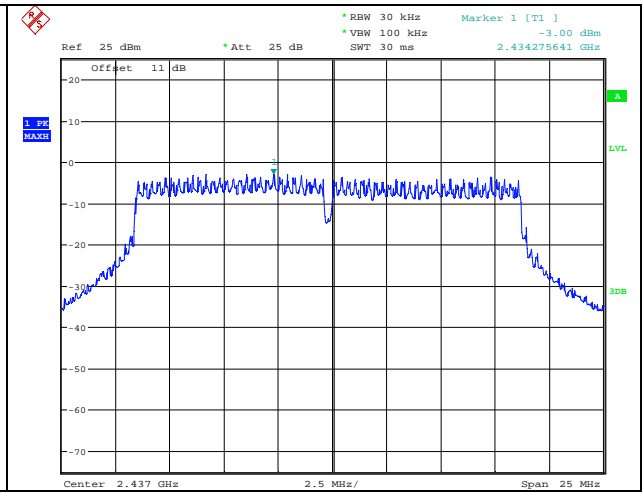

11n HT 40 CH3/Chain 1

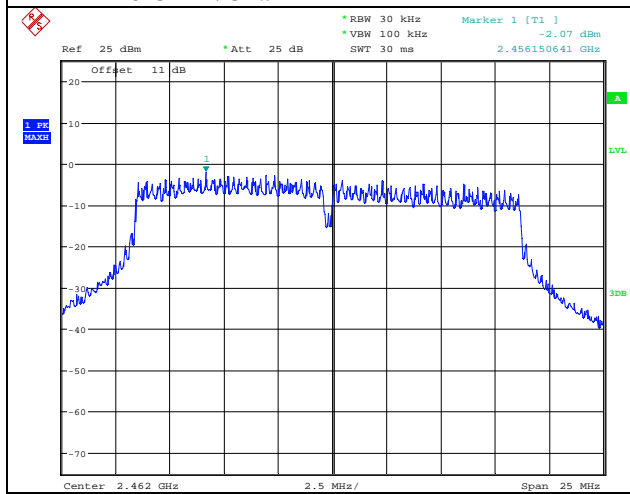

11n HT 40 CH6/Chain 1

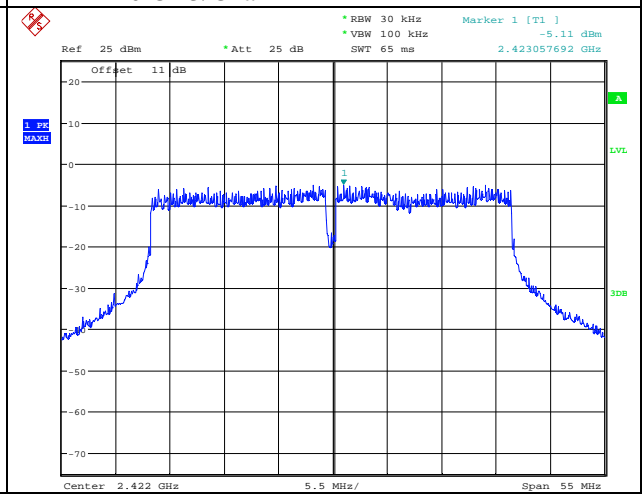

11n HT 40 CH9/Chain 1

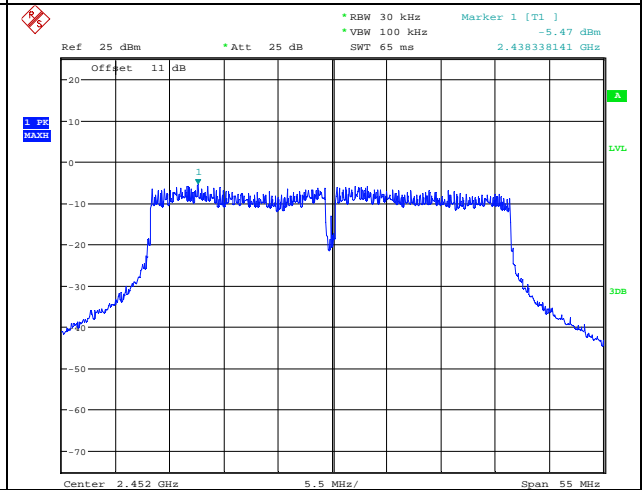
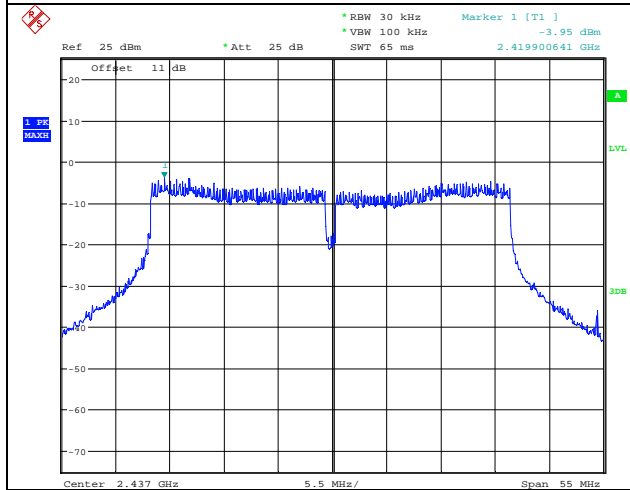

7. Emissions in non-restricted frequency bands

7.1. Test equipment

Please refer to Section 3 this report.

7.2. Block diagram of test setup

Same with 4.2

7.3. Limits

In any 100kHz bandwidth outside the frequency bands in which the spread spectrum intentional radiator is operating, the radio frequency power that is produced by the intentional radiator shall be at least 20dB below that in the 100kHz bandwidth within the band that contains the highest level of the desired power.

7.4. Test Procedure

- (1) Configure EUT and assistant system according clause 2.4 and 7.2
- (2) Connect EUT's antenna output to spectrum analyzer by RF cable.
- (3) Configure EUT work in test mode as stated in clause 2.4.
- (4) Establish a reference level by using the following procedure:

Center frequency	DTS Channel center frequency
RBW:	100KHz
VBW:	300KHz
Span	1.5times the DTS bandwidth
Detector Mode:	Peak
Sweep time:	auto
Trace mode	Max hold

- (5) Allow the trace to stabilize, use the peak marker function to determine the maximum peak power level to establish the reference level.
- (6) Set the spectrum analyzer as follows:

RBW:	100KHz
VBW:	300KHz
Span	Encompass frequency range to be measured
Number of measurement points	\geq span/RBW
Detector Mode:	Peak
Sweep time:	auto
Trace mode	Max hold

- (7) Allow the trace to stabilize, use the peak marker function to determine the maximum amplitude of all

unwanted emissions outside of the authorized frequency band

7.5. Test Result

EUT Set Mode	CH or Frequency	Measured Range	Result (dBm)	EUT Set Mode	CH or Frequency	Measured Range	Result (dBm)
11b	CH1	30MHz-1GHz	PASS	11g	CH1	30MHz-1GHz	PASS
		1GHz-25GHz	PASS			1GHz-25GHz	PASS
		2.3GHz-2.43GHz	PASS			2.3GHz-2.43GHz	PASS
	CH6	30MHz-1GHz	PASS		CH6	30MHz-1GHz	PASS
		1GHz-25GHz	PASS			1GHz-25GHz	PASS
	CH11	30MHz-1GHz	PASS		CH11	30MHz-1GHz	PASS
		1GHz-25GHz	PASS			1GHz-25GHz	PASS
		2.45GHz-2.6GHz	PASS			2.45GHz-2.6GHz	PASS
	11n HT 20/China 0	CH1	30MHz-1GHz		PASS	11n HT 40/China 0	CH1
1GHz-25GHz			PASS	1GHz-25GHz	PASS		
2.3GHz-2.43GHz			PASS	2.3GHz-2.43GHz	PASS		
CH6		30MHz-1GHz	PASS	CH6	30MHz-1GHz		PASS
		1GHz-25GHz	PASS		1GHz-25GHz		PASS
CH11		30MHz-1GHz	PASS	CH11	30MHz-1GHz		PASS
		1GHz-25GHz	PASS		1GHz-25GHz		PASS
		2.45GHz-2.6GHz	PASS		2.45GHz-2.6GHz		PASS
11n HT 20/China 1		CH1	30MHz-1GHz	PASS	11n HT 40/China 1		CH1
	1GHz-25GHz		PASS	1GHz-25GHz		PASS	
	2.3GHz-2.43GHz		PASS	2.3GHz-2.43GHz		PASS	
	CH6	30MHz-1GHz	PASS	CH6		30MHz-1GHz	PASS
		1GHz-25GHz	PASS			1GHz-25GHz	PASS
	CH11	30MHz-1GHz	PASS	CH11		30MHz-1GHz	PASS
		1GHz-25GHz	PASS			1GHz-25GHz	PASS
		2.45GHz-2.6GHz	PASS			2.45GHz-2.6GHz	PASS
	Test Date : 2015/9/14					Test Engineer : Leo	

7.6. Original test data

11b CH1

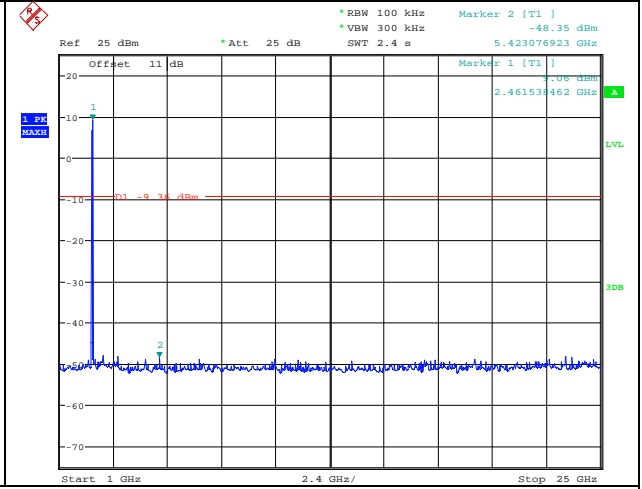
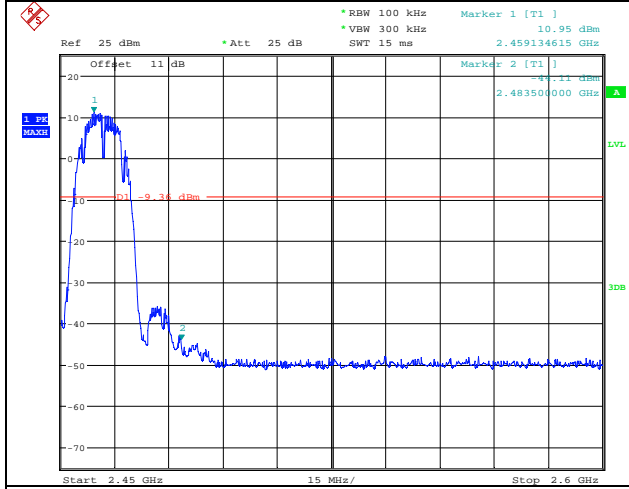
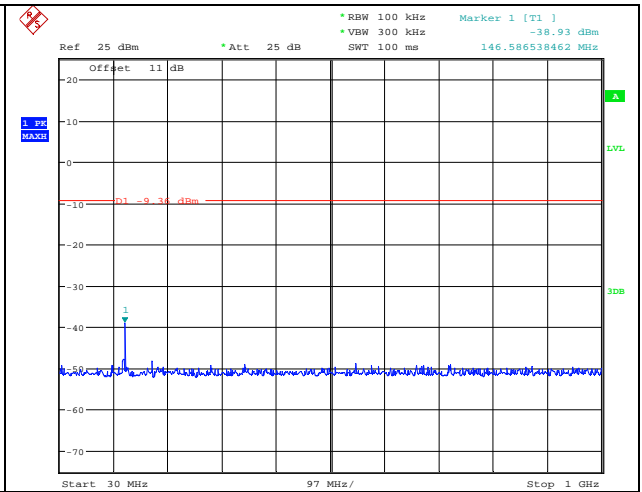
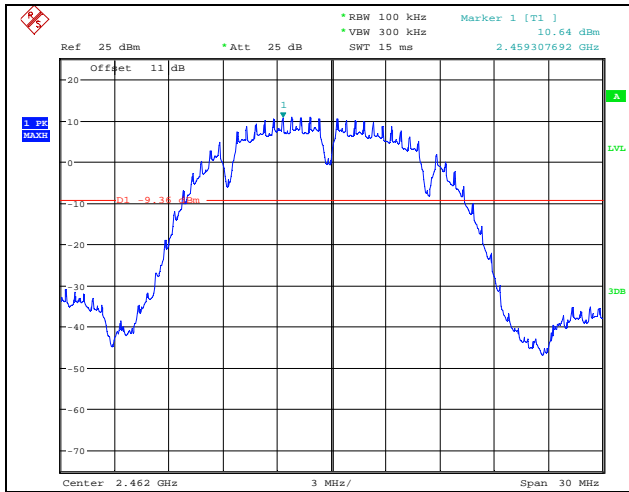

11b CH6

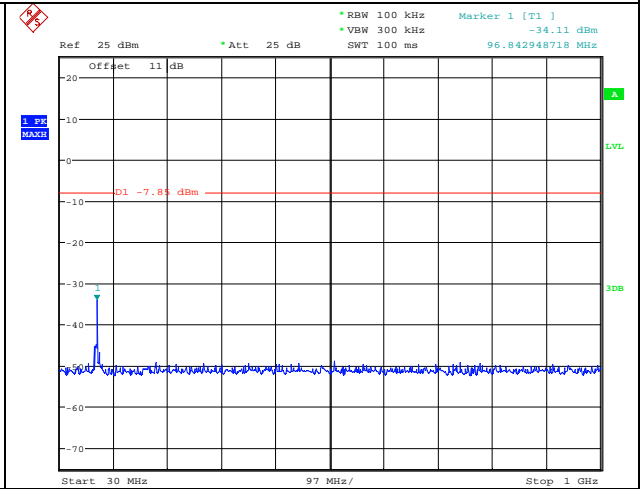
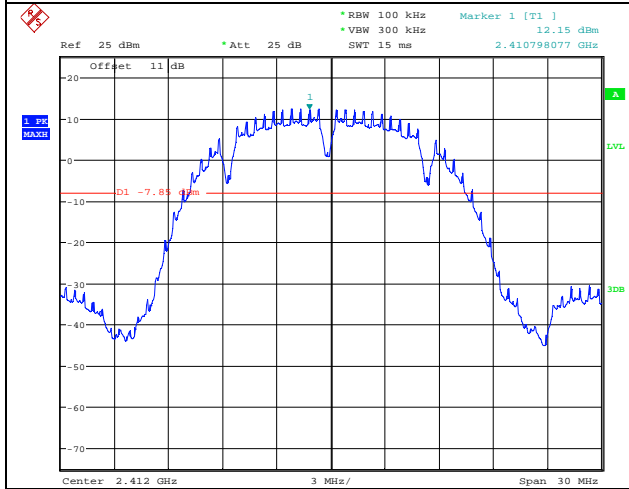

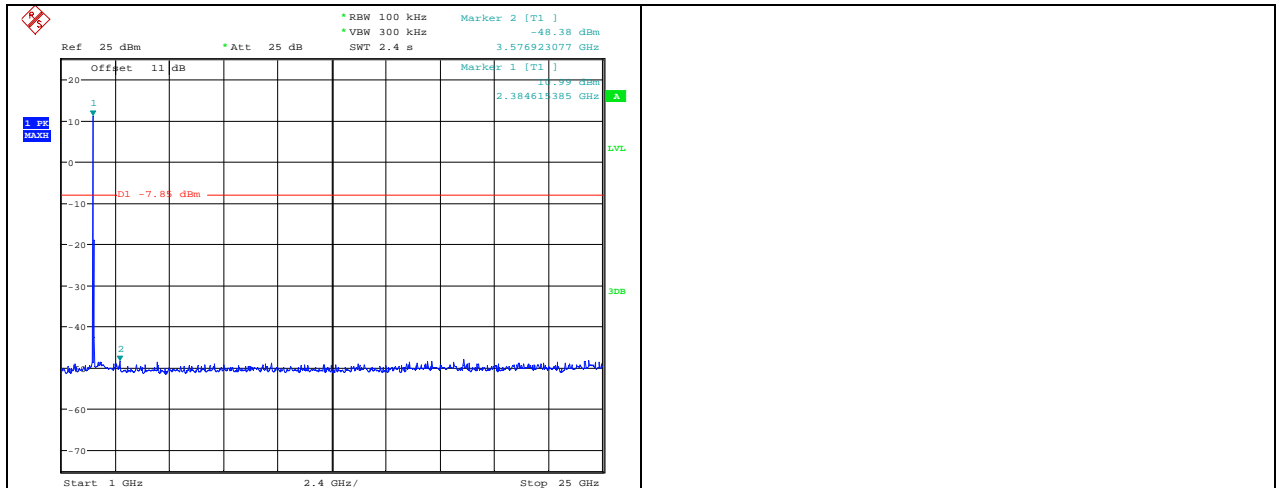

11b CH11

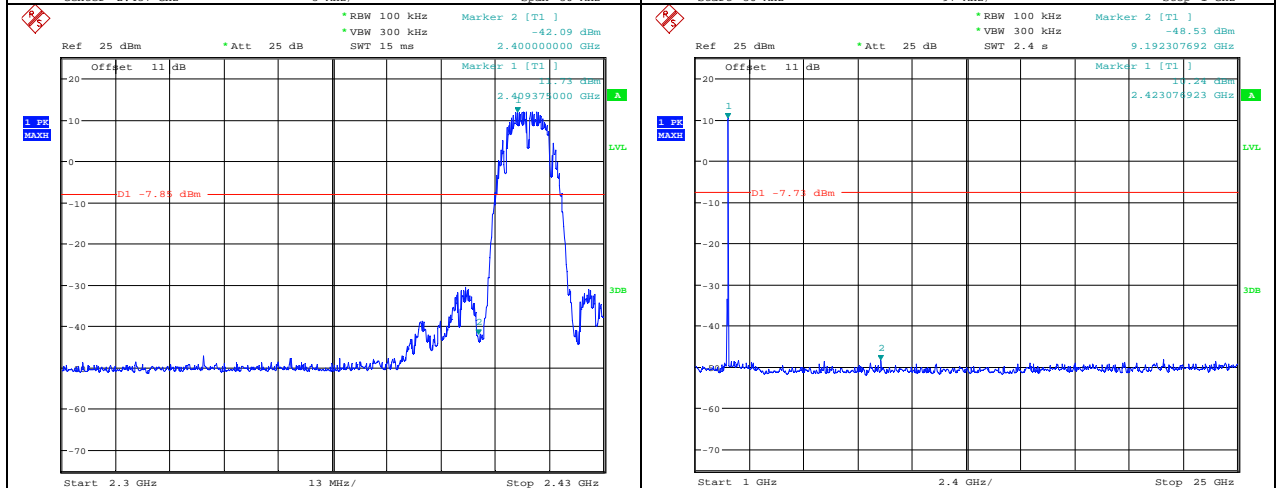
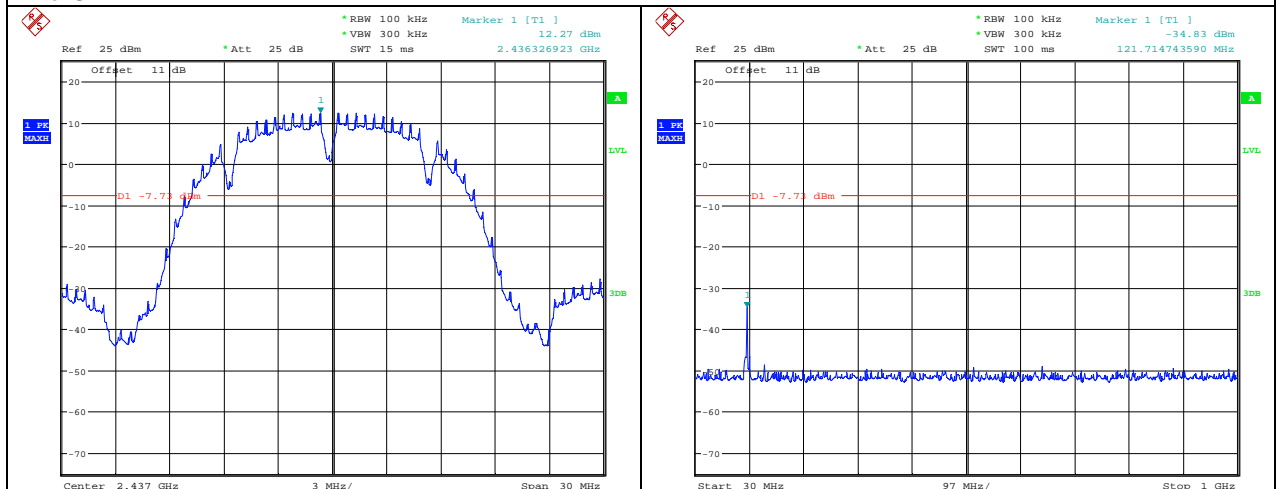

11g CH1

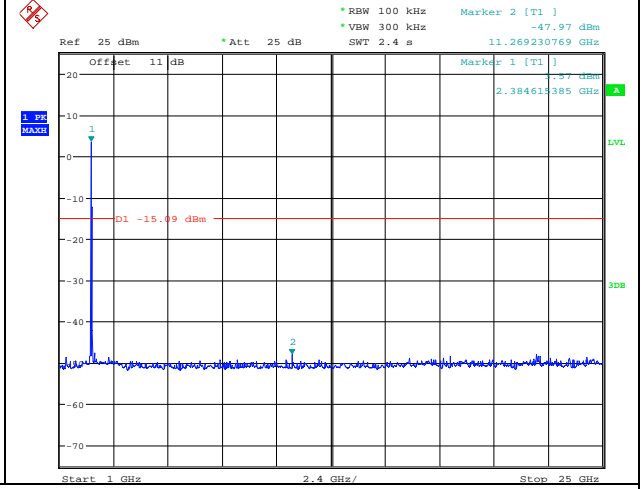
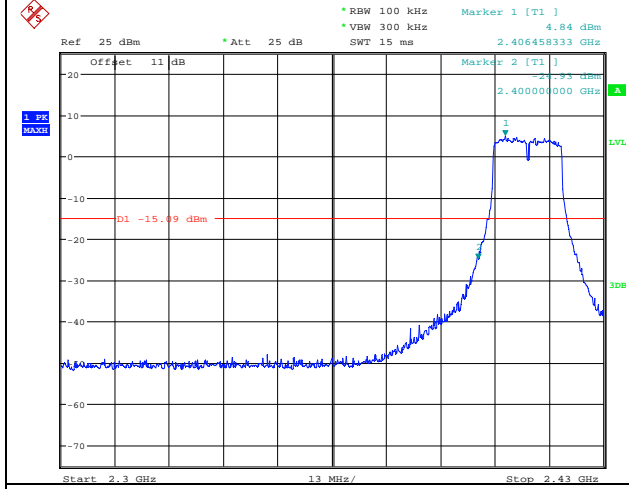
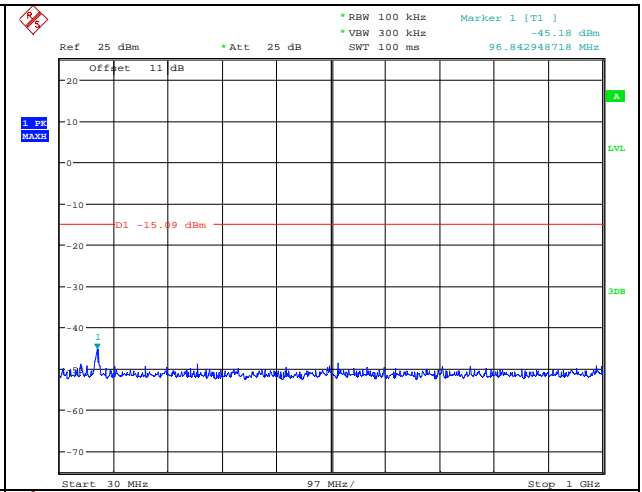
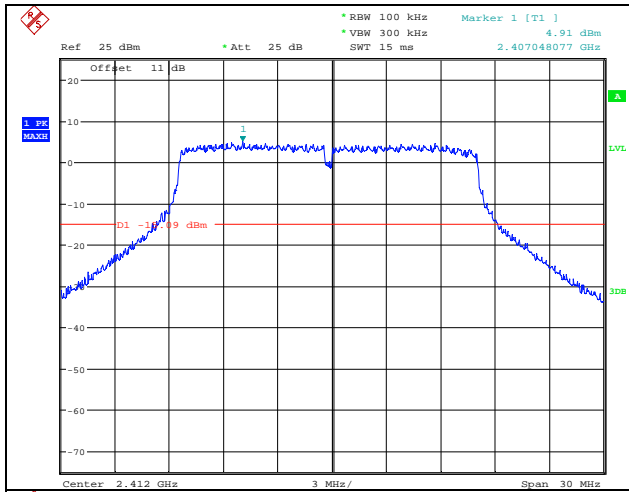

11g CH6

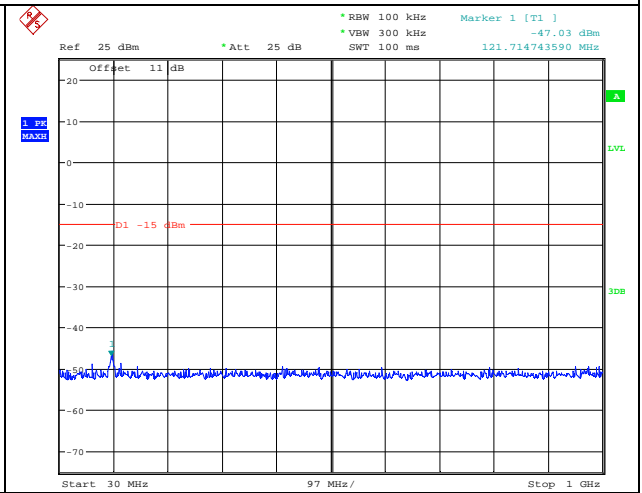
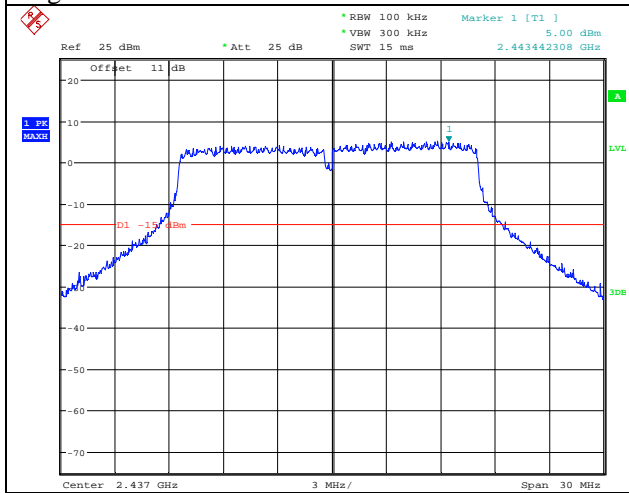

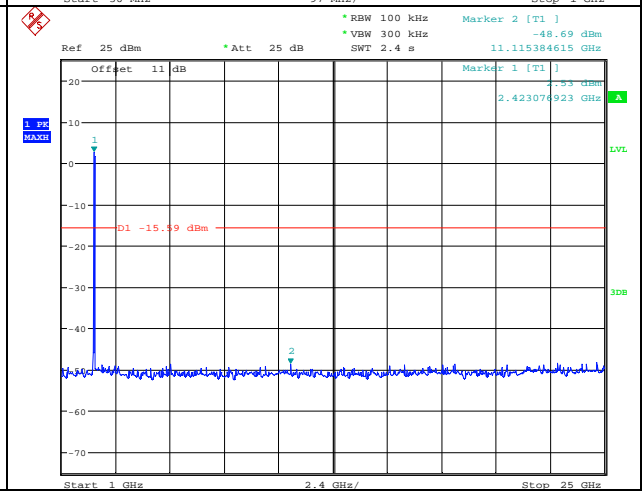
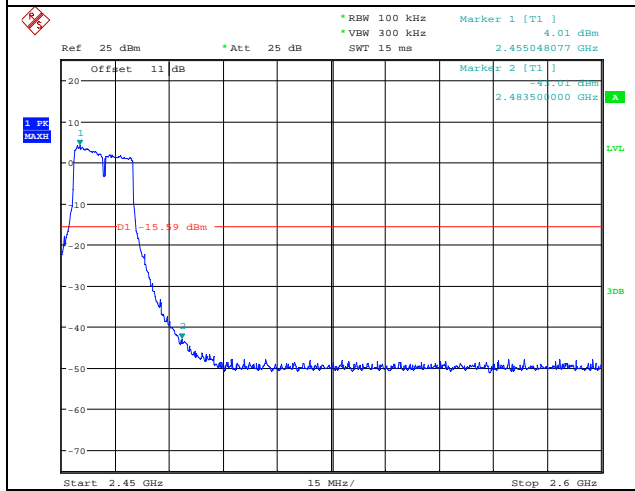
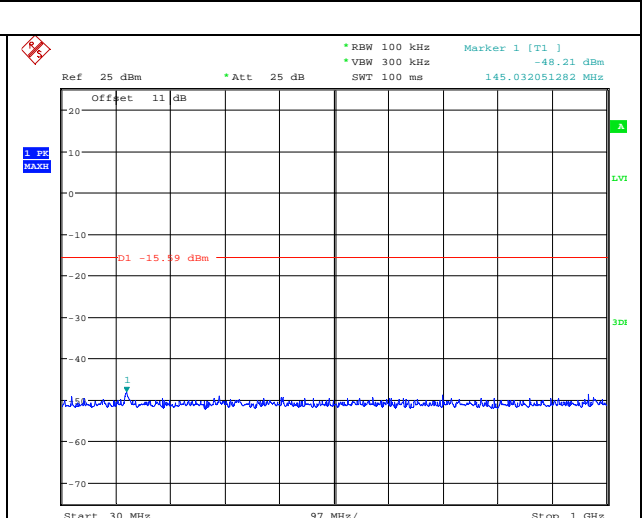
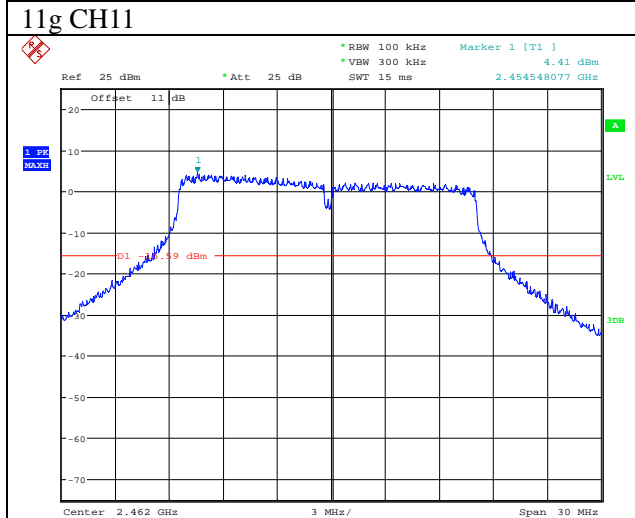
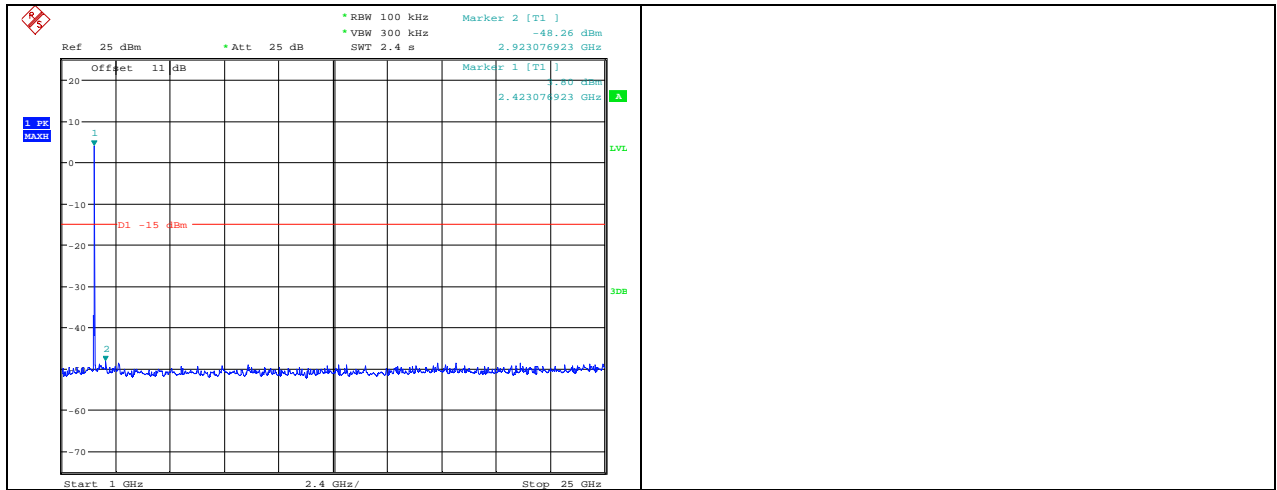

11n HT 20 CH1/China 0

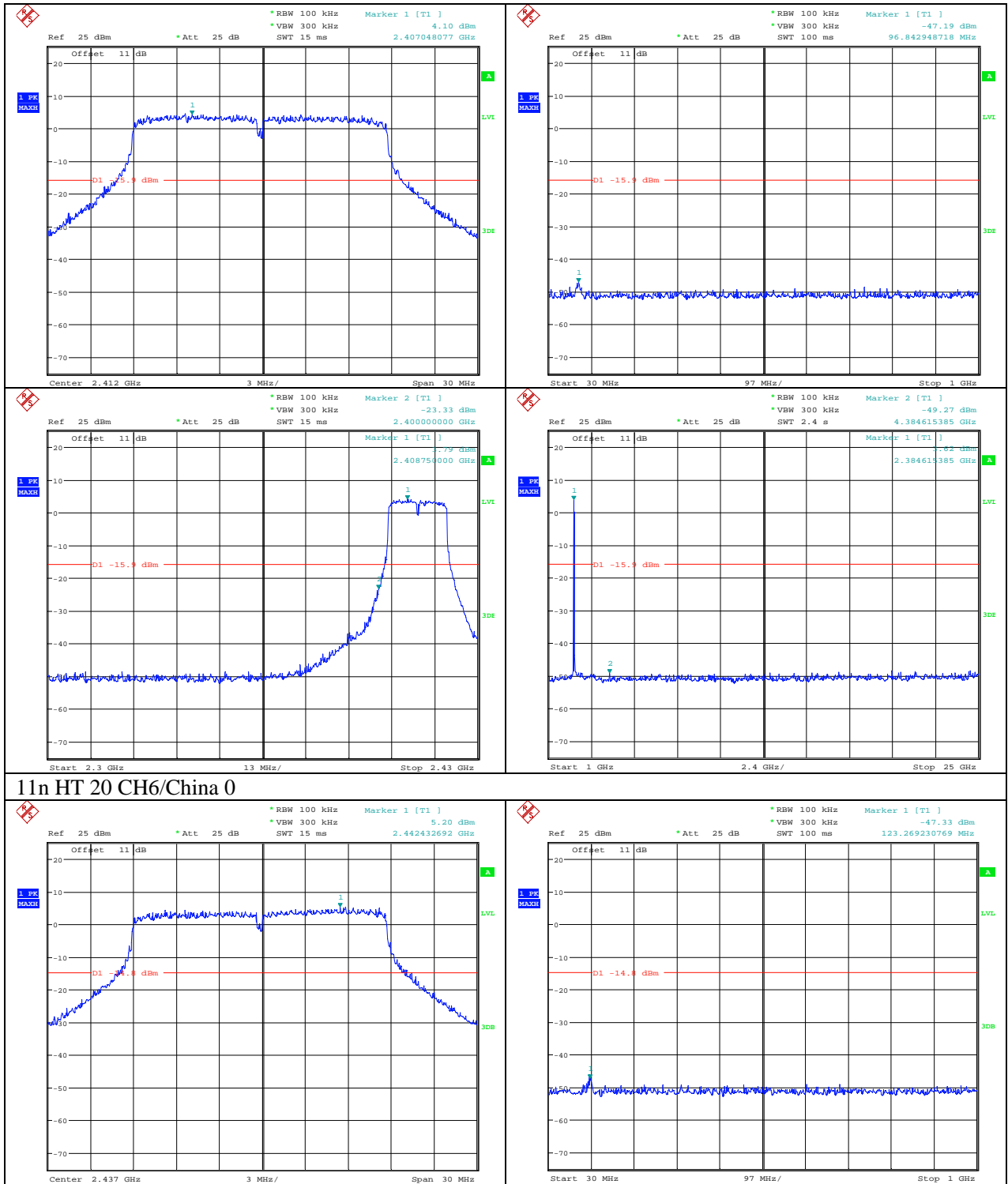

11n HT 20 CH6/China 0

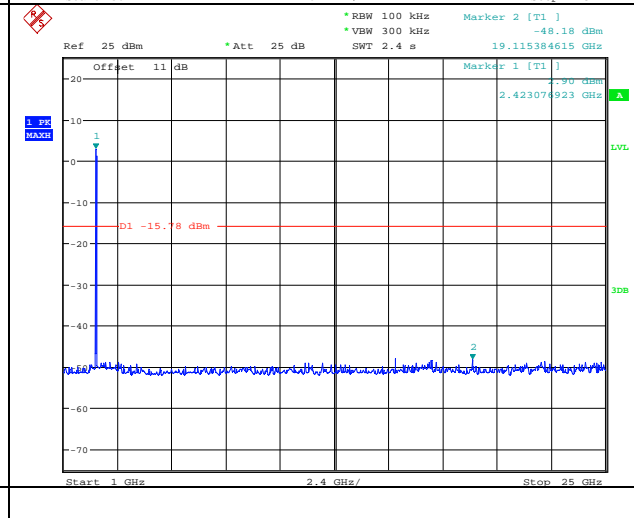
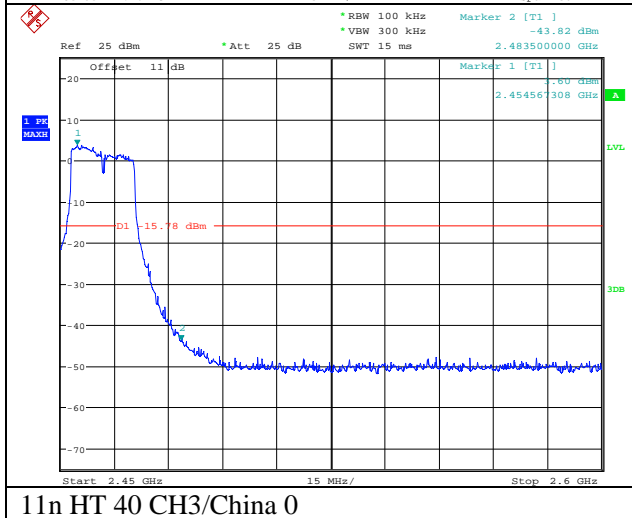
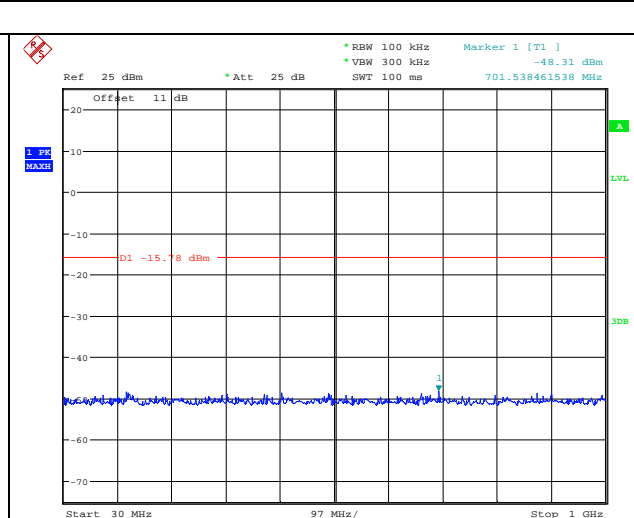
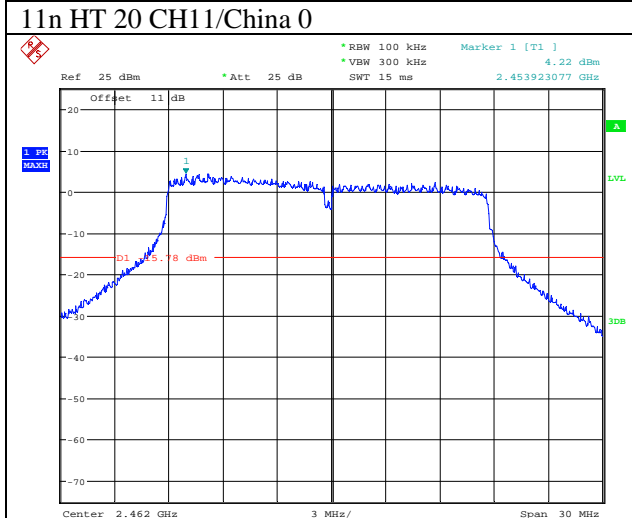
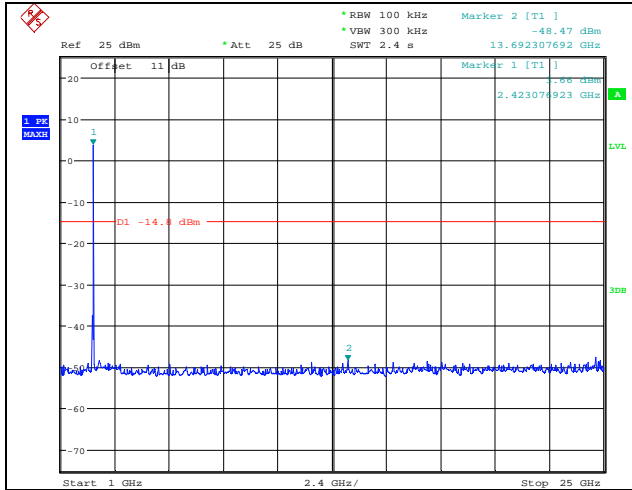

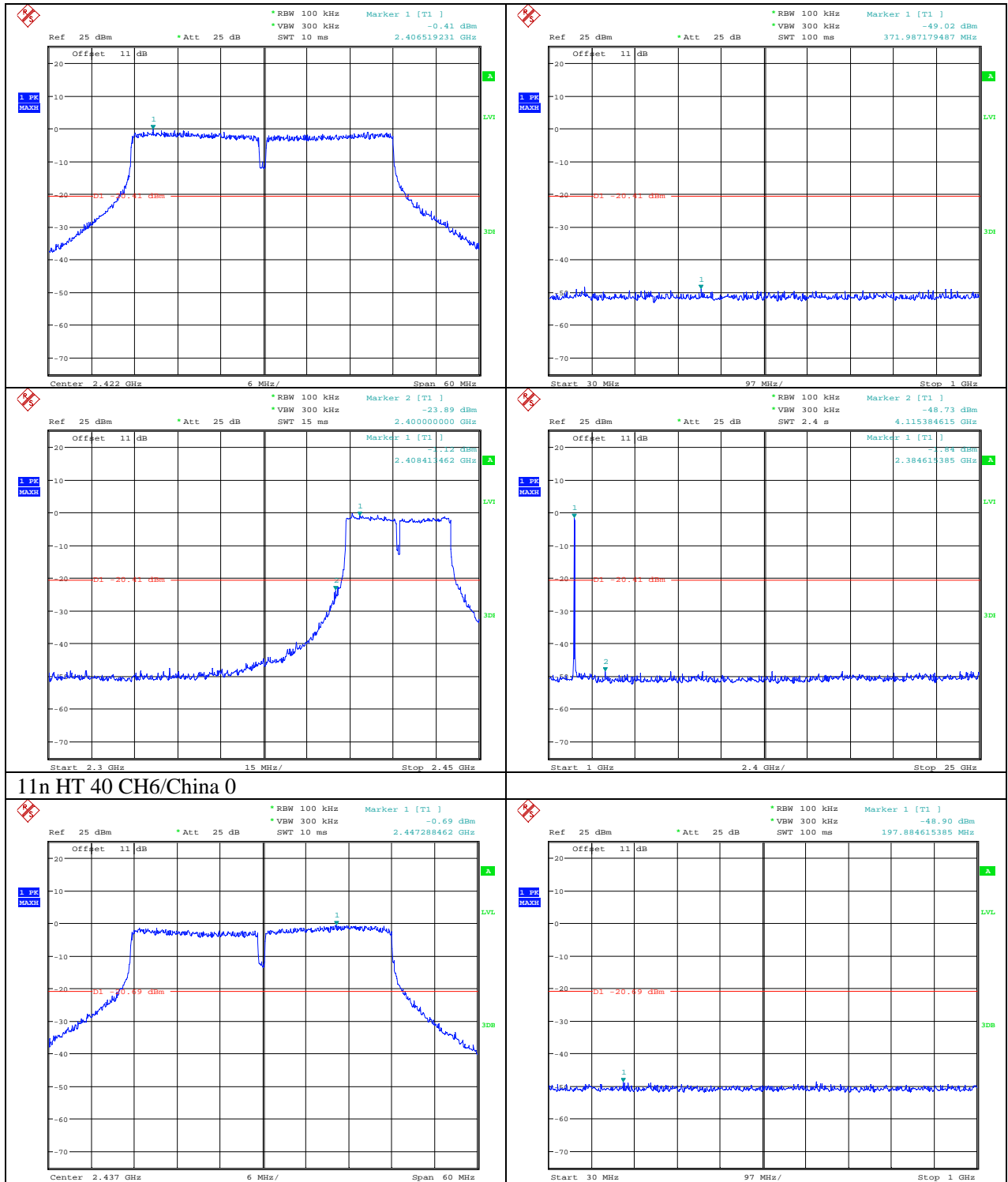

11n HT 40 CH6/China 0

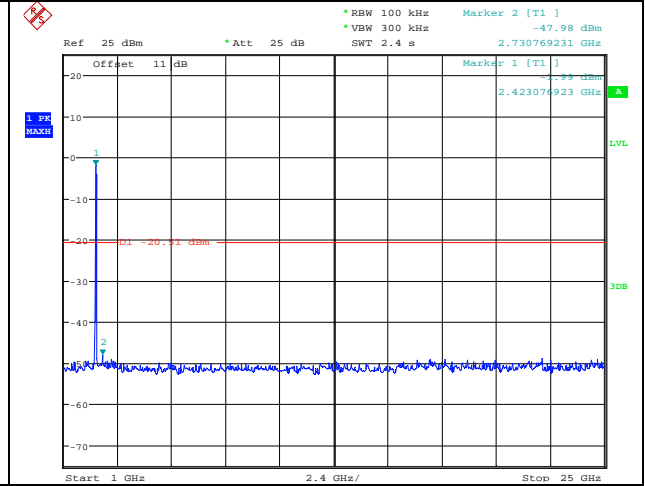
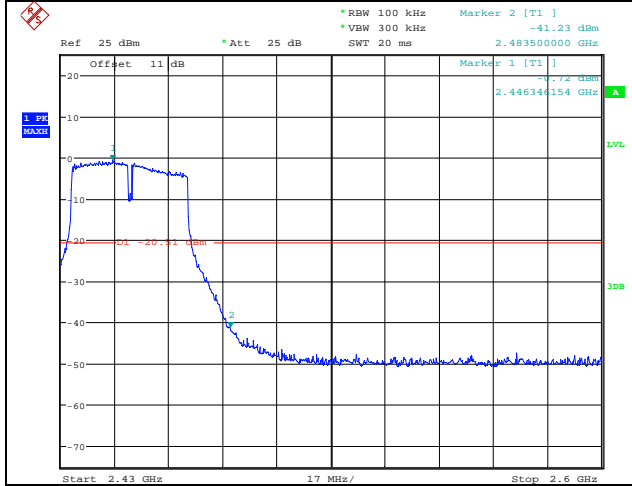
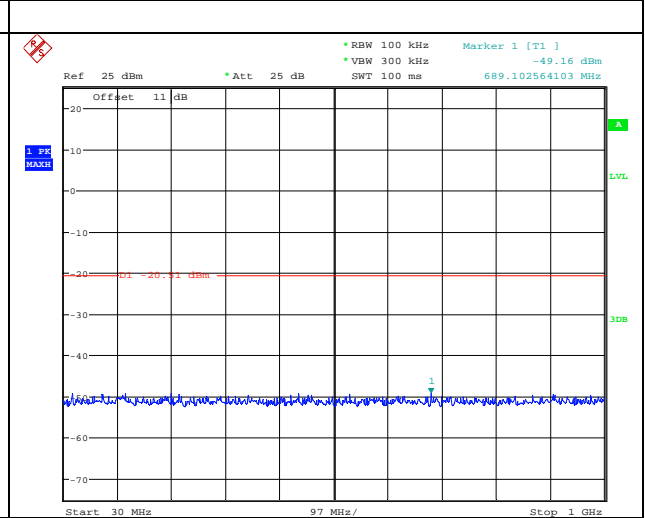
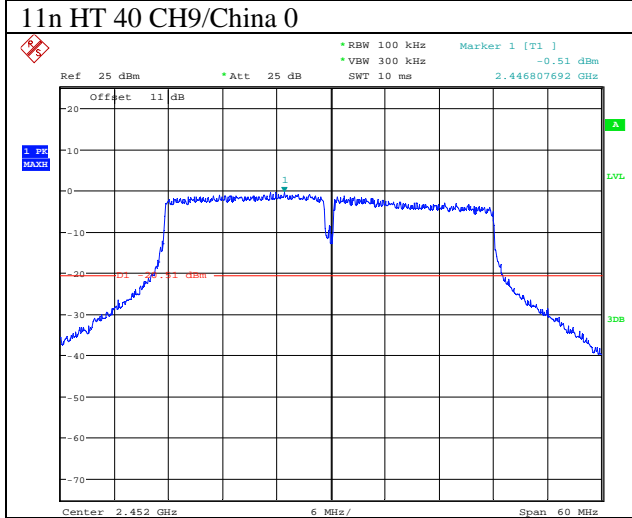
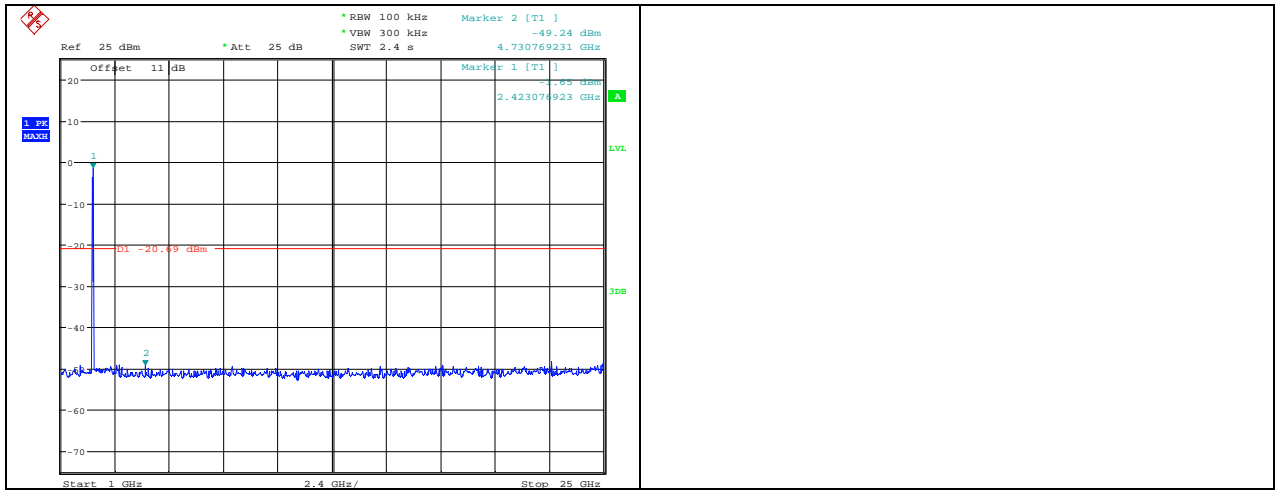

11n HT 20 CH1/China 1

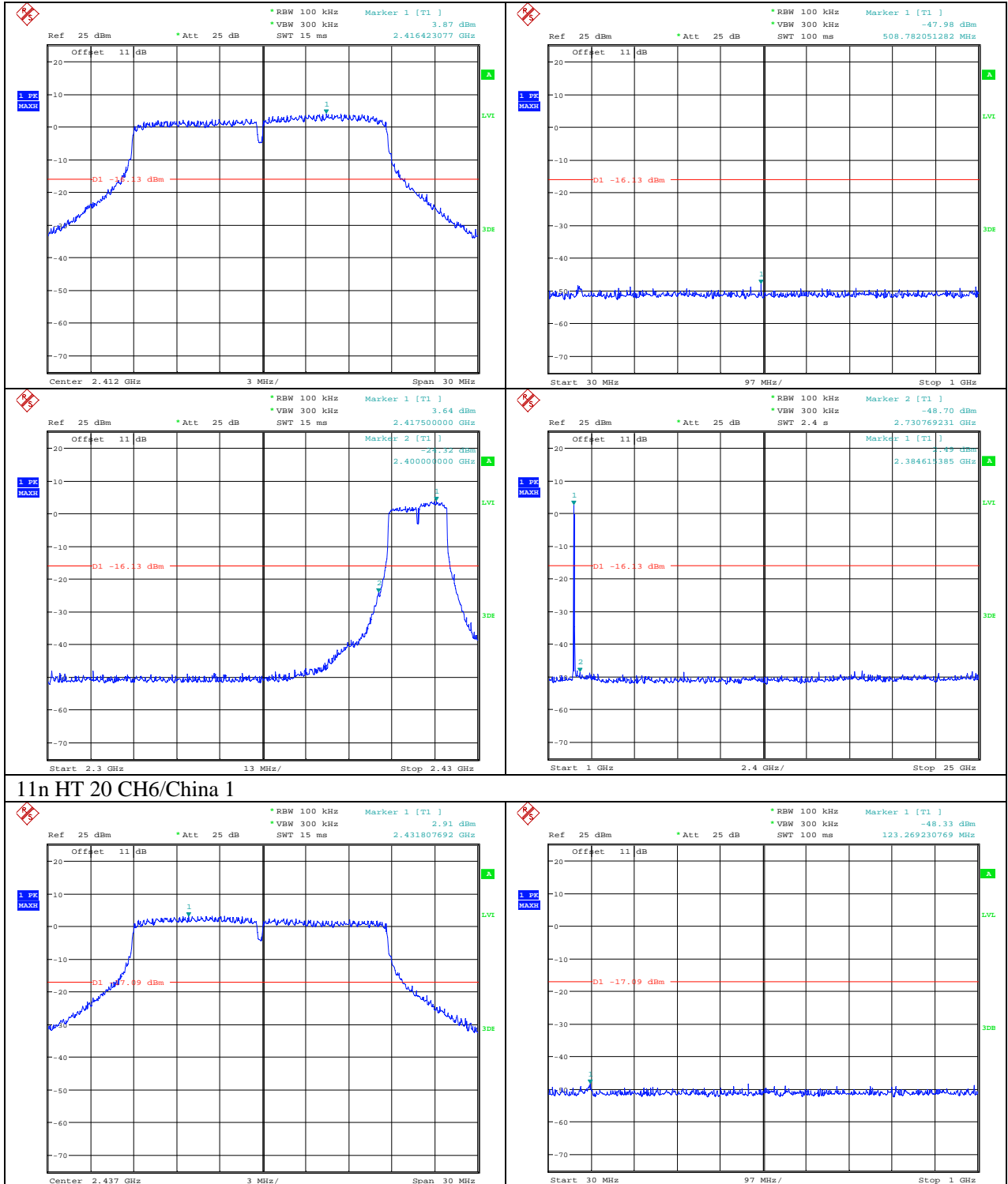

11n HT 20 CH6/China 1

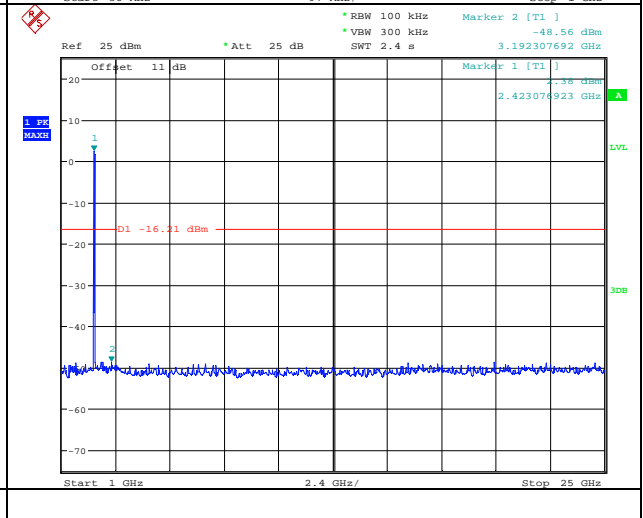
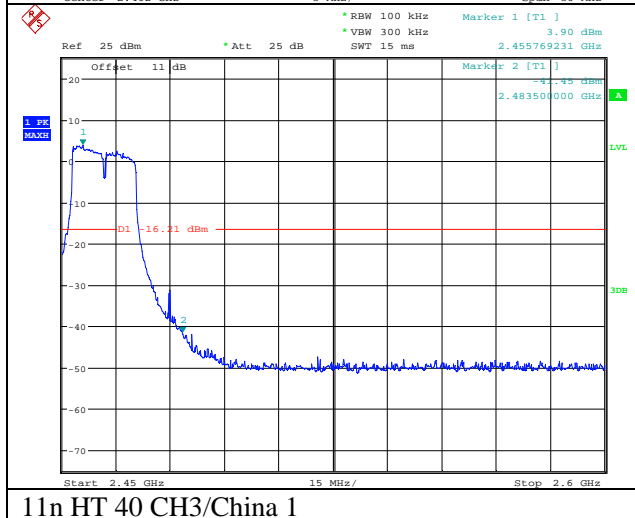
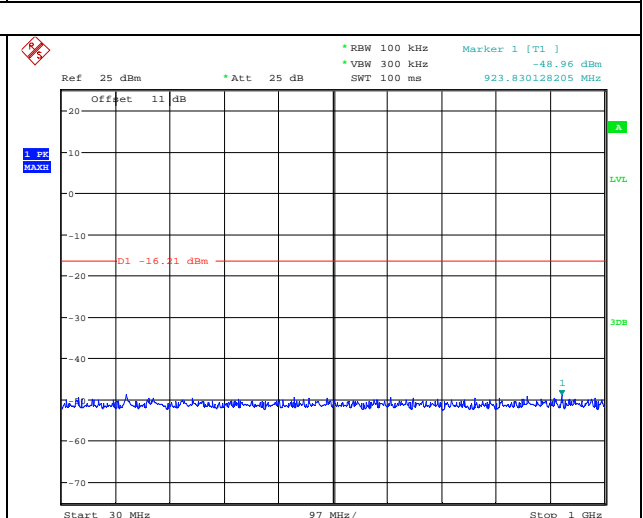
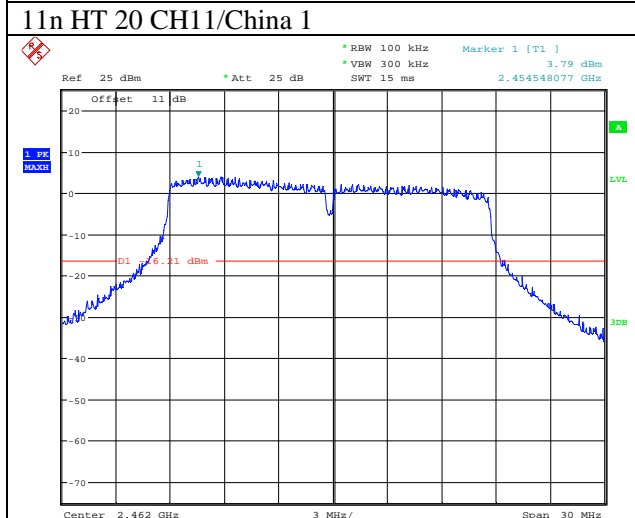
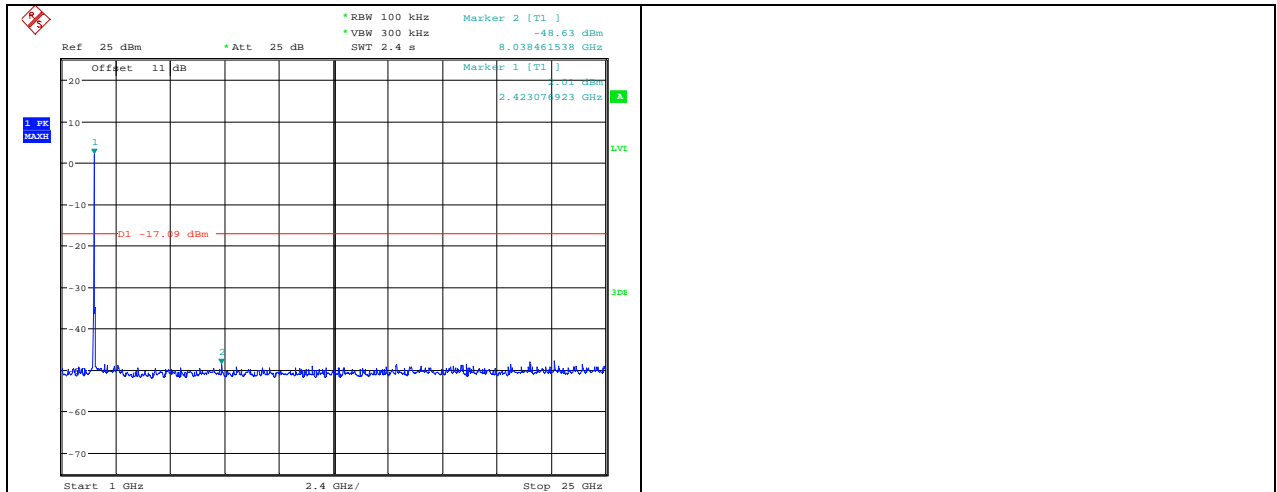

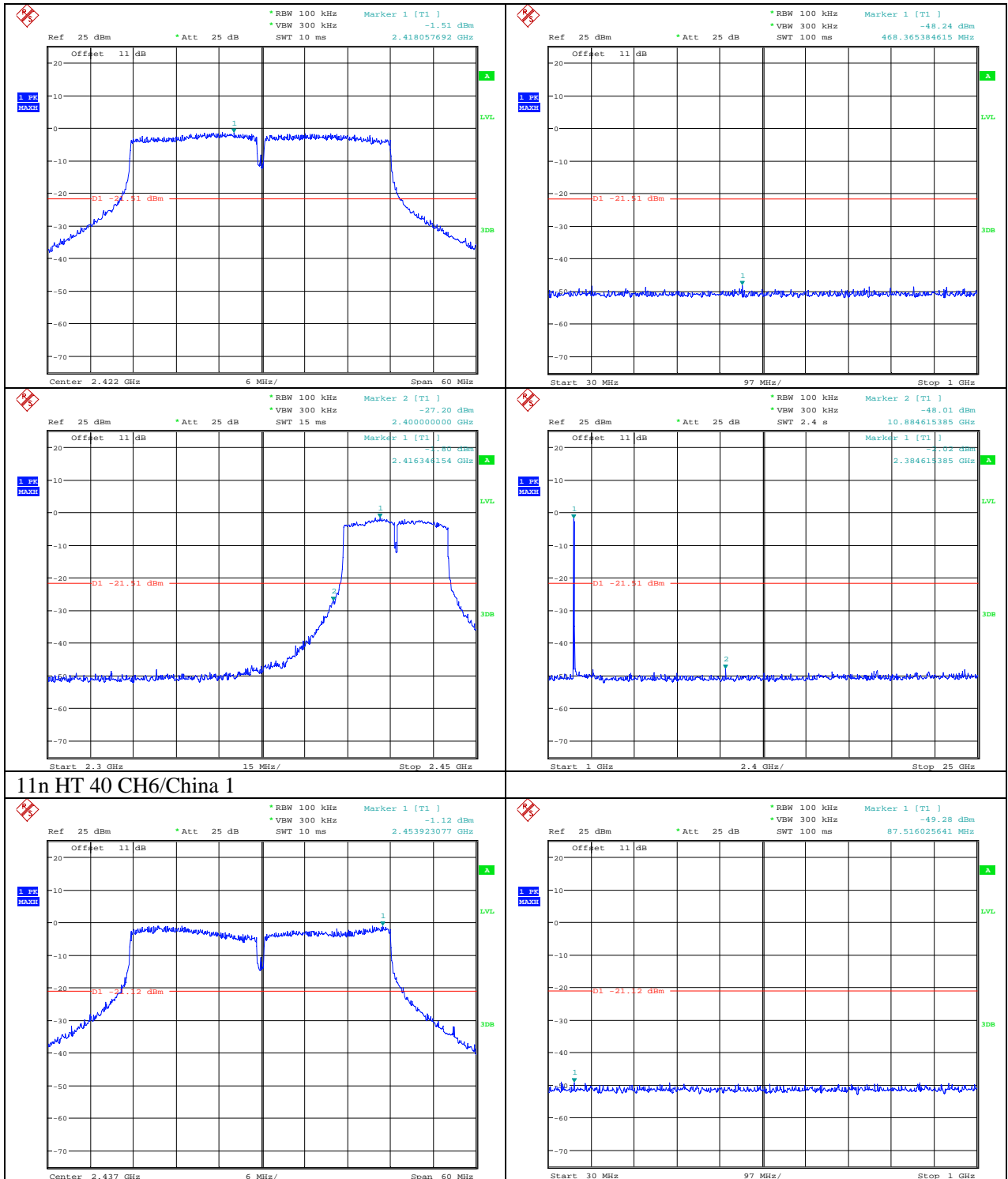

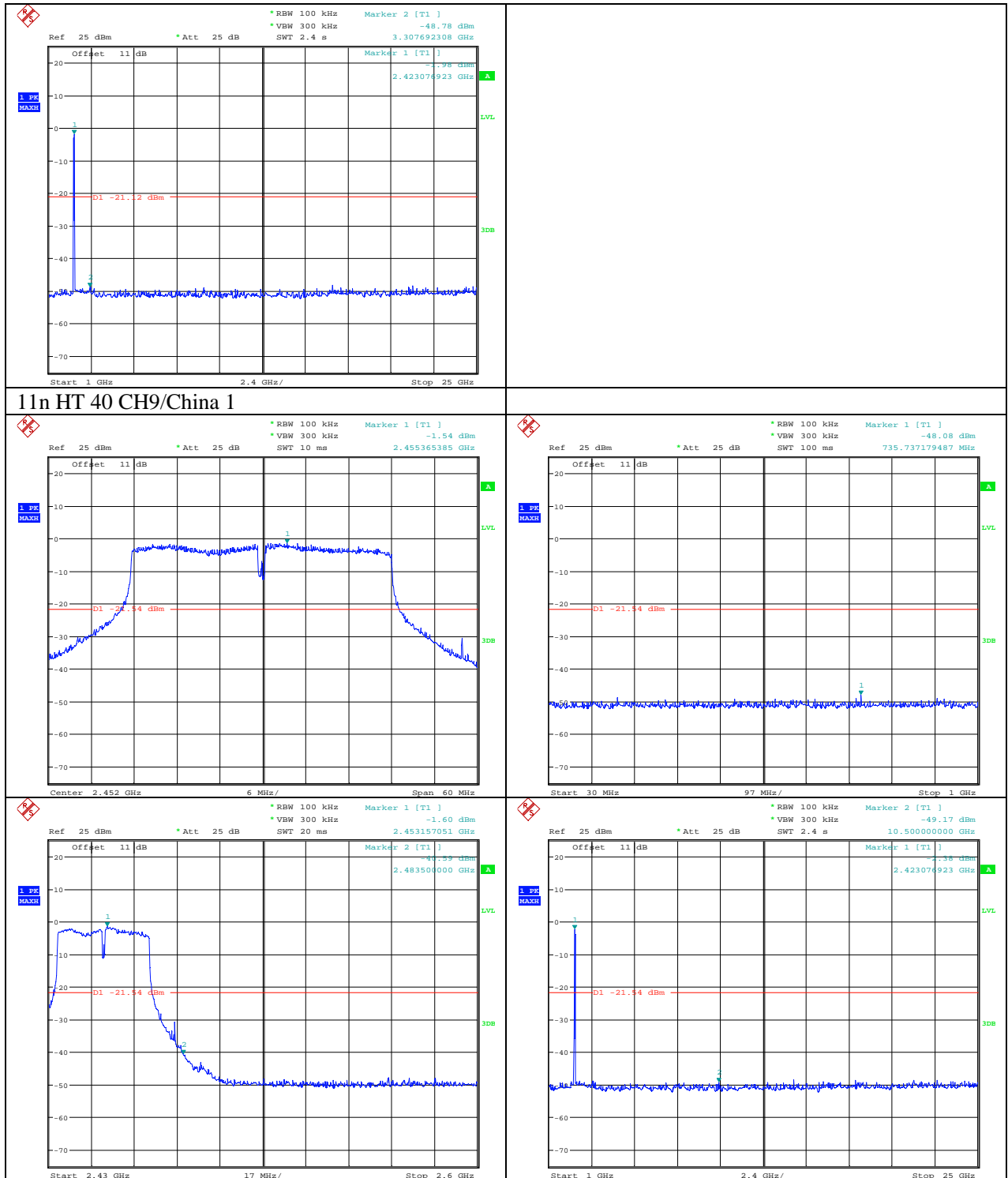

8. Emissions in restricted frequency bands

8.1. Test equipment

Please refer to Section 3 this report.

8.2. Block diagram of test setup

In 3m Anechoic Chamber Test Setup Diagram for 9KHz-30MHz

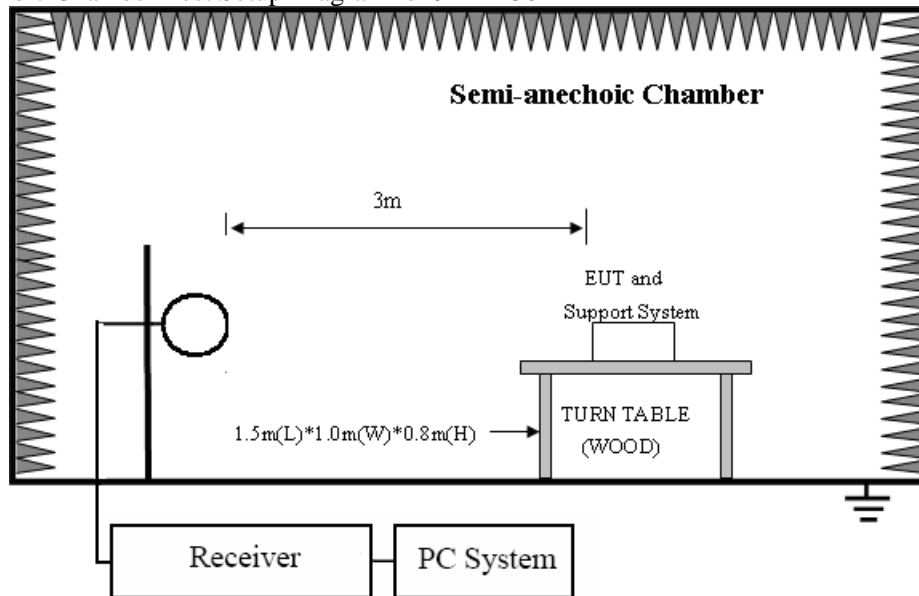

In 3m Anechoic Chamber Test Setup Diagram for 30MHz-1GHz

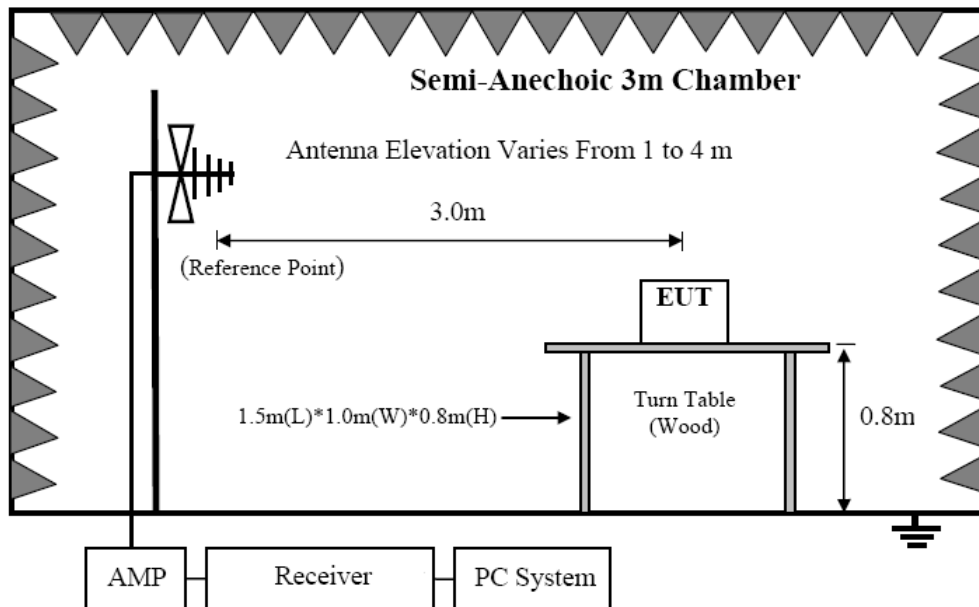

In 3m Anechoic Chamber Test Setup Diagram for frequency above 1GHz

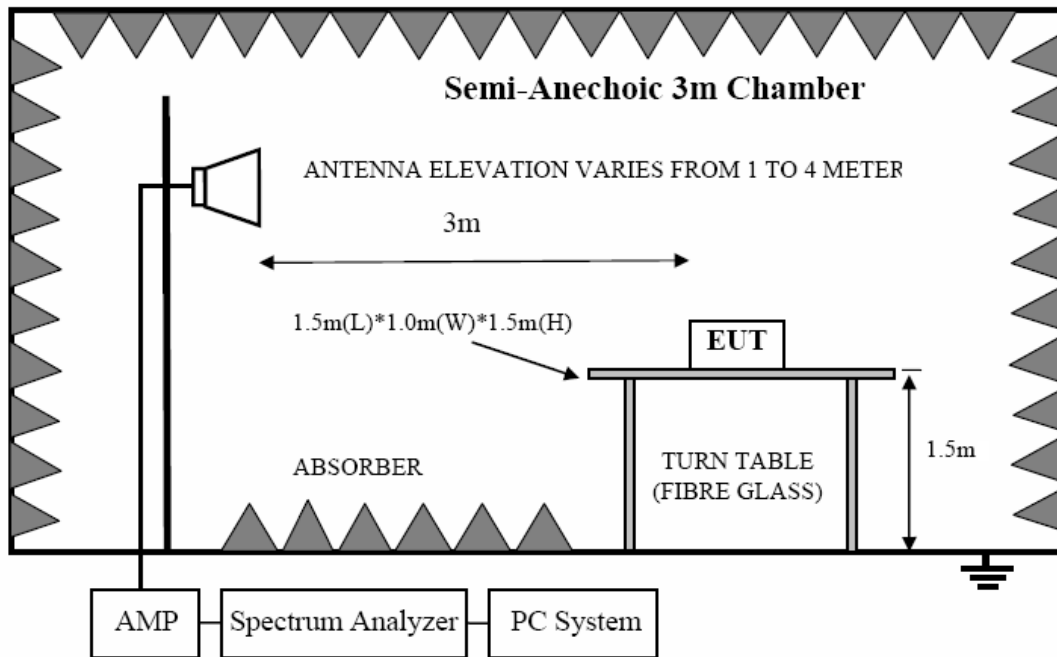

Note: For harmonic emissions test a appropriate high pass filter was inserted in the input port of AMP.

8.3. Limit

8.3.1 FCC 15.205 Restricted frequency band

MHz	MHz	MHz	GHz
0.090 - 0.110	16.42 - 16.423	399.9 - 410	4.5 - 5.15
¹ 0.495 - 0.505	16.69475 - 16.69525	608 - 614	5.35 - 5.46
2.1735 - 2.1905	16.80425 - 16.80475	960 - 1240	7.25 - 7.75
4.125 - 4.128	25.5 - 25.67	1300 - 1427	8.025 - 8.5
4.17725 - 4.17775	37.5 - 38.25	1435 - 1626.5	9.0 - 9.2
4.20725 - 4.20775	73 - 74.6	1645.5 - 1646.5	9.3 - 9.5
6.215 - 6.218	74.8 - 75.2	1660 - 1710	10.6 - 12.7
6.26775 - 6.26825	108 - 121.94	1718.8 - 1722.2	13.25 - 13.4
6.31175 - 6.31225	123 - 138	2200 - 2300	14.47 - 14.5
8.291 - 8.294	149.9 - 150.05	2310 - 2390	15.35 - 16.2
8.362 - 8.366	156.52475 - 156.52525	2483.5 - 2500	17.7 - 21.4
8.37625 - 8.38675	156.7 - 156.9	2690 - 2900	22.01 - 23.12
8.41425 - 8.41475	162.0125 - 167.17	3260 - 3267	23.6 - 24.0
12.29 - 12.293	167.72 - 173.2	3332 - 3339	31.2 - 31.8
12.51975 - 12.52025	240 - 285	3345.8 - 3358	36.43 - 36.5
12.57675 - 12.57725	322 - 335.4	3600 - 4400	(²)

8.3.2 FCC 15.209 Limit.

FREQUENCY MHz	DISTANCE Meters	FIELD STRENGTHS LIMIT	
		μV/m	dB(μV)/m
0.009 ~ 0.490	300	2400/F(KHz)	67.6-20log(F)
0.490 ~ 1.705	30	24000/F(KHz)	87.6-20log(F)
1.705 ~ 30.0	30	30	29.54
30 ~ 88	3	100	40.0
88 ~ 216	3	150	43.5

216 ~ 960	3	200	46.0
960 ~ 1000	3	500	54.0
Above 1000	3	74.0 dB(μ V)/m (Peak) 54.0 dB(μ V)/m (Average)	

Note: (1) The emission limits shown in the above table are based on measurements employing a CISPR QP detector except for the frequency bands 9-90KHz, 110-490KHz and above 1000MHz. Radiated emissions limits in these three bands are based on measurements employing an average detector.

(2) At frequencies below 30MHz, measurement may be performed at a distance closer than that specified, and the limit at closer measurement distance can be extrapolated by below formula:

$$\text{Limit}_{3m}(\text{dB}\mu\text{V}/\text{m}) = \text{Limit}_{30m}(\text{dB}\mu\text{V}/\text{m}) + 40\text{Log}(30\text{m}/3\text{m})$$

8.3.3 Limit for this EUT

All the emissions appearing within 15.205 restricted frequency bands shall not exceed the limits shown in 15.209, all the other emissions shall be at least 20dB below the fundamental emissions, or comply with 15.209 limits.

8.4. Test Procedure

(1) EUT height should be 0.8m for below 1GHz at a semi - anechoic chamber while EUT height should be 1.5m for above 1GHz at full chamber or semi - anechoic chamber ground with absorbers.

(2) Setup EUT and assistant system according clause 2.4 and 8.2

(3) The antenna used as below table.

Test frequency range	Test antenna used	Measuring distance
9KHz-30MHz	Active Loop antenna	3 m
30MHz-1GHz	Trilog Broadband Antenna	3 m
1GHz-18GHz	Double Ridged Horn Antenna(1GHz-18GHz)	3 m
18GHz-40GHz	Horn Antenna(18GHz-40GHz)	1 m

According ANSI C63.10:2013 clause 6.4.4.2 and 6.5.3, for measurements below 30 MHz, the loop antenna was positioned with its plane vertical from the EUT and rotated about its vertical axis for maximum response at each azimuth position around the EUT. And the loop antenna also be positioned with its plane horizontal at the specified distance from the EUT. The center of the loop is 1 m above the ground. for measurement above 30MHz, the Trilog Broadband Antenna or Horn Antenna was located 3m from EUT, Measurements were made with the antenna positioned in both the horizontal and vertical planes of Polarization, and the measurement antenna was varied from 1 m to 4 m. in height above the reference ground plane to obtain the maximum signal strength.

(4) Below pre-scan procedure was first performed in order to find prominent frequency spectrum radiated emissions from 9KHz to 25GHz:

(a) Scanning the peak frequency spectrum with the antenna specified in step (3), and the EUT was rotated 360 degree, the antenna height was varied from 1m to 4m(Except loop antenna, it's fixed 1m above

ground.)

- (b) Change work frequency or channel of device if practicable.
- (c) Change modulation type of device if practicable.
- (d) Change power supply range from 85% to 115% of the rated supply voltage
- (e) Rotated EUT though three orthogonal axes to determine the attitude of EUT arrangement produces highest emissions.

Spectrum frequency from 9KHz to 25GHz (tenth harmonic of fundamental frequency) was investigated, and no any obvious emission were detected from 18GHz to 25GHz, so below final test was performed with frequency range from 9KHz to 18GHz.

- (5) For final emissions measurements at each frequency of interest, the EUT was rotated and the antenna height was varied between 1m and 4m in order to maximize the emission. Measurements in both horizontal and vertical polarities were made and the data was recorded. In order to find the maximum emission, the relative positions of equipments and all of the interface cables were changed according to ANSI C63.10 2013 on Radiated Emission test.
- (6) The emissions from 9KHz to 1GHz were measured based on CISPR QP detector except for the frequency bands 9-90KHz, 110-490KHz, for emissions from 9KHz-90KHz,110KHz-490KHz and above 1GHz were measured based on average detector, for emissions above 1GHz, peak emissions also be measured and need comply with Peak limit.
- (7) The emissions from 9KHz to 1GHz, QP or average values were measured with EMI receiver with below RBW

Frequency band	RBW
9KHz-150KHz	200Hz
150KHz-30MHz	9KHz
30MHz-1GHz	120KHz

- (8) For emissions above 1GHz, both Peak and Average level were measured with Spectrum Analyzer, and the RBW is set at 1MHz, VBW is set at 3MHz for Peak measure; RMS detector RBW 1MHz VBW 3MHz for Average measure(according ANSI C63.10:2013 clause 4.2.3.2.3 procedure for average measure).

8.5. Test result

PASS. (See below detailed test result)

All the emissions except fundamental emission from 9KHz to 25GHz were comply with 15.209 limit.

Note1: According exploratory test no any obvious emission were detected from 9kHz to 30MHz and 18GHz to 25GHz, so the final test was performed with frequency range from 30MHz to 18GHz and recorded in below.

Note2: For emissions below 1GHz, according exploratory explorer test, when change Tx mode and channel, have no distinct influence on emissions level, so for emissions below 1GHz, the final test was only performed with EUT working in 11b, Tx CH6 mode.

Radiated Emission test (below 1GHz)

TR-4-E-009 Radiated Emission Test Result

Test Site : DDT 3m Chamber E:\2015 Report Data\15Q0831-1\RE.EM6
Test Date : 2015-09-24 **Tested By** : Toby
EUT : Outdoor Access Point **Model Number** : DCWL-7962OT
Power Supply : DC 50V from external POE adapter **Test Mode** : TX Mode
Condition : Temp:24.5'C,Humi:55%, **Antenna/Distance** : 2014 VULB 9163/3m/VERTICAL
Press:100.1kPa
Memo :

Data: 5

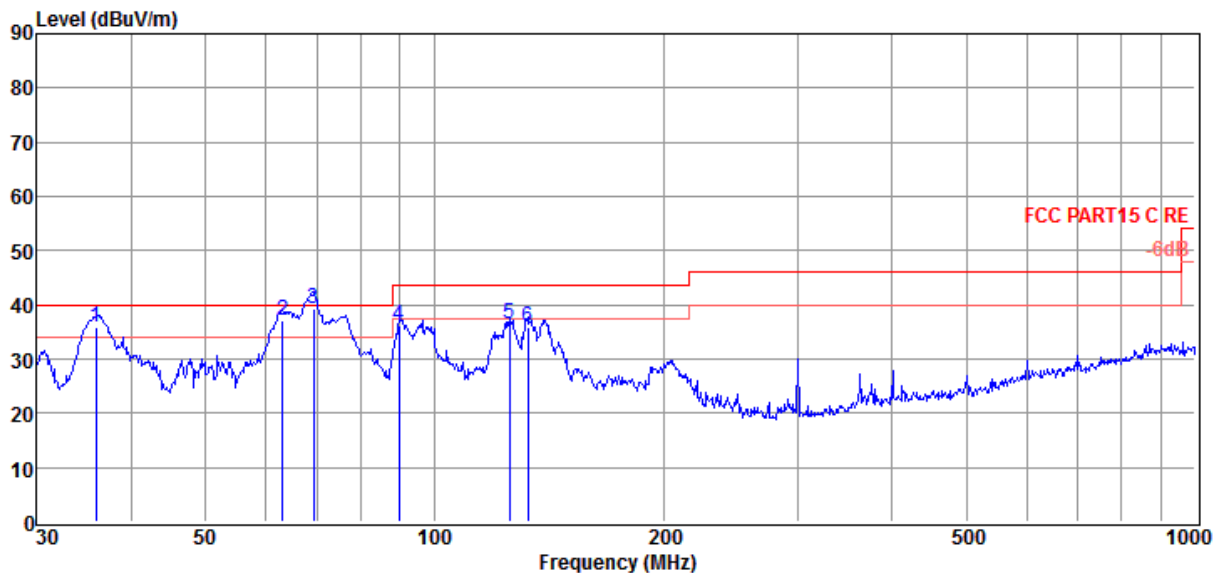

Item (Mark)	Freq (MHz)	Read Level (dBμV)	Antenna Factor (dB/m)	Cable Loss (dB)	Result Level (dBμV/m)	Limit Line (dBμV/m)	Over Limit (dB)	Detector	Polarization
1	35.88	22.48	12.30	0.95	35.73	40.00	-4.27	Peak	VERTICAL
2	63.09	23.81	12.10	1.15	37.06	40.00	-2.94	Peak	VERTICAL
3	69.36	29.04	9.10	1.20	39.34	40.00	-0.66	Peak	VERTICAL
4	89.91	23.08	11.60	1.43	36.11	43.50	-7.39	Peak	VERTICAL
5	125.45	25.67	9.37	1.59	36.63	43.50	-6.87	Peak	VERTICAL
6	132.69	25.65	8.50	1.64	35.79	43.50	-7.71	Peak	VERTICAL

- Note: 1. Result Level = Read Level + Antenna Factor + Cable loss.
 2. If Peak Result complies with QP limit, QP Result is deemed to comply with QP limit.
 3. Test setup: RBW: 120 kHz, VBW: 300 kHz, Sweep time: auto.

TR-4-E-009 Radiated Emission Test Result

Test Site	: DDT 3m Chamber	E:\2015 Report Data\15Q0831-1\RE.EM6
Test Date	: 2015-09-24	Tested By : Toby
EUT	: Outdoor Access Point	Model Number : DCWL-79620T
Power Supply	: DC 50V from external POE adapter	Test Mode : TX Mode
Condition	: Temp:24.5°C,Humi:55%, Press:100.1kPa	Antenna/Distance : 2014 VULB 9163/3m/HORIZONTAL
Memo	:	

Data: 6

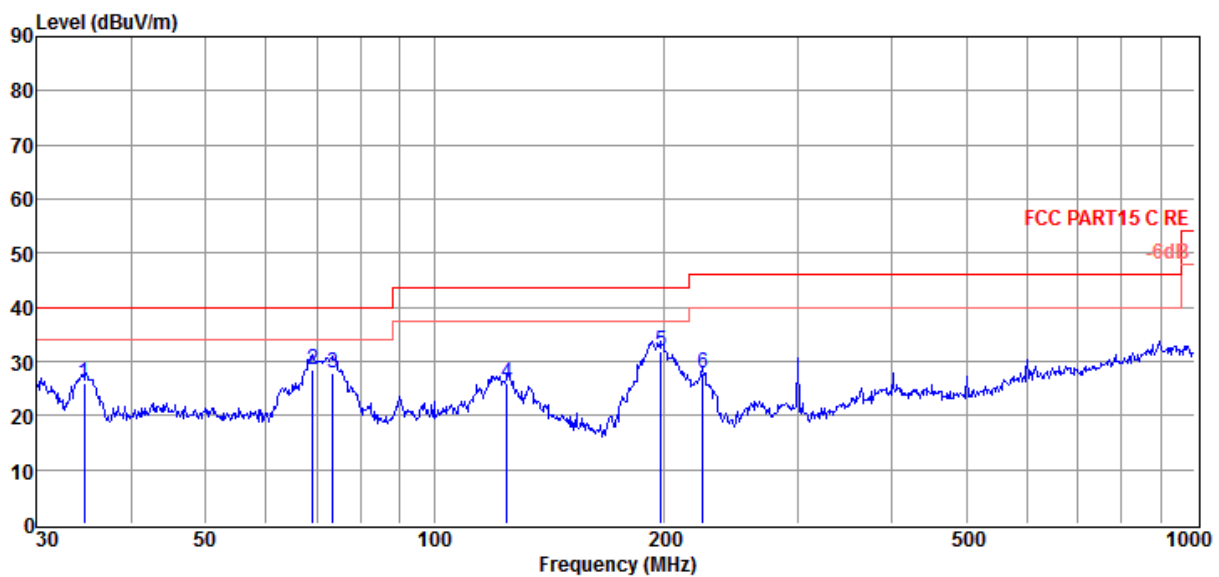

Item (Mark)	Freq (MHz)	Read Level (dBμV)	Antenna Factor (dB/m)	Cable Loss (dB)	Result Level (dBμV/m)	Limit Line (dBμV/m)	Over Limit (dB)	Detector	Polarization
1	34.64	12.71	12.30	0.94	25.95	40.00	-14.05	QP	HORIZONTAL
2	69.11	17.01	10.15	1.20	28.36	40.00	-11.64	QP	HORIZONTAL
3	73.62	19.32	7.20	1.26	27.78	40.00	-12.22	QP	HORIZONTAL
4	124.57	15.00	9.37	1.59	25.96	43.50	-17.54	QP	HORIZONTAL
5	198.59	19.82	9.80	2.15	31.77	43.50	-11.73	QP	HORIZONTAL
6	225.31	15.25	10.30	2.23	27.78	46.00	-18.22	QP	HORIZONTAL

- Note: 1. Result Level = Read Level + Antenna Factor + Cable loss.
 2. If Peak Result complies with QP limit, QP Result is deemed to comply with QP limit.
 3. Test setup: RBW: 120 kHz, VBW: 300 kHz, Sweep time: auto.

Radiated Emission test (above 1GHz)

Freq (MHz)	Read level (dB μ V)	Antenna Factor (dB/m)	PRM Factor (dB)	Cable Loss (dB)	Result Level (dB μ V/m)	Limit (dB μ V/m)	Margin (dB)	Detector type	Polarization
11b CH1									
4824.00	32.22	35.42	29.13	8.09	46.60	74.00	-27.40	Peak	HORIZONTAL
7402.00	34.02	37.35	30.03	10.04	51.38	74.00	-22.62	Peak	HORIZONTAL
13338.00	33.75	40.01	35.36	12.92	51.32	74.00	-22.68	Peak	HORIZONTAL
16502.00	35.52	43.70	36.65	13.77	56.34	74.00	-17.66	Peak	HORIZONTAL
16502.00	20.39	43.70	36.65	13.77	41.21	54.00	-12.79	Average	HORIZONTAL
4824.00	33.38	35.42	29.13	8.09	47.76	74.00	-26.24	Peak	VERTICAL
7318.00	33.79	37.30	29.88	9.99	51.20	74.00	-22.80	Peak	VERTICAL
10412.00	33.52	38.57	33.66	11.26	49.69	74.00	-24.31	Peak	VERTICAL
16292.00	35.07	43.46	36.56	13.73	55.70	74.00	-18.30	Peak	VERTICAL
16292.00	20.70	43.46	36.56	13.73	41.33	54.00	-12.67	Average	VERTICAL
11b CH6									
4874.00	32.62	35.51	29.08	8.14	47.19	74.00	-26.81	Peak	HORIZONTAL
6940.00	35.22	36.98	29.41	9.82	52.61	74.00	-21.39	Peak	HORIZONTAL
11028.00	33.48	38.90	34.08	11.75	50.05	74.00	-23.95	Peak	HORIZONTAL
15732.00	35.51	42.27	36.39	13.65	55.04	74.00	-18.96	Peak	HORIZONTAL
15732.00	21.11	42.27	36.39	13.65	40.64	54.00	-13.36	Average	HORIZONTAL
4874.00	36.47	35.51	29.08	8.14	51.04	74.00	-22.96	Peak	VERTICAL
5218.00	37.03	35.53	29.04	8.30	51.82	74.00	-22.18	Peak	VERTICAL
7178.00	34.11	37.20	29.62	9.92	51.61	74.00	-22.39	Peak	VERTICAL
16572.00	34.19	43.69	36.69	13.78	54.97	74.00	-19.03	Peak	VERTICAL
16572.00	20.49	43.69	36.69	13.78	41.27	54.00	-12.73	Average	VERTICAL
11b CH11									
4924.00	31.94	35.59	29.06	8.16	46.63	74.00	-27.37	Peak	HORIZONTAL
6940.00	33.86	36.98	29.41	9.82	51.25	74.00	-22.75	Peak	HORIZONTAL
11238.00	33.93	38.90	34.24	11.93	50.52	74.00	-23.48	Peak	HORIZONTAL
14668.00	35.55	41.83	35.84	13.34	54.88	74.00	-19.12	Peak	HORIZONTAL
14668.00	21.00	41.83	35.84	13.34	40.33	54.00	-13.67	Average	HORIZONTAL
4924.00	37.76	35.59	29.06	8.16	52.45	74.00	-21.55	Peak	VERTICAL
5162.00	38.06	35.57	29.04	8.28	52.87	74.00	-21.13	Peak	VERTICAL
6912.00	34.75	36.94	29.41	9.80	52.08	74.00	-21.92	Peak	VERTICAL
16418.00	34.85	43.60	36.62	13.75	55.58	74.00	-18.42	Peak	VERTICAL
16418.00	21.71	43.60	36.62	13.75	42.44	54.00	-11.56	Average	VERTICAL
Conclusion: Pass									
Test Date : 2015/10/19					Test Engineer: Toby				

Note: 1.30MHz~18GHz: (Scan with 11b, 11g, 11n HT20 and 11n HT40, the worst case is 11b Mode)

2. Result Level = Read Level + Antenna Factor + Cable loss - PRM Factor.

3. Test setup: RBW: 1 MHz, VBW: 3 MHz, Sweep time: auto.

9. Band Edge Compliance

9.1. Test equipment

Please refer to Section 3 this report.

9.2. Block diagram of test setup

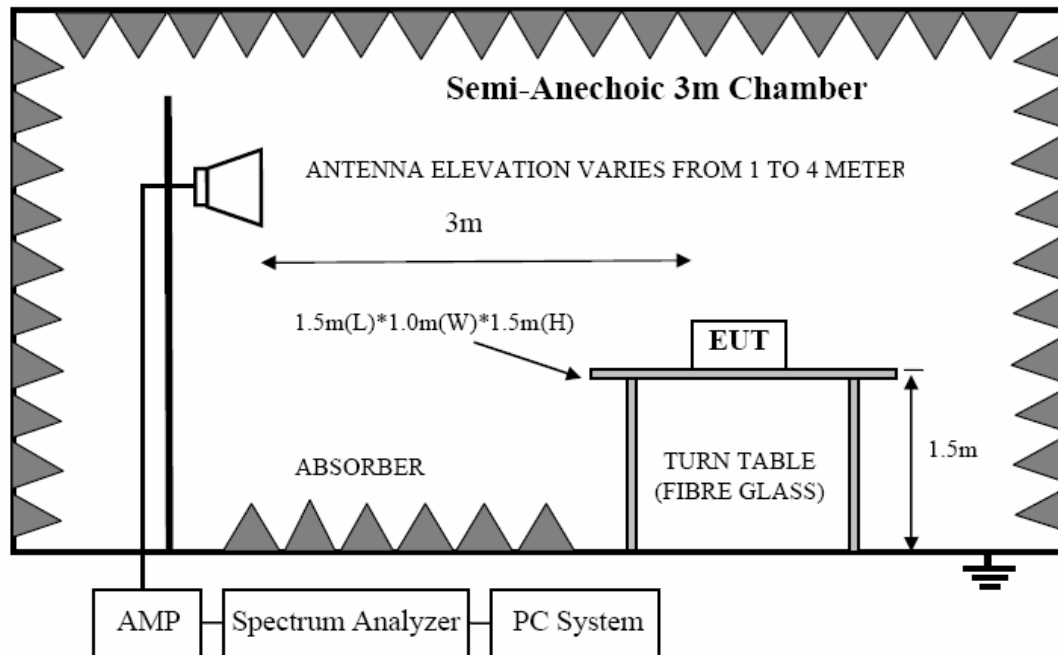

9.3. Limit

All restricted frequency bands shall not exceed the limits shown in 15.209, all the other emissions outside operation frequency band 2400MHz to 2483.5MHz shall be at least 20dB below the fundamental emissions, or comply with RSS-Gen Issue 3 clause 7.2.5 (Same as FCC 15.209) limits.

9.4. Test Procedure

Same with clause 8.4 except change investigated frequency range from 2100MHz to 2450MHz and 2450MHz to 2500MHz.

Remark: All restriction band have been tested, and only the worse case is shown in report.

9.5. Test result

PASS. (See below detailed test result)

TR-4-E-009 Radiated Emission Test Result

Test Site	: DDT 3m Chamber	E:\2015 Report Data\15Q0831-1\RE.EM6
Test Date	: 2015-10-19	Tested By : Toby
EUT	: Outdoor Access Point	Model Number : DCWL-7962OT
Power Supply	: DC 50V from external POE adapter	Test Mode : 11b CH1
Condition	: Temp:24.5°C,Humi:55%, Press:100.1kPa	Antenna/Distance : 2014 HF907/3m/HORIZONTAL
Memo	:	

Data: 15

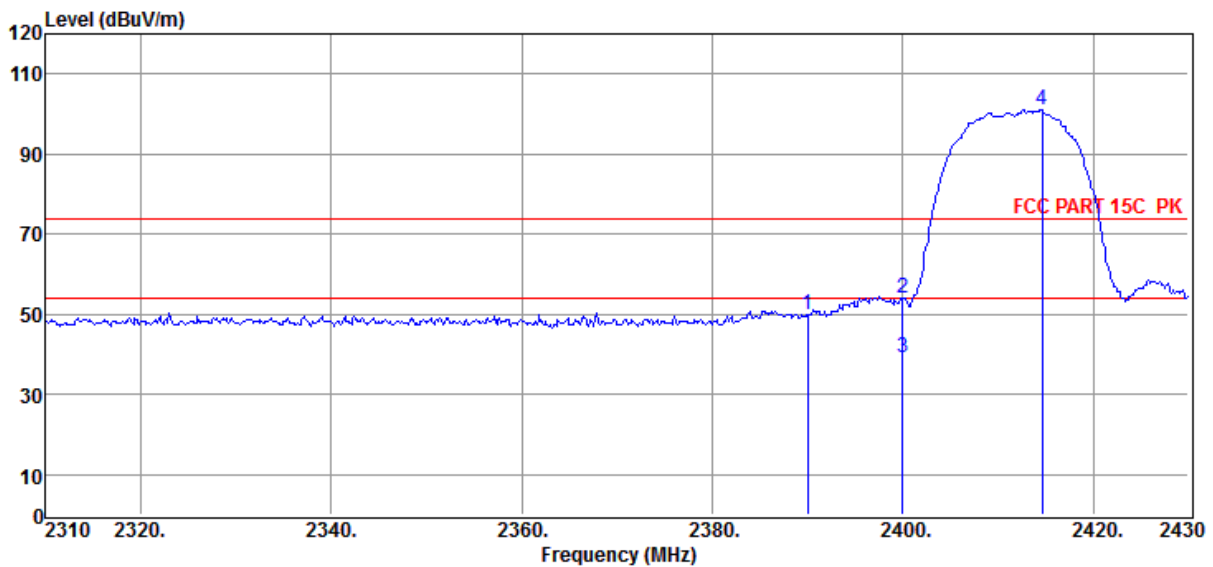

Item (Mark)	Freq (MHz)	Read Level (dBμV)	Antenna Factor (dB/m)	PRM Factor dB	Cable Loss dB	Result Level (dBμV/m)	Limit Line (dBμV/m)	Over Limit (dB)	Detector	Polarization
1	2390.04	44.92	29.99	30.21	5.17	49.87	74.00	-24.13	Peak	HORIZONTAL
2	2400.00	49.15	29.99	30.21	5.17	54.10	74.00	-19.90	Peak	HORIZONTAL
3	2400.00	34.10	29.99	30.21	5.17	39.05	54.00	-14.95	Average	HORIZONTAL
4	2414.64	96.00	30.04	30.21	5.17	101.00	74.00	27.00	Peak	HORIZONTAL

Note: 1. Result Level = Read Level + Antenna Factor + Cable loss - PRM Factor.
 2. If Peak Result complies with AV limit, AV Result is deemed to comply with AV limit.
 3. Test setup: RBW: 1 MHz, VBW: 3 MHz, Sweep time: auto.

TR-4-E-009 Radiated Emission Test Result

Test Site : DDT 3m Chamber	E:\2015 Report Data\15Q0831-1\RE.EM6
Test Date : 2015-10-19	Tested By : Toby
EUT : Outdoor Access Point	Model Number : DCWL-7962OT
Power Supply : DC 50V from external POE adapter	Test Mode : 11b CH1
Condition : Temp:24.5°C,Humi:55%, Press:100.1kPa	Antenna/Distance : 2014 HF907/3m/VERTICAL
Memo :	

Data: 16

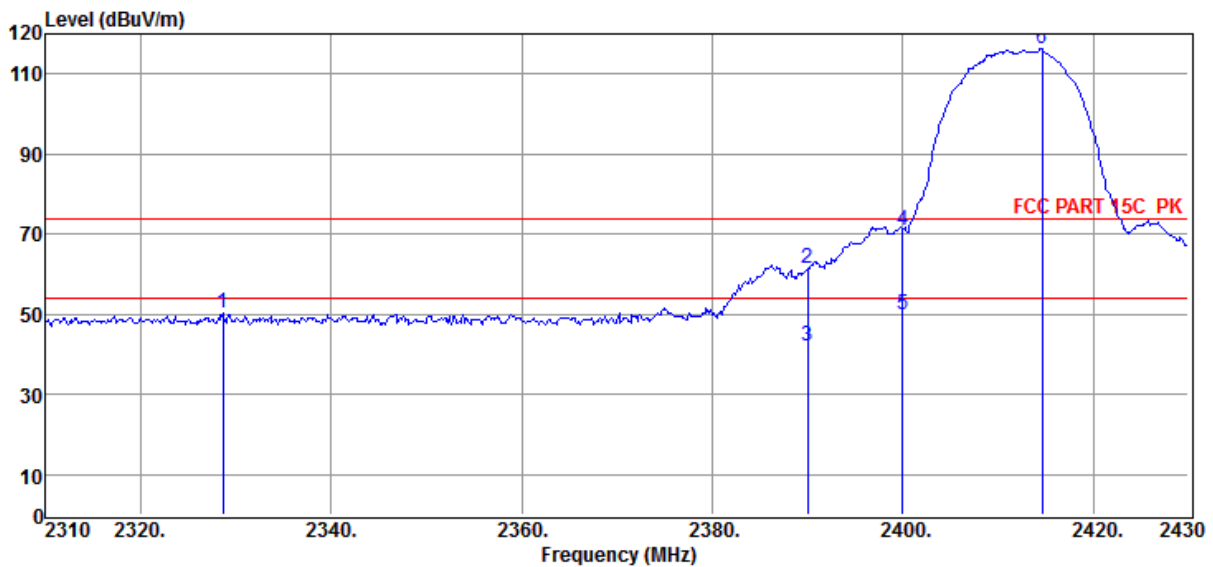

Item (Mark)	Freq (MHz)	Read Level (dBμV)	Antenna Factor (dB/m)	PRM Factor dB	Cable Loss dB	Result Level (dBμV/m)	Limit Line (dBμV/m)	Over Limit (dB)	Detector	Polarization
1	2328.60	45.83	29.78	30.18	5.06	50.49	74.00	-23.51	Peak	VERTICAL
2	2390.04	56.29	29.99	30.21	5.17	61.24	74.00	-12.76	Peak	VERTICAL
3	2390.04	37.10	29.99	30.21	5.17	42.05	54.00	-11.95	Average	VERTICAL
4	2400.00	65.81	29.99	30.21	5.17	70.76	74.00	-3.24	Peak	VERTICAL
5	2400.00	45.10	29.99	30.21	5.17	50.05	54.00	-3.95	Average	VERTICAL
6	2414.64	111.17	30.04	30.21	5.17	116.17	74.00	42.17	Peak	VERTICAL

- Note: 1. Result Level = Read Level + Antenna Factor + Cable loss - PRM Factor.
 2. If Peak Result complies with AV limit, AV Result is deemed to comply with AV limit.
 3. Test setup: RBW: 1 MHz, VBW: 3 MHz, Sweep time: auto.

TR-4-E-009 Radiated Emission Test Result

Test Site	: DDT 3m Chamber	E:\2015 Report Data\15Q0831-1\RE.EM6
Test Date	: 2015-10-19	Tested By : Toby
EUT	: Outdoor Access Point	Model Number : DCWL-7962OT
Power Supply	: DC 50V from external POE adapter	Test Mode : 11b CH11
Condition	: Temp:24.5°C,Humi:55%, Press:100.1kPa	Antenna/Distance : 2014 HF907/3m/HORIZONTAL
Memo	:	

Data: 27

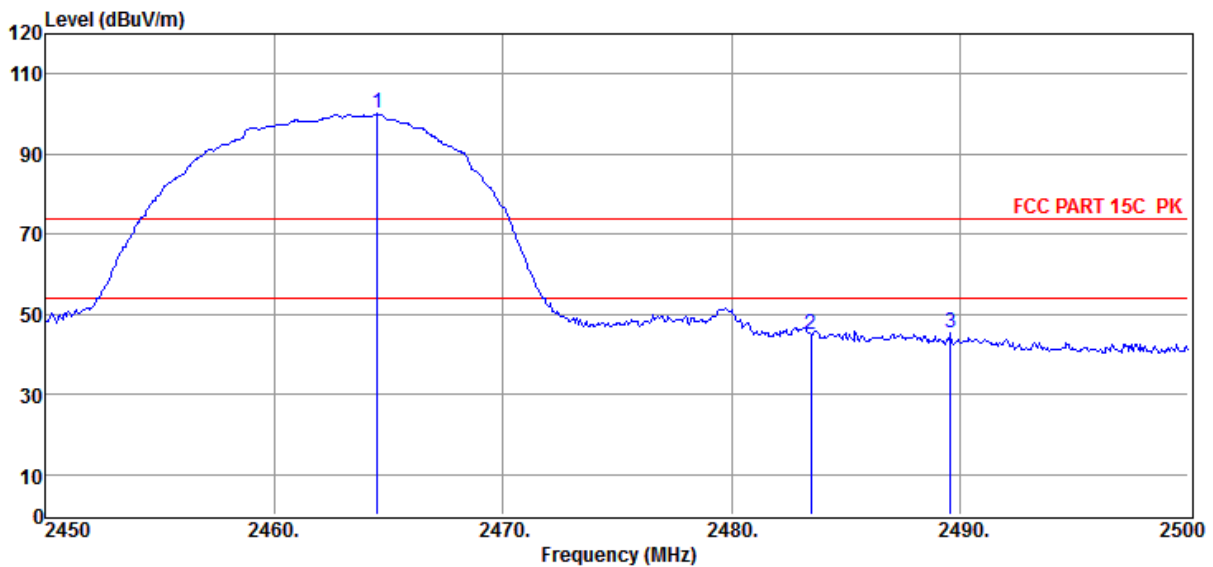

Item (Mark)	Freq (MHz)	Read Level (dBμV)	Antenna Factor (dB/m)	PRM Factor dB	Cable Loss dB	Result Level (dBμV/m)	Limit Line (dBμV/m)	Over Limit (dB)	Detector	Polarization
1	2464.50	94.74	30.20	30.25	5.31	100.00	74.00	26.00	Peak	HORIZONTAL
2	2483.50	39.56	30.25	30.25	5.31	44.87	74.00	-29.13	Peak	HORIZONTAL
3	2489.60	40.17	30.30	30.25	5.31	45.53	74.00	-28.47	Peak	HORIZONTAL

- Note: 1. Result Level = Read Level + Antenna Factor + Cable loss - PRM Factor.
 2. If Peak Result complies with AV limit, AV Result is deemed to comply with AV limit.
 3. Test setup: RBW: 1 MHz, VBW: 3 MHz, Sweep time: auto.

TR-4-E-009 Radiated Emission Test Result

Test Site : DDT 3m Chamber	E:\2015 Report Data\15Q0831-1\RE.EM6
Test Date : 2015-10-19	Tested By : Toby
EUT : Outdoor Access Point	Model Number : DCWL-7962OT
Power Supply : DC 50V from external POE adapter	Test Mode : 11b CH11
Condition : Temp:24.5°C,Humi:55%, Press:100.1kPa	Antenna/Distance : 2014 HF907/3m/VERTICAL
Memo :	

Data: 28

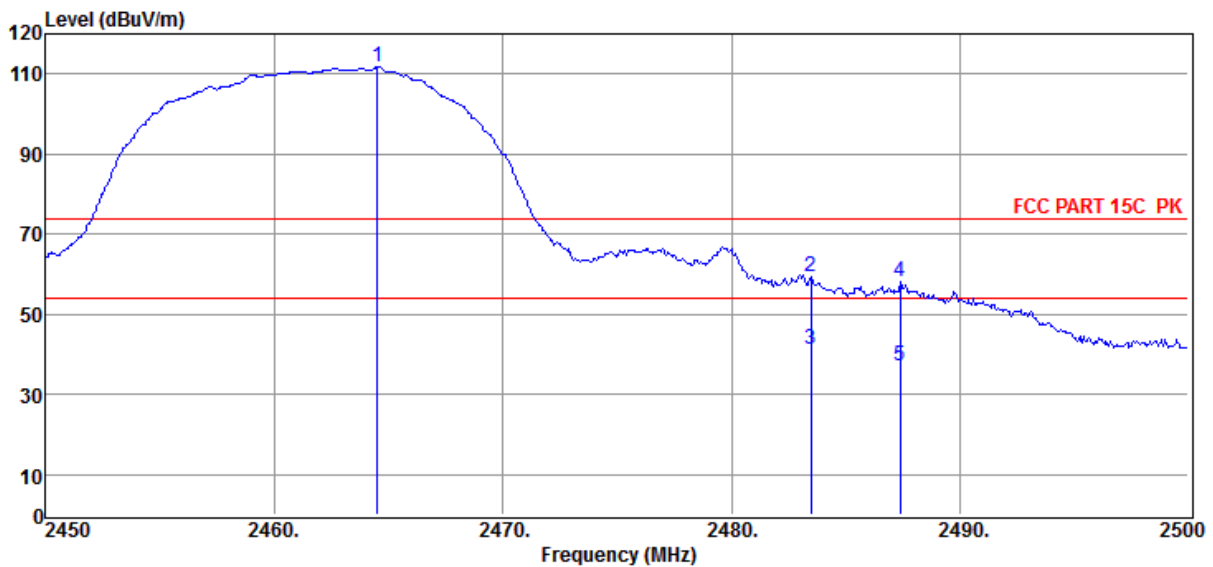

Item (Mark)	Freq (MHz)	Read Level (dBμV)	Antenna Factor (dB/m)	PRM Factor dB	Cable Loss dB	Result Level (dBμV/m)	Limit Line (dBμV/m)	Over Limit (dB)	Detector	Polarization
1	2464.50	106.44	30.20	30.25	5.31	111.70	74.00	37.70	Peak	VERTICAL
2	2483.50	53.87	30.25	30.25	5.31	59.18	74.00	-14.82	Peak	VERTICAL
3	2483.50	36.10	30.25	30.25	5.31	41.41	54.00	-12.59	Average	VERTICAL
4	2487.40	52.70	30.25	30.25	5.31	58.01	74.00	-15.99	Peak	VERTICAL
5	2487.40	31.90	30.25	30.25	5.31	37.21	54.00	-16.79	Average	VERTICAL

- Note: 1. Result Level = Read Level + Antenna Factor + Cable loss - PRM Factor.
 2. If Peak Result complies with AV limit, AV Result is deemed to comply with AV limit.
 3. Test setup: RBW: 1 MHz, VBW: 3 MHz, Sweep time: auto.

TR-4-E-009 Radiated Emission Test Result

Test Site : DDT 3m Chamber	E:\2015 Report Data\15Q0831-1\RE.EM6
Test Date : 2015-10-19	Tested By : Toby
EUT : Outdoor Access Point	Model Number : DCWL-7962OT
Power Supply : DC 50V from external POE adapter	Test Mode : 11b CH1
Condition : Temp:24.5°C,Humi:55%, Press:100.1kPa	Antenna/Distance : 2014 HF907/3m/HORIZONTAL
Memo :	

Data: 31

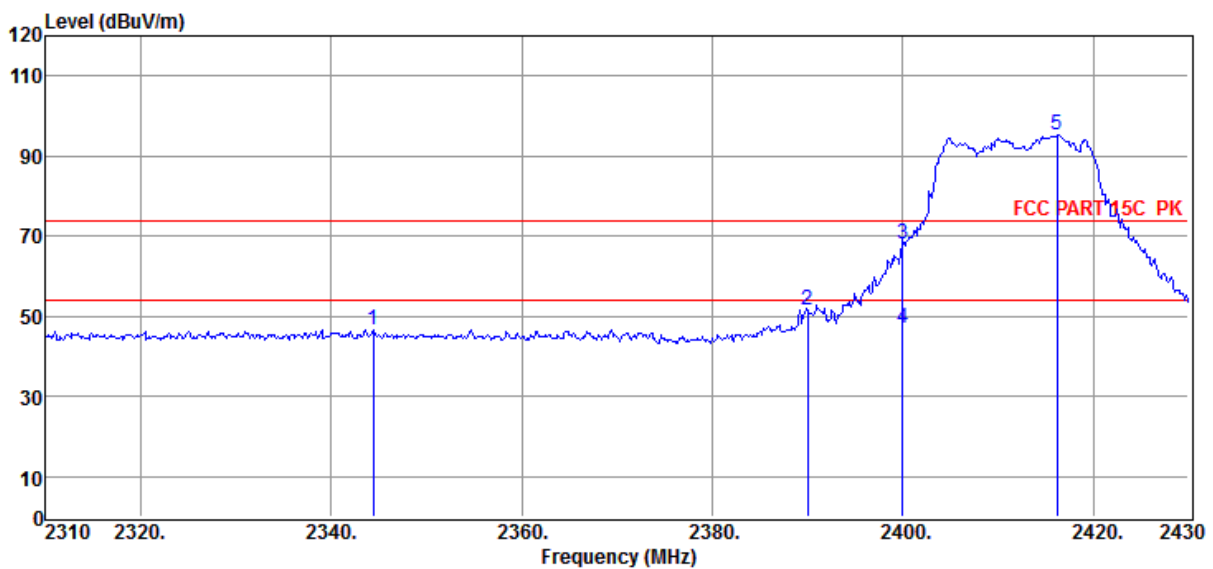

Item (Mark)	Freq (MHz)	Read Level (dBμV)	Antenna Factor (dB/m)	PRM Factor dB	Cable Loss dB	Result Level (dBμV/m)	Limit Line (dBμV/m)	Over Limit (dB)	Detector	Polarization
1	2344.44	41.93	29.83	30.19	5.11	46.68	74.00	-27.32	Peak	HORIZONTAL
2	2390.00	46.64	29.99	30.21	5.17	51.59	74.00	-22.41	Peak	HORIZONTAL
3	2400.00	63.19	29.99	30.21	5.17	68.14	74.00	-5.86	Peak	HORIZONTAL
4	2400.00	42.10	29.99	30.21	5.17	47.05	54.00	-6.95	Average	HORIZONTAL
5	2416.20	90.11	30.04	30.23	5.24	95.16	74.00	21.16	Peak	HORIZONTAL

- Note: 1. Result Level = Read Level + Antenna Factor + Cable loss - PRM Factor.
 2. If Peak Result complies with AV limit, AV Result is deemed to comply with AV limit.
 3. Test setup: RBW: 1 MHz, VBW: 3 MHz, Sweep time: auto.

TR-4-E-009 Radiated Emission Test Result

Test Site : DDT 3m Chamber	E:\2015 Report Data\15Q0831-1\RE.EM6
Test Date : 2015-10-19	Tested By : Toby
EUT : Outdoor Access Point	Model Number : DCWL-7962OT
Power Supply : DC 50V from external POE adapter	Test Mode : 11b CH1
Condition : Temp:24.5°C,Humi:55%, Press:100.1kPa	Antenna/Distance : 2014 HF907/3m/VERTICAL
Memo :	

Data: 32

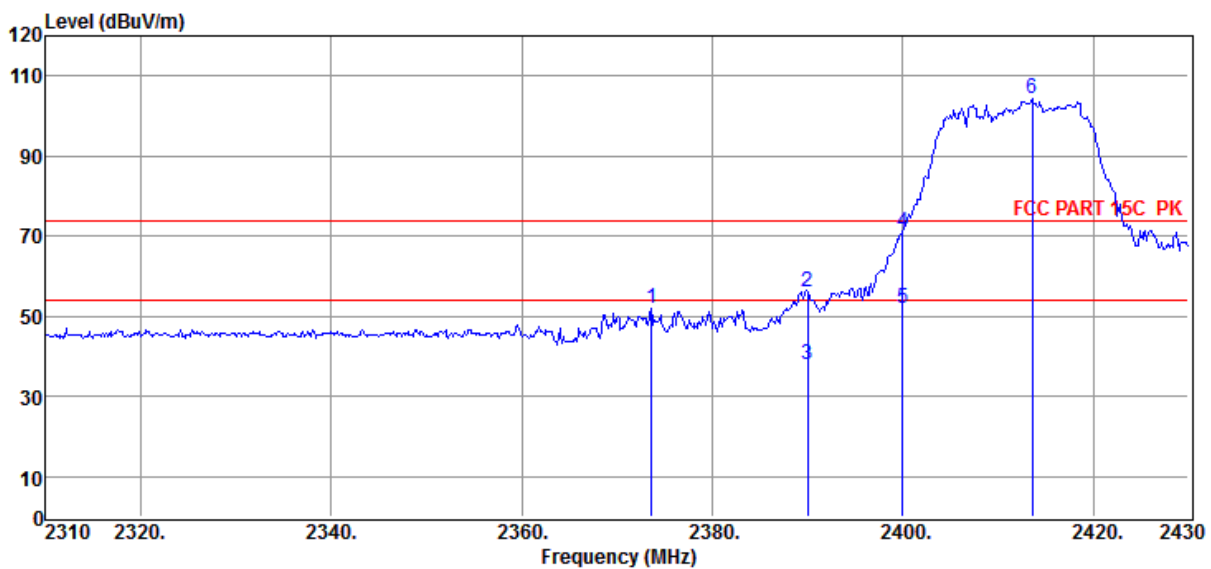

Item (Mark)	Freq (MHz)	Read Level (dBμV)	Antenna Factor (dB/m)	PRM Factor dB	Cable Loss dB	Result Level (dBμV/m)	Limit Line (dBμV/m)	Over Limit (dB)	Detector	Polarization
1	2373.60	47.02	29.94	30.19	5.11	51.88	74.00	-22.12	Peak	VERTICAL
2	2390.04	51.24	29.99	30.21	5.17	56.19	74.00	-17.81	Peak	VERTICAL
3	2390.04	32.90	29.99	30.21	5.17	37.85	54.00	-16.15	Average	VERTICAL
4	2400.00	65.86	29.99	30.21	5.17	70.81	74.00	-3.19	Peak	VERTICAL
5	2400.00	46.90	29.99	30.21	5.17	51.85	54.00	-2.15	Average	VERTICAL
6	2413.56	99.49	30.04	30.21	5.17	104.49	74.00	30.49	Peak	VERTICAL

- Note: 1. Result Level = Read Level + Antenna Factor + Cable loss - PRM Factor.
 2. If Peak Result complies with AV limit, AV Result is deemed to comply with AV limit.
 3. Test setup: RBW: 1 MHz, VBW: 3 MHz, Sweep time: auto.

TR-4-E-009 Radiated Emission Test Result

Test Site	: DDT 3m Chamber	E:	:\2015 Report Data\15Q0831-1\RE.EM6
Test Date	: 2015-10-19	Tested By	: Toby
EUT	: Outdoor Access Point	Model Number	: DCWL-7962OT
Power Supply	: DC 50V from external POE adapter	Test Mode	: 11b CH11
Condition	: Temp:24.5°C,Humi:55%, Press:100.1kPa	Antenna/Distance	: 2014 HF907/3m/VERTICAL
Memo	:		

Data: 41

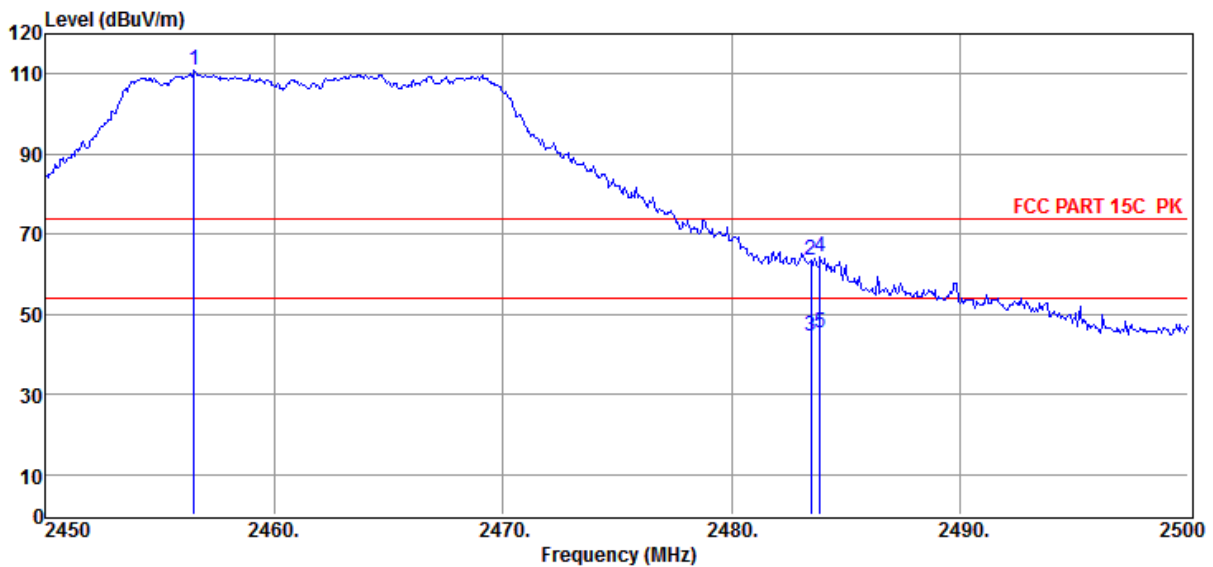

Item (Mark)	Freq (MHz)	Read Level (dBμV)	Antenna Factor (dB/m)	PRM Factor dB	Cable Loss dB	Result Level (dBμV/m)	Limit Line (dBμV/m)	Over Limit (dB)	Detector	Polarization
1	2456.50	105.55	30.20	30.25	5.31	110.81	74.00	36.81	Peak	VERTICAL
2	2483.50	58.09	30.25	30.25	5.31	63.40	74.00	-10.60	Peak	VERTICAL
3	2483.50	39.10	30.25	30.25	5.31	44.41	54.00	-9.59	Average	VERTICAL
4	2483.90	59.10	30.25	30.25	5.31	64.41	74.00	-9.59	Peak	VERTICAL
5	2483.90	39.90	30.25	30.25	5.31	45.21	54.00	-8.79	Average	VERTICAL

- Note: 1. Result Level = Read Level + Antenna Factor + Cable loss - PRM Factor.
 2. If Peak Result complies with AV limit, AV Result is deemed to comply with AV limit.
 3. Test setup: RBW: 1 MHz, VBW: 3 MHz, Sweep time: auto.

TR-4-E-009 Radiated Emission Test Result

Test Site	: DDT 3m Chamber	E:\2015 Report Data\15Q0831-1\RE.EM6
Test Date	: 2015-10-19	Tested By : Toby
EUT	: Outdoor Access Point	Model Number : DCWL-7962OT
Power Supply	: DC 50V from external POE adapter	Test Mode : 11b CH11
Condition	: Temp:24.5°C,Humi:55%, Press:100.1kPa	Antenna/Distance : 2014 HF907/3m/HORIZONTAL
Memo	:	

Data: 42

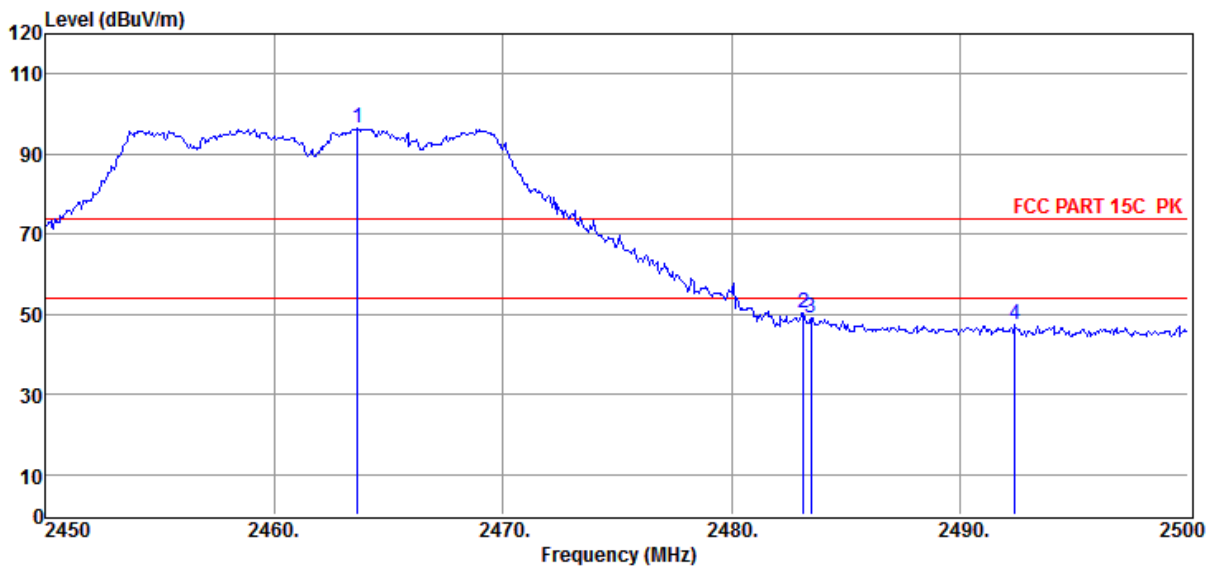

Item (Mark)	Freq (MHz)	Read Level (dBμV)	Antenna Factor (dB/m)	PRM Factor dB	Cable Loss dB	Result Level (dBμV/m)	Limit Line (dBμV/m)	Over Limit (dB)	Detector	Polarization
1	2463.65	91.15	30.20	30.25	5.31	96.41	74.00	22.41	Peak	HORIZONTAL
2	2483.15	45.10	30.25	30.25	5.31	50.41	74.00	-23.59	Peak	HORIZONTAL
3	2483.50	43.83	30.25	30.25	5.31	49.14	74.00	-24.86	Peak	HORIZONTAL
4	2492.40	41.88	30.30	30.25	5.31	47.24	74.00	-26.76	Peak	HORIZONTAL

Note: 1. Result Level = Read Level + Antenna Factor + Cable loss - PRM Factor.
 2. If Peak Result complies with AV limit, AV Result is deemed to comply with AV limit.
 3. Test setup: RBW: 1 MHz, VBW: 3 MHz, Sweep time: auto.

TR-4-E-009 Radiated Emission Test Result

Test Site	: DDT 3m Chamber	E:\2015 Report Data\15Q0831-1\RE.EM6
Test Date	: 2015-10-19	Tested By : Toby
EUT	: Outdoor Access Point	Model Number : DCWL-7962OT
Power Supply	: DC 50V from external POE adapter	Test Mode : 11n HT20 CH1
Condition	: Temp:24.5°C,Humi:55%, Press:100.1kPa	Antenna/Distance : 2014 HF907/3m/VERTICAL
Memo	:	

Data: 49

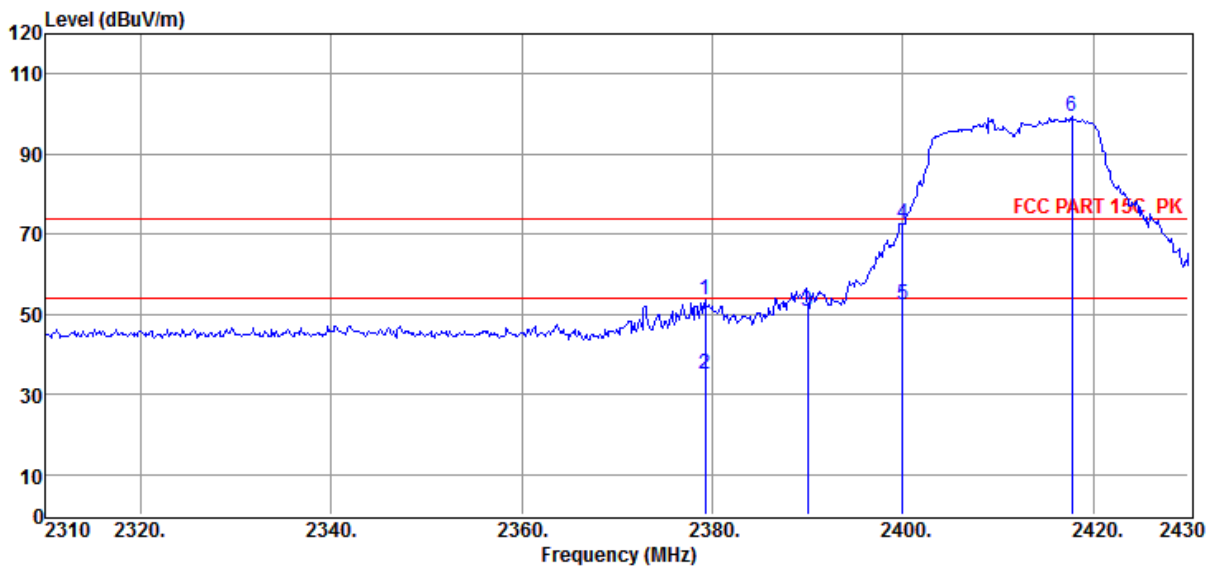

Item (Mark)	Freq (MHz)	Read Level (dBμV)	Antenna Factor (dB/m)	PRM Factor dB	Cable Loss dB	Result Level (dBμV/m)	Limit Line (dBμV/m)	Over Limit (dB)	Detector	Polarization
1	2379.24	48.84	29.94	30.21	5.17	53.74	74.00	-20.26	Peak	VERTICAL
2	2379.24	30.10	29.94	30.21	5.17	35.00	54.00	-19.00	Average	VERTICAL
3	2390.04	45.91	29.99	30.21	5.17	50.86	74.00	-23.14	Peak	VERTICAL
4	2400.00	67.50	29.99	30.21	5.17	72.45	74.00	-1.55	Peak	VERTICAL
5	2400.00	47.60	29.99	30.21	5.17	52.55	54.00	-1.45	Average	VERTICAL
6	2417.76	94.14	30.04	30.23	5.24	99.19	74.00	25.19	Peak	VERTICAL

- Note: 1. Result Level = Read Level + Antenna Factor + Cable loss - PRM Factor.
 2. If Peak Result complies with AV limit, AV Result is deemed to comply with AV limit.
 3. Test setup: RBW: 1 MHz, VBW: 3 MHz, Sweep time: auto.

TR-4-E-009 Radiated Emission Test Result

Test Site : DDT 3m Chamber	E:\2015 Report Data\15Q0831-1\RE.EM6
Test Date : 2015-10-19	Tested By : Toby
EUT : Outdoor Access Point	Model Number : DCWL-7962OT
Power Supply : DC 50V from external POE adapter	Test Mode : 11n HT20 CH1
Condition : Temp:24.5°C,Humi:55%, Press:100.1kPa	Antenna/Distance : 2014 HF907/3m/HORIZONTAL
Memo :	

Data: 50

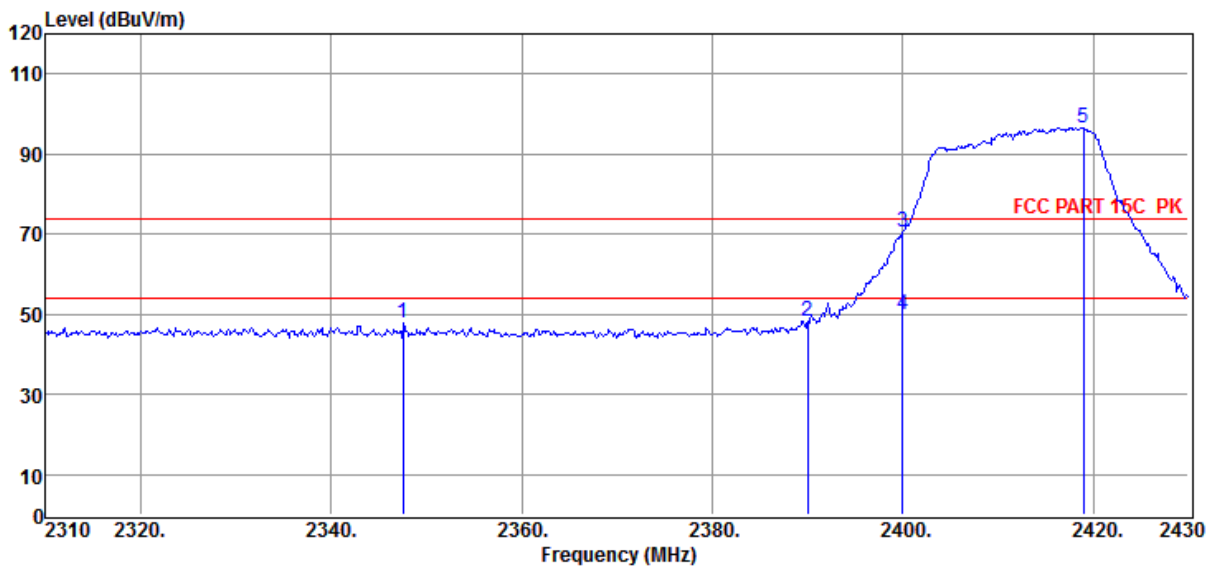

Item (Mark)	Freq (MHz)	Read Level (dBμV)	Antenna Factor (dB/m)	PRM Factor (dB)	Cable Loss (dB)	Result Level (dBμV/m)	Limit Line (dBμV/m)	Over Limit (dB)	Detector	Polarization
1	2347.56	42.90	29.83	30.19	5.11	47.65	74.00	-26.35	Peak	HORIZONTAL
2	2390.00	43.43	29.99	30.21	5.17	48.38	74.00	-25.62	Peak	HORIZONTAL
3	2400.00	65.55	29.99	30.21	5.17	70.50	74.00	-3.50	Peak	HORIZONTAL
4	2400.00	45.10	29.99	30.21	5.17	50.05	54.00	-3.95	Average	HORIZONTAL
5	2418.96	91.61	30.04	30.23	5.24	96.66	74.00	22.66	Peak	HORIZONTAL

Note: 1. Result Level = Read Level + Antenna Factor + Cable loss - PRM Factor.
 2. If Peak Result complies with AV limit, AV Result is deemed to comply with AV limit.
 3. Test setup: RBW: 1 MHz, VBW: 3 MHz, Sweep time: auto.

TR-4-E-009 Radiated Emission Test Result

Test Site	: DDT 3m Chamber	E:\2015 Report Data\15Q0831-1\RE.EM6
Test Date	: 2015-10-19	Tested By : Toby
EUT	: Outdoor Access Point	Model Number : DCWL-7962OT
Power Supply	: DC 50V from external POE adapter	Test Mode : 11n HT20 CH11
Condition	: Temp:24.5°C,Humi:55%, Press:100.1kPa	Antenna/Distance : 2014 HF907/3m/HORIZONTAL
Memo	:	

Data: 59

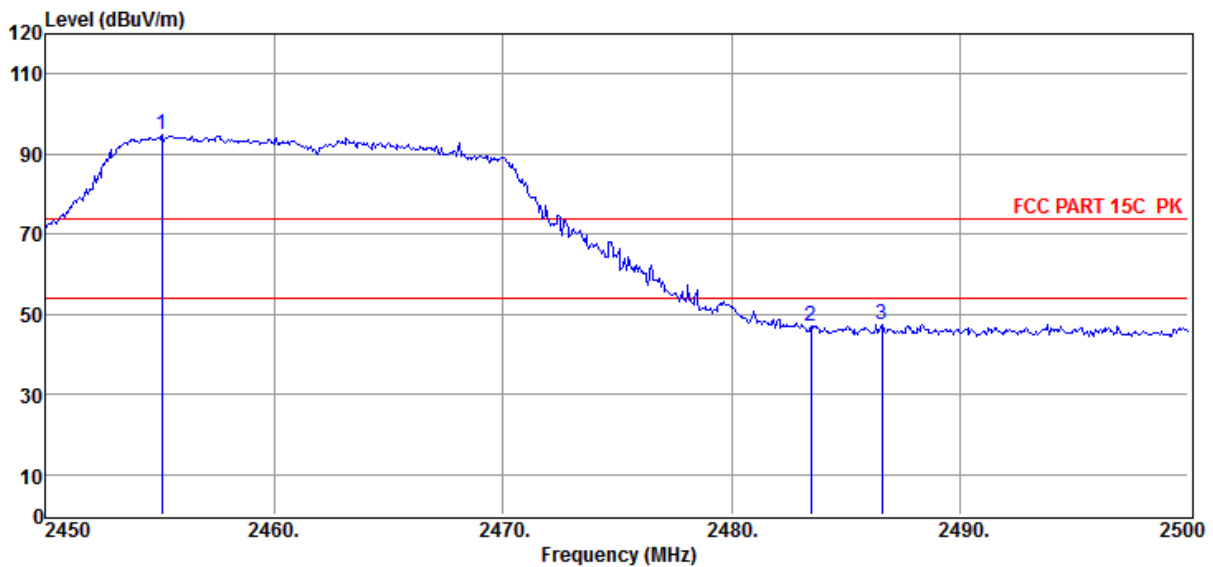

Item (Mark)	Freq (MHz)	Read Level (dBμV)	Antenna Factor (dB/m)	PRM Factor dB	Cable Loss dB	Result Level (dBμV/m)	Limit Line (dBμV/m)	Over Limit (dB)	Detector	Polarization
1	2455.10	89.61	30.20	30.23	5.24	94.82	74.00	20.82	Peak	HORIZONTAL
2	2483.50	41.66	30.25	30.25	5.31	46.97	74.00	-27.03	Peak	HORIZONTAL
3	2486.60	42.24	30.25	30.25	5.31	47.55	74.00	-26.45	Peak	HORIZONTAL

- Note: 1. Result Level = Read Level + Antenna Factor + Cable loss - PRM Factor.
 2. If Peak Result complies with AV limit, AV Result is deemed to comply with AV limit.
 3. Test setup: RBW: 1 MHz, VBW: 3 MHz, Sweep time: auto.

TR-4-E-009 Radiated Emission Test Result

Test Site	: DDT 3m Chamber	E:\2015 Report Data\15Q0831-1\RE.EM6
Test Date	: 2015-10-19	Tested By : Toby
EUT	: Outdoor Access Point	Model Number : DCWL-7962OT
Power Supply	: DC 50V from external POE adapter	Test Mode : 11n HT20 CH11
Condition	: Temp:24.5°C,Humi:55%, Press:100.1kPa	Antenna/Distance : 2014 HF907/3m/VERTICAL
Memo	:	

Data: 60

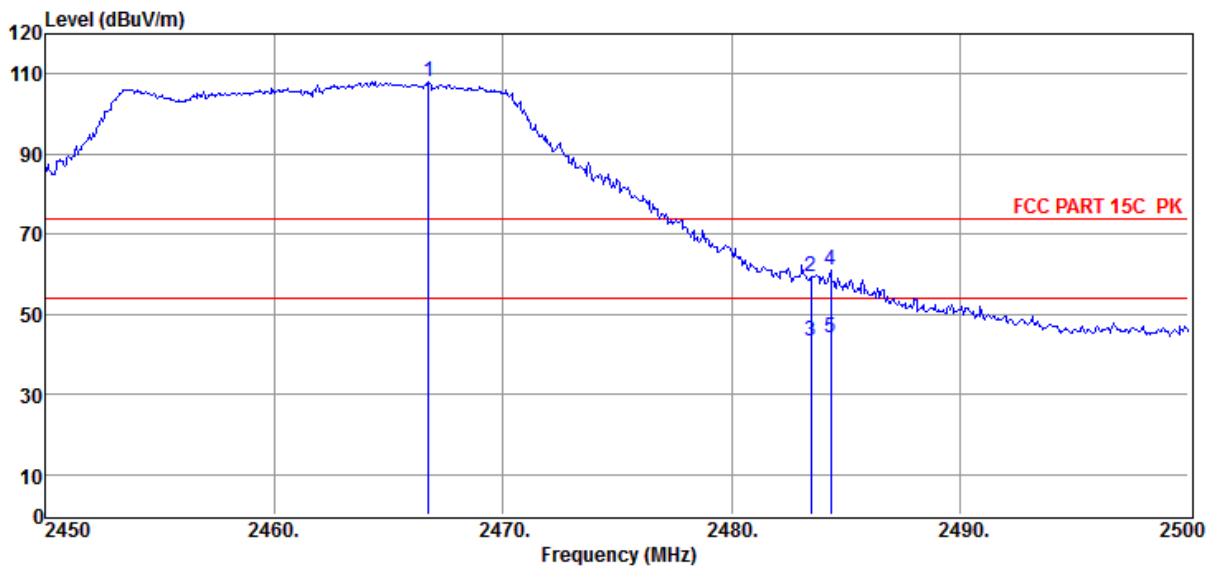

Item (Mark)	Freq (MHz)	Read Level (dBμV)	Antenna Factor (dB/m)	PRM Factor dB	Cable Loss dB	Result Level (dBμV/m)	Limit Line (dBμV/m)	Over Limit (dB)	Detector	Polarization
1	2466.75	102.89	30.20	30.25	5.31	108.15	74.00	34.15	Peak	VERTICAL
2	2483.50	53.98	30.25	30.25	5.31	59.29	74.00	-14.71	Peak	VERTICAL
3	2483.50	38.10	30.25	30.25	5.31	43.41	54.00	-10.59	Average	VERTICAL
4	2484.35	55.63	30.25	30.25	5.31	60.94	74.00	-13.06	Peak	VERTICAL
5	2484.35	38.90	30.25	30.25	5.31	44.21	54.00	-9.79	Average	VERTICAL

- Note: 1. Result Level = Read Level + Antenna Factor + Cable loss - PRM Factor.
 2. If Peak Result complies with AV limit, AV Result is deemed to comply with AV limit.
 3. Test setup: RBW: 1 MHz, VBW: 3 MHz, Sweep time: auto.

TR-4-E-009 Radiated Emission Test Result

Test Site : DDT 3m Chamber	E:\2015 Report Data\15Q0831-1\RE.EM6
Test Date : 2015-10-19	Tested By : Toby
EUT : Outdoor Access Point	Model Number : DCWL-7962OT
Power Supply : DC 50V from external POE adapter	Test Mode : 11n HT40 CH3
Condition : Temp:24.5°C,Humi:55%, Press:100.1kPa	Antenna/Distance : 2014 HF907/3m/HORIZONTAL
Memo :	

Data: 63

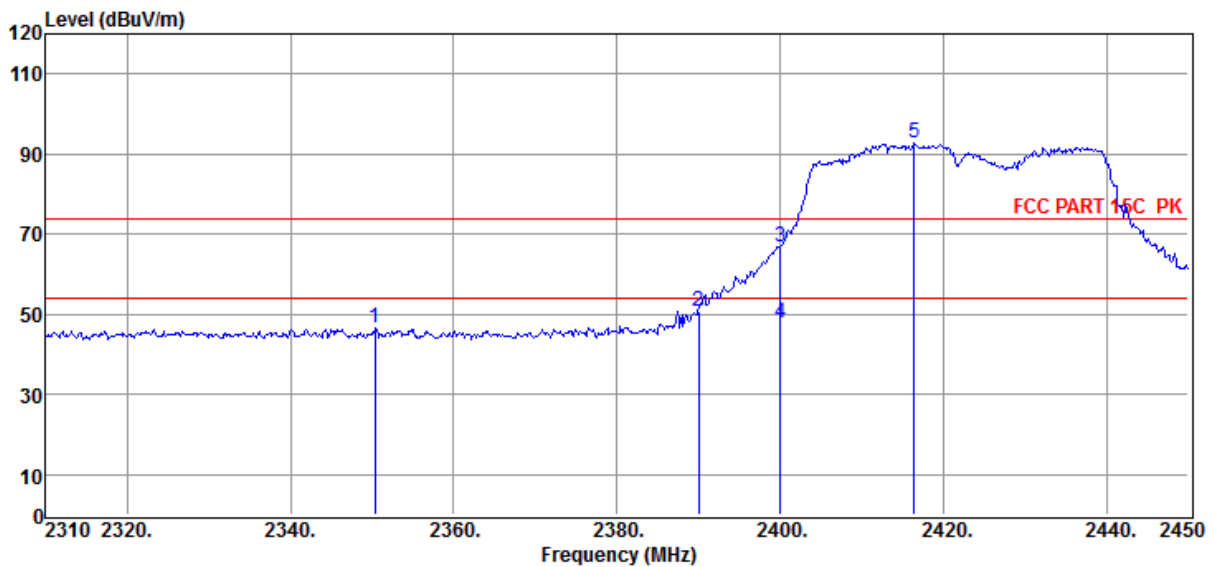

Item (Mark)	Freq (MHz)	Read Level (dBμV)	Antenna Factor (dB/m)	PRM Factor dB	Cable Loss dB	Result Level (dBμV/m)	Limit Line (dBμV/m)	Over Limit (dB)	Detector	Polarization
1	2350.32	41.99	29.83	30.19	5.11	46.74	74.00	-27.26	Peak	HORIZONTAL
2	2390.00	45.87	29.99	30.21	5.17	50.82	74.00	-23.18	Peak	HORIZONTAL
3	2400.00	61.68	29.99	30.21	5.17	66.63	74.00	-7.37	Peak	HORIZONTAL
4	2400.00	42.80	29.99	30.21	5.17	47.75	54.00	-6.25	Average	HORIZONTAL
5	2416.40	87.93	30.04	30.23	5.24	92.98	74.00	18.98	Peak	HORIZONTAL

Note: 1. Result Level = Read Level + Antenna Factor + Cable loss - PRM Factor.
 2. If Peak Result complies with AV limit, AV Result is deemed to comply with AV limit.
 3. Test setup: RBW: 1 MHz, VBW: 3 MHz, Sweep time: auto.

TR-4-E-009 Radiated Emission Test Result

Test Site	: DDT 3m Chamber	E:\2015 Report Data\15Q0831-1\RE.EM6
Test Date	: 2015-10-19	Tested By : Toby
EUT	: Outdoor Access Point	Model Number : DCWL-7962OT
Power Supply	: DC 50V from external POE adapter	Test Mode : 11n HT40 CH3
Condition	: Temp:24.5°C,Humi:55%, Press:100.1kPa	Antenna/Distance : 2014 HF907/3m/VERTICAL
Memo	:	

Data: 64

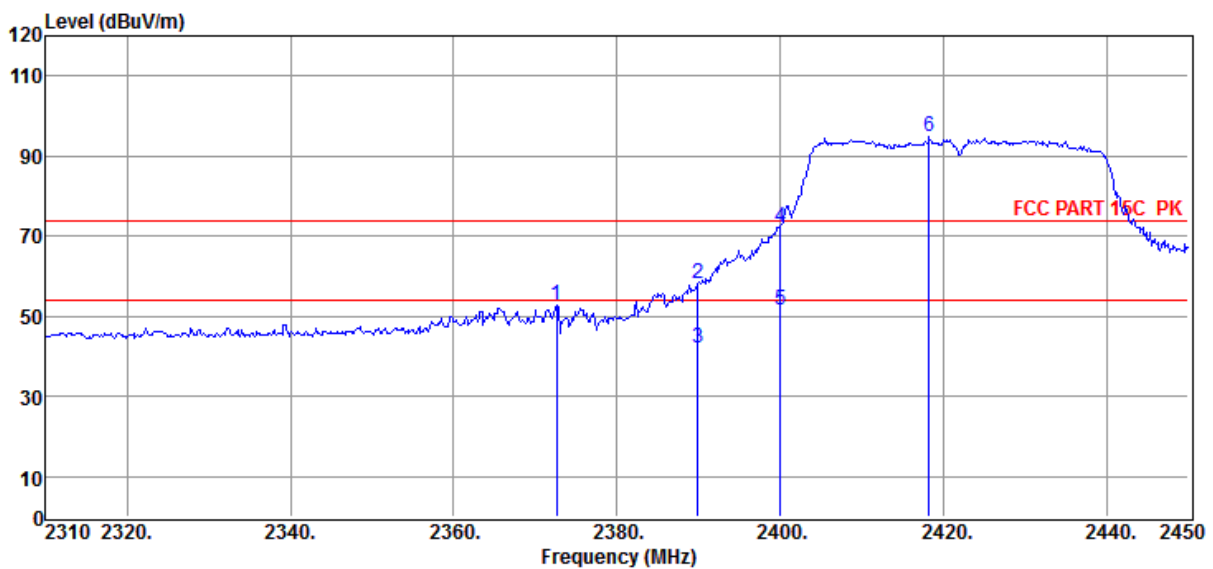

Item (Mark)	Freq (MHz)	Read Level (dBμV)	Antenna Factor (dB/m)	PRM Factor dB	Cable Loss dB	Result Level (dBμV/m)	Limit Line (dBμV/m)	Over Limit (dB)	Detector	Polarization
1	2372.58	48.08	29.94	30.19	5.11	52.94	74.00	-21.06	Peak	VERTICAL
2	2389.94	53.14	29.99	30.21	5.17	58.09	74.00	-15.91	Peak	VERTICAL
3	2389.94	37.10	29.99	30.21	5.17	42.05	54.00	-11.95	Average	VERTICAL
4	2400.00	67.30	29.99	30.21	5.17	72.25	74.00	-1.75	Peak	VERTICAL
5	2400.00	46.50	29.99	30.21	5.17	51.45	54.00	-2.55	Average	VERTICAL
6	2418.22	89.77	30.04	30.23	5.24	94.82	74.00	20.82	Peak	VERTICAL

- Note: 1. Result Level = Read Level + Antenna Factor + Cable loss - PRM Factor.
 2. If Peak Result complies with AV limit, AV Result is deemed to comply with AV limit.
 3. Test setup: RBW: 1 MHz, VBW: 3 MHz, Sweep time: auto.

TR-4-E-009 Radiated Emission Test Result

Test Site	: DDT 3m Chamber	E:	:\2015 Report Data\15Q0831-1\RE.EM6
Test Date	: 2015-10-19	Tested By	: Toby
EUT	: Outdoor Access Point	Model Number	: DCWL-7962OT
Power Supply	: DC 50V from external POE adapter	Test Mode	: 11n HT40 CH9
Condition	: Temp:24.5°C,Humi:55%, Press:100.1kPa	Antenna/Distance	: 2014 HF907/3m/VERTICAL
Memo	:		

Data: 73

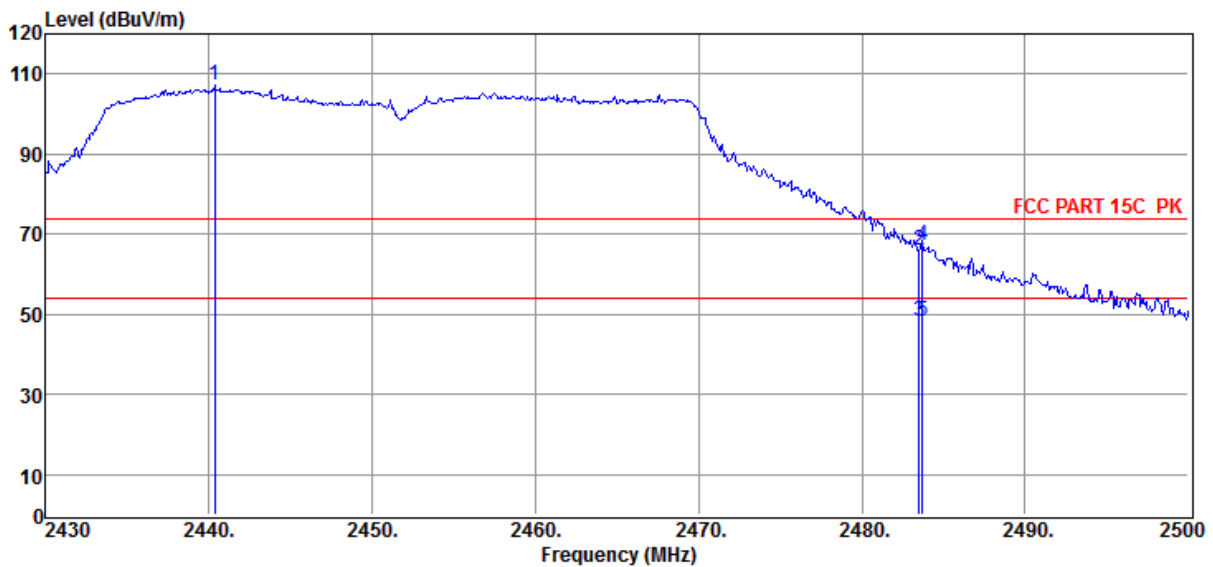

Item (Mark)	Freq (MHz)	Read Level (dBμV)	Antenna Factor (dB/m)	PRM Factor dB	Cable Loss dB	Result Level (dBμV/m)	Limit Line (dBμV/m)	Over Limit (dB)	Detector	Polarization
1	2440.36	101.92	30.14	30.23	5.24	107.07	74.00	33.07	Peak	VERTICAL
2	2483.50	60.87	30.25	30.25	5.31	66.18	74.00	-7.82	Peak	VERTICAL
3	2483.50	43.10	30.25	30.25	5.31	48.41	54.00	-5.59	Average	VERTICAL
4	2483.69	62.05	30.25	30.25	5.31	67.36	74.00	-6.64	Peak	VERTICAL
5	2483.69	42.90	30.25	30.25	5.31	48.21	54.00	-5.79	Average	VERTICAL

- Note: 1. Result Level = Read Level + Antenna Factor + Cable loss - PRM Factor.
 2. If Peak Result complies with AV limit, AV Result is deemed to comply with AV limit.
 3. Test setup: RBW: 1 MHz, VBW: 3 MHz, Sweep time: auto.

TR-4-E-009 Radiated Emission Test Result

Test Site	: DDT 3m Chamber	E:\2015 Report Data\15Q0831-1\RE.EM6
Test Date	: 2015-10-19	Tested By : Toby
EUT	: Outdoor Access Point	Model Number : DCWL-7962OT
Power Supply	: DC 50V from external POE adapter	Test Mode : 11n HT40 CH9
Condition	: Temp:24.5°C,Humi:55%, Press:100.1kPa	Antenna/Distance : 2014 HF907/3m/HORIZONTAL
Memo	:	

Data: 74

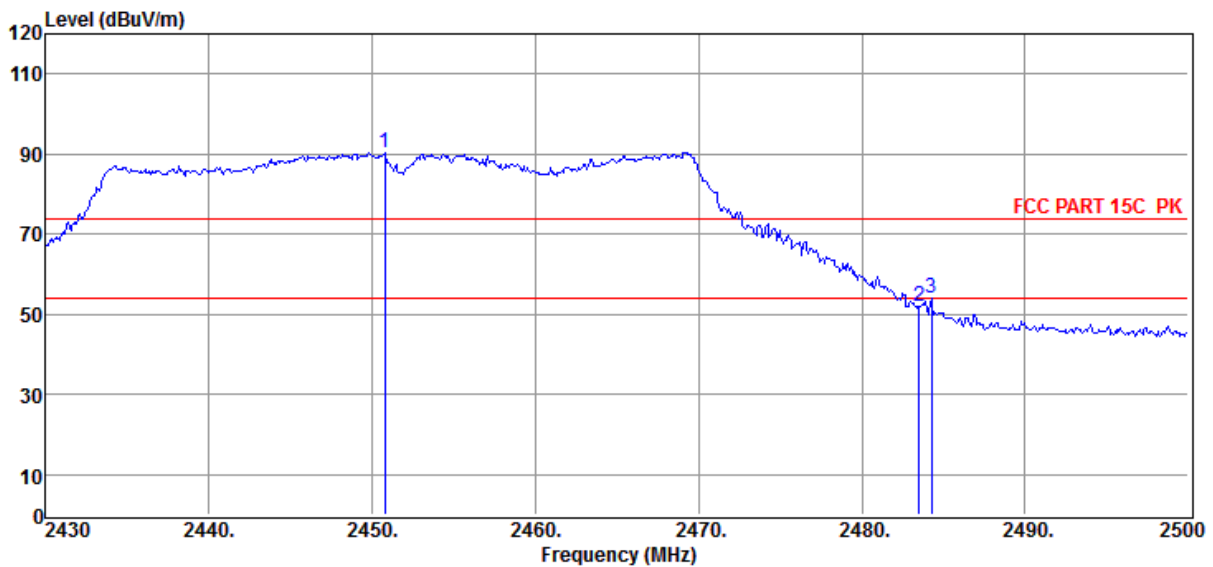

Item (Mark)	Freq (MHz)	Read Level (dBμV)	Antenna Factor (dB/m)	PRM Factor dB	Cable Loss dB	Result Level (dBμV/m)	Limit Line (dBμV/m)	Over Limit (dB)	Detector	Polarization
1	2450.79	85.22	30.14	30.23	5.24	90.37	74.00	16.37	Peak	HORIZONTAL
2	2483.48	46.58	30.25	30.25	5.31	51.89	74.00	-22.11	Peak	HORIZONTAL
3	2484.25	48.61	30.25	30.25	5.31	53.92	74.00	-20.08	Peak	HORIZONTAL

- Note: 1. Result Level = Read Level + Antenna Factor + Cable loss - PRM Factor.
 2. If Peak Result complies with AV limit, AV Result is deemed to comply with AV limit.
 3. Test setup: RBW: 1 MHz, VBW: 3 MHz, Sweep time: auto.

10. Power Line Conducted Emission

10.1. Test equipment

Please refer to Section 3 this report.

10.2. Block diagram of test setup

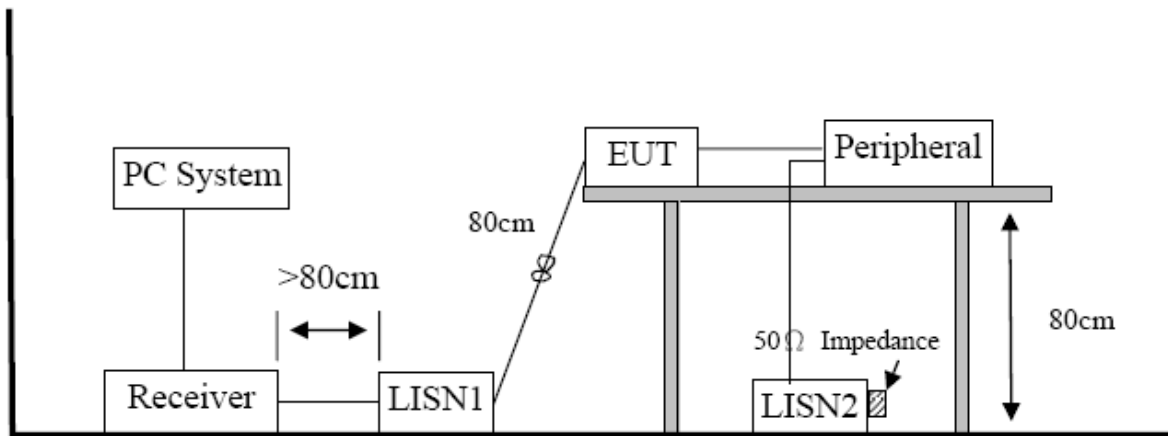

10.3. Power Line Conducted Emission Limits(Class B)

Frequency	Quasi-Peak Level dB(μV)	Average Level dB(μV)
150kHz ~ 500kHz	66 ~ 56*	56 ~ 46*
500kHz ~ 5MHz	56	46
5MHz ~ 30MHz	60	50

Note 1: * Decreasing linearly with logarithm of frequency.

Note 2: The lower limit shall apply at the transition frequencies.

10.4. Test Procedure

The EUT and Support equipment, if needed, were put placed on a non-metallic table, 80cm above the ground plane.

Configuration EUT to simulate typical usage as described in clause 2.4 and test equipment as described in clause 10.2 of this report.

All I/O cables were positioned to simulate typical actual usage as per ANSI C63.4.

All support equipment power received from a second LISN.

Emissions were measured on each current carrying line of the EUT using an EMI Test Receiver connected to the LISN powering the EUT.

The Receiver scanned from 150 kHz to 30MHz for emissions in each of the test modes.

During the above scans, the emissions were maximized by cable manipulation.

The test mode(s) described in clause 2.4 were scanned during the preliminary test.

After the preliminary scan, we found the test mode producing the highest emission level.

The EUT configuration and worse cable configuration of the above highest emission levels were recorded for reference of the final test.

EUT and support equipment were set up on the test bench as per the configuration with highest emission level in the preliminary test.

A scan was taken on both power lines, Neutral and Line, recording at least the six highest emissions.

Emission frequency and amplitude were recorded into a computer in which correction factors were used to calculate the emission level and compare reading to the applicable limit.

The test data of the worst-case condition(s) was recorded.

The bandwidth of test receiver is set at 9 KHz.

10.5. Test Result

PASS. (See below detailed test result)

Note1: All emissions not reported below are too low against the prescribed limits.

Note2: “----” means peak detection; “-----” mans average detection

TR-4-E-010 Conducted Emission Test Result

	: DDT 1# Shield Room	E:\2015 report data\15Q0831-1\CE.EM6
Test Date	: 2015-09-24	Tested By : Sincere
EUT	: Outdoor Access Point	Model Number : DCWL-7962OT
Power Supply	: DC 50V from external POE adapter	Test Mode : TX Mode
Condition	: Temp:24.5°C,Humi:55%, Press:100.1kPa	LISN : 2014 ENV216/LINE
Memo	:	

Data: 10

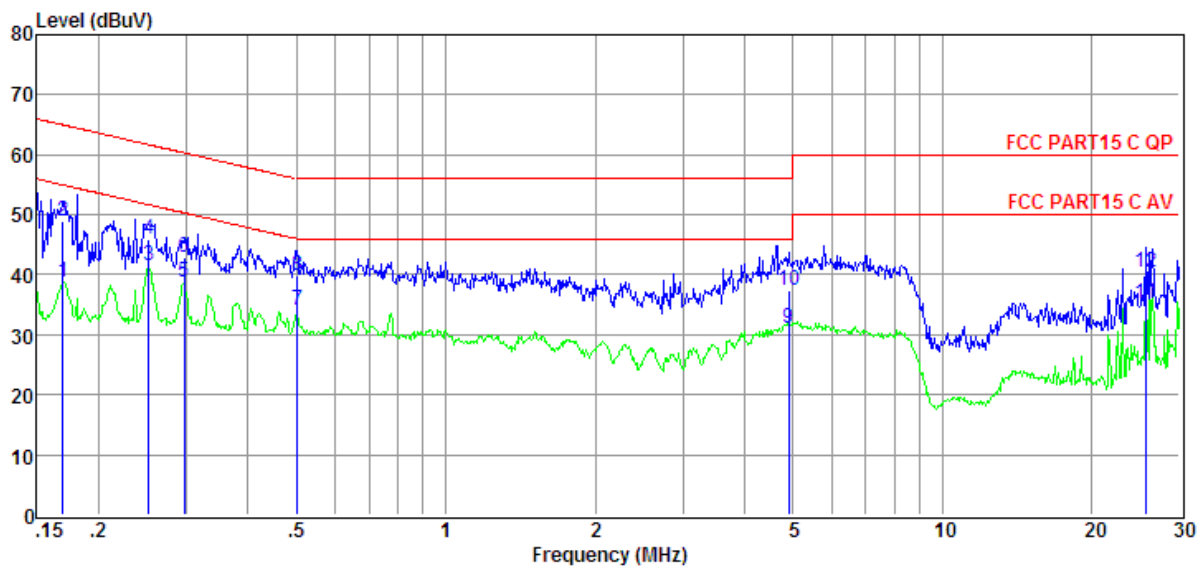

Item (Mark)	Freq (MHz)	Read Level (dBμV)	LISN Factor (dB)	Cable Loss (dB)	Pulse Limiter Factor (dB)	Result Level (dBμV)	Limit Line (dBμV)	Over Limit (dB)	Detector	Phase
1	0.17	19.31	9.61	0.01	9.84	38.77	54.99	-16.22	Average	LINE
2	0.17	29.36	9.61	0.01	9.84	48.82	64.99	-16.17	QP	LINE
3	0.25	22.03	9.62	0.02	9.85	41.52	51.69	-10.17	Average	LINE
4	0.25	26.49	9.62	0.02	9.85	45.98	61.69	-15.71	QP	LINE
5	0.30	19.14	9.62	0.02	9.85	38.63	50.32	-11.69	Average	LINE
6	0.30	23.45	9.62	0.02	9.85	42.94	60.32	-17.38	QP	LINE
7	0.50	14.57	9.63	0.03	9.87	34.10	46.00	-11.90	Average	LINE
8	0.50	20.22	9.63	0.03	9.87	39.75	56.00	-16.25	QP	LINE
9	4.90	11.32	9.68	0.11	9.88	30.99	46.00	-15.01	Average	LINE
10	4.90	17.76	9.68	0.11	9.88	37.43	56.00	-18.57	QP	LINE
11	25.59	15.11	9.97	0.17	9.97	35.22	50.00	-14.78	Average	LINE
12	25.59	20.39	9.97	0.17	9.97	40.50	60.00	-19.50	QP	LINE

Note: 1. Result Level = Read Level + LISN Factor + Pulse Limiter Factor + Cable loss.

2. If QP Result complies with AV limit, AV Result is deemed to comply with AV limit.

3. Test setup: RBW: 200 Hz (9 kHz—150 kHz), 9 kHz (150 kHz—30 MHz), Step size: 4 kHz, Scan time: auto.

TR-4-E-010 Conducted Emission Test Result

: DDT 1# Shield Room E:\2015 report data\15Q0831-1\CE.EM6
Test Date : 2015-09-24 **Tested By** : Sincere
EUT : Outdoor Access Point **Model Number** : DCWL-7962OT
Power Supply : DC 50V from external POE adapter **Test Mode** : TX Mode
Condition : Temp:24.5°C,Humi:55%, **LISN** : 2014 ENV216/NEUTRAL
 Press:100.1kPa
Memo :

Data: 12

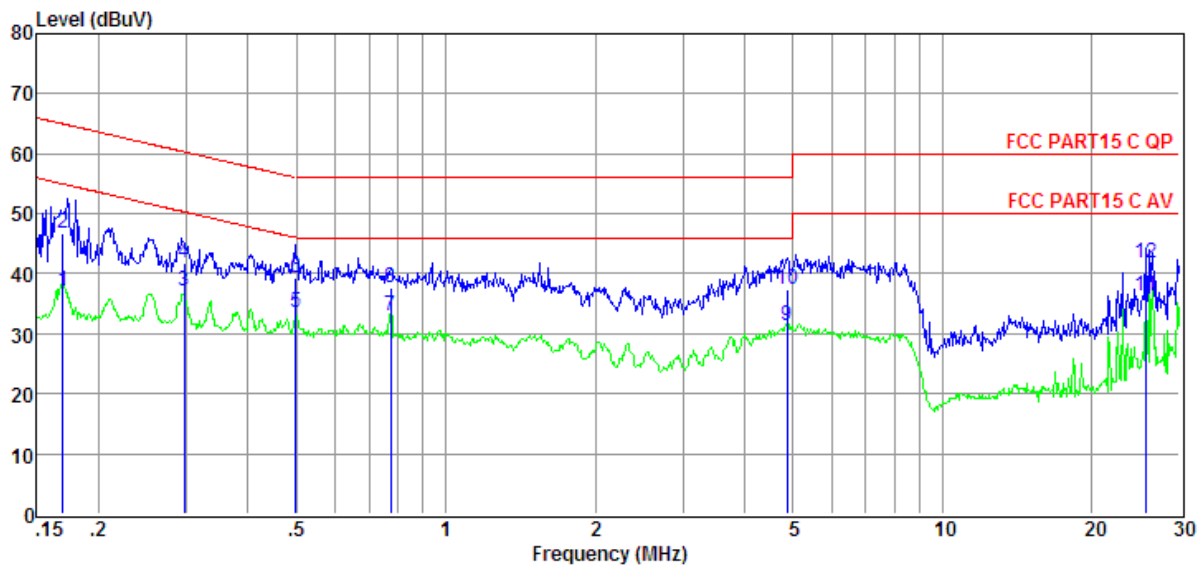

Item (Mark)	Freq (MHz)	Read Level (dBμV)	LISN Factor (dB)	Cable Loss (dB)	Pulse Limiter Factor (dB)	Result Level (dBμV)	Limit Line (dBμV)	Over Limit (dB)	Detector	Phase
1	0.17	17.58	9.60	0.01	9.84	37.03	54.99	-17.96	Average	NEUTRAL
2	0.17	27.28	9.60	0.01	9.84	46.73	64.99	-18.26	QP	NEUTRAL
3	0.30	17.57	9.60	0.02	9.85	37.04	50.32	-13.28	Average	NEUTRAL
4	0.30	22.33	9.60	0.02	9.85	41.80	60.32	-18.52	QP	NEUTRAL
5	0.50	14.11	9.61	0.03	9.87	33.62	46.01	-12.39	Average	NEUTRAL
6	0.50	19.81	9.61	0.03	9.87	39.32	56.01	-16.69	QP	NEUTRAL
7	0.78	13.42	9.61	0.08	9.86	32.97	46.00	-13.03	Average	NEUTRAL
8	0.78	18.24	9.61	0.08	9.86	37.79	56.00	-18.21	QP	NEUTRAL
9	4.87	11.60	9.62	0.11	9.88	31.21	46.00	-14.79	Average	NEUTRAL
10	4.87	17.70	9.62	0.11	9.88	37.31	56.00	-18.69	QP	NEUTRAL
11	25.59	16.27	10.01	0.17	9.97	36.42	50.00	-13.58	Average	NEUTRAL
12	25.59	21.60	10.01	0.17	9.97	41.75	60.00	-18.25	QP	NEUTRAL

Note: 1. Result Level = Read Level + LISN Factor + Pulse Limiter Factor + Cable loss.

2. If QP Result complies with AV limit, AV Result is deemed to comply with AV limit.

3. Test setup: RBW: 200 Hz (9 kHz—150 kHz), 9 kHz (150 kHz—30 MHz), Step size: 4 kHz, Scan time: auto.

11. Antenna Requirements

11.1. Limit

For intentional device, according to FCC 47 CFR Section 15.203, an intentional radiator shall be designed to ensure that no antenna other than that furnished by the responsible party shall be used with the device. And according to FCC 47 CFR Section 15.247 (b), if transmitting antennas of directional gain greater than 6dBi are used, the power shall be reduced by the amount in dB that the directional gain of the antenna exceeds 6dBi.

11.2. Result

The antennas used for this product are external antenna MIMO 2x2, this requirement must be professionally installed, the maximum antenna gain 3.4dBi Single root Antenna and MIMO 2X2. Total ANT=3.4+10*LOG(2)=6.4dBi; therefore power limit reduction due to antenna gain is 0.4dBi.

12. Test setup photograph

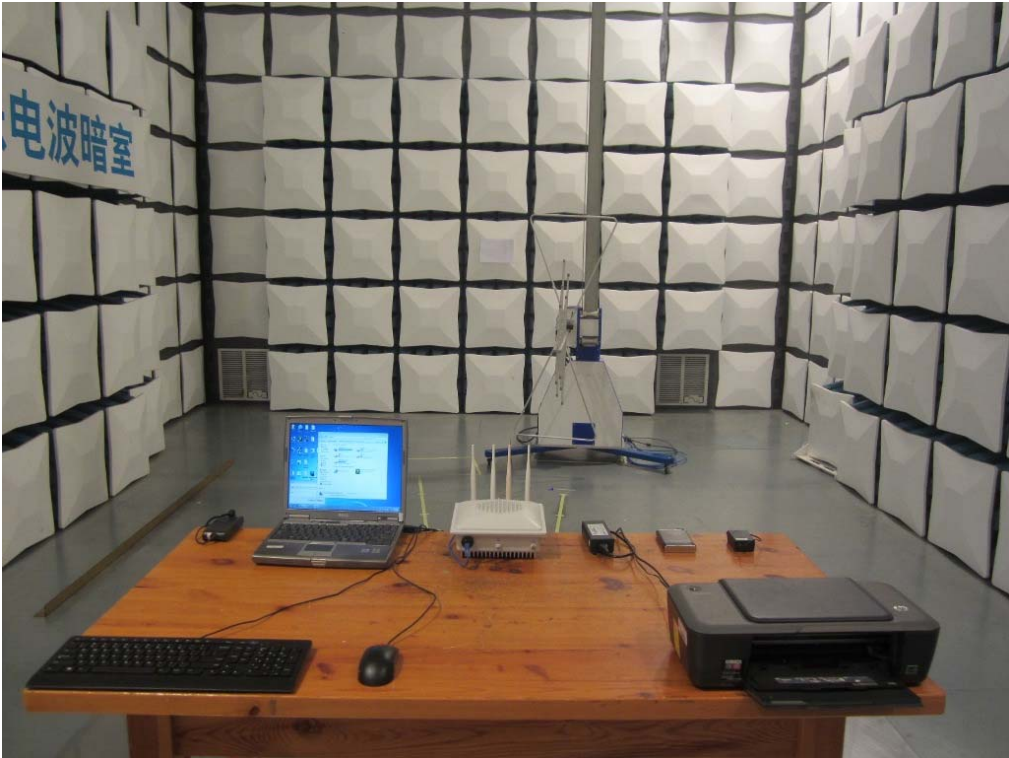

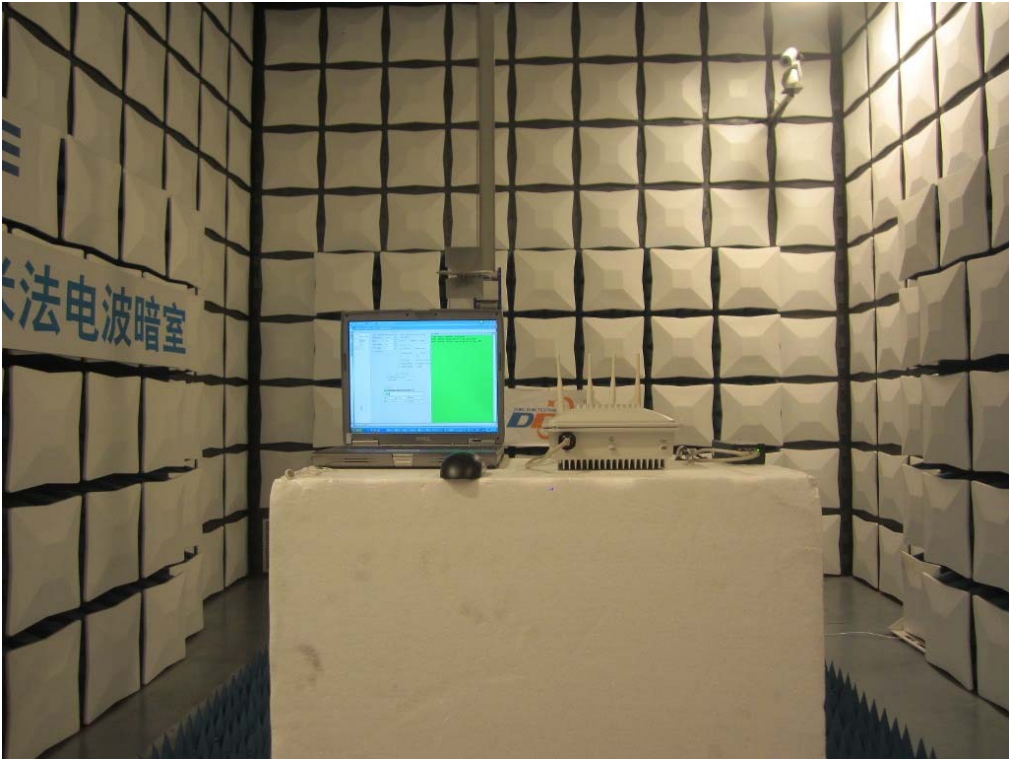

13. Photos of the EUT

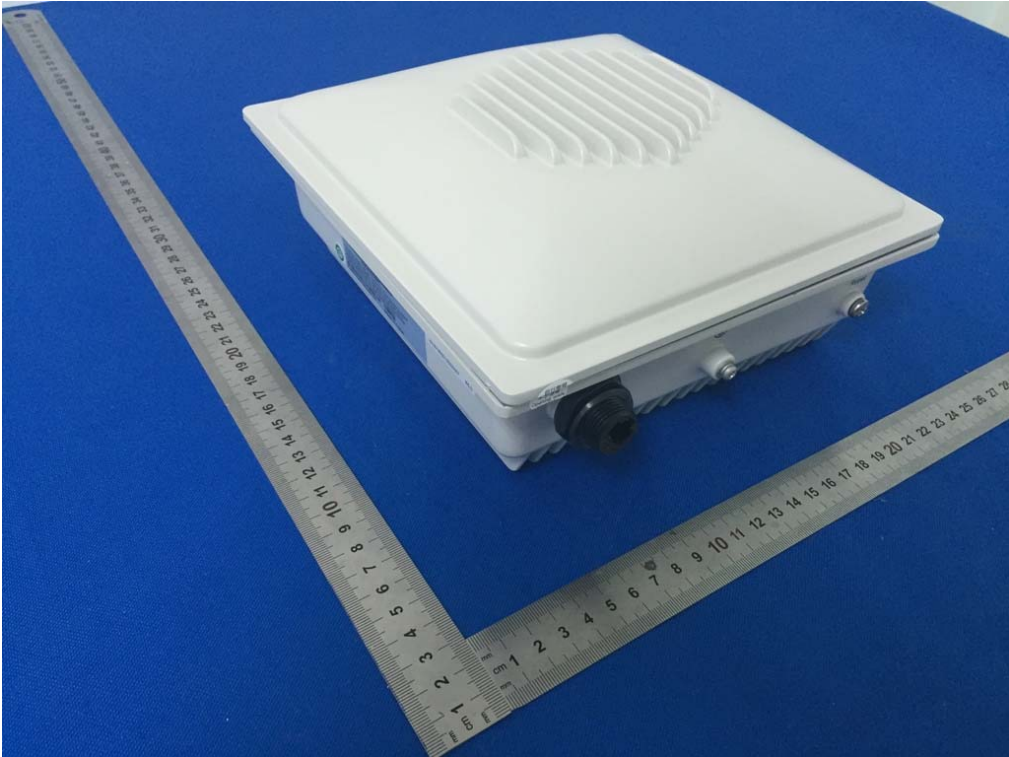
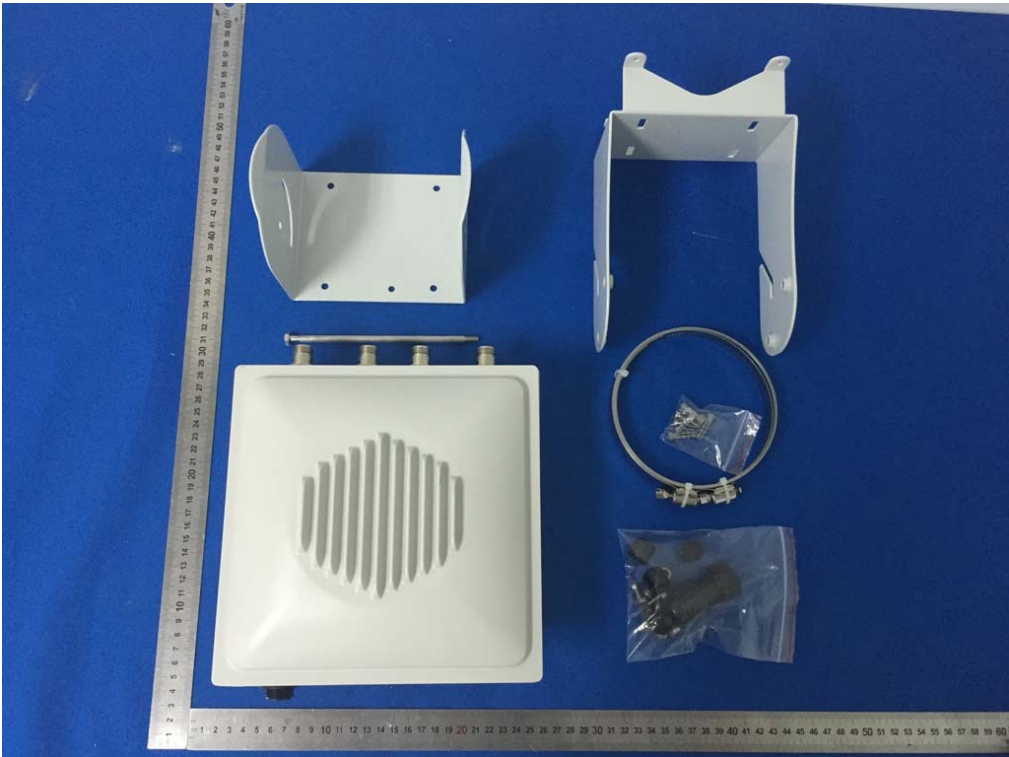

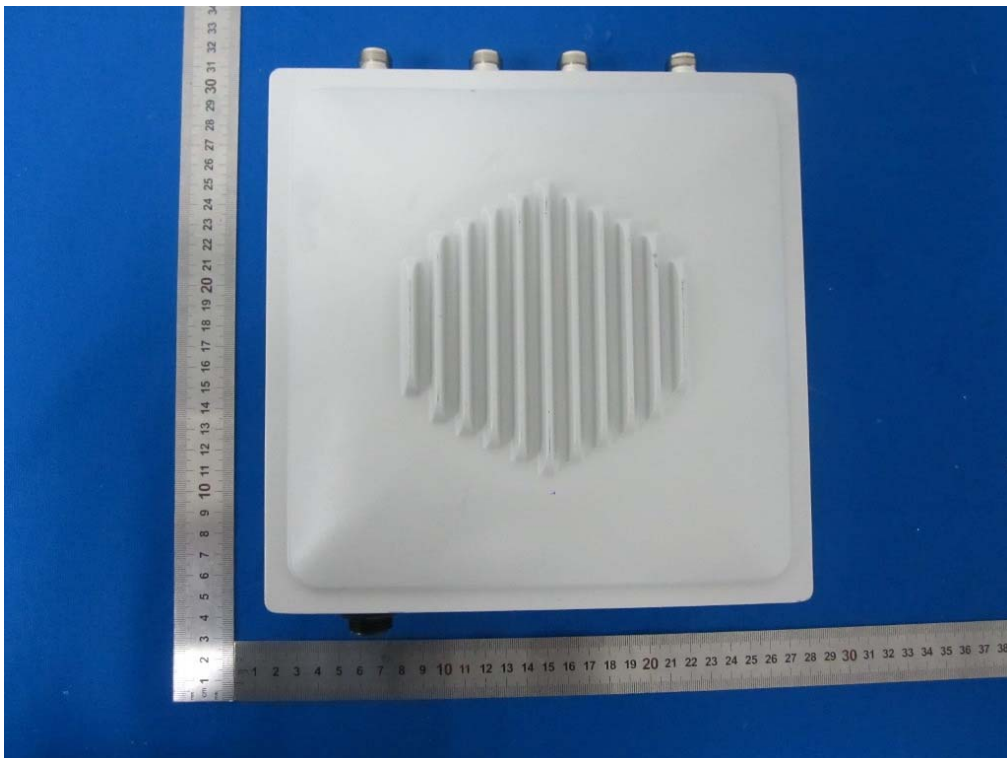

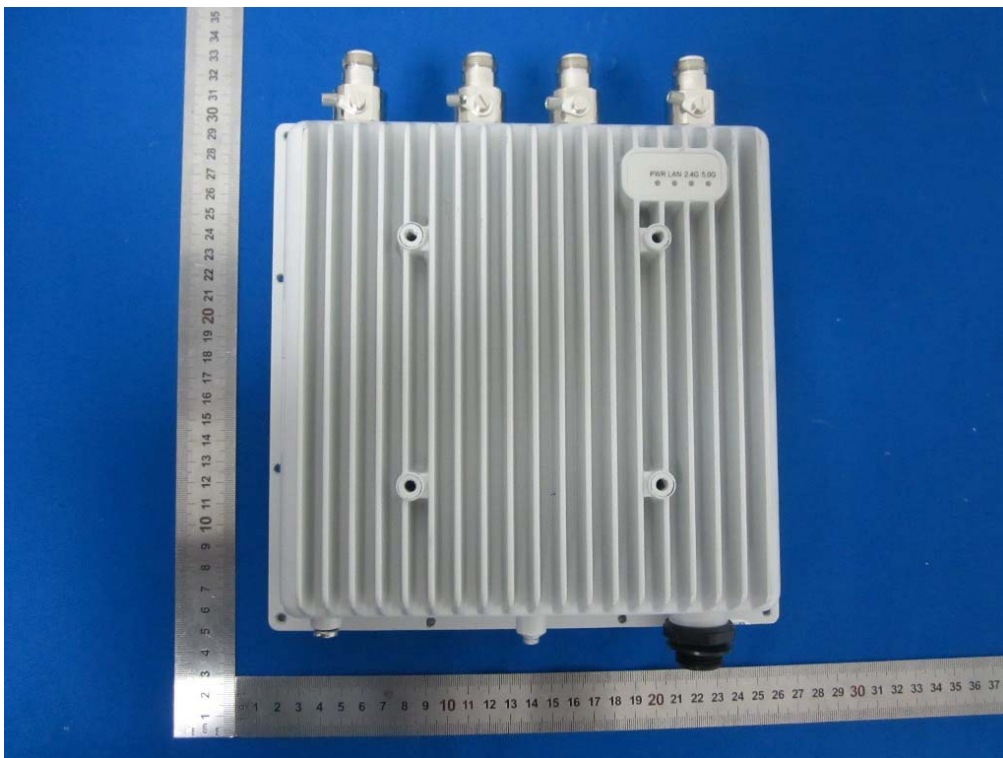

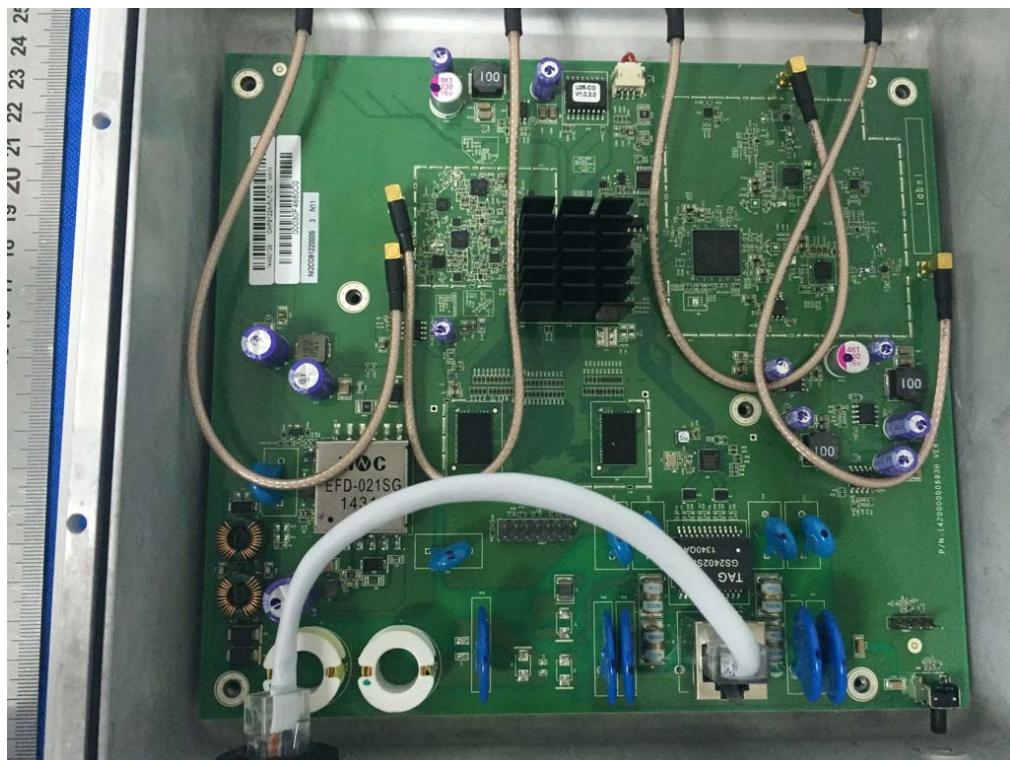
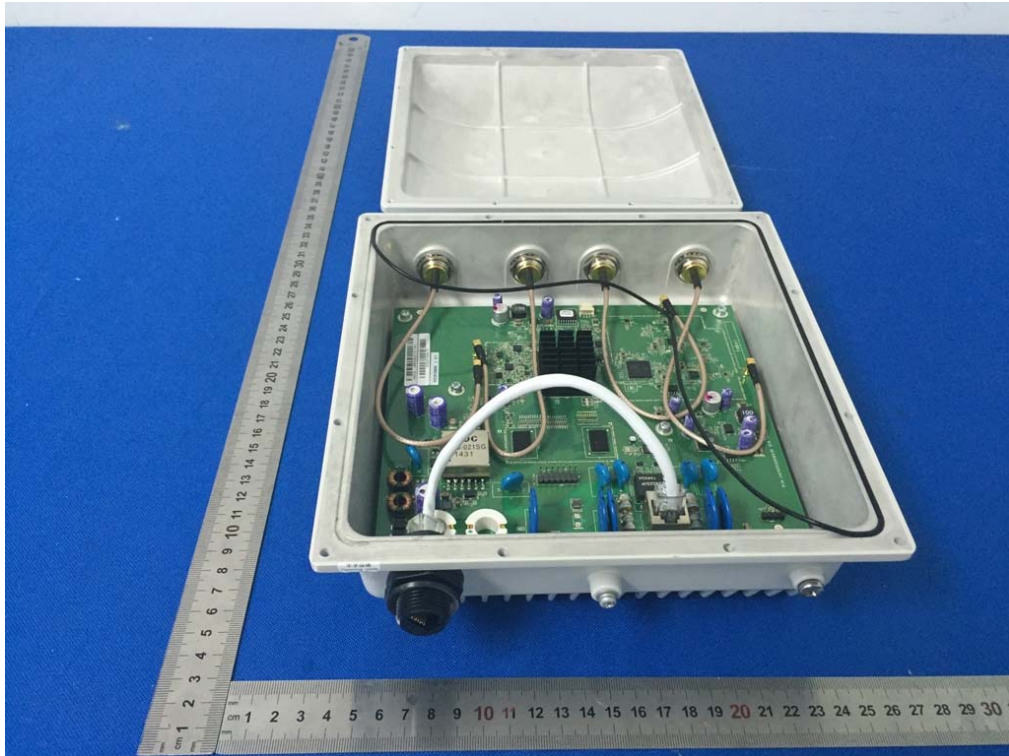

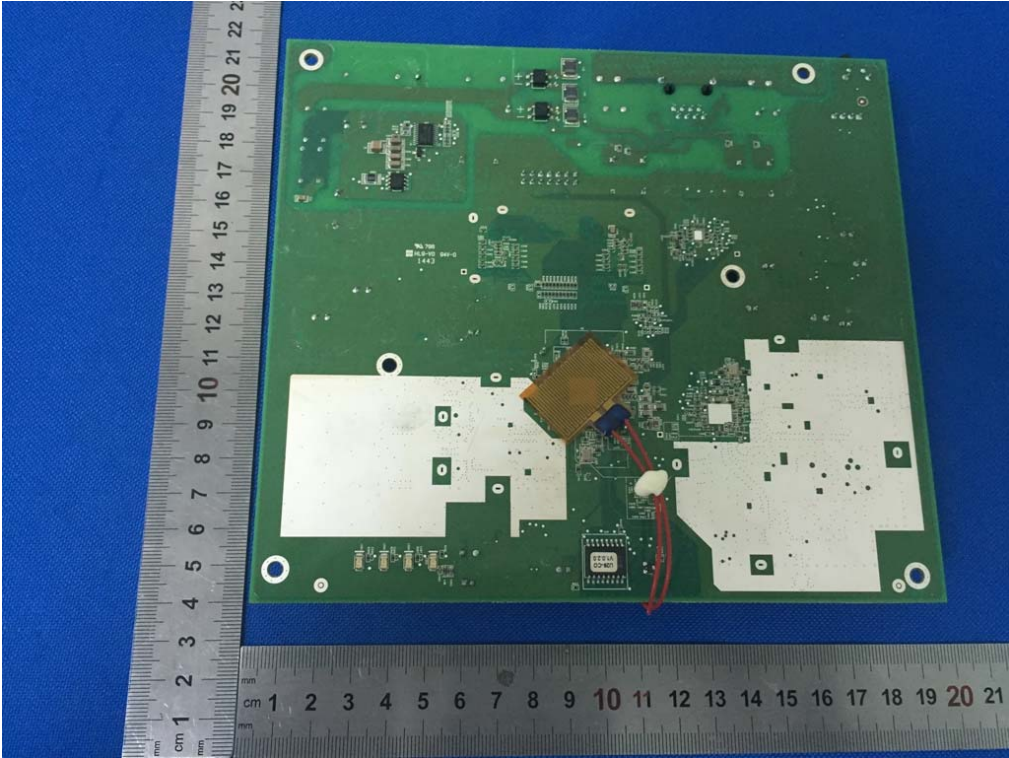
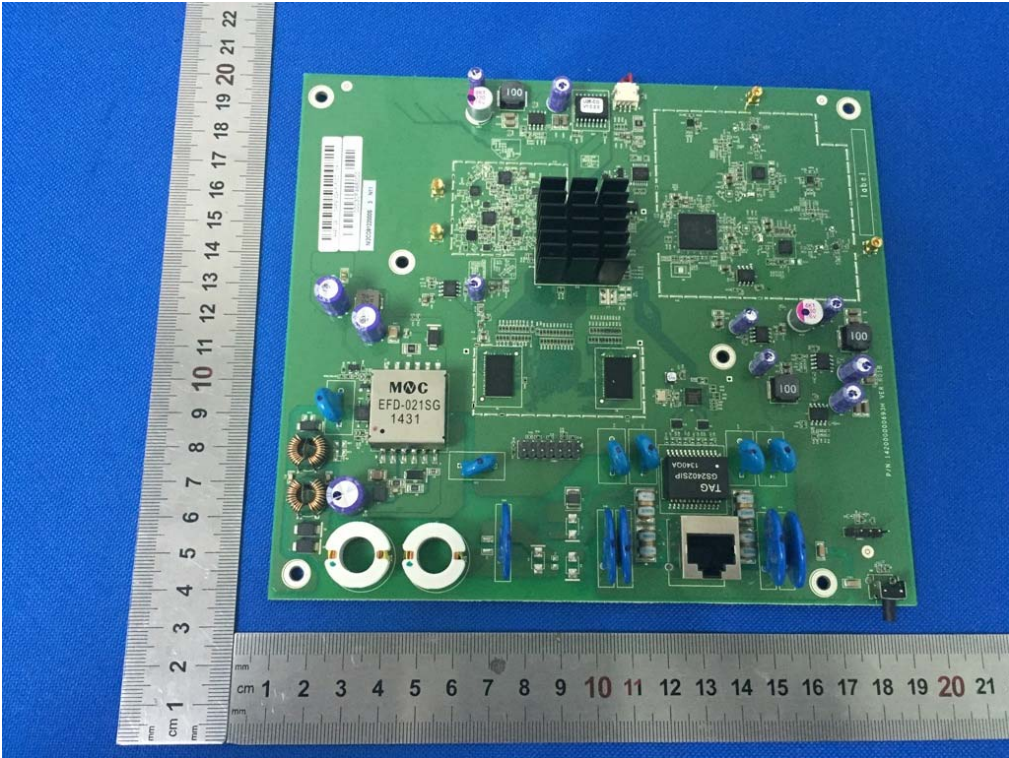

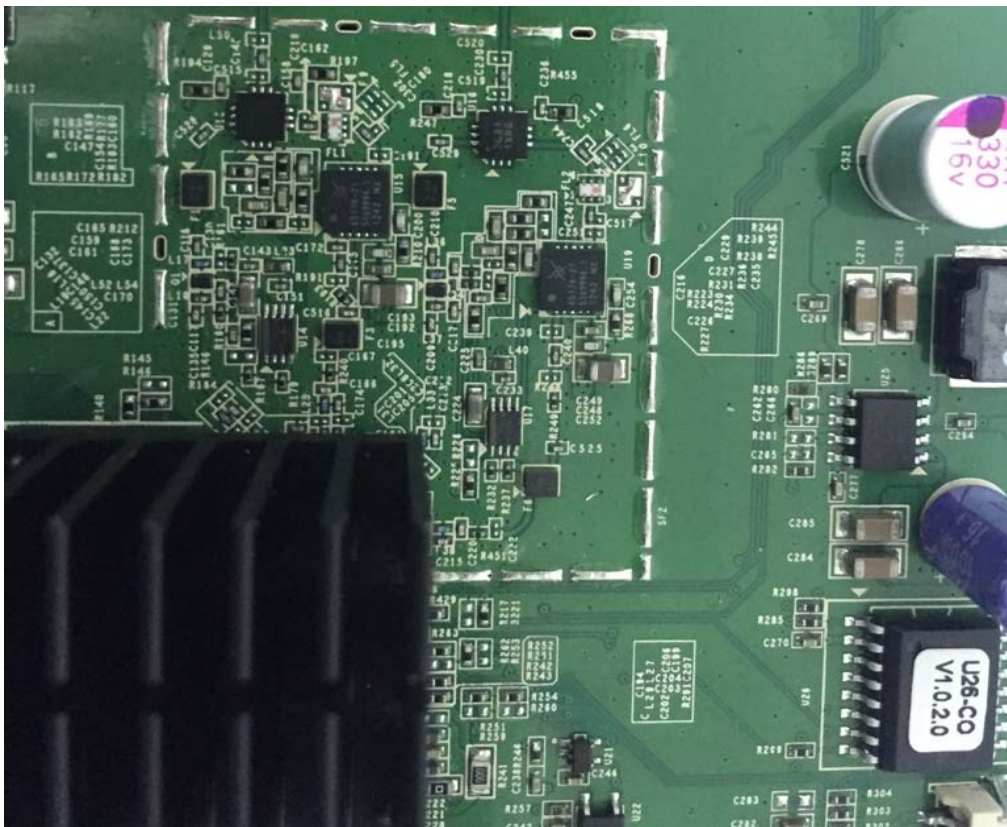
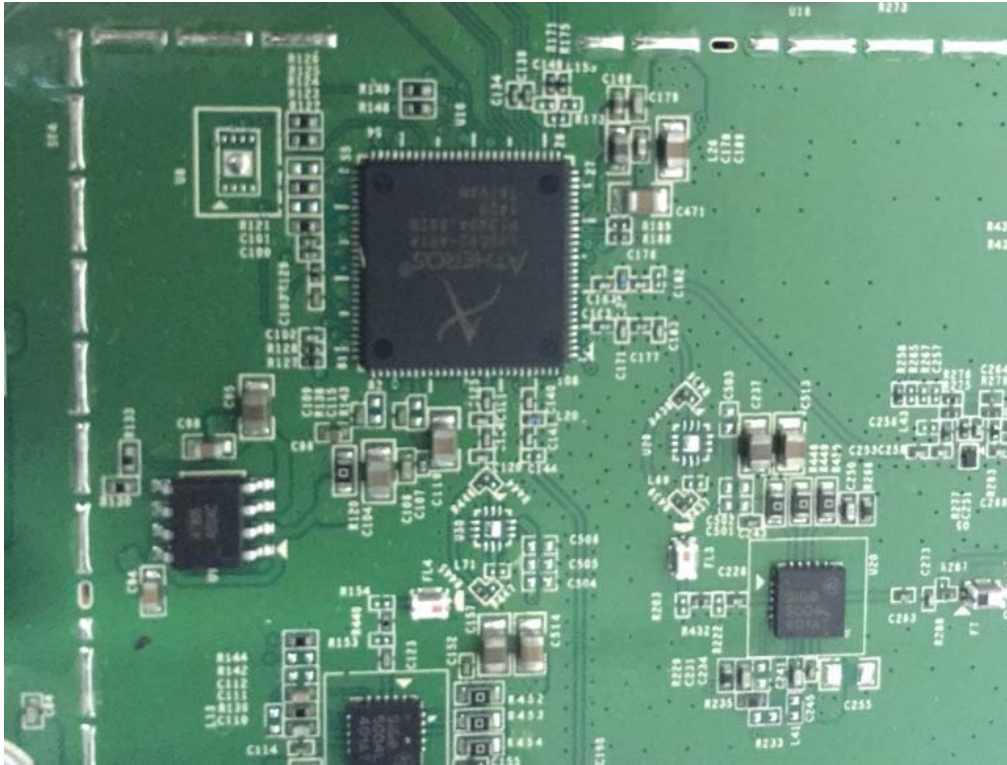

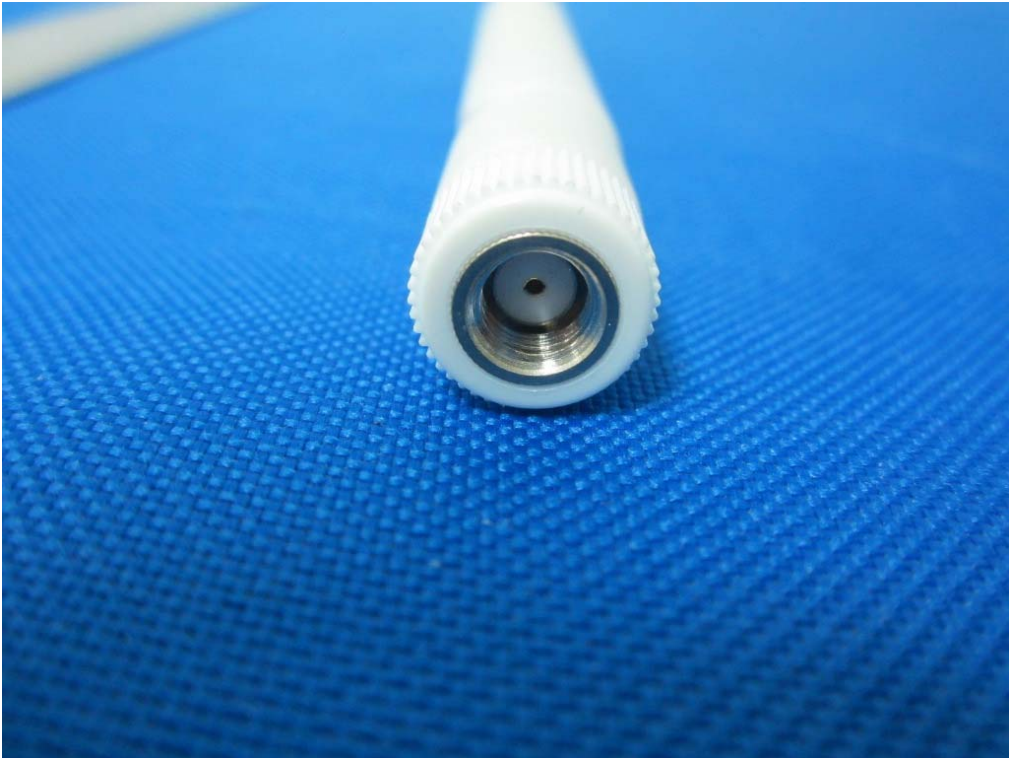

END OF REPORT