

FCC CERTIFICATION TEST REPORT

FOR

Applicant	:	Digital China Networks (Beijing) Limited
Address	:	Digital Technology Plaza, No.9 shangdi 9th street, Haidian District Beijing China
Equipment under Test	:	Outdoor Access Point
Model No	:	DCWL-7962OT
FCC ID	:	2ABKDCWL-7962OT
Trade Mark	:	
Manufacturer	:	Digital China Networks (Beijing) Limited
Address	:	Digital Technology Plaza, No.9 shangdi 9th street, Haidian District Beijing China

Issued By: Dongguan Dongdian Testing Service Co., Ltd.

Add: No. 17, Zongbu Road 2, Songshan Lake Sci&Tech, Industry Park, Dongguan City,
Guangdong Province, China, 523808

Tel: +86-0769-22891499 [Http://www.dgddt.com](http://www.dgddt.com)

REPORT

TABLE OF CONTENTS

	Test report declares.....	4
1.	Summary of test results	5
2.	General test information.....	6
2.1.	Description of EUT	6
2.2.	Assistant equipment used for test.....	6
2.3.	Block diagram of EUT configuration for test	6
2.4.	Deviations of test standard	7
2.5.	Test environment conditions	7
2.6.	Test laboratory.....	7
2.7.	Measurement uncertainty	8
3.	Equipment used during test.....	9
4.	26dB Bandwidth and 6dB Bandwidth.....	9
4.1.	Test equipment	9
4.2.	Block diagram of test setup.....	9
4.3.	Test Procedure.....	9
4.4.	Test Result.....	10
4.5.	Original test data	11
5.	Maximum Peak Output Power	18
5.1.	Test equipment	18
5.2.	Block diagram of test setup.....	18
5.3.	Limits	18
5.4.	Test Procedure.....	18
5.5.	Test Result.....	18
5.6.	The worst of the original test data.....	19
6.	Power Spectral Density	20
6.1.	Test equipment	20
6.2.	Block diagram of test setup.....	20
6.3.	Limits	20
6.4.	Test Procedure.....	21
6.5.	Test Result.....	21
6.6.	The worst of the original test data.....	21
7.	Frequency Stability Measurement.....	26
7.1.	Limit of Frequency Stability	26
7.2.	Measuring Instruments	26
7.3.	Test Procedures	26
7.4.	Test Setup.....	27

7.5.	Test Result of Frequency Stability	27
8.	Emissions in restricted frequency bands	28
8.1.	Test equipment	28
8.2.	Block diagram of test setup	28
8.3.	Limit	29
8.4.	Test Procedure	30
8.5.	Test result	31
9.	Band Edge Compliance	36
9.1.	Test equipment	36
9.2.	Block diagram of test setup	36
9.3.	Limit	36
9.4.	Test Procedure	36
9.5.	Test result	36
10.	Power Line Conducted Emission	61
10.1.	Test equipment	61
10.2.	Block diagram of test setup	61
10.3.	Power Line Conducted Emission Limits(Class B)	61
10.4.	Test Procedure	61
10.5.	Test Result	62
11.	Antenna Requirements	65
11.1.	Limit	65
11.2.	Result	65
12.	Test setup photograph	66
13.	Photos of the EUT	68

TEST REPORT DECLARE

Applicant	:	Digital China Networks (Beijing) Limited
Address	:	Digital Technology Plaza, No.9 shangdi 9th street, Haidian District Beijing China
Equipment under Test	:	Outdoor Access Point
Model No	:	DCWL-7962OT
FCC ID	:	2ABKCDCWL-7962OT
Trade Mark	:	DCN
Manufacturer	:	Digital China Networks (Beijing) Limited
Address	:	Digital Technology Plaza, No.9 shangdi 9th street, Haidian District Beijing China

Test Standard Used: FCC Rules and Regulations Part 15 Subpart C: 2015.

Test procedure used: ANSI C63.4:2014, 789033 D02 General UNII Test Procedures New Rules v01.

We Declare:

The equipment described above is tested by Dongguan Dongdian Testing Service Co., Ltd and in the configuration tested the equipment complied with the standards specified above. The test results are contained in this test report and Dongguan Dongdian Testing Service Co., Ltd is assumed of full responsibility for the accuracy and completeness of these tests.

After test and evaluation, our opinion is that the equipment provided for test compliance with the requirement of the above FCC standards.

Report No:	DDT-R15Q0831-1E3		
Date of Test:	Sept. 24, 2015~Oct. 20, 2015	Date of Report:	Oct. 21, 2015

Prepared By:



Leo Liu/Engineer



Kevin Peng/EMC Manager

Note: This report applies to above tested sample only. This report shall not be reproduced in parts without written approval of Dongguan Dongdian Testing Service Co., Ltd.

1. Summary of test results

The EUT have been tested according to the applicable standards as referenced below.		
Description of Test Item	Standard	Results
Emission Bandwidth	FCC Part 15: 15.407(a)	PASS
Peak Output Power	FCC Part 15: 15.407(a)	PASS
Power Spectral Density	FCC Part 15: 15.407(a)	PASS
Frequency Stability Measurement	FCC Part 15: 15.407(g)	PASS
Emissions in restricted frequency bands	FCC Part 15: 15.209 FCC Part 15: 15.407(a)	PASS
Band Edge Compliance	FCC Part 15: 15.209 FCC Part 15: 15.407(a)	PASS
Power Line Conducted Emission	FCC Part 15: 15.207 ANSI C63.4:2014	PASS
Antenna requirement	FCC Part 15: 15.203	PASS

2. General test information

2.1. Description of EUT

EUT* Name	: Outdoor Access Point
Model Number	: DCWL-7962OT
EUT function description	: Please reference user manual of this device
Power supply	: DC 50V from external POE adapter : Note: This device not sales with power adapter, and a typical power adapter was by provided by Manufacturer for test.
Radio Technology	: IEEE802.11n/a
FCC Operation frequency	: IEEE 802.11n HT20: 5180MHz—5240MHz,5745MHz—5825MHz : IEEE 802.11n HT40: 5190MHz—5230MHz,5755MHz—5795MHz IEEE 802.11a:5180MHz—5240MHz,5745MHz—5825MHz
Modulation	: IEEE 802.11n HT20, HT40: OFDM (64QAM, 16QAM, QPSK,BPSK) : IEEE 802.11a: OFDM (64QAM, 16QAM, QPSK,BPSK)
Antenna Type	: 5G: External Antenna, 3.4dBi Single root Antenna gain, : MIMO 2X2.Total ANT=3.4+10*LOG(2)=6.4dBi
Date of Receipt	: 2015/9/24
Sample Type	: Series production

Note: EUT is the ab.of equipment under test.

2.2. Assistant equipment used for test

Description of Assistant equipment	Manufacturer	Model number or Type	EMC Compliance	SN
Notebook	DELL	Latitude D610	FCC DOC	00045-534-136-300
Mouse	HP	M-SBF96	FCC DOC	417441-001
Earphone	Apple inc	A1429	FCC DOC	/
POE Adapter	Digital China Networks (Beijing) Limited	DCWL-PoEINJ-G+(R3)	FCC VOC	WL005630DC3000022 3
Printer	HP	LaserJet 1020 plus	FCC DOC	CNCFV90866
Keyboard	HP	KB-0316	FCC DOC	BAUEK00VB 2B0VB

2.3. Block diagram of EUT configuration for test

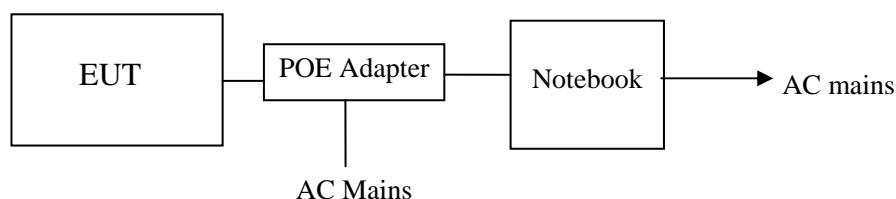

EUT was connected to control to provided by manufacturer which has a standard RSS-232 connector to connect to Notebook, and the Notebook will run a special test software “artgui” provided by manufacturer to control EUT work in Continuous TX mode (>98% duty cycle), and select test channel, wireless mode and data rate.

Tested mode, channel, and data rate information			
Mode	data rate (Mbps) (see Note)	Channel	Frequency (MHz)
IEEE 802.11n HT20	6.5	Low :CH36	5180
	6.5	Middle: CH40	5200
	6.5	High: CH48	5240
	6.5	Low :CH149	5745
	6.5	Middle: CH157	5785
	6.5	High: CH165	5825
IEEE 802.11n HT40	13.5	Low :CH38	5190
	13.5	High: CH46	5230
	13.5	Low :CH151	5755
	13.5	High: CH159	5795
IEEE 802.11a	6	Low :CH36	5180
	6	Middle: CH40	5200
	6	High: CH48	5240
	6	Low :CH149	5745
	6	Middle: CH157	5785
	6	High: CH165	5825
Note: According exploratory test, EUT will have maximum output power in those data rate, so those data rate were used for all test.			
After verification, all tests were carried out with the worst case test modes as shown in this report			

2.4. Deviations of test standard

No Deviation.

2.5. Test environment conditions

During the measurement the environmental conditions were within the listed ranges:

Temperature range:	21-25°C
Humidity range:	40-75%
Pressure range:	86-106kPa

2.6. Test laboratory

Dongguan Dongdian Testing Service Co., Ltd

Add: No. 17, Zongbu Road 2, Songshan Lake Sci&Tech, Industry Park, Dongguan City, Guangdong Province, China, 523808 Tel: +86-0769-22891499 <http://www.dgddt.com>

FCC Registration Number: 270092 Industry Canada site registration number: 10288A-1

2.7. Measurement uncertainty

Test Item	Uncertainty
Occupied Channel Bandwidth	±1%
Uncertainty for radio frequency	1×10^{-9}
RF Output power, conducted	±0.6dB
Power Spectral Density, Conducted	±1.2dB
Unwanted Emissions, Conducted	±0.6dB
Temperature	±0.2°C
Humidity	±1%
DC and Low frequency voltage	±0.5%
Time	±1%
Duty Cycle	±1%
Uncertainty for Radiation Emission test (30MHz-1GHz)	3.14 dB (Polarize: V)
	3.16 dB (Polarize: H)
Uncertainty for Radiation Emission test (1GHz to 25GHz)	2.08dB(Polarize: V)
	2.56dB (Polarize: H)
Uncertainty for Conduction emission test(150KHz-30MHz)	2.44dB
Uncertainty for Radiation Emission test (9KHz-150KHz)	3.89dB
Uncertainty for Radiation Emission test (150KHz-30MHz)	3.21dB
Note: This uncertainty represents an expanded uncertainty expressed at approximately the 95% confidence level using a coverage factor of k=2.	

3. Equipment used during test

Equipment	Manufacturer	Model No.	Serial No.	Last Cal.	Cal. Interval
RF Connected Test					
Spectrum analyzer	R&S	FSU26	1166.1660.26	2014/10/25	1Year
Attenuator	Mini-Circuits	BW-S10W2	101109	2014/10/25	1Year
RF Cable	Micable	C10-01-01-1	100309	2015/08/18	1Year
Radiated Emission Test					
Spectrum analyzer	Agilent	E4447A	MY52090876	2015/09/22	1 Year
Trilog Broadband Antenna	Schwarzbeck	VULB9163	9163-462	2015/05/30	1 Year
Active Loop antenna	Schwarzbeck	FMZB-1519	1519-038	2014/11/01	1 Year
Double Ridged Horn Antenna	R&S	HF907	100276	2014/11/01	1 Year
Pre-amplifier	A.H.	PAM-0118	360	2015/08/18	1 Year
RF Cable	HUBSER	CP-X2	W11.03	2014/10/25	1Year
RF Cable	HUBSER	CP-X1	W12.02	2014/10/25	1 Year
MI Cable	HUBSER	C10-01-01-1M	1091629	2014/10/25	1 Year
Test software	Audix	E3	V 6.11111b	/	/
Power Line Conducted Emissions Test					
Test Receiver	R&S	ESU8	100316	2014/10/25	1 Year
LISN 1	R&S	ENV216	101109	2014/10/25	1 Year
Pulse Limiter	R&S	ESH3-Z2	101242	2014/10/25	1 Year
CE Cable 1	HUBSER	ESU8/RF2	W10.01	2014/10/25	1 Year
Test software	Audix	E3	V 6.11111b	/	/

4. 26dB Bandwidth and 6dB Bandwidth

4.1. Test equipment

Please refer to Section 3 this report.

4.2. Block diagram of test setup

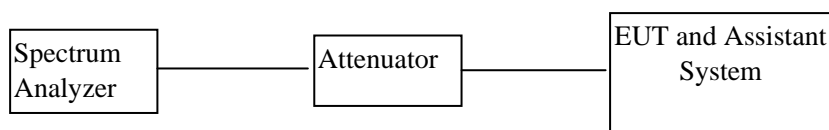

4.3. Test Procedure

- (1) Configure EUT and assistant system according clause 2.3 and 4.2

- (2) Connect EUT's antenna output to spectrum analyzer by RF cable.
 (3) Configure EUT work in test mode as stated in clause 2.3.
 (4) Set the spectrum analyzer as follows:

RBW:	100KHz
VBW:	300KHz
Detector Mode:	Peak
Sweep time:	auto
Trace mode	Max hold

- (5) Allow the trace to stabilize, measure the maximum width of the emission that is constrained by the frequencies associated with the two outermost amplitude points (upper and lower frequencies) that are attenuated by 26 dB and 6dB relative to the maximum level measured in the fundamental emission.

4.4. Test Result

5180-5240MHz Band/Mode					
Mode	CH or Frequency	26dB bandwidth Result (MHz)	Mode	CH or Frequency	26dB bandwidth Result (MHz)
11a	CH36	26.410	N/A	N/A	N/A
	CH40	26.731		N/A	N/A
	CH48	26.218		N/A	N/A
11n HT20 /Chain 0	CH36	27.372	11n HT20 /Chain 1	CH36	27.436
	CH40	27.308		CH40	26.859
	CH48	27.608		CH48	27.821
11n HT40 /Chain 0	CH38	51.410	11n HT40 /Chain 1	CH38	51.667
	CH46	51.538		CH46	51.026
Conclusion: Pass					
Test Date : 2015/10/13			Test Engineer : Toby		

5745-5825MHz Band/Mode							
Mode	CH or Frequency	26dB bandwidth Result (MHz)	6dB bandwidth Result (MHz)	Mode	CH or Frequency	26dB bandwidth Result (MHz)	6dB bandwidth Result (MHz)
11a	CH149	26.282	16.410	N/A	N/A	N/A	N/A
	CH157	26.667	16.410		N/A	N/A	N/A
	CH165	26.667	16.410		N/A	N/A	N/A
11n HT20 /Chain 0	CH149	27.179	17.564	11n HT20 /Chain 1	CH149	26.731	17.821
	CH157	27.051	17.564		CH157	27.372	17.821
	CH165	27.372	17.564		CH165	27.436	17.821
11n HT40 /Chain 0	CH151	49.103	36.538	11n HT40 /Chain 1	CH151	50.641	36.538
	CH159	50.256	36.667		CH159	51.154	36.667

Conclusion: Pass

Test Date : 2015/10/13

Test Engineer : Toby

4.5. Original test data

5180-5240MHz Band (26dB bandwidth)

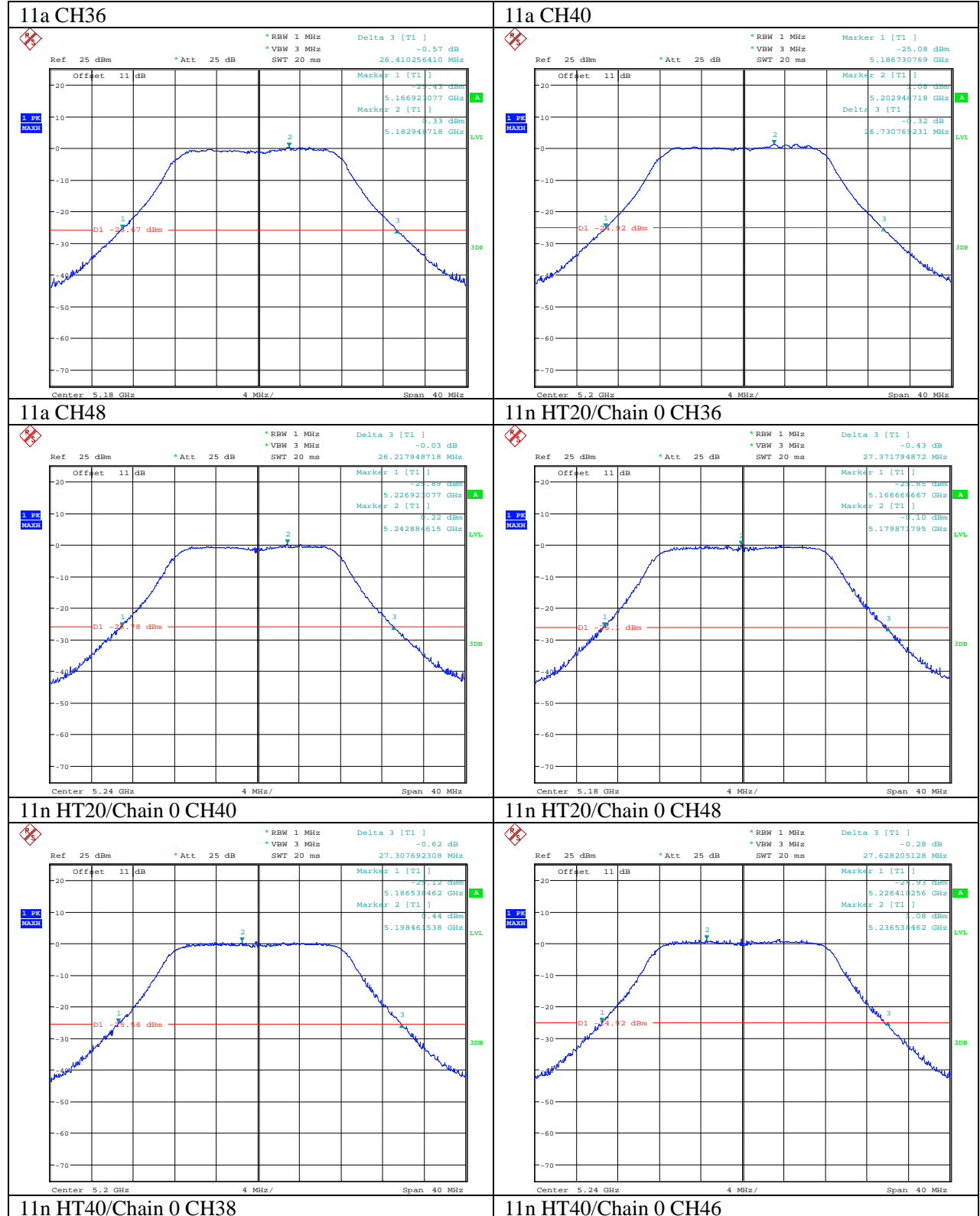

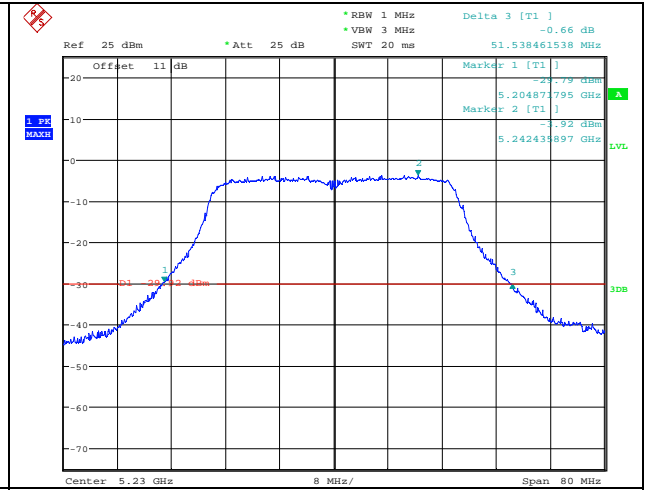
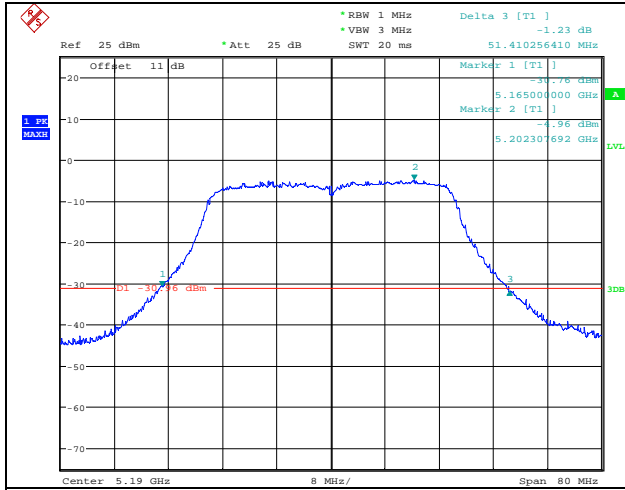

11n HT20/Chain 1 CH36

11n HT20/Chain 1 CH40

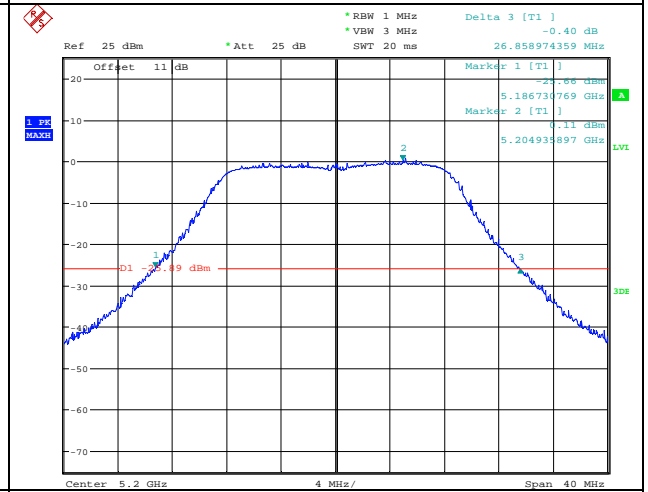
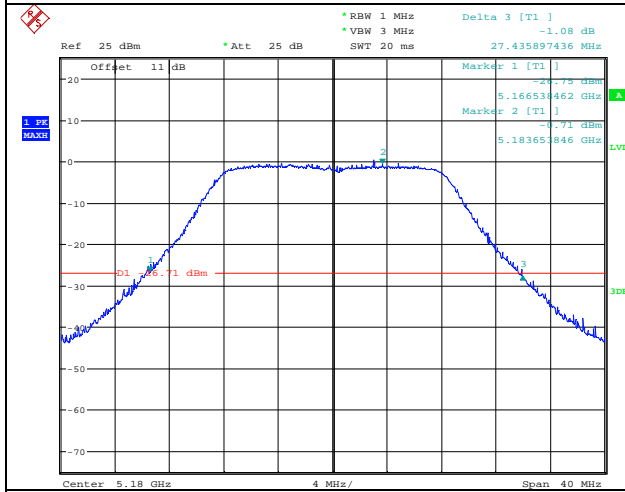

11n HT20/Chain 1 CH46

11n HT40/Chain 1 CH38

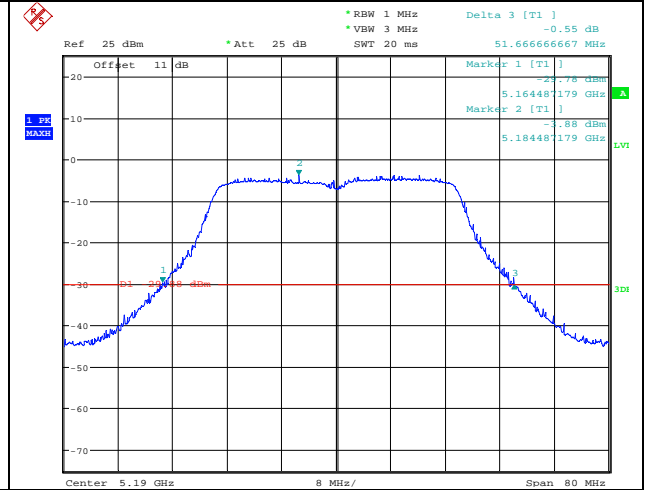
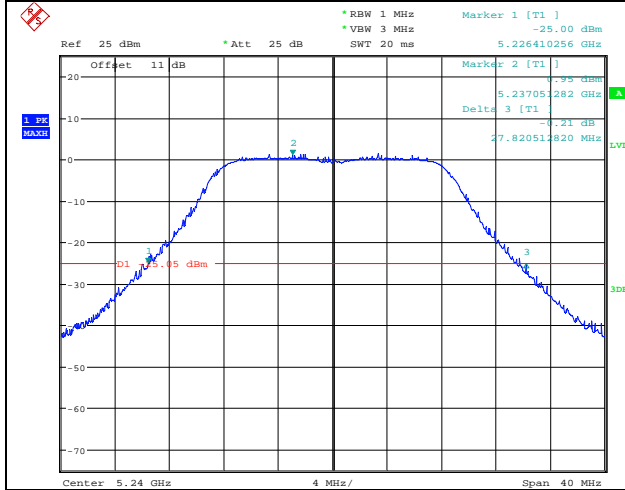

11n HT40/Chain 1 CH46

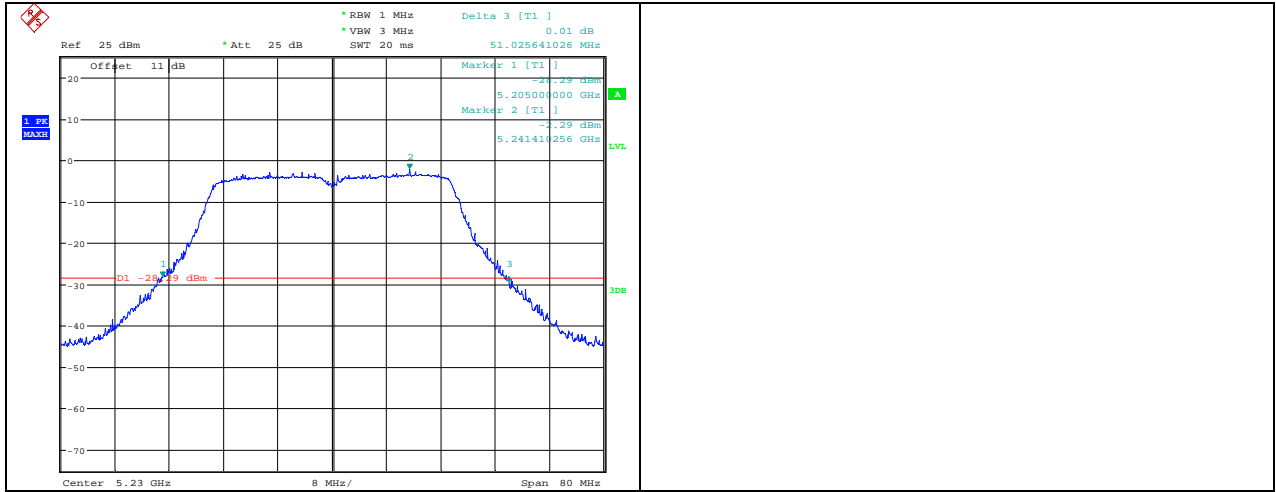

5745-5825MHz Band (26dB bandwidth)

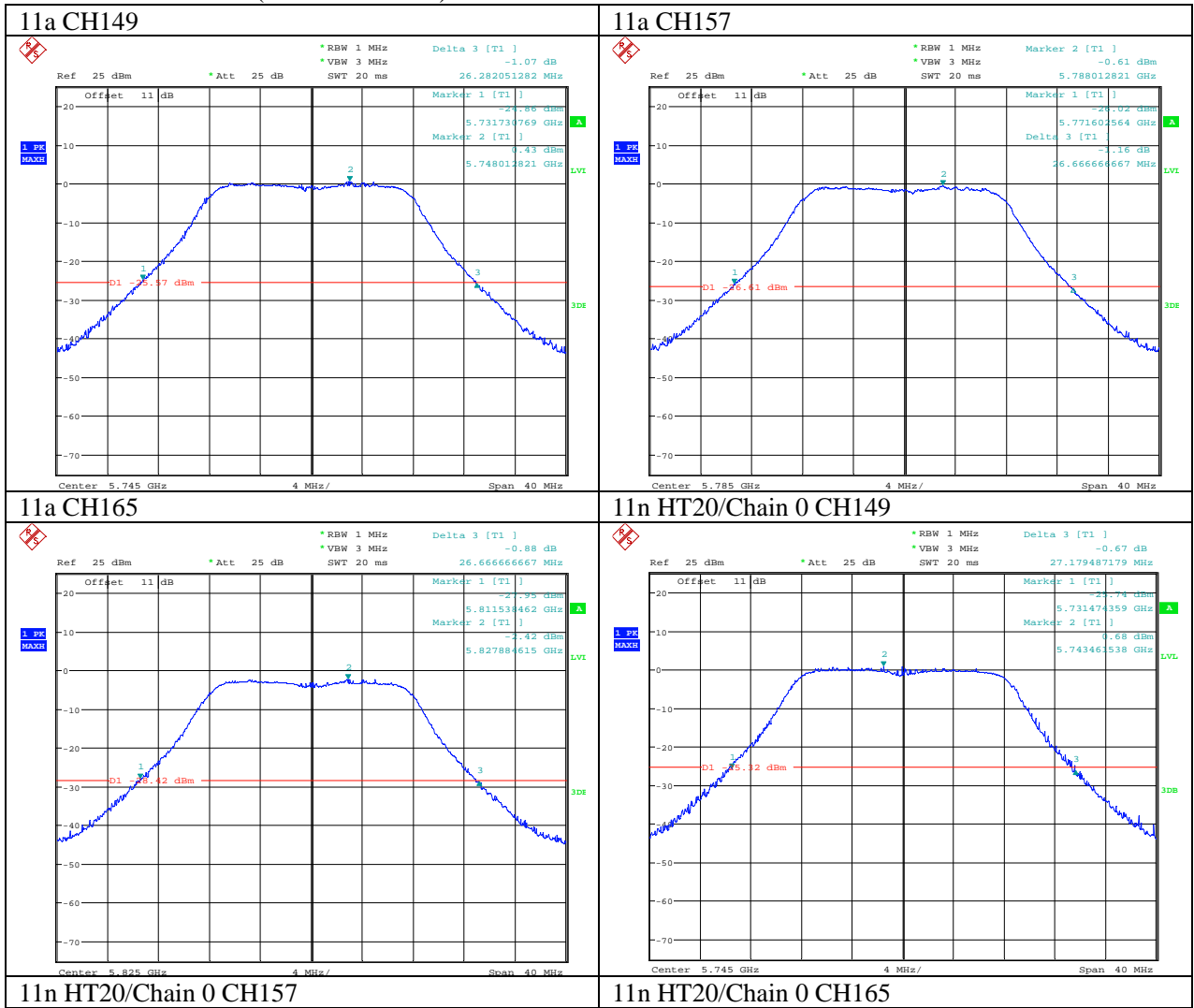

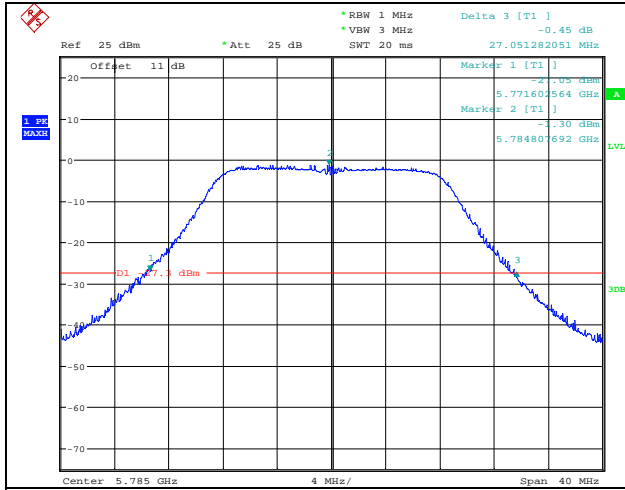

11n HT40/Chain 0 CH151

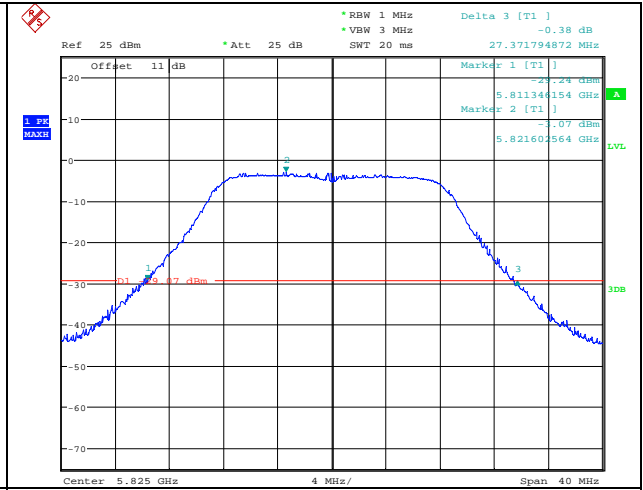

11n HT40/Chain 0 CH159

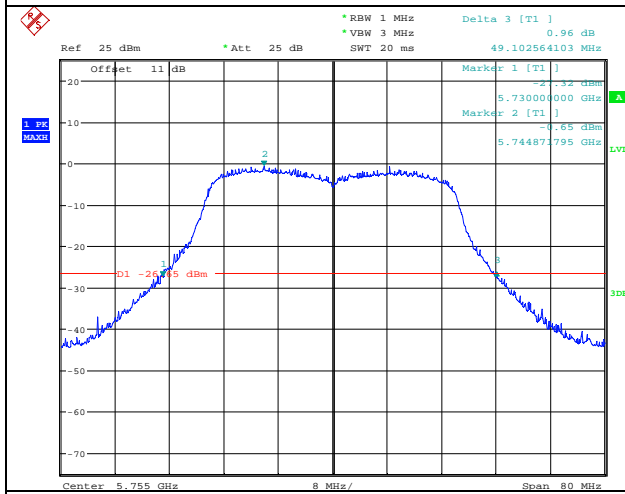

11n HT20/Chain 1 CH149

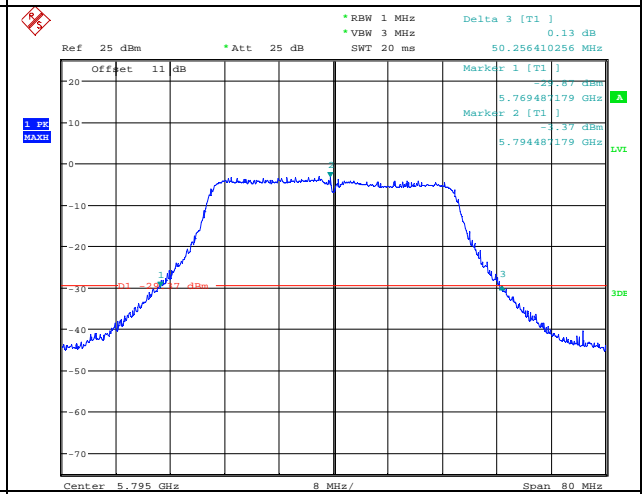

11n HT20/Chain 1 CH157

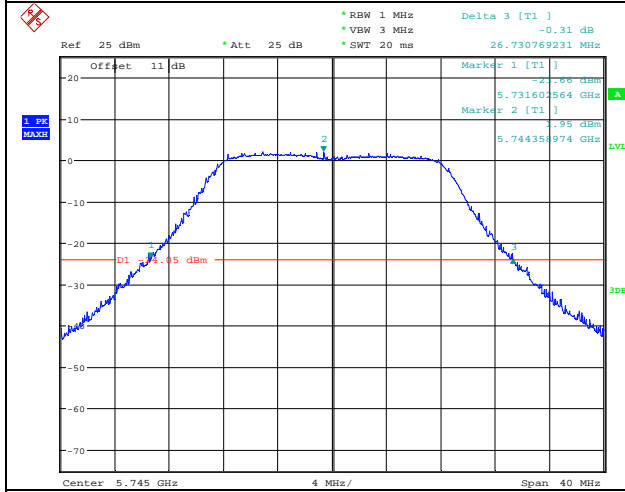

11n HT20/Chain 1 CH165

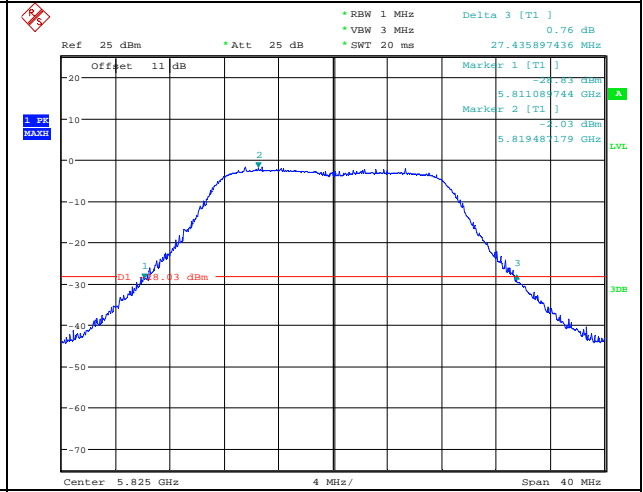

11n HT40/Chain 1 CH151

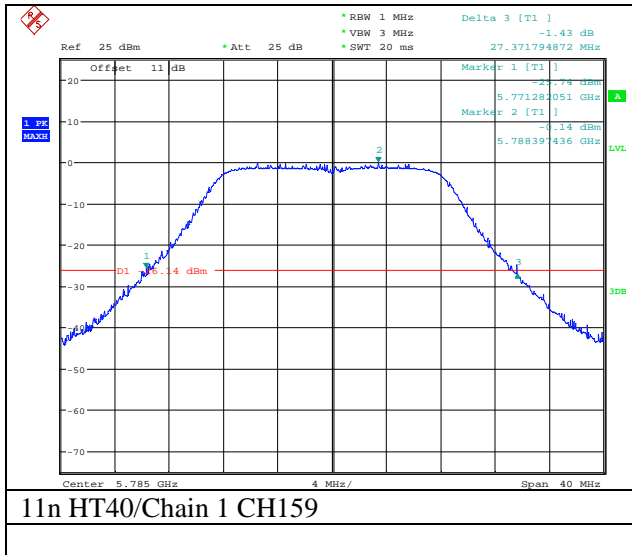

5745-5825MHz Band (6dB bandwidth)

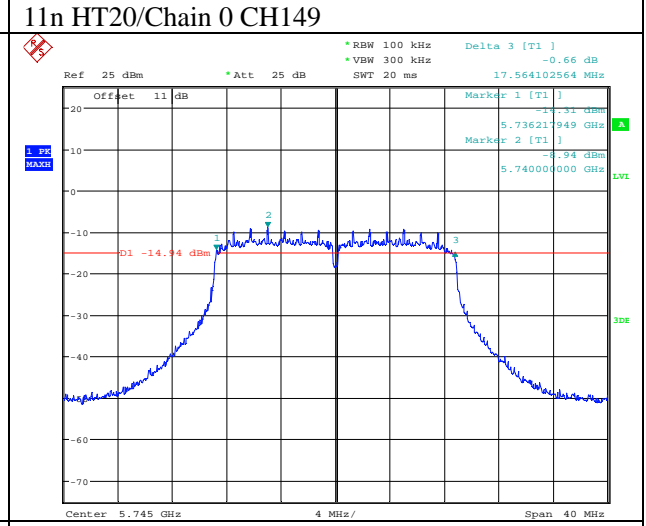
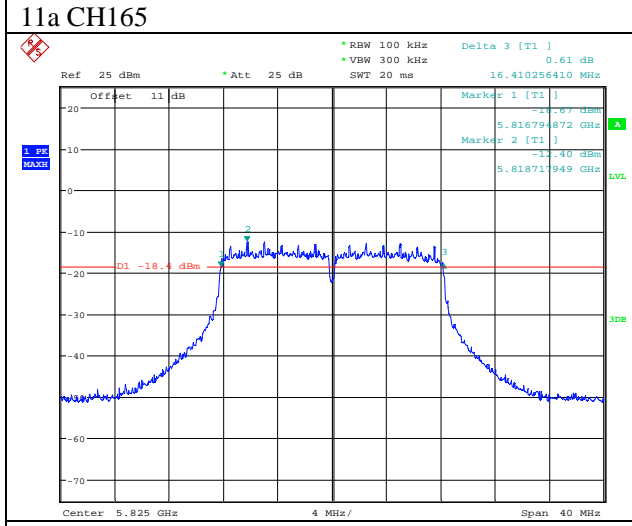
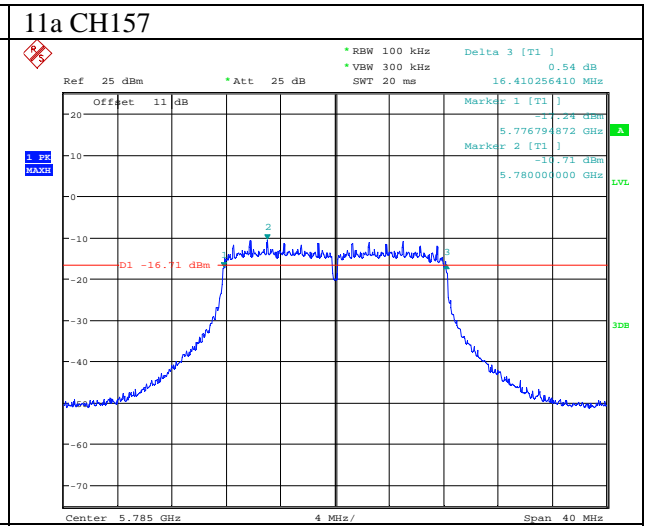
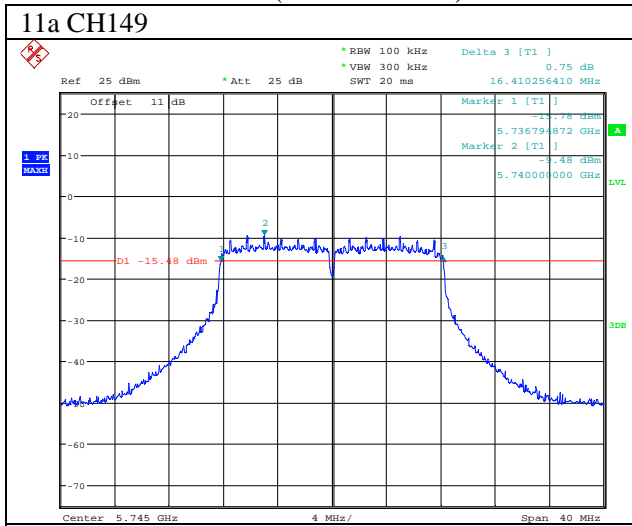

11n HT20/Chain 0 CH157

11n HT20/Chain 0 CH165

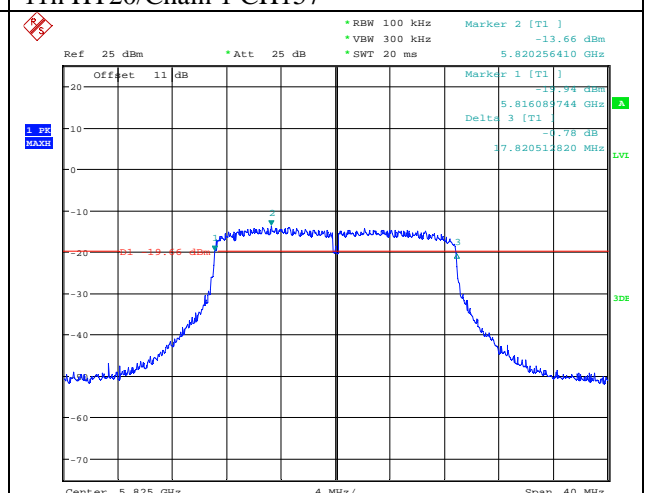
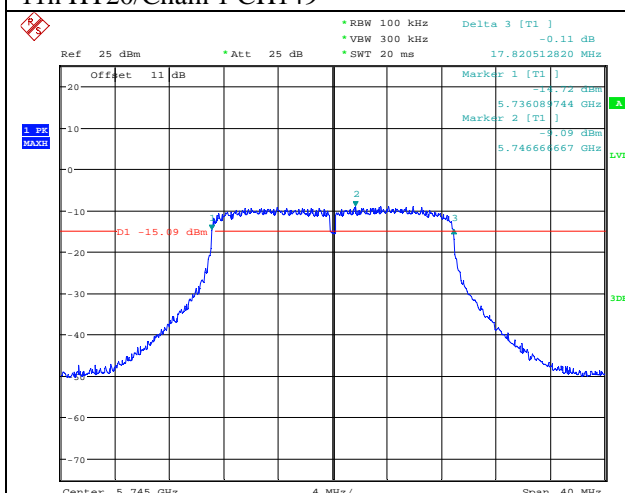
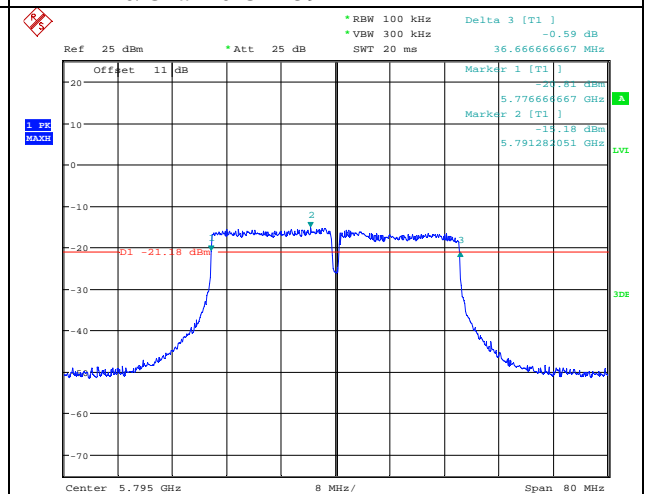
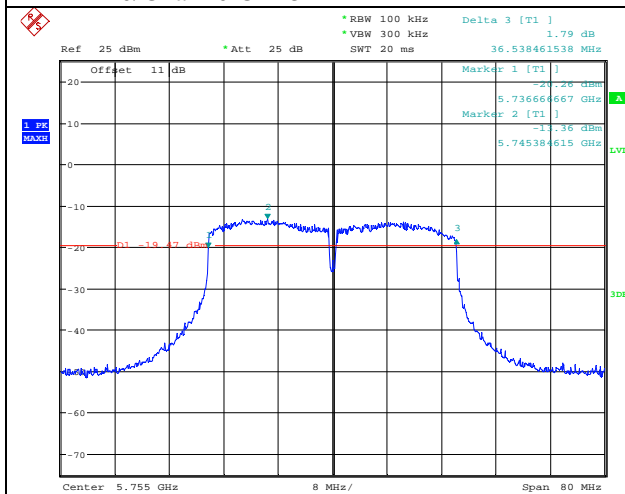
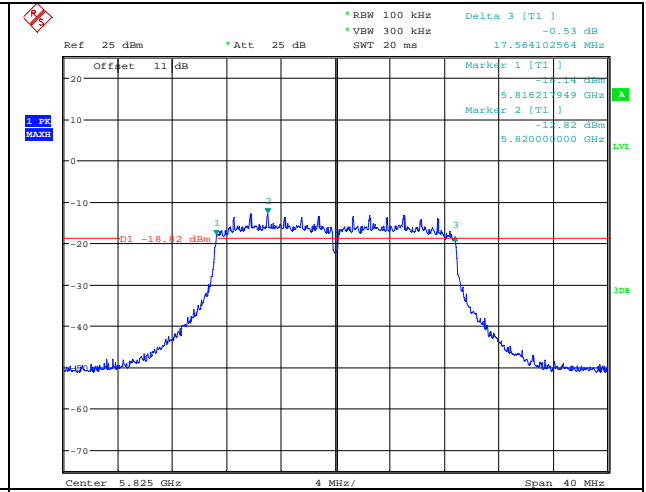
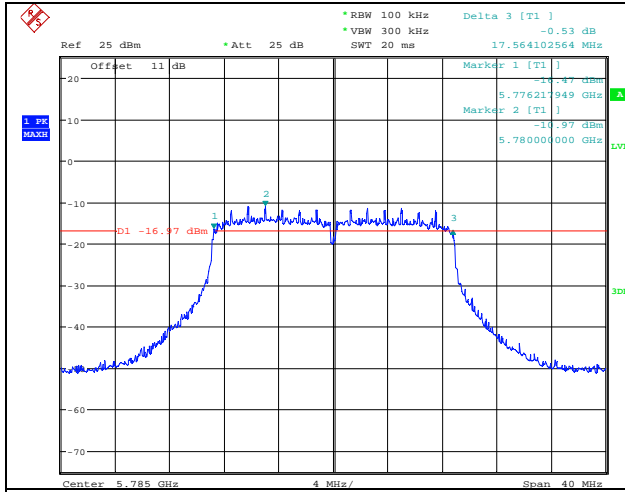

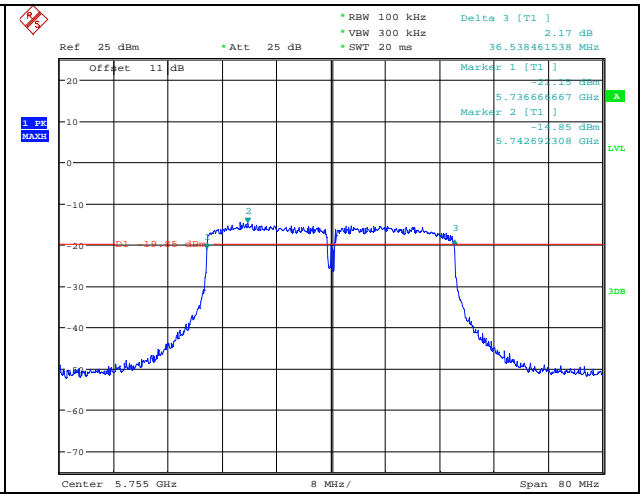
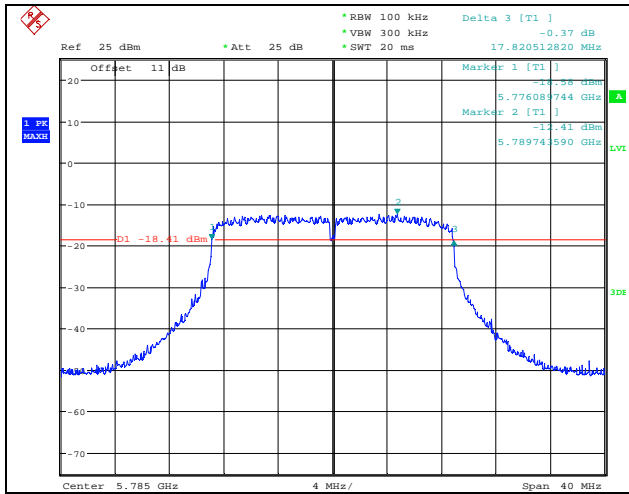

11n HT40/Chain 1 CH159

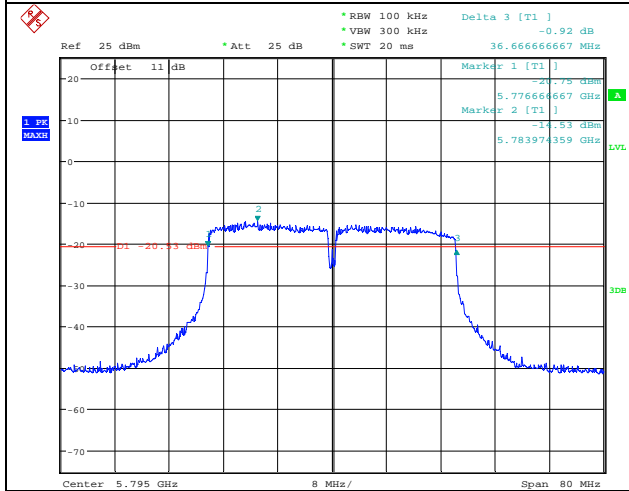

5. Maximum Peak Output Power

5.1. Test equipment

Please refer to Section 3 this report.

5.2. Block diagram of test setup

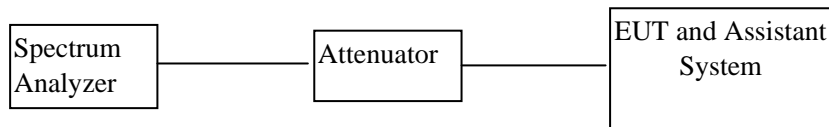

5.3. Limits

For an indoor access point operating in the band 5.15-5.25 GHz, the maximum conducted output power over the frequency band of operation shall not exceed 1 W provided the maximum antenna gain does not exceed 6 dBi. In addition, the maximum power spectral density shall not exceed 17 dBm in any 1 megahertz band. If transmitting antennas of directional gain greater than 6 dBi are used, both the maximum conducted output power and the maximum power spectral density shall be reduced by the amount in dB that the directional gain of the antenna exceeds 6 dBi.

For the band 5.725-5.85 GHz, the maximum conducted output power over the frequency band of operation shall not exceed 1 W. In addition, the maximum power spectral density shall not exceed 30 dBm in any 500-kHz band. If transmitting antennas of directional gain greater than 6 dBi are used, both the maximum conducted output power and the maximum power spectral density shall be reduced by the amount in dB that the directional gain of the antenna exceeds 6 dBi. However, fixed point-to-point U-NII devices operating in this band may employ transmitting antennas with directional gain greater than 6 dBi without any corresponding reduction in transmitter conducted power. Fixed, point-to-point operations exclude the use of point-to-multipoint systems, omnidirectional applications, and multiple collocated transmitters transmitting the same information. The operator of the U-NII device, or if the equipment is professionally installed, the installer, is responsible for ensuring that systems employing high gain directional antennas are used exclusively for fixed, point-to-point operations.

5.4. Test Procedure

- (1) Configure EUT and assistant system according clause 2.3 and 5.2

Connect each EUT's antenna output to Spectrum Analyzer by RF cable and attenuator

- (2) Configure EUT work in test mode as stated in clause 2.3.
- (3) Add each antenna port's results to get the total output power of EUT.

5.5. Test Result

5180-5240MHz Band				
Mode	CH	Channel0	Channel1	Result
		PK Level (dBm)	PK Level (dBm)	PK Total/Max Power
11a	CH36	N/A	N/A	10.57
	CH40	N/A	N/A	10.38
	CH48	N/A	N/A	10.22
11n HT20	CH36	10.47	10.42	13.46
	CH40	10.77	10.49	13.64
	CH48	9.90	11.16	13.59
11n HT40	CH38	9.65	9.58	12.63
	CH46	9.03	10.18	12.65

Limit: 29.6dBm	Conclusion: PASS
Test Date : 2015/10/13	Test Engineer : Toby
Remark: 1.Total Output Power (w) = Chain 0 (10^(Output Power /10)/1000)+ Chain 1 (10^(Output Power /10)/1000)	
2. The maximum antenna gain is 6.4dBi; therefore the reduction due to antenna gain is 0.4dBi, so the limit is 29.6dBm.	

5745-5825MHz Band				
Mode	CH	Channel0	Channel1	Result
		PK Level (dBm)	PK Level (dBm)	PK Total/Max Power
11a	CH149	N/A	N/A	9.65
	CH157	N/A	N/A	9.31
	CH165	N/A	N/A	10.67
11n HT20	CH149	10.33	11.36	13.89
	CH157	9.22	10.49	12.91
	CH165	8.87	9.64	12.28
11n HT40	CH151	9.03	10.71	12.96
	CH159	8.60	10.29	12.54

Limit: 29.6dBm	Conclusion: PASS
Test Date : 2015/10/13	Test Engineer : Toby
Remark: 1.Total Output Power (w) = Chain 0 (10^(Output Power /10)/1000)+ Chain 1 (10^(Output Power /10)/1000)	
2. The maximum antenna gain is 6.4dBi; therefore the reduction due to antenna gain is 0.4dBi, so the limit is 29.6dBm.	

5.6. The worst of the original test data

The worst case is 11n HT20 mode was selected and recorded in this report
5180-5240MHz Band

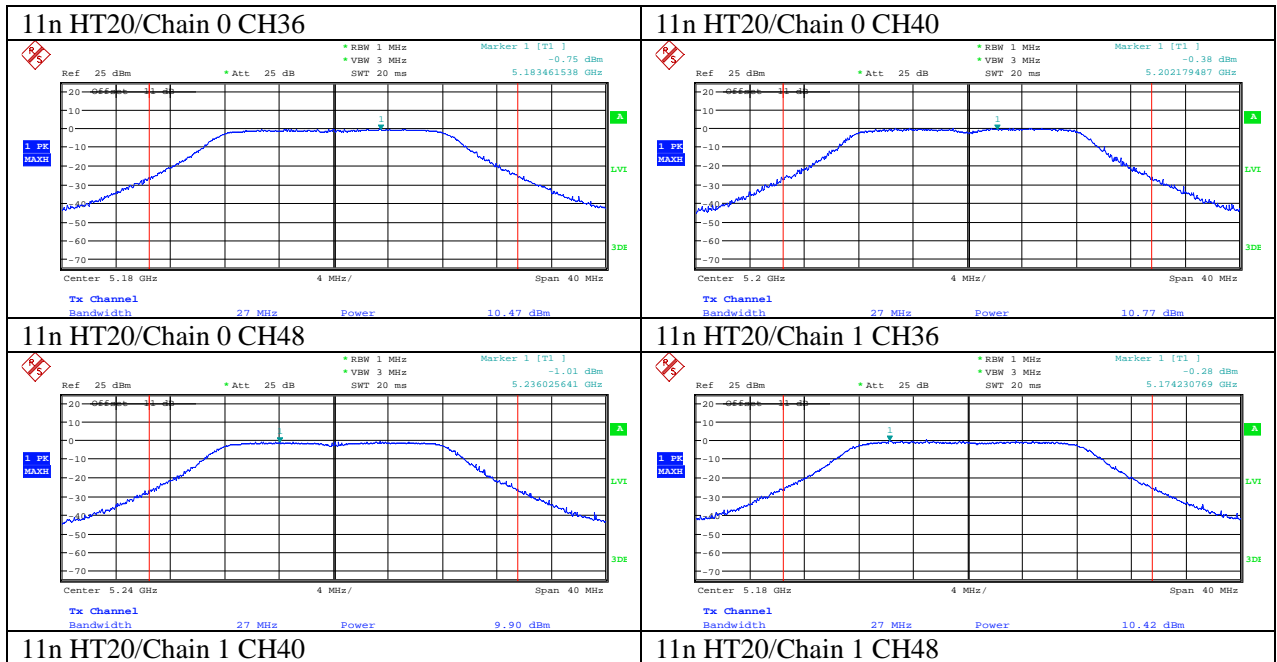

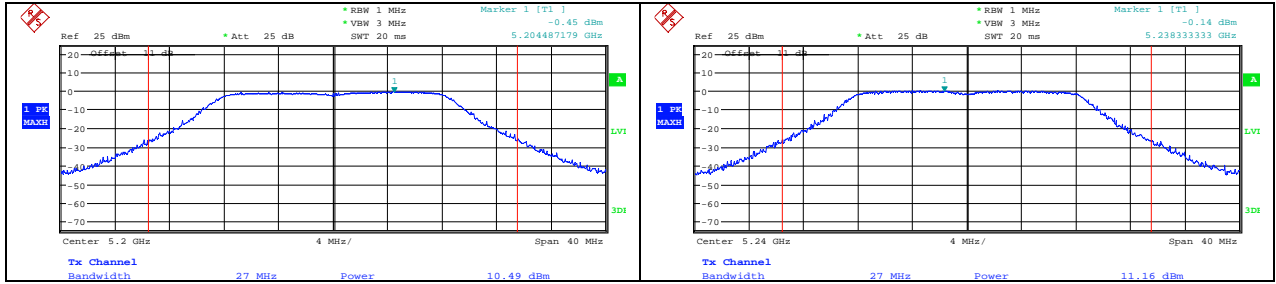

5745-5825MHz Band

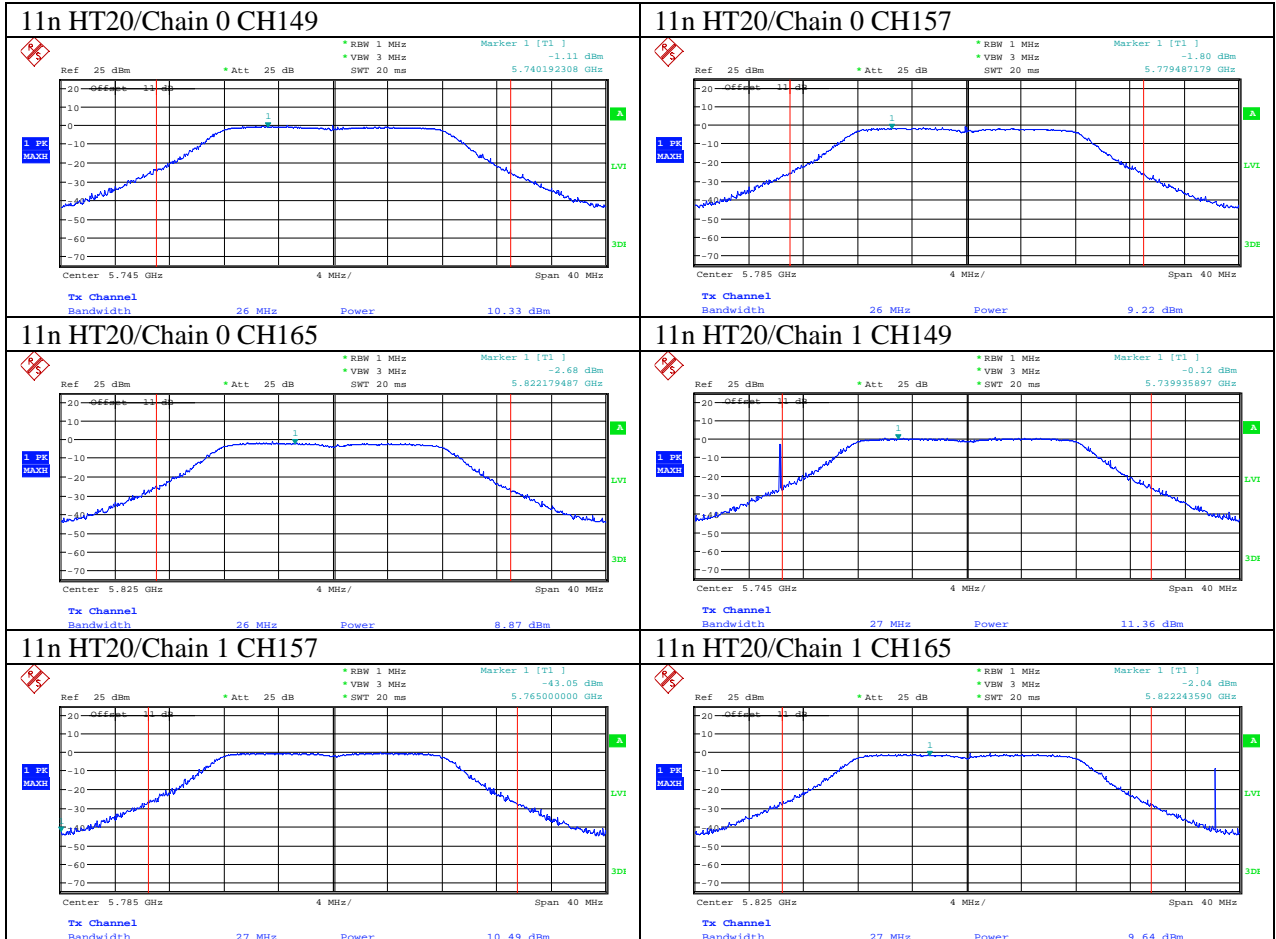

6. Power Spectral Density

6.1. Test equipment

Please refer to Section 3 this report.

6.2. Block diagram of test setup

Same with 4.2

6.3. Limits

For the band 5.15-5.25 GHz, the peak power spectral density shall not exceed 17 dBm in any 1-MHz band. If transmitting antennas of directional gain greater than 6 dBi are used, the peak power spectral density

shall be reduced by the amount in dB that the directional gain of the antenna exceeds 6 dBi.
For the band 5.825-5.85 GHz,, the power spectral density conducted from the intentional radiator to the antenna shall not be greater than 8dBm in any 3 kHz band during any time interval of continuous transmission

6.4. Test Procedure

The transmitter output was connected to a spectrum analyzer. Power density was measured by spectrum analyzer with 1MHz RBW and 3MHz VBW.

6.5. Test Result

5180-5240MHz Band				
Mode	CH	Channel0 (dBm/1MHz)	Channel1 (dBm/1MHz)	Result (dBm/1MHz)
11a	CH36	N/A	N/A	1.04
	CH40	N/A	N/A	-0.19
	CH48	N/A	N/A	0.39
11n HT20	CH36	-0.79	-0.96	2.14
	CH40	-0.07	-0.20	2.88
	CH48	-1.24	1.06	3.07
11n HT40	CH38	-4.95	-3.85	-1.35
	CH46	-4.03	-3.11	-0.54
Limit: 16.6dBm/1MHz			Conclusion: PASS	
Test Date : 2015/10/13			Test Engineer : Toby	
Remark: 1.Total Output Power (w) = Chain 0 (10^(Output Power /10)/1000)+ Chain 1 (10^(Output Power /10)/1000)				
2. The maximum antenna gain is 6.4dBi; therefore the reduction due to antenna gain is 0.4dBi, so the limit is 16.6dBm.				
5725-5850MHz Band				
Mode	CH	Channel0 (dBm/1MHz)	Channel1 (dBm/0.5MHz)	Result (dBm/0.5MHz)
11a	CH149	N/A	N/A	-3.21
	CH157	N/A	N/A	-4.15
	CH165	N/A	N/A	-6.26
11n HT20	CH149	-3.64	-1.98	0.28
	CH157	-5.52	-4.66	-2.06
	CH165	-7.47	-5.58	-3.41
11n HT40	CH151	-5.64	-7.03	-3.27
	CH159	-7.43	-7.03	-4.22
Limit: 29.6dBm/500KHz			Conclusion: PASS	
Test Date : 2015/10/13			Test Engineer : Toby	
Remark: 1.Total Output Power (w) = Chain 0 (10^(Output Power /10)/1000)+ Chain 1 (10^(Output Power /10)/1000)				
2. The maximum antenna gain is 6.4dBi; therefore the reduction due to antenna gain is 0.4dBi, so the limit is 29.6dBm.				

6.6. The worst of the original test data

5180-5240MHz Band

11a CH36	11a CH40
----------	----------

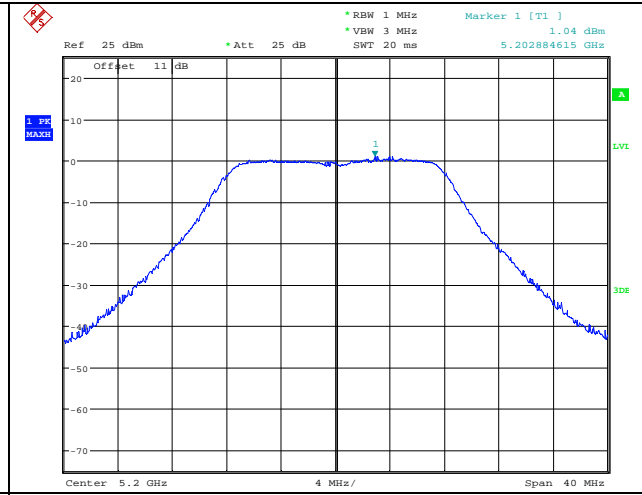
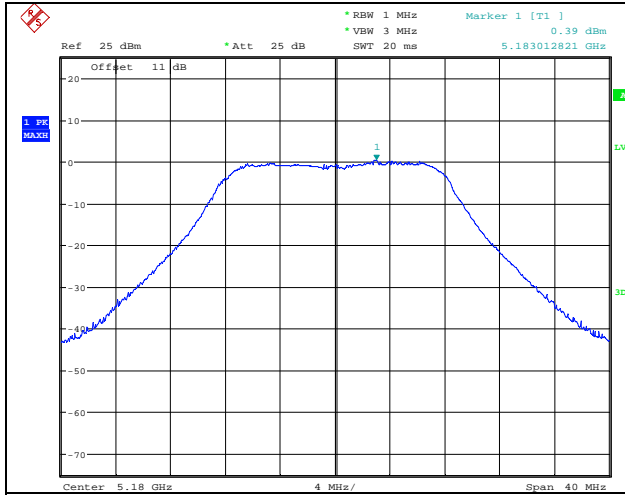

11a CH48

11n HT20/Chain 0 CH36

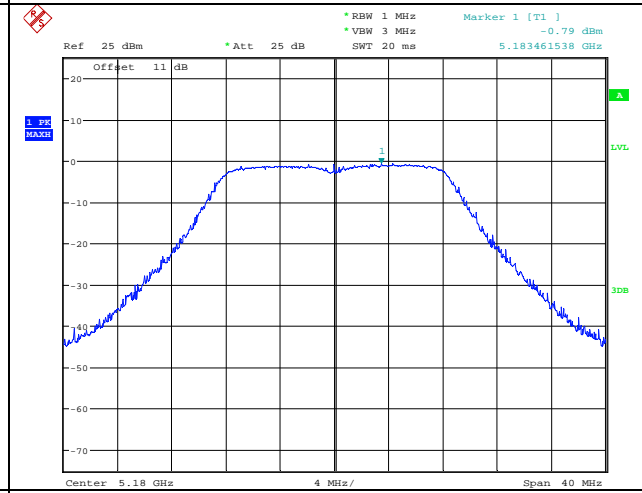
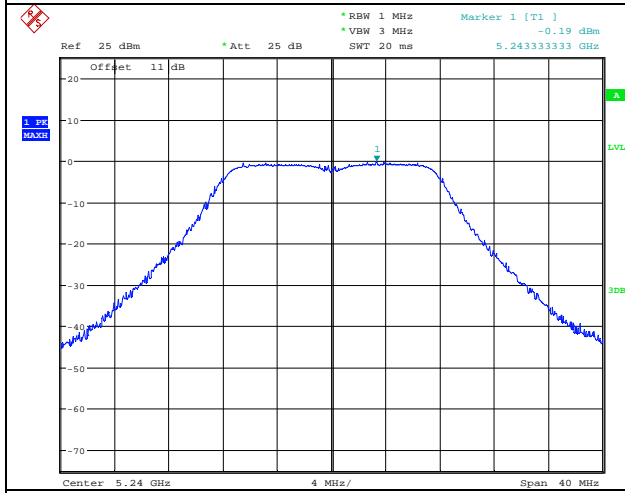

11n HT20/Chain 0 CH40

11n HT20/Chain 0 CH38

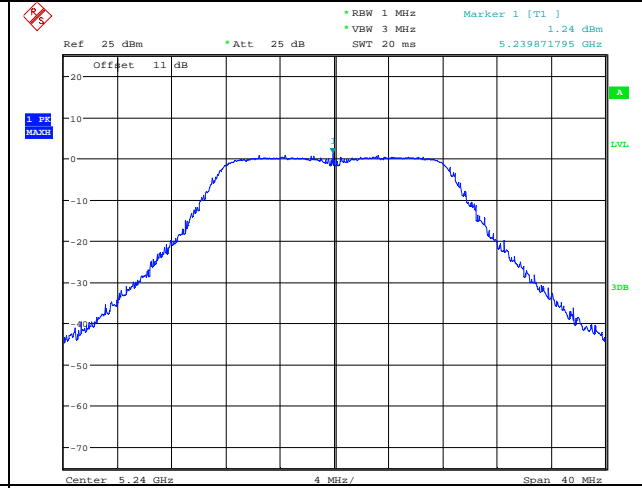
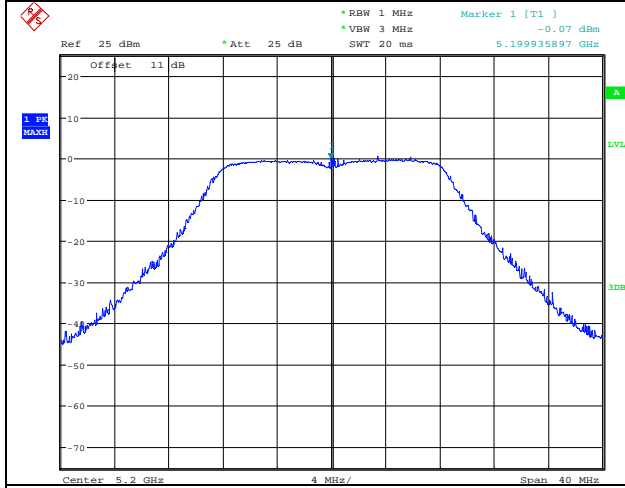

11n HT40/Chain 0 CH38

11n HT40/Chain 0 CH46

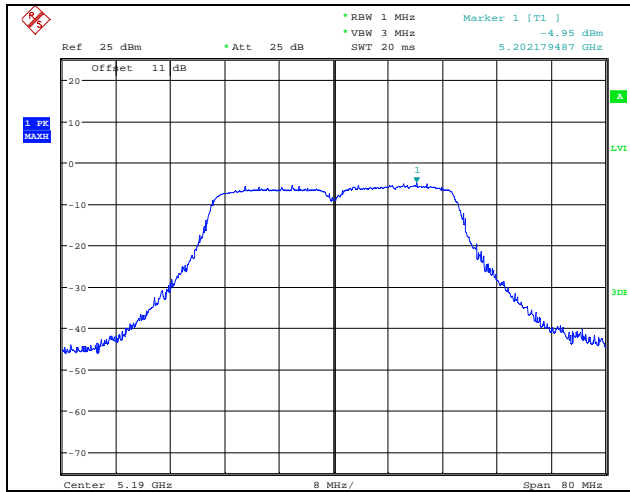

11n HT20/Chain 1 CH36

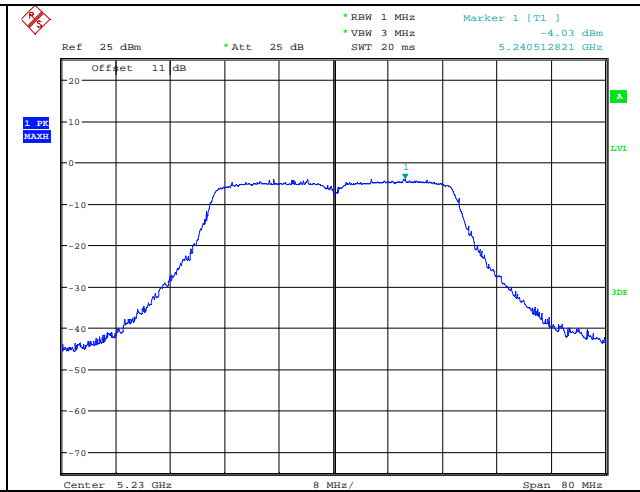

11n HT20/Chain 1 CH40

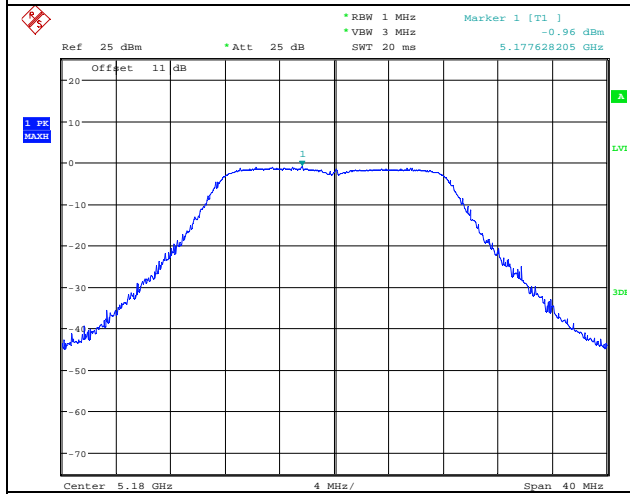

11n HT40/Chain 1 CH48

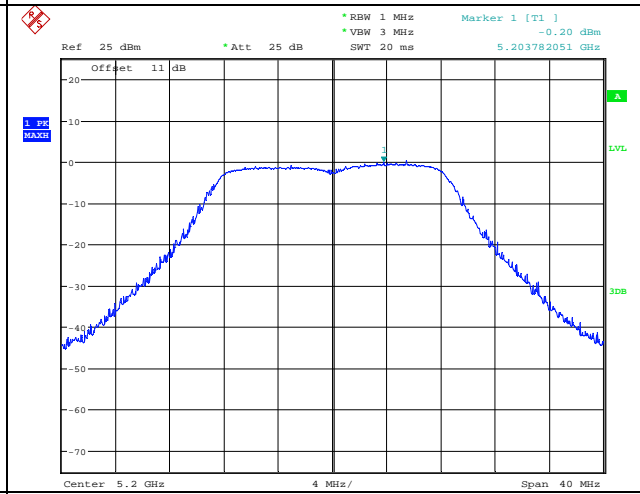

11n HT40/Chain 1 CH38

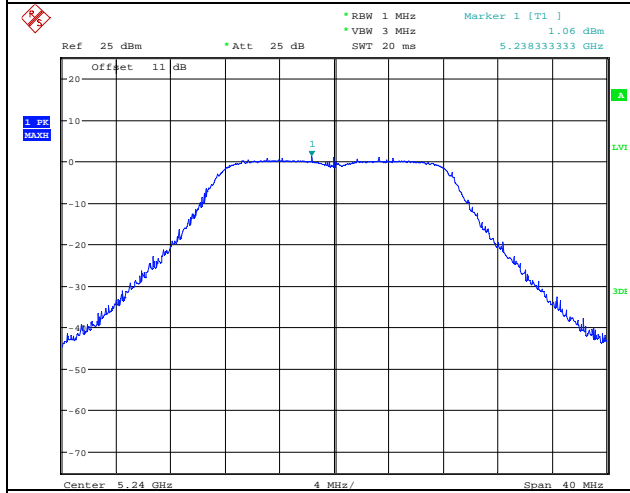

11n HT40/Chain 1 CH46

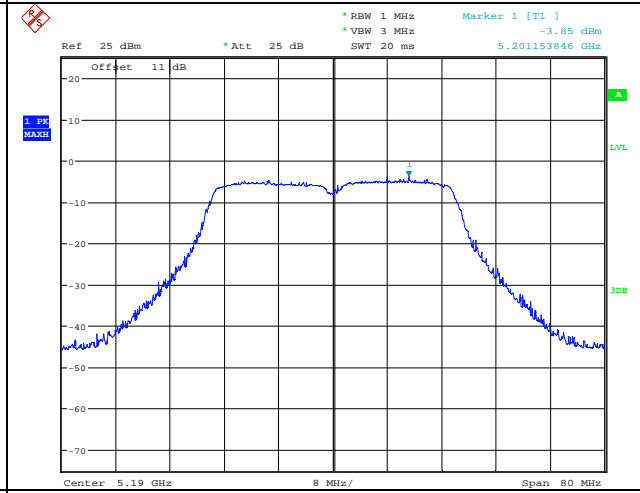

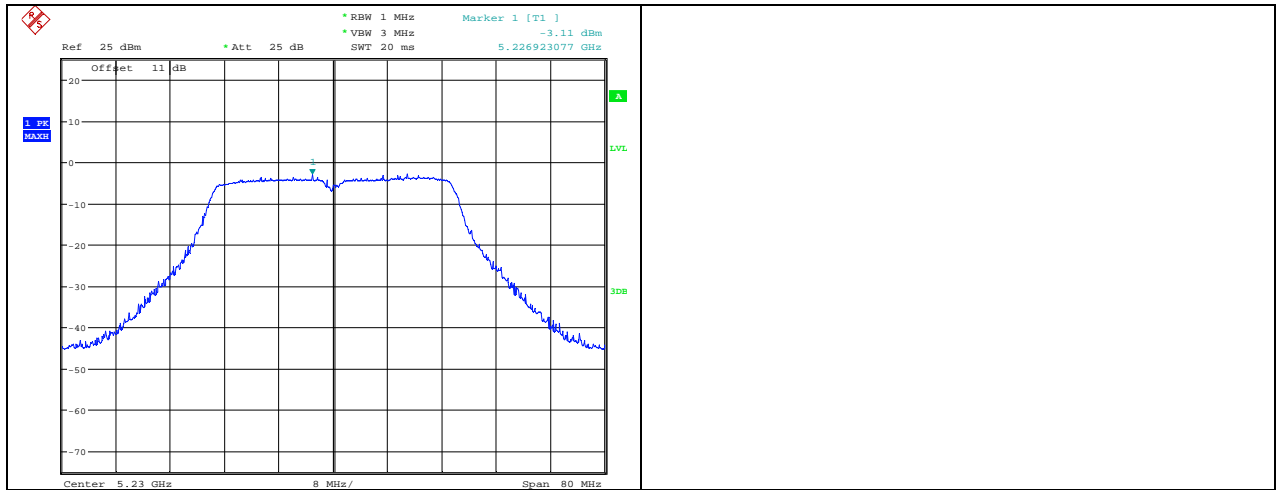

5745-5825MHz Band

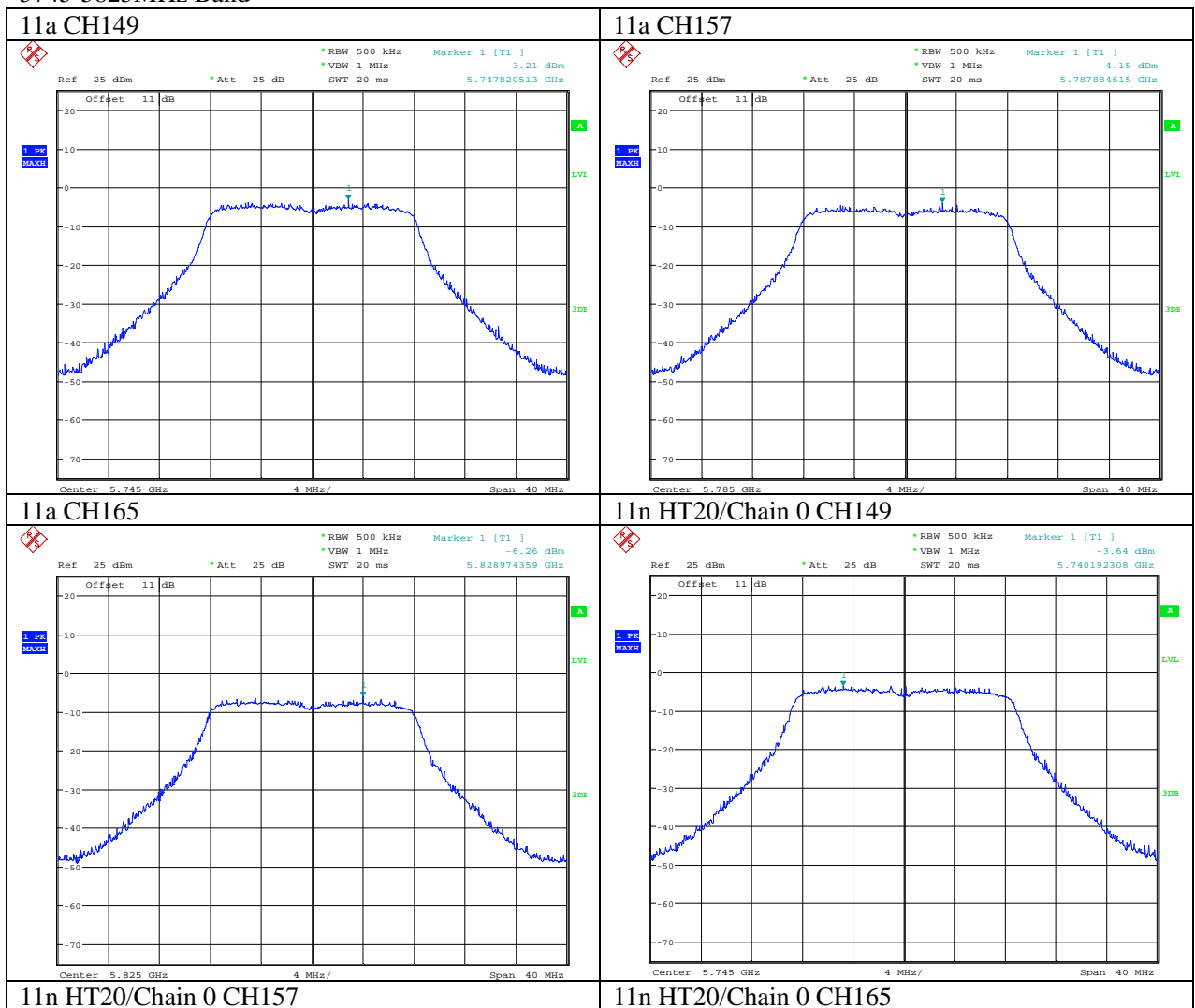

11n HT20/Chain 0 CH157

11n HT20/Chain 0 CH165

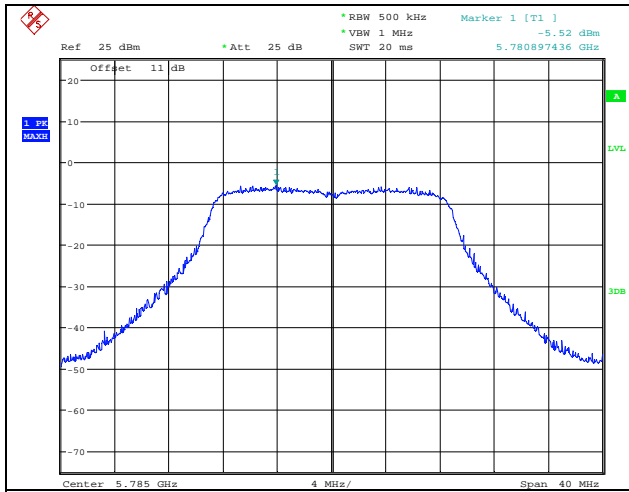

11n HT40/Chain 0 CH151

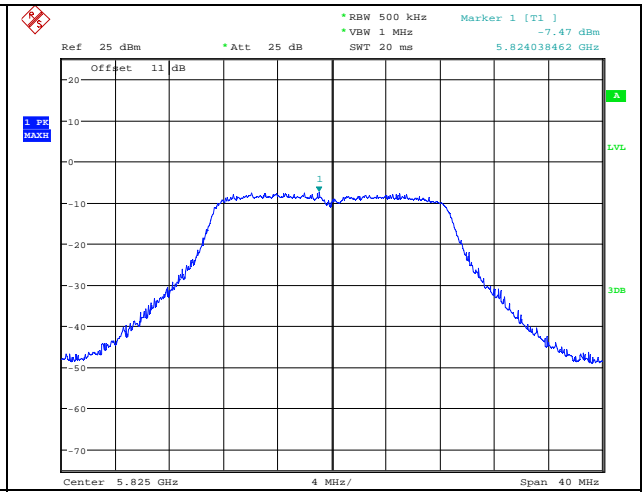

11n HT40/Chain 0 CH159

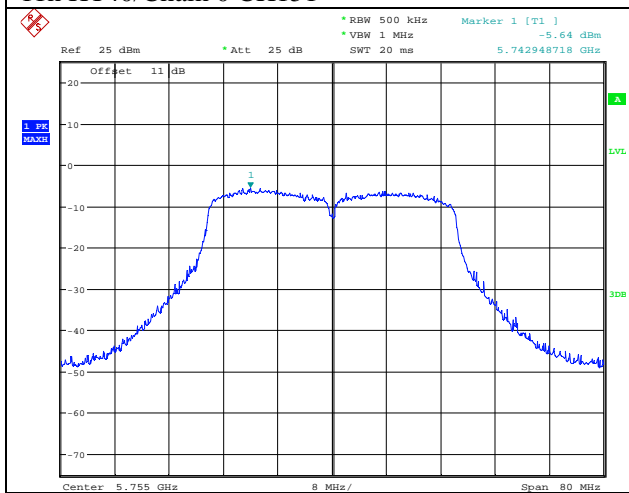

11n HT20/Chain 1 CH149

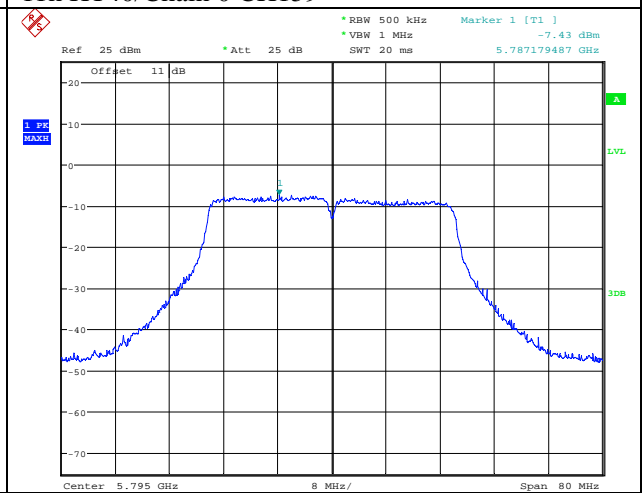

11n HT20/Chain 1 CH157

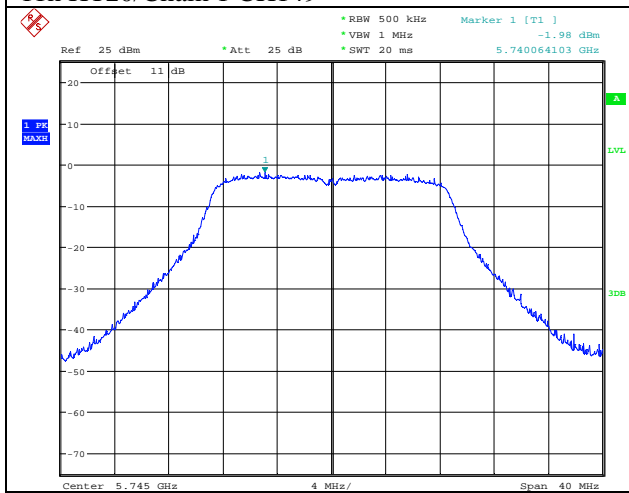

11n HT40/Chain 1 CH165

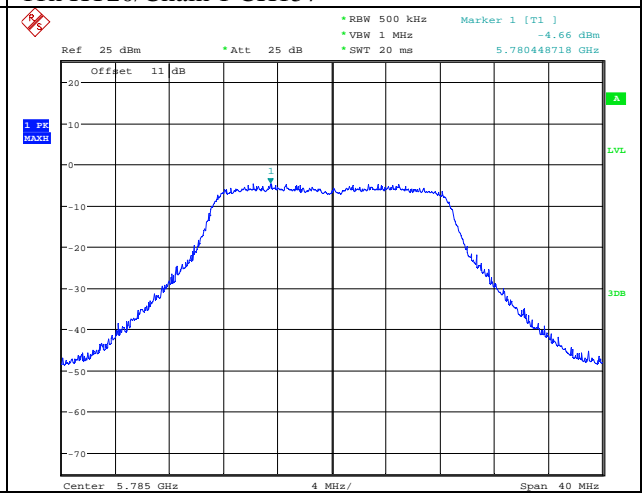

11n HT40/Chain 1 CH151

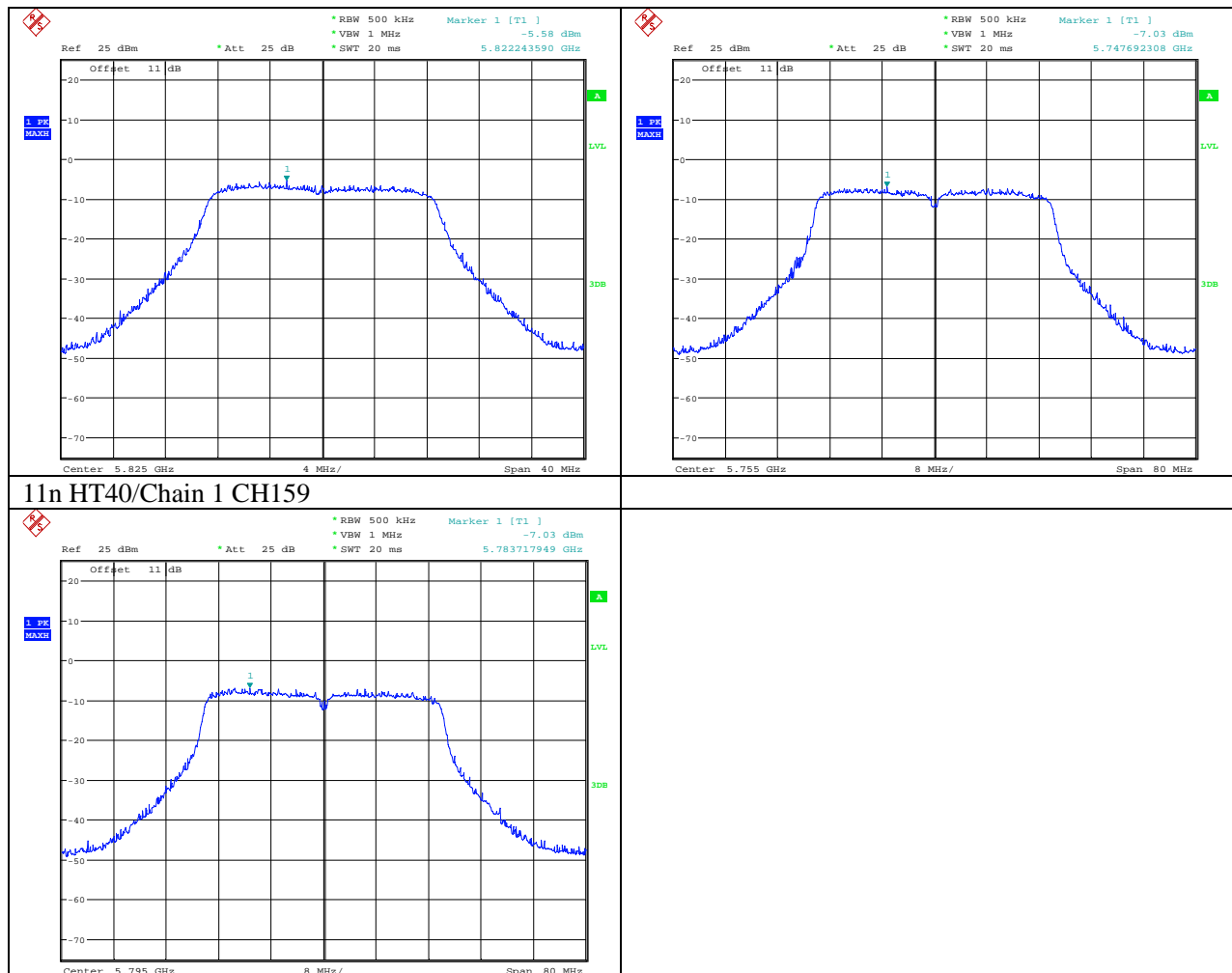

7. Frequency Stability Measurement

7.1. Limit of Frequency Stability

Manufacturers of U-NII devices are responsible for ensuring frequency stability such that an emission is maintained within the band of operation under all conditions of normal operation as specified in the user's manual.

7.2. Measuring Instruments

The measuring equipment is listed in the section 4 of this test report.

7.3. Test Procedures

- (1) To ensure emission at the band edge is maintained within the authorized band, those values shall be measured by radiation emissions at upper and lower frequency points, and finally compensated by frequency deviation as procedures below.
- (2) The EUT was operated at the maximum output power, and connected to the spectrum analyzer, which is set to maximum hold function and peak detector. The peak value of the power envelope was measured and noted. The upper and lower frequency points were respectively measured relatively 10dB lower than the measured peak value.
- (3) The frequency deviation was calculated by adding the upper frequency point and the lower frequency

point divided by two. Those detailed values of frequency deviation are provided in table below.

7.4. Test Setup

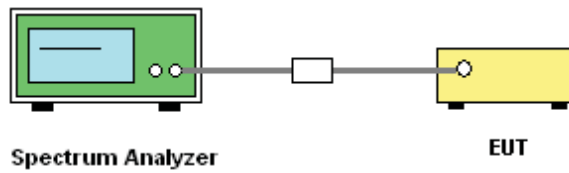

7.5. Test Result of Frequency Stability

Mod.	Data Rate	NT X	Channel	Freq. (MHz)	Center Frequency (MHz)	Frequency Deviation (MHz)	Frequency Stability (ppm)	Temperature (C-)	Voltage (V)
11a	6Mbps	1	36	5180	5180.019	0.019	3.67	25	45
11a	6Mbps	1	36	5180	5180.024	0.024	4.63	25	55
11a	6Mbps	1	36	5180	5180.025	0.025	4.83	55	50
11a	6Mbps	1	36	5180	5180.031	0.031	5.98	45	50
11a	6Mbps	1	36	5180	5180.029	0.029	5.6	35	50
11a	6Mbps	1	36	5180	5180.041	0.041	7.92	25	50
11a	6Mbps	1	36	5180	5180.044	0.044	8.49	10	50
11a	6Mbps	1	36	5180	5180.054	0.054	1.04	0	50
11a	6Mbps	1	36	5180	5180.032	0.032	6.18	-10	50

Note1: Center Frequency = (Low Frequency + High Frequency) / 2.

Note2: The frequency band 5180-5240MHz which was verified by testing against other standard is less than 20 ppm which is sufficient to maintain the signal within the 5150-5250MHz band.

8. Emissions in restricted frequency bands

8.1. Test equipment

Please refer to Section 3 this report.

8.2. Block diagram of test setup

In 3m Anechoic Chamber Test Setup Diagram for 9KHz-30MHz

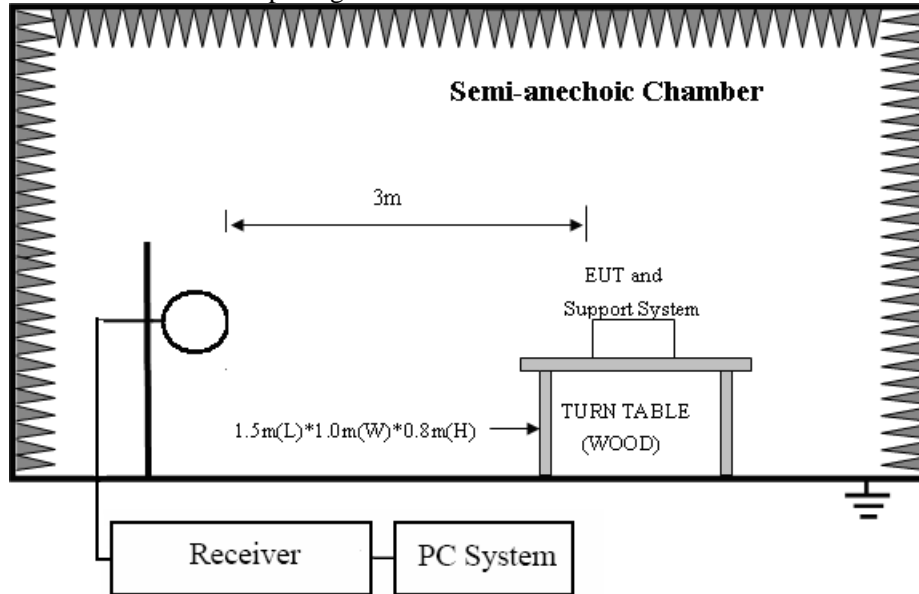

In 3m Anechoic Chamber Test Setup Diagram for 30MHz-1GHz

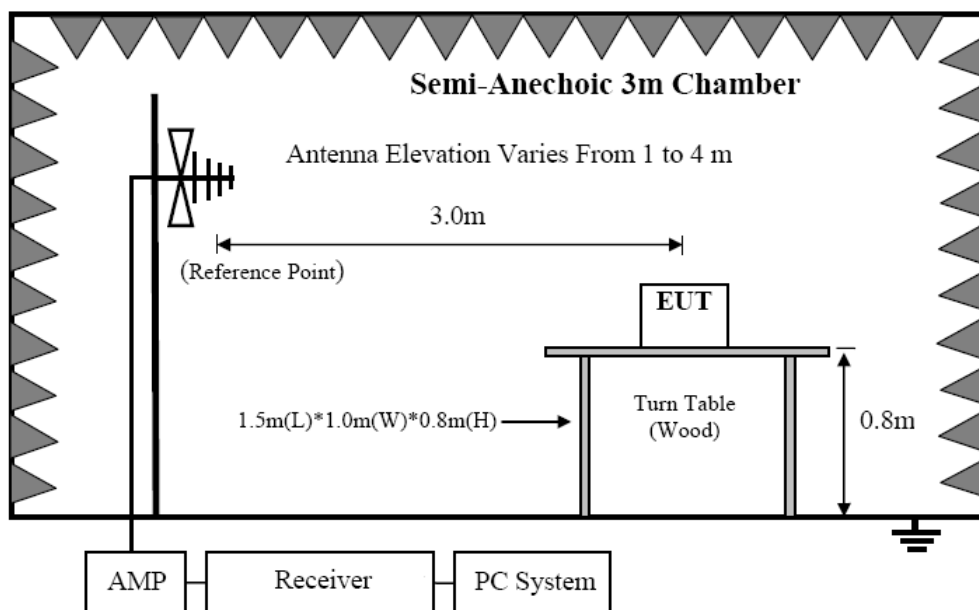

In 3m Anechoic Chamber Test Setup Diagram for frequency above 1GHz

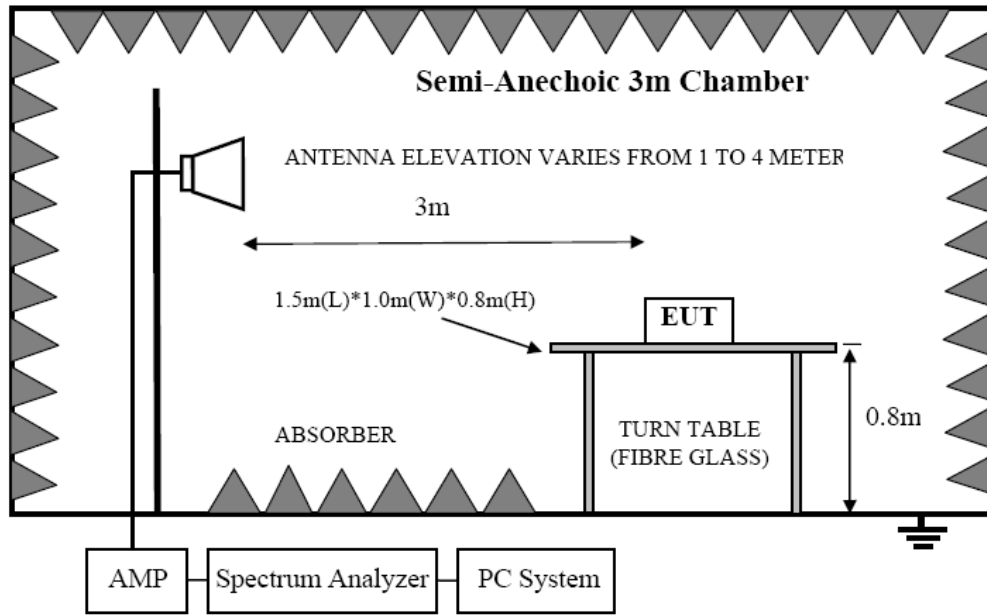

Note: For harmonic emissions test a appropriate high pass filter was inserted in the input port of AMP.

8.3. Limit

8.3.1 FCC 15.205 Restricted frequency band

MHz	MHz	MHz	GHz
0.090 - 0.110	16.42 - 16.423	399.9 - 410	4.5 - 5.15
¹ 0.495 - 0.505	16.69475 - 16.69525	608 - 614	5.35 - 5.46
2.1735 - 2.1905	16.80425 - 16.80475	960 - 1240	7.25 - 7.75
4.125 - 4.128	25.5 - 25.67	1300 - 1427	8.025 - 8.5
4.17725 - 4.17775	37.5 - 38.25	1435 - 1626.5	9.0 - 9.2
4.20725 - 4.20775	73 - 74.6	1645.5 - 1646.5	9.3 - 9.5
6.215 - 6.218	74.8 - 75.2	1660 - 1710	10.6 - 12.7
6.26775 - 6.26825	108 - 121.94	1718.8 - 1722.2	13.25 - 13.4
6.31175 - 6.31225	123 - 138	2200 - 2300	14.47 - 14.5
8.291 - 8.294	149.9 - 150.05	2310 - 2390	15.35 - 16.2
8.362 - 8.366	156.52475 - 156.52525	2483.5 - 2500	17.7 - 21.4
8.37625 - 8.38675	156.7 - 156.9	2690 - 2900	22.01 - 23.12
8.41425 - 8.41475	162.0125 - 167.17	3260 - 3267	23.6 - 24.0
12.29 - 12.293	167.72 - 173.2	3332 - 3339	31.2 - 31.8
12.51975 - 12.52025	240 - 285	3345.8 - 3358	36.43 - 36.5
12.57675 - 12.57725	322 - 335.4	3600 - 4400	(²)

8.3.2 FCC 15.209 Limit.

FREQUENCY MHz	DISTANCE Meters	FIELD STRENGTHS LIMIT	
		μV/m	dB(μV)/m
0.009 ~ 0.490	300	2400/F(KHz)	67.6-20log(F)
0.490 ~ 1.705	30	24000/F(KHz)	87.6-20log(F)
1.705 ~ 30.0	30	30	29.54
30 ~ 88	3	100	40.0
88 ~ 216	3	150	43.5
216 ~ 960	3	200	46.0

960 ~ 1000	3	500	54.0
Above 1000	3	74.0 dB(μ V)/m (Peak) 54.0 dB(μ V)/m (Average)	

Note: (1)The emission limits shown in the above table are based on measurements employing a CISPR QP detector except for the frequency bands 9-90KHz, 110-490KHz and above 1000MHz. Radiated emissions limits in these three bands are based on measurements employing an average detector.

(2) At frequencies below 30MHz, measurement may be performed at a distance closer than that specified, and the limit at closer measurement distance can be extrapolated by below formula:

$$\text{Limit}_{3m}(\text{dB}\mu\text{V}/\text{m}) = \text{Limit}_{30m}(\text{dB}\mu\text{V}/\text{m}) + 40\text{Log}(30\text{m}/3\text{m})$$

8.3.3 Limit for this EUT

All the emissions appearing within 15.205 restricted frequency bands shall not exceed the limits shown in 15.209, all the other emissions shall be at least 20dB below the fundamental emissions, or comply with 15.209 limits.

8.4. Test Procedure

- (1) EUT height should be 0.8m for below 1GHz at a semi - anechoic chamber while EUT height should be 1.5m for above 1GHz at full chamber or semi - anechoic chamber ground with absorbers
- (2) Setup EUT and assistant system according clause 2.3 and 8.2
- (3) Test antenna was located 3m from the EUT on an adjustable mast, and the antenna used as below table.

Test frequency range	Test antenna used
9KHz-30MHz	Active Loop antenna
30MHz-1GHz	Trilog Broadband Antenna
1GHz-18GHz	Double Ridged Horn Antenna(1GHz-18GHz)
18GHz-40GHz	Horn Antenna(18GHz-40GHz)

According ANSI C63.10:2013 clause 6.4.4.2 and 6.5.3, for measurements below 30 MHz, the loop antenna was positioned with its plane vertical from the EUT and rotated about its vertical axis for maximum response at each azimuth position around the EUT. And the loop antenna also be positioned with its plane horizontal at the specified distance from the EUT. The center of the loop is 1 m above the ground. for measurement above 30MHz, the Trilog Broadband Antenna or Horn Antenna was located 3m from EUT, Measurements were made with the antenna positioned in both the horizontal and vertical planes of Polarization, and the measurement antenna was varied from 1 m to 4 m. in height above the reference ground plane to obtain the maximum signal strength.

- (4) Below pre-scan procedure was first performed in order to find prominent frequency spectrum radiated emissions from 9KHz to 25GHz:

(a) Scanning the peak frequency spectrum with the antenna specified in step (3), and the EUT was rotated 360 degree, the antenna height was varied from 1m to 4m(Except loop antenna, it's fixed 1m above ground.)

(b) Change work frequency or channel of device if practicable.

(c) Change modulation type of device if practicable.

(d) Change power supply range from 85% to 115% of the rated supply voltage

(e) Rotated EUT though three orthogonal axes to determine the attitude of EUT arrangement produces highest emissions.

Spectrum frequency from 9KHz to 25GHz (tenth harmonic of fundamental frequency) was investigated, and no any obvious emission were detected from 9KHz to 30MHz and 18GHz to 25GHz, so below final test was performed with frequency range from 30MHz to 18GHz.

(5) For final emissions measurements at each frequency of interest, the EUT was rotated and the antenna height was varied between 1m and 4m in order to maximize the emission. Measurements in both horizontal and vertical polarities were made and the data was recorded. In order to find the maximum emission, the relative positions of equipments and all of the interface cables were changed according to ANSI C63.10 2013 on Radiated Emission test.

(6) The emissions from 9KHz to 1GHz were measured based on CISPR QP detector except for the frequency bands 9-90KHz, 110-490KHz, for emissions from 9KHz-90KHz,110KHz-490KHz and above 1GHz were measured based on average detector, for emissions above 1GHz, peak emissions also be measured and need comply with Peak limit.

(7) The emissions from 9KHz to 1GHz, QP or average values were measured with EMI receiver with below RBW

Frequency band	RBW
9KHz-150KHz	200Hz
150KHz-30MHz	9KHz
30MHz-1GHz	120KHz

(8) For emissions above 1GHz, both Peak and Average level were measured with Spectrum Analyzer, and the RBW is set at 1MHz, VBW is set at 3MHz ,Peak detector for Peak measure , RMS detector for AV value

8.5. Test result

PASS. (See below detailed test result)

All the emissions except fundamental emission from 9KHz to 40GHz were comply with 15.209 limit.

Note1: According exploratory test no any obvious emission were detected from 9KHz to 30MHz and 18GHz to 40GHz, so the final test was performed with frequency range from 30MHz to 18GHz and recorded in below.

Note2: For emissions below 1GHz, according exploratory explorer test, when change Tx mode and channel, have no distinct influence on emissions level, so for emissions below 1GHz, the final test was only performed with EUT working in 11a, Tx CH40 mode.

Note3: For below test data, when the limit tabular marked “/” means this frequency point is the fundamental emission and no need comply with this limit.

Radiated Emission test (below 1GHz)

TR-4-E-009 Radiated Emission Test Result

Test Site : DDT 3m Chamber E:\2015 Report Data\15Q0831-1\RE.EM6
Test Date : 2015-09-24 **Tested By** : Toby
EUT : Outdoor Access Point **Model Number** : DCWL-7962OT
Power Supply : DC 50V from external POE adapter **Test Mode** : TX Mode
Condition : Temp:24.5'C,Humi:55%,
 : Press:100.1kPa **Antenna/Distance** : 2014 VULB 9163/3m/HORIZONTAL
Memo :

Data: 3

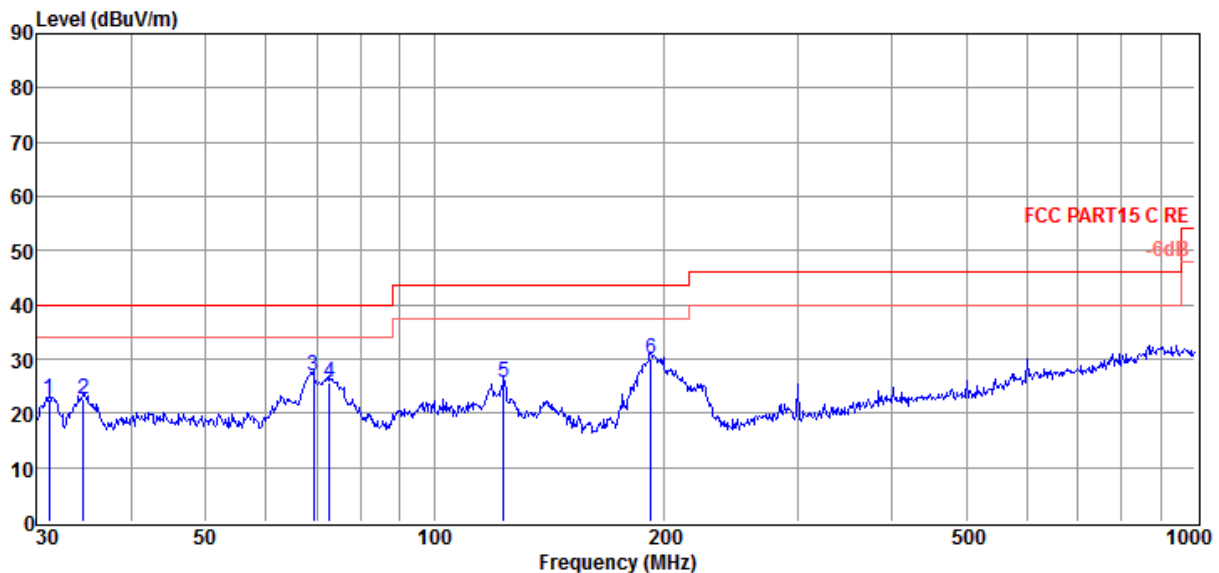

Item (Mark)	Freq (MHz)	Read Level (dBμV)	Antenna Factor (dB/m)	Cable Loss (dB)	Result Level (dBμV/m)	Limit Line (dBμV/m)	Over Limit (dB)	Detector	Polarization
1	31.18	9.77	11.95	0.92	22.64	40.00	-17.36	QP	HORIZONTAL
2	34.52	9.35	12.30	0.94	22.59	40.00	-17.41	QP	HORIZONTAL
3	69.36	16.54	9.10	1.20	26.84	40.00	-13.16	QP	HORIZONTAL
4	72.85	17.36	7.20	1.25	25.81	40.00	-14.19	QP	HORIZONTAL
5	123.27	14.80	9.37	1.58	25.75	43.50	-17.75	QP	HORIZONTAL
6	192.42	17.48	10.53	2.12	30.13	43.50	-13.37	QP	HORIZONTAL

- Note: 1. Result Level = Read Level + Antenna Factor + Cable loss.
 2. If Peak Result complies with QP limit, QP Result is deemed to comply with QP limit.
 3. Test setup: RBW: 120 kHz, VBW: 300 kHz, Sweep time: auto.

TR-4-E-009 Radiated Emission Test Result

Test Site	: DDT 3m Chamber	E:\2015 Report Data\15Q0831-1\RE.EM6
Test Date	: 2015-09-24	Tested By : Toby
EUT	: Outdoor Access Point	Model Number : DCWL-79620T
Power Supply	: DC 50V from external POE adapter	Test Mode : TX Mode
Condition	: Temp:24.5'C,Humi:55%, Press:100.1kPa	Antenna/Distance : 2014 VULB 9163/3m/VERTICAL
Memo	:	

Data: 4

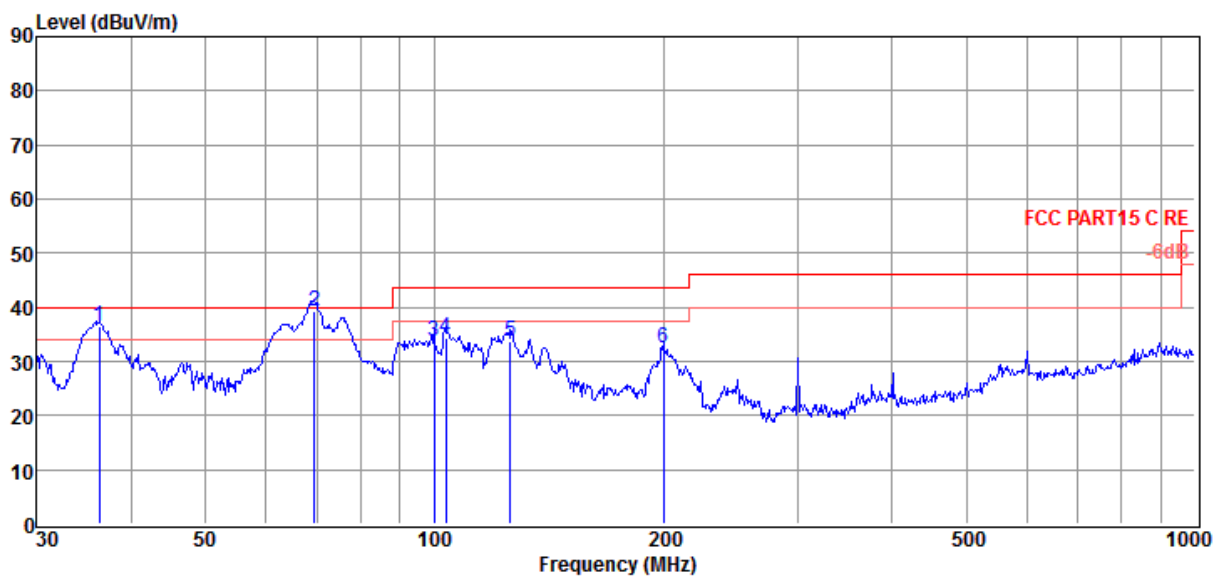

Item (Mark)	Freq (MHz)	Read Level (dBμV)	Antenna Factor (dB/m)	Cable Loss dB	Result Level (dBμV/m)	Limit Line (dBμV/m)	Over Limit (dB)	Detector	Polarization
1	36.25	23.12	12.30	0.95	36.37	40.00	-3.63	QP	VERTICAL
2	69.60	28.92	9.10	1.21	39.23	40.00	-0.77	QP	VERTICAL
3	99.88	19.86	12.50	1.49	33.85	43.50	-9.65	QP	VERTICAL
4	103.44	20.44	12.43	1.50	34.37	43.50	-9.13	QP	VERTICAL
5	125.89	23.41	8.83	1.59	33.83	43.50	-9.67	QP	VERTICAL
6	199.99	20.45	9.80	2.15	32.40	43.50	-11.10	QP	VERTICAL

- Note: 1. Result Level = Read Level + Antenna Factor + Cable loss.
 2. If Peak Result complies with QP limit, QP Result is deemed to comply with QP limit.
 3. Test setup: RBW: 120 kHz, VBW: 300 kHz, Sweep time: auto.

Radiated Emission test (above 1GHz)

Freq (MHz)	Read level (dB μ V)	Antenna Factor (dB/m)	PRM Factor (dB)	Cable Loss (dB)	Result Level (dB μ V/m)	Limit (dB μ V/m)	Margin (dB)	Detector type	Polarization
11a CH36									
10360.00	32.48	38.55	33.64	11.24	48.63	74.00	-25.37	Peak	HORIZONTAL
16606.00	34.71	43.68	36.72	13.79	55.46	74.00	-18.54	Peak	HORIZONTAL
16606.00	20.30	43.68	36.72	13.79	41.05	54.00	-12.95	Average	HORIZONTAL
10360.00	33.95	38.55	33.64	11.24	50.10	74.00	-23.90	Peak	VERTICAL
16589.00	34.47	43.68	36.69	13.78	55.24	74.00	-18.76	Peak	VERTICAL
16589.00	20.80	43.68	36.69	13.78	41.57	54.00	-12.43	Average	VERTICAL
11a CH40									
10400.00	33.36	38.56	33.66	11.26	49.52	74.00	-24.48	Peak	HORIZONTAL
16521.00	34.79	43.70	36.67	13.77	55.59	74.00	-18.41	Peak	HORIZONTAL
16521.00	21.10	43.70	36.67	13.77	41.90	54.00	-12.10	Average	HORIZONTAL
10400.00	36.15	38.56	33.66	11.26	52.31	74.00	-21.69	Peak	VERTICAL
16844.00	34.86	43.63	36.88	13.85	55.46	74.00	-18.54	Peak	VERTICAL
16844.00	21.00	43.63	36.88	13.85	41.60	54.00	-12.40	Average	VERTICAL
11a CH48									
10480.00	32.11	38.59	33.69	11.30	48.31	74.00	-25.69	Peak	HORIZONTAL
16674.00	34.54	43.67	36.74	13.80	55.27	74.00	-18.73	Peak	HORIZONTAL
16674.00	21.19	43.67	36.74	13.80	41.92	54.00	-12.08	Average	HORIZONTAL
10480.00	36.68	38.59	33.69	11.30	52.88	74.00	-21.12	Peak	VERTICAL
16521.00	35.18	43.70	36.67	13.77	55.98	74.00	-18.02	Peak	VERTICAL
16521.00	21.00	43.70	36.67	13.77	41.80	54.00	-12.20	Average	VERTICAL
Conclusion: Pass									
Test Date : 2015/10/19					Test Engineer: Toby				

Note: 1.30MHz~18GHz: (Scan with 11a, 11n HT20 and 11n HT40, the worst case is 11a Mode)

2. Result Level = Read Level + Antenna Factor + Cable loss - PRM Factor.

3. Test setup: RBW: 1 MHz, VBW: 3 MHz, Sweep time: auto.

Freq (MHz)	Read level (dB μ V)	Antenna Factor (dB/m)	PRM Factor (dB)	Cable Loss (dB)	Result Level (dB μ V/m)	Limit (dB μ V/m)	Margin (dB)	Detector type	Polarization
11a CH149									
8055.00	34.66	37.52	31.24	10.39	51.33	74.00	-22.67	Peak	HORIZONTAL
11490.00	31.34	38.90	34.37	12.08	47.95	74.00	-26.05	Peak	HORIZONTAL
16436.00	33.97	43.62	36.62	13.75	54.72	74.00	-19.28	Peak	HORIZONTAL
16436.00	21.01	43.62	36.62	13.75	41.76	54.00	-12.24	Average	HORIZONTAL
6984.00	34.44	37.07	29.42	9.84	51.93	74.00	-22.07	Peak	VERTICAL
11490.00	32.41	38.90	34.37	12.08	49.02	74.00	-24.98	Peak	VERTICAL
16640.00	35.47	43.67	36.74	13.80	56.20	74.00	-17.80	Peak	VERTICAL
16640.00	21.70	43.67	36.74	13.80	42.43	54.00	-11.57	Average	VERTICAL
11a CH157									
7001.00	34.33	37.10	29.42	9.86	51.87	74.00	-22.13	Peak	HORIZONTAL
11570.00	32.25	38.93	34.40	12.12	48.90	74.00	-25.10	Peak	HORIZONTAL
16606.00	35.22	43.68	36.72	13.79	55.97	74.00	-18.03	Peak	HORIZONTAL
16606.00	21.20	43.68	36.72	13.79	41.95	54.00	-12.05	Average	HORIZONTAL
7035.00	34.98	37.12	29.42	9.86	52.54	74.00	-21.46	Peak	VERTICAL
11570.00	32.16	38.93	34.40	12.12	48.81	74.00	-25.19	Peak	VERTICAL
16521.00	34.87	43.70	36.67	13.77	55.67	74.00	-18.33	Peak	VERTICAL
16521.00	21.20	43.70	36.67	13.77	42.00	54.00	-12.00	Average	VERTICAL
11a CH165									
7205.00	34.91	37.22	29.68	9.94	52.39	74.00	-21.61	Peak	HORIZONTAL
11650.00	31.17	38.96	34.44	12.16	47.85	74.00	-26.15	Peak	HORIZONTAL
16470.00	34.51	43.66	36.63	13.76	55.30	74.00	-18.70	Peak	HORIZONTAL
16470.00	20.69	43.66	36.63	13.76	41.48	54.00	-12.52	Average	HORIZONTAL
11650.00	33.16	38.96	34.44	12.16	49.84	74.00	-24.16	Peak	VERTICAL
16470.00	34.23	43.66	36.63	13.76	55.02	74.00	-18.98	Peak	VERTICAL
16470.00	21.89	43.66	36.63	13.76	42.68	54.00	-11.32	Average	VERTICAL
Conclusion: Pass									
Test Date : 2015/10/19					Test Engineer: Toby				

Note: 1.30MHz~18GHz: (Scan with 11a, 11n HT20 and 11n HT40, the worst case is 11a Mode)

2. Result Level = Read Level + Antenna Factor + Cable loss - PRM Factor.

3. Test setup: RBW: 1 MHz, VBW: 3 MHz, Sweep time: auto.

9. Band Edge Compliance

9.1. Test equipment

Please refer to Section 3 this report.

9.2. Block diagram of test setup

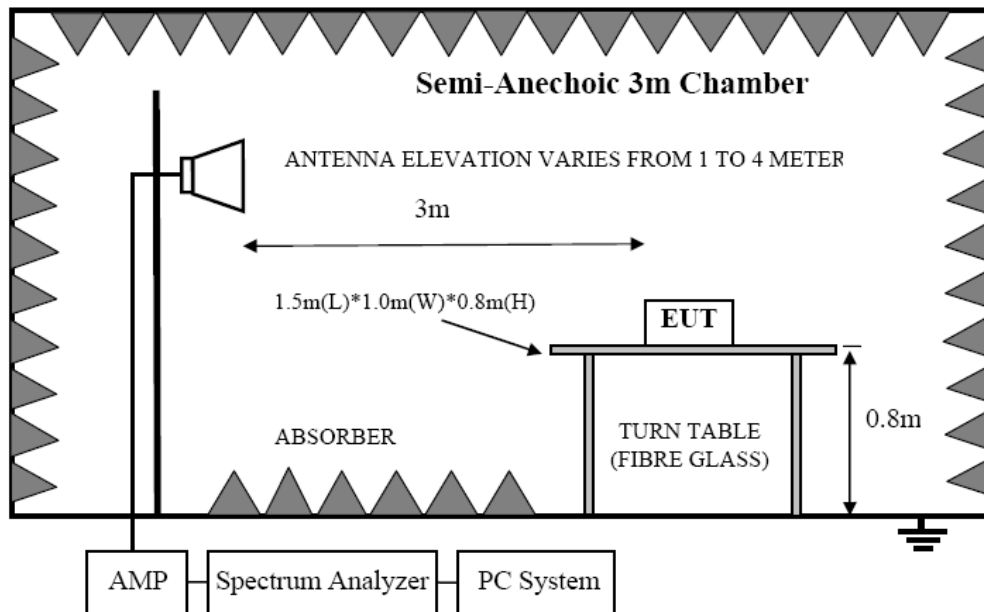

9.3. Limit

For transmitters operating in the 5.15-5.25 GHz and 5.725-5.85G band: all emissions outside of the 5.15-5.35 GHz band shall not exceed an EIRP of -27 dBm/MHz.

9.4. Test Procedure

Same with clause 7.4 except change investigated frequency range from 5.15-5.25 GHz, 5.725-5.85G.

Remark: All restriction band have been tested, and only the worse case is shown in report.

9.5. Test result

PASS. (See below detailed test result)

TR-4-E-009 Radiated Emission Test Result

Test Site	: DDT 3m Chamber	E:\2015 Report Data\15Q0831-1\RE.EM6
Test Date	: 2015-10-19	Tested By : Toby
EUT	: Outdoor Access Point	Model Number : DCWL-7962OT
Power Supply	: DC 50V from external POE adapter	Test Mode : 11a Tx mode 5180MHz
Condition	: Temp:24.5'C,Humi:55%, Press:100.1kPa	Antenna/Distance : 2014 HF907/3m/HORIZONTAL
Memo	:	

Data: 79

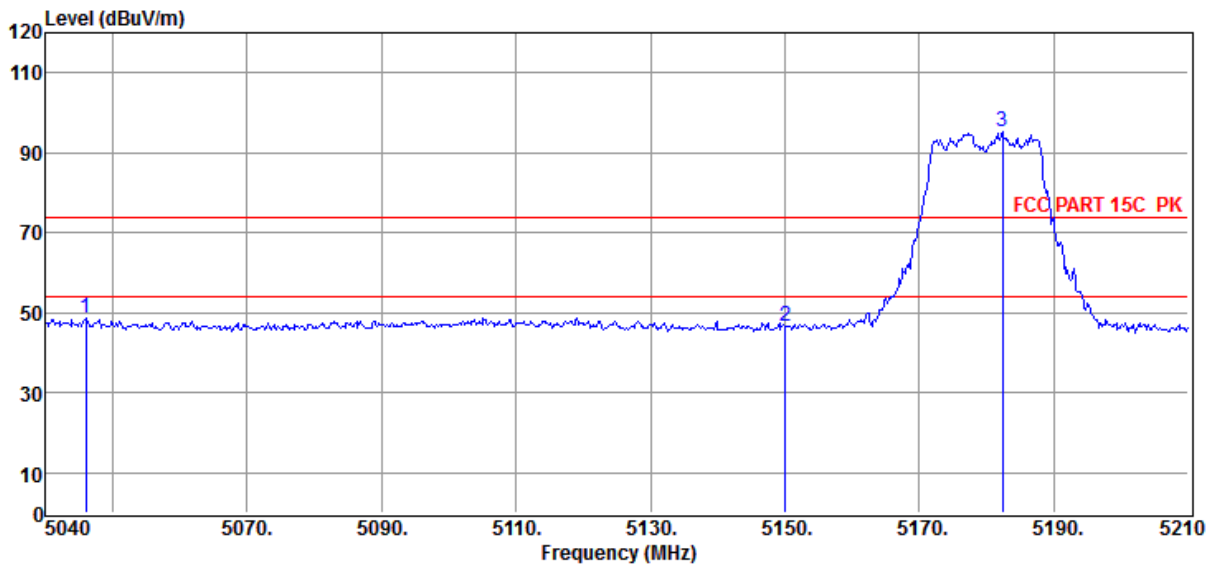

Item (Mark)	Freq (MHz)	Read Level (dBμV)	Antenna Factor (dB/m)	PRM Factor dB	Cable Loss dB	Result Level (dBμV/m)	Limit Line (dBμV/m)	Over Limit (dB)	Detector	Polarization
1	5045.95	33.79	35.66	29.02	8.22	48.65	74.00	-25.35	Peak	HORIZONTAL
2	5150.00	31.93	35.58	29.04	8.28	46.75	74.00	-27.25	Peak	HORIZONTAL
3	5182.29	80.38	35.55	29.04	8.30	95.19	/	/	Peak	HORIZONTAL

- Note: 1. Result Level = Read Level + Antenna Factor + Cable loss - PRM Factor.
 2. If Peak Result complies with AV limit, AV Result is deemed to comply with AV limit.
 3. Test setup: RBW: 1 MHz, VBW: 3 MHz, Sweep time: auto.

TR-4-E-009 Radiated Emission Test Result

Test Site	: DDT 3m Chamber	E:\2015 Report Data\15Q0831-1\RE.EM6
Test Date	: 2015-10-19	Tested By : Toby
EUT	: Outdoor Access Point	Model Number : DCWL-7962OT
Power Supply	: DC 50V from external POE adapter	Test Mode : 11a Tx mode 5180MHz
Condition	: Temp:24.5°C,Humi:55%, Press:100.1kPa	Antenna/Distance : 2014 HF907/3m/VERTICAL
Memo	:	

Data: 80

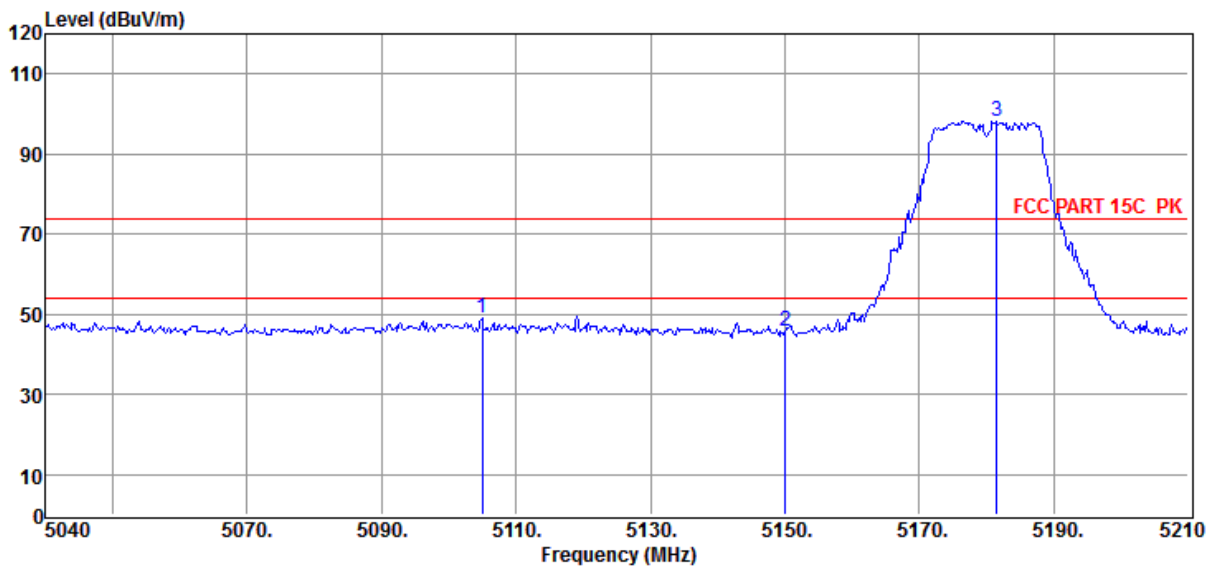

Item (Mark)	Freq (MHz)	Read Level (dBμV)	Antenna Factor (dB/m)	PRM Factor dB	Cable Loss dB	Result Level (dBμV/m)	Limit Line (dBμV/m)	Over Limit (dB)	Detector	Polarization
1	5104.94	34.38	35.62	29.03	8.26	49.23	74.00	-24.77	Peak	VERTICAL
2	5150.00	30.80	35.58	29.04	8.28	45.62	74.00	-28.38	Peak	VERTICAL
3	5181.44	83.45	35.55	29.04	8.30	98.26	/	/	Peak	VERTICAL

- Note: 1. Result Level = Read Level + Antenna Factor + Cable loss - PRM Factor.
 2. If Peak Result complies with AV limit, AV Result is deemed to comply with AV limit.
 3. Test setup: RBW: 1 MHz, VBW: 3 MHz, Sweep time: auto.

TR-4-E-009 Radiated Emission Test Result

Test Site : DDT 3m Chamber	E:\2015 Report Data\15Q0831-1\RE.EM6
Test Date : 2015-10-19	Tested By : Toby
EUT : Outdoor Access Point	Model Number : DCWL-7962OT
Power Supply : DC 50V from external POE adapter	Test Mode : 11a Tx mode 5240MHz
Condition : Temp:24.5°C,Humi:55%, Press:100.1kPa	Antenna/Distance : 2014 HF907/3m/VERTICAL
Memo :	

Data: 85

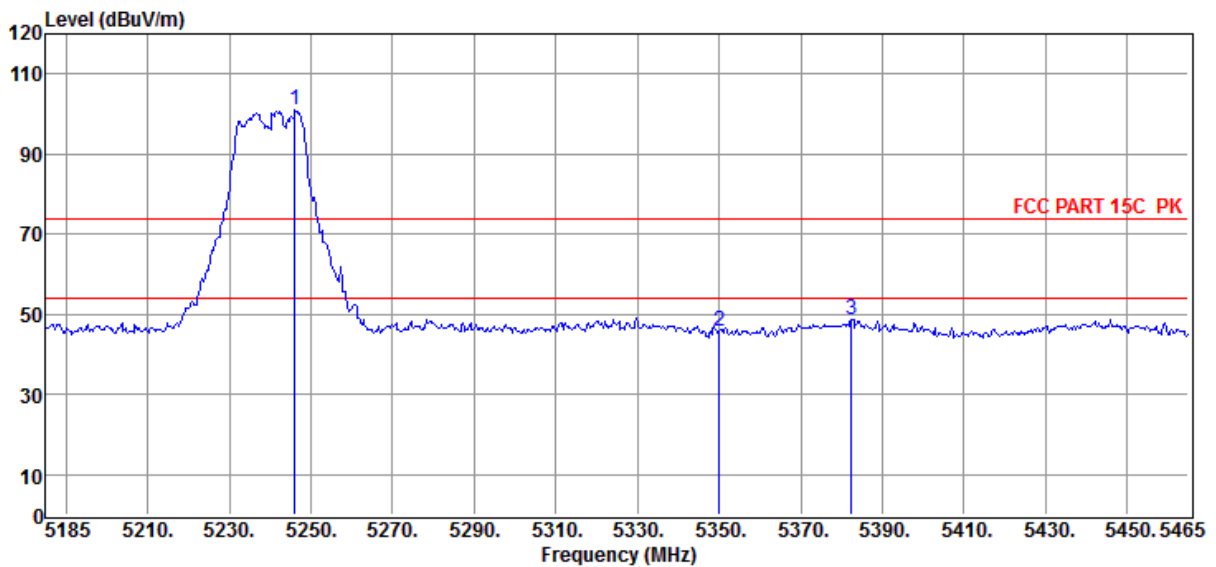

Item (Mark)	Freq (MHz)	Read Level (dBμV)	Antenna Factor (dB/m)	PRM Factor dB	Cable Loss dB	Result Level (dBμV/m)	Limit Line (dBμV/m)	Over Limit (dB)	Detector	Polarization
1	5246.04	86.18	35.50	29.05	8.32	100.95	/	/	Peak	VERTICAL
2	5350.00	30.95	35.42	29.06	8.39	45.70	74.00	-28.30	Peak	VERTICAL
3	5382.40	33.95	35.39	29.07	8.41	48.68	74.00	-25.32	Peak	VERTICAL

- Note: 1. Result Level = Read Level + Antenna Factor + Cable loss - PRM Factor.
 2. If Peak Result complies with AV limit, AV Result is deemed to comply with AV limit.
 3. Test setup: RBW: 1 MHz, VBW: 3 MHz, Sweep time: auto.

TR-4-E-009 Radiated Emission Test Result

Test Site	: DDT 3m Chamber	E:\2015 Report Data\15Q0831-1\RE.EM6
Test Date	: 2015-10-19	Tested By : Toby
EUT	: Outdoor Access Point	Model Number : DCWL-7962OT
Power Supply	: DC 50V from external POE adapter	Test Mode : 11a Tx mode 5240MHz
Condition	: Temp:24.5°C,Humi:55%, Press:100.1kPa	Antenna/Distance : 2014 HF907/3m/HORIZONTAL
Memo	:	

Data: 86

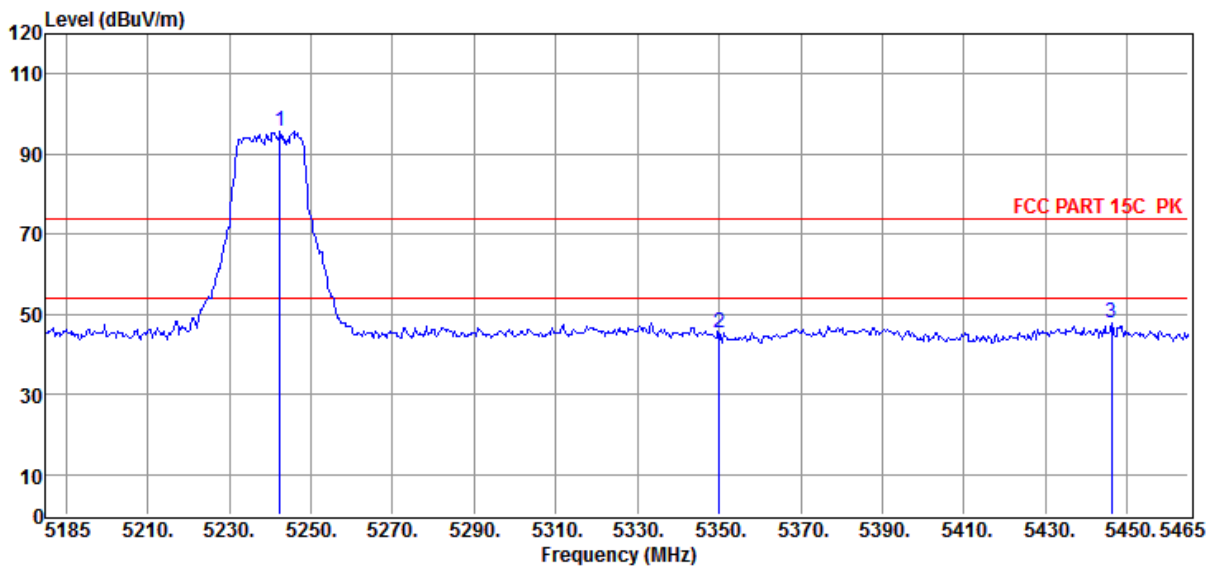

Item (Mark)	Freq (MHz)	Read Level (dBμV)	Antenna Factor (dB/m)	PRM Factor dB	Cable Loss dB	Result Level (dBμV/m)	Limit Line (dBμV/m)	Over Limit (dB)	Detector	Polarization
1	5242.40	80.91	35.50	29.05	8.32	95.68	/	/	Peak	HORIZONTAL
2	5350.00	30.55	35.42	29.06	8.39	45.30	74.00	-28.70	Peak	HORIZONTAL
3	5446.24	32.96	35.34	29.08	8.44	47.66	74.00	-26.34	Peak	HORIZONTAL

- Note: 1. Result Level = Read Level + Antenna Factor + Cable loss - PRM Factor.
 2. If Peak Result complies with AV limit, AV Result is deemed to comply with AV limit.
 3. Test setup: RBW: 1 MHz, VBW: 3 MHz, Sweep time: auto.

TR-4-E-009 Radiated Emission Test Result

Test Site : DDT 3m Chamber	E:\2015 Report Data\15Q0831-1\RE.EM6
Test Date : 2015-10-19	Tested By : Toby
EUT : Outdoor Access Point	Model Number : DCWL-7962OT
Power Supply : DC 50V from external POE adapter	Test Mode : 11n HT20 Tx mode 5180MHz
Condition : Temp:24.5°C,Humi:55%, Press:100.1kPa	Antenna/Distance : 2014 HF907/3m/VERTICAL
Memo :	

Data: 89

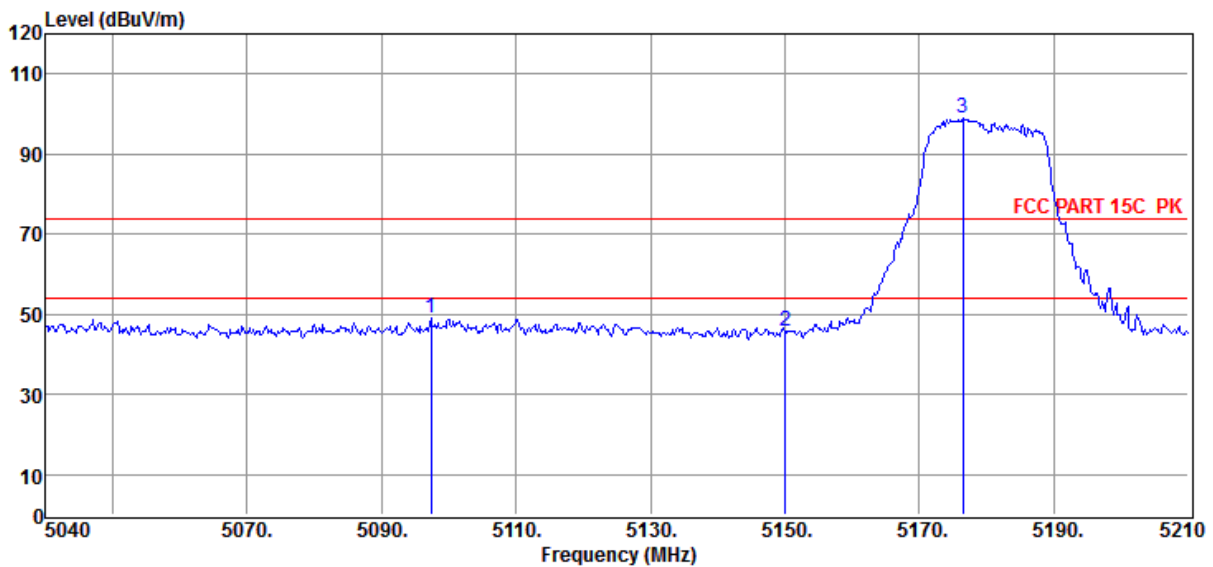

Item (Mark)	Freq (MHz)	Read Level (dBμV)	Antenna Factor (dB/m)	PRM Factor dB	Cable Loss dB	Result Level (dBμV/m)	Limit Line (dBμV/m)	Over Limit (dB)	Detector	Polarization
1	5097.29	34.13	35.62	29.03	8.24	48.96	74.00	-25.04	Peak	VERTICAL
2	5150.00	31.06	35.58	29.04	8.28	45.88	74.00	-28.12	Peak	VERTICAL
3	5176.51	84.02	35.55	29.04	8.28	98.81	/	/	Peak	VERTICAL

- Note: 1. Result Level = Read Level + Antenna Factor + Cable loss - PRM Factor.
 2. If Peak Result complies with AV limit, AV Result is deemed to comply with AV limit.
 3. Test setup: RBW: 1 MHz, VBW: 3 MHz, Sweep time: auto.

TR-4-E-009 Radiated Emission Test Result

Test Site : DDT 3m Chamber	E:\2015 Report Data\15Q0831-1\RE.EM6
Test Date : 2015-10-19	Tested By : Toby
EUT : Outdoor Access Point	Model Number : DCWL-7962OT
Power Supply : DC 50V from external POE adapter	Test Mode : 11n HT20 Tx mode 5180MHz
Condition : Temp:24.5°C,Humi:55%, Press:100.1kPa	Antenna/Distance : 2014 HF907/3m/HORIZONTAL
Memo :	

Data: 90

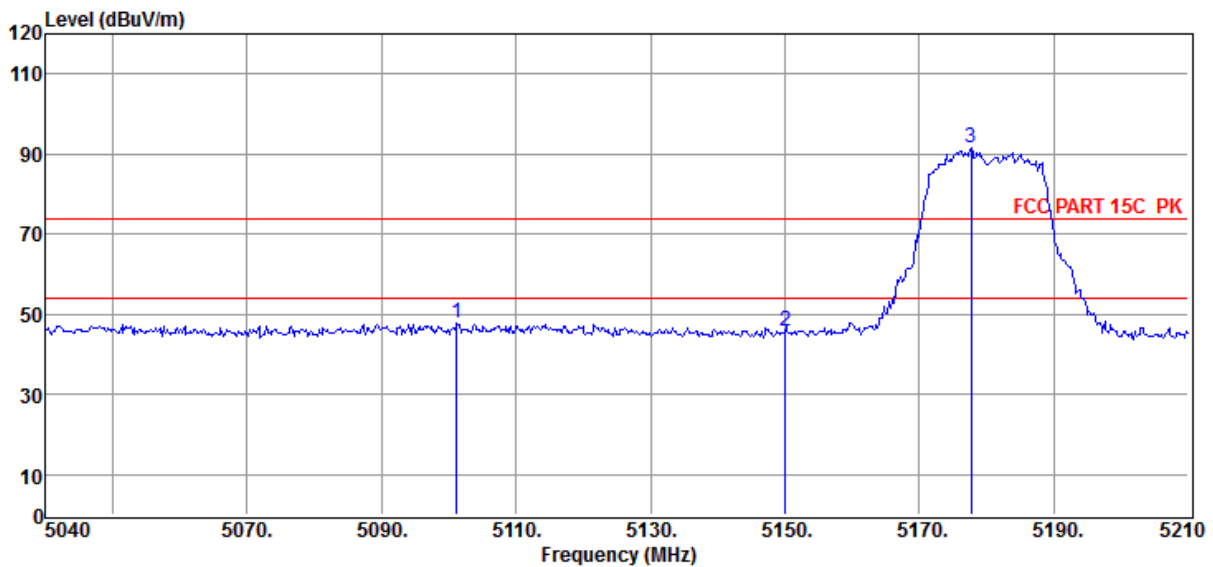

Item (Mark)	Freq (MHz)	Read Level (dBμV)	Antenna Factor (dB/m)	PRM Factor dB	Cable Loss dB	Result Level (dBμV/m)	Limit Line (dBμV/m)	Over Limit (dB)	Detector	Polarization
1	5101.20	32.84	35.62	29.03	8.24	47.67	74.00	-26.33	Peak	HORIZONTAL
2	5150.00	30.98	35.58	29.04	8.28	45.80	74.00	-28.20	Peak	HORIZONTAL
3	5177.70	76.86	35.55	29.04	8.28	91.65	/	/	Peak	HORIZONTAL

- Note: 1. Result Level = Read Level + Antenna Factor + Cable loss - PRM Factor.
 2. If Peak Result complies with AV limit, AV Result is deemed to comply with AV limit.
 3. Test setup: RBW: 1 MHz, VBW: 3 MHz, Sweep time: auto.

TR-4-E-009 Radiated Emission Test Result

Test Site : DDT 3m Chamber	E:\2015 Report Data\15Q0831-1\RE.EM6
Test Date : 2015-10-19	Tested By : Toby
EUT : Outdoor Access Point	Model Number : DCWL-7962OT
Power Supply : DC 50V from external POE adapter	Test Mode : 11n HT20 Tx mode 5240MHz
Condition : Temp:24.5°C,Humi:55%, Press:100.1kPa	Antenna/Distance : 2014 HF907/3m/HORIZONTAL
Memo :	

Data: 95

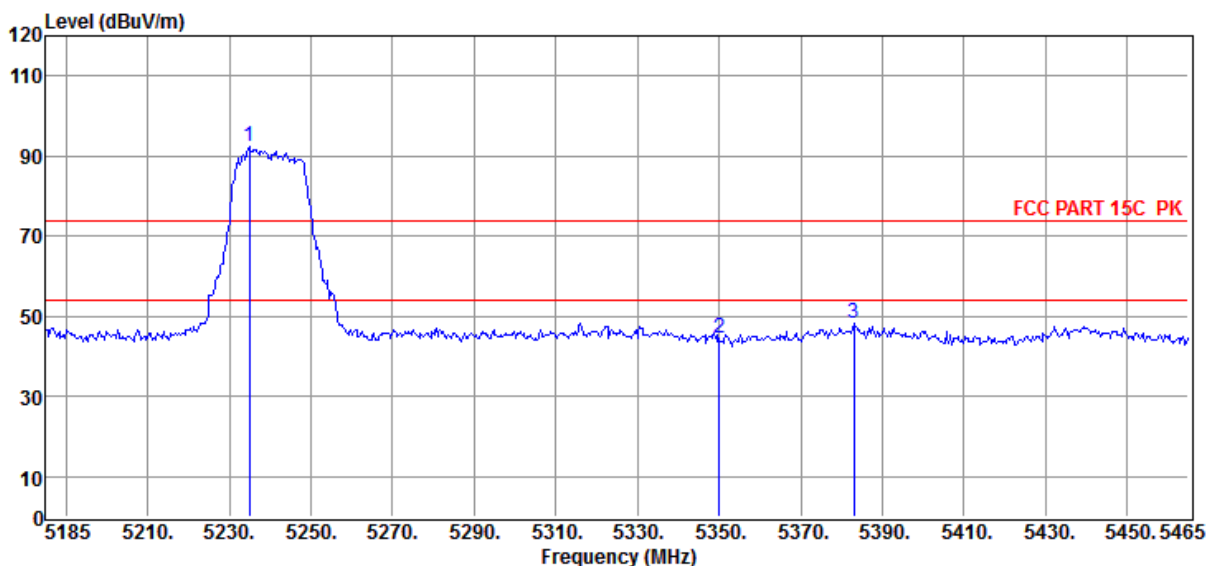

Item (Mark)	Freq (MHz)	Read Level (dBμV)	Antenna Factor (dB/m)	PRM Factor dB	Cable Loss dB	Result Level (dBμV/m)	Limit Line (dBμV/m)	Over Limit (dB)	Detector	Polarization
1	5234.84	77.63	35.51	29.05	8.32	92.41	/	/	Peak	HORIZONTAL
2	5350.00	29.81	35.42	29.06	8.39	44.56	74.00	-29.44	Peak	HORIZONTAL
3	5382.96	33.38	35.39	29.07	8.41	48.11	74.00	-25.89	Peak	HORIZONTAL

Note: 1. Result Level = Read Level + Antenna Factor + Cable loss - PRM Factor.
 2. If Peak Result complies with AV limit, AV Result is deemed to comply with AV limit.
 3. Test setup: RBW: 1 MHz, VBW: 3 MHz, Sweep time: auto.

TR-4-E-009 Radiated Emission Test Result

Test Site	: DDT 3m Chamber	E:\2015 Report Data\15Q0831-1\RE.EM6
Test Date	: 2015-10-19	Tested By : Toby
EUT	: Outdoor Access Point	Model Number : DCWL-7962OT
Power Supply	: DC 50V from external POE adapter	Test Mode : 11n HT20 Tx mode 5240MHz
Condition	: Temp:24.5°C,Humi:55%, Press:100.1kPa	Antenna/Distance : 2014 HF907/3m/VERTICAL
Memo	:	

Data: 96

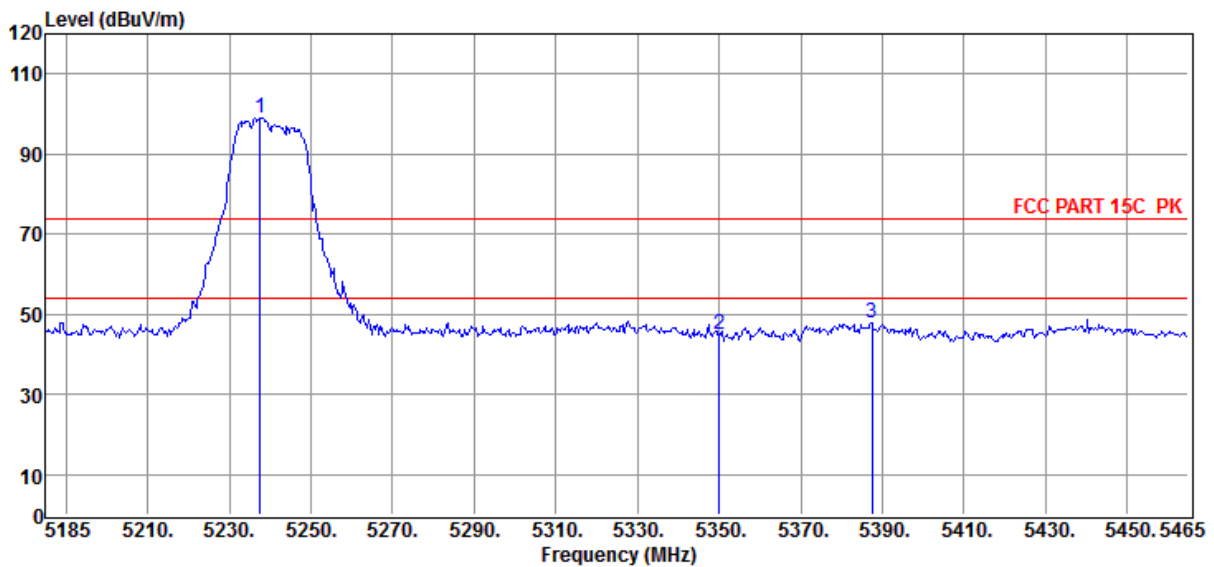

Item (Mark)	Freq (MHz)	Read Level (dBμV)	Antenna Factor (dB/m)	PRM Factor dB	Cable Loss dB	Result Level (dBμV/m)	Limit Line (dBμV/m)	Over Limit (dB)	Detector	Polarization
1	5237.64	84.38	35.51	29.05	8.32	99.16	/	/	Peak	VERTICAL
2	5350.00	30.24	35.42	29.06	8.39	44.99	74.00	-29.01	Peak	VERTICAL
3	5387.44	33.15	35.39	29.07	8.41	47.88	74.00	-26.12	Peak	VERTICAL

- Note: 1. Result Level = Read Level + Antenna Factor + Cable loss - PRM Factor.
 2. If Peak Result complies with AV limit, AV Result is deemed to comply with AV limit.
 3. Test setup: RBW: 1 MHz, VBW: 3 MHz, Sweep time: auto.

TR-4-E-009 Radiated Emission Test Result

Test Site : DDT 3m Chamber	E:\2015 Report Data\15Q0831-1\RE.EM6
Test Date : 2015-10-19	Tested By : Toby
EUT : Outdoor Access Point	Model Number : DCWL-7962OT
Power Supply : DC 50V from external POE adapter	Test Mode : 11n HT40 Tx mode 5190MHz
Condition : Temp:24.5°C,Humi:55%, Press:100.1kPa	Antenna/Distance : 2014 HF907/3m/HORIZONTAL
Memo :	

Data: 99

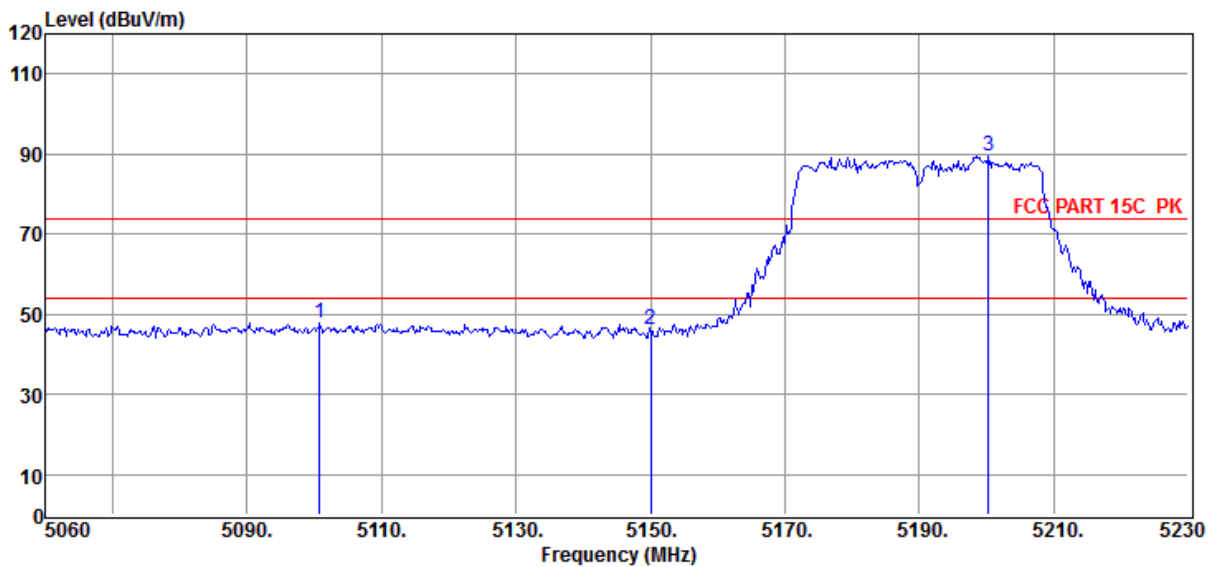

Item (Mark)	Freq (MHz)	Read Level (dBμV)	Antenna Factor (dB/m)	PRM Factor dB	Cable Loss dB	Result Level (dBμV/m)	Limit Line (dBμV/m)	Over Limit (dB)	Detector	Polarization
1	5100.80	32.94	35.62	29.03	8.24	47.77	74.00	-26.23	Peak	HORIZONTAL
2	5150.00	31.41	35.58	29.04	8.28	46.23	74.00	-27.77	Peak	HORIZONTAL
3	5200.25	74.60	35.54	29.04	8.30	89.40	/	/	Peak	HORIZONTAL

- Note: 1. Result Level = Read Level + Antenna Factor + Cable loss - PRM Factor.
 2. If Peak Result complies with AV limit, AV Result is deemed to comply with AV limit.
 3. Test setup: RBW: 1 MHz, VBW: 3 MHz, Sweep time: auto.

TR-4-E-009 Radiated Emission Test Result

Test Site : DDT 3m Chamber	E:\2015 Report Data\15Q0831-1\RE.EM6
Test Date : 2015-10-19	Tested By : Toby
EUT : Outdoor Access Point	Model Number : DCWL-7962OT
Power Supply : DC 50V from external POE adapter	Test Mode : 11n HT40 Tx mode 5190MHz
Condition : Temp:24.5°C,Humi:55%, Press:100.1kPa	Antenna/Distance : 2014 HF907/3m/VERTICAL
Memo :	

Data: 100

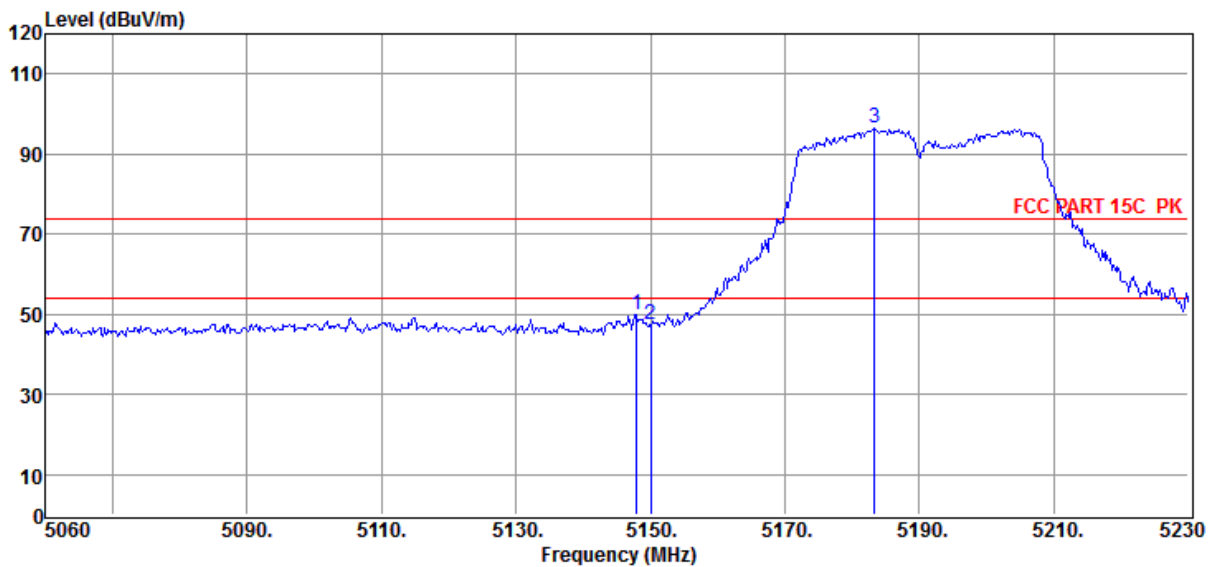

Item (Mark)	Freq (MHz)	Read Level (dBμV)	Antenna Factor (dB/m)	PRM Factor dB	Cable Loss dB	Result Level (dBμV/m)	Limit Line (dBμV/m)	Over Limit (dB)	Detector	Polarization
1	5147.89	35.07	35.58	29.04	8.28	49.89	74.00	-24.11	Peak	VERTICAL
2	5150.00	32.41	35.58	29.04	8.28	47.23	74.00	-26.77	Peak	VERTICAL
3	5183.25	81.62	35.55	29.04	8.30	96.43	/	/	Peak	VERTICAL

- Note: 1. Result Level = Read Level + Antenna Factor + Cable loss - PRM Factor.
 2. If Peak Result complies with AV limit, AV Result is deemed to comply with AV limit.
 3. Test setup: RBW: 1 MHz, VBW: 3 MHz, Sweep time: auto.

TR-4-E-009 Radiated Emission Test Result

Test Site	: DDT 3m Chamber	E:\2015 Report Data\15Q0831-1\RE.EM6
Test Date	: 2015-10-19	Tested By : Toby
EUT	: Outdoor Access Point	Model Number : DCWL-7962OT
Power Supply	: DC 50V from external POE adapter	Test Mode : 11n HT40 Tx mode 5230MHz
Condition	: Temp:24.5°C,Humi:55%, Press:100.1kPa	Antenna/Distance : 2014 HF907/3m/HORIZONTAL
Memo	:	

Data: 103

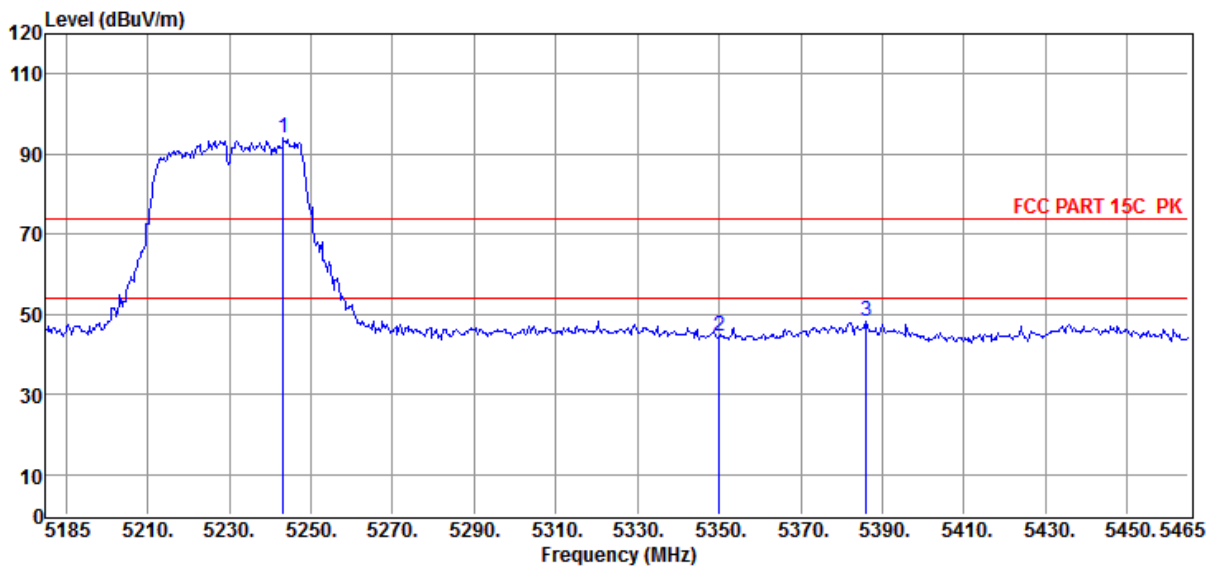

Item (Mark)	Freq (MHz)	Read Level (dBμV)	Antenna Factor (dB/m)	PRM Factor dB	Cable Loss dB	Result Level (dBμV/m)	Limit Line (dBμV/m)	Over Limit (dB)	Detector	Polarization
1	5243.24	79.12	35.50	29.05	8.32	93.89	/	/	Peak	HORIZONTAL
2	5350.00	29.76	35.42	29.06	8.39	44.51	74.00	-29.49	Peak	HORIZONTAL
3	5386.04	33.55	35.39	29.07	8.41	48.28	74.00	-25.72	Peak	HORIZONTAL

- Note: 1. Result Level = Read Level + Antenna Factor + Cable loss - PRM Factor.
 2. If Peak Result complies with AV limit, AV Result is deemed to comply with AV limit.
 3. Test setup: RBW: 1 MHz, VBW: 3 MHz, Sweep time: auto.

TR-4-E-009 Radiated Emission Test Result

Test Site : DDT 3m Chamber	E:\2015 Report Data\15Q0831-1\RE.EM6
Test Date : 2015-10-19	Tested By : Toby
EUT : Outdoor Access Point	Model Number : DCWL-7962OT
Power Supply : DC 50V from external POE adapter	Test Mode : 11n HT40 Tx mode 5230MHz
Condition : Temp:24.5°C,Humi:55%, Press:100.1kPa	Antenna/Distance : 2014 HF907/3m/VERTICAL
Memo :	

Data: 104

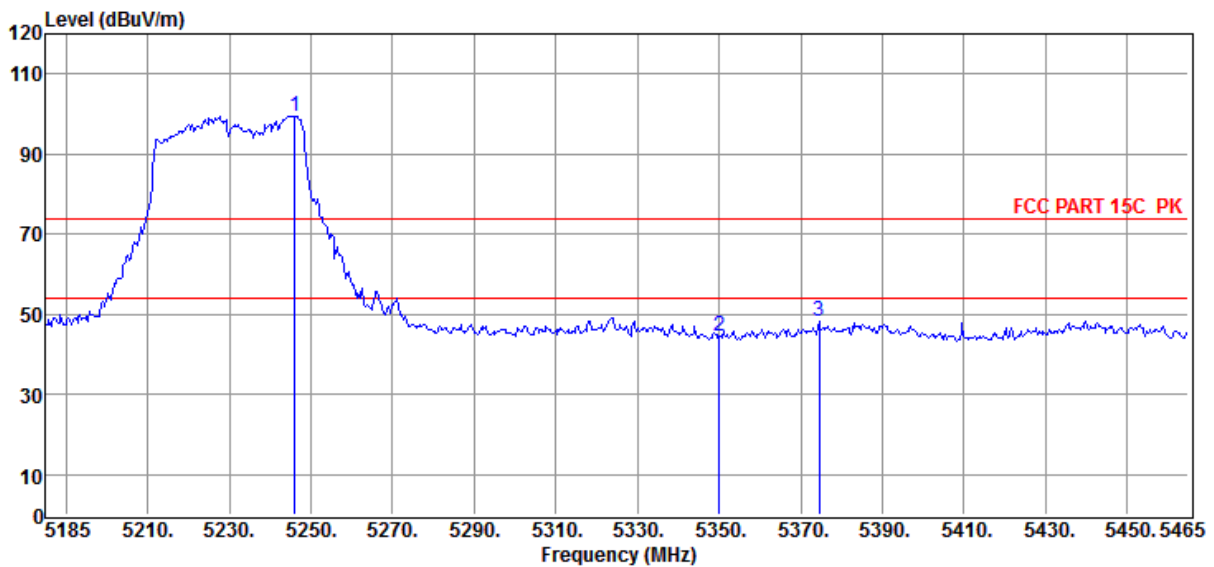

Item (Mark)	Freq (MHz)	Read Level (dBμV)	Antenna Factor (dB/m)	PRM Factor dB	Cable Loss dB	Result Level (dBμV/m)	Limit Line (dBμV/m)	Over Limit (dB)	Detector	Polarization
1	5246.04	84.79	35.50	29.05	8.32	99.56	/	/	Peak	VERTICAL
2	5350.00	29.61	35.42	29.06	8.39	44.36	74.00	-29.64	Peak	VERTICAL
3	5374.56	33.52	35.41	29.06	8.39	48.26	74.00	-25.74	Peak	VERTICAL

- Note: 1. Result Level = Read Level + Antenna Factor + Cable loss - PRM Factor.
 2. If Peak Result complies with AV limit, AV Result is deemed to comply with AV limit.
 3. Test setup: RBW: 1 MHz, VBW: 3 MHz, Sweep time: auto.

TR-4-E-009 Radiated Emission Test Result

Test Site : DDT 3m Chamber	E:\2015 Report Data\15Q0831-1\RE.EM6
Test Date : 2015-10-19	Tested By : Toby
EUT : Outdoor Access Point	Model Number : DCWL-7962OT
Power Supply : DC 50V from external POE adapter	Test Mode : 11a Tx mode 5745MHz
Condition : Temp:24.5°C,Humi:55%, Press:100.1kPa	Antenna/Distance : 2014 HF907/3m/HORIZONTAL
Memo :	

Data: 107

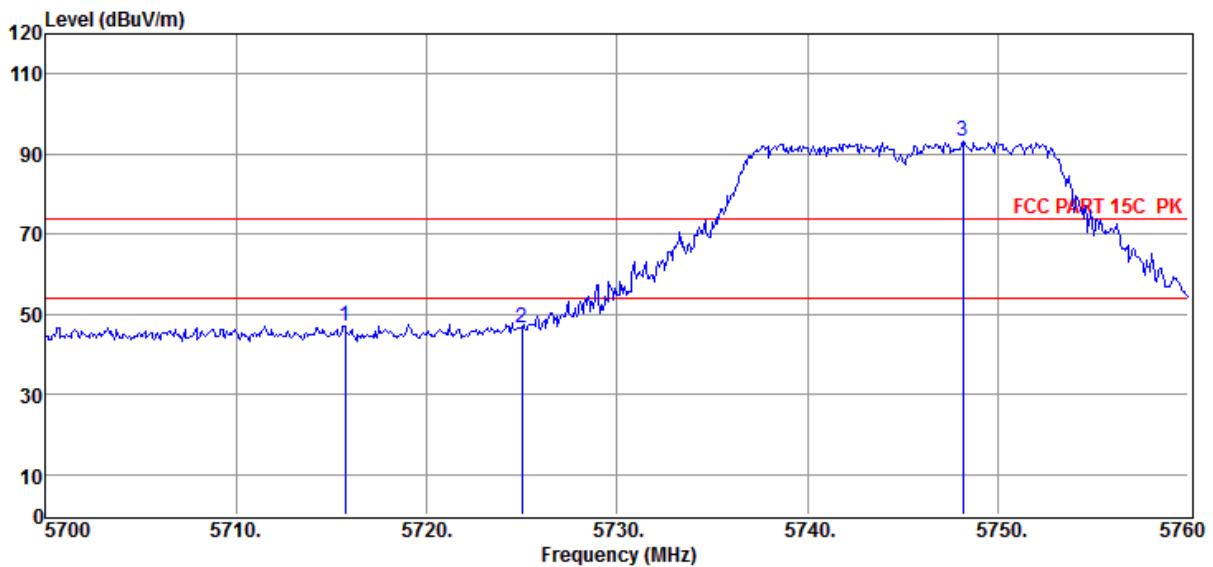

Item (Mark)	Freq (MHz)	Read Level (dBμV)	Antenna Factor (dB/m)	PRM Factor dB	Cable Loss dB	Result Level (dBμV/m)	Limit Line (dBμV/m)	Over Limit (dB)	Detector	Polarization
1	5715.72	32.01	35.63	29.13	8.65	47.16	74.00	-26.84	Peak	HORIZONTAL
2	5725.00	31.58	35.66	29.13	8.65	46.76	74.00	-27.24	Peak	HORIZONTAL
3	5748.18	77.88	35.69	29.14	8.69	93.12	/	/	Peak	HORIZONTAL

Note: 1. Result Level = Read Level + Antenna Factor + Cable loss - PRM Factor.
 2. If Peak Result complies with AV limit, AV Result is deemed to comply with AV limit.
 3. Test setup: RBW: 1 MHz, VBW: 3 MHz, Sweep time: auto.

TR-4-E-009 Radiated Emission Test Result

Test Site	: DDT 3m Chamber	E:\2015 Report Data\15Q0831-1\RE.EM6
Test Date	: 2015-10-19	Tested By : Toby
EUT	: Outdoor Access Point	Model Number : DCWL-7962OT
Power Supply	: DC 50V from external POE adapter	Test Mode : 11a Tx mode 5745MHz
Condition	: Temp:24.5°C,Humi:55%, Press:100.1kPa	Antenna/Distance : 2014 HF907/3m/VERTICAL
Memo	:	

Data: 108

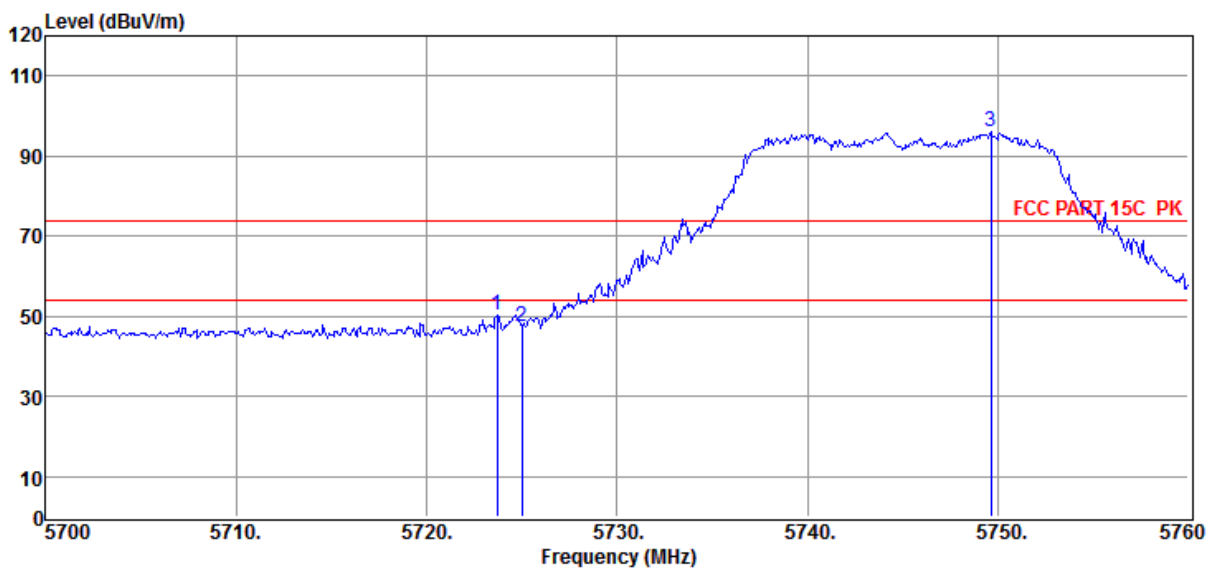

Item (Mark)	Freq (MHz)	Read Level (dBμV)	Antenna Factor (dB/m)	PRM Factor dB	Cable Loss dB	Result Level (dBμV/m)	Limit Line (dBμV/m)	Over Limit (dB)	Detector	Polarization
1	5723.70	35.18	35.66	29.13	8.65	50.36	74.00	-23.64	Peak	VERTICAL
2	5725.00	32.44	35.66	29.13	8.65	47.62	74.00	-26.38	Peak	VERTICAL
3	5749.62	80.81	35.69	29.14	8.69	96.05	/	/	Peak	VERTICAL

Note: 1. Result Level = Read Level + Antenna Factor + Cable loss - PRM Factor.
 2. If Peak Result complies with AV limit, AV Result is deemed to comply with AV limit.
 3. Test setup: RBW: 1 MHz, VBW: 3 MHz, Sweep time: auto.

TR-4-E-009 Radiated Emission Test Result

Test Site	: DDT 3m Chamber	E:\2015 Report Data\15Q0831-1\RE.EM6
Test Date	: 2015-10-19	Tested By : Toby
EUT	: Outdoor Access Point	Model Number : DCWL-7962OT
Power Supply	: DC 50V from external POE adapter	Test Mode : 11a Tx mode 5825MHz
Condition	: Temp:24.5°C,Humi:55%, Press:100.1kPa	Antenna/Distance : 2014 HF907/3m/VERTICAL
Memo	:	

Data: 113

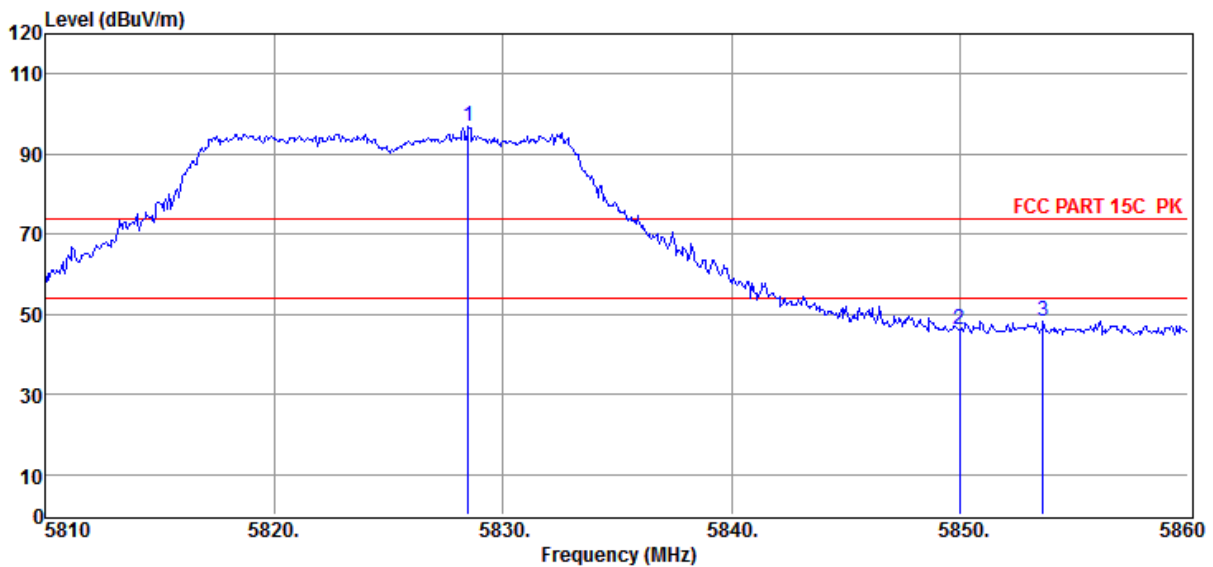

Item (Mark)	Freq (MHz)	Read Level (dBμV)	Antenna Factor (dB/m)	PRM Factor dB	Cable Loss dB	Result Level (dBμV/m)	Limit Line (dBμV/m)	Over Limit (dB)	Detector	Polarization
1	5828.50	81.27	35.82	29.16	8.77	96.70	/	/	Peak	VERTICAL
2	5850.00	30.75	35.85	29.16	8.77	46.21	74.00	-27.79	Peak	VERTICAL
3	5853.65	32.68	35.88	29.17	8.81	48.20	74.00	-25.80	Peak	VERTICAL

- Note: 1. Result Level = Read Level + Antenna Factor + Cable loss - PRM Factor.
 2. If Peak Result complies with AV limit, AV Result is deemed to comply with AV limit.
 3. Test setup: RBW: 1 MHz, VBW: 3 MHz, Sweep time: auto.

TR-4-E-009 Radiated Emission Test Result

Test Site	: DDT 3m Chamber	E:\2015 Report Data\15Q0831-1\RE.EM6
Test Date	: 2015-10-19	Tested By : Toby
EUT	: Outdoor Access Point	Model Number : DCWL-7962OT
Power Supply	: DC 50V from external POE adapter	Test Mode : 11a Tx mode 5825MHz
Condition	: Temp:24.5°C,Humi:55%, Press:100.1kPa	Antenna/Distance : 2014 HF907/3m/HORIZONTAL
Memo	:	

Data: 114

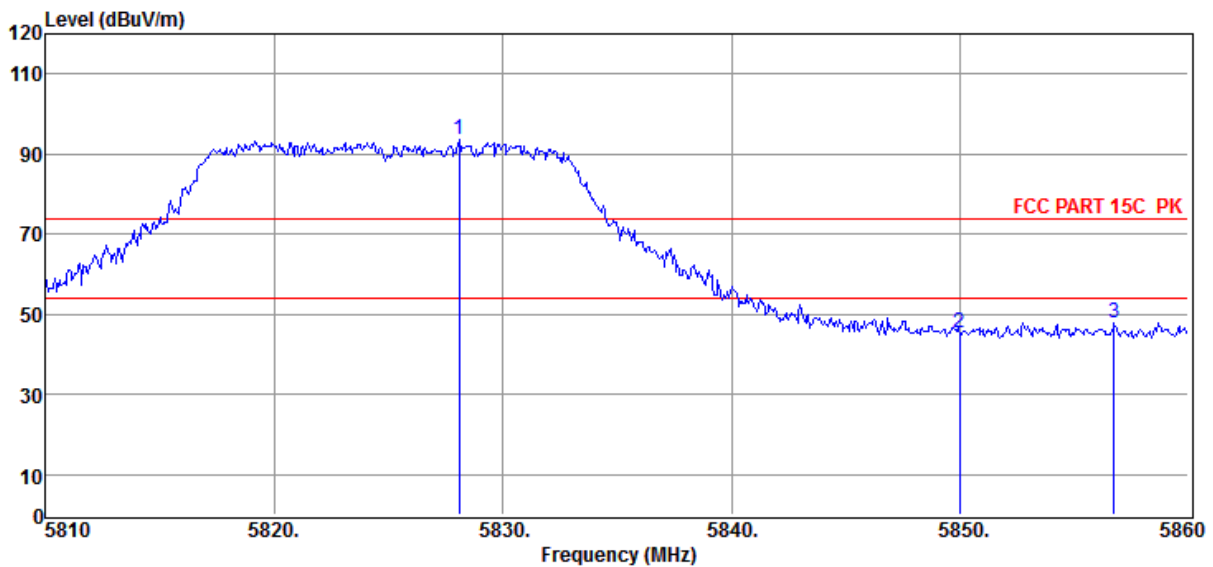

Item (Mark)	Freq (MHz)	Read Level (dBμV)	Antenna Factor (dB/m)	PRM Factor dB	Cable Loss dB	Result Level (dBμV/m)	Limit Line (dBμV/m)	Over Limit (dB)	Detector	Polarization
1	5828.10	78.21	35.82	29.16	8.77	93.64	/	/	Peak	HORIZONTAL
2	5850.00	29.87	35.85	29.16	8.77	45.33	74.00	-28.67	Peak	HORIZONTAL
3	5856.75	32.17	35.88	29.17	8.81	47.69	74.00	-26.31	Peak	HORIZONTAL

Note: 1. Result Level = Read Level + Antenna Factor + Cable loss - PRM Factor.
 2. If Peak Result complies with AV limit, AV Result is deemed to comply with AV limit.
 3. Test setup: RBW: 1 MHz, VBW: 3 MHz, Sweep time: auto.

TR-4-E-009 Radiated Emission Test Result

Test Site	: DDT 3m Chamber	E:\2015 Report Data\15Q0831-1\RE.EM6
Test Date	: 2015-10-19	Tested By : Toby
EUT	: Outdoor Access Point	Model Number : DCWL-7962OT
Power Supply	: DC 50V from external POE adapter	Test Mode : 11n HT20 Tx mode 5745MHz
Condition	: Temp:24.5°C,Humi:55%, Press:100.1kPa	Antenna/Distance : 2014 HF907/3m/HORIZONTAL
Memo	:	

Data: 117

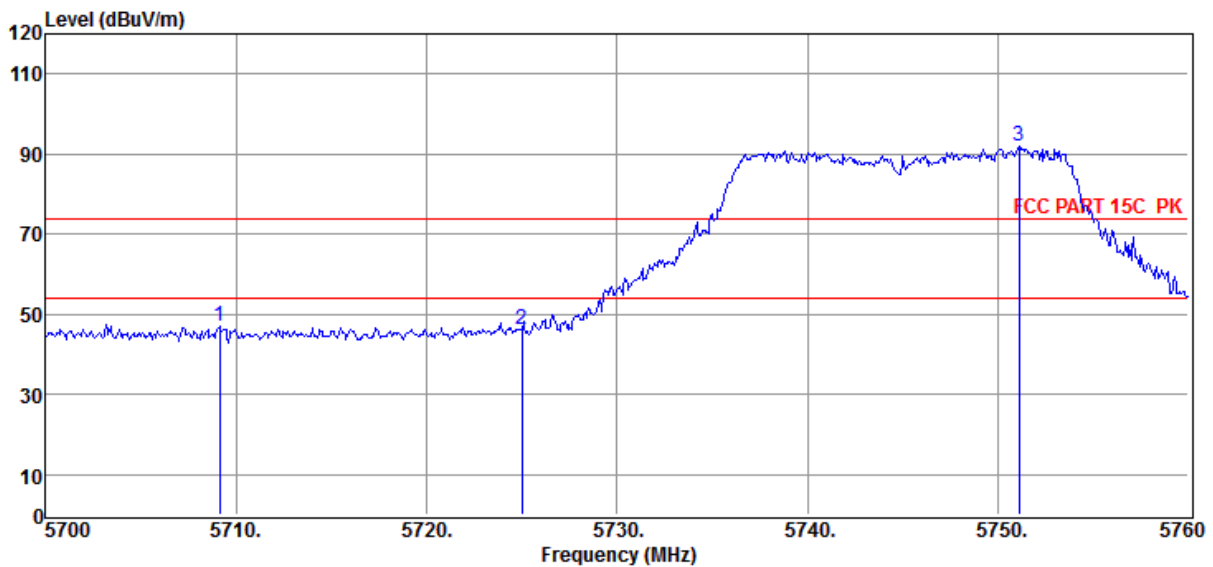

Item (Mark)	Freq (MHz)	Read Level (dBμV)	Antenna Factor (dB/m)	PRM Factor dB	Cable Loss dB	Result Level (dBμV/m)	Limit Line (dBμV/m)	Over Limit (dB)	Detector	Polarization
1	5709.12	31.85	35.63	29.13	8.65	47.00	74.00	-27.00	Peak	HORIZONTAL
2	5725.00	31.02	35.66	29.13	8.65	46.20	74.00	-27.80	Peak	HORIZONTAL
3	5751.12	76.52	35.69	29.14	8.69	91.76	/	/	Peak	HORIZONTAL

- Note: 1. Result Level = Read Level + Antenna Factor + Cable loss - PRM Factor.
 2. If Peak Result complies with AV limit, AV Result is deemed to comply with AV limit.
 3. Test setup: RBW: 1 MHz, VBW: 3 MHz, Sweep time: auto.

TR-4-E-009 Radiated Emission Test Result

Test Site	: DDT 3m Chamber	E:	:\2015 Report Data\15Q0831-1\RE.EM6
Test Date	: 2015-10-19	Tested By	: Toby
EUT	: Outdoor Access Point	Model Number	: DCWL-7962OT
Power Supply	: DC 50V from external POE adapter	Test Mode	: 11n HT20 Tx mode 5745MHz
Condition	: Temp:24.5°C,Humi:55%, Press:100.1kPa	Antenna/Distance	: 2014 HF907/3m/VERTICAL
Memo	:		

Data: 118

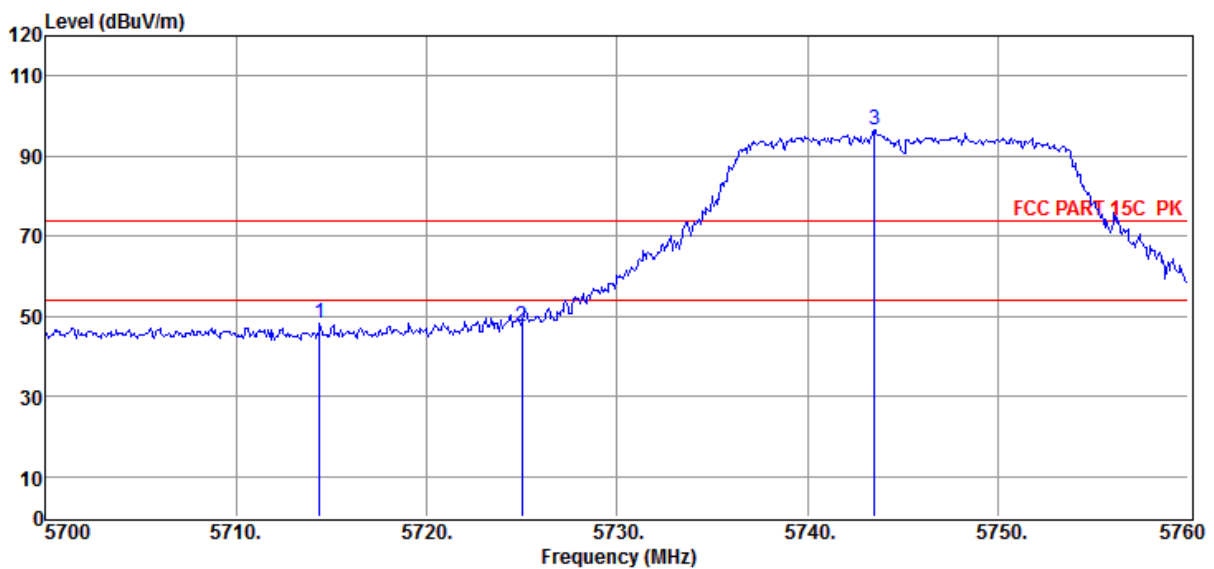

Item (Mark)	Freq (MHz)	Read Level (dBμV)	Antenna Factor (dB/m)	PRM Factor dB	Cable Loss dB	Result Level (dBμV/m)	Limit Line (dBμV/m)	Over Limit (dB)	Detector	Polarization
1	5714.40	33.04	35.63	29.13	8.65	48.19	74.00	-25.81	Peak	VERTICAL
2	5725.00	32.08	35.66	29.13	8.65	47.26	74.00	-26.74	Peak	VERTICAL
3	5743.50	81.25	35.69	29.14	8.69	96.49	/	/	Peak	VERTICAL

- Note: 1. Result Level = Read Level + Antenna Factor + Cable loss - PRM Factor.
 2. If Peak Result complies with AV limit, AV Result is deemed to comply with AV limit.
 3. Test setup: RBW: 1 MHz, VBW: 3 MHz, Sweep time: auto.

TR-4-E-009 Radiated Emission Test Result

Test Site	: DDT 3m Chamber	E:\2015 Report Data\15Q0831-1\RE.EM6
Test Date	: 2015-10-19	Tested By : Toby
EUT	: Outdoor Access Point	Model Number : DCWL-7962OT
Power Supply	: DC 50V from external POE adapter	Test Mode : 11n HT20 Tx mode 5825MHz
Condition	: Temp:24.5°C,Humi:55%, Press:100.1kPa	Antenna/Distance : 2014 HF907/3m/VERTICAL
Memo	:	

Data: 123

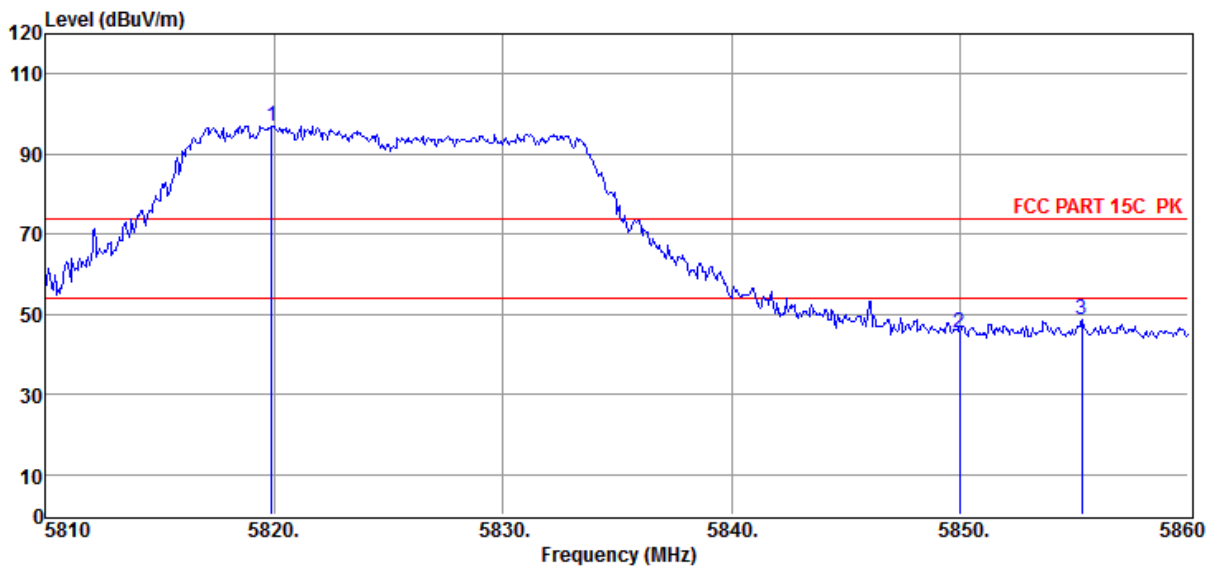

Item (Mark)	Freq (MHz)	Read Level (dBμV)	Antenna Factor (dB/m)	PRM Factor dB	Cable Loss dB	Result Level (dBμV/m)	Limit Line (dBμV/m)	Over Limit (dB)	Detector	Polarization
1	5819.90	81.58	35.82	29.16	8.77	97.01	/	/	Peak	VERTICAL
2	5850.00	29.71	35.85	29.16	8.77	45.17	74.00	-28.83	Peak	VERTICAL
3	5855.35	33.04	35.88	29.17	8.81	48.56	74.00	-25.44	Peak	VERTICAL

Note: 1. Result Level = Read Level + Antenna Factor + Cable loss - PRM Factor.
 2. If Peak Result complies with AV limit, AV Result is deemed to comply with AV limit.
 3. Test setup: RBW: 1 MHz, VBW: 3 MHz, Sweep time: auto.

TR-4-E-009 Radiated Emission Test Result

Test Site	: DDT 3m Chamber	E:\2015 Report Data\15Q0831-1\RE.EM6
Test Date	: 2015-10-19	Tested By : Toby
EUT	: Outdoor Access Point	Model Number : DCWL-7962OT
Power Supply	: DC 50V from external POE adapter	Test Mode : 11n HT20 Tx mode 5825MHz
Condition	: Temp:24.5°C,Humi:55%, Press:100.1kPa	Antenna/Distance : 2014 HF907/3m/HORIZONTAL
Memo	:	

Data: 124

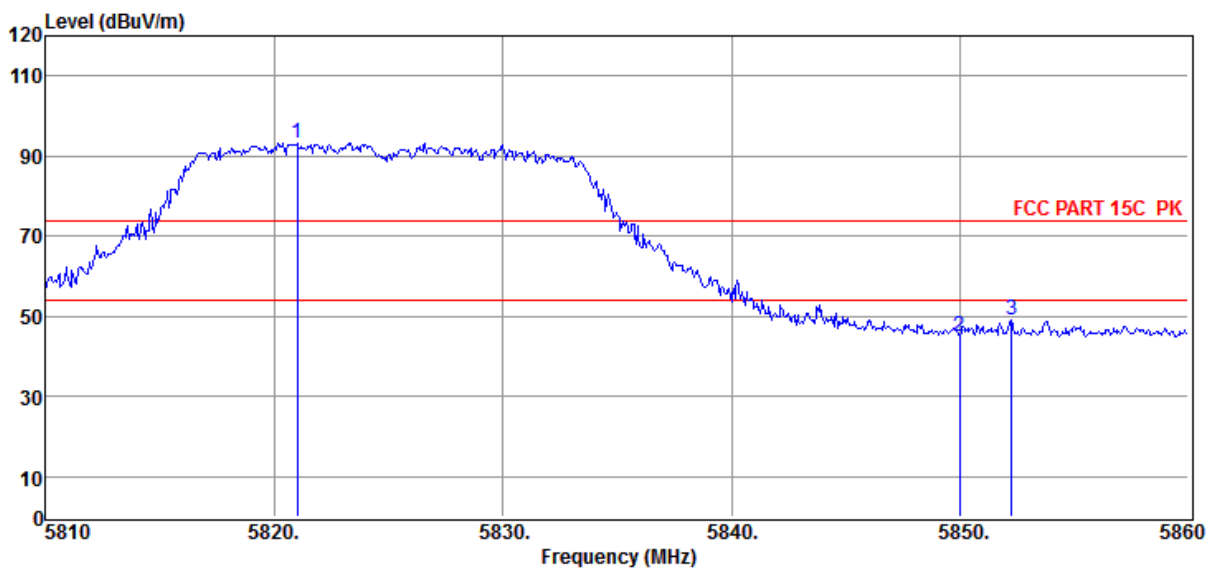

Item (Mark)	Freq (MHz)	Read Level (dBμV)	Antenna Factor (dB/m)	PRM Factor dB	Cable Loss dB	Result Level (dBμV/m)	Limit Line (dBμV/m)	Over Limit (dB)	Detector	Polarization
1	5821.00	77.80	35.82	29.16	8.77	93.23	/	/	Peak	HORIZONTAL
2	5850.00	29.65	35.85	29.16	8.77	45.11	74.00	-28.89	Peak	HORIZONTAL
3	5852.25	33.46	35.85	29.17	8.81	48.95	74.00	-25.05	Peak	HORIZONTAL

Note: 1. Result Level = Read Level + Antenna Factor + Cable loss - PRM Factor.
 2. If Peak Result complies with AV limit, AV Result is deemed to comply with AV limit.
 3. Test setup: RBW: 1 MHz, VBW: 3 MHz, Sweep time: auto.

TR-4-E-009 Radiated Emission Test Result

Test Site	: DDT 3m Chamber	E:\2015 Report Data\15Q0831-1\RE.EM6
Test Date	: 2015-10-19	Tested By : Toby
EUT	: Outdoor Access Point	Model Number : DCWL-7962OT
Power Supply	: DC 50V from external POE adapter	Test Mode : 11n HT40 Tx mode 5755MHz
Condition	: Temp:24.5°C,Humi:55%, Press:100.1kPa	Antenna/Distance : 2014 HF907/3m/VERTICAL
Memo	:	

Data: 127

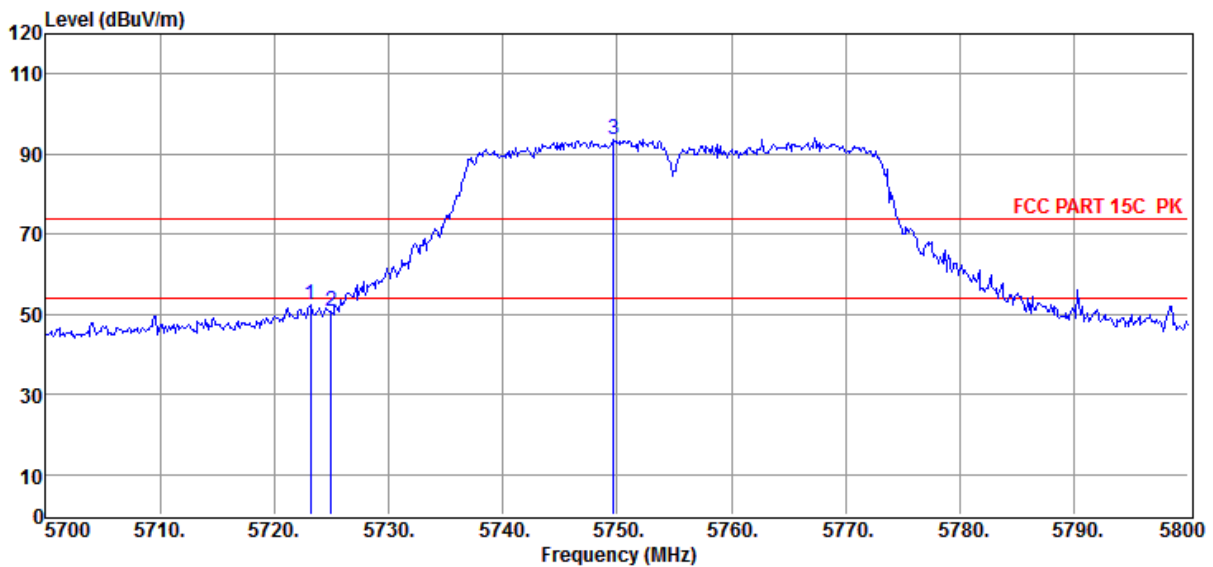

Item (Mark)	Freq (MHz)	Read Level (dBμV)	Antenna Factor (dB/m)	PRM Factor dB	Cable Loss dB	Result Level (dBμV/m)	Limit Line (dBμV/m)	Over Limit (dB)	Detector	Polarization
1	5723.20	37.34	35.66	29.13	8.65	52.52	74.00	-21.48	Peak	VERTICAL
2	5725.00	35.73	35.66	29.13	8.65	50.91	74.00	-23.09	Peak	VERTICAL
3	5749.70	78.55	35.69	29.14	8.69	93.79	/	/	Peak	VERTICAL

- Note: 1. Result Level = Read Level + Antenna Factor + Cable loss - PRM Factor.
 2. If Peak Result complies with AV limit, AV Result is deemed to comply with AV limit.
 3. Test setup: RBW: 1 MHz, VBW: 3 MHz, Sweep time: auto.

TR-4-E-009 Radiated Emission Test Result

Test Site	: DDT 3m Chamber	E:\2015 Report Data\15Q0831-1\RE.EM6
Test Date	: 2015-10-19	Tested By : Toby
EUT	: Outdoor Access Point	Model Number : DCWL-7962OT
Power Supply	: DC 50V from external POE adapter	Test Mode : 11n HT40 Tx mode 5755MHz
Condition	: Temp:24.5°C,Humi:55%, Press:100.1kPa	Antenna/Distance : 2014 HF907/3m/HORIZONTAL
Memo	:	

Data: 128

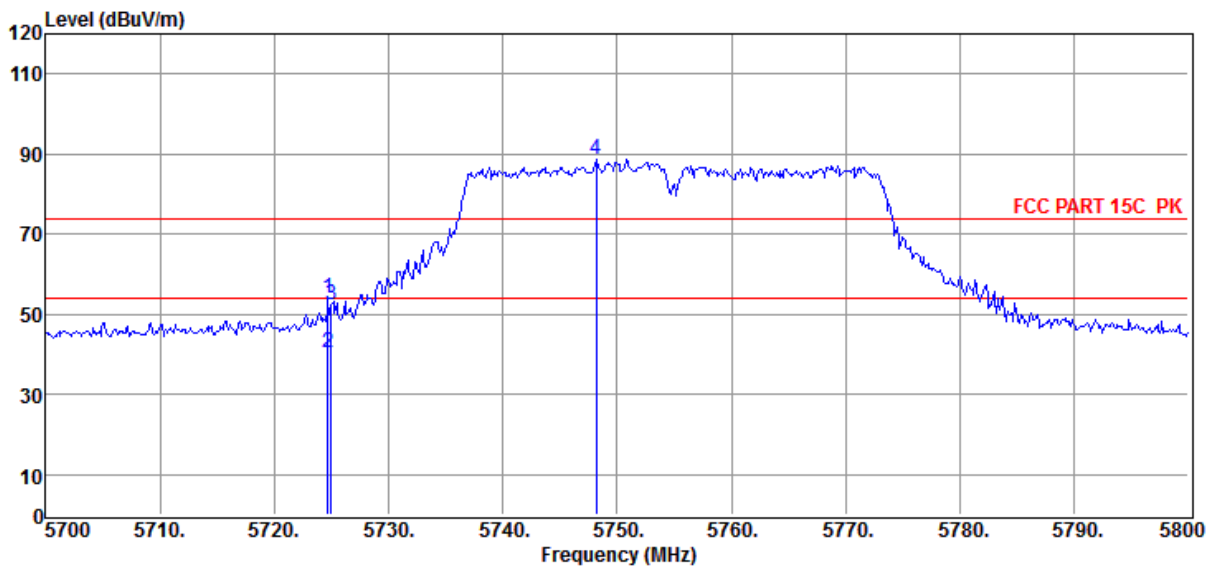

Item (Mark)	Freq (MHz)	Read Level (dBμV)	Antenna Factor (dB/m)	PRM Factor dB	Cable Loss dB	Result Level (dBμV/m)	Limit Line (dBμV/m)	Over Limit (dB)	Detector	Polarization
1	5724.70	38.94	35.66	29.13	8.65	54.12	74.00	-19.88	Peak	HORIZONTAL
2	5724.70	25.10	35.66	29.13	8.65	40.28	54.00	-13.72	Average	HORIZONTAL
3	5725.00	37.30	35.66	29.13	8.65	52.48	74.00	-21.52	Peak	HORIZONTAL
4	5748.20	73.54	35.69	29.14	8.69	88.78	/	/	Peak	HORIZONTAL

Note: 1. Result Level = Read Level + Antenna Factor + Cable loss - PRM Factor.
 2. If Peak Result complies with AV limit, AV Result is deemed to comply with AV limit.
 3. Test setup: RBW: 1 MHz, VBW: 3 MHz, Sweep time: auto.

TR-4-E-009 Radiated Emission Test Result

Test Site	: DDT 3m Chamber	E:\2015 Report Data\15Q0831-1\RE.EM6
Test Date	: 2015-10-19	Tested By : Toby
EUT	: Outdoor Access Point	Model Number : DCWL-7962OT
Power Supply	: DC 50V from external POE adapter	Test Mode : 11n HT40 Tx mode 5795MHz
Condition	: Temp:24.5°C,Humi:55%, Press:100.1kPa	Antenna/Distance : 2014 HF907/3m/VERTICAL
Memo	:	

Data: 131

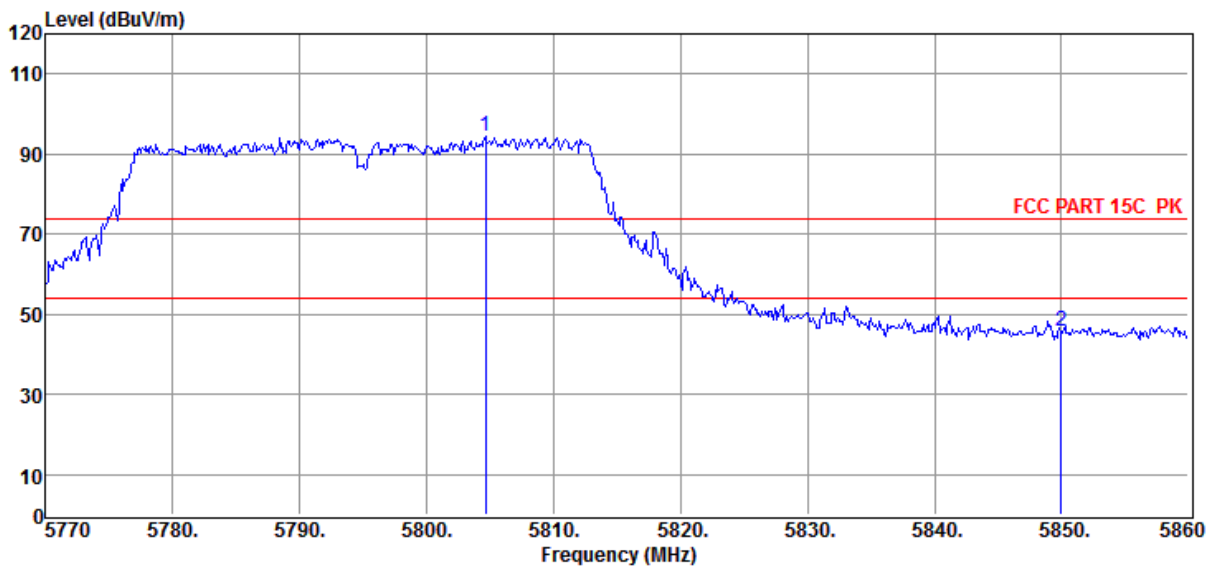

Item (Mark)	Freq (MHz)	Read Level (dBμV)	Antenna Factor (dB/m)	PRM Factor dB	Cable Loss dB	Result Level (dBμV/m)	Limit Line (dBμV/m)	Over Limit (dB)	Detector	Polarization
1	5804.65	78.90	35.80	29.15	8.73	94.28	/	/	Peak	VERTICAL
2	5850.00	30.20	35.85	29.16	8.77	45.66	74.00	-28.34	Peak	VERTICAL

- Note: 1. Result Level = Read Level + Antenna Factor + Cable loss - PRM Factor.
 2. If Peak Result complies with AV limit, AV Result is deemed to comply with AV limit.
 3. Test setup: RBW: 1 MHz, VBW: 3 MHz, Sweep time: auto.

TR-4-E-009 Radiated Emission Test Result

Test Site : DDT 3m Chamber	E:\2015 Report Data\15Q0831-1\RE.EM6
Test Date : 2015-10-19	Tested By : Toby
EUT : Outdoor Access Point	Model Number : DCWL-7962OT
Power Supply : DC 50V from external POE adapter	Test Mode : 11n HT40 Tx mode 5795MHz
Condition : Temp:24.5°C,Humi:55%, Press:100.1kPa	Antenna/Distance : 2014 HF907/3m/HORIZONTAL
Memo :	

Data: 132

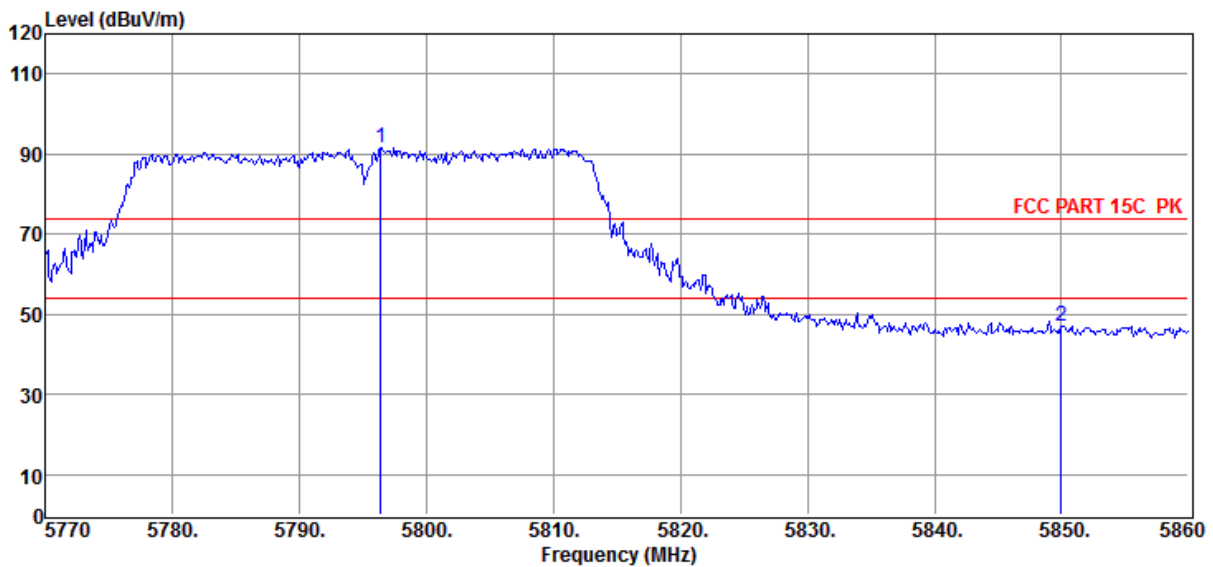

Item (Mark)	Freq (MHz)	Read Level (dBμV)	Antenna Factor (dB/m)	PRM Factor dB	Cable Loss dB	Result Level (dBμV/m)	Limit Line (dBμV/m)	Over Limit (dB)	Detector	Polarization
1	5796.37	76.05	35.77	29.15	8.73	91.40	/	/	Peak	HORIZONTAL
2	5850.00	31.59	35.85	29.16	8.77	47.05	74.00	-26.95	Peak	HORIZONTAL

- Note: 1. Result Level = Read Level + Antenna Factor + Cable loss - PRM Factor.
 2. If Peak Result complies with AV limit, AV Result is deemed to comply with AV limit.
 3. Test setup: RBW: 1 MHz, VBW: 3 MHz, Sweep time: auto.

10. Power Line Conducted Emission

10.1. Test equipment

Please refer to Section 3 this report.

10.2. Block diagram of test setup

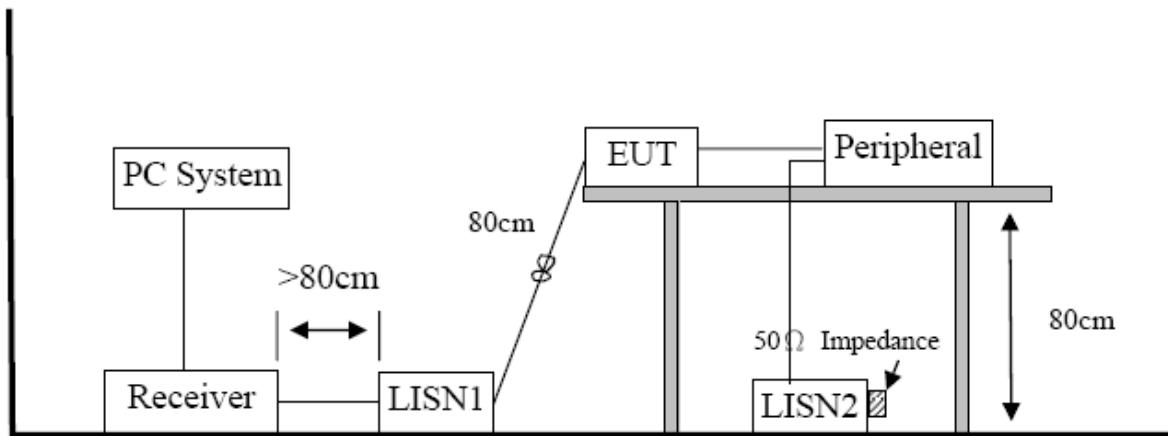

10.3. Power Line Conducted Emission Limits(Class B)

Frequency	Quasi-Peak Level dB(μ V)	Average Level dB(μ V)
150kHz ~ 500kHz	66 ~ 56*	56 ~ 46*
500kHz ~ 5MHz	56	46
5MHz ~ 30MHz	60	50

Note 1: * Decreasing linearly with logarithm of frequency.

Note 2: The lower limit shall apply at the transition frequencies.

10.4. Test Procedure

The EUT and Support equipment, if needed, were put placed on a non-metallic table, 80cm above the ground plane.

Configuration EUT to simulate typical usage as described in clause 2.3 and test equipment as described in clause 10.2 of this report.

All I/O cables were positioned to simulate typical actual usage as per ANSI C63.4.

All support equipment power received from a second LISN.

Emissions were measured on each current carrying line of the EUT using an EMI Test Receiver connected to the LISN powering the EUT.

The Receiver scanned from 150 kHz to 30MHz for emissions in each of the test modes.

During the above scans, the emissions were maximized by cable manipulation.

The test mode(s) described in clause 2.3 were scanned during the preliminary test.

After the preliminary scan, we found the test mode producing the highest emission level.

The EUT configuration and worse cable configuration of the above highest emission levels were recorded for reference of the final test.

EUT and support equipment were set up on the test bench as per the configuration with highest emission level in the preliminary test.

A scan was taken on both power lines, Neutral and Line, recording at least the six highest emissions.

Emission frequency and amplitude were recorded into a computer in which correction factors were used to calculate the emission level and compare reading to the applicable limit.

The test data of the worst-case condition(s) was recorded.

The bandwidth of test receiver is set at 9 KHz.

10.5. Test Result

PASS. (See below detailed test result)

Note1: All emissions not reported below are too low against the prescribed limits.

Note2: “-----” means peak detection; “-----” mans average detection

TR-4-E-010 Conducted Emission Test Result

: DDT 1# Shield Room E:\2015 report data\15Q0831-1\CE.EM6
Test Date : 2015-09-24 **Tested By** : Sincere
EUT : Outdoor Access Point **Model Number** : DCWL-7962OT
Power Supply : DC 50V from external POE adapter **Test Mode** : TX Mode
Condition : Temp:24.5°C,Humi:55%,
 : Press:100.1kPa **LISN** : 2014 ENV216/LINE
Memo :

Data: 14

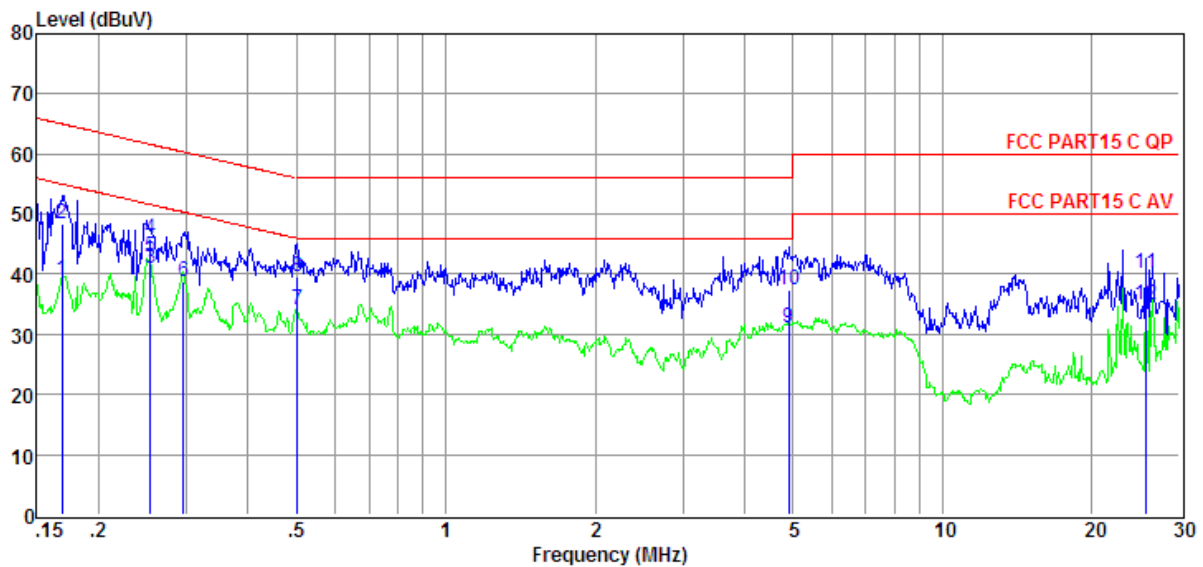

Item (Mark)	Freq (MHz)	Read Level (dBμV)	LISN Factor (dB)	Cable Loss (dB)	Pulse Limiter Factor (dB)	Result Level (dBμV)	Limit Line (dBμV)	Over Limit (dB)	Detector	Phase
1	0.17	19.47	9.61	0.01	9.84	38.93	55.04	-16.11	Average	LINE
2	0.17	28.97	9.61	0.01	9.84	48.43	65.04	-16.61	QP	LINE
3	0.25	21.48	9.62	0.02	9.85	40.97	51.61	-10.64	Average	LINE
4	0.25	26.37	9.62	0.02	9.85	45.86	61.61	-15.75	QP	LINE
5	0.25	23.51	9.62	0.02	9.85	43.00	61.61	-18.61	QP	LINE
6	0.30	19.26	9.62	0.02	9.85	38.75	50.34	-11.59	Average	LINE
7	0.50	14.62	9.63	0.03	9.87	34.15	46.00	-11.85	Average	LINE
8	0.50	20.14	9.63	0.03	9.87	39.67	56.00	-16.33	QP	LINE
9	4.90	11.32	9.68	0.11	9.88	30.99	46.00	-15.01	Average	LINE
10	4.90	17.85	9.68	0.11	9.88	37.52	56.00	-18.48	QP	LINE
11	25.59	20.15	9.97	0.17	9.97	40.26	60.00	-19.74	QP	LINE
12	25.65	14.87	9.98	0.17	9.97	34.99	50.00	-15.01	Average	LINE

Note: 1. Result Level = Read Level + LISN Factor + Pulse Limiter Factor + Cable loss.

2. If QP Result complies with AV limit, AV Result is deemed to comply with AV limit.

3. Test setup: RBW: 200 Hz (9 kHz—150 kHz), 9 kHz (150 kHz—30 MHz), Step size: 4 kHz, Scan time: auto.

TR-4-E-010 Conducted Emission Test Result

: DDT 1# Shield Room
 E:\2015 report data\15Q0831-1\CE.EM6
Test Date : 2015-09-24
Tested By : Sincere
EUT : Outdoor Access Point
Model Number : DCWL-7962OT
Power Supply : DC 50V from external POE adapter
Test Mode : TX Mode
Condition : Temp:24.5°C,Humi:55%,
 Press:100.1kPa
LISN : 2014 ENV216/NEUTRAL
Memo :

Data: 16

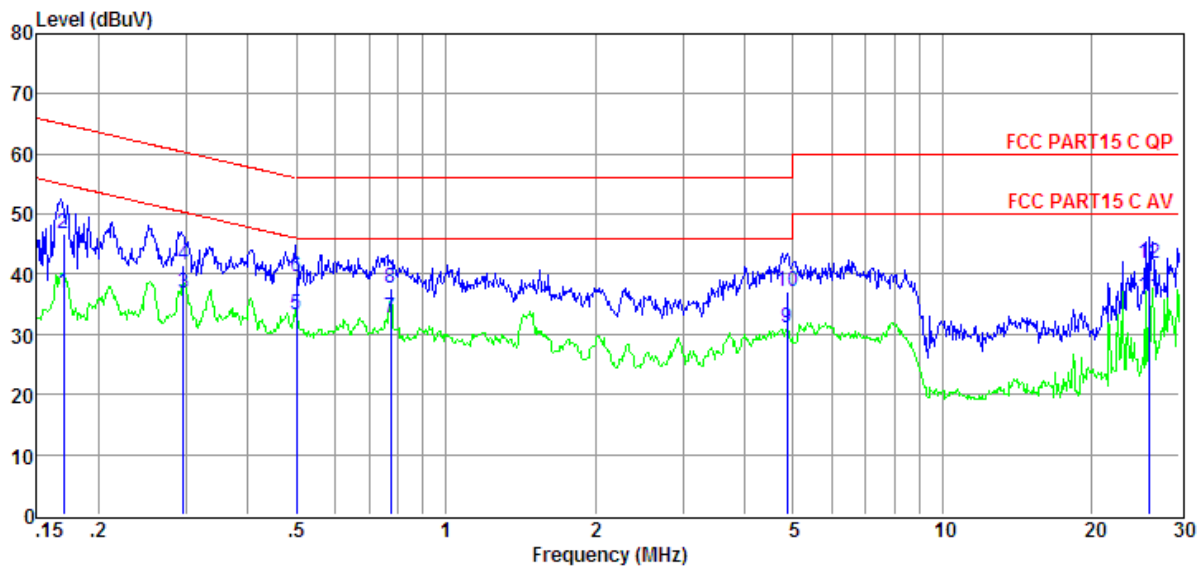

Item (Mark)	Freq (MHz)	Read Level (dBμV)	LISN Factor (dB)	Cable Loss (dB)	Pulse Limiter Factor (dB)	Result Level (dBμV)	Limit Line (dBμV)	Over Limit (dB)	Detector	Phase
1	0.17	17.46	9.60	0.01	9.84	36.91	54.95	-18.04	Average	NEUTRAL
2	0.17	27.37	9.60	0.01	9.84	46.82	64.95	-18.13	QP	NEUTRAL
3	0.30	17.25	9.60	0.02	9.85	36.72	50.34	-13.62	Average	NEUTRAL
4	0.30	22.14	9.60	0.02	9.85	41.61	60.34	-18.73	QP	NEUTRAL
5	0.50	13.87	9.61	0.03	9.87	33.38	46.00	-12.62	Average	NEUTRAL
6	0.50	20.14	9.61	0.03	9.87	39.65	56.00	-16.35	QP	NEUTRAL
7	0.78	13.25	9.61	0.08	9.86	32.80	46.00	-13.20	Average	NEUTRAL
8	0.78	18.01	9.61	0.08	9.86	37.56	56.00	-18.44	QP	NEUTRAL
9	4.87	11.54	9.62	0.11	9.88	31.15	46.00	-14.85	Average	NEUTRAL
10	4.87	17.54	9.62	0.11	9.88	37.15	56.00	-18.85	QP	NEUTRAL
11	26.05	16.16	10.03	0.17	9.97	36.33	50.00	-13.67	Average	NEUTRAL
12	26.05	21.49	10.03	0.17	9.97	41.66	60.00	-18.34	QP	NEUTRAL

Note: 1. Result Level = Read Level + LISN Factor + Pulse Limiter Factor + Cable loss.

2. If QP Result complies with AV limit, AV Result is deemed to comply with AV limit.

3. Test setup: RBW: 200 Hz (9 kHz—150 kHz), 9 kHz (150 kHz—30 MHz), Step size: 4 kHz, Scan time: auto.

11. Antenna Requirements

11.1. Limit

For intentional device, according to FCC 47 CFR Section 15.203, an intentional radiator shall be designed to ensure that no antenna other than that furnished by the responsible party shall be used with the device. And according to FCC 47 CFR Section 15.247 (b), if transmitting antennas of directional gain greater than 6dBi are used, the power shall be reduced by the amount in dB that the directional gain of the antenna exceeds 6dBi.

11.2. Result

The antennas used for this product are external antenna MIMO 2x2, this requirement must be professionally installed, the maximum antenna gain 3.4dBi Single root Antenna and MIMO 2X2. Total ANT=3.4+10*LOG(2)=6.4dBi; therefore power limit reduction due to antenna gain is 0.4dBi.

12. Test setup photograph

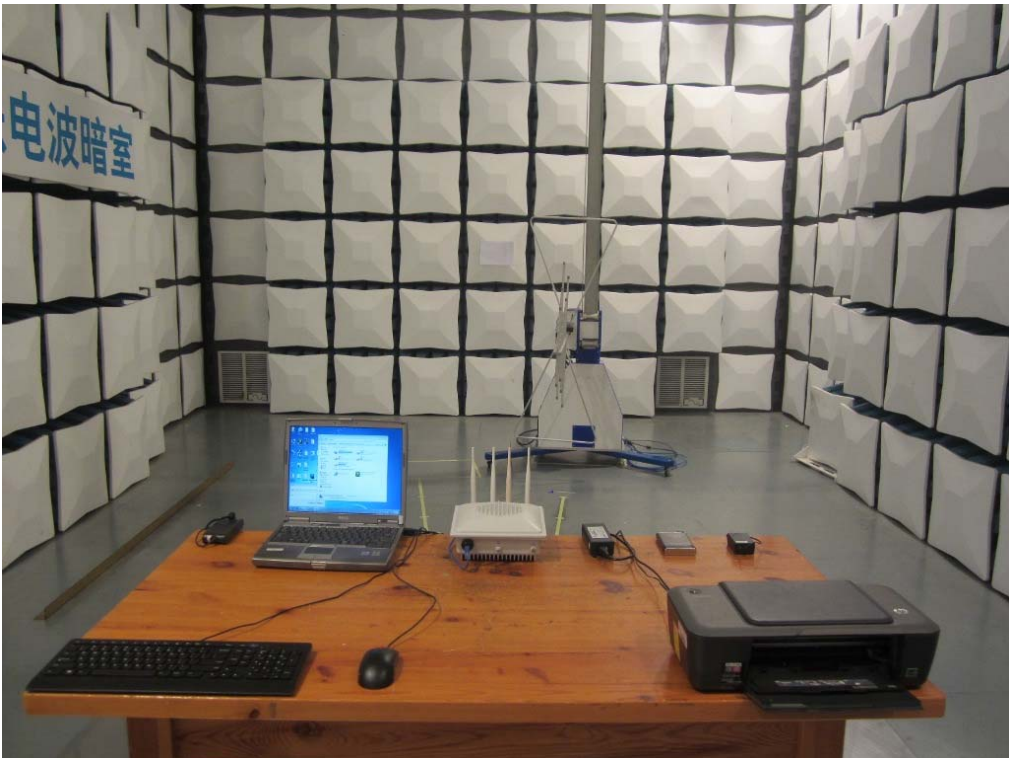

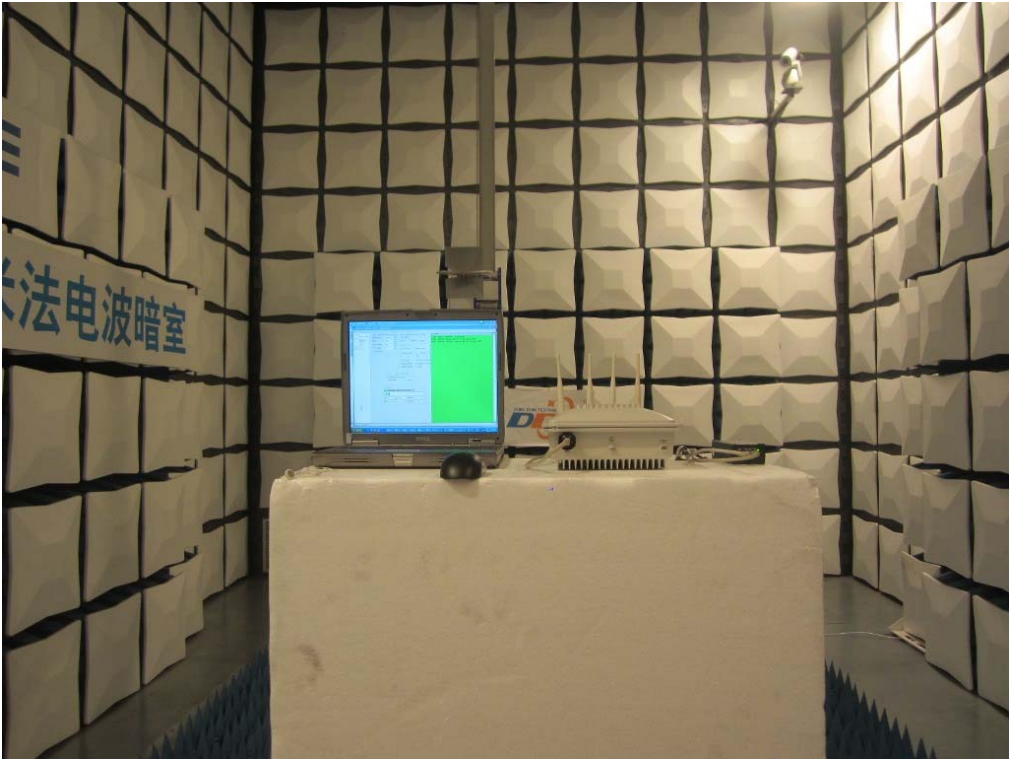

13. Photos of the EUT

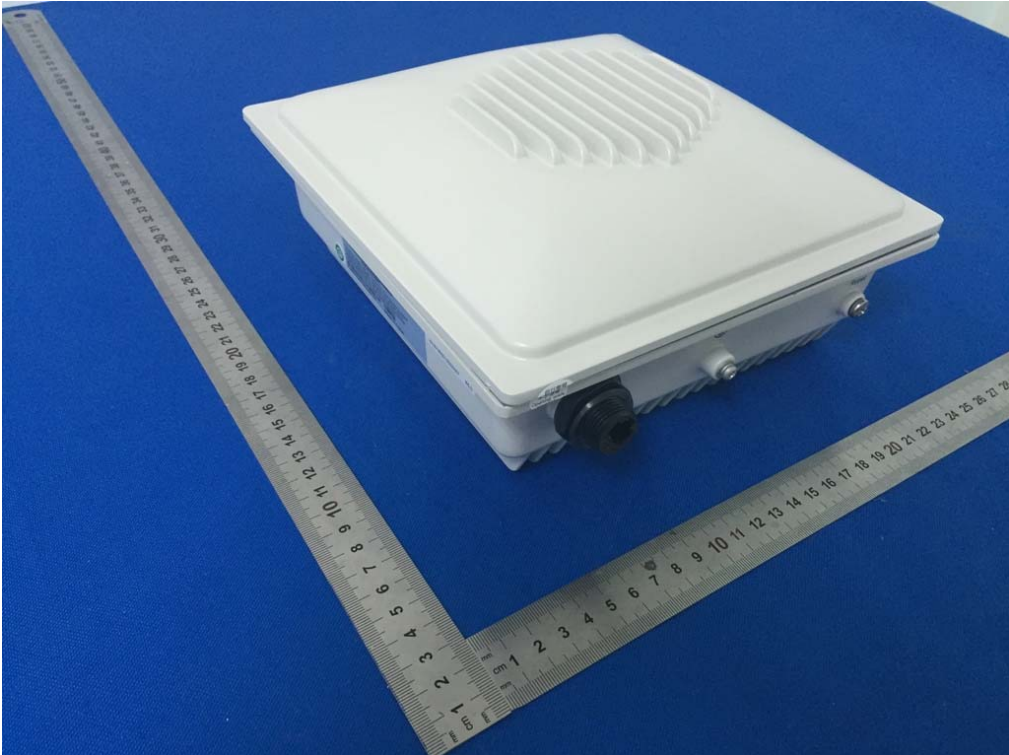
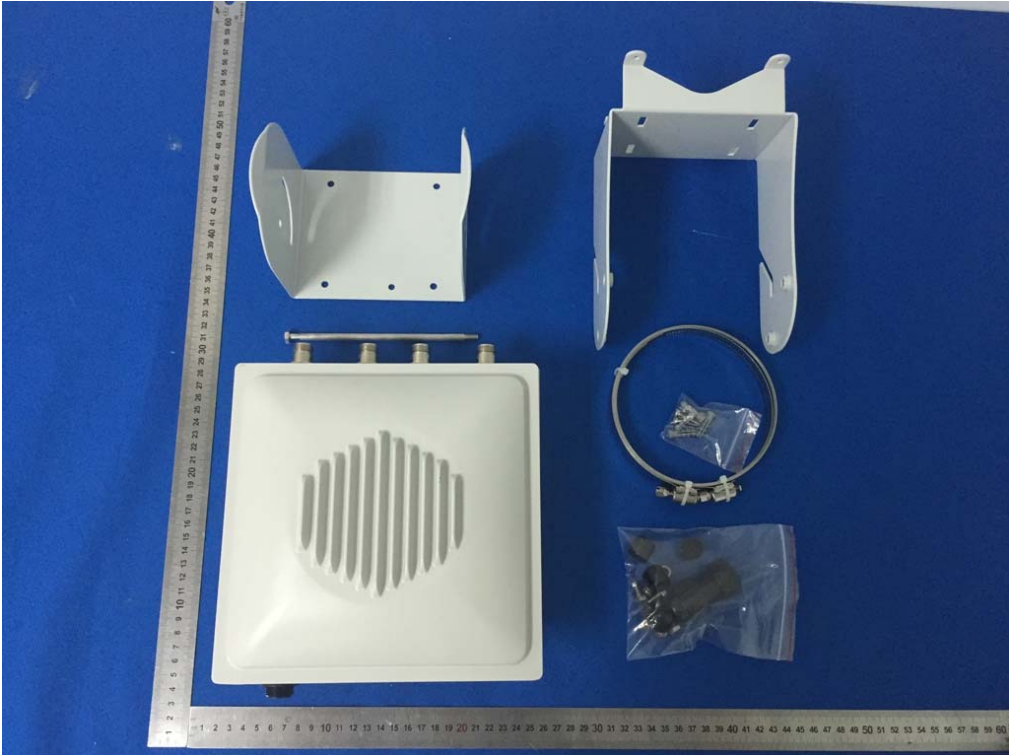

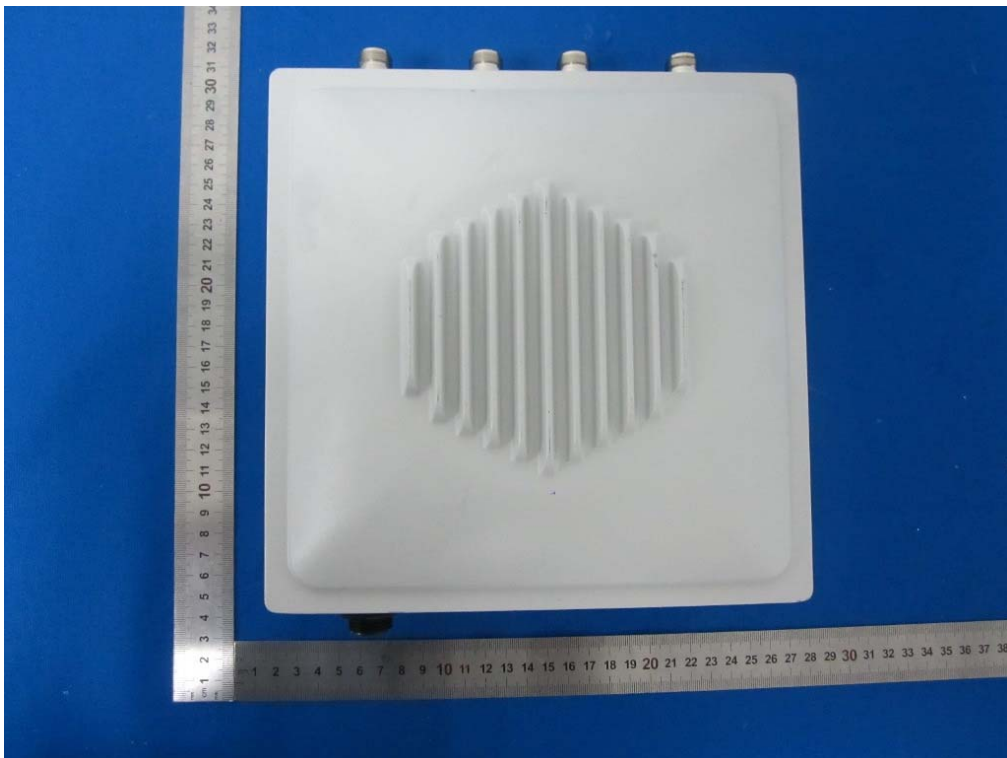
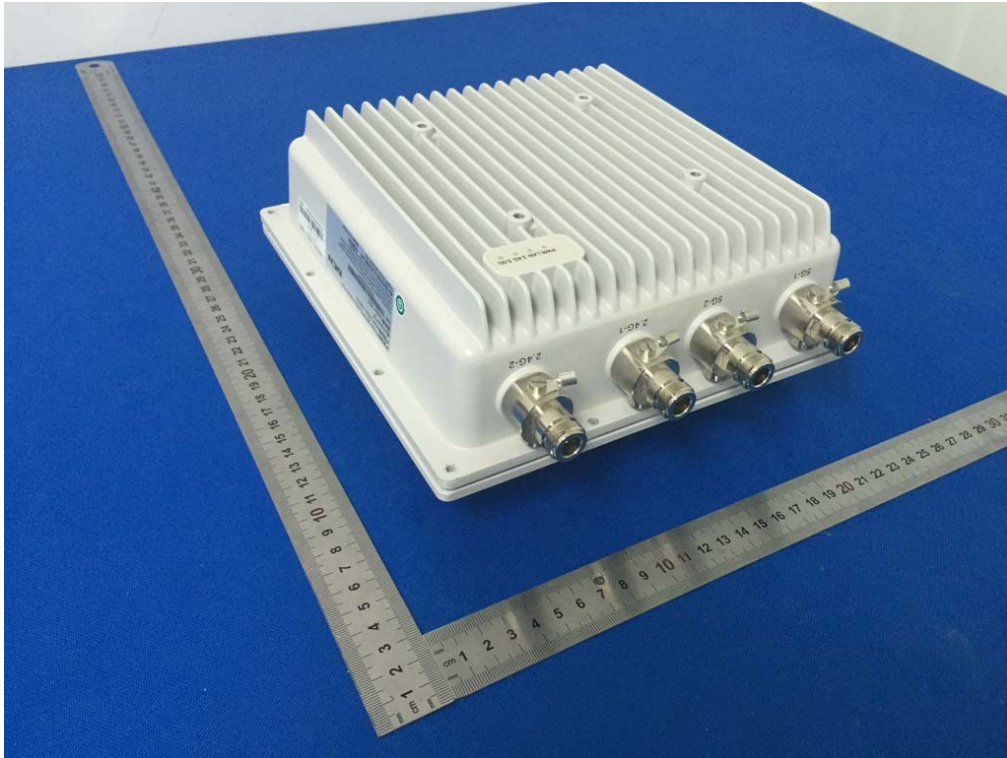

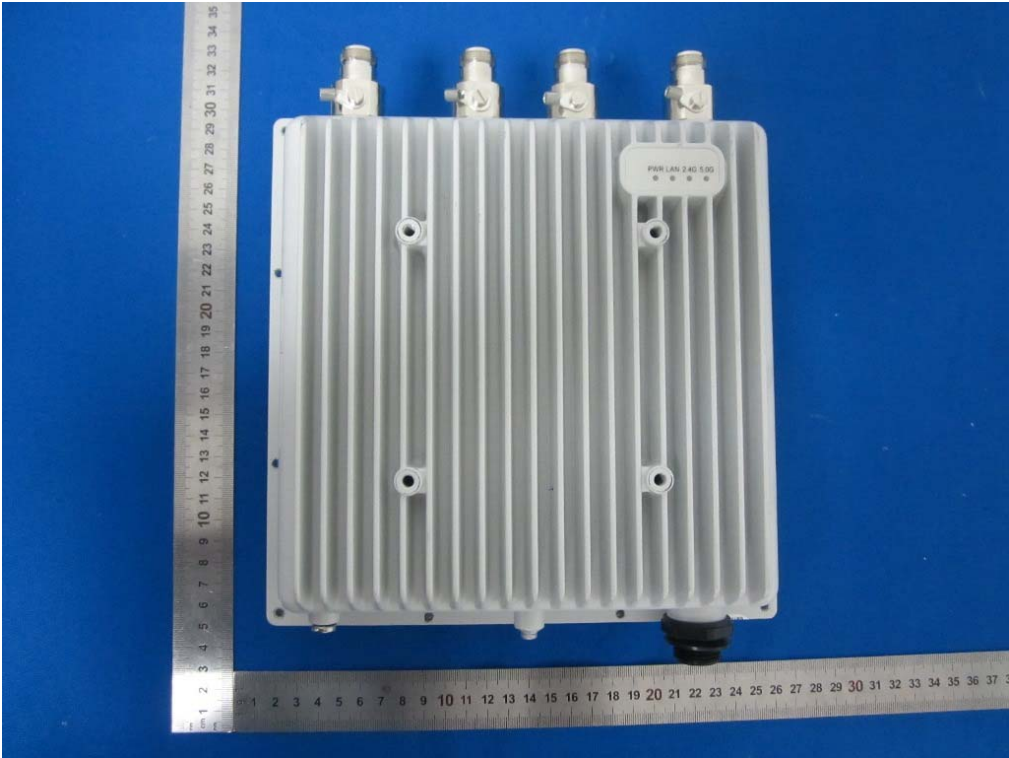

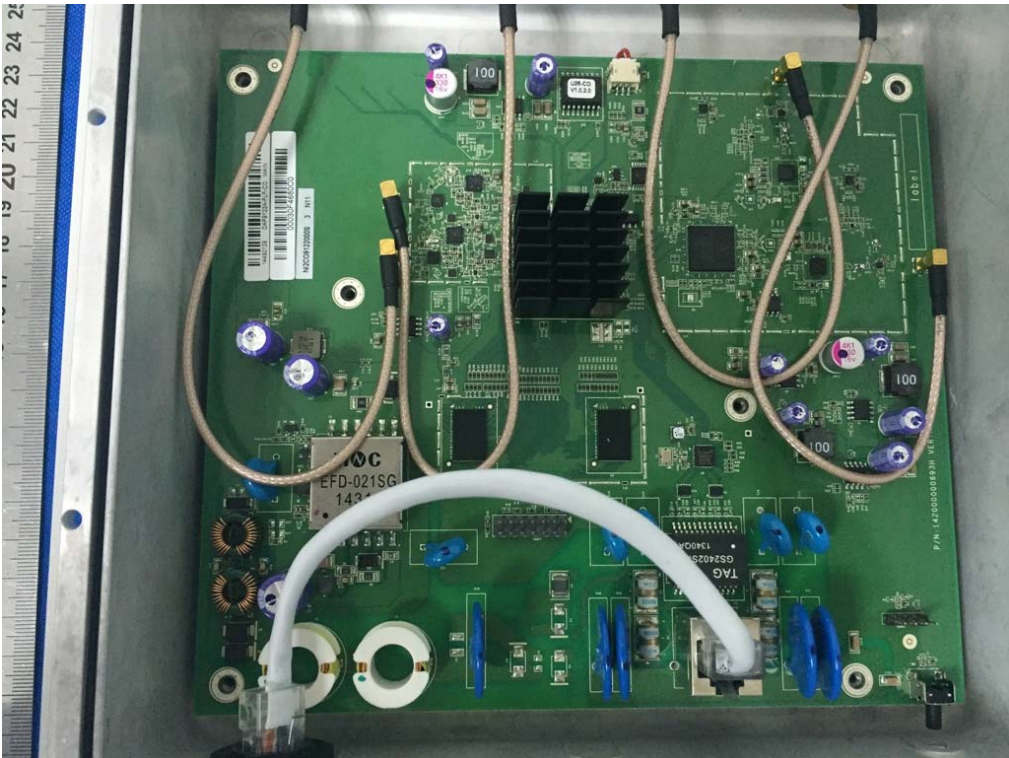
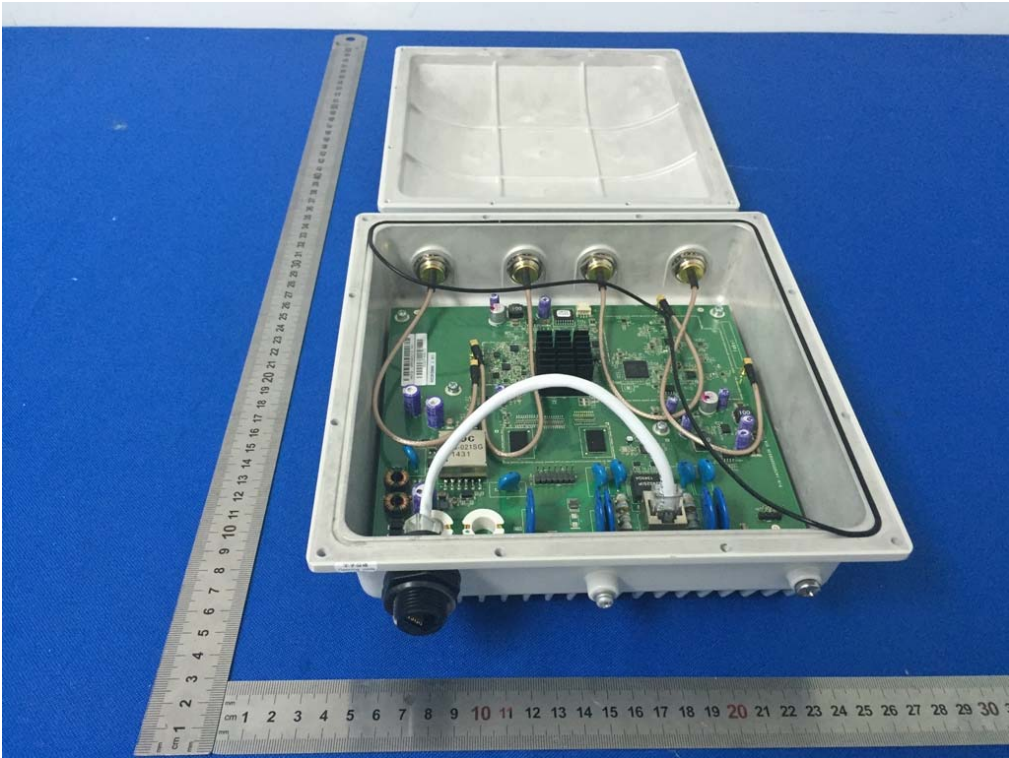

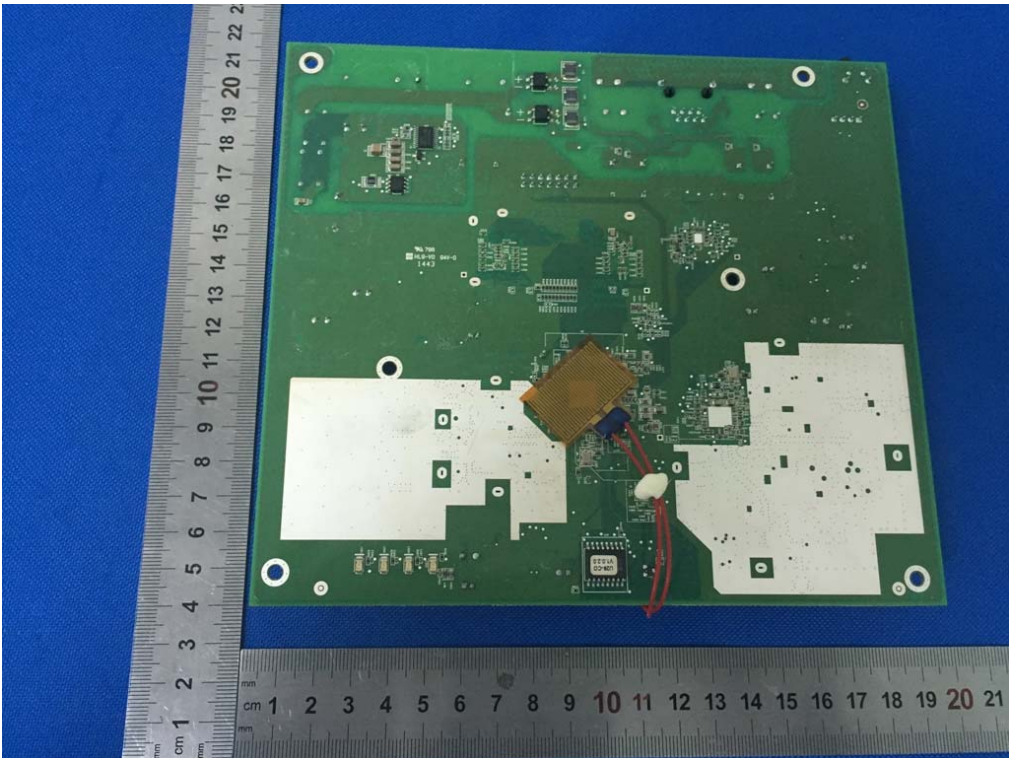
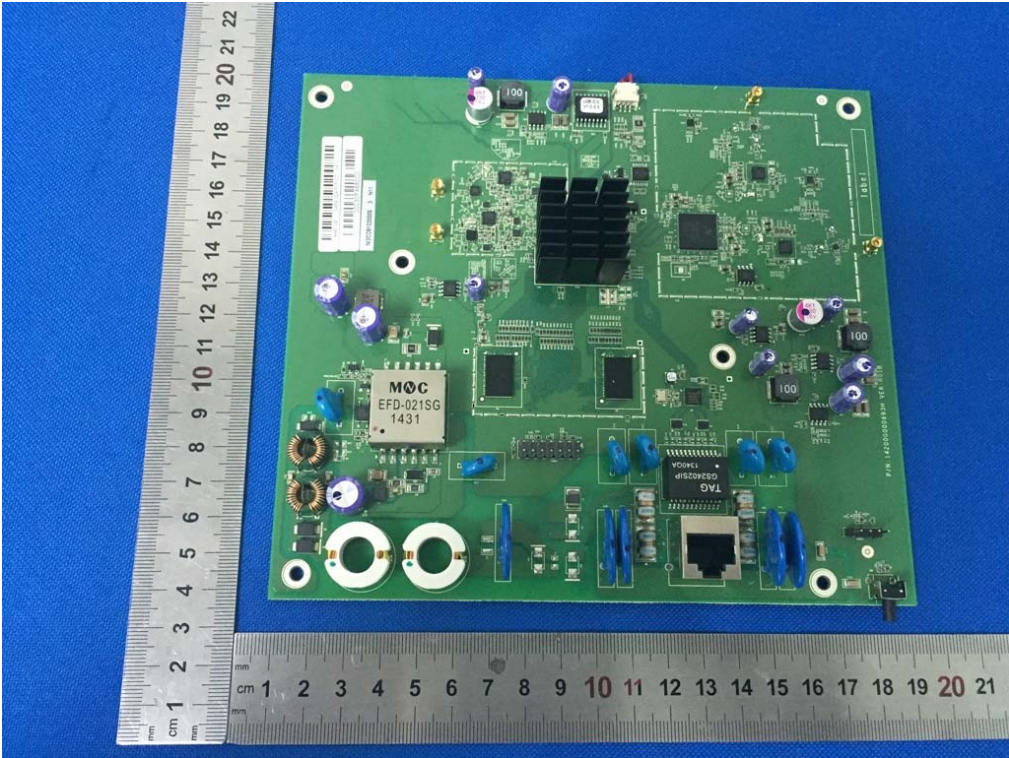

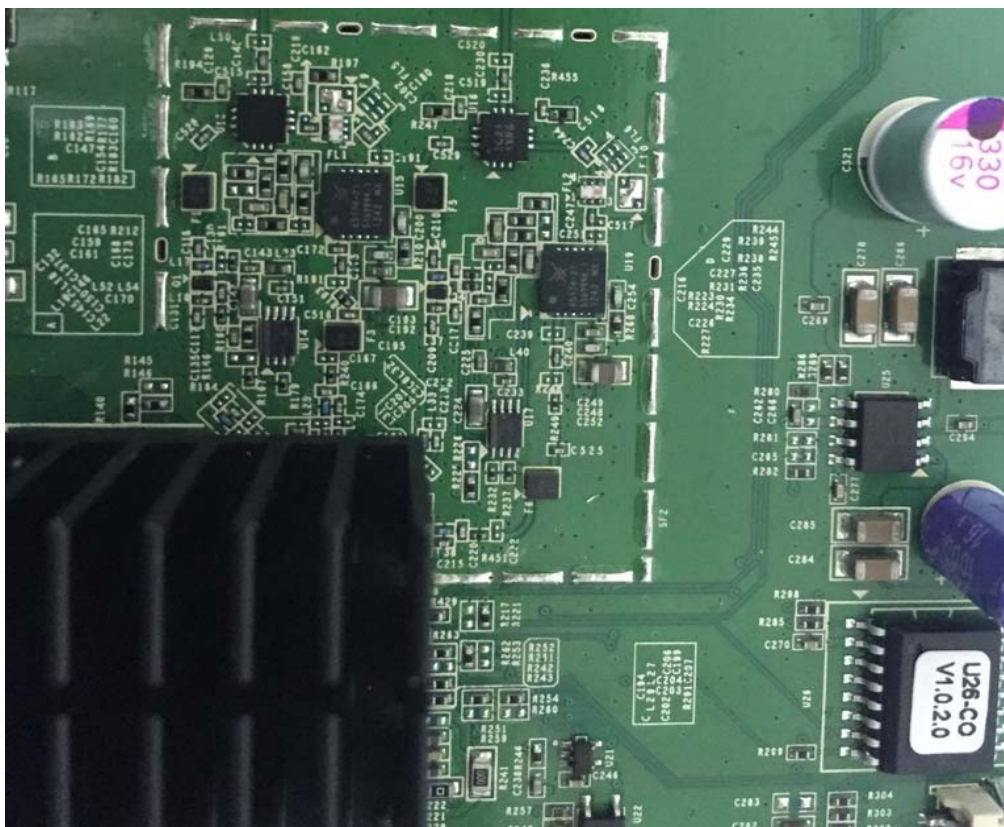
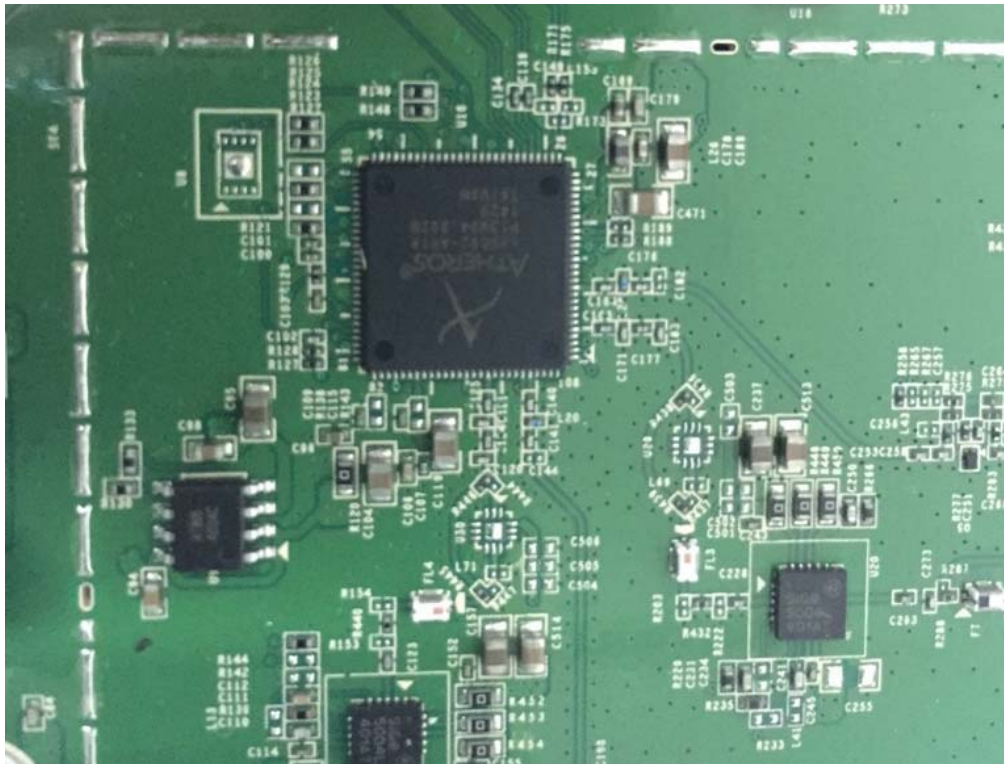

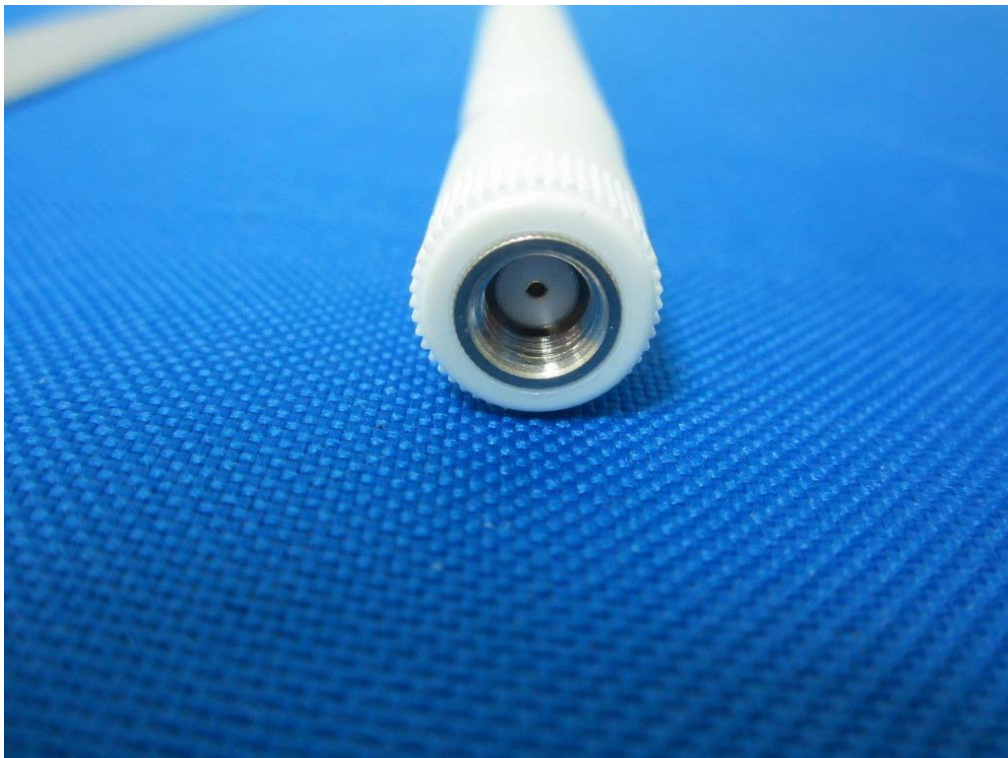

END OF REPORT