

FCC Radio Test Report

FCC ID: 2ABHA7123-04

Original Grant

Report No. : TB-FCC142365
Applicant : NINGBO CSTAR IMP&EXP CO., LTD.
Equipment Under Test (EUT)
EUT Name : Mobile Odyssey Duke Waterproof Bluetooth Speaker
Model No. : 7123-04
Series Model No. : N/A
Receipt Date : 2014-10-28
Test Date : 2014-10-28 to 2014-11-05
Issue Date : 2014-11-05
Standards : FCC Part 15: 2014, Subpart C(15.247)
Test Method : ANSI C63.4:2003
Conclusions : **PASS**

In the configuration tested, the EUT complied with the standards specified above,
The EUT technically complies with the FCC requirements

Test/Witness Engineer :

IVAN SU

Approved & Authorized :

IVAN SU



This report details the results of the testing carried out on one sample. The results contained in this test report do not relate to other samples of the same product. The manufacturer should ensure that all products in series production are in conformity with the product sample detailed in the report.

Contents

CONTENTS.....	2
1. GENERAL INFORMATION ABOUT EUT	4
1.1 Client Information.....	4
1.2 General Description of EUT (Equipment Under Test)	4
1.3 Block Diagram Showing the Configuration of System Tested.....	6
1.4 Description of Support Units	6
1.5 Description of Test Mode.....	6
1.6 Description of Test Software Setting	7
1.7 Test Facility.....	8
2. TEST SUMMARY.....	9
3. CONDUCTED EMISSION TEST	10
3.1 Test Standard and Limit.....	10
3.2 Test Setup.....	10
3.3 Test Procedure.....	10
3.4 Test Equipment Used.....	11
3.5 EUT Operating Mode	11
3.6 Test Data.....	11
4. RADIATED EMISSION TEST	14
4.1 Test Standard and Limit.....	14
4.2 Test Setup.....	15
4.3 Test Procedure.....	16
4.4 EUT Operating Condition	16
4.5 Test Equipment.....	17
5. RESTRICTED BANDS REQUIREMENT	32
5.1 Test Standard and Limit.....	32
5.2 Test Setup.....	32
5.3 Test Procedure.....	32
5.4 EUT Operating Condition	33
5.5 Test Equipment.....	33
6. NUMBER OF HOPPING CHANNEL	46
6.1 Test Standard and Limit.....	46
6.2 Test Setup.....	46
6.3 Test Procedure.....	46
6.4 EUT Operating Condition	46
6.5 Test Equipment.....	46
6.6 Test Data.....	46
7. AVERAGE TIME OF OCCUPANCY.....	48
7.1 Test Standard and Limit.....	48
7.2 Test Setup.....	48
7.3 Test Procedure.....	48

7.4 EUT Operating Condition	48
7.5 Test Equipment	48
7.6 Test Data	49
8. CHANNEL SEPARATION AND BANDWIDTH TEST	61
8.1 Test Standard and Limit	61
8.2 Test Setup	61
8.3 Test Procedure	61
8.4 EUT Operating Condition	61
8.5 Test Equipment	62
8.6 Test Data	62
9. PEAK OUTPUT POWER TEST	70
9.1 Test Standard and Limit	70
9.2 Test Setup	70
9.3 Test Procedure	70
9.4 EUT Operating Condition	70
9.5 Test Equipment	70
9.6 Test Data	70
10. ANTENNA REQUIREMENT	75
10.1 Standard Requirement	75
10.2 Antenna Connected Construction	75
10.2 Result	75

1. General Information about EUT

1.1 Client Information

Applicant : NINGBO CSTAR IMP&EXP CO., LTD.
Address : Floor 4, Building E, No. 655-90, Qiming Road, Yinzhou Investment & Innovation Center, Ningbo, China.
Manufacturer : NINGBO CSTAR IMP&EXP CO., LTD.
Address : Floor 4, Building E, No. 655-90, Qiming Road, Yinzhou Investment & Innovation Center, Ningbo, China.

1.2 General Description of EUT (Equipment Under Test)

EUT Name	:	Mobile Odyssey Duke Waterproof Bluetooth Speaker	
Models No.	:	7123-04	
Model Difference	:	N/A	
Product Description	:	Operation Frequency: Bluetooth:2402~2480MHz	
		Number of Channel:	Bluetooth:79 Channels see note (2)
		Max Peak Output Power:	8-DPSK: 2.661dBm (Conducted Power)
		Antenna Gain:	0 dBi PCB Antenna
		Modulation Type:	GFSK 1Mbps(1 Mbps) π /4-DQPSK(2 Mbps) 8-DPSK(3 Mbps)
Power Supply	:	DC Voltage supplied from Host System by USB cable DC power by 400mA Li-ion Battery	
Power Rating	:	DC 5.0V by USB cable. DC 3.7V Li-ion Battery.	
Connecting I/O Port(S)	:	Please refer to the User's Manual	
Note:			

Note:

- (1) For a more detailed features description, please refer to the manufacturer's specifications or the User's Manual.
- (2) This Test Report is FCC Part 15.247 for Bluetooth, and test procedure in accordance with Public Notice: DA 00-705.
- (3) Channel List:

Channel	Frequency (MHz)	Channel	Frequency (MHz)	Channel	Frequency (MHz)
00	2402	27	2429	54	2456
01	2403	28	2430	55	2457
02	2404	29	2431	56	2458
03	2405	30	2432	57	2459
04	2406	31	2433	58	2460
05	2407	32	2434	59	2461
06	2408	33	2435	60	2462
07	2409	34	2436	61	2463
08	2410	35	2437	62	2464
09	2411	36	2438	63	2465
10	2412	37	2439	64	2466
11	2413	38	2440	65	2467
12	2414	39	2441	66	2468
13	2415	40	2442	67	2469
14	2416	41	2443	68	2470
15	2417	42	2444	69	2471
16	2418	43	2445	70	2472
17	2419	44	2446	71	2473
18	2420	45	2447	72	2474
19	2421	46	2448	73	2475
20	2422	47	2449	74	2476
21	2423	48	2450	75	2477
22	2424	49	2451	76	2478
23	2425	50	2452	77	2479
24	2426	51	2453	78	2480
25	2427	52	2454		
26	2428	53	2455		

(4) The Antenna information about the equipment is provided by the applicant.

1.3 Block Diagram Showing the Configuration of System Tested

TX Mode

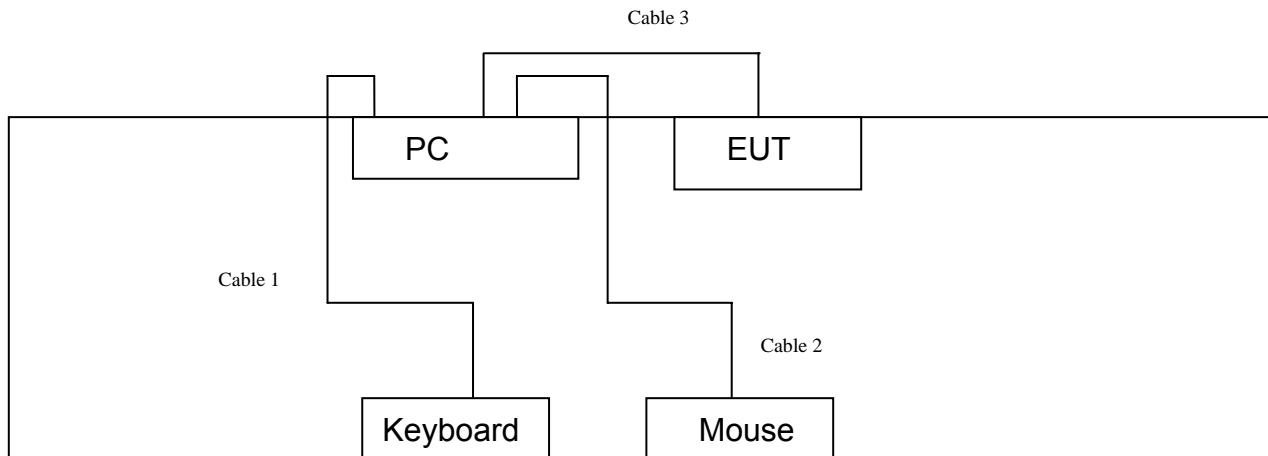

1.4 Description of Support Units

Equipment Information				
Name	Model	FCC ID/DOC	Manufacturer	Used “√”
LCD Monitor	E170Sc	DOC	DELL	√
PC	OPTIPLEX380	DOC	DELL	√
Keyboard	L100	DOC	DELL	√
Mouse	M-UARDEL7	DOC	DELL	√
Cable Information				
Number	Shielded Type	Ferrite Core	Length	Note
Cable 1	YES	NO	1.5M	
Cable 2	YES	NO	1.5M	
Cable 3	NO	NO	0.8M	Accessories

1.5 Description of Test Mode

To investigate the maximum EMI emission characteristics generated from EUT, the test system was pre-scanning tested based on the consideration of following EUT operation mode or test configuration mode which possibly have effect on EMI emission level. Each of these EUT operation mode(s) or test configuration mode(s) mentioned follows was evaluated respectively.

For Conducted Test	
Final Test Mode	Description
Mode 1	USB Charging with TX GFSK Mode

For Radiated Test	
Final Test Mode	Description
Mode 1	USB Charging with TX GFSK Mode
Mode 2	TX Mode(GFSK) Channel 00/39/78
Mode 3	TX Mode($\pi/4$ -DQPSK) Channel 00/39/78
Mode 4	TX Mode(8-DPSK) Channel 00/39/78
Mode 5	Hopping Mode(GFSK)
Mode 6	Hopping Mode($\pi/4$ -DQPSK)
Mode 7	Hopping Mode(8-DPSK)

Note:

- For all test, we have verified the construction and function in typical operation. And all the test modes were carried out with the EUT in transmitting operation in maximum power with all kinds of data rate. We have pretested all the test mode above.
According to ANSI C63.4 standards, the measurements are performed at the highest, middle, lowest available channels, and the worst case data rate as follows:
TX Mode: GFSK (1 Mbps)
TX Mode: 8-DPSK (3 Mbps)
- The EUT is considered a portable unit; it was pre-tested on the positioned of each 3 axis, X-plane, Y-plane and Z-plane. The worst case was found positioned on X-plane as the normal use. Therefore only the test data of this X-plane was used for radiated emission measurement test.

1.6 Description of Test Software Setting

During testing channel & Power controlling software provided by the customer was used to control the operating channel as well as the output power level. The RF output power selection is for the setting of RF output power expected by the customer and is going to be fixed on the firmware of the final end product power parameters of Bluetooth mode.

Test Software Version	Bluetooth Authentication Test Tool v1.3.3-CE/FCC		
	2402 MHz	2441MHz	2480 MHz
Frequency	2402 MHz	2441MHz	2480 MHz
GFSK	DEF	DEF	DEF
$\pi/4$ -DQPSK	DEF	DEF	DEF
8-DPSK	DEF	DEF	DEF

1.7 Test Facility

The testing was performed by the Shenzhen Toby Technology Co., Ltd., in their facilities located at:

1A/F., Bldg.6, Yusheng Industrial Zone, The National Road No.107 Xixiang Section 467, Xixiang, Bao'an, Shenzhen, Guangdong, China.

At the time of testing, the following bodies accredited the Laboratory:

CNAS (L5813)

The Laboratory has been accredited by CNAS to ISO/IEC 17025: 2005 General Requirements for the Competence of Testing and Calibration Laboratories for the competence in the field of testing. And the Registration No.: CNAS L5813.

FCC List No.: (811562)

The Laboratory is listed in the United States of American Federal Communications Commission (FCC), and the registration number is 811562.

IC Registration No.: (11950A-1)

The Laboratory has been registered by Certification and Engineering Bureau of Industry Canada for radio equipment testing. The site registration: Site# 11950A-1.

2. Test Summary

FCC Part 15 Subpart C(15.247)			
Standard Section	Test Item	Judgment	Remark
15.203	Antenna Requirement	PASS	N/A
15.207	Conducted Emission	PASS	N/A
15.205	Restricted Bands	PASS	N/A
15.247(a)(1)	Hopping Channel Separation	PASS	N/A
15.247(a)(1)	Dwell Time	PASS	N/A
15.247(b)(1)	Peak Output Power	PASS	N/A
15.247(b)(1)	Number of Hopping Frequency	PASS	N/A
15.247(c)	Radiated Spurious Emission	PASS	N/A
15.247(c)	Antenna Conducted Spurious Emission	PASS	N/A
15.247(a)	20dB Bandwidth	PASS	N/A

Note: N/A is an abbreviation for Not Applicable.

3. Conducted Emission Test

3.1 Test Standard and Limit

3.1.1 Test Standard

FCC Part 15.207

3.1.2 Test Limit

Conducted Emission Test Limit

Frequency	Maximum RF Line Voltage (dB μ V)	
	Quasi-peak Level	Average Level
150kHz~500kHz	66 ~ 56 *	56 ~ 46 *
500kHz~5MHz	56	46
5MHz~30MHz	60	50

Notes:

(1) *Decreasing linearly with logarithm of the frequency.

(2) The lower limit shall apply at the transition frequencies.

(3) The limit decrease in line with the logarithm of the frequency in the range of 0.15 to 0.50MHz.

3.2 Test Setup

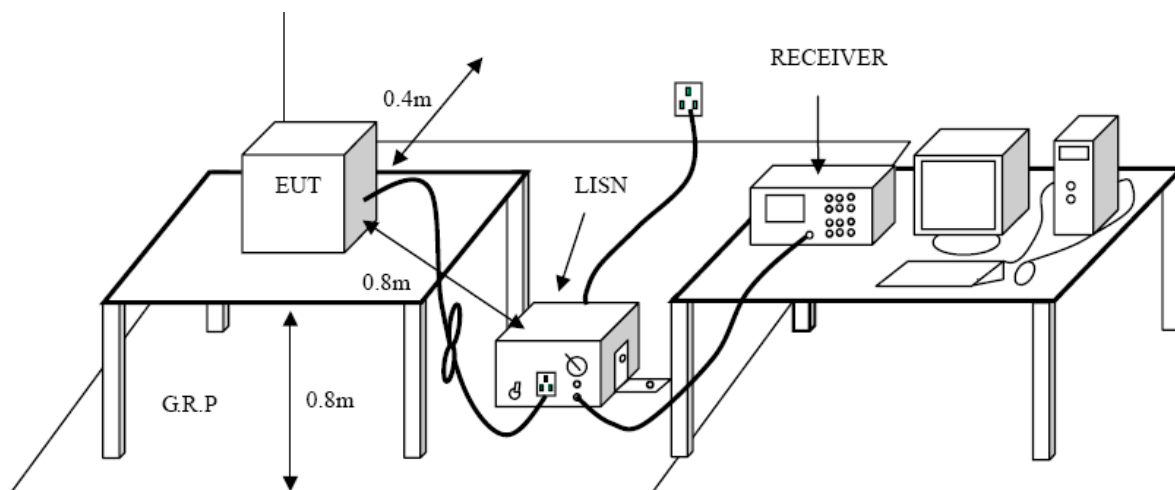

3.3 Test Procedure

The EUT was placed 0.8 meters from the horizontal ground plane with EUT being connected to the power mains through a line impedance stabilization network (LISN). All other support equipments powered from additional LISN(s). The LISN provide 50 Ohm/ 50uH of coupling impedance for the measuring instrument.

Interconnecting cables that hang closer than 40 cm to the ground plane shall be folded back and forth in the center forming a bundle 30 to 40 cm long.

I/O cables that are not connected to a peripheral shall be bundled in the center. The end of the cable may be terminated, if required, using the correct terminating impedance. The overall length shall not exceed 1 m.

LISN at least 80 cm from nearest part of EUT chassis

The bandwidth of EMI test receiver is set at 9kHz, and the test frequency band is from 0.15MHz to 30MHz.

3.4 Test Equipment Used

Description	Manufacturer	Model No.	Serial No.	Cal. Date	Cal. Due Date
EMI Test Receiver	ROHDE& SCHWARZ	ESCI	100321	Aug. 08, 2014	Aug.07, 2015
50ΩCoaxial Switch	Anritsu	MP59B	X10321	Aug. 08, 2014	Aug.07, 2015
L.I.S.N	Rohde & Schwarz	ENV216	101131	Aug. 08, 2014	Aug.07, 2015
L.I.S.N	SCHWARZBECK	NNBL 8226-2	8226-2/164	Aug. 08, 2014	Aug.07, 2015

3.5 EUT Operating Mode

Please refer to the description of test mode.

3.6 Test Data

Please see the next page.

EUT:	Mobile Odyssey Duke Waterproof Bluetooth Speaker	Model Name :	7123-04
Temperature:	25 °C	Relative Humidity:	55%
Test Voltage:	AC 120V/60 Hz		
Terminal:	Line		
Test Mode:	USB Charging with TX GFSK Mode 2402 MHz		
Remark:	Only worse case is reported		

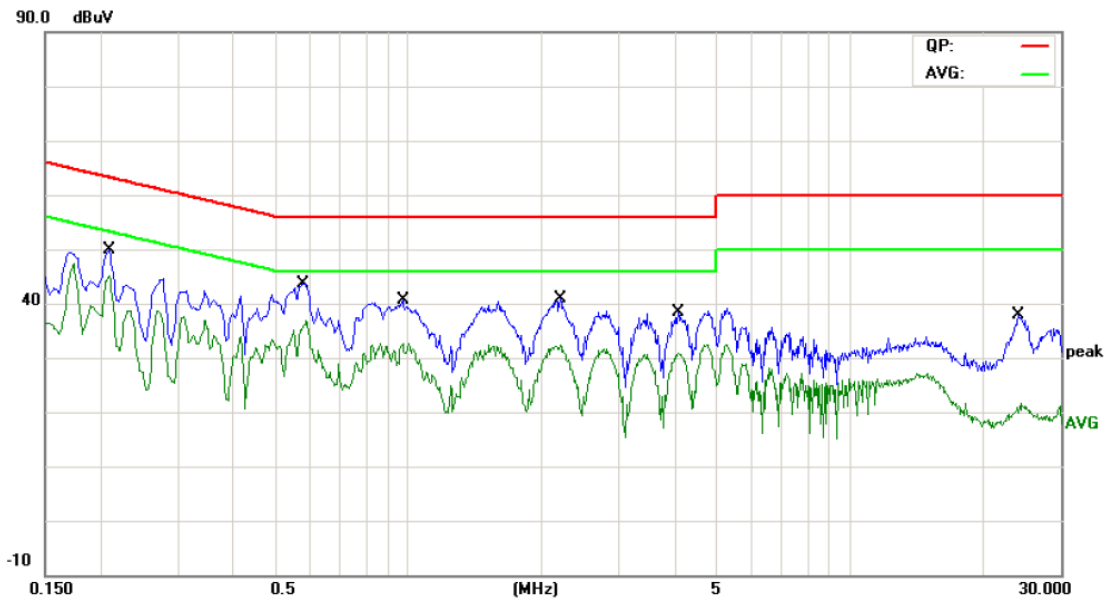

No.	Mk.	Freq. MHz	Reading Level dBuV	Correct Factor dB	Measure- ment dBuV	Limit dBuV	Over dB	Detector
1		0.2100	38.04	10.02	48.06	63.20	-15.14	QP
2	*	0.2100	34.70	10.02	44.72	53.20	-8.48	AVG
3		0.5780	32.94	10.06	43.00	56.00	-13.00	QP
4		0.5780	25.54	10.06	35.60	46.00	-10.40	AVG
5		0.9700	28.62	10.07	38.69	56.00	-17.31	QP
6		0.9700	22.27	10.07	32.34	46.00	-13.66	AVG
7		2.2060	25.55	10.05	35.60	56.00	-20.40	QP
8		2.2060	22.07	10.05	32.12	46.00	-13.88	AVG
9		4.0900	24.62	9.99	34.61	56.00	-21.39	QP
10		4.0900	20.83	9.99	30.82	46.00	-15.18	AVG
11		24.1340	21.57	10.16	31.73	60.00	-28.27	QP
12		24.1340	8.86	10.16	19.02	50.00	-30.98	AVG

Emission Level= Read Level+ Correct Factor

EUT:	Mobile Odyssey Duke Waterproof Bluetooth Speaker	Model Name :	7123-04
Temperature:	25 °C	Relative Humidity:	55%
Test Voltage:	AC 120V/60 Hz		
Terminal:	Neutral		
Test Mode:	USB Charging with TX GFSK Mode 2402 MHz		
Remark:	Only worse case is reported		

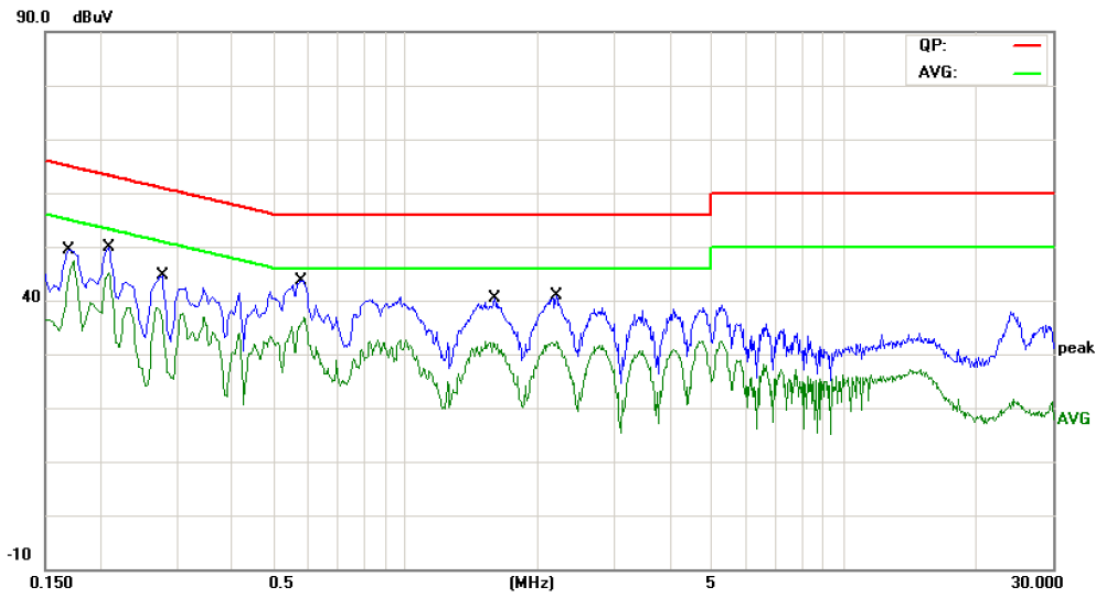

No.	Mk.	Freq. MHz	Reading Level dBuV	Correct Factor dB	Measure- ment dBuV	Limit dBuV	Over dB	Detector
1		0.1700	36.13	10.12	46.25	64.96	-18.71	QP
2		0.1700	32.80	10.12	42.92	54.96	-12.04	AVG
3		0.2100	34.19	10.12	44.31	63.20	-18.89	QP
4		0.2100	31.60	10.12	41.72	53.20	-11.48	AVG
5		0.2779	26.02	10.09	36.11	60.88	-24.77	QP
6		0.2779	20.38	10.09	30.47	50.88	-20.41	AVG
7		0.5780	34.67	10.02	44.69	56.00	-11.31	QP
8	*	0.5780	27.28	10.02	37.30	46.00	-8.70	AVG
9		1.5940	27.36	10.10	37.46	56.00	-18.54	QP
10		1.5940	21.68	10.10	31.78	46.00	-14.22	AVG
11		2.2060	25.68	10.06	35.74	56.00	-20.26	QP
12		2.2060	22.42	10.06	32.48	46.00	-13.52	AVG

Emission Level= Read Level+ Correct Factor

4. Radiated Emission Test

4.1 Test Standard and Limit

4.1.1 Test Standard

FCC Part 15.209

4.1.2 Test Limit

Radiated Emission Limit (9 kHz~1000MHz)

Frequency (MHz)	Field Strength (microvolt/meter)	Measurement Distance (meters)
0.009~0.490	2400/F(KHz)	300
0.490~1.705	24000/F(KHz)	30
1.705~30.0	30	30
30~88	100	3
88~216	150	3
216~960	200	3
Above 960	500	3

Radiated Emission Limit (Above 1000MHz)

Frequency (MHz)	Class B (dBuV/m)(at 3m)	
	Peak	Average
Above 1000	74	54

Note:

- (1) The tighter limit applies at the band edges.
- (2) Emission Level (dBuV/m)=20log Emission Level (uV/m)

4.2 Test Setup

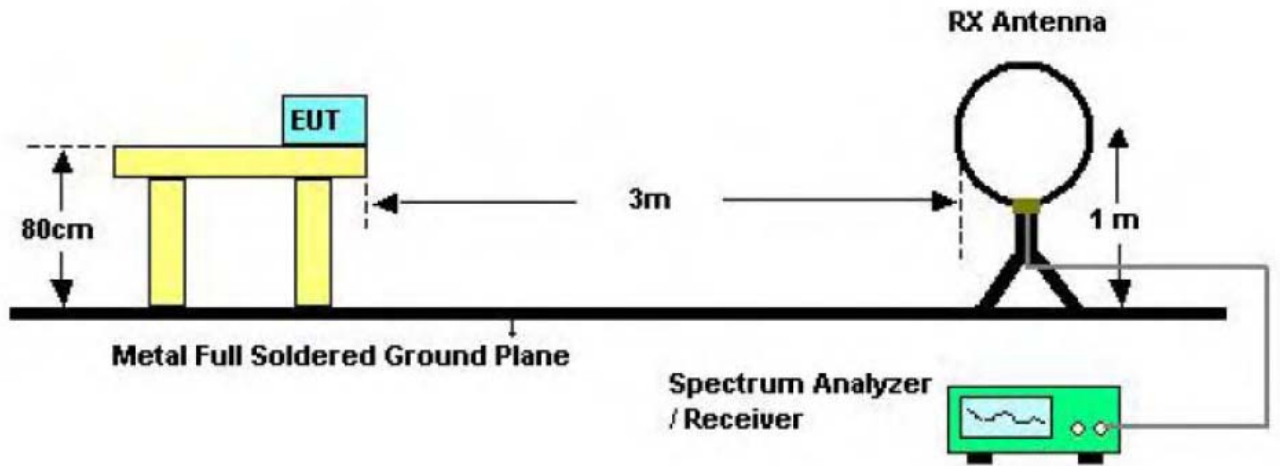

Bellow 30MHz Test Setup

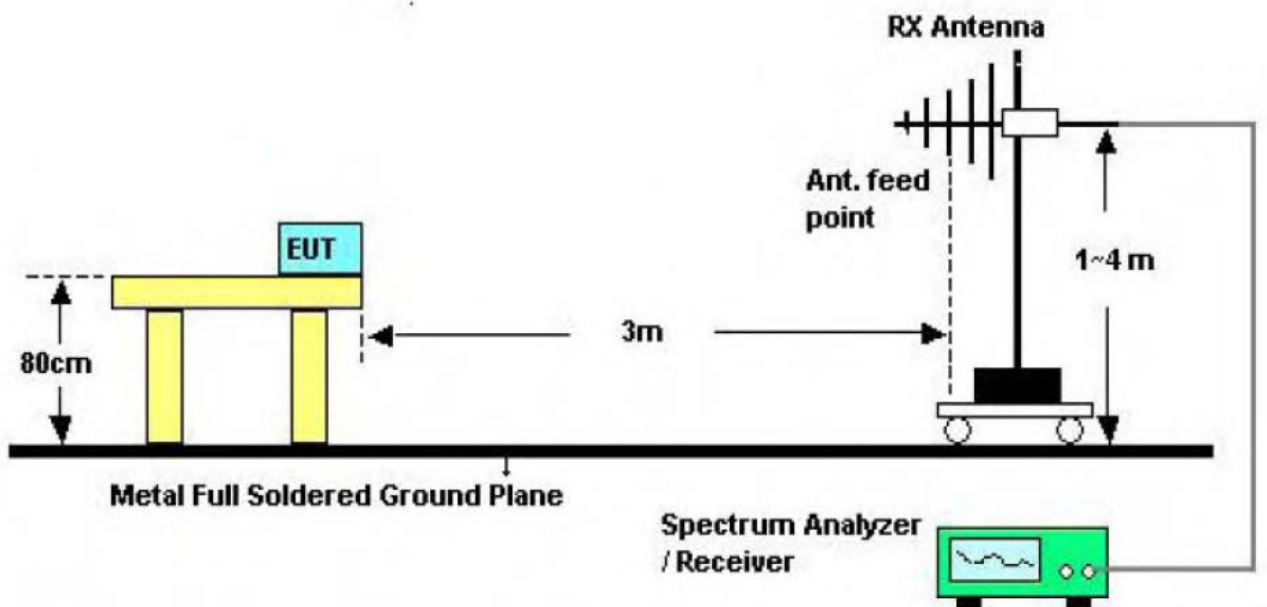

Bellow 1000MHz Test Setup

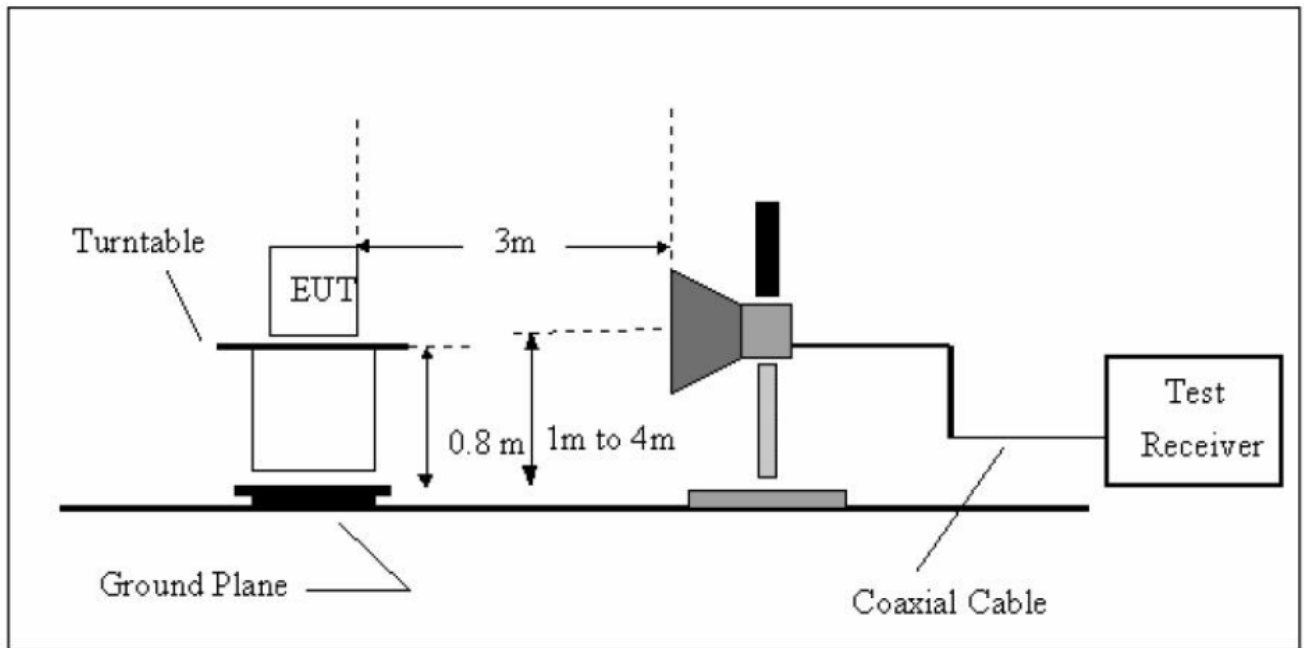

Above 1GHz Test Setup

4.3 Test Procedure

- (1) The measuring distance of 3m shall be used for measurements at frequency up to 1GHz and above 1 GHz. The EUT was placed on a rotating 0.8m high above the ground, the table was rotated 360 degrees to determine the position of the highest radiation.
- (2) The Test antenna shall vary between 1m and 4m, Both Horizontal and Vertical antenna are set to make measurement.
- (3) The initial step in collecting conducted emission data is a spectrum analyzer peak detector mode pre-scanning the measurement frequency range. Significant peaks are then marked and then Quasi Peak detector mode re-measured.
- (4) If the Peak Mode measured value compliance with and lower than Quasi Peak Mode Limit Bellow 1 GHz, the EUT shall be deemed to meet QP Limits and then no additional QP Mode measurement performed. But the Peak Value and average value both need to comply with applicable limit above 1 GHz.
- (5) Testing frequency range below 1GHz the measuring instrument use VBW=120 kHz with Quasi-peak detection.
- (6) Testing frequency range above 1GHz the measuring instrument use RBW=1 MHz and VBW=3 MHz with Peak Detector for Peak Values, and use RBW=1 MHz and VBW=10 Hz with Peak Detector for Average Values.
- (7) For the actual test configuration, please see the test setup photo.

4.4 EUT Operating Condition

The Equipment Under Test was set to Continual Transmitting in maximum power in TX mode.

4.5 Test Equipment

Equipment	Manufacturer	Model No.	Serial No.	Last Cal.	Cal. Due Date
Spectrum Analyzer	Agilent	E4407B	MY45106456	Mar. 20, 2014	Mar. 19, 2015
Spectrum Analyzer	Rohde & Schwarz	FSP30	DE25181	Aug. 08, 2014	Aug.07, 2015
EMI Test Receiver	Rohde & Schwarz	ESCI	101165	Aug. 08, 2014	Aug.07, 2015
Bilog Antenna	ETS-LINDGREN	3142E	00117537	Mar. 07, 2014	Mar.06, 2015
Horn Antenna	ETS-LINDGREN	3117	00143207	Mar. 07, 2014	Mar.06, 2015
Pre-amplifier	HP	11909A	185903	Mar. 07, 2014	Mar.06, 2015
Pre-amplifier	HP	8447B	3008A00849	Mar. 07, 2014	Mar.06, 2015
Cable	HUBER+SUHNER	100	SUCOFLEX	Mar. 07, 2014	Mar.06, 2015
Signal Generator	Rohde & Schwarz	SML03	IKW682-054	Feb. 11, 2014	Feb.10, 2015
Positioning Controller	ETS-LINDGREN	2090	N/A	N/A	N/A

4.6 Test Data

Remark: During testing above 1GHz the measuring instrument use RBW=1 MHz and VBW=3 MHz with Peak Detector for Peak Values, and use RBW=1 MHz and VBW=10 Hz with Peak Detector for Average Values.

Test data please refer the following pages.

EUT:	Mobile Odyssey Duke Waterproof Bluetooth Speaker	Model Name :	7123-04
Temperature:	25 °C	Relative Humidity:	55%
Test Voltage:	DC 5V		
Ant. Pol.	Horizontal		
Test Mode:	TX GFSK Mode 2402MHz		
Remark:	Only worse case is reported		

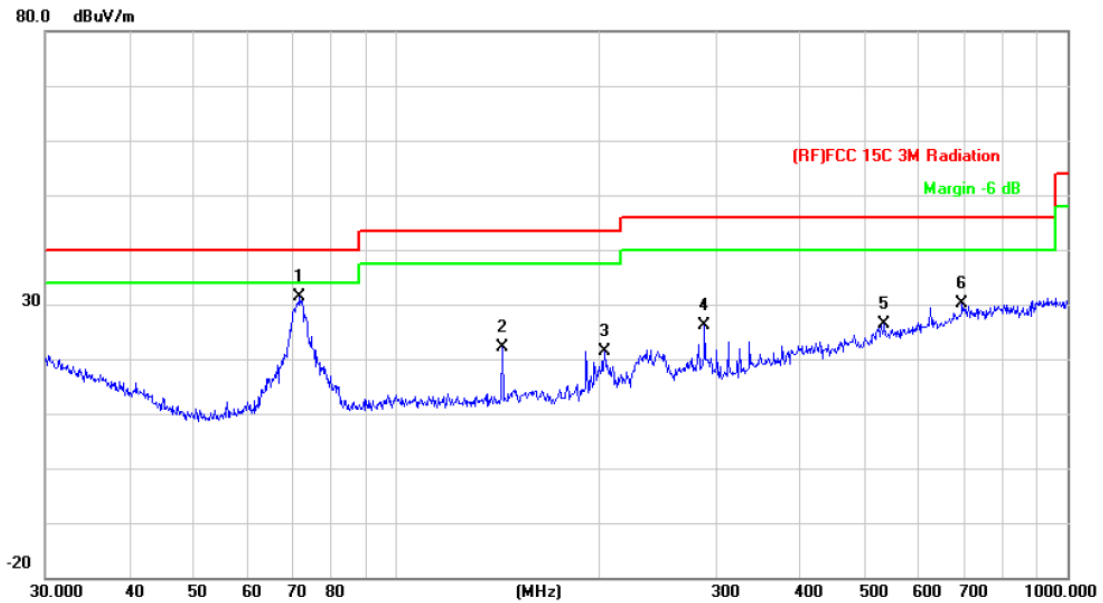

No.	Mk.	Freq. MHz	Reading Level dBuV	Correct Factor dB/m	Measure- ment dBuV/m	Limit dBuV/m	Over dB	Detector
1	*	71.8320	55.05	-23.56	31.49	40.00	-8.51	peak
2		143.8295	43.75	-21.67	22.08	43.50	-21.42	peak
3		204.2377	41.67	-20.20	21.47	43.50	-22.03	peak
4		287.9904	43.37	-17.32	26.05	46.00	-19.95	peak
5		533.8321	36.42	-10.14	26.28	46.00	-19.72	peak
6		696.8567	37.17	-6.95	30.22	46.00	-15.78	peak

*:Maximum data x:Over limit !:over margin

Emission Level= Read Level+ Correct Factor

EUT:	Mobile Odyssey Duke Waterproof Bluetooth Speaker	Model Name :	7123-04
Temperature:	25 °C	Relative Humidity:	55%
Test Voltage:	DC 5V		
Ant. Pol.	Vertical		
Test Mode:	TX GFSK Mode 2402MHz		
Remark:	Only worse case is reported		

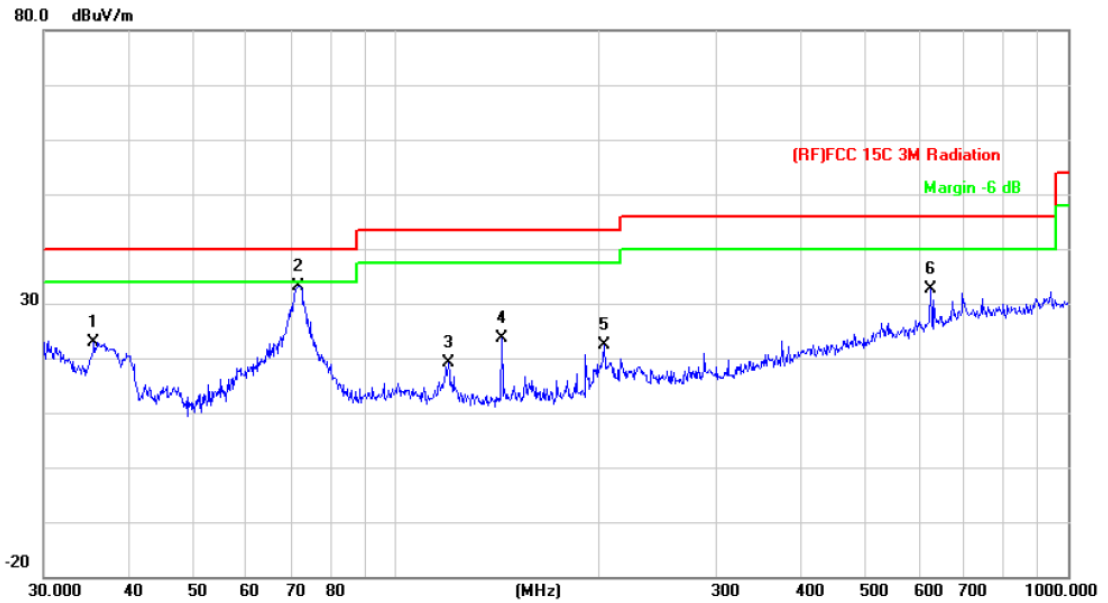

No.	Mk.	Freq. MHz	Reading Level dBuV	Correct Factor dB/m	Measure- ment dBuV/m	Limit dBuV/m	Over dB	Detector
1		35.6240	40.23	-17.45	22.78	40.00	-17.22	peak
2	*	71.8320	56.80	-23.56	33.24	40.00	-6.76	peak
3		119.8556	41.71	-22.50	19.21	43.50	-24.29	peak
4		143.8295	45.23	-21.67	23.56	43.50	-19.94	peak
5		204.2377	42.67	-20.20	22.47	43.50	-21.03	peak
6		625.0780	41.17	-8.51	32.66	46.00	-13.34	peak

*:Maximum data x:Over limit !:over margin

Emission Level= Read Level+ Correct Factor

EUT:	Mobile Odyssey Duke Waterproof Bluetooth Speaker	Model Name :	7123-04
Temperature:	25 °C	Relative Humidity:	55%
Test Voltage:	DC 3.7V		
Ant. Pol.	Horizontal		
Test Mode:	TX GFSK Mode 2402MHz		
Remark:	No report for the emission which more than 10 dB below the prescribed limit.		

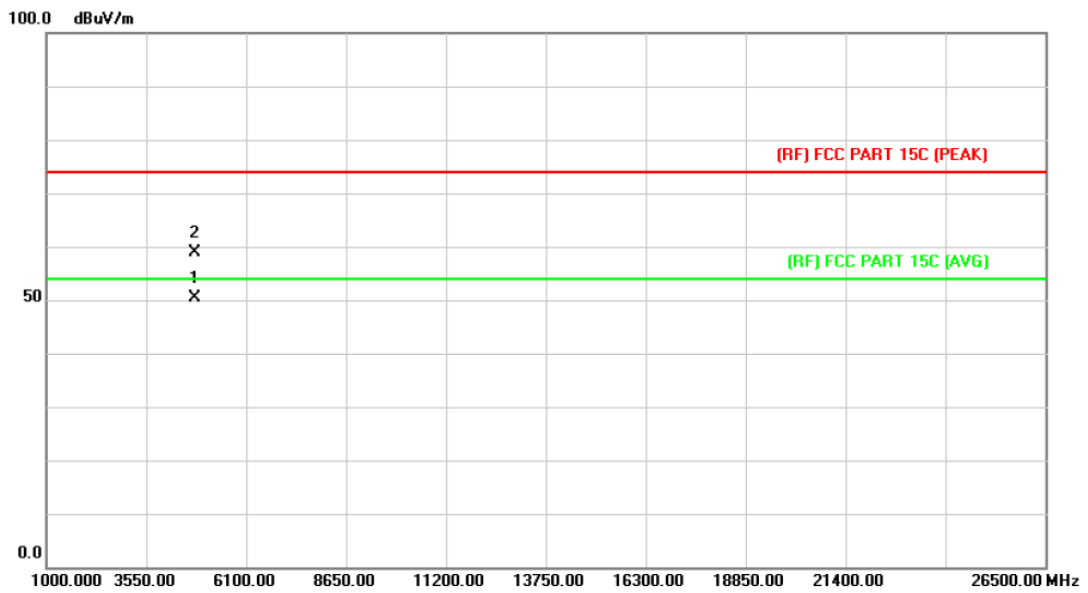

No.	Mk.	Freq.	Reading Level	Correct Factor	Measurement	Limit	Over	
		MHz	dBuV	dB/m	dBuV/m	dBuV/m	dB	Detector
1	*	4803.695	37.01	13.44	50.45	54.00	-3.55	AVG
2		4804.070	45.50	13.44	58.94	74.00	-15.06	peak

Emission Level= Read Level+ Correct Factor

EUT:	Mobile Odyssey Duke Waterproof Bluetooth Speaker	Model Name :	7123-04
Temperature:	25 °C	Relative Humidity:	55%
Test Voltage:	DC 3.7V		
Ant. Pol.	Vertical		
Test Mode:	TX GFSK Mode 2402MHz		
Remark:	No report for the emission which more than 10 dB below the prescribed limit.		

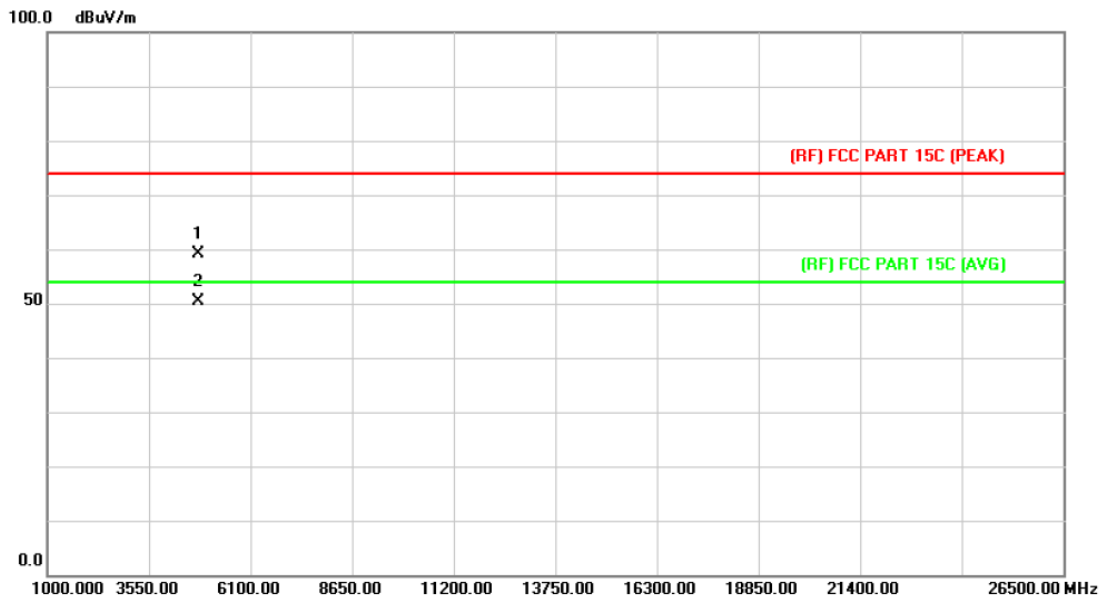

No.	Mk.	Freq. MHz	Reading Level dBuV	Correct Factor dB/m	Measure- ment dBuV/m	Limit dBuV/m	Over dB	Detector
1		4803.720	45.65	13.44	59.09	74.00	-14.91	peak
2	*	4804.005	36.99	13.44	50.43	54.00	-3.57	AVG

Emission Level= Read Level+ Correct Factor

EUT:	Mobile Odyssey Duke Waterproof Bluetooth Speaker	Model Name :	7123-04
Temperature:	25 °C	Relative Humidity:	55%
Test Voltage:	DC 3.7V		
Ant. Pol.	Horizontal		
Test Mode:	TX GFSK Mode 2441MHz		
Remark:	No report for the emission which more than 10 dB below the prescribed limit.		

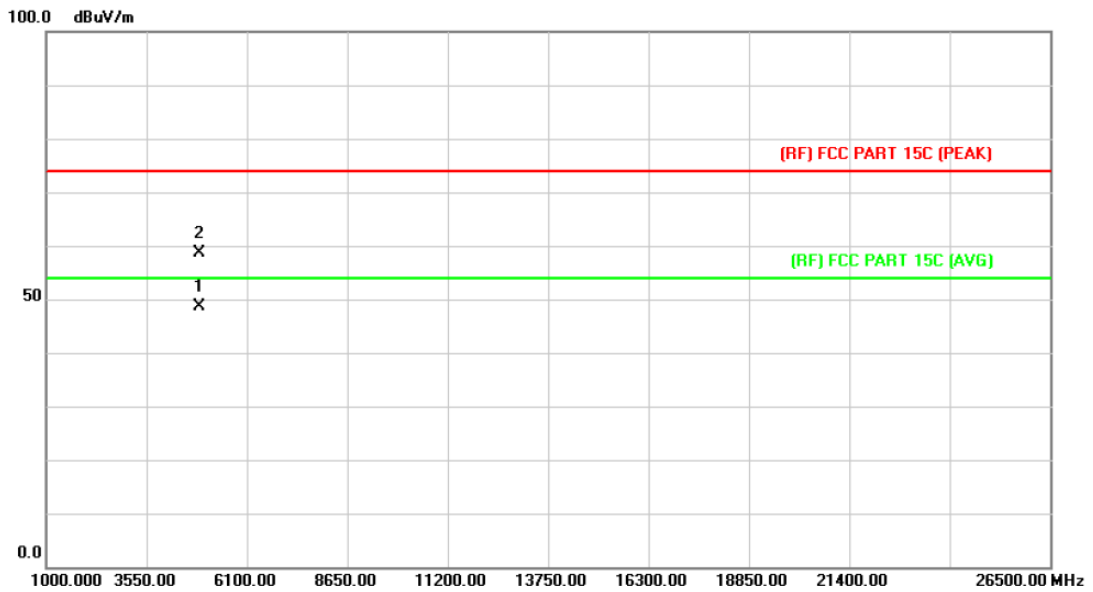

No.	Mk.	Freq.	Reading Level	Correct Factor	Measurement	Limit	Over	Detector
		MHz	dBuV	dB/m	dBuV/m	dBuV/m	dB	
1	*	4881.950	34.83	13.90	48.73	54.00	-5.27	AVG
2		4882.235	44.71	13.90	58.61	74.00	-15.39	peak

Emission Level= Read Level+ Correct Factor

EUT:	Mobile Odyssey Duke Waterproof Bluetooth Speaker	Model Name :	7123-04
Temperature:	25 °C	Relative Humidity:	55%
Test Voltage:	DC 3.7V		
Ant. Pol.	Vertical		
Test Mode:	TX GFSK Mode 2441MHz		
Remark:	No report for the emission which more than 10 dB below the prescribed limit.		

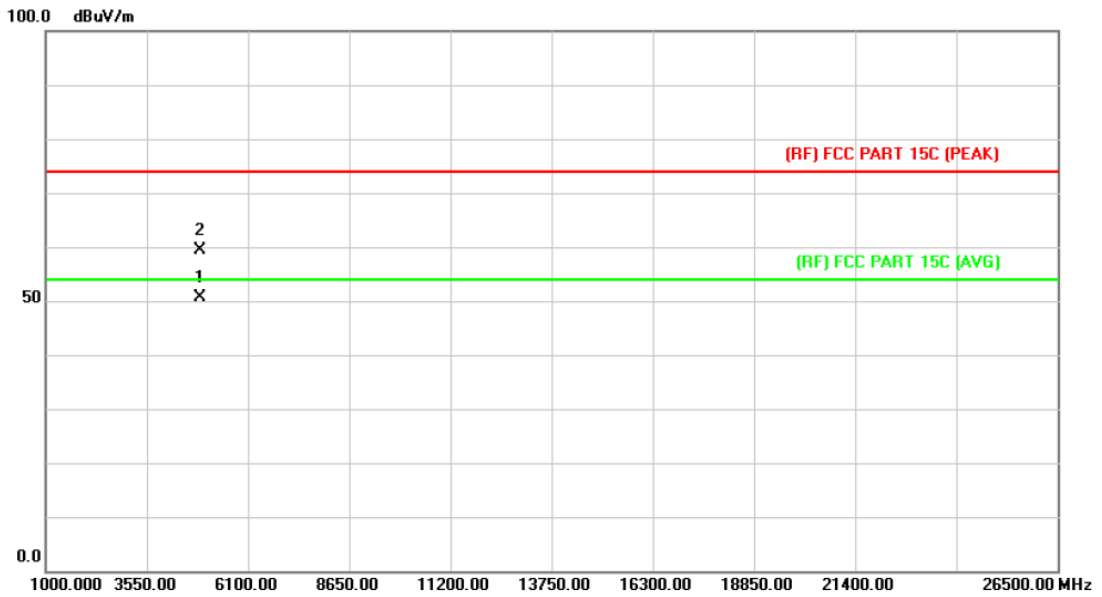

No.	Mk.	Freq. MHz	Reading Level dBuV	Correct Factor dB/m	Measure- ment dBuV/m	Limit dBuV/m	Over dB	Detector
1	*	4882.045	36.79	13.90	50.69	54.00	-3.31	AVG
2		4882.055	45.52	13.90	59.42	74.00	-14.58	peak

Emission Level= Read Level+ Correct Factor

EUT:	Mobile Odyssey Duke Waterproof Bluetooth Speaker	Model Name :	7123-04
Temperature:	25 °C	Relative Humidity:	55%
Test Voltage:	DC 3.7V		
Ant. Pol.	Horizontal		
Test Mode:	TX GFSK Mode 2480MHz		
Remark:	No report for the emission which more than 10 dB below the prescribed limit.		

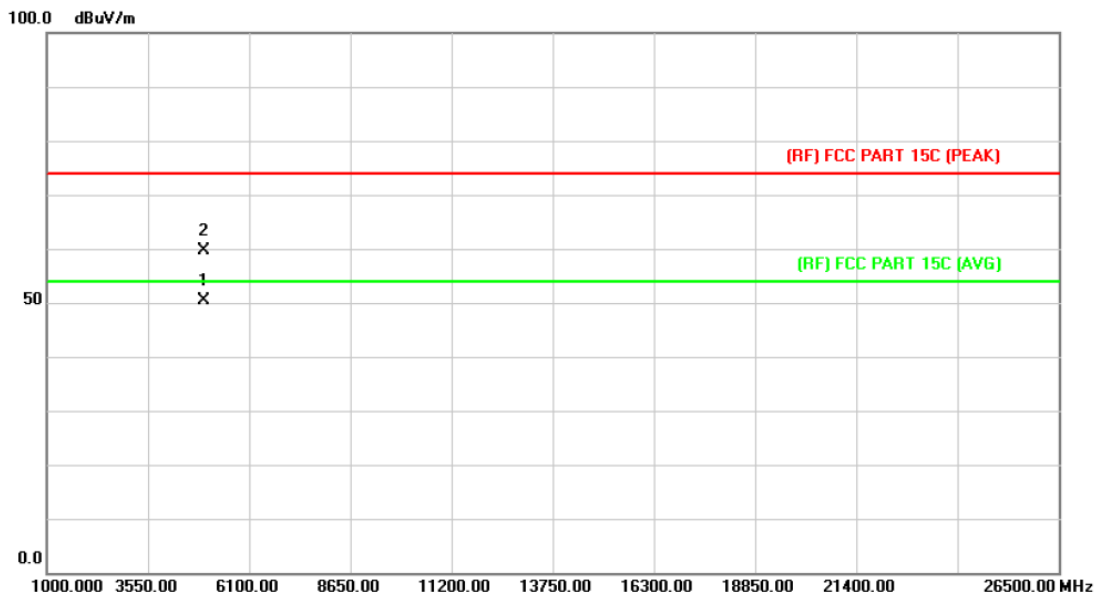

No.	Mk.	Freq.	Reading Level	Correct Factor	Measurement	Limit	Over	Detector
		MHz	dBuV	dB/m	dBuV/m	dBuV/m	dB	
1	*	4959.775	36.03	14.36	50.39	54.00	-3.61	AVG
2		4960.145	45.22	14.36	59.58	74.00	-14.42	peak

Emission Level= Read Level+ Correct Factor

EUT:	Mobile Odyssey Duke Waterproof Bluetooth Speaker	Model Name :	7123-04
Temperature:	25 °C	Relative Humidity:	55%
Test Voltage:	DC 3.7V		
Ant. Pol.	Vertical		
Test Mode:	TX GFSK Mode 2480MHz		
Remark:	No report for the emission which more than 10 dB below the prescribed limit.		

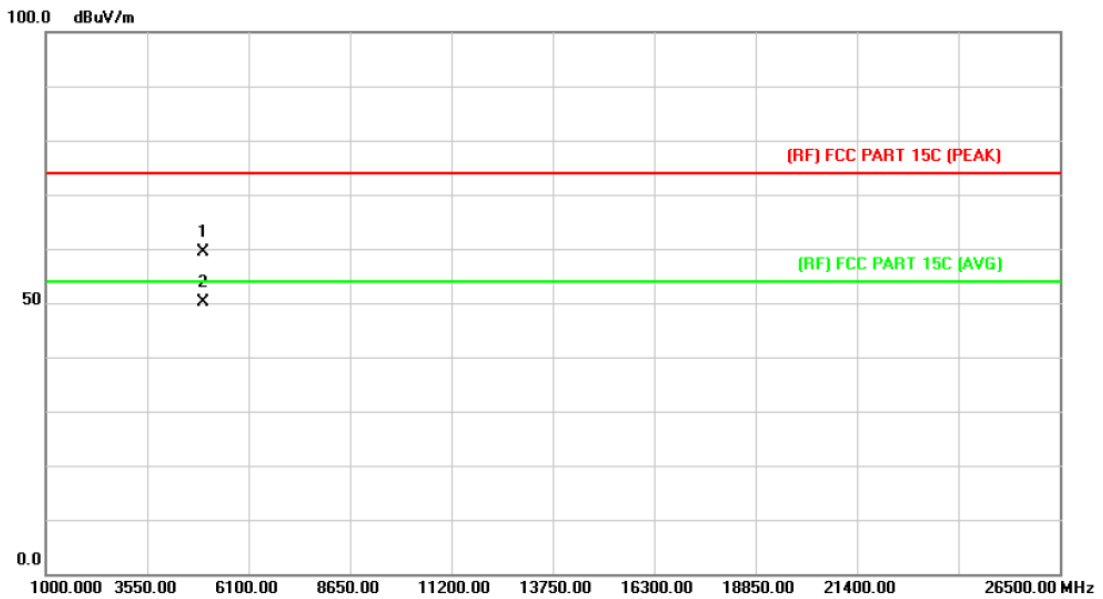

No.	Mk.	Freq. MHz	Reading Level dBuV	Correct Factor dB/m	Measure- ment dBuV/m	Limit dBuV/m	Over dB	Detector
1		4959.940	45.09	14.36	59.45	74.00	-14.55	peak
2	*	4959.955	35.71	14.36	50.07	54.00	-3.93	AVG

Emission Level= Read Level+ Correct Factor

EUT:	Mobile Odyssey Duke Waterproof Bluetooth Speaker	Model Name :	7123-04
Temperature:	25 °C	Relative Humidity:	55%
Test Voltage:	DC 3.7V		
Ant. Pol.	Horizontal		
Test Mode:	TX 8-DPSK Mode 2402MHz		
Remark:	No report for the emission which more than 10 dB below the prescribed limit.		

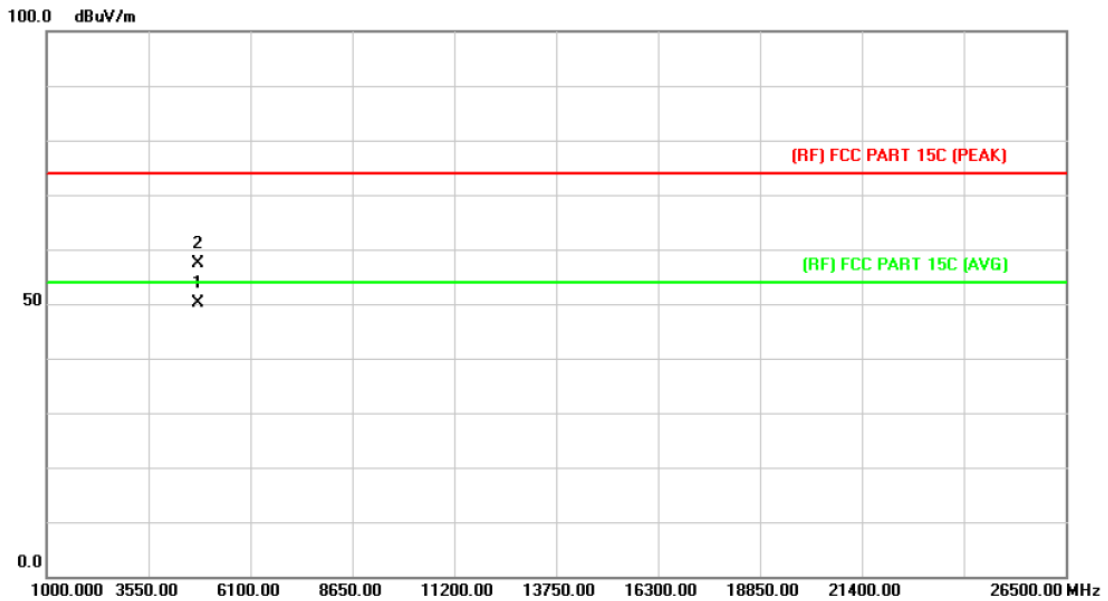

No.	Mk.	Freq.	Reading Level	Correct Factor	Measurement	Limit	Over	
		MHz	dBuV	dB/m	dBuV/m	dBuV/m	dB	Detector
1	*	4803.984	36.57	13.44	50.01	54.00	-3.99	AVG
2		4804.014	43.92	13.44	57.36	74.00	-16.64	peak

Emission Level= Read Level+ Correct Factor

EUT:	Mobile Odyssey Duke Waterproof Bluetooth Speaker	Model Name :	7123-04
Temperature:	25 °C	Relative Humidity:	55%
Test Voltage:	DC 3.7V		
Ant. Pol.	Vertical		
Test Mode:	TX 8-DPSK Mode 2402MHz		
Remark:	No report for the emission which more than 10 dB below the prescribed limit.		

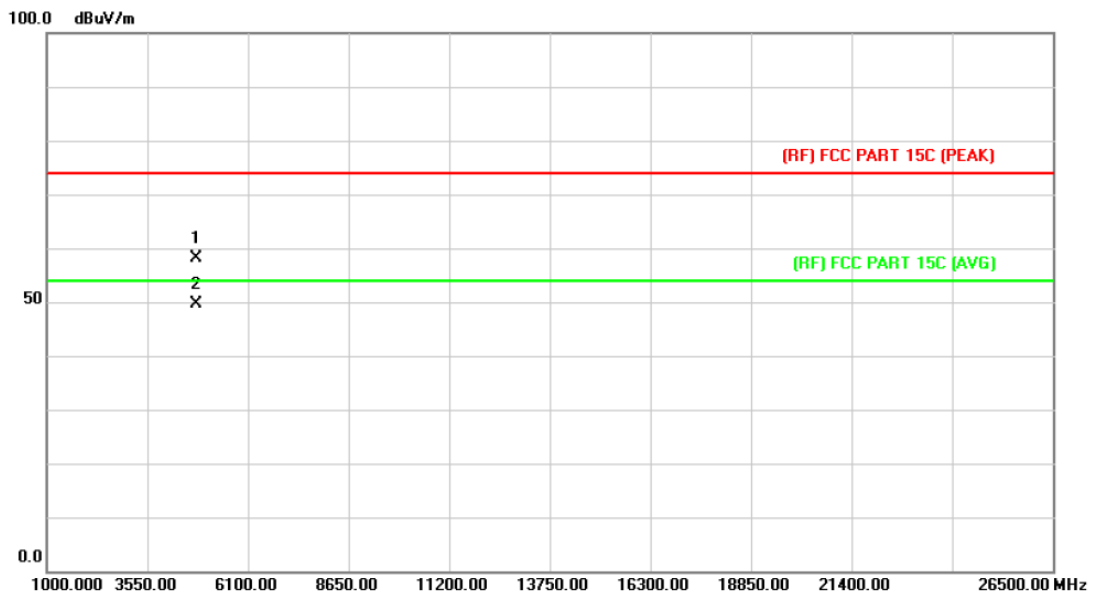

No.	Mk.	Freq. MHz	Reading Level dBuV	Correct Factor dB/m	Measure- ment dBuV/m	Limit dBuV/m	Over dB	Detector
1		4803.984	44.60	13.44	58.04	74.00	-15.96	peak
2	*	4804.011	36.10	13.44	49.54	54.00	-4.46	AVG

Emission Level= Read Level+ Correct Factor

EUT:	Mobile Odyssey Duke Waterproof Bluetooth Speaker	Model Name :	7123-04
Temperature:	25 °C	Relative Humidity:	55%
Test Voltage:	DC 3.7V		
Ant. Pol.	Horizontal		
Test Mode:	TX 8-DPSK Mode 2441MHz		
Remark:	No report for the emission which more than 10 dB below the prescribed limit.		

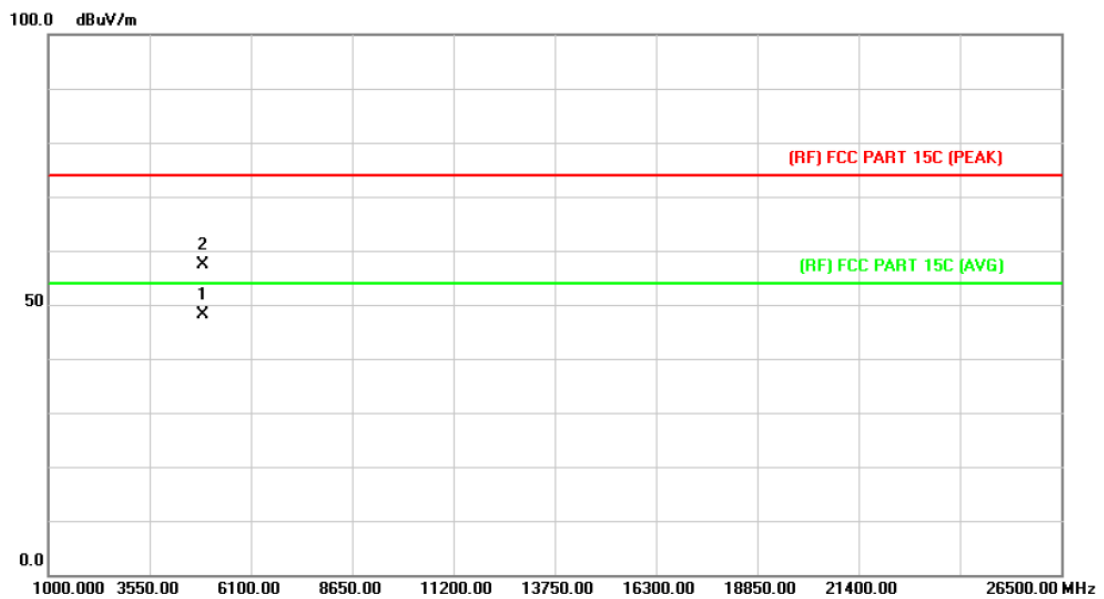

No.	Mk.	Freq.	Reading Level	Correct Factor	Measurement	Limit	Over	Detector
		MHz	dBuV	dB/m	dBuV/m	dBuV/m	dB	
1	*	4881.947	34.24	13.90	48.14	54.00	-5.86	AVG
2		4882.112	43.58	13.90	57.48	74.00	-16.52	peak

Emission Level= Read Level+ Correct Factor

EUT:	Mobile Odyssey Duke Waterproof Bluetooth Speaker	Model Name :	7123-04
Temperature:	25 °C	Relative Humidity:	55%
Test Voltage:	DC 3.7V		
Ant. Pol.	Vertical		
Test Mode:	TX 8-DPSK Mode 2441MHz		
Remark:	No report for the emission which more than 10 dB below the prescribed limit.		

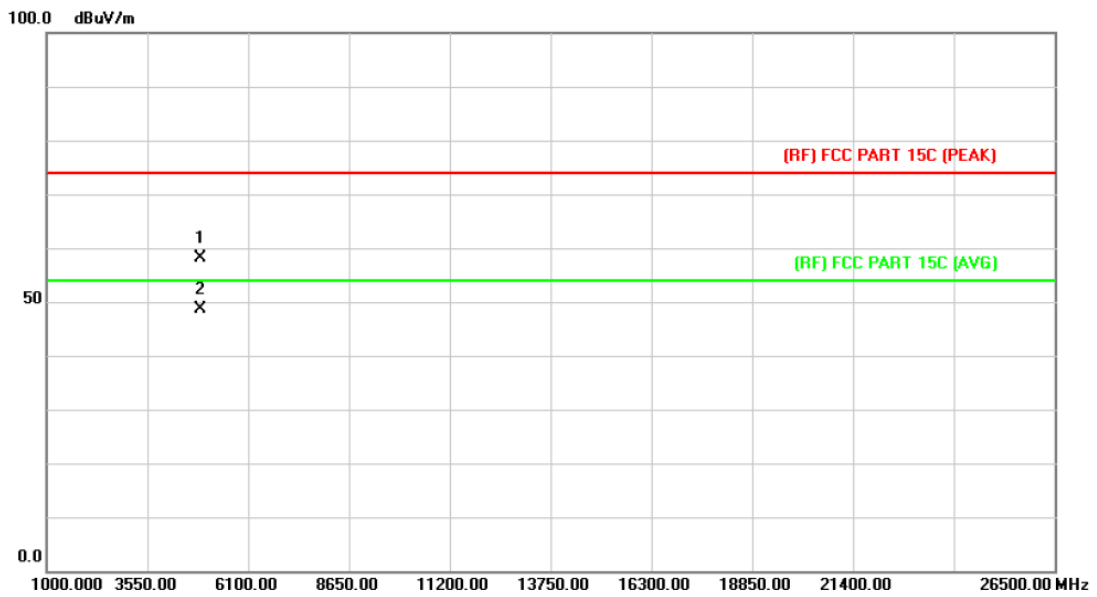

No.	Mk.	Freq.	Reading Level	Correct Factor	Measurement	Limit	Over	
		MHz	dBuV	dB/m	dBuV/m	dBuV/m	dB	Detector
1		4882.031	44.22	13.90	58.12	74.00	-15.88	peak
2	*	4882.351	34.78	13.90	48.68	54.00	-5.32	AVG

Emission Level= Read Level+ Correct Factor

EUT:	Mobile Odyssey Duke Waterproof Bluetooth Speaker	Model Name :	7123-04
Temperature:	25 °C	Relative Humidity:	55%
Test Voltage:	DC 3.7V		
Ant. Pol.	Horizontal		
Test Mode:	TX 8-DPSK Mode 2480MHz		
Remark:	No report for the emission which more than 10 dB below the prescribed limit.		

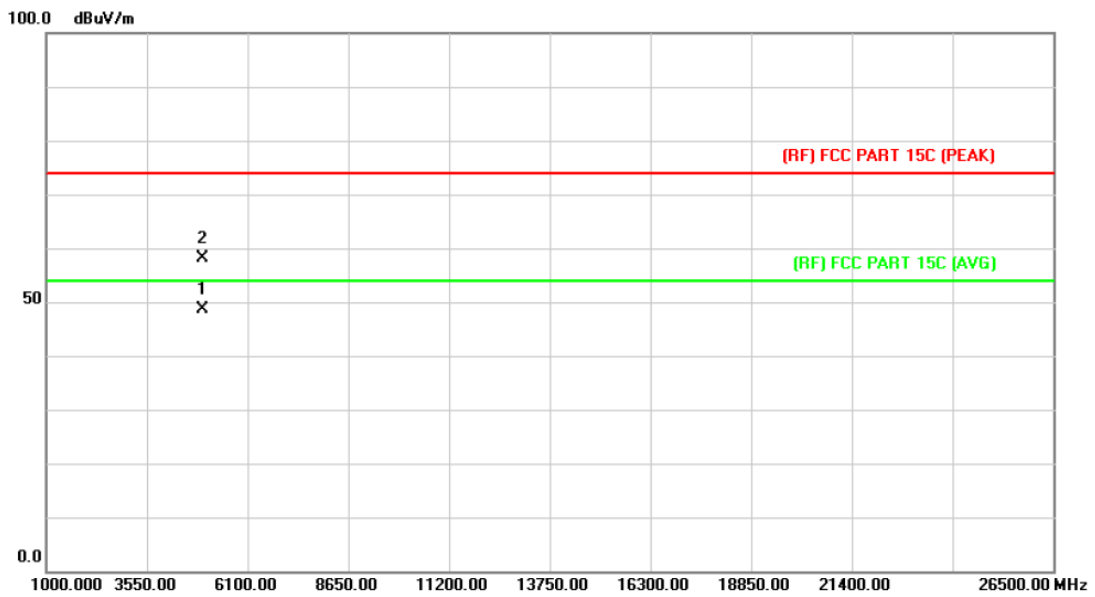

No.	Mk.	Freq. MHz	Reading Level dBuV	Correct Factor dB/m	Measure- ment dBuV/m	Limit dBuV/m	Over dB	Detector
1		4959.932	43.12	14.36	57.48	74.00	-16.52	peak
2	*	4959.988	33.96	14.36	48.32	54.00	-5.68	AVG

Emission Level= Read Level+ Correct Factor

EUT:	Mobile Odyssey Duke Waterproof Bluetooth Speaker	Model Name :	7123-04
Temperature:	25 °C	Relative Humidity:	55%
Test Voltage:	DC 3.7V		
Ant. Pol.	Vertical		
Test Mode:	TX 8-DPSK Mode 2480MHz		
Remark:	No report for the emission which more than 10 dB below the prescribed limit.		

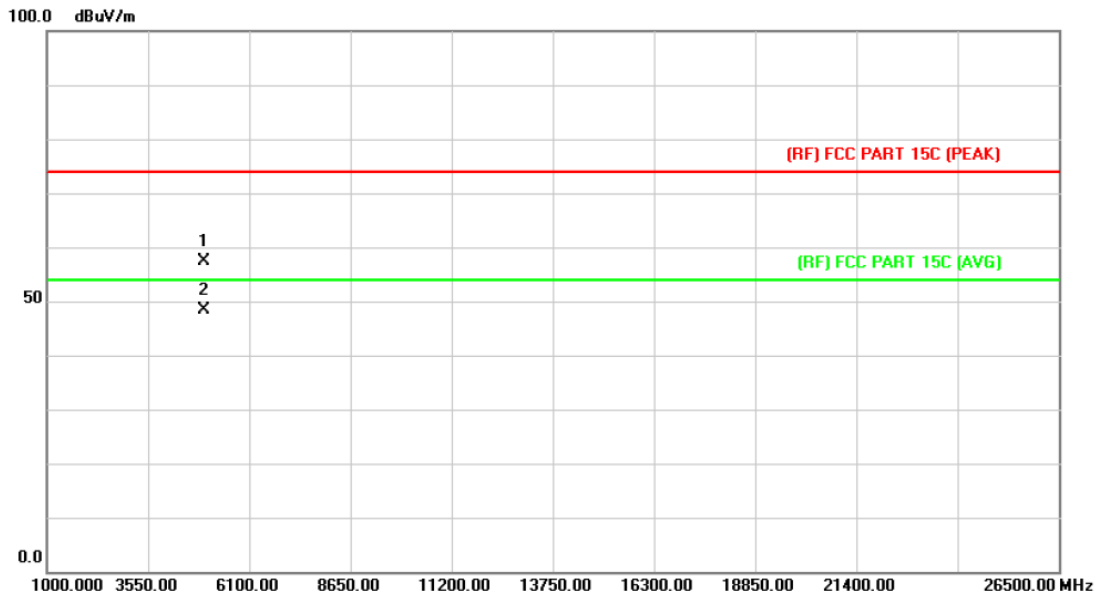

No.	Mk.	Freq.	Reading Level	Correct Factor	Measurement	Limit	Over	
		MHz	dBuV	dB/m	dBuV/m	dBuV/m	dB	Detector
1		4959.932	43.12	14.36	57.48	74.00	-16.52	peak
2	*	4959.988	33.96	14.36	48.32	54.00	-5.68	AVG

Emission Level= Read Level+ Correct Factor

5. Restricted Bands Requirement

5.1 Test Standard and Limit

5.1.1 Test Standard

FCC Part 15.209

FCC Part 15.205

5.1.2 Test Limit

Restricted Frequency Band (MHz)	Class B (dBuV/m)(at 3m)	
	Peak	Average
2310 ~2390	74	54
2483.5 ~2500	74	54

Note: All restriction bands have been tested, only the worst case is reported.

5.2 Test Setup

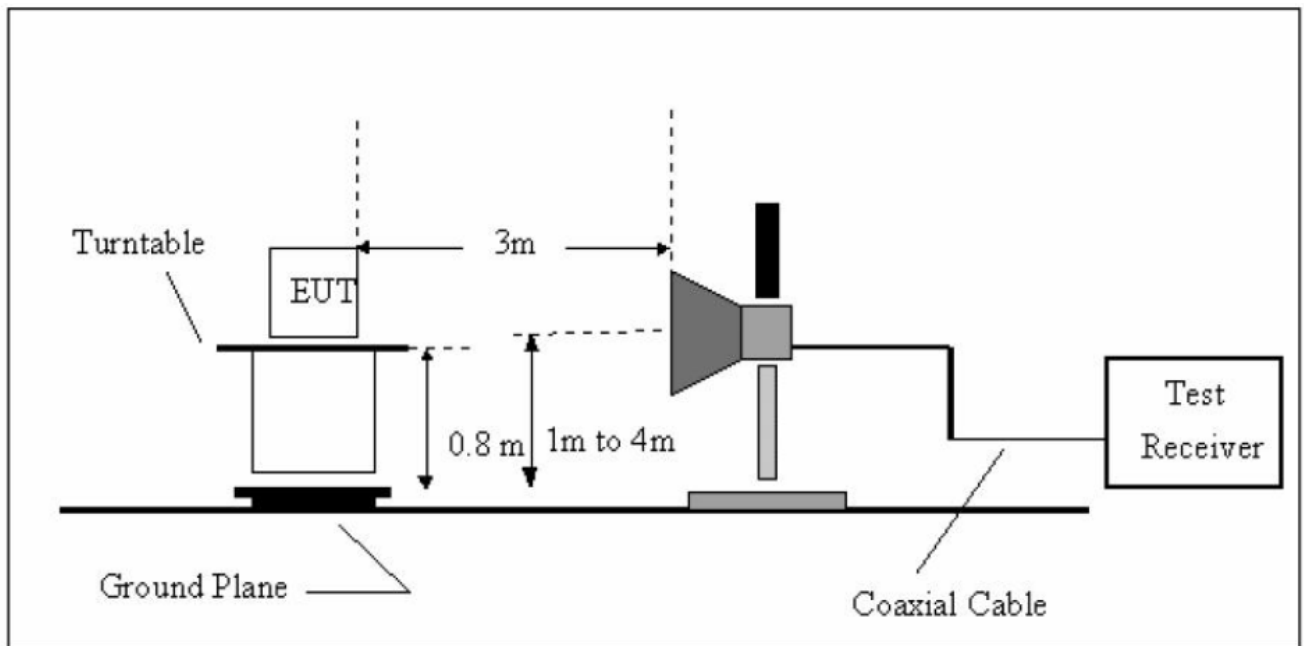

5.3 Test Procedure

- (1) The measuring distance of 3m shall be used for measurements at frequency up to 1GHz and above 1 GHz. The EUT was placed on a rotating 0.8m high above ground, the table was rotated 360 degrees to determine the position of the highest radiation.
- (2) The Test antenna shall vary between 1m and 4m, Both Horizontal and Vertical antenna are set to make measurement.
- (3) The initial step in collecting conducted emission data is a spectrum analyzer peak detector mode pre-scanning the measurement frequency range. Significant peaks are then marked

and then Quasi Peak detector mode re-measured.

- (4) If the Peak Mode measured value compliance with and lower than Quasi Peak Mode Limit Bellow 1 GHz, the EUT shall be deemed to meet QP Limits and then no additional QP Mode measurement performed. But the Peak Value and average value both need to comply with applicable limit above 1 GHz.
- (5) Testing frequency range below 1GHz the measuring instrument use VBW=120 kHz with Quasi-peak detection.
- (6) Testing frequency range above 1GHz the measuring instrument use RBW=1 MHz and VBW=3 MHz with Peak Detector for Peak Values, and use RBW=1 MHz and VBW=10 Hz with Peak Detector for Average Values.
- (7) For the actual test configuration, please see the test setup photo.

5.4 EUT Operating Condition

The Equipment Under Test was set to Continual Transmitting in maximum power.

5.5 Test Equipment

Equipment	Manufacturer	Model No.	Serial No.	Last Cal.	Cal. Due Date
Spectrum Analyzer	Agilent	E4407B	MY45106456	Mar. 20, 2014	Mar. 19, 2015
Spectrum Analyzer	Rohde & Schwarz	FSP30	DE25181	Aug. 08, 2014	Aug. 07, 2015
EMI Test Receiver	Rohde & Schwarz	ESCI	101165	Aug. 08, 2014	Aug.07, 2015
Bilog Antenna	ETS-LINDGREN	3142E	00117537	Mar. 07, 2014	Mar.06, 2015
Horn Antenna	ETS-LINDGREN	3117	00143207	Mar. 07, 2014	Mar.06, 2015
Pre-amplifier	HP	11909A	185903	Mar. 07, 2014	Mar.06, 2015
Pre-amplifier	HP	8447B	3008A00849	Mar. 07, 2014	Mar.06, 2015
Cable	HUBER+SUHNE R	100	SUCOFLEX	Mar. 07, 2014	Mar.06, 2015
Signal Generator	Rohde & Schwarz	SML03	IKW682-054	Feb. 11, 2014	Feb.10, 2015
Positioning Controller	ETS-LINDGREN	2090	N/A	N/A	N/A

5.6 Test Data

Remark: During testing above 1GHz the measuring instrument use RBW=1 MHz and VBW=3 MHz with Peak Detector for Peak Values, and use RBW=1 MHz and VBW=1 KHz with Peak Detector for Average Values.

All restriction bands have been tested, only the worst case is reported.

(1) Radiation Test

EUT:	Mobile Odyssey Duke Waterproof Bluetooth Speaker	Model Name :	7123-04
Temperature:	25 °C	Relative Humidity:	55%
Test Voltage:	DC 3.7V		
Ant. Pol.	Horizontal		
Test Mode:	TX GFSK Mode 2402MHz		
Remark:	N/A		

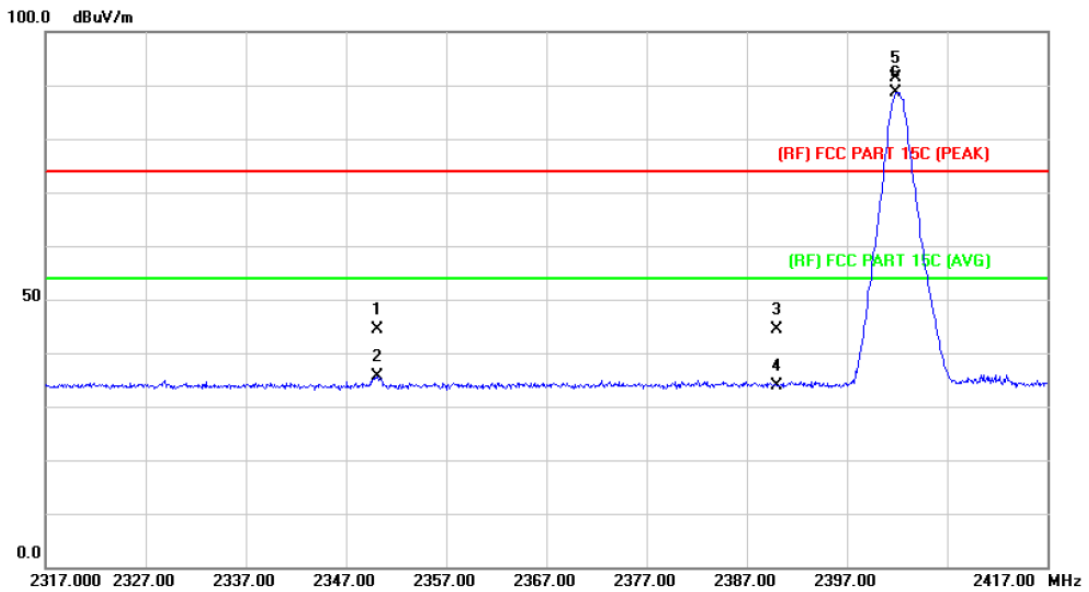

No.	Mk.	Freq. MHz	Reading Level dBuV	Correct Factor dB/m	Measure- ment dBuV/m	Limit dBuV/m	Over dB	Detector
1		2350.100	43.79	0.61	44.40	74.00	-29.60	peak
2		2350.100	34.96	0.61	35.57	54.00	-18.43	AVG
3		2390.000	43.59	0.77	44.36	74.00	-29.64	peak
4		2390.000	33.19	0.77	33.96	54.00	-20.04	AVG
5	X	2401.900	90.53	0.82	91.35	Fundamental Frequency		peak
6	*	2401.900	87.83	0.82	88.65	Fundamental Frequency		AVG

Emission Level= Read Level+ Correct Factor

EUT:	Mobile Odyssey Duke Waterproof Bluetooth Speaker	Model Name :	7123-04
Temperature:	25 °C	Relative Humidity:	55%
Test Voltage:	DC 3.7V		
Ant. Pol.	Vertical		
Test Mode:	TX GFSK Mode 2402MHz		
Remark:	N/A		

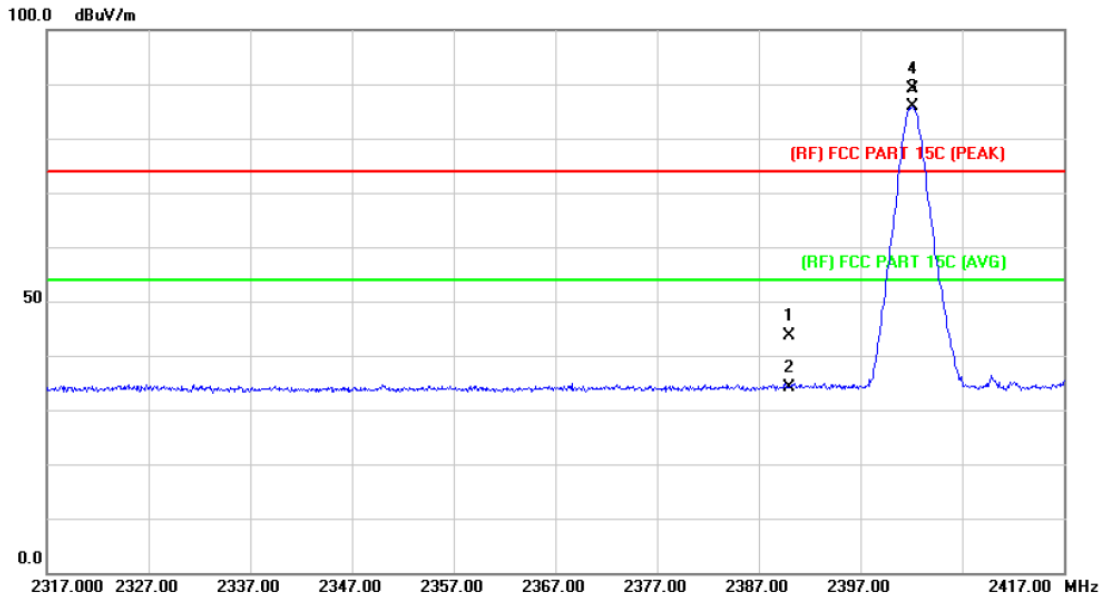

No.	Mk.	Freq. MHz	Reading Level dBuV	Correct Factor dB/m	Measure- ment dBuV/m	Limit dBuV/m	Over dB	Detector
1		2390.000	42.97	0.77	43.74	74.00	-30.26	peak
2		2390.000	33.34	0.77	34.11	54.00	-19.89	AVG
3	*	2402.100	85.03	0.82	85.85	Fundamental Frequency		AVG
4	X	2402.200	88.19	0.82	89.01	Fundamental Frequency		peak

Emission Level= Read Level+ Correct Factor

EUT:	Mobile Odyssey Duke Waterproof Bluetooth Speaker	Model Name :	7123-04
Temperature:	25 °C	Relative Humidity:	55%
Test Voltage:	DC 3.7V		
Ant. Pol.	Horizontal		
Test Mode:	TX GFSK Mode 2480 MHz		
Remark:	N/A		

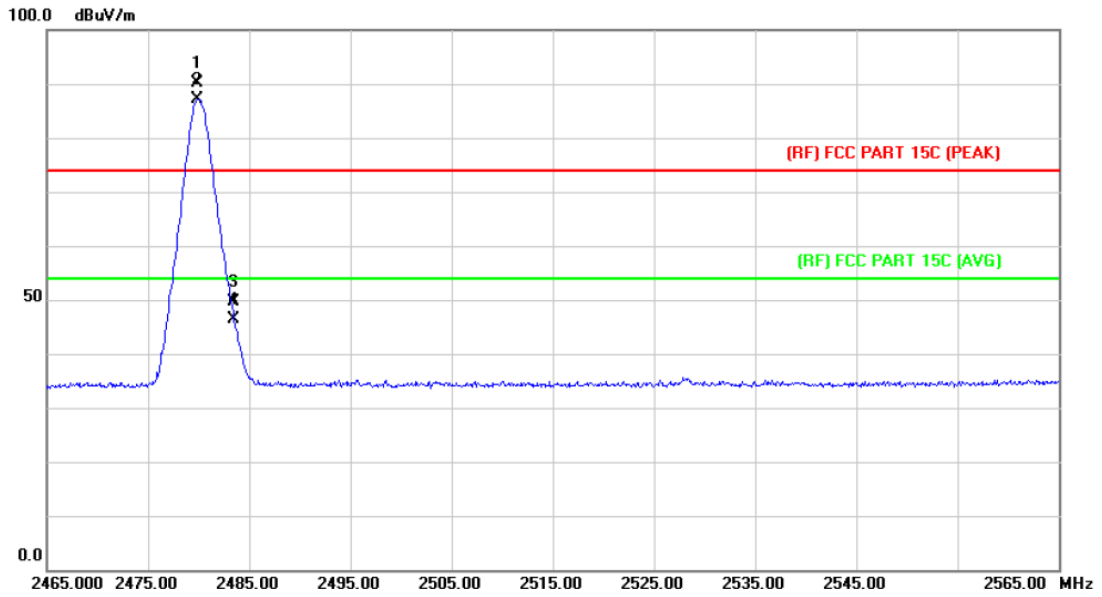

No.	Mk.	Freq. MHz	Reading Level dBuV	Correct Factor dB/m	Measure- ment dBuV/m	Limit dBuV/m	Over dB	Detector
1	X	2479.900	89.06	1.15	90.21	Fundamental Frequency		peak
2	*	2479.900	86.05	1.15	87.20	Fundamental Frequency		AVG
3		2483.500	48.55	1.17	49.72	74.00	-24.28	peak
4		2483.500	45.33	1.17	46.50	54.00	-7.50	AVG

Emission Level= Read Level+ Correct Factor

EUT:	Mobile Odyssey Duke Waterproof Bluetooth Speaker	Model Name :	7123-04
Temperature:	25 °C	Relative Humidity:	55%
Test Voltage:	DC 3.7V		
Ant. Pol.	Vertical		
Test Mode:	TX GFSK Mode 2480 MHz		
Remark:	N/A		

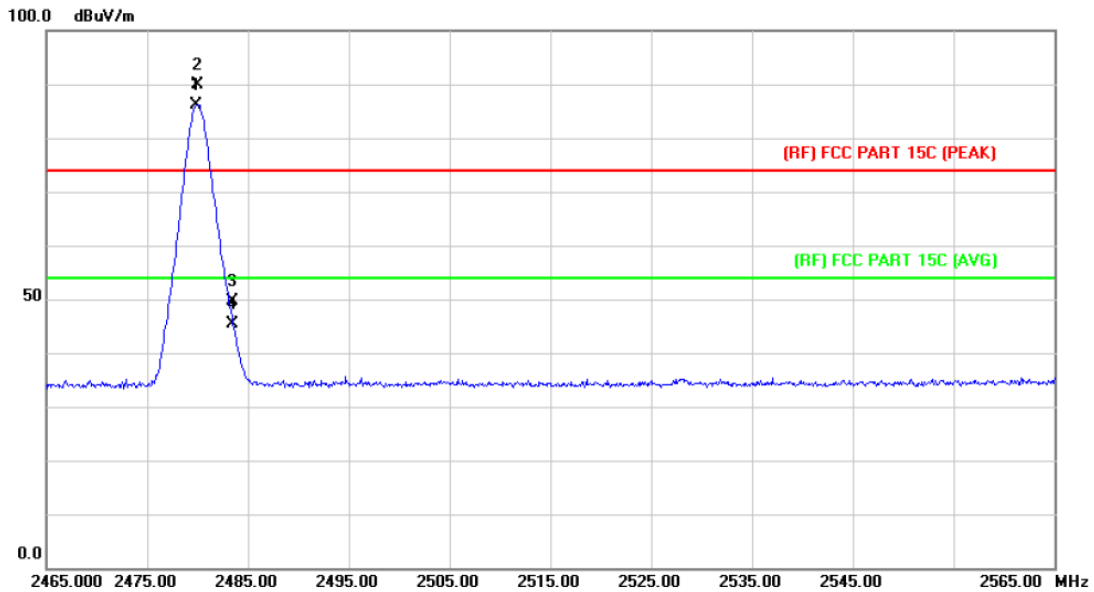

No.	Mk.	Freq. MHz	Reading Level dBuV	Correct Factor dB/m	Measure- ment dBuV/m	Limit dBuV/m	Over dB	Detector
1	*	2479.900	85.08	1.15	86.23	Fundamental Frequency		AVG
2	X	2480.000	88.82	1.15	89.97	Fundamental Frequency		peak
3		2483.500	48.39	1.17	49.56	74.00	-24.44	peak
4		2483.500	44.31	1.17	45.48	54.00	-8.52	AVG

Emission Level= Read Level+ Correct Factor

EUT:	Mobile Odyssey Duke Waterproof Bluetooth Speaker	Model Name :	7123-04
Temperature:	25 °C	Relative Humidity:	55%
Test Voltage:	DC 3.7V		
Ant. Pol.	Horizontal		
Test Mode:	TX 8-DPSK Mode 2402MHz		
Remark:	N/A		

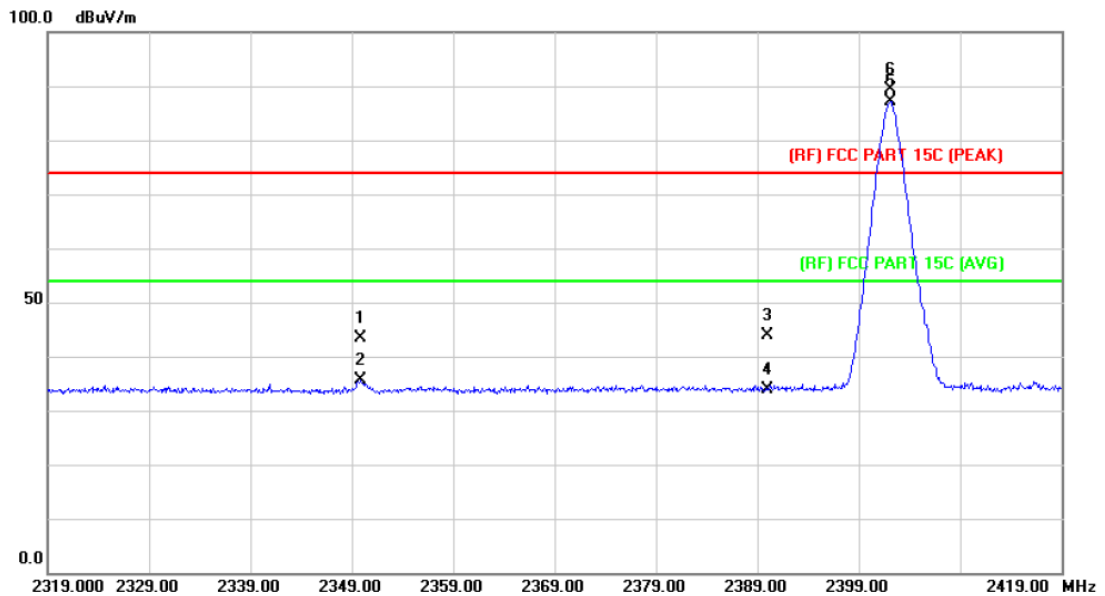

No.	Mk.	Freq. MHz	Reading Level dBuV	Correct Factor dB/m	Measure- ment dBuV/m	Limit dBuV/m	Over dB	Detector
1		2349.900	42.84	0.61	43.45	74.00	-30.55	peak
2		2349.900	35.05	0.61	35.66	54.00	-18.34	AVG
3		2390.000	43.20	0.77	43.97	74.00	-30.03	peak
4		2390.000	33.15	0.77	33.92	54.00	-20.08	AVG
5	*	2402.100	86.35	0.82	87.17	Fundamental Frequency		AVG
6	X	2402.200	88.54	0.82	89.36	Fundamental Frequency		peak

Emission Level= Read Level+ Correct Factor

EUT:	Mobile Odyssey Duke Waterproof Bluetooth Speaker	Model Name :	7123-04
Temperature:	25 °C	Relative Humidity:	55%
Test Voltage:	DC 3.7V		
Ant. Pol.	Vertical		
Test Mode:	TX 8-DPSK Mode 2402MHz		
Remark:	N/A		

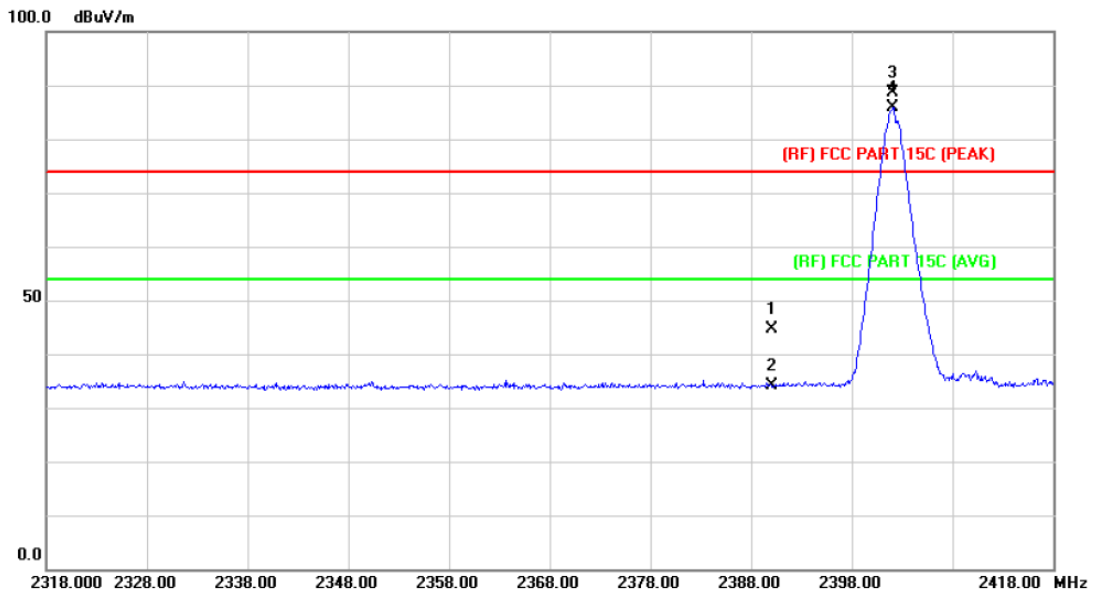

No.	Mk.	Freq.	Reading Level	Correct Factor	Measurement	Limit	Over	Detector
		MHz	dBuV	dB/m	dBuV/m	dBuV/m	dB	
1		2390.000	43.98	0.77	44.75	74.00	-29.25	peak
2		2390.000	33.38	0.77	34.15	54.00	-19.85	AVG
3	X	2402.100	87.72	0.82	88.54	Fundamental Frequency		peak
4	*	2402.100	85.06	0.82	85.88	Fundamental Frequency		AVG

Emission Level= Read Level+ Correct Factor

EUT:	Mobile Odyssey Duke Waterproof Bluetooth Speaker	Model Name :	7123-04
Temperature:	25 °C	Relative Humidity:	55%
Test Voltage:	DC 3.7V		
Ant. Pol.	Horizontal		
Test Mode:	TX 8-DPSK Mode 2480MHz		
Remark:	N/A		

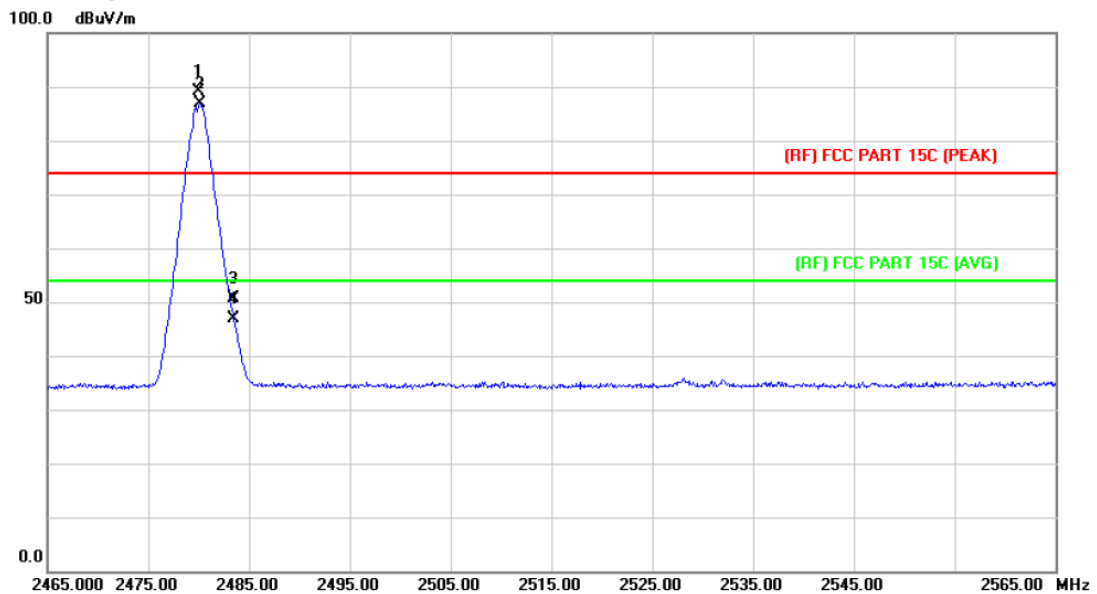

No.	Mk.	Freq.	Reading Level	Correct Factor	Measurement	Limit	Over	Detector
		MHz	dBuV	dB/m	dBuV/m	dBuV/m	dB	
1	X	2480.000	87.96	1.15	89.11	Fundamental Frequency		peak
2	*	2480.100	85.78	1.15	86.93	Fundamental Frequency		AVG
3		2483.500	49.38	1.17	50.55	74.00	-23.45	peak
4		2483.500	45.70	1.17	46.87	54.00	-7.13	AVG

Emission Level= Read Level+ Correct Factor

EUT:	Mobile Odyssey Duke Waterproof Bluetooth Speaker	Model Name :	7123-04
Temperature:	25 °C	Relative Humidity:	55%
Test Voltage:	DC 3.7V		
Ant. Pol.	Vertical		
Test Mode:	TX 8-DPSK Mode 2480MHz		
Remark:	N/A		

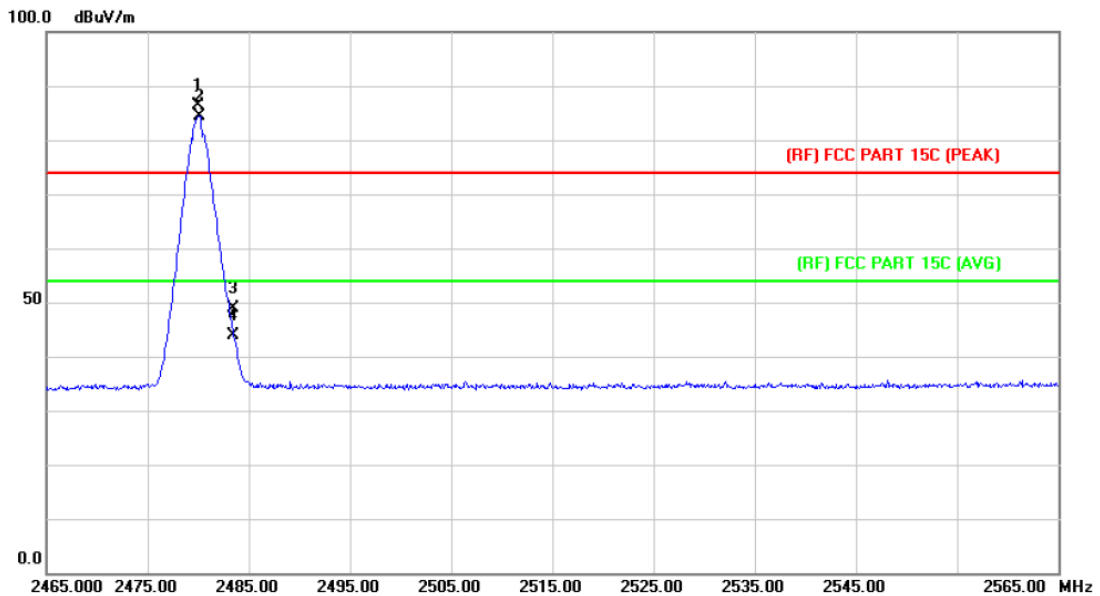

No.	Mk.	Freq. MHz	Reading Level dBuV	Correct Factor dB/m	Measure- ment dBuV/m	Limit dBuV/m	Over dB	Detector
1	X	2480.000	85.19	1.15	86.34	Fundamental Frequency		peak
2	*	2480.100	83.26	1.15	84.41	Fundamental Frequency		AVG
3		2483.500	47.70	1.17	48.87	74.00	-25.13	peak
4		2483.500	42.80	1.17	43.97	54.00	-10.03	AVG

Emission Level= Read Level+ Correct Factor

(2) Conducted Test

EUT:	Mobile Odyssey Duke Waterproof Bluetooth Speaker	Model Name :	7123-04
Temperature:	25 °C	Relative Humidity:	55%
Test Voltage:	DC 3.7V		
Test Mode:	TX GFSK Mode 2402MHz / 2480 MHz		
Remark:	N/A		

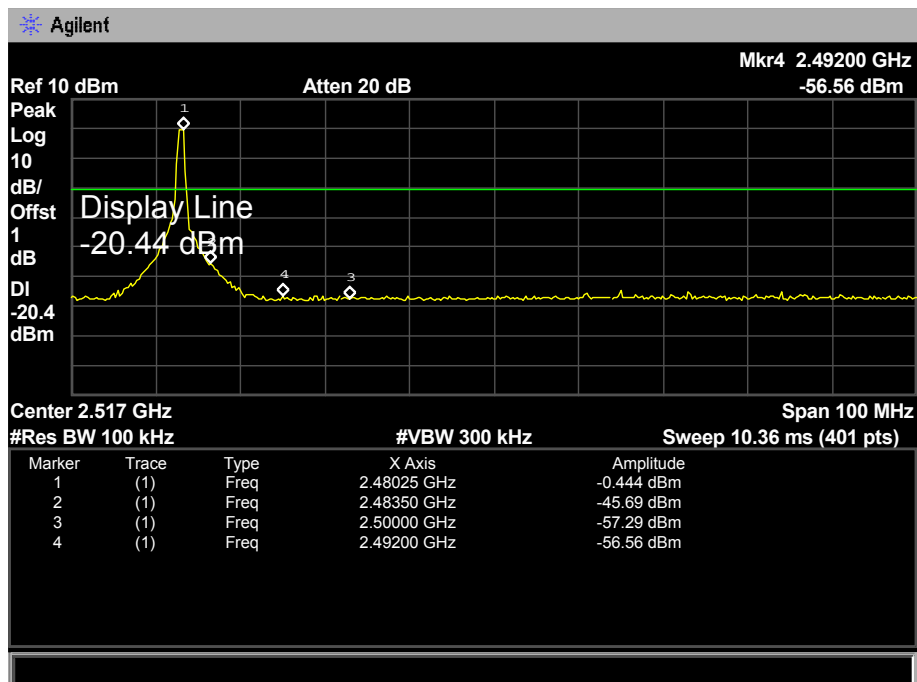
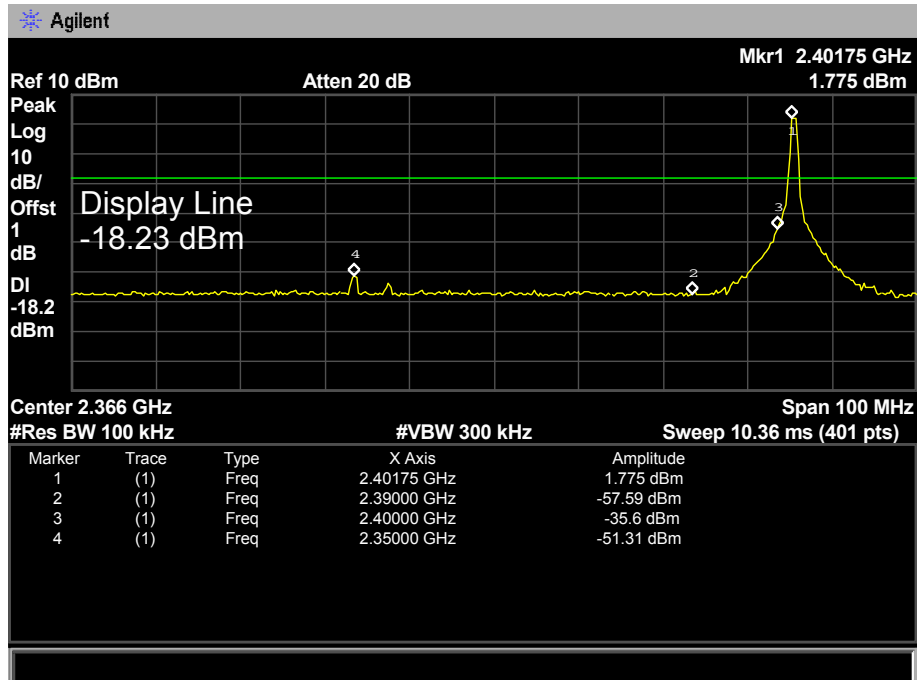

EUT:	Mobile Odyssey Duke Waterproof Bluetooth Speaker	Model Name :	7123-04
Temperature:	25 °C	Relative Humidity:	55%
Test Voltage:	DC 3.7V		
Test Mode:	GFSK Hopping Mode		
Remark:	N/A		

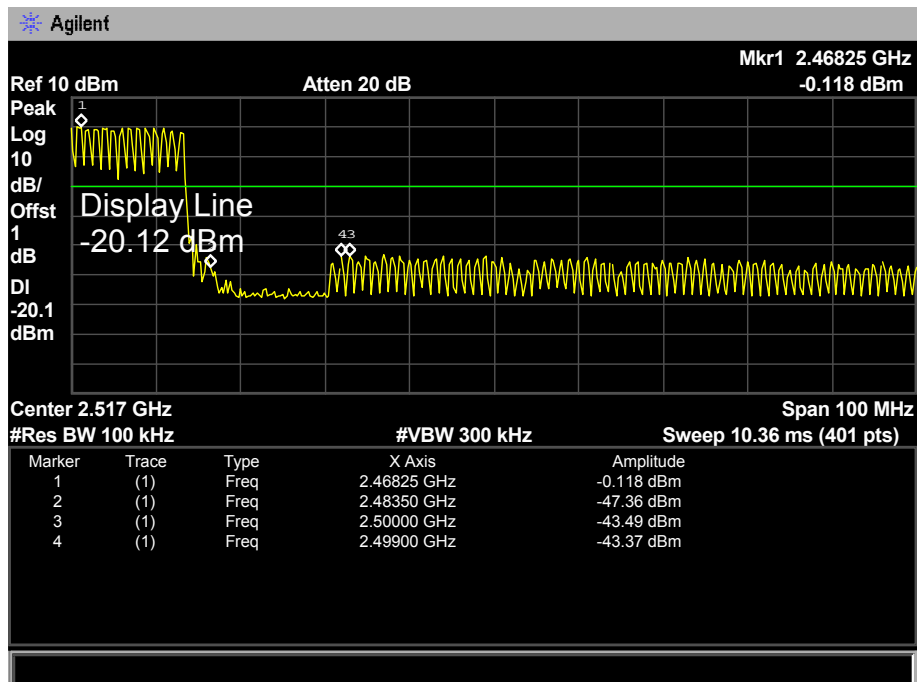
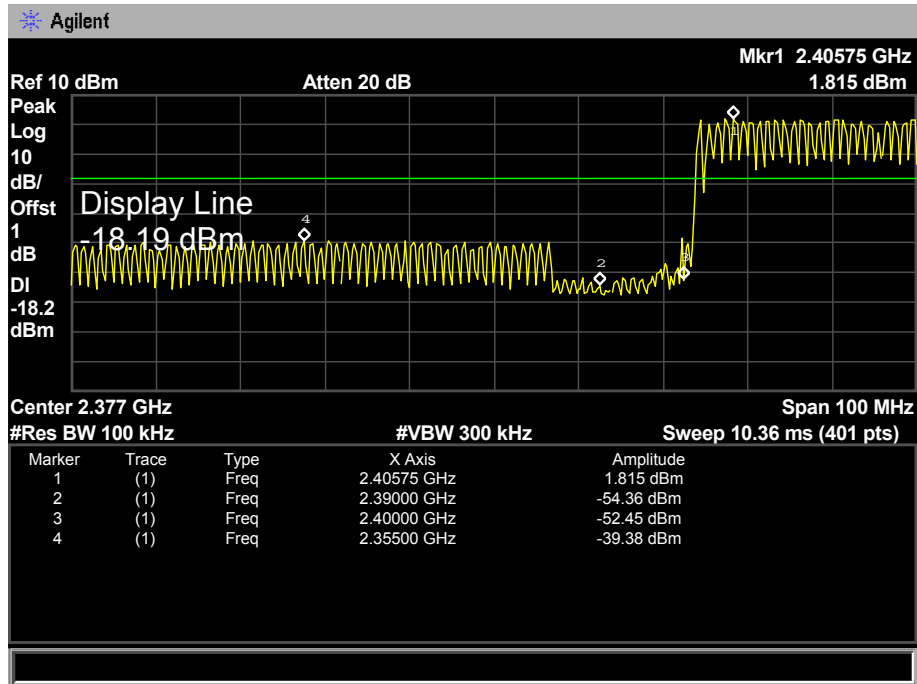

EUT:	Mobile Odyssey Duke Waterproof Bluetooth Speaker	Model Name :	7123-04
Temperature:	25 °C	Relative Humidity:	55%
Test Voltage:	DC 3.7V		
Test Mode:	TX 8-DPSK Mode 2402MHz / 2480 MHz		
Remark:	N/A		

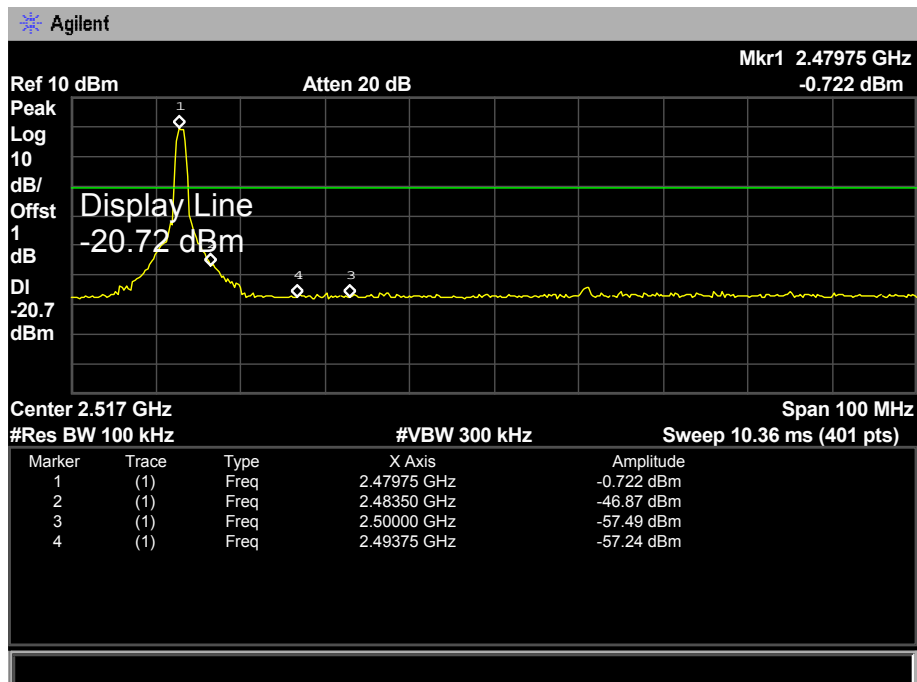
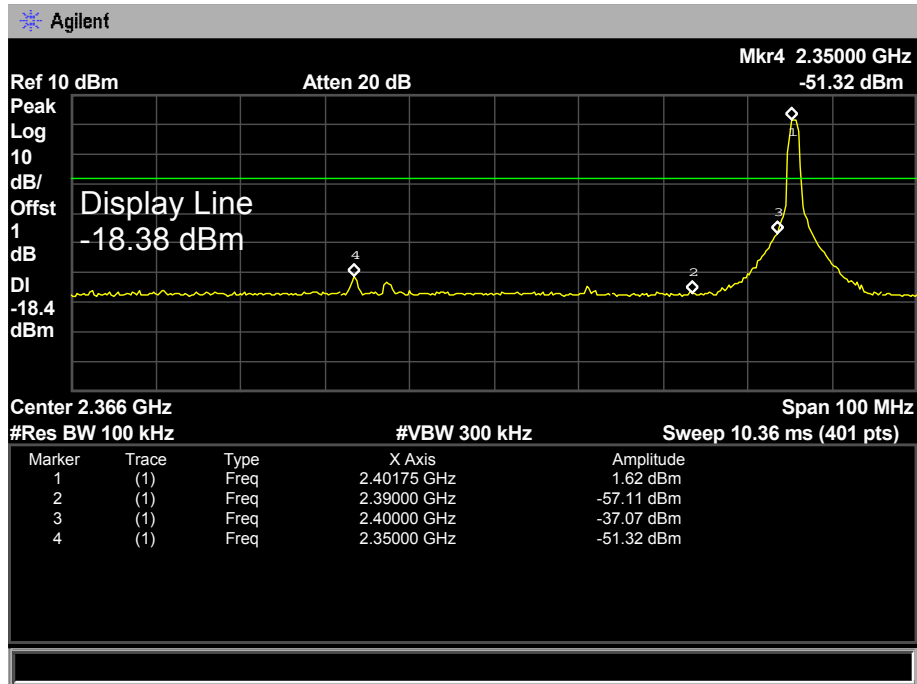

EUT:	Mobile Odyssey Duke Waterproof Bluetooth Speaker	Model Name :	7123-04
Temperature:	25 °C	Relative Humidity:	55%
Test Voltage:	DC 3.7V		
Test Mode:	8-DPSK Hopping Mode		
Remark:	N/A		

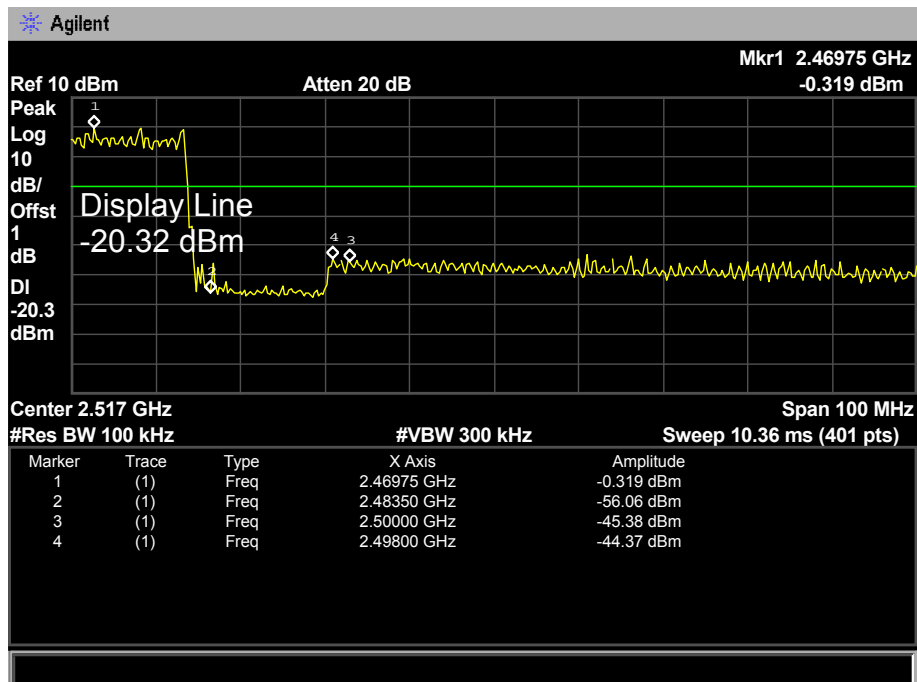
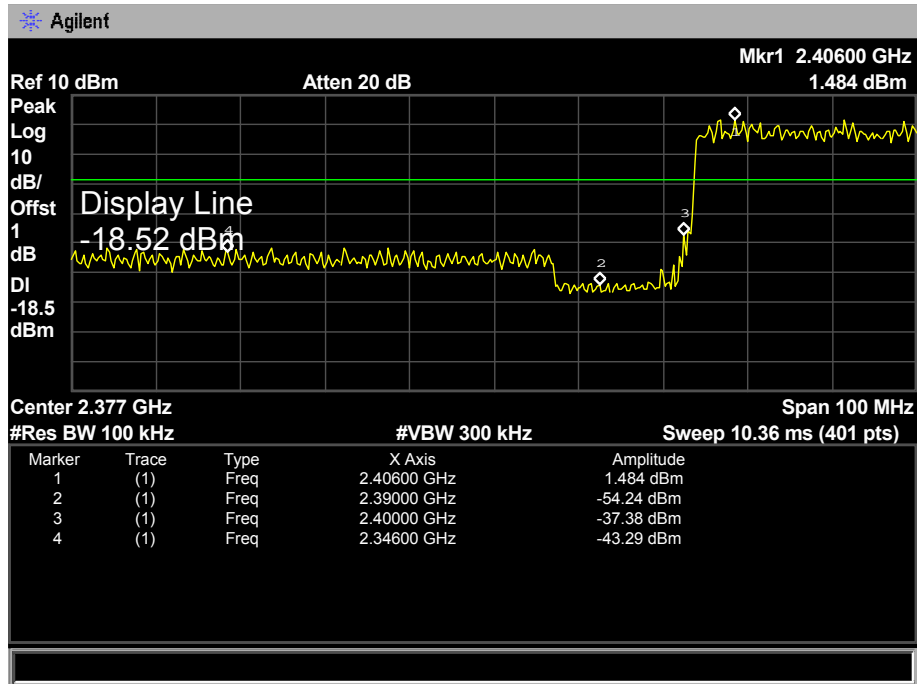

6. Number of Hopping Channel

6.1 Test Standard and Limit

- 6.1.1 Test Standard
FCC Part 15.247 (a)(1)
- 6.1.2 Test Limit

Section	Test Item	Limit
15.247	Number of Hopping Channel	>15

6.2 Test Setup

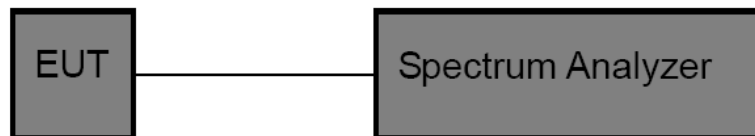

6.3 Test Procedure

- (1) The EUT was directly connected to the spectrum analyzer and antenna output port as show in the block diagram above.
- (2) Spectrum Setting: RBW=100 KHz, VBW=100 KHz, Sweep time= Auto.

6.4 EUT Operating Condition

The EUT was set to the Hopping Mode by the Customer.

6.5 Test Equipment

Equipment	Manufacturer	Model No.	Serial No.	Last Cal.	Cal. Due Date
Spectrum Analyzer	Agilent	E4407B	MY45106456	Mar. 20, 2014	Mar. 19, 2015

6.6 Test Data

EUT:	Mobile Odyssey Duke Waterproof Bluetooth Speaker	Model Name :	7123-04
Temperature:	25 °C	Relative Humidity:	55%
Test Voltage:	DC 3.7V		
Test Mode:	Hopping Mode (GFSK/ 8-DPSK)		
Frequency Range	Quantity of Hopping Channel		Limit
2402MHz~2480MHz	79		>15
	79		

GFSK Mode

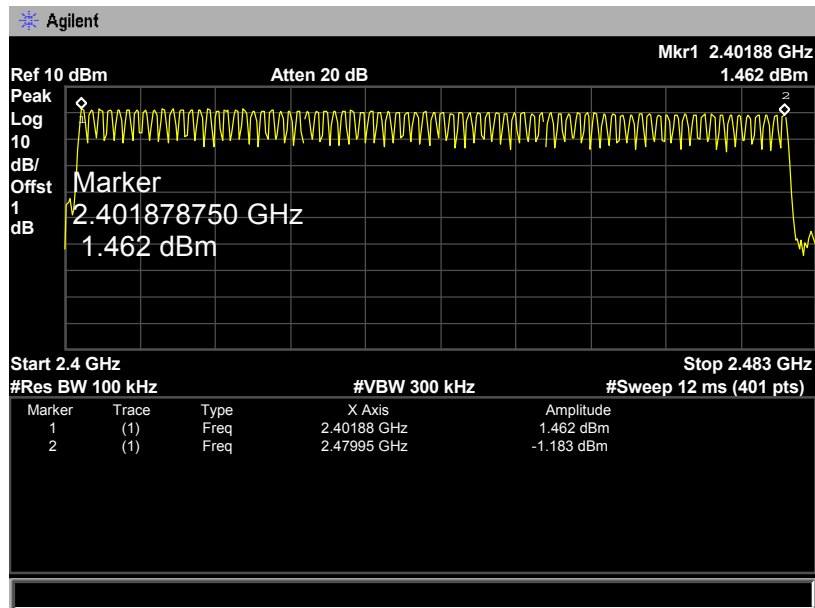

8-DPSK Mode

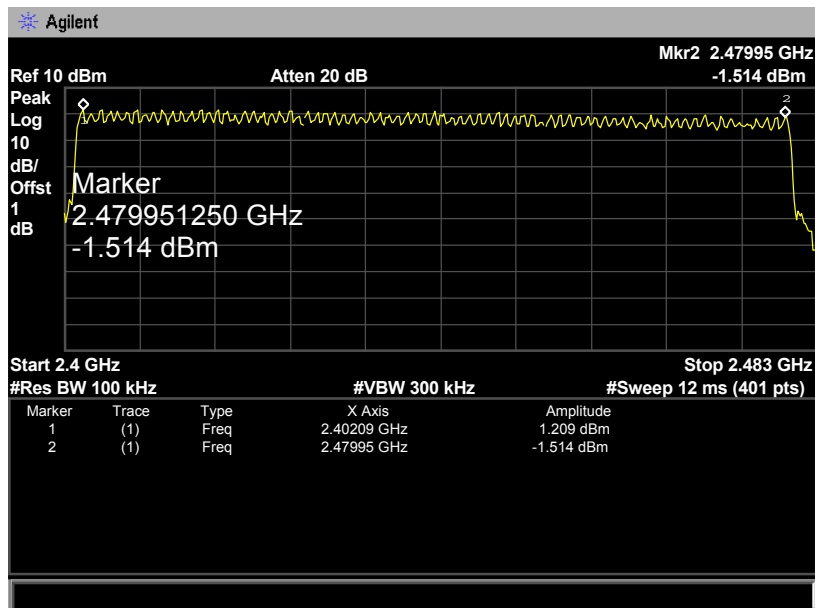

7. Average Time of OcCupancy

7.1 Test Standard and Limit

- 5.1.1 Test Standard
FCC Part 15.247 (a)(1)
- 5.1.2 Test Limit

Section	Test Item	Limit
15.247(a)(1)/ RSS-210 Annex 8(A8.1d)	Average Time of OcCupancy	0.4 sec

7.2 Test Setup

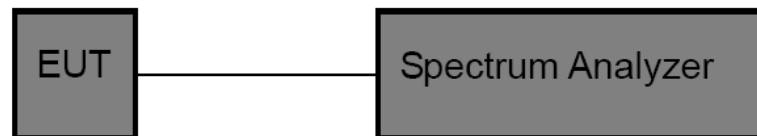

7.3 Test Procedure

- (1) The EUT was directly connected to the spectrum analyzer and antenna output port as show in the block diagram above.
- (2) Spectrum Setting: RBW=1MHz, VBW=1MHz.
- (3) Use video trigger with the trigger level set to enable triggering only on full pulses.
- (4) Sweep Time is more than once pulse time.
- (5) Set the center frequency on any frequency would be measure and set the frequency span to zero.
- (6) Measure the maximum time duration of one single pulse.
- (7) Set the EUT for packet transmitting.
- (8) Measure the maximum time duration of one single pulse.

7.4 EUT Operating Condition

The EUT was set to the Hopping Mode by the Customer.

7.5 Test Equipment

Equipment	Manufacturer	Model No.	Serial No.	Last Cal.	Cal. Due Date
Spectrum Analyzer	Agilent	E4407B	MY45106456	Mar. 20, 2014	Mar. 19, 2015

7.6 Test Data

EUT:	Mobile Odyssey Duke Waterproof Bluetooth Speaker	Model Name :	7123-04		
Temperature:	25 °C	Relative Humidity:	55%		
Test Voltage:	DC 3.7V				
Test Mode:	Hopping Mode (GFSK DH1)				
Channel (MHz)	Pulse Time (ms)	Total of Dwell (ms)	Period Time (s)	Limit (ms)	Result
2402	0.420	134.40	31.60	400	PASS
2441	0.420	134.40			
2480	0.420	134.40			

GFSK Hopping Mode DH1

2402 MHz

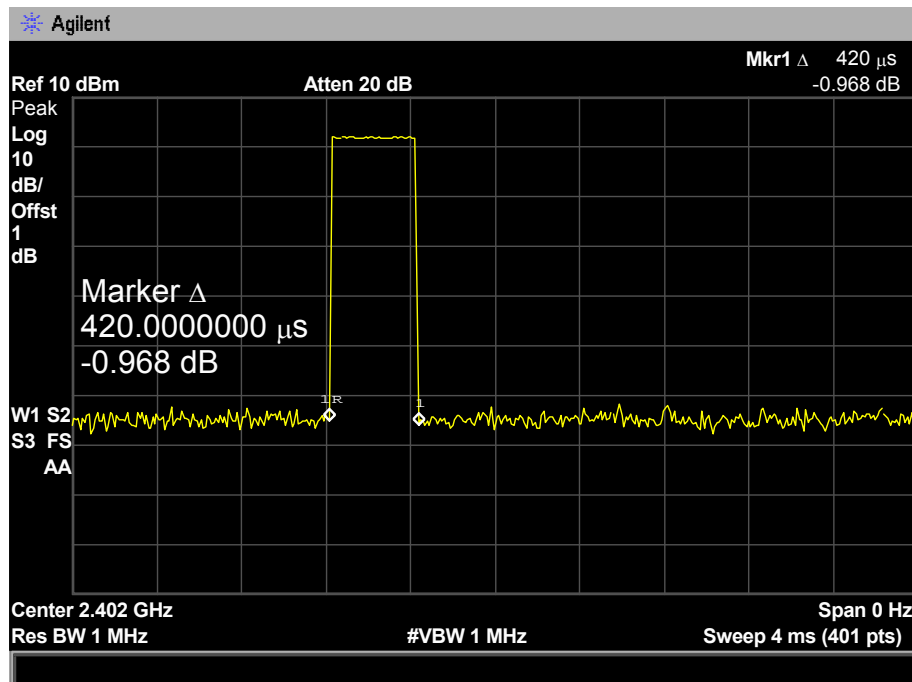

GFSK Hopping Mode DH1

2441 MHz

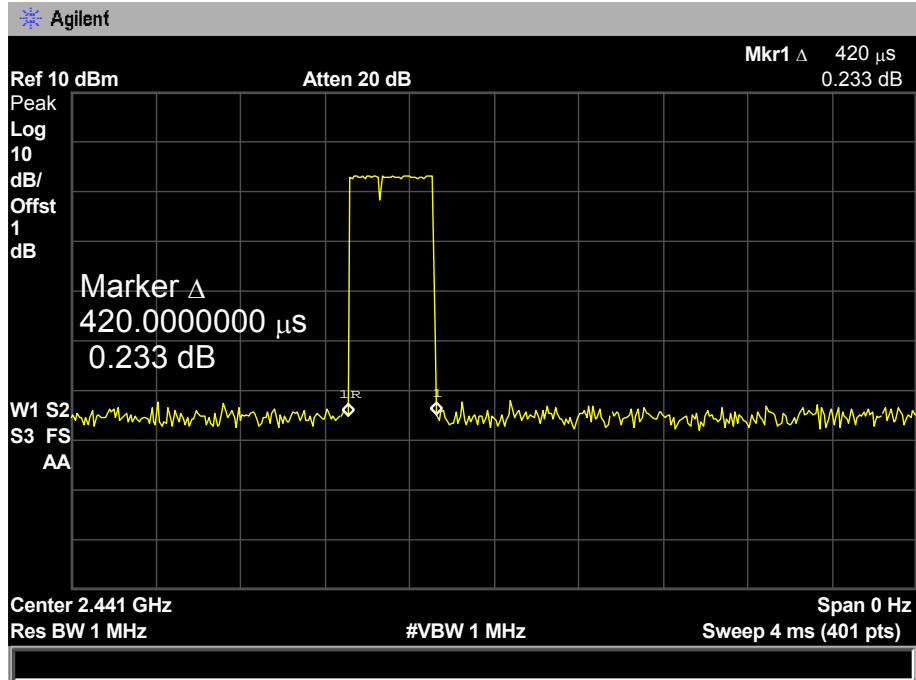

GFSK Hopping Mode DH1

2480 MHz

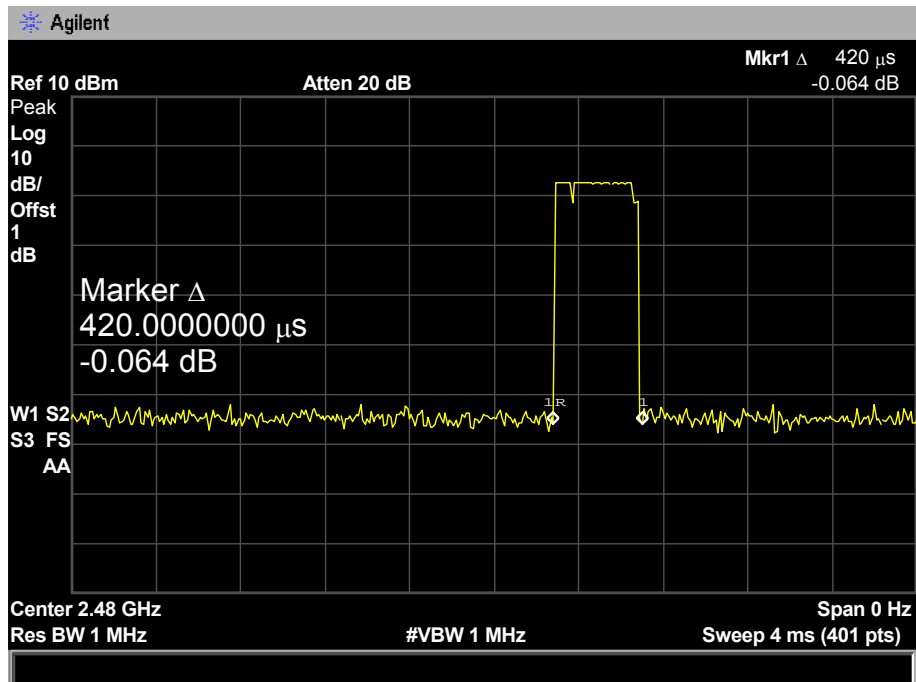

EUT:	Mobile Odyssey Duke Waterproof Bluetooth Speaker	Model Name :	7123-04		
Temperature:	25 °C	Relative Humidity:	55%		
Test Voltage:	DC 3.7V				
Test Mode:	Hopping Mode (GFSK DH3)				
Channel (MHz)	Pulse Time (ms)	Total of Dwell (ms)	Period Time (s)	Limit (ms)	Result
2402	1.700	272.00	31.60	400	PASS
2441	1.700	272.00			
2480	1.700	272.00			

GFSK Hopping Mode DH3

2402 MHz

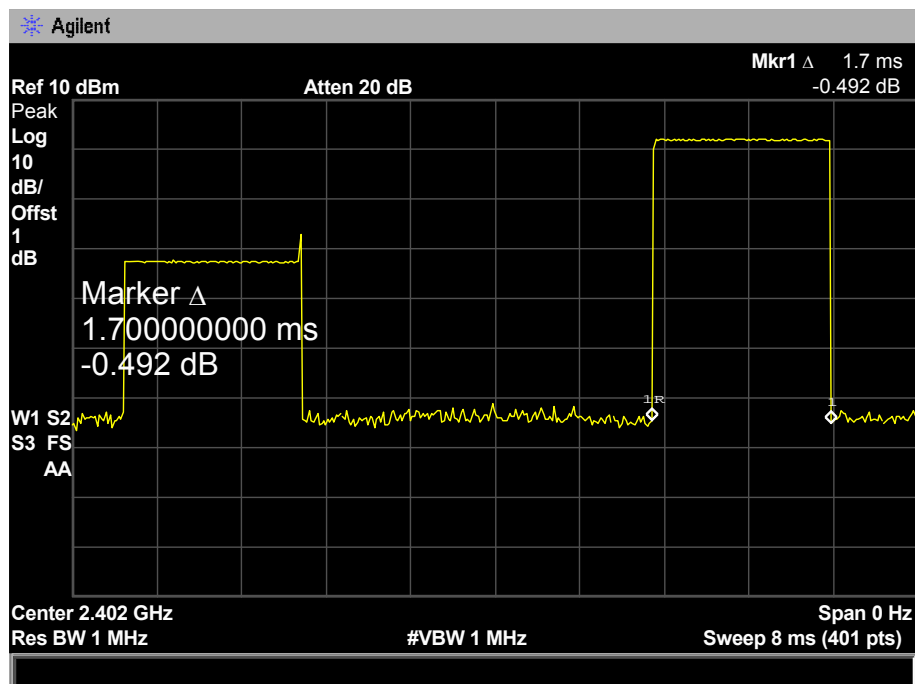

GFSK Hopping Mode DH3

2441 MHz

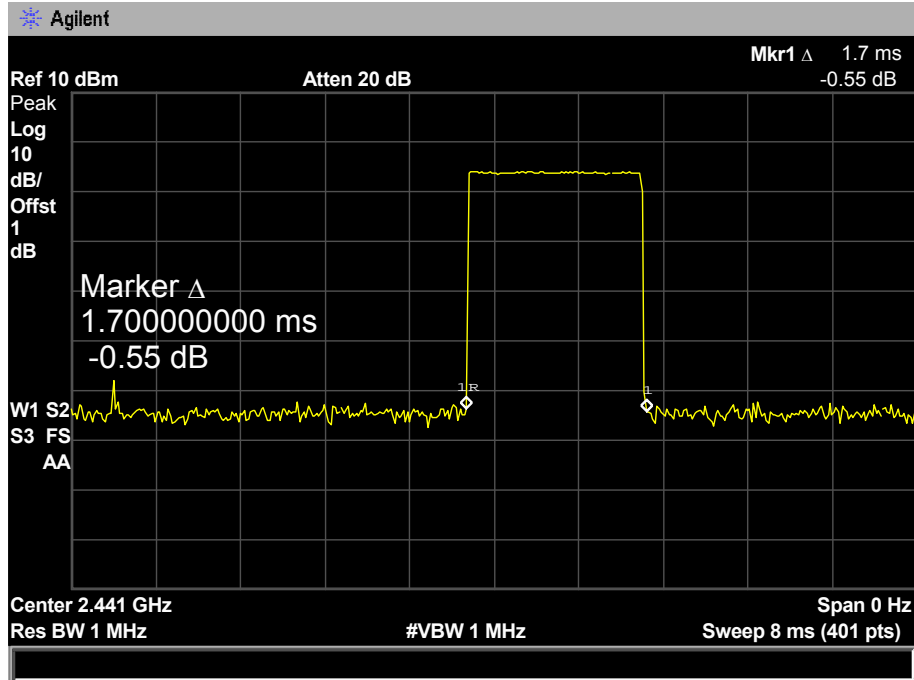

GFSK Hopping Mode DH3

2480 MHz

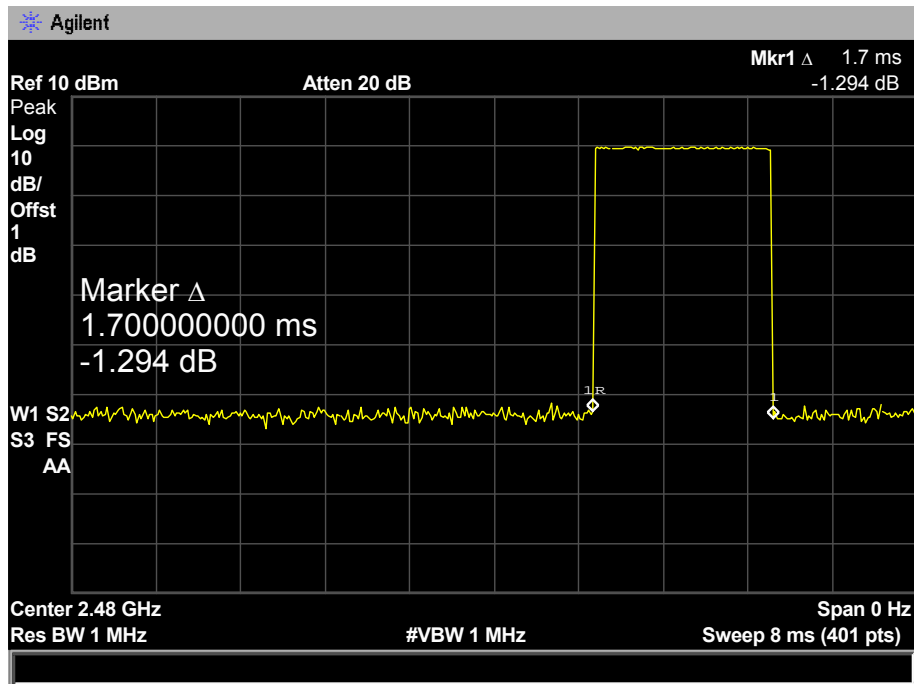

EUT:	Mobile Odyssey Duke Waterproof Bluetooth Speaker	Model Name :	7123-04		
Temperature:	25 °C	Relative Humidity:	55%		
Test Voltage:	DC 3.7V				
Test Mode:	Hopping Mode (GFSK DH5)				
Channel (MHz)	Pulse Time (ms)	Total of Dwell (ms)	Period Time (s)	Limit (ms)	Result
2402	3.000	320.00	31.60	400	PASS
2441	3.000	320.00			
2480	3.000	320.00			

GFSK Hopping Mode DH5

2402 MHz

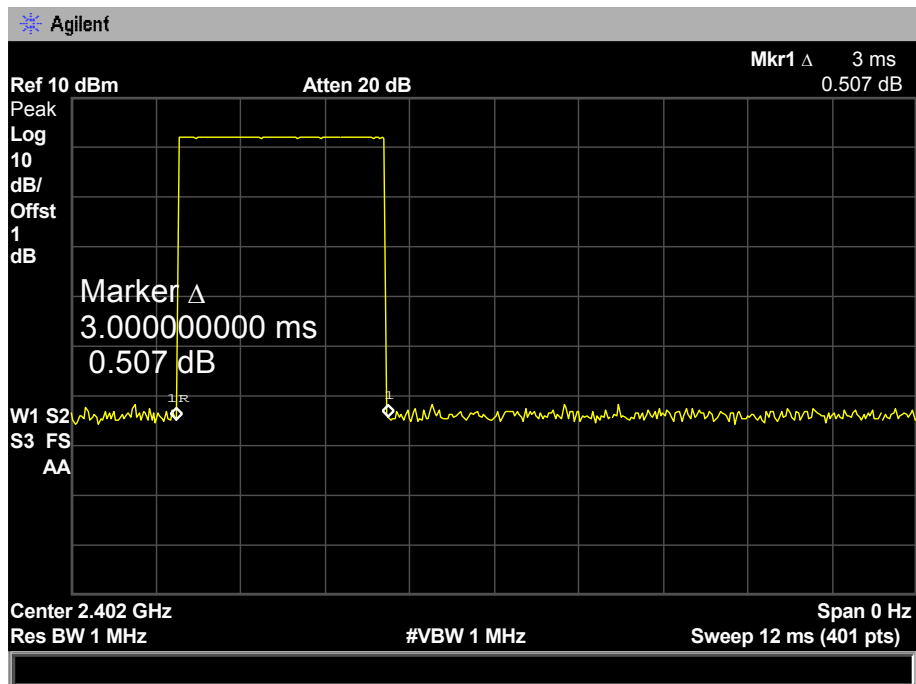

GFSK Hopping Mode DH5

2441 MHz

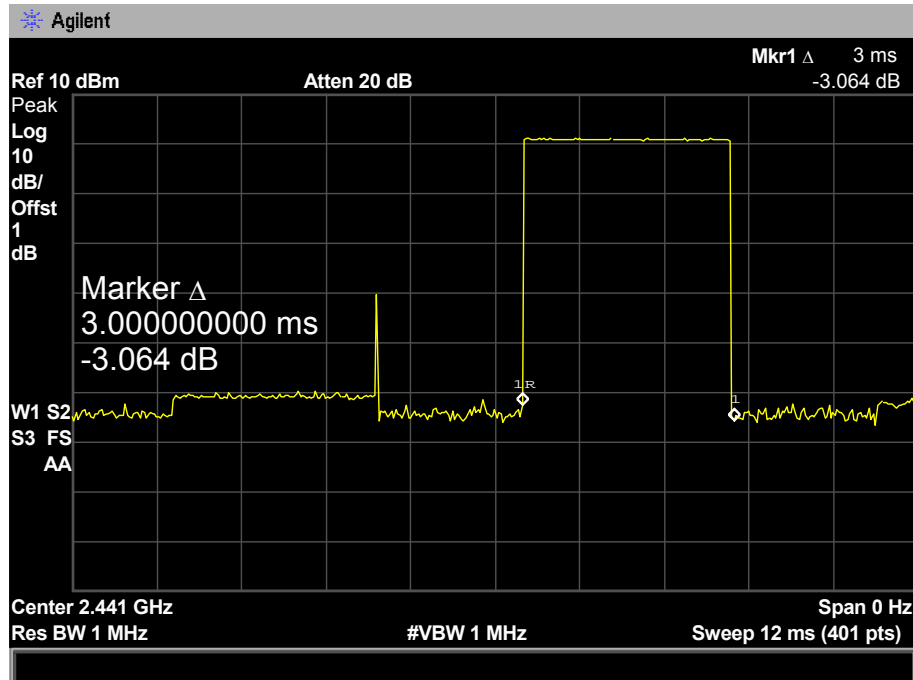

GFSK Hopping Mode DH5

2480 MHz

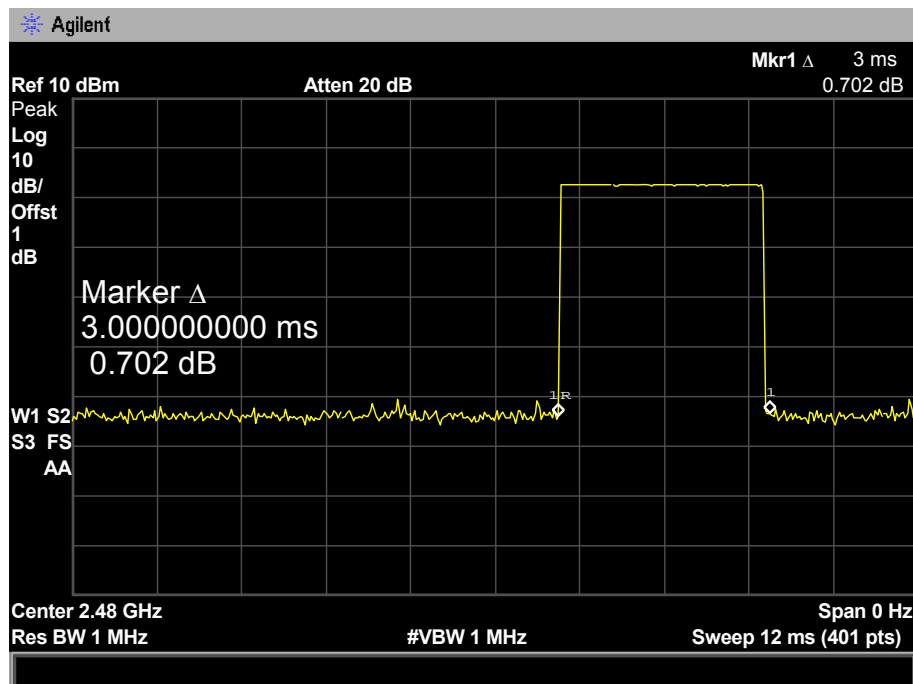

EUT:		Mobile Odyssey Duke Waterproof Bluetooth Speaker	Model Name :		7123-04
Temperature:		25 °C	Relative Humidity:		55%
Test Voltage:		DC 3.7V			
Test Mode:		Hopping Mode (8-DPSK DH1)			
Channel (MHz)	Pulse Time (ms)	Total of Dwell (ms)	Period Time (s)		Result
2402	0.410	131.20	31.6 0		PASS
2441	0.410	131.20			
2480	0.420	134.40			
8-DPSK Hopping Mode DH1					
2402 MHz					
<p>Agilent Ref 10 dBm Atten 20 dB Mkr1 Δ 410 μs -2.487 dB Peak Log 10 dB/ Offst 1 dB Marker Δ 410.000000 μs -2.487 dB W1 S2 S3 FS AA Center 2.402 GHz Res BW 1 MHz #VBW 1 MHz Span 0 Hz Sweep 4 ms (401 pts)</p>					

8-DPSK Hopping Mode DH1

2441 MHz

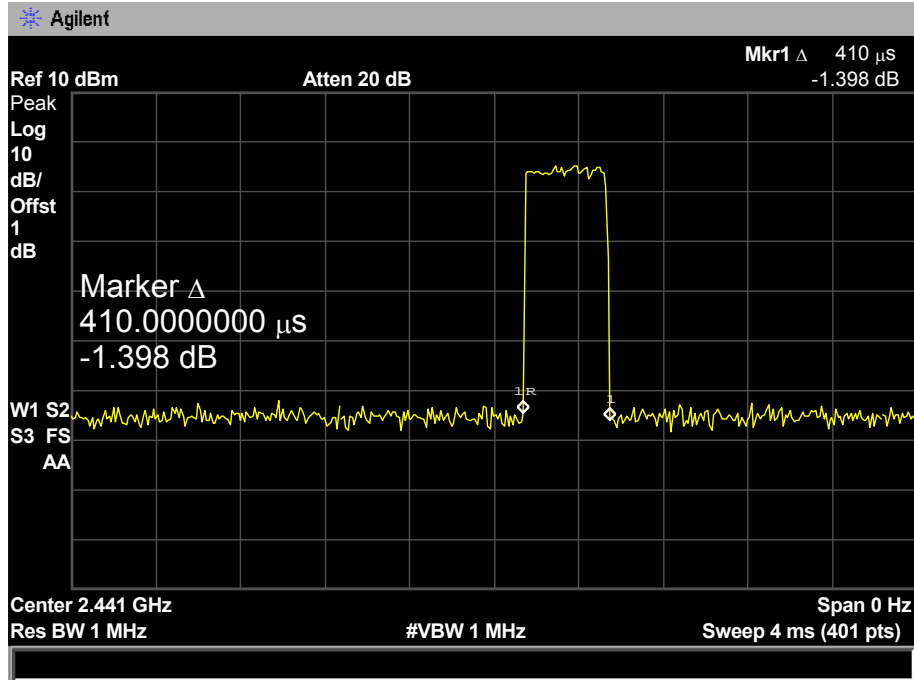

8-DPSK Hopping Mode DH1

2480 MHz

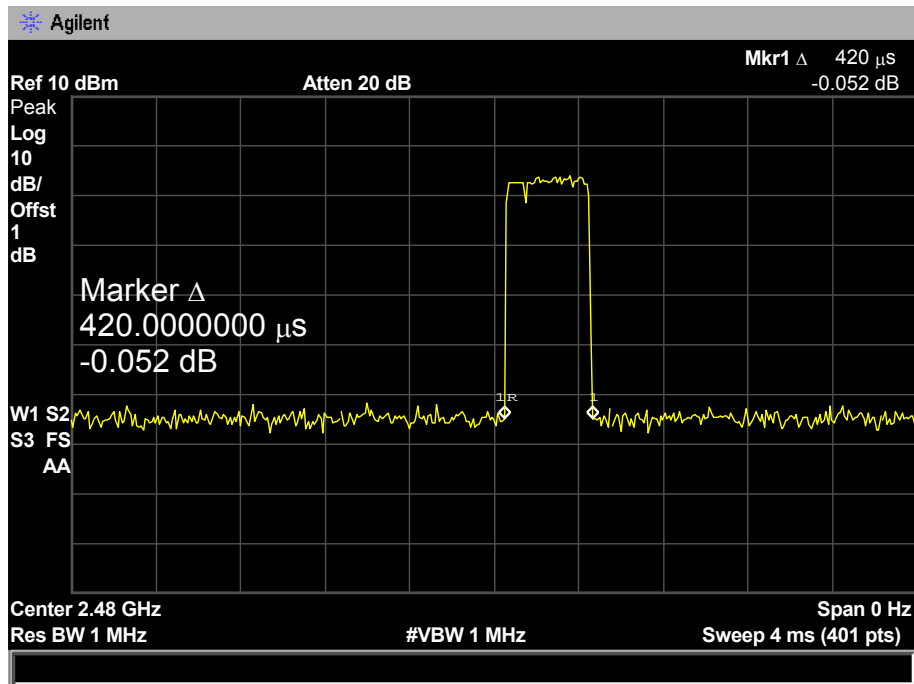

EUT:	Mobile Odyssey Duke Waterproof Bluetooth Speaker	Model Name :	7123-04		
Temperature:	25 °C	Relative Humidity:	55%		
Test Voltage:	DC 3.7V				
Test Mode:	Hopping Mode (8-DPSK DH3)				
Channel (MHz)	Pulse Time (ms)	Total of Dwell (ms)	Period Time (s)	Limit (ms)	Result
2402	1.680	268.80	31.60	400	PASS
2441	1.680	268.80			
2480	1.680	268.80			

8-DPSK Hopping Mode DH3

2402 MHz

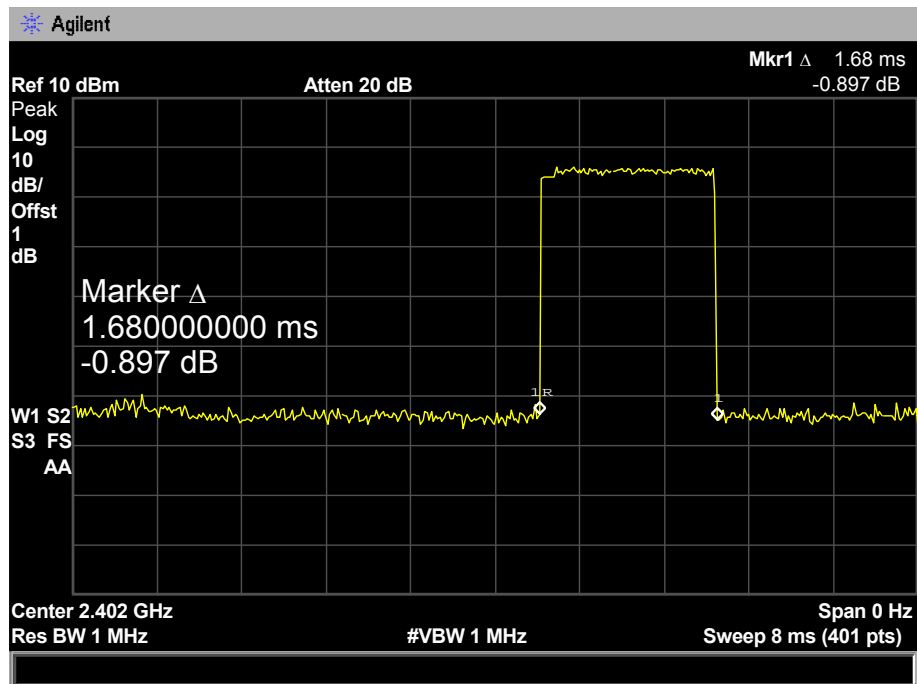

8-DPSK Hopping Mode DH3

2441 MHz

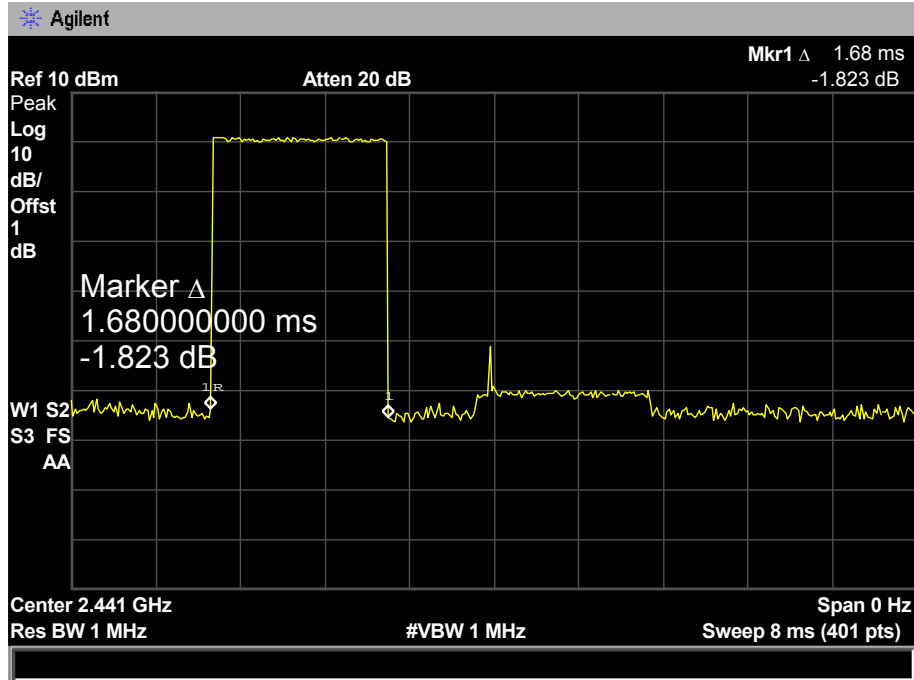

8-DPSK Hopping Mode DH3

2480 MHz

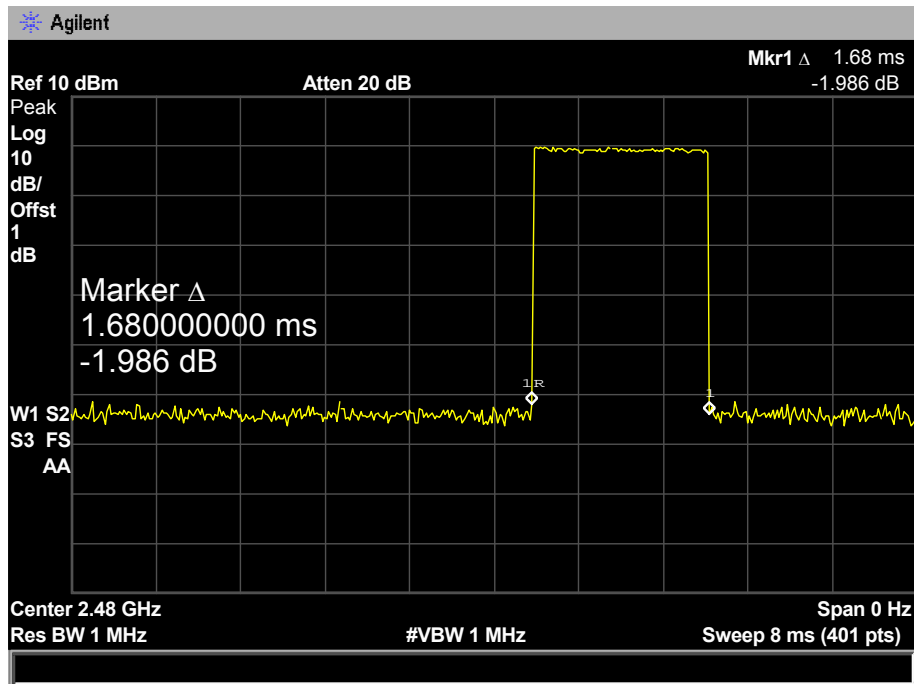

EUT:	Mobile Odyssey Duke Waterproof Bluetooth Speaker	Model Name :	7123-04		
Temperature:	25 °C	Relative Humidity:	55%		
Test Voltage:	DC 3.7V				
Test Mode:	Hopping Mode (8-DPSK DH5)				
Channel (MHz)	Pulse Time (ms)	Total of Dwell (ms)	Period Time (s)	Limit (ms)	Result
2402	2.940	313.60	31.60	400	PASS
2441	2.970	316.80			
2480	2.970	316.80			

8-DPSK Hopping Mode DH5

2402 MHz

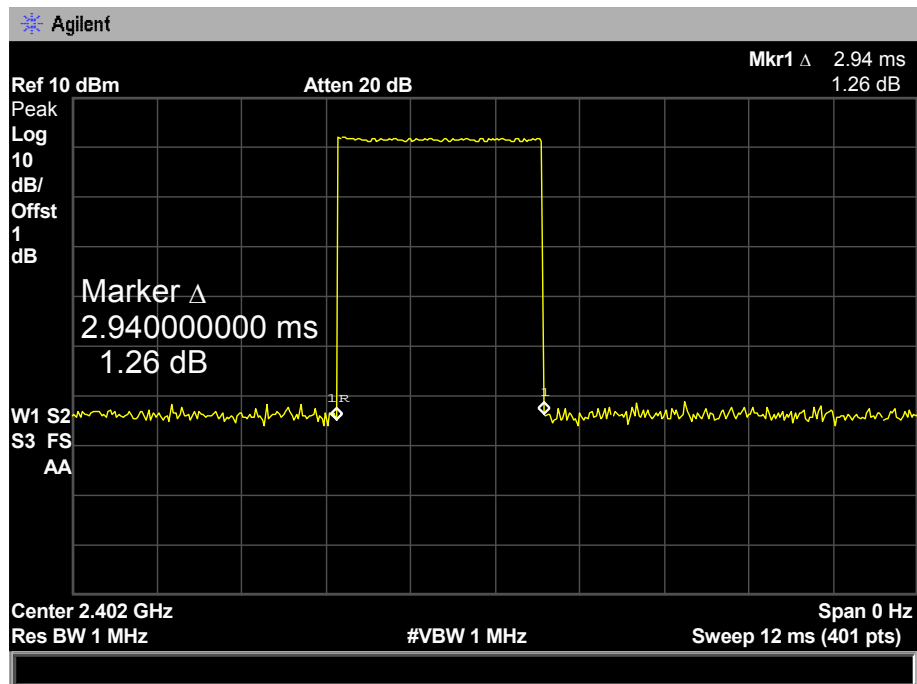

8-DPSK Hopping Mode DH5

2441 MHz

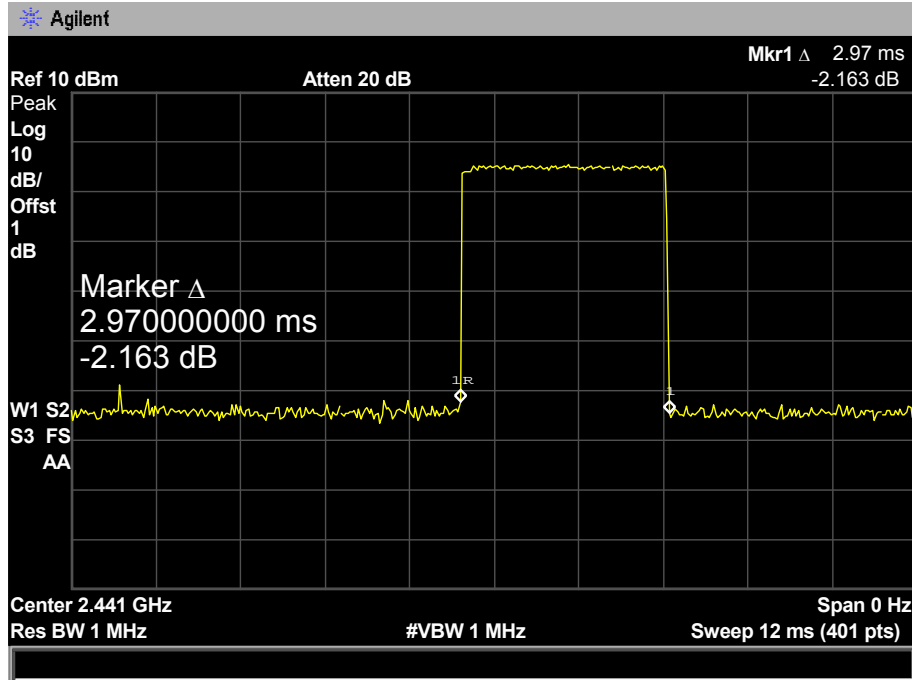

8-DPSK Hopping Mode DH5

2480 MHz

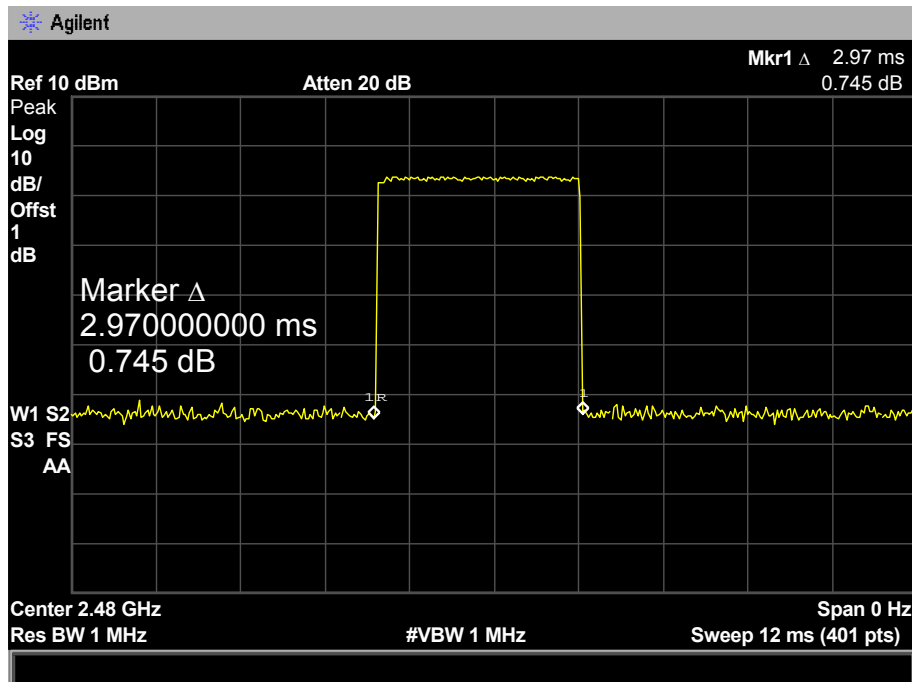

8. Channel Separation and Bandwidth Test

8.1 Test Standard and Limit

8.1.1 Test Standard

FCC Part 15.247

8.1.2 Test Limit

Test Item	Limit	Frequency Range(MHz)
Bandwidth	≤ 1 MHz (20dB bandwidth)	2400~2483.5
Channel Separation	>25 KHz or $>$ two-thirds of the 20 dB bandwidth Which is greater	2400~2483.5

8.2 Test Setup

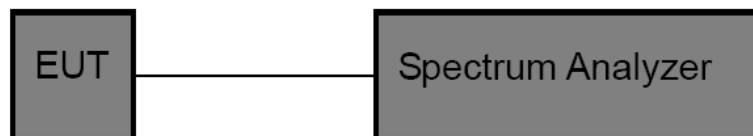

8.3 Test Procedure

- (1) The EUT was directly connected to the spectrum analyzer and antenna output port as show in the block diagram above.
- (2) Spectrum Setting:
 Channel Separation: RBW=30 kHz, VBW=100 kHz.
 Bandwidth: RBW=30 kHz, VBW=100 kHz.
- (3) The bandwidth is measured at an amplitude level reduced 20dB from the reference level. The reference level is the level of the highest amplitude signal observed from the transmitter at the fundamental frequency. Once the reference level is established, the equipment is conditioned with typical modulating signal to produce the worst –case (i.e the widest) bandwidth.
- (4) Measure the channel separation the spectrum analyzer was set to Resolution Bandwidth:30 kHz, and Video Bandwidth:100 kHz. Sweep Time set auto.

8.4 EUT Operating Condition

The EUT was set to the Hopping Mode for Channel Separation Test and continuously transmitting for the Bandwidth Test.

8.5 Test Equipment

Description	Manufacturer	Model No.	Serial No.	Cal. Date	Cal. Due Date
Spectrum Analyzer	Agilent	E4407B	MY45106456	Mar. 20, 2014	Mar. 19, 2015

8.6 Test Data

EUT:	Mobile Odyssey Duke Waterproof Bluetooth Speaker	Model Name :	7123-04
Temperature:	25 °C	Relative Humidity:	55%
Test Voltage:	DC 3.7V		
Test Mode:	TX Mode (GFSK)		
Channel frequency (MHz)	99% OBW (kHz)	20dB Bandwidth (kHz)	
2402	846.2283	859.847	
2441	839.1092	851.661	
2480	828.9790	855.023	

GFSK TX Mode
2402 MHz

Agilent
Ref 10 dBm
Atten 20 dB
#Peak
Log
10
dB/
Offst
1
dB
Center
2.402000000 GHz
Center 2.402 GHz
#Res BW 30 kHz
#VBW 100 kHz
Span 3 MHz
Sweep 5 ms (401 pts)
Occupied Bandwidth
846.2283 kHz
Occ BW % Pwr 99.00 %
x dB -20.00 dB
Transmit Freq Error -21.802 kHz
x dB Bandwidth 859.847 kHz

GFSK TX Mode

2441 MHz

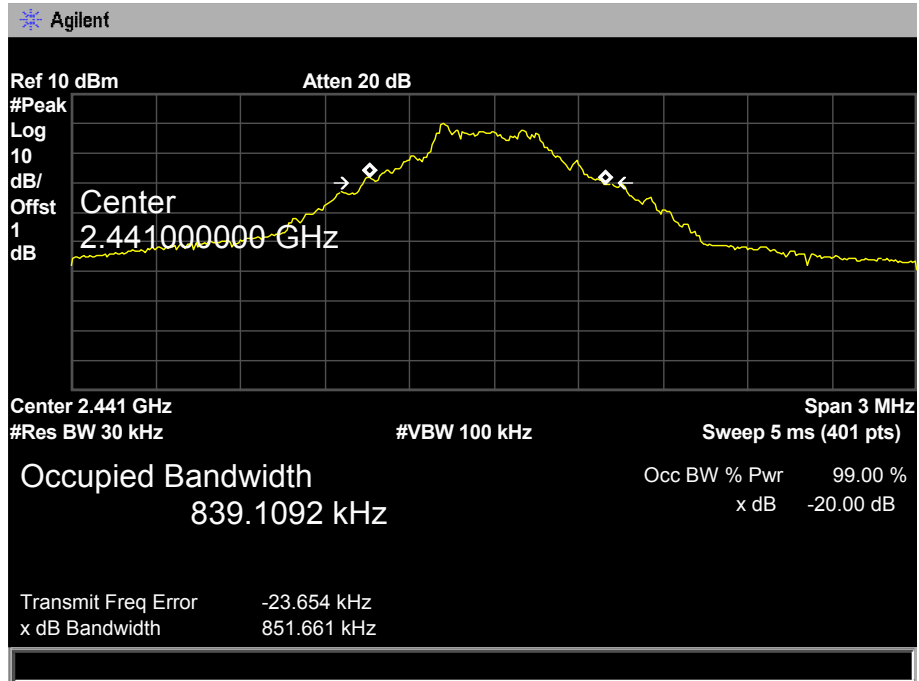

GFSK TX Mode

2480 MHz

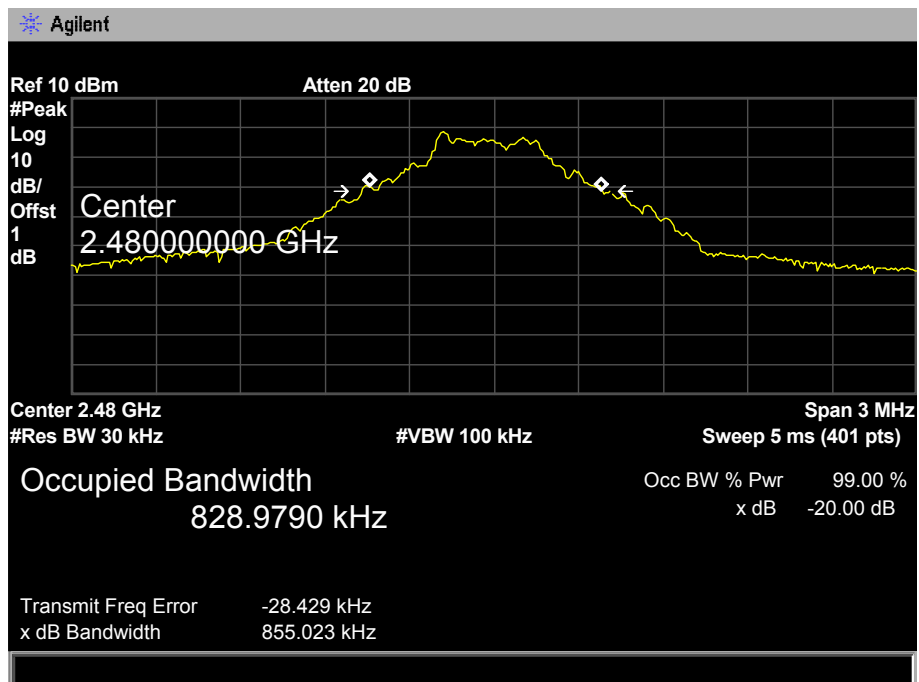

EUT:	Mobile Odyssey Duke Waterproof Bluetooth Speaker	Model Name :	7123-04
Temperature:	25 °C	Relative Humidity:	55%
Test Voltage:	DC 3.7V		
Test Mode:	TX Mode (8-DPSK)		
Channel frequency (MHz)	99% OBW (kHz)	20dB Bandwidth (kHz)	20dB Bandwidth *2/3 (kHz)
2402	1179.70	1300.00	866.67
2441	1176.10	1300.00	866.67
2480	1171.00	1289.00	859.33

8-DPSK TX Mode
2402 MHz

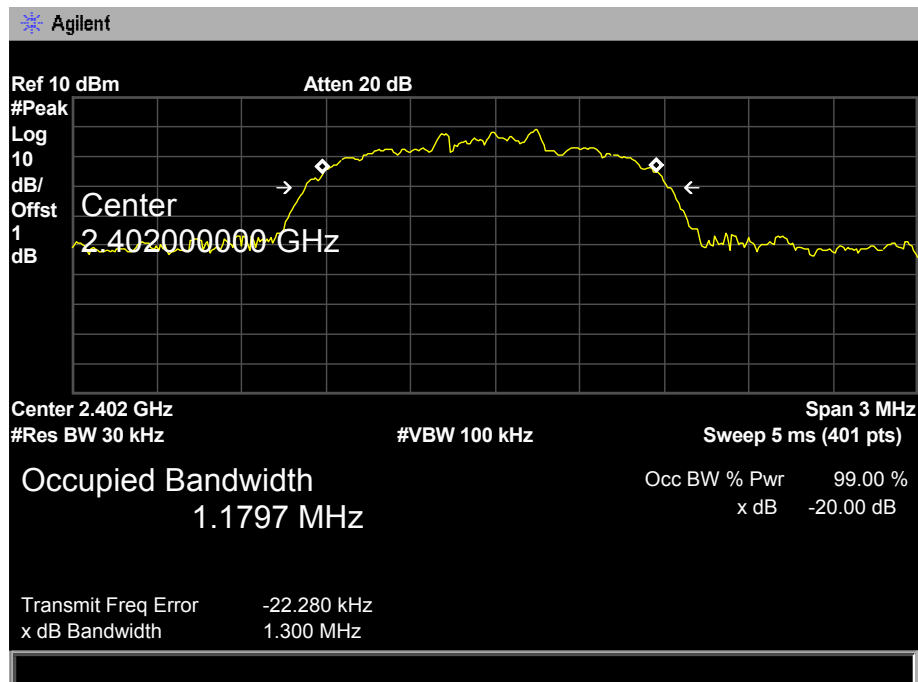

8-DPSK TX Mode

2441 MHz

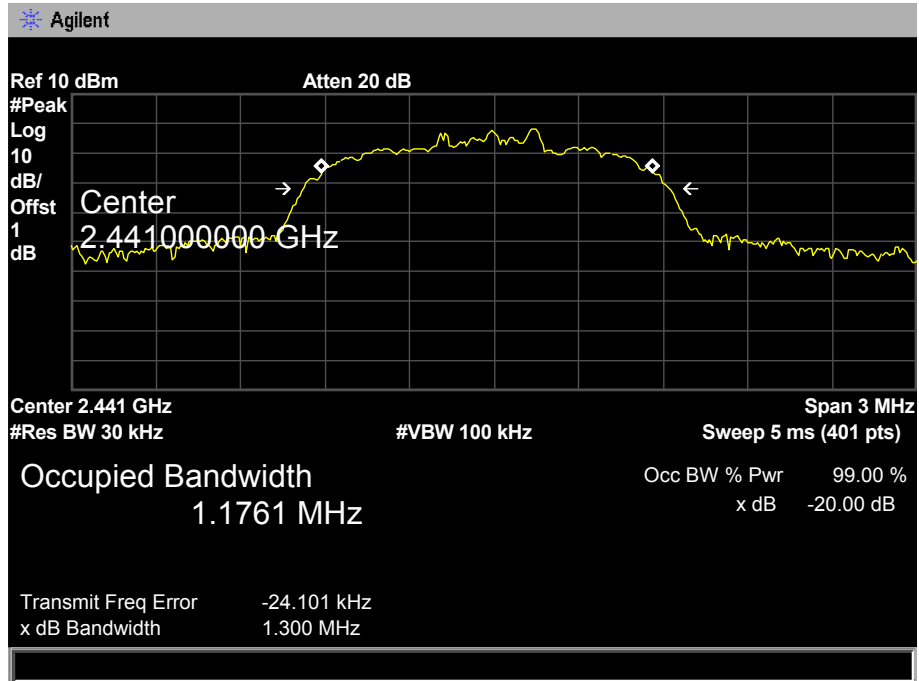

8-DPSK TX Mode

2480 MHz

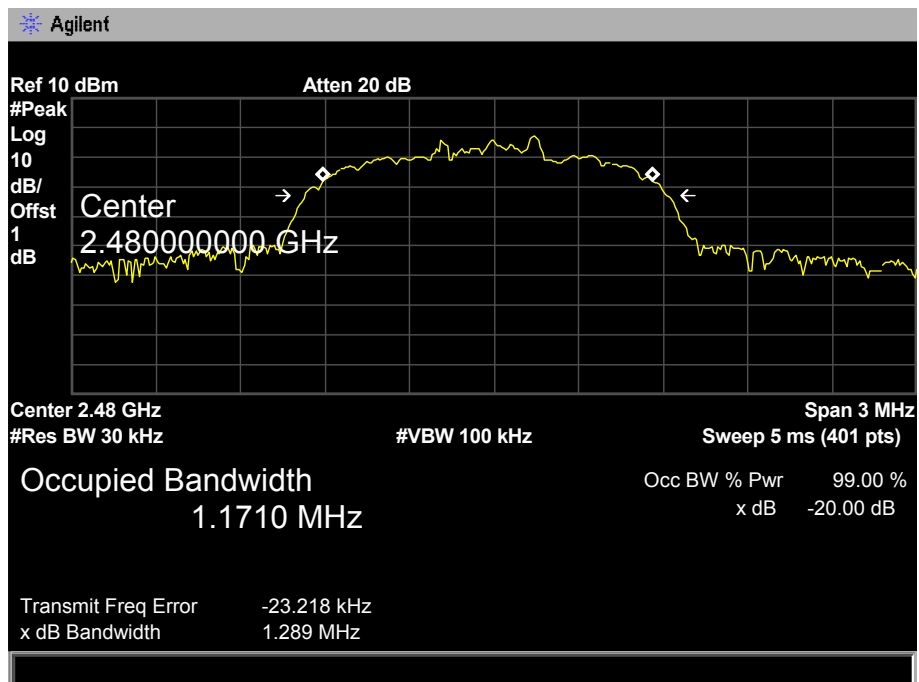

EUT:	Mobile Odyssey Duke Waterproof Bluetooth Speaker	Model Name :	7123-04
Temperature:	25 °C	Relative Humidity:	55%
Test Voltage:	DC 3.7V		
Test Mode:	Hopping Mode (GFSK)		
Channel frequency (MHz)	Separation Read Value (kHz)	Separation Limit (kHz)	
2402	1005.00	859.847	
2441	1005.00	851.661	
2480	1005.00	855.023	

GFSK Hopping Mode

2402 MHz

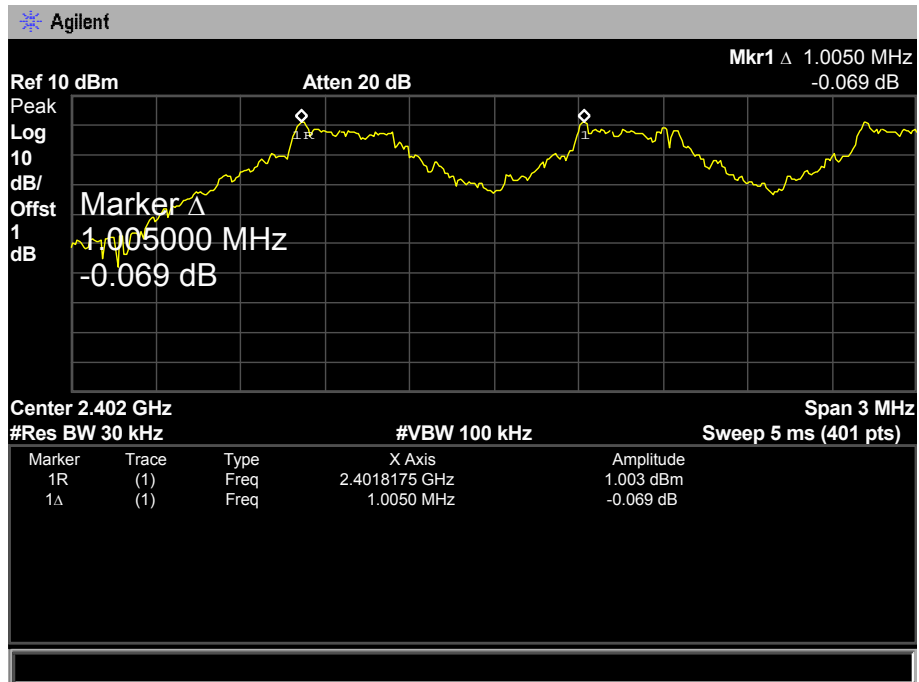

GFSK Hopping Mode

2441 MHz

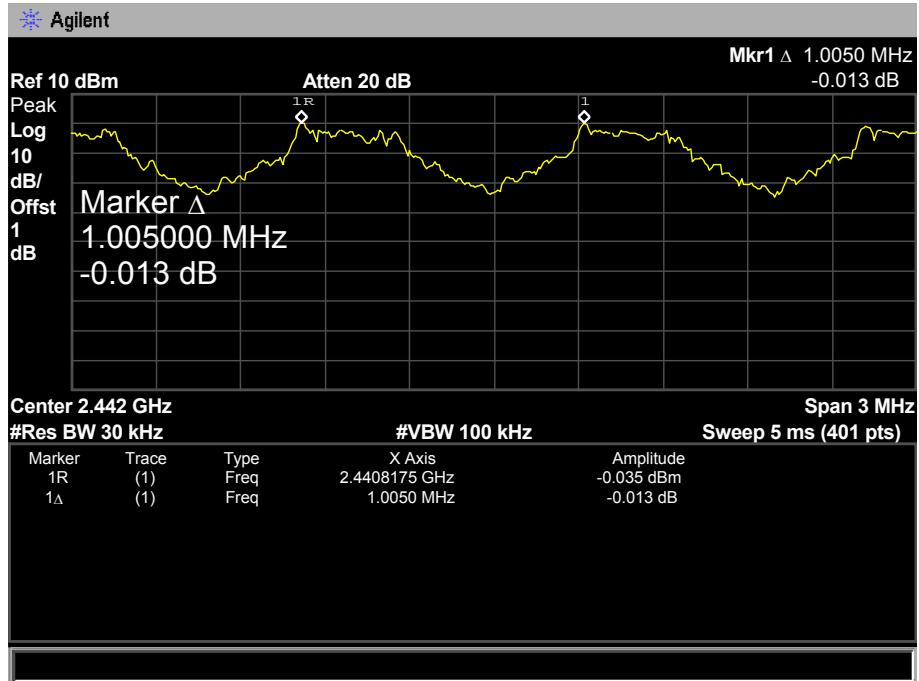

GFSK Hopping Mode

2480 MHz

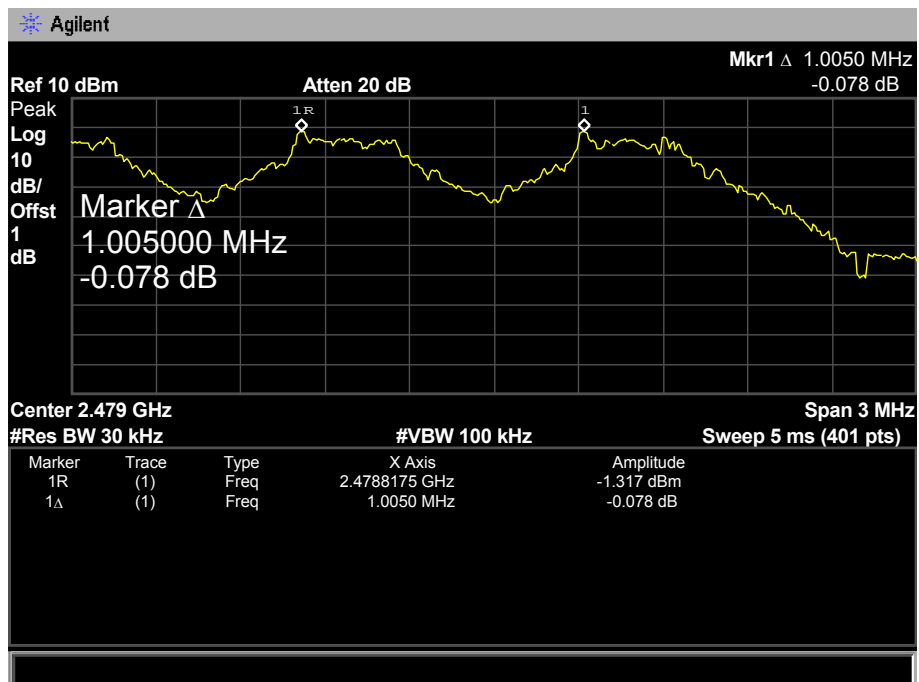

EUT:	Mobile Odyssey Duke Waterproof Bluetooth Speaker	Model Name :	7123-04
Temperature:	25 °C	Relative Humidity:	55%
Test Voltage:	DC 3.7V		
Test Mode:	Hopping Mode (8-DPSK)		
Channel frequency (MHz)	Separation Read Value (kHz)	Separation Limit (kHz)	
2402	1005.00	866.67	
2441	1005.00	866.67	
2480	1005.00	859.33	

8-DPSK Hopping Mode

2402 MHz

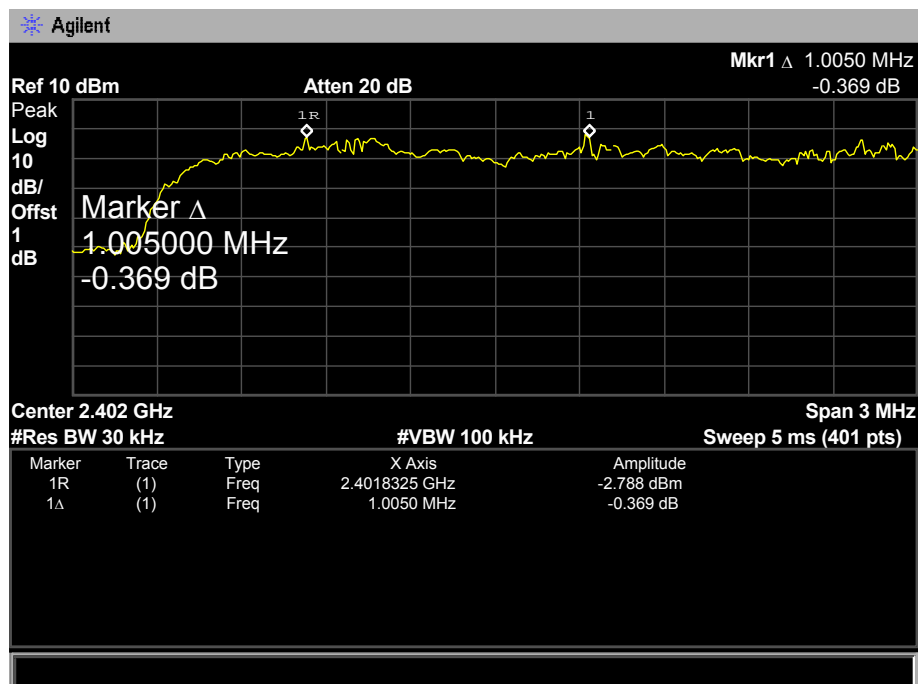

8-DPSK Hopping Mode

2441 MHz

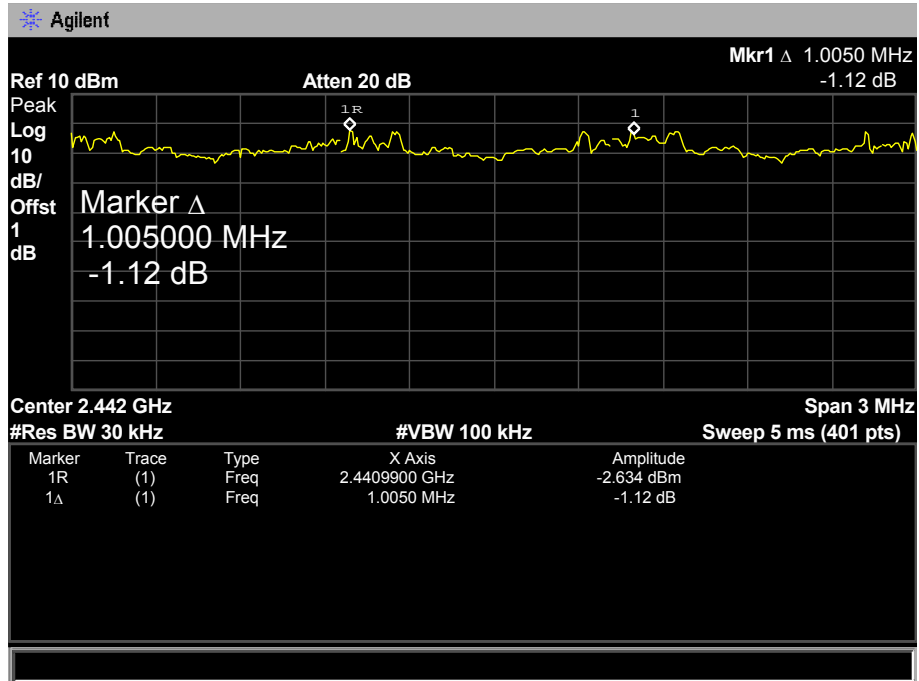

8-DPSK Hopping Mode

2480 MHz

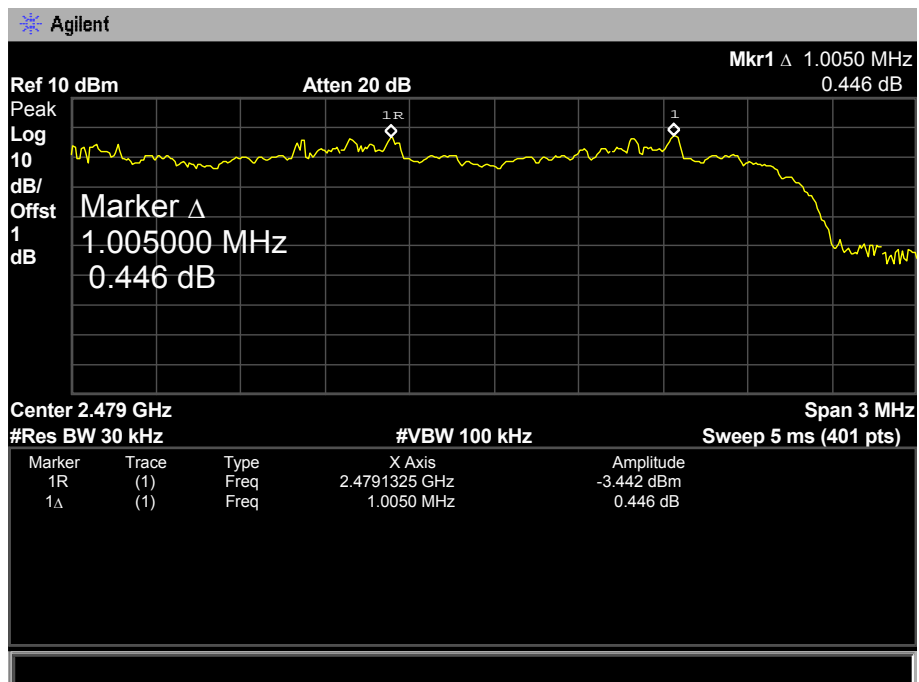

9. Peak Output Power Test

9.1 Test Standard and Limit

9.1.1 Test Standard

FCC Part 15.247 (b) (1)

9.1.2 Test Limit

Test Item	Limit	Frequency Range(MHz)
Peak Output Power	Hopping Channels>75 Power<1W(30dBm) Other <125 mW(21dBm)	2400~2483.5

9.2 Test Setup

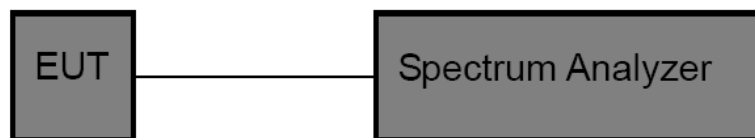

9.3 Test Procedure

- (1) The EUT was directly connected to the spectrum analyzer and antenna output port as show in the block diagram above.
- (2) Spectrum Setting:
Peak Detector: RBW=1 MHz, VBW=3 MHz for bandwidth less than 1MHz.
RBW=3 MHz, VBW=3 MHz for bandwidth more than 1MHz.

9.4 EUT Operating Condition

The EUT was set to continuously transmitting in the max power during the test.

9.5 Test Equipment

Description	Manufacturer	Model No.	Serial No.	Cal. Date	Cal. Due Date
Spectrum Analyzer	Agilent	E4407B	MY45106456	Mar. 20, 2014	Mar. 19, 2015

9.6 Test Data

EUT:	Mobile Odyssey Duke Waterproof Bluetooth Speaker	Model Name :	7123-04
Temperature:	25 °C	Relative Humidity:	55%
Test Voltage:	DC 3.7V		
Test Mode:	TX Mode (GFSK)		
Channel frequency (MHz)	Test Result (dBm)	Limit (dBm)	
2402	2.112	30	
2441	1.169		
2480	-0.175		

GFSK TX Mode

2402 MHz

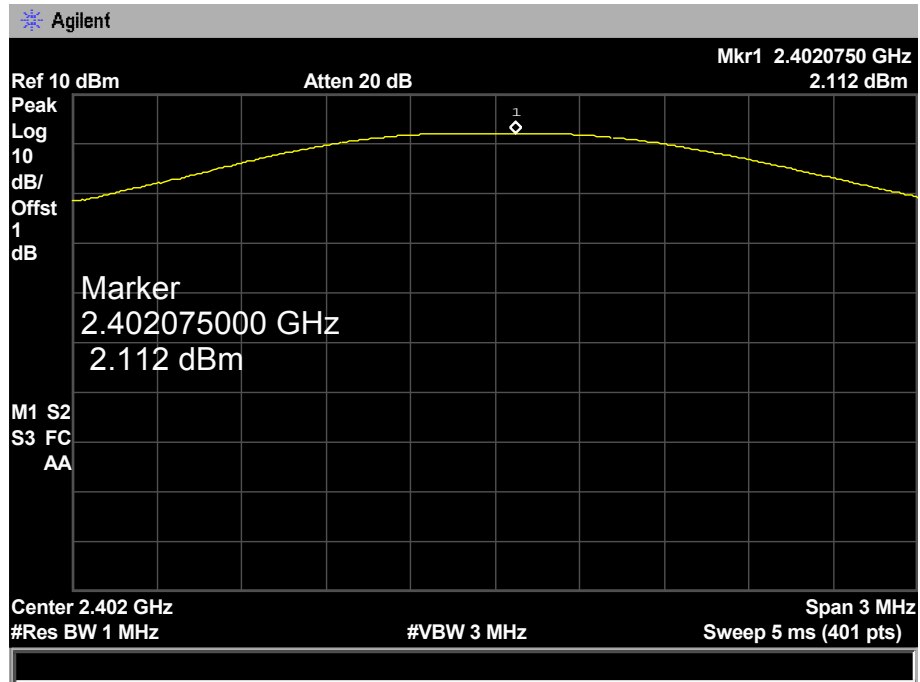

GFSK TX Mode

2441 MHz

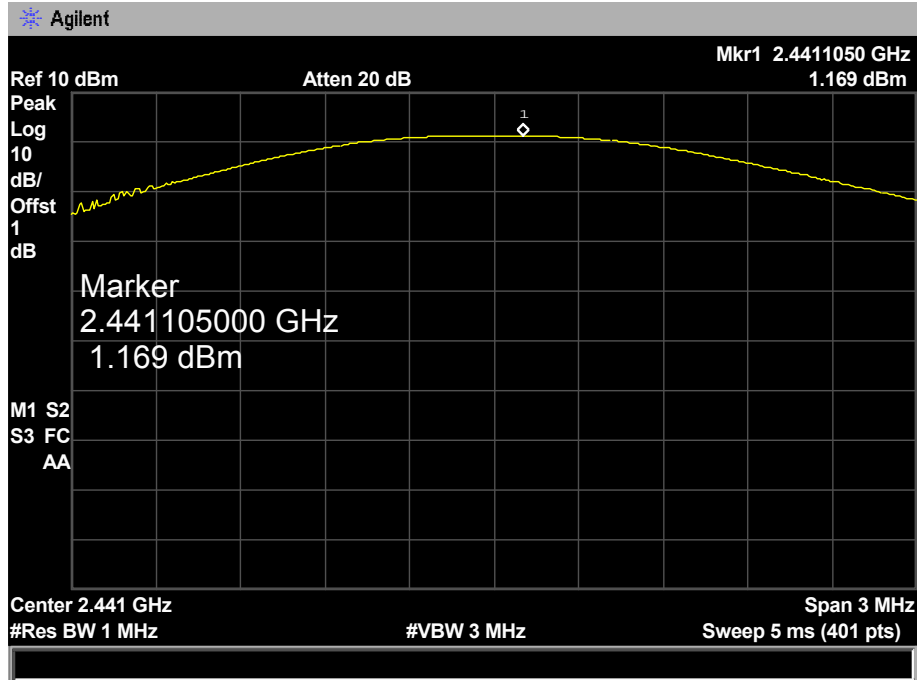

GFSK TX Mode

2480 MHz

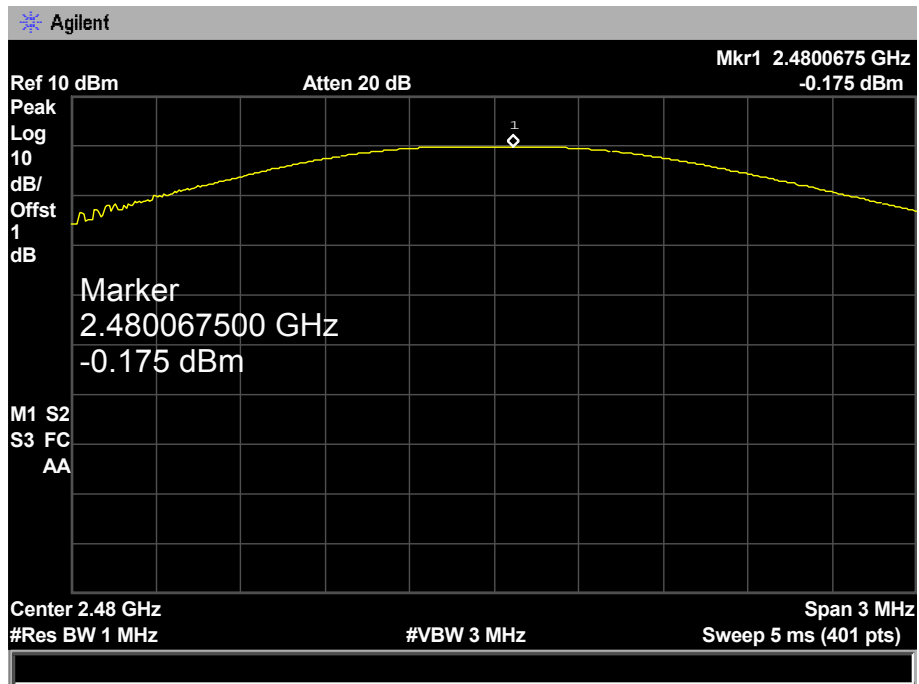

EUT:	Mobile Odyssey Duke Waterproof Bluetooth Speaker	Model Name :	7123-04
Temperature:	25 °C	Relative Humidity:	55%
Test Voltage:	DC 3.7V		
Test Mode:	TX Mode (8-DPSK)		
Channel frequency (MHz)	Test Result (dBm)	Limit (dBm)	
2402	2.661	21	
2441	1.867		
2480	0.595		

8-DPSK TX Mode

2402 MHz

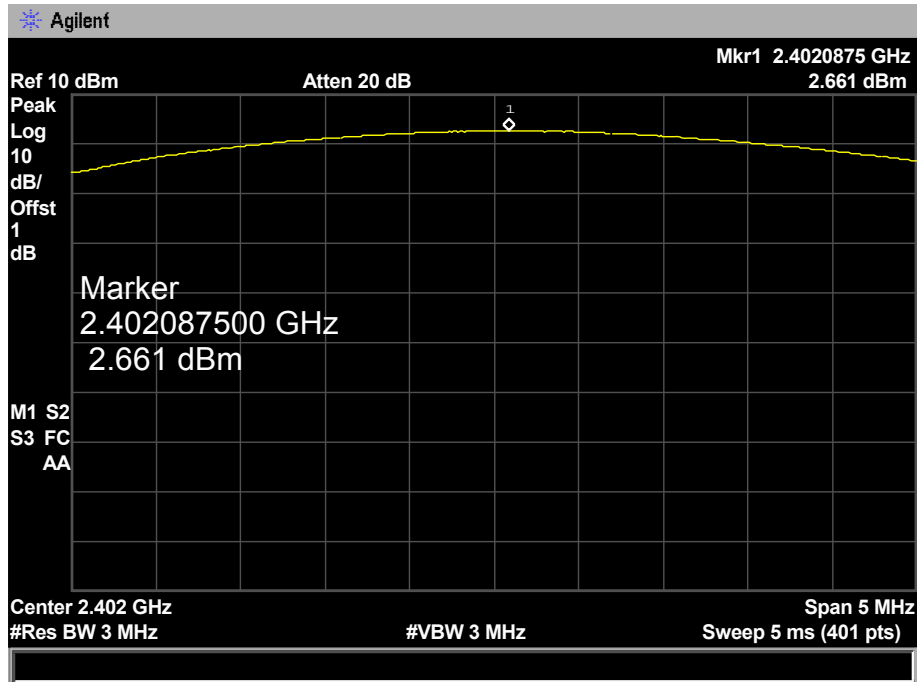

8-DPSK TX Mode

2441 MHz

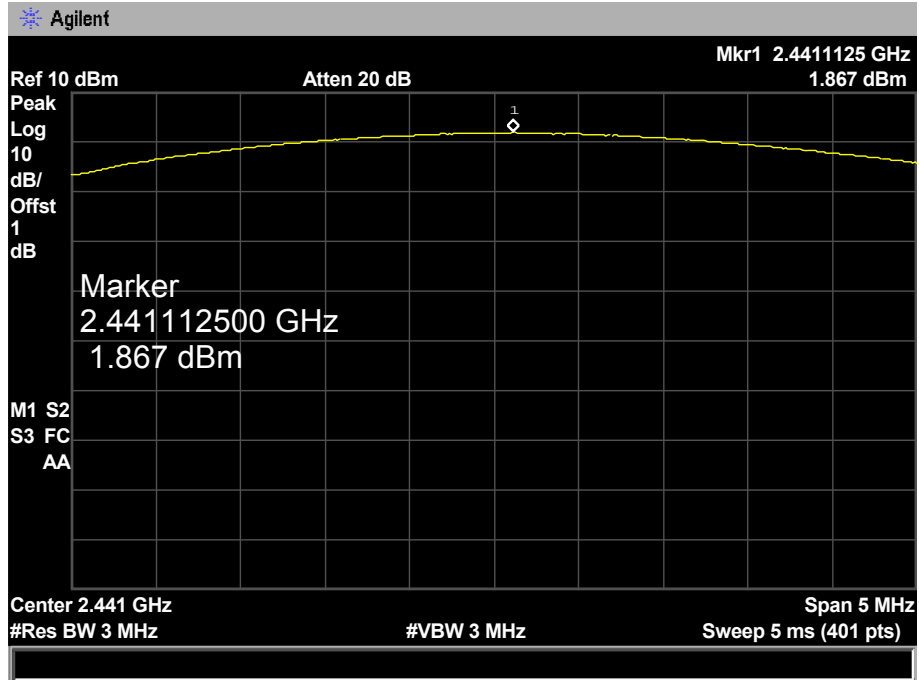

8-DPSK TX Mode

2480 MHz

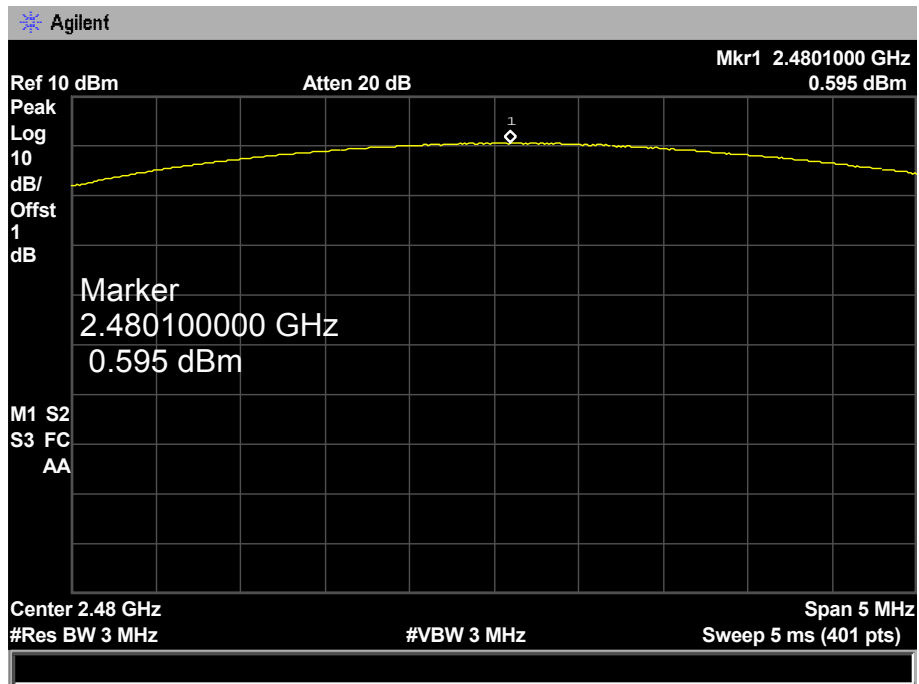

10. Antenna Requirement

10.1 Standard Requirement

10.1.1 Standard

FCC Part 15.203

10.1.2 Requirement

An intentional radiator shall be designed to ensure that no antenna other than that furnished by the responsible party shall be used with the device. The use of a permanently attached antenna or of an antenna that uses a unique coupling to the intentional radiator shall be considered sufficient to comply with the provisions of this Section. The manufacturer may design the unit so that a broken antenna can be replaced by the user, but the use of a standard antenna jack or electrical connector is prohibited.

10.2 Antenna Connected Construction

The directional gains of the antenna used for transmitting is 0 dBi, and the antenna connector is de-signed with permanent attachment and no consideration of replacement. Please see the EUT photo for details.

10.2 Result

The EUT antenna is a PCB Antenna. It complies with the standard requirement.