

**ELECTROMAGNETIC EMISSIONS COMPLIANCE REPORT  
INTENTIONAL RADIATOR CERTIFICATION TO  
FCC PART 15 SUBPART C REQUIREMENT**

*OF*

**Wireless charger speaker**

**Model No.: SL241, SP77, ESP-PT19**

**Trademark: N/A**

**FCC ID: 2ABHA0060**

**Report No.: ES190227060E02**

**Issue Date: March 21, 2019**

*Prepared for*

**Ningbo Cstar Imp & Exp CO., LTD  
Floor 4, Building E, No. 655-90, Qiming Road, Yinzhou Investment  
& Innovation Center, Ningbo, China**

*Prepared by*

**EMTEK(SHENZHEN) CO., LTD.**

**Bldg 69, Majialong Industry Zone, Nanshan District, Shenzhen,  
Guangdong, China.**

**TEL: 86-755-26954280**

**FAX: 86-755-26954282**

**This report shall not be reproduced, except in full, without the written approval of  
EMTEK(SHENZHEN) CO., LTD.**

**VERIFICATION OF COMPLIANCE**

Applicant:	Ningbo Cstar Imp & Exp CO., LTD Floor 4,Building E, No. 655-90,Qiming Road, Yinzhou Investment &Innovation Center, Ningbo, China
Manufacturer:	Ningbo Cstar Imp & Exp CO., LTD Floor 4,Building E, No. 655-90,Qiming Road, Yinzhou Investment &Innovation Center, Ningbo, China
Product Description:	Wireless charger speaker
Trade Mark:	N/A
Model Number:	SL241,SP77, ESP-PT19 (Note: These models are same except model number, here model:SL241 was selected for full test.)

**We hereby certify that:**

The above equipment was tested by EMTEK(SHENZHEN) CO., LTD. The test data, data evaluation, test procedures, and equipment configurations shown in this report were made in accordance with the procedures given in ANSI C63.10-2013 and the energy emitted by the sample EUT tested as described in this report is in compliance with conducted and radiated emission limits of FCC Rules Part 15.247(2017).

Date of Test : March 01, 2019 to March 15, 2019

*Yaping Shen*

Prepared by : Yaping Shen/Editor

*Joe Xia*

Reviewer : Joe Xia/Supervisor

*Lisa Wang*

Approved & Authorized Signer : Lisa Wang/Manager

### Modified Information

Version	Summary	Revision Date	Report No.
Ver.1.0	Original Report	/	ES190227060E02

## Table of Contents

<b>1. GENERAL INFORMATION.....</b>	<b>6</b>
1.1 PRODUCT DESCRIPTION.....	6
1.2 EST FACILITY 7	
<b>2. SYSTEM TEST CONFIGURATION.....</b>	<b>8</b>
2.1 EUT CONFIGURATION.....	8
2.2 EUT EXERCISE 8	
2.3 TEST PROCEDURE 8	
2.4 CONFIGURATION OF TESTED SYSTEM.....	9
<b>3. SUMMARY OF TEST RESULTS.....</b>	<b>10</b>
<b>4. DESCRIPTION OF TEST MODES.....</b>	<b>11</b>
<b>5. TEST SYSTEM UNCERTAINTY.....</b>	<b>13</b>
<b>6. CONDUCTED EMISSIONS TEST.....</b>	<b>14</b>
6.1 MEASUREMENT PROCEDURE:.....	14
6.2 TEST SET-UP (BLOCK DIAGRAM OF CONFIGURATION).....	14
6.3 MEASUREMENT EQUIPMENT USED:.....	14
6.4 MEASUREMENT RESULT:.....	14
6.5 CONDUCTED MEASUREMENT PHOTOS:.....	17
<b>7. RADIATED EMISSION TEST.....</b>	<b>18</b>
7.1 MEASUREMENT PROCEDURE.....	18
7.2 TEST SET-UP (BLOCK DIAGRAM OF CONFIGURATION).....	20
7.3 MEASUREMENT EQUIPMENT USED:.....	21
7.4 RADIATED EMISSION LIMIT.....	22
7.5 MEASUREMENT RESULT.....	23
7.5 RADIATED MEASUREMENT PHOTOS:.....	29
<b>8. CHANNEL SEPARATION TEST.....</b>	<b>30</b>
8.1 MEASUREMENT PROCEDURE.....	30
8.2 TEST SET-UP (BLOCK DIAGRAM OF CONFIGURATION).....	30
8.3 MEASUREMENT EQUIPMENT USED:.....	30
8.4 MEASUREMENT RESULTS:.....	30
<b>9. 20DB BANDWIDTH TEST.....</b>	<b>35</b>
9.1 MEASUREMENT PROCEDURE.....	35
9.2 TEST SET-UP (BLOCK DIAGRAM OF CONFIGURATION).....	35
9.3 MEASUREMENT EQUIPMENT USED:.....	35
9.4 MEASUREMENT RESULTS:.....	35
<b>10. QUANTITY OF HOPPING CHANNEL TEST.....</b>	<b>40</b>

10.1 MEASUREMENT PROCEDURE ..... 40

10.2 TEST SET-UP (BLOCK DIAGRAM OF CONFIGURATION)..... 40

10.3 MEASUREMENT EQUIPMENT USED:..... 40

10.4 MEASUREMENT RESULTS: ..... 40

**11. TIME OF OCCUPANCY (DWELL TIME) TEST ..... 41**

11.1 TEST DESCRIPTION..... 41

11.2 TEST SET-UP (BLOCK DIAGRAM OF CONFIGURATION)..... 41

11.3 MEASUREMENT EQUIPMENT USED:..... 41

11.4 TEST REQUIREMENTS / LIMITS..... 41

11.5 TEST RESULT ..... 42

**12. MAXIMUM PEAK OUTPUT POWER TEST ..... 44**

12.1 MEASUREMENT PROCEDURE ..... 44

12.2 TEST SET-UP (BLOCK DIAGRAM OF CONFIGURATION)..... 44

12.3 MEASUREMENT EQUIPMENT USED:..... 44

12.4 MEASUREMENT RESULTS: ..... 45

**13. BAND EDGE TEST..... 49**

13.1 MEASUREMENT PROCEDURE..... 49

13.2 TEST SET-UP (BLOCK DIAGRAM OF CONFIGURATION)..... 50

13.3 MEASUREMENT EQUIPMENT USED:..... 50

13.4 MEASUREMENT RESULTS: ..... 51

**14. ANTENNA APPLICATION ..... 65**

14.1 ANTENNA REQUIREMENT ..... 65

14.2 RESULT..... 65

Appendix I (Photos of EUT) (3 pages)

## 1. GENERAL INFORMATION

### 1.1 Product Description

Characteristics	Description
Product Name	Wireless charger speaker
Model number	SL241
Input rating	DC 5V from adapter or DC 3.7V battery
Power Supply	AC 120V/60Hz for adapter, DC 3.7V Battery
Kind of Device	Bluetooth Ver 4.2
Modulation	GFSK, $\pi/4$ -DQPSK
Operating Frequency Range	2402-2480MHz
Number of Channels	79
Transmit Power Max(PK)	-10.92dBm(0.000081W)
Antenna Type	Internal PCB antenna
Antenna Gain	0dBi

## 1.2 Test Facility

### Site Description

EMC Lab. : Accredited by CNAS, 2016.10.24  
The certificate is valid until 2022.10.28  
The Laboratory has been assessed and proved to be in compliance with CNAS-CL01:2006 (identical to ISO/IEC 17025:2005)  
The Certificate Registration Number is L2291.

Accredited by TUV Rheinland Shenzhen 2016.5.19  
The Laboratory has been assessed according to the requirements ISO/IEC 17025.

Accredited by FCC, August 03, 2017  
Designation Number: CN1204  
Test Firm Registration Number: 882943

Accredited by Industry Canada, November 24, 2015  
The Certificate Registration Number is 4480A.

Accredited by A2LA, July 31, 2017  
The Certificate Number is 4321.01.

Name of Firm : EMTEK(SHENZHEN) CO., LTD.

Site Location : Bldg 69, Majialong Industry Zone, Nanshan District, Shenzhen, Guangdong, China.

## **2. System Test Configuration**

### **2.1 EUT Configuration**

The EUT configuration for testing is installed on RF field strength measurement to meet the Commissions requirement and operating in a manner which intends to maximize its emission characteristics in a continuous normal application.

### **2.2 EUT Exercise**

The Transmitter was operated in the normal operating mode. The Tx frequency was fixed which was for the purpose of the measurements.

### **2.3 Test Procedure**

#### **2.3.1 Conducted Emissions**

The EUT is placed on a turn table which is 0.8 m above ground plane. According to the requirements in Section 13.1.4.1 of ANSI C63.10-2013. Conducted emissions from the EUT measured in the frequency range between 0.15 MHz and 30MHz using CISPR Quasi-Peak and average detector mode.

#### **2.3.2 Radiated Emissions**

Below 1000MHz, The EUT was placed on a turn table which is 0.8m above ground plane. And above 1000MHz, The EUT was placed on a styrofoam table which is 1.5m above ground plane. The turn table shall rotate 360 degrees to determine the position of maximum emission level. EUT is set 3m away from the receiving antenna which varied from 1m to 4m to find out the highest emission. And also, each emission was to be maximized by changing the polarization of receiving antenna both horizontal and vertical. In order to find out the max. emission, the relative positions of EUT was rotated according to the requirements in Section 13.1.4.1 of ANSI C63.10-2013.



## 2.4 Configuration of Tested System

**Fig. 2-1 Configuration of Tested System**

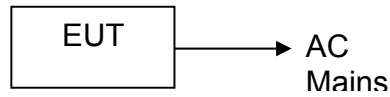

Table 2-1 Equipment Used in Tested System

Item	Equipment	Trade Mark	Model No.	FCC ID	Note
1.	Wireless charger speaker	N/A	SL241	2ABHA0060	<b><i>EUT</i></b>
2	Adapter	N/A	YSV6-0501000	N/A	<b><i>Support Equipment</i></b>

**Note:**

- (1) Unless otherwise denoted as EUT in 『Remark』 column , device(s) used in tested system is a support equipment.

### 3. Summary of Test Results

<b>FCC Rules</b>	<b>Description Of Test</b>	<b>Result</b>
§15.207	AC Power Conducted Emission	Compliant
§15.247(d),§15.209	Radiated Emission	Compliant
§15.247(a)(1)	Channel Separation test	Compliant
§15.247(a)(1)	20dB Bandwidth	Compliant
§15.247(a)(1)(iii)	Quantity of Hopping Channel	Compliant
§15.247(a)(1)(iii)	Time of Occupancy(Dwell Time)	Compliant
§15.247(b)	Max Peak output Power test	Compliant
§15.247(d)	Band edge test	Compliant
§15.203	Antenna Requirement	Compliant

#### **4. Description of test modes**

The EUT has been tested under its typical operating condition. Pre-defined engineering program for regulatory testing used to control the EUT for staying in continuous transmitting. Only the worst case data were reported.

The EUT has been associated with peripherals pursuant to ANSI C63.10-2013 and configuration operated in a manner tended to maximize its emission characteristics in a typical application. Frequency range investigated: radiation (9 KHz to the 10th harmonic of the highest fundamental frequency or to 40 GHz, whichever is lower).

The details of test channels and bandwidth were for RF conductive measurement.

Channel List:

Channel	Frequency (MHz)	Channel	Frequency (MHz)	Channel	Frequency (MHz)
01	2402	28	2429	55	2456
02	2403	29	2430	56	2457
03	2404	30	2431	57	2458
04	2405	31	2432	58	2459
05	2406	32	2433	59	2460
06	2407	33	2434	60	2461
07	2408	34	2435	61	2462
08	2409	35	2436	62	2463
09	2410	36	2437	63	2464
10	2411	37	2438	64	2465
11	2412	38	2439	65	2466
12	2413	39	2440	66	2467
13	2414	40	2441	67	2468
14	2415	41	2442	68	2469
15	2416	42	2443	69	2470
16	2417	43	2444	70	2471
17	2418	44	2445	71	2472
18	2419	45	2446	72	2473
19	2420	46	2447	73	2474
20	2421	47	2448	74	2475
21	2422	48	2449	75	2476
22	2423	49	2450	76	2477
23	2424	50	2451	77	2478
24	2425	51	2452	78	2479
25	2426	52	2453	79	2480
26	2427	53	2454		
27	2428	54	2455		

Note:

Test of channel was included the lowest 2402MHz, middle 2441MHz and highest frequency 2480MHz in highest data rate and to perform the test, then record on this report.

## 5. TEST SYSTEM UNCERTAINTY

The following measurement uncertainty levels have been estimated for tests performed on the apparatus:

Parameter	Uncertainty
Radio Frequency	$\pm 1 \times 10^{-5}$
Maximum Peak Output Power Test	$\pm 1.0\text{dB}$
Conducted Emissions Test	$\pm 2.0\text{dB}$
Radiated Emission Test	$\pm 2.0\text{dB}$
Power Density	$\pm 2.0\text{dB}$
Occupied Bandwidth Test	$\pm 1.0\text{dB}$
Band Edge Test	$\pm 3\text{dB}$
All emission, radiated	$\pm 3\text{dB}$
Antenna Port Emission	$\pm 3\text{dB}$
Temperature	$\pm 0.5^\circ\text{C}$
Humidity	$\pm 3\%$

Remark: The coverage Factor (k=2), and measurement Uncertainty for a level of Confidence of 95%

## 6. Conducted Emissions Test

### 6.1 Measurement Procedure:

1. The EUT was placed on a table, which is 0.8m above ground plane.
2. Maximum procedure was performed on the six highest emissions to ensure EUT compliance.
3. Repeat above procedures until all frequency measured was complete.

### 6.2 Test SET-UP (Block Diagram of Configuration)

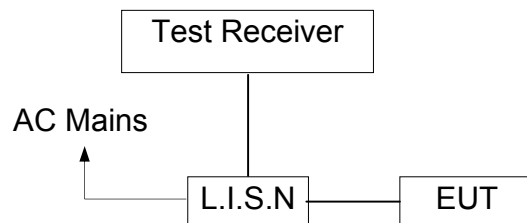

### 6.3 Measurement Equipment Used:

Conducted Emission Test Site						
EQUIPMENT TYPE	MFR	MODEL NUMBER	SERIAL NUMBER	Characteristics	Last Cal.	Due date
Test Receiver	Rohde & Schwarz	ESCS30	100018	9kHz~3GHz	05/16/2018	05/15/2019
L.I.S.N	Rohde & Schwarz	ENV216	100017	9KHz-300MHz	05/16/2018	05/15/2019
RF Switching Unit	CDS	RSU-M2	38401	9KHz-300MHz	05/16/2018	05/15/2019
Coaxial Cable	CDS	79254	46107086	9kHz~3GHz	05/16/2018	05/15/2019

### 6.4 Measurement Result:

Pass.

All the modulation modes were tested the data of the worst mode (Π/4-DQPSK TX 2480MHz) are recorded in the following pages and the others modulation methods do not exceed the limits.

Please refer to the following data.

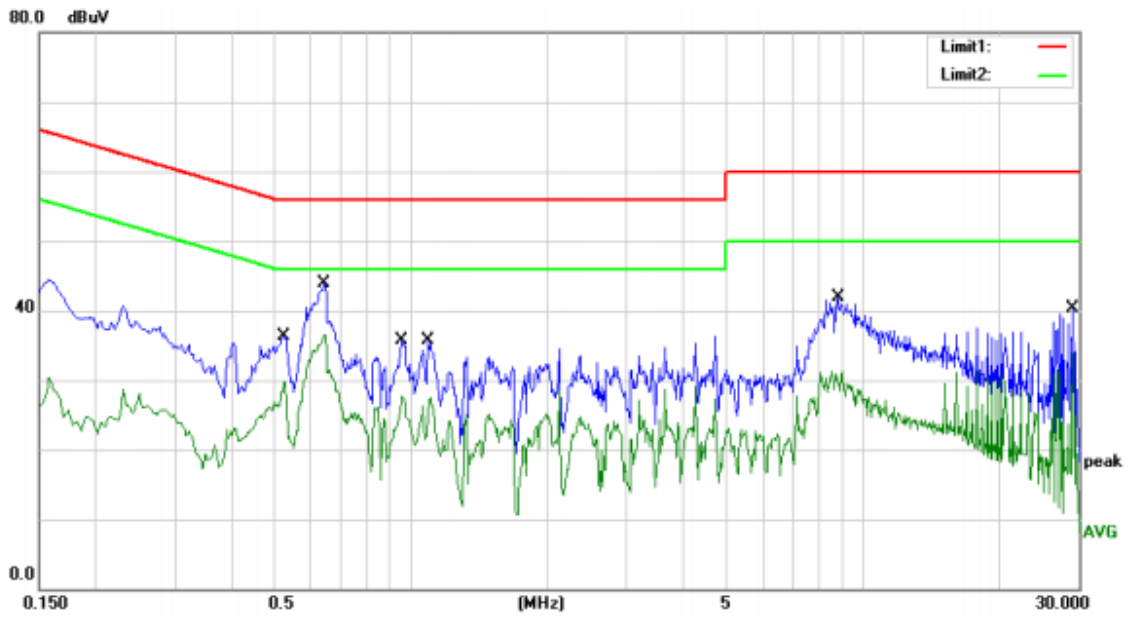

Site site #1 Phase: **L1** Temperature: 25  
 Limit: (CE)FCC PART 15 C\_QP Power: AC 120V/60Hz Humidity: 55 %  
 Mode: TX2480  
 Note:

No.	Mk.	Freq.	Reading Level	Correct Factor	Measurement	Limit	Over	Detector	Comment
		MHz	dBuV	dB	dBuV	dBuV	dB		
1		0.5220	26.20	10.18	36.38	56.00	-19.62	QP	
2		0.5220	19.58	10.18	29.76	46.00	-16.24	AVG	
3		0.6420	33.67	10.18	43.85	56.00	-12.15	QP	
4	*	0.6420	26.38	10.18	36.56	46.00	-9.44	AVG	
5		0.9580	25.46	10.18	35.64	56.00	-20.36	QP	
6		0.9580	17.56	10.18	27.74	46.00	-18.26	AVG	
7		1.0900	25.60	10.18	35.78	56.00	-20.22	QP	
8		1.0900	17.23	10.18	27.41	46.00	-18.59	AVG	
9		8.8220	31.63	10.20	41.83	60.00	-18.17	QP	
10		8.8220	21.20	10.20	31.40	50.00	-18.60	AVG	
11		29.0980	29.99	10.33	40.32	60.00	-19.68	QP	
12		29.0980	23.48	10.33	33.81	50.00	-16.19	AVG	

\*:Maximum data    x:Over limit    !:over margin    Comment: Factor build in receiver.    Operator: Lin

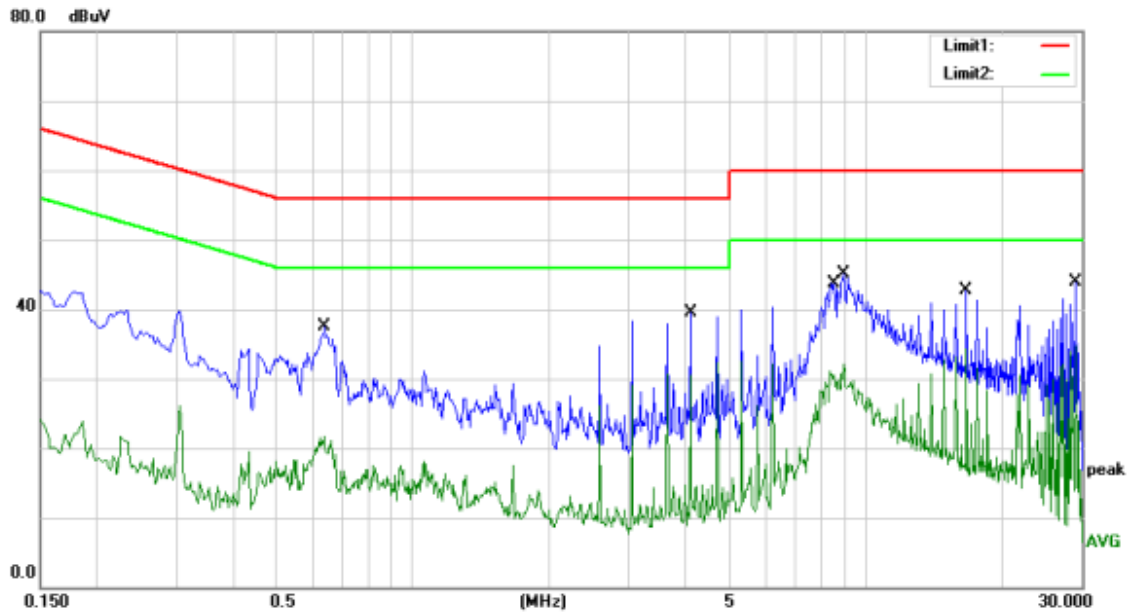

Site site #1 Phase: **N** Temperature: 25  
 Limit: (CE)FCC PART 15 C\_QP Power: AC 120V/60Hz Humidity: 55 %

Mode: TX2480

Note:

No. Mk.	Freq. MHz	Reading Level dBuV	Correct Factor dB	Measurement dBuV	Limit dBuV	Over dB	Detector	Comment
1	0.6380	27.40	10.18	37.58	56.00	-18.42	QP	
2	0.6380	11.53	10.18	21.71	46.00	-24.29	AVG	
3	4.1060	29.31	10.18	39.49	56.00	-16.51	QP	
4	4.1060	20.25	10.18	30.43	46.00	-15.57	AVG	
5	8.5140	33.56	10.20	43.76	60.00	-16.24	QP	
6	8.5140	20.93	10.20	31.13	50.00	-18.87	AVG	
7 *	8.9620	34.86	10.21	45.07	60.00	-14.93	QP	
8	8.9620	21.99	10.21	32.20	50.00	-17.80	AVG	
9	16.7180	32.40	10.25	42.65	60.00	-17.35	QP	
10	16.7180	24.00	10.25	34.25	50.00	-15.75	AVG	
11	29.1860	33.63	10.33	43.96	60.00	-16.04	QP	
12	29.1860	24.41	10.33	34.74	50.00	-15.26	AVG	

\*:Maximum data x:Over limit !:over margin Comment: Factor build in receiver. Operator: Lin



**6.5 Conducted Measurement Photos:**



## 7. Radiated Emission Test

### 7.1 Measurement Procedure

1. The testing follows the guidelines in Spurious Radiated Emissions of ANSI C63.10-2013.
2. Below 1000MHz, The EUT was placed on a turn table which is 0.8m above ground plane. And above 1000MHz, The EUT was placed on a Styrofoam table which is 1.5m above ground plane.
3. The EUT was set 3 meters from the interference receiving antenna, which was mounted on the top of a variable height antenna tower.
4. For each suspected emission, the EUT was arranged to its worst case and then tune the Antenna tower (From 1m to 4m) and turntable (from 0 degree to 360 degree) to find the maximum reading. A pre-amp and a high pass filter are used for the test in order to get better signal level to comply with the guidelines.
5. Set to the maximum power setting and enable the EUT transmit continuously.
6. Final measurement (Above 1GHz): The frequency range will be divided into different sub ranges depending of the frequency range of the used horn antenna. The EMI Receiver set to peak and average mode and a resolution bandwidth of 1MHz. The measurement will be performed in horizontal and vertical polarization of the measuring antenna and while rotating the EUT in its vertical axis in the range of 0 degree to 360 degree in order to have the antenna inside the cone of radiation.
7. Test Procedure of measurement (For Above 1GHz):
  - 1) Monitor the frequency range at horizontal polarization and move the antenna over all sides of the EUT(if necessary move the EUT to another orthogonal axis).
  - 2) Change the antenna polarization and repeat 1) with vertical polarization.
  - 3) Make a hardcopy of the spectrum.
  - 4) Measure the frequency of the detected emissions with a lower span and resolution bandwidth to increase the accuracy and note the frequency value.
  - 5) Change the analyser mode to Clear/ Write and found the cone of emission.
  - 6) Rotate and move the EUT, so that the measuring distance can be enlarged to 3m and the antenna will be still inside the cone of emission.
  - 7) Measure the level of the detected frequency with the correct resolution bandwidth, with the antenna polarization and azimuth and the peak and average detector, which causes the maximum emission.
  - 8) Repeat steps 1) to 7) for the next antenna spot if the EUT is larger than the antenna beamwidth.

Use the following spectrum analyzer settings:

When spectrum scanned from 30MHz to 1GHz setting resolution bandwidth 120KHz and video bandwidth 300KHz:

EMI Test Receiver	Setting
Attenuation	Auto
RB	120KHz
VB	300KHz
Detector	QP
Trace	Max hold

When spectrum scanned above 1GHz setting resolution bandwidth 1MHz, video bandwidth 3MHz:

EMI Test Receiver	Setting
Attenuation	Auto
RB	1MHz
VB	3MHz
Detector	Peak
Trace	Max hold

When spectrum scanned above 1GHz setting resolution bandwidth 1MHz, video bandwidth 10Hz:

EMI Test Receiver	Setting
Attenuation	Auto
RB	1MHz
VB	10Hz
Detector	Peak
Trace	Max hold

**7.2 Test SET-UP (Block Diagram of Configuration)**

(A) Radiated Emission Test Set-Up, Frequency Below 30MHz

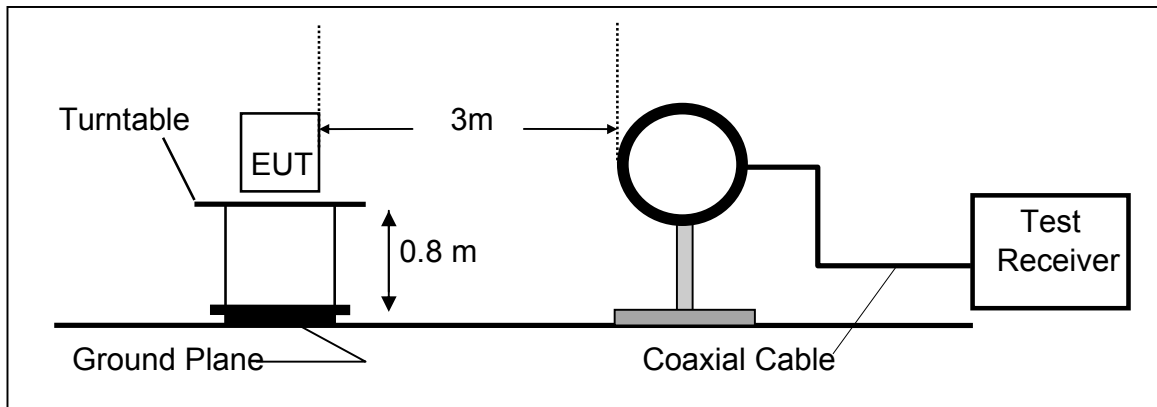

(B) Radiated Emission Test Set-Up, Frequency Below 1000MHz

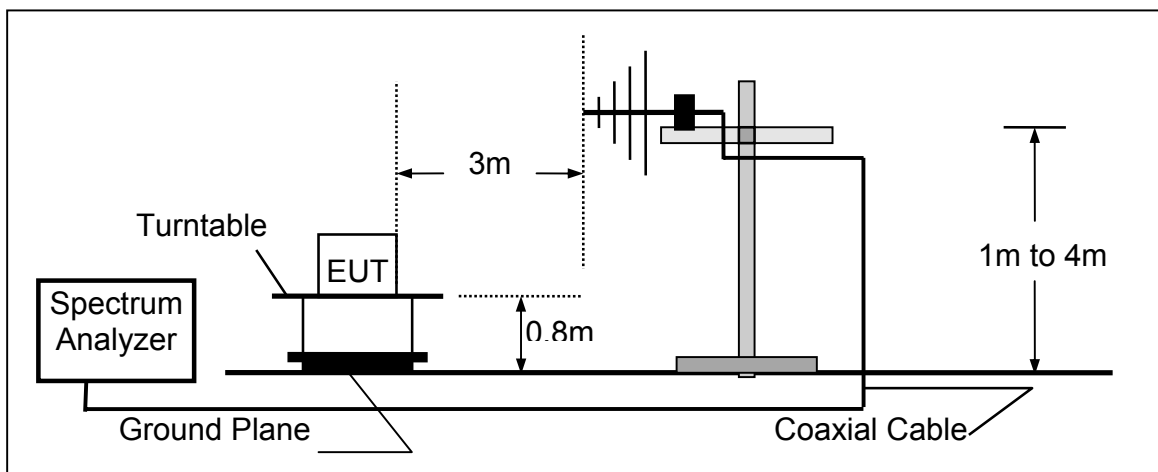

(C) Radiated Emission Test Set-Up, Frequency above 1000MHz

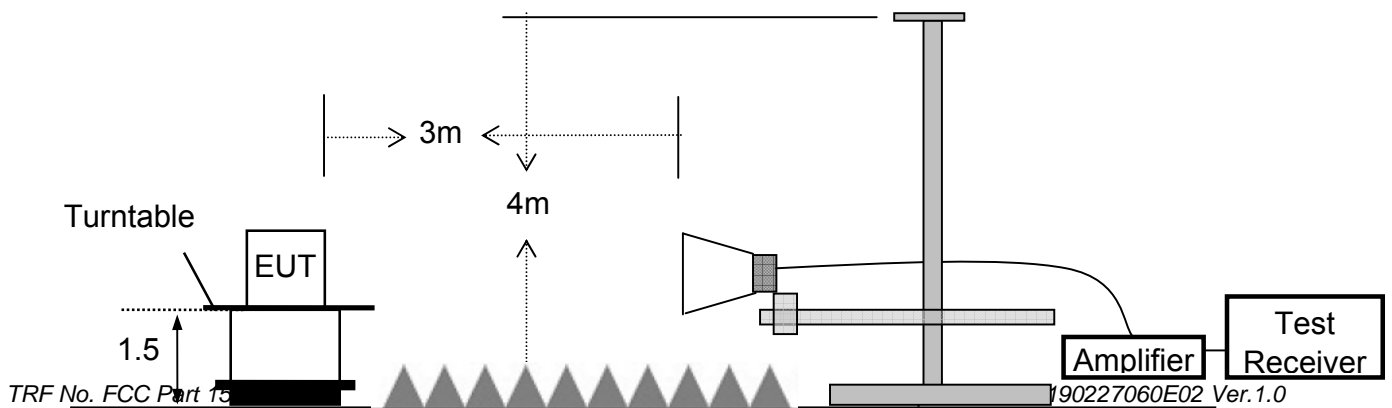

### 7.3 Measurement Equipment Used:

Item	Equipment	Manufacturer	Model No.	Serial No.	Characteristics	Last Cal.	Cal. Interval
1.	Test Receiver	Rohde & Schwarz	ESCI	1166.5950.03	9KHz-3GHz	05/16/2018	1 Year
2.	Loop Antenna	Schwarzbeck	FMZB 1519	012	9 KHz -30MHz	05/16/2018	1 Year
3.	Bilog Antenna	Schwarzbeck	VULB9163	000141	25MHz-2GHz	05/16/2018	1 Year
4.	Power Amplifier	CDS	RSU-M352	818	1MHz-1GHz	05/16/2018	1 Year
5.	Power Amplifier	HP	8447F	OPT H64	1GHz-26.5GHz	05/16/2018	1 Year
6.	Color Monitor	SUNSPO	SP-140A	N/A	--	05/16/2018	1 Year
7.	Single Line Filter	JIANLI	XL-3	N/A	--	05/16/2018	1 Year
8.	Single Phase Power Line Filter	JIANLI	DL-2X100B	N/A	--	05/16/2018	1 Year
9.	3 Phase Power Line Filter	JIANLI	DL-4X100B	N/A	--	05/16/2018	1 Year
10.	DC Power Filter	JIANLI	DL-2X50B	N/A	--	05/16/2018	1 Year
11.	Cable	Schwarzbeck	PLF-100	549489	9KHz-3GHz	05/16/2018	1 Year
12.	Cable	Rosenberger	CIL02	A0783566	9KHz-3GHz	05/16/2018	1 Year
13.	Cable	Rosenberger	RG 233/U	525178	9KHz-3GHz	05/16/2018	1 Year
14.	Signal Analyzer	Rohde & Schwarz	FSV30	103040	9KHz-40GHz	05/16/2018	1 Year
15.	Horn Antenna	Schwarzbeck	BBHA9120D	9120D-1272	1GHz-18GHz	05/16/2018	1 Year
16.	Horn Antenna	Schwarzbeck	BBHA 9170	BBHA9170399	14GHz -26.5GHz	05/16/2018	1 Year
17.	Power Amplifier	LUNAR EM	LNA1G18-40	J10100000081	1GHz-26.5GHz	05/16/2018	1 Year
18.	Cable	H+S	CBL-26	N/A	1GHz-26.5GHz	05/16/2018	1 Year
19.	Cable	H+S	CBL-26	N/A	1GHz-26.5GHz	05/16/2018	1 Year
20.	Cable	H+S	CBL-26	N/A	1GHz-26.5GHz	05/16/2018	1 Year

### 7.4 Radiated Emission Limit

The emissions from an intentional radiator shall not exceed the field strength levels specified in the following table 15.209(a):

Frequencies (MHz)	Field Strength (microrvolts/meter)	Measurement Distance (meters)
0.009~0.490	2400/F(KHz)	300
0.490~1.705	24000/F(KHz)	30
1.705~30.0	30	30
30~88	100	3
88~216	150	3
216~960	200	3
Above 960	500	3

### 15.205 Restricted bands of operation

MHz	MHz	MHz	GHz
0.090 - 0.110	16.42 - 16.423	399.9 - 410	4.5 - 5.15
<sup>1</sup> 0.495 - 0.505	16.69475 - 16.69525	608 - 614	5.35 - 5.46
2.1735 - 2.1905	16.80425 - 16.80475	960 - 1240	7.25 - 7.75
4.125 - 4.128	25.5 - 25.67	1300 - 1427	8.025 - 8.5
4.17725 - 4.17775	37.5 - 38.25	1435 - 1626.5	9.0 - 9.2
4.20725 - 4.20775	73 - 74.6	1645.5 - 1646.5	9.3 - 9.5
6.215 - 6.218	74.8 - 75.2	1660 - 1710	10.6 - 12.7
6.26775 - 6.26825	108 - 121.94	1718.8 - 1722.2	13.25 - 13.4
6.31175 - 6.31225	123 - 138	2200 - 2300	14.47 - 14.5
8.291 - 8.294	149.9 - 150.05	2310 - 2390	15.35 - 16.2
8.362 - 8.366	156.52475 - 156.52525	2483.5 - 2500	17.7 - 21.4
8.37625 - 8.38675	156.7 - 156.9	2690 - 2900	22.01 - 23.12
8.41425 - 8.41475	162.0125 - 167.17	3260 - 3267	23.6 - 24.0
12.29 - 12.293	167.72 - 173.2	3332 - 3339	31.2 - 31.8
12.51975 - 12.52025	240 - 285	3345.8 - 3358	36.43 - 36.5
12.57675 - 12.57725	322 - 335.4	3600 - 4400	( <sup>2</sup> )

Remark 1. Emission level in dBuV/m=20 log (uV/m)

: 2. Measurement was performed at an antenna to the closed point of EUT distance of meters.

3. Only spurious frequency is permitted to locate within the Restricted Bands specified in provision of § 15.205, and the emissions located in restricted bands also comply with 15.209 limit.

## 7.5 Measurement Result

### Below 30MHz:

Operation Mode:	TX	Test Date :	March 01, 2019
Frequency Range:	9KHz~30MHz	Temperature :	26°C
Test Result:	PASS	Humidity :	65 %
Measured Distance:	3m	Test By:	LIN

Freq. (MHz)	Ant.Pol. H/V	Emission Level (dBuV/m)	Limit 3m (dBuV/m)	Over (dB)
--	--	--	--	--

Note: the amplitude of spurious emission that is attenuated by more than 20dB below the permissible limit has no need to be reported.

### Below 1000MHz:

Pass.

All the modulation modes were tested the data of the worst mode (π/4-DQPSK TX 2480MHz) are recorded in the following pages and the others modulation methods do not exceed the limits.

Please refer to the following data.

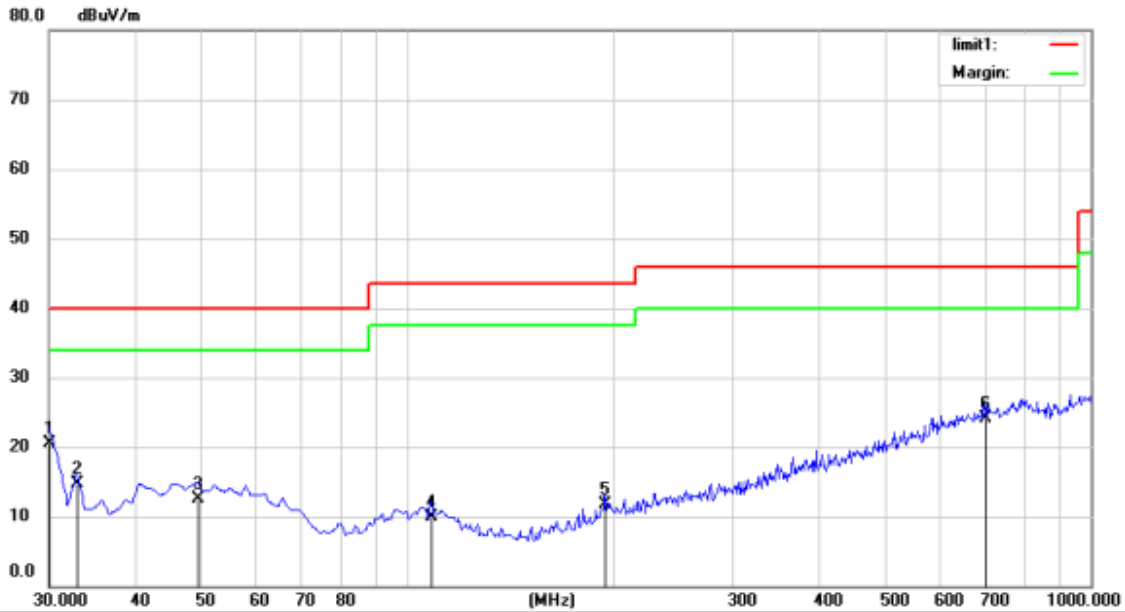

Site Chamber #1      Polarization: *Horizontal*      Temperature: 26  
 Limit: (RE)FCC PART 15 C 3m      Power: AC 120V 60Hz      Humidity: 55 %

Mode: TX2480  
 Note:

No.	Mk.	Freq. MHz	Reading Level dBuV	Correct Factor dB	Measure- ment dBuV/m	Limit dBuV/m	Over dB	Antenna Height cm	Table Degree	Detector	Comment
1	*	30.0000	39.25	-18.76	20.49	40.00	-19.51			QP	
2		32.9100	33.62	-18.98	14.64	40.00	-25.36			QP	
3		49.4000	28.15	-15.64	12.51	40.00	-27.49			QP	
4		108.5700	28.33	-18.34	9.99	43.50	-33.51			QP	
5		194.9000	29.35	-17.73	11.62	43.50	-31.88			QP	
6		700.2700	28.35	-4.20	24.15	46.00	-21.85			QP	

\*:Maximum data    x:Over limit    !:over margin

Operator:



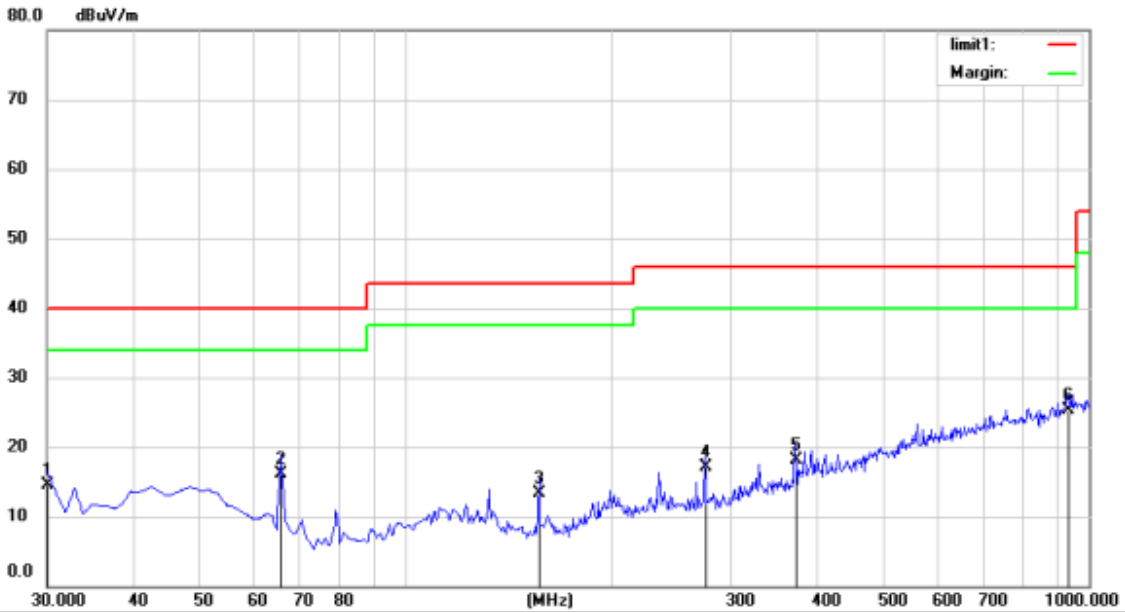

Site Chamber #1      Polarization: **Vertical**      Temperature: 26  
 Limit: (RE)FCC PART 15 C 3m      Power: AC 120V 60Hz      Humidity: 55 %  
 Mode: TX2480  
 Note:

No.	Mk.	Freq. MHz	Reading Level dBuV	Correct Factor dB	Measure- ment dBuV/m	Limit dBuV/m	Over dB	Antenna Height cm	Table Degree	Comment
1		30.0000	33.26	-18.76	14.50	40.00	-25.50	QP		
2		65.8900	37.19	-21.03	16.16	40.00	-23.84	QP		
3		157.0700	34.16	-20.87	13.29	43.50	-30.21	QP		
4		274.4400	32.85	-15.81	17.04	46.00	-28.96	QP		
5		372.4100	30.59	-12.51	18.08	46.00	-27.92	QP		
6	*	931.1300	27.61	-2.28	25.33	46.00	-20.67	QP		

\*:Maximum data    x:Over limit    !:over margin

Operator:

**Above 1000MHz**

Please refer to the following data.

Operation Mode: GFSK (CH1: 2402MHz) Test Date : March 04, 2019

Freq. (MHz)	Ant. Pol. H/V	Emission Level(dBuV/m)		Limit 3m(dBuV/m)		Margin(dB)	
		PK	AV	PK	AV	PK	AV
4804	V	64.5	45.32	74	54	-9.5	-8.68
7206	V	61.5	42.65	74	54	-12.5	-11.35
9608	V	59.55	40.68	74	54	-14.45	-13.32
12010	V	56.33	37.58	74	54	-17.67	-16.42
14412	V	56.31	37.47	74	54	-17.69	-16.53
16814	V	55.32	37.01	74	54	-18.68	-16.99
4804	H	64.05	45.1	74	54	-9.95	-8.9
7206	H	61.23	42.3	74	54	-12.77	-11.7
9608	H	58.86	40.63	74	54	-15.14	-13.37
12010	H	56.47	37.47	74	54	-17.53	-16.53
14412	H	55.36	36.46	74	54	-18.64	-17.54
16814	H	54.78	35.85	74	54	-19.22	-18.15

Operation Mode: GFSK (CH40: 2441MHz) Test Date : March 04, 2019

Freq. (MHz)	Ant. Pol. H/V	Emission Level(dBuV/m)		Limit 3m(dBuV/m)		Margin(dB)	
		PK	AV	PK	AV	PK	AV
4882	V	64.12	45.02	74	54	-9.88	-8.98
7323	V	65.25	40.23	74	54	-8.75	-13.77
9764	V	57.47	40.58	74	54	-16.53	-13.42
12205	V	56.14	37.58	74	54	-17.86	-16.42
14646	V	56.02	37.47	74	54	-17.98	-16.53
17087	V	55.66	36.85	74	54	-18.34	-17.15
4882	H	64.02	45.11	74	54	-9.98	-8.89
7323	H	58.6	41.02	74	54	-15.4	-12.98
9764	H	59.47	40.57	74	54	-14.53	-13.43
12205	H	56.02	37.58	74	54	-17.98	-16.42
14646	H	55.36	36.47	74	54	-18.64	-17.53
17087	H	55.36	37.02	74	54	-18.64	-16.98

Operation Mode: GFSK (CH79: 2480MHz) Test Date : March 04, 2019

Freq. (MHz)	Ant. Pol. H/V	Emission Level(dBuV/m)		Limit 3m(dBuV/m)		Margin(dB)	
		PK	AV	PK	AV	PK	AV
4960	V	63.15	44.5	74	54	-10.85	-9.5
7440	V	61.32	40.02	74	54	-12.68	-13.98
9920	V	55.47	37.72	74	54	-18.53	-16.28
12400	V	55.25	36.8	74	54	-18.75	-17.2
14880	V	55.35	36.47	74	54	-18.65	-17.53
17360	V	55.23	36.4	74	54	-18.77	-17.6
4960	H	62.05	45.25	74	54	-11.95	-8.75
7440	H	61.23	42.5	74	54	-12.77	-11.5
9920	H	57.84	37.47	74	54	-16.16	-16.53
12400	H	56.12	38.58	74	54	-17.88	-15.42
14880	H	55.36	37.58	74	54	-18.64	-16.42
17360	H	55.21	38.47	74	54	-18.79	-15.53

Operation Mode: Pi/4-DQPSK (CH1: 2402MHz) Test Date : March 04, 2019

Freq. (MHz)	Ant. Pol. H/V	Emission Level(dBuV/m)		Limit 3m(dBuV/m)		Over(dB)	
		PK	AV	PK	AV	PK	AV
4804	V	63.25	44.6	74	54	-10.75	-9.4
7206	V	62.32	43.58	74	54	-11.68	-10.42
9608	V	59.36	40.65	74	54	-14.64	-13.35
12010	V	56.47	37.47	74	54	-17.53	-16.53
14412	V	56.02	37.47	74	54	-17.98	-16.53
16814	V	55.69	36.25	74	54	-18.31	-17.75
4804	H	65.02	46.23	74	54	-8.98	-7.77
7206	H	62.2	43.02	74	54	-11.8	-10.98
9608	H	59.4	40.58	74	54	-14.6	-13.42
12010	H	54.6	37.47	74	54	-19.4	-16.53
14412	H	56.44	37.47	74	54	-17.56	-16.53
16814	H	55.19	36.66	74	54	-18.81	-17.34

Operation Mode: Pi/4-DQPSK (CH40: 2441MHz) Test Date : March 04, 2019

Freq. (MHz)	Ant. Pol. H/V	Emission Level(dBuV/m)		Limit 3m(dBuV/m)		Over(dB)	
		PK	AV	PK	AV	PK	AV
4882	V	63.54	45.88	74	54	-10.46	-8.12
7323	V	61.32	42.36	74	54	-12.68	-11.64
9764	V	58.47	39.58	74	54	-15.53	-14.42
12205	V	55.25	37.58	74	54	-18.75	-16.42
14646	V	55.47	36.58	74	54	-18.53	-17.42
17087	V	56.47	37.7	74	54	-17.53	-16.3
4882	H	64.23	45.2	74	54	-9.77	-8.8
7323	H	61.32	42.3	74	54	-12.68	-11.7
9764	H	59.33	40.58	74	54	-14.67	-13.42
12205	H	57.02	38.2	74	54	-16.98	-15.8
14646	H	56.47	37.32	74	54	-17.53	-16.68
17087	H	56.17	37.58	74	54	-17.83	-16.42

Operation Mode: Pi/4-DQPSK (CH79: 2480MHz) Test Date : March 04, 2019

Freq. (MHz)	Ant. Pol. H/V	Emission Level(dBuV/m)		Limit 3m(dBuV/m)		Over(dB)	
		PK	AV	PK	AV	PK	AV
4960	V	63.44	45.26	74	54	-10.56	-8.74
7440	V	62.36	43.35	74	54	-11.64	-10.65
9920	V	59.58	42.58	74	54	-14.42	-11.42
12400	V	57.25	38.52	74	54	-16.75	-15.48
14880	V	56.14	37.47	74	54	-17.86	-16.53
17360	V	55.13	36.14	74	54	-18.87	-17.86
4960	H	65.25	46.25	74	54	-8.75	-7.75
7440	H	62.29	43.36	74	54	-11.71	-10.64
9920	H	59.14	40.58	74	54	-14.86	-13.42
12400	H	57.32	38.25	74	54	-16.68	-15.75
14880	H	55.32	36.32	74	54	-18.68	-17.68
17360	H	55.61	37.56	74	54	-18.39	-16.44

**Other harmonics emissions are lower than 20dB below the allowable limit.**

- Note:**
- (1) All Readings are Peak Value and AV.
  - (2) Emission Level= Reading Level+ Probe Factor +Cable Loss.
  - (3) The average measurement was not performed when the peak measured data under the limit of average detection.
  - (4) Measuring frequencies from 1GHz to 25GHz.

**7.5 Radiated Measurement Photos:**

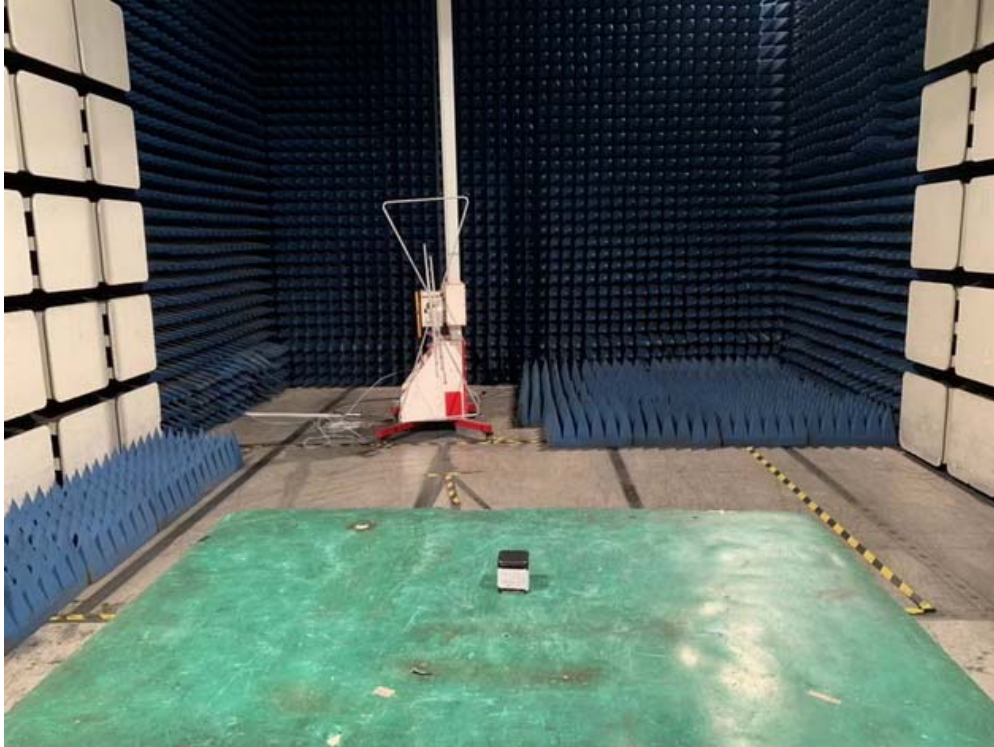

## 8. Channel Separation test

### 8.1 Measurement Procedure

The EUT was operating in hopping mode or could be controlled its channel. Printed out the test result from the spectrum by hard copy function.

### 8.2 Test SET-UP (Block Diagram of Configuration)

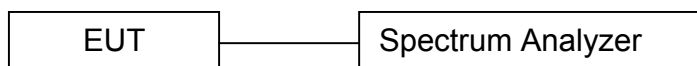

### 8.3 Measurement Equipment Used:

EQUIPMENT TYPE	MFR	MODEL NUMBER	SERIAL NUMBER	Characteristics	LAST CAL.	CAL DUE.
Spectrum Analyzer	Rohde & Schwarz	FSV30	1321.3008K	10Hz-30GHz	05/16/2018	05/15/2019
Coaxial Cable	CDS	79254	46107086	10Hz-30GHz	05/16/2018	05/15/2019
Antenna Connector	ARTHUR-YANG	2244-N1TG1	N/A	10Hz-30GHz	05/16/2018	05/15/2019

Remark: The temporary antenna connector is soldered on the PCB board in order to perform conducted tests and this temporary antenna connector is listed in the equipment list.

### 8.4 Measurement Results:

Refer to attached data chart.

Spectrum Detector:	PK	Test Date :	March 15, 2019
Test By:	Andy	Temperature :	25 °C
Test Result:	PASS	Humidity :	50 %
Modulation:	GFSK		

Channel number	Channel frequency (MHz)	Separation Read Value (kHz)	Separation Limit 2/3 20dB Down BW(kHz)
1	2402	1003	>738
40	2441	1003	>738
79	2480	1003	>738

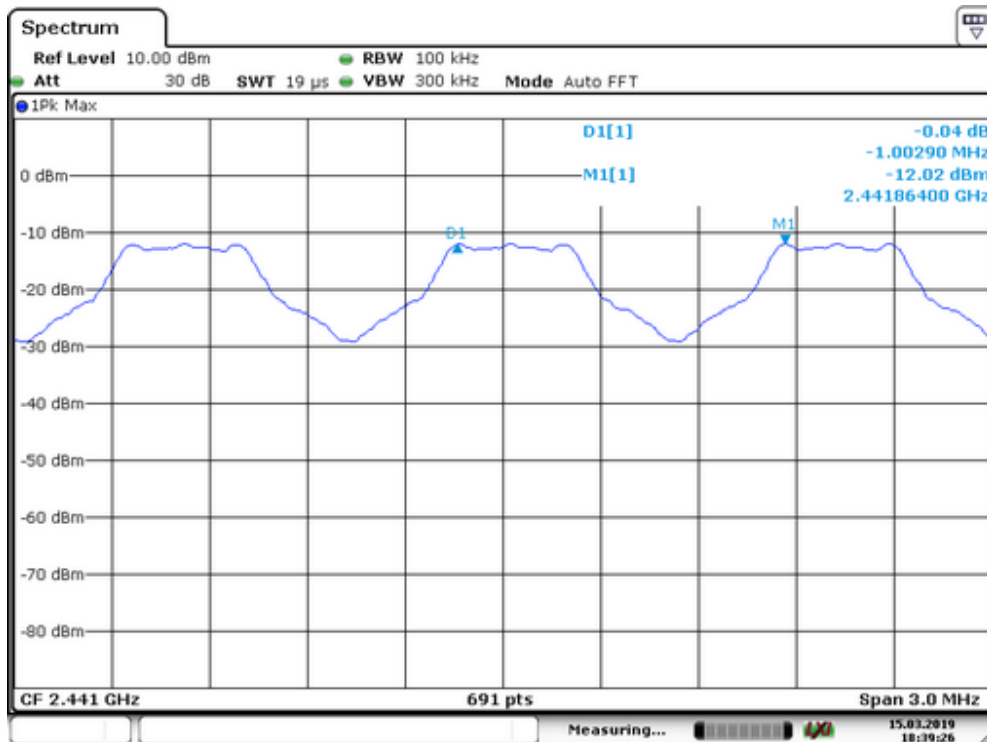
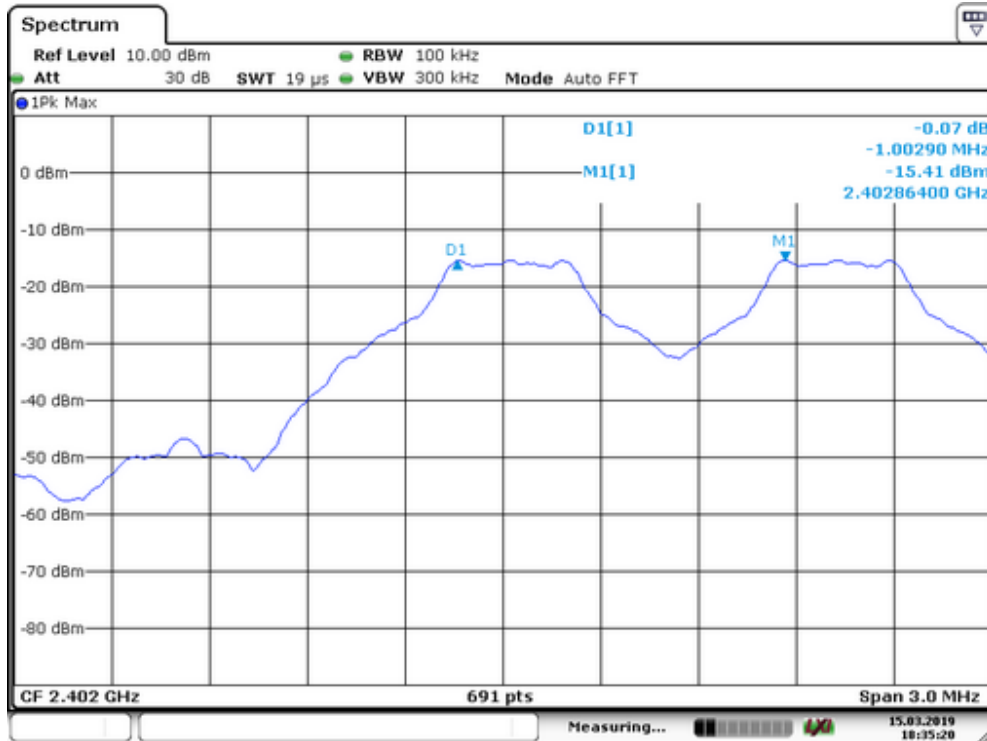

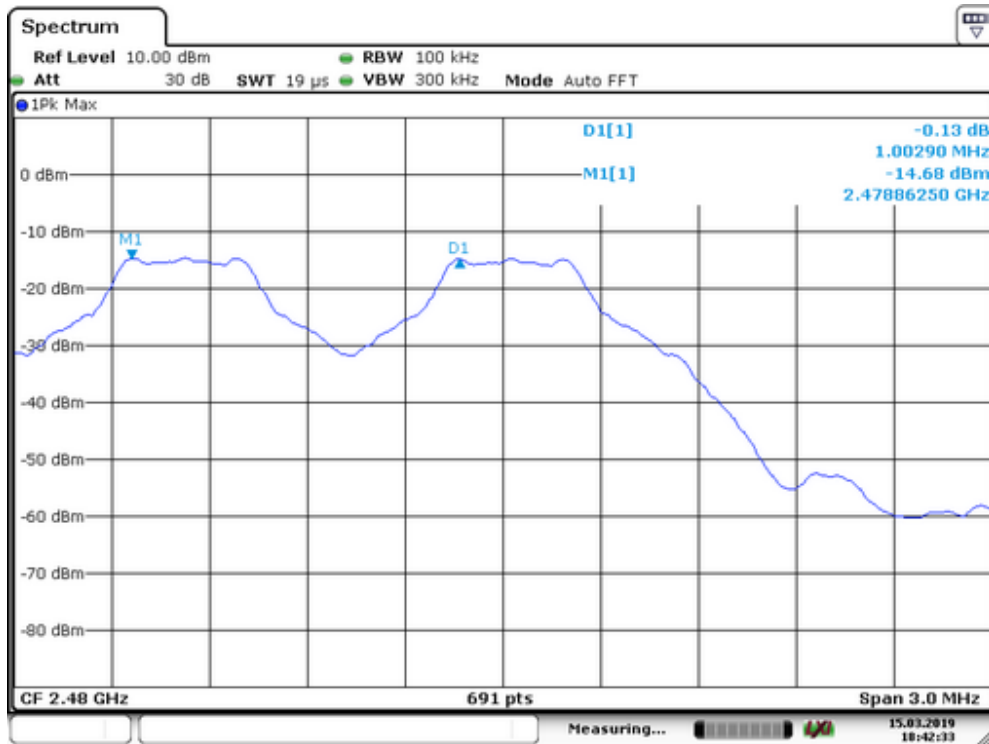

Spectrum Detector:	PK	Test Date :	March 15, 2019
Test By:	Andy	Temperature :	24°C
Test Result:	PASS	Humidity :	53 %
Modulation:	Π/4-DQPSK		

Channel number	Channel frequency (MHz)	Separation Read Value (kHz)	Separation Limit 2/3 20dB Down BW(kHz)
1	2402	1003	>921
40	2441	1003	>917
79	2480	1003	>921



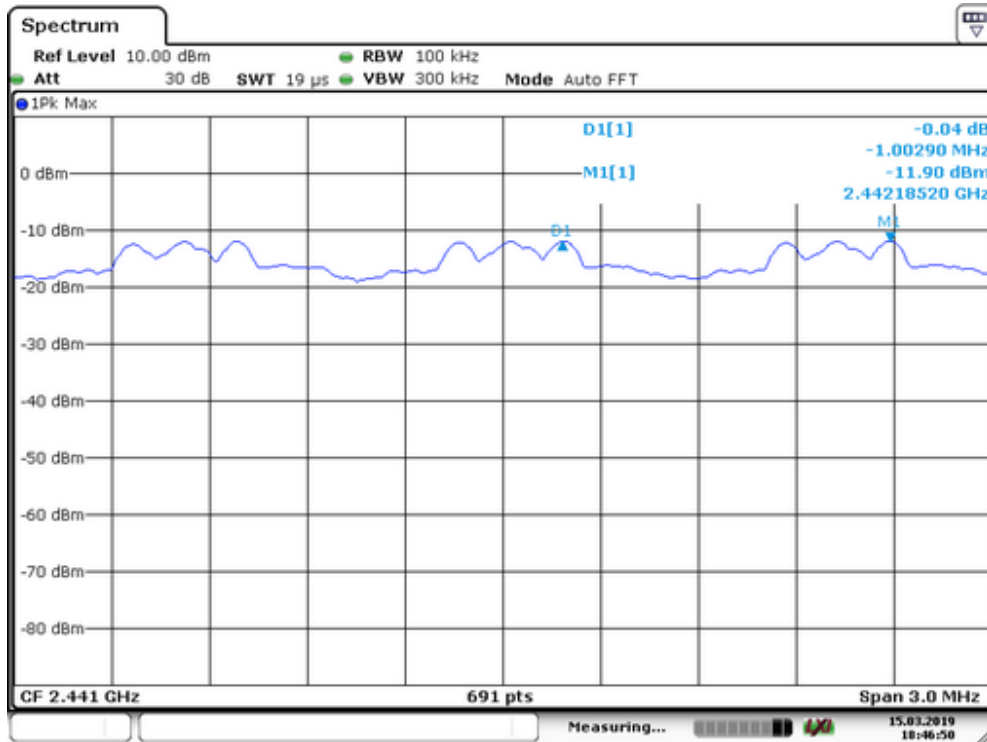
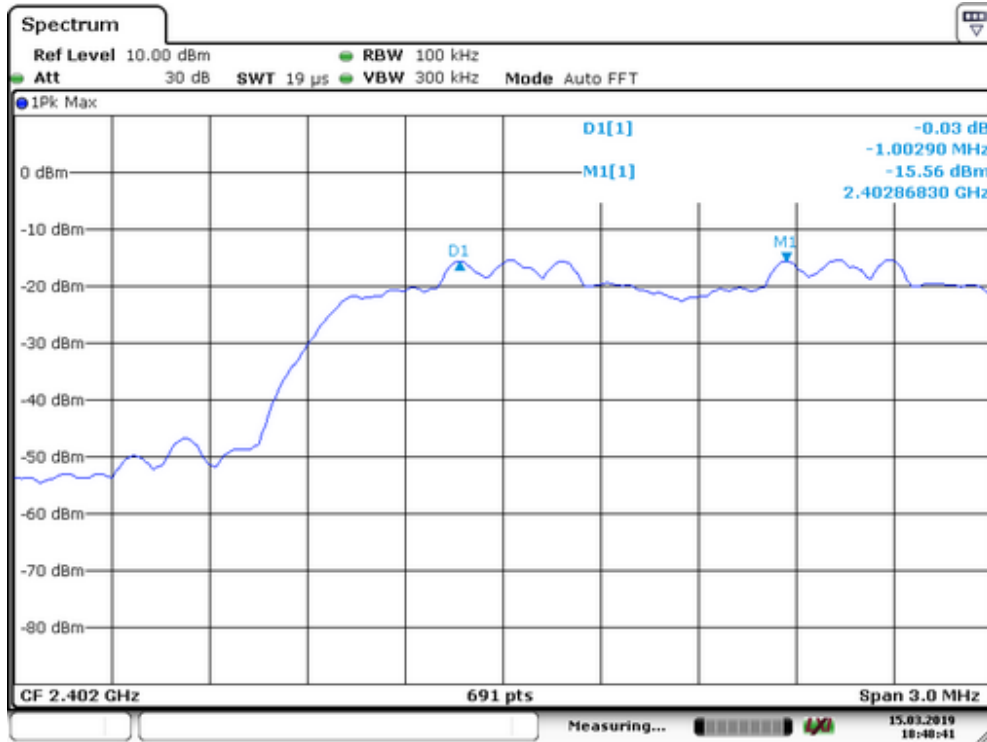

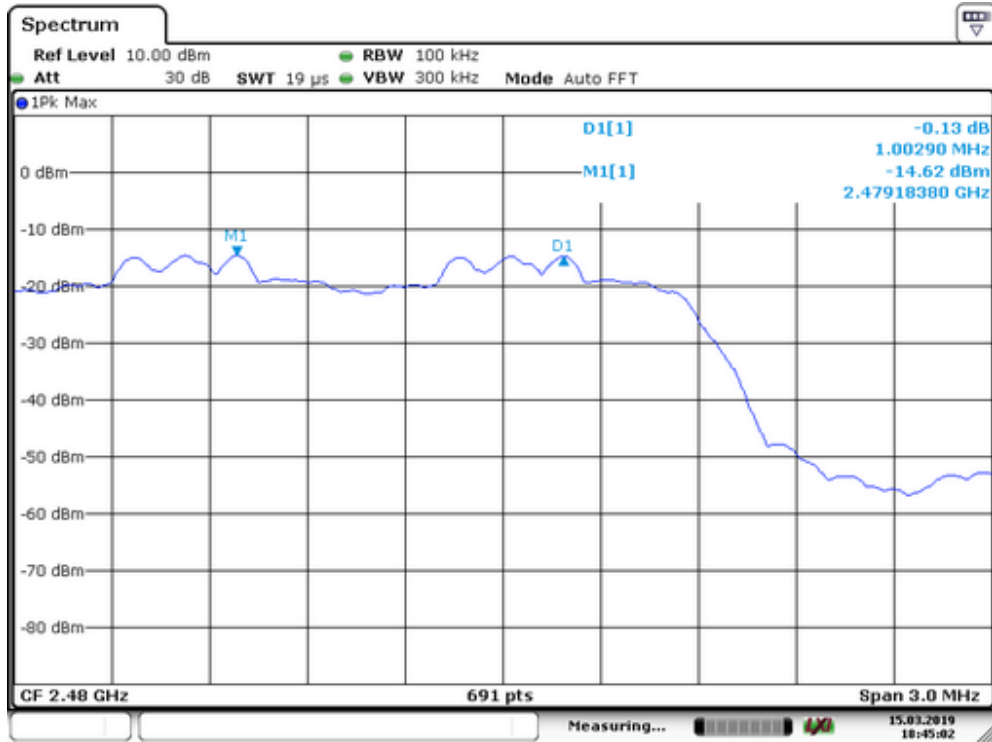

## 9. 20dB Bandwidth test

### 9.1 Measurement Procedure

The EUT was operating in hopping mode or could be controlled its channel. Printed out the test result from the spectrum by hard copy function.

### 9.2 Test SET-UP (Block Diagram of Configuration)

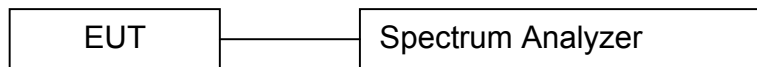

### 9.3 Measurement Equipment Used:

EQUIPMENT TYPE	MFR	MODEL NUMBER	SERIAL NUMBER	Characteristics	LAST CAL.	CAL DUE.
Spectrum Analyzer	Rohde & Schwarz	FSV30	1321.3008K	10Hz-30GHz	05/16/2018	05/15/2019
Coaxial Cable	CDS	79254	46107086	10Hz-30GHz	05/16/2018	05/15/2019
Antenna Connector	ARTHUR-YANG	2244-N1TG1	N/A	10Hz-30GHz	05/16/2018	05/15/2019

Remark: The temporary antenna connector is soldered on the PCB board in order to perform conducted tests and this temporary antenna connector is listed in the equipment list.

### 9.4 Measurement Results:

Refer to attached data chart.

Spectrum Detector:	PK	Test Date :	March 15, 2019
Test By:	Andy	Temperature :	24°C
Test Result:	PASS	Humidity :	53 %
Modulation:	GFSK		

Channel number	Channel frequency (MHz)	20dB Down BW(kHz)
1	2402	1107
40	2441	1107
79	2480	1107

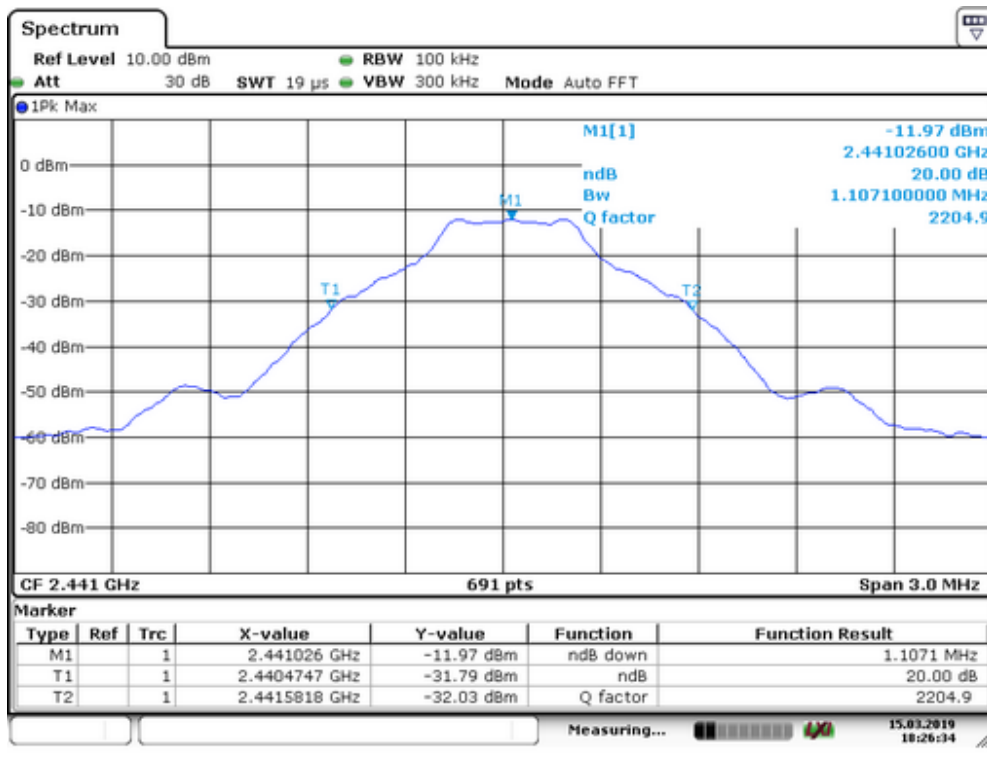
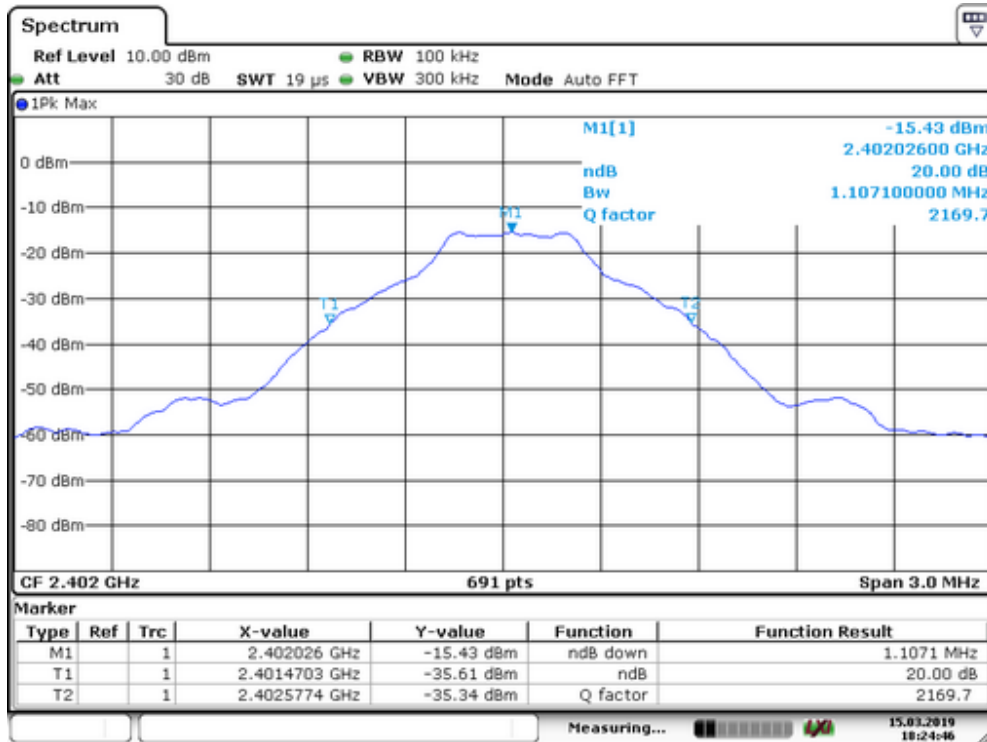

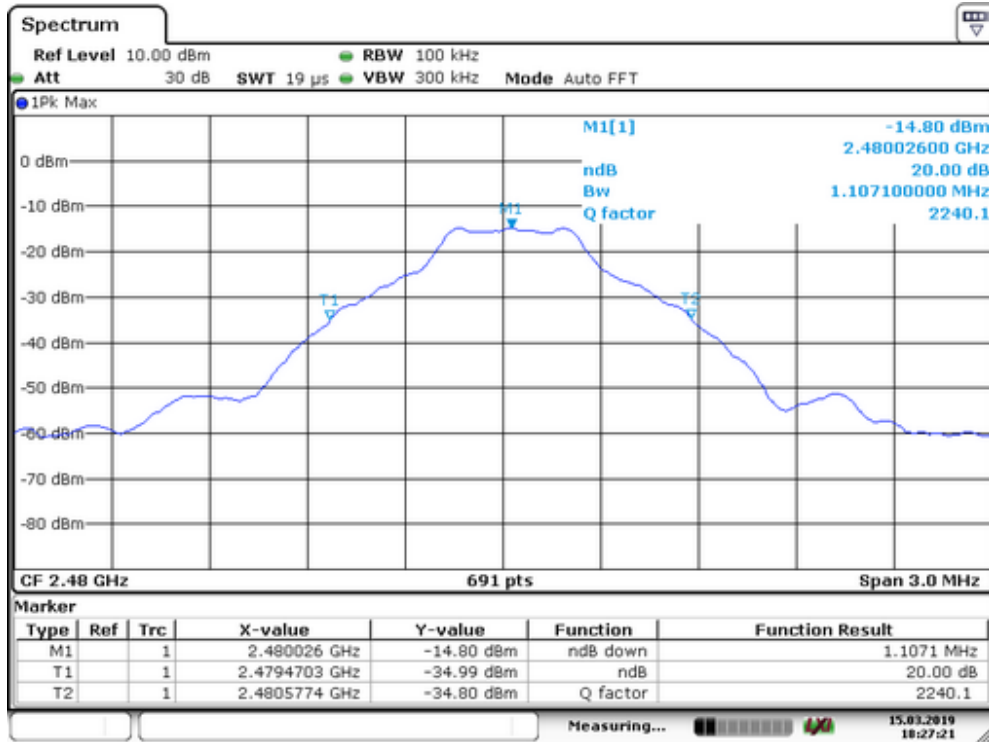

Spectrum Detector:	PK	Test Date :	March 15, 2019
Test By:	Andy	Temperature :	24°C
Test Result:	PASS	Humidity :	53 %
Modulation:	Π/4-DQPSK		

Channel number	Channel frequency (MHz)	20dB Down BW(kHz)
1	2402	1381
40	2441	1376
79	2480	1381

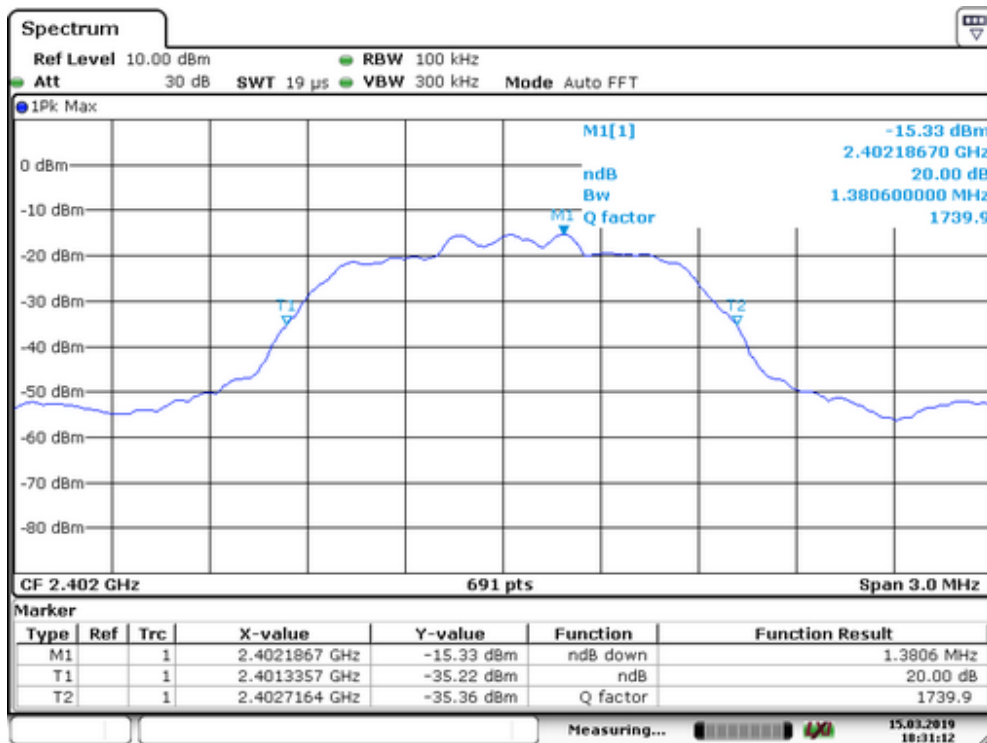

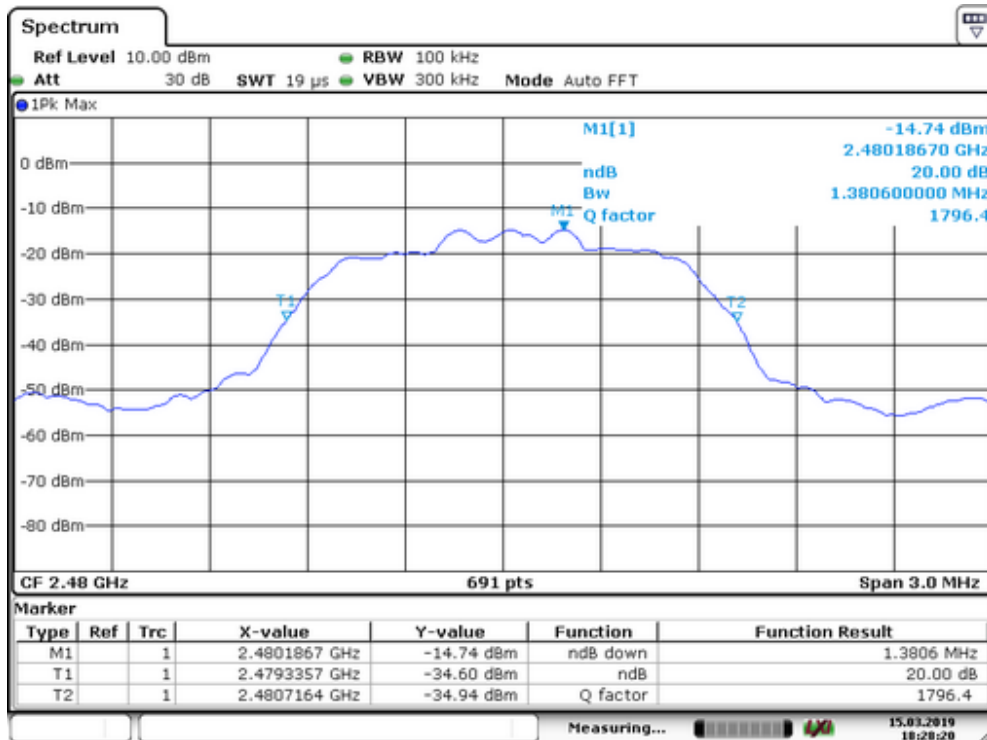
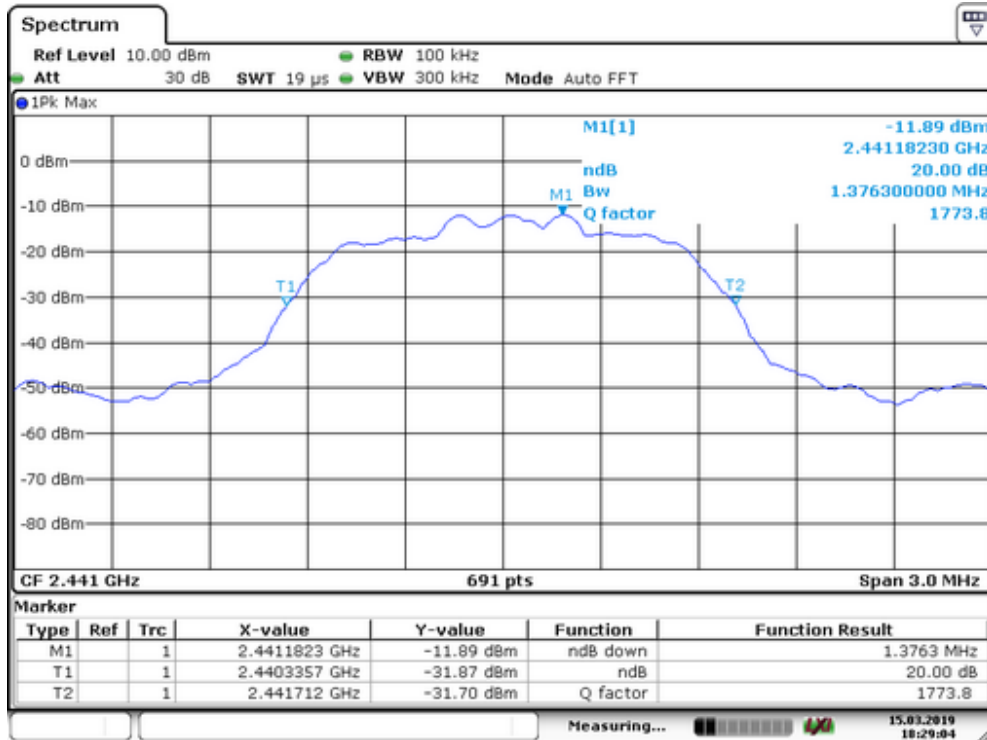

## 10. Quantity of Hopping Channel Test

### 10.1 Measurement Procedure

The EUT was operating in hopping mode or could be controlled its channel. Printed out the test result from the spectrum by hard copy function.

### 10.2 Test SET-UP (Block Diagram of Configuration)

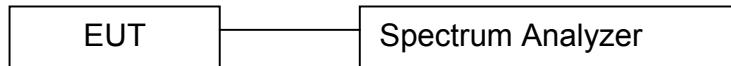

### 10.3 Measurement Equipment Used:

EQUIPMENT TYPE	MFR	MODEL NUMBER	SERIAL NUMBER	Characteristics	LAST CAL.	CAL DUE.
Spectrum Analyzer	Rohde & Schwarz	FSV30	1321.3008K	10Hz-30GHz	05/16/2018	05/15/2019
Coaxial Cable	CDS	79254	46107086	10Hz-30GHz	05/16/2018	05/15/2019
Antenna Connector	ARTHUR-YANG	2244-N1TG1	N/A	10Hz-30GHz	05/16/2018	05/15/2019

Remark: The temporary antenna connector is soldered on the PCB board in order to perform conducted tests and this temporary antenna connector is listed in the equipment list.

### 10.4 Measurement Results:

Refer to attached data chart.

Worst Test Mode	GFSK	Test Date :	March 15, 2019
Test By:	Andy	Temperature :	25 °C
Test Result:	PASS	Humidity :	50 %

Hopping Channel Frequency Range	Quantity of Hopping Channel	Quantity of Hopping Channel
2402-2480	79	> 15

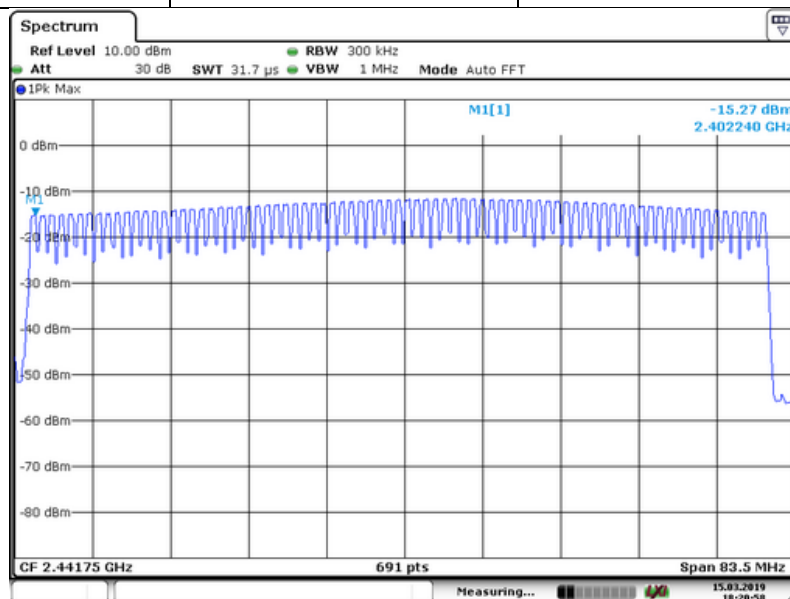



## 11. Time of Occupancy (Dwell Time) test

### 11.1 Test Description

The Equipment Under Test (EUT) was set up to perform the dwell time measurements. The EUT was connected to the spectrum analyzer via a short coax cable. The dwell time is calculated by:

$$\text{Dwell time} = \text{time slot length} * \text{hop rate} / \text{number of hopping channels} * 31.6\text{s}$$

with:

- hop rate =  $1600 * 1/\text{s}$  for DH1 packets =  $1600 \text{ s}^{-1}$
- hop rate =  $1600/3 * 1/\text{s}$  for DH3 packets =  $533.33 \text{ s}^{-1}$
- number of hopping channels = 79
- $31.6 \text{ s} = 0.4 \text{ seconds multiplied by the number of hopping channels} = 0.4 \text{ s} * 79$

The highest value of the dwell time is reported.

### 11.2 Test SET-UP (Block Diagram of Configuration)

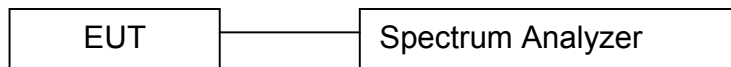

### 11.3 Measurement Equipment Used:

EQUIPMENT TYPE	MFR	MODEL NUMBER	SERIAL NUMBER	Characteristics	LAST CAL.	CAL DUE.
Spectrum Analyzer	Rohde & Schwarz	FSV30	1321.3008K	10Hz-30GHz	05/16/2018	05/15/2019
Coaxial Cable	CDS	79254	46107086	10Hz-30GHz	05/16/2018	05/15/2019
Antenna Connector	ARTHUR-YANG	2244-N1TG1	N/A	10Hz-30GHz	05/16/2018	05/15/2019

Remark: The temporary antenna connector is soldered on the PCB board in order to perform conducted tests and this temporary antenna connector is listed in the equipment list.

### 11.4 Test Requirements / Limits

FCC Part 15, Subpart C, §15.247 (a) (1) (iii)

Frequency hopping systems in the 2400-2483.5 MHz band shall use at least 15 channels. The average time of occupancy on any channel shall not be greater than 0.4 seconds within a period of 0.4 seconds multiplied by the number of hopping channels employed. Since the Bluetooth technology uses 79 channels this period is calculated to be 31.6seconds. Refer to attached data chart.

**11.5 Test result**

GFSK:

Mode	Number of transmission in a 31.6( 79 Hopping*0.4)	Length of transmissions time(msec)	Result (msec)	Limit (msec)
DH1	$1600/(2*79) \times 31.6 = 320$	0.410	131.2	400
DH3	$1600/(4*79) \times 31.6 = 160$	1.670	267.2	400
DH5	$1600/(6*79) \times 31.6 = 106.67$	2.913	310.7	400

Remark: The results of worst cased was recorded.

DH1:

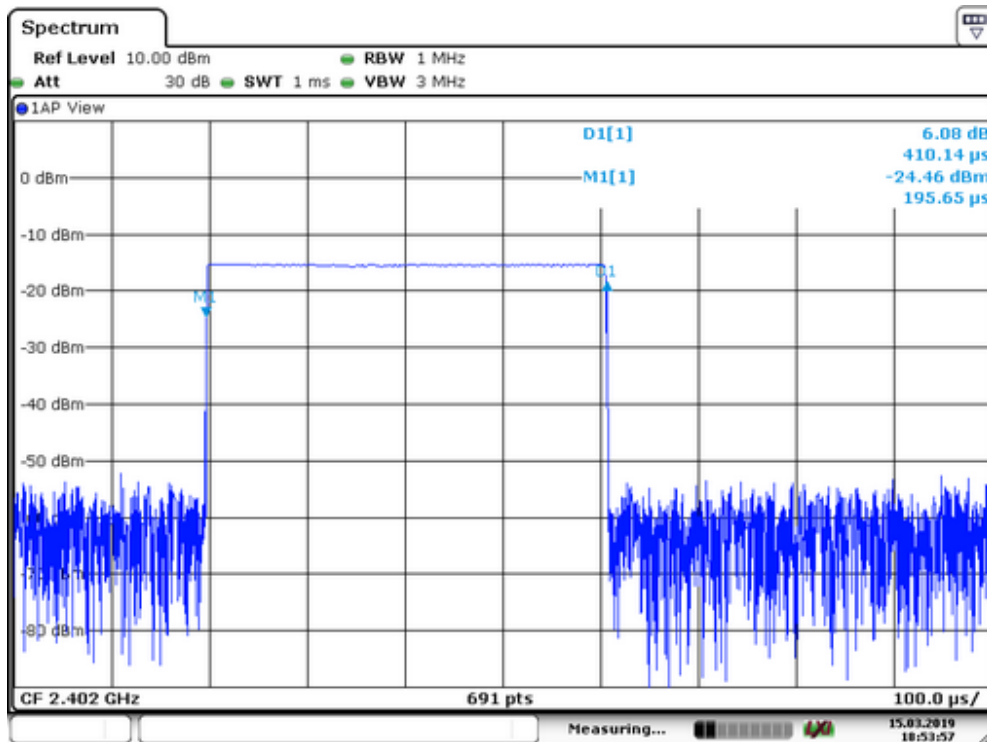

DH3:

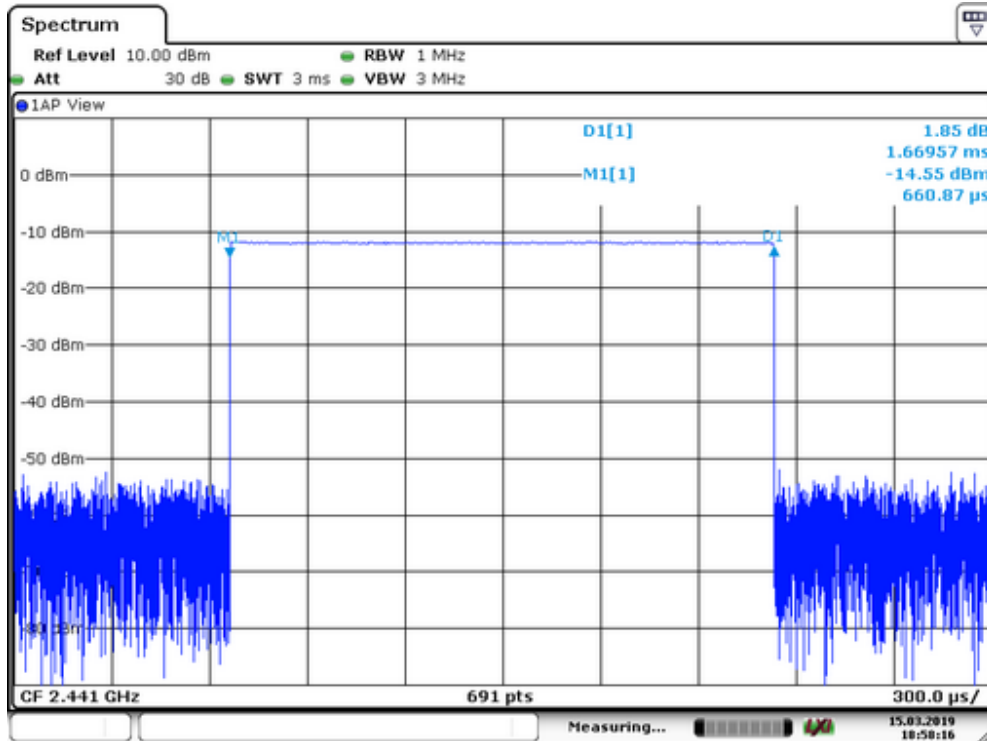

DH5:

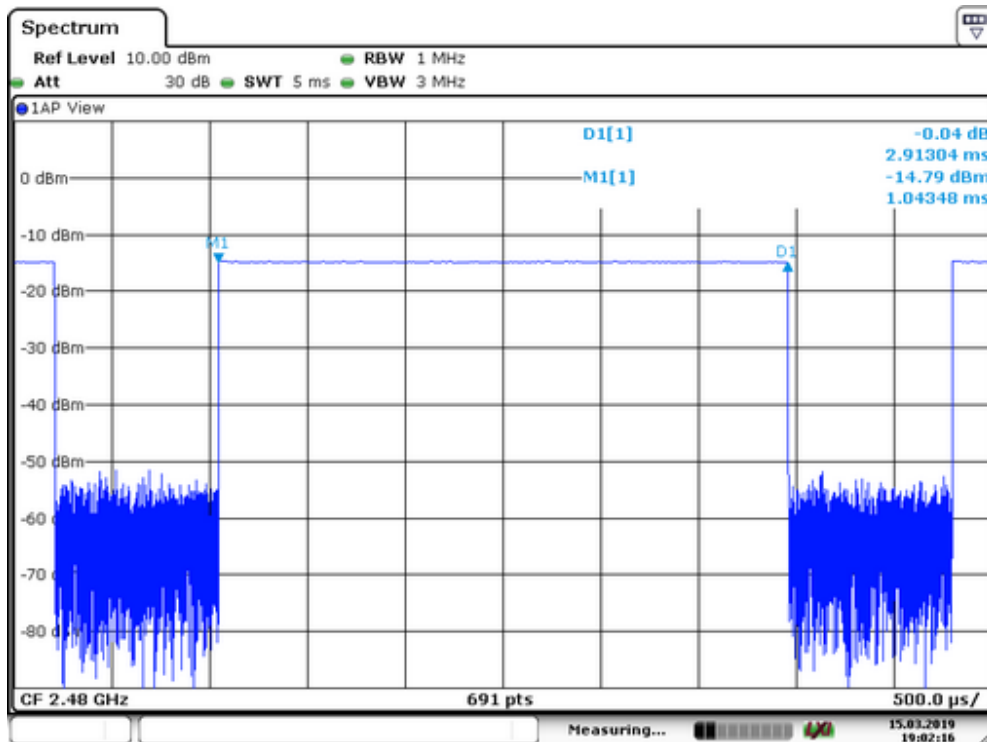

## 12. MAXIMUM PEAK OUTPUT POWER TEST

### 12.1 Measurement Procedure

- a. Check the calibration of the measuring instrument(SA) using either an internal calibrator or a known signal from an external generator.
- b. Turn on the EUT and connect it to measurement instrument. Then set it to any one convenient frequency within its operating range. Set a reference level on the measuring instrument equal to the highest peak value.
- c. The center frequency of the spectrum analyzer is set to the fundamental frequency and using proper RBW and VBW setting.
- d. Measure the captured power within the band and recording the plot.
- e. Repeat above procedures until all frequencies required were complete.

### 12.2 Test SET-UP (Block Diagram of Configuration)

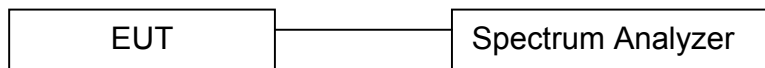

### 12.3 Measurement Equipment Used:

EQUIPMENT TYPE	MFR	MODEL NUMBER	SERIAL NUMBER	Characteristics	LAST CAL.	CAL DUE.
Spectrum Analyzer	Rohde & Schwarz	FSV30	1321.3008K	10Hz-30GHz	05/16/2018	05/15/2019
Coaxial Cable	CDS	79254	46107086	10Hz-30GHz	05/16/2018	05/15/2019
Antenna Connector	ARTHUR-YANG	2244-N1TG1	N/A	10Hz-30GHz	05/16/2018	05/15/2019

Remark: The temporary antenna connector is soldered on the PCB board in order to perform conducted tests and this temporary antenna connector is listed in the equipment list.

**12.4 Measurement Results:**

Refer to attached data chart.

Spectrum Detector:	PK	Test Date :	March 15, 2019
Test By:	Leon	Temperature :	25 °C
Test Result:	PASS	Humidity :	50 %
Modulation:	GFSK		

Channel number	Channel Frequency (MHz)	Peak Power output(dBm)	Peak Power output(mW)	Peak Power Limit(mW)	Pass/Fail
01	2402	<b>-12.23</b>	<b>0.060</b>	125	PASS
40	2441	-12.78	0.053	125	PASS
79	2480	-13.51	0.045	125	PASS

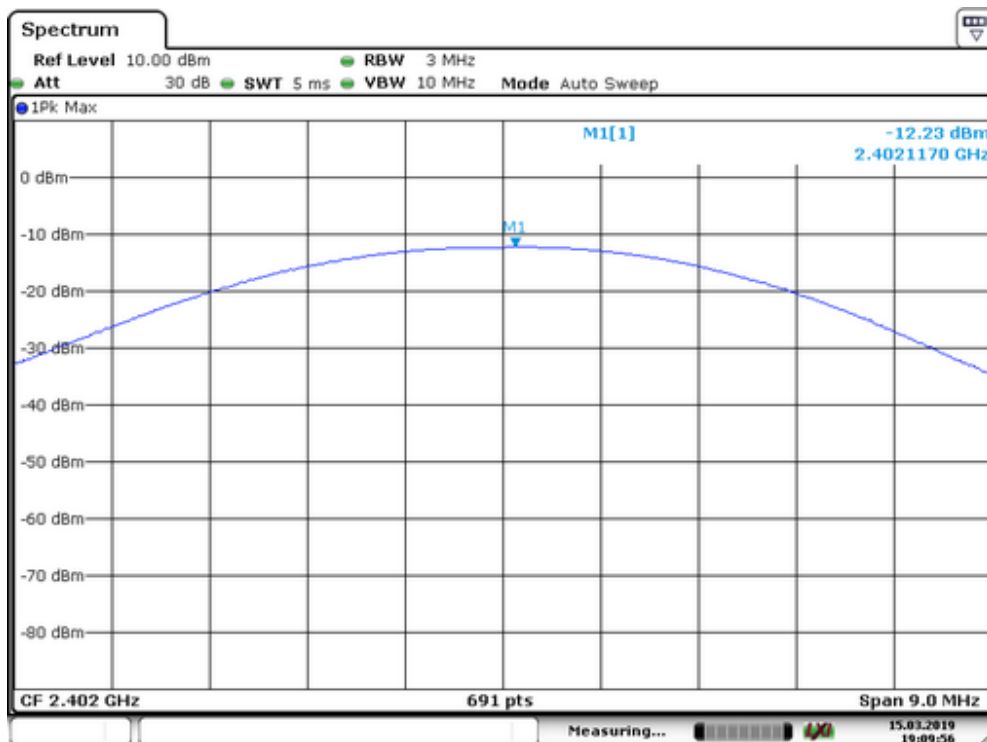

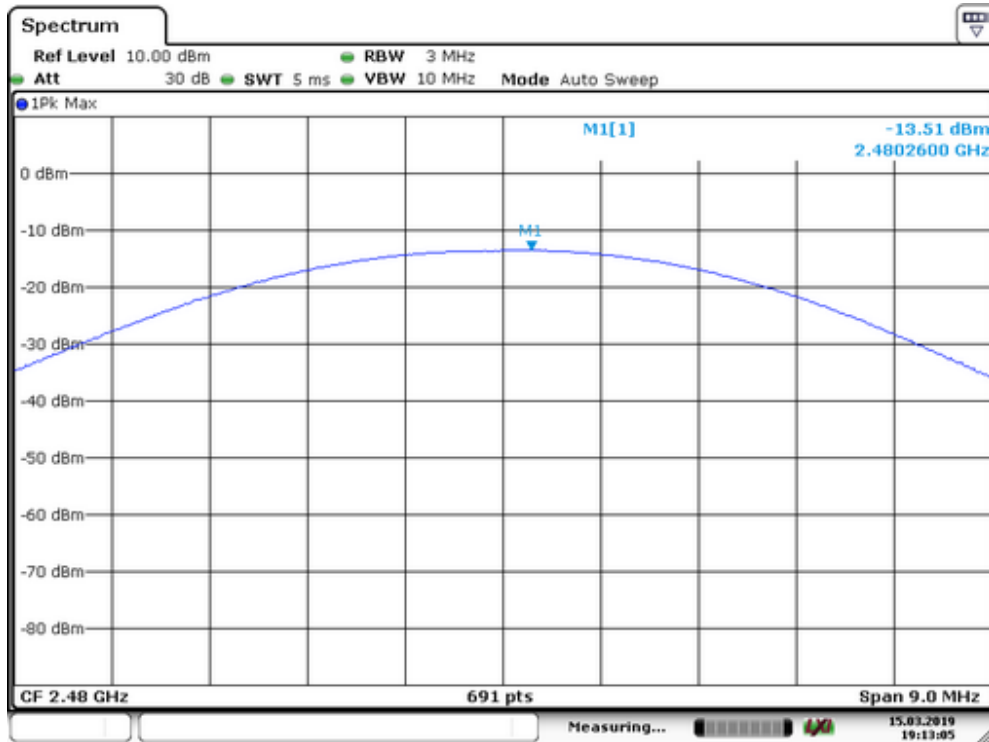
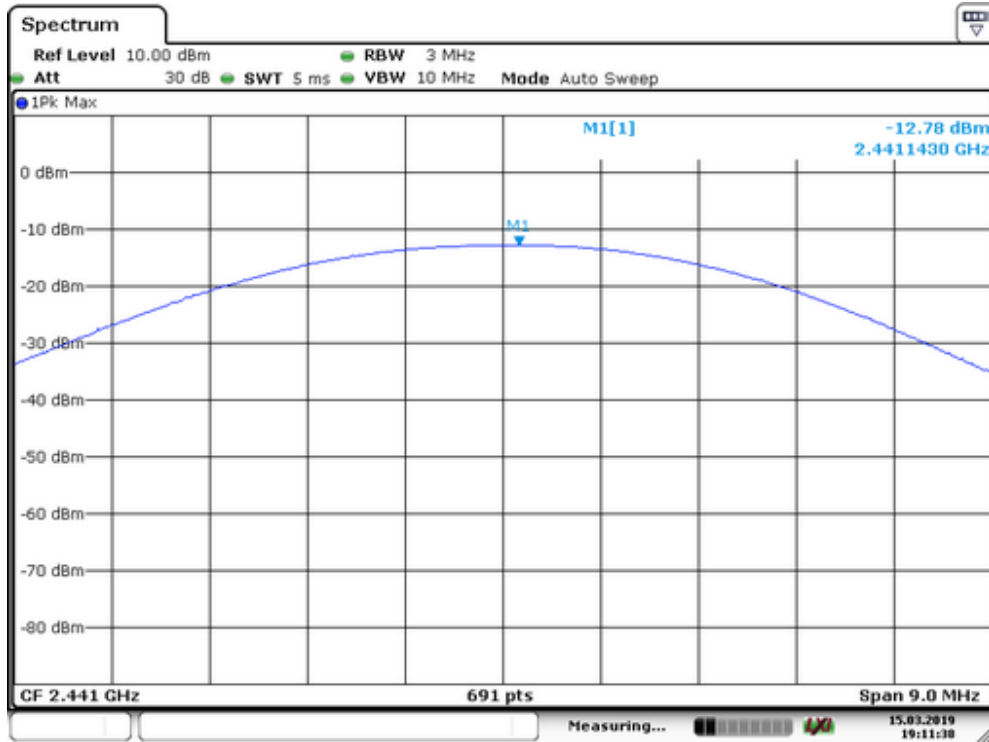

Spectrum Detector: PK                      Test Date :                      March 15, 2019  
 Test By: Andy                              Temperature :                      25 °C  
 Test Result: PASS                          Humidity :                          50 %  
 Modulation: Π/4-DQPSK

Channel number	Channel Frequency (MHz)	Peak Power output(dBm)	Peak Power output(mW)	Peak Power Limit(mW)	Pass/Fail
01	2402	<b>-10.92</b>	<b>0.081</b>	125	PASS
40	2441	-11.61	0.069	125	PASS
79	2480	-12.38	0.058	125	PASS

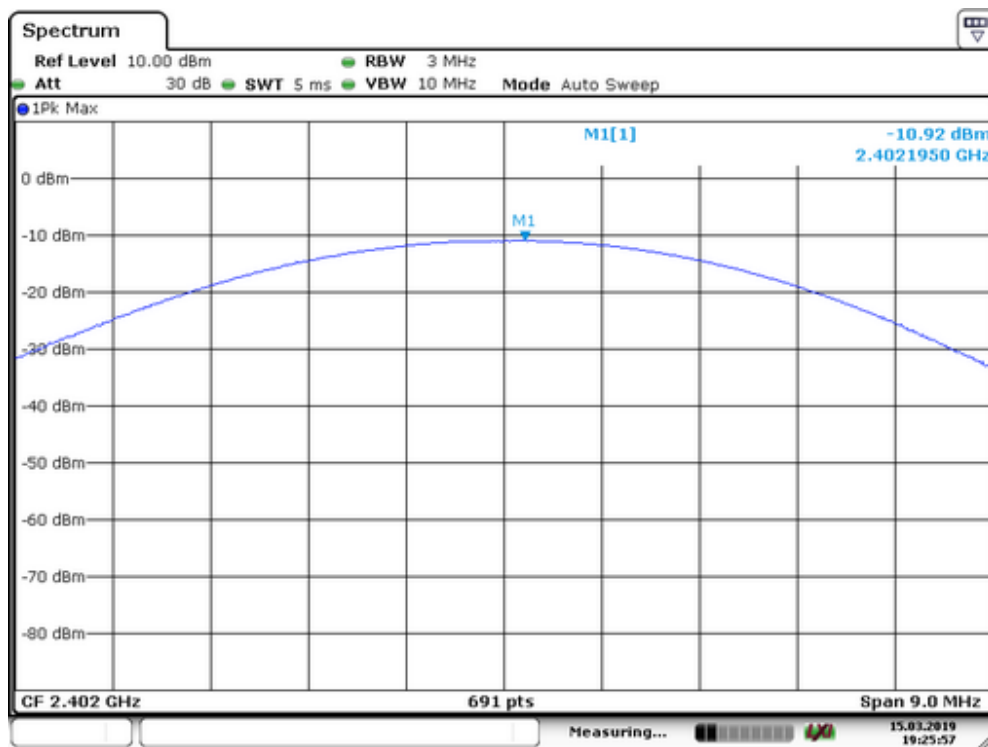

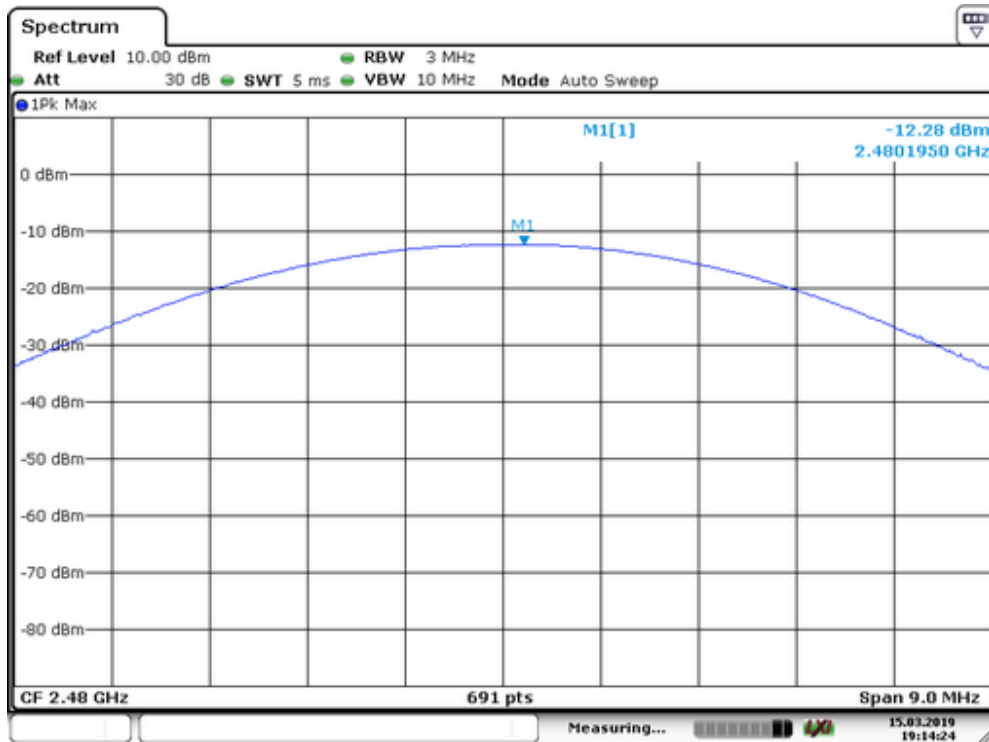
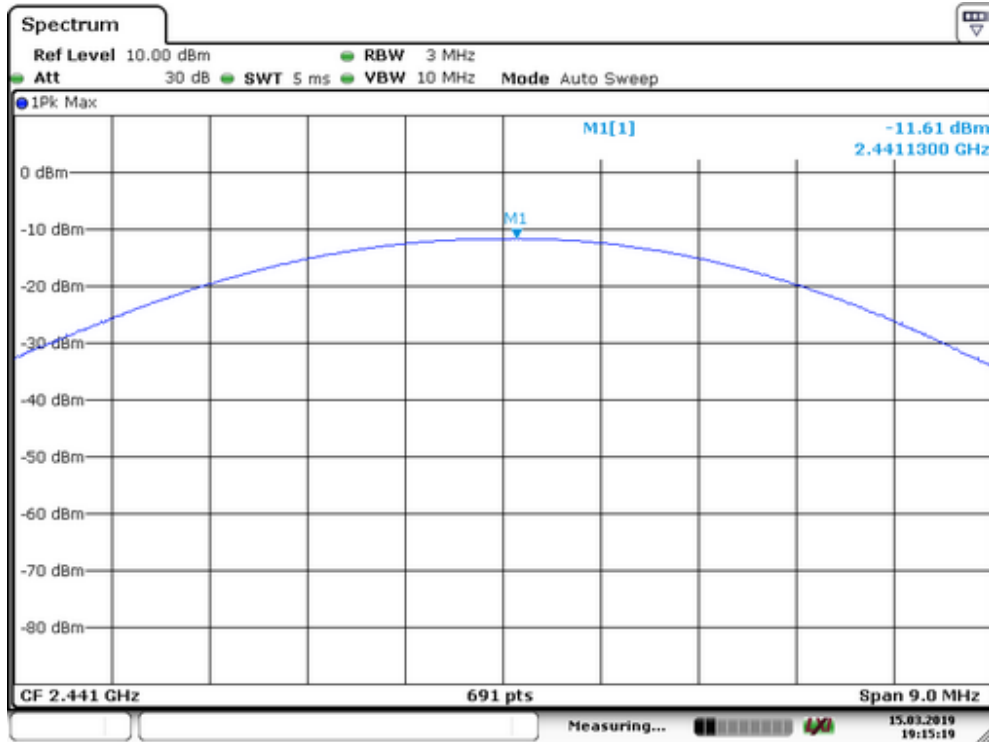



### 13. Band EDGE test

#### 13.1 Measurement Procedure

##### For Conducted Test

1. The transmitter output is connected to a spectrum analyzer. The resolution bandwidth is set to 100KHz. The video bandwidth is set to 300KHz.
2. The spectrum from 30MHz to 26 GHz is investigated with the transmitter set to the lowest, middle, and highest channels.

EMI Test Receiver	Setting
Attenuation	Auto
RBW	100KHz
VBW	300KHz
Detector	Peak
Trace	Max hold

##### For Radiated emission Test

The EUT was placed on a styrofoam table which is 1.5m above ground plane.

The measurement procedure at the ban edges was simplified by performing the measurement in just one plot. Both, the in-band-emission and the unwanted emission were be encompassed by the span. After trace stabilization, the maximum peak was be determined by a peak detector and the value was marked by an appropriate limit line. The second limit line, which is 20dB below the first, marks the limit for the emissions in the unrestricted band. A maximum-peak-detector marks the highest emission in the unrestricted band next to the band edge.

The measurements were performed at the lower end of the 2.4GHz band.

Use the following spectrum analyzer settings:

For Restricted Band, When spectrum scanned above 1GHz setting resolution bandwidth 1MHz, video bandwidth 3MHz:

EMI Test Receiver	Setting
Attenuation	Auto
RBW	1MHz
VBW	3MHz
Detector	Peak
Trace	Max hold

For Non-Restricted Band, When spectrum scanned above 1GHz setting resolution bandwidth 100KHz, video bandwidth 300KHz:

EMI Test Receiver	Setting
Attenuation	Auto
RBW	100KHz
VBW	300KHz
Detector	Peak
Trace	Max hold

### 13.2 Test SET-UP (Block Diagram of Configuration)

For Conducted Test

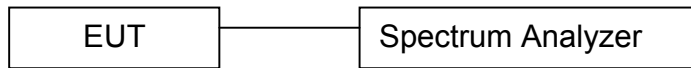

For Radiated emission Test

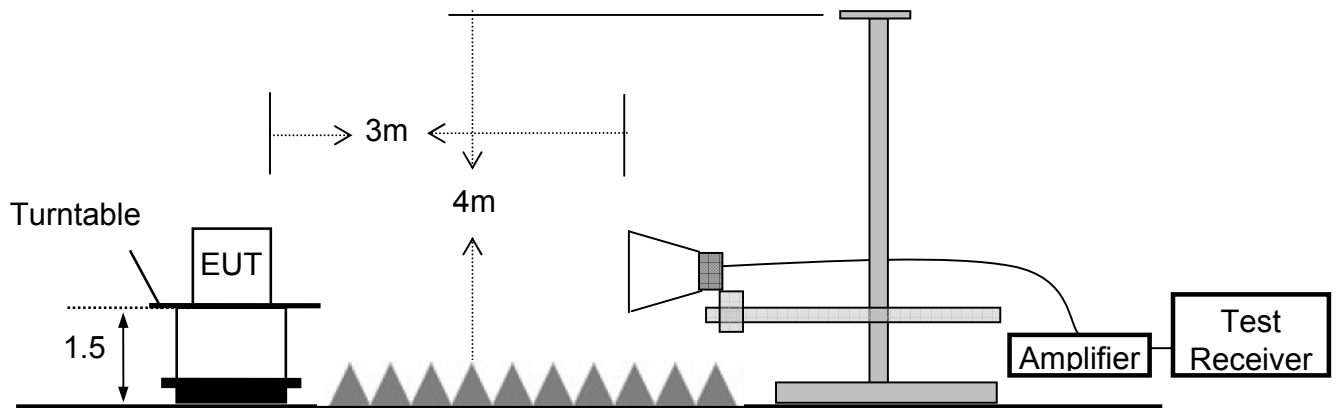

### 13.3 Measurement Equipment Used:

For Conducted Test

EQUIPMENT TYPE	MFR	MODEL NUMBER	SERIAL NUMBER	Characteristics	LAST CAL.	CAL DUE.
Spectrum Analyzer	Rohde & Schwarz	FSV30	1321.3008K	10Hz-30GHz	05/16/2018	05/15/2019
Coaxial Cable	CDS	79254	46107086	10Hz-30GHz	05/16/2018	05/15/2019
Antenna Connector	ARTHUR-YANG	2244-N1TG1	N/A	10Hz-30GHz	05/16/2018	05/15/2019

Remark: The temporary antenna connector is soldered on the PCB board in order to perform conducted tests and this temporary antenna connector is listed in the equipment list.

For Radiated emission Test

Item	Equipment	Manufacturer	Model No.	Serial No.	Characteristics	Last Cal.	Cal. Interval
1	Signal Analyzer	Rohde & Schwarz	FSV30	103040	9KHz-40GHz	05/16/2018	1 Year
2	Horn Antenna	Schwarzbeck	BBHA9120D	9120D-1272	1GHz-18GHz	05/16/2018	1 Year
3	Power Amplifier	LUNAR EM	LNA1G18-40	J10100000081	1GHz-26.5GHz	05/16/2018	1 Year
4	Cable	H+S	CBL-26	N/A	1GHz-26.5GHz	05/16/2018	1 Year
5	Cable	H+S	CBL-26	N/A	1GHz-26.5GHz	05/16/2018	1 Year
6	Cable	H+S	CBL-26	N/A	1GHz-26.5GHz	05/16/2018	1 Year

**13.4 Measurement Results:**

Refer to attached data chart.

Spectrum Detector: PK                      Test Date :                      March 06, 2019  
 Test By: Andy                              Temperature :                      25 °C  
 Test Result: PASS                        Humidity :                        50 %

1. Conducted Test

For Non-Hopping Mode:

Frequency (MHz)	Modulation	Peak Power Output(dBm)	Result of Band edge(dBc)	Band edge Limit(dBc)
2401.87	GFSK	-12.52	33.15	>20dBc
2402.19	pi/4-DQPSK	-12.44	30.3	>20dBc
2480.19	GFSK	-13.80	43.1	>20dBc
2480.19	pi/4-DQPSK	-13.70	43.65	>20dBc

**Test plots of GFSK**

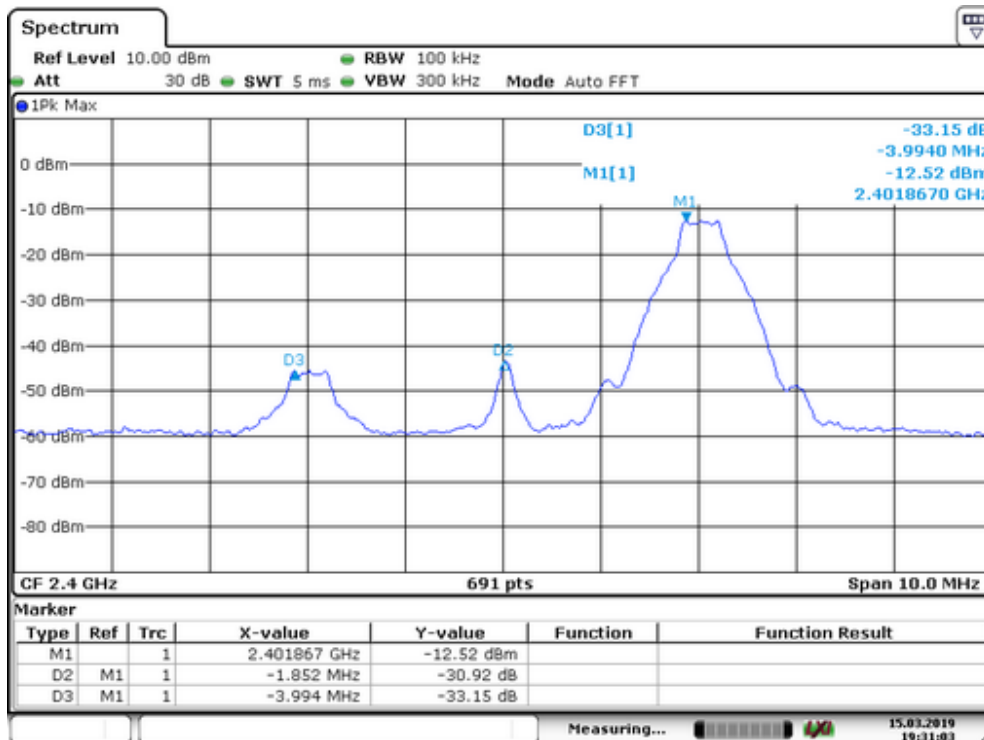

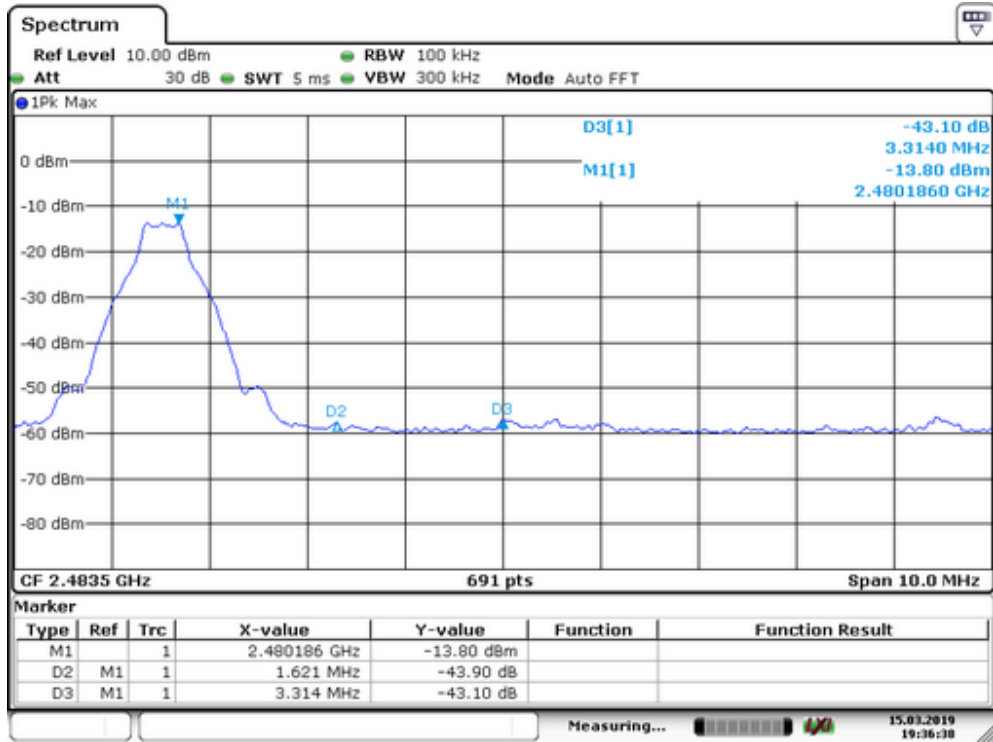

## Test plots of pi/4-DQPSK

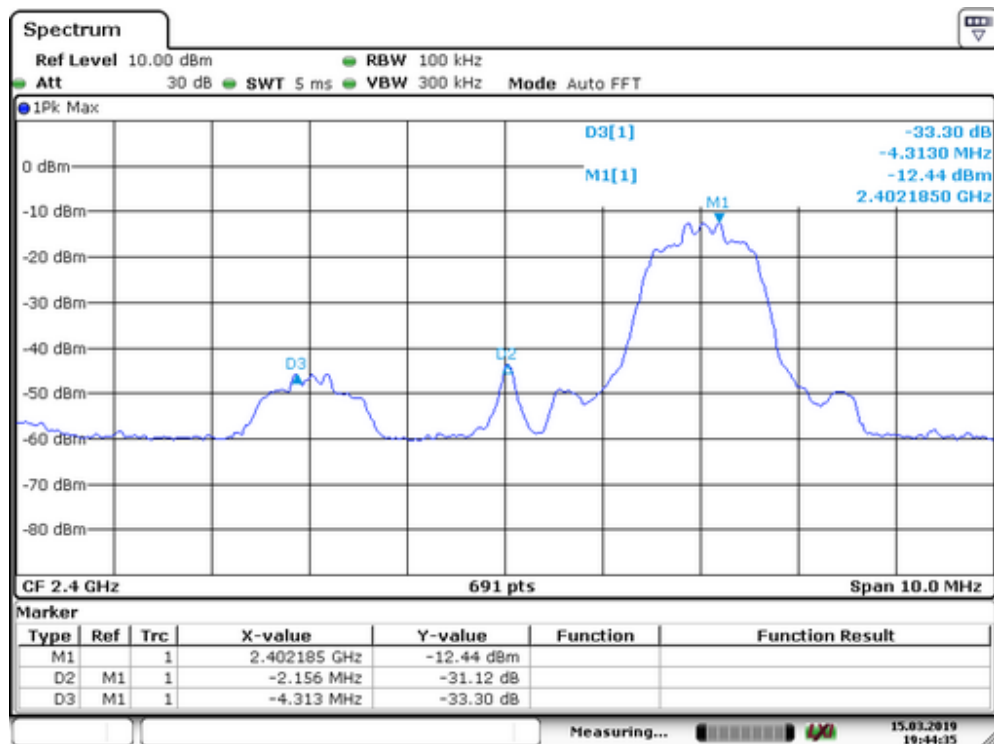

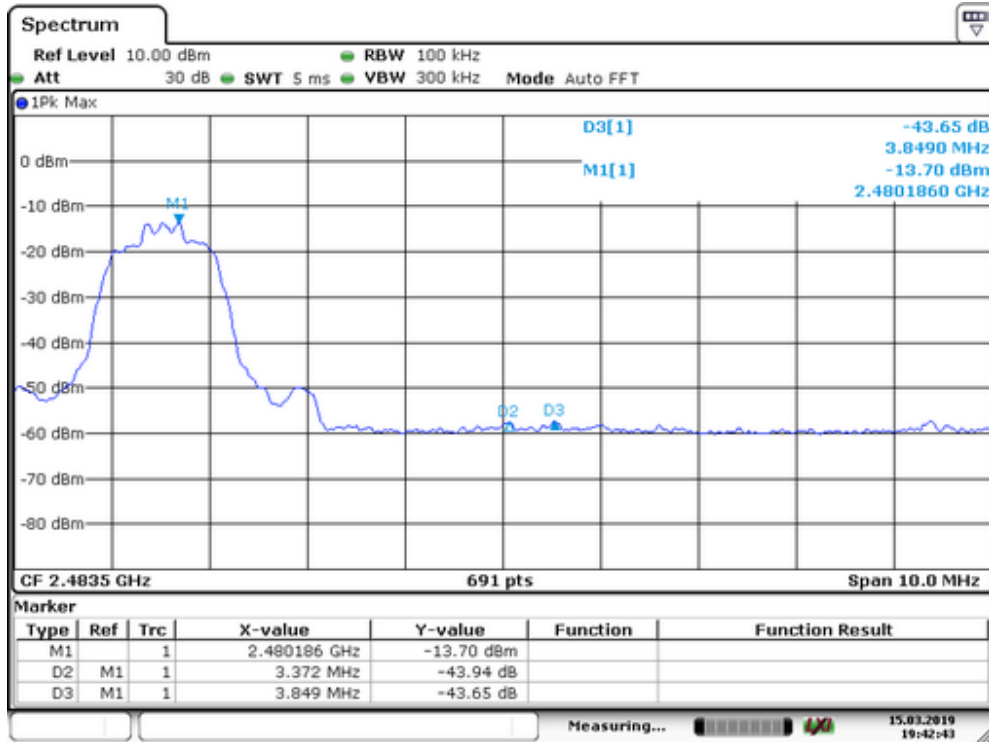

For Hopping Mode:

Frequency (MHz)	Modulation	Peak Power Output(dBm)	Result of Band edge(dBc)	Band edge Limit(dBc)
2401.87	GFSK	-12.57	33.29	>20dBc
2401.87	pi/4-DQPSK	-12.60	32.92	>20dBc
2480.19	GFSK	-13.72	41.29	>20dBc
2480.19	pi/4-DQPSK	-13.72	41.15	>20dBc

**Test plots of GFSK**

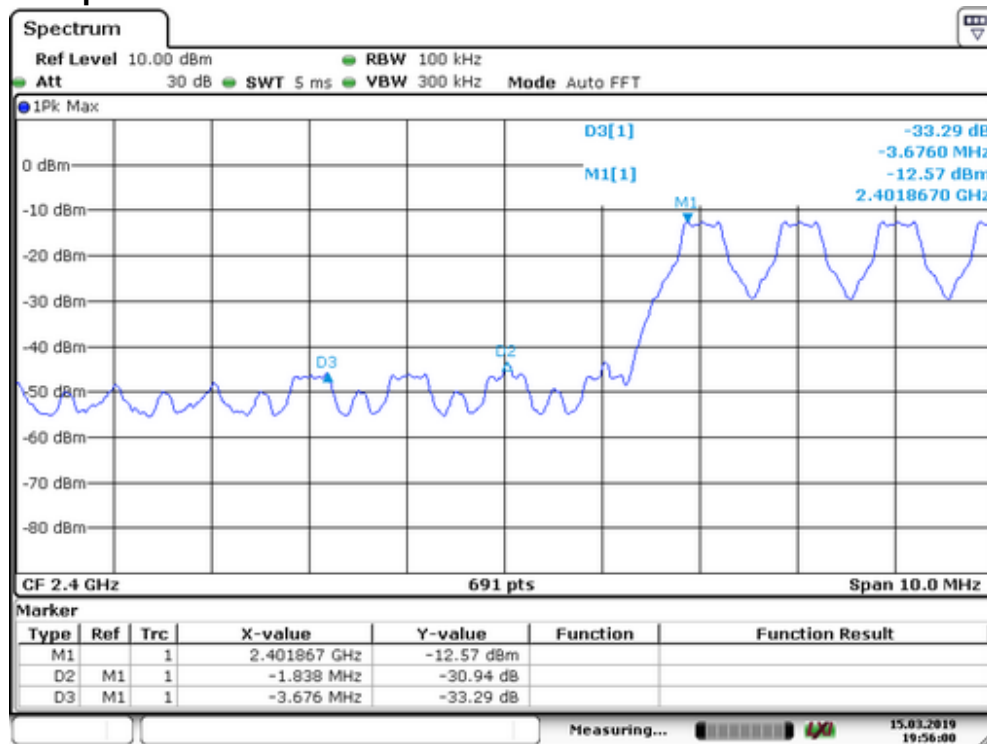

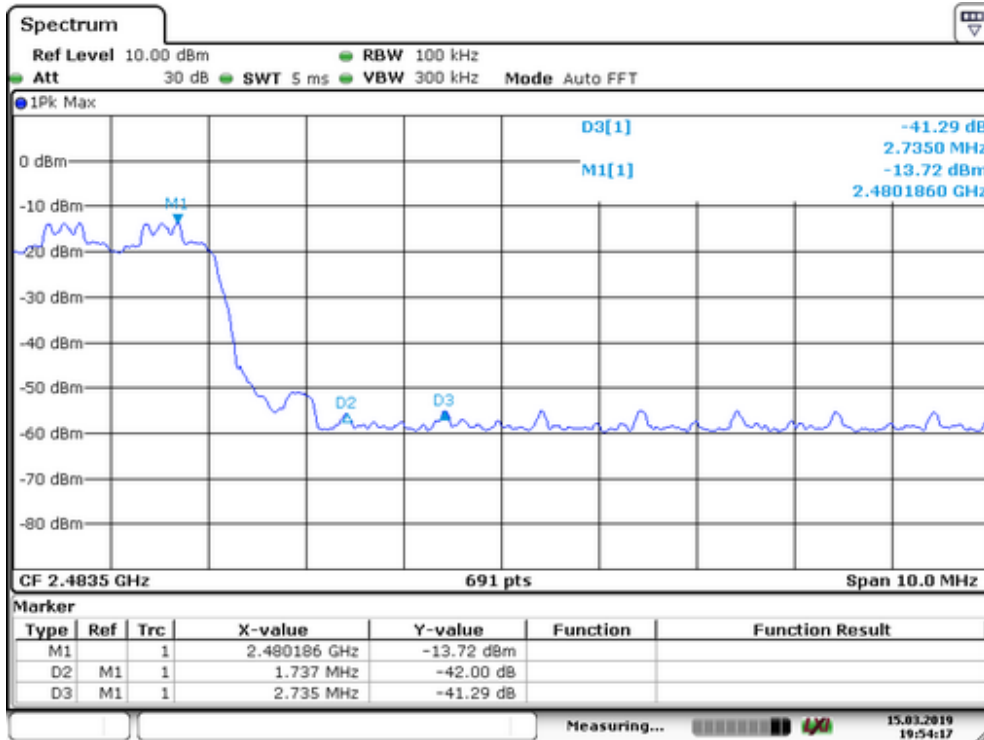

## Test plots of pi/4-DQPSK

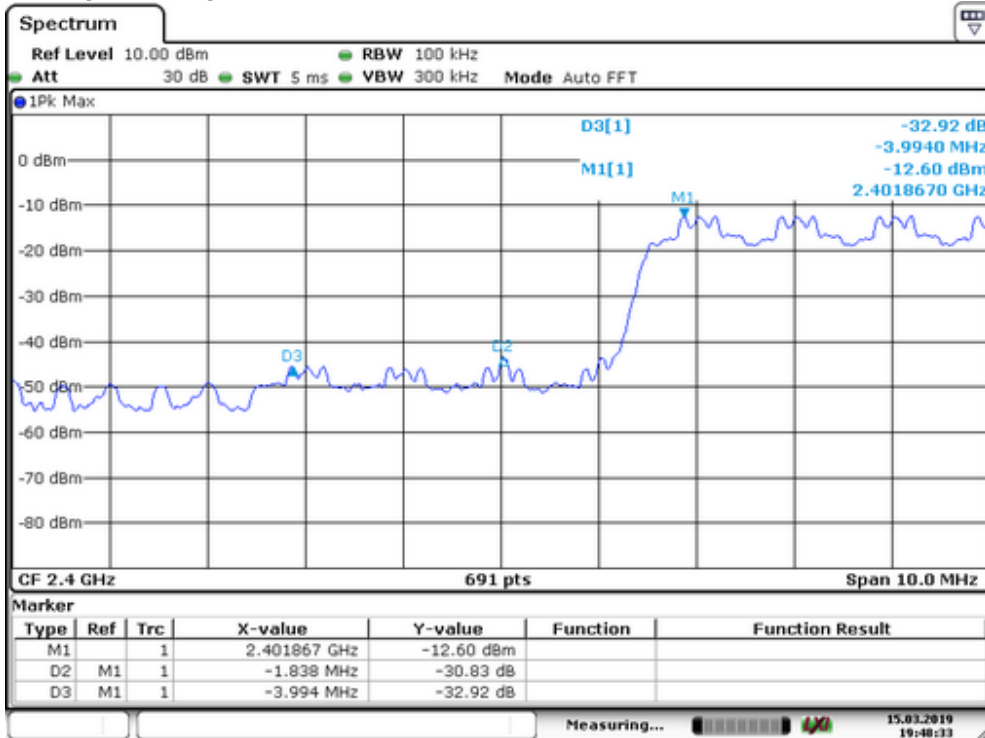

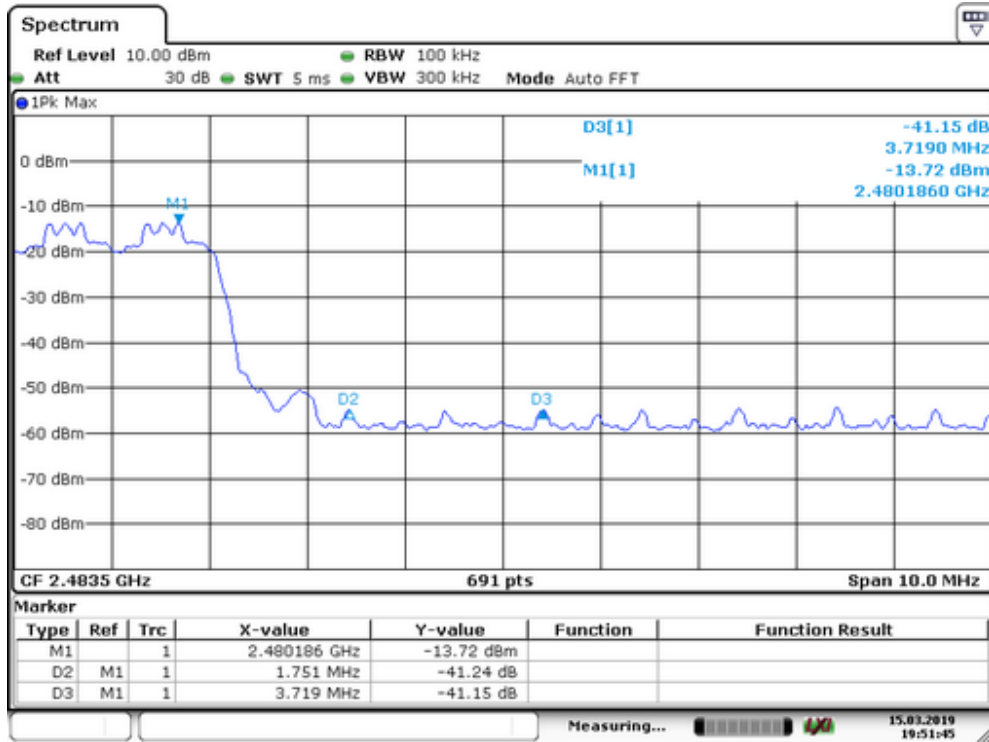



2. Radiated emission Test  
**Worst test modulation  $\Pi/4$ -DQPSK**  
 For Non-Hopping Mode:

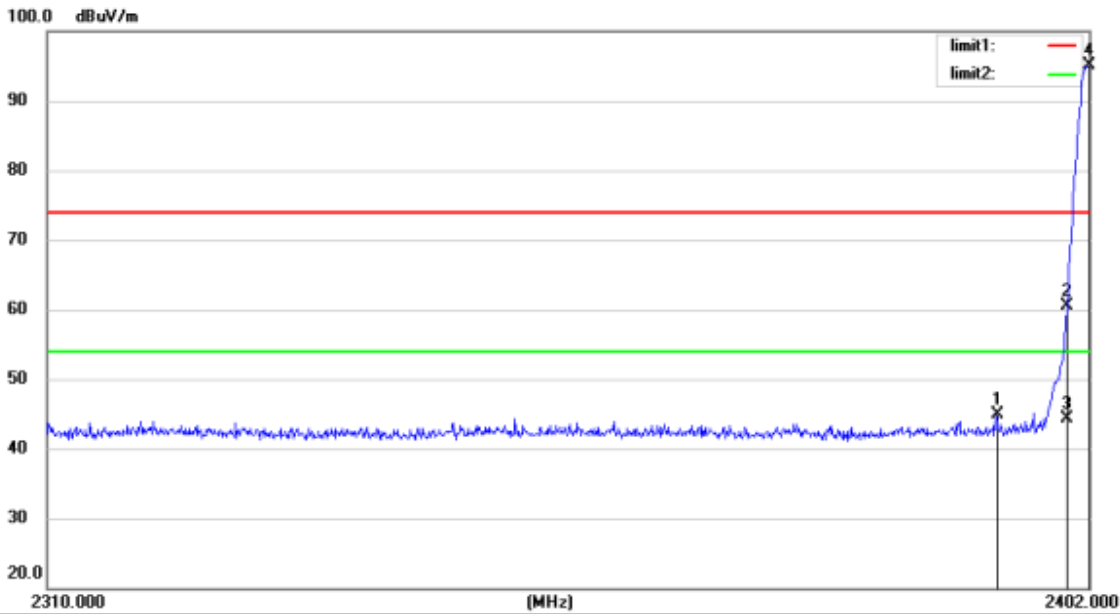

Site Chamber #1      Polarization: *Horizontal*      Temperature: 25  
 Limit: (RE)FCC PART 15 C 3m\_PEAK      Power: Battery 3.7V      Humidity: 55 %  
 Mode: TX2402  
 Note:

No.	Mk.	Freq.	Reading Level	Correct Factor	Measurement	Limit	Over	Antenna Height	Table Degree	
		MHz	dBuV	dB	dBuV/m	dBuV/m	dB	cm	degree	Comment
1		2393.720	56.48	-11.64	44.84	74.00	-29.16			peak
2		2400.000	72.15	-11.63	60.52	74.00	-13.48			peak
3		2400.000	55.98	-11.63	44.35	54.00	-9.65			AVG
4	*	2402.000	106.64	-11.63	95.01	74.00	21.01			peak

\*:Maximum data    x:Over limit    !:over margin      Operator: huang

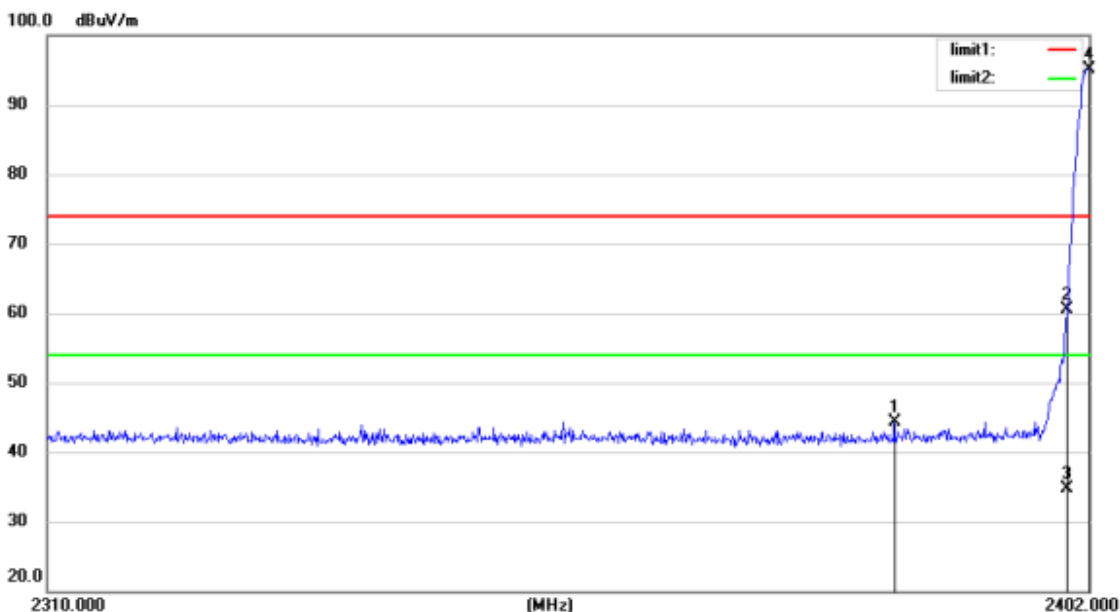

Site Chamber #1

Polarization: *Vertical*

Temperature: 25

Limit: (RE)FCC PART 15 C 3m\_PEAK

Power: Battery 3.7V

Humidity: 55 %

Mode: TX2402

Note:

No.	Mk.	Freq.	Reading Level	Correct Factor	Measurement	Limit	Over	Antenna Height	Table Degree	
		MHz	dBuV	dB	dBuV/m	dBuV/m	dB	cm	degree	Comment
1		2384.612	56.04	-11.65	44.39	74.00	-29.61			peak
2		2400.000	72.14	-11.63	60.51	74.00	-13.49			peak
3		2400.000	46.25	-11.63	34.62	54.00	-19.38			AVG
4	*	2402.000	106.71	-11.63	95.08	74.00	21.08			peak

\*:Maximum data    x:Over limit    !:over margin

Operator: huang

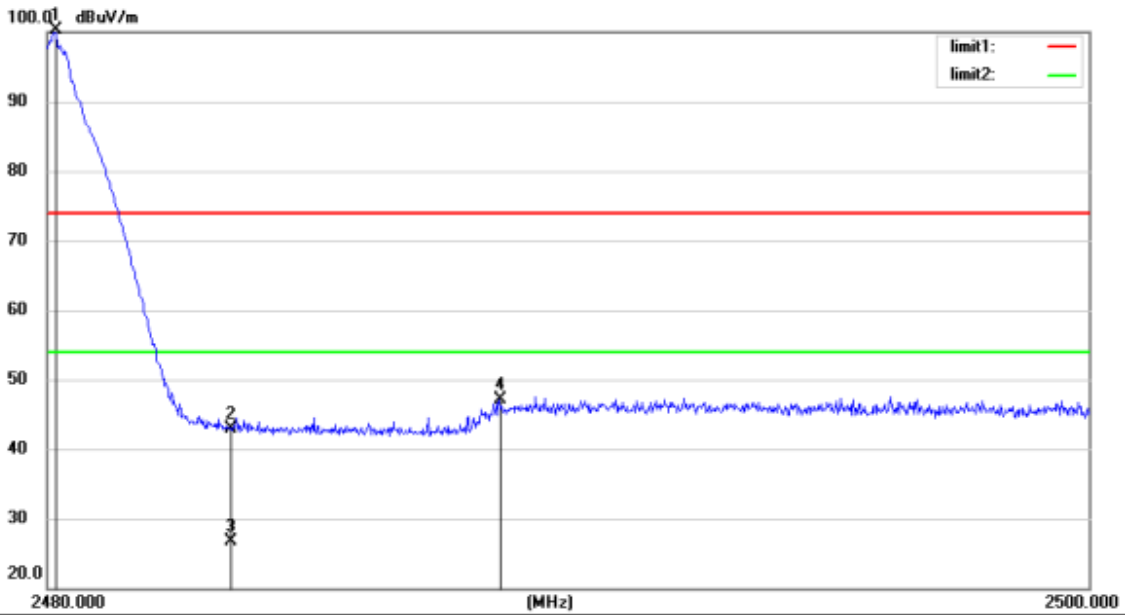

Site Chamber #1 Polarization: *Horizontal* Temperature: 25  
 Limit: (RE)FCC PART 15 C 3m\_PEAK Power: Battery 3.7V Humidity: 55 %

Mode: TX2480

Note:

No.	Mk.	Freq. MHz	Reading Level dBuV	Correct Factor dB	Measure- ment dBuV/m	Limit dBuV/m	Over dB	Antenna Height cm	Table Degree degree	Detector	Comment
1	*	2480.140	111.68	-11.45	100.23	74.00	26.23			peak	
2		2483.500	54.31	-11.46	42.85	74.00	-31.15			peak	
3		2483.500	38.16	-11.46	26.70	54.00	-27.30			AVG	
4		2488.680	58.50	-11.44	47.06	74.00	-26.94			peak	

\*:Maximum data x:Over limit !:over margin

Operator: huang

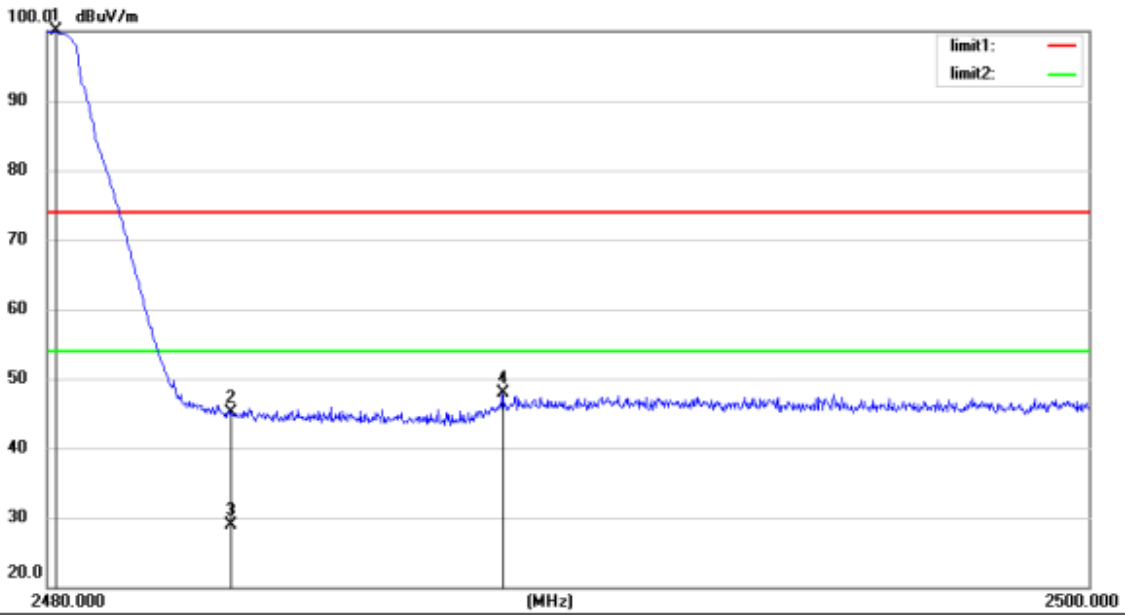

Site Chamber #1 Polarization: **Vertical** Temperature: 25  
 Limit: (RE)FCC PART 15 C 3m\_PEAK Power: Battery 3.7V Humidity: 55 %  
 Mode: TX2480  
 Note:

No.	Mk.	Freq.	Reading Level	Correct Factor	Measurement	Limit	Over	Antenna Height	Table Degree	
		MHz	dBuV	dB	dBuV/m	dBuV/m	dB	cm	degree	Comment
1	*	2480.140	110.11	-10.02	100.09	74.00	26.09			peak
2		2483.500	55.16	-10.01	45.15	74.00	-28.85			peak
3		2483.500	38.99	-10.01	28.98	54.00	-25.02			AVG
4		2488.740	57.88	-9.98	47.90	74.00	-26.10			peak

\*:Maximum data x:Over limit !:over margin

Operator: huang

For Hopping Mode:

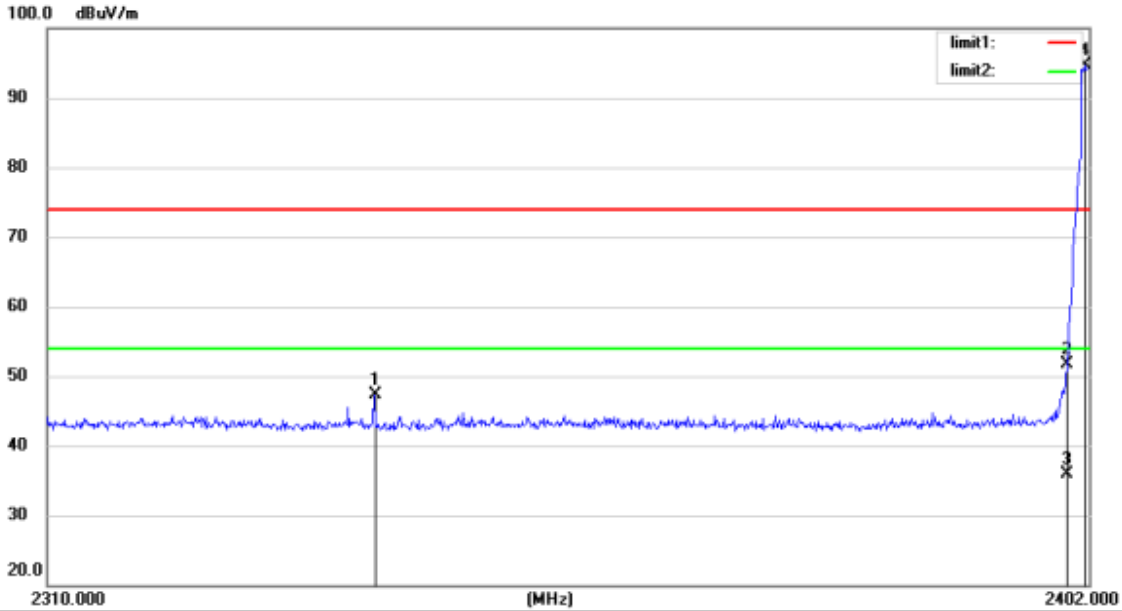

Site Chamber #1 Polarization: **Horizontal** Temperature: 25  
 Limit: (RE)FCC PART 15 C 3m\_PEAK Power: Battery 3.7V Humidity: 55 %  
 Mode:Hopping  
 Note:

No.	Mk.	Freq. MHz	Reading Level dBuV	Correct Factor dB	Measure- ment dBuV/m	Limit dBuV/m	Over dB	Detector	Antenna Height cm	Table Degree	Comment
1		2338.520	59.14	-11.77	47.37	74.00	-26.63	peak			
2		2400.000	63.29	-11.63	51.66	74.00	-22.34	peak			
3		2400.000	47.58	-11.63	35.95	54.00	-18.05	AVG			
4	*	2401.632	106.38	-11.63	94.75	74.00	20.75	peak			

\*:Maximum data x:Over limit !:over margin Operator: huang

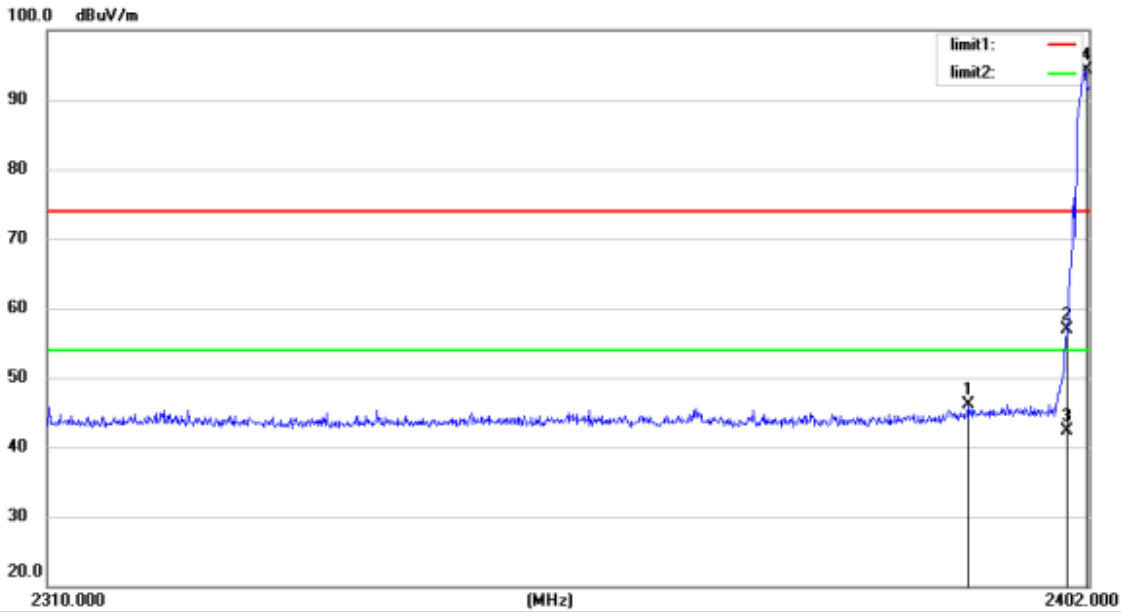

Site Chamber #1      Polarization: **Vertical**      Temperature: 25  
 Limit: (RE)FCC PART 15 C 3m\_PEAK      Power: Battery 3.7V      Humidity: 55 %  
 Mode:Hopping  
 Note:

No.	Mk.	Freq.	Reading Level	Correct Factor	Measure-ment	Limit	Over	Antenna Height	Table Degree	
		MHz	dBuV	dB	dBuV/m	dBuV/m	dB	cm	degree	Comment
1		2391.144	56.59	-10.52	46.07	74.00	-27.93			peak
2		2400.000	67.35	-10.47	56.88	74.00	-17.12			peak
3		2400.000	52.68	-10.47	42.21	54.00	-11.79			AVG
4	*	2401.724	104.85	-10.46	94.39	74.00	20.39			peak

\*:Maximum data    x:Over limit    !:over margin

Operator: huang

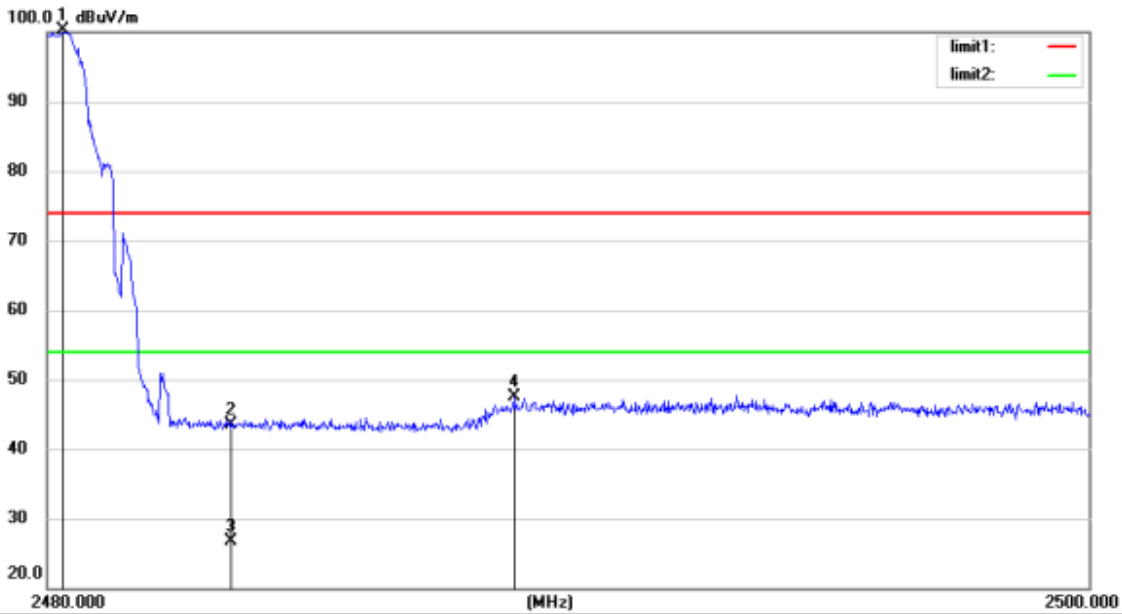

Site Chamber #1 Polarization: *Horizontal* Temperature: 25  
 Limit: (RE)FCC PART 15 C 3m\_PEAK Power: Battery 3.7V Humidity: 55 %

Mode:Hopping

Note:

No.	Mk.	Freq. MHz	Reading Level dBuV	Correct Factor dB	Measure- ment dBuV/m	Limit dBuV/m	Over dB	Antenna Height cm	Table Degree	Detector	Comment
1	*	2480.280	111.81	-11.45	100.36	74.00	26.36			peak	
2		2483.500	55.03	-11.46	43.57	74.00	-30.43			peak	
3		2483.500	38.15	-11.46	26.69	54.00	-27.31			AVG	
4		2488.960	58.88	-11.44	47.44	74.00	-26.56			peak	

\*:Maximum data x:Over limit !:over margin

Operator: huang

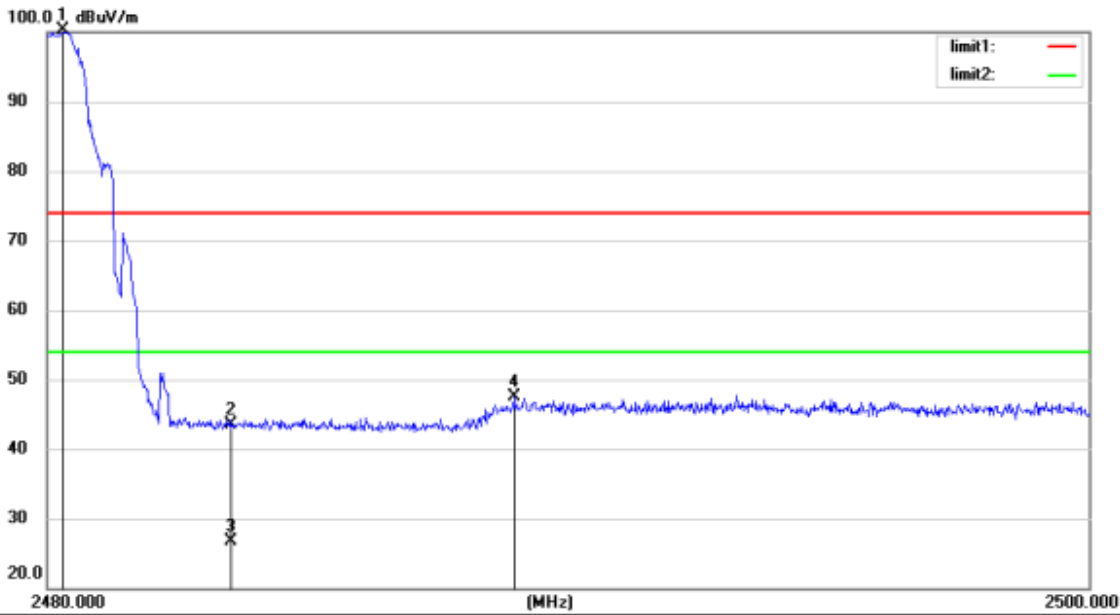

Site Chamber #1 Polarization: **Horizontal** Temperature: 25  
 Limit: (RE)FCC PART 15 C 3m\_PEAK Power: Battery 3.7V Humidity: 55 %  
 Mode:Hopping  
 Note:

No.	Mk.	Freq.	Reading Level	Correct Factor	Measurement	Limit	Over	Antenna Height	Table Degree	
		MHz	dBuV	dB	dBuV/m	dBuV/m	dB	cm	degree	Comment
1	*	2480.280	111.81	-11.45	100.36	74.00	26.36			peak
2		2483.500	55.03	-11.46	43.57	74.00	-30.43			peak
3		2483.500	38.15	-11.46	26.69	54.00	-27.31			AVG
4		2488.960	58.88	-11.44	47.44	74.00	-26.56			peak

\*:Maximum data x:Over limit !:over margin

Operator: huang



## **14. Antenna Application**

### **14.1 Antenna requirement**

The EUT'S antenna is met the requirement of FCC part 15C section 15.203 and 15.247.

FCC part 15C section 15.247 requirements:

Systems operating in the 2402-2480MHz band that are used exclusively for fixed, point-to-point operations may employ transmitting antennas with directional gain greater than 6dBi provided the maximum peak output power of the intentional radiator is reduced by 1dB for every 3dB that the directional gain of the antenna exceeds 6dBi.

### **14.2 Result**

The EUT's antenna, permanent attached antenna, used a PCB antenna and integrated on PCB, The antenna's gain is 0dBi and meets the requirement.

# APPENDIX I (Photos of EUT)

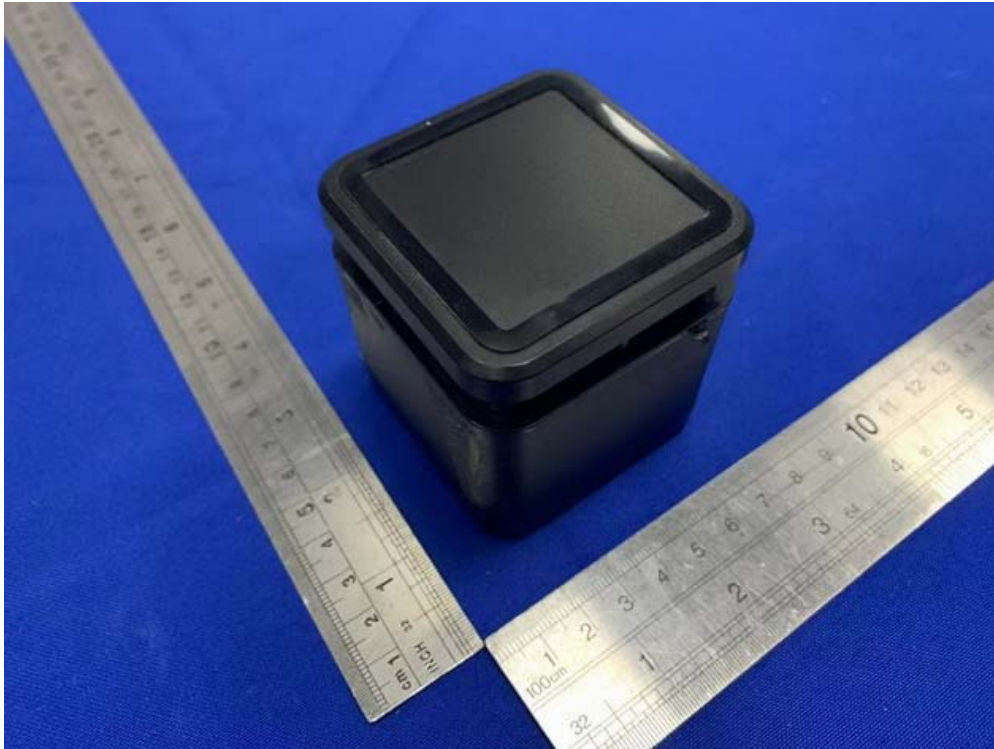

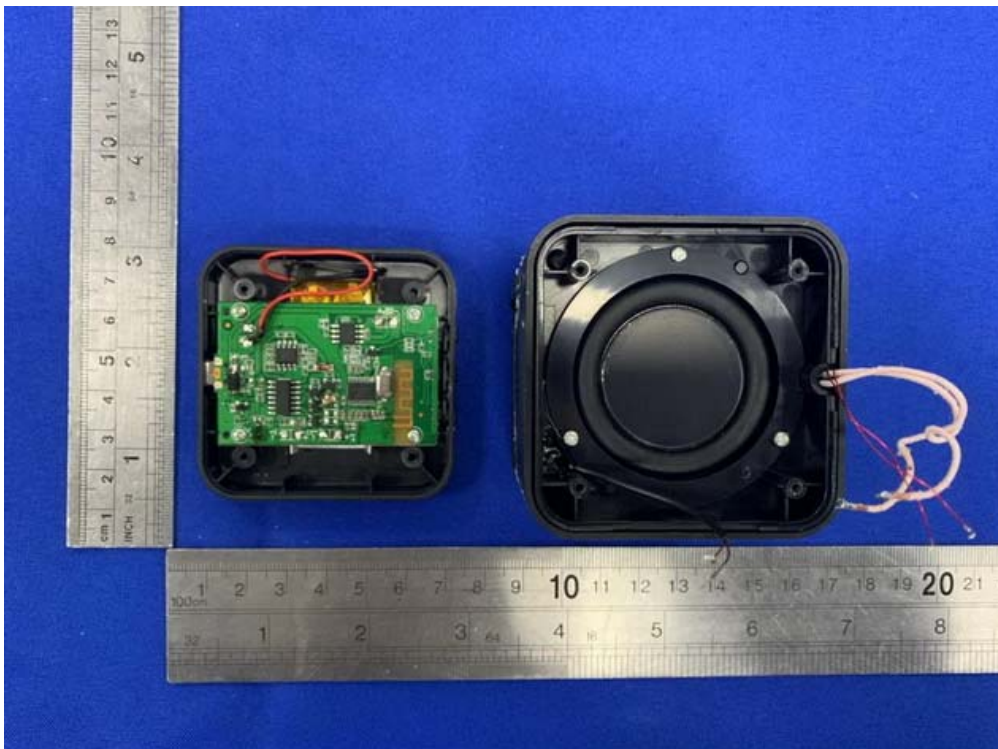

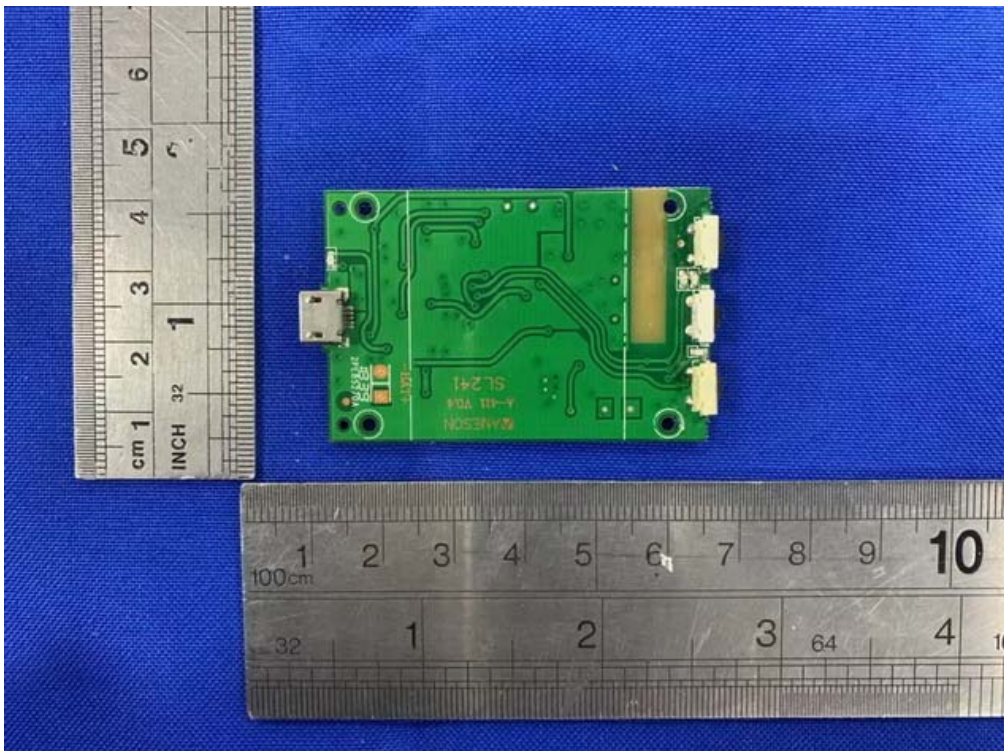
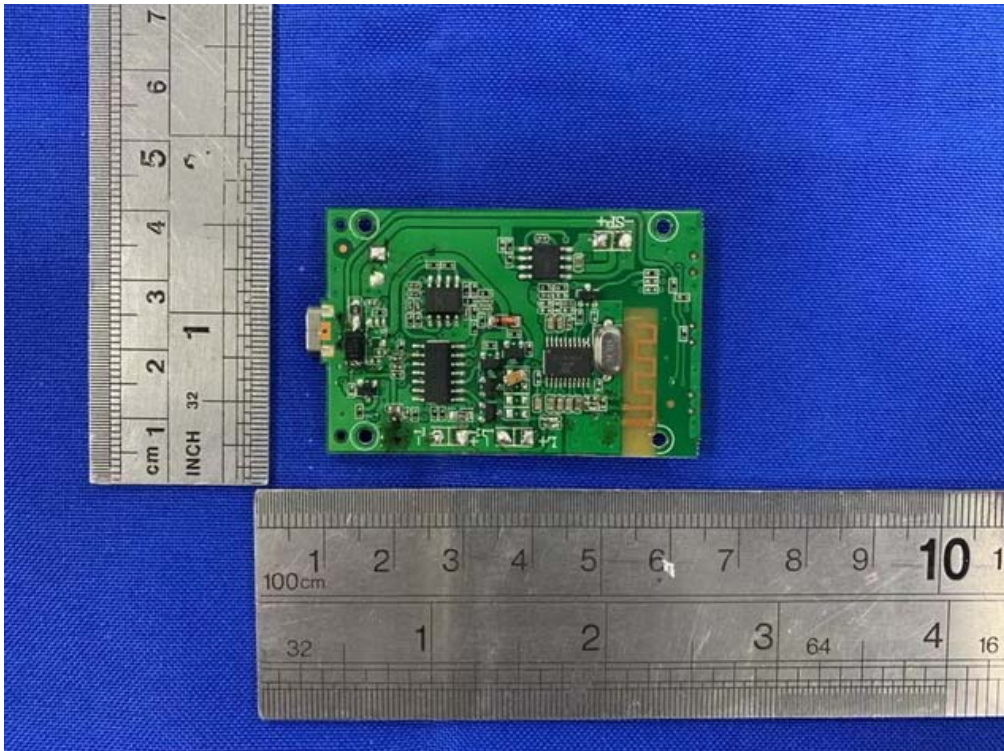

-----The end-----