

**ELECTROMAGNETIC EMISSIONS COMPLIANCE REPORT
INTENTIONAL RADIATOR CERTIFICATION TO
FCC PART 15 SUBPART C REQUIREMENT**

OF

Wireless mouse

Model No.: CT188059, OM19

Trade Mark: N/A

FCC ID: 2ABHA0056

Report No.: ES181204012E

Issue Date: December 08, 2018

Prepared for

**Ningbo Cstar Imp & Exp CO., LTD
Floor 4, Building E, No. 655-90, Qiming Road, Yinzhou Investment
& Innovation Center, Ningbo, China**

Prepared by

EMTEK(SHENZHEN) CO., LTD.

**Bldg 69, Majialong Industry Zone, Nanshan District, Shenzhen,
Guangdong, China.**

TEL: 86-755-26954280

FAX: 86-755-26954282

**This report shall not be reproduced, except in full, without the written approval of
EMTEK(SHENZHEN) CO., LTD.**

VERIFICATION OF COMPLIANCE

Applicant:	Ningbo Cstar Imp & Exp CO., LTD Floor 4,Building E, No. 655-90,Qiming Road, Yinzhou Investment &Innovation Center, Ningbo, China
Manufacturer:	Ningbo Cstar Imp & Exp CO., LTD Floor 4,Building E, No. 655-90,Qiming Road, Yinzhou Investment &Innovation Center, Ningbo, China
Product Description:	Wireless mouse
Trade Mark:	N/A
Model Number:	CT188059, OM19

We hereby certify that:

The above equipment was tested by EMTEK(SHENZHEN) CO., LTD. The test data, data evaluation, test procedures, and equipment configurations shown in this report were made in accordance with the procedures given in ANSI C63.10-2013 and the energy emitted by the sample EUT tested as described in this report is in compliance with conducted and radiated emission limits of FCC Rules Part 15.249(2018).

Date of Test : December 04, 2018 to December 08, 2018

Yaping Shen

Prepared by : _____
Yaping Shen/Editor

Joe Xia

Reviewer : _____
Joe Xia/Supervisor

Approved & Authorized Signer : _____
Lisa Wang
Lisa Wang/Manager

Modified Information

Version	Summary	Revision Date	Report No.
Ver.1.0	Original Report	/	ES181204012E

Table of Contents

1. GENERAL INFORMATION.....	5
1.1 PRODUCT DESCRIPTION.....	5
1.2 TEST FACILITY	6
2. TEST CONFIGURATION.....	7
3. SUMMARY OF TEST RESULTS	8
4. DESCRIPTION OF TEST MODES.....	9
5. TEST SYSTEM UNCERTAINTY	10
6. 20DB BANDWIDTH TEST	11
6.1 MEASUREMENT PROCEDURE.....	11
6.2 TEST SET-UP (BLOCK DIAGRAM OF CONFIGURATION).....	11
6.3 MEASUREMENT EQUIPMENT USED:	11
6.4 MEASUREMENT RESULTS:.....	11
7. BAND EDGE TEST	14
7.1 MEASUREMENT PROCEDURE	14
7.2 TEST SET-UP (BLOCK DIAGRAM OF CONFIGURATION).....	15
7.3 MEASUREMENT EQUIPMENT USED:	15
7.4 MEASUREMENT RESULTS:.....	15
8. RADIATED EMISSION TEST	21
8.1 MEASUREMENT PROCEDURE	21
8.2 TEST SET-UP (BLOCK DIAGRAM OF CONFIGURATION).....	23
8.3 MEASUREMENT EQUIPMENT USED:	24
8.4 LIMIT:.....	25
8.5 MEASUREMENT RESULT.....	26
8.5 RADIATED MEASUREMENT PHOTOS:.....	31
9. ANTENNA REQUIREMENT	32
9.1 LIMIT.....	32
9.2 RESULT.....	32

Appendix I (Photos of EUT) (9 pages)

1. General Information

1.1 Product Description

Characteristics	Description
Product Name	Wireless mouse
Model number	CT188059, OM19 (Note: These models are same except model number and appearance, here the model CT188059 was selected for full test.)
Input rating	Battery 2*1.5V
Test Power Supply	Battery 2*1.5V
Modulation	GFSK
Operating Frequency Range	2405-2475MHz
Number of Channels	13
Antenna Type	Internal antenna
Antenna Gain	0 dBi

1.2 Test Facility

Site Description

- EMC Lab. : Accredited by CNAS, 2016.10.24
The certificate is valid until 2022.10.28
The Laboratory has been assessed and proved to be in compliance with CNAS-CL01:2006 (identical to ISO/IEC 17025:2005)
The Certificate Registration Number is L2291.
- Accredited by TUV Rheinland Shenzhen 2016.5.19
The Laboratory has been assessed according to the requirements ISO/IEC 17025.
- Accredited by FCC, August 03, 2017
Designation Number: CN1204
Test Firm Registration Number: 882943
- Accredited by Industry Canada, November 24, 2015
The Certificate Registration Number is 4480A.
- Accredited by A2LA, July 31, 2017
The Certificate Number is 4321.01.
- Name of Firm : EMTEK(SHENZHEN) CO., LTD.
- Site Location : Bldg 69, Majialong Industry Zone, Nanshan District, Shenzhen, Guangdong, China.

2. Test Configuration

EUT

Table 2-1 Equipment Used in Tested System

Item	Equipment	Trade Mark	Model No.	FCC ID	Note
1.	Wireless mouse	N/A	CT188059	2ABHA0056	<i>EUT</i>

Note:

- (1) Unless otherwise denoted as EUT in 『Remark』 column , device(s) used in tested system is a support equipment.

3. Summary of Test Results

FCC Rules	Description Of Test	Result
§15.207	AC Power Conducted Emission	N/A
2.1049	20dB Bandwidth	Complies
§15.249/15.205	Band Edge	Complies
§15.249(a)	Field Strength of Fundamental Emissions	Complies
§15.249(a)(d)	Radiated Spurious Emissions	Complies
§15.203	Antenna Requirements	Complies

Remark: The product was tested under the battery fully charged.

4. Description of test modes

The EUT is used as a receiver together with dongles, but it still has the function of transmitting. More detailed feature description, please refer to the operation description or Users Manual.

The test mode is programmed on the EUT. The measurements are performed at Channel 1 (2405MHz), Channel 7 (2451MHz) and Channel 13 (2475MHz) are chosen for the final testing.

Channel List:

Channel	Frequency (MHz)	Channel	Frequency (MHz)	Channel	Frequency (MHz)
1	2405	2	2408	3	2411
4	2414	5	2417	6	2448
7	2451	8	2454	9	2457
10	2466	11	2469	12	2472
13	2475				

5. TEST SYSTEM UNCERTAINTY

The following measurement uncertainty levels have been estimated for tests performed on the apparatus:

Parameter	Uncertainty
Radio Frequency	$\pm 1 \times 10^{-5}$
Maximum Peak Output Power Test	$\pm 1.0\text{dB}$
Conducted Emissions Test	$\pm 2.0\text{dB}$
Radiated Emission Test	$\pm 2.0\text{dB}$
Power Density	$\pm 2.0\text{dB}$
Occupied Bandwidth Test	$\pm 1.0\text{dB}$
Band Edge Test	$\pm 3\text{dB}$
All emission, radiated	$\pm 3\text{dB}$
Antenna Port Emission	$\pm 3\text{dB}$
Temperature	$\pm 0.5^\circ\text{C}$
Humidity	$\pm 3\%$

Remark: The coverage Factor (k=2), and measurement Uncertainty for a level of Confidence of 95%.

6. 20dB Bandwidth test

6.1 Measurement Procedure

The EUT was operating in hopping mode or could be controlled its channel. Printed out the test result from the spectrum by hard copy function.

6.2 Test SET-UP (Block Diagram of Configuration)

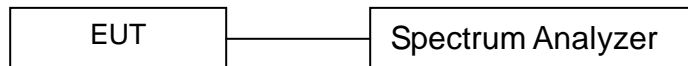

6.3 Measurement Equipment Used:

EQUIPMENT TYPE	MFR	MODEL NUMBER	SERIAL NUMBER	Characteristics	LAST CAL.	CAL DUE.
Spectrum Analyzer	Rohde & Schwarz	FSV30	1321.3008K	10Hz-30GHz	05/16/2018	05/16/2019
Coaxial Cable	CDS	79254	46107086	10Hz-30GHz	05/16/2018	05/16/2019
Antenna Connector	ARTHUR-YANG	2244-N1TG1	N/A	10Hz-30GHz	05/16/2018	05/16/2019

Remark: The temporary antenna connector is soldered on the PCB board in order to perform conducted tests and this temporary antenna connector is listed in the equipment list. The cable loss is 0.4dBm, and impedance is 50Ω for the antenna connector.

6.4 Measurement Results:

Refer to attached data chart.

Spectrum Detector:	PK	Test Date :	December 08, 2018
Test By:	Andy	Temperature :	24°C
Test Result:	PASS	Humidity :	53 %
Modulation:	FSK		

Channel frequency (MHz)	20dB Down BW(kHz)
2405	2800
2451	2902
2475	2807

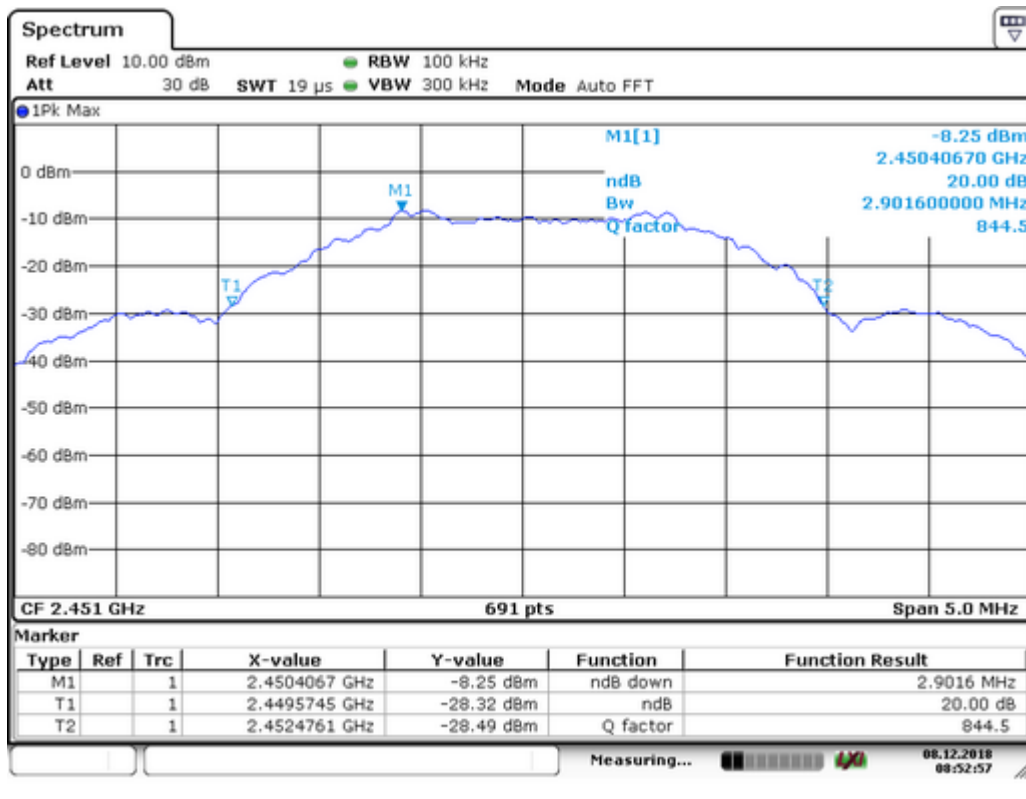
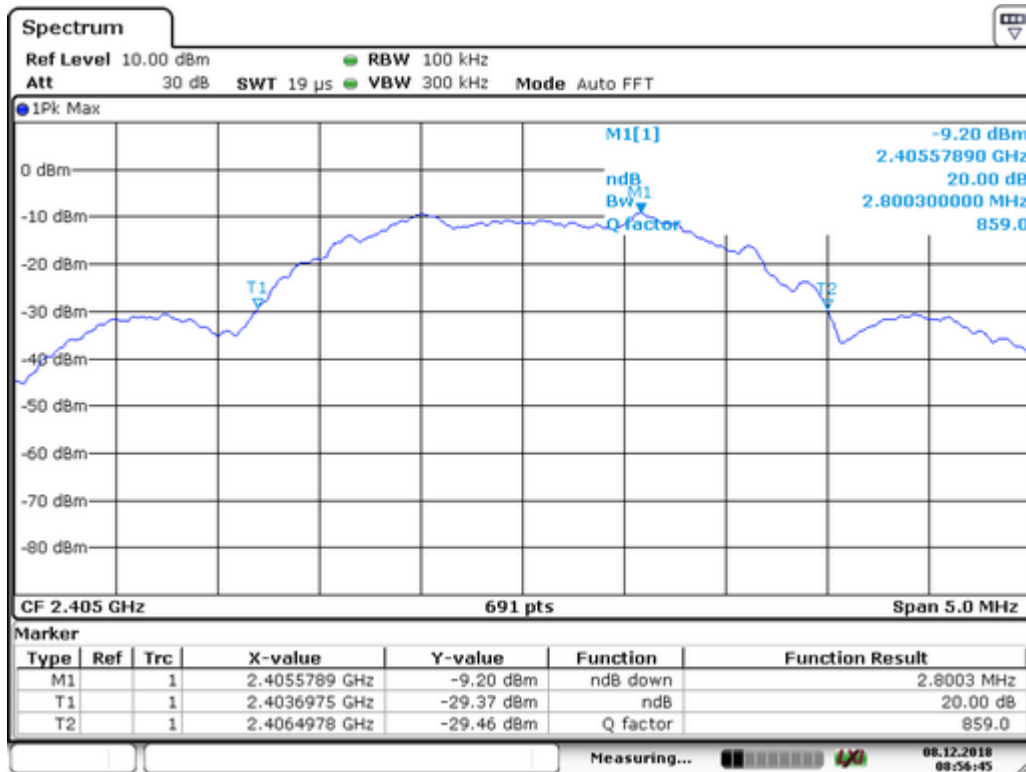

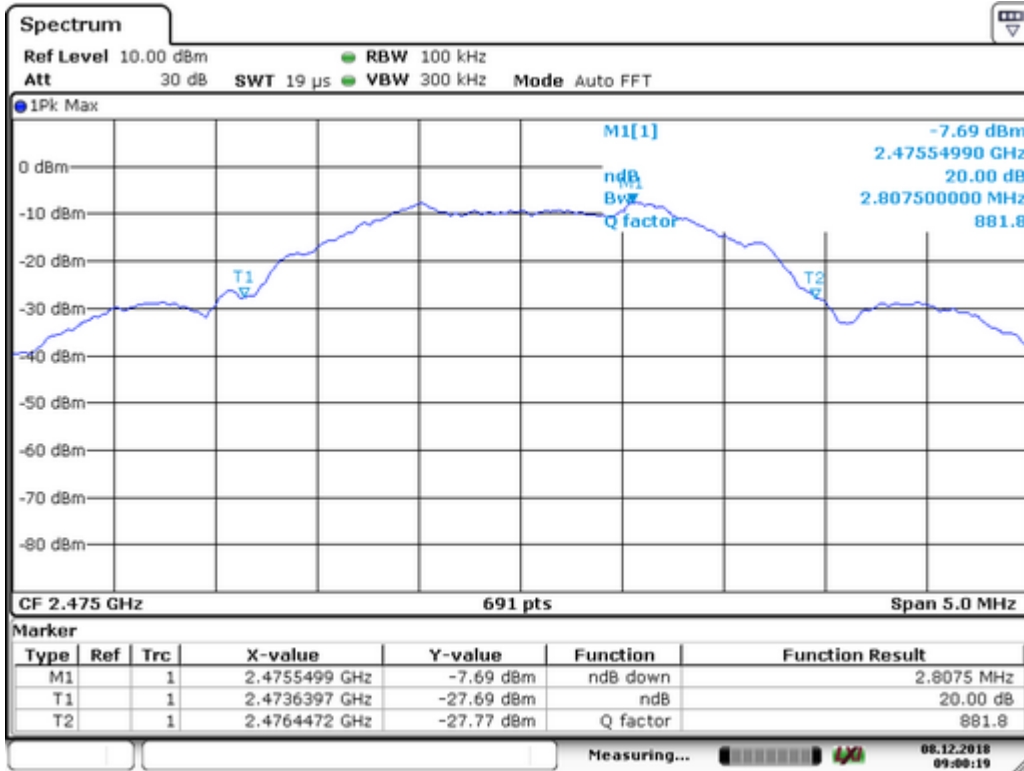

7. Band EDGE test

7.1 Measurement Procedure

The EUT was placed on a styrofoam table which is 1.5m above ground plane.

The measurement procedure at the band edges was simplified by performing the measurement in just one plot. Both, the in-band-emission and the unwanted emission were encompassed by the span. After trace stabilization, the maximum peak was determined by a peak detector and the value was marked by an appropriate limit line. The second limit line, which is 20dB below the first, marks the limit for the emissions in the unrestricted band. A maximum-peak-detector marks the highest emission in the unrestricted band next to the band edge.

The measurements were performed at the lower end of the 2.4GHz band. Use the following spectrum analyzer settings:

When spectrum scanned above 1GHz setting resolution bandwidth 1MHz, video bandwidth 3MHz:

EMI Test Receiver	Setting
Attenuation	Auto
RB	1MHz
VB	3MHz
Detector	Peak
Trace	Max hold

When spectrum scanned above 1GHz setting resolution bandwidth 1MHz, video bandwidth 10Hz:

EMI Test Receiver	Setting
Attenuation	Auto
RB	1MHz
VB	10Hz
Detector	Peak
Trace	Max hold

7.2 Test SET-UP (Block Diagram of Configuration)

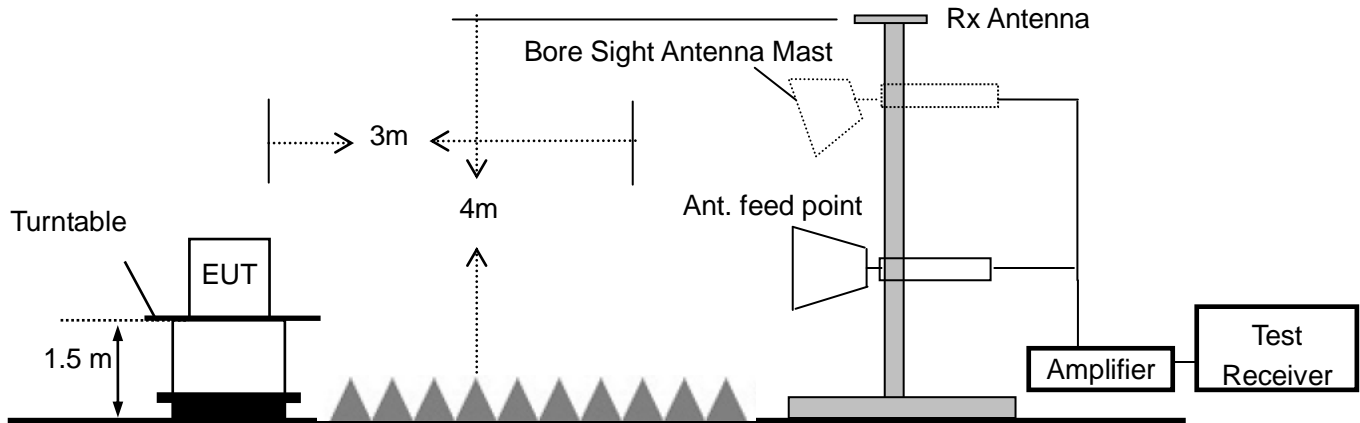

7.3 Measurement Equipment Used:

Item	Equipment	Manufacturer	Model No.	Serial No.	Characteristics	Last Cal.	Cal. Interval
1	Signal Analyzer	Rohde & Schwarz	FSV30	103040	9KHz-40GHz	05/16/2018	1 Year
2	Horn Antenna	Schwarzbeck	BBHA9120D	9120D-1272	1GHz-18GHz	05/16/2018	1 Year
3	Power Amplifier	LUNAR EM	LNA1G18-40	J10100000081	1GHz-26.5GHz	05/16/2018	1 Year
4	Cable	H+S	CBL-26	N/A	1GHz-26.5GHz	05/16/2018	1 Year
5	Cable	H+S	CBL-26	N/A	1GHz-26.5GHz	05/16/2018	1 Year
6	Cable	H+S	CBL-26	N/A	1GHz-26.5GHz	05/16/2018	1 Year

7.4 Measurement Results:

Spectrum Detector: PK Test Date : December 08, 2018
 Test By: Andy Temperature : 25 °C
 Test Result: PASS Humidity : 50 %

1. Conducted Test

Frequency (MHz)	Modulation	Peak Power Output(dBm)	Result of Band edge(dBc)	Band edge Limit(dBc)
2399.13	GFSK	-9.97	40.71	>20dBc
2483.99	GFSK	-8.05	46.43	>20dBc

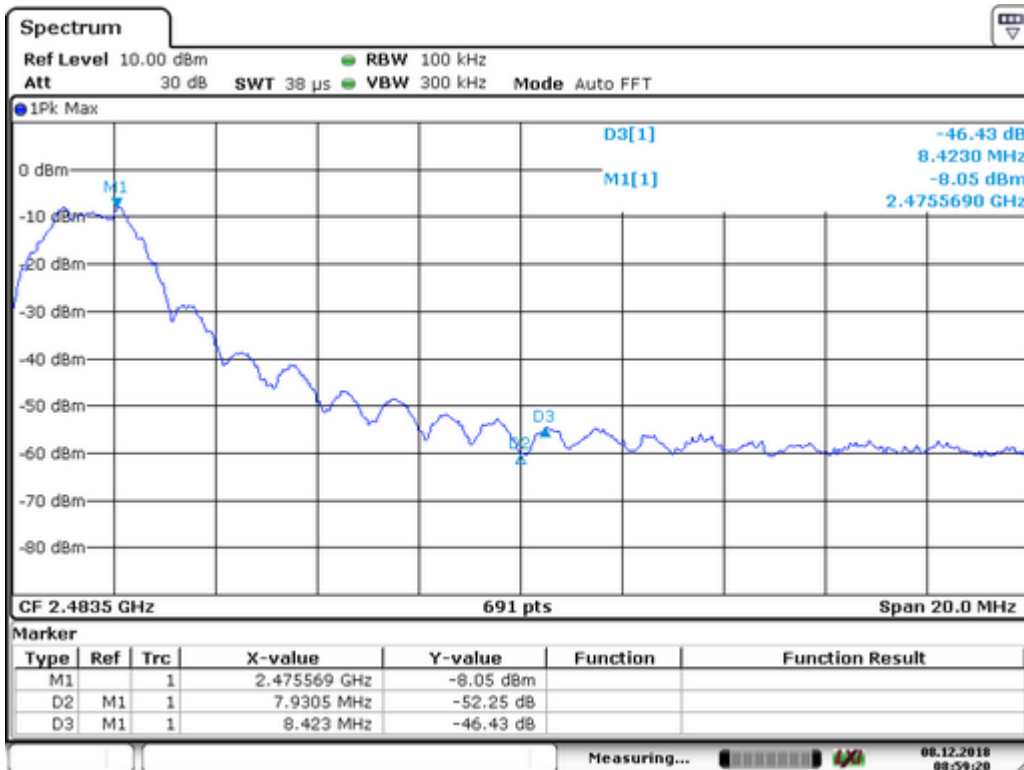
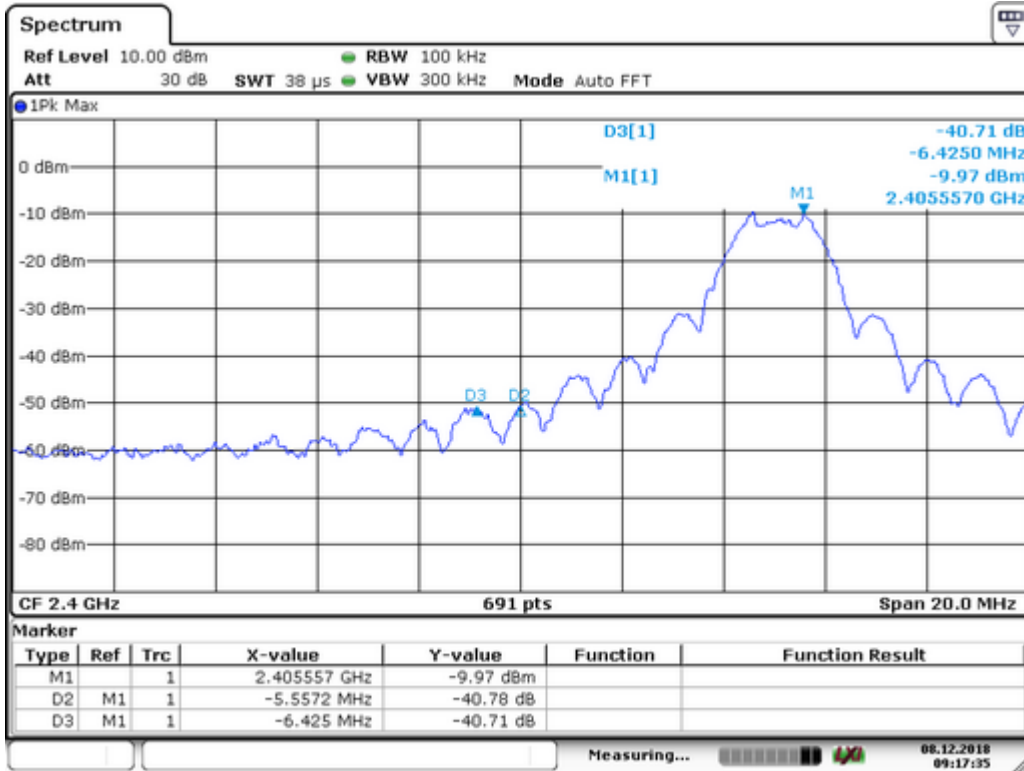

8. Radiated Emission Test

8.1 Measurement Procedure

1. Below 1000MHz, The EUT was placed on a turn table which is 0.8m above ground plane. And above 1000MHz, The EUT was placed on a styrofoam table which is 1.5m above ground plane.
2. The EUT was set 3 meters from the interference receiving antenna, which was mounted on the top of a variable height antenna tower.
3. For each suspected emission, the EUT was arranged to its worst case and then tune the Antenna tower (From 1m to 4m) and turntable (from 0 degree to 360 degree) to find the maximum reading. A pre-amp and a high pass filter are used for the test in order to get better signal level to comply with the guidelines.
4. Set to the maximum power setting and enable the EUT transmit continuously.
5. Final measurement (Above 1GHz): The frequency range will be divided into different sub ranges depending of the frequency range of the used horn antenna. The EMI Receiver set to peak and average mode and a resolution bandwidth of 1MHz. The measurement will be performed in horizontal and vertical polarization of the measuring antenna and while rotating the EUT in its vertical axis in the range of 0 degree to 360 degree in order to have the antenna inside the cone of radiation.
6. Test Procedure of measurement (For Above 1GHz):
 - 1) Monitor the frequency range at horizontal polarization and move the antenna over all sides of the EUT(if necessary move the EUT to another orthogonal axis).
 - 2) Change the antenna polarization and repeat 1) with vertical polarization.
 - 3) Make a hardcopy of the spectrum.
 - 4) Measure the frequency of the detected emissions with a lower span and resolution bandwidth to increase the accuracy and note the frequency value.
 - 5) Change the analyser mode to Clear/ Write and found the cone of emission.
 - 6) Rotate and move the EUT, so that the measuring distance can be enlarged to 3m and the antenna will be still inside the cone of emission.
 - 7) Measure the level of the detected frequency with the correct resolution bandwidth, with the antenna polarization and azimuth and the peak and average detector, which causes the maximum emission.
 - 8) Repeat steps 1) to 7) for the next antenna spot if the EUT is larger than the antenna beamwidth.

The following table is the setting of spectrum analyzer:

When spectrum scanned from 30MHz to 1GHz setting resolution bandwidth 120KHz and video bandwidth 300KHz:

EMI Test Receiver	Setting
Attenuation	Auto
RB	120KHz
VB	300KHz
Detector	QP
Trace	Max hold

For harmonics emission .When spectrum scanned above 1GHz setting resolution bandwidth 1MHz, video bandwidth 3MHz:

EMI Test Receiver	Setting
Attenuation	Auto
RB	1MHz
VB	3MHz
Detector	Peak
Trace	Max hold

For fundamental emission .When spectrum scanned above 1GHz setting resolution bandwidth 3MHz, video bandwidth 10MHz:

EMI Test Receiver	Setting
Attenuation	Auto
RB	3MHz
VB	10MHz
Detector	Peak / AV
Trace	Max hold

When spectrum scanned above 1GHz setting resolution bandwidth 1MHz, video bandwidth 10Hz:

EMI Test Receiver	Setting
Attenuation	Auto
RB	1MHz
VB	10Hz
Detector	Peak
Trace	Max hold

8.2 Test SET-UP (Block Diagram of Configuration)

(A) Radiated Emission Test Set-Up, Frequency Below 30MHz

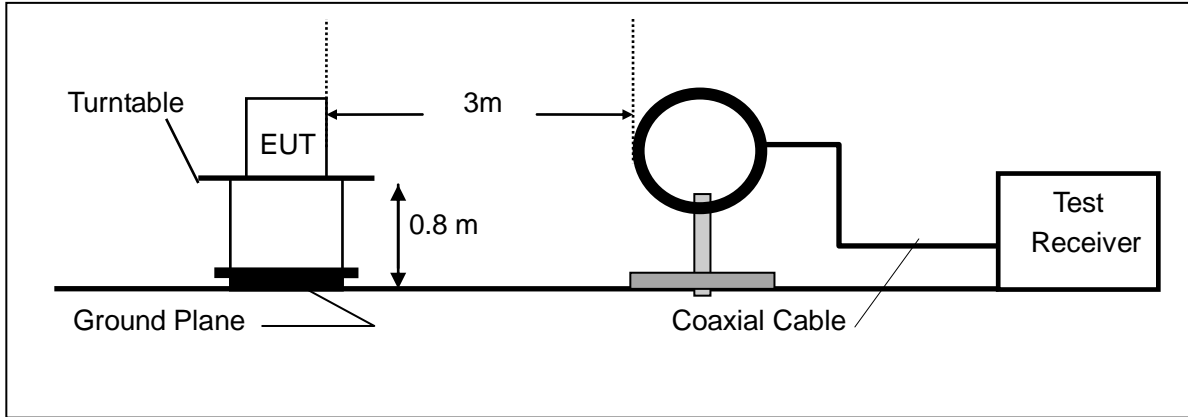

(B) Radiated Emission Test Set-Up, Frequency Below 1000MHz

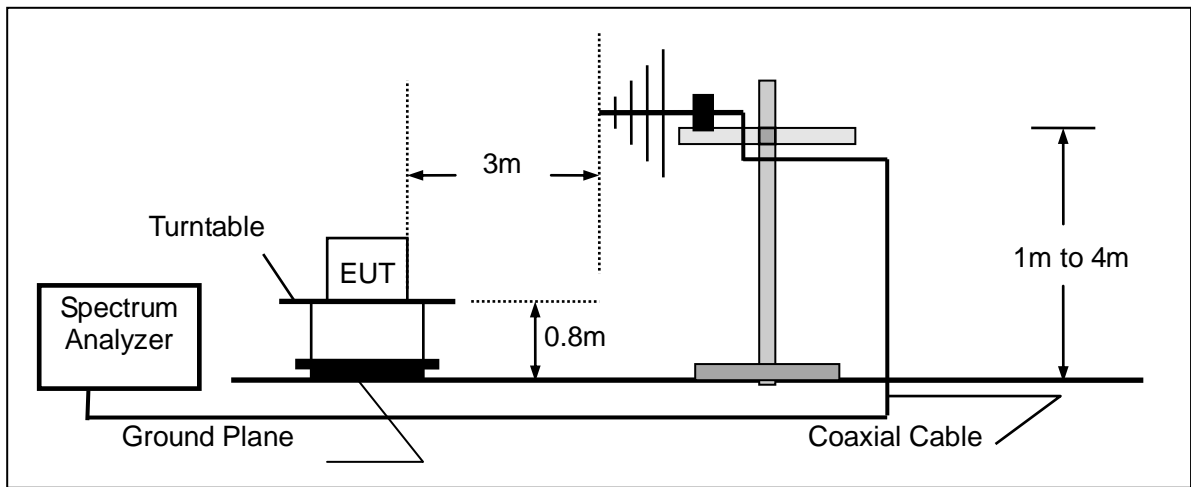

(C) Radiated Emission Test Set-Up, Frequency above 1000MHz

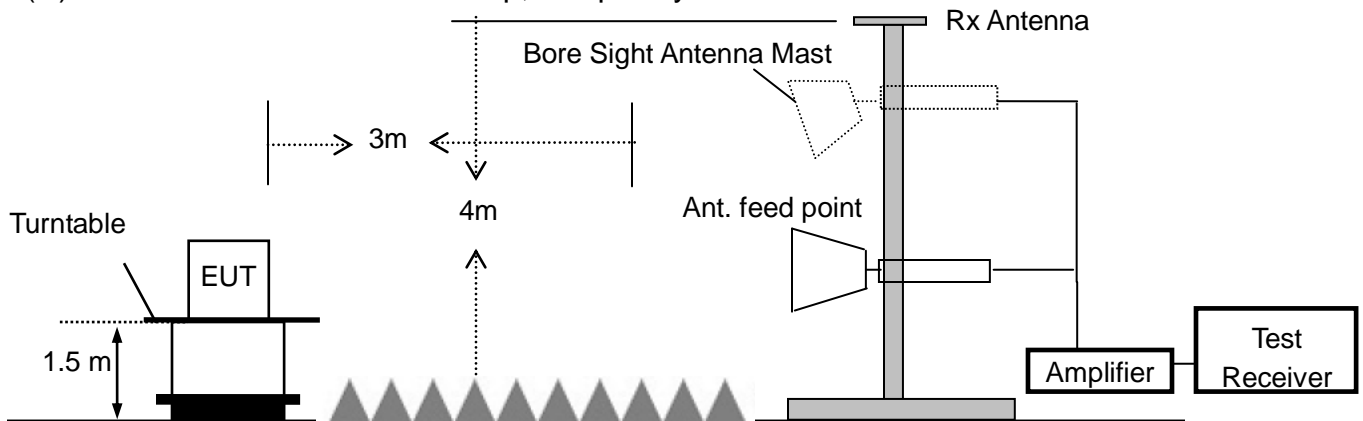

8.3 Measurement Equipment Used:

Item	Equipment	Manufacturer	Model No.	Serial No.	Characteristics	Last Cal.	Cal. Interval
1.	Test Receiver	Rohde & Schwarz	ESCI	1166.5950.03	9KHz-3GHz	05/16/2018	1 Year
2.	Loop Antenna	Schwarzbeck	FMZB 1519	012	9 KHz -30MHz	05/16/2018	1 Year
3.	Bilog Antenna	Schwarzbeck	VULB9163	000141	25MHz-2GHz	05/16/2018	1 Year
4.	Power Amplifier	CDS	RSU-M352	818	1MHz-1GHz	05/16/2018	1 Year
5.	Power Amplifier	HP	8447F	OPT H64	1GHz-26.5GHz	05/16/2018	1 Year
6.	Color Monitor	SUNSP0	SP-140A	N/A	--	05/16/2018	1 Year
7.	Single Line Filter	JIANLI	XL-3	N/A	--	05/16/2018	1 Year
8.	Single Phase Power Line Filter	JIANLI	DL-2X100B	N/A	--	05/16/2018	1 Year
9.	3 Phase Power Line Filter	JIANLI	DL-4X100B	N/A	--	05/16/2018	1 Year
10.	DC Power Filter	JIANLI	DL-2X50B	N/A	--	05/16/2018	1 Year
11.	Cable	Schwarzbeck	PLF-100	549489	9KHz-3GHz	05/16/2018	1 Year
12.	Cable	Rosenberger	CIL02	A0783566	9KHz-3GHz	05/16/2018	1 Year
13.	Cable	Rosenberger	RG 233/U	525178	9KHz-3GHz	05/16/2018	1 Year
14.	Signal Analyzer	Rohde & Schwarz	FSV30	103040	9KHz-40GHz	05/16/2018	1 Year
15.	Horn Antenna	Schwarzbeck	BBHA9120D	9120D-1272	1GHz-18GHz	05/16/2018	1 Year
16.	Horn Antenna	Schwarzbeck	BBHA 9170	BBHA9170399	14GHz -26.5GHz	05/16/2018	1 Year
17.	Boresight Antenna Tower	EMEC	AM-BS-4500-D	N/A	N/A	05/16/2018	1 Year
18.	Power Amplifier	LUNAR EM	LNA1G18-40	J10100000081	1GHz-26.5GHz	05/16/2018	1 Year
19.	Cable	H+S	CBL-26	N/A	1GHz-26.5GHz	05/16/2018	1 Year
20.	Cable	H+S	CBL-26	N/A	1GHz-26.5GHz	05/16/2018	1 Year
21.	Cable	H+S	CBL-26	N/A	1GHz-26.5GHz	05/16/2018	1 Year

8.4 Limit:

The emissions from an intentional radiator shall not exceed the field strength levels specified in the following table 15.209(a):

Frequencies (MHz)	Field Strength (micovolts/meter)	Measurement Distance (meters)
0.009~0.490	2400/F(KHz)	300
0.490~1.705	24000/F(KHz)	30
1.705~30.0	30	30
30~88	100	3
88~216	150	3
216~960	200	3
Above 960	500	3

- Remark: 1. Emission level in dBuV/m=20 log (uV/m)
2. Measurement was performed at an antenna to the closed point of EUT distance of meters.

The field strength of emissions from intentional radiators operated within these frequency bands shall comply with the following:

Frequency(MHz)	Filed Strength of Fundamental(at 3m)		Filed Strength of Harmonics(at 3m)	
	PEAK	AVERAGE	PEAK	AVERAGE
902-928	114	94	74.0	54.0
2400-2483.5	114	94	74.0	54.0
5725-5875	114	94	74.0	54.0
24000-24250	128	108	88.0	68.0

8.5 Measurement Result

Below 30MHz:

Operation Mode:	TX	Test Date :	December 06, 2018
Frequency Range:	9KHz~30MHz	Temperature :	28°C
Test Result:	PASS	Humidity :	65 %
Measured Distance:	3m	Test By:	Andy

Freq. (MHz)	Ant.Pol. H/V	Emission Level (dBuV/m)	Limit 3m (dBuV/m)	Over (dB)
--	--	--	--	--

Note: the amplitude of spurious emission that is attenuated by more than 20dB below the permissible limit has no need to be reported.

Below 1000MHz:

Pass.

All the modulation modes were tested the worst data of the mode (TX 2405MHz) are recorded in the following pages and the others modulation methods do not exceed the limits.

Please refer to the following data.

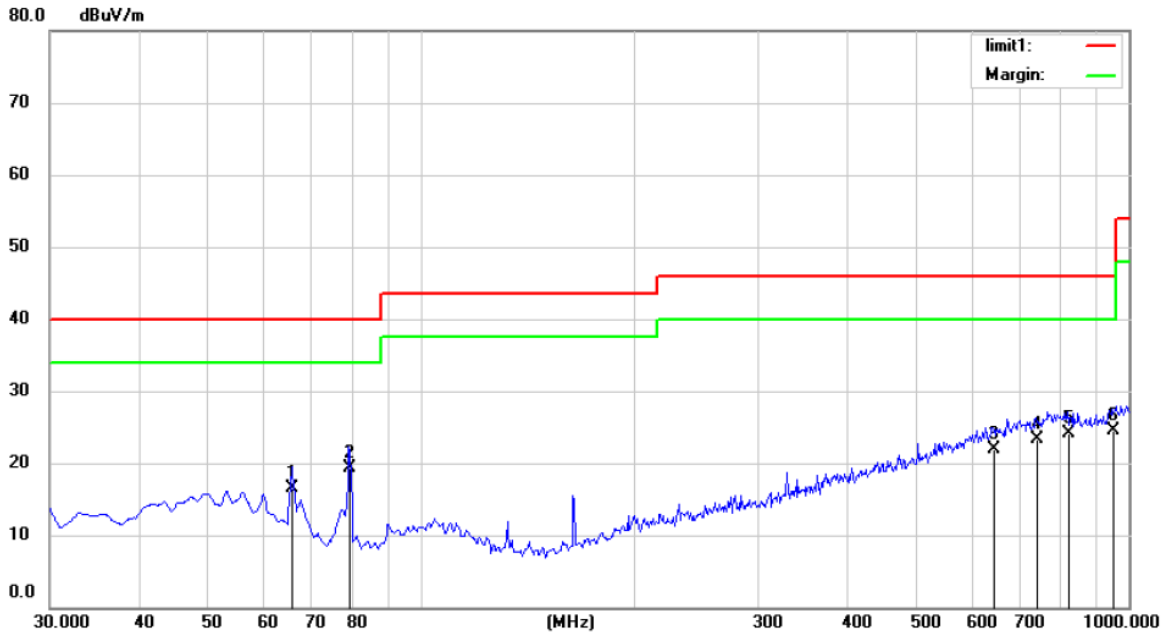

Site Chamber #1 Polarization: *Horizontal* Temperature: 26
 Limit: (RE)FCC PART 15 C 3m Power: Battery 2*1.5V Humidity: 55 %
 Mode:TX2405
 Note:

No.	Mk.	Freq.	Reading Level	Correct Factor	Measurement	Limit	Over	Antenna Height	Table Degree	
		MHz	dBuV	dB	dBuV/m	dBuV/m	dB	cm	degree	Comment
1		65.8900	34.55	-18.09	16.46	40.00	-23.54			QP
2	*	79.4700	40.92	-21.55	19.37	40.00	-20.63			QP
3		644.0100	27.35	-5.35	22.00	46.00	-24.00			QP
4		741.0100	27.04	-3.73	23.31	46.00	-22.69			QP
5		821.5200	27.36	-3.18	24.18	46.00	-21.82			QP
6		949.5600	26.59	-2.01	24.58	46.00	-21.42			QP

*:Maximum data x:Over limit !:over margin

Operator: huang

Above 1000MHz~10th Harmonics:

Operation Mode: GFSK(CH1: 2405MHz) Test Date : December 06, 2018

Freq. (MHz)	Ant. Pol. H/V	Emission Level(dBuV/m)		Limit 3m(dBuV/m)		Margin(dB)	
		PK	AV	PK	AV	PK	AV
2405(F)	V	85.32	66.35	114	94	-28.68	-27.65
4810	V	63.21	43.25	74	54	-10.79	-10.75
7215	V	60.25	41.02	74	54	-13.75	-12.98
9620	V	58.14	39.64	74	54	-15.86	-14.36
12025	V	56.32	37.15	74	54	-17.68	-16.85
14430	V	55.14	36.2	74	54	-18.86	-17.8
16835	V	55.16	36.28	74	54	-18.84	-17.72
2405(F)	H	85.47	66.3	114	94	-28.53	-27.7
4810	H	63.2	44.02	74	54	-10.8	-9.98
7215	H	60.15	41.2	74	54	-13.85	-12.8
9620	H	56.47	37.65	74	54	-17.53	-16.35
12025	H	55.23	36.85	74	54	-18.77	-17.15
14430	H	55.17	36.98	74	54	-18.83	-17.02
16835	H	55.2	36.15	74	54	-18.8	-17.85

Operation Mode: GFSK(CH7: 2451MHz) Test Date : December 06, 018

Freq. (MHz)	Ant. Pol. H/V	Emission Level(dBuV/m)		Limit 3m(dBuV/m)		Margin(dB)	
		PK	AV	PK	AV	PK	AV
2451(F)	V	86.32	67.69	114	94	-27.68	-26.31
4902	V	63.2	44.3	74	54	-10.8	-9.7
7353	V	61.26	42.16	74	54	-12.74	-11.84
9804	V	59.32	40.27	74	54	-14.68	-13.73
12255	V	57.32	38.62	74	54	-16.68	-15.38
14706	V	56.3	37.23	74	54	-17.7	-16.77
17157	V	55.6	36.24	74	54	-18.4	-17.76
2451(F)	H	86.21	67.02	114	94	-27.79	-26.98
4902	H	63.36	44.58	74	54	-10.64	-9.42
7353	H	61.58	42.36	74	54	-12.42	-11.64
9804	H	59.2	40.32	74	54	-14.8	-13.68
12255	H	57.56	38.3	74	54	-16.44	-15.7
14706	H	56.21	37.45	74	54	-17.79	-16.55
17157	H	55.3	36.58	74	54	-18.7	-17.42

Operation Mode: GFSK(CH13: 2475MHz) Test Date : December 06, 2018

Freq. (MHz)	Ant. Pol. H/V	Emission Level(dBuV/m)		Limit 3m(dBuV/m)		Margin(dB)	
		PK	AV	PK	AV	PK	AV
2475(F)	V	86.98	68.2	114	94	-27.02	-25.8
4950	V	63.47	44.33	74	54	-10.53	-9.67
7425	V	61.2	42.02	74	54	-12.8	-11.98
9900	V	58.66	39.52	74	54	-15.34	-14.48
12375	V	56.32	37.58	74	54	-17.68	-16.42
14850	V	56.47	37.23	74	54	-17.53	-16.77
17325	V	55.18	36.17	74	54	-18.82	-17.83
2475(F)	H	86.45	68.32	114	94	-27.55	-25.68
4950	H	64.41	44.88	74	54	-9.59	-9.12
7425	H	61.3	42.32	74	54	-12.7	-11.68
9900	H	58.3	39.69	74	54	-15.7	-14.31
12375	H	56.34	37.23	74	54	-17.66	-16.77
14850	H	55.21	36.17	74	54	-18.79	-17.83
17325	H	55.2	36.11	74	54	-18.8	-17.89

Other harmonics emissions are lower than 20dB below the allowable limit.

- Note:**
- (1) All Readings are Peak Value and AV.
 - (2) Emission Level= Reading Level+ Probe Factor +Cable Loss.
 - (3) The average measurement was not performed when the peak measured data under the limit of average detection.
 - (4) Measuring frequencies from 1GHz to 25GHz.

8.5 Radiated Measurement Photos:

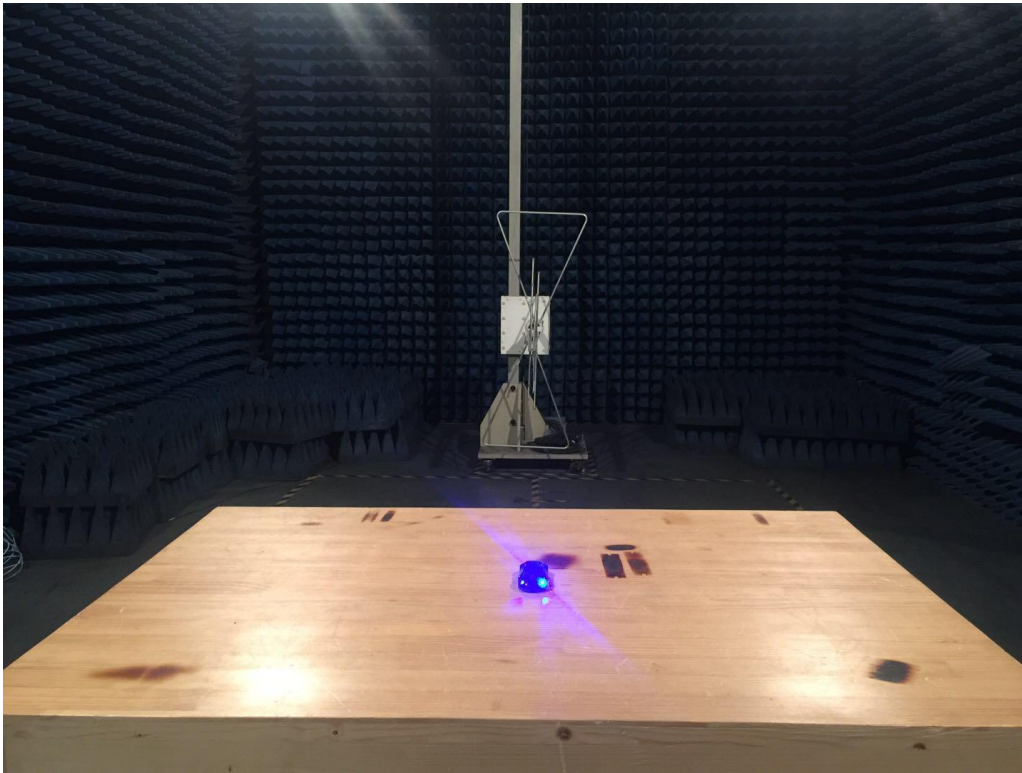

9. Antenna requirement

9.1 Limit

Except for special regulations, the Low-power Radio-Frequency Devices must not be equipped with any jacket for installing an antenna with extension cable. An intentional radiator shall be designed to ensure that no antenna other than that furnished by the responsible party shall be used with the device. The use of a permanently attached antenna or of an antenna that uses a unique coupling to the intentional radiator shall be considered sufficient to comply with the provisions of this section. The manufacture may design the unit so that the user can replace a broken antenna, but the use of a standard antenna jack or electrical connector is prohibited.

9.2 Result

The EUT's antenna, permanent attached antenna, used a Internal antenna, The antenna's gain is 0 dBi and meets the requirement.

APPENDIX I (Photos of EUT)



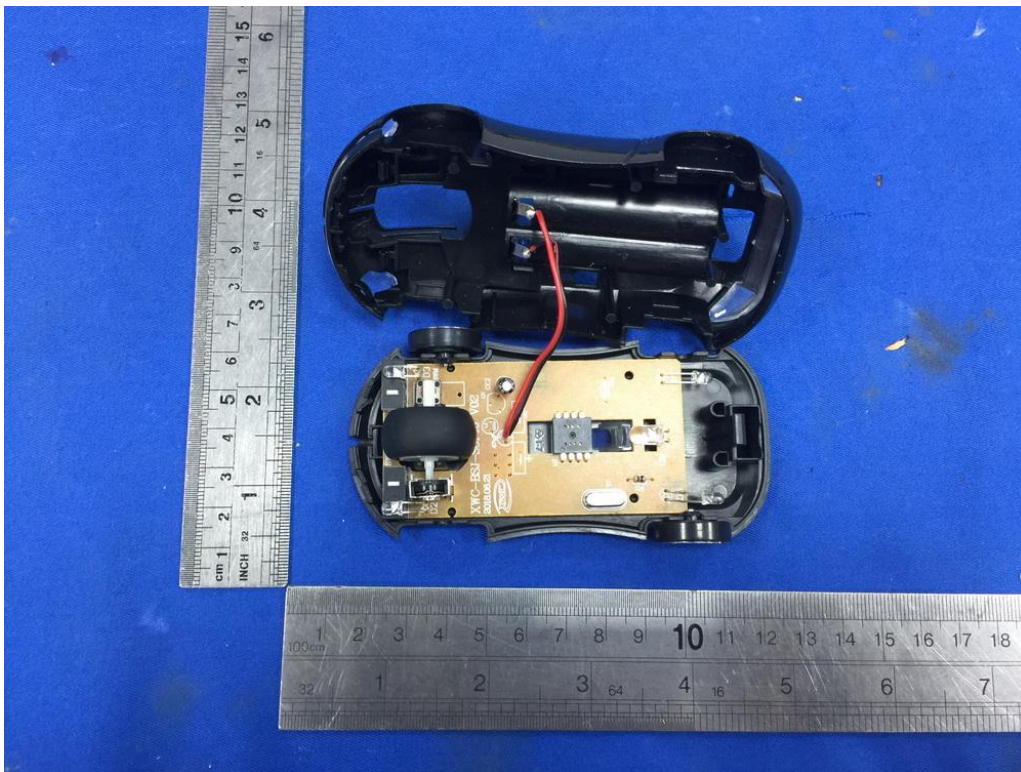

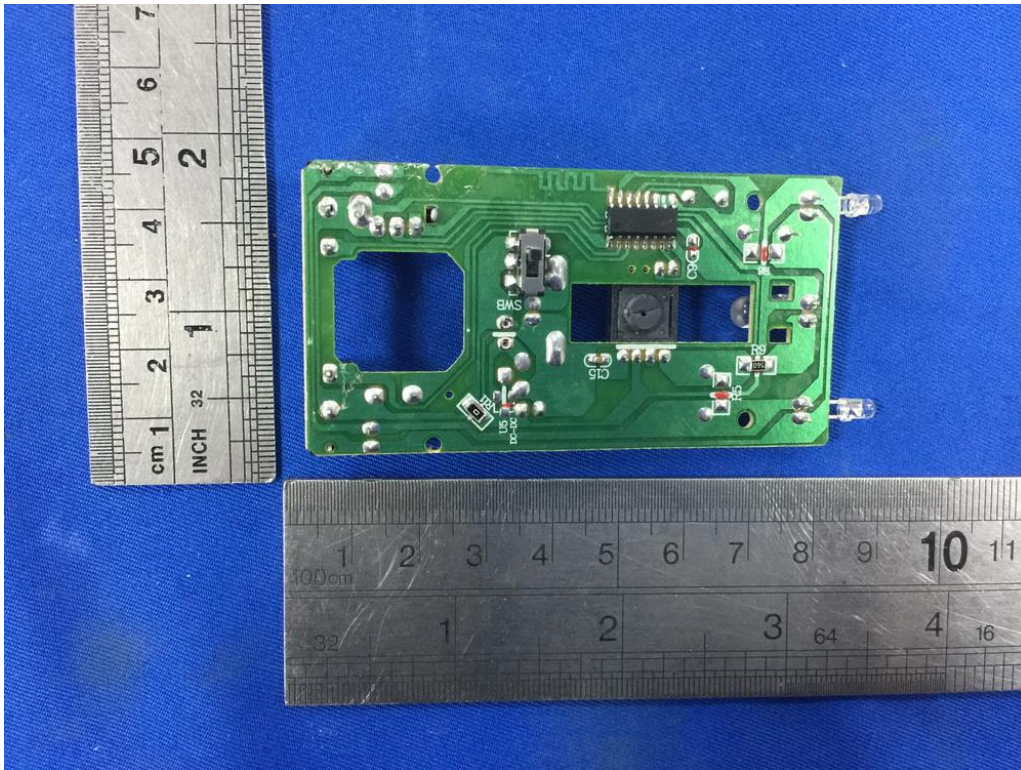
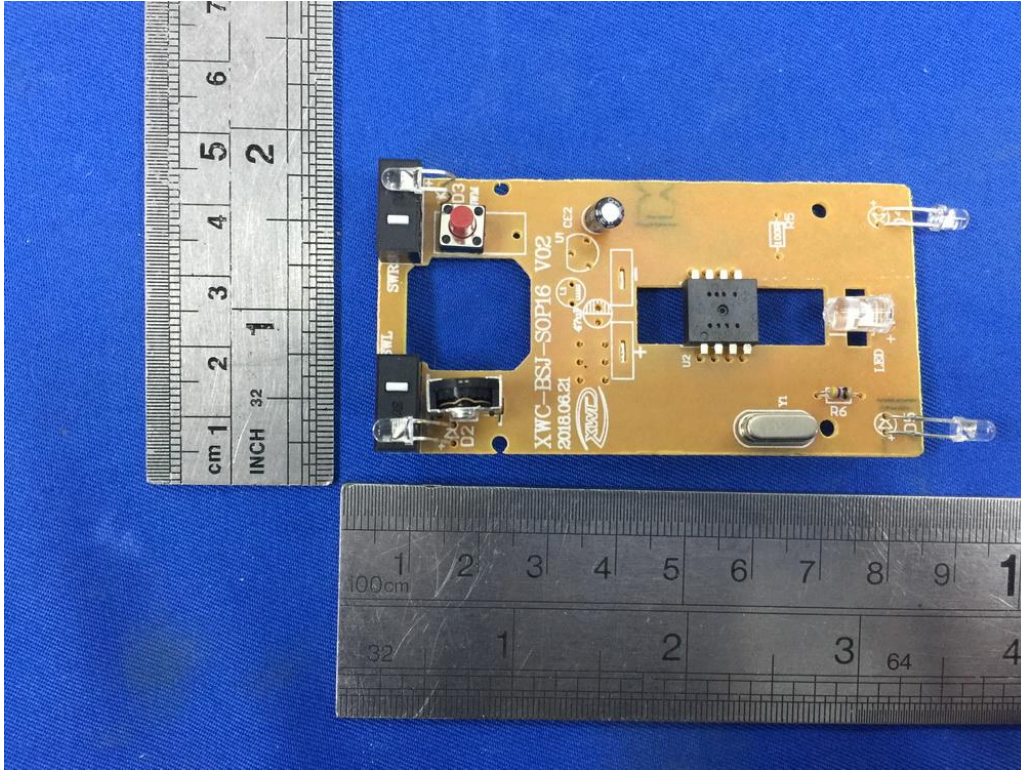

-----The end-----